

HOME-BUILT MARINE DIRECTION FINDER

RADIO & TV NEWS

**JUNE
1957
35 CENTS**

World's Leading Electronics Magazine

Including
**HIGH-FIDELITY
FEATURES**

ALL ABOUT AUDIO & HI-FI
Room Effects!

**GEIGER COUNTER WITH
TRANSISTOR POWER SUPPLY**

**ONE-TUBE, 10-METER
TRANSCEIVER**

"THE XOPHONIC"
Reverberation Unit
for Hi-Fi

**MAINTAIN & REPAIR YOUR
OWN SWEEP GENERATOR**

**BATTERIES
FOR TRANSISTOR RADIOS**

**A TRANSISTORIZED
MARINE DIRECTION FINDER**
(See Page 42)



How



Help

Independent Service Dealers with their TV-Radio Service Business

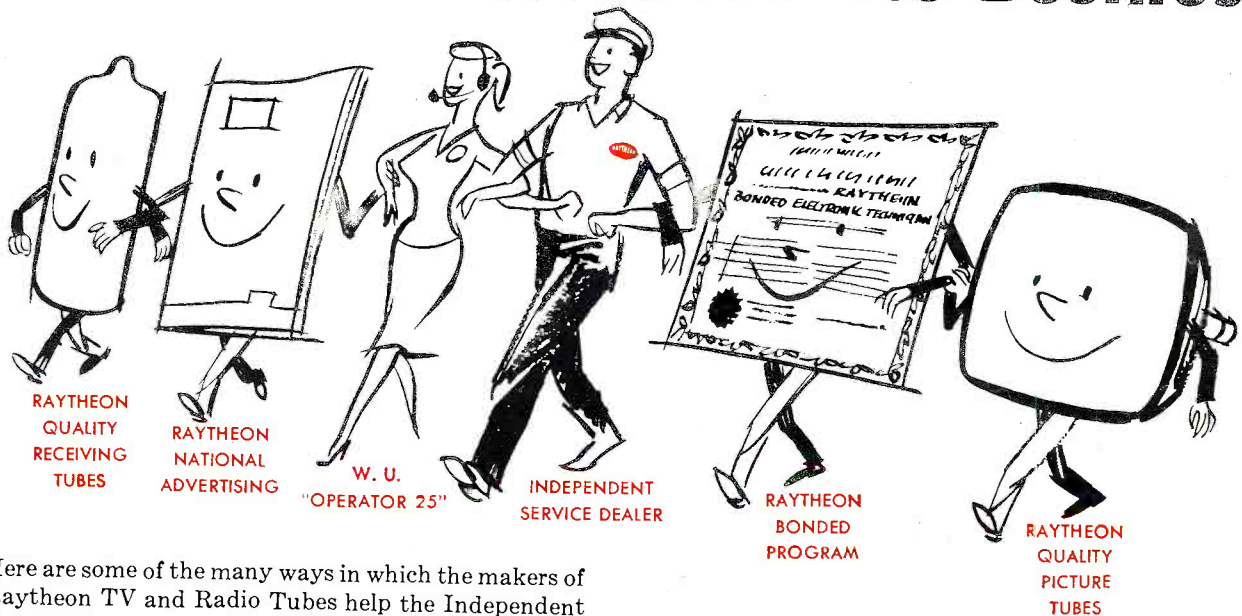

Here are some of the many ways in which the makers of Raytheon TV and Radio Tubes help the Independent Service Dealer with his business.

1 For nearly 12 years Raytheon has offered the Raytheon Bonded Electronic Technician program to Independent Service Dealers. Dealers who qualify have their service and parts guarantee backed by a bond issued through Continental Casualty Company, one of the country's largest insurance companies. It gives them real prestige in the eyes of the customer.

2 Raytheon provides "Western Union Operator 25" service for Bonded Dealers in 23,000 cities and towns. In answer to phoned requests for fast, dependable, bonded TV-Radio service, "Operator 25" sends customers to Bonded Dealers.

3 Raytheon consistently runs national advertising, presenting Independent Service Dealers as the best in the business.

4 Raytheon has a network of independent distributors with well trained personnel who are eager to help independent dealers.

5 Raytheon makes a complete line of TV and Radio Tubes that are tops for replacement work — Raytheon All-Set Tubes — designed to help the versatile service dealer who repairs all makes and models.

For the whole Raytheon story, get in touch with your nearest Raytheon Tube Distributor.

TV-Radio service is your business . . . serving you is ours



RAYTHEON MANUFACTURING COMPANY

Receiving and Cathode Ray Tube Operations

Newton, Mass. • Chicago, Ill. • Atlanta, Ga. • Los Angeles, Calif.

Raytheon makes all these { Receiving and Picture Tubes, Reliable Subminiature and Miniature Tubes, Semiconductor Diodes and Transistors, Nucleonic Tubes, Microwave Tubes.



Excellence in Electronics

You Can Train at Home for Good Jobs, Career Opportunities

Find out What N.R.I., Oldest, Largest, Home Study Radio-TV School can do for You

Whether you're on the "OUTSIDE" and want to get in; or on the "INSIDE" and want to advance, N.R.I. has specialized training for you.



J. E. SMITH,
FOUNDER

Training plus opportunity is the ideal combination for success. And today's opportunity field is Radio-Television. Over 125 million home radios plus 30 million sets in cars plus 40 million TV sets mean top money, top jobs for trained Radio-TV technicians. More than 4,000 Radio and TV broadcasting stations offer interesting and important positions for technicians, operators. Color television, portable TV sets, Hi-Fi, other developments, assure future growth.

N.R.I. IS TESTED WAY TO BETTER PAY

If you want to gain knowledge and skill for success and security, find out what N.R.I. offers. Since 1914—for more than 40 years—N.R.I. has specialized in training ambitious men at home in spare time for Radio-TV. As the outstanding leader, you are assured dependable training when you enroll with N.R.I. You are backed by the record and reputation of the oldest and largest home study Radio-TV school. With an N.R.I. diploma, you command respect because you are a skilled operator equipped to do important work.

ADD TO YOUR INCOME STARTING SOON

Whether you know very little or whether you have some knowledge of Radio-TV, N.R.I. training can help you. We send you easy-to-understand, illustrated texts. As part of our Servicing Course you get many kits to build Radio Receiver, Multi-tester, other equipment that "brings to life" what you study. Soon after starting many N.R.I. Students earn \$10, \$15 a week extra fixing neighbors' sets in spare time.



N.R.I. SUPPLIES EQUIPMENT FOR PRACTICAL EXPERIENCE. 17" picture tube, all tubes, parts to build UHF-VHF Television Receiver, a 5" high definition Oscilloscope and a Television Signal Generator supplied with Advanced TV Training.

N.R.I. Communications Training provides the practical knowledge you need for a career in Broadcasting. We send kits to build a Transmitter, Signal Generator, etc.; practice methods, procedures required of licensed Commercial Radio-TV operators.

TV SERVICE EXPERTS EARN TOP PAY, TOP JOBS

N.R.I.'s All Practice Professional TV Servicing Course is designed for the man who wants to reach the top in TV Servicing. Not for beginners, this course is for the man with a knowledge of basic theory, either from Radio-TV serv-

icing experience or planned training. We send you 17" picture tube, components for TV Receiver, 5" TV Oscilloscope and a TV Signal Generator. You learn methods to diagnose and correct TV Service problems quickly, correctly, with confidence.

SAMPLE LESSON AND CATALOG SENT FREE

Mail coupon today. Check the Radio-Television training that interests you. We will send you Sample Lesson and Catalog. Address: National Radio Institute, Dept. 7FE, Washington 16, D. C.

MAIL COUPON NOW

NATIONAL RADIO INSTITUTE, Dept. 7FE, Washington 16, D.C.

Please send information on opportunities and training checked below. (No salesman will call.)

Radio-TV Servicing Training.

Radio-TV Communications Training.

Advanced TV Servicing.

**VETS: Write in date of
discharge**

Name _____ Age _____

Address _____

City _____ Zone _____ State _____

Accredited Member, National Home Study Council

RADIO & TV NEWS is published monthly by Ziff-Davis Publishing Company, William B. Ziff, Chairman of the Board (1946-1953), at 64 E. Lake St., Chicago 1, Ill. Entered as second-class matter July 21, 1948, at the Post Office, Chicago, Ill., under the act of March 3, 1879. Authorized by Post Office Department, Ottawa, Canada, as second-class matter. SUBSCRIPTION RATES: one year U. S. and possessions, and Canada \$4.00; Pan American Union Countries \$4.50; all other foreign countries \$5.00.

Publisher
OLIVER READ, B.Sc. WIETI
Editor
WM. A. STOCKLIN, B. S.
Technical Editor
MILTON S. SNITZER
Service Editor
SIDNEY C. SILVER
Associate Editor
P. B. HOEFER
Assistant Editor
J. JUSTER
Television Consultant
WALTER H. BUCHSBAUM
Art Editor
HERBERT ASCHER
Art and Drafting Dept.
J. A. GOLANEK
W. K. VAHLSING
JAMES A. ROTH
Advertising Director
L. L. OSTEN
Advertising Manager
MURRAY GOLDMAN
Midwest Adv. Manager
JOHN A. RONAN, JR.
Western Adv. Manager
JOHN E. PAYNE

RADIO & TV NEWS

*First in radio-
television-audio-electronics*

Average Net Paid Circulation 258,790

Radio & Television News • Radio News • Television News Trademarks Reg. U. S. Pat. Off.

CONTENTS

JUNE, 1957

EDITORIAL—INDUSTRY NEWS

For the Record.....	O. Read	8
Spot Radio News.....	Washington Correspondent	20
New Television Station Grants.....		20
Radio Pill Broadcasts from Stomach.....		114
Calendar of Events.....		147

HIGH FIDELITY AND AUDIO

All About Audio and Hi-Fi—Room Effects (Part 2).....	G. A. Briggs	38
The "SR-200" Hi-Fi Control Amplifier.....	L. W. Rayment	49
A Reverberation Unit for Hi-Fi Reproduction—The "Xophonic".....		56
Coded Stereo for Hi-Fi—Questions and Answers.....	Norman H. Crowhurst	60
Certified Record Revue.....	Bert Whyte	62
Hi-Fi—Audio Product Review.....		86
Measuring Amplifier Damping Factor.....		92
Sound on Tape.....	Bert Whyte	94
FM "Musicasting"—a New Industry.....	Walton N. Hershfield	128

SERVICING

Television-Radio

Batteries for Transistor Radios.....		40
Motorola Color TV Receivers.....	Robert Gary	46
Selling Service.....	William Leonard	52
Mac's Service Shop.....	John T. Frye	70
"Hi-Fi" Video Output Stages.....	Charles Erwin Cohn	112
First 21" 110-Degree CRT.....		116
Repairing Shorts in Vacuum Tubes.....	Hyman Herman	120
"Pure Signal" CRT Eliminates TV Stage.....		121
Adding "Volumatic Control".....	Charles Erwin Cohn	146
Service Industry News.....		158

Test Equipment

Temperature Tests in Radio-TV Troubleshooting.....	Robert G. Middleton	45
Maintain and Repair Your Own Sweep Generator.....	Walter H. Buchsbaum	53
A Pocket CRT Checker.....	Dwight V. Jones	63
The "Dyna-Box" Doublechecks Tube Tester.....	Haydn P. Roberts	64
Monitoring Short-Term Intermittents.....	James A. McRoberts	108
New Tube Tester Data.....		122

AMATEUR

One-Tube, 10-Meter Transceiver.....	Norman Fleming, W8ZXL	58
"Operation Smoke-Puff".....	O. R. Villard, Jr., W6QYT & R. S. Rich, W6OPX	126
A High-Stability Oscillator Circuit.....	Robert J. Ropes	142

ELECTRONIC CONSTRUCTION

Geiger Counter with Transistor Power Supply.....	J. E. Pugh, Jr.	35
A Transistorized Marine Direction Finder.....	Oliver Read	42
Multiband FM Receiver.....	Edwin T. Bohr	66
Solar Radio with Surface Barrier Transistor.....	Edwin T. Bohr	132

DEPARTMENTS

Within the Industry.....	28	What's New in Radio.....	148
Technical Books.....	137	Manufacturers' Literature.....	155
Sales Aids.....	164		



COVER PHOTO: Bill Harvey, who handles the "Gaspar Mariner," and operates the Bay Shore Small Boat Center, Newport Beach, Calif., navigates with the tiny direction finder described in this month's issue, page 42. (Ektachrome by Peter J. Samerjan)

ZIFF-DAVIS PUBLISHING COMPANY

President
B. G. DAVIS
Vice-President
H. J. MORGANROTH
Vice-President
B. H. FROELICH
Vice-President & Circulation Dir.
M. MICHAELSON
Secretary-Treasurer
G. E. CARNEY
Art Director
AL GRUEN

BRANCH OFFICES

CHICAGO (1)
 64 E. Lake St., AN 3-5200
 LOS ANGELES (1A)
 275 W. 7th St., (Rcam 472) Tenth Bldg



ZIFF-DAVIS PUBLISHING COMPANY
WILLIAM B. ZIFF (1898-1953) FOUNDER
 Executive Office: 366 Madison Ave.
 New York 17, N. Y. MU 7-8080
 Editorial Office: 1 Park Ave.
 New York 16, N. Y. MU 5-6367
VOLUME 57 • NUMBER 6



Member
 Audit Bureau of
 Circulations

Copyright © 1957 by Ziff-Davis Publishing Company. All rights reserved.

SUBSCRIPTION SERVICE. All communications concerning subscriptions should be addressed to Circulation Dept., 64 E. Lake St., Chicago 1, Ill. Subscribers should allow at least four weeks for change of address. Include your old address as well as new—enclosing, if possible, an address label from a recent issue of this magazine.

CONTRIBUTIONS: Contributors are advised to retain a copy of their manuscripts and illustrations. Contributions should be mailed to the New York Editorial Office and must be accompanied by return postage. Contributions will be handled with reasonable care, but this magazine assumes no responsibility for their safety. Any copy accepted is subject to whatever adaptations and revisions are necessary to meet the requirements of this publication. Payment covers all author's, contributor's, and contestant's rights, title, and interest in and to the material accepted and will be made at our current rates upon acceptance. All photos and drawings will be considered as part of the material purchased.

**DEVRY TECH CAN PREPARE YOU
IN SPARE TIME AT HOME AS AN**

ELECTRONICS TECHNICIAN!

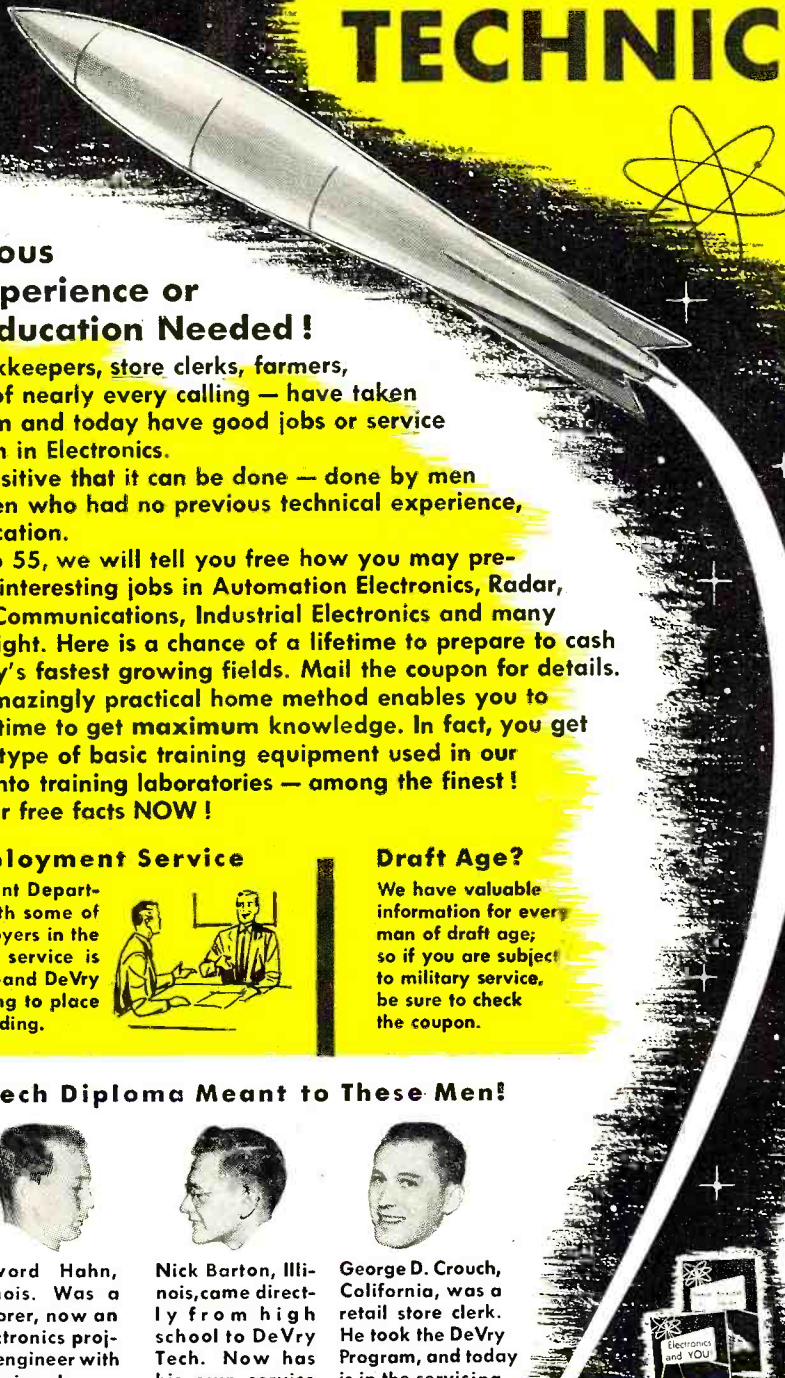

No Previous Technical Experience or Advanced Education Needed!

Laborers and bookkeepers, store clerks, farmers, salesmen — men of nearly every calling — have taken the DeVry program and today have good jobs or service shops of their own in Electronics.

Here's proof positive that it can be done — done by men like yourself — men who had no previous technical experience, no advanced education.

If you are 17 to 55, we will tell you free how you may prepare for exciting, interesting jobs in Automation Electronics, Radar, Guided Missiles, Communications, Industrial Electronics and many others shown at right. Here is a chance of a lifetime to prepare to cash in on one of today's fastest growing fields. Mail the coupon for details.

DeVry Tech's amazingly practical home method enables you to spend minimum time to get maximum knowledge. In fact, you get exactly the same type of basic training equipment used in our Chicago and Toronto training laboratories — among the finest!

Send coupon for free facts NOW!

Live-Wire Employment Service

DeVry Tech's Placement Department is in contact with some of the best-known employers in the Electronics field. The service is free to all graduates—and DeVry Tech's record in helping to place men has been outstanding.



Draft Age?

We have valuable information for every man of draft age; so if you are subject to military service, be sure to check the coupon.

What a DeVry Tech Diploma Meant to These Men!



G. F. Beane, W. Virginia, was a truck driver. He took the DeVry Tech Training Program, and is now a technical electronics sales representative.



Edward Hahn, Illinois. Was a laborer, now an electronics project engineer with Televiso, Inc. DeVry Tech training helped him prepare for his present position.



Nick Barton, Illinois, came directly from high school to DeVry Tech. Now has his own service shop and tells us he is "literally snowed with work."



George D. Crouch, California, was a retail store clerk. He took the DeVry Program, and today is in the servicing field for himself.

**AN
INDEX
to a
BETTER JOB,
A BRIGHTER
FUTURE**

COMMUNICATIONS

RADAR

GUIDED
MISSILES

TELEVISION

MICRO-WAVES

RADIO

INDUSTRIAL
ELECTRONICS

COMPUTERS

AUTOMATION
ELECTRONICS

Sample Lesson **FREE!**

See for yourself how DeVry Tech trains you for real opportunities in Electronics. We'll also give you a free copy of an interesting booklet, "Electronics and YOU."



Mail Coupon Today!

DeVry Technical Institute
4141 Belmont Ave., Chicago 41, Ill., Dept. RN-6-N
Please give me FREE Sample Lesson and your booklet, "Electronics and YOU," and tell me how I may prepare to enter one or more branches of Electronics as listed above.

Name _____ Age _____

Street _____ Please Print _____ Apt. _____

City _____ Zone _____ State _____

Check here if subject to military training.
DeVry Tech's Canadian Training Center is located at 626 Roselawn Avenue, Toronto 12, Ontario 2004

"One of North America's Foremost Electronics Training Centers"



Accredited Member of
National Home Study Council

DEVRY TECHNICAL INSTITUTE

CHICAGO 41, ILLINOIS

FORMERLY

DEFOREST'S TRAINING, INC.



everyone's acclaiming the extraordinary new



\$59.85

incl. 1 mil diamond stylus!

Fluxvalve-Unipoise pickup-arm

WITH ITS OWN BUILT-IN CARTRIDGE CONTAINING AN EASILY REPLACEABLE STYLUS... ALL STYLUS SIZES ARE AVAILABLE INCLUDING THE EXCLUSIVE 1/2 MIL

The all-knowing, the cognoscenti, music critics and record-playing enthusiasts have accorded the Fluxvalve-Unipoise Arm an acceptance never before seen in the history of Hi-Fi equipment. Here is the ultimate arm-cartridge for perfect tracking... for minimum stylus wear... for maximum record life and for optimum performance... there's nothing like it... nothing to compare.

The Fluxvalve-Unipoise Arm, latest development in record-playing arm-cartridge combinations, embodies all the features exclusive to the Fluxvalve... and at the remarkably low price of \$59.85 for the arm-cartridge combination - including 1 mil diamond stylus!

This combination of features is exclusive with the Fluxvalve-Unipoise:

- Very high compliance
- Very low tracking force, 2-4 grams
- Resonance-free, flat frequency response to 30kc
- Distortion-free dynamic tracking
- All stylus sizes, including 1/2 mil
- Maximum stylus life
- Minimum record wear
- Feather-weight, airframe design
- Single friction-free pivot bearing
- High output
- Easily replaceable styli

Ultra-dynamic styling to match ultra-dynamic performance!



PICKERING & CO., INC. OCEANSIDE, N. Y.

Professional Audio Components

"For those who can hear the difference"

EXPORT: AD. ABRIMA, INC., 89 BROAD ST., NEW YORK / CANADA: CHARLES W. POINTON LTD., 45 ALCINA AVE., TORONTO

Enjoy a demonstration at your hi-fi sound studio... you'll hear the difference. For the dealer nearest you or for literature write Dept. C-16

RADIO & TV NEWS

RCA offers you the
 finest training
 at home in
 Radio-TV
 electronics,
 TV servicing,
 Color TV

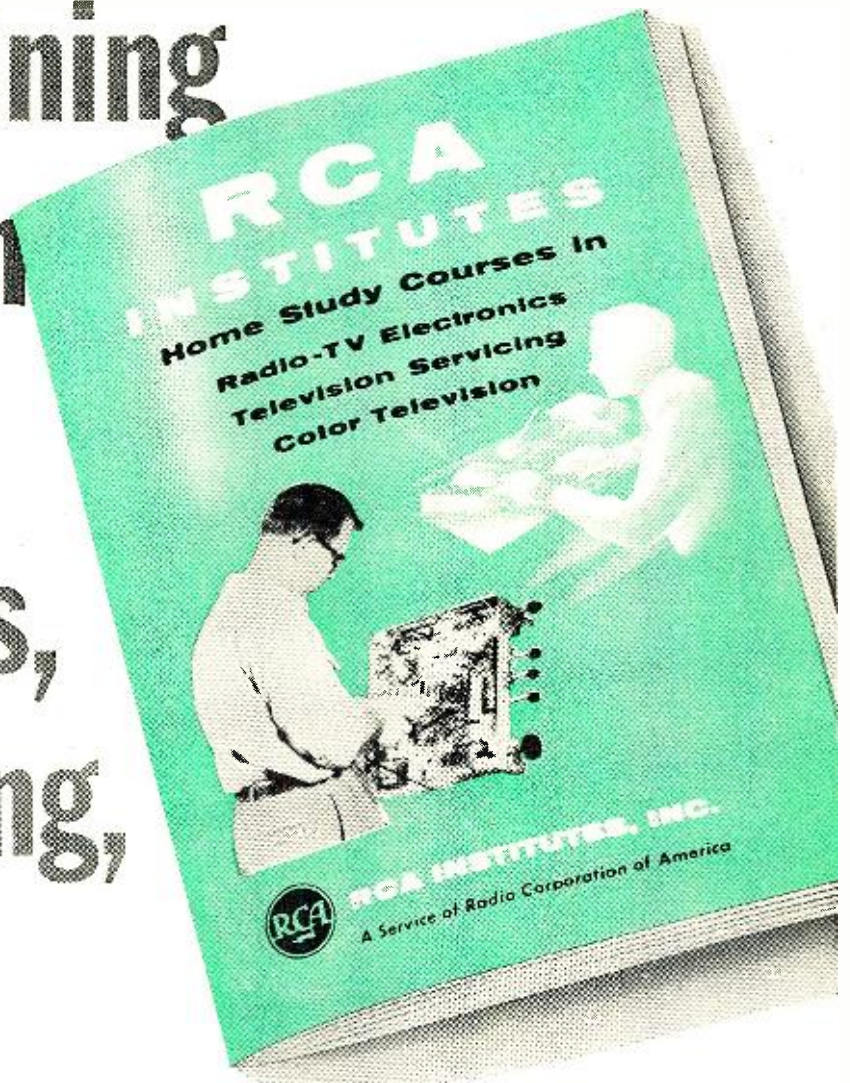

**SEND FOR THIS FREE
 BOOK NOW!**

The instruction you receive and equipment you get (and keep) will start you on your way. Pay-as-you-learn. You pay for only one study group at a time. This 52 page book contains complete information on Home Study Courses for the beginner and the advanced student.



RCA INSTITUTES, INC.
 A SERVICE OF RADIO CORPORATION OF AMERICA
 350 WEST FOURTH STREET, NEW YORK 14, N.Y.

In Canada—RCA Victor Company, Ltd.,
 5001 Cote de Liesse Rd., Montreal 9, Que.

RCA Institutes, Inc., Home Study N-67,
 350 West Fourth Street New York 14, N. Y.
 Without obligation, send me FREE CATALOG
 on Home Study Courses in Radio, Television
 and Color TV. No salesman will call.

Name
 Please Print
 Address
 City Zone State

VETERANS
 KOREAN G.I.
 P.L. 550
 CHECK HERE
 ()

Free

to the
professional
television man

**NEW 1957
TELEVISION
REPLACEMENT
GUIDE**

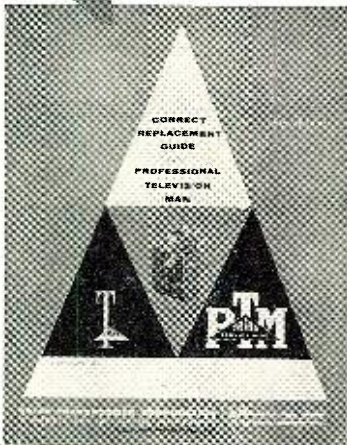

Send for your free copy today. Lists all the Triad Correct Replacement Transformers, including composite items designed to provide correct transformer replacement for television receivers.



4055 REDWOOD AVENUE
VENICE, CALIFORNIA
812 EAST STATE STREET
HUNTINGTON, INDIANA

A SUBSIDIARY OF LITTON INDUSTRIES

For the RECORD.

THE NEW GENERATION OF VIKINGS

AN INTERESTING and relatively quiet "revolution" has been under way in this country during the last ten years—one that indirectly affects many of us in the electronic industry.

We are, of course, speaking of the emergence of boating as the new and popular "family hobby." According to the National Association of Engine and Boat Manufacturers, Inc., the industry's trade association, there are some 5,971,000 craft of all types bobbing around on rivers, ponds, creeks, lakes, inland waterways, canals, off-shore waters, etc. This means that *one out of every twenty-eight persons* in the United States owned some sort of pleasure craft at the end of 1956!

The time-worn jokes about being an Admiral in the "Nebraska Navy" are no longer valid since with the many vast dam and waterway projects being undertaken by the federal government, man-made lakes are providing a readily accessible playground to those who formerly lived in what were popularly known as "land locked" areas.

Last year enthusiasts spent \$1,250,000,000 (one and one-fourth billion dollars) on new and used boats, accessories, safety equipment, fuel, insurance, docking, maintenance, etc. This is big business with a vengeance and the interesting thing about this hobby is the way its tentacles reach out into so many diverse fields. The oil companies, textile firms, and electronic equipment manufacturers have all received a share in this bonanza. Marinas, waterfront docking, launching facilities, and other service businesses all command an impressive portion of the total amount of the boating check.

While the electronics industry has not, as yet, been as vitally affected as other segments, some slight idea of the growth of marine electronics can be obtained by noting that the Federal Communications Commission now lists 55,000 marine radiotelephones (at the end of 1956) as compared with a mere 8204 in 1947. Serious yachtsmen who operate in coastal waters are buying and installing more and more elaborate gear to insure the safety of their passengers and craft and add to the operating convenience of their vessels when the boats are cruising at a distance from shore. Small boat radars, two-way radio gear, depth finders, modified sonars for spotting obstructions, direction finders, and other gear which was formerly associated only with ocean-going vessels of commercial tonnage have been scaled down in size,

complexity, and price and are finding their way into the modest size week-end pleasure craft.

The original dollar outlay for such equipment makes a pleasant tinkle in the cash registers of the dealers who handle the sale and installation of such marine electronic gear. This pleasant sound becomes an ear-soothing jangle to the service technicians who keep the equipment in top-notch condition! The reason is simple and has an interesting psychological twist. The customer who could "be heard in the next county" if presented with a \$5.00 service bill for repairing his a.c.-d.c. table model radio receiver is an altogether different individual when it comes to settling up for work done on his marine gear.

Just as the domestic tyrant who protests the purchase of a new broom becomes a veritable spendthrift when the bill arrives for his new fishing gear, so the avid boatsman considers any outlay which will make his hobby more fun, cash well spent.

From the technician's point of view, this type of service holds an additional charm in that it is not a field where he has to battle competition from the "boy next door who just loves to fiddle with radios." This is a field for the "men"—the "boys" learn to grow up or get out.

The very nature of the equipment used on boats is such that only "professionals" can handle the work. Those who work on radiotelephone gear or any other signal-producing equipment must hold pertinent FCC licenses and maintain the highest standards of competence. This fact and because of the nature of the equipment itself, most boat owners have a healthy respect for the men to whom they entrust their service business. The relationship is that of the expert or "pro" rather than a service operation.

Handling such business entails certain sacrifices on the part of the technician in the way of additional schooling, preparation for FCC license exams (2nd class radiotelephone ticket or better) and the purchase of several non-standard service shop test equipment items, but the rewards are commensurate. The pay is good, the work is interesting, and the future looks as rosy as the sun over the mainmast. It is a field well worth the consideration of the would-be technician as well as the old hand who is a bit disenchanted with his routine radio and TV service work. O. R.



Save on Famous knight® HI-FI



THE VERY BEST FOR LESS: Knight Custom components are built to ALLIED'S own special high standards to deliver outstanding musical quality with distinguished appearance at money-saving minimum cost. Each unit is unconditionally guaranteed for one full year.

EXCLUSIVE WITH
ALLIED

NEW



Sensational Knight "Tri-Fi" 3-Way 12" Hi-Fi Speaker

MORE FOR YOUR HI-FI DOLLAR

ALLIED'S SPECIAL PRICE **\$49⁵⁰**

- Heavy 1¾-Pound Alnico-V Magnet
- 3 Radiating Elements for Smooth Response
- Compression-Type Horn-Loaded Tweeter
- Response, ± 5 db, 35-15,000 Cycles!

equal to the best

Here's incomparable Hi-Fi speaker value—the new 3-way type Knight "Tri-Fi" combining a 12" cone for bass reproduction, a special conical radiator for mid-frequencies and a built-in compression-type tweeter for highest frequencies. Includes L-pad tweeter level control with calibrated dial and control knob. Full 1¾-pound woofer magnet for solid bass response; heavy rattle-proof frame. Overall range is ± 5 db, 35-15,000 cps. First crossover at 2,000 cps; automatic crossover from mid-range to tweeter at 4,000 cps. Cone resonance: 50 cps; power capacity, 25 watts program material; impedance, 16 ohms. Diameter 12-1/16"; depth, 8". Unconditionally guaranteed for one full year. Shpg. wt., 12 lbs. **81 DX 839.** Knight "Tri-Fi" Speaker, only **\$49⁵⁰**

Only \$4.95 down on our Easy Terms

SAVE!

Knight "Tri-Fi" Speaker Installed in Knight-Klipsch Enclosure



Save **\$12.50**

ALLIED'S SPECIAL PRICE **\$99⁵⁰**

ALLIED'S OWN KLIPSCH-LICENSED ENCLOSURE

Comes to you ready to play—complete with Knight "Tri-Fi" speaker installed in handsome Knight-Klipsch enclosure. Enclosure is designed to use walls of room to extend bass range; "Tri-Fi" speaker covers entire spectrum of audible sound. Enclosure measures 32 x 21 x 14½". Speaker impedance, 16 ohms; power handling capacity, 25 watts. Available in Blonde or Mahogany finish. You save \$12.50 over the price of the separate units! Shpg. wt., 44 lbs.

94 DZ 787. Blonde finish.
94 DZ 786. Mahogany finish.

Each, only **\$99⁵⁰**

Only \$9.95 down on our Easy Pay terms

TOP VALUE knight HI-FI COMPONENTS

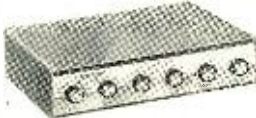

ONLY **\$94⁵⁰**

DeLuxe 24-Watt Amplifier "Space-Saver" design; response, ± 0.75 db, 20-40,000 cps; 12-position compensation; variable damping; loudness control; rumble filter; tape head input; hum balance. U.L. Approved. 30 lbs. **Model 94 SZ 709.** Net. **\$94.50**



ONLY **\$99⁵⁰**

DeLuxe Basic FM-AM Tuner. Matches DeLuxe amplifier; AFC; tuning meter; tuned RF on FM and AM; FM discriminator; 2 cathode followers; exceptional sensitivity. FCC Approved Radiation; U.L. Approved. 17 lbs. **Model 94 SX 711.** Net. **\$99.50**



ONLY **\$64⁵⁰**

"Bantam" 12-Watt Amplifier. Response, ± 0.5 db, 20-20,000 cps; 3-position compensation; variable damping; loudness control; built-in preamp; tape head input; 7 inputs; "Space-Saver" design. U.L. Approved. 18 lbs. **Model 94 SX 708.** Net. **\$64.50**



ONLY **\$74⁵⁰**

"Bantam" Basic FM-AM Tuner. Matches "Bantam" Amplifier; AFC; FM limiter and discriminator; output level control; RF stage; high sensitivity; temperature-compensated oscillator. FCC Approved Radiation; U.L. Approved. 13 lbs. **Model 94 SX 710.** Net. **\$74.50**

EASY TERMS AVAILABLE

Save \$44.72 On This Quality Knight "Space-Saver" Hi-Fi Phono System

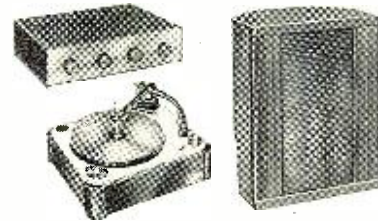

ONLY **\$199⁵⁰**

Top value in a superb Hi-Fi music system. You save \$44.72 over cost of individual components. No cabinets required. Includes Knight 12-Watt "Bantam" Amplifier; Garrard RC 121-4 Changer and base, with G.E. RPX 052-A Triple-Play Cartridge (diamond-sapphire styli); Knight-Klipsch enclosure with Knight 12" Tri-Fi speaker installed (specify Blonde or Mahogany finish). Easy to install anywhere. Shpg. wt., 92 lbs. **92 PA 505.** Knight Phono System.

Only **\$199⁵⁰**

Only \$19.95 down on our Easy Terms

order from **ALLIED RADIO**
America's Hi-Fi Center

FREE

SPECIAL VALUE SUPPLEMENT NO. 165



Send for it. Packed with top values in Hi-Fi systems and components; Recorders and supplies; all-new Public Address systems and components; super-value build-your-own Knight-Kits; Amateur equipment; electronic tubes and parts; tools, books, etc. **FREE**—send coupon today for your copy of ALLIED Supplement No. 165.

ALLIED RADIO CORP., Dept. 1-F7
100 N. Western Ave., Chicago 80, Ill.

OUR 36th YEAR

Ship the following KNIGHT Hi-Fi equipment

\$. enclosed. (All prices Net F.O.B. Chicago)

Send FREE ALLIED Supplement No. 165

Name

Address

City Zone State



Bell Laboratories researchers Henry S. McDonald, Dr. Eng. from Johns Hopkins, and Max V. Mathews, Sc.D. from M.I.T., examine magnetic tape used in new research technique. Voice waves are con-

verted into sequences of numbers by periodic sampling of amplitudes, 8000 samples per second. General purpose electronic computers act on these numbers as a proposed transmitting device might.

They send real voices on imaginary journeys

In their quest for better telephone service, Bell Laboratories researchers must explore many new devices proposed for the transmission of speech signals. For example, apparatus can be made to transmit speech in the form of pulses. But researchers must always answer the crucial question: how would a voice sent through a proposed device sound to the listener?

In the past it often has been necessary to construct costly apparatus to find out. Now the researchers have devised a way to make a high-speed electronic computer perfectly imitate the behavior of the device, no matter how complicated it may be. The answer is obtained without building any apparatus at all.

The researchers set up a "program" to be followed by the computer. Actual voice waves are converted into a sequence of numbers by sampling the waves 8000 times per second. Numbers and program are then fed into the computer which performs the calculations and "writes out" a new sequence of numbers. This new sequence is converted back into real speech. Listeners hear exactly how well the non-existent device could transmit a real voice.

With this novel technique, new transmission ideas are screened in only a fraction of the time formerly required. Thus valuable time and scientific manpower are saved in Bell Laboratories' constant search to provide still better telephone service for our subscribers.

BELL TELEPHONE LABORATORIES
World center of communications research and development



RADIO & TV NEWS



SAM: Looking for something?



YOU: That's right! I'm looking for a real all-purpose P. A. speaker and microphone combination. I want a combination that will stand up and do a top-quality job in any application.



SAM: The fact is that Electro-Voice has what is probably the handiest, most versatile P. A. speaker and microphone combination in the business.

ELECTRO-VOICE CDP® SPEAKERS—Compound Diffraction Projectors—are overwhelmingly superior to conventional P. A. horns because: CDP gives you two coaxially-mounted horns operating from a single diaphragm . . . a large one for lows, a small one for highs; 2½ additional octaves of sound reproduction plus dispersion through a solid 120° angle. CDP reaches more people more clearly. Two sizes to meet your needs.

MODEL 848 CDP handles the biggest jobs. 25 watts, 16 ohms. Response: 175-10,000 cps, crossover at 1000 cps. Sensitivity rating, 52 db. Size, 10½" x 20½" x 20". Wt., 12 lbs. List, \$75.

MODEL 847 CDP for smaller areas. 12 watts, 16 ohms. Response: 250-10,000 cps, crossover at 1500 cps. Sensitivity rating, 51 db. Size, 11¼" x 7¾" x 10⅞". Wt., 6½ lbs. List, \$46.33.



YOU: Sounds great! But what about the all-around general-purpose microphone?



SAM: Electro-Voice has the mike to do the job. In fact, the E-V Model 664 High-Fidelity Cardioid Dynamic is so good that Electro-Voice **GUARANTEES** it to outperform any other P. A. cardioid or your money back. Model 664 with unique E-V Variable D® gives you amazing versatility. It provides highly directional sound selectivity, smooth, peak-free response at all frequencies from 40 to 15,000 cps, no boominess. Exclusive, indestructible Acoustalloy diaphragm assures dependable, long-life operation indoors and outdoors. It lists for only \$82.50 (less stand).



YOU: Looks like the answer to my problems.



SAM: It is! Send for Bulletin 195-76. It's a 24-page handbook with a lot of answers on public address problems. Cat. No. 126-76 will give you complete details on Electro-Voice P. A. and general-purpose microphones. Bulletin No. 246-76, "The A B C's of Microphones," is packed with facts about the different types of microphones and how they work. Send for them today!

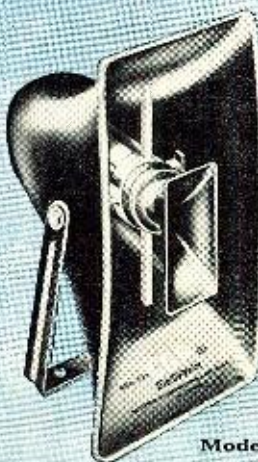

Model 848 CDP

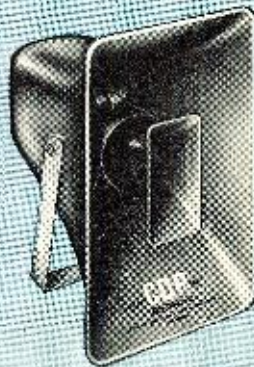

Model 847 CDP

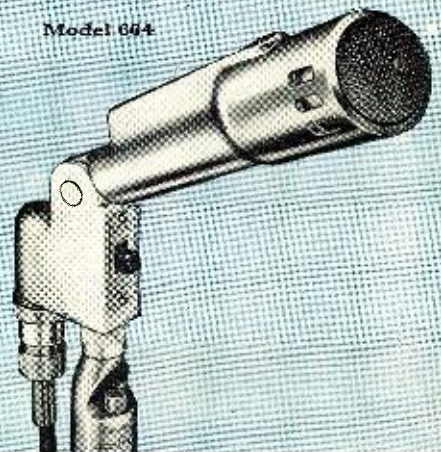

Model 664

Electro-Voice®

ELECTRO-VOICE, INC. • BUCHANAN, MICHIGAN

Export: 13 East 40th Street, New York 16, U.S.A. Cables: ARLAB

www.americanradiohistory.com

Build it yourself Famous BOGEN DB20 DF Amplifier

Now in kit form for the first time!
anyone can do it!



BUILD THE BEST! Of 3 dozen hi-fi amplifiers examined, a famous consumer testing organization found the BOGEN DB20 to be the finest! Take a look at the specifications at the right and you'll see why. It's the ideal 20-watt amplifier for any home installation. Never before has BOGEN offered any kit. Now you can do it yourself and save up to one third of the regular price!

STEPpak* MAKES IT EASY.

All parts needed for each step are packaged together in a separate envelope. No guesswork. No mistakes. No trouble identifying what goes

where. Even the wires are pre-cut to the proper length. Detailed STEP-BOOK tells you and shows you exactly what to do every step of the way, and gives basic theory in non-technical language so that you understand why your amplifier works so much better than any other.

NO EXPERIENCE NEEDED.

No knowledge of electronics or hi-fi required. Anyone who can turn a screwdriver can build this K-DB20DF. A great do-it-yourself project. A gift that will always be remembered. Complete BOGEN guarantee. See your BOGEN dealer now.

K-DB20DF SPECIFICATIONS

CONTROLS

Separate 5-position loudness contour selector; 4 input positions; 7 record equalization positions; continuously variable damping factor control; separate continuously variable bass and treble controls; volume control.

SPECIFICATIONS

0.3% distortion at 20 watts; peak 30 watts; response, 20-20,000 cps \pm 0.7 db.

only \$69⁵⁰ complete

*COPYRIGHT

FOR THE SMALLER SYSTEM

BOGEN K-DB110 12-watt Amplifier Kit. Assemble this BOGEN DB110 at home. Only 0.65% distortion at rated 12 watts; response, \pm 0.5 db from 15-30,000 cps. 4 controls: volume, separate continuously variable treble and bass controls, one control provides four input selector positions plus 3 record equalizer positions.

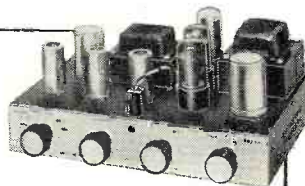

PRICE TO BE ANNOUNCED

SEE YOUR BOGEN DEALER

— Or write to us today for his name & address. David Bogen Co., Inc., Dept. MR P.O. Box 500, Paramus, New Jersey.

component or kit... buy

Bogen

HIGH FIDELITY
because it sounds better

RADIO & TV NEWS

Mr. Service Dealer...



**PHILCO 7100A—Newest Philco
Universal Color and Dot Bar Generator**

PHILCO is the Best Buy in Color Servicing



The new Philco Universal Color and Dot Bar Generator, like all Philco Test Equipment, was designed by expert engineers who know service work best. Built by trained technicians to rigid and high quality standards for more dependable, more accurate, faster work on the job.

BUILT-IN QUALITY FEATURES

- 4 crystals for maximum accuracy.
- Crystal controlled sound carrier, picture carrier, sync circuitry and color display.
- Visual marker signal to identify color bars.
- Regulated power supply.
- Separate R.F. and video attenuators.
- Positive and negative video signals for localizing trouble.
- Complete with R.F. and video cables.
- Tube complement of 14 tubes: 7-12AT7, 1-12AU7, 2-6CS7, 1-6CL6, 1-513, 2-OD3.

For Sure Success in Color Servicing

Philco Test Equipment is designed to help your profits grow by being faster and more accurate in solving every service problem. This latest Philco Universal Color Bar and Dot Bar Generator combining both services in one compact, lightweight case eliminates the nuisance of using separate instruments. Improved convergence signals are provided and a "white-raster" display is included to speed up accurate "color-purity" adjustments.

Now, it's no longer necessary to disable the set by removing a tube or changing circuit to obtain the "quiet", snow-free raster required. Halves the work time and eliminates old-fashioned methods requiring you to handle hot tubes. Front panel of etched aluminum with black knobs and easy-to-read etched markings. 18 lbs. light. Dimensions: 13 $\frac{3}{8}$ " wide, 11 $\frac{1}{8}$ " high, 9 $\frac{3}{4}$ " deep.

*Get the full story on how the
Philco Universal Color Bar and Dot Bar Generator
can streamline color servicing.*

PHILCO CORPORATION
Accessory Division • Phila. 34, Penna.



PHILCO CORPORATION ACCESSORY DIVISION
"A" Street and Allegheny Avenue
Philadelphia 34, Pa.

Please send me information on Philco Universal Color Bar and Dot Bar Generator with superior accuracy and speed.

Name _____

Address _____

City _____ Zone _____ State _____

RT-657

RCA Custom Convertible SPEAKER SYSTEMS

hi-quality... hi-fidelity... anywhere and any way you like it!

Soft and sweet or loud and lively... in your den or in your living room, RCA CUSTOM CONVERTIBLE SPEAKER SYSTEMS offer *the finest in sound satisfaction.*

Buy with confidence! RCA CUSTOM CONVERTIBLE SPEAKER SYSTEMS through exclusive RCA bottom-porting,

are readily convertible for use as INFINITE BAFFLE... BASS REFLEX... CORNER DRIVER... to suit your room acoustics, and your personal taste. Custom-built appearance is readily obtainable... panels and grill cloths can be removed and interchanged easily for matching or contrasting effects.

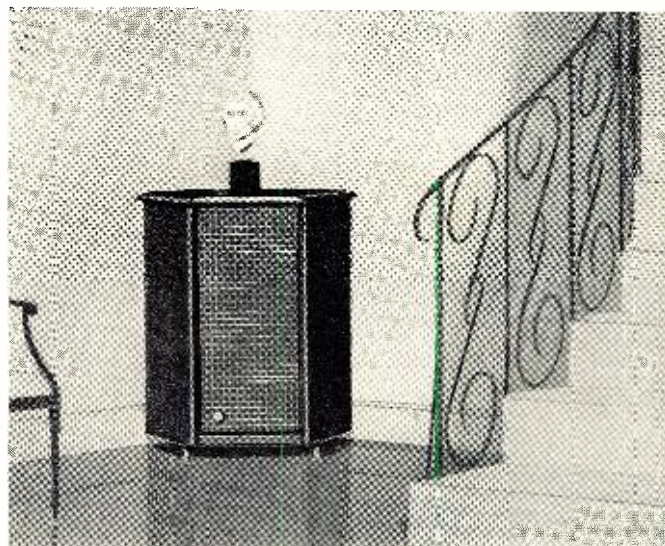
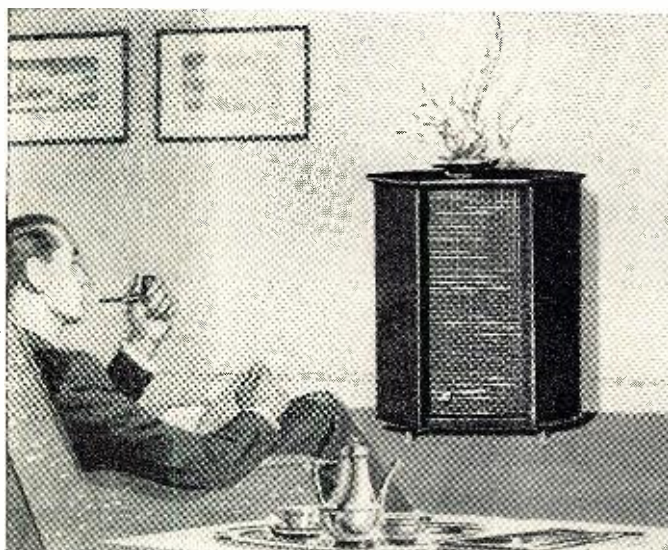

RCA 501S1 Bixial Speaker—compares with models two or three times the price! Features 14.5 ounce Alnico-V magnet and 8-ohm voice coil. Its 12-inch woofer employs



Olson-developed foam damping ring; 3-inch tweeter is mounted off-axis to minimize crossover interference; high frequency response extends beyond 18,000 cps.

Suggested User Price (optional) \$33.50

RCA 502S1 Direct Radiator Speaker—outstandingly smooth, unsurpassed in its frequency range to 16,000 cps. Features same construction as 501S1 and incorporates



medium-weight curved cone for smoothness, range, damping, and sensitivity to equal sound pressure of higher power speakers using double the power input.

Suggested User Price (optional) \$25.25

RCA Enclosures—Beauty in cherry or blonde cabinetry, the solid Honduras Mahogany will enhance room decor with the expensive look and feel of fine woods. Built for a lifetime of use, RCA enclosures feature mortise-and-tenon joints, glue-block

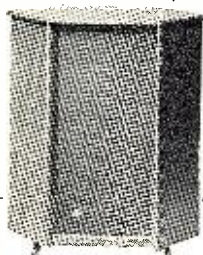

reinforcements and wood-screw clamping. For 12-inch speakers.

Suggested User 300W1 Cherry \$69.95
Price (optional) 301W1 Blonde \$74.50

301X1 Adapter Panel—converts 12-inch enclosures for use with 8-inch speakers. **Suggested User Price (optional) \$2.45**



RADIO CORPORATION of AMERICA

COMPONENTS DIVISION

CAMDEN, N. J.

RCA SPEAKERS FOR TV • RADIO • PHONOGRAPH • HIGH FIDELITY • PUBLIC ADDRESS • AT RCA DISTRIBUTORS EVERYWHERE!

COMPARE

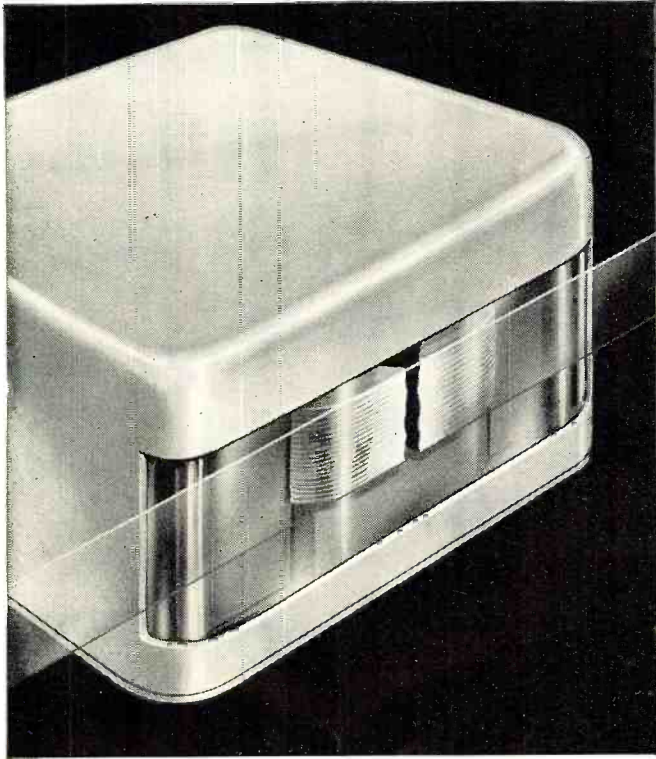

Picture of a recorder head's contact surface, with critical center gap eroded and enlarged by the wearing action of conventional magnetic tape.

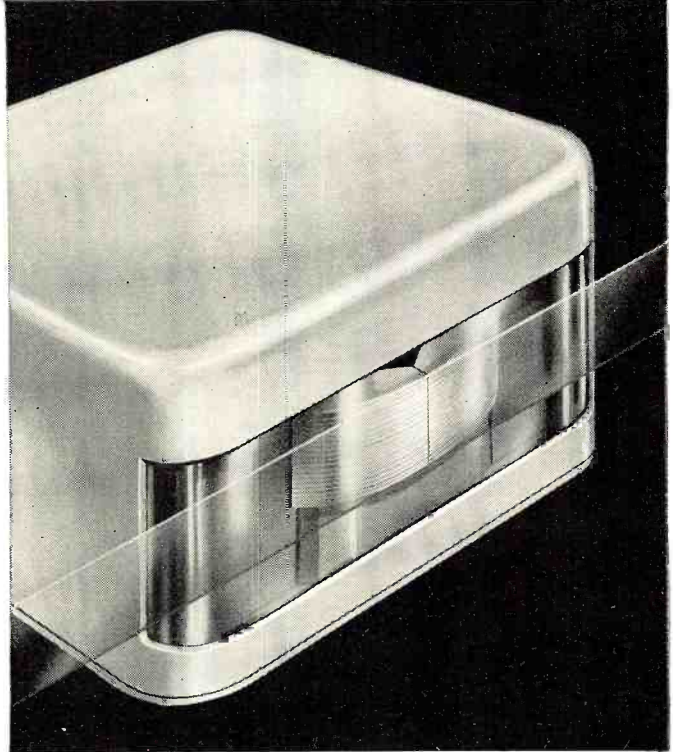

Same type head, same period of use. But see how silicone lubricated "Scotch" Brand Magnetic Tape has saved the head from wear—assuring perfect response!

Read how "Scotch" Brand's built-in dry lubrication reduces recorder abrasion

Know what's the most vulnerable part of your recorder? It's the sensitive magnetic head—the tiny, precision-made part where lack of proper lubrication can cause annoying wow, flutter and harmful friction.

Compare the two magnetic heads magnified above. See for yourself what lack of proper lubrication can do. Like the heads in your recorder, each head is made with an almost invisible quarter mil gap over which tape passes. At left, abrasive action by conventional tape has worn down the head

.0025 of an inch. (Small, yes, but enough to cause a frequency drop of a full octave!) Now, look how "Scotch" Brand Magnetic Tape has saved the head on the right. No wear. . . so no loss of sound.

Only "Scotch" Brand Magnetic Tapes perform this critical lubricating job for you. Exclusive silicone lubrication process (dry lubrication) lets tape glide smoothly, safely over the magnetic heads. And this famous safety feature lasts the life of the tape. Treat your machine to a reel soon.

Free Tape Tips—write Dept. PF-67.

ONLY "SCOTCH" BRAND HAS SILICONE LUBRICATION



#190 Extra playing time #150 Extra strength #120 Higher output #111 True economy



Your guarantee of quality

The term "SCOTCH" and the plaid design are registered trademarks for Magnetic Tape made in U.S.A. by MINNESOTA MINING AND MFG. CO., St. Paul 6, Minn. Export Sales Office: 99 Park Avenue, New York 16, N. Y. © 3M Co., 1957

Sylvania IF Amplifier Tubes



“fixed-bias” tested

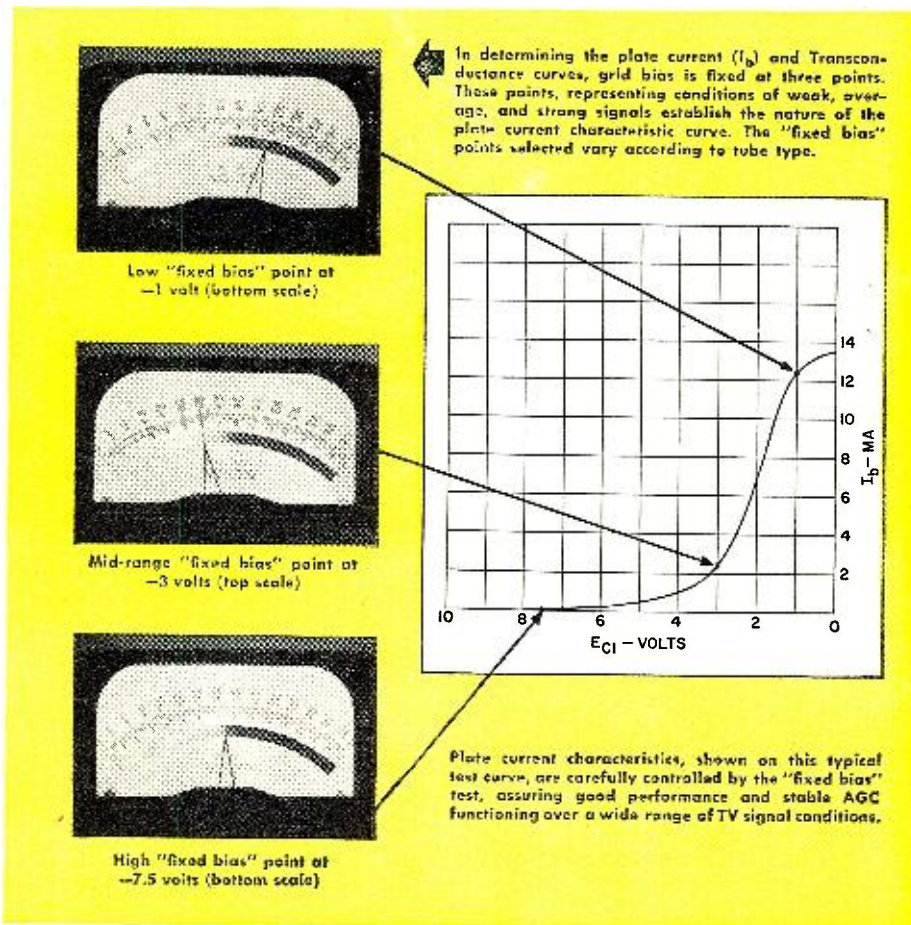

Dynamic TV set conditions are set up in these test bridges making the “fixed bias” test a true measure of how the tube will perform in TV sets encountered by you in the field.

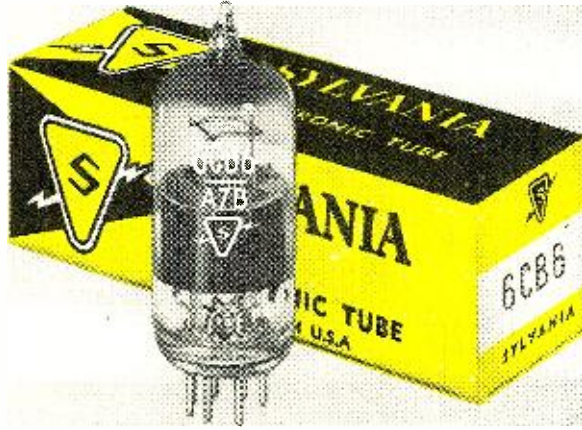

for stable performance and service dependability

IT HAS always been Sylvania's policy to search for new and better ways to test tubes under dynamic conditions for closer control over performance. The "fixed bias" test is typical of these techniques. It places a more stringent, realistic measure on the tube's ability to perform under varying circuit conditions.

By controlling the plate current characteristics and transconductance of IF amplifier tubes, the "fixed bias" test gives the serviceman an extra measure of dependability regardless of make, model, or age of the TV set serviced.

The range of stable operation is controlled, too, for smooth AGC action over wide variations in signal strength.

These are the same reasons that Sylvania IF types are the choice of leading TV set manufacturers, attested by the wide assortment of Sylvania original types listed among IF tubes now in popular use.

In addition to the "fixed bias" test many other electrical tests are performed on Sylvania IF amplifier types including stability during life. During life tests, close controls are placed on interelectrode leakage.

In every way, Sylvania IF amplifier types offer you maximum assurance of trouble-free service based on sound, newly developed testing methods. Specify Sylvania IF amplifier tubes in the new yellow and black carton.

 **SYLVANIA**

SYLVANIA ELECTRIC PRODUCTS INC.
1740 Broadway, New York 17, N. Y.
In Canada: Sylvania Electric (Canada) Ltd.
University Tower Bldg., Montreal

WE TRADE HIGHER!



GOING MOBILE? - SEE WALTER ASHE FIRST!

NOVICES AND TECHNICIANS FOR YOU

GONSET COMMUNICATOR. Complete station (transmitter-receiver) for home or mobile use. Available for either 2 or 6 meters. NET.....\$229.50

CONVERTERS

GONSET SUPER SIX. Net \$52.50

MORROW 5BR-2. Net.....\$74.95

MORROW

MORROW MOBILE RECEIVER
MODEL MBR-5. 80 thru 10 meters. Dual conversion. 13 tubes. Less power supply and speaker. Net..\$ 224.50

MORROW MOBILE TRANSMITTER
MODEL MB-560. 80 thru 10 meters. VFO or xtal. 90W CW, 60W phone. Less power supply. Net.....\$214.50

GONSET

GONSET MOBILE RECEIVER
MODEL G-66. 80 thru 10 meters plus BC band. Dual conversion. 9 tubes. Less P.S. and speaker. Net...\$189.50

GONSET MOBILE TRANSMITTER
MODEL G-77. 80 thru 10 meters. VFO or xtal. 50-60 watts input, pi-network. With power supply. Net.....\$279.50

ELMAC

ELMAC MOBILE RECEIVER
MODEL PMR-7. 160 thru 10 meters, plus BC band. Dual conversion. 10 tubes. Less P.S. & spkr. Net \$159.00

ELMAC MOBILE TRANSMITTER
MODEL AF-67. 160 thru 10 meters. VFO or xtal. 60 watts phone, CW, or NBFM. Less P.S. Net.....\$ 177.00

WRITE FOR FULL DETAILS ABOUT OUR TIME PAYMENT PLAN

All prices f. o. b. St. Louis • Phone Chestnut 1-1125



OUR 35TH YEAR

WALTER ASHE RADIO COMPANY
1125 Pine Street, St. Louis, Mo.

Rush "Surprise" Trade-In Offer on my.....
for..... (show make and model of new equipment desired) RN-6-57

Send NEW 1957 Walter Ashe catalog.

Name.....
Address.....
City..... Zone..... State.....

here's
another
Independent
.....
Service Ad
.....
to grow on

We're telling the advantages of your *independent* service in advertisements like this every month . . . pre-selling for you the millions of readers of all 44 local editions of TV Guide.

Ask your distributor how you can profit. Get the free PA-131 folder giving complete details about your Independent Service campaign.



*For your TV repairs
call the man who cares*

**THE INDEPENDENT
SERVICE-DEALER**

He'll do a better job for you because he wants to. He's your neighbor. He pays taxes in your town. He has the same common interests and problems. He cares what *you* think of him and the service he gives you . . . because it's important to *his* business success.

So when your radio or TV needs repairs, call the man who cares. Call your independent service-dealer . . . the skilled technician who is trained and equipped to service promptly *all* makes of radio and TV sets at fair prices.



And if your set needs new tubes, ask him for CBS tubes. They have the Good Housekeeping Guaranty Seal . . . and there are no better tubes made.

Look for this emblem to identify your independent radio and television service-dealer.



© CBS-HYTRON, Danvers, Mass.
A Division of
Columbia Broadcasting System, Inc.



Ask also for this free decalcomania . . . for free window display and ad mats. And for other special tie-in material: Postal cards, doorknob hanger and consumer booklet selling your service.

Help us help you. Join with other independent service-dealers . . . your independent parts distributor . . . and CBS Tubes to make independent service strong.



CBS-HYTRON
DANVERS, MASSACHUSETTS
A Division of
Columbia Broadcasting System, Inc.

Remember.

The more you say, "I want CBS Tubes!", the greater support you give to your independent service-dealer campaign. Keep saying it. It will keep paying you business dividends.

BUILD THE BEST—

BUILD ALLIED'S OWN

knight-kits[®]

LOWEST COST because our giant buying power passes biggest savings on to you... you do the easy assembly, get professional results and **SAVE!**

knight-kits

EASIEST TO BUILD because KNIGHT-KIT "Step-and-Check" instruction manuals are marvels of clarity—it's just like having a good instructor at your side.

knight-kits

MONEY-BACK GUARANTEE: When properly assembled, KNIGHT-KITS fully meet published specifications, or we refund your money.

EASY TERMS AVAILABLE

knight-kit HI-FI VALUE SENSATIONAL HI-FI FM TUNER KIT

NEW



Model Y-751 ★ Deluxe custom hi-fi styling
★ AFC and Flywheel tuning
★ Printed circuit—easy wiring

\$37⁷⁵

The best-looking, best-performing tuner kit your money can buy. Covers 88 to 108 mc; features AFC (with special disabling circuit); pre-adjusted RF coils; pre-aligned IF's; cascode broad-band RF amplifier; drift-compensated oscillator; illuminated lucite pointer. Sensitivity is 10 microvolts for 20 db of quieting across entire band. Ideal for use with Knight-Kit 20-Watt Amplifier or any amplifier with phono-tuner switch. 13 x 8 x 4". Complete, ready for easy assembly. Shpg. wt., 12 lbs.

Model Y-751. Net, F.O.B. Chicago **\$37⁷⁵**

See our Supplement No. 165 for additional knight-kit Hi-Fi values

free SUPPLEMENT

featuring **knight-kits**

Send for our FREE Supplement No. 165 featuring 45 great Knight-Kits, including Test Instruments, Hi-Fi, Hobbyist and Amateur kits. Write for your copy today.



ORDER FROM
ALLIED RADIO

Dept. 01-F-7, 100 N. Western Ave., Chicago 80, Ill.

Spot Radio News

★ Presenting latest information on the Radio Industry.

By RADIO & TV NEWS
WASHINGTON EDITOR

FEDERAL OPERATION of the airway systems across the country, that has been sharply criticized by Congress and a number of civic groups, will soon have a "new look" that is expected to satisfy even the harshest complainant. The new look will take the form of a multi-million dollar network of electronic-communication centers from coast-to-coast that will supplement the present setup of 214 stations.

Commenting on the size of the program, CAA's director of the technical development center in Indianapolis, Don Stuart, said that the total plant investment in the Federal Airways system prior to June, 1956, was \$172,000,000. In the fiscal-year 1957, \$75,000,000 was appropriated for the establishment of air-navigation facilities, and the fiscal-year 1958 budget for the same activity is \$175 million. The fiscal '58-dollar investment in air navigation, if all goes well, Stuart added, will be greater than the total plant investment over the past 30 years, or since the passage of the Air Commerce Act of 1926.

During the next five years, the CAA expert reported, radar control will be extended to additional terminal areas, to high-density routes, and to high-

altitude area control. Longer range primary radar and secondary (beacon) radar will extend the advantages of radar-control methods beyond the present approach and departure areas, it was emphasized; it will expand the safe capacity of the air-traffic control system through better utilization of air space, simplification of the control function, and extension of control of traffic to an area basis.

In addition, Stuart said, airport surface detection equipment will permit improved control of traffic on the surface of major airports under poor visibility conditions. And by means of additional peripheral ground station facilities, improved contact for direct controller-pilot communications will be possible.

A DYNAMIC ILLUSTRATION of how the streamlined program of CAA is being carried out appeared recently in an announcement on contract awards.

It was disclosed that the air agency had ordered over \$3-million worth of microwave-link installations that will be used to remote radar information from antenna sites into CAA air-route traffic-control centers. This will be done where, because of critical siting

NEW TELEVISION STATION GRANTS

An additional listing of new construction permits and changes that have been made in station call letters. List continued next month.

STATE	CITY	CALL	CHANNEL	FREQUENCY	POWER*
Florida	Jacksonville	WETJ	7	174-180	16.4
Montana	Glendive	5	76-82	4.62
Texas	San Angelo	3	60-66	3.02

NEW CALL LETTER ASSIGNMENTS

STATE	CITY	CALL	CHANNEL	FREQUENCY
Arizona	Tucson	KGUN-TV (Formerly KDWI-TV)	9	186-192
California	Eureka	KHUM-TV	13	210-216
	San Francisco	KPRT	26	542-548
Massachusetts	North Adams	WCDC (Formerly WMGT)	19	500-506
Montana	Helena	KABL-TV	10	192-198
Texas	Big Spring	KEDY-TV	4	66-72
Washington	Walla Walla	(Formerly KBST-TV) KRTV (Formerly KWAR)	8	180-186

* ERP = (effective radiated power, kw.)

**GREATEST
ADVANCE IN
SHOP-METHOD
HOME TRAINING**

EARN MORE MONEY...GET INTO TELEVISION ELECTRONICS-RADIO

Learn ALL 8 PHASES in ONE MODERN HOME-STUDY COURSE
At Home - In Spare Time

YOU GET ALL THIS NEWEST PRACTICAL EQUIPMENT

- Parts to build a modern TV set, including all tubes plus a large screen Picture Tube
- Parts to build a powerful Superhet Receiver, standard broadcast and short wave
- Parts to conduct many experiments and build Continuity Checker, RF Oscillator, TV Circuits, Audio Oscillator, TRF Receiver, Signal Generator
- A Valuable Professional Multitester

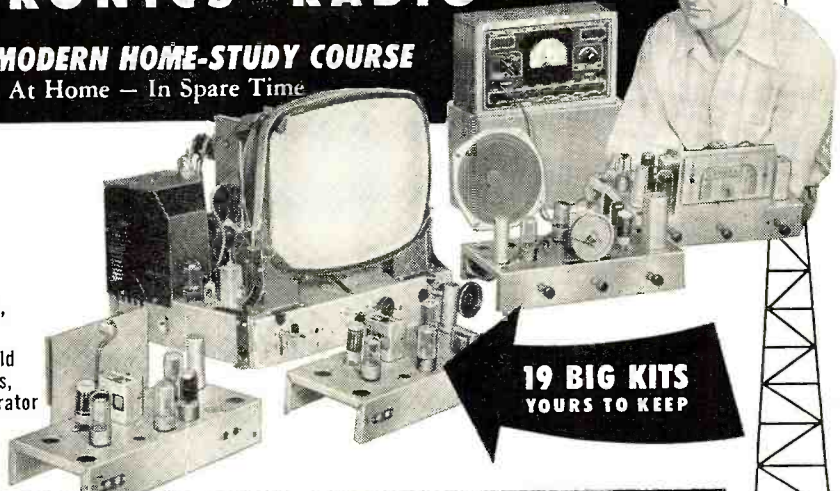

**19 BIG KITS
YOURS TO KEEP**

YOUR NATIONAL SCHOOLS TELERAMA COURSE COVERS ALL 8 PHASES

- | | |
|------------------------------------|--------------------------------|
| 1. TELEVISION, INCLUDING COLOR TV | 5. PREPARATION FOR FCC LICENSE |
| 2. RADIO, FM AND AM | 6. AUTOMATION |
| 3. INDUSTRIAL ELECTRONICS | 7. RADAR AND MICRO WAVES |
| 4. SOUND RECORDING AND HI FIDELITY | 8. COMMUNICATIONS |

YOU ARE NEEDED IN THE TELEVISION-ELECTRONICS-RADIO INDUSTRY!

You can build a secure future for yourself if you get into Electronics NOW! Today's shortage of trained technicians creates tremendous opportunities. National Schools Shop-Method trained technicians are in constant and growing demand for high-pay jobs in Broadcasting and Communications, Electronic Research, Servicing and Repair, and many other branches.

Let National Schools, a Resident Technical School for over 50 years train you for today's unlimited opportunities in electronics! Our Shop Method trains you to be a MASTER-TECHNICIAN. Completely up to date, developed by experienced instructors and engineers, your Telerama Course will teach you all phases of the industry quickly, clearly and correctly. You can master the most modern projects, such as Color TV, printed circuits - even prepare for FCC License without taking a special

course. You can handle sales, servicing, manufacturing, or make good money in your own business. SEND FOR FACTS TODAY!

EARN AS YOU LEARN. Many of our students earn their entire tuition and more in Spare Time jobs we show them how to do while learning.

YOU GET EVERYTHING YOU NEED - Clear, profusely illustrated lessons, shop-tested manuals, modern circuit diagrams, practical job projects - all the valuable equipment shown above

- many other materials and services
- consultation privilege with our qualified staff, and Graduate Employment Service. EVERYTHING YOU NEED for outstanding success in Electronics.

RESIDENT TRAINING AT LOS ANGELES

If you wish to take your training in our Resident School at Los Angeles, the world's TV capital, start NOW in our big, modern Shops, Labs and Radio-TV Studios. Here you work with latest Electronic equipment—professionally installed—finest, most complete facilities offered by any school. Expert, friendly instructors. Personal attention. Graduate Employment Service. Help in finding home near school—and part time job while you learn. Check box in coupon for full information.



NATIONAL SCHOOLS

TECHNICAL TRADE TRAINING SINCE 1905
LOS ANGELES 37, CALIFORNIA

GET FAST SERVICE—MAIL NOW TO OFFICE NEAREST YOU!

NATIONAL SCHOOLS, DEPT. RH-67

4000 S. FIGUEROA ST.
LOS ANGELES 37, CALIF.

Rush free TV-Radio "Opportunity" Book and sample lesson. No salesman will call.

NAME _____ AGE _____

ADDRESS _____

CITY _____ ZONE _____ STATE _____

Check if interested ONLY in Resident School training at Los Angeles.
VETERANS. Give date of Discharge _____

**SAMPLE LESSON
RADIO TELEVISION
AND ALLIED ELECTRONICS**

**YOUR FUTURE
IN RADIO
TELEVISION**

FREE!

Fully illustrated "Career" Book in TV-Radio-Electronics. PLUS actual sample lesson—yours at no cost, no obligation. CLIP COUPON NOW... MAIL IT TODAY!

APPROVED FOR G. I. TRAINING

NATIONAL SCHOOLS

4000 S. FIGUEROA ST., LOS ANGELES 37, CALIF.

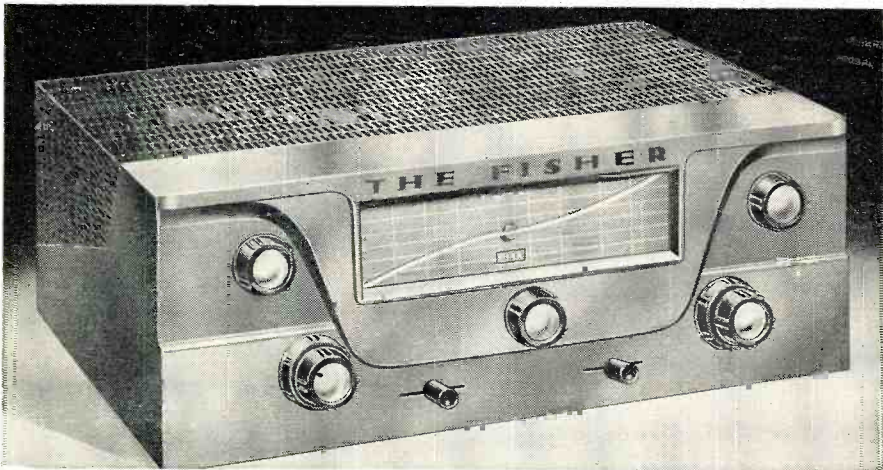

THE FISHER 25-WATT

Master Control-Amplifier · CA-40

■ Complete in every respect — and it's by FISHER! A new 25-watt amplifier with *complete* Audio Controls. Less than 1% distortion at 25 watts! Six inputs. Six equalization positions. *Exclusive* FISHER TONE-SCOPE provides graph-form indication of Tone Control settings. Direct, tape-head playback and microphone preamplifier. Uniform frequency response within 0.5 db, 10 to 90,000 cycles. Less than 1% IM distortion at 15 watts. Hum and noise level better than 90 db below full output. Cathode-follower tape recorder output. Speaker output impedances: 4, 8 and 16-ohms. Nine controls. TUBE COMPLEMENT: 1-12AU7A, 3-12AX7, 4-EL84, 2-6BW4. SIZE: 12¾" wide x 10¾" deep x 5" high. WEIGHT: 24 pounds.

\$139.50

Two Great Audio Units!

THE FISHER

MODEL CA-40 · MODEL 80-C

THE FISHER

Master Audio Control · 80-C

■ "Breathtaking!"—*Edward Tatnall Canby*. The Master Audio Control can be used with any amplifier. Provides professional phono and tape-head equalization, plus full mixing and fading facilities for from two to five channels. Seven inputs. Two cathode-follower outputs. Uniform response within 0.25 db, 20 to 20,000 cycles. IM distortion and hum virtually non-measurable. DC on all filaments. Separate equalization and preamplification *directly* from tape playback head. Eight controls. TUBE COMPLEMENT: 3-12AX7, 1-12AU7A. SIZE: 12¾" wide x 7¾" deep x 4¼" high. WEIGHT: 10 pounds.

\$99.50

Prices Slightly Higher In The Far West Mahogany or Blonde Cabinet \$9.95

WRITE TODAY FOR COMPLETE SPECIFICATIONS

FISHER RADIO CORP. · 21-23 44th DRIVE · L. I. CITY 1, N. Y.

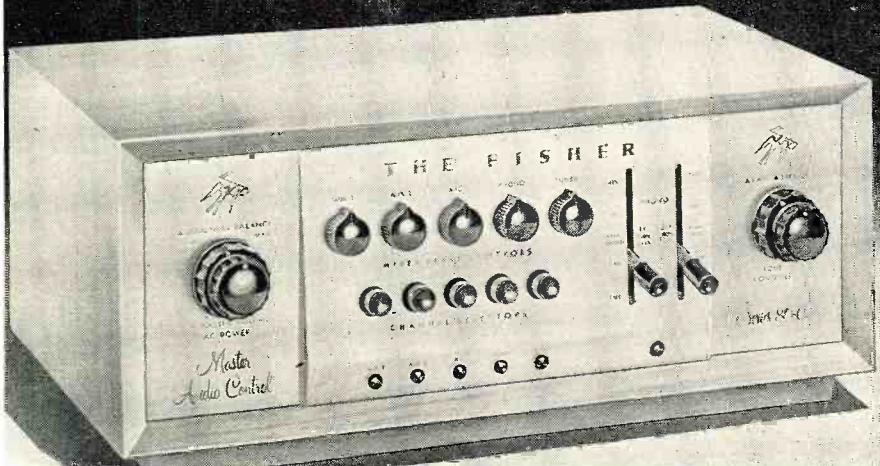

problems, the antenna is placed more than two miles from the control center, or where radar coverage is required over congested areas many miles away from the control center.

The equipment, which operates at 7000 megacycles, breaks down the radar information at the antenna site and transmits it to the traffic-control center, where it is re-assembled before it reaches the radar scope as a display. The newly ordered equipment operates on line-of-sight and will require relay towers to carry information over long distances, because of the curvature of the earth's surface.

The longest distance to be covered by the links will be between Houston and the air-route traffic-control center at San Antonio, Texas, a distance of approximately 200 miles. This will require six of the sixteen relay towers provided for in the contract. Another link will be established between the Air Defense Command radar installation at Lackland Air Force Base into the San Antonio center. The area around Atlantic City, N. J., will have radar coverage from a Navy installation there, which will be remoted into the New York center by link with the help of a pair of relay towers.

Other locations where the new equipment will be used to carry information to air-route traffic-control centers will be: Boston, Pittsburgh, Cleveland, Atlanta, El Paso, Fort Worth, Miami, New Orleans, with one relay for each area; Detroit, Kansas City, one relay; St. Louis, one relay; Denver, one relay; Los Angeles and Oakland, two relays; Phoenix, where a new center is to be established; Salt Lake City, one relay; Seattle and Spokane, one relay.

In addition to those locations where the information will be remoted into an air-route traffic-control center, a link will be used at Benson, North Carolina, where a radar will be established and operated on the spot as a purely local operation to handle approach-control functions for Raleigh-Durham, Fayetteville Municipal, Pope Field at Fort Bragg near Fayetteville, and Seymour Johnson Air Force Base at Goldsboro, North Carolina, and for low-altitude tower control in the congested triangle covered by these installations.

The microwave link order, covering 22 installations, was the second largest purchase of electronic equipment in the history of the CAA, exceeded only by a \$9-million contract for long-range radar issued last November.

THE AIR FORCE, also concerned with the growth of air traffic, not only nationally, but world-wide, has decided to explore ways to revamp its communications system.

Today, it was pointed out, it is necessary to adopt many of the commercial practices in the high-quality radio relay, multiplex and long-distance switching systems developed for 4000-mile communication-system operation and adapt these to 10,000 to 15,000-

QUIET

**Trouble-
shooter
at
work**

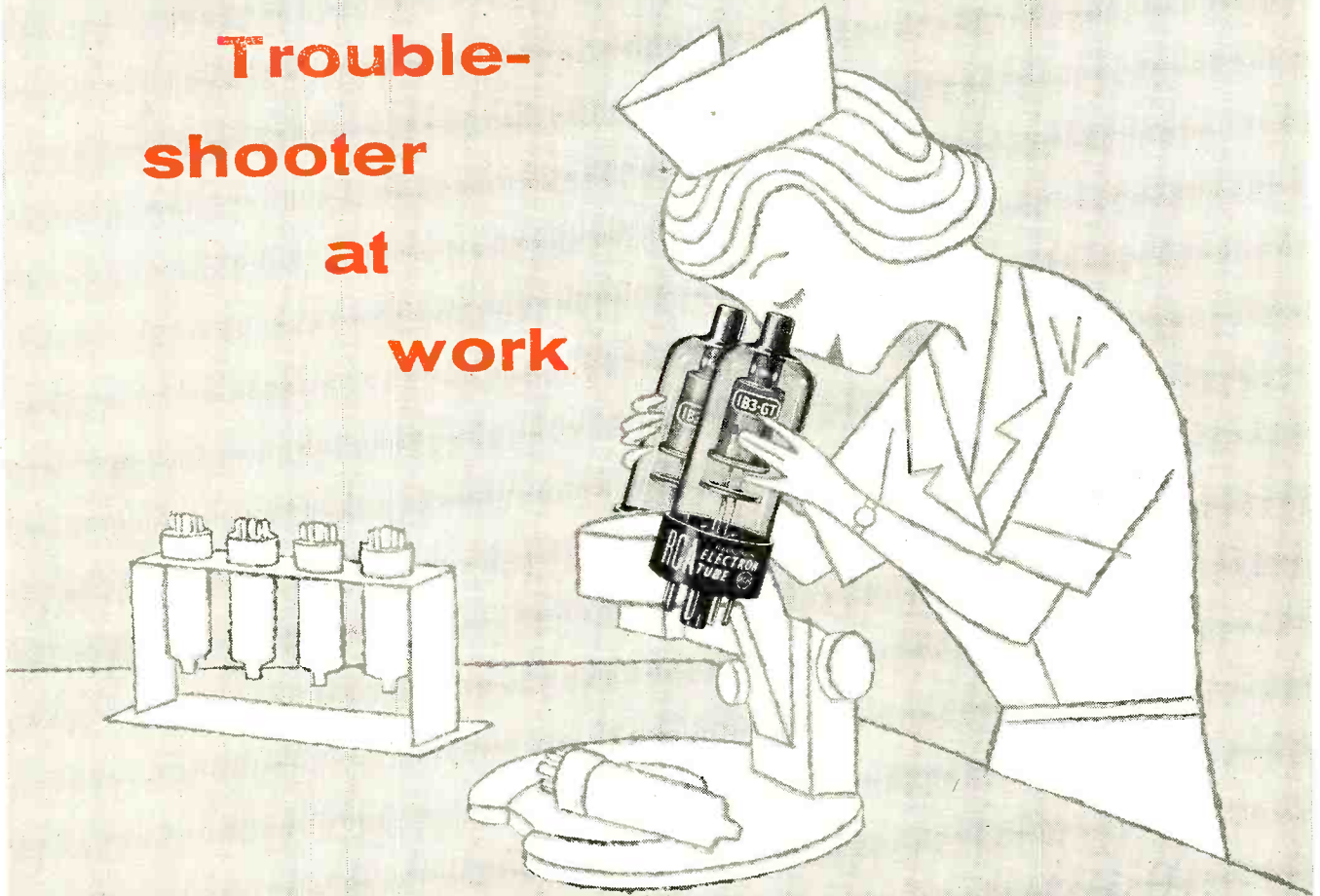

Here's how Microscopic Inspection by RCA helps reduce costly callbacks...

A bad tube, or a potential trouble-maker—can it get by this gal? Not likely. She's part of the specially trained RCA group of inspectors whose important job it is to find trouble and help prevent it from happening to you.

RCA Quality-Control Procedures include MICROSCOPIC INSPECTION OF POPULAR TV RECEIVING TYPES! These types are closely examined for possible poor welds, weld splatter, bad crimps, damaged stems, improper assembly, and many other factors that can affect top quality, long-term performance. Though the tubes may pass all electrical tests, such defects could slip by and mean the difference between a profitable service call and a costly callback.

You gain valuable assurances from this *extra* care: (1) that popular TV receiving types shipped to RCA Tube Distributors have had the *extra* benefit of the MICROSCOPIC INSPECTION PROGRAM and (2) that you can always service your customers with the confidence that RCA TV Receiving Types are top quality replacement tubes.

When you order—tell your distributor "RCA only" and watch your profits grow,



RECEIVING TUBES

RADIO CORPORATION OF AMERICA

Tube Division, Harrison, N. J.



Are These SAMS "BEST SELLERS" Among Your Reference Books?

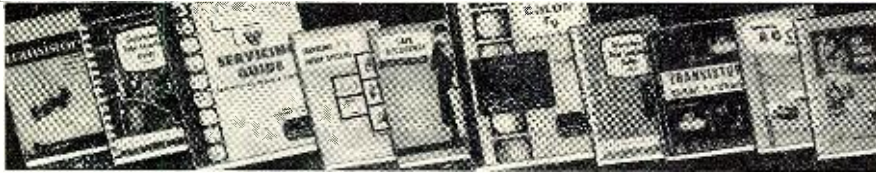

Transistors and Their Application in Television—Radio—Electronics. The first practical book about transistors for servicemen, engineers, amateurs and experimenters. Easy-to-understand explanation of transistor theory, properties, circuitry, installation, testing techniques and servicing. 100 pages; 5½ x 8½"; illustrated. . . . **\$1.50**

TV Servicing Guide. Explains how to apply proper trouble-shooting procedures based on analysis of symptoms (most of which are illustrated by picture-tube screen photos). Shows how to locate and eliminate trouble in every section of the TV receiver circuit. 132 pages; 8½ x 11"; illustrated. . . . **\$2.00**

Servicing TV Sweep Systems. Describes the operation, circuit function and circuit variations of vertical and horizontal sweep systems common to most TV receivers. Tells how to analyze circuits; trouble-shoots for you. Explanatory photographs, waveforms, service hints and components description. 212 pages; 5½ x 8½"; illustrated. . . . **\$2.75**

Tape Recorders—How They Work. Explains recording theory, tape characteristics, motorboard mechanisms, drive motors, amplifiers, magnetic heads, volume indicators, equalization circuits—covers everything you want to know about recorders and how to get best results from them. 176 pages; 5½ x 8½"; illustrated. . . . **\$2.75**

TV Tube Location Guides. Shows tube positions and functions in hundreds of TV receiver models; helps locate faulty tube quickly; cuts trouble diagnosis and replacement time.

Vol. 6. Covers receivers produced in 1955-1956. 236 pages; 5½ x 8½". . . . **\$2.00**

Vol. 5. Covers receivers produced in 1953-1954. 200 pages; 5½ x 8½". . . . **\$2.00**

Color TV Training Manual. Prepares the service technician for Color TV work. Covers principles of the Color TV system; Color receiver circuits; installation and servicing of receivers. Includes color blocks outlining use of color test equipment. 260 pages; 8½ x 11"; 300 illustrations. . . . **\$6.95**

Transistor Circuit Handbook. This authoritative book completely covers transistor types, construction, characteristics, wiring and testing techniques, basic circuits, circuit applications; includes reference charts, definitions; formulas. 430 pages; 6 x 9"; illustrated. . . . **\$4.95**

Servicing AGC Systems. Describes the operation and circuit variations of the different types of AGC systems and explains the servicing techniques that can be applied. Illustrated by actual case histories and photos of symptoms. 132 pages; 5½ x 8½"; illustrated. . . . **\$1.75**

Key Checkpoints in TV Receivers. Time-saving information on how to make quick tests at key points in TV receiver circuits to determine the section in which the trouble lies and how to check overall performance of the receiver to insure against callbacks.

Vol. 2. Covers receivers produced in late 1952 and 1953. 184 pages; 5½ x 8½". . . . **\$2.00**

Vol. 1. Covers receivers produced in late 1951 and 1952. 182 pages; 5½ x 8½". . . . **\$2.00**

95 OTHER SAMS BOOKS KEEP YOU AHEAD IN ELECTRONICS

There is an authoritative Sams book on virtually any electronic subject in which you're interested. Check below for FREE Book List describing all Sams books.

mile systems over large water areas as well as land masses. In this adaptation, one must remember that the capabilities of a civilian communications system must be used for normal as well as wartime operations. It has been found that it is too costly to duplicate such civilian systems with large military systems; and in addition there would be an impossible drain on technical manpower for engineering, installation, and operation in such a duplicate system.

The problem could be resolved, Air Force experts believed, through a system that would establish a standard for everyone.

In such a setup, now under investigation, there would be a modular multiplex system of 4-kilocycle channels with a basic 12-channel group and a 60-channel super group designed as a maximum 600-channel system. The plan would also provide radio relays with amplifiers for knife-edge diffraction and tropospheric scatter applications for transmission over large land areas and adjacent islands.

The complete operation, it was noted, would have to be engineered for universal application so that it could be used for voice, teletype, facsimile, telephoto, or data transmissions.

NOT ONLY ARE THE AIR FORCE and the CAA worried about airline control, but the FCC is also beset by many problems. With more than 1¼-million transmitters in operation and the radio services expanding and multiplying, the scarcity of frequencies in many portions of the spectrum presents a serious situation.

Currently, three conservation techniques are offering aid in relieving heavily congested bands. They are known as offset carrier, single-sideband, and split-channel.

In TV broadcasting, as an example, a station may be required to operate with its carrier frequency offset 10 kilocycles above or below the normal carrier frequency. The channel assigned to such a station is, in consequence, designated plus or minus, as the case may be. Through careful planning, the application of this offset-carrier technique has resulted in less mutual interference between stations, making it possible to assign more channels.

Single-sideband has been used for many years on international radio-telephone circuits and, to some extent, for ship-to-shore communication. However, the percentage of stations using this type of transmission is very small, and most stations continue to transmit two sidebands, one slightly above and one slightly below the carrier signal. Since each of the two sidebands contains all of the information transmitted, technically there is a duplication of effort, and more frequency space is used than is actually required. By eliminating either of the sidebands, a narrower channel may be used and assignments

(Continued on page 161)

NEW

LEARNING ELECTRICITY FUNDAMENTALS



This easy-to-understand new book covers the complete story of electricity: historical development; electron theory; static electricity; electrical fundamentals; types and uses of fuses and switches; electrical resistance; Ohm's Law; magnetism; electro-magnetism; work, energy and power; theory, construction and use of transformers; operation and uses of generators and motors (DC and AC); circuits and controls; practical wiring and electrical apparatus. Complete and authoritative. 480 pages; 5½ x 8½"; illustrated. . . . **\$5.95**

USE THIS ORDER FORM

Learning Electricity Fundamentals. . . **\$5.95**

- Transistors and Their Application. . . **\$1.50**
- TV Servicing Guide. **\$2.00**
- Servicing TV Sweep Systems. . . . **\$2.75**
- Tape Recorders. **\$2.75**
- TV Tube Location Guide, Vol. 1. . . **\$2.00**
- TV Tube Location Guide, Vol. 2. . . **\$2.00**

- Color TV Training Manual. **\$6.95**
- Transistor Circuit Handbook. . . . **\$4.95**
- Servicing AGC Systems. **\$1.75**
- Key Checkpoints in TV Sets, Vol. 1. **\$2.00**
- Key Checkpoints in TV Sets, Vol. 2. **\$2.00**

Send FREE Book List

HOWARD W. SAMS & CO., INC.

Order from your Parts Jobber today, or mail to Howard W. Sams & Co., Inc., Dept. 1-F7 2201 East 46th St., Indianapolis 5, Indiana.

Send books checked above. My (check) (money order) for \$ is enclosed.

Name _____
Address _____
City _____ Zone _____ State _____
(outside U.S.A. priced slightly higher)

Look for SAMS BOOKS on the "Book Tree" at your Parts Distributor



OVER 1,000,000 SAMS BOOKS SOLD TO DATE



only complete line of

TV and COMMUNICATION TOWERS

proven in Profits and Customer Satisfaction

• • • • HIGHLIGHTS OF THE ROHN LINE • • • •

look at these
ROHN exclusives

● HOT DIPPED GALVANIZED

The finest, most durable finish is available for ROHN Towers and accessories . . . all done entirely on the ROHN premises under careful ROHN supervision.

● UNEQUALLED DESIGN AND ENGINEERING

ROHN is the only design that has stood up over the years. ROHN has been first and foremost . . . and always the leader in new products to meet the changing demands.

● MASS PRODUCTION FOR LOW COSTS

ROHN was the first to utilize mass production techniques to build a superior tower at the most competitive prices. This means no sacrifice in quality yet far greater profits for you.

● UNIVERSAL CUSTOMER ACCEPTANCE

Thousands and thousands of installations prove the ROHN line first in customer satisfaction.

● PIONEER MANUFACTURERS

Pioneers in tower manufacturing—and today one of the world's largest manufacturers of this type equipment. The ROHN Company was built on satisfaction on the part of distributor, dealer and customer alike.

● COMPLETE LINE

Only ROHN offers a full line—one dependable one-stop source for all TV installation equipment. Save headaches, save shipping costs, save time . . . use ROHN unequalled service *exclusively*.

ALSO a full line of ROHN ACCESSORIES

Rotor posts, house brackets, eave brackets, peak and flat roof mounts, instant drive-in bases, hinged base sections, telescoping mast bases, guying brackets, UHF antenna mounts, erection fixtures, variety of mounts and supports for masts or tubing,

tower installation accessories, TV service tables, mast and TV hot-dipped galvanized tubing, guy rings, "twister-anchors", rubber tower grommets, insulator sections, hinged rotor platform, accessory shelf and platform and dozens of other items. Get the complete catalog TODAY!

ROHN Manufacturing Company

116 LIMESTONE, BELLEVUE
PEORIA, ILLINOIS

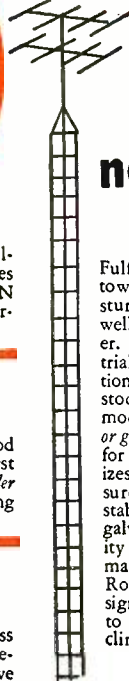

no. 6 tower

"All-Purpose" tower

Fulfills 75% of your general tower needs—is structurally as sturdy—yet costs less than the well-known Rohn No. 10 Tower. Ideal for home and industrial installations, communication requirements . . . eliminates stocking many different tower models. *Self-supporting to 50 ft. or guyed to 120 ft.!* Easy to climb for fast, efficient servicing. Utilizes "Magic Triangle" which insures far greater strength and stability. Permanent hot-dipped galvanized coating. Dependability—a feature customers demand—is assured with the Rohn No. 6 Tower . . . designed to "stand up" for years to the rigors of weather and climatic conditions.

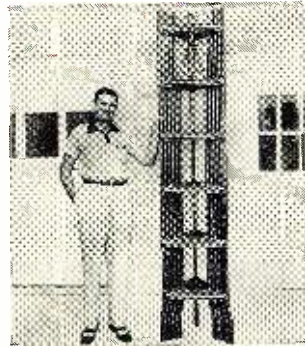

Package Tower

"Space Saver"—cuts storage space 300% or more!

Popular PT-48 has almost 50' of sturdy tower within a compact 8' x 20" package! "Magic Triangle" design is adapted to a pyramid shape using a wide 19" base with progressively decreasing size upward. Decreases your overhead . . . easy to transport and assemble—cuts shipping costs. Galvanized throughout. Available in heights of 24, 32, 40, 48, 56 and 64 feet!

COMMUNICATIONS TOWER

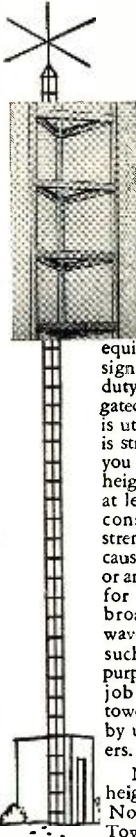

For extreme heights and communication purposes of all kinds, the Rohn No. 40 gives you strength and durability on which you can depend. The time tested and proven

equilateral triangle design using extra heavy duty tubing and corrugated steel cross-bracing is utilized. The No. 40 is structurally sound so you can install it for heights up to 300'; or at lesser heights when considerably greater strength is required because of excessive wind or antenna loading. Use for radio telephone, broadcasting, microwave relay and all other such communication purposes. If a particular job calls for this type tower, save real money by using ROHN towers.

Note: For lesser heights, use the Rohn No. 20 or No. 30 Tower.



Both Towers Feature THE ROHN MAGIC TRIANGLE

For structural superiority, famed wrap-around "magic triangle" design is featured in these all-steel towers. Towers have full 2 1/2" wide corrugated cross-bracing welded to tubular steel legs. The exclusive design assures dependable strength and permanence.



Telescoping Masts

Heavy-duty hot-dipped galvanized steel tubing and rigid joints give extraordinary strength. *Quick installation* . . . mast attached to base—antenna fixed, then mast hoisted quickly to desired height. Utilizes special clamp and guy ring arrangement. Flanged interior section; crimped exterior section gives mast stability that can't be beat. Complete with guy rings and necessary erection parts. In 20, 30, 40 and 50 ft. sizes. Bases and ground mounts available.

* pat. pending

ROHN FOLD-OVER TOWERS

These unique fold-over towers are perfect for experimentation, TV service departments, amateur use, and special purposes. Uses regular ROHN tower sections with kit. Now available in standard No. 10 tower to 50', and in ROHN No. 30 & No. 40 towers for heavy-duty use.

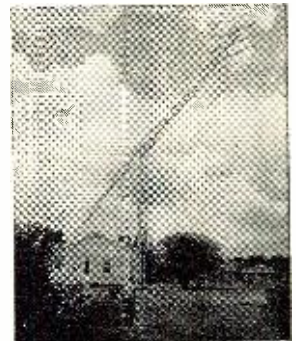

MAIL THIS COUPON FOR FREE LITERATURE!

Rohn Manufacturing Company
116 Limestone, Bellevue
Peoria, Illinois

Gentlemen: Please rush me complete details on the full line of Rohn Towers and Accessories.

Firm _____
Name _____ Title _____
Address _____
City _____ State _____

New Low-Cost, Precision Instruments for Service Calls or Shop Work

from **KAY ELECTRIC**

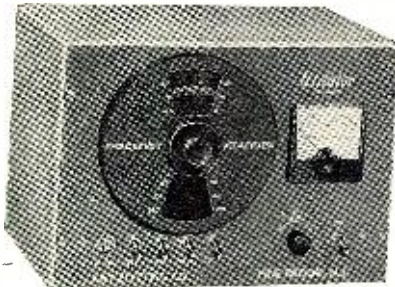

NEW KAY *Utilator*

Portable, Compact Utility Oscillator

FEATURES

- AGC'd for Flatness
- Metered Output 0.7 V rms into 75 ohms
- Broad-Band 4.5 to 220 mc
- Direct Reading Dial
- High Quality—Low Price

A small, compact utility oscillator designed for bench or field service, the new Kay *Utilator* covers the 4.5 to 220 megacycle range. The unit is completely self-contained with attenuators, power supply and output meter. The *Utilator* provides a high level RF output AGC'd for flatness over the range, and a direct-reading frequency dial accurate to $\pm 1\%$.

SPECIFICATIONS

Frequency Range: 4.5 to 220 mc, in six switched bands, fundamental frequency

RF Output: 0.7 volts rms into nominal 75 ohms, metered, AGC'd

Flatness: ± 0.5 db over the range

Frequency Calibration: Direct reading frequency dial calibrated to within $\pm 1\%$

Attenuators: Switched steps of 20 db, 20 db, 10 db and 6 db, plus continuously variable 6 db

Dimensions: Width 11", Depth 6 1/2", Height 8 1/2"

Weight: 19 lbs.

Price: \$295.00 F.O.B. Pine Brook, New Jersey

For Literature

on the Complete Line of Kay Transistorized Instruments, Write:

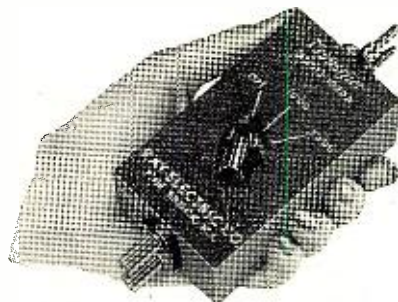

NEW KAY *Transifier*

All-Transistorized, Plug-In Wide-Band Video Amplifier

FEATURES

- Broad-Band Response to 15 mc
- Completely Transistorized—Small, Self-Contained, Compact Portable Unit
- Signal Gain Controlled By Overall Feedback—Built-In Stabilization
- No Hum
- Long Stable Life—Powered By Two Penlight or Mercury Cells
- Units May Be Cascaded to Provide Additional Gain

The Kay *Transifier* is a true modular unit, completely transistorized, with built-in feedback circuit for stabilized signal gain. The unit is self-contained in a cast-aluminum housing with standard banana plug input and output.

The *Transifier* may also be used as a low level pulse amplifier or as a pre-amplifier for video and audio instruments, vacuum tube voltmeters, cathode ray oscilloscopes, tape recorders and microphones. Other uses include, use as a humless Audio Amplifier and as a Modular in control circuitry, and all types of Audio-Video Electronic devices.

SPECIFICATIONS

Frequency Response: 10 db Position: 3 db down at 20 cycles and 15 mc
20 db Position: 3 db down at 20 cycles and 10 mc

Gain: 10 db and 20 db switchable

Input Impedance: Capacitance 15 mmf—Resistive Component—20,000 ohms at 1 mc to 15,000 ohms at 10 mc

Output Impedance: 500 ohms, approximately

Maximum Output Voltage: 0.15 volts 10 db position
0.30 volts 20 db position

Price: \$85.00 F.O.B. Pine Brook, New Jersey

See us at the Armed Forces Communications & Electronics Convention May 20-22, Washington, D. C., Booth 46

KAY ELECTRIC COMPANY

Dept. RT-6

14 Maple Ave., Pine Brook, N. J.

CAldwell 6-4000

WHERE WILL YOU BE IN

Electronics

6 MONTHS FROM TODAY?

add technical training to your practical experience

get your FCC license quickly!

then use our effective job-finding service

Get These Valuable Booklets FREE . . .



learn how

We guarantee

to train you until you receive

Your FCC license

If you fail to pass your Commercial License exam after completing our course, we guarantee to continue your training, without additional cost of any kind, until you successfully obtain your Commercial license.

Employers Make Offers Like These To Our Trainees Every Month!

Radio Operators & Technicians — American Airlines has openings for radio operators and radio mechanics. Operators start at \$334.53 per month. Radio mechanic's salary up to \$1.99 per hour. Periodic increases with opportunity for advancement. Many company benefits.

Electronic Technicians — Convair Electronics Department: Radio and Radar Mechanics, Electronics Technicians, and Junior Engineers are wanted for a special program on fire control development and installation. Beginning rate: \$365 and up.

Here's Proof:

Name and Address	License	Time
John H. Johnson, Boise City, Okla.	1st	20 weeks
Prentice Harrison, Lewes, Delaware	1st	27 weeks
Francis W. Bartley, Danbury, Conn.	2nd	15 weeks
Herbert W. Clay, Phoenix, Ariz.	2nd	22 weeks
Thomas J. Bingham, Finley, N. Dak.	2nd	9 weeks

(Names and addresses of trainees in your area sent on request)

We can provide names in your area on request

Accredited by National Home Study Council

learn how

OUR AMAZINGLY EFFECTIVE JOB-FINDING SERVICE Helps CIRE Trainees Get Better Jobs . . . Here are some recent examples:

Chief Engineer—"Since enrolling with Cleveland Institute I have received my 1st class license, served as a transmitter engineer and am now Chief Engineer of Station WAIN. I also have a Motorola 2-Way Service Station. Thanks to the Institute for making this possible."
Lewis M. Owens, Columbia, Ky.

Airlines—"In a year and a half, he received his first class FCC License. He is continuing his training with Cleveland Institute. His goal is much higher than his present position with Eastern Airlines, so he is adding technical "know-how" to his practical experience."
Bob Thompson, Nashville 14, Tennessee

Test Engineer—"I am pleased to inform you that I recently secured a position as Test Engineer with Melpar, Inc. (Subsidiary of Westinghouse). A substantial salary increase was involved. My Cleveland Institute training played a major role in qualifying me for this position."
Boyd Daugherty, Falls Church, Va.

CLEVELAND INSTITUTE OF RADIO ELECTRONICS
Desk RN-6 4900 Euclid Bldg. Cleveland 3, Ohio

June, 1957

Cleveland Institute of Radio Electronics

Desk RN-6, 4900 Euclid Ave., Cleveland 3, O.

Please send Free Booklets prepared to help me get ahead in Electronics. I have had training or experience in Electronics as indicated below:

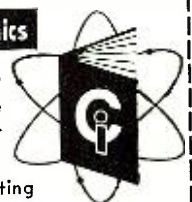

- | | |
|---|---|
| <input type="checkbox"/> Military | <input type="checkbox"/> Broadcasting |
| <input type="checkbox"/> Radio-TV Servicing | <input type="checkbox"/> Home Experimenting |
| <input type="checkbox"/> Manufacturing | <input type="checkbox"/> Telephone Company |
| <input type="checkbox"/> Amateur Radio | <input type="checkbox"/> Other _____ |

In what kind of work are you now engaged? _____

In what branch of Electronics are you interested? _____

Name _____ Age _____

Address _____

City _____ Zone _____ State _____

Special Tuition Rates to Members of Armed Forces

BUILD THE BEST—
BUILD ALLIED'S OWN
knight-kits

Here is a typical Knight-Kit value—available only from ALLIED—one of 45 great Knight-Kits you'll find in our special Supplement No. 165. Write for your FREE copy today.

knight-kit HI-FI VALUE
25-WATT LINEAR-DELUXE AMPLIFIER KIT

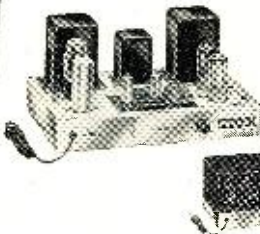

Model
Y-755
\$44.50

Luxury quality at modest cost! Williamson-type circuit delivers 25 watts of virtually flawless response. Can be used with any tuner or preamp with a full set of controls (for volume, tone and equalization). Printed circuit wiring board for simplified assembly; balance control for precise matching of output tubes; variable damping control. Response: ± 0.5 db, 10-120,000 cps at 20 watts. Harmonic Distortion: 0.15% at 20 watts. Intermodulation: 0.4% at 20 watts. Output Impedances: 4, 8 and 16 ohms. 6 $\frac{3}{4}$ x 14 x 9" deep. Chrome-plated chassis. With all parts, tubes and easy-to-follow instructions. Shpg. wt., 25 lbs.

Model Y-755. Net, F.O.B. Chicago \$44.50
Y-759. Metal top cover for above. \$4.25

OTHER knight-kit HI-FI VALUES



FM HI-FI TUNER KIT
Model Y-751
\$37.75



10-WATT HI-FI
AMPLIFIER KIT
Y-753 \$23.50



20-WATT HI-FI
AMPLIFIER KIT
Y-750 \$35.75

See our Supplement No. 165 for other
knight-kit Hi-Fi values

free SUPPLEMENT
featuring knight-kits



Send for our FREE Supplement No. 165 featuring 45 great Knight-Kits, including Test Instruments, Hi-Fi, Hobbyist and Amateur Kits. Write for your copy today.

ORDER FROM
ALLIED RADIO

Dept. 01-F-7, 100 N. Western Ave., Chicago 80, Ill.

Within the **Industry**

THOMAS E. DAVIS has been named national sales manager of the instrumentation division, *Ampex Corporation*.

Associated until last September with the electronics division of *Bing Crosby Enterprises*, Mr. Davis has been active in company sales since 1948. His earlier experience includes two years in charge of the Naval Air Transport Service Radar Lab. at Oakland Airport in California.

An electrical engineering graduate of the University of California at Los Angeles, he holds memberships in the Institute of Radio Engineers, Instrument Society of America, and American Institute of Electrical Engineers.



VICTOR H. POMPER has been elected vice-president of *Hermon Hosmer Scott, Inc.*, manufacturers of electronic instruments and high-fidelity amplifiers, tuners, and turntables. He will continue as a director of the corporation and will be responsible for over-all marketing, manufacturing, and personnel activities.

Mr. Pomper joined the company in 1950 as sales engineer, and successively was sales manager and assistant general manager. He received his bachelor and master degrees in electrical engineering from the Massachusetts Institute of Technology, where he was elected to Tau Beta Pi and Eta Kappa Nu, honorary engineering fraternities.

A registered professional engineer in Massachusetts, he is a Senior Member of the Institute of Radio Engineers, a member of the Acoustical Society of America, and belongs to several other national organizations in the field.

R. K. BURNS has been appointed to the position of distributor sales manager of *Gramer-Halldorson Transformer Corporation*, according to an announcement by the president of the firm.

Mr. Burns is no newcomer to the electronics parts field. Prior to his joining this organization, he had a background of 19 years with *Belden Manufacturing Company*, calling on distributors as district manager in major territories in the United States.



PACO ELECTRONICS COMPANY, INC., a newly formed division of the *Preci-*

sion Apparatus Company, has launched a new line of electronic test instruments in kit form.

These kits are expected to find wide application in radio and TV servicing, hi-fi custom building and service, electronic hobbies and amateur radio, science education and technical schools, as well as industrial testing and quality control.

In designing, engineering, packaging, and market researching the new kit line, the company has drawn heavily on the parent organization's 25 years of experience in the manufacture of test instruments and meters. Particular attention has been paid to ruggedness, ease of operation, simplicity of assembly and wiring, as well as appearance.

R. H. G. MATHEWS has been named manager of a newly formed high-fidelity radio-phonograph department of the television-radio division of *Westinghouse Electric Corporation*.

Mr. Mathews comes to the firm from the *Magnavox Company*, with which he had been associated for the past three and one-half years in the capacities of director of the high-fidelity division, and assistant to the vice-president and general manager, television-radio-phonograph division.

Having spent practically all of his adult life in radio and electronics, he brings to his new position a strong background of engineering, sales management, sales promotion, advertising, and administration in this field.

ASSOCIATION OF ELECTRONIC PARTS AND EQUIPMENT MANUFACTURERS, INC. has elected its officers to new positions at the group's first meeting as a not-for-profit corporation.

A. N. (Bud) Haas, *Bud Radio*, was named president. Helen Staniland Quam, *Quam Nichols Co.*, was elected first vice-president. Ken Hathaway, *Ward Leonard*, was re-elected treasurer, and Kenneth C. Prince was re-named executive secretary. Gail Carter, *Merit Coil & Transformer*, was elected to the new position of second vice-president.

Karl Jensen, *Jensen Industries*, was named to serve from August, 1957 to August, 1959 as one of two EP&EM representatives on the Electronic Industry Show Corporation, sponsors of the annual Electronic Parts Distributors Show.

In addition, nine directors also were chosen. They are: Wilfred Larson,

Build 20 Useful Transistor Sets from this NEW RCA BOOKLET...

Just Out!



24 exciting pages of up-to-the-minute information are contained in this brand new booklet—*RCA Transistors and Semiconductor Diodes*—one of the newest members of the RCA family of authoritative publications.

Whether you are a student, service technician, experimenter, radio amateur, or design engineer—you're sure to profit from the wealth of knowledge in the sections on *Characteristics* and *Theory*. Of special interest, too, is the *Transistor Interchangeability Directory*, which lists more than 500 types produced by 27 different manufacturers. There is valuable experience to be gained in building your own transistor sets. And 20 of the latest tried-and-tested circuits with *all parts values*, including coil and transformer details, are given in this RCA booklet.

For your next transistor project, remember that RCA *superior-quality* TRANSISTORS are now available through your RCA distributor.

GET YOUR COPY TODAY. ONLY 25¢ AT YOUR RCA DISTRIBUTOR!

RCA **TRANSISTORS**
RADIO CORPORATION OF AMERICA
Semiconductor Division • Somerville, N. J.



THESE 20 CIRCUITS!

- Code-Practice Oscillator
- Hearing Aid
- Grid-Dip Meter
- Phonograph Amplifier
- Phonograph Preamplifier
- 2-Transistor Receiver
- High-Gain Low-Distortion Low-Drain Audio Amplifier
- Portable Low-Drain High-Voltage Power Supply
- Sensitive Relay
- High-Gain Transformerless Signal-Tracing Probe
- 2-Stage Unneutralized 455-Kc IF Amplifier
- 1-Stage Neutralized 455-Kc IF Amplifier
- 4-Transistor Receiver
- Telephone-Pickup Amp.
- 6-Transistor Receiver
- Three-Tube, Two-Transistor Receiver
- 2-Stage 10.7-mc IF Amp.
- IF and Broadcast-Band Signal Tracer
- Microphone Preamplifier
- RF and Mixer-Oscillator Stages for 3-Band Receiver

HANDY TABLE OF POPULAR RCA TRANSISTORS

Class A AF amplifier.....	2N77, 2N104, 2N105, 2N206, 2N215
Class A Low-noise AF amplifier.....	2N175, 2N220
Push-pull Class B AF amplifier.....	2N109, 2N217, 2N270
Class A 455-Kc IF amplifier.....	2N139, 2N218
Converter in 540-to-1640-Kc band.....	2N140, 2N219
Class A RF amplifier.....	2N247
Push-pull Class B Power amplifier.....	2N301, 2N301-A

MAIL THIS COUPON TODAY!

RCA Commercial Engineering, Section F-41-NN
415 South 5th Street
Harrison, New Jersey

I am enclosing 25 cents in coin. Please rush my copy of the new 24-page booklet "RCA Transistors & Semiconductor Diodes", Form SCD-108.

Name

Address

City Zone State

ENGINEERED

for those who expect much

PRICED

for those who must buy many

the
PRECISION
model

68
VTVM

METAL CASED

RUGGED



- **Peak-to-Peak Voltage Ranges**
up to 3200 volts peak-to-peak
- **Extra-Large 5 1/4" Wide-Angle Meter**
easy-reading, long scales
- **High-Impedance Voltage Ranges (AC and DC)**
up to 1200 volts
- **Measures Resistance up to 1000 Megohms**
in 5 overlapping ranges
- **Zero-Center Reference Ranges**
simplify FM discriminator balancing

Model 68: In rugged, blue-gray ripple-finished steel cabinet. Size 5 7/8" x 7 3/4" x 3 1/2". Complete with tubes, internal ohmmeter battery and detailed instruction manual. Net Price.....\$54.50

Accessories Available for Models 68 & 78
RF-12 High Freq. Probe...Net Price: \$10.95
TV-4 High Volt. Probe...Net Price: 14.75
Send for free 1956 catalog with detailed descriptions and specifications of the entire PRECISION line of test instruments for industry and electronic service-maintenance.



Model 78
Battery-Operated
VTVM

A must where power line is not available or where power line connection is undesirable. Provides every modern VTVM function. Metal cased. Rugged.

Net Price\$62.50
(Including Batteries)

Switchcraft; Ted Rossman, Pentron Corp.; Robert Svoboda, Amphenol; Roy Laird, Ohmite; Les Thayer, Belden Mfg.; Earl Templeton, P. R. Mallory; Karl Jensen, Jensen Industries; Ralph Hill, Grayhill; and Norman Ackerman, Perma-Power.

* * *

E. A. LINK, founder and chairman of Link Aviation, Inc., has been elected to the newly created post of vice-chairman of the board. He has also been appointed to the executive committee of General Precision Equipment Corporation, parent organization of the firm, according to the announcement.



Mr. Link is the originator of aerial trainers and simulators, and received the United States Air Force's highest civilian award, the Exceptional Service Award, in 1954.

* * *

RADIO-ELECTRONICS-TELEVISION MANUFACTURERS ASSOCIATION has proposed that its name be changed in recognition of industry trends.

The board of directors, upon the recommendation of the set, military products, and technical products divisions, referred to the organization committee a proposal that the present name be changed by substituting "Electronics" for the present "Radio-Electronics-Television" in the interest of simplicity, and in keeping with the growing diversity of the products of the entire industry.

The organization committee was asked to consider the proposals and make its recommendations to the board of directors at its next meeting. Among the new names suggested were "Electronic Industry Association" and "Electronic Manufacturers Association." If a name change is approved by the board, it will be submitted to the membership before being adopted.

* * *

LAMOTTE T. COHU, president of Kay Lab., was elected head of the newly formed Cohu Electronics, Inc.

Mr. Cohu said that the new corporation was formed to provide financial and business management for electronics manufacturing and development firms.



He has headed the senior firm for approximately two years. Prior to his joining the company, he was a former president of American Airlines, TWA, Convair, and Northrop Aircraft.

* * *

NATIONAL ELECTRONIC DISTRIBUTORS ASSOCIATION has moved to 343 South Dearborn Street, Chicago 4, Ill. . . . The Mincom Division of **MINNESOTA MINING & MANUFACTURING CO.** moved into new quarters at 11701 Mississippi Avenue, West Los Angeles, Calif. . . . A new 25,000 square foot plant for

RADIO & TV NEWS



PRECISION Apparatus Company, Inc.

70-31 84th Street, Glendale 27, L. I., N. Y.

Export: 458 Broadway, New York 13, N.Y., U.S.A. • Cables: MORHANEX
Canada: Atlas Radio Corp. Ltd. • 50 Wingold Ave., Toronto 10, Ontario



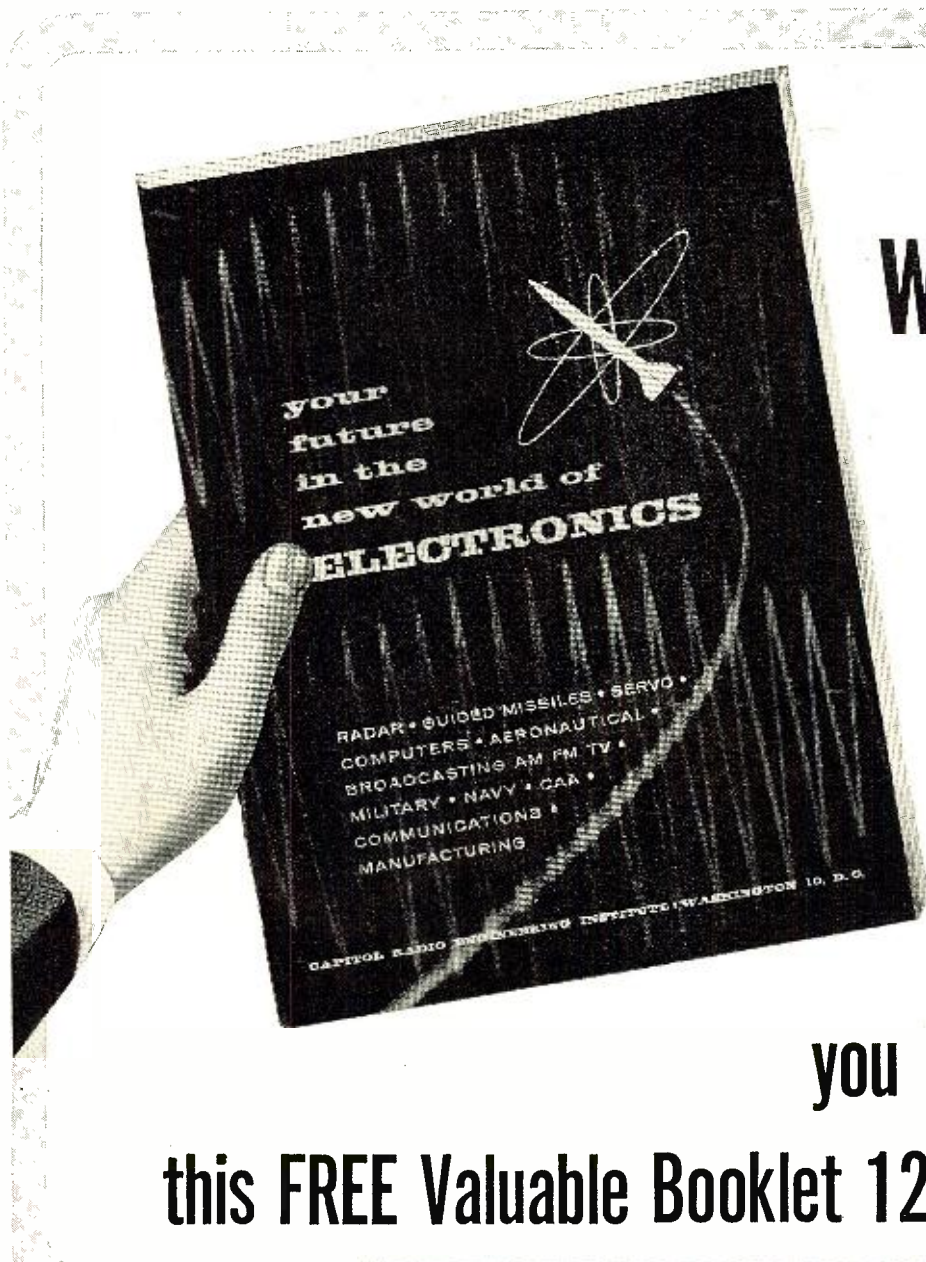

**WHERE
Would You
be Today
in Radio-TV
Electronics
IF...**

**you had sent for
this FREE Valuable Booklet 12 Months Ago**

TAKE A MINUTE TO MAIL THIS COUPON FOR FREE BOOKLET!

Thousands of men did send for it. They read it. And now they are a full year ahead in their march toward:

- a better job
- better pay
- promotion
- greater security
- greater confidence
- better living for self and family

All these benefits can be yours . . . if you act now to see what the rapidly expanding field of Electronics offers you. Take that first big step this minute. No obligation whatsoever!

CAPITOL RADIO ENGINEERING INSTITUTE

ECPD Accredited Technical Institute Curricula. Founded 1927

Dept. 116-D 3224 16th St., N.W., Washington 10, D. C.

Please send me your course outline and FREE Illustrated Booklet "Your Future in the New World of Electronics" . . . describing opportunities and CREI home study courses in Practical Electronics Engineering Technology.

- CHECK FIELD OF GREATEST INTEREST
- Electronic Engineering Technology
 - Broadcast (AM, FM, TV) Engineering Technology
 - Television Engineering Technology
 - Aeronautical Electronic Engineering Technology

Name Age

Street

City Zone State

Check: Home Study Residence School Korean Veteran

To help us answer your request intelligently, please give the following information:

EMPLOYED BY

TYPE OF PRESENT WORK

SCHOOL BACKGROUND

ELECTRONICS EXPERIENCE

IN WHAT BRANCH OF ELECTRONICS ARE YOU MOST INTERESTED?

The Case of The Serviceman WHO KEPT IT CLEAN!



The fringe area Jones family wanted TV entertainment but got "snow". When Junior's favorite show was ruined once too often, the serviceman was called in.



He pointed out that even with a good antenna weak signals are affected by line loss and noise, making good reception impossible . . . recommended a Jerrold DE-SNOWER.

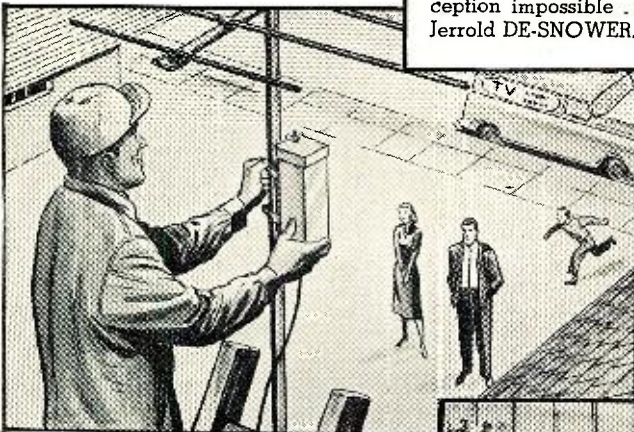

Antenna mounted, the DE-SNOWER captures the signal before loss and noise affect it, delivers it to the set over shielded coax . . . providing snow-free pictures.

Thanks to the serviceman and Jerrold the Joneses get high fidelity color and black and white pictures every time!

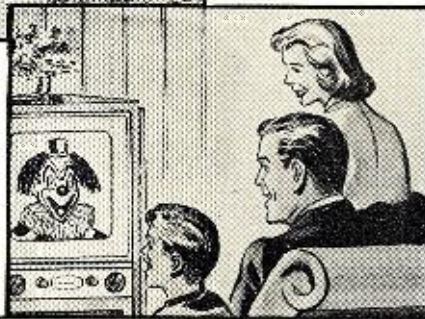

THE JERROLD DE-SNOWER

A high profit pre-amplifier accepted everywhere!
Combines 25 db gain with low noise input—only 6 db. No AC outlet or separate wiring on mast.

Available in 3 models—Single Channel; Broadband Chs. 2-6, Broadband Chs. 2-13. Packed complete with remote 24 volt power supply.

See the DE-SNOWER line at leading distributors or write direct for illustrated brochure to: Dept. P. D. #6

JERROLD

ELECTRONICS CORPORATION

23rd & Chestnut Sts.

Philadelphia 3, Pa.

LOOK TO JERROLD FOR AIDS TO BETTER TELEVIEWING

REK-O-KUT is scheduled to go into operation soon. The plant will be at 108th St. and 39th Avenue in Queens, N.Y. . . . **JERROLD ELECTRONICS CORPORATION** has formed an instruments and test equipment division . . . The electronic systems division of **SYLVANIA ELECTRIC PRODUCTS INC.** announces the establishment of a new reconnaissance systems laboratory at Mountain View, Calif. . . . **GENERAL TRANSISTOR CORP.** purchased a 20,000 square foot building, and the adjoining 20,000 square feet of ground at 91-27 138th Place, Jamaica, N.Y. The firm's executive and administrative offices are now being moved into the new quarters . . . **BLONDER-TONGUE LABORATORIES** consolidated its engineering, manufacturing, and administrative operations at 9-25 Alling Street, Newark, N.J. . . . **SPERRY RAND CORPORATION** announces plans for the construction of a new 150,000 square foot plant near Bristol, Tenn. . . . **RAYTHEON MANUFACTURING COMPANY** announces that construction is under way on its 42,000 square foot electronic laboratory at Santa Barbara, Calif. . . . Expansion plans for **THE BABCOCK & WILCOX COMPANY'S** research center are in the offing . . . Establishment of the **PACKARD BELL COMPUTER CORPORATION**, an affiliate of **PACKARD-BELL ELECTRONICS CORPORATION**, has been announced. The new facility is located at 11766 West Pico Blvd., West Los Angeles, Calif. . . . **DIAMONITE PRODUCTS MANUFACTURING COMPANY** has opened research laboratory, product development, and pilot production facilities in connection with its recently occupied manufacturing plant. Coincident with the opening of the research laboratories, general offices of the company have moved to larger quarters at 1232 Cleveland Avenue, N. W., Canton 3, Ohio . . . **CBS-HYTRON**, tube and semiconductor manufacturing division of **COLUMBIA BROADCASTING SYSTEM, INC.**, announces a consolidation of all packing, shipping, testing, and warehousing operations of its receiving tube plants in Salem, Danvers, and Newburyport, Mass. in a modern warehouse on Parker Street in Newburyport . . . **BECKMAN INSTRUMENTS, INC.** is now located at 325 North Muller Avenue, Anaheim, Calif.

* * *

THE DATICS CORPORATION, serving government, science, and industry in data reduction, research, and development in the computing, data reduction, and data processing fields, scientific computation, data processing, and consulting services has been formed. The firm is located at 6000 Camp Bowie Blvd., Fort Worth, Texas . . . **AMPEX CORPORATION** has finalized plans for the formation of a completely integrated subsidiary company devoted exclusively to products designed for the consumer retail market. The new firm is known as **AMPEX AUDIO, INCORPORATED**, and is located at Sunnyvale, Calif. Phillip L. Gundy, who is a vice-president of the parent company, is the president . . . **EL-TRONICS, INC.**

(Continued on page 134)

NEW! 12-WATT Williamson-type HIGH FIDELITY INTEGRATED AMPLIFIER HF12



with Preamplifier, Equalizer & Control Section
KIT \$34⁹⁵ WIRED \$57⁹⁵

Compact, beautifully packaged & styled. Provides complete "front-end" facilities and true high fidelity performance. Direct tape head & magnetic phono inputs with NARTB (tape) & RIAA (phono) feedback equalizations. 6-tube circuit, dual triode for variable turnover bass & treble feedback-type tone controls. **Output Power:** 12 w cont., 25 w pk. **IM Dist.** (60 & 6000 cps @ 4:1): 1.5% @ 12 w; 0.55% @ 6 w; 0.3% @ 4 w. **Freq. Resp.:** 1 w: ±0.5 db 12 cps - 50 kc; 12 w: ±0.5 db 25 cps - 20 kc. **Harmonic Dist:** 20 cps: 2% @ 4.2 w; 1/2% @ 2.5 w; 30 cps: 2% @ 11 w; 1/2% @ 6.3 w; 40 cps: 1% @ 12 w; 1/2% @ 9.3 w; 2000 cps: 1/2% @ 12 w; 10 kc: 1% @ 10 w; 1/2% @ 6 w. **Transient Resp:** excellent square wave reproduction (4 usec rise-time); negligible ringing, rapid settling on 10 kc square wave. **Inverse Feedback:** 20 db. **Stability Margin:** 12 db. **Damping Factor:** above 8, 20 cps - 15 kc. **Speaker Connections:** 4, 8, 16 ohms. **Tone Control Range:** @ 10 kc, ±13 db; @ 500 cps, ±16 db. **Tubes:** 2-ECC83/12AX7, 1-ECC82/12AU7, 2-EL84, 1-EZ81. **Size:** HWD: 3 3/8" x 12" x 8 3/4". 15 lbs. **COMING SOON**

NEW! 50-WATT

Ultra-Linear HIGH FIDELITY POWER AMPLIFIER

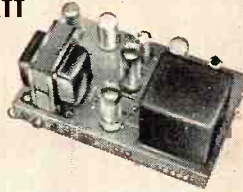

HF50 KIT \$57⁹⁵ WIRED \$87⁹⁵

Like the HF60 shown below, the HF50 features virtually absolute stability, flawless transient response under either resistive or reactive (speaker) load, & no bounce or flutter under pulsed conditions. Extremely high quality output transformer with extensively interleaved windings, 4, 8, & 16 ohm speaker connections, grain-oriented steel, & fully potted in seamless steel case. Otherwise identical to HF60. **Output Power:** 50 w cont., 100 w pk. **IM Distortion** (60 & 6000 cps @ 4:1): below 1% at 50 w; 0.5% @ 45 w. **Harmonic Dist.:** below 0.5% between 20 cps & 20 kc within 1 db of rated power. **Freq. Resp.** at 1 w: ±0.5 db 6 cps - 60 kc; ±0.1 db 15 cps - 30 kc at any level from 1 mw to rated power; no peaking or raggedness outside audio range. All other specs identical to HF60 below. Matching Cover E-2 \$4.50.

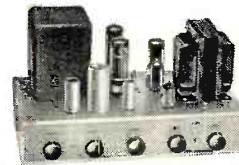

NEW! 50-WATT Ultra-Linear HIGH-FIDELITY

INTEGRATED POWER AMPLIFIER HF52 with Preamplifier, Equalizer & Control Section
KIT \$69⁹⁵ WIRED \$109⁹⁵

Combines a power amplifier section essentially identical to the HF50 power amplifier with a preamp-equalizer control section similar to HF20 below. Provision for use with electronic crossover network & additional amplifier(s). See HF50 for response & distortion specs; HF60 for square wave response, rise-time, inverse feedback, stability margin, damping factor, speaker connections; HF20 for preamplifier, equalizer & control section description. Hum & noise 60 db below rated output on magnetic phono input (8 mv input for rated output), & 75 db below rated output on high level inputs (0.6 v input for rated output). Matching Cover E-1 \$4.50.

The specs are the proof...
7 NEW BEST BUYS by



NEW HIGH FIDELITY PREAMPLIFIER

#HF61A KIT \$24⁹⁵, WIRED \$37⁹⁵

With Power Supply: #HF61 KIT \$29⁹⁵, WIRED \$44⁹⁵

Will not add distortion or detract from the wide-band or transient response of the finest power amplifiers at any control settings. High quality feedback circuitry throughout plus the most complete control & switching facilities. Heavy-gauge solid brushed brass panel, concentric controls, one-piece brown enamel steel cabinet for lasting attractive appearance. Feedback-type, sharp cut-off (12 db/octave) scratch & rumble filters. Low-distortion feedback equalization: 5 most common recording curves for LPs & 78s including RIAA. Low-distortion feedback tone controls: provide large boost or cut in bass or treble with mid-freqs & volume unaffected. Centralab printed-circuit Senior "Compentrol" loudness control with concentric level control. 4 hi-level switched inputs (tuner, tv, tape, aux.) & 3 low-level inputs (separate front panel low-level input selector permits concurrent use of changer & turntable). Proper pick-up loading & attenuation provided for all quality cartridges. Hum bal. control. DC superimposed on filament supply. 4 convenience outlets. Extremely flat wideband freq. resp: ±1 db 8-100,000 cps; ±0.3 db 12-50,000 cps. Extremely sensitive. Negligible hum, noise, harmonic or IM distortion. **Size:** 4-7/8" x 12-5/16" x 4-7/8". 8 lbs.

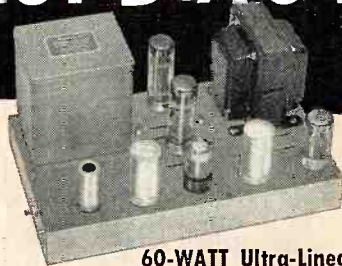

NEW 60-WATT Ultra-Linear

HIGH FIDELITY POWER AMPLIFIER #HF60 with ACRO TO-330 OUTPUT TRANSFORMER
KIT \$72⁹⁵ WIRED \$99⁹⁵

Superlative performance, obtained through finest components & circuitry. EF86 low-noise voltage amplifier direct-coupled to 6SN7GTB cathode coupled phase inverter driving a pair of Ultra-Linear connected push-pull EL34 output tubes operated with fixed bias. **Rated power output:** 60 w (130 w peak). **IM Distortion** (60 & 6000 cps @ 4:1): less than 1% at 60 w; less than 0.5% at 50 w. **Harmonic Distortion:** less than 0.5% at any freq. between 20 cps & 20 kc within 1 db of 60 w. **Sinusoidal Freq. Resp.:** at 1 w: ±0.5 db 5 cps - 100 kc; ±0.1 db 15 cps to 35 kc at any level from 1 mw to rated power; no peaking or raggedness outside audio range. **Square Wave Resp.:** excellent from 20 cps to 25 kc, 3 usec rise-time. **Sensitivity:** 0.55 v for 60 w. **Damping Factor:** 17. **Inverse Feedback:** 21 db. **Stability Margin:** 16 db. **Hum:** 90 db below rated output. **ACRO TO-330 Output Transformer** (fully potted). **Speaker Taps:** 4, 8, 16 ohms. GZ34 extra-rugged rectifier (indirectly-heated cathode eliminates high starting voltage on electrolytics & delays B+ until amplifier tubes warm up). **Input level control.** Panel mount fuse holder. Both bias and DC - balance adjustments. Std. oval socket provided for pre-amplifier power take-off. **Size:** 7" x 14" x 8". 30 lbs. Matching cover Model E-2 \$4.50.



NEW

COMPLETE with Preamplifier, Equalizer & Control Section
20-WATT Ultra-Linear Williamson-Type HIGH FIDELITY AMPLIFIER #HF-20
KIT \$49⁹⁵ WIRED \$79⁹⁵

A low-cost, complete-facility amplifier of the highest quality that sets a new standard of performance at the price, kit or wired. **Rated Power Output:** 20 w (34 w peak). **IM Distortion** (60 & 6000 cps/4:1) at rated power: 1.3%. **Max. Harmonic Distortion** between 20 & 20,000 cps at 1 db under rated power: approx. 1%. **Mid-band Harmonic Distortion** at rated power: 0.3%. **Power Response** (20 w): ±0.5 db 20-20,000 cps; ±1.5 db 10-40,000 cps. **Freq. Resp.** (1/4 w): ±0.5 db 13-35,000 cps; ±1.5 db 7-50,000 cps. 5 feedback equalizations for LPs & 78s. **Low-distortion feedback tone controls:** large boosts or cuts in bass or treble with mid-freqs. & volume unaffected. **Loudness control** & separate level set control on front panel. **Low Z output** to tape recorder. **4 hi-level switched inputs** for proper loading with all cartridges. **Hum bal. control.** DC superimposed on filament supply. **Extremely fine output transformer:** interleaved windings, tight coupling, careful balancing, grain-oriented steel. 8 1/2" x 15" x 10". 24 lbs. Matching cover Model E-1. \$4.50.

NEW COMPLETE with FACTORY-BUILT CABINET - 2-WAY HI-FI SPEAKER SYSTEM #HF51 \$39⁹⁵

See the "BEST BUYS" NOW IN STOCK at your nearest distributor. Fill out coupon on other side for FREE CATALOG.

Prices 5% higher on West Coast.



Genuine 2-way book-shelf size speaker system. Jensen heavy duty 8" woofer (6.8 oz. magnet) & matching Jensen compression-driver exponential horn tweeter with level control. Smooth clean bass & crisp extended highs free of coloration or artificial brilliance. **Factory-built** tuned bass reflex birch hardwood cabinet (not a kit) constructed to high quality standards. Neutral acoustical grille cloth framed by a smooth-sanded solid birch molding. **Freq. Resp.** measured 2 ft. away on principal axis in anechoic chamber with 1 watt input - **Woofer:** ±4 db 80-1800 cps; **Tweeter:** ±2 db 2800-10,000 cps; **Crossover Region:** 1800-2800 cps. shift in level over this region depends on tweeter level control setting. **Power-handling capacity:** 25 watts. **Size:** 23" x 11" x 9". 25 lbs. **Wiring Time:** 15 min.



84 Withers Street, Brooklyn 11, N. Y.

Turn page for other EICO ad.

the specs prove it . .
your **BEST BUY** is

EICO®

for COLOR & Monochrome TV servicing

FREE CATALOG

shows you **HOW TO SAVE 50%**
on 50 models of top quality
professional test equipment.
MAIL COUPON NOW!



NEW!
**TV-FM SWEEP
GENERATOR &
MARKER #368**
KIT \$69⁹⁵ WIRED \$119⁹⁵

Entirely electronic sweep circuit (no mechanical devices) with accurately-biased inductor for excellent linearity. Extremely flat RF output: new AGC circuit automatically adjusts osc. for max. output on each band with min. ampl. variations. Exceptional tuning accuracy: edge-lit hairlines eliminate parallax. Swept Osc. Range 3-216 mc in 5 fund. bands. Variable Marker Range 2-75 mc in 3 fund. bands; 60-225 mc on harmonic band. 4.5 mc Xtal Marker Osc., xtal supplied. Ext. Marker provision. Sweep Width 0-3 mc lowest max. deviation to 0-30 mc highest max. dev. 2-way blanking. Narrow range phasing. Attenuators: Marker Size, RF Fine, RF Coarse (4-step decade). Cables: output, 'scope horiz., 'scope vertical. Deep-etched satin aluminum panel; rugged grey wrinkle steel cabinet.

**NEW! RF
SIGNAL GENERATOR
#324**
KIT \$26⁹⁵ WIRED \$39⁹⁵



150 kc to 435 mc with ONE generator! Better value than generators selling at 2 or 3 times its cost! Ideal for IF-RF alignment, signal tracing & trouble-shooting of TV, FM, AM sets; marker gen.; 400 cps audio testing; lab. work. 6 fund. ranges: 150-400 kc, 400-1200 kc, 1.2-3.5 mc, 3.5-11 mc, 11-37 mc, 37-145 mc; 1 harmonic band 111-435 mc. Freq. accurate to ±1.5%; 6:1 vernier tuning & excellent spread at most important alignment freqs. Etched tuning dial, plexiglass windows, edge-lit hairlines. Colpitts RF osc. directly plate-modulated by K-follower for improved mod. Variable depth of int. mod. 0-50% by 400 cps Colpitts osc. Variable gain ext. amplifier: only 3.0 v needed for 30% mod. Turret-mounted coils slug-tuned for max. accuracy. Fine & Coarse (3-step) RF attenuators. RF output 100,000 uv; AF sine wave output to 10 v. 50-ohm output Z. 5-way jack-top binding posts for AF in/out; coaxial connector & shielded cable for RF out. 12AU7, 12AV7, selenium rectifier; xmfr-operated. Deep-etched satin aluminum panel; rugged grey wrinkle steel cabinet.

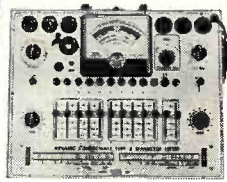

**NEW! DYNAMIC
CONDUCTANCE
TUBE & TRANSISTOR
TESTER #666**
KIT \$69⁹⁵ WIRED \$109⁹⁵

COMPLETE with steel cover and handle. **SPEED**, ease, unexcelled accuracy & thoroughness. Tests all receiving tubes (and picture tubes with adapter). Composite indication of Gm, Gp & peak emission. Simultaneous sel of any 1 of 4 combinations of 3 plate voltages, 3 screen voltages, 3 ranges of continuously variable grid voltage (with 5% accurate pot). New series-string voltages: for 600, 450, 300 ma types. Sensitive 200 ua meter. 5 ranges meter sensitivity (1% shunts & 5% pot). 10 SIX-position lever switches: freepoint connection of each tube pin. 10 pushbuttons: rapid insert of any tube element in leakage test circuit & speedy sel. of individual sections of multi-section tubes in merit tests. Direct-reading of inter-element leakage in ohms. New gear-driven rollchart. Checks n-p-n & p-n-p transistors: separate meter readings of collector leakage current & Beta using internal dc power supply. Deep-etched satin aluminum panel; rugged grey wrinkle steel cabinet. CRA Adapter \$4.50

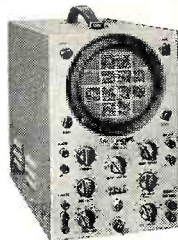

NEW!
**COLOR
and Monochrome
DC to 5 MC LAB & TV
5" OSCILLOSCOPE
#460**
KIT \$79⁹⁵ WIRED \$129⁵⁰

Flat from DC-4.5 mc, usable to 10 mc. VERT. AMPL.: sens. 25 rms mv/in; input Z 3 megs; direct-coupled & push-pull thruout; K-follower coupling bet. stages; 4-step freq-compensated attenuator up to 1000:1. SWEEP: perfectly linear 10 cps-100 kc (ext: cap. for range to 1 cps); preset TV V&H positions; auto. sync. ampl. & lim. PLUS: direct or cap. coupling; bal. or unbal. inputs; edge-lit engraved lucite graph screen; dimmer; filter; bezel fits std photo equip. High intensity trace CRT. 0.06 usec rise time. Push-pull hor. ampl., flat to 400 kc, sens. 0.6 rms mv/in. Built-in volt. calib. Z-axis mod. Sawtooth & 60 cps outputs. Astig. control. Retrace blanking. Phasing control.

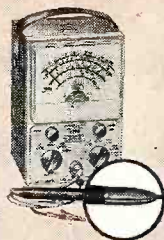

**NEW! PEAK-to-PEAK
VTM #232 & UNI-
PROBE (pat. pend.)**
KIT \$29⁹⁵ WIRED \$49⁹⁵

Half-turn of probe tip selects DC or AC-Ohms. Uni-Probe - exclusive with EICO - only 1 probe performs all functions! Latest circuitry, high sensitivity & precision, wide ranges & versatility. Calibration without removing from cabinet. New balanced bridge circuit. High Z input for negligible loading. 4 1/2" meter, can't burn-out circuit. 7 non-skip ranges on every function. 4 functions: +DC Volts, -DC Volts, AC Volts, Ohms. Uniform 3 to 1 scale ratio for extreme wide-range accuracy. Zero center. One zero-adj. for all functions & ranges. 1% precision ceramic multiplier resistors. Measure directly peak-to-peak voltage of complex & sine waves: 0-4, 14, 42, 140, 420, 1400, 4200. DC/RMS sine volts: 0-1.5, 5, 15, 50, 150, 500, 1500 (up to 30,000 v. with HVP probe & 250 mc with PRF probe). Ohms: 0.2 ohms to 1,000 megs. 12AU7, 6AL5, selenium rectifier; xmfr-operated. Deep-etched satin aluminum panel, rugged grey wrinkle steel cabinet.



**5" PUSH-PULL
OSCILLOSCOPE
#425**
KIT \$44.95
Wired \$79.95



**7" PUSH-PULL
OSCILLOSCOPE
#470**
KIT \$79.95
Wired \$129.50

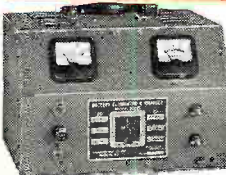

**TUBE TESTER
#625**
KIT \$34.95
Wired \$49.95

- tests 600 mil series string type tubes
- illuminated roll-chart

Pix Tube Test Adapter\$4.50

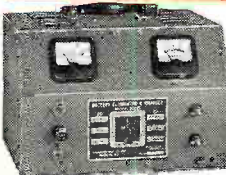

Sep. volt-
meter &
ammeter
KIT
\$29.95
Wired
\$38.95

6V & 12V BATTERY ELIMINATOR &
CHARGER #1050



Sep. hi-gain RF
& lo-gain audio
inputs.
Special noise
locator. Calibra-
ted wattmeter.
KIT \$24.95
Wired \$39.95

DELUXE MULTI-SIGNAL TRACER #147



20,000 Ohms/Volt
MULTIMETER #565
KIT 24.95
Wired 29.95



1000 Ohms/Volt
MULTIMETER
#536
KIT 12.90
Wired 14.90



Reads 0.5 ohms
-500 megs, 10
mmd-5000 mfd,
power factor.

KIT
\$19.95
Wired
\$29.95

R-C BRIDGE & R-C-L COMPARATOR
#950B



VTVM PROBES	KIT	Wired
Peak-to-Peak	\$4.95	\$6.95
RF	\$3.75	\$4.95
High Voltage Probe-1		\$6.95
High Voltage Probe-2		\$4.95

SCOPE PROBES	KIT	Wired
Demodulator	\$3.75	\$5.75
Direct	\$2.75	\$3.95
Low Capacity	\$3.75	\$5.75

TURN PAGE
FOR MORE
EICO VALUES

EICO®

Send for
FREE CATALOG
now

EICO, Brooklyn 11, N. Y. R-6

Show me **HOW TO SAVE 50%** on Test Equip-
ment and Hi-Fi. Send me **FREE** Catalog and
name of neighborhood distributor.

Name.....
Address.....
City..... Zone..... State.....

Prices 5% higher on West Coast.

BROOKLYN 11, N. Y.

Geiger Counter with Transistor Power Supply

By J. E. PUGH, JR.

SIX desirable features which a geiger counter power supply should have are: 1. small size, 2. light weight, 3. small initial cost, 4. economical operation, 5. long and trouble-free life, and 6. easily obtained batteries.

A comparison of the various types of power supplies (high-voltage battery, vibrator type, vacuum-tube oscillator type, and transistor oscillator type) shows that the transistorized power supply is superior to any of the other types except that the initial cost is slightly greater. Because of the low battery drain, low maintenance costs, and use of inexpensive batteries, the operating cost of the transistorized type is so much lower that this disadvantage is minor.

The geiger counter to be described is built around an efficient transistorized power supply designed to reduce the battery drain to a minimum. All parts, except the shoulder strap, are standard easy-to-get items and are operated well below their ratings to insure long trouble-free operation. The shoulder strap shown above is a special item and is not available at any of the regular suppliers but could be improvised or substituted.

Circuit Description

As can be seen in the schematic of Fig. 3, the transistor (V_1) is in a conventional class C Hartley oscillator circuit operating between 30 to 100 cycles-per-second. The potentiometer, R_2 , controls the output voltage level by controlling the oscillator frequency. Resistor R_1 sets a limit on the minimum resistance in the transistor base circuit, and thus sets a limit on the maximum collector current. The actual value of R_1 was selected so as to limit the collector current to about 10

Simple unit for summer prospecting uses transistor oscillator supply and features long battery life.

ma. maximum when $B_1 = 9$ volts, and at the same time to permit the full V_2 anode voltage of 900 volts to be obtained when the battery voltage drops to 6 volts.

The a.c. voltage developed across the primary of T_1 is approximately equal to the battery voltage since the oscillator operates class C. This voltage is stepped up about 16 to 1 in the secondary of T_1 and is then fed to the rectifier circuit. The rectifier is of the voltage-multiplier type giving a multiplication of 10, thus the total voltage

multiplication of the entire circuit is about 160. The rectifier circuit is such that the voltage across each of the associated capacitors, C_1 to C_{13} , is one-fifth of the output voltage. This permits capacitors with a lower voltage rating to be used. In addition, the peak inverse voltage across each of the rectifiers is well below the maximum permissible value to insure long component life. This also keeps the input power low because the losses in each rectifier go up rapidly as the voltage across it increases.

Fig. 1. Side view of completed unit shown with case removed.

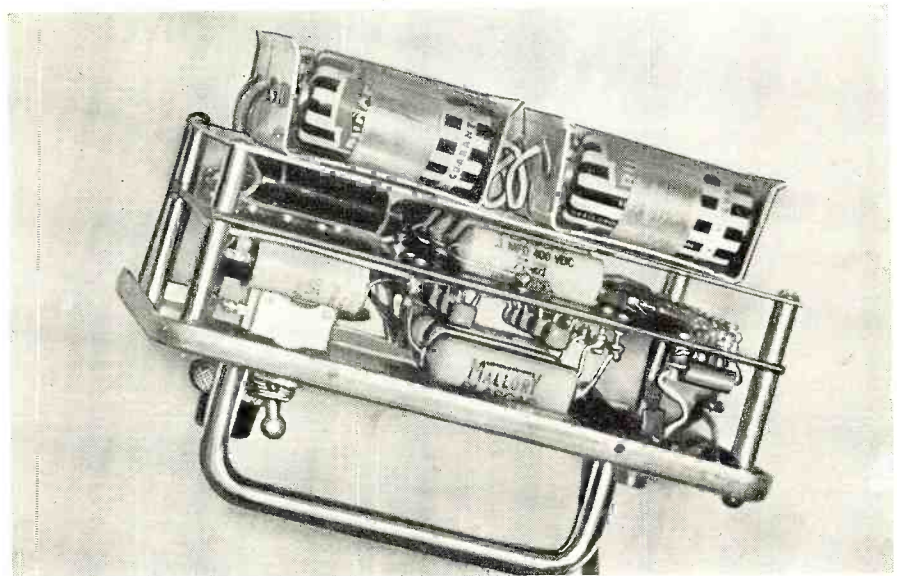

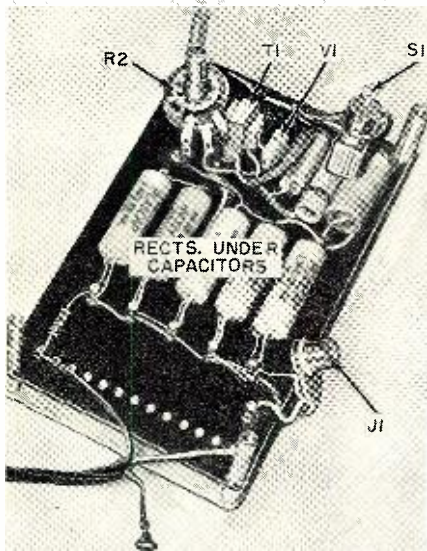

Fig. 2. Top view of unit's subpanel.

The d.c. output from the rectifier circuit is filtered by R_3 and C_{14} and is then fed to V_2 , the geiger counter tube. This filter reduces the a.c. ripple to less than 1%. When measured across the headphones, this ripple is more than 60 db below the level of the geiger tube output pulse at which point it is just audible.

The string of neon lamps, PL_1 to PL_{12} , limits the voltage across V_2 to approximately 900 volts. This voltage can be made greater or smaller in 75 volt steps by increasing or decreasing the number of neon lamps. Thus if a 300 volt geiger tube were used, four neon lamps would be required. The operation of this circuit is very simple. Potentiometer R_2 is adjusted until the voltage across the string of neon lamps is just below the value needed to fire the lamps. At this point the V_2 anode voltage is at the pre-determined level, and since the lamps are not firing, the current through them is zero, which means that they do not put a drain on the battery during normal operation. Compared with the conventional voltage regulator, this limiter has several advantages—and one disadvantage. The disadvantage is that it does not have automatic control over the high voltage level while the voltage regulator does—over a limited range. This lack of automatic control means that under normal operating conditions R_2 will need a slight adjustment about every 80 to 100 hours of use to compensate for the normal drop-off in battery voltage. In contrast the voltage limiter costs less to build, less to operate, and does not require a meter for adjusting to the optimum operating point.

The RC network, R_4 and C_{15} , is used to minimize the current through the neon lamps when they fire. This re-

sults in a more easily made and a more precise, output voltage setting than would be possible if the neon lamps were permitted to load the high voltage circuit excessively when they fire, and at the same time it keeps the V_2 output pulse, as would be developed across the headphones, at a high level.

The geiger tube is a low-cost halogen-quenched type. It will have a very long life since it is not affected by the number of counts nor by accidental over-voltage as it can go into continuous discharge without being damaged. The output pulse is of sufficient amplitude that an amplifier is not needed for headphone monitoring. If the builder wishes, one of the very small speakers now available can be used instead of the headphones by adding a stage of amplification.

It will be noticed that the amplitude of the geiger tube pulse decreases slightly with an increase in the count rate. This is a normal condition in this tube and has been minimized by making R_4 large.

Six small flashlight cells (size C) are used to supply the transistor with 9 volts. This voltage was selected so as to keep the collector current at a low value—normally less than 6 ma.—thereby keeping the battery drain low. When the battery has dropped to 6 volts this current is less than 10 ma. for the full 900-volt V_2 anode voltage. Tests show that the battery life will exceed 600 hours when used 40 hours per week. A considerable reduction in size is possible by using size Z penlite cells, one set of which should last through a prospecting season.

Construction

The smallest standard parts obtainable are used. Special high-priced sub-miniature parts are not used, but if the builder wishes, a considerable reduction in size is possible by using such parts.

The case is a deep drawn aluminum box with matching cover. It is available in various sizes at a reasonable cost direct from the manufacturer—The Zero Manufacturing Company, Burbank, California. The bottom and sides are fabricated from the same sheet of aluminum without any openings which simplifies the problem of moisture- and dirt-proofing. One of the ordinary boxes available at most radio parts suppliers can be used but will not be quite as satisfactory in this respect.

Most of the parts are mounted on a base made of a good grade of insulation material using turret-type terminal lugs. See Figs. 1, 2, and 5. The insulation material used is XXXP-26 but any other type with a high insulation resistance, low moisture absorption, and moderate mechanical strength will do. Most of the thin sheets of Bakelite available at radio parts suppliers will be satisfactory.

The terminal lugs are USECO turret lugs and are available at Newark Electric Company, Chicago, Burstein-

Fig. 3. Complete schematic diagram of the transistorized geiger counter unit.

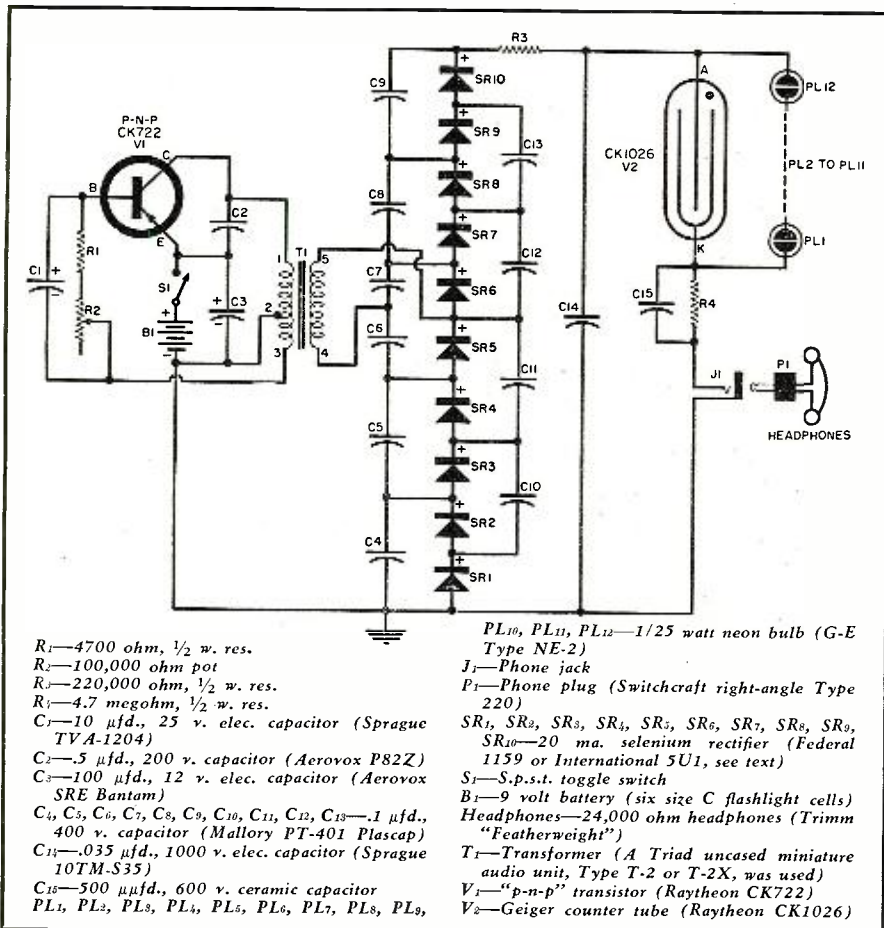

Applebee, Kansas City, Missouri, and *The Radio Shack*, Boston. Four types of these lugs were used to obtain the neatest construction. These are: a single lug (Type 1350), a double lug (1300), a small feedthrough (1290), and a large feedthrough (1320). Swaging tools (available at these same suppliers) are used to fasten these lugs, but if the builder wishes to eliminate this investment in swaging tools, the 1300T lug can be used. This lug is fastened with a 4-40 nut, and for the most compact arrangement this nut should be $\frac{3}{16}$ " across the flats (*Walsco* 4-40 hex nuts, Item #8804-N). The first mentioned group of lugs is available for use with different thicknesses of panel while the 1300T is made in one length only. It can be used on panels up to $\frac{1}{8}$ " thick.

The battery boxes are mounted on a sheet of thin aluminum which is fastened to the chassis with $\frac{5}{8}$ " threaded spacers. This assembly is mounted to the box cover with $1\frac{1}{4}$ " spacers or two $\frac{5}{8}$ " spacers arranged in series.

The layout used permits the geiger tube to be used in a probe as shown or to be located inside the case. The probe is very easy to construct and the details are shown in Fig. 4 above. It consists of an aluminum tubing handle with an end cap, a female coax receptacle used as the geiger tube anode connector, a helical #16 bus wire cathode connector, and a plastic cover for the geiger tube. The inner conductor of the coax connector will need to be enlarged slightly to provide a better fit for the V_2 anode pin. If available, a #68 drill can be used for this job, otherwise a short length of an ordinary paper clip can be used. Simply cut off a short straight length of the paper clip with a pair of diagonal pliers and use the cut end for reaming. After the reaming job is completed, bend the contact fingers together slightly with a sharp pointed tool. The outer shell of the coax connector has a $\frac{1}{4}$ -28 threaded portion which is mounted in the section of $\frac{7}{8}$ " polystyrene rod as is shown in detail in Fig. 4.

If a $\frac{1}{4}$ -28 tap is not available, simply drill a $\frac{15}{64}$ " diameter hole and screw the coax connector in. It will cut its own thread.

If the counter tube is mounted inside the case, a Type 45 *Fahnestock* clip can be mounted on the base (in the middle of the space occupied by R_3) for use as the anode connector. The same type helix of #16 bus used in the probe can be used for the cathode connector.

The builder can choose either of two suitable rectifiers. The *Federal* Type 1159 costs less but it is cardboard encased and *must* be moisture-proofed. This can be done by first baking the rectifier in an oven set to 150°F for about 1 hour. Next the rectifier is coated thoroughly with paraffin, beeswax, or polystyrene coil dope. The *International Rectifier* Type 5U1 (available at *Burstein-Applebee Company*,

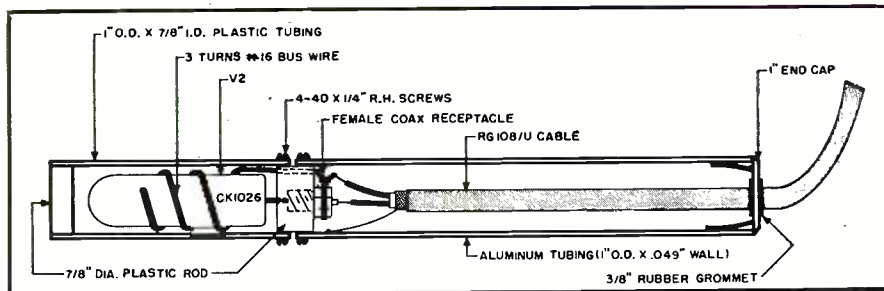

Fig. 4. Details on the construction of the geiger counter probe.

Kansas City, Missouri) is more expensive but it is smaller and does not need to be moisture-proofed since it is plastic encased. The losses in these units are very low and this may cause the oscillator frequency to be very low, resulting in a very slow charging rate for capacitors C_1 to C_{13} . If the initial charging rate is too slow it can be corrected by connecting about 220 megohms (ten 22 megohm resistors in series) across the string of rectifiers.

A #6 solder lug can be used to connect the negative terminal of the battery to the aluminum mounting plate at one of the corner posts. This will provide a convenient point for monitoring the transistor current when construction is completed. This current should be approximately 8 to 10 ma. when the switch is first closed. It should then drop fairly rapidly to 5 or 6 ma. if the 1159 rectifier is used and to 2 or 3 ma. if the Type 5U1 is used.

Adjustment

1. Loosen the knurled shaft lock and turn the control maximum counterclockwise.
2. Throw the switch to "on."
3. Wait about 30 seconds.
4. Rotate the control knob clockwise until loud regular clicks are

heard in the headphones. These clicks are caused by firing of the neon lamps and are louder than the geiger tube clicks. The counter tube clicks are easily identified and no confusion should result.

5. Back the control off slowly until these loud clicks are no longer heard.

6. Tighten the knurled lock nut and start looking for uranium.

After the anode voltage of V_2 has reached 900 volts it will usually continue to rise very slowly for several minutes. This is a normal condition and seems to be caused by a slight change in transistor gain due to internal heating. All that is required is to back the control off slightly—just enough to stop the neon lamps from firing.

After 80 to 100 hours of use the control should be rotated clockwise by a very small amount to compensate for the normal loss in battery voltage.

When the batteries are renewed, repeat the outlined adjustment procedure, making sure that the control has been backed off (counterclockwise) before throwing the switch to "on." This will keep the battery drain at a minimum and will also reduce the strain on some of the other components. -30-

Fig. 5. Bottom view of unit's subpanel showing the line-up of 12 neon bulbs. Note also the construction of the battery clips.

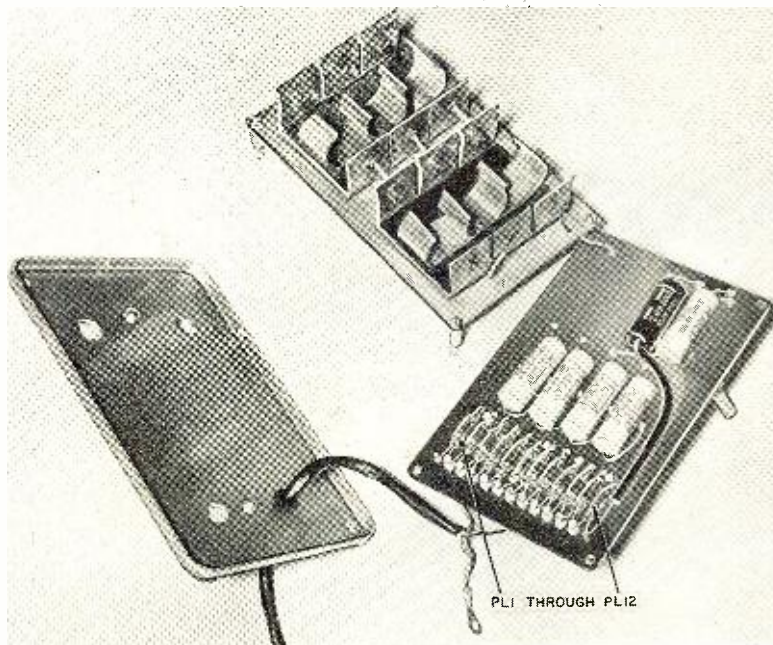

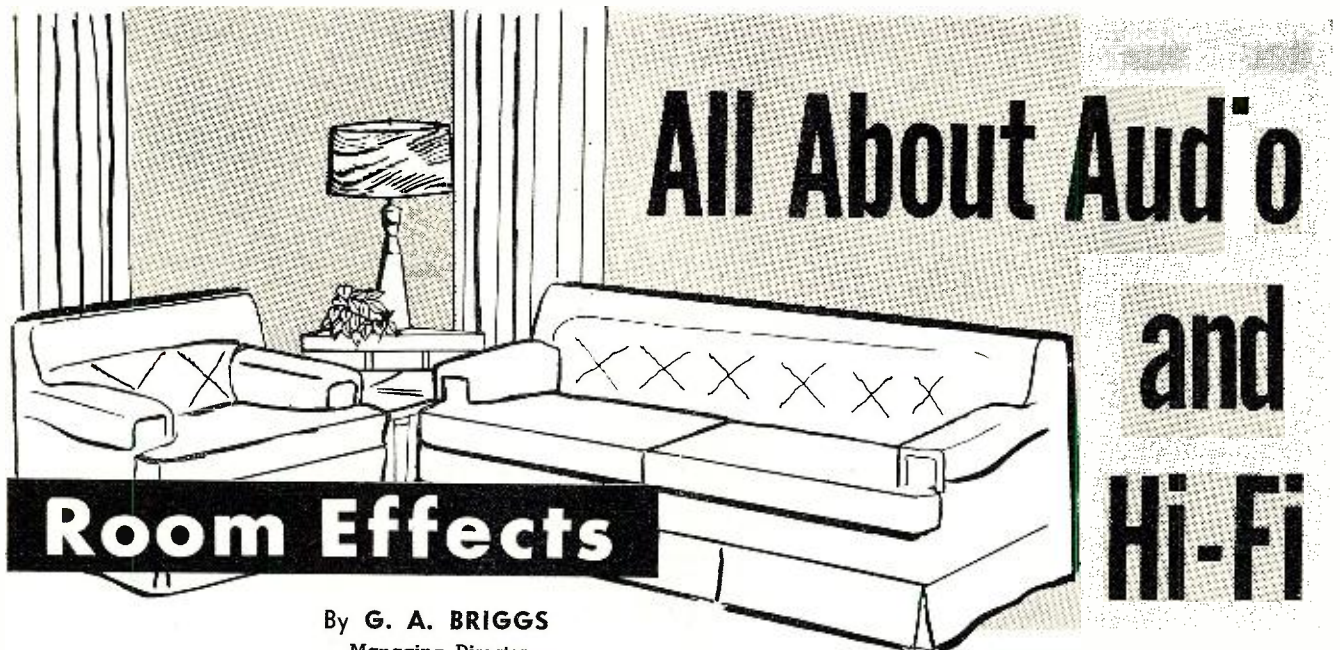

Room Effects

By G. A. BRIGGS

Managing Director
Wharfedale Wireless Works Ltd.

Part 2. Experiments with speaker placement show that listening room has considerable effect on reproduction.

HAVING dealt in a non-medical and non-technical way with the human ear, we naturally arrive at the room in which the ear is normally used for listening to reproduced music. Tonal discrimination must clearly involve an appreciation of what the room is doing to the sound.

Much has been written on room acoustics, but I still believe that the effects are greater than most people realize.

As the questions of room treatment, reverberation, and absorption were fully covered by Mr. H. A. Hartley in the May and June 1956 issues of this magazine, there would be no point in going over the same ground again; I will therefore endeavor to describe what actually happens in certain specified rooms in the hope that readers may be able to pick up a few useful hints.

Size of Room

Some textbooks state that to reproduce a low-frequency sound the room must be at least as long as the wavelength you wish to reproduce, which means that a 50-cycle note requires a room nearly 24 feet long. The minimum usually advocated is half a wavelength, which means a 12-foot room for good bass down to 50 cycles, and I agree with this, but I do not agree that even smaller rooms are adequate.

As a matter of fact, a room about 11 feet long will have a main resonance at 50 cycles (with harmonics at 100 and 150 cps) and would tend to emphasize power-line hum from a noisy amplifier working into a good woofer. This, of course, refers to British power lines. At the 60-cycle

power line frequency prevalent in the U. S. the equivalent room dimension would be 9 feet. It is clear that large rooms are better than small ones because the room resonances are lower in frequency and help to build up the bass in a region where it is often deficient. Nobody says that a sound is inaudible if the room length is less than half the wavelength. It is simply not so well reproduced.

Concert Halls

The obvious way to avoid small room effects is to move into a good concert hall, where it is possible to hear what a loudspeaker is doing *before* it is affected by reflections from walls, and where the room (hall) resonances occur at much lower frequencies where they are less harmful. I know of no quicker or better way of assessing speaker performance, and I am unable to understand why nobody else advocates this technique; my voice is still like one crying in the wilderness.

It is not suggested that the final choice of one speaker for domestic use—out of say half a dozen samples—should be made in a concert hall, where conditions are different (and superior), but it is claimed that the reliable information so obtained can be applied to good purpose. I remember testing a speaker system with a new foam suspension to the cones, compared with a similar system with different cone surrounds, in St. George's Hall, Bradford, and in Carnegie Hall, New York, when everybody present immediately heard and appreciated the difference.

In short, a decision to adopt a new type of construction—cone, suspension,

centering device, or a different cabinet, baffle, or horn, or even a change to electrostatic units—can often be made in a few minutes instead of hours or days. This is achieved simply by improving the listening conditions.

Many of the effects to be observed cannot be produced by response curves taken in anechoic chambers or the open air.

Readers who do not own concert halls may wonder how all this affects them, and I agree it appears to be of rather doubtful value to amateurs. But there are thousands of halls which are used only a few hours a week, and serious investigators of sound reproduction could arrange tests without abnormal difficulty or expense. They would at least learn by comparison something of what a normal living room actually does to sound waves.

Ordinary Rooms

To get back to earth (before the Editor starts using his blue pencil), a general outline of my own listening room at home is given in Fig. 7. Apart from the fact that it is usually cluttered up with equipment and numerous loudspeakers (my wife is case-hardened), the furnishings, carpets, and curtains are normal.

The room measures 20 x 14 x 11 feet, so the main resonances occur at about 28, 40, and 50 cycles, but the odd shape at one end helps to break up the horizontal modes.

At *A* there is a permanent 3-speaker corner installation, which gives better results than any speaker ever tested in any other position in the room—in spite of the rude things often said about corners and room resonance. At *B*, *C*, *D*, and *E* we do *not* find four more speakers, but simply one speaker tested in four positions. This is a 3-speaker sand filled baffle, measuring 34" x 31" with 12" sides, with 12" and

10" units facing forward, and a 3" tweeter mounted on a separate small baffle facing upward. The speakers radiate from both sides of the cones, and the main baffle therefore performs as a doublet at low frequencies (Fig. 6). (As the tweeter also radiates from two sides in a vertical direction, I suppose the whole system could be described as a "Quadlet," but I doubt if the Acoustical Society of America or if the A. E. S. will ever accept this new term!)

A speaker which radiates in one direction only, say from a reflex cabinet, is known as a simple radiator (not a "Singlet") and appears to be less susceptible to room effects than a doublet. I have therefore selected the open baffle, stand-anywhere model as the basis of this test, because results were easier to observe. Although a simple radiator does not behave in the same way as a doublet, many of the room deductions would still apply.

The first and most important lesson to be learned is that strong directional effects in middle and upper registers must be avoided like the plague. With a simple radiator this can often be done by facing the speaker into a corner or at an angle of 45° towards a hard wall, so that the sound is splashed into the room and thus loses some of its "loudspeaker" quality. In a good concert hall, undue directional effects give an even more unnatural result.

To revert to Fig. 7, the general conclusions are as follows, but it will be understood that other rooms, other speakers, other ears would give different results. It is equally important to remember that results vary according to the type of record or radio transmission being used. Large choral and orchestral works often contain a good deal of studio coloration or ambience which might clash with the room resonance. A rather dry, crisp recording is essential. Solo voice is an excellent test, but a good, clean piano record is hard to beat, as the frequency range covers seven octaves and any "boxiness" in reproduction is easily noticed. It is worthy of note here that the type of recording which sounds "right" in a good concert hall, and is therefore free from excessive recorded ambience, is ideal for these tests as it will not lead the ear astray.

Here are the findings for the various positions:

Position A: This has already been awarded pride of place. The 3-speaker system in use here is not movable, in common with many reflex cabinets and back loading horns designed to give optimum results from a corner. In short, the speaker objects to being pushed around, so it cannot conveniently take part in the tests under consideration. Room resonance may or may not be prominent, but can easily be countered by the use of an extra speaker, which may be comparatively small, suitably placed in the room. Experiments on these lines will be described in Part 3 of this series.

Position B runs very close to *A*,

without exciting the full room resonance. Any speaker with a pronounced enclosure resonance around 50 cycles might sound better here than at *A*. Suits dance bands.

Position C: A nice combination of medium bass and good reflection of rear sound waves. Suits most types of music.

Position D: Ideal for those who prefer completely nondirectional effects. (There is no reason why the loudspeaker should always look the listener straight in the eye, or ear.) Very good on guitar and similar instruments. Room resonance well masked.

Position E: This position gives the impression that the music is being played in the room rather than through a hole in the wall, and is liked by some listeners.

A-B Testing

Some readers may suspect that the effects of speaker placing are being exaggerated, but an *A-B* test of two similar speakers often proves its importance. For instance, if speaker *A* happens to be standing in a better position, acoustically, than *B*, a preference for *A* might be transferred to *B* simply by transposing the speakers. This is another reason why large hall tests are safer: a difference of two or three feet in position is of no consequence, but in a small room this may be serious.

Load Matching: Connecting an extra speaker in parallel with one already in use obviously halves the impedance, assuming that both speakers are the same. With modern negative-feedback amplifiers the output resistance is low and the damping factor is high, so a mismatch to the speaker load does not cause distortion—it merely reduces the available distortion-free power. Assuming your amplifier will give 20 watts clean output, connecting a (perfect) 16-ohm speaker to a 16-ohm output circuit would make available the full 20 watts. If you then add another 16-ohm speaker in parallel, and halve the

impedance of the load, the available power is also approximately halved. If you are not using more than 10 watts at any time, there is nothing to worry about; but if you are likely to exceed 10 watts, it is desirable to change to an 8-ohm output tap or thereabouts for better results.

"Perfect" matching never comes our way, because speaker impedance varies with frequency, so it is only necessary to come reasonably near. For instance, an output circuit rated at 8 ohms is quite satisfactory with nominal speaker loads between 6 and 10 ohms impedance.

If two or more speakers are to be added in parallel it would be advisable to work on a low output impedance, say 3-5 ohms, so that more power becomes available as the extra power-handling capacity is increased by connecting the extra speakers.

I hope these comments will encourage readers to try various experiments where room and furniture will permit. Even results from an ordinary radio set can often be improved enormously by removing the back and placing the cabinet across a corner at a suitable distance from the wall.

In Part 3 the use of two or more speaker systems in a room with single and/or two-channel input will be considered.

(To be continued)

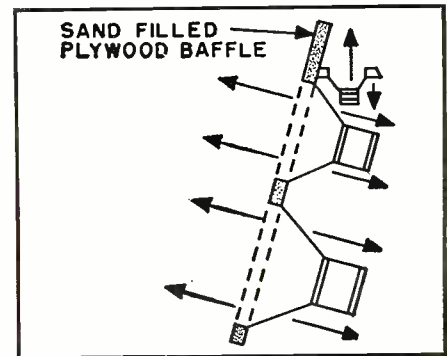

Fig. 6. Doublet speaker system used.

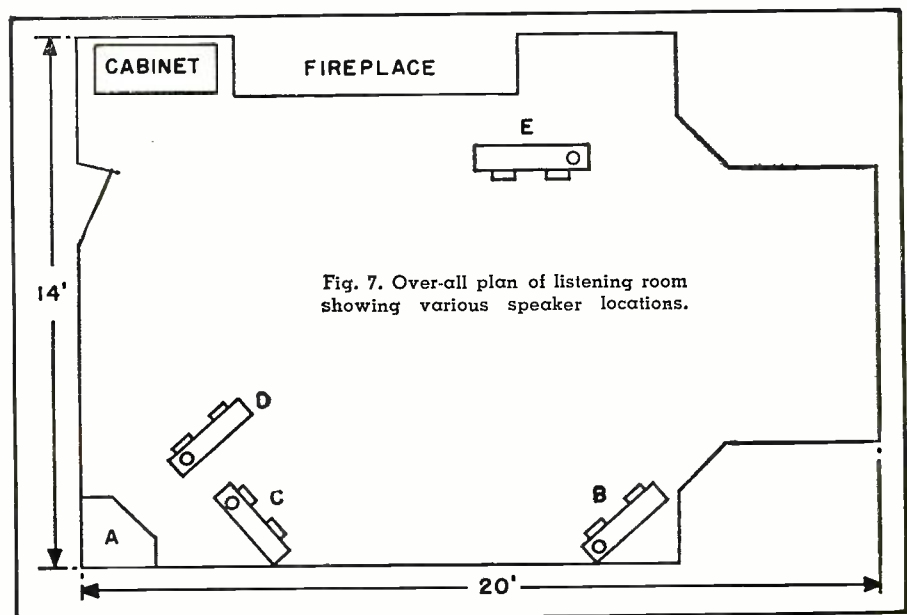

Fig. 7. Over-all plan of listening room showing various speaker locations.



Fig. 1. The batteries shown here are only three of the many types, sizes, and shapes found in current transistor sets.

Tubeless radios have increased the potential for batteries, but also introduced confusion.

IN 1956, about 31 per-cent of all portable radios sold used transistors. In 1957, predicts J. A. McIlnay, vice-president for sales of the *Ray-O-Vac Company*, transistorized units will probably account for close to 60 per-cent of all portable sales. In step with this trend, McIlnay expects the present annual retail sales volume in batteries of about \$50 million to swing to the \$200-million mark by 1965.

Whatever the exact figures will be, there is little doubt that the average service establishment will be devoting more attention to replacement battery sales than in the past; or that both technician and consumer will be seeking answers to questions pertaining to the types of batteries that are used, their differences from previously existing types, availability of replacements, initial cost, cost per hour of operation, storage life, and life in use, among others.

To find the answers, *RADIO & TV News* has polled the battery industry. Information on which this article is based has been provided by *Burgess Battery Co.*, *National Carbon Co. (Eveready)*, *P. R. Mallory & Co.*, *Radio Corp. of America*, and *Ray-O-Vac Company*. The general impression is that the trend is too young to permit final answers to all questions. However, it is certainly not too early, even in the unsettled areas, to observe the possible alternate trends and to engage in well-informed speculation.

Tubes versus Transistors

Whatever type of construction is used, the battery for the transistorized radio is asked to provide a much lower

voltage than its cousin employed in tube radios. The latter may range up to 90 volts or more for "B" supply. An "A" battery, with up to 9 volts, is also required for tube portables, except in those cases where a single multiple unit—which effectively combines both batteries in a single container—is used.

The transistorized portable generally relies on a single-voltage source, which may be as low as 3 volts but sometimes edges beyond 20. Most sets now available fall into the 6-to-12-volt category, with the most usual value being 9 volts. This voltage may be provided by a single battery or by an arrangement of series or series-parallel 1.5-volt cells. Some of the receiver manufacturers provide optional mounting arrangements for either the single unit or the multi-cell string—an indication of uncertainty as to what long-range public preference will be.

Current Drain

Battery current drain is approximately the same on low transistor voltage as it is on high battery voltage. There is doubtless some confusion on this score, since it is generally recognized that the lower-voltage transistor radios enjoy an appreciable advantage with respect to power consumed. Nevertheless, *Ray-O-Vac* engineers, having sampled models of all types, report that tube radios require from 8 to 14 ma. "B" supply, while transistor receivers draw between 5 and 20 ma. Although the average runs about the same, one reason for the greater range in transistor sets is that these units are relatively sensitive to volume-control settings, whereas the

current pulled by tube sets is varied only slightly when the volume level is changed. Of course, with transistor receivers still in the infant stage, forthcoming developments may reduce current requirements substantially.

Dry Battery Types

Still the most common type of dry cell for radio use is the LeClanche cell, the zinc-carbon unit that is the basis for the familiar flashlight battery. Also enjoying considerable popularity is the mercury cell, which provides longer life in smaller size. *Mallory* markets a full line of these, but *RCA* and *Eveready* also have some available.

There is much talk of the development of special types, such as "sun" batteries, alkaline cells, "atomic" batteries, and metallic-oxide cells, but only some of these are now available. Some alkaline cells have already reached the market, but present production costs for most other types of "super" batteries prohibit their commercialization.

Some segments of the battery industry tend toward the opinion that the special types will eventually obsolete the zinc-carbon standby. More conservative elements point out that the zinc-carbon system has yet to touch its potential limits. Presently available LeClanche batteries have capacities up to 50 per-cent greater than their pre-war forebears, and the end is not yet in sight.

Design Features

In physical appearance, one would be pressed to distinguish between, say, a carbon-zinc battery and a mercury unit except that, for a given capacity, the mercury energizers are much smaller. Shapes range from the cylindrical (as in the pen-light and flashlight types), through the slim, flat types, and through the various cubic configurations. Some popular shapes are shown in Fig. 1. Sizes range from the pen-light size to some as large as the smaller "B" batteries for tube radios. Connectors range from the simple contacts of the flashlight cell to the snap-in and snap-on fasteners. They do not vary greatly from connectors used on other battery radios, if at all.

More interesting are the differences that may exist between units of the same type, nominally, as offered by different manufacturers. The venerable carbon-zinc LeClanche cell provides a good illustration of this point.

When these batteries deteriorate, the contents swell and eventually burst the container, as many an owner of a ruined flashlight knows. The corrosive chemicals thus released present a more serious threat to the interior of an expensive transistor radio than they do to a simple flashlight. Ingenious manufacturers have devised various ways of preventing this action, and many now offer firm guarantees against such action. Earliest of the "leakproof" types is the *Ray-O-Vac* metal-clad "sealed-in-steel" battery.

Another limitation on life, both on the shelf or in use, has been the drying out of the electrolyte in the carbon-zinc batteries. It may take no more than a thimbleful of water added to the mix used in this type to put it in business, but without this amount the energizer is useless. The metal-clad construction is one method that keeps the water from evaporating. *Burgess* and other manufacturers use such techniques as special wafer-cell construction or Mylar and Pliofilm moisture barriers. Other life-prolonging measures include the addition of small quantities of compounds to the electrolyte of the LeClanche units that were unheard of for this purpose 15 years ago. Over that same period, the rated life of these batteries has gone up 50 per-cent, and even better, where most recent know-how is used.

Life Characteristics

The shelf or storage life of carbon-zinc batteries is in the range of 8 to 12 months, when they are stored in a "cool, dry place." Recommended storage temperatures are in the range of 65 to 70 degrees F. Under the same conditions, mercury batteries can be stored for 2 years or more.

As for life in use, Fig. 2 tells us how the familiar "D" size flashlight cell fares in transistor-radio use. The conditions of use are for three rates of drain, turned on for 4 hours a day, every day, at a room temperature of 70 degrees. At the average rate of drain imposed by a transistor radio, such a cell will have a useful life of about 500 hours, or about 4 months.

In another test, two 1.5-volt cells, one carbon-zinc and the other mercury, were operated under the same drain-and-temperature conditions. As shown in Fig. 3, the mercury type yielded useful output for five times as long a period.

Operating Costs

At present, the cost of operating a transistor radio is estimated to be about one-tenth the cost of operating a tube radio, where both use carbon-zinc batteries. One set of batteries for a tubeless set will cost about half as much and last about five times as long as the complement for a tube radio.

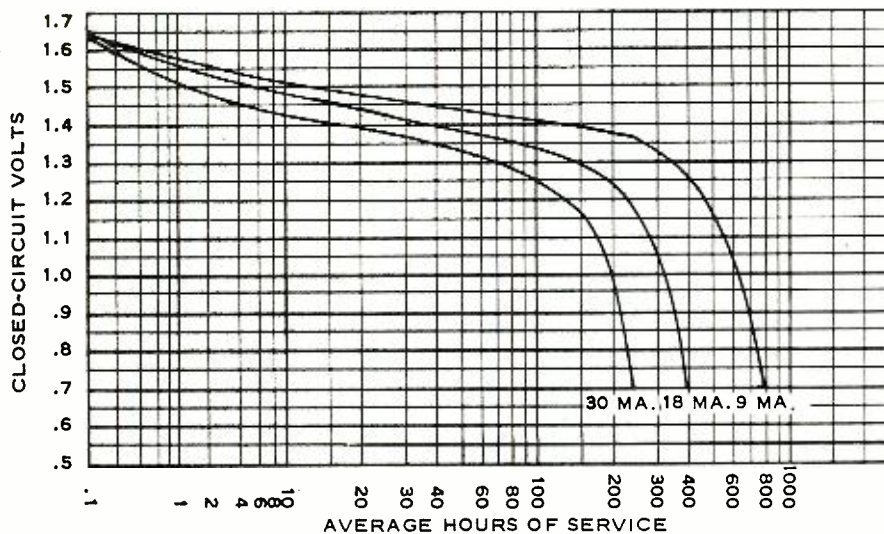

Fig. 2. Voltage-output life of a Ray-O-Vac "D" cell. See text for use conditions.

This puts the operating cost of the transistorized receivers in the same class with tube radios operated on house current, and has led to the prediction that the cordless house radio, safer, more adaptable to movement and room placement, and more attractive due to the absence of the unsightly cord, attached to present home receivers, is on its way.

Although there are no exact figures, even proponents of the LeClanche cell do not deny that the initially more expensive mercury batteries provide still more favorable cost-per-hour ratios. They feel that this does not put their product to serious disadvantage because people will prefer the small single outlay of cash for a complete carbon-zinc complement, and also that the standardization in size and type of these power packs will simplify replacement problems.

Replacement Problems

Physical and electrical characteristics of batteries used in tube radios have become so standardized that it has been possible for the National Electronic Distributors Association to promulgate a standard list, assigning type numbers to cover all variations as to voltage output, physical dimensions, and connections, and to cross-reference existing corresponding types of all manufacturers.

This publication has attempted a

like project with respect to transistor-radio batteries, but it appears to be too early to organize in an area where development is still under way. In soliciting manufacturers for lists of most popular replacement types, for example, it is found that one source will list as popular types units that do not yet have equivalents in other manufacturers' lines! NEDA has attempted to assign numbers to transistor types, but battery manufacturers have units that do not conform to these designations.

Ray-O-Vac, which has generally adapted the NEDA system, has not been able to apply it to transistor units. *Mallory* attempts to list equivalents (on the jacket of each of its batteries) in the lines of other manufacturers.

Furthermore, it has not been possible to recommend battery types according to receiver manufacturers, as the same manufacturer will design different models for different batteries. The best bet is to obtain the replacement guide from the battery manufacturer—all of them have such lists available—which give the units in his line that can be used in the various radios of all set makers.

The one bright spot for dealers who must be concerned with stocking replacements is the large number of transistor radios that can be operated with the familiar flashlight cells. —30—

Fig. 3. Mallory's comparison of useful life between mercury and LeClanche cells.

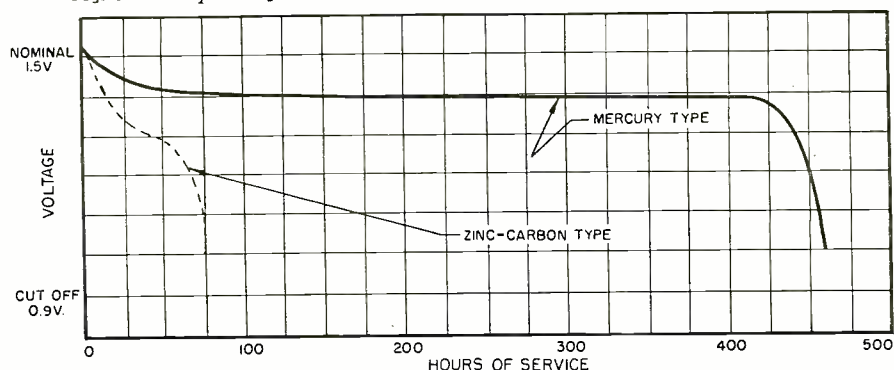

A Transistorized Marine Direction Finder

By
OLIVER READ

Publisher, RADIO & TV NEWS and POPULAR ELECTRONICS

Compact, portable unit operates from self-contained battery. Provides sensitive and accurate bearings.

ONE of the fastest moving hobbies is that of boating. It is estimated that more than 200,000 new boat owners join the ranks each year. The greatest number comprise the "small boat" owner who is limited both in time and money necessary to pursue this hobby.

Until recent years, many electronic safety devices were not within financial reach of these boatmen. Small boats, generally, have not been equipped with any form of power supply which would permit the owner to utilize essential

marine navigational or communications devices. In our own case, a real need was found for a portable, compact direction finder which could be carried aboard a small boat which is operated in waters often blanketed by fog. The compact d.f. herein described is the result of that need. This tiny d.f. is housed in an aluminum box measuring 7" x 5" x 3" and utilizes a standard transistor superheterodyne circuit. It is self-contained and operates from its own battery.

The behavior of the transistor in r.f. circuits seemed to offer several possibilities for the inclusion of a "null indicator." Reference to the schematic shows the point chosen for insertion of the meter. A variation of approximately .8 ma. in the emitter circuit between a "no signal" and "maximum signal" condition is almost ideal for the purpose of indicating field strength. We used a conventional 0-1 milliammeter, which may be either mounted as shown in Fig. 1, or inverted 180° with the indicator pointing down. As shown, resonance (maximum signal) results in a sharp dip when the station signal is properly tuned. The null point (minimum signal) is indicated by a maxi-

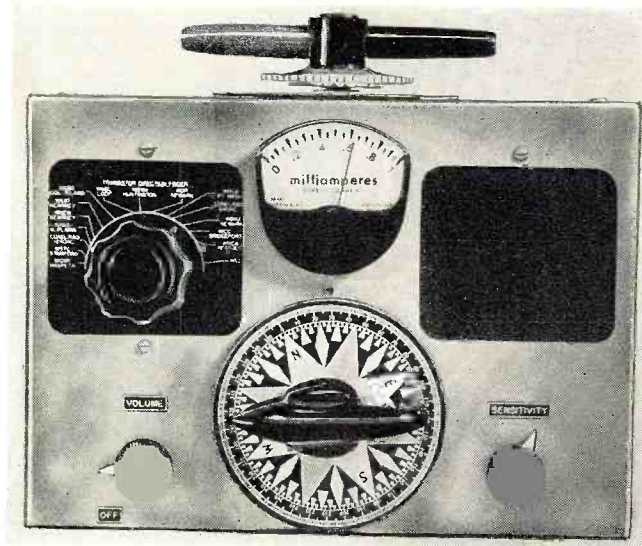
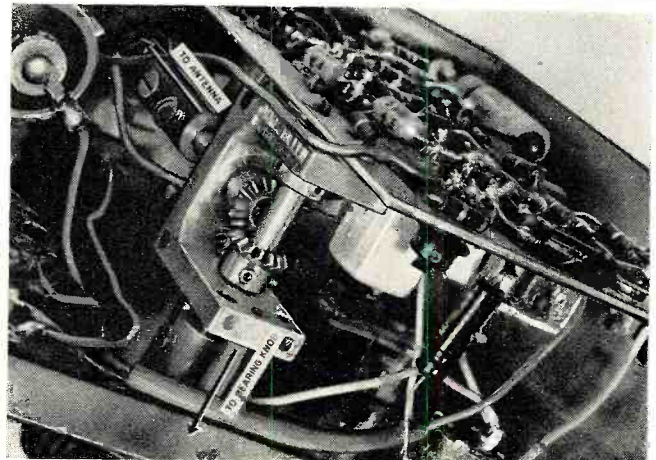

Fig. 1. Front view of d.f. showing operating controls.

Fig. 2. Inside view of unit showing details of gear drive.



imum current swing of the meter. This is just the opposite from the usual nulling instrument found on the expensive direction finders. The meter may be inverted to obtain conventional action.

Construction of the circuitry may be done either on an aluminum chassis or on one of the perforated board chassis supplied by the kit makers. Wiring is not critical and there is no hum problem. In addition, none of the component values is critical except that the various transformers and coils must be of design for transistorized circuitry. Most of the parts needed were found in the Lafayette KT-119 transistor receiver kit. We modified the chassis to fit our design.

A right-angle drive, a Millen 10012, permits the loop to be rotated from a line-of-sight position in front of the pilot or operator. This was found to be almost mandatory for the small out-board skipper who is in a sitting position and should be able to accurately read either the nulling or to follow his compass course without standing. Spacers were used to provide shaft clearance behind the meter, Fig. 2.

There are two compass roses provided—both independent of the mechanical coupling between the right-angle drive shaft and the loop assembly. The compass rose mounted beneath the loop is useful in boats where the pilot is standing and looking down on the d.f. From the null position of the loop, he is able to set the rose to a relative compass heading very simply.

It was decided, for maximum utility, that the dial on the tuning capacitor be marked for known transmitting station towers in the area in which the d.f. was to be used. In our case, this was Long Island Sound. The exact location of transmitting towers is easily obtained by calling the station and then plotting the point on the marine chart, as well as marking it directly on the tuning dial of the d.f. Conelrad frequencies are also plotted on the dial so that the d.f. can be used as a monitor on boats equipped with radiotelephone.

A small PM loudspeaker serves for checking the station or for general reception.

Headphones were not incorporated as it is not necessary to hear the signal over engine noise for navigational purposes. As a matter of fact, any contacts such as in a phone jack were eliminated in the design as insurance against failures due to salt air or water corrosion. Following final test the entire circuitry was sprayed with several coats of clear Krylon plastic to keep out moisture.

The construction of the loop designed by the author is optional. We utilized a conventional three-circuit phone or microphone jack and modified a conventional three-circuit plug which provided us with a simple means for obtaining wiping contacts for the loop circuits to the transistor mixer. This is shown in Fig. 3. We added a metal

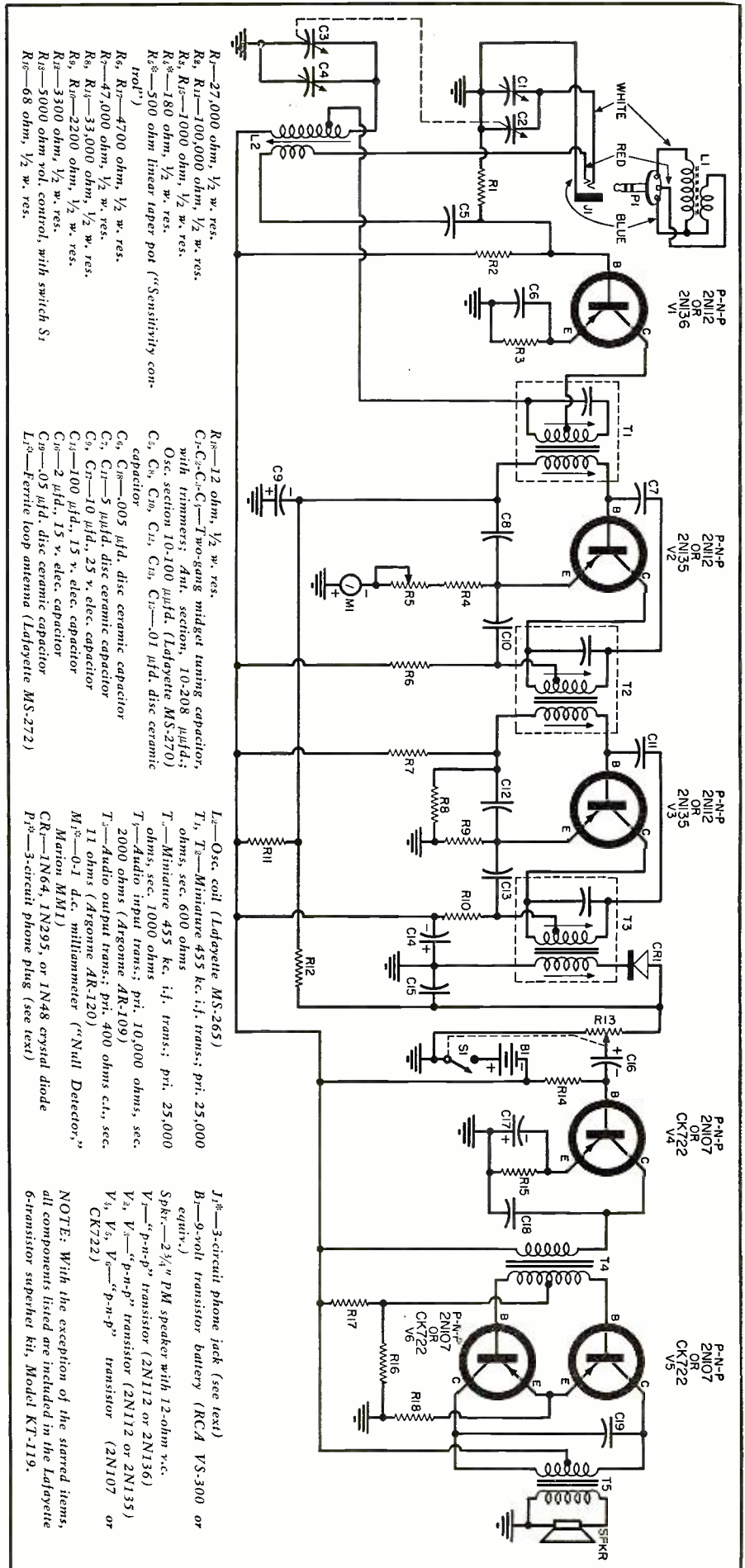

- R₁—27,000 ohm, 1/2 w. res.
- R₂, R₃—100,000 ohm, 1/2 w. res.
- R₄, R₅—1,000 ohm, 1/2 w. res.
- R₆—180 ohm, 1/2 w. res.
- R₇—500 ohm linear taper pot ("Sensitivity control")
- R₈, R₉—4700 ohm, 1/2 w. res.
- R₁₀—47,000 ohm, 1/2 w. res.
- R₁₁—33,000 ohm, 1/2 w. res.
- R₁₂—2200 ohm, 1/2 w. res.
- R₁₃—3300 ohm, 1/2 w. res.
- R₁₄—5000 ohm vol. control, with switch S₁
- R₁₅—68 ohm, 1/2 w. res.

- R₁₆—12 ohm, 1/2 w. res.
- C₁, C₂, C₃—C₁₀—Two-gang midgeet tuning capacitor, with trimmers; Ant. section, 10-208 μfd.; Osc. section 10-100 μfd. (Lafayette MS-270)
- C₁₁, C₁₂, C₁₃, C₁₄, C₁₅—0.1 μfd. disc ceramic capacitor
- C₁₆, C₁₇—0.05 μfd. disc ceramic capacitor
- C₁₈, C₁₉—5 μfd. disc ceramic capacitor
- C₂₀, C₂₁—10 μfd. 25 v. elec. capacitor
- C₂₂—100 μfd., 15 v. elec. capacitor
- C₂₃—2 μfd., 15 v. elec. capacitor
- C₂₄—0.5 μfd. disc ceramic capacitor
- L₁—Ferrite loop antenna (Lafayette MS-272)

- L₂—Osc. coil (Lafayette MS-265)
- T₁, T₂—Miniature 455 kc. i.f. trans.; pri. 25,000 ohms, sec. 600 ohms
- T₃—Miniature 455 kc. i.f. trans.; pri. 25,000 ohms, sec. 1000 ohms
- T₄—Audio input trans.; pri. 10,000 ohms, sec. 2000 ohms (Argonne AR-109)
- T₅—Audio output trans.; pri. 400 ohms c.t., sec. 11 ohms (Argonne AR-120)
- M₁—0.1 d.c. milliammeter ("Null Detector," Marion MM1)
- CR₁—1N64, 1N295, or 1N48 crystal diode
- P₁—3-circuit phone plug (see text)

- J₃—3-circuit phone jack (see text)
- B₁—9-volt transistor battery (RCA VS-300 or equiv.)
- S₁—2 1/2" PM speaker with 12-ohm v.c.
- V₁—"p-n-p" transistor (2N112 or 2N136)
- V₂, V₃—"p-n-p" transistor (2N107 or 2N135)
- V₄, V₅, V₆—"p-n-p" transistor (2N107 or CK722)

NOTE: With the exception of the starred items, all components listed are included in the Lafayette 6-transistor superhet kit, Model KT-119.

Complete schematic diagram and parts list for the transistorized marine direction finder described in the above text.

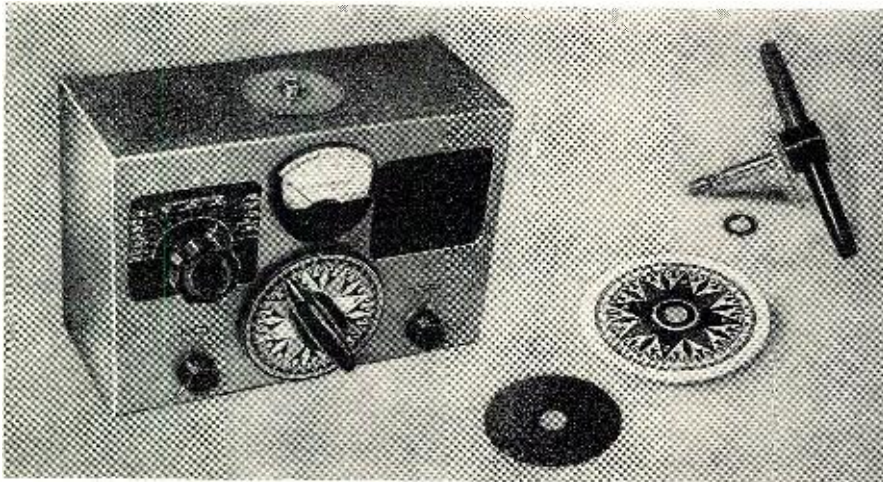

Fig. 3. The d.f. loop and its compass rose have been removed in this view.

spacer on the tip end of the plug and substituted a very small threaded bolt to secure it so that a shaft coupling could be mounted. The vertical right-angle shaft from the drive unit connects to the other end of the coupling. This provided means for uninterrupted (360°) rotation of the loop.

The average builder of this device can eliminate this somewhat complicated utility and simply provide a hollow shaft to the loop through which the leads may pass from the ferrite antenna to the tuning capacitor. This simplified technique should have means for limiting the rotation of the loop to 180 degrees. This will prevent damage to the leads as a result of twisting.

The ferrite antenna is ¼ inch in diameter and 3½ inches in length. Long flexible leads are provided by the manufacturer. Holding-tape is removed from one end and the leads are shifted to the center of the rod. For loop protection, the author utilized the plastic barrels from a ball-point pen. The cap of the phone plug was cut off and a slot provided so that the cap could hold the loop with a generous application of household cement. This, in turn, was cemented to the phone plug.

A handy selection of small aluminum dial plates was found in our junk box and these were utilized to mount the compass roses, as well as to provide spacers so that the compass rose can be rotated without engaging the shaft. A bit of ingenuity will be required if the builder prefers this refinement.

It is important to observe the polarity of the various electrolytic capacitors. The positive side of the battery connects through a switch to ground. A precaution should be taken to color-code the connecting leads to the battery as a protection to the transistors.

As mentioned previously, the layout for the components is not critical. However, it is recommended that the oscillator coil be located on one end of the chassis so that leads from the loop may be as short as possible. It is also important that access to the trimmers, located at the rear of the tuning capacitors, be provided, Fig. 4, as well as to keep wiring clear from the eyelets seen on the bottom of the i.f. transformers. The trimmers for the i.f.'s are reached through these eyelets by a small non-metallic screwdriver for peaking.

The chassis should not be mounted

Fig. 4. Rear view of transistorized d.f. is shown with its back cover off.

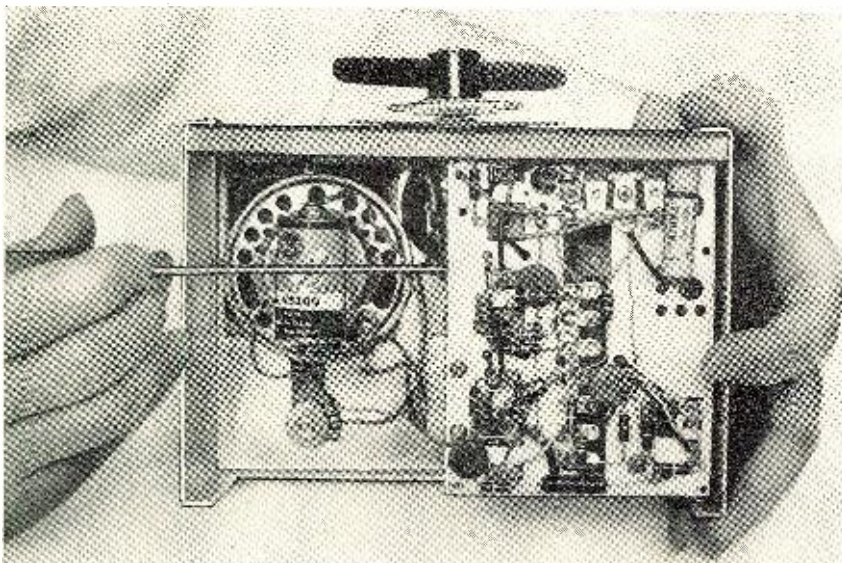

in the metal box until its performance is known and after all the transistors have proven to be functioning. It is a good idea to operate the receiver continuously for 24 hours as pre-insurance, after which a generous coating of *Krylon* should be applied. We mounted our chassis directly to the drive assembly and allowed enough clearance so that the rear cover would fit snugly, but without interference.

The only component that may be difficult to duplicate would be the compass rose. We were not successful in locating one printed on plastic or other stiff material, so we photographed a conventional rose (found in many boating books) and had a reduction made, one as a positive and the other as a negative. These were carefully cemented to aluminum dials and trimmed with a razor blade after drying.

Operation

Maximum signal from a broadcast transmitter tower will be at right angles to the ferrite antenna. When the ferrite antenna points directly at the source, the loop will show its lowest sensitivity. The use of such an antenna is therefore almost ideal for nulling simply because the assembly will actually point to the station in the same manner as sighting a rifle. The d.f. should be mounted on the boat at right angles to the "lubber line" or keel. When the boat is heading directly toward a signal, then the antenna will also point directly at the signal. The compass rose should be rotated until an imaginary line drawn through 360 degrees and 180 degrees is parallel to the keel of the boat with 360 degrees pointing dead ahead. All d.f. bearings will then be relative to the boat's heading. Boat owners will find much information in "The Light List" obtainable from the Superintendent of Documents, Washington, D. C., and from information contained in text books devoted to seamanship.

The above mentioned booklets also provide the boat owner with essential information as to the proper use of marine navigational aids and are recommended reading.

After you have built your transistorized direction finder and are satisfied with its operation, we suggest that you make continuous use of the unit in your boat under good weather conditions so that you have confidence in the instrument under storm conditions, in darkness, and during periods of heavy fog.

Two or more bearings should be taken on stations of known location and your position plotted on your chart. With experience, you can take three- and four-point bearings with this gear which has an accuracy of plus or minus two degrees—which should keep you out of trouble.

We have just learned at press time that a complete kit, based on this mechanical design, will soon be available from Heath. This is welcome news and will simplify construction and provide the compass roses and loop assembly as finished components.

-50-

Temperature Tests in Radio-TV Troubleshooting

THE USE of heat tests in troubleshooting, a procedure that is not new, is often effective in handling circuit faults that have escaped detection by other methods. There are two general approaches that may be useful.

The first of these approaches—also the more familiar—involves the use of a lamp or other heat-producing device to apply heat to circuit components. In the second method, an electric thermometer is used to measure the operating temperatures of various components.

As an illustration of the first method, consider a service job in which the receiver operates in a satisfactory manner until it is warmed up; then appear such trouble symptoms as raster-shrinking, sync pulling, or intermittent reception. These are typical thermal troubles.

By applying a heat lamp over various portions of the under-chassis area, the thermal trouble may be aggravated. In this way, the general area in which the troublesome component lies is localized. Next, a soldering iron may be brought close to (but not touching) individual components within this area, to help identify the particular capacitor, resistor, or other component that is thermally responsive. While practical experience shows that capacitors are the most frequent offenders with this type of fault and that resistors run second, it is also possible for transformers to develop leakage or shorts when their operating temperature is raised slightly.

This test method is fairly well known and is, in fact, put to use on occasion by large numbers of experienced technicians. Less well known, but equally useful, is the second method mentioned. In this technique, a faulty component is localized, not by artificially elevating its temperature to cause breakdown, but by measuring operating temperature in the presence of faulty operation.

The basis for the test is not an innovation: actually, we are putting this same principle to work whenever we inspect resistors for charring, or whenever we touch various other components to determine whether they are running "hot." However, the test becomes more accurate—and considerably more useful—when an electric thermometer is used. One such instru-

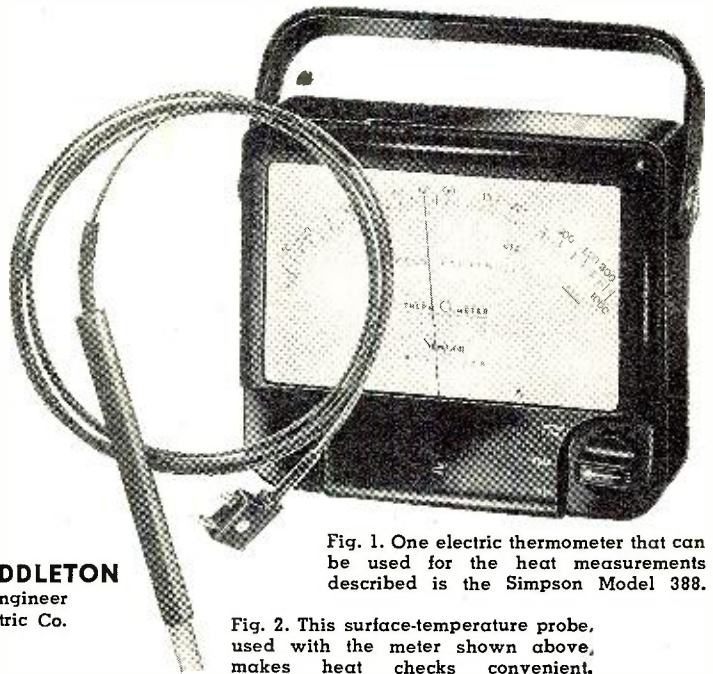

By

ROBERT G. MIDDLETON
Chief Field Engineer
Simpson Electric Co.

Fig. 1. One electric thermometer that can be used for the heat measurements described is the Simpson Model 388.

Fig. 2. This surface-temperature probe, used with the meter shown above, makes heat checks convenient.

*An electric thermometer can pay its own way
by turning many "dogs" into routine repairs.*

ment, the *Simpson Model 388* "Therm-O-Meter," is shown in Fig. 1.

An instrument of this type has the wide range (over 1000 degrees Fahrenheit) that is required for practical test work. Thermometers with more limited indicating ranges may become damaged if accidentally applied to very hot spots on a chassis.

Another important feature of the instrument is the surface temperature probe, shown in Fig. 2, which permits heat to be applied effectively and conveniently to the meter by way of the temperature-sensing element in the probe.

For the purpose of using temperature testing as a troubleshooting technique, it is important to know what heat readings to anticipate with various types of components. Capacitors normally run quite cool: they are practically at the ambient temperature in their chassis area. However, if a capacitor is leaking, there is a voltage and power drop across it. This will cause its operating temperature to exceed the temperature of other capacitors in the circuit nearby. Comparative tests, then, will often put a leaking capacitor on the spot when the electronic thermometer is used.

The question may arise here of whether determination of defectiveness in a case like this one could not be made without the heat-sensitive device, using a simple "touch" or "finger" test. However, a rise in temperature that can be noted unequivocally on the instrument may yet be too small to show up on body contact.

As for resistors, it is normal for them to operate above ambient temperature. For this reason, comparative

tests against the operating temperatures of resistors in similar configurations take on greater importance in ferreting out circuit faults. The following is one example of how such a check would be made in one circuit. It is suspected that the screen-dropping resistor in the second stage of a three-stage amplifier is running hot. Its temperature is checked and compared to the temperatures of the screen resistors in the first and third stages. If it is found to be running considerably hotter than the other two, immediate investigation is obviously in order.

Likewise, if a decoupling resistor is running substantially hotter in one stage than similarly functioning resistors in nearby similar stages, additional checks in the related circuit would be called for.

The method can be carried further, if necessary, by making comparative checks of the operating temperatures of tubes, too, in similar receivers. Let us suppose, for example, that the horizontal-output or damper tube in a defective receiver is appreciably hotter than the same tube or tubes in a reference receiver. Trouble is indicated in the associated circuit. The converse of this proposition also holds true: if the tube in the first receiver is cooler than its counterpart in a reference receiver, trouble is also indicated.

No argument is being made in behalf of heat measurement as a panacea for all troubles. However, the technique is advanced as one more useful approach that can turn certain types of "dogs" into fairly simple repair jobs often enough to make the investment in an additional piece of equipment well worth while.

Motorola Color TV Receivers

Fig. 1. Motorola Model 21CT2 color receiver, showing convenience of adjusting convergence with the separate subchassis, which can be removed from the cabinet with the hinged top swung back.

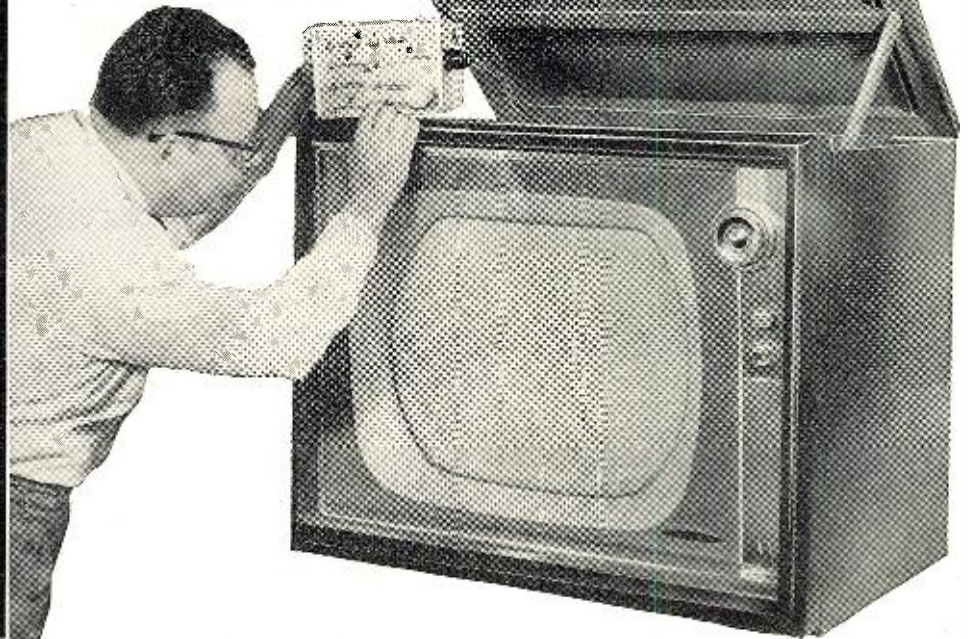

By **ROBERT GARY**

New tubes, new circuits, and an improved method for obtaining convergence adjustment are noted.

COLOR TV sets are being offered by more and more of the large-volume manufacturers. In 1956, many TV firms felt that they could still make money on black-and-white sets as long as they used small-size picture tubes and sold them at low prices. Now it becomes increasingly evident that this philosophy will not keep the receiver market booming indefinitely. With color sets, on the other hand, there has been no appreciable slump, although sales are still modest. *RCA* managed to sell practically everything it made in color. As our readers will know from recent articles, *G-E*, *Sylvania*, *Hoffman*, and other manufacturers have joined *RCA* in the color TV field. Now *Motorola* may be counted in.

It may be remembered that, two years ago, *Motorola* started to offer a 19-inch color model, but that, after a short time, this set was discontinued. The new 1957 *Motorola* color TV receiver is, in many respects, similar to other recent color sets, but there are some distinctive features. The color decoder circuits are unique, and *Motorola* has done considerable development work on a more precise system for adjusting purity and convergence. These new circuits, additional adjustment procedures not used on other color sets, as well as the mechanical features of the new *Motorola* Models 21CT2 and 21CK3 are of definite in-

terest to those who wish to keep up with color.

At the time of writing, only two cabinet styles have been announced. One, the Model 21CT2, shown in Fig. 1, is a compact consolette available in sienna mahogany and Swedish oak. The second, Model 21CK3, is a modern-style console, available in the same type of finishes and featuring tapered legs with self-leveling glides. Both cabinet styles house the same chassis and have the same service arrangements. The only controls openly available are the channel tuning, a push-button type "on-off" switch, and a dual control for volume and contrast. All other controls are either located under the subpanel, the rear of the chassis, or on a separate subchassis which can be removed for convergence and purity alignment. The consolette has a small loudspeaker mounted at the side of the cabinet while the Model 21CK3 has the speaker below the screen.

The set uses conventional wiring and parts; no attempt has been made to employ modules, printed circuits, or any other novel assembly method. Instead, both the mechanical and electrical design features of this receiver show that *Motorola's* engineers have emphasized reliability and circuit performance. Since servicing will always be required to some extent, accessibility of all adjustments and an ample

number of test points have been provided. Technicians will find this receiver easier to handle than some earlier models.

A total of 29 tubes plus the picture tube is used. As in most color sets, a great many of the tubes are multiple-purpose types incorporating several tubes in a single envelope. Latest tube types used here are the 6BV8 (a triode and dual diode), 6AU8 (a pentode-triode), and the 6BH8 (a pentode-triode), each contained in a nine-pin miniature glass envelope. Most of the other tubes used are in the usual color set complement. The power supply consists of a conventional power transformer with two 5U4 rectifiers followed by a pi filter network.

The tuner is a cascode type with u.h.f. attachment optional. Four i.f. stages are used, followed by separate video and audio detectors. The 4.5-mc. intercarrier sound section as well as the "Y" channel are conventional.

Vertical and horizontal sweep, h.v., and the color-sync section are also very similar to those previously described in this publication for other sets. A crystal-stabilized 3.58-mc. oscillator furnishes the demodulating signal to the novel color demodulators. The chroma amplifier and the color-killer circuit controlling it are also well known, but the color demodulating section is worthy of some detailed discussion. As shown in the circuit of Fig. 2, the last bandpass amplifier acts as a cathode follower and drives two sets of diode demodulators, which provide the red and blue color-difference signals to the following video amplifiers.

The principles of operation of this type of circuit are identical to those used in the phase-detector circuit

found in horizontal and some color-sync sections. Consider first the signals applied through C_3 and C_4 in Fig. 2. Due to the arrangement of L_1 , these two signals are of equal amplitude but are 180° out-of-phase. At the common junction of the opposite diode sections, the locally generated 3.58-mc. color-sync signal is applied. The phase of this latter signal is that of the reference signal as sent out by the TV station.

If there were no phase difference between this and the chroma signal, no voltage would appear at the junction of R_2 and R_3 . Actually, the difference in phase determines the polarity and amplitude of the "error" voltage, except that in this case the "error" voltage is the desired color video signal. In horizontal-sync circuits, the voltage developed at the junction of R_3 and R_2 would control the horizontal-oscillator frequency. The two series coils, L_2 and L_3 , are self-resonant at 3.58 mc., and act as filters to keep the color-sync signal out of the video section.

As in many other receivers, the third color-difference signal is obtained by mixing the output of the red and blue amplifiers and feeding it into a third video amplifier, which then feeds the green color-difference signal to its particular grid in the color picture tube. While the 3.58-mc. oscillator is not shown in Fig. 2, its output network consists of L_4 and L_5 , which must be set to give the proper phase relationships at the demodulators. Over-all phase is varied by the color-phase control potentiometer, located under the subpanel on the front of the receiver.

Another novel circuit feature in the Motorola set is the addition of three new adjustments in the deflection and convergence section. Fig. 4 shows the top view of the receiver with the top panel tilted upward. Just above the deflection yoke, a small box is visible, its hinged top opened. Inside are the horizontal-yoke balancing coil and the vertical-yoke balancing pot. A lead is visible going to the round, black cardboard-enclosed blue lateral-size switch. This switch is also visible in the photograph of Fig. 6, the rear view of the chassis in the cabinet.

From the circuit of Fig. 3, the operation of these controls can be examined. The horizontal yoke-balancing coil permits adjustment of the current flowing through either of the yoke coils. It should be noted here that the deflection coils are connected in parallel while, in most previously described sets, they have been connected in series. As the horizontal balance adjusts the relative linearity of the horizontal deflection coils, so does the vertical control permit balancing the vertical coils. Again a parallel connection is used. The diagram of Fig. 3 shows only the simplified circuit with the centering controls and their bypass capacitors omitted, for the sake of clarity.

All color sets reviewed to date have used a permanent-magnet blue lateral-position magnet. This magnet is re-

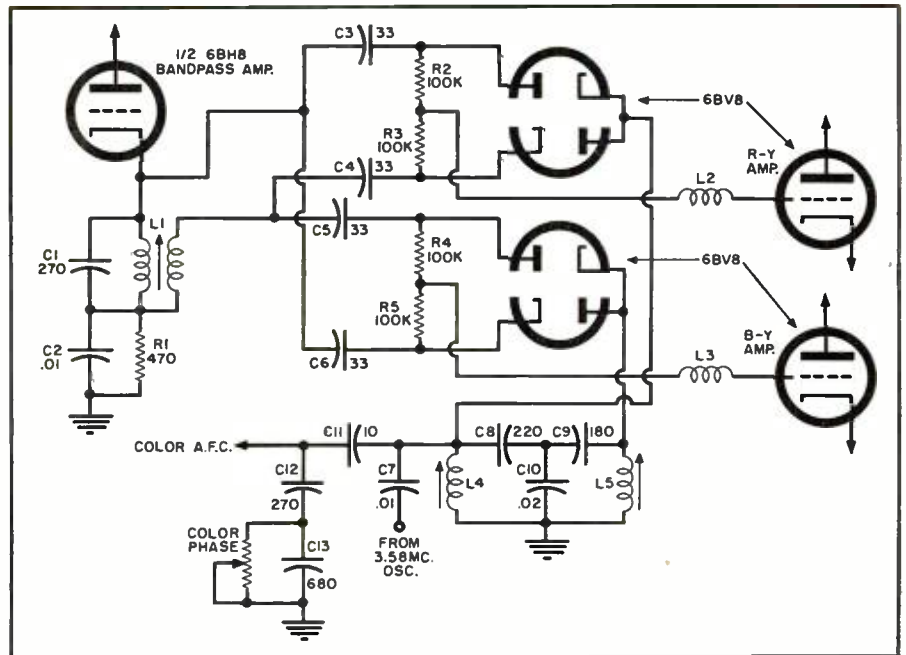

Fig. 2. A cathode-follower bandpass amplifier drives two sets of demodulators.

quired to position the blue electron beam laterally with respect to the other two colors, an adjustment made for good static convergence after the convergence magnets have been set up correctly. To permit a more accurate adjustment, Motorola uses an additional tapped coil and a switch which permits variation of the magnetic field without moving the magnet physically. As apparent from Fig. 3, in addition to the d.c., there is also a small 15-kc. saw-tooth component acting on the lateral magnet which will improve the convergence of the blue beam at the edges of the screen.

At the right side of the deflection yoke in Fig. 6, two small tabs are visible which permit the adjustment of the top and bottom keystone-corrector magnets. In addition to these novel linearity adjustments, the receiver also

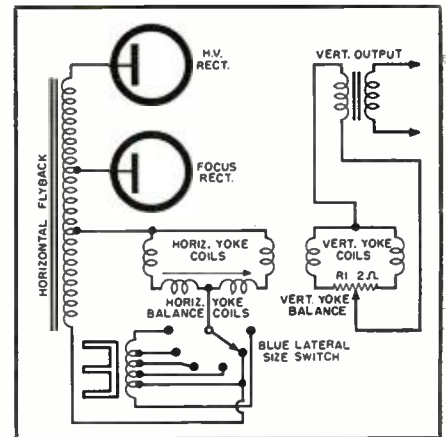
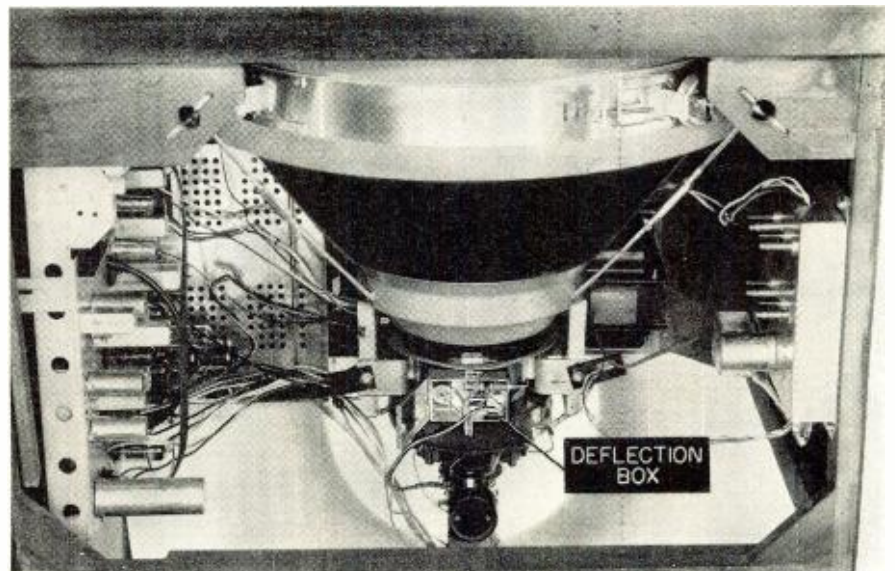

Fig. 3. Vertical and horizontal yoke coils are parallel-connected. The horizontal balancing coil and vertical balancing potentiometer are shown.

Fig. 4. The deflection box, viewed from above with hinged top open, houses the yoke balancing controls. One lead goes to the blue lateral-size switch.



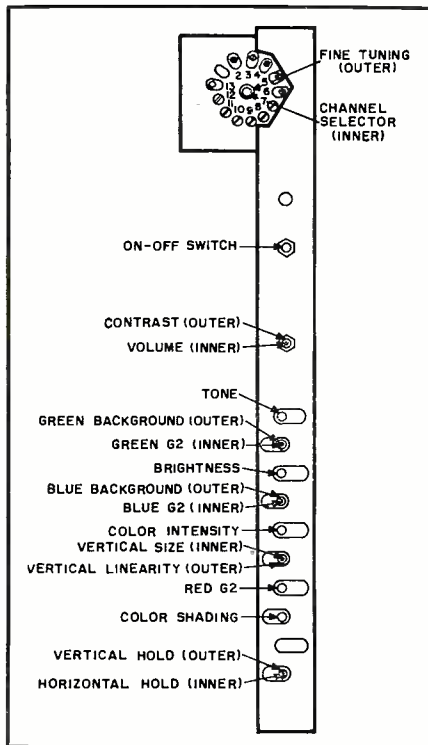

Fig. 5. Controls on the front subpanel.

has the purity, convergence, and neutralizing-magnet adjustments, found in all other color TV sets. The remaining color controls, such as the gray-background, gray-scale, and chroma-gain controls, are very similar to previously described circuits.

Color Adjustment

As mentioned in the beginning of this article, all service controls are concentrated in three areas: the subpanel on the front, the rear of the

main chassis, and a separate subchassis which can be removed for servicing. Fig. 5 shows the location of these controls on the front subpanel. Fig. 1 shows how, by lifting the cover, the convergence subchassis can be removed and adjustments made from the front of the set. Since the adjustment of the customer-operated controls has been described many times before, we shall concentrate here on the unusual procedures required for the *Motorola* set and also cover those service adjustments which are made in connection with the novel circuitry already noted.

First adjust the vertical and horizontal controls for the correct monochrome picture stability. Adjustment of these controls will have some effect on the convergence system; for that reason, they should not need further setting after the initial setup. The horizontal-sync circuit is especially subject to marginal adjustment, and should be checked on all channels. Both centering controls will also affect convergence, and should therefore be set accurately on the monochrome pictures of various channels.

Next, adjusting the high-voltage, contrast, and three screen-voltage controls for a proper shade of gray with correct brightness and contrast is in order. To remove the convergence subchassis, open the hinged cabinet top and loosen the subchassis mounting screws. The rear panel of the cabinet must be removed in order to get to the two locking bars at the inside of the cabinet which hold the hinged top in place.

Once these bars have been retracted, the top cover can be raised from the front and propped open by the small wooden brace provided for this purpose. The subchassis can be slipped out without unscrewing the screws and

there is sufficient cable length, as shown in Fig. 1, to permit operating the receiver with the convergence subchassis held in front of the screen. For d.c. convergence, which is the first step, the dynamic-convergence circuitry can be disabled by disconnecting the octal plug from the subchassis.

The manufacturer suggests that, for red-purity adjustment, the blue and green grid leads be removed from their plugs on the main chassis and plugged into adjacent grounded jacks. Without any station being received and with rather low brightness setting, the red-screen control is set for a red background. Then the purity magnet is adjusted for the largest possible purely red area. Moving the deflection yoke forward or backward will show the best position for red purity around the edges of the raster. Neutralizing magnets are adjusted in the usual manner for best over-all purity. Next the procedure is repeated individually for the green and blue fields, and any necessary compromises and re-adjustments are made until a satisfactory gray raster is obtained.

A cross-hatch pattern can be used for adjusting the d.c. convergence by means of the three permanent magnets on the convergence assembly and by positioning the blue lateral-correction magnet. Set the switch on top of this magnet for zero current, which is the second position as indicated on the circuit diagram in Fig. 3.

Observe the red and green horizontal lines at the center of the screen and adjust the tuning slug of the horizontal yoke balance coil until these lines are parallel to each other across the entire center of the screen. This coil is located in the little box over the deflection yoke, but the adjustment handle protrudes over the side of the yoke housing. The top keystone corrector magnet is adjusted until the green and red horizontal lines at the top of the raster are parallel across the screen. Similarly, the bottom keystone magnet is set for parallel green and red lines at the bottom of the screen.

The purpose of the vertical yoke balance adjustment is to give equal deflection over the upper and lower halves of the screen. To check this, observe the relative position of a green and red horizontal pattern line at the top and at the bottom of the screen. If, at the top, the red line is above the green, while at the bottom the green line is above the red, the vertical yoke needs better balancing. The correct setting of the potentiometer on the yoke housing is achieved when the red and green lines are in the same relative position at the top and bottom.

With the cross-hatch pattern still on the screen, the blue horizontal-size switch is varied until, at the left and right edges of the raster, the blue vertical lines fall *between* the red and green vertical lines. Once all these adjustments are made, the convergence subchassis is connected again, and the

(Continued on page 141)

Fig. 6. Rear view of receiver, with keystone adjusting tabs highlighted.

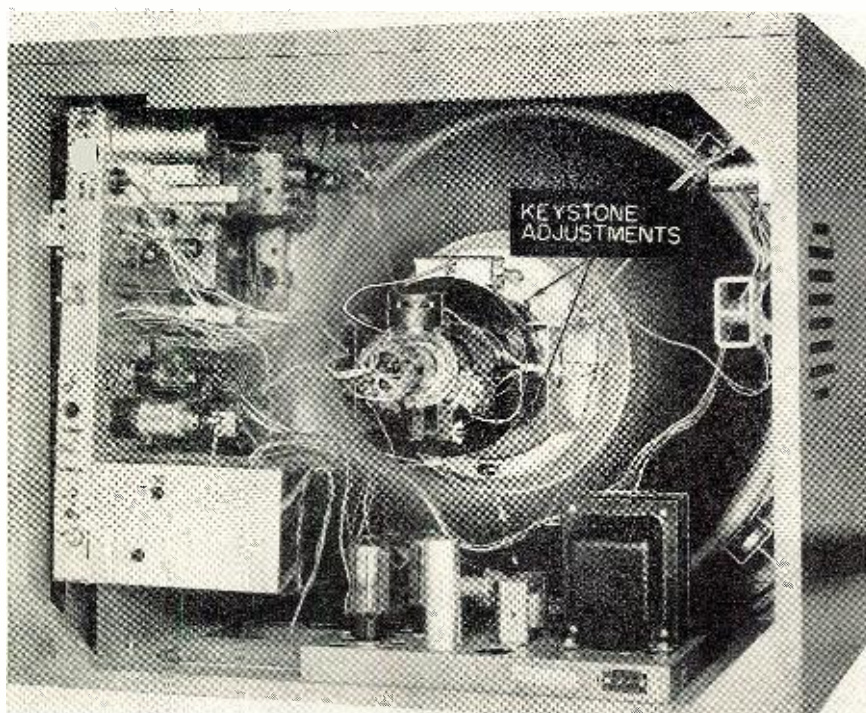



The "SR-200" Hi-Fi Control Amplifier

Shown on the table are the control amplifier (left) and matching AM-FM tuner unit.



By
L. W. RAYMENT

Sargent-Rayment's new control amplifier has unique styling and unusual variable rumble, scratch filters.

TO THE casual observer, the problems of high-fidelity reproduction of sound would appear to have been pretty well solved—at least insofar as the purely electronic aspects of the reproducing chain are concerned. Time and again one reads that our electronic problems are over, and that now we must go to work and make the transducer elements (loudspeakers and pickups) the equal of amplifiers.

One would certainly be naive to think that the electronic elements of the high-fidelity reproducing chain are not far and away superior to the transducer elements, at least as far as distortion, frequency response, transient response, etc., are concerned. But it is because of this very fact, *i.e.*, relatively high distortion in the non-electronic elements, that it has been felt here that much could be done to improve the over-all quality of the *whole* reproducing chain by incorporating some electronic innovations. These innovations were designed to compensate for the inadequacies of the transducer elements.

To do this, it was first decided that a survey should be made in order to determine what sound-system problems are encountered by the average high-fidelity fan. It was thus hoped that by designing an amplifier around these particular problems it would be possible to come up with a new amplifier that would contribute to the listening enjoyment of the average audiophile. It was found, as one might suspect, that when conditions were ideal throughout the reproducing chain the sound was very good indeed. But it

was also found that conditions were rarely, if ever, ideal.

To the surprise of some, it was evident quite early in the survey that high power was *not* one of the main problems (more on this later). Similarly, frequency response, important as it is, was not found to be a burning issue (probably because frequency response is so good in most present-day amplifiers). Instead, a somewhat insignificant factor was found to be the biggest obstacle to pleasant, high-fidelity reproduction: *worn records!* To the purist (and rich) this is only a matter of always playing new or nearly new records; but the average individual with a reasonably good system finds that after he has played a record a dozen or two times he no longer plays it because of the fuzzy sound that has begun to appear. Tape, of course, offers a wonderful solution to this problem of rapid record wear, but there are still a very small number of tape selections available, particularly when compared to the LP catalogue. The obvious practical solution to this worn record problem seems to be some sort of high-frequency filter.

Several step-type designs were tried, but all had only limited use in that they either cut off too much of the highs or too little. Also, many of them tended to peak just before the cut-off frequency, thus giving the resultant sound a harshness that is unpleasant.

By designing a *continuously* variable, non-peaking filter it was found that precise rejection of the worn record "buzz" could be effected, and without eliminating any of the usable frequencies. This circuit employs no unusual parts, nor is it tricky or unstable. Further, it contributes practically no distortion to the signal. It is incorporated in the diagram of Fig. 1 as the "Scratch Filter" section, shown in heavy lines at left of circuit. Using a standard 365 $\mu\text{fd.}$ -per-section, three-gang AM tuning capacitor as the variable factor, the filter achieves the 18 db-per-octave cut-off, and is continuously variable from 2000 to 20,000 cycles, thus giving a very large number of cut-off frequencies and the most efficient possible filtering action. It is quite amazing how much better even slightly worn records sound when played with this filter in the amplifier circuit. As can be seen from Fig. 2 with the bass and treble controls set "flat," the cut-off is quite sharp, preventing the control from being used as a tone compensator by the uninitiated. Also, there is no audible peaking just before cut-off.

Second among the annoying problems that were discovered was one of low-frequency noise, whether it be hum or turntable rumble. Speakers reproduce so well in the low end that, except for the most expensive, almost all turntables (and changers, more so)

basis for the circuits used in the SR-200, but more extreme equalization was found necessary in some rooms than is provided for in ordinary Fletcher-Munson compensation. Hence a very wide range of compensation is provided in the final design. Obviously, someone will ask why ordinary tone controls would not do the same job. The answer is that tone controls give an entirely different type of result from that of a properly designed balance control. The reason lies in that the *point* of boost or cut in tone controls is usually fixed, while in the balance control the *point and amount* of control can be varied with different settings, the shape of the resultant curve having been determined beforehand by the specific function the control is to perform. Accordingly, a pleasing balance is possible in any room, using this very widely variable control.

Another extremely important problem that the average audiophile encounters is that of his wife refusing to allow the amplifier in the living room unless it is cabineted in a large, expensive piece of furniture. In designing the SR-200 cabinet the industrial designer was instructed not only to make the unit appealing to the eye, but also functional. Thus, as can be seen from the photo the controls can all be clearly seen whether one is standing or seated in a chair near the amplifier. Further the knobs are mounted on a cantilevered section which makes for easy gripping of the knobs, and avoids hand cramping positions. The slide-rule-type dial indicates all of the phonograph equalization positions as well as the various inputs that are provided. This makes for easy identification of all functions, and further pleases the "better half" in that an engineer is not required to determine what is going on. The dial is edge-lighted, and the pointer is cabled through a detent, making each position discrete.

While it was not the engineer's desire to neglect the fundamentals of good amplifier design (low distortion, good power capabilities, etc.) the more unusual features have been discussed first. As stated earlier the problems of frequency response, distortion, etc., have been solved quite well before. In the SR-200 a high-quality circuit is used, based on a fairly straightforward screen-tap-type output stage driven by a cathodyne phase inverter. The advantages of triode operation are thereby achieved, but with considerably greater power handling capabilities than would occur in straight triode operation.

Power handling capabilities exceed 20 watts over the entire rated frequency range. While we do not wish to become involved in the amplifier-power argument that is currently raging, we have tested with the most inefficient cloth-surround speaker we could find; and in a cabinet that is essentially acoustically dead (not a horn or reflex which allows some of

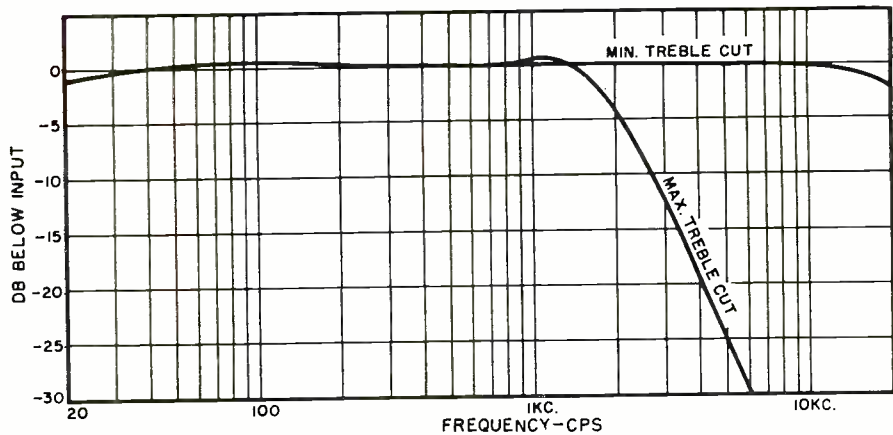

Fig. 2. Operation of variable scratch filter is shown by these response curves.

the rear radiation to be used). In a room of considerable size (20 x 32 x 9 feet), and at a volume level even the deafest of audiophiles considered ear-splitting, it was found that even on the most extravagant peaks the power used never exceeded 12 watts²; so it was felt that 25 watts should suffice for home use! Further, an A-B test was set up using a high power amplifier (50-60 watts) along with a 14-watt job.

Several persons with highly trained ears, *i.e.*, musicians, audio consultants, etc., were asked to listen to each and to indicate which had the lower distortion. Even at very high levels and with the same inefficient speaker system, not one of the panel of experts was able to distinguish between the two amplifiers. Of course, on peaks or "tone bursts," an amplifier capable of 15 watts can well reach 30 to 40 watts. Honest ratings were confirmed before these tests. In any event, with true ratings the *two amplifiers sounded* the same. And with the more usual type of speaker that is more efficient, it could probably be shown that considerably less power output from the amplifier would produce the same results.

As is almost commonplace these days, total harmonic distortion at mid-range is under .3 of one per-cent, while at the extremes it rises to only 1% at 22 watts output. IM distortion is below 1.5% at 18 watts. Although 20 db of feedback is used to lower the distortion even more, the amplifier has no

tendency to oscillate at supersonic frequencies, and the more-than-adequate power supply filtering and care in maintaining proper time constants has prevented any low-frequency instability. As is usual in this sort of circuit, feedback is carried from the secondary of the output stage back to the first post-tone-control voltage amplifier cathode. Balancing of the power amplifier is achieved through the use of special, 1% tolerance, precision resistors, rather than through the use of potentiometers. It was found that even though balancing potentiometers are properly set at the factory and later at the time of sale, components tend to change value as they age, thus throwing the amplifier out of balance. Also someone often seems to unwittingly change the balancing potentiometer setting, also resulting in unbalance. Precision resistors of the type used in the SR-200 allow extremely close balance to be maintained throughout the life of the amplifier without any adjustments whatever by the user.

The output transformer has a tap at 4 ohms as well as 8 and 16 ohms, in recognition of the increasing use of 4 ohm speakers. Damping controls were avoided, as it was found that most damping control circuits that are *audibly* effective are, in reality, nothing more than post-amplifier bass boosting circuits. Those that do not make an appreciable audible change were found to present a problem not entirely un-

(Continued on page 98)

Fig. 3. The operation of the twin-T variable rumble filter may be seen here.

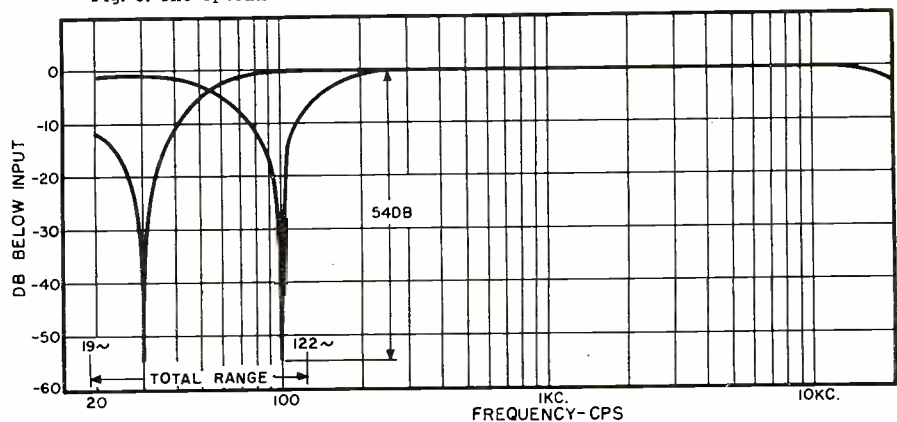

Selling Service

By WILLIAM LEONARD

All business is more or less "seasonal". Try these business stimulators to level out the "valleys".

EVERY four years, the electronic service industry enjoys a six-month business boom that tends to breed a feeling of complacency about the future. The succession of events starting with the quadrennial national political conventions and continuing on through the fall and winter months generates a lot of TV service calls. Business is so good that, during its peak, most service dealers bemoan the fact they cannot get enough technicians to handle the requests for service.

The rude awakening that the business is still highly seasonal starts with the first warm days of spring when indoor entertainment starts to play second fiddle to yards and parks and the open highway. The volume of service calls dips sharply. As business starts its sharp slide the average service dealer begins to wonder where he will find the money to meet his operating expenses and pay his bills during the summer months ahead.

Every business that caters to the general public has similar seasonal business problems. Some types of businesses have adopted industry-wide sales programs to cushion these drops in volume. A good percentage of the public will buy "out of season" when they are offered what appears to be a bargain. People who understand the "merchandising" of products to the general public prepare their most aggressive promotional programs for the known off-seasons for their merchandise.

Service can be merchandised like any

tangible product. Without reducing rates or income, bargain packages of service can be offered during the normal off-seasons that will inspire many people to have work done that they otherwise would put off until fall.

July and August have always been the roughest months in the electronic service business. One of the old, reliable stand-bys in selling radio service during the summer months is to offer a bargain package. This is an offer to service any five- or six-tube table model radio for a nominal charge, like three dollars for labor plus parts. In several instances shops that aggressively promoted a package of this kind had to set up a repair production line to handle all of the sets that came in. Similar summer-time service specials on TV sets have been equally effective in producing business when it was most needed.

To be effective, service specials must be promoted vigorously and intensively. They require a series of promotions. A single card, letter, or flyer will not do it. Striking postcards or handbills must be made up and distributed at regular intervals during the period of the promotion. Each piece in a well-planned campaign has a cumulative value in getting customer attention and action.

The most important factor involved in putting on a business-creating service-selling program is the planning of the campaign in all of its details. In addition to the planning of the cards or flyers that are to be used, attention

should be given to the possibilities of the telephone and the ways technicians can generate the interest of neighbors of their TV service customers.

MAY
JUNE
JULY
AUG.
SEPT.
OCT.
NOV.
DEC.

Since July and August normally are the worst months of the year for a TV service business, promotions to stimulate business should be focused on the period from the middle of July until the end of August. Early in June a study should be made of the trade area in which the promotion is to be carried out. The purpose of this study should be to determine the type of special service offer that will be made and the method or methods to be used in conducting the campaign effectively and economically. The dealer should estimate the number of homes he must reach with his promotion material to supply the volume of business he needs. His survey should tell him about the size of the residential area he will have to cover to reach his objective. Finally, the amount of money that can be allocated to finance the program will be the determining factor in the type of media that can be used.

In the normal service area of the average shop, it is possible to cover from fifteen hundred to three thousand homes with cards or flyers distributed house-to-house. Most high schools have a student employment bureau that welcomes all job opportunities for students who register for off-hours work. Students who are placed on jobs by the school bureaus usually are diligent in carrying out the work assigned to them. They are reliable in distributing material to the homes.

The general plan for the campaign should be determined no later than the middle of June. This will allow ample time to get the printed material that is to be used in the promotion. If several pieces are to be distributed in the same area, copy should be prepared for all of the pieces with the advertising messages focused on the "service special."

The most economical way to have special promotion material printed is by the photo-offset process of printing. Striking cards and flyers can be made up by combining copy from manufacturers' consumer advertising pieces. The printer will help to make up the circulars or cards so that they are both professional in appearance and effective in getting the "service special" idea across to the reader.

If all of the printing and planning details are completed before the campaign starts, the dealer can concentrate his attention on carrying out the program. After a dealer has put on one long-range program of this kind the experience he gains is invaluable in planning all of his future business promotional activities.

There are times when some dealer dreams up an ingenious "one-shot" promotion that results in the stimulation of business over a long period of time. This type of promotion is usually developed around some type of "gimmick." A program of this type

(Continued on page 165)

Maintain and Repair Your Own Sweep Generator

By **WALTER H. BUCHSBAUM**
Television Consultant, RADIO & TV NEWS

Don't lose the use of this instrument because it is out for repair. You can learn to recognize and correct many common troubles on your own.

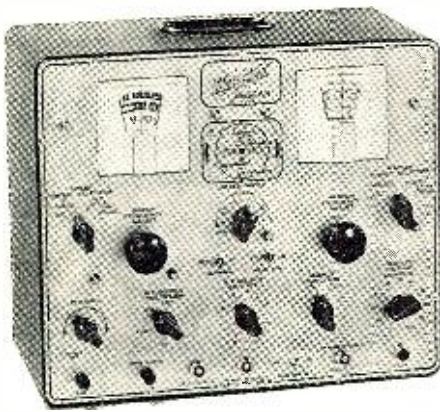

Typical sweep generators for use in service shops include units by Hickok (top), Precision (center), and EICO (bottom).

THE OLD saying about a craftsman being no better than his tools still applies to such an advanced technical field as TV servicing. A service technician is limited in his work by the tools and instruments he has available. If half of his instruments are out of order, his efficiency suffers and in the end he is reduced to the level of the screwdriver mechanic.

Most test equipment is designed for years of service and should require little attention. Nevertheless, whenever tubes are used, for example, a certain amount of aging must be expected, as well as outright failures. In some types of test gear, the sensitivity of the unit will decline as the tubes grow gradually weaker. Unless occasional calibration checks are made, erroneous readings can be obtained. Some marginal TV receiver troubles, which seem so difficult to locate because they give only slightly wrong readings, can be complicated by poorly calibrated test equipment.

Readers are surely familiar with the need to recalibrate an ohmmeter frequently because of the aging of the batteries. Less well recognized is the need for calibrating and adjusting the v.t.v.m., oscilloscope, sweep generator, marker generator, and others. Yet insufficient output from the latter two instruments will often result in unnecessary troubleshooting and even wrong diagnoses.

Before dealing with the specific problems of test equipment maintenance and repair, a few words of caution must be offered concerning the extent to which test equipment *should* be repaired by the service technician. Whenever a warranty is still in effect, the owner will naturally want to have the manufacturer repair his product. If it appears obvious that a tube substitution will cure the trouble, this is often simpler than shipping a piece of equipment back. If, however, extensive troubleshooting is required or special parts must be replaced, it is wiser to utilize the warranty and return the unit. Certain types of very critical calibrations require voltage or frequency standards which the service shop does not usually have. For that reason, either the manufacturer or some specialist must be contacted. This applies especially to meter movements, r.f. field-strength indicators, frequency meters, and the like.

The immediate interest of this article is the maintenance and repair of TV sweep generators.

The one thing common to every sweep generator is the nature of the output signal. This signal is at the frequency of some TV channel, but varies rapidly back and forth within a certain band. For example, when a generator is set for channel 6, the r.f. output signal will usually change from 80 to 90 mc. at a rate of 60 times each second. The effect is the same as if some very rapid operator were to twirl the dial of an oscillator back and forth.

Sweep Generator Principles

Electrically the frequency sweeping action is performed either by some mechanical device, like a vibrator or motor-driven capacitor, or else this is done electronically by modulating a frequency-sensitive circuit with a 60-cycle signal from the power line. When the sweep signal thus produced is applied to the TV set, each frequency is amplified according to the frequency characteristic of the receiver. At the second detector (usually) the higher frequencies are removed and the remaining envelope corresponds to the frequency-response curve of the receiver circuits through which the signal has passed. To view this curve on the oscilloscope it is only necessary that the horizontal-deflection circuits of the latter instrument operate in synchronism with the frequency-sweeping mechanism of the sweep generator. This synchronism is assured by feeding the horizontal-sweep signal directly from the generator to the oscilloscope.

Fig. 1. Typical alignment set-up for sweep generator, receiver, and scope.

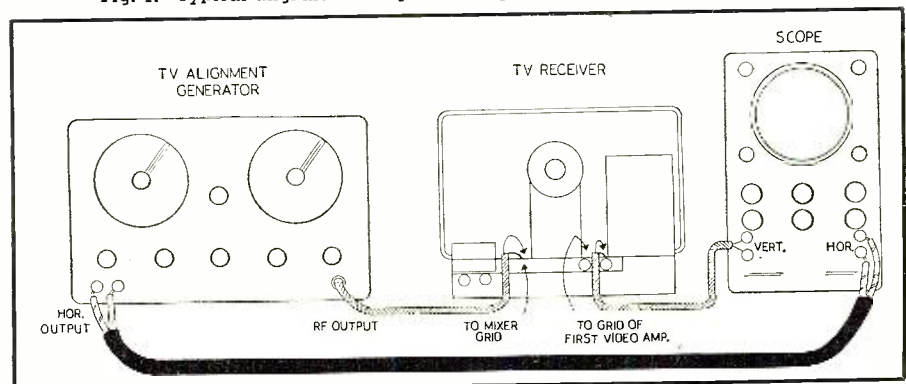



Fig. 2. Degrees of phasing adjustment without blanking of return trace.

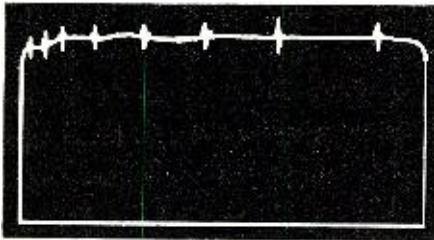

Fig. 3. Frequency markers 1 mc. apart expose frequency nonlinearity in sweep.

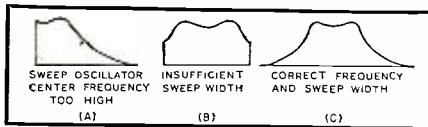

Fig. 4. Response curves may be distorted by incorrect generator adjustments.

A typical sweep-generator set-up is shown in Fig. 1. This is the one recommended by the *Heath Company* for its alignment generator. To avoid the usual double trace due to slight phase shifting in the oscilloscope leads and amplifiers, most sweep generators cut the oscillator off during one half of its cycle. To insure proper frequency linearity, provision is made to adjust the phase of the scope sweep signal with relation to the actual frequency-sweeping device in the generator. This adjustment is made with both traces visible as shown in Fig. 2, for best coincidence of both traces. Trace (A) demonstrates optimum phase coincidence, while traces (B) and (C) show varying degrees of phase displacement.

Almost all sweep-frequency generators can be set for at least the v.h.f. TV channels and the i.f. bands. Naturally, when the tuner is aligned, the sweep generator will be set for the channel under study. If only the r.f. bandpass is observed, the oscilloscope can be connected to the test point on the mixer grid provided on most TV tuners (through a 1-meg. resistor). This point corresponds to the mixer grid-leak bias, which provides an indication of the frequency response of the circuits preceding it. To check the i.f. amplifiers the signal may be injected

either at the mixer or at some later stage.

Unless the second detector is used to demodulate the response curve for the scope, a separate diode probe must be used. Quite a few sweep generators, nowadays, have built-in markers to indicate certain frequencies, usually the video carrier and the sound carrier of the channel under study. For calibration and repair purposes, it is usually best to have an additional source of known frequency markers, and most technicians ordinarily use the sweep generator in conjunction with an external marker generator, often crystal controlled.

Performance Requirements

Ordinarily the sweep generator used for TV servicing is expected to live up to certain minimum standards without which it is hardly useful. Whenever these lower limits are reached, it is time to devote some attention to the device to bring its performance up to original specifications.

The quality of the r.f. or i.f. output signal is judged by its amplitude, sweep width, and the flatness or uniformity of the output over a sweep band. Typical minimum values for sweep width are 12 mc. for channels 7 to 13, 10 mc. for channels 2 to 6, 6 mc. for i.f. alignment and at least from 100 kc. to 5 mc. for the video. How sweep width and the rest of the parameters are measured and how they can be adjusted are described later.

The r.f. output can be measured in several different ways, depending on whether power or voltage is considered and what load is used. For our purpose, absolute values are not required and the voltage output of a high-impedance detector is measured. If the output of a standard diode probe connected to the sweep generator is at least 0.1 volt, the r.f. amplitude is sufficient for most needs.

The sweep generator output should be reasonably uniform within any band it is expected to sweep. Any point in a swept bandwidth should not be more than 3 db from any other point in the same band. A typical, acceptable instrument, for example, may have an output that is substantially flat over its maximum sweep width, with a slight drop-off of about 1 db at one of its ends. The phasing control should have a range of at least 120 degrees,

or better than half a turn on the *un-blanked* pattern produced in the scope.

Frequency linearity, another important attribute, is measured by comparing the frequency spread covered by a given horizontal distance on the scope trace with another similar distance on the same trace. Nonlinearity will usually show up as a difference in this spread between one end of the trace and the spread at the center portion of the trace. To illustrate, the trace in Fig. 3, approximately 10 mc. wide, carries eight 1-mc. markers. If output from the generator were linear with respect to frequency, these markers would be uniformly spaced. Where frequency linearity is off, as in this case, the varying spacings between markers will quickly indicate the situation.

The generator's horizontal output is not very critical in amplitude and is not a frequent source of trouble. As long as the scope shows proper horizontal sweep, this portion of the instrument can be taken for granted. Where built-in markers are available, they should be visible on the scope trace irrespective of the sweep-generator output amplitude. Frequency accuracy is usually maintained by crystals; or else a means of checking against a crystal is available.

A word should be said about the importance of using the right cable for the sweep-generator output. Probably the most troublesome part of the entire generator is the cable, because it is subjected to a great deal of abuse. Dangling test leads get stepped on; on the bench they get accidentally burned, squashed, pulled, covered with dust, and suffer other mishaps. As a result the test clips, the wires leading to them, and the terminating network are all often damaged—and frequently such damage is invisible because of the insulation. Therefore, whenever the sweep generator is suspected of malfunction, the r.f. cable should be checked first. Similarly, whenever any measurements are made, be sure to use only a good cable with the right kind of termination.

Sweep Width Troubles

Sweep width can only be measured by means of markers of known frequency. One of the first symptoms to indicate insufficient or misaligned sweeps is the appearance of response curves like those in Fig. 4. To measure actual sweep width, the circuit of Fig. 5 can be used and, if possible, markers from an external source should be applied. The method is one recommended by *RCA*. Some sweep generators, like the *RCA WR-59C*, have provision for adjusting the center frequency of the sweep signal for individual channels. The rear view of Fig. 6 shows these adjustments on that unit. To vary the sweep width, the voltage on the vibrator is usually set by a fine control on the front panel, and a coarser setting is available on the instrument chassis. Care must be taken in changing the coarse setting, since excessive swing of the vibrator can

Fig. 5. Technique for measuring sweep width on *RCA WR-59C* and other generators.

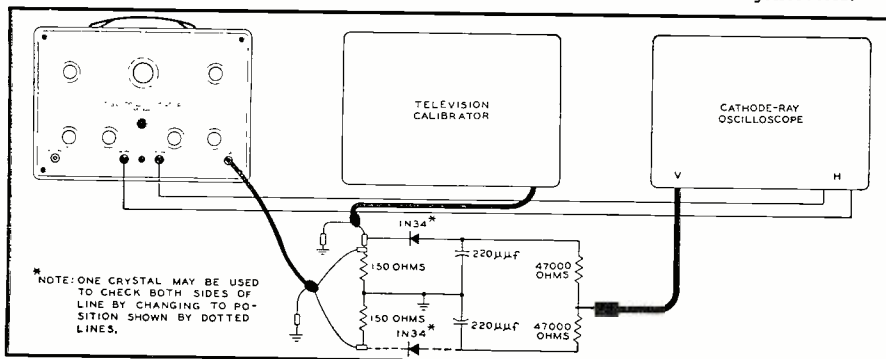

damage the mechanism or upset the mechanical alignment of the entire sweep oscillator.

Insufficient sweep is often caused by aging of the vibrator itself (where one is used), by changes in the series resistance of the vibrator or the motor control circuit, or by some mechanical defect such as warped plates or loose parts. In generators using the beat oscillator system, tube failure can affect sweep width. In those systems using a permeability type sweep, insufficient sweep width can even be due to magnetic changes in the materials. Most likely, however, the circuits providing the frequency-changing power are at fault.

The v.h.f. oscillator ordinarily is quite a tricky circuit. When it is supposed to oscillate with equal strength over a wide band, the circuit becomes even more touchy. A few test equipment manufacturers house the sweep oscillator in a separate, sealed case, and warn the technician against attempting repairs of this section. In any event, extreme care is required and by no means should force be used on any of the v.h.f. oscillator components.

Signal Output Amplitude

Sweep generators are usually furnished with a set of cables which have their own built-in terminations. These resistors are intended to match the generator to the input impedance of the TV set. When the generator is connected to the 300-ohm antenna terminals, the 300-ohm r.f. cable will match the generator to the load and in addition to providing maximum power transfer, it minimizes the chance of reflections. Often, however, the generator is used to align only the i.f. section, and connections can be made in a number of ways.

One popular system, shown in Fig. 7, is recommended by *Allied Radio (Knight)*. Here the actual impedance is anyone's guess. The signal is coupled capacitively to the mixer-tube elements, but the signal strength here depends on the tube used, on the position of the tube shield, and on connections. Whenever weak signal output is suspected, the following measurements can be made: Calibrate the oscilloscope to show 1 volt peak-to-peak as at least 1 inch vertical deflection on the screen. Then connect a diode detector probe directly across the output terminals of the sweep-generator output cable. Connect the horizontal sweep-generator signal to the oscilloscope, and measure the amplitude of the diode output on the screen. It should measure at least one tenth of a volt.

Weak signal output is most often caused by a weak oscillator tube. Fortunately, tube replacement is not too difficult. It is a good idea to try several tubes, since at v.h.f. tube selection is often required to give equally good performance at all channels. If tube replacement is not the solution, look for a bad ground or poor connection in the r.f. output system. Espe-

cially vulnerable are the various types of attenuators having a small pick-up loop which is moved closer or farther from the tank circuit. A more difficult trouble in this respect is the case of no output at all at certain frequencies or bands. Check the contacts of the bandswitch and the grounding at all points. Where a variable capacitor is used, check for contact between the rotor and stator plates, intermittent or worn grounding springs, broken bypass capacitors, or similar defects. The coaxial cable going to the front panel, as well as the test cable itself, are also prime suspects.

Amplitude Flatness

If the generator output varies in amplitude this will affect the apparent frequency-response curve of the receiver under test. While absolute flatness is not always possible, the variations and dips must be kept to less than 3 db. Fig. 8 shows the scope trace obtained with the set-up of Fig. 5 and indicates its limits. On the oscilloscope trace, 3 db corresponds to 0.707 of the maximum amplitude, since the scope shows voltage only and not power.

Tube failure is the most frequent cause for uneven generator output. In addition to the various defects just mentioned for insufficient output, so-called "suck-out" is often the cause of "holes" or dips in the output. This may be caused by a change in wiring of such minor components as filament chokes, the various bypass or coupling capacitors, or even just poor grounds. Tube selection may help to solve this type of defect, as well as careful lead dress. It is very important to check all frequency bands of the generator to make sure that the amplitude re-

sponse is sufficiently flat everywhere.

Phasing Control

Since the return trace is usually blanked out, misadjustment of the phasing control will give the appearance of poor frequency linearity or even off-center sweep width. Typical of this are the illustrations of Fig. 9. Only when the blanking switch is turned off so that both traces are visible, as in Fig. 2, can proper phasing adjustments be made. Both traces should coincide in at least four different points. If the phasing control appears to have insufficient range or its adjustment has no effect at all, then the phasing circuit should be investigated. The most widely used basic circuit is shown in Fig. 10. The controlling elements are the resistor-and-capacitor network, which determines the relative phase between the blanking signal and the horizontal-sweep output signal. If any of the capacitors or resistors become defective, proper phasing will not be possible. In this connection, it might be mentioned that occasionally the blanking diode or its associated components become defective, so that either no blanking takes place or else the blanking occurs at the wrong portion of the cycle, producing a rather weird response curve.

Miscellaneous Troubles

The linearity of frequency *versus* horizontal displacement on the scope depends on the sweeping mechanism and its circuitry. In capacitor-type sweep generators, there is usually some correction circuit provided to improve the frequency linearity. As the capacity is increased by the upward stroke of the vibrator, the frequency

(Continued on page 154)

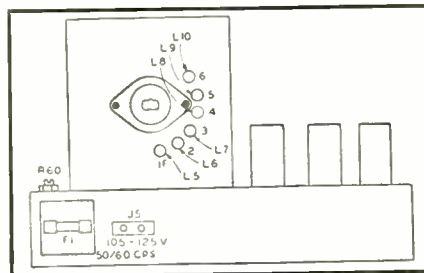

Fig. 6. Center-frequency adjustments for each channel on the RCA WR-59C.

Fig. 7. Signal injection to the mixer tube through a floating tube shield.

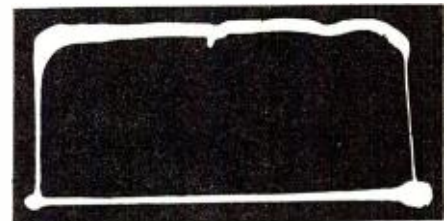
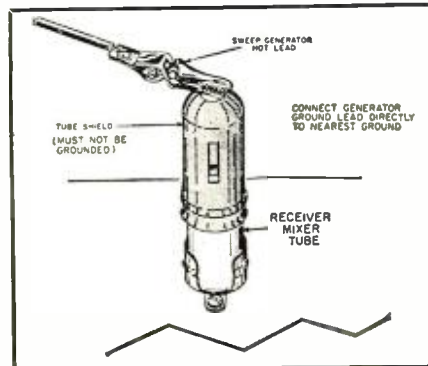
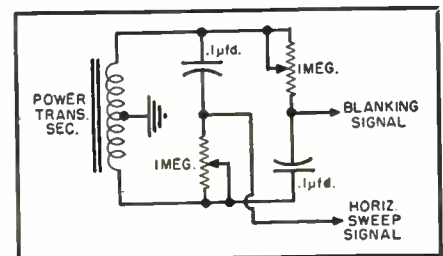

Fig. 8. Scope display of response on a swept band, after probe detection.



Fig. 9. Effects of phasing adjustment.

Fig. 10. Widely used basic circuit for providing the proper phase adjustment.



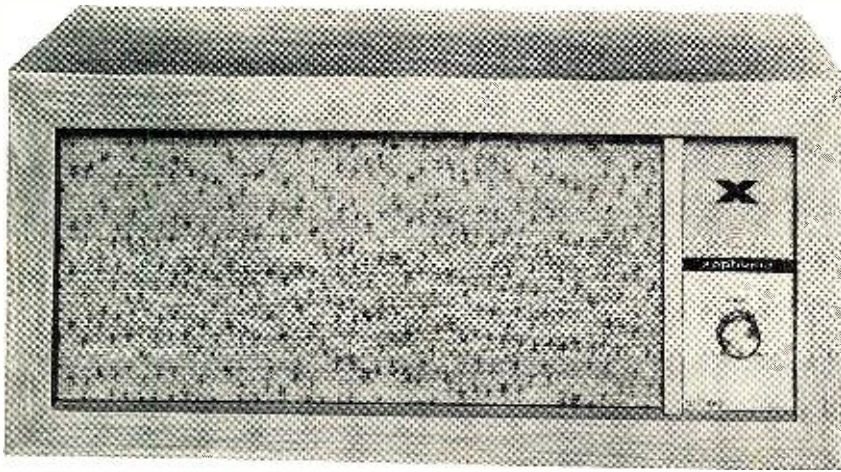

A Reverberation Unit For Hi-Fi Reproduction

Radio Craftsmen unit provides a method of obtaining concert hall reverberation by means of acoustic delay.

THE recent announcement regarding "Xophonic" sound has stimulated the curiosity of all audiophiles. It is the purpose of this article to explain how such a unit can acoustically convert a small room so that it sounds like a concert hall, and also to summarize the design and development of the device for the technically minded.

Actually, the unit was developed to fill a definite need. The upsurge of interest in high-fidelity reproduction during recent years has made the average consumer aware of the superiority of a high-fidelity system over a conventional radio or phonograph. As a by-product of the increase in the use of high-fidelity equipment, we find that the "appreciation level" of most listeners is rising. Audiophiles and "laymen" alike are asking for even better approaches to "concert hall realism."

For this reason, audio engineers for some time have been carefully re-examining the physical differences between the actual performance and the home reproduction, in an effort to overcome (insofar as possible) such differences as may exist.

Past work has been devoted primarily to reproducing the sense of "location," that is, the relative position of the soloist to the orchestra, or of the various sections of the orchestra to each other. To do this requires two or more sound pickups and a similar number of recording or broadcasting and reproducing channels. Although this sense of "location" has proven effective, the necessary equipment is fairly complex. This has kept it out of the price range of the average home

hi-fi listener in a good many cases.

There are, however, other differences between the concert hall performance and the reproduction in the home. One of the primary characteristics of a concert hall is its quality of reverberation. In a large auditorium, the sound from the performers reaches the listener directly, and also is reflected from the walls and ceiling of the hall. These reflected sounds reach the listener a fraction of a second after the direct sound, and are then re-reflected (and re-heard) again and again for a period dependent upon the reverberation time of the auditorium. The combination of undelayed (direct) and delayed (reflected) sound gives a concert hall its "character." An auditorium that produces these after-sounds is said to reverberate.

The type of room in which we do most of our music listening differs from an auditorium in two respects: (a) The walls and ceiling of residential rooms are relatively closely spaced compared to a concert hall. Sounds are therefore reflected only a very short time after leaving the speaker, and there is no significant delay; (b) there is usually a good deal of sound-absorbing material present, for example, upholstery, carpets, drapes, open doors, etc., which prevent repeated reflections.

For these reasons, a living room will not produce significant reverberation, and this is a serious difference between "reproduced" and "performed" music.

The engineering staff of *Radio Craftsmen* decided to attempt the development of a system for producing rever-

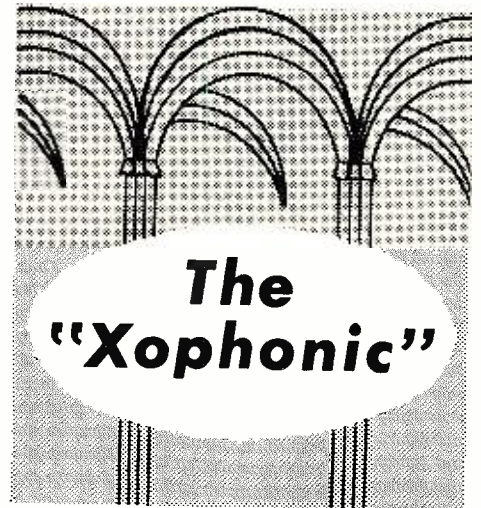

The "Xophonic"

By

THE ENGINEERING DEPARTMENT

Radio Craftsmen, Division of
Precision Radiation Instruments, Inc.

beration similar to those of a large auditorium, in an average-sized room. It was determined that a very realistic effect could be obtained with two sound sources: one "undelayed" (or conventional source) and a second source whose sound output followed the first by about 1/20th of a second.

A block diagram of a home reproduction system with reverberation was then drawn (Fig. 1). The heart of such a system is, of course, the delay device or network. Preliminary calculations indicated that an electrical LC "artificial delay line" was out of the question; to provide a relatively long and uniform delay at an audio frequency would require an inordinately large number of high-quality chokes and capacitors. The method used by Vermeulen to control theater reverberations appeared quite feasible for this application. See Fig. 2. In brief, a circular length of magnetic tape would "store" a short portion of the selection being reproduced for a time corresponding to one tape revolution, and the recording and playback heads would be displaced by 1/20th of a second in tape-travel-time. The recording head would be connected in parallel with the "conventional" speaker, and the playback head would drive the "delayed" speaker through the auxiliary amplifier. Of course, a bias-erase head and appropriate circuitry are also necessary.

The primary objection to this method is one of cost. The tape system, as outlined, is fairly expensive in even moderately performing equipment; but to maintain a good signal-to-noise ratio when continuously recording, erasing, recording, etc., requires the best of equipment. This is beyond the economic reach of the average listener.

A third approach, and one which ul-

timately resulted in the design of the "Xophonic," was the construction of an acoustic delay device. The velocity of sound in air is approximately 1100 feet-per-second. The distance covered by a sound wave in 1/20th second is, therefore, 1100/20 or 55 feet. If we could build a confined air path approximately 50 feet long, generate a "sound" wave at one end and receive it at the other, the delay between generation and reception would be about 1/20th of a second. This delay would be inherently "flat," or uniform, over the audio range. The system would have to be confined so as not to lose energy. Also, we use "sound" in its physical sense as a wave motion of air—not as the auditory sensation of hearing.

There followed a good deal of experimenting to find a satisfactory combination of an exciter-driver unit, a suitable confined air path, and a sensitive microphone detector. After experimenting with different delaying structures, such as labyrinths, etc., we decided on a hollow-pipe air path. One of the problems encountered was to find a combination giving fairly uniform frequency response. To produce a uniform response, it was necessary that the driver-microphone combination compensate for the frequency sensitivity of the pipe.

At one end of the hollow aluminum pipe is the magnetic transducer as shown in Fig. 3. This is a loudspeaker-type device that is coupled via an impedance transformer to the 50-foot length of aluminum pipe. At the other end of the pipe is a sensitive crystal microphone which is made in a convenient configuration for coupling to the pipe. The over-all arrangement is shown in Fig. 4, which indicates the driver at one end of the pipe and a microphone at the other end of the 50-foot pipe.

Note the use of a 7.5-ohm series resistor between the output of the main amplifier (input of "Xophonic" unit) and the driver unit. This resistor serves a twofold function. In the first place, it raises the impedance level into the unit to 16 ohms, that is, it furnishes about 8 ohms in series with the 8-ohm impedance of the driver unit. It is important that the unit represent a high input impedance as it will be used by bridging it across the voice coil of the present speaker system. Therefore, in order not to present a severe mismatch, it should represent an impedance which is high with respect to that of the speaker system. The 16-ohm "Xophonic" input impedance performs satisfactorily with both 4- and 8-ohm voice coils. When used in conjunction with 16-ohm voice coils, it is advisable to connect both the "Xophonic" and the main speaker system to the 8-ohm output tap of the amplifier.

The second function of R_1 is to raise the input power rating of the unit so that, if it is connected to a 25-watt or higher rated amplifier, and the main speaker is inadvertently disconnected,

the voice coil of the "Xophonic" driver will not be overloaded. The resistor then acts as a fuse and variable resistance which protects the driver voice coil.

Another problem was obtaining parts which permitted a tight, secure mechanical and acoustical assembly. We soon discovered that any vibrations or "sound leaks" would lead to impaired performance of the "Xophonic" reverberation unit.

After these problems were overcome, and a satisfactorily operating delay device had been designed and constructed, we turned our attention to the auxiliary amplifier. Since the power contained in the "reverberatory" sound should be less than that of the main sound, it was felt that it would be unnecessary and wasteful to utilize a high-powered amplifier. The circuit shown in Fig. 5 was designed and tested, and performed quite satisfactorily. The only unusual feature of the design is the floating paraphase phase inverter. This circuit, which utilizes negative feedback from plate (pin 6) to grid (pin 7) is fully described in the literature.

The last step in producing the unit was "packaging" it in a reasonably sized, attractively styled enclosure (see photo). The 50-foot length of pipe was coiled around a large diameter cylinder in the unit. In producing this coil, extreme care is necessary not to dent or "bend" the pipe. An integral speaker is incorporated, and the inside of the cylinder acts as part of the speaker backloading. Patents on this design have been applied for. The amplifier is assembled and tested separately, and then connected to the microphone and speaker at the final assembly of the unit.

In listening tests made on the unit both during development and subsequently, the "concert hall effect" has

(Continued on page 97)

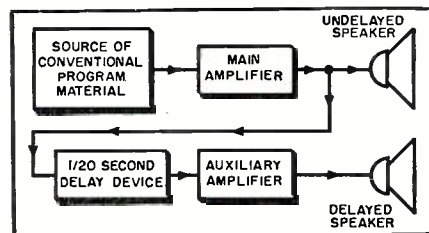

Fig. 1. Diagram of reverberation system.

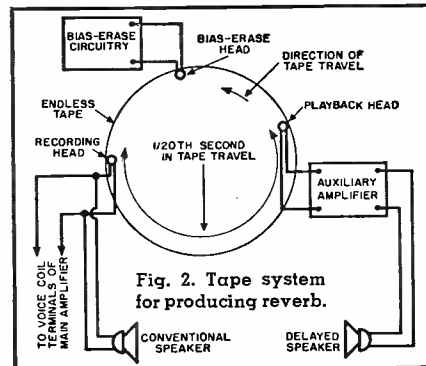

Fig. 2. Tape system for producing reverb.

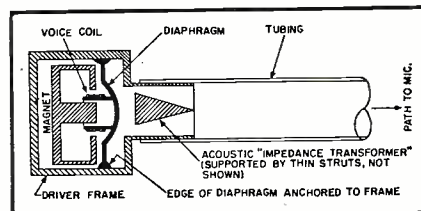

Fig. 3. Driver at input to hollow pipe.

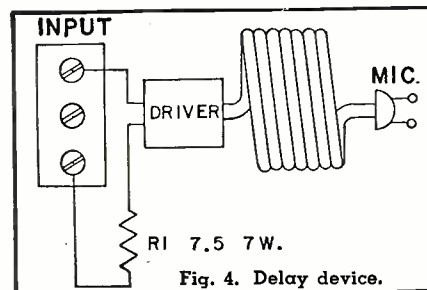
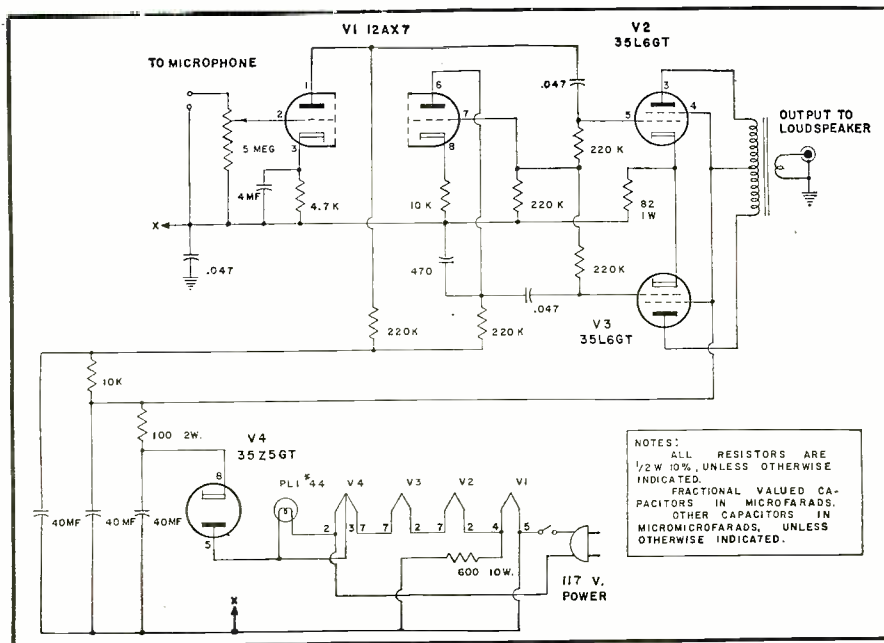
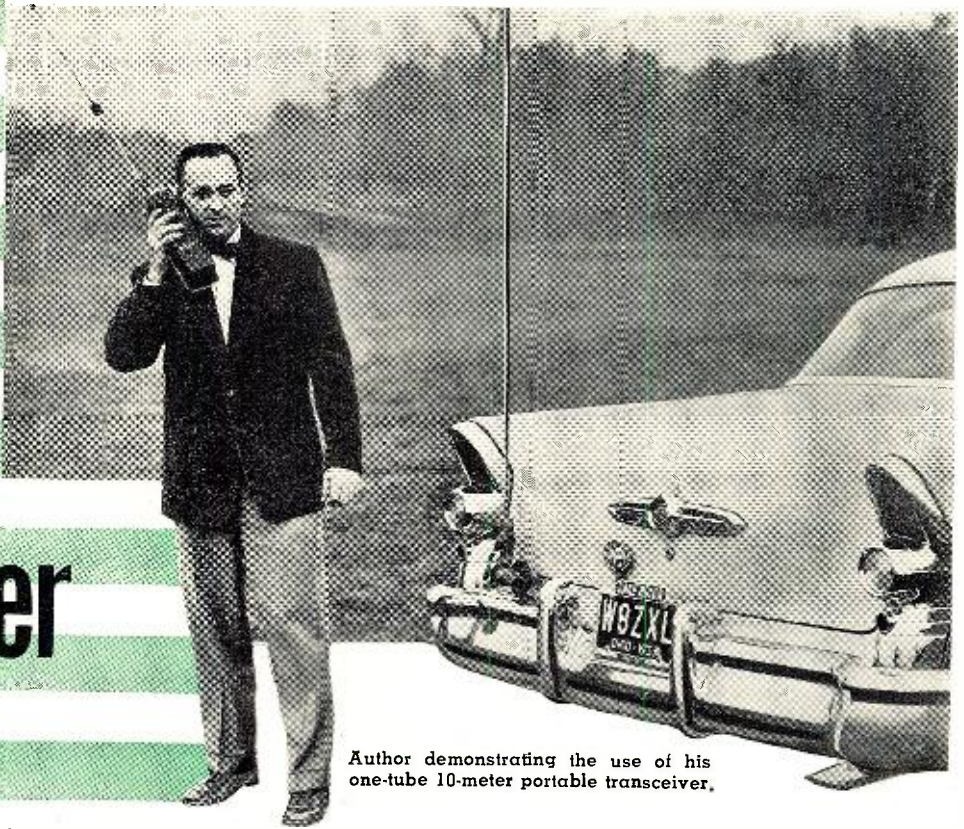

Fig. 4. Delay device.

Fig. 5. Complete schematic diagram of the auxiliary amplifier used in "Xophonic."



One-Tube 10-Meter Transceiver



Author demonstrating the use of his one-tube 10-meter portable transceiver.

By **NORMAN FLEMING, W8ZXL**
Designers for Industry, Inc.

*Achieves maximum performance with minimum of parts.
Suitable for emergency and Civil Defense applications.*

WHEN the great rush for emergency and Civil Defense gear began to gather momentum, the writer plunged in and built a two-tube, 10-meter transceiver. The battery drain was a little too high so the idea occurred, "Use just one tube and make the batteries go twice as far."

The transceiver to be described is nothing new circuit-wise, but it is a crystal-controlled, single-tube unit which uses the barest minimum of parts. It is a little giant in performance.

Most of the components were picked up from the junk box or on the surplus market. The case is a surplus plug-in coil set container, type CW-47029. The mouthpiece for the T1 mike button was cut from a push-button shaving soap can. An F1 mike button works fine, also, but it is considerably larger.

The first attempt to switch from "transmit" to "receive" was accomplished with a ceramic wafer switch but was discarded in favor of a switch that could be pushed so as to leave one hand free for writing.

Two 4-pole, 2-position push-button switches were mounted back-to-back and their flat plungers soldered together. A single push-button was mounted on the end. Any midget push-button or sliding switch can be used if it has the required number of contacts.

Various types of microphone transformers were tried. They worked but they were large and occupied too much space. A chance trip to a surplus house uncovered a BC-347 interphone amplifier which contained two "Ouncer" transformers. One of the "Ouncers," stamped C-339, was tried. It filled the bill perfectly. The proper connections are noted on the schematic diagram. When this article was written, the BC-347 units were still available at some surplus stores and were usually priced at two dollars.

Poor results were obtained with the receiver when using some of the more common, low-impedance-type surplus earphones. A little time spent in securing a high-impedance earphone will pay off in greatly improved reception.

After much experimenting, the loading coil form factor was arrived at and found to give the best results with the particular length of antenna used. The antenna was made from an old pair of telescoping TV rabbit ears. A brass screw was driven into the hollow end of one leg of the TV antenna and soldered. The other leg of the antenna was dismantled and only the largest section used. A brass screw was soldered in this piece also.

A solid piece of polystyrene rod, 1" o.d. by 1" long, was used as the loading coil form. This piece was tapped at both ends and the two antenna sec-

tions were screwed in. A phone-jack plug was soldered to the end of the completed antenna to provide for easy removal from the case when going through doorways or low-hanging obstructions.

The transmitter doubles frequency in the plate circuit so a 20-meter crystal, whose second harmonic falls in the desired part of the 10-meter band, should be used.

All coils should be closewound and then coated with coil dope. Coils L_3 and L_5 should have sufficient lead lengths so their location can be adjusted to obtain optimum coupling. Be sure to wind all the coils in the same direction. Coil L_6 is wound over the cold or ground end of L_4 .

The transmitter should be tuned up like any tri-tet circuit and the link coupling coil L_3 should be adjusted to give the largest reading on the "S" meter of a nearby receiver. Always re-dip the final after any adjustment.

Plate modulation was first tried but the percentage of modulation was way down. This transmitter is suppressor-grid-modulated, hence the necessity for a small "C" bias battery. Be sure to connect the positive side to the "C" battery to ground.

If a grid-dip oscillator is handy, the receiver can be lined up quickly. Capacitor C_3 is adjusted until the band limits are found by picking up the signal from the grid dipper. Capacitor C_2 is then used for tuning and will cover the entire 10-meter band.

When receiving signals within the output range of the transmitter, fairly loose coupling between L_4 and

L_2 should be used. This will keep any body-capacity effects down to a minimum. In fact, no trouble of any kind due to body-capacity was experienced in the present model when receiving local signals. If the desire to pull in a little DX is encountered, (and no doubt it will be), tighten up the coupling. With a little care in adjusting the regeneration control R_{reg} , the receiver will still be stable.

If the schematic values are followed fairly closely and all leads kept as short as possible, little trouble should be experienced in firing up this little rig within a few minutes after the last bit of solder has cooled.

No doubt each reader will see ways to improve or re-arrange his own model to suit individual tastes and components on hand. Perhaps some will go a step farther with printed circuitry, or even a transistor or two.

The performance of this little transceiver has been more than originally expected. A range of up to nine miles has been covered with the transmitter and when band conditions were right, practically every call area in the States was heard on the receiver, not to mention a mobile operating in Panama, and a few South Americans.

EDITOR'S NOTE: This transceiver is intended for use only by licensed radio amateurs. It cannot be legally built or operated without the appropriate ham ticket. It cannot be adapted for use on the Citizens Radio Band and any attempts to do so would be contrary to Federal law.

-30-

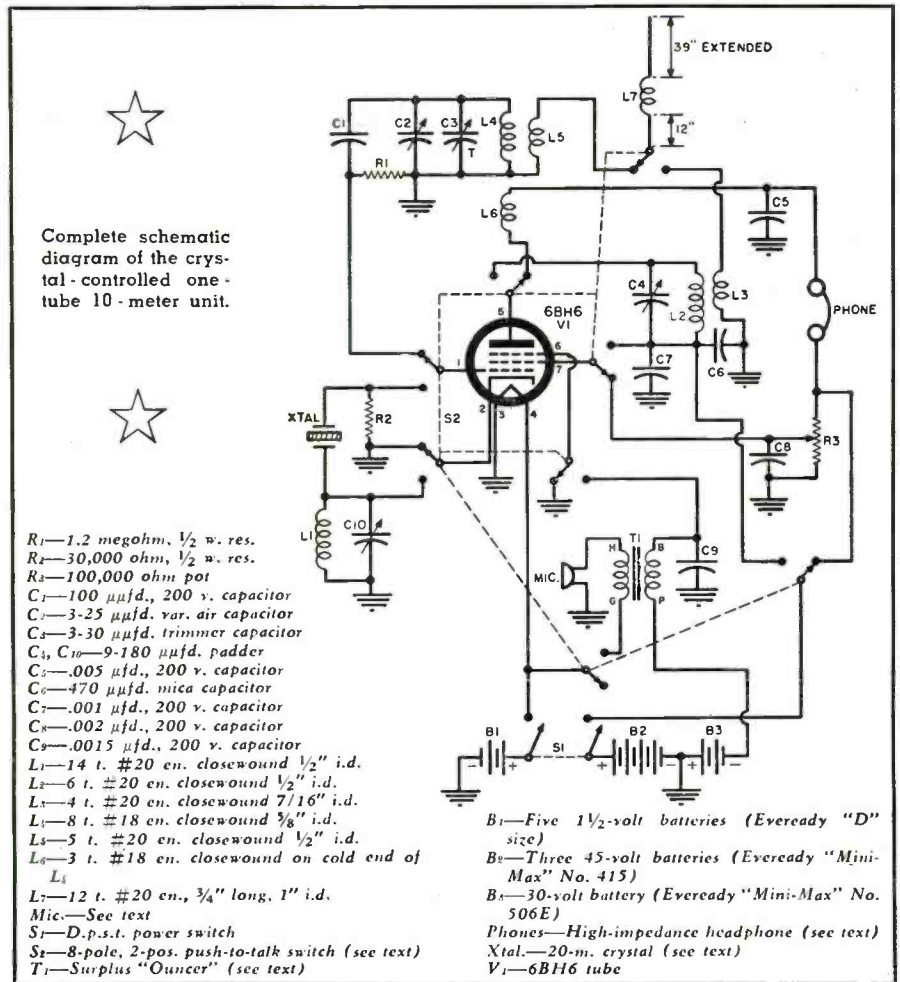

Over-all view of transceiver showing the operating controls.

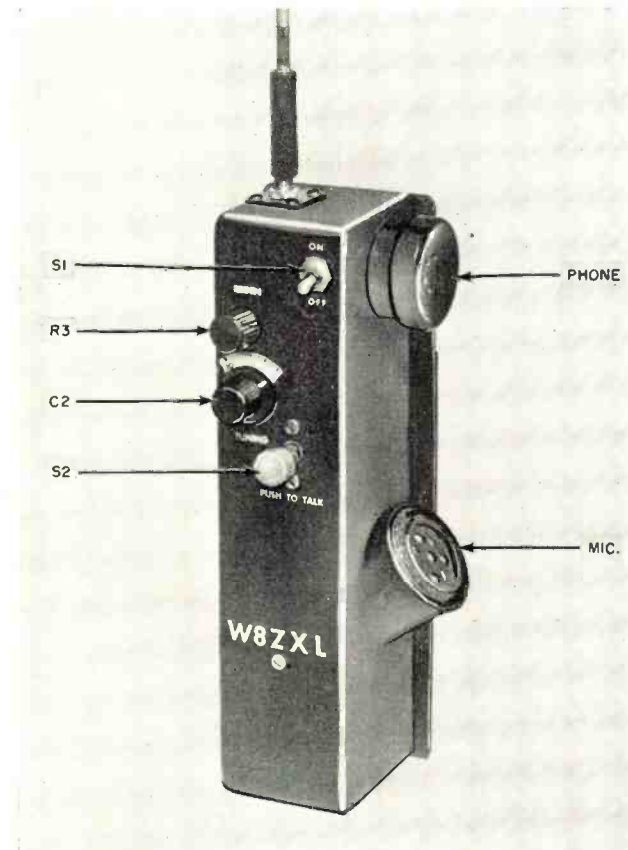

Inside view with side removed to show the internal layout.

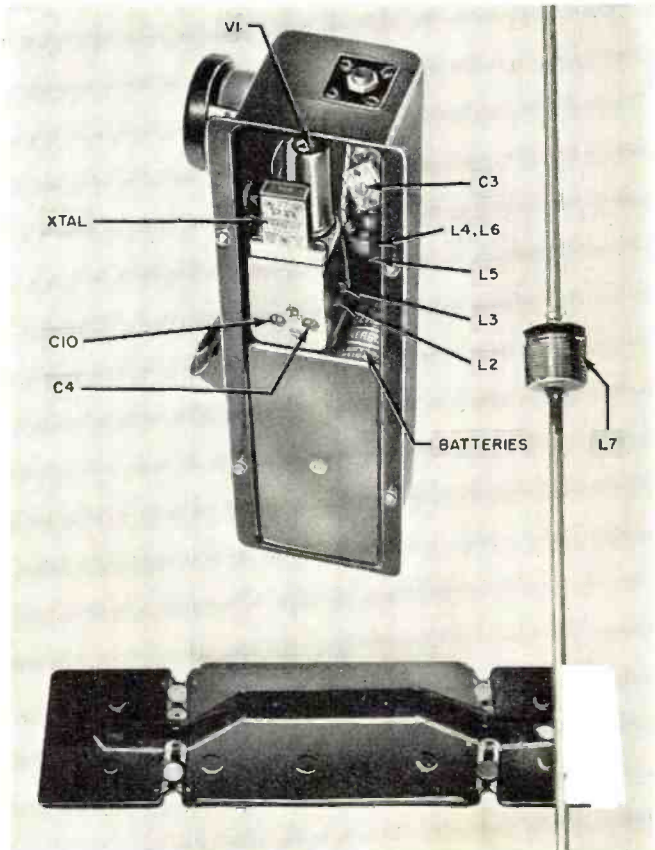

Coded Stereo for Hi-Fi

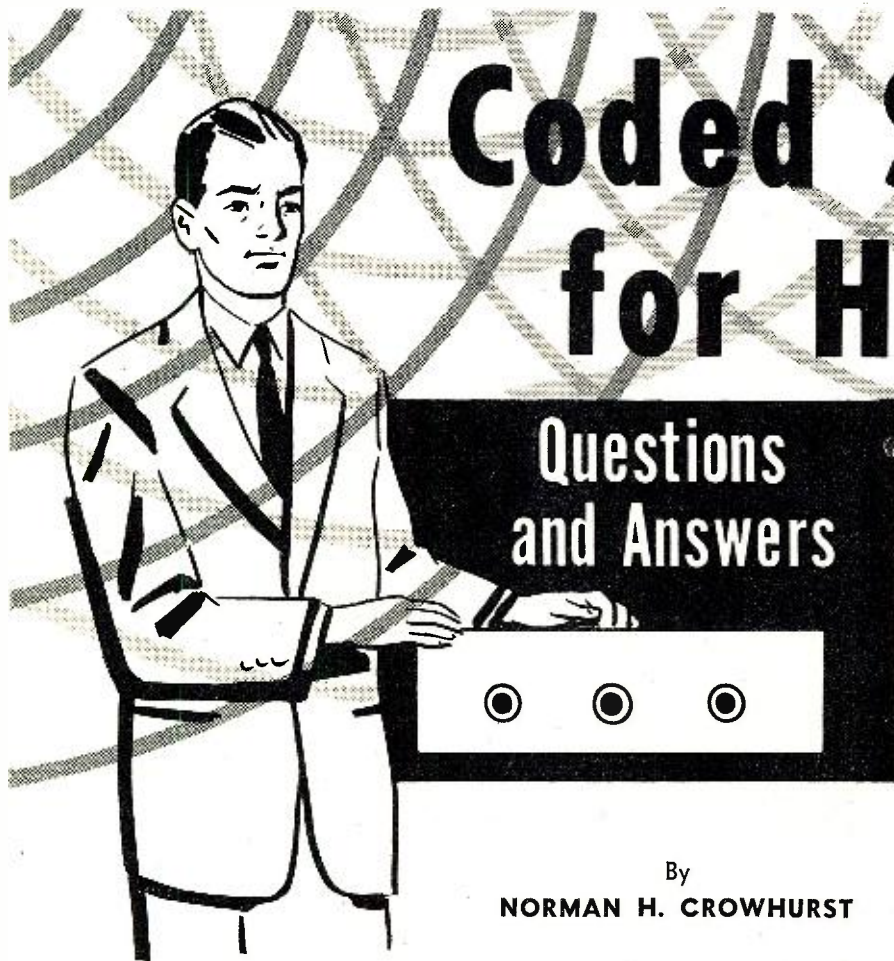

By
NORMAN H. CROWHURST

Answers to readers' questions about the "Perspecta" coded stereo system described in August, 1956 issue.

SINCE the article, "A New Approach to Hi-Fi Stereophonics" appeared in the August, 1956 issue, we have received a steady flow of letters with questions about various aspects of the coded stereo system therein described. It would be impossible here to answer all the questions that have been asked, but we have gone over the letters carefully, selected questions that have been asked by more than one reader, and arranged them in a sequence that, we hope, will avoid confusion by keeping to the same general aspect in consecutive questions.

Some readers wrote in asking for complete details, wanting chassis size, layouts, details of components, parts lists, blueprints, etc., for the complete system. Others have wanted to get details about the theater system that was mentioned in the article. Questions of this kind cannot, of course, be answered at any length. It would require a whole series of articles to describe the construction of such a system. Different readers have varied ideas on the way they want to build it which would complicate any attempt to cover construction details.

The theater system has been quite extensively used and whatever data is available for release to anyone out-

side (or inside) the motion picture industry, can be obtained by applying to *Perspecta Sound, Inc.*, 711 5th Ave., New York 22, N. Y. The author cannot release any such information about the theater system.

At the outset it should be made clear that the system, some details of which were suggested in the previous article, had not been built. The theater system works perfectly well, using the same principles. Individual parts for the system, schematics for which were given in the previous article had been built, sometimes for other purposes. But the entire system had not been put together as a coded stereo system. The data put forward was given for the benefit of people who want to experiment and thus help forward the development of such a system, either for their own interest or as a contribution toward ultimate progress for all of us. The details that follow are offered with the same objective in mind.

Question 1. How do you make sure none of the low audio frequencies operate the control, and that the control frequencies are not heard?

This question arises out of calling the control frequencies "sub-audio." The "sub-" here is used in two senses: it means the control frequencies are

lower in *frequency* than the band normally used for amplifying audio, at least in this system; and also that they are below the *level* that will allow them to be audible. Additionally, high-pass and low-pass filters are used in the system to separate the frequencies, so as to insure that not enough residual audio gets into the control circuits to upset their action, on the one hand, and that the control frequencies do not get through into the audio channels and produce an audible tone on the other hand.

In the theater system, the control frequencies of 30, 35, and 40 cycles are at least 20 to 26 decibels below the maximum audio level. This, however, is to allow for the possibility of a *Perspecta* track being played in a theater not equipped for this kind of sound, and which might therefore reproduce these frequencies at their recorded intensity. This margin proves adequate to insure the control frequencies are inaudible, even without filtering.

But when filtering is provided to eliminate the control frequencies from the audio, they can be operated at a somewhat higher level without risk of this kind of interference.

Some are probably going to object here that 30, 35, and 40 cycles are definitely within the audio range, so *how can they be called sub-audio?*

In application to theater systems it was found that most theaters failed to reproduce anything appreciably below 70 cycles. Consequently, nothing is lost by introducing a high-pass filter that cuts off everything *below* 70 cycles, so we can use frequencies down there for control purposes.

In the living room we have a further factor to help us in the same direction. Unless your living room is at least a 50 foot cube (which is rather large for a living room!) you cannot possibly hope to develop even one complete wave of 20 cycle frequency in the room. It is true such a frequency might be audible *if* reproduced, but the theory about reproducing it is very different from practice.

Despite the stress that has been laid on requiring response down to 20 cycles, satisfactory fidelity for the living room can be achieved easily by reproducing down to 50 cycles. This only requires a living room with the dimen-

sion of a 20 foot cube to produce one complete wave. Most living rooms are even smaller than this!

Question 2. How do you set up the control frequency oscillators and tune the control frequency amplifiers?

The circuits originally given showed the components which set the frequency marked with an asterisk. These have to be adjusted by trying different values until the frequency comes out right.

The first thing to do is to set up the control frequency oscillators. The frequency for 30 cycles can be found by means of an oscilloscope. If you don't have an oscilloscope it would be good to arrange to borrow one for an evening, or some suitable time, from your local service shop. Many service shops have an oscilloscope which they seldom use and will be glad to lend if they are satisfied you know how to use it.

Getting a 30 cycle frequency is very easy with an oscilloscope, using the 2 to 1 Lissajous pattern. Forty cycles gives a 3 to 2 pattern. This is using line frequency as a time base. Almost all modern oscilloscopes have a multiple switch for selecting horizontal deflection: the internal time base, the line time base, or an external connection. Using the "line" position of this switch, and applying the output from your control frequency oscillator to the normal vertical scope input, will produce the Lissajous patterns shown in Fig. 1 when the frequencies are correct.

Adjusting the values of the capacitors will alter the rate at which the pattern moves until you can get a steady or stationary pattern. Then you have the right frequency.

Having set up the 30 cycle and 40 cycle control frequency oscillators, the next step is to set up the corresponding control frequency amplifiers. This can be achieved by a similar method. Turning the gain adjustment up to the point where they oscillate, the frequency is adjusted in the same manner. Then the gain adjustment is turned down until they just do not oscillate. Finally set the gain of each control frequency amplifier so that the same input from the corresponding control frequency oscillator gives you the same output voltage from each.

Now you have a tool for setting up the 35 cycle frequency, which is not quite as easy as the 30 and 40 cycles, because there is not a convenient Lissajous pattern. Adjust the frequency of the 35 cycle oscillator until it gives an equal output from both the 30 cycle and 40 cycle control frequency amplifiers, showing there is equal leak-through each way. (This output should be considerably less than when the correct frequency of 30 or 40 cycles is applied to its own amplifier, of course.)

Finally you can set up the 35 cycle control frequency amplifier by aligning it until it gives a maximum output on the 35 cycle oscillator.

This is quite a convenient way of setting up the frequencies without needing to have "reference standards,"

which is the method used for the motion picture system.

Question 3. How about using more than three channels to get greater realism, say 4 or 5? What control frequencies should I use?

This question illustrates the general trend of the correspondence on this subject in many aspects. One reader will be wanting to go down from three channels to two channels; another would like to extend it from three to four, or five, or maybe even six. One wants to combine the system with some special features he may have in mind, while another wants to make a totally different combination. This trend in thinking shows there is plenty of healthy initiative drifting around and we should come up with some really good developments as the result of all this experimentation. But to answer this question.

If you want to extend to, say, five channels, the best frequencies to choose would be down to 20 and 25 cycles. If you want six you can also go up to 45 cycles. The 45 cycle Lissajou pattern, that would be used on the oscilloscope to align the frequency, is fairly simple, as shown in Fig. 2. The 20 cycle pattern is easy, but 25 cycles is not. The author suggests making the 20 cycle oscillator and amplifier first and then fitting the 25 in as a midway point between 20 and 30, in the same way as 35 was fitted in between 30 and 40.

Using a combination ranging from 20 to 40 cycles would have the advantage that would not encroach any more on the audio frequency range than the three channel system. As you might run into difficulties in satisfactory recording of 20 cycles, it may be a good thing to use this channel for the position of the loudspeaker that you consider least important.

Question 4. Is it possible to add electronic reverberation effect with this system?

This question touches on the vast potentialities of a system of this type. As originally set up, this coded system just produces an equivalent of three-channel stereo. But it would be equally possible to utilize additional control channels for the purpose of adding artificial reverberation, in variable quantity, to suit the program. This opens a new vista of versatility in reproduction. Possibly, if you use five channels, the extra two, utilizing maybe the frequencies 20 and 25 cycles for control purposes, could be used to control reverberation distributed by two more speakers in a position behind the listener from the main three speakers.

This reverberation could use a second pickup. In the case of tape, this is quite easy to do, by putting a second pickup head so the tape passes it a fraction of a second later than the existing one. In the case of disc, a little more complication might arise. Possibly a special pickup would need to be developed with two stylus assemblies, one in front of the other. But for experimental purposes, at any rate, we

could certainly use magnetic tape.

The output from the second head could be delivered to another preamplifier and the control frequencies picked off by the first head applied to control the output from the second preamplifier feeding the reverberation loudspeakers. A block diagram of this idea is shown in Fig. 3.

Before leaving this question, however, I would suggest that this is rather an ambitious arrangement, and it would be much better to get the system working in its simplest form and then add details like this as further refinements and improvements at a later date. This is one advantage of having a system which is adaptable in this manner.

Question 5. Can the control frequency oscillators and amplifiers be made so the frequency can be adjusted with a trimmer, instead of having to be set by a trial and error method?

Trimmer capacitors only come in values up to about 2000 micromicrofarads (.002 microfarad), but the tuning capacitors for these circuits are in the region of .1 microfarad. So any of the available trimmer capacitors would be totally inadequate as a means of frequency adjustment.

The only way to overcome this would be to use one of the phase shift oscillators where the frequency is adjusted
(Continued on page 107)

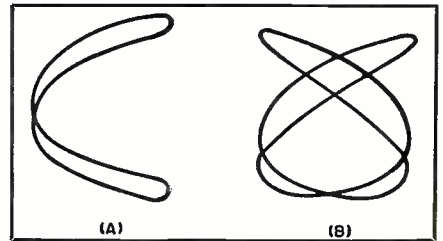

Fig. 1. (A) shows a 30-cycle Lissajous figure. (B) shows a 40-cycle pattern.

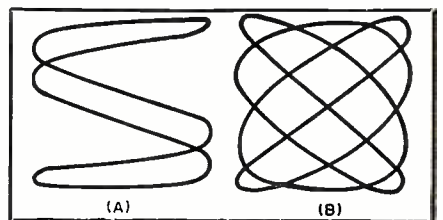
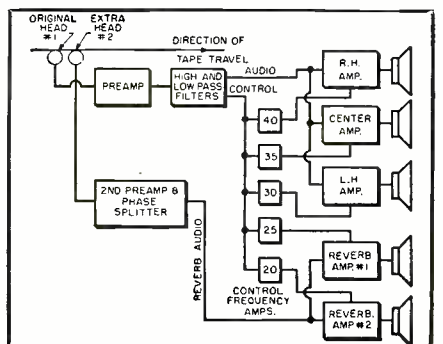

Fig. 2. (A) shows a 20-cycle Lissajous figure. (B) shows a 45-cycle pattern.

Fig. 3. Block diagram showing method employed to introduce reverberation.



Certified
RECORD REVUE

By BERT WHYTE

THE summertime used to be a slack period in the world of recorded music and record critics had a chance to divorce themselves from their phonographs. Some of the more affluent of my colleagues hid themselves to the festivals in Europe, others caught up on their golf, or ventured onto or into the briny deep; and no doubt many readers who have purchased records on the strength of a good review and have been disappointed, are quite sure that if nothing else, the summertime was a good time for some critics to have their ears re-tinned!

Whatever happy pursuits we enjoyed in those halcyon days, are, alas, denied us now. These past few summers the record companies may have faltered slightly in their mad churning out of releases, but they most assuredly never stopped! More than that, they have not neglected quality with their quantity. Many "big" and important works are now released in the summertime, a practice unheard of in former years. All kidding aside, this is a source of considerable satisfaction to a record critic. It shows that there is a place for good music in this troubled and war-weary world.

That more and more people are becoming educated to the delights of good music can be attributed to the booming market in hi-fi equipment. And the potential is vast and still relatively unscratched! In their most wild and optimistic dreams, the record companies never envisioned today's tremendous market. Caught up in the feverish pace imposed by this cultural revolution, the record companies have stepped up their release programs so that now there is very little seasonal difference. It is true that there is much dross issued along with the "gold" but even with careful, if not sometimes ruthless culling, the number of good recordings is somewhat staggering and about all a conscientious critic can do is dive in and start writing. So without further ado, here is the "cream" of the current record release crop!

ROUSSEL

SYMPHONIES #3 AND #4
L'Orchestre de la Suisse Romande conducted by Ernest Ansermet. London LL1495. RIAA curve. Price \$3.98.

Roussel is best known to music lovers for his ballet score, "The Spider's Feast". Yet I venture to predict that in this age of the hi-fi phonograph, these two symphonies will soon rival the ballet in popularity. For these are ingratiating scores which, although strongly modern in flavor, are singularly easy to digest. Here are all the elements which endear this type of music to the hi-fi sound enthusiast. The "3rd" symphony opens with a powerful *allegro*, very robust and hearty with splendid string ensemble work and resounding brass. After a relatively tranquil but expressive 2nd movement, the *scherzo* explodes in one of those rollicking dance-like episodes so

typical of Roussel. Here the bouncy strings are joined by flute, piccolo, clarinet, and other woodwind, the scoring being exceptionally facile and full of humorous touches. The finale is vigorous, in fact earthy with its broad themes and rough wit. Here are rousing brass fanfares, more of the jubilant woodwind and heavy bass accents from tympani and contrabass. The work comes to its conclusion with several grandiose forte which make liberal use of percussion.

The "4th" symphony opens quite slowly with strings interspersed with successive passages from the English horn, tenor sax (the use of this is rather typical of French composers who had been influenced by the "Impressionistic" school which flourished in the early 1900's), and oboe. In swift transposition, the strings and brass leading the other instruments, the scoring becomes very vigorous and rhythmic. The second movement is characterized by beguiling melodies carried mostly by strings and woodwind and builds to a climax of intense emotionalism. The third movement is again a spritely *scherzo* with much bright trumpet work and ebullient woodwind. The final movement starts out with a recapitulation of the thematic material found in the opening bars of the *allegro* section of the first movement. Again much brass, rapid string and woodwind passages, strong percussion including a solid weighty bass drum, heavily accented tympani and a triangle whose sharply etched "tinkle" will delight the hearts of audiophiles addicted to this instrument. The work concludes with a great dance-like staccato figure in which most of the orchestral forces are employed.

Throughout both works Ansermet shows that this type of repertoire is certainly his metier. The performances are brilliant, perhaps even scintillant. Tempi, dynamics, orchestral balance . . . all are superbly integrated in his logical and convincing exposition. Best of all from the Suisse Romande, not always the most consistent of orchestras, he gets playing of a very high lustre. The *London* engineers have contributed a sound of outstanding cleanness. Frequency and dynamic range are very wide, transients are sharp with no audible distortions. Recording was rather close-up, proper for this type of scoring where instrumental detail and definition are of prime importance. In spite of this, the engineers have managed enough hall reverb to "round" out the sound and add that last little fillip of realism. While this review has been lengthier than most, I feel there is an obligation to go more fully into this less familiar music which may be wholly new to a great many readers. This is especially justified when we are dealing with a recording

The opinions expressed in this column are those of the reviewer and do not necessarily reflect the views or opinions of the editors or the publishers of this magazine.

which is outstanding from both the sonic and musical viewpoints. This *London* disc certainly qualifies for that distinction.

BACH
VIOLIN CONCERTO IN E MAJOR
BEETHOVEN
ROMANCE IN G MAJOR
ROMANCE IN F MAJOR

Igor Oistrakh, violinist, with Gewandhaus Orchestra of Leipzig, conducted by Franz Konwitschny. Decca DL9875. RIAA curve. Price \$3.98.

You've got to admire young Igor Oistrakh! This is about the fifth or sixth recording in which he has been in direct competition with his illustrious father, the great David Oistrakh. Here in the Bach concerto, he has the Francescatti and Heifetz versions to contend with as well as his father's *Columbia* disc. As far as I'm concerned, Igor seems to have a better command of this type of repertoire than that which he is usually given to perform. The result is a superior reading of the Bach in which he defers to no one, including Papa Oistrakh. His tone is firm and pleasing, his techniques irreproachable and he displays considerably more life and less pedantry than does his competition.

In the "Romances" he does well enough, but here he is up against Heifetz in a Heifetz specialty, and in the comparison he is found wanting in several aspects. Soundwise, Igor fares very well, with his instrument and the orchestra afforded clean and well balanced reproduction. Konwitschny and the Gewandhaus Orchestra furnish a knowledgeable and sympathetic accompaniment.

BRAHMS

PIANO CONCERTO #1
Rudolph Firkusny, pianist, with Pittsburgh Symphony Orchestra conducted by William Steinberg. Capitol P-8346. RIAA curve. Price \$3.98.

Firkusny's first concerto recording since he signed with *Capitol* and an impressive debut. Firkusny's playing is at a consistently high technical level and if he could have managed to imbue his reading with a little more poetry and warmth, he would have shared top honors with the Rubenstein version. As it is, this recording is notable for the superb piano sound and for the wondrous playing Steinberg elicits from his Pittsburgh men. This orchestra has come a long way under Steinberg, and the precision of their ensemble work is breathtaking. Piano sound is ultra-clean, free from any transient-ringing, the strings are butter smooth, brass and woodwind have exceptional projection. Piano/orchestral balance is logical and spacious acoustics make for a highly realistic sound. All factors considered, the recording should have wide appeal especially to sound fanciers.

BARTOK

CONCERTO FOR ORCHESTRA
L'Orchestre de la Suisse Romande conducted by Ernest Ansermet. London LL1632. RIAA curve. Price \$3.98.

There seems to be a new recording of this work every other month, which is understandable in view of the popularity of the score. This version by Ansermet replaces one of the very oldest recordings in the *London* catalogue, the Van Beinum reading of the "Concerto for Orchestra" on *London* LL-5. It is interesting to compare the sound of these two *London* recordings separated in time eight years. While the older recording was considered a fine example of the art in those days, in comparison with the latest effort, it sounds very thin and dry . . . lacking that essential quality of "presence" that characterizes today's *London* records.

I understand Ansermet has wanted to record this Bartok work for a long time. With
(Continued on page 103)



Fig. 1. The completed CRT checker can be housed in a hand-held case.

By DWIGHT V. JONES
Cathode-Ray Tube Department
General Electric Company

SMALL enough to fit into the palm of the hand, the conveniently portable picture-tube checker described here will quickly resolve many cases in which there is question as to whether the failure to obtain a raster—or a picture when a bright raster is present—lies in a defect in the CRT or in the associated circuits. The checker's foremost utility is during the house call, since it requires minimum set-up procedure and minimum disturbance to the chassis. The back cover of the TV set is removed, the hand tester is plugged to the base of the picture tube (Fig. 2) in lieu of the CRT socket, the tester is plugged into the nearest a.c. outlet, and—after a brief warm-up period—a button on the checker is depressed.

An NE-2 neon lamp built into the checker gives rapid indications covering five conditions, depending on whether one, both, or neither of the lamp elements glow. The conditions are tabulated in Fig. 3, together with their associated visual indications on the neon lamp.

This information enables the service technician who is faced with a blacked out set, or one with a bright raster and no video, to decide immediately: (1) whether to make repairs on the spot, (2) remove only the chassis, or (3) take both tube and chassis to the shop.

The simple checker can be wired in a short time with a total material cost of less than \$3.00. The author assembled the circuit of Fig. 4 using the case of the G-E Series-Heater Checker available through distributors. This case is convenient because it already has a picture tube socket mounted on it, and all the components, including the filament transformer, can be fitted inside. The complete picture tube checker is shown in Fig. 1.

How the Checker Is Used

The chart shown in Fig. 3 may be attached to the checker for ready ref-

*Is the CRT defective or is the set at fault?
This handy unit will usually give the answer
without removal of the set from its cabinet.*

erence to interpret what the neon lamp indicates. Since the push-button switch, S_1 of Fig. 4, is wired so that it normally is in the position shown, the heater-cathode condition is indicated immediately after plugging the checker on the base of the picture tube. If there is a heater-to-cathode short, both elements of the NE-2 lamp will glow. Then after a warm-up time of about one minute, the push-button switch is pressed for the second and final check on the tube. The NE-2 lamp will indicate *one* of the three possible conditions shown in Fig. 3. For "Tube Operable" only one element of the NE-2

lamp will glow; for "Open Element or Low Emission" neither element will glow; and for "Grid No. 1-to-Cathode Short" both elements will glow. If the checker indicates "Tube Operable," then the tube should be able to produce a picture, with the exception of the few isolated cases mentioned later.

Circuit Operation

When sufficient voltage is applied to the electrodes of the NE-2 lamp, light is produced at the negative electrode. Thus, for "Tube Operable," only one (Continued on page 145)



Fig. 2. The handy tester plugs directly into the receiver-mounted CRT.

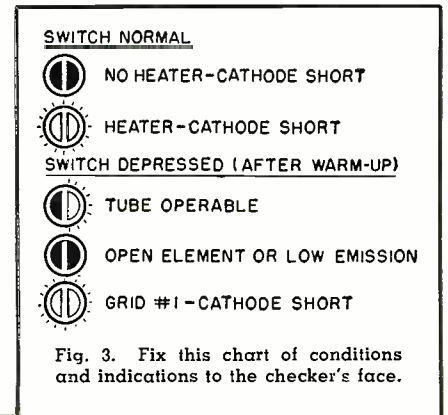
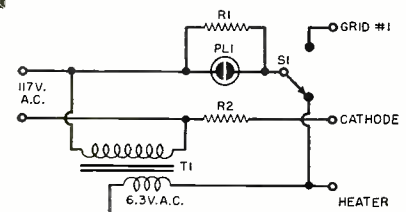

Fig. 3. Fix this chart of conditions and indications to the checker's face.

Fig. 4. Schematic of the test unit.

R_1 —680,000 ohm, $\frac{1}{2}$ w. res. $\pm 10\%$
 R_2 —220,000 ohm, $\frac{1}{2}$ w. res. $\pm 10\%$
 S_1 —S.p. 2-circuit push-button switch
 PL_1 —NE-2 neon lamp
 T_1 —6.3 v. fl. trans., .6 amp or better
 1—A.c. line cord
 1—Case with CRT socket, see text



The "Dyna-Box" Doublechecks Tube Tester

Fig. 1. The completed "Dyna-Box" (left) connected to its associated instrument.

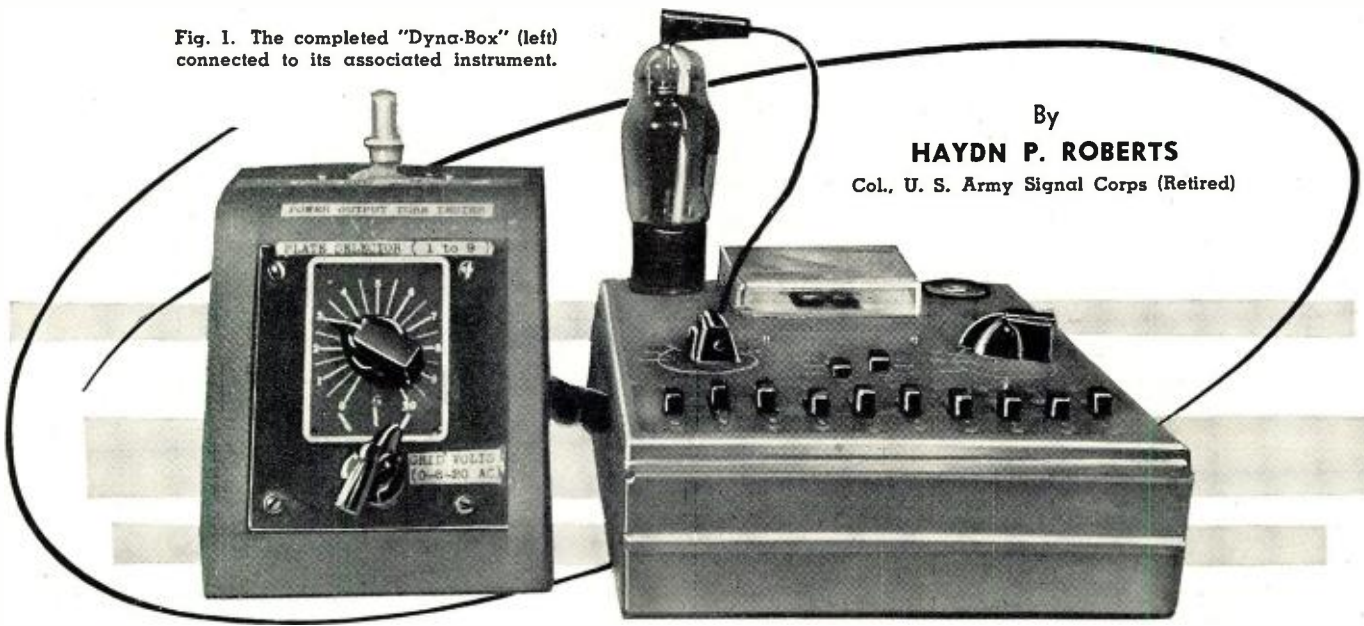

By

HAYDN P. ROBERTS

Col., U. S. Army Signal Corps (Retired)

Simple accessory for standard emission-type tube checkers provides a dynamic power-output test.

A SIMPLE emission-type tube tester, which also tests for shorts and leakage between tube electrodes, is considered essential by many service technicians and experimenters. When this checker indicates a short, a very bad leak, or very low emission, the tube under test is obviously defective, and the job of testing has been successfully completed. But when these factors check all right, it doesn't necessarily mean that you can stick an

OK tab on the tube and go looking for trouble someplace else. Any experienced service technician knows that quite a number of tubes which test high on emission prove to be inferior, performance-wise, to other tubes whose emission is lower.

"Active spots" often develop on cathodes. An excessive stream of electrons may emit from such a spot, beyond the control of adjacent grid areas, while the rest of the cathode

might be quite useless. In such cases, the emission looks very good on the meter but the tube may be inoperative.

To know what shape a tube is really in, it should be tested under conditions akin to its actual operating performance. The "grid-shift" transconductance test gives more information about the tube, but it is still a static test. The dynamic transconductance test comes much closer to actual operating conditions, but tube testers employing it are rather expensive.

Of all the tube tests, the power-output test comes closest to actual operating conditions. In its "Receiving Tube Manual," RCA has this to say: "In the case of voltage amplifiers, the power-output is indicative of the amplification and output voltages obtainable from the tube. In the case of power-output tubes, the performance of the tube is closely checked. Consequently, although more complicated to set up, the power-output test will give closer correlation with actual performance than any other single test."

The "Dyna-Box" is a simple accessory which, when used with an emission-type tester, provides a dynamic test of the power-output type. It can hardly be expected that such an inexpensive and simple device will provide the necessary power for a full-power test of power tubes. Within its power limitations, it will, however, provide a real power-output (if the user wishes to calculate the actual plate current and load resistance) which can be used for relative performance checks. As in the case of emission-type tube testers, the "Dyna-Box" is useful for relative rather than absolute readings, and these are used for comparison with performance of new tubes or those known to be good. The change in plate current

Fig. 2. Circuit of "Dyna-Box" and part of checker (left) shows interconnections.

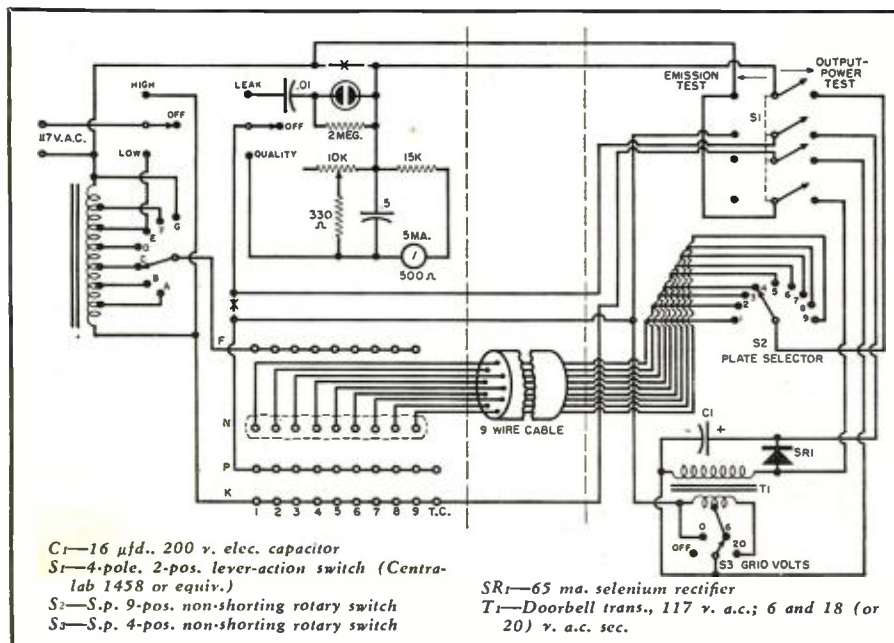

due to a change in the value of a.c. grid voltages provides an excellent measure of the tube's ability to perform.

Although applicable to any type of emission tube tester, in this case the *Superior* Model TC-55 was employed. This tester, when used for emission testing, connects all elements to the cathode except the control grid, and it uses this grid as an anode. The "Dyna-Box," when switched into operation, selects the plate element, putting about 155 volts d.c. on it, and provides for tying all free grids together and supplying a choice of 0, 6, or 20 volts a.c. to the combined grids, in class B operation of the tube. By flipping a lever-type switch on the "Dyna-Box," the tube tester is immediately returned to its original status, as an emission-type tester. There is nothing complicated in the set-up and the entire accessory can be housed in a sloping, panelled meter box, cut with a hole for a three-inch meter, and measuring only 4" by 4". (See Fig. 1.)

The first step is the slight modification of the TC-55 tester. Referring to Fig. 2, obtain or make up a cable of 14 wires, each 12" to 15" long. (Differently colored wires will simplify connecting.) Under the TC-55 panel, it will be noticed that the *N* (neutral) strip of contacts are unwired. Connect nine of the wires in the cable to these nine contacts (omitting the tenth which is marked *T.C.* [top cap], which, of course, will never be selected for plate voltage). Now cut two wires at the points *X* (Fig. 2), connecting two wires in the cable across each cut. This completes all necessary modification in the tube tester, excepting a U-shaped cut in the side of the tester, large enough for the cable to be taken out. Tape the cable at this point of exit.

On a piece of $\frac{1}{16}$ " *Bakelite* or other insulating material, 3" by $3\frac{1}{2}$ ", mount the 9-position rotary switch with its center $1\frac{3}{8}$ " from the top. Directly below, mount the 4-position rotary switch with its center $1\frac{1}{16}$ " from the bottom of the panel.

In consecutive order (1 to 9) wire the 9-position switch with the nine wires in the cable, from the *N* strip in the tube tester. Wire the secondary of the doorbell transformer as shown. Now wire the 16- μ fd. capacitor in series with the selenium rectifier, across the primary of the doorbell transformer.

On the top of the meter box, drill two $\frac{7}{16}$ " holes with centers $1\frac{5}{8}$ " from either side. Cut a slot between these two holes for the lever of the switch to rock back and forth in. Drill two $\frac{3}{32}$ " holes with centers $1\frac{3}{16}$ " from either side, for the screws for mounting the lever switch. Now wire the lever switch as shown in Fig. 2, utilizing the remaining five wires of the cable. Mount the switch assembly on the *Bakelite* panel, upon the sloping front of the meter box, so that it covers the hole.

The doorbell transformer can now

TUBE	EMISSION		METER READINGS for Grid Voltages of			DIODES	ELEMENT NUMBERS	
	1st Half	2nd Half	0	6	20		Plate	Grids
6AG5	71		0	8	11		5	1, 6.
6AU5	66		0	41	64		5	1, 8.
6AU5	68		0	22	48	(Higher emission but lower performance)		
6B8	54		0	7	19	4, 5, OK	3	6, T.C.
6BK7A	71		66	83			1	2.
		72	62	82			6	7.
6CB6	71		0	6	12		5	1, 6, 7.
6J5	64			48	77		3	5.
6J5	64			54	85		3	5.
6J6	72		64	84		(Bad match)	1	6.
		71	52	76		(Bad match)	2	5.
6J6	70		58	78				
		70	50	72				
6J7	58		0	8	38		3	4, 5, T.C.
6J7	67		0	9	44			
6K6	61		0	6	20		3	4, 5.
6K6	61		0	11	36			
6K7	60		0	8	38		3	4, 5, T.C.
6K7	61		0	11	46			
6L6	65		0	30	60		3	4, 5.
6L6	68		0	30	59	(match for P.P., dynamically)		
6L7	65		0	10	40		3	4, 5, T.C.
6L7	66		0	12	44			
6L7	60		0	11	53			
6SN7	64		38	46	78		2	1.
		64	40	48	78		5	4.
6SN7	68		43	53	86		2	1.
		69	40	51	82		5	1.
5U4	65					4		
		68				6		
5U4	72					4		
		74				6		

Table 1. Specimen chart of recorded typical readings for many tube types.

be mounted with four small bolts to the base of the meter box, and the "Dyna-Box" is now complete.

1. Throw switch S_1 on the "Dyna-Box" over to "Emission," and insert tube to be tested in the TC-55. Make the normal test for leaks, shorts, and emission.
2. If not known, find out from a

tube manual which element of the tube is the plate. (And while looking this up, record what elements are free grids, unless the tube is a triode.) If the tube is a double tube, record the number of both plates, as well as the grid or grids for each plate.

3. Set the "Plate Selector" (switch
- (Continued on page 144)



Rear view of the "Dyna-Box" shows disposition of parts with switch on top, doorbell transformer on the bottom, and the selenium rectifier mounted on switch.

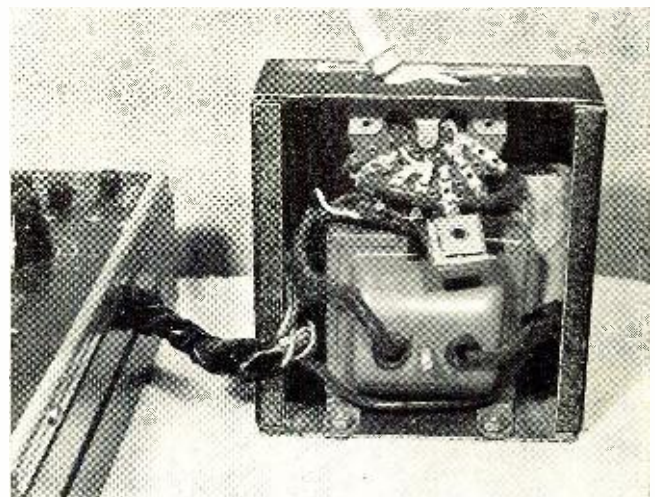

Mult band FM Receiver

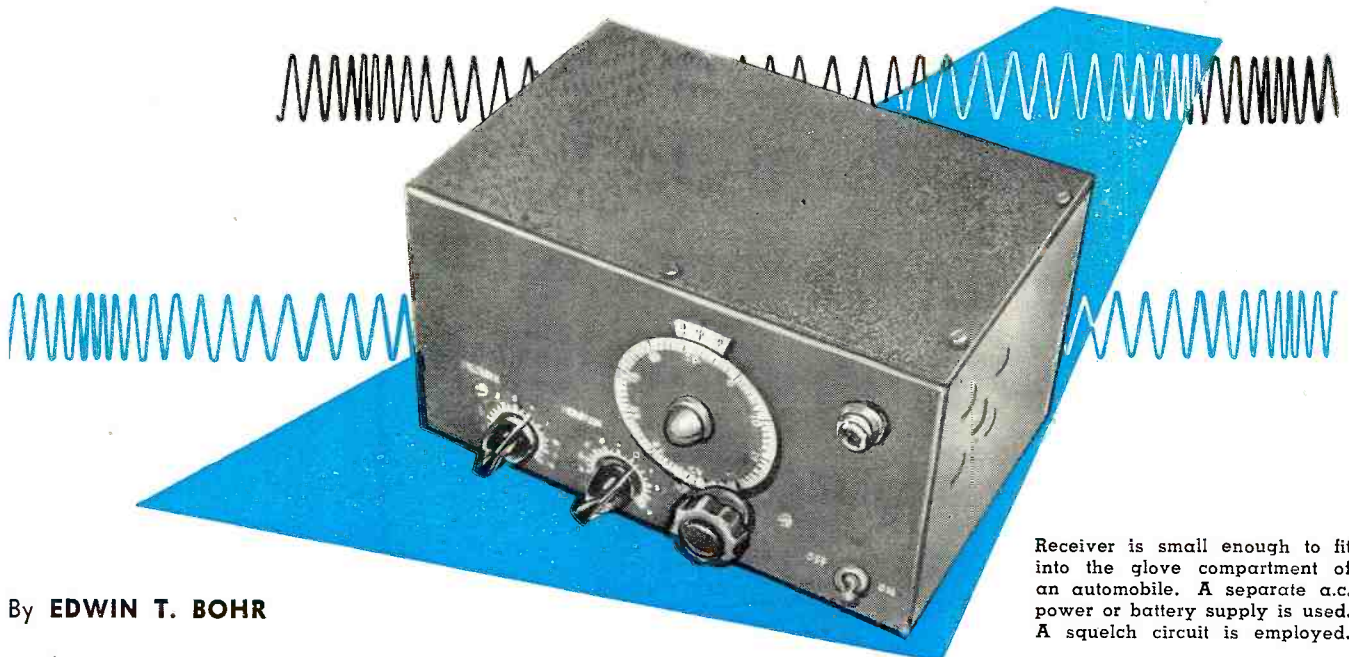

Receiver is small enough to fit into the glove compartment of an automobile. A separate a.c. power or battery supply is used. A squelch circuit is employed.

By EDWIN T. BOHR

Covers amateur, police, emergency, and utility services, plus standard FM broadcasts. Operates from line or battery.

THIS high-frequency FM receiver, whose construction will be described in detail here, will cover just about all of the present FM bands including: amateur, police, emergency and utility services, plus standard FM broadcast.

The circuit contains: a 6BK7 grounded-grid r.f. stage, an oscillator-mixer using a 6U8, temperature-compensated oscillator, high-gain i.f.

stages, 6BN6 combined limiter-discriminator, and a smooth working squelch circuit. Even if you do not build the receiver, there are probably many ideas you can adapt to your own purposes.

The requirements of several people influenced the design of this receiver. The first was to pick up police calls in the 30-50 mc. band. This is the reason

a squelch circuit is used. During the periods when there is no carrier the background noise is very objectionable. This made the squelch a top priority item.

It was considered desirable to be able to operate the receiver from either 117 volts a.c. or from 6 volts d.c. This is accomplished by means of a flexible dual power supply arrangement. Each supply remains in its respective location—home or automobile—and the receiver is simply transferred from one location to the other.

Sooner or later the thrill of listening to emergency broadcasts begins to fade, so the design includes possible reception of the other bands, especially commercial FM. The easily changed tuning units make the receiver extremely versatile in this respect.

The final requirements included small size, professional appearance, and a reserve of power. As can be seen in the photographs, the receiver is small enough to fit into the glove compartment of an automobile.

The complete receiver has undergone several revisions. The mechanical and electrical features have been slicked-up and improved. For this reason the author is offering this as a "bug-free" piece of equipment.

R.F. Amplifier

One half of a 6BK7 dual triode functions as the r.f. amplifier. The familiar grounded-grid circuit gives a substantial amount of gain and at the same time reduces oscillator radiation.

This circuit originally used a 12AT7 but the socket was later rewired for the 6BK7 with better internal shielding and slightly greater gain.

The input circuit for the 6BK7 is inherently broadband and does not

View of topside of chassis. Note the locations of the tubes and tuning unit.

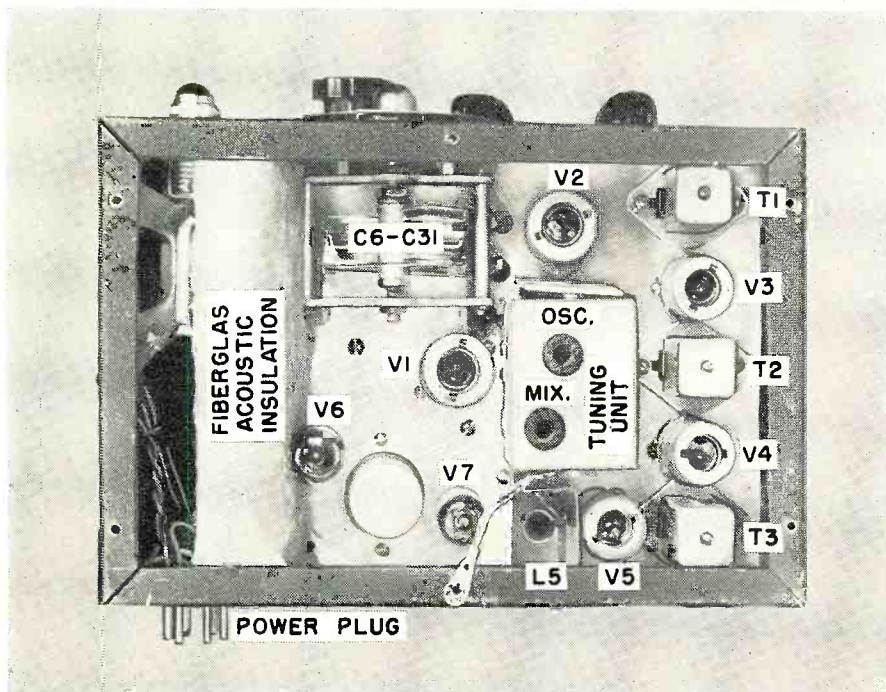

need to be tuned with a variable capacitor. This permits the use of a two-gang tuning capacitor, simplifying the construction and alignment of the tuning units.

The 6BK7 is roughly equivalent to a 200-ohm resistor shunted across the antenna transformer. (This accounts for the wide bandpass.) Nevertheless, the plate circuit is quite selective since it is resonated to the signal frequency by the tuning capacitor.

Some practical experimentation went into the antenna transformer for the grounded-grid stage. This unit matches 75-ohm or 300-ohm balanced and unbalanced antennas to the r.f. stage. The first arrangement tried was an autotransformer, however, the present two-coil unit is compact, simple to construct, and more efficient.

Three sets of winding data are given for this input transformer. The first is for the geometric center of the range from 30 to 108 mc. This gives the best *over-all* sensitivity for both emergency and FM broadcast. Two other sets of data are given for antenna coils that peak in each band.

As an example: The 30-50 mc. coil will give the greatest gain in the 30-50 mc. band, yet it will operate in the 88-108 mc. band and *vice versa*. The 88-108 mc. coil, of course, peaks in the FM broadcast range.

Mixer

The 6U8 is a combined oscillator and mixer. This tube is similar to a 6AG5 and one half of a 6J6—it makes a hot combination!

The mixer is the plate detector type biased near cut-off by a 470-ohm cathode resistor. Oscillator voltage is injected into the control grid circuit by wiring capacitance. A small negative temperature coefficient capacitor is placed across the oscillator tuning circuit. The method for determining the value of this capacitor can be used on almost any piece of equipment.

This is how the value of the compensating capacitor was determined. We arrived at how many micromicrofarads change each division on the tuning dial represents by dividing the capacitance range of the tuning capacitor by the number of graduations on the dial (this was a straight line capacitance tuning capacitor).

Next, as soon as the receiver is switched on it is tuned to a carrier for maximum signal by meter reading at the "test point" and the tuning dial position is recorded. A centigrade thermometer is placed inside the cabinet. When the temperature in the cabinet has reached a maximum, the receiver is *retuned* for maximum signal strength reading.

By noting the difference between dial settings for the set cold and after it has reached normal operating temperature, it is possible, by simple arithmetic, to calculate the capacitance drift. For this receiver, using the components shown, the total drift was about .7 $\mu\mu\text{fd}$. When this value is divided by the temperature rise, it

gives the capacitance drift in micro-microfarads per degree centigrade.

It only remains to choose a suitable negative coefficient capacitor to equalize this drift. Two things determine the equalization; (1) the negative coefficient of the capacitor, and (2) its capacitance. A 10 $\mu\mu\text{fd}$. capacitor will give twice as much compensation as a 5 $\mu\mu\text{fd}$. unit with the same coefficient.

The capacitance multiplied by the coefficient (in $\mu\mu\text{fd}/\mu\mu\text{fd}/C^\circ$) will give the compensation in micromicrofarads per degree centigrade. This value should be as close as possible to the amount the receiver drifts. To avoid changing the tuning range appreciably the smallest capacitance possible is used. This capacitor was an *Erie N750* 5 $\mu\mu\text{fd}$. "Ceramicon" ordered from one of the mail order catalogues.

Tuning

For the 30-50 mc. band no trimmer is used across the oscillator coil—the mixer coil is made to do the tracking. The oscillator coil must cover a greater range than the mixer coil since the oscillator operates below the signal frequency.

A large tuning capacitor is necessary to cover the almost two-to-one range of 30-50 mc., but considerably less range is needed for the 88-108 mc. band. Therefore, a considerable slowing down of *both* the oscillator and antenna coils is necessary to spread out the 88-108 mc. band. This is done with shunt trimmer capacitors across *both* coils.

Separate tuning units are built for each band. Each unit is a small aluminum box containing the oscillator and mixer coils, plus the necessary trimmers and adjustments for each range.

Rigid support for the tuning unit is

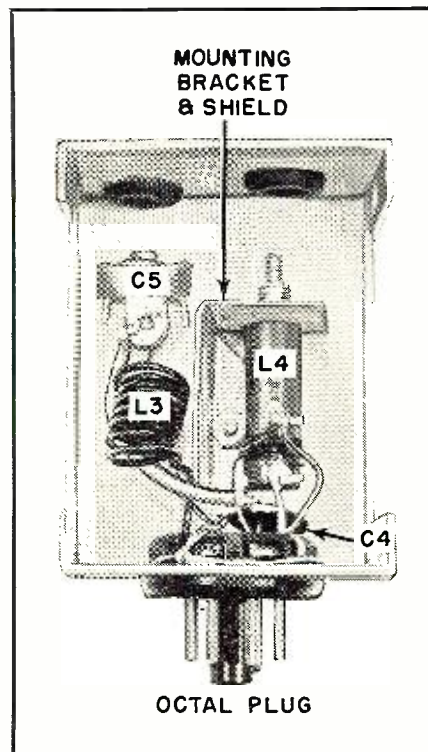

Inside view of the 30 to 50 megacycle tuning unit used in multiband receiver.

provided by an aluminum upright bolted to the chassis and just clearing the tuning unit box by one sixteenth of an inch. The unit is held to the upright by a heavy rubber band.

Be sure the frame and rotor of the tuning capacitor are grounded to the chassis at *several* points, either by large area metal-to-chassis contacts or heavy braid. At frequencies higher than 120 mc., fixed coils, wired to the tuning capacitor, should be used rather than the tuning units.

Photograph showing underside of the chassis used in the receiver. Note the placement of the various components with respect to the tube sockets.

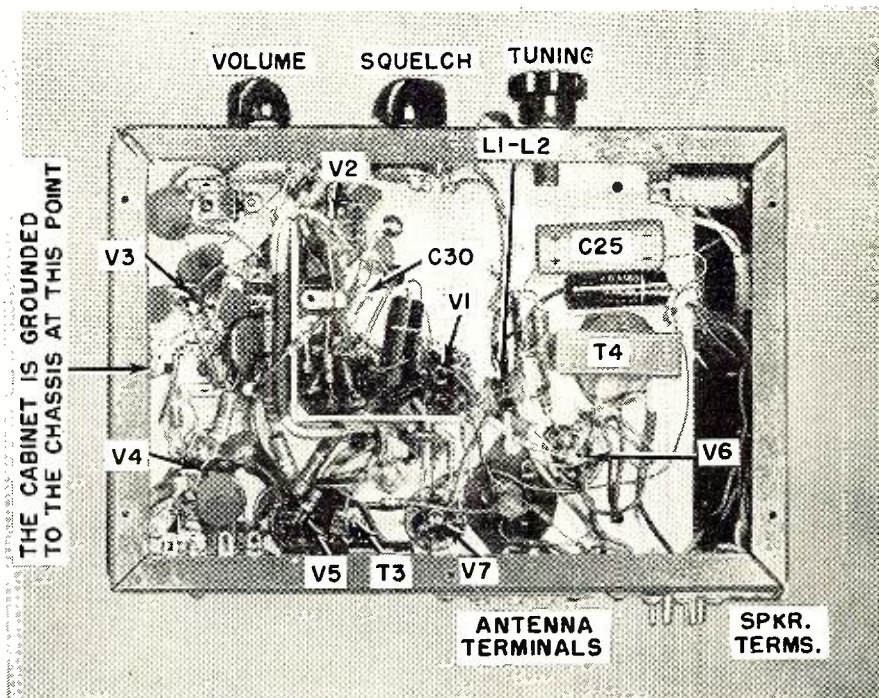

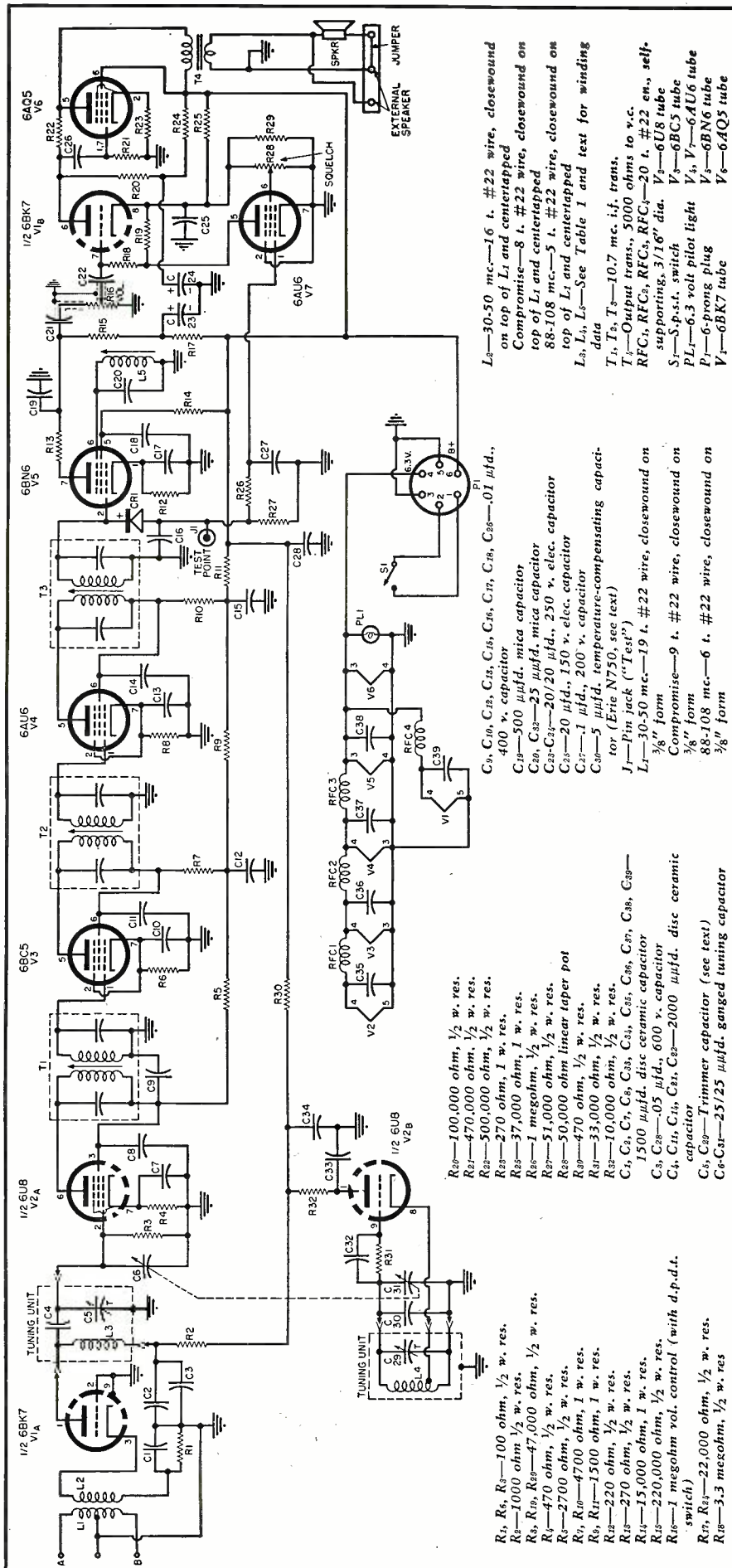

1/2 6BK7 V1A
1/2 6BK7 V1B
6BN6 V2A
6BC5 V3
6AU6 V4
6AG5 V5
6AU6 V6
6AQ5 V6
6BK7 V7

Res—100,000 ohm, 1/2 w. res.
R21—470,000 ohm, 1/2 w. res.
R22—500,000 ohm, 1/2 w. res.
R23—270 ohm, 1 w. res.
R24—37,000 ohm, 1 w. res.
R25—1 megohm, 1/2 w. res.
R26—51,000 ohm, 1/2 w. res.
R27—50,000 ohm linear taper pot
R28—470 ohm, 1/2 w. res.
R29—33,000 ohm, 1/2 w. res.
R30—10,000 ohm, 1/2 w. res.
C1, C2, C3, C4, C5, C6, C7, C8, C9, C10, C11, C12, C13, C14, C15, C16, C17, C18, C19, C20, C21, C22, C23, C24, C25, C26, C27, C28, C29, C30, C31, C32, C33, C34, C35, C36, C37, C38, C39—1500 μ fd. disc ceramic capacitor
C5, C28—05 μ fd., 600 v. capacitor
C4, C7, C11, C21, C22—2000 μ fd. disc ceramic capacitor
C5, C29—Trimmer capacitor (see text)
C6-C39—25/25 μ fd. ganged tuning capacitor

L1—30-50 mc.—19 t. #22 wire, closewound on 1/8" form
L2—30-50 mc.—16 t. #22 wire, closewound on top of L1 and center-tapped
L3—30-50 mc.—8 t. #22 wire, closewound on top of L1 and center-tapped
L4, L5—See Table 1 and text for winding data
T1, T2, T3—10.7 mc. i.f. trans.
T4—Output trans., 5000 ohms to v.c.
RFC1, RFC2, RFC3, RFC4—20 t. #22 en., self-supporting, 3/16" dia. V2—6U8 tube
S1—S.p.s.t. switch
PL1—6.3 volt pilot light
V1, V2—6AU6 tube
V3—6BC5 tube
V4, V5, V6, V7—6AU6 tube
V8—6-prong plug
V9—6BK7 tube
V10—6AQ5 tube

R5, R6, R7—100 ohm, 1/2 w. res.
R8—1000 ohm, 1/2 w. res.
R9, R10, R11—47,000 ohm, 1/2 w. res.
R12—470 ohm, 1/2 w. res.
R13—2700 ohm, 1/2 w. res.
R14—4700 ohm, 1/2 w. res.
R15, R16—1500 ohm, 1 w. res.
R17—220 ohm, 1/2 w. res.
R18—270 ohm, 1/2 w. res.
R19—15,000 ohm, 1 w. res.
R20—220,000 ohm, 1/2 w. res.
R21—1 megohm vol. control (with d.p.d.t. switch)
R22, R23—22,000 ohm, 1/2 w. res.
R24—3.3 megohm, 1/2 w. res.

BAND	L ₁	L ₂	MIXER TRIMMER	OSC. TRIMMER
30-50 mc.	8 t.	8 t.	(tapped 2 t.) 0-30 μ fd.	Omit
88-108 mc.	3 t.	3 t.	(tapped 3/4 t.) 0-30 μ fd.	0-30 μ fd.

Table 1. Coil data for tuning units.

Bypassing

Bypassing in the mixer stage is very critical—much more so than in the i.f. stages. The bypass capacitor from the plate of the 6U8 triode should run *directly* to the metal tube socket saddle. Two bypass capacitors are used in the screen circuit: one to ground directly at the socket and another at the i.f. transformer lug. The cathode bypass capacitor should go *directly* to ground. Do not attempt to ground these mixer bypass capacitors to a single point. Get them to ground by the shortest route. This simple expedient cleared out all mixer troubles in the original model.

Spurious oscillation in the mixer stage may make it appear that every stage in the receiver is squealing or blocked with oscillation. Every component will become hypersensitive to capacitance effects.

I.F. Stages

By tying pins 2 and 7 together at the socket it is possible to use 6BC5, 6CB6, 6AG5, 6AU6, or 6BA6 tubes in the i.f. strip. With the 6BA6 it is necessary to change the cathode resistor to 100 ohms. The 6BC5-6AU6 is the recommended combination shown in the diagram.

The shelf-type chassis comes into contact with the cabinet only at the front and back. The end of the chassis containing the i.f. stages does not touch the cabinet. To prevent oscillation in these stages it is necessary to electrically connect the chassis and cabinet at this point with a piece of shielded braid. This can probably be seen in the under-chassis photograph. Otherwise, there is no tendency toward oscillation. The plate supply voltage can increase as much as 60 volts with still no signs of instability. Close attention to the decoupling of filament and plate leads gives "built in" insurance against oscillation.

Any wire passing in the vicinity of the i.f. stages is capable of inducing feedback. For this reason simple uncluttered wiring is the most satisfactory. The under chassis shield helps to confine wiring to their respective stages.

6BN6 Limiter-Discriminator

There are several reasons for using the 6BN6 discriminator. First of all, the 6BN6 makes FM tuning as smooth and easy as AM tuning. The three-point tuning and distortion typical of slight mistuning are gone. The limiting action of the 6BN6 has no time constant. With the 6BN6 it is unnecessary to apply a.v.c. to the preceding

← Complete schematic diagram of multiband FM receiver. Separate power supply is used.

i.f. or mixer stages. The discriminator uses a very simple single-tuned circuit obviating the expensive discriminator transformer used with other detectors. This saving will more than balance the extra cost of the 6BN6.

The quadrature coil should be mounted above chassis in a shielded location as near to the 6BN6 as possible. A shield around this coil may be seen in the photographs but it is not absolutely necessary.

The quadrature circuit is made to oscillate at the intermediate frequency by energy coupled from the electron beam inside the tube. When the carrier swings above and below its center frequency, the quadrature "gates through" larger or smaller pulses of electrons, causing the plate current to vary at the audio modulation frequency. This makes it a true FM detector.

Audio Stages

A 6AQ5 and one half of the 6BK7 comprise the audio section. The 6AU6 squelch tube controls the bias on the 6BK7, driving it to cut-off when there is no carrier. A single 1N34 diode supplies the control voltage for the 6AU6. This 1N34 should be soldered directly to the i.f. transformer lug and directly bypassed to ground.

A voltage control in the screen circuit of the 6AU6 determines at what signal level the audio amplifier begins to function. Any carrier producing twelve volts or more of signal at the "test point" will cause the audio amplifier to operate no matter what position the squelch control is in.

Inverse feedback is used in the output stage. This produces a noticeable improvement in audio quality even on voice transmissions with the small in-ternal speaker.

One trouble was noted on police calls. The sharp "attention" tone used to alert the police cars would set up receiver microphonics. A double layer of Fiberglas behind the speaker eliminated this condition.

Coil Data

In the tuning units the antenna coils are $\frac{3}{8}$ inch in diameter, and wound with #22 enamel wire. The turns should be closewound and then spaced for tracking.

The 30-50 mc. oscillator coil is closewound with #26 enamel wire on a Cambridge Thermionic LS3 coil form. Number 16 enamel wire is used for the 88-108 mc. oscillator winding. The wire is rigid enough to be self-supporting around the coil form. Details for winding L_s and L_a are given in Table 1.

This winding data can be changed proportionately to hit other bands.

The quadrature coil L_r is 22 turns of #26 enamel wire closewound on an LS3 form.

Alignment

To align the i.f. stages, pull the tuning unit from its socket and apply a 10.7 mc. signal to the stator plates of the mixer section of the tuning capacitor, after setting the unit at minimum capacity. A voltmeter, 0 to 5 volts will do, should be connected from the "test point" to ground. The meter will read the signal strength. Now adjust the i.f. tuning slugs for maximum meter reading, progressively reducing the output of the signal generator as the i.f. stages are peaked.

The quadrature circuit is tuned for greatest audio output and has no effect on the signal strength at the test point.

To align the 30-50 mc. tuning unit: First, adjust the oscillator slug until the radio will receive a 30 mc. signal with the tuning capacitor plates fully meshed. The antenna coil is adjusted by squeezing or spreading the turns for maximum sensitivity on the low end of the band. The antenna coil trimmer is used to track the antenna coil at frequencies near 50 mc.

For best tracking, go back to the low-frequency end of the band and repeat the above procedure once or twice more. If only one or two stations are

to be received, adjust the antenna coil trimmer for maximum sensitivity and best tracking near these stations.

Alignment of the 88-108 mc. unit is much the same, except the oscillator coil has an added parallel trimmer capacitor. This trimmer reduces the tuning range to the required 20 mc. Slowly screw down the oscillator trimmer until the receiver covers the 20 mc. range. More capacity reduces the range and less tuning capacity increases the range. The oscillator slug is adjusted until an 88 mc. signal can be picked up with the tuning capacitor plates completely meshed. The antenna coil is adjusted for best tracking in the same way as the 30-50 mc. unit.

Power Supplies

Four selenium rectifiers are used in the a.c. power supply. A 6X5 or a 5Y3 rectifier tube, however, can be used just as well and will be slightly cheaper. Rubber lamp cord is used for the filament and switch wires between the receiver and power supply.

Stranded "primary wire" should be used to interconnect the receiver and vibrator power supply 6 volt leads. Notice the battery lead goes directly to the socket that fits the receiver rather than into the power supply. Since the vibrator supply is in a separate metal box, there is no hash from this source.

The life of the vibrator to a large extent will depend upon how accurately the buffer capacitor is chosen. Constants of the vibrator transformer determine the value of the buffer. In this case the value shown in the diagram is the capacitance specified by the manufacturer of the transformer.

One final word. While the FCC has no rule prohibiting the use of mobile FM receivers capable of tuning the police bands, many states have laws against such sets. To avoid any trouble of this sort, the FCC suggests that would-be builders check local police authorities before installing such gear in their family cars.

-30-

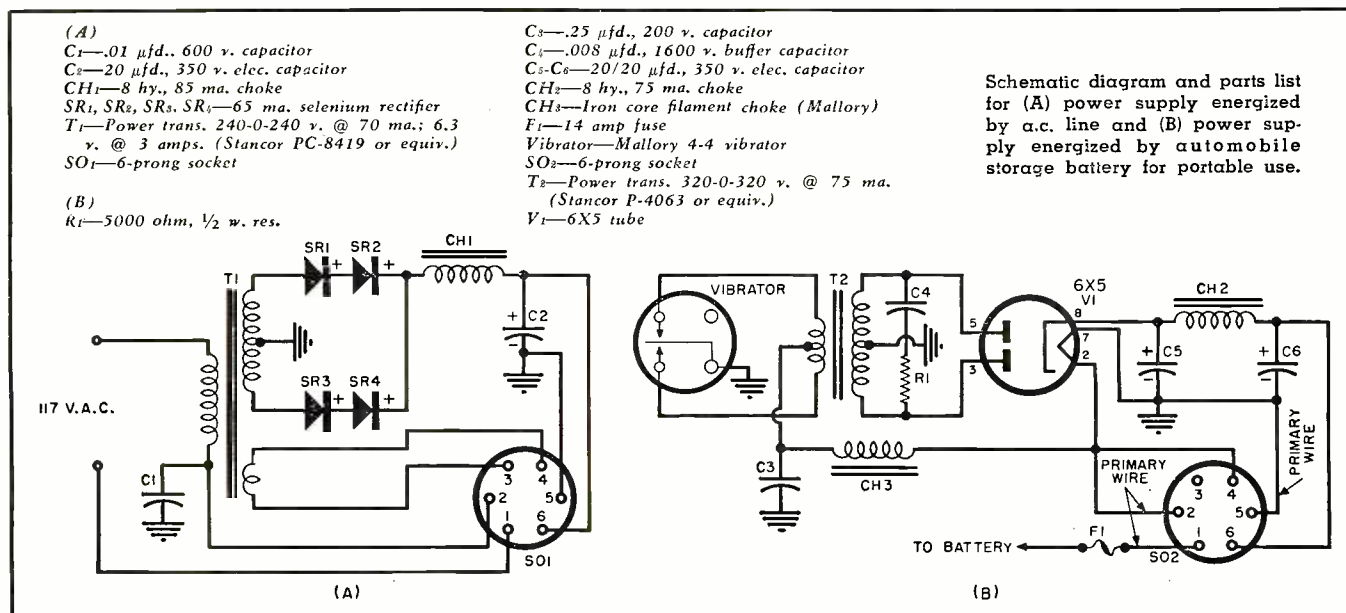



By JOHN T. FRYE

MAC MEETS COLOR

IT WAS a beautiful June day, the kind that makes it hard to stay indoors; so Mac was quite understanding as Barney, his assistant, floated in from lunch a full quarter of an hour late.

"Ah, spring!" Mac said with a teasing grin as he looked at the dreamy expression in the blue eyes of the red-haired Irish youth.

"It's got me, all right," Barney admitted. "I drove Margie around a little before I took her back to work—but say! What's that huge cardboard carton doing on your front porch? I spotted it as we went past. You holding out on me again?"

"I might have known I couldn't keep anything from you," Mac sighed. "What would you say if I told you a new twenty-one-inch color TV set arrived in that box?"

"You kidding? Did you really get a color set? How does it work? When do I get a look-see?"

"Easy! Slow down!" Mac said with a chuckle. "No, I'm not kidding. I really do have the set, and it's quite a beauty. It has a 21AXP22A kinescope; mahogany cabinet; triple speakers; tuning, brightness, and volume controls up on the side; and a lighted window that shows you what channel you are watching even when you're sitting clear across the room."

"Sounds great, but what made you take the plunge?"

"It is sort of a plunge, for color sets are few and far between in this weak-signal area where most people are still trying to get a good reliable black-and-white picture; but as you know we are getting an increasing number of inquiries from our customers about the feasibility of buying a color set. Many of the questions are downright embarrassing simply because we don't know the answers."

"You can say that again. Just yesterday Mr. Palmer collared me down at the bank and wanted to know if he could expect good enough color reception here to warrant his buying a set."

"That question is thrown at me two or three times a week," Mac said with

a nod; "and I hate to keep saying I don't know. After all, since we're in the TV business, we *should* know. Of course, we can quote from what we've read and heard in the TV clinics; but this information is, of necessity, of a general nature. What people around here want is specific information applying to this particular locality. That's why I decided to get a color set and find out the answers for myself."

"Most of the technicians I hear talk are discouraging the purchase of color sets around here."

"I know that, but I also know most of them have no more personal experience to back up their advice than I have. In fact, some of them have admitted they hate to think of having to service the new and complicated circuits in color TV receivers and are deliberately trying to keep color out of this area as long as possible. Doubtless some of the others are unconsciously acting from the same motives, even though they do not admit it, even to themselves."

"That's a kind of crazy attitude," Barney exclaimed.

"Maybe so, but it's also pretty human. When you're young and have no responsibilities, it's natural to be eager to try new things; but when you get a little older and have discovered that mastering something new usually entails a lot more effort and hard work than it does fun, you're not quite so eager. This is especially true when the innovation touches your way of making a living. In such a case you may feel the new thing poses a serious threat to your bread-and-butter and that of your family. I can see why many technicians are actually afraid of color television."

"You think they're right in knocking color?" Barney asked in amazement.

"Certainly not. You can understand a person's motives without condoning his behavior. Knocking color, for purely selfish personal reasons, will hurt the technician in the long run. Color is coming inevitably and faster than many people realize. The technician

who disparages it in the hope of holding it back is in about the same position as the person who tried to sweep back the tide with a broom. All such a technician will succeed in doing is to convince people he is a mossy reactionary, unwilling or unable to keep up with advances in his own field."

"Then you think we should advise everyone to buy a color set right away?"

"Will you quit trying to put words into my mouth? That would be like advising everyone to go out and buy a Cadillac. Color television is still expensive; there is definitely room for improvement in both transmission and reception; good color reception requires somewhat more signal strength than does a 'passable' picture in black-and-white—although not as much more as I had imagined—and there still are not nearly enough color broadcasts on the air. But for the man who can afford it, who likes to be in on new and exciting developments, and who feels the thrill of watching a spectacle such as the Rose Bowl Parade in full colors repays him for his considerable investment, color is here!"

"Tell me more about your reception. How long did it take you to set up the color set? I understand that's quite a job."

"How long does it take you to plug in a line cord and turn on a switch?" Mac asked quizzically.

"You mean that's all you did? You didn't have to spend hours de-gaussing the tube, correcting the purity, adjusting the convergence?"

"Nope. We simply took the set out of the shipping carton, put it alongside the good old black-and-white set, arranged the antenna lead-in so it could be switched to either set, and turned on the color receiver. There was no color on at the time, but stations rolled in on black-and-white without so much as having to adjust the vertical or horizontal hold controls."

"Maybe it was set up before you got it."

"Only at the factory. Since I wanted to learn exactly what to expect in all phases of color reception, I specified the set was to be delivered still sealed in a factory carton; and that's the way it came."

"And you're getting a perfect color picture?"

"'Perfect' is a pretty strong word to use in connection with any TV picture, black-and-white or colored. Let's say I'm getting a much better picture than I have a right to expect for not having done a thing to the set except turn it on. Practically everyone who has seen the set—and that is quite a parade!—exclaims about how wonderful the picture is; but most of these people are seeing color television for the very first time and are not too critical. I am quite aware that there is some room for improvement both in purity and convergence; and as soon as the dot generator I have ordered arrives, I'm going to see what I can do about this."

(Continued on page 130)

SHOW ANY PICTURE or PATTERN

at any time — ON ANY TV SET

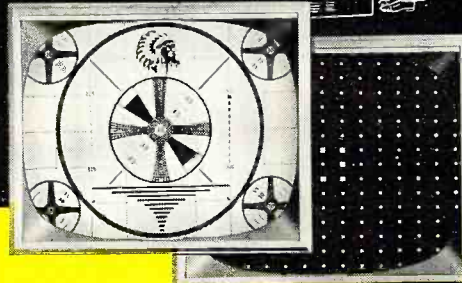
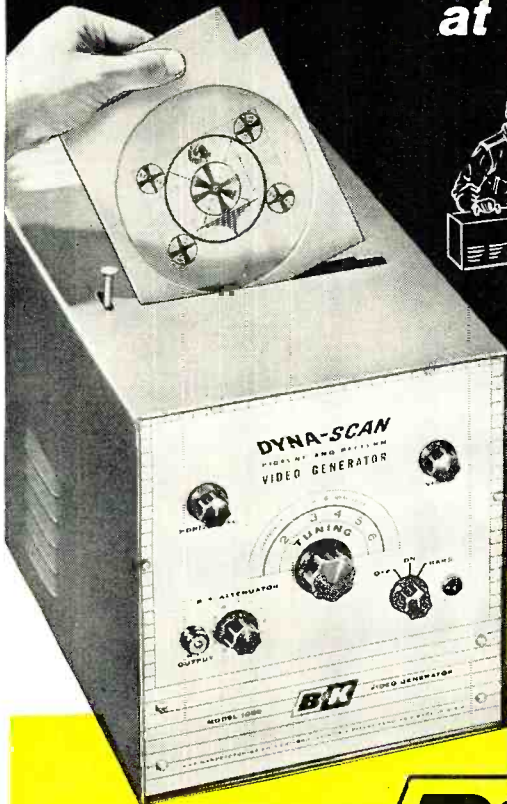

For Both Black & White and Color TV
Provides standard Indian Head Test Pattern for proper TV set alignment, and stable White Dot and White Line Patterns for color convergence adjustments.

For Merchandising & Industrial Uses
Provides closed circuit TV system. Transmits pictures or messages for advertising, educational and commercial visual communication.

MODEL 1000



DYNA-SCAN PICTURE AND PATTERN VIDEO GENERATOR

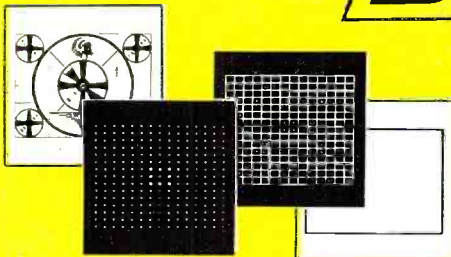

3 TEST PATTERN TRANSPARENCIES AND ONE CLEAR ACETATE SUPPLIED

- 1 Indian Head Test Pattern
- 2 White Dot Pattern
- 3 White Line Crosshatch Pattern

These are broadcast-quality transparencies, and assure accurate, high-definition TV images. You can also transmit your own transparencies of any subject you wish. The clear acetate can be used for special messages. Extra transparencies and acetate available.

Make the most of this *Complete Flying Spot Scanner*. It produces a composite video and sync signal that operates any standard black & white or color TV receiver. Can be used with one or more TV sets or fed into a master antenna system or community antenna system. Maximum resolution capability is well in excess of 450 lines; band width in excess of 5 mc. Projects and reproduces pattern or picture with high definition from any slide transparency. Transmits messages typed or written on clear acetate. Makes convenient stand-by and break-in for community distribution operation. Rugged, compact, portable, and ready to operate.

NET \$199⁹⁵

See your B&K Distributor, or Write for Bulletin No. 1000-N

AVAILABLE ON EASY TIME PAYMENT PLAN

B & K MANUFACTURING CO.

3726 N. SOUTHPORT AVENUE · CHICAGO 13, ILL.



Model 950 Dyna-Scan Pickup and RF Generator only. Enables you to make your own picture and pattern video generator, at a saving. Supplied with three test pattern transparencies and one clear acetate. Net, \$69.95



Model 500 DYNA-QUIK
Dynamic mutual conductance tube tester. Accurately tests tubes faster. Net, \$109.95



Model 400 CRT
Cathode Rejuvenator Tester. Tests and repairs TV picture tubes. Net, \$54.95



Model 750 CALIBRATOR
Designed to check and adjust test instruments with laboratory accuracy. Net, \$54.95

New



MODEL O-11

Shpg. Wt.
21 Lbs.

\$69⁵⁰

- * An improved model of what was already an outstanding instrument.
- * Performance is unmatched in this price range..
- * Incorporates the extra features required for color TV servicing.

Extra!

A FULL YEAR TO PAY

SEND FOR DETAILS OF HEATH
TIME-PAYMENT PLAN.

**5
BIG
REASONS
WHY**



**HEATH
COMPANY**

A SUBSIDIARY OF DAYSTROM, INC.

BENTON HARBOR 15, MICH.

HEATHKIT ETCHED CIRCUIT, PUSH-PULL

5" Oscilloscope Kit COLOR TV

The previous Heathkit oscilloscope (Model O-10) which was already a most remarkable instrument, has been improved even further with the release of the Heathkit Model O-11. It incorporates all the outstanding features of the preceding model, *plus* improved vertical linearity, better sync stability, especially at low frequencies, and much-improved over-all stability of operation, including less vertical bounce with changes in level. These improvements in the Model O-11 circuit make it even more ideally suited for color TV servicing, and for critical observations in the electronic laboratory. Vertical response extends from 2 CPS to 5 MC without extra switching. Response only down 2.2' DB at 3.58 MC. The 11-tube circuit features a 5UP1 cathode-ray tube. Sync circuit functions effectively from 20 CPS to better than 500 kc in five steps. Modern etched circuit boards employed in the oscilloscope circuit cut assembly time almost in half, permit a level of circuit stability never before achieved in an oscilloscope of this type, and insure against errors in assembly. Both vertical and horizontal output amplifiers are push-pull. Built-in peak-to-peak calibrating source — step-attenuated input — plastic molded capacitors and top-quality parts throughout — pre-formed and cabled wiring harness — and numerous other "extra" features. A professional instrument for the serveshop or laboratory. Compare its specifications with those of scopes selling in much higher price brackets. You can't beat it!

1 FEWER DOLLARS BRING MORE REAL QUALITY.

- Factory-to-you sales eliminate extra profit margin.
- "Build-it-yourself" eliminates labor charge.
- Heath purchasing power cuts component costs.

2 PERSONAL SERVICE ASSURES CUSTOMER SATISFACTION.

- You deal directly with the manufacturer.
- We are interested in you before and after sale.

Heathkits®

ARE YOUR BEST BUY...

3 PROVEN DESIGNS MEAN RELIABLE PERFORMANCE.

- Research and development efforts concentrated on kits only.
- All kits guaranteed to meet advertised specifications.

4 EVERY KIT BACKED BY WORLD-WIDE REPUTATION.

- The world's largest manufacturer of electronic equipment in kit form.
- Producer of more than a million electronic kits for the home workshop and industry.

5 EASY TIME-PAYMENT PLAN TO FIT YOUR BUDGET.

GREATEST SELECTION . . .

Whether your particular special interest is in servicing, ham-radio, high-fidelity, or just experimenting—there are Heathkits to fill your needs. You can equip an entire service shop or lab, buy a complete ham station or high-fidelity system, or set up a really deluxe home workshop, by choosing from the more than 70 different "do-it-yourself" electronic kits by Heath. Just glance through the kits displayed in this ad, and you will get some idea of the tremendous array of low-priced, high-quality electronic equipment available.

New HEATHKIT ETCHED CIRCUIT 5" Oscilloscope Kit

- * Brand new model with improved performance specifications.
- * Full 5" scope for service work at a remarkably low price.
- * Attractively styled front panel in charcoal gray with sharp white lettering.
- * Easy to build from step-by-step instructions and large pictorials. Not necessary to read schematic.

This new and improved oscilloscope retains all the outstanding features of the preceding model, but provides wider vertical frequency response, extended sweep-generator coverage, and increased stability. A new tube complement and improvements in the circuit make these new features possible. Vertical frequency response is essentially flat to over 1 mc, and down only 1½ DB at 500 kc. The sweep generator multivibrator functions reliably from 30 to 200,000 CPS, almost twice the coverage provided by the previous model. Deflection amplifiers are push-pull, and modern etched circuits are employed in critical parts of the design. A 5BP1 cathode-ray tube is used. The scope features external or internal sweep and sync, one volt peak-to-peak reference voltage, 3-position step-attenuated input, adjustable spot-shape control, and many other "extras" not expected at this price level. A calibrated grid screen is also provided for the face of the CRT, allowing more precise observation of wave shapes displayed. The new Model OM-2 is designed for general application wherever a reliable instrument with good response characteristics may be required. Complete step-by-step instructions and large pictorial diagrams assure easy assembly.



MODEL OM-2
\$42.50

Shpg. Wt.
21 Lbs.

HEATHKIT LOW CAPACITY PROBE KIT

Oscilloscope investigation of high frequency, high impedance, or broad bandwidth circuits encountered in television requires the use of a low-capacity probe to prevent loss of gain, circuit loading, or waveform distortion. The Heathkit low-capacity probe may be used with your oscilloscope to eliminate these effects. It features a variable capacitor, to provide correct instrument impedance match. Also, the ratio of attenuation can be varied.

No. 342
\$3.50
Shpg. Wt. 1 lb.

HEATHKIT ELECTRONIC SWITCH KIT

This handy device allows simultaneous oscilloscope observation of two signals by producing both signals, alternately, at its output. It features an all-electronic switching circuit, with no moving parts. Four switching rates are selected by a panel switch. Provides actual gain for input signals, and has a frequency response of ± 1 DB from 0 to 100 kc. Sync output provided to control and stabilize scope sweep. Will function at signal levels as low as 0.1 volt. This modern device finds many applications in the laboratory and service shop. It employs an entirely new circuit, and yet is priced lower than its predecessor.

MODEL S-3
\$21.95
Shpg. Wt. 8 Lbs.

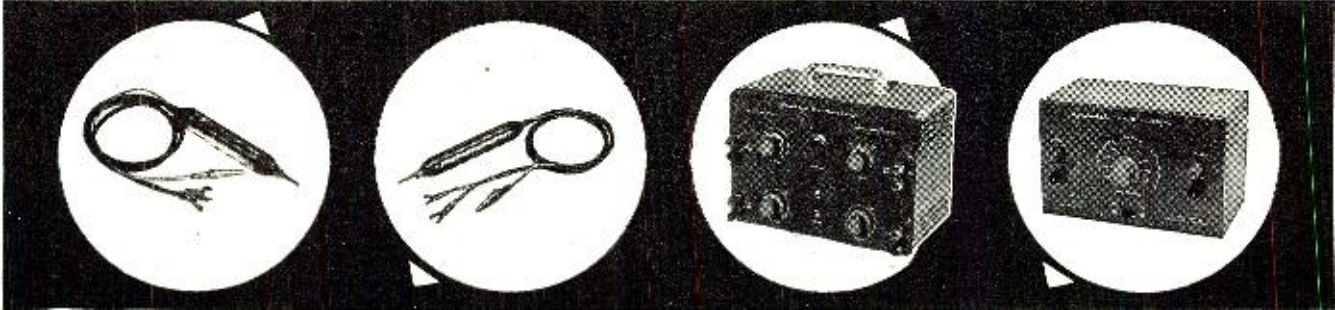

HEATHKIT SCOPE DEMODULATOR PROBE KIT

Extend the usefulness of your oscilloscope by employing this probe. Makes it possible to observe modulation of RF or IF carriers found in TV and radio receivers. Functions much like an AM detector to pass only modulation of signal, and not the signal itself. Among other uses, it will be helpful in alignment work, as a signal tracer, and for determining relative gain. Applied voltage limits are 30 volts (RMS) and 500 volts DC. It uses an etched circuit board to simplify assembly.

NO. 337-C
\$3.50
Shpg. Wt. 1 lb.

HEATHKIT VOLTAGE CALIBRATOR KIT

This entirely new voltage calibrator produces near-perfect square wave signals of known amplitude. Precision 1% attenuator resistors assure accurate output amplitude, and multivibrator circuit guarantees good, sharp square waves, as distinguished from clipped sine waves. Output frequency is approximately 1000 CPS. Fixed outputs selected by panel switch are; .03, 0.1, 0.3, 1.0, 3.0, 10, 30, and 100 volts peak-to-peak. Allows measurement of unknown signal amplitudes by comparing to known peak-to-peak output of VC-3 on an oscilloscope. Will also double as a square wave generator at 1000 cycles for determining gain, frequency response, or phase-shift characteristics of audio amplifiers. Equally valuable in the laboratory or in radio and TV service shops.

MODEL VC-3
\$12.50
Shpg. Wt. 4 Lbs.

HEATHKIT ETCHED CIRCUIT VACUUM TUBE



MODEL
V-7A

\$24⁵⁰

Shpg. Wt.
7 Lbs

- * Easy to build — a pleasure to use.
- * 1% precision resistors employed for high accuracy.
- * Etched circuit board cuts assembly time in half.

Voltmeter Kit

The fact that this instrument is the world's largest-selling VTVM says a great deal about its accuracy, reliability, and overall quality. The V-7A is equally popular in the laboratory or service shop, and represents an unbelievable test equipment bargain, without a corresponding sacrifice in quality. Its appearance reflects the performance of which it is capable. A large 4½" panel meter is used for indication, with clear, sharp calibrations for all ranges. Front panel controls consist of a rotary function switch and a rotary range selector switch, zero-adjust, and ohms-adjust controls. Precision 1% resistors are used in the voltage divider circuits and etched circuits are employed for most of the circuitry. This makes the kit much easier to build, eliminates the possibility of wiring errors, and assures duplication of laboratory instrument performance. This multi-function VTVM will measure AC voltage (rms), AC voltage (peak-to-peak), DC voltage, and resistance. There are 7 AC (rms) and DC voltage ranges of 0-1.5, 5, 15, 50, 150, 500, and 1500. In addition, there are 7 peak-to-peak AC ranges of 0-4, 14, 40, 140, 400, 1400, and 4000. 7 ohmmeter ranges provide multiplying factors of X1, X10, X100, X1000, X10K, X100K, and X1 megohm. Center-scale resistance readings are 10, 100, 1000, 10K, 100K ohms, 1 megohm, and 10 megohms. A DB scale is also provided. The precision and quality of the components used in this VTVM cannot be duplicated at this price through any other source. Model V-7A is the kind of instrument you will be proud to own and use.

HEATHKIT Etched Circuit RF PROBE KIT

This RF probe extends the frequency response of any 11-megohm VTVM so that it will measure RF up to 250 megacycles within ± 10%. Employs printed circuits for increased stability and ease of assembly. Ideal for extending service and laboratory applications of your Heathkit VTVM. **\$3⁵⁰** Shpg. Wt. 1 Lb.

No. 309-C

HEATHKIT 20,000 OHMS/VOLT VOM KIT

Sensitivity of this instrument is 20,000 ohms-per-volt DC and 5,000 ohms-per-volt AC. Measuring ranges are 0-1.5, 5, 50, 150, 500, 1500, and 5000 volts for both AC and DC. Also measures current in the ranges of 0-150 microamperes, 15 ma, 150 ma, 500 ma, and 15 a. Resistance ranges provide multipliers of X1, X100, and X10,000, resulting in center scale readings of 15, 15,000, and 150,000 ohms. DB ranges cover from -10 db to +65 db. Housed in attractive black bakelite case with plastic carrying handle, this fine instrument provides a total of 25 meter ranges on its two-color scale. It employs a sensitive 50 microampere, 4½" meter and features all 1% precision multiplier resistors. Requires no external power, and is, therefore, valuable in portable applications where no AC power is available. **\$29⁵⁰** Shpg. Wt. 6 Lbs.

MODEL MM-1

ETCHED CIRCUIT PEAK-TO-PEAK PROBE KIT

Use this peak-to-peak probe with your 11-megohm VTVM to measure peak-to-peak voltages directly on the DC scales of the instrument. Will measure p-to-p voltages in the frequency range of 5 kc to 5 mc. Employs etched circuit boards for increased circuit stability and simplified construction. Extend the usefulness of your VTVM. NOTE: Not required for the Heathkit V-7A VTVM. **\$5⁵⁰** Shpg. Wt. 2 Lbs.

No. 338-C

HEATHKIT 30,000 VOLT DC HIGH VOLTAGE PROBE KIT

This probe provides a multiplication factor of 100 on the DC ranges of the Heathkit 11-megohm VTVM. Precision multiplier resistor mounted inside the two-color plastic probe body. Plenty of insulation for completely safe operation, even at highest TV potentials. Designed especially for TV service work. **\$4⁵⁰** Shpg. Wt. 2 Lbs.

No. 336

Shpg. Wt. 2 Lbs.

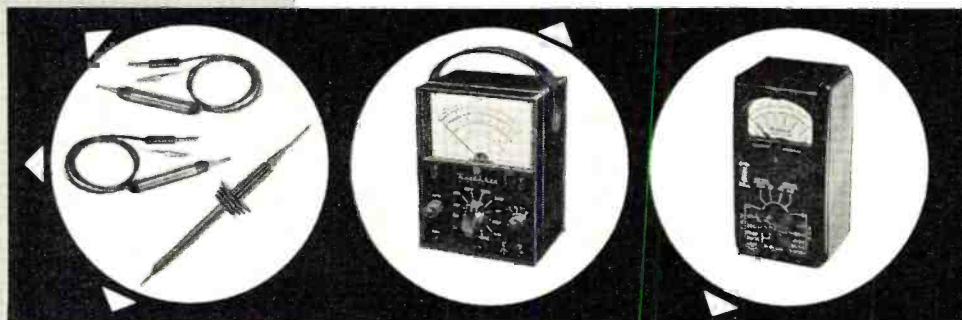

HEATHKIT HANDITESTER KIT

The Model M-1 measures AC or DC voltage at 0-10, 30, 300, 1000, and 5000 volts. Direct current ranges are 0-10 ma, and 0-100 ma. Ohmmeter ranges are 0-3000 (30 ohm center scale) and 0-300,000 ohms (3,000 ohms center scale). Uses a 400 microampere meter for sensitivity of 1000 ohms-per-volt. A very popular test device for the home experimenter, electricians, and appliance repairmen, and for use as an "extra" instrument in the service shop. Its small size and rugged construction make it perfect for any portable application. Easily slips into your tool box, glove compartment, coat pocket, or desk drawer. Top quality, precision components employed throughout. **\$14⁵⁰** Shpg. Wt. 3 Lbs.

MODEL M-1



HEATH COMPANY
A Subsidiary of Daystrom, Inc.
BENTON HARBOR 15, MICH.

CONTROLLED QUALITY . . .

Incoming parts inspection, and inspection of material coming off of our own production line assures you of the finest "build-it-yourself" kit that money can buy. Each kit contains all the components you need for assembly—and you can have confidence in the quality of the parts themselves. In addition to this inspection procedure, an extensive proof-building program for each new kit guarantees easy-to-follow instructions and reliable performance.

HEATHKIT NEW AUDIO VACUUM TUBE

Voltmeter Kit

- * Brand new circuit for extended frequency response and added stability.
- * Ten accurate ranges from 0-.01 to 0-300 volts.
- * Modern, functional panel styling. "On-off" switch at both extreme ends of range switch.



MODEL AV-3

\$29⁹⁵

Shpg. Wt.
5 lbs.

This brand new AC vacuum tube voltmeter emphasizes stability, broad frequency response, and sensitivity. It is designed especially for audio measurements, and low-level AC measurements in power supply filters, etc. Employs a cascode amplifier circuit with cathode-follower isolation between the input and the amplifier, and between the output stage and the preceding stages. An extremely stable circuit with high input impedance (1 megohm at 1000 CPS). Response of the AV-3 is essentially flat from 10 CPS to 200 kc, and is usable for tests even beyond these frequency limits. Increased damping in the meter circuit stabilizes the meter for low frequency tests. Nylon insulating bushings at the input terminals reduce leakage, and permit the use of the 5-way Heath binding post.

The extremely wide voltage range covered by the AV-3 makes it especially valuable not only in high-fidelity and service work, but also in experimental laboratories. AC (RMS) voltage ranges are 0-.01, .03, .1, .3, 1, 3, 10, 30, 100, and 300 V. Decibel ranges cover -52 DB to +52 DB. An entirely new circuit as compared to the previous model. Employs 1% precision multiplier resistors for maximum accuracy. Handles AC measurements from a low value of one millivolt to a maximum of 300 volts.

HEATHKIT AUDIO WATTMETER KIT

This instrument measures audio power directly at 4, 8, 16, or 600 ohms. Load resistors are built in. Covers 0-5 MW, 50 MW, 500 MW, 5 W, and 50 W full scale. Provides 5 switch-selected DB ranges covering from -10 DB to +30 DB. Large 4½" 200 microampere meter and precision multiplier resistors insure accuracy. Frequency response is ± 1 DB from 10 CPS to 250 kc. Functions from AC power line. Use in the audio laboratory or in home workshop.

MODEL AW-1

\$29⁵⁰

Shpg. Wt. 6 lbs.

HEATHKIT AUDIO ANALYZER KIT

This multi-function instrument combines an AC VTVM, an audio wattmeter, and an intermodulation analyzer into one case, with combined input and output terminals and built-in high and low frequency oscillators. The VTVM ranges are .01, .03, .1, .3, 1, 3, 10, 30, 100, and 300 volts (RMS). Wattmeter ranges are .15 MW, 1.5 MW, 15 MW, 150 MW, 1.5 W, 15 W, 150 W. IM scales are 1%, 3%, 10%, 30%, and 100%. Provides internal load resistors of 4, 8, 16, or 600 ohms. A valuable instrument for the engineer or serious audiophile.

MODEL AA-1

\$49⁹⁵

Shpg. Wt. 13 lbs.

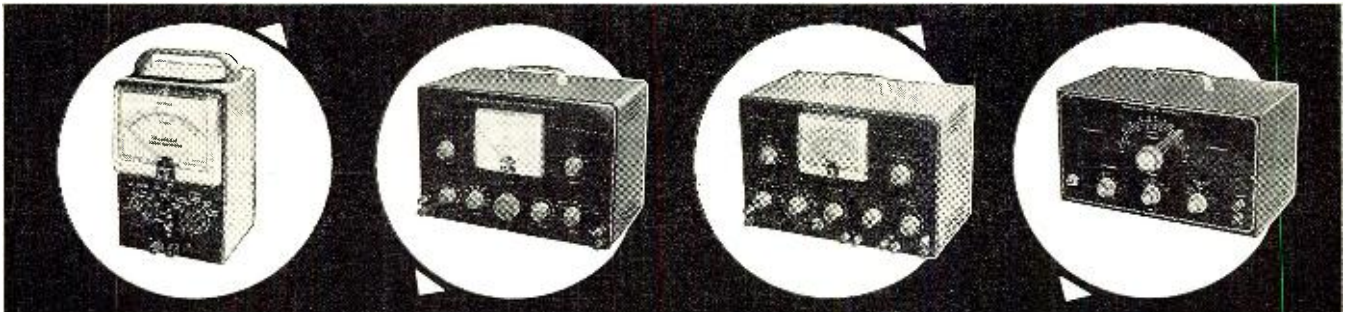

HEATHKIT HARMONIC DISTORTION METER KIT

The HD-1 is equally valuable for the audio engineer or the serious audiophile. Used with a low-distortion audio signal generator, this instrument will measure the harmonic content of various amplifiers under a variety of conditions. Functions between 20 and 20,000 CPS, and reads distortion directly on the panel meter in ranges of 0-1, 3, 10, 30, and 100 percent full scale. Built-in VTVM for initial reference settings and final distortion readings has voltage ranges of 0-1, 3, 10, and 30 volts. 1% precision resistors employed for maximum accuracy. Features voltage regulation and other "extras". Meter calibrated in volts (RMS), percent distortion, and DB.

MODEL HD-1

\$49⁵⁰

Shpg. Wt. 13 lbs.

HEATHKIT AUDIO OSCILLATOR KIT

Producing both sine waves and square waves, the Model AO-1 covers a frequency range of 20 to 20,000 CPS in three ranges. An extra feature is thermistor regulation of output for flat response through the entire frequency range. AF output is provided at low impedance, and with low distortion. Produces good sine waves, and good, clean square waves with a rise time of only two micro-seconds for checking square wave response of audio amplifiers, etc. Designed especially for the serviceman and high-fidelity enthusiast. A real dollar value in test equipment.

MODEL AO-1

\$24⁵⁰

Shpg. Wt. 10 lbs.

HEATHKIT



MODEL
AG-9

\$34⁵⁰

Shpg. Wt.
8 Lbs.

- * Less than 0.1% distortion — ideal for hi fi work.
- * Large 4½" meter indicates output.
- * Step-type tuning for maximum convenience.

Audio Generator Kit

This particular audio generator is "made to order" for high fidelity applications. It provides quick and accurate selection of low-distortion signals throughout the audio range. Three rotary selector switches on the front panel allow selection of two significant figures and a multiplier for determining audio frequency. In addition, it incorporates a step-type output attenuator and a continuously variable attenuator. Output is indicated on a large 4½" panel meter calibrated in volts and in db. Attenuator system operates in steps of 10 db, corresponding with the meter calibration. Output ranges are 0-.003, .01, .03, .1, .3, 1, 3, and 10 volts rms. A "load" switch provides for the use of a built-in 600 ohm load or an external load of higher impedance when required. Output and frequency indicators accurate to within ± 5%. Distortion is less than .1 of 1% between 20 cps and 20,000 cps. Total range is 10 cps to 100 kc. New engineering details combine to provide the user with an unusually high degree of operating efficiency. Oscillator frequency selected entirely by the switch method means that accurate resetability is provided. Comparable to units costing many dollars more, and ideal for use in critical high fidelity applications. Shop and compare, and you will appreciate the genuine value of this professional instrument.

HEATHKIT RESISTANCE SUBSTITUTION BOX KIT

The RS-1 contains 36 10% 1-watt resistors ranging from 15 ohms to 10 megohms in standard RETMA values. All values are switch-selected for use in determining desirable resistance values in experimental circuits. Many applications in radio and TV service work.

MODEL RS-1
\$5⁵⁰

Shpg. Wt. 2 Lbs.

HEATHKIT CONDENSER SUBSTITUTION BOX KIT

This kit contains 18 RETMA standard condenser values that can be selected by a rotary switch. Values range from 0.00001 mfd to 0.22 mfd. All capacitors rated at 400 volts or higher. Capacitors are either silver-mica, or plastic molded.

MODEL CS-1
\$5⁵⁰

Shpg. Wt. 2 Lbs.

HEATHKIT AUDIO GENERATOR KIT

The Model AG-8 is a low cost, high performance unit for use in service shop, or home workshop. It covers the frequency range of 20 cps to 1 mc in five ranges. Output is 600 ohms, and overall distortion will be less than .4 of 1% from 100 cps through the audible range. Output is available up to 10 volts, under no load conditions, and output remains constant within ± 1 db from 20 cps to 400 kc. A five-step attenuator provides control of the output. Precision resistors are employed in the frequency determining network.

MODEL AG-8
\$29⁵⁰

Shpg. Wt. 11 Lbs.

HEATHKIT DECADE CONDENSER KIT

Precision, 1% silver-mica capacitors are employed in the Model DC-1 in such a way that a selection of precision capacitor values is provided ranging from 100 mmf (0.001 mfd) to 0.11 mfd (110,000 mmf) in 100 mmf steps. Extremely valuable in all types of design and development work. Switches are ceramic wafer types.

MODEL DC-1
\$16⁵⁰

Shpg. Wt. 3 Lbs.

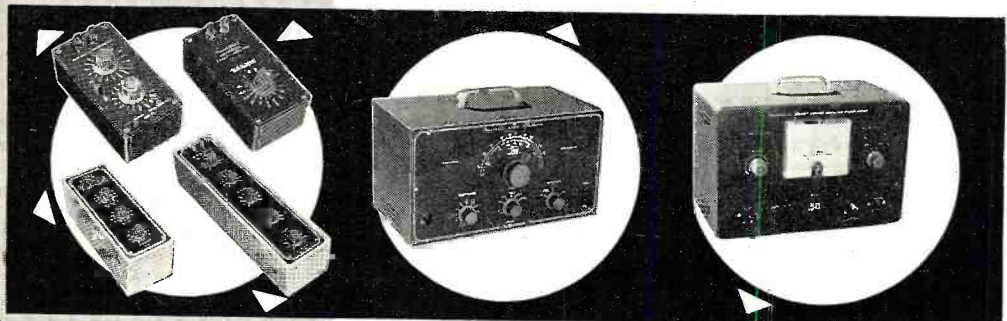

HEATHKIT DECADE RESISTANCE KIT

The Model DR-1 incorporates twenty 1% precision resistors arranged around five rugged switches so that various combinations of switch positions will provide a total range of 1 ohm to 99,999 ohms in 1-ohm steps. Switches are labeled "units," "tens," "hundreds," "thousands," and "ten thousands." Use it for ohm-meter calibration in bridge circuits as test values in multiplier circuits, etc.

MODEL DR-1
\$19⁵⁰

Shpg. Wt. 4 Lbs.

HEATHKIT VARIABLE VOLTAGE REGULATED POWER SUPPLY KIT

This power supply is regulated for stability, and the amount of DC output available from the power supply can be controlled manually from zero to 500 volts. Will provide regulated output at 450 volts up to 10 ma, or up to 130 ma at 200 volts output. In addition to furnishing B-plus, the power supply provides 6 volts AC at 4 amperes for filaments. Both the B-plus output and the filament output are isolated from ground. Ideal power supply for use in experimental work in the laboratory, the home workshop, or the ham shack. Large 4½" panel meter indicates output voltage or current.

MODEL PS-3
\$35⁵⁰

Shpg. Wt. 17 Lbs.



HEATH COMPANY
A Subsidiary of Daystrom, Inc.
BENTON HARBOR 15, MICH.

BONUS PERFORMANCE . . .
 If a single word had to be selected to describe Heath Company advertising policy, it would be "conservative." By this we mean that the performance specifications and features are not exaggerated, and that the descriptions are accurate. We specify performance on the conservative side so you can be sure of equaling or exceeding our specifications. In almost every instance our kits will do more than we claim. Extra care in construction, and calibration against an accurate standard can extend performance well beyond advertised levels.

HEATHKIT

Signal Generator Kit

- * No calibration required with pre-aligned coils.
- * Modulated or unmodulated RF output.
- * 110 mc to 220 mc frequency coverage.



MODEL SG-8

\$19⁵⁰ Shpg. Wt. 8 lbs.

Here is an RF signal generator for alignment applications in the service shop or the home workshop. Thousands of these units are in use in service shops all over the country. Produces RF signals from 160 kc to 110 mc on fundamentals on five bands. Also covers from 110 mc to 220 mc on calibrated harmonics. RF output is in excess of 100,000 microvolts at low impedance. Output is controllable with a step-type and a continuously variable attenuator. Front panel controls provide selection of either unmodulated RF output or RF modulated at 400 cps. In addition, two to three volts of audio at approximately 400 cps are available at the output terminals for testing AF circuits. Employs a 12AU7 and a 6C4 tube. Built-in power supply uses a selenium rectifier.

One of the most outstanding features about the Model SG-8 is the fact that it can be built in just a few hours, even by one not thoroughly experienced in electronics work. Complete step-by-step instructions combined with large pictorial diagrams assure successful assembly. Pre-aligned coils make calibration from an external source unnecessary.

HEATHKIT LABORATORY GENERATOR KIT

This laboratory RF signal generator covers from 100 kc to 30 mc on fundamentals in five bands. The output signal may be pure RF, or may be modulated at 400 cycles from 0 to 50%. Provision for external modulation has been made. RF output available up to 100,000 microvolts. Output controlled by a fixed step and a variable attenuator. Output impedance is 50 ohms. Panel meter reads RF output or percentage of modulation. Incorporates voltage regulated B+ supply, double shielding of oscillator circuits, copper plated chassis, and other "extras."

MODEL LG-1
\$48⁹⁵

Shpg. Wt. 16 lbs.

HEATHKIT TV ALIGNMENT GENERATOR KIT

This improved sweep generator model provides essential stability and flexibility for work on FM, monochrome TV, or color TV sets. Covers 3.6 mc to 220 mc in four bands. Provides usable output even on harmonics. Sweep deviation from 0-42 mc, depending on base frequency. All-electronic sweep circuit eliminates unwieldy mechanical arrangements. Includes built-in crystal marker generator providing output at 4.5 mc and multiples thereof, and variable marker covering 19 to 60 mc on fundamentals and from 57 to 180 mc on harmonics. Effective two-way blanking.

MODEL TS-4A
\$49⁵⁰

Shpg. Wt. 16 lbs.

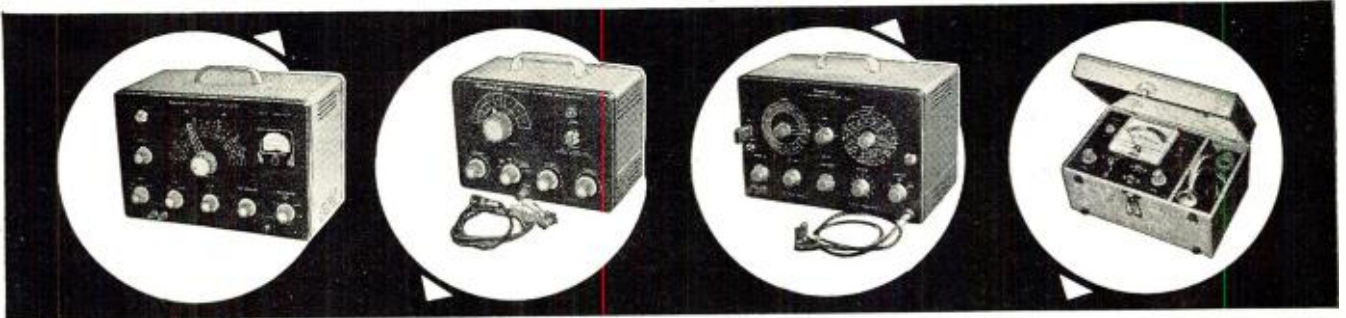

HEATHKIT LINEARITY PATTERN GENERATOR KIT

This instrument supplies information for white dots, cross-hatch pattern, horizontal bar pattern, or vertical bar pattern. It feeds video and sync signals to the set under test, with completely controlled gain, and unusual stability. Covering channels 2 to 13, the LP-2 will produce 5 to 6 vertical bars and 4 to 5 horizontal bars. The dot pattern presentation is a *must* for the setting of color convergence controls in the color TV set. Panel provision made for external sync if desired. Use for adjustment of vertical and horizontal linearity, picture size, aspect ratio, and focus. Power supply is regulated for added stability. Essential in the up-to-date TV service shop.

MODEL LP-2
\$22⁵⁰

Shpg. Wt. 7 lbs.

HEATHKIT CATHODE RAY TUBE CHECKER KIT

This instrument checks cathode emission, beam current, shorted elements, and leakage between elements in electro-magnetic picture tube types. It eliminates all doubt for the TV serviceman, and even more important, for the customer. Features its own self-contained power supply, transformer operated to furnish normal test voltages for the CRT. Employs spring-loaded switches for maximum operator protection. Large 4 1/2" meter indicates CRT condition on "good-bad" scale. Luggage-type portable case ideal for home service calls. Special "shadowgraph" test permits projection of light spot on screen. Also gives relative check of picture tube screen coating.

MODEL CC-1
\$22⁵⁰

Shpg. Wt. 10 lbs.

HEATHKIT



MODEL
TC-2

\$29⁵⁰

Shpg. Wt.
12 lbs.

- * Attractive counter-style cabinet.
- * Wiring-harness simplifies assembly.
- * Large 4½" meter with two-color "good-bad" scale.
- * Separate tube element switches prevent obsolescence.

HEATHKIT PORTABLE TUBE CHECKER KIT

This portable tube checker is identical, electrically, with the Model TC-2. However, it is housed in an attractive and practical carrying case, finished in proxylin impregnated material. The cover is detachable, and the hardware is brass plated. This rugged unit is ideal for home service calls or any portable application.

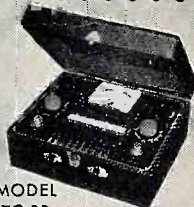

MODEL
TC-2P

\$34⁵⁰ Shpg. Wt.
15 lbs.

HEATHKIT DIRECT READING CAPACITY METER KIT

Operation of this instrument is simplicity itself. One has only to connect a capacitor to the terminals, select the proper range, and read the capacity value directly on the large 4½" meter calibrated in mmf and mfd.

Ranges are 0 to 100 mmf, 1,000 mmf, 0.01 mfd, and 0.1 mfd full scale. Precision calibrating capacitors supplied. Not susceptible to hand capacity effects. Residual capacity less than 1 mmf. Especially valuable in production line checking, or in quality control.

MODEL CM-1

\$29⁵⁰

Shpg. Wt.
7 lbs.



HEATH COMPANY
A Subsidiary of Daystrom, Inc.
BENTON HARBOR 15, MICH.

Tube Checker Kit

This fine piece of test gear checks tubes for quality, emission, shorted elements, open elements, and filament continuity. Will test all tube types normally encountered in radio and TV service work. Sockets provided for 4, 5, 6, and 7-pin large, rectangular, and miniature types, octal and loctal types, the Hytron 9-pin miniatures, and pilot lamps. Condition of tubes indicated on a large 4½" meter with multi-color "good-bad" scale. An illuminated roll chart is built right in, providing test data for various tube types. This tester provides switch selection of 14 different filament voltage values from 0.75 volts to 117 volts. Individual switches control each tube element. Close tolerance resistors employed in critical test circuits for maximum accuracy. A professional instrument both in appearance and performance.

The Model TC-2 is very simple to build, even for a beginner. It employs a color-coded cable harness for neat, professional under-chassis wiring. Comes with attractive counter style cabinet, and portable cabinet is available separately. At this price, even the part-time serviceman can afford his own tube checker for maximum efficiency in service work.

HEATHKIT TV PICTURE TUBE TEST ADAPTER

Designed especially for use with the Model TC-2 tube checker. Use it to test TV picture tubes for emission, shorts, etc. Consists of 12-pin TV tube socket, 4 ft. cable, octal connector, and necessary technical data. Not a kit.



MODEL 355

\$4⁵⁰

Shpg. Wt.
1 lb.

HEATHKIT VISUAL-AURAL SIGNAL TRACER KIT

Although designed primarily for radio receiver work, this valuable instrument finds extensive application in FM and TV servicing as well. Features a high-gain channel with demodulator probe, and a low-gain channel with audio probe. Will trace signals in all sections of a radio receiver and in many sections of a FM set or TV receiver. Uses built-in speaker and electron beam eye tube for indication. Also features built-in wattmeter and a noise locator circuit. Provision for patching speaker and/or output transformer into external set.

MODEL T-3

\$23⁵⁰

Shpg. Wt. 9 lbs.



HEATHKIT CONDENSER CHECKER KIT

The Model C-3 consists of an AC powered bridge for both capacitive and resistive measurements. Bridge balance is indicated on electron beam eye tube, and capacity or resistance value is indicated on front panel calibrations. Measures capacity in four ranges from .00001 mfd to .005 mfd, .001 mfd to .5 mfd, .1 mfd to 50 mfd, and 20 mfd to 1000 mfd. Measures resistance in two ranges, from 100 ohms to 50,000 ohms, and from 10,000 ohms to 5 megohms. Selection of five different polarizing voltages for checking capacitors, from 25 volts DC to 450 volts DC. Checks paper, mica, ceramic, and electrolytic capacitors. Indicates power factor of electrolytic condensers.

MODEL C-3

\$19⁵⁰

Shpg. Wt. 7 lbs.

PIONEER DESIGN . . .
 New and unique approaches to instrument and equipment designs are a Heath Company tradition. We concentrate all our development efforts on kit projects, since this is our prime activity—and not just a sideline. This logically results in more efficient, more reliable circuit designs—and you benefit from this constant engineering progress. Buying from the undisputed leader in the electronic kit field assures you of completely modern equipment, with outstanding advanced design features.

HEATHKIT

Impedance Bridge Kit

- * ½% precision resistors and silver-mica capacitors.
- * Battery-type tubes, no warm-up required.
- * Built-in phase shift generator and amplifier.

The Model IB-2 is a completely self-contained unit. It has a built-in power supply, a built-in 1000 cycle generator, and a built-in vacuum tube detector. Provision has been made on the panel for connection to an external detector, an external signal generator, or an external power supply. A 100-0-100 micro-ampere meter on the front panel provides for null indications. Measures resistance from 0.1 ohm to 10 megohms, capacitance from 10 mmf to 100 mfd, inductance from 10 mh to 100 h, dissipation factor (D) from 0.002 to 1, and storage factor (Q) from 0.1 to 1000. ½ of 1% decade resistors employed for maximum accuracy. Typical accuracy figures are: resistance, ±3T; capacitance ±3%; inductance, ±10%; dissipation factor, ±20%; storage factor, ±20%. Employs a Wheatstone bridge, a Capacity Comparison bridge, a Maxwell bridge, and a Hay bridge. Special two-section CRL dial provides maximum convenience in operation. Use the Model IB-2 for determining values of unmarked components, checking production or design samples, etc. A real professional instrument.



MODEL
 IB-2
\$59⁵⁰ Shpg. Wt.
 12 Lbs.

HEATHKIT "Q" METER KIT

The Q Meter permits measurement of inductance from 1 microhenry to 10 millihenries, "Q" on a scale calibrated up to 250 full scale, with multiplying factors of 1 or 2, and capacitance from 40 mmf to 450 mmf, ±3 mmf. Built-in variable oscillator permits testing components from 150 kc to 18 mc. Large 4½" panel-mounted meter is features. Very handy for checking peaking coils, chokes, etc. Use to determine values of unknown condensers, both variable and fixed. Compile data for coil winding purposes, or measure RF resistance. Distributed capacity, and Q of coils.

MODEL QM-1
\$44⁵⁰
 Shpg. Wt. 14 Lbs.

HEATHKIT ISOLATION TRANSFORMER KIT

This device isolates equipment under test from the power line. It is rated at 100 volt-amperes continuously, or 200 volt-amperes intermittently. AC-DC sets may be plugged directly into the IT-1 without the chassis becoming "hot." Additionally, since the IT-1 is fused, it is ideal for use as a buffer between the power line and a questionable receiver, or a new piece of equipment. Protects main fuses. Features voltage control, allowing control of the output from 90 volts to 130 volts. Panel meter monitors output voltage. A very handy device at an extremely low price.

MODEL IT-1
\$16⁵⁰
 Shpg. Wt. 9 Lbs.

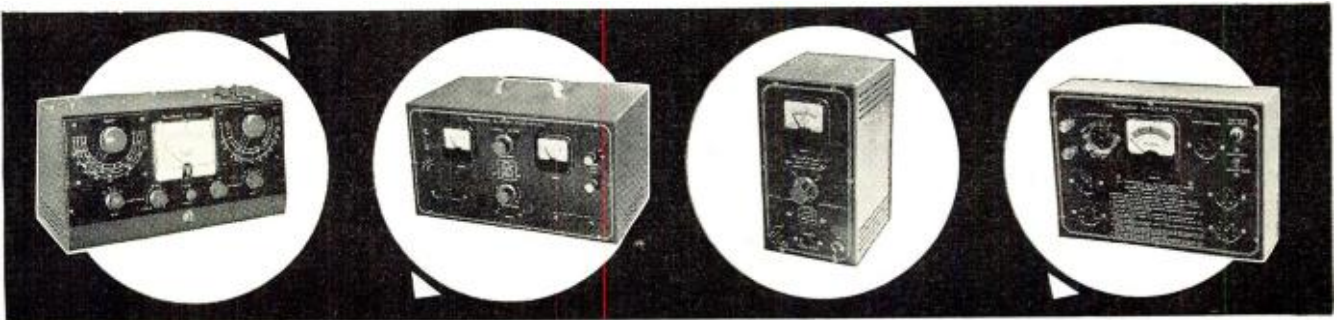

HEATHKIT 6-12 VOLT BATTERY ELIMINATOR KIT

This completely modern battery eliminator will supply DC output in two ranges for both 6-volt and 12-volt automobile radios. The output is variable for each range, so that operating voltage can be raised or lowered to determine how the receiver functions under adverse conditions. Range is 0-8 volts DC or 0-16 volts DC. Will supply up to 15 amperes on the 6-volt range, or up to 7 amperes on the 12-volt range. Two 10,000 microfarad output filter capacitors insure smooth DC output. Two separate panel meters indicate output voltage or output current. Makes it possible to test automobile radios inside at the workbench. Will also double as a battery charger.

MODEL BE-4
\$31⁵⁰
 Shpg. Wt. 17 Lbs.

HEATHKIT 6-VOLT VIBRATOR TESTER KIT

This instrument functions very much like a tube checker, to test auto radio vibrators. Vibrator condition is indicated on a simple "good-bad" scale. Tests for proper starting and overall quality of operation, of both interrupter and self-rectifier types of 6-volt vibrators. The model VT-1 is designed to operate from any battery eliminator capable of delivering continuously variable output from 4 to 6 volts DC at 4 amperes or more. It is an ideal companion unit for the Heathkit Model BE-4 battery eliminator. The construction book for the VT-1 contains vibrator test chart for popular 6-volt vibrator types. A real time saver!

MODEL VT-1
\$14⁵⁰
 Shpg. Wt. 6 Lbs.

HEATHKIT DX-100 PHONE AND CW



**MODEL
DX-100**
Shpg. Wt.
107 Lbs.

\$189⁵⁰

Shipped motor freight unless otherwise specified. \$50.00 deposit required on c.o.d. orders.

- * Phone or CW on 160, 80, 40, 20, 15, 11 and 10 meters.
- * Built-in VFO, modulator, and power supplies.
- * High quality components used throughout for reliable performance.
- * Features 5-point TVI suppression.

HEATHKIT COMMUNICATIONS TYPE

ALL BAND RECEIVER KIT

This receiver covers 550 kc to 30 mc in four bands, and is ideal for the short-wave listener or beginning amateur. It provides good sensitivity and selectivity, combined with good image rejection. Amateur bands clearly marked on illuminated dial scale. Employs transformer type power supply—electrical bandspread—antenna trimmer—separate RF and AF gain controls—noise limiter—headphone jack—BFO for CW reception.

CABINET: Fabric covered cabinet with aluminum panel as shown. Part 91-15A. Shipping weight 5 Lbs. \$4.95

MODEL AR-3
\$29⁹⁵

INCLUDING NEW EXCISE TAX (Less Cabinet)
Shpg. Wt. 12 Lbs.

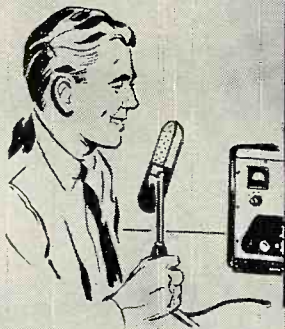

EASY ON THE BUDGET!

You can buy Heathkits on an easy time-payment plan that provides a full year to pay. Write for complete details and special order blank.



HEATH COMPANY
A Subsidiary of Daystrom, Inc.
BENTON HARBOR 15, MICH.

Transmitter Kit

The Heathkit DX-100 transmitter is in a class by itself in that it offers features far beyond those normally received at this price level. It takes very little listening on the bands to discover how many of these transmitters are in operation today. A truly amazing piece of amateur gear. The DX-100 features a built-in VFO and a built-in modulator. It is TVI suppressed, and uses pi network interstage coupling and output coupling. Will match antenna impedances from approximately 50 to 600 ohms. Extensive shielding is employed, and all incoming and outgoing circuits are filtered. The cabinet features interlocking seams for simplified assembly and minimum RF radiation outside of the cabinet. Provides a clean strong signal on either phone or CW, with RF output in excess of 100 watts on phone, and 120 watts on CW. Completely bandswitching from 160 through 10 meters. A pair of 1625 tubes are used in push-pull for the modulator, and the final consists of a pair of 6146 tubes in parallel. The VFO dial and meter face are illuminated, and all front panel controls are located for maximum convenience. Panel meter reads driver plate I, final grid I, final plate I, final plate voltage, and modulator current. The chassis is constructed of heavy #16 gauge copper-plated steel. Other high-quality components include potted transformers, ceramic switch and variable capacitor insulation, silver-plated or solid-silver switch terminals, etc. All coils are pre-wound, and the main wiring cable is pre-harnessed. The kit can be built by a beginner from the comprehensive step-by-step instructions supplied. It is a proven, trouble-free rig, that will insure many hours of "on-the-air" enjoyment in your ham shack.

HEATHKIT VFO KIT

You can go VFO for less than you might expect. Here is a variable frequency oscillator that covers 160, 80, 40, 20, 15, 11, and 10 meters with three basic oscillator frequencies, that sells for less than \$20. Provides better than 10 volt average RF output on fundamentals. Plenty of drive for most modern transmitters. Requires a power source of only 250 VDC at 15 to 20 ma. and 6.3 VAC at 0.45A. Incorporates a regulator tube for frequency stability. Illuminated frequency dial reads frequency directly on the band being employed. Temperature-compensated capacitors offset coil heating.

MODEL VF-1

\$19⁵⁰

Shpg. Wt. 7 Lbs.

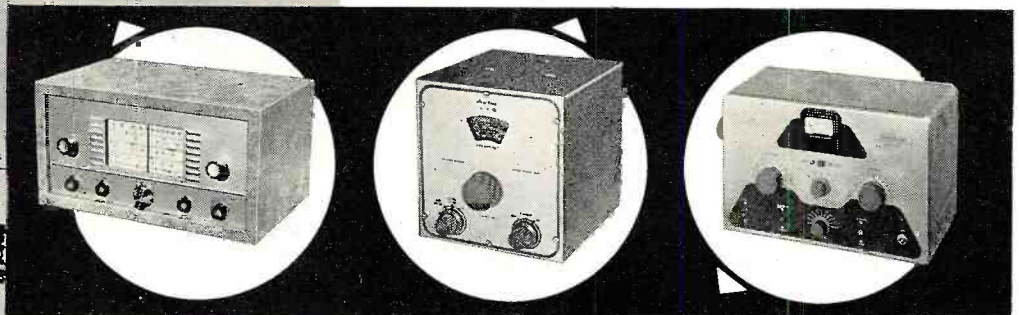

NEW HEATHKIT CW TRANSMITTER KIT

The brand new Heathkit Model DX-20 Transmitter is one of the most efficient little rigs available today. Featuring an entirely new circuit, it is ideal for the novice, and even for the advanced-class CW operator. A 6DQ6A final amplifier provides plate power input of 50 watts. A 6CL6 oscillator is employed, and a 5U4GB rectifier. The transmitter features one-knob bandswitching to cover 80, 40, 20, 15, 11 and 10 meters. It is designed for crystal excitation, but may be excited by an external VFO. A pi network output circuit matches antenna impedances between 50 and 1000 ohms. Front panel controls are functionally located for your convenience. If you appreciate a good signal on the CW bands, this is the transmitter for you!

MODEL DX-20

\$35⁹⁵

Shpg. Wt. 18 Lbs.

DOLLAR-SAVING ECONOMY . . .
 There would be no particular achievement in selling inexpensive merchandise at a low price—although it is being done every day. However, there is something to crow about when, through tremendous purchasing power and factory-to-you distribution, Heath Company can offer top-quality equipment, using name-brand components, at such low prices. This is real economy, as opposed to the so-called "bargains". Needless to say, there is a big difference.

**HEATHKIT PHONE AND CW
 Transmitter Kit**

- * 6146 final amplifier for full 65-watt plate power input.
- * Phone and CW operation on 80, 40, 20, 15, 11, and 10 meters. Pi network output coupling.
- * Switch selection of three crystals — provision for external VFO excitation.

The DX-35 features a 6146 final amplifier to provide 65 watts plate power input on CW, with controlled carrier modulation peaks up to 50 watts on phone. In addition, it is a most attractive transmitter. Modulator and power supplies are built-in, and the rig covers 80, 40, 20, 15, 11, and 10 meters with a single band-change switch. Pi network output coupling provided for matching various antenna impedances. A 12BY7 buffer stage provided ahead of the final amplifier for plenty of drive on all bands. 12BY7 oscillator and 12AU7 modulator. Provision for switch selection of three different crystals. Crystals reached through access door at rear. Front panel controls marked "off—CW—stand-by—phone", "final tuning", "antenna coupling", "drive level control", and "band change switch". Panel meter indicates final grid current or final plate current. A perfect low-power transmitter both for the novice, and for the more experienced operator. A remarkable power package for the price. Incidentally, the price includes tubes, and all other components necessary for assembly. As with all Heathkits, comprehensive instruction manual assures successful assembly.



MODEL DX-35
\$56⁹⁵ Shpg. Wt. 24 Lbs.

HEATHKIT ANTENNA IMPEDANCE METER KIT

This instrument employs a 100 microampere panel meter and covers the impedance range of 0-600 ohms for RF tests. Functions up to 150 mc. Used in conjunction with signal source, such as the Heathkit Model GD-1B grid dip meter, the Model AM-1 will determine antenna resistance and resonance, match transmission lines for minimum standing wave ratio, determine receiver input impedance, etc. Will also double as a phone monitor. A very valuable device for many uses in the ham shack.

MODEL AM-1
\$14⁵⁰
 Shpg. Wt. 2 Lbs.

HEATHKIT "Q" MULTIPLIER KIT

The QF-1 functions with any receiver with an IF frequency between 450 and 460 kc that is not AC-DC type. Operates from the receiver power supply, requiring only 6.3 VAC at 300 ma. and 150 to 250 VDC at 2 ma. Simple to connect with cable and plugs supplied. Provides additional selectivity for separating two signals, or will reject one signal and eliminate heterodyne. A big help on crowded bands. Provides an effective Q of approximately 4,000 for sharp "peak" or "null". Tunes to any signal within the IF bandpass of the receiver, without changing main receiver tuning dial.

MODEL QF-1
\$9⁹⁵
 Shpg. Wt. 3 Lbs.

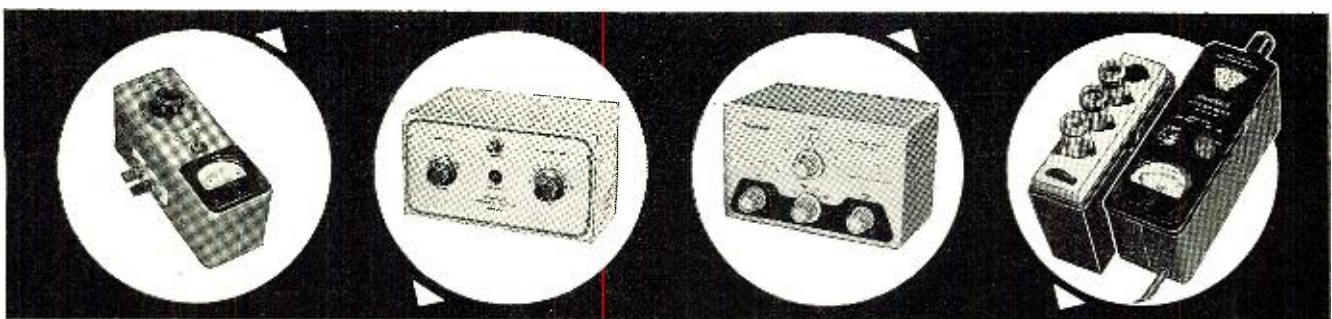

HEATHKIT ANTENNA COUPLER KIT

This device is designed to match the Model AT-1 transmitter to a long-wire antenna. In addition to impedance matching, this unit incorporates an L-type filter which attenuates signals above 36 megacycles, thereby reducing TVI. Designed for 52 ohm coaxial input. Handles power up to 75 watts, 10 through 80 meters. Uses a tapped inductor and variable capacitor. Neon RF indicator on front panel. Copper-plated chassis—high quality components throughout—simple to build. Eliminates waste of valuable communications power due to improper matching. A "natural" for all AT-1 transmitter owners.

MODEL AC-1
\$14⁵⁰
 Shpg. Wt. 4 Lbs.

HEATHKIT GRID DIP METER KIT

The grid dip meter was originally designed for the ham shack. However, its use has been extended into the service shop and laboratory. Continuous frequency coverage from 2 mc to 250 mc with pre-wound coils. 500 microampere panel meter employed for indication. Use for locating parasitics, neutralizing, determining RF circuit resonant frequencies, etc. Coils are included with kit, as is a coil rack. Front panel controls include sensitivity control for meter, and phone jack for listening to zero-beat. Will also double as an absorption-type wavemeter.

MODEL GD-1B
\$19⁹⁵
 Shpg. Wt. 4 Lbs.

HEATHKIT BROADCAST BAND



MODEL BR-2
(Less Cabinet)
Shpg. Wt. 10 Lbs.

\$18⁹⁵

INCLUDING NEW
EXCISE TAX*

ATTENTION BEGINNERS . . .

This kit is an ideal "first project" if you have never built a Heathkit before. A good chance to "learn by doing."

- * Miniature tubes and high-gain IF transformer.
- * 5½-inch PM speaker.
- * Rod-type built-in antenna. Good sensitivity and selectivity.
- * Provision for phono jack.
- * Transformer - operated power supply.

Receiver Kit

You need no previous experience in electronics to build this table-model radio. The Model BR-2 receiver covers 550 kc to 1620 kc and features good sensitivity and selectivity over the entire band. A 5½" PM speaker is employed, along with high gain miniature tubes and a new rod-type built-in antenna. Provision has been made in the design of this receiver for its use as a phonograph amplifier. The phono jack is located on the back chassis apron. A transformer operated power supply is featured for safety of operation, as opposed to the usual AC-DC supply commonly found in "economy radio kits." Don't let the low Heathkit price deceive you. This is the kind of set you will want to show off to your family and friends after you have finished building it.

Construction of this radio kit is very simple. Giant size pictorial diagrams and detailed step-by-step instructions assure your success. The construction manual also includes an explanation of basic receiver circuit theory so you can "learn by doing" as the receiver is built. The manual even provides information on resistor and capacitor color codes, soldering techniques, use of tools, etc. If you have ever had the urge to build your own radio receiver, the outstanding features of this popular Heathkit deserve your attention.

CABINET: Proxylin impregnated fabric covered plywood cabinet available for the BR-2 receiver as shown. Complete with aluminum panel, reinforced speaker grill, and protective rubber feet. Shipping weight 5 lbs., part No. 91-9A. \$4.95*

HEATHKIT PROFESSIONAL RADIATION COUNTER KIT

This sensitive and reliable instrument has already found extensive application in prospecting, and also in medical and industrial laboratories. It offers outstanding performance at a reasonable price. Front-panel meter indicates radiation level, and oral indication produced by panel-mounted speaker. Meter ranges are 0-100, 600, 6,000 and 60,000 counts per minute, and 0-.02, .1, 1 and 10 milliroentgens per hour. The probe, with expansion cord, employs type 6306 bismuth counter tube, sensitive to both beta and gamma radiation. It is simple to build, even for a beginner.

MODEL RC-1
\$79⁹⁵

Shpg. Wt. 8 Lbs.

HEATHKIT CRYSTAL RECEIVER KIT

The crystal radio of Dad's day is back again, but with big improvements! The Model CR-1 employs a sealed germanium diode, eliminating the critical "cat's whisker" adjustment. It is housed in a compact plastic box, and features two Hi-Q tank circuits, employing ferrite core coils and variable air tuning capacitors. The CR-1 covers the standard broadcast band from 540 kc to 1600 kc, and no external power is required for operation. Could prove valuable for emergency signal reception. This easy-to-build kit is a real "learn by doing" experience for the beginner, and makes an interesting project for all ages.

MODEL CR-1
\$7⁹⁵

INCLUDING NEW
EXCISE TAX*
Shpg. Wt. 3 Lbs.

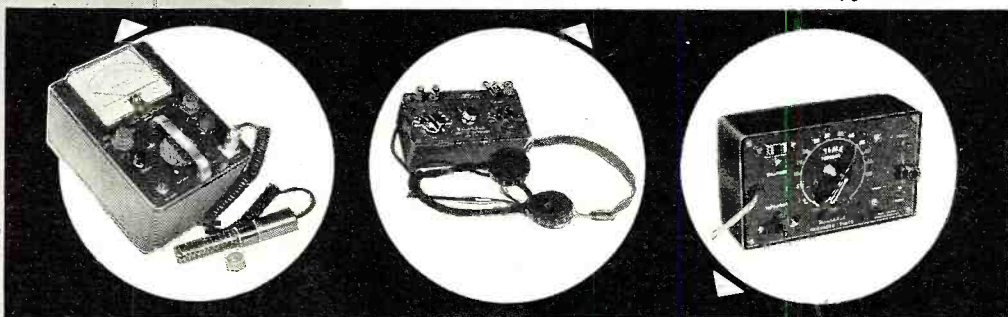

- * Amazing new circuit for high efficiency.
- * Compact, portable and rugged.
- * Stable circuit requires only one 67½ volt "B" battery and two 1½ volt "A" batteries.

HEATHKIT ENLARGER TIMER KIT

The Model ET-1 is an easy-to-build device for use by amateur or professional photographers in controlling the timing cycle of an enlarger. It covers the range of 0 to 1 minute with a continuously variable, clearly calibrated scale. The timing period is pre-set, and the timing cycle is initiated by depressing the spring-return switch to the "print" position. Front panel provision is made for plugging in the enlarger and a safelight. The safelight is automatically turned "on" when the enlarger is "off". Handles up to 350 watts. The timing cycle is controlled electronically for maximum accuracy and reliability. Very simple to build in only one evening, even by a beginner.

MODEL ET-1
\$11⁵⁰

Shpg. Wt. 3 Lbs.



HEATH COMPANY
A Subsidiary of Daystrom, Inc.
BENTON HARBOR 15, MICH.

HEATHKIT HIGH FIDELITY

Preamplifier Kit

COMPREHENSIVE INSTRUCTIONS . . .

The step-by-step assembly instructions provided with each Heathkit are the finest available anywhere. Each manual begins at the beginning, and assumes no previous training or experience on the part of the kit builder. This means that our kits can be built successfully by anyone who can follow instructions. As a matter of fact, new manuals are tested by having the kit built by someone in our office who has had no previous experience in electronics. This is your guarantee of complete and thorough instruction material.

- * 5 switch-selected inputs, each with its own level control.
- * Equalization for LP, RIAA, AES, and Early 78's.
- * Separate bass and treble tone controls, and special hum control.
- * Clean, modern lines and satin-gold enamel finish.

Literally thousands of these preamplifiers are in use today, because the kit meets or exceeds specifications for the most rigorous high-fidelity applications, and will do justice to the finest available program sources. Provides a total of 5 inputs, each with individual level controls (three high-level and two low-level). Frequency response is within 1 DB from 25 CPS to 30,000 CPS, or within 1 1/2 DB from 15 CPS to 35,000 CPS. Hum and noise are extremely low, with special balance control for absolute minimum hum level. Tone control provides 18 DB boost and 12 DB cut at 50 CPS, and 15 DB boost and 20 DB cut at 15,000 CPS. Cabinet measures only 12-9/16" W. x 3 3/8" H. x 4 7/8" D, and it is finished in beautiful satin-gold enamel. 4-position turnover and 4 position roll-off controls provide "LP," "RIAA," "AES," and "early 78" equalization, and 8, 12, 16, and 1 flat position for roll-off. Derives operating power from the main amplifier, requiring only 6.3 VAC at 1 ampere and 300 VDC at 10 MA. Easy to construct from step-by-step instructions and pictorial diagrams provided.

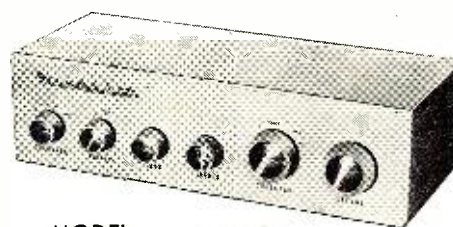

MODEL WA-P2 (With Cabinet)
Shpg. Wt. 7 Lbs.

\$19⁷⁵

HEATHKIT HIGH FIDELITY FM TUNER KIT

- * Illuminated slide-rule dial covers 88 to 108 MC.
- * Modern circuit emphasizes sensitivity and stability.
- * Housed in attractive satin-gold cabinet to match WA-P2 and BC-1.

This amazing new FM tuner can provide you with real high-fidelity performance at an unbelievably low price level. Covering 88 to 108 MC, the modern circuit features a stabilized, temperature-compensated, oscillator, A.G.C., broadbanded

IF circuits, and better than 10 UV sensitivity for 20 DB of quieting. A high gain, cascaded, RF amplifier is used ahead of the mixer to increase overall gain and reduce oscillator leakage. It employs a ratio detector for high efficiency without sacrifice in high-fidelity performance. IF and ratio transformers are pre-aligned, as is the front end tuning unit. This means the kit can be constructed by a beginner, without elaborate test and alignment equipment. The FM-3A is designed to match the WA-P2 preamplifier and the BC-1 AM tuner. An illuminated slide-rule dial is employed for frequency indication. Step-by-step instructions and large pictorial diagrams assure success.

MODEL FM-3A
\$25⁹⁵
INCLUDING NEW
EXCISE TAX
(With Cabinet)
Shpg. Wt. 7 Lbs.

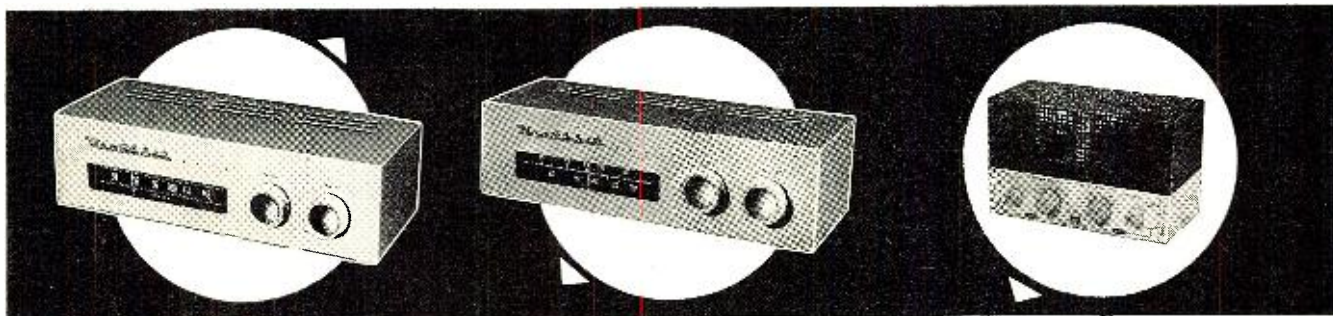

HEATHKIT BROADBAND AM TUNER KIT

This AM tuner has been designed especially for high-fidelity applications. It incorporates a low-distortion detector, a broadband IF, and other features essential to usefulness in high-fidelity. Special voltage-doubler detector employs crystal diodes for low distortion. Sensitivity and selectivity are excellent. Audio response is ± 1 DB from 20 CPS to 2 kc, with 5 DB of pre-emphasis at 10 kc to compensate for station roll-off. Covers the standard broadcast band from 550 to 1600 kc. Incorporates a 10 kc whistle-filter and provides a 6 DB signal-to-noise ratio at 2.5 UV. RF and IF coils are pre-aligned, and power supply is built-in. Incorporates AVC, two outputs, and two antenna inputs.

MODEL BC-1
\$25⁹⁵
INCLUDING NEW
EXCISE TAX
(With Cabinet)
Shpg. Wt. 8 Lbs.

HEATHKIT ELECTRONIC CROSS-OVER KIT

This unusual device functions to separate low frequencies and high frequencies so that they may be fed to separate amplifiers and to separate speakers. This eliminates the need for conventional cross-over circuits, since the Model XO-1 does the complete job electronically. Cross-over frequencies of 100, 200, 400, 700, 1,200, 2,000 and 3,500 CPS are selectable with front panel controls on the XO-1, and a separate level control is provided for each channel. Minimizes inter-modulation distortion problems. Handles unlimited power, since frequency division is accomplished ahead of the power stage. Attenuation is 12 DB per octave, with sharp "knee" at cut-off frequency.

MODEL XO-1
\$18⁹⁵
Shpg. Wt. 6 Lbs.

HEATHKIT ADVANCED-DESIGN

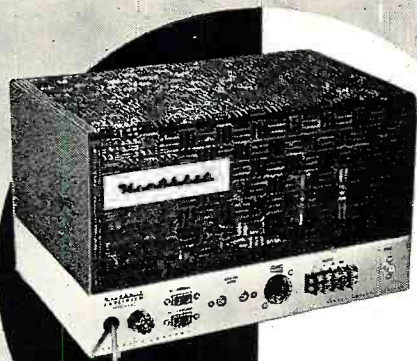

MODEL W-5M
Shpg. Wt. 31 Lbs.
Express Only

\$59⁷⁵

MODEL W-5

Consists of Model W-5M plus Model WA-P2 pre-amplifier.

Shpg. Wt. 38 Lbs.
Express only... \$79.50

- * Full 25 watt output with KT-66 output tubes.
- * All connectors brought out to front chassis apron.
- * Protective cover over all above-chassis components.

HEATHKIT DUAL-CHASSIS—WILLIAMSON TYPE HIGH FIDELITY AMPLIFIER KIT

This 20-watt high-fidelity amplifier employs the famous Acro-sound Model TO-300 "ultra-linear" output transformer and uses 5881 output tubes. The power supply is built on a separate chassis, and the two chassis are inter-connected with a power cable. This provides additional flexibility in mounting. Frequency response is ± 1 DB from 6 CPS to 150 kc at 1 watt. Harmonic distortion is only 1% at 21 watts, and 1M distortion is only 1.3% at 20 watts. (60 and 3,000 CPS). Output impedance is 4, 8, or 16 ohms. Hum and noise are 88 DB below 20 watts. A very popular high-fidelity unit employing top-quality components throughout.

MODEL W-3M: Shpg. Wt. 29 Lbs. Express only... \$49.75

MODEL W-3: Consists of Model W-3M plus Model WA-P2 pre-amplifier. Shpg. Wt. 37 Lbs. Express only... \$69.50

HEATHKIT 7-WATT AMPLIFIER KIT

This amplifier is more limited in power than other Heathkit models, but it still qualifies as a high-fidelity unit, and its performance definitely exceeds that of many so-called "high-fidelity" phonograph amplifiers. Using a tapped-screen output transformer of new design, the Model A-7D provides a frequency response of $\pm 1\frac{1}{2}$ DB from 20 to 20,000 CPS. Total distortion is held to a surprisingly low level. Output stage is push pull, and separate bass and treble tone controls are provided. Shpg. Wt. 10 Lbs.

MODEL A-7E: Similar to the A-7D, except that a 12SL7 tube has been added for pre-amplification. Two inputs, RIAA compensation, and extra gain.

MODEL A-7D
\$17⁹⁵

INCLUDING NEW EXCISE TAX

\$19.95[†]

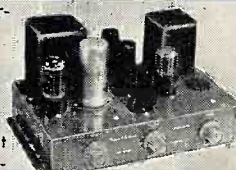
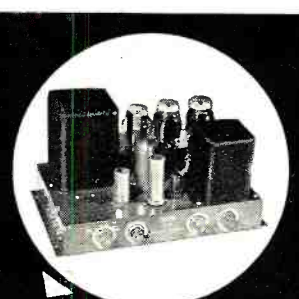
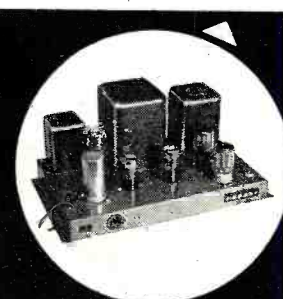
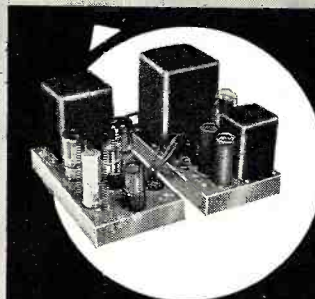

HEATHKIT 20-WATT HIGH FIDELITY AMPLIFIER KIT

This high-fidelity amplifier features full 20-watt output using push pull 6L6 tubes. Built-in preamplifier provides 4 separate inputs, selected by a panel-mounted switch. It has separate bass and treble tone controls, each offering 15 DB boost and cut. Output transformer is tapped at 4, 8, 16, and 500 ohms. Designed primarily for home installations, but also used extensively for public address applications. True high-fidelity performance with frequency response of ± 1 DB from 20 CPS to 20,000 CPS. Total harmonic distortion only 1% (at 3 DB below rated output).

MODEL A-9B
\$35⁵⁰

Shpg. Wt. 23 Lbs.



HEATH COMPANY

A Subsidiary of Daystrom, Inc.

BENTON HARBOR 15, MICH.

HIGH FIDELITY

Amplifier Kit

This 25 watt unit is our finest high-fidelity amplifier. Using a special design peerless output transformer, and KT-66 output tubes by Genalex, the Model W-5M provides performance characteristics unsurpassed at this price level. Frequency response is ± 1 DB from 5 to 160,000 CPS at 1 watt. Harmonic distortion is less than 1% at 25 watts and 1M distortion is less than 1% at 20 watts (60 and 3,000 CPS, 4 to 1). Hum and noise are 99 DB below 25 watts. Damping factor is 40 to 1. Input voltage for 5 watts output is 1 volt. Tubes employed are a pair of 12AU7's, a pair of KT-66's and a 5R4GY rectifier. Measures 13-3/32" W. x 8 1/2" D. x 8 1/4" H. Output impedance is 4, 8, or 16 ohms. Featured, also, is the "tweeter saver" which suppresses high frequency oscillation, and a new type balancing circuit requiring only a voltmeter for indication. This balance is easier to adjust, and results in a closer "dynamic" balance between output tubes. The Model W-5M provides improved phase shift characteristics, reduced IM and harmonic distortion, and improved frequency response. Conservatively rated high-quality components are used throughout to insure years of trouble-free operation. No technical background or training is required for assembly. Step-by-step instructions are provided for every stage of construction, and large pictorial diagrams illustrate exactly where each wire and component is to be placed. An amplifier for music lovers who can appreciate subtle differences in performance. Just ask the audiophile who owns one!

HEATHKIT SINGLE CHASSIS—WILLIAMSON TYPE HIGH FIDELITY AMPLIFIER KIT

The 20-watt Model W-4AM Williamson type amplifier is a tremendous high-fidelity bargain. Combining the power supply and main amplifier on one chassis, and using a special-design output transformer by Chicago Standard brings you savings without a sacrifice in quality. Employing 5881 output tubes, the frequency response of the W-4AM is ± 1 DB from 10 CPS to 100 kc at 1 watt. Harmonic distortion is only 1.5% at 20 watts. Output impedance is 4, 8, or 16 ohms. Hum and noise are 95 DB below 20 watts.

MODEL W-4AM: Shpg. Wt. 28 Lbs. Express only... \$39.75

MODEL W-4A: Consists of Model W-4AM plus Model WA-P2 pre-amplifier. Shpg. Wt. 35 Lbs. Express only... \$59.50

All prices marked with a ‡ include a new federal excise tax that now applies to receivers, tuners and some amplifiers, even though they may be in kit form. Since the tax is in effect as of July 5, 1956, we have no choice but to reflect it in our kit prices. This note is just to let you know we are not increasing our prices on some kits, but merely including this new tax in them.

Thank you,
HEATH COMPANY

HEATHKIT HIGH FIDELITY

Range Extending SPEAKER SYSTEM KIT

- * High quality speakers of special design — 15" woofer and compression-type super-tweeter.
- * Easy-to-assemble cabinet of furniture-grade plywood.
- * Attractively styled to fit into any living room. Matches Model SS-1.

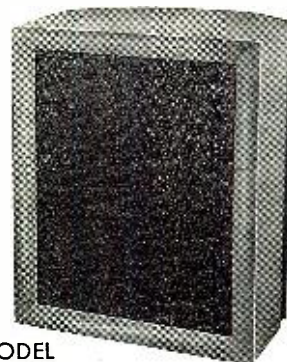

MODEL
SS-1B

\$99⁹⁵

Shpg. Wt. 80 Lbs.

This range extending unit is designed especially for use with the Model SS-1 speaker system. It consists of a 15" woofer, providing output between 35 and 600 CPS, and a compression-type super-tweeter that provides output between 4,000 and 16,000 CPS. Cross-over frequencies are 600, 1,600, and 4,000 CPS. The SS-1 provides the mid-range, and the SS-1B extends the coverage at both ends of the spectrum. Together, the two speaker systems provide output from 35 to 16,000 CPS within ± 5 DB. This easy-to-assemble speaker enclosure kit is made of top-quality furniture-grade plywood. All parts are pre-cut and pre-drilled, ready for assembly and the finish of your choice. Complete step-by-step instructions are provided for quick assembly by one not necessarily experienced in woodworking. Coils and capacitors for proper cross-over network are included, as is a balance control for super-tweeter output level. The SS-1 and SS-1B can provide you with unbelievably rich audio reproduction, and yet these units are priced reasonably. The SS-1B measures 29" H. x 23" W. x 17½" D. The speakers are both special-design Jensens, and the power rating is 35 watts. Impedance is 16 ohms.

HEATHKIT HIGH FIDELITY SPEAKER SYSTEM KIT



MODEL
SS-1

\$39⁹⁵

Shpg. Wt. 30 Lbs.

- * Special design ducted-port, bass-reflex enclosure.
- * Two separate speakers for high and low frequencies.
- * Kit includes all parts and complete instructions for assembly.

This speaker system is a fine reproducer in its own right, covering 50 to 12,000 CPS within ± 5 DB. However, the story does not end there. Should you desire to expand the system later, the SS-1 is designed to work with the SS-1B range extending unit — providing additional frequency coverage at both ends of the spectrum. It can fulfill your present needs, and still provide for the future. The SS-1 uses two Jensen speakers; an 8" midrange-woofer, and a compression-type tweeter. Cross-over frequency is 1,600 CPS, and the system is rated at 25 watts. Nominal impedance is 16 ohms. The cabinet is a ducted-port bass-reflex type. Attractively styled, the Model SS-1 features a broad "picture-frame" molding that will blend with any room decorating scheme. Pre-cut and pre-drilled wood parts are of furniture grade plywood. The kit is easy-to-build, and all component parts are included, along with complete step-by-step instructions for assembly. Can be built in just one evening, and will provide you with many years of listening enjoyment thereafter.

HEATH COMPANY A Subsidiary of Daystrom, Inc. **BENTON HARBOR 15, MICH.**

ORDER BLANK

NOTE: All prices subject to change without notice.

Enclosed find () check () money order for _____
Please ship C.O.D. () postage enclosed for _____ pounds.

On Express orders do not include transportation charges — they will be collected by the express agency at time of delivery.

ON PARCEL-POST ORDERS include postage for weight shown. ORDERS FROM CANADA and APO'S must include full remittance.

Name _____

SHIP VIA

- Parcel Post
- Express
- Freight
- Best Way

Address _____

City & Zone _____ State _____

(PLEASE PRINT)

QUANTITY	ITEM	MODEL NO.	PRICE

**MORE POWER
with LESS
DISTORTION**



EL34 / 6CA7

Mullard
MADE FOR MUSIC

Recognized as the finest high power output pentode, up to 100 watts in push-pull. Designed specifically for High Fidelity and produced by precision craftsmen with these design features:

- Golden grids.
- Linear characteristics.
- Low-drive voltage.
- Clean crisp output.

OTHER Mullard TUBES
designed specifically for High Fidelity:

EL37	High-power pentode, 69 W PP
EL84/6BQ5	Miniature output pentode, 20 W PP
EF86/6267	Low-noise input pentode
ECC81/12AT7	Low-noise medium μ dual triode
ECC82/12AU7	Low-noise low μ dual triode
ECC83/12AX7	Low-noise high μ dual triode
EZ80/6V4	Miniature rectifier cathode type, 90 ma.
EZ81/6CA4	Miniature rectifier cathode type, 150 ma.
GZ34	Bantam rectifier cathode type, 250 ma.

Mullard

Available at all leading distributors.
For detailed technical data and application information write:



Trade Mark Mullard, Ltd.

INTERNATIONAL ELECTRONICS CORP.
81 Spring Street, New York 12, N. Y.

World's Most Complete Range of audio tubes



NEW LOWBOY ENCLOSURE

James B. Lansing Sound, Inc., 2439 Fletcher Drive, Los Angeles 39, Calif. is now offering its "Harkness" Model C40, a rear-loading horn which has

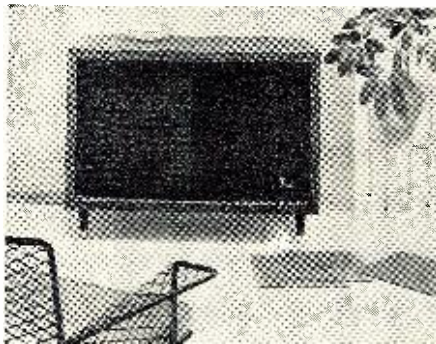

been especially designed for the smaller living rooms of city dwellers.

Entirely contained and independent of room position, this lowboy enclosure can be used against the wall or as an end table. Height without legs is under 24" and under 30" with legs. The enclosure measures nearly 38" wide and just under 20" in depth. This new unit is so designed that it can be used at a later time in an expanded two-way system.

EQUIPMENT HOUSINGS

American Loudspeaker, Division of Contemporary American Furniture, Inc., 725 S. LaSalle, Chicago 5, Ill. has recently introduced a new line of housings especially designed for the high-fidelity equipment market.

Initially, the new line includes two matched speaker systems and one equipment console. Finishes include traditional mahogany, sandalwood mahogany, and natural walnut.

The equipment console will house a complete audio system, except for

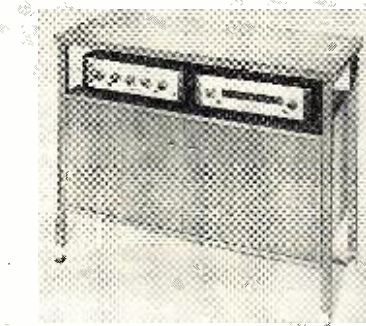

speakers, and stores over 100 records. The Mark 100 unit includes solid brass ferrules on the legs, brass piano hinges for the doors, magnetic door catches, ball-bearing drawer slides for the changer, pre-cut changer drawer, and

a rubbed finish. In addition, the lacquered hardboard back is pre-drilled to make installation simple. The unit is 36" wide, 27" high, and 16" deep.

The two speaker systems are designed to match and complement the equipment console. The smaller unit measures 24" wide, 10" high, and 12" deep, the larger 27" wide, 23" high, and 14" deep. Speakers are included.

Write the manufacturer for full electrical and physical details on any or all of these cabinets.

16-WATT AMP-PREAMP

Madison Fielding Corp., 863 Madison St., Brooklyn 21, N. Y. is now offering a 16-watt amplifier which features an all-transistor preamplifier.

The Series A-15 has a uniform frequency response from 20 to 20,000 cps \pm .5 db and from 10 to 75,000 cps \pm 2 db. Distortion is less than 1% at full output and less than .1% at 1 watt. Output impedances of 4, 8, and 16 ohms are provided plus a low im-

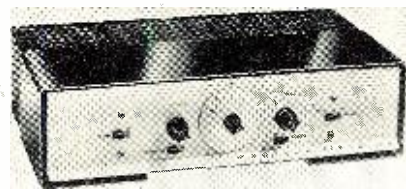

pedance recorder output which provides 10 db of gain from input ahead of all volume and tone controls.

The instrument includes four high impedance, one low level, and one low impedance inputs. NARTB equalization is provided for tape playback and the RIAA curve within .5 db for phono reproduction. Accurately calibrated controls offer six other playback curves. Equalization is continuously variable for optimum settings under all conditions of program material and listening.

Over-all size of the unit is 14 1/8" x 7" x 3 5/8" high. Full details will be supplied by the manufacturer on request.

FISHER FM TUNER

Fisher Radio Corporation, 21-21 44th Drive, Long Island City 1, N. Y. has developed a new FM tuner which features a gold cascode r.f. amplifier.

The gold cascode, which is the costliest tube of its type in the world, together with special circuitry, brings the Model FM-90X to the theoretical limits of sensitivity, according to the manufacturer.

The tuner uses a full wide-band de-

When you build your High Fidelity sound system, use **THE VERY BEST** LOUDSPEAKERS YOU CAN GET

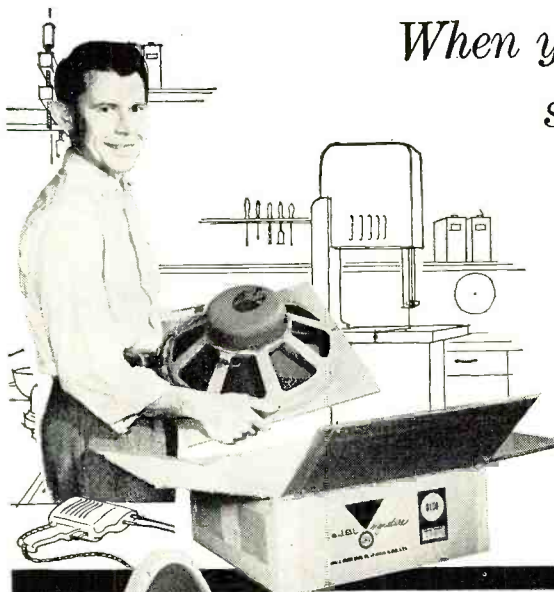

You are planning to build, or improve, your high fidelity sound system. Unstintingly, you will pour out your enthusiasm, time, and energy to get the finest music reproduction you can bring into your home. Get a loudspeaker that will do full credit to your handiwork... Install a JBL Signature Extended Range Loudspeaker, or two-way speaker system, in your enclosure.

JBL Signature Loudspeakers are made with the same careful craftsmanship, the same precision forming and fitting that you yourself would use if you set out to make the finest loudspeaker the world had ever heard. JBL Signature precision speakers are the most efficient loudspeakers made.

With a JBL Signature Loudspeaker in your high fidelity system, you can exhibit your components with pride, confident that those you have made yourself are being demonstrated in the most effective way possible.



MODEL D130-15" extended range loudspeaker The only 15" extended range speaker made with a 4" voice coil is the world-famous JBL Signature D130. The large voice coil stiffens the cone for crisp, clean bass; smooth, extended highs. Your basic speaker, the D150 works alone at first, later becomes a low frequency driver when you add a JBL Signature high frequency unit and dividing network to achieve the ultimate excellence of a JBL Signature two-way system.



MODEL D208-8" extended range loudspeaker A precision transducer in every sense of the word, the famed JBL Signature 8" D208 is made with the same care and precision as the larger units in the James B. Lansing Sound, Inc. line. If space and cost are major considerations, the D208, properly enclosed, provides the most lastingly satisfactory sound you can get. It is widely used in top quality systems where extension speakers are desired for areas other than the main listening room.



MODEL D123-12" extended range loudspeaker With outstanding "presence" and clean response throughout the entire audio spectrum, the D123 features an unusual shallow construction. Only 3 3/8" deep, it is designed to mount flush with the wall, between studding, in any standard wall or partition. Frequently, the D123 is used in multiples in "infinite baffle" wall installations. In this case the JBL Signature 075 is a logical high frequency unit to add when you advance to a two-way system.



MODEL 175DLH high frequency assembly The acoustical lens is only available on JBL Signature high frequency units. The 14 element lens on the 175DLH disperses sound within the listening area over a 90° solid angle, smoothly, with equal intensity regardless of frequency. The acoustical lens is the greatest contribution to lifelike high frequency reproduction in 20 years, and it was developed for use with high fidelity equipment by James B. Lansing Sound, Inc. In addition to the lens, the 175DLH consists of a high precision driver with complex phasing plug and a machined aluminum exponential horn. Designed for crossover at 1200 cycles with the JBL Signature N1200 Network.



MODEL 075 high frequency unit Another exclusive for James B. Lansing Sound, Inc. is the ring radiator in the JBL Signature 075 high frequency unit. A ring, rather than a diaphragm, radiates into the annular throat of an exponential horn. The result is high frequency reproduction of unmatched smoothness and clarity, absolutely free of resonances and strident peaks. The horn is beautifully machined from aluminum, the entire unit a gratifying, solid piece of fine craftsmanship. Designed for crossover at 2500 cycles with the JBL Signature N2500 Network.

JBL Signature two-way systems are available as kits

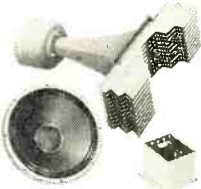

086 KIT This two-way system is made up of units which have been acclaimed by impartial authorities as the finest available anywhere today. Included in the kit are the 150-4C Low Frequency Driver, N500H Network, 375 High Frequency Driver, 537-509 Horn-Lens Assembly. These are the same units—including the serpentine acoustical lens—which are used in The Hartsfield... units designed originally for installation in the most modern theaters in the world.



002 KIT Including some of the newest speakers made, the JBL Signature 002 Kit includes a D123 for low frequency reproduction, N2500 Network, 075 High Frequency Unit. The 002 Kit is moderately priced, yet gives the user all the advantages of a two-way system made with independent drivers.



001 KIT Probably the most popular high quality two-way system on the market, the JBL Signature 001 system consists of a 130A Low Frequency Driver, N1200 Network, 175DLH High Frequency Assembly. The D130 may be substituted for the 130A without disturbing the balance or coverage of the system.

There are many more kits and loudspeakers in the JBL Signature line. Whatever your needs, you will find exactly the right unit or system in the complete JBL Signature catalog. Send for your free copy. A limited number of technical bulletins are also available. Please ask only for those in which you are vitally interested.



JAMES B. LANSING SOUND, INC.

2439 Fletcher Drive • Los Angeles 39, California

Please send me the following:

- Free Catalog of JBL Signature Products Name and address of Authorized JBL Signature Audio Specialist in my community

TECHNICAL BULLETINS ON:

- D130 D123 D208 175DLH 075 130A 150-4C

Name _____

Address _____

City _____ Zone _____ State _____

This is the house that Jack built.

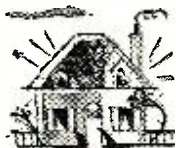

This is the clatter that came from the house that Jack built.



For all was the matter with the musical clatter, that came from the house that Jack built.

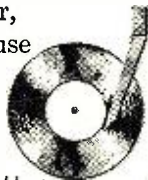

This was the platter? Which made all the matter with the musical clatter, that came from the house that Jack built.



Reviewing the data 'twas not the platter which made all the matter with the musical clatter, that came from the house that Jack built.

The difficulty was traced and was found to arise from the loudspeaker. It was promptly replaced with a Norelco FRS Speaker. And now...

This is the house with the Norelco horn and the maiden who's no longer forlorn.



Her mate's lust for data discovered the platter was not ere the matter that made musical clatter, that came from the house that Jack built.



Norelco F.R.S. Speakers are available in 5", 8" or 12" sizes in standard impedances. Priced from \$6.75 to \$59.98.*

ADD TO... and improve any sound system with **Norelco® *FULL RESPONSE SPEAKERS**

Write today to Dept. 33 brochure and prices of these unique speakers.



NORTH AMERICAN PHILIPS CO., INC.
High Fidelity Products Division
230 Duffy Ave. Hicksville, L. I., N. Y.

tor, dual dynamic limiters, variable a.f.c., and interchannel muting. Two meters are provided for micro-accurate

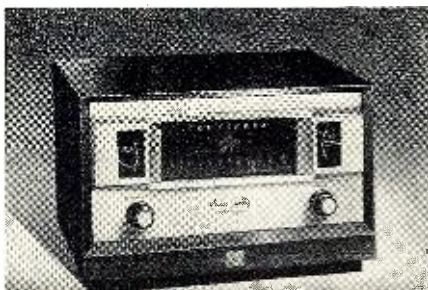

tuning—one indicating signal strength and the other indicating center-of-channel.

The tuner is available with optional cabinets in either blonde or mahogany finishes. The tuner measures 13 $\frac{7}{16}$ " wide, 6 $\frac{1}{2}$ " high, and 8 $\frac{3}{8}$ " deep, plus 1" for knobs.

SOUND SYSTEM CONTROLS

Clarostat Mfg. Co., Inc., of Dover, N. H. has released three new constant impedance attenuators for controlling remote speakers that lend themselves to more compact housings or outlet boxes, due to their reduced depth and diameter.

The new CIT43 controls are based on the popular 1 $\frac{1}{2}$ " diameter potentiometers. Rated at 2 watts d.c., these controls handle up to 4 watts of audio. The attenuation range is 0 to 30 db over 90% of the rotation and 60 db in the remaining 10%. Attenuation increases approximately linearly up to 30 db with counterclockwise rotation. Insertion loss is less than 6 db.

The CIT43 (T-pad) and the CIBT43 (bridged tap pad) have constant input and output impedances, while the CIL43 (L-pad) has constant impedance for input only. Shafts and bushings are insulated from circuit elements and all pads are supplied with bar knobs and dial plates.

"AUDIO-ELITE" SPEAKER

American Elite, Inc., 7 Park Avenue, New York 16, N. Y. is now offering a speaker system with changeable

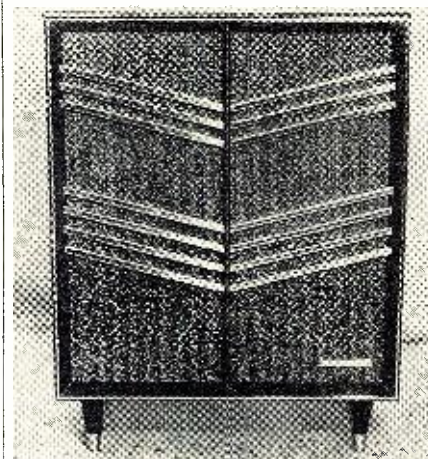

grille which is being marketed as the "Custom."

The enclosure includes six speakers —two 12" dynamic oval speakers, two

8" dynamic oval speakers, and two tweeters. Frequency response is 20-20,000 cps when the system is used with the *Audio-Elite* tuner and amplifier. The cabinet is 32" high, 24" wide, and 12 $\frac{1}{2}$ " deep. It is available in high gloss mahogany or blonde finishes.

A unique feature of the enclosure is the changeable grille which makes possible a variety of decorative schemes. The grille is available with either model at additional charge.

ERIE AMPLIFIER KIT

Erie Resistor Corporation of Erie, Pa. has designed a new four-tube audio amplifier kit for the "do-it-yourself" market.

The kit includes one of the company's "PAC" modules of pre-assembled resistors and capacitors, an embossed wiring board, and additional plug-in components consisting of tubes,

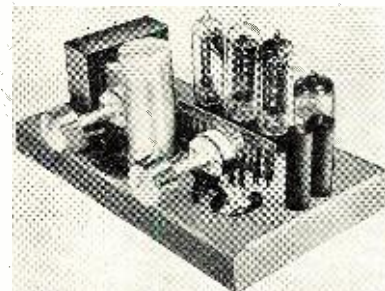

tube sockets, output transformer, filter capacitor, volume control and switch, and tone control.

Complete instructions and recommendations for construction are included with the kit which is being handled by the company's regular distributors.

STEREO AMPLIFIER CHANGES

Bell Sound Systems, Inc., 555 Marion Road, Columbus 7, Ohio has announced that its Model 3-DTG two-channel stereophonic amplifier has been re-engineered and improved.

Power output is now fully rated in excess of 24 watts, 12 watts each channel, with peak output of 50 watts. New low-noise input tubes are now being used. The amplifier will operate in either the stereo or monaural mode. Stereo features include two separate amplification channels with single knob, simultaneous control of both channels. A six-position function switch provides selection of stereo or monaural amplification with or without loudness control.

A reverse speaker switch makes it possible to switch the two stereo channels into the opposite speakers. A single-knob balance control assures simple component difference correction.

COVER LIFTS

Counter Balance Inc., Box 72, Stoughton, Wis. has added two new units to its line of equipment cabinet hardware.

The X300 and XB400 "Cover Lifts," which have been especially designed for use on record player cabinet lids, offer a number of unique features which compensate for the rough usage such

closure devices often receive. For factory assembly or servicing of the equip-

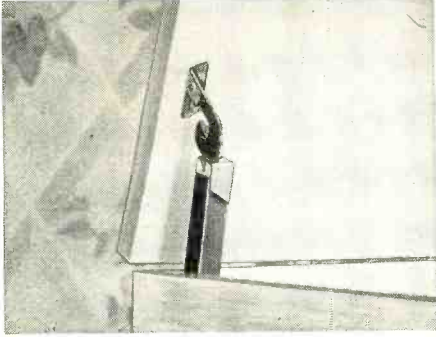

ment a cam pressure point has been provided so that the shoulder rivet is placed in a forward position and the cover remains locked in a wide open position for easy accessibility. Other features include compensation for cover weight at varying degrees of opening; reverse cam action which eliminates sudden jars when the cover is thrown open violently, thus protecting stylus and record; and torsional rigidity which preserves the alignment of cabinet back and delicate corner joints.

These units are being offered in a new two-tone finish with solid bright brass top slide and the balance dead black, making the units compatible with either blonde or dark finished cabinets.

Write the manufacturer for full specifications for various sized cabinets.

PRINTED CIRCUIT AMPLIFIER

Printed Electronic Research, Inc., 4212 Lankershim Blvd., North Hollywood, Calif. is now offering an easy-to-assemble, 50-watt amplifier kit which utilizes a deep-etched photoelectronic circuit board to speed construction and eliminate the need for special tools and equipment.

The circuit board replaces all wiring and forms the complete base of the "Peri-50" amplifier. The kit is not only



complete as to all components, including tubes, but even provides the correct type of solder and a soldering iron.

The amplifier has a power output of 50 watts continuous with 100 watts peak. IM distortion is less than 1% at

Louis "Satchmo" Armstrong

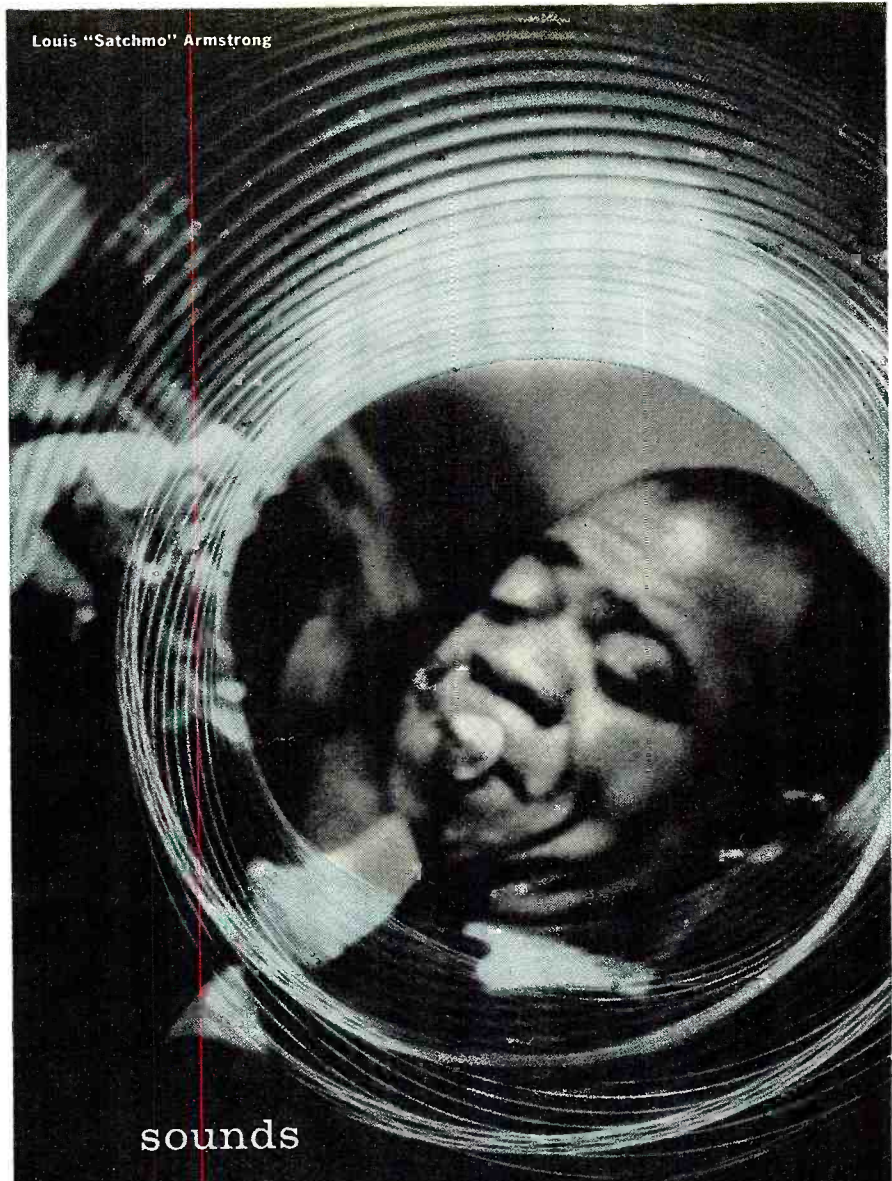

sounds
of our time
are timeless on
SOUNDCRAFT TAPES
with MYLAR* BASE

Ageless "Mylar" base and ageless plasticizer-free Soundcraft oxide coating—these are the reasons why lifelike sound is yours forever, only with Soundcraft "Mylar" base tapes. Because no other tapes offer comparable quality, a Soundcraft product is inevitably the choice of those who immortalize historic events, masterworks in music, or the sound in a great CinemaScope film! When you record sounds worth saving...enjoy their re-creation...their re-living...on Soundcraft "Mylar" base tapes! Write for free booklet! Buy these Soundcraft tapes:

PLUS 50 - 50% longer play— PLUS 100 - twice as much on a reel -
LIFETIME - guaranteed for life

*DuPont Trade Mark



REEVES SOUNDCRAFT CORP., 10 E. 52 St., N.Y. 22, N.Y. West Coast: 338 N. LaBrea, L. A. 36, Cal.

coming soon...
NEW EDITION
UNIVERSITY
TECHNILOG
ON LOUDSPEAKERS

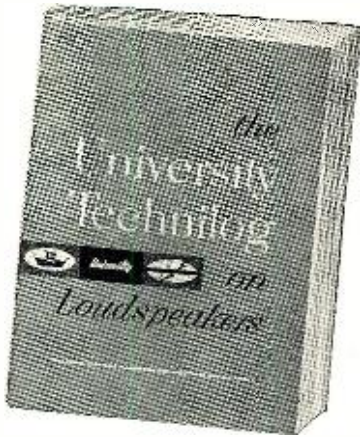

THIS INVALUABLE 96 PAGE REFERENCE BOOK WILL SAVE TIME AND MONEY PLANNING SOUND SYSTEMS.

More comprehensive than the previous edition . . . shows new products, new techniques, new technical charts and diagrams . . . and includes the exclusive Sound Planning Chart, ingenious aid for planning efficient sound installations. Only 75c

TWELVE AUTHORITATIVE CHAPTERS COVER:

Wide angle horns vs. directional horns, How to best use radial trumpets, High fidelity in P.A. applications, How to select drivers properly, Methods of overload protection, Series vs. parallel impedance operation, Power ratings vs. efficiency, Coping with reverberation, How to handle matching transformers, Constant voltage distribution systems, Controlling loudspeaker volume, Typical sound installations, and many others.

PLEASE NOTE: Demand for the previous Technilog was so great that many orders couldn't be filled. To be sure you get your copy, fill in and return the coupon now. . . .

MAIL TODAY

Desk S-22 University Loudspeakers, Inc.
 80 So. Kensico Ave., White Plains, N. Y.
 I am enclosing 75c. Please reserve my copy of the new 96 page University Technilog.

Name _____
 Street _____
 City _____ Zone _____ State _____
 Occupation _____



50 watts, less than .24% at 35 watts, and under .125% at 10 watts. Frequency response is 6 to 60,000 cps \pm .5 db, and \pm .1 db from 20 to 35,000 cps at any level from 1 mw. to 50 watts.

A free illustrated brochure showing the complete unit and supplying full specifications is available on request.

NEW TONE ARM

Audio Specialties, 13167 Steel Ave., Detroit 27, Mich. is now offering a new tone arm of the radial type. The design of the AS-30 completely eliminates tracking error, according to the company.

The tone arm transports the stylus carriage on precision jewel bearings which provide a good lateral compliance and extremely low lateral starting torque. The arm is engineered in such a manner that the stylus travels the same path established by the cutting head at the time the original master was made.

The arm is designed for automatic indexing of the stylus to the starting groove of 12" records. By raising the arm slightly, the stylus automatically positions itself, when lowered, and the stylus engages the starting groove.

DUAL PREAMP FOR STEREO

David Bogen Co., Inc. of Paramus, N. J. has recently released a moderately priced unit for stereo tape playback applications.

The Model ST-10 incorporates dual preamplifiers and a 10-watt amplifier in a single compact unit, plus volume and tone controls. When used with a tape playback deck, the outputs of the stereo tape head are fed into both preamps. One of these drives the built-in amplifier while the other drives an external amplifier from a cathode follower. Frequency response is flat from 20 to 20,000 cps, \pm 2 db; distortion is 1% at 10 watts on channel 1 and 2% at $\frac{1}{2}$ volt on channel 2. Equalization is fixed and hum and noise are said to be undetectable.

KLIPSCH-DESIGNED KIT

Allied Radio Corporation, 100 N. Western Ave., Chicago 80, Ill. has announced the availability of a new line of low-priced, pre-finished speaker en-



losures which are being offered in easy-to-assemble, knocked-down form.

Known as the "Quik-Craft" series, these enclosures are of the Klipsch corner-horn type. All exposed wood panels

of the enclosures are furniture-finished in mahogany or blonde. Models for 12" or 15" loudspeakers are available at the present time.

The cabinets are designed so that they can be assembled with just a screwdriver. All parts are precision cut and there is no need for sawing, sanding, glueing or drilling. Six different versions of the enclosure are available: finished but not assembled 12" and 15"; unfinished unassembled 12" and 15"; and pre-finished and completely assembled 12" and 15". The enclosures are exclusive with this distributor.

CATALOGUES

PHONO AMPLIFIER DATA

The Commercial Engineering Department of *Radio Corporation of America*, Harrison, N. J., has issued a 4-page pamphlet describing a 200 mw. output battery-operated phonograph amplifier using RCA-2N109 junction transistors, which is of interest to audiophile.

The publication describes a three-stage transistorized audio amplifier which has been specifically designed for use in battery-operated portable phonographs. When driven by a medium-output crystal or ceramic pickup and operated from a 9-volt supply, the amplifier is capable of delivering 200 mw. output at the 10 per-cent distortion level.

A copy of Application Note AN-169 containing full details and a schematic diagram is available without charge on request.

UNIVERSITY "POWRPAGE"

University Loudspeakers, Inc., 80 S. Kensico Ave., White Plains, N. Y. is offering, without charge, copies of a new bulletin which graphically illustrates the wide variety of uses for its new ultra-lightweight portable sound-casting systems.

Details on two "Powrpage" models are included, the PP-1 and the PP-2. The former is a completely weather-proof 7 $\frac{1}{2}$ pound unit which provides high-power localized soundcasting via a speaker that projects sound in any direction, a base stand that can be hung from a nail or hook, and a hand microphone with 11 feet of cable.

The Model PP-2 weighs 4 $\frac{1}{2}$ pounds and consists of a compact loudspeaker-microphone unit with an easy-grip handle that holds the battery supply and the "press-to-talk" switch. The entire unit is held in one hand and directs the voice in the direction desired.

"AUDIOFILE" CATALOGUE

The *Audiofile* division of *United File-O-Matic, Inc.*, 60 Madison Ave., Hempstead, N. Y. has announced a new catalogue service for high-fidelity, sound, and audio dealers, and distributors.

The "Audiofile" is perpetually up-to-date. It completely catalogues the products of more than 228 manufacturers of high-fidelity and sound equipment in eight product sections: sound systems, tuners, amplifiers, and intercoms; speakers, enclosures, furniture;

microphones, stands, and accessories; phono motors and record players; recorders and recording equipment; recording discs, wire, and tape; pickups and cartridges; and needles.

Alphabetically arranged, each section catalogues the information of all manufacturers producing the respective products. Both catalogue and pricing replacement pages are sent to subscribers as often as necessary.

Complete information and rates on this service are available from the publisher.

BACKGROUND MUSIC EQUIPMENT

Browning Laboratories, Inc., 750 Main St., Winchester, Mass. has issued a new catalogue which provides complete details on its line of background music equipment.

Included are specs on the firm's line of "simplex-multiplex" receivers and tuners for various frequencies, a line of amplifiers for the background music operator, and a new "simplex-multiplex" broadcast monitor and relay receiver.

LAFAYETTE BROCHURE

Lafayette Radio, 165-08 Liberty Ave., Jamaica 33, N. Y. is offering a free 16-page brochure which covers a wide variety of equipment of special appeal to the audiophile.

Pictured and described are speaker systems, tuners, amplifiers, and other audio accessories. Copies of the HF-250 brochure may be picked up at any of the company's six hi-fi centers or it will be forwarded by mail on written request.

-30-

ROCKY MOUNTAIN ARRL MEET

THE Denver Radio Club, Inc. will play host to this year's Rocky Mountain Division Convention to be held at Elkhorn Lodge, Estes Park, Colorado on June 15th and 16th.

The Club has planned activities for all, including technical talks, transmitter hunt, mobile judging contest, special programs for the ladies, riding, and swimming.

Registration fee is \$3.50 per person with a special rate of \$2.50 for those whose registration is postmarked before June 4th. Hotel reservations should be made direct with Elkhorn Lodge. Walter M. Reed, WØWRO, 1355 E. Amherst Circle, Denver 10, will supply registration information and other convention data on request.

-30-

RAMONA RADIO CLUB MEET

THE Ramona Radio Club, K6SIR, has picked Sunday, July 28th as the date for its annual picnic and hamfest and Barnes Memorial Park, Monterey Park, California, as the site.

Last year 1200 persons attended the event and the committee is hoping for an even larger turn-out this year.

A full and interesting program has been planned with contests, prizes, and fun for all.

The club can be contacted at 717 Anderson Way, San Gabriel, California, or through the club station K6SIR; the club president, Ray Meyers, W6MLZ; or John S. Rice, K6GJV.

-30-

June, 1957

Specifications

Description: The 121-C is a self-powered equalizer and preamplifier, complete with the dynamic noise suppressor.

Input Facilities: 2 magnetic inputs, switched on front panel; crystal or ceramic input; five high-level channels including provision for tuner, tape and TV sound. **Tape Recording and Monitoring:** Two special tape recorder output connections, plus monitor channel with monitor-playback switch. **Tape Playback:** Separate channel, with NARTB tape equalization, for playback of tape direct from tape heads. **Frequency Response:** Flat from 19 cps to 35 kc. **Total hum and noise:** On high level inputs 85 db below full output; on low level inputs, 3.2 microvolts equivalent noise input. **Dimensions in mahogany case:** 13 1/4" x 5" x 9 1/2" \$159.95 — Mahogany Case \$19.95.



**THE 121-C
Dynaural Equalizer Preamplifier**

The most versatile control and compensation unit ever offered. It includes continually variable record equalizers and Scott's patented Dynamic Noise Suppressor.

**H. H. Scott presents
Components for the Perfectionist**



H. H. Scott, Inc., 385 Putnam Ave
Cambridge, Mass.

- The Most Versatile Control and Compensation Unit Ever Offered — The 121-C Dynaural Preamplifier.
- The Cleanest Sounding Power Amplifier Ever Developed — The "280" 80 Watt Power Amplifier.

**The "280" 80 Watt
Laboratory Power Amplifier**

The 80-watt output of this superb amplifier provides ample power reserve for the most demanding applications. Its exclusive Dynamic Power Monitor affords full output on music, yet automatically protects expensive speakers against burnout.



Specifications

Power ratings: 80 watts on music wave-forms (short-time maximum r.m.s.); long-time continuous output 65 watts r.m.s. instantaneous peak output 160 watts. **Frequency response:** Flat from 12 cps to 80 kc. **Dynamic Power Monitor:** Reduces possibility of speaker burnout on overload by limiting maximum continuous output to any value desired between full power and 10 watts. **Speaker Damping control:** Permits continuous adjustment of output impedance to any value between 3% and 200% of load impedance. **Total Hum and Noise:** 90 db below full output. **Harmonic Distortion:** Less than 0.5%. **First-order difference tone IM distortion:** Less than 0.1%. **Outputs:** 3 to 24 ohms and 70 volt tap. \$199.95.

Also from H. H. Scott: The "240" 40 Watt Laboratory Power Amplifier incorporating many of the features of the "280" ... only \$99.95

Complete H. H. Scott Amplifiers Start at \$99.95!

WRITE FOR YOUR FREE COPY OF H. H. SCOTT'S NEW CATALOG
H. H. Scott, Inc., 385 Putnam Avenue, Cambridge, Mass.

Rush me your new catalog R-6 showing complete high fidelity systems for my home.

Name _____

Address _____

City _____ Zone _____ State _____

Export Dept. Telesco International Corp.
86 W. 40th St., New York City

**IMPROVE
your
AMPLIFIER
in 5 ways**



with the
**Amperex®
GZ34 RECTIFIER**

A LOW-IMPEDANCE, INDIRECTLY HEATED, FULL-WAVE RECTIFIER WITH 250 MA OUTPUT CAPACITY

The unique AMPEREX GZ34 replaces without circuit changes, in the majority of amplifier circuits, an entire line of popular, heavy-duty 5-volt rectifiers—5U4G, 5V4G, 5T4, etc. — with the following benefits:

- Better voltage regulation due to lowered power supply impedance;
- Higher power supply output voltage for more power;
- Added filter condenser protection due to reduced ripple;
- Cooler operation due to lower voltage drop;
- Protection of costly power output tubes through delayed warm-up.

OTHER Amperex TUBES FOR HIGH-FIDELITY AUDIO APPLICATIONS:

- | | |
|-------------|-------------------------------------|
| EL84/6BQ5 | 9-pin power pentode; 17 W PP |
| 6CA7/EL34 | High-power pentode; 100 W PP |
| EF86/6267 | Low-noise high- μ pentode |
| ECC81/12AT7 | Low-noise medium- μ dual triode |
| ECC82/12AU7 | Low-noise low- μ dual triode |
| ECC83/12AX7 | Low-noise high- μ dual triode |
| EZ80/6V4 | 9-pin rectifier; cathode; 90 ma. |
| EZ81/6CA4 | 9-pin rectifier; cathode; 150 ma. |

At All Leading Electronic Parts Distributors

**Amperex
ELECTRONIC CORP.**
230 Duffy Ave., Hicksville, Long Island, N.Y.

Measuring Amplifier Damping Factor

Described here are two methods that may be used to measure the damping factor of an audio amplifier.

THE KNOWLEDGE of what your amplifier's damping factor is has become more important recently. With high-efficiency speakers it was usually felt that the higher an amplifier's damper factor the better this would be for the speaker in damping out undesired resonances. However, with the advent of high-quality, low-efficiency speakers, and especially with such speakers mounted in infinite baffles or other such enclosures that do not add to the bass response, the use of an amplifier with too high a damping factor is undesirable. This would result in overdamping the speaker and reducing its output, especially at the bass end. Perhaps the day is not too far away when speaker manufacturers will specify optimum damping factors for their speakers when used in specific enclosures. Several values might be given for different types of listening tastes. The amplifier manufacturers have already started the ball rolling by providing, in some cases, a variable damping control that allows the user to set the damping factor at whatever value he requires.

At present most speaker manufacturers are quite reluctant to quote any optimum damping factors for amplifiers to be used with their loudspeakers. This is partly due to the fact that not enough experiments have been done along these lines and also that the results obtained at various damping factors is so subjective. Some listeners might like the way their speakers sound with one certain damping factor, others might prefer another value.

Typical values of amplifier damping factor depend, in the main, on the output circuit used. For example, with push-pull triodes without feedback the damping factors are in the range of 2 to 4. With push-pull beam power

tubes the damping factor is apt to be less than this unless negative feedback is used. With large amounts of negative feedback, tetrode damping factors may run as high as 10. Recent designs using triodes with feedback or "Ultra-Linear" stages with feedback may have damping factors from 10 to 30.*

The measurement of an amplifier's damping factor is quite simple. This article will describe two methods of measurement.

Variable Resistance Method

To use this method a signal voltage is introduced into the input of the amplifier to be checked. This signal may come from an audio generator or even from the a.c. heater supply of the amplifier itself. Next the load is removed from the output terminals and the output voltage is measured with a suitable audio voltmeter. The input signal should be kept well below the overload point of the amplifier and below that point that might cause arc-over in the unloaded output transformer. Then a low value variable resistor (the author uses a 15-ohm wire-wound unit) is connected across the output terminals and this is adjusted until the voltmeter reading falls to one-half the unloaded value. Under these conditions the voltage across the variable resistor is equal to the voltage across the actual output impedance of the amplifier. See (A) of diagram. Now the variable resistor is removed and its resistance is carefully measured. This value of resistance is equal to the output impedance (technically, the effective source impedance) of the amplifier. If this resistance value is simply divided into the nominal output impedance of the amplifier (the value frequently marked on the amplifier itself), the result is the damping factor. For example, in the diagram shown assume that the value of the variable resistor is 1 ohm and that the measurement is being

* See "Control of Amplifier Damping Factor" by David Hafer in the July, 1955 issue.

Equivalent circuits for two methods described above for measuring damping factor.

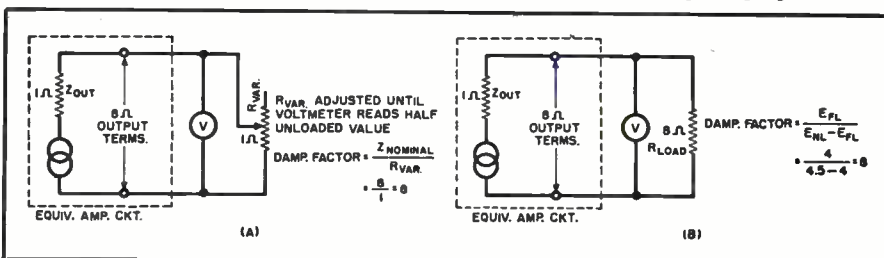

made on the 8-ohm tap of the amplifier, the damping factor is 8/1, or 8.

If it is found that the output voltage of the amplifier should rise when the load is applied, then this indicates that the amplifier has a negative damping factor. The resistance value that causes the loaded output voltage to be doubled is equal to the negative impedance of the amplifier.

Several problems may be encountered in using this method. One is that with amplifiers having very high damping factors, it might be difficult to adjust and to measure the very small values of resistance required to make the voltage drop to one-half. Another problem occurs when very low resistances are shunted across the output terminals of an amplifier; the primary impedance of the output transformer falls and the plate current through the output tubes may be excessive. In one case where this method was used, the plates of the output tubes became dangerously red. Another method that will yield the same answer but with none of the drawbacks is described below.

Voltage Regulation Method

To use this method a signal is applied to the amplifier and an output voltage measurement is taken with no load connected. Let us call this no-load voltage E_{NL} . Next, a resistor with a value equal to the nominal output impedance is connected to the output terminals of the amplifier. The amplifier is now properly matched. Then, a second voltage reading is taken under these fully loaded conditions. Call this full-load voltage E_{FL} . The damping factor of the amplifier is simply equal to the full-load voltage divided by the difference between the no-load and the full-load voltage, or $E_{FL}/(E_{NL} - E_{FL})$. This may be recognized as the inverse of the regulation formula. As a matter of fact the damping factor of an amplifier is a measure of its regulation. If, for example, the output voltage falls only a very small amount when the circuit is loaded, its regulation is good (low) and its damping factor is high.

To show that this method gives the same results as the variable resistance method, consider (B) of the diagram. Assume that the same amplifier with its 8-ohm output tap and its 1-ohm output impedance mentioned before is used. Assume further that the no-load voltage measures 4.5 volts. There is no drop across the 1-ohm output impedance with no current flow. With the 8-ohm load connected, the full-load voltage will fall to 8/9 the no-load voltage, or 4 volts, in the simple series circuit. The damping factor then is $4/(4.5 - 4)$, or 8. This is the same value that was obtained with the first method described above.

Obtaining the damping factor, using either of the methods described, may help you to evaluate the performance of your loudspeaker system, and it will certainly give you one more important characteristic of your amplifier. —30—

the ALTEC BIFLEX principle

(A new development in loudspeaker design)

Biflex loudspeakers are the product of a new principle in loudspeaker design developed by Altec. They have an efficient frequency range far greater than any other type of single voice-coil speaker and equal to or exceeding the majority of two or three-way units. This truly amazing frequency range, which is guaranteed when the speaker is properly baffled, is the result of the Altec developed viscous damped concentric mid-cone compliance.

This compliance serves as a mechanical crossover providing the single voice-coil with the area of the entire cone for the propagation of the lower frequencies and reducing this area and mass for the more efficient reproduction of the higher ranges. Below 1000 cycles per second the inherent stiffness of the Biflex compliance is such that it effectively couples the inner and outer sections of the cone into a single integral unit. The stiffness of the compliance is balanced to the mechanical resistance and inertia of the peripheral cone sec-

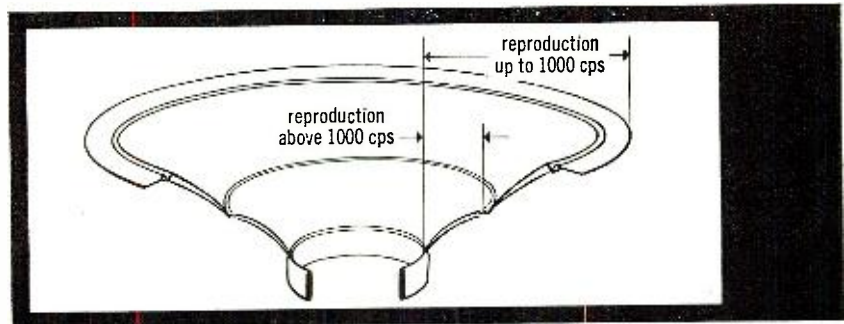

tion so that the mass of this outer section effectively prevents the transmission of sounds above 1000 cycles beyond the mid-compliance and the cone uncouples at this point permitting the inner section to operate independently for the reproduction of tones above 1000 cycles. Proper phasing between the two cone sections is assured by the controlled mechanical resistance provided by the viscous damping applied to the compliance.

In each of the three Biflex speakers, this mid-compliance cone is driven by an edge-wound aluminum voice-coil operating in an extremely deep gap of regular flux density provided by an Alnico V magnetic circuit shaped for maximum efficiency.

If you have not had an opportunity to listen to the Altec Biflex speakers, do so soon. You will be surprised by their quality and efficiency. Compare them with any single voice-coil speaker made; you will find them far superior. You will also find them comparable to many higher-priced coaxial and three-way speaker systems.

An Altec Biflex is the world's greatest value in high fidelity loudspeakers.

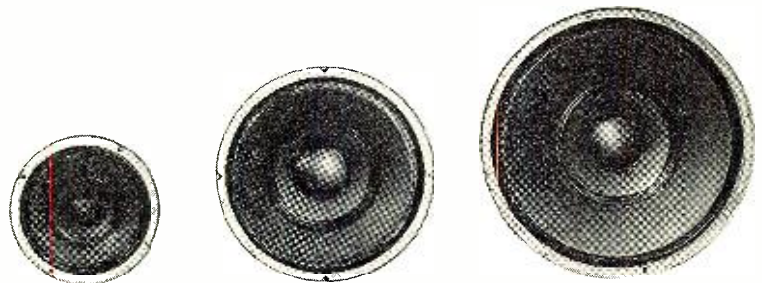

	408A	412A	415A
Diameter:	8 1/4"	12 1/4"	15 3/8"
Guaranteed Frequency Range:	60 to 16,000 cycles	40 to 15,000 cycles	30 to 14,000 cycles
Price:	\$27.00	\$48.00	\$63.00



ALTEC FIDELITY IS HIGHEST FIDELITY

ALTEC
LANSGING CORPORATION

Dept. 6TM
1515 So. Manchester Avenue, Anaheim, Calif.
161 Sixth Avenue, New York 13, N. Y.

Building Blocks by **BOZAK**

*The Very Best
in Sound...*

With these three simple elements you can build your speaker system, step-by-step if you wish, into the crowning achievement in the re-creation of sound — a Bozak B-310 or B-400. Infinite baffling means unlimited flexibility — and at each stage of growth the sound is unchallenged in its class.



**B-207A
COAXIAL
SPEAKER**

A complete wide-range two-way speaker system: 40 to 16,000 cycles, 8 Ohms, 15 Watts or more. Use in multiples to extend bass range and increase power-handling capacity.

**B-209
MID-RANGE
SPEAKER**



The only speaker made specifically for the middle frequencies. For maximum precision in the middles, add it to one or more B-207A's.



**N-10102
CROSSOVER
NETWORK**

Adaptable to one-woofer and two-woofer three-way systems by a simple change in connections; for four woofers add the N-25 Condenser Bank.

Complete systems are available factory-assembled in infinite-baffle enclosures, or you can build your own from plans on request. The 5-cu-ft E-300 cabinet comes as a complete kit for only \$42.50

Quality Loudspeakers

BOZAK

THE R. T. BOZAK SALES COMPANY
Box 966 • Darien • Connecticut

EXPORTS: Electronics Manufacturers' Export Company • Plainview • New York

Sound on Tape

By BERT WHYTE

IT IS pleasant to be able to announce that music recorded on tape has grown to such proportions to report on it adequately requires a new column, separate from the "Certified Record Revue." It will be the function of this column to review both monaural and stereophonic tapes which are commercially available and to make introductory comments on all matters pertaining to such recorded tape. This month we'll get right into the reviews. Next month, if plans jell in time, I hope to be able to bring you some technical information on stereophonic sound . . . such as the perception of stereophonic sound and why we hear it as we do . . . important factors in stereophonic sound reproduction in the home, including the effects of room acoustics, and some new ideas on speaker placement. A broad and fascinating subject, this recorded tape! I hope this column will be an effective instrument in helping you in your tape activities, as well as helping the cause of recorded tape in general.

STRAVINSKY L'HISTOIRE DU SOLDAT

Ars Nova Chamber Orchestra conducted by Robert Mandell. *Sonotape* SWB8003, stereo, 7" reel, 7.5 ips. NARTB tape curve. Price \$9.95.

As most people probably know, *Sonotape* is a subsidiary company of *Westminster Records*. All the time *Sonotape* has been producing its excellent monaural tapes, its entry into the stereophonic tape field has been eagerly anticipated. At the last New York High Fidelity Show, *Sonotape* demonstrated a group of stereophonic tapes and they were one of the sensations of the show. Now *Sonotape* is in full production and its stereo release program is very ambitious indeed. You can expect that a large percentage of the repertoire which has appeared on *Westminster* discs in the past year or so, will be soon available in the stereo format.

This recording of "L'Histoire du Soldat" is from the first *Sonotape* stereo release and if subsequent tapes are as good, we are in for some rare musical treats! Sensational is not too strong a word to use in describing this recording. It has virtually all the desirable qualities a good stereo tape should possess. First and foremost, the sound is surpassingly clean and free from distortion, a fact which is instantly and audibly apparent. Frequency response and dynamic range are very wide, transient response is superb in its razor-sharpness and lack of distortion. As you will learn in dealing with stereophonic sound, this matter of frequency range and transient

response is vitally important in the mechanics and perception of this type of sound. Directionality in this recording was excellent and quite equal to the demands of the score. The "hole-in-the-middle" effect, a common failing of much two-channel stereo, was absent to a most unusual degree. Thus this tape displayed the very open, spacious type of sound that is typical of the best in stereophony. The apparent depth effect was considerable and with the wonderful ability of stereo to "separate" and discriminate between the various instruments, the over-all definition and clarity of tone was astounding.

"L'Histoire" is a piece for a chamber orchestra of rather unusual instrumentation and a work highly effective for stereo recording. Here, again, as in most chamber works, we have the opportunity to reproduce in our living rooms, music which belongs in and which could be contained and performed in a living room. Chamber music reproduced through a very high quality monaural system at the same sound level that would obtain with a "live" performance in an average living room, attains a realism that is almost verisimilitude. Chamber music reproduced through a high quality stereophonic sound system, at the same loudness level as the live performance is as close to that overworked phrase, "on-the-spot-presence", as we are likely to get, barring some fantastic system wherein there is a separate channel for each instrumentalist. Such a system is, of course, economically unfeasible, indeed, one might get the ultimate in realism—the chamber group itself—cheaper than the multi-channel setup!

The *Sonotape* engineers wisely realized the chamber nature of this work and very sensibly used an extremely close-up microphone technique. They also used a moderate amount of reverberation. They can be forgiven for this since they could hardly be expected to know the acoustic conditions which prevail in all homes and thus they logically decided to use the "liveness" advantages of reverb, even though it is generally felt that to simulate a chamber group in the home no reverb should be used at all. Indeed, the subject of reverberation and hall acoustics in stereo recording and reproduction is a very touchy and controversial thing among audio engineers. Some feel that all stereo recording should employ reverb judiciously and that it should be played back in a room which has almost totally "dead", highly absorptive acoustics—others feel that to avoid some of the problems imposed by hall acoustics and reverb, the recording should be as "dead" and non-reverberant as possible and then reproduced in rooms with moderate reverberation times. Both sides have their points, but I personally feel the first approach is the easier to control and the more effective of the two.

Well, back to this recording. Be-

RADIO & TV NEWS

cause of the manner of recording and the intelligent spacing of the instrumentalists, the result is incredibly realistic. Remember, this music is one of Stravinsky's most "modern" sounding works employing all the devices of atonality and dissonance. Yet in spite of this and its seemingly limited appeal for many people, I have been flabbergasted by the number of people who commented on how much they enjoyed the music, after they had heard a stereo demonstration of this recording. That's the impressive thing about a good stereo tape. Most of these people had previously either ignored "modern" music or displayed a distinct antipathy towards it. Most extraordinary of all, the ladies (bless 'em) who usually wince when they hear *any* kind of music, modern or otherwise played at loud levels through a hi-fi system, never even flinched and smiled beatifically when this tape was reproduced at levels far beyond anything they would have previously tolerated! This is a wonderful score and as heard with this marvelous stereophonic sound is an outstanding listening experience.

For hi-fi fanciers there is a terrific sharp brazen cornet, the weighty blare of the trombone, sometimes growly sometimes guttural—a bassoon and clarinet so pure-toned they have an almost palpable "liveness"—a violin which is played with smoothness and mellowness, with searing intensity, played with pizzicato, spicatto, and numberless other violin gymnastics, a double bass speaking in heavy but clear-voiced accents and percussion that is truly outstanding. There is a bass drum of noble proportion that gives forth mighty "whumps", the coruscating clash of cymbal, the tinkle of triangle and rattling jingle of tambourine and the explosive impact of side drums and the gutty snarl of the snares.

As for the performance of "L'Histoire", Mandell does not imbue the score with as much wit or humor as does Bernstein, for instance, but he gets virtuoso caliber playing from his men and the performance is generally quite good. A quick listen to several disc versions serves to confirm one's judgment of performance, but so strong are the blandishments of this stereo version that it overcomes all possible objections. Don't miss this outstanding tape.

LEIBERT TAKES A HOLIDAY ON THE MIGHTY WURLITZER

Dick Leibert playing the organ of the Byrd Theater, Richmond, Va. Sonotape SWB8012, stacked stereo, 7" reel, 7.5 ips. NARTB tape curve. Price \$9.95.

At the opposite end of the pole from the close-up, chamber-sized recording of "L'Histoire", is this brilliant stereophonic organ recording. The sound here is gigantic, both in power and in apparent depth and spaciousness. This is an impressive and enjoyable tape from all musical aspects. From the hi-fi angle this should satisfy the most ardent lover of organ power and thun-



ARKAY

takes the blind spots out of kit buying!

NEWS! . . . If you've always wanted to **save the money** and have the **fun of building** your very own HI-FI system or radio, here's sensational news: ARKAY the world's leading name in audio kits now lets you "HEAR IT—BEFORE YOU BUILD IT" . . . ARKAY takes all the gamble out of kit building . . . See your favorite ARKAY dealer . . . ask for a demonstration unit of any model in the line . . . examine it, play it, give it any test you wish . . . then compare and you'll agree that an ARKAY kit is **easiest to build** and the **best dollar value!**

NOW! Hi-Fi units also available.
WIRED AND TESTED . . .
Ready-to-hear!



ARKAY 6 TRANSISTOR PORTABLE SUPERHET KIT

This model TR-6 is a completely newly designed "powerhouse" with push-pull Class B output providing clear, crisp output better than 275 milliwatts. Construction is extremely simple because of advanced engineering technique employed. Electrical Rating: 9 volt transistor energizer. Tuning range: 5.44-1420kc. IF amplifier: 455kc. Transistor Complement: (X1) oscillator-converter, (X2) 1st IF Amp, (X3) 2nd IF amp, (D1) diode detector-AGC takeoff, (X4) class B driver (X5) class B output, (X6) class B output. Case: stunning saddle-stitched texon leather.

Model TR-6—\$37.50
Fed. Ex. Tax Incl.

ARKAY MODEL HFT-7 HI-FI AM-FM TUNER



Tops in performance! 4UV sensitivity for 20db quieting. Automatic Frequency Control with provisions for AFC erase. Allows pinpoint, high selectivity tuning. Foster-Seely discriminator, high efficiency AM loop stick antenna and temperature compensated oscillator circuit. Tube complement: (2) 12AT7, (1) 6BE6, (1) 6BA6, (2) AU6, (1) 6AL5; selenium rectifier.

Model HFT-7—KIT \$32.00. WIRED AND TESTED \$56.95.

Model FM-6 (FM only)—KIT \$25.75. WIRED AND TESTED \$44.95.

Cover for above \$3.95—Fed. Ex. Tax Incl.



ARKAY 30 WATT AMP- PRE-AMP

with
transistorized
Front end

Here's the talk of the HI-FI field! For use with reluctance pickup, assures you of high-gain low noise front end, gives the finest in reproduction. Record equalization for more than 30 labels (LP, RIAA and Europ). Uses 2 Mullard EL34's. Power: 30 watts @ 17 IM Freq. Response: ±1/2db-10-40,000 cps. Hum: -120db below rated output. Inputs: for phono, tuner, tape, Aux 1 and 2 provided by front panel selection (Tape output unaffected by bass treble and loudness). Controls: (6) Func. selector, loudness, bass, treble, level set and 5 position balance 2 AC outlets. Cabinet: Ebony with rose gold panel.

Model FL-30—KIT \$49.95. WIRED AND TESTED \$74.95.

SEE THE OTHER AMPLIFIERS IN THE ARKAY LINE

ARKAY ALL- TRANSISTOR PERSONAL PORTABLE KIT



Printed Circuit
with Printed
Component
Layout Board

A kit builder's dream, employing all the latest techniques. Uses 5 transistors plus crystal diode. Printed Circuit and component layout board cuts construction time, eliminates errors. Consists of converter, 2 stages of IF amplification, diode detector, audio driver and class A power amp output stage. Subminiature components used throughout. Loudspeakers: 2 3/4" Alnico V. Power output: 150 mW audio system Battery drain: 5.5Ma. Earphone Jack for pvt. listening. Cabinet: HI-impact styrene (unbreakable). Dimensions: 5 1/2 x 3 1/4 x 1 3/8".

Model TR-5—\$31.45. Fed. Ex. Tax Incl.
Carrying Case \$1.75

SEE 'N HEAR the unmatched quality of the ARKAY line at your dealer. Ask for the new, big FREE CATALOGUE of AUDIO, HI-FI AND TV units.

*Prices 5% higher West of Miss.

ARKAY • 120 Cedar Street • N. Y.

WANTED

Willing to pay cash for Early Phonographs with outside horns

WANT Coronet (illustrated), Double Bell Wonder, Victor Types A, D, and O, Monarch Special, and Improved Monarch. Also Edison Idelia, Excelsior, and Treadle Phonographs. Want early Bell-Tainter, American Gramophones, Multiphone, Multinola, Scott Magazine Phonograph, Peerless, Sovereign, Wizard Phonograph, Regina Hexaphone, and Graphophones. Also catalogues or old literature on phonos made prior to 1906. Want unusual machines and coin-in-slot cylinder phonographs.

A few duplicate Edisons and graphophones are now available for sale or trade.

Send clear snapshot and full information to
Box 50

RADIO & TV NEWS

366 Madison Ave., New York 17, N. Y.

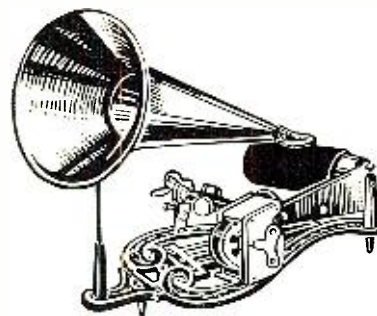

BUILD THE SUPERB PERI-50

50 WATT —
100 WATT PEAK



\$69.75
CALIF. RESIDENTS
ADD 4% SALES TAX

Now YOU can re-create in your own home the breathtaking realism in sound that has been known only to design engineers!

The PERI-50 engineering is "built in" through the revolutionary new deep-etched copper circuit board—a development of Printed Electronic Research Inc.

The DEEP-ETCHED copper circuit board replaces all wiring and guarantees that every PERI-50 AMPLIFIER built will perform exactly like the laboratory original—whether built by amateur, audiophile or electronic engineer!

EVERYTHING PROVIDED—including an Ungar soldering iron and solder! All components literally "plug in" to the self-contained circuit board. No schematics to follow (although provided).

ANYONE can build and hear the laboratory realism of the PERI-50 AMPLIFIER in 90 minutes or less.... utilizing the most advanced circuitry and the incomparable Dynaco Output Transformer for unsurpassed transient response and stability.

GUARANTEED TO PERFORM TO THESE SPECIFICATIONS:

POWER OUTPUT 50 watts cont. — 100 watts peak.

DISTORTION — Intermodulation distortion less than 1.0% at 50 watts, less than 0.25% at 35 watts.

FREQUENCY RESPONSE 6 cps to 60,000 cps within ± 0.5 DB, ± 0.1 DB from 20 cps to 35,000 at any level from 1 milliwatt to 50 watts.

POWER RESPONSE less than 0.1% harmonic distortion at 50 watts from 20 cps to 25,000 cps and flat within 1 DB.

SENSITIVITY 50 watts output from 0.75 volt RMS input 100 watts output from 1.0 volt RMS input.

SQUARE WAVE RESPONSE essentially undistorted on speaker load at frequencies 20 cps to 35,000 cps. Damping Factor — 15. Output impedances 8 ohm and 16 ohm.

TUBE COMPLEMENT Two EL-34, one 6AN8 one 5U4.

ORDER DIRECT FROM

PRINTED ELECTRONIC RESEARCH INC.

4212 LANKERSHIM BLVD. NO. HOLLYWOOD, CALIF.

CHECK OR MONEY ORDER C.O.D.

SEND FREE BROCHURE DEPT. A-2

Name

Address

City Zone State

dering pedal. From still another angle, this is an important tape and should be listened to if at all possible. For this tape represents still another departure and innovation in stereophonic recording techniques.

Believe it or not, *eleven* microphones . . . two *Telefunken*s, six *Altec* condenser types, and three special design types were used to make this recording. All these were fed into three *Westminster* six-channel mixers and thence into specially modified *Ampeex* stereo recorders operating at 30 ips. Over 3500 feet of mike cable were used to suspend this magnum array of microphones from the auditorium ceiling. The pipe chambers for this organ are wide and shallow and spread across the proscenium arch of the theater, making for a very open and brilliant sound. This extreme width evidently dictated the unusual microphoning. Is it effective? Are the results worth all the trouble? Decidedly so! In spite of the complexity of the organ scoring every voice is beautifully clean and articulate.

The organ here is not the traditional "grand blur", but takes on the fresh and lively aspects of the live instrument. As you might expect, directionality here is extremely good, yet ensemble tone is not adversely affected. The "hole-in-the-middle" here is reduced to insignificance. The sharp and heavy transients generated by the big organ are perfectly reproduced and for owners of really big speaker systems, the pedal will make your house shudder.

Leibert is organist of Radio City Music Hall in New York, and a crack-erjack on techniques leavened with fine musicianship and good taste. In eleven numbers like "Laura", "Washington Post March", "All the Things You Are", "Donkey Serenade", etc., Leibert runs the full gamut of organ instrumentation and expression and exploits the dynamic resources of his tremendous instrument. For lovers of the organ, a must!

RACHMANINOFF RHAPSODY ON A THEME OF PAVANINI

Arthur Rubenstein, pianist, with Chicago Symphony Orchestra conducted by Fritz Reiner. Victor CCS-20, stereo, 7" reel, 7.5 ips. NARTB tape curve. Price \$10.95.

Victor, the big name pioneer in the stereophonic tape field, continues to release superb material utilizing its illustrious artists and organizations. It is also using a new stereo recording technique. Now all the recordings are made on 3-channel tape machines and later in the studio the three channel master is post-mixed and re-recorded for both monaural disc use and for stereo. In the stereo the middle channel is "ghosted" with the two other channels . . . so many db to each of these "outer" channels. This is done to minimize the "hole-in-the-middle" effect, which it seems to do with a fair degree of success, success depending mainly on the type of repertoire.

Musically this tape is a masterpiece by Rubenstein. As I said about the disc recording of this work, it is hard to conceive a better and more positive statement of the "Rhapsody". Stereophonically this is sheer magnificence. Directionality is better than in most other *Victor* tapes and the piano stays "fixed" in its proper position. This is big, lush, romantic sound, not miked too close so that with the hall reverb the apparent depth is considerably enhanced.

As usual, the acoustics of Orchestra Hall in Chicago and the wonderful sound Reiner gets from his superb orchestra make for a very spacious, ultra-live perspective. The piano tone of Rubenstein can be appreciated as never before in reproduced music. Strong and confident, yet clean and pristine of line, it is a thing of rare beauty. The music, of course, is one of Rachmaninoff's finest achievements and when it can be heard so splendidly performed in the full glory of stereophonic sound, one cannot help but be sorry that everyone can't enjoy this in their homes except at considerable expense. It is to be hoped that stereo grows so fast that the means for reproducing it and the tapes themselves are soon brought down to a price more people can afford. Let us hope that this day is not too far off, 'cause it's a shame to miss the fun.

-30-

TUNER MODIFICATION

By KENNETH W. BETSH

THE Fisher Models 80R and 80RT tuners contain two tuning meters, one for AM and one for FM. By means of a simple solder connection on the back of the selector switch, the AM tuning meter serves as an FM signal-strength meter. The regular FM meter indicates discriminator balance-center of channel tuning in these two tuner units.

A section of the switch opens the AM meter circuit on FM. Two contacts are used. They can be easily identified because one goes directly to one terminal of the meter. The other switch contact is right beside the other. These two are the only white wires in the area. To defeat the switch, merely solder a link between the switch contacts.

The meter is tied to the "B+" leads of the first and second i.f. stages. Since the same tubes act as i.f. amplifiers on both AM and FM, similar action occurs on both bands. Meter reading corresponds to reduction in plate current of the second i.f. by limiting. To prevent overdriving the meter, its other lead goes to the first i.f. "B+" (the end where on real strong signals the first i.f. plate current decreases).

This meter is in a strictly d.c. circuit and does not affect the sensitivity of either AM or FM. The writer has used this for several months with no effect on the tuner.

This added meter function is ideal for positioning a rotatable antenna. However, for extremely weak signals that are just audible, so little deflection is shown that the meter does not serve a useful purpose. The author suspects this to be the reason the manufacturer did not do this. All signals that limit to any degree to be listenable register between 1/2 and 5 on the meter.

-30-

The "Xophonic"
(Continued from page 57)

been noted by audio hobbyist and layman alike. These tests have proven that the reverberation effect is not dependent on the relative placement of the main speaker and "Xophonic" system within a room. This was to be expected, as the acoustic delay is completely in the reverberation unit.

An interesting "A-B" comparison between a system providing "location" effect and an "Xophonic" system was made in our sound laboratories. A two-channel recording was used as the source material in the "A" position of the comparison switch, and this was reproduced through a pair of identical amplifiers into two matching speakers. The placement of the speakers was carefully chosen to provide the best feeling of orchestral "location." In the "B" switch position, the two original channels were mixed to provide the normal monaural source. This was reproduced in one of the speakers, and also by the "Xophonic." In this way, an immediate-comparison "A-B" test was made between a two-channel system and "Xophonic" sound.

The result of the comparison was as follows: 6% of the listeners could not distinguish between the two-channel reproduction and "Xophonic" sound; 94%, however, were able to differentiate between the "location" effect and the reverberation effect of "Xophonic" reproduction. What was significant was that, although all agreed that both systems were very pleasing, 65% of the listeners actually preferred the reverberation effect to the "location" effect of the two-channel system.

In the second phase of this test the effect of changing relative speaker positions was evaluated for each system. It was found that if the matching speakers of the two-channel system were placed in moderately close proximity, this system completely lost its effectiveness and the preference became unanimous in favor of the reverberation effect. On the other hand, the main and "Xophonic" speakers could be placed side-by-side with no apparent loss of effect.

One noteworthy feature of the unit is that it does not depend on special recordings or on two-channel broadcasts, but can be used with any standard disc or tape recording, or with any standard broadcast, AM, FM, or television. Secondly, it is not necessary to discard existing equipment since this unit can be used with any sound system irrespective of manufacturer or type; in fact, it can be used in conjunction with a hi-fi system, a phonograph, radio, tape-player, or a television set. Finally, the reverberation effect is not dependent on placement of speakers, room acoustics, etc. Thus, the listener is free to arrange the equipment to suit his own convenience without regard to unusual and critical speaker placements.

-30-

ESL

Dust Bug

THE AUTOMATIC RECORD CLEANER

Your dealer has the new

Only \$5.75 complete!

Write for details.

FOR LISTENING AT ITS BEST

Electro-Sonic Laboratories, Inc.

Dept. R • 35-54 Thirty-sixth Street • Long Island City 6, N. Y.

Famous for the ESL cartridge, the world's most advanced phono pickup

pfK
pre-finished
Kits

PFK-120/150 PFK-500 PFK-300

designed by
Paul Klipsch

Now you need only a screw-driver to put together a furniture-finished Klipsch speaker enclosure, indistinguishable from factory-assembled Rebel 3, 4 or 5. Also available as conventional, unfinished kits.

cabinart

Write for Complete Catalog!

36 pages . . . 16 other hi-fi kits . . . 29
equipment cabinets . . . 4 matched speaker
systems . . . 20 hi-fi accessories.

57

Cabinart
99 North 11th Street
Brooklyn 11, N. Y.

largest manufacturer of cabinets and kits for hi-fi
a division of G & H Wood Products Co., Inc.

Rauland

"Golden Series" HI-FI



The "GOLDEN ENSEMBLE"...
Tuner, Preamp and Amplifier
in a single, compact, balanced
unit...complete Hi-Fi at
extremely low cost...

one of a complete line of
advanced design high fidelity
tuners, amplifiers and components...

hear these quality RAULAND units at
your Hi-Fi dealer or write for details...

RAULAND-BORG CORPORATION

3515 W. Addison St., Dept. T, Chicago 18, Ill.

DON'T

Let summertime heat and humidity damage the quality of your tape recordings and equipment!

DO

use LONG LIFE Fluids to safeguard precious recordings and keep equipment in factory-fresh condition.

LONG LIFE Fluids are specially compounded to:

- Reduce tape friction to a minimum.
- Eliminate troublesome hot weather squeal.
- Reduce wow and flutter.
- Improve frequency response and uniformity of output.
- Remove foreign matter from heads and tapes.

The LONG LIFE Tape Maintenance Kit offers two separate solutions for complete tape and recorder protection. LONG LIFE Red Fluid cleans and protects the heads and capstan of your machine. LONG LIFE Blue Fluid lubricates both the machine and the tape. Both solutions are absolutely guaranteed safe for use with any machine or tape.

DON'T stand the risk of hot weather troubles from your fine tape recordings. DO get LONG LIFE FLUIDS today! Only \$1.50 for complete kit from your quality high fidelity dealer.

LONG LIFE



a product of

emc

EMC Recordings Corporation
St. Paul 6, Minnesota

SR-200 Control Amplifier

(Continued from page 51)

like that Crowhurst³ recently pointed out with regard to microphones. An electronic device that varies source impedance with the frequency, when handling a multitude of frequencies may very well accurately follow the static complementary response of the loudspeaker system; but what is not taken into consideration is the fact that when the signal is a complex of frequencies, and dynamic as well, the decay rates for the boomy speaker system are entirely different from the decay rates of the amplifier. The amplifier with variable damping is always damping with regard to its incoming signal; while the loudspeaker system is thousands of milliseconds behind, resonating as much as ever. In *extreme* cases, the "mush" that results is worse than if the speakers were in an undamped state. The only real solution to speakers that have a high resonance (and carefully designed speakers need not have such peaks) is either a horn that *acoustically* damps the peak out, or some sort of resistance unit like Villchur's⁴ that also damps acoustically. But for those who insist on using speaker systems that are not either inherently low resonance or *acoustically* damped, the best solution is the tunable, notched low-frequency filter control supplied in the SR-200, which can be adjusted so that the amplifier simply does not respond to the offending frequencies, thereby eliminating the boom and distortion that results from an amplifier trying to drive a speaker when badly mismatched.

Various types of tone controls circuits were tested, and while feedback types were found desirable from low distortion considerations, all had other objectionable characteristics: some peak badly in the 40 kc. range, others cannot be made to give a true "flat" response, while most were found to affect each other (bass boosting caused some treble boosting, etc.). And it was felt that the mid-frequencies should definitely be unaffected. A very conventional circuit was therefore chosen, primarily for its very high degree of accuracy and stability; and by driving the associated voltage amplifiers only moderately⁵ the resultant distortion is quite low.

The preamplifier is an all-triode design, using feedback exclusively as a means of equalization. Even though the distortion created by using "T" type equalizing networks is small, it was felt that in such low level stages as these, distortion must be kept as close to non-existent as possible.

Inputs (with separate incoming volume controls) for all types of equipment that are likely to be associated with this amplifier are provided: tuner, tape, TV, crystal, FM pickup, etc. Provision for input direct from a tape head is included. Output for recording

into a tape recorder is also available.

Extensive testing of output tubes revealed the clear-cut superiority of the EL34/6CA7 type, even though the rated power desired was but 25 watts. Distortion content was considerably lower with this tube than with any other type. As is well known, the EL34/6CA7 is usually found in 50-watt amplifiers, but with somewhat lower plate voltages, it is able to loaf along at 25 clean watts, resulting in long life and extreme reliability.

Hum and noise are kept to a maximum of 60 db below full output on phono channels, and 70 db below full output on all others. Careful layout of critical sections, chassis shields, and high-grade transformers that have very low radiated field characteristics make the use of d. c. on the filaments unnecessary.

The chassis is of 18 gauge steel, cadmium plated to prevent rusting. Special heat dissipating plates are employed to make the whole unit run within component manufacturers' tolerance, and yet be of such dimensions that the modern, functional styling was possible. Cabinets are of solid woods (either walnut, mahogany, or birch), hand crafted and finished with five coats of lacquer, each hand rubbed. The brass front plates are acid-etched and permanently treated with special chemicals to make the lettering literally un-removable. The total unit weighs 23 lbs.

REFERENCES

1. Fleming, Lawrence: "A Variable Low-Pass Filter," RADIO & TELEVISION NEWS, May, 1955.
2. Hartley, H. A.: "Realistic High Fidelity—The Power That Drives the Speaker," RADIO & TELEVISION NEWS, January, 1957.
3. Crowhurst, Norman H.: "Why Do Loudspeakers Sound Different?," RADIO & TELEVISION NEWS, October, 1956.
4. Villchur: Audio, October, 1954.
5. Bernard: "Distortion in Voltage Amplifiers," Audio Engineering, February, 1953.

-30-

MOUNTAIN OBSTACLES BOOST RADIO, TV SIGNALS

Methods for using high mountains between a radio or television transmitter and receiver to improve, rather than hinder, the reception of u.h.f. signals were described recently by R. E. Lacy of the Signal Corps Engineering Laboratories, Fort Monmouth, N. J. An extensive series of tests made at forty different locations in California has verified that sharp mountain peaks blocking the transmission path will actually strengthen the signal on the other side by a process much like the diffraction of light rays when passing by the edges of opaque objects. Tests were conducted over a wide range of frequencies above 50 mc.—the range used for television and communication services.

The phenomenon, technically known as "obstacle gain," was first noticed by American GI's during the Korean War who discovered that radio reception was unaccountably improved in the mountainous terrain of Korea.

The information gained from the tests makes it possible to compute the "obstacle gain" accurately and to locate transmitting and receiving sites to take advantage of the diffraction phenomenon described above.

-30-

SPECIAL! FOR THE TV-RADIO SERVICE TECHNICIAN

NOW! have the complete

PHOTOFACT Service Data Library

for as little as . . .

\$10 DOWN

UP TO 24 MONTHS TO PAY—
NO INTEREST—NO CARRYING CHARGES

NOW—for as little as \$10 down, you can have at your fingertips the *complete* PHOTOFACT Service Data Library and a sturdy four-drawer steel cabinet for easy-reference filing. It's the *only* Service Data Library covering over 28,000 TV, Radio, Record Changer, Recorder and Amplifier models . . . the *only* library that gives you *all* the information you need to repair *more* jobs per day . . . Faster—Better—Easier—and pays for itself as it earns for you!

**MAKE YOUR MOVE
TO BIGGER PROFITS
TODAY!**

Fill out the form you'll find on the back page of this insert, and take it to your regular PHOTOFACT Distributor, or mail with your down payment to:

HOWARD W. SAMS & CO., INC.
2201 East 46th Street
Indianapolis 5, Indiana

the world's
**BEST TV-RADIO
SERVICE DATA**

START EARNING MORE NOW . . . SEE FOLLOWING PAGES FOR FULL DETAILS

here's what makes PHOTOFACT the world's best

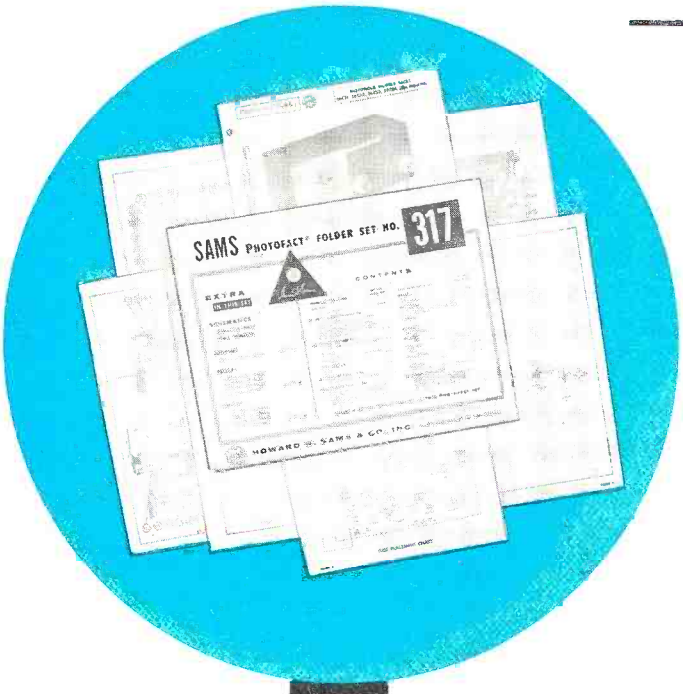

PHOTOFACT Service Data is the *only verified* service information based upon first-hand examination of the actual production-run receivers and equipment. It is authentic, accurate, uniform data developed through actual study and analysis by expert service engineers in the Howard W. Sams Laboratories. PHOTOFACT is the *only data* prepared from the practical point of view of the Service Technician.

Over 29,000 Service Technicians have standing orders with their suppliers to receive every set of PHOTOFACT Folders as they are published. Thousands of others use PHOTOFACT daily for time-saving, profit-boosting service operations. Over twelve million sets of PHOTOFACT Folders are in use. When you own and use PHOTOFACT, you realize your full earning power in a way you never dreamed possible. And now, Howard W. Sams offers you a great opportunity to own the complete PHOTOFACT Library—your instant service guide to over 28,000 TV, Radio, Recorder, Changer, Amplifier and Tuner models—on a remarkable EASY PAY PLAN—with *no interest* and *no carrying charges!*

these great features are exclusive in **PHOTOFACT...**

Full Schematic Coverage

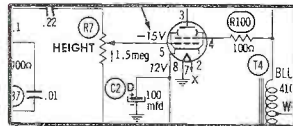

Famous "Standard Notation" uniform symbols (exclusive with PHOTOFACT) are used in every schematic. Diagrams are large, easy to read and handle. Waveforms and voltages are shown right on the schematic for fast analysis. Transformer lead color-coding and winding resistances appear on the schematic. Schematics are keyed to parts lists and to parts on chassis photos.

Alignment Instructions

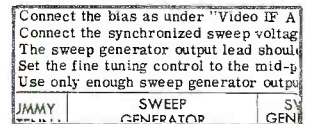

Complete, detailed alignment data is standard and uniformly presented in all PHOTOFACT Folders. Alignment frequencies are shown on radio photos adjacent to adjustment number—adjustments are keyed to schematic and photos.

Full Photographic Coverage



Photos of all chassis views are provided for each model (exclusive with PHOTOFACT); all parts are numbered and keyed to the schematic and to the parts lists for quicker parts identification and location.

Tube Placement Charts

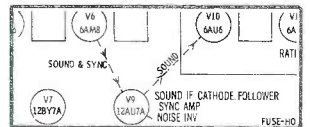

Both top and bottom views are shown. Top view is positioned as seen from back of cabinet. Blank pin or locating key on each tube is shown. Charts include fuse location for quick service reference.

Tube Failure Check Charts

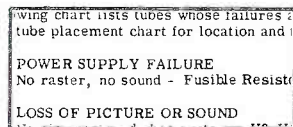

Shows common trouble symptoms and tubes generally responsible for such troubles. Series filament strings are schematically presented for quick reference.

Complete Parts Lists

C54A	4700	169-0033	B
B	4700		
C55	4700	169-0025	B
C56	1000	169-0024	B
C57	1000	169-0024	B
C58	10000	169-0026	B
C59	.022	160-08122	B
C60	100	169-00097	1A

Detailed parts list is given for each model. Proper replacement parts are listed (with installation notes where required). All parts are keyed to chassis photos and schematics for quick reference.

AS LITTLE AS \$10 DOWN PUTS THE PHOTOFACT LIBRARY

TV-RADIO SERVICE DATA

**AS LITTLE AS \$10 DOWN
PUTS THE PHOTOFACT
LIBRARY IN YOUR SHOP!**

Yes, only \$10 down now puts the PHOTOFACT Library in your shop! You'll make more repairs daily, you'll earn bigger profits . . . you'll do your work faster, easier, better with PHOTOFACT Service Data at your fingertips.

And with our Easy Pay Plan, you'll find that PHOTOFACT actually pays for itself as your earnings grow. Here's the best investment you can make in the future of your service business—so make your move to **BIGGER PROFITS now**—own the PHOTOFACT Library the Easy-Pay-Way!

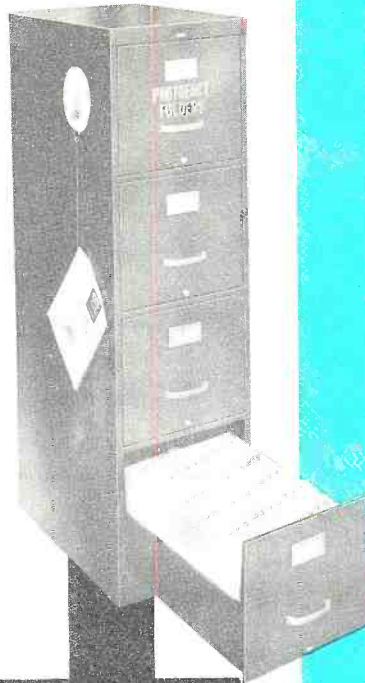

TO HELP YOU EARN MORE DAILY

Field Service Notes

Each PHOTOFACT Folder includes time-saving tips for servicing in the customer's home. Gives valuable hints for quick access to pertinent adjustments, safety glass removal, special advice covering the specific chassis, etc.

Outstanding General Features

Each and every PHOTOFACT Folder is presented in a standard, uniform layout. You'll always find the information you need quickly and easily. PHOTOFACT gives you complete, up-to-date coverage—TV, Radio, Record Changers, Amplifiers and Tuners. PHOTOFACT maintains an inquiry service bureau for the benefit of its customers.

With the PHOTOFACT Library at your fingertips, you solve your service problems in just minutes—**YOU SERVICE MORE SETS AND EARN MORE DAILY!** Make the best investment of your business career—put a profit-building PHOTOFACT Library in your shop now!

**ACT
TODAY!**

IN YOUR SHOP NOW!

own the profit-boosting
PHOTOFACT LIBRARY
the **EASY-PAY-WAY**

**use order form on other side
HERE'S ALL YOU HAVE TO DO:**

- 1** Check the PHOTOFACT Sets you require to complete your library.
- 2** Select one of the two convenient filing systems, and enter the quantity of file cabinets or deluxe binders required. (One file cabinet will hold 200 PHOTOFACT Sets. Each binder will hold 10 Sets.)
- 3** Fill in the value of the binders or file cabinets (if ordered) and total value of the PHOTOFACT Sets.
- 4** Add the entries in column to find total cost; deduct the proper down payment, to find balance due.
- 5** Figure your monthly payments (\$396 or under, you have up to 18 months—over \$396, 24 months to pay the balance) and enter them in the proper spaces and sign your name.
- 6** Fill in your complete name and address and give this form and your down payment to your regular Sams PHOTOFACT Distributor or mail (along with your distributor's name) to:

HOWARD W. SAMS & CO., INC.

2201 East 46th Street
Indianapolis 5, Indiana

That's all you have to do . . . your library will be shipped to you prepaid. (File cabinet, if ordered, is shipped separately collect.)

**NO CARRYING CHARGES!
NO INTEREST!**

**USE ORDER FORM
ON REVERSE SIDE** →

MAKE YOUR MOVE TO BIGGER PROFITS WITH THE



PHOTOFACT TIME PAYMENT PLAN

FILL OUT THIS FORM—DO IT TODAY!

I understand I may select and order a library of PHOTOFACT Sets as long as I order a *minimum of fifty (50)*. I may also order as a part of this agreement, up to two (2) File Cabinets or as many PHOTOFACT Binders as I may require. I also understand there will be no interest or carrying charges added to this agreement. I agree to the terms as outlined and enclose my down payment.

ONLY SETS ALREADY PUBLISHED MAY BE ORDERED ON THIS PLAN

1	31	61	91	121	151	181	211	241	271	301	331
2	32	62	92	122	152	182	212	242	272	302	332
3	33	63	93	123	153	183	213	243	273	303	333
4	34	64	94	124	154	184	214	244	274	304	334
5	35	65	95	125	155	185	215	245	275	305	335
6	36	66	96	126	156	186	216	246	276	306	336
7	37	67	97	127	157	187	217	247	277	307	337
8	38	68	98	128	158	188	218	248	278	308	338
9	39	69	99	129	159	189	219	249	279	309	339
10	40	70	100	130	160	190	220	250	280	310	340
11	41	71	101	131	161	191	221	251	281	311	341
12	42	72	102	132	162	192	222	252	282	312	342
13	43	73	103	133	163	193	223	253	283	313	343
14	44	74	104	134	164	194	224	254	284	314	344
15	45	75	105	135	165	195	225	255	285	315	345
16	46	76	106	136	166	196	226	256	286	316	346
17	47	77	107	137	167	197	227	257	287	317	347
18	48	78	108	138	168	198	228	258	288	318	348
19	49	79	109	139	169	199	229	259	289	319	349
20	50	80	110	140	170	200	230	260	290	320	350
21	51	81	111	141	171	201	231	261	291	321	351
22	52	82	112	142	172	202	232	262	292	322	352
23	53	83	113	143	173	203	233	263	293	323	353
24	54	84	114	144	174	204	234	264	294	324	354
25	55	85	115	145	175	205	235	265	295	325	355
26	56	86	116	146	176	206	236	266	296	326	
27	57	87	117	147	177	207	237	267	297	327	
28	58	88	118	148	178	208	238	268	298	328	
29	59	89	119	149	179	209	239	269	299	329	
30	60	90	120	150	180	210	240	270	300	330	

PHOTOFACT **PHOTOFACT**
File Cabinets OR **Binders**
\$32.95 ea. Net | **\$3.50 ea. Net**

Specify Quantity Here | Specify Quantity Here

*Value of Cabinets (if ordered) \$ _____
 Value of Binders (if ordered) \$ _____
 Value of Sets—\$1.95 each **3** \$ _____
TOTAL COST \$ _____
 LESS DOWN PAYMENT \$ _____
 \$ 87.50 to \$200.00—\$10.00 Down
 \$201.00 to \$300.00—\$20.00 Down **4**
 Over \$300.00— \$30.00 Down
BALANCE \$ _____

State Tax, if any, must be paid along with Down Payment. \$ _____

TO REMOVE THIS FORM—TEAR ALONG DOTTED LINE

I agree to pay the balance of \$ _____ in _____ monthly payments (if balance is \$396.00 or under you have up to 18 months, over \$396.00 up to 24 months), _____ payments of (\$10.00 **5** minimum monthly payments) \$ _____, and a final payment of \$ _____ due the _____ day of each month. My first payment is due the _____ day of _____, 195_____.

Until full payment is made, I agree that title to and right of possession of the merchandise shall remain in you, that I will not sell, remove, or encumber the same without your written consent, that I assume and shall be responsible for all loss or damage to said goods, and that upon default of any payment or payments, you may, at your option, take back the merchandise or affirm the sale and hold me liable for the full unpaid balance.

Your Signature Here—WRITE—do not print X _____ (Purchaser)

NOTE: If you wish, we will gladly figure the payments for you. Just indicate the sets you want, sign your name above and enclose your down payment, we'll do the rest. NO INTEREST—NO CARRYING CHARGES.

YOUR DISTRIBUTOR'S NAME AND ADDRESS
 (PLEASE PRINT)
 Name _____
 Address _____
 City _____ Zone _____
 State _____

YOUR NAME AND ADDRESS
 (PLEASE PRINT) I am a full time; part time
 Service Technician
6
 Name _____
 Address _____
 City _____ (Do Not Use P. O. Box Number) Zone _____
 State _____

A ORDERS ACCEPTED—SUBJECT TO CREDIT APPROVAL

Certified Record Revue

(Continued from page 62)

his well-known reputation for success in conducting modern repertoire, Ansermet would certainly seem a logical choice. Yet I'm sorry to say that his reading is somewhat of a disappointment. And it is a pity, because there are so many other things to admire in the recording. Oh, all the notes are in the right places, but the over-all effect is lifeless. Why a conductor as astute in the ways of modern music as Ansermet would choose such slow tempi and conduct with such deliberation is really puzzling. I grant that the scoring calls for clarity and maximum articulation, but not at the expense of life and spirit.

Soundwise this is one of *London's* most stellar efforts, and Ansermet had evidently been building his orchestra up to this work, for I have never heard them play so well. Summing up . . . this will have its share of buyers for the excellent sound, as well as loyal adherents of Ansermet, but will not supplant several previous editions in the eyes of Bartok enthusiasts.

DVORAK SYMPHONY #5

RIAS Symphony Orchestra conducted by Ferenc Fricstay. Decca DL9845. RIAA curve. Price \$3.98.

There are now twenty versions of this popular work, and to the hi-fi fan and the classical music enthusiast, this is a most confuzzin' situation! Of all these recordings which shall he buy? I would say that choice is largely dependent on individual temperament, education, and attitudes. What version appeals to the sound nut, may not necessarily stimulate the more musically erudite, and vice versa. Generally the Kubelik and Toscanini readings have been most successful from the sound and performance standpoints. This edition with Fricstay now must be given room at the top of the list. Here, in fact, is a reading that will have appeal for the connoisseur. The performance is powerful, well integrated and, above all, songful and unashamedly sentimental. It has more of the "folk" approach than the other versions, yet with all this "gemutlichkeit" and sentiment, Fricstay never oversteps the bounds of good taste. With the superb playing and beautifully balanced orchestration, and with fine clean sound of the "big hall" large-acoustic-frame type, this should satisfy the desires of many music lovers.

STRAUSS, RICHARD DEATH AND TRANSFIGURATION TILL EULENSPIEGEL

Vienna Philharmonic Orchestra conducted by Fritz Reiner. Victor LM2077. RIAA curve. Price \$3.98.

This recording is one of the first fruits of the new association of *Victor* with *London* (English *Decca*) Records. What a combination for the music of Richard Strauss . . . Reiner and the Vienna Philharmonic! The results are as good as you might expect. I have never heard "Death and Transfiguration" so magnificently performed as on this disc. The eerie scoring and the way Reiner builds his tensions will make the hair on the back of your neck rise! "Till Eulenspiegel" is somewhat less successful, as Reiner drives a little too hard and loses some of the pathos of the work. But I quibble, for otherwise his "Eulenspiegel" is exemplary. Soundwise, this is typical of *London* recordings of the Vienna Philharmonic except for a somewhat closer perspective favored by the *Victor* engineers in their quest for greater orchestral definition. This is a huge sound, dark and rich, smooth of string and powerful of brass and percussion. The acoustics are superbly "live"



stands for **Precision**

means
Starlight

HIGH FIDELITY TURNTABLE

. . . and they got
together in this
masterpiece of
fine craftsmanship
for only . . . \$59.50

Model 60



- ★ Wow & flutter less than 0.2%.
- ★ Rumble & noise better than 40 DB N.A.R.T.B. reference level.
- ★ Built-in illuminated Stroboscope.
- ★ Continuously variable from 16-2/3 to 83 RPM.

P/S Ask your dealer for a comparison demonstration!

METZNER ENGINEERING CORPORATION

1041 N. SYCAMORE AVE., HOLLYWOOD 38, CALIF.

SPRAY it OR DROP it



the NEW
**QUIETROLE
Spray-
Pack**

or the
QUIETROLE
Bottle with the
Eye Dropper Cap

Now **QUIETROLE** offers you both types of containers. Either way assures you of the same unflinching results that **QUIETROLE** is known for.

Make your next purchase **QUIETROLE**, get both and learn the difference between quality and poor substitutes. **QUIETROLE** is the original product of its kind, it is a **FIRST** of the Industry and you can depend on it to end your noisy control and switch troubles.



RONETTE new hi-fi cartridge

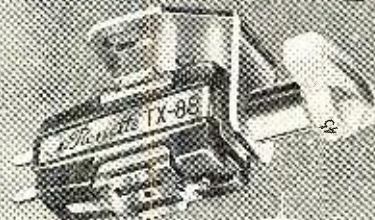

eliminates preamp

Ronette TX-88, a new wide range Hi-Fi cartridge that requires no preamp.

- Response: flat from 20 cps. to beyond 20 kc
- IM distortion is negligible
- Output: 4V, as measured on Columbia test record RD103
- With preamp, performance exceeds expensive magnetic pickups
- Unique design permits quick and positive styli replacement without any tools whatsoever.
- Stylus assembly color dot coded for easy identification.
- No hum problems—4 pole motor not required—No turntable pull.

See your nearest Ronette distributor or write to:

Ronette Acoustical Corp.
190 Earle Avenue - Lynbrook, N.Y.

PARTS SHOW Room 612 • Booth 887
Conrad Hilton Hotel

**MORE POWER
with LESS
DISTORTION**



EL34 / 6CA7

Mullard
MADE FOR MUSIC

Recognized as the finest high power output pentode, up to 100 watts in push-pull. Designed specifically for High Fidelity and produced by precision craftsmen with these design features:

- Golden grids.
- Linear characteristics.
- Low-drive voltage.
- Clean crisp output.

OTHER Mullard TUBES
designed specifically for High Fidelity:

EL37	High-power pentode, 69 W PP
EL84/6BQ5	Miniature output pentode, 20 W PP
EF86/6Z67	Low-noise input pentode
ECC81/12A77	Low-noise medium μ dual triode
ECC82/12AU7	Low-noise low μ dual triode
ECC83/12AX7	Low-noise high μ dual triode
EZ80/6V4	Miniature rectifier cathode type, 90 ma.
EZ81/6CA4	Miniature rectifier cathode type, 150 ma.
GZ34	Bantam rectifier cathode type, 250 ma.

Mullard

Available at all leading distributors.
For detailed technical data and application information write:



Trade Mark Mullard, Ltd.

INTERNATIONAL ELECTRONICS CORP.
81 Spring Street, New York 12, N. Y.

World's Most Complete Range of audio tubes

104

sounding. The Vienna orchestra plays with great precision and tonal beauty for Reiner and I must say they sound as good under his baton as any conductor since the late Clemens Krauss. I believe these performances were also recorded stereophonically and if true, the "Death and Transfiguration" should be overwhelming. I am drooling in anticipation! Don't miss hearing this reading of "Transfiguration".

ANDERSON, LEROY
MUSIC OF LEROY ANDERSON

Eastman Rochester Pops Orchestra conducted by Frederick Fennell. Mercury MG50130. RIAA curve. Price \$3.98.

Well how about this! Freddie Fennell, the young conductor who has made such a tremendous impression with his notable series of band recordings for Mercury has entered the "Pops" sweepstakes and is already a front-runner! This boy really has talent which is easy to discern in his readings of works by the popular LeRoy Anderson. In such classics as "Sleigh Ride", "Trumpeter's Lullaby" and the "Sandpaper Ballet", to name a few of what is on this disc, he shows that he knows how to handle strings as well as his beloved brass and percussion. His tempi are well-chosen, his phrasing and dynamics neatly expressive. Fennell is, above all, never heavy-handed and he lets the essential humor and grace of the works speak for themselves.

On the flip side of the disc is Anderson's wonderful arrangement of traditional Irish tunes in what he calls the "Irish Suite". Faith now, oi didn't know Fennell was a Hibernian, but how can it be otherwise with him givin' a lovin' performance of the Suite and him wearin' a foine green jacket in his picture which adorns the record shuck! In matters of sound, I venture to predict that this disc will be widely used for demonstration in sound rooms. With the almost universally liked repertoire coupled with strings which are smooth and edgeless, yet bright and incisive, the very "forward" projection of the weighty brass, the mellow sweetness of the woodwind, and the impact and clean articulation of the percussion, this is a sure thing. In the "Sandpaper Ballet" the sandpaper blocks furnish a superb test for high frequencies. As usual with Mercury, the frequency and dynamics are ultra-wide, acoustic perspective is that magic blend of live spaciousness and fine orchestral definition. Don't miss this one.

MOZART

MASS IN C MAJOR (CORONATION)
Maria Stader, soprano; Sieglinde Wagner, alto; Helmut Krebs, tenor; J. Greindl, bass; with choir of St. Hedwig's Cathedral, Berlin.

SYMPHONY #38 (PRAGUE)
Berlin Philharmonic Orchestra conducted by Igor Markevitch. Decca DL-9805. RIAA curve. Price \$3.98.

The "Prague" symphony receives a fine performance at the hands of Markevitch, but the plum on this disc is the superb "Coronation Mass". This is the second recording of the Mass to appear on LP, the first being an ancient Haydn Society effort, too old now especially in sonic terms, to challenge the splendor of this new edition. For those not familiar with this Mass or any of Mozart's choral work, I urge you to become acquainted with them. This is music making on an exalted plane, profoundly beautiful and moving and at the same time highly exciting. This "Coronation Mass" is the easiest of all to assimilate at first try. The performance on this disc is remarkable for the obvious zeal of the participants.

The soloists are of very high caliber, with a special bow to the lovely-voiced Maria Stader. St. Hedwig's Choir sings with proper reverence and what they lack in control they make up in enthusiasm. The instrumental

**HERE'S WHY
MANUFACTURERS
OF QUALITY
AMPLIFIERS
SPECIFY ACRO-SOUND
OUTPUT TRANSFORMERS**

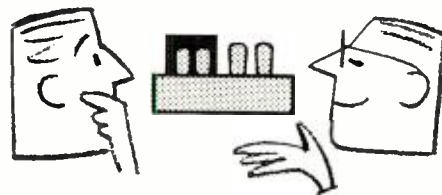

Performance is the answer . . . and it's unique with Acrosound transformers developed specifically for quality audio amplifiers.

**HOW DO YOU MEASURE
QUALITY IN AN
OUTPUT TRANSFORMER?**

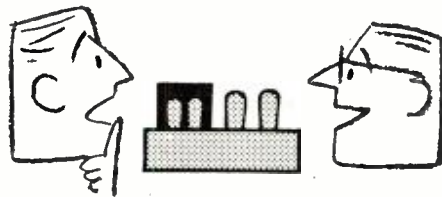

Several ways . . . Acrosound transformers are designed for wider bandwidth—far in excess of the audio band to insure high feedback stability and good transient response. Tightly coupled screen and plate windings result in low distortion over a very wide frequency band. The finest grades of care material and potting compounds are used to insure optimum performance. And most important of all—Acrosound transformers are correctly tapped for best Ultra-Linear* operation.

For the ultimate in high fidelity reproduction, make sure you get an Acrosound transformer. Look for it in quality amplifiers and kits . . . or use it to convert your present amplifier to Ultra-Linear operation.

*Ultra-Linear is the most imitated circuit in the audio field today. You can get the full story on Ultra-Linear



. . . from
KEROES ENTERPRISES
owner of U.S. Pat. No. 2,710,312

ACRO PRODUCTS CO.
Sole Licensing Agent

Acro Products, 369 Shurs Lane, Phila. 28, Pa.
I am enclosing 25c for your new booklet "Theory and Operation of the Ultra-Linear Circuit."

Name
Address
City State

RADIO & TV NEWS

sections are expertly integrated with the vocal elements. Soundwise, the Mass was evidently recorded in a large Cathedral and as might be expected under this circumstance, there is some choral/orchestral blur and fusion. However, the acoustic perspective is one of the larger attractions of the disc as it is a completely authentic setting for the score. Here is that ultra large, highly reverberant sound, that achieves a liveliness suited to the music. Sound is generally quite clean, with wide dynamic range. All in all, a superb recording of some of Mozart's finest music.

TCHAIKOVSKY

SYMPHONY #4
Leningrad Symphony Orchestra conducted by Kurt Sanderling. Decca DL-9879. RIAA curve. Price \$3.98.

This recording is actually part of a three-record album entitled, "The Last Three Symphonies of Tchaikovsky", all performed by the Leningrad Symphony Orchestra under its conductors Sanderling and Mravinsky. However, Decca has wisely made them separately available for those who can't afford the tab on the big album. This is the first chance we Americans have had to hear an Iron Curtain orchestra recorded with high-fidelity sound. Or more properly I should say Russian orchestra, because the Czech Philharmonic and several other orchestras have had the benefits of good hi-fi recording. As far as this version of Tchaikovsky's rampant warhorse is concerned, it is strictly sensational! For one thing, the *Deutsch Grammophon* engineers have furnished a sound of the big, over-all type they favor of compelling realism. For another thing, all the reports one has heard about the excellence of the Leningrad Orchestra are most certainly confirmed. This is indeed a virtuoso group with a huge lush string tone, brass that is very full and weighty, percussion of notable accuracy. Only in the woodwind did the orchestra seem to be a little weak, as a good deal of the intonation was on the thin side. Sanderling is a conductor who, on the basis of what we hear on this disc, must be considered a master of the Tchaikovsky medium. Not since the old Koussevitsky days have I heard a performance that is so unabashedly romantic. This is a big, full blown reading with soaring strings, huge climaxes. The tempi essayed by Sanderling are moderate giving him plenty of time to exploit the resources of his orchestra. This simply exudes drama, or perhaps it should be called melodrama. At any rate, it is a refreshing change from the dry, hurried treatment with tragic overtones favored by so many conductors. Try this for a new view of Tchaikovsky.

Although it has become quite *de rigueur* for the musical sophisticate to sneer at Tchaikovsky and those who enjoy his music, there is something to be said for a well-loved and familiar piece. Only through repeated hearings is it possible to extract all of the meaning of any given selection—and if such a piece is easy on the ears, so much the better. If this is a "warhorse" it is a "favorite" and one likely to remain in the running for a long time to come—no matter what other entries make the race.

BALAKIREV

SYMPHONY #1 IN C MAJOR
Royal Philharmonic Orchestra conducted by Sir Thomas Beecham. Angel 35399. RIAA curve. \$3.48 standard package.

Leave it to Sir Thomas to champion the unusual! Without the attention of someone of the stature of a Beecham, worthwhile music like this spritely first symphony of Balakirev would go unnoticed. In this first LP recording, we have a work which was begun while Balakirev was a young man and was not finished until he was quite old. He had very little formal music training and yet as a member of Russia's "Mighty Five" . . . Cui, Borodin, Moussorgsky, and Rimsky-Korsakov, he came under many influences, a fact which is reflected in the character of this symphony. The scoring is as you might suspect, fairly exotic with more than a touch of orientalism. Highly listenable, it contains much that will delight the hi-fi ear, with extensive use of brass and percussion. Sir Thomas and his superb orchestra create some lovely sounds in their sparkling performances and the *Angel* engineers have contributed one of the best recordings yet heard on this label. All is wide in frequency and dynamic transient reproduction is literally distortionless, acoustic frame permits of a very live sound. Highly recommended.

BEETHOVEN

SYMPHONY #3 (EROICA)
Berlin Philharmonic Orchestra conducted by Eugen Jochum. Decca DL-9865. RIAA curve. Price \$3.98.

To those who may groan and wince and proclaim loudly that they've had their fill of "Eroica" recordings, let me recommend a listen to this disc. The performance is quite outstanding, ranking with the Klemperer and Toscanini as the best yet produced. Jochum in his reading is strictly no nonsense . . . there are no idiosyncrasies or temperament to contend with, no mannerisms to detract from one's enjoyment. The treatment is about as straight-forward as you will find but the success of the interpretation lies in the unerring musicianship of Jochum. His tempi, phrasing, dynamics . . . all show a deep understanding of the music's valües and tensions of the score. Add

June, 1957



TRANSISTOR MANUAL HAS THE FULL STORY

What they are—How they work—Where they are used

Every ham, hobbyist, technician, and dealer needs this manual. The 60 fact-packed pages—illustrated with diagrams, sketches, and circuits—contain these seven important sections:

- **Principle of Semiconductors** . . . how electrons move through the transistor, and how the movement is directed.
- **How Transistors Are Constructed** . . . telling the methods for producing all types—and how they are biased.
- **Transistor Applications** . . . describes the circuit design, and transistor function of each design.
- **Specifications on G-E Transistors** . . . complete specs on all G-E types, with chart explaining parameter symbols.
- **Registered RETMA Transistor Types** . . . Tabulation of all transistors now recognized by RETMA, with information on each and cross-referenced to General Electric types.
- **Transistor Circuit Diagrams** . . . carefully selected circuits for typical transistor applications—from simple to complex.
- **Cross-Reference Chart for Transistorized Radios.**

Rush your order for this invaluable transistor book now. Only 50¢. Send coupon, or obtain at your General Electric Tube Distributor. Not available in bookstores. *General Electric Company, Semiconductor Products Department, Electronics Park, Syracuse, New York.*

GENERAL ELECTRIC COMPANY
Semiconductor Products Department, Section S5867
Electronics Park, Syracuse, New York

Send me the new Transistor Manual—50¢ remittance is enclosed.
(PLEASE PRINT)

NAME.....

ADDRESS.....

CITY..... STATE.....

Progress Is Our Most Important Product

GENERAL  ELECTRIC

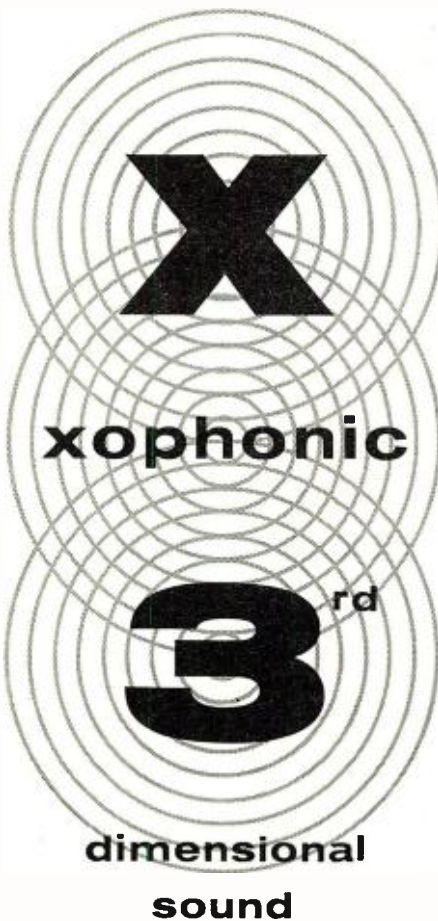

A startling new invention by Radio Craftsmen, Pioneer maker of high fidelity equipment. Introducing an entirely new concept in sound reproduction. Add thrilling third dimensional sound to your present high fidelity system, conventional radio or phonograph.



"XOPHONIC" MODEL CX-17

Write for free Xophonic booklet. Xophonic is an exclusive development by

RADIO craftsmen

4223 RT WEST JEFFERSON BOULEVARD,
LOS ANGELES 16, CALIFORNIA

(Some dealerships and distributorships available. Write for information on the entirely new market created by the XOPHONIC.)



the virtuoso playing of the Berlin Philharmonic, sounding as close to their pre-war eminence as I've heard, and wrap all this in hugely sonorous sound of the "big hall" full bodied, yet highly detailed type and this is an outstanding listening experience.

**STRAUSS, JOHANN, JR.
GRADUATION BALL
MEYERBEER**

LES PATINEURS
Ballet Theatre Orchestra conducted by Joseph Levine. Capitol P-8360. RIAA curve. Price \$3.98.

One of the most delightful ballet recordings to appear in some time, this features the by-now-familiar arrangement Antal Dorati made of Strauss pieces . . . called "Graduation Ball" and the late Constant Lambert's equally famous derivation from two Meyerbeer works, "Les Patineurs". Levine gives a fine performance of these scores . . . poised, very glossy, and above all spirited and full of animation.

ALBANESE SINGS PUCCINI
Licia Albanese, soprano. Victor LM-2033. RIAA curve. Price \$3.98.

Here in a potpourri of arias from such Puccini operas as "Madame Butterfly", "Tosca", "Turandot", "La Boheme", and "Manon Lescaut", Licia Albanese gives us ample evidence of her particular flair for the works of this composer. Albanese has in abundance two qualities all good opera singers must possess . . . a beautiful voice and the ability to act. Hers may not be the most steady of voices, nor has she the strength of some others, but in her vocal projection and her inherent sense of the drama of these works she makes for very exciting listening. One has but to listen to her heart-rending version of "Un bel di Vedremo" from "Butterfly", to confirm this. With the high order of singing and the generally clean, well-balanced sound, this is a "must" for the opera lover.

BACH
SEVEN TOCCATAS
FOUR FANTASIAS

Agi Jambor, pianist. Capitol PBR-8354. RIAA curve. Price \$7.96. Two discs.

Encouraged by the excellent reception afforded Agi Jambor's two-disc album of the Bach "Clavier Partitas", Capitol has boldly ventured another multiple disc album, to display her considerable talents. I must say I am impressed even more by Jambor's reading of these fascinating Bach "Toccatas and Fantasias", than I was with her handling of the "Clavier Partitas". Her playing, although technically unexceptionable, was a shade too mechanical in the "Partitas". Here she retains the technical facility, but somewhere along the way she has found the key to much greater warmth and more expression in her playing. With the dazzling brilliance of these superb Bach works and well-modeled, clean-lined piano sound, this is a treat for all Bach enthusiasts.

RHYTHMS OF THE SOUTH
Edmundo Ros and his Orchestra. London LL1612. RIAA curve. Price \$3.98.

With all the accent these days on mambo, cha-cha-cha, and calypso, this new London disc should meet with much favor. A collection of tunes, some familiar and Latin such as "Siboney", "Isle of Capri"; and others familiar but transposed to Latin rhythms such as (believe it or not!) "The Blue Danube" and "Barcarolle". You will find just about every Latin rhythm represented here in very tasty and original arrangements. Ros is noted for this type of music and his orchestra is a top-notch ensemble. The sound is really terrific, with heavy accent on percussion of which there is a large and unusual variety. About the highest "fi" available with a Latin beat and an outstanding record.

SAVE 1/2 — PAY PART-BY-PART — HAVE FUN
Assembling the Schober

ELECTRONIC ORGAN in KIT form

NO SPECIAL SKILLS NEEDED

Now you can afford a real, full concert organ, just like those made by the foremost organ manufacturers. Because over 1/2 the cost is saved when you assemble it yourself. And it's REALLY EASY: only 24 separate units, all with printed circuits, and detailed-to-the-smallest-step instructions. In addition, you purchase each of the 24 kits when you are ready for it — and can afford it.

You'll get a real kick out of putting the *Schober Electronic Organ together — and then sitting down and pulling out the stops for Strings, Trumpets, Clarinets, Diapasons, Flutes, etc.

Compact CONSOLE

One of the many exclusive features of this exceptional offer is the handsome console, made by hand in Old World Craftsman manner. It is equally at home in a traditional or modern setting, and takes little more space than a spinet piano.

Free Literature

Complete descriptive booklet and price list are available on request. And, if you wish to hear the glorious pipe organ tone of the Schober Electronic Organ, a 10" long playing recording by Dr. C. A. J. Parmentier, renowned organist, is available for \$2. This is refundable when you order. Write today and see what a fine instrument you can get at such a great saving.

The SCHOBER ORGAN CORPORATION

2248-A Broadway, New York 24, N. Y.
* Designed by Richard H. Dorf.

RESEARCH
EDUCATION
SERVICE

FIGHT CANCER

AMERICAN
CANCER
SOCIETY

BE QUALITY WISE . . . BUY QUAL-KITS!



HI-FI AMP. KIT
Complete 6 tube-10 watt amplifier. Push-pull beam power output, built-in pre-amp, 5 position selector switch, 3 position record equalization, LP, RIAA, Eur. Response 1/2 db. 20-20,000 cps. Output 10 watts at less than 2% IM. Low noise level and harmonic distortion. **\$28.50**

Every kit complete with 28 page fully illustrated instruction and assembly manual. Cover and legs optional.



HI-FI AM-FM TUNER KIT
Advanced 7 tube circuit plus Rectifier for full sensitivity and selectivity. Distortion less than 1%. Sensitivity is 5 uv for 30 db quieting on FM, 25 uv AM. Armstrong FM Circuit with limiter. Foster-Seeley Discriminator. 20-20,000 cps response. Full AFC control — no drift. Easy assembly. **\$28.95**

Add 10% Fed. Tax Write for FREE catalog and name of nearest dealer carrying these remarkable units.

QUALITY-ELECTRONICS

319 Church St. Dept. T-6 New York 13, N. Y.

Coded Stereo

(Continued from page 61)

by varying one or more of the components in the circuit. I have developed a simple circuit for this purpose which gives quite good waveform and requires a lower plate current supply than the original circuit. This helps with the design of the power supply for the system.

Question 6. Are there any steps that can be taken to reduce the cost of this system, or to improve its performance?

This question really summarizes what many readers have asked in different ways, and with different specific suggestions. Editorial limitations prevent my going into any detail to answer these here. The high-voltage supply, as given in the original article, was only just sufficient for the requirements of the system as described. But several readers are interested in extending the system to include ideas of their own, and then they run into difficulties in getting enough "B+" supply conveniently.

Accordingly, to help this problem, I have gone over most of the sections of the system and redesigned them using different tubes and circuits, making very small plate current demand. As it is not practical to devote the large amount of space that would be required, we are preparing this information so it can be sent out on mimeographed sheets, to give the readers who are interested in pursuing the matter further the information they will need.

It still is not practical to give complete constructional details—chassis layout, drillings, detailed parts lists, and data of that nature, because of the variety of ways in which individual readers want to build this thing. But the data offered in this way will be sufficient for any reader who can work from a schematic, and will include details on setting up the complete system, to make it work, and answers to many questions that have been asked about different aspects of the system, that we do not have space to answer here. As a reader service, we are making this data available for a nominal cost of \$1. This should be sent directly to the author at 150-47 14th Rd., Whitestone 57, N. Y.

Some of these changes will reduce cost. But it is still an experimental system. The real possibilities in cost reduction would come if and when it is designed for the consumer market. Then the whole system would be packaged into one unit, like a TV chassis, and the author foresees the possibility of this taking place in a unit that will not cost very much more than a single channel system of today. Coded stereo recordings need cost *no* more than the equivalent program time in single channel. But whether this all comes about is not entirely a matter of "engineerability," so we cannot prognosticate in this realm.

-30-

Save Money with the Easy to Build NEW ERIE AUDIO-AMPLIFIER KIT

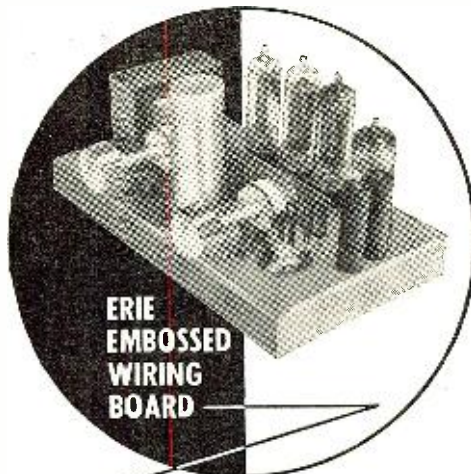

ERIE
EMBOSSED
WIRING
BOARD

featuring
**ERIE
"PAC"**

PRE-ASSEMBLED
COMPONENTS

This unique kit includes all components required to assemble a high quality, four tube, Push-Pull Audio-Amplifier, including tubes and output transformer.

The use of the ERIE "PAC" and the ERIE Embossed Wiring Board is a new concept in amplifier design which results in a compact, easy to assemble Kit. Complete instructions and recommendations for construction are provided.

with these plug-in components

Tubes • Tube Sockets • Filter
Capacitor • Volume Control and
Switch • Tone Control • Capacitors

See and hear it at
your local distributor
or Write for
nearest source.

ERIE
Electronics

ERIE ELECTRONICS DISTRIBUTOR DIVISION

ERIE RESISTOR CORPORATION
Main Offices: ERIE, PA.

Factories: ERIE, PA. • LONDON, ENGLAND • TRENTON, ONTARIO

NEW—TRANSISTORIZED RADIO KIT



Model TK-104, a professionally engineered, completely transistorized superhet receiver kit.

- Printed Circuit Chassis 4 transistors
- Self Contained Speaker—18 mw. Output
- External Phone Jack
- High Gain Ferrite Loopstick Antenna
- Texon Leather Case
- Completely Sub-miniature
- Measures Only 6 x 4 x 2"
- Complete Easy To Follow Instructions

Model TK-201, a two transistor preamplifier kit on a printed circuit board. Complete with all parts and simple easy to follow instructions. The wide frequency range of this preamplifier will please even the most discriminate audiophile.

Order from your dealer or jobber or for more information write today to:

TRAN-KIT ELECTRONICS

467 SOUTH 5th AVE., DEPT. RT-6 MT. VERNON, N. Y.

MOBILE IT'S ~~SPRING~~ TIME



MODEL
CM 1

NET
\$9.95

The Bell Products CM1 Carbon Mike is a high output Mobile Mike designed for rugged use—yet low priced.

SEE YOUR DISTRIBUTOR OR WRITE:

BELL PRODUCTS CO., ST. LOUIS 8, MO.

Monitoring Short-Term Intermittents

By JAMES A. McROBERTS

Simple devices that can be triggered, like relays or neon lamps, will "record" transitory changes.

MONITORING a suspected circuit with a voltmeter or ammeter is the classic method of troubleshooting intermittents. The intermittent condition may be excited by vibration, heat, and surges, and the meter reading is noted. A change—or lack of a change—is interpreted. For those cases in which the intermittent lasts long enough, such monitoring pays off.

Unfortunately, some intermittents occur so infrequently, or are of such a short duration, that any meter change escapes notice. Either no information or faulty data may be noted. The technician may then proceed to some other section believing the faulty stage OK. Or, the trouble may be of the once-an-hour type, which cannot be watched continuously with profit. For these jobs a monitor with a more permanent indication than a meter provides is both desirable and profitable. If the intermittent trouble affects a particular section being monitored, then it should leave some definite, tell-tale sign of that fact.

Permanent Indicators

For those once-in-a-long-time cases, multiple monitoring of several points is the most feasible approach. Here an indicating or recording monitor rather than a meter immediately settles the question of which circuit(s) changed. Such "annunciator" type monitors stay put while the observer walks a few feet to inspect them.

Two very simple circuits are shown in the schematics of Fig. 2. Both the relay and the neon versions can serve as indicating monitors for many applications where an improved type, to be described later, is not required. With the variations noted, these monitors can check an intermittent TV set's several "B+" busses, boosted "B+," audio output, drive to the CRT, horizontal-output drive, vertical drive, and other points simultaneously. These indicators may be employed wherever the circuit will permit the current drain, which is quite low. Their advantage lies in the fact that they will indicate intermittent rise or fall of volt-

age lasting for as brief a period as a tenth of a second. Furthermore, the v.t.v.m. or v.o.m. is freed for other productive work.

Undervoltage Indicator

To detect a momentary drop of voltage below some "normal" value, the pot forming the series resistance of Fig. 2A is adjusted so that the relay is energized and then turned *almost* to the point where the relay armature drops out.

Any significant decrease in the voltage being monitored will decrease current through the relay coil, and the armature will drop out under spring tension. The normally closed contact will now be released, and connection is made to the upper contact which can be wired to a lamp and transformer, as shown, to provide indication. Or, if the relay is monitoring the audio-output or picture-tube drive, it could be wired to ring a bell to indicate that an intermittent had occurred. In this arrangement, the technician checks the other relays on different circuits to ascertain visually which has been tripped or has failed to trip on that intermittent. Then he can move the relays to a new set of circuits to be tested, if necessary.

The reason for the recording action of the relay lies in the difference between the relay's pull-in current and its drop-out current. The latter is always lower. This prevents a tripped relay from closing again when the intermittent clears up. Two recommended relays have the following factory characteristics in this respect: The *Sigma* "4F" pulls in at 1.5 ma. (12 volts across its 8000-ohm coil), but drops out at 0.75 ma. (6 volts across the coil). The *Argonne* Jewel pulls in at 1.4 ma. (7.2 volts across its 5000-ohm coil) and drops out at 1.2 ma. (6 volts). The Jewel is smaller and less expensive than the *Sigma*, but does not have the *Sigma's* ease of adjustment.

A relay can be adjusted for different current ranges as well as different pull-in and drop-out points. Range is adjusted by the retracting spring. Ad-

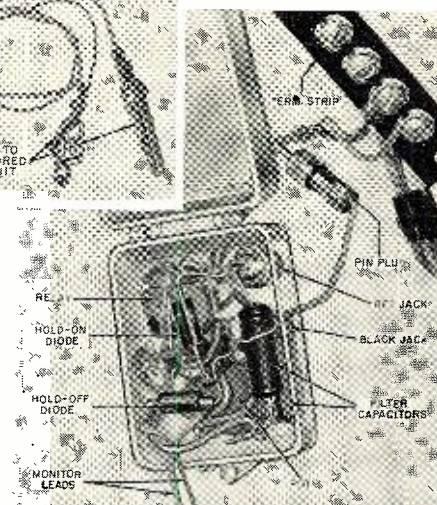
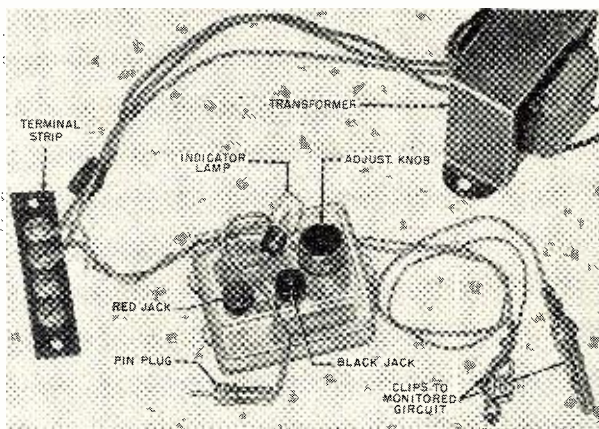

Fig. 1. These two views show the layout of the latching-monitor circuit, rendered schematically in Fig. 6, after it had been built into a compact plastic case, which accommodates all parts except the transformer, terminal strip, plug, and leads. It is more convenient to have the last three externally available.

justments of the fixed points change drop-out (adjust normally closed contact) and pull-in (adjust normally open contact). Do not make any adjustment that allows the armature to touch the core pole, else the relay may stick.

Overvoltage Indication

Relays can also indicate either momentary or prolonged overvoltage. Adjust the pot to bring current through the relay to just below the pull-in value. Any surge or overvoltage will now pull in the armature. It will hold, in most cases, after the overvoltage drops back to normal, because of the differential between pull-in and drop-out values. In some cases, however, the return to normal voltage is low enough so that the relay will not hold. Such cases are fortunately rare.

Checking Actuating Points

The circuit of Fig. 3 may be utilized to check hold-in and drop-out points. A 22.5-volt battery in series with the relay input circuit and a milliammeter (0.3 to 0.5 ma. preferred) permits easy adjustment of the hold-in and drop-out values. Marks may be made for the various points on the potentiometer knob. The milliammeter can be left in the circuit if it is inserted between the coil and the series potentiometer. (A bypass capacitor may be required in some applications involving rectified a.c. through the meter.)

Neon Indicator

A neon glow lamp, type NE-2, can

be utilized as a monitor instead of a relay, as is shown in Fig. 2B. The neon indicator is less expensive than the one using the relay, and employs a simpler circuit. Its operating voltage is much higher, however. The NE-2 draws about 0.66 ma. at 60 volts. Like the relay, it has a higher striking (lighting) voltage than its normal value and extinguishing voltage. The adjustment for detecting a surge is just under the striking voltage. For monitoring a drop-in voltage, set at a trifle above the extinguishing point, or drop-out, as in a relay.

A.C. Monitoring

In the circuit of Fig. 4, a crystal diode rectifies a.c. from a signal source and applies this to the relay coil through an RC filter. Adjustment for operating points is the same as for straight d.c. service. This arrangement is good for checking grid drive, CRT drive, audio drive, etc., whenever a constant signal is supposed to be present. Use an oscillator to furnish this constant video or audio input to some previous point in the set.

Current Applications

To monitor current, the relay is inserted in series with the circuit broken at "X" in Fig. 5. The potentiometer is now used as a shunt across the coil. Decreasing its resistance decreases the current through the coil. Operating points for over- and under-current monitoring are set similarly to voltage duty with this equipment.

Latching Circuit

For some critical applications, more positive latching may be desired. A circuit that will provide this is shown in Fig. 6. This circuit was actually built, using a Jewel relay, inside of the transparent plastic shipping case for the relay. Use of small parts of the type now readily available for transistorized circuits enabled this compact construction, which is shown in Fig. 1. The transformer cannot be included in the plastic container.

The function of the transformer is to supply a voltage to the diode(s). The diodes rectify this a.c. voltage, the output of the two rectifiers being in opposite polarity with respect to each other. After filtering by the capacitors, the d.c. voltages produced by these diodes become available at the output jacks. The pin plug is then used to select either a positive (red jack) or negative (black jack) voltage to be used as a holding voltage for the relay, depending on existing conditions.

Thus, whenever the relay armature swings to the energized position, inserting the pin plug in the red jack will supply an augmenting voltage. If the condition in the external circuit were such that the relay were in the dropped-out state, connecting the pin plug to the black jack would apply a negative voltage to the coil to re-inforce the dropped-out condition. With both voltages thus pulling the relay in the same direction, it would take a

substantial change in voltage in the opposite direction in the circuit under test to cause a reversal of the armature's position. While the circuit is polarized, all that is required to permit the monitoring of a negative voltage is the reversal of the connecting leads.

Do not try to make any relay adjustments with the local power supply on. During such adjustment, both fixed contacts may touch the moving contact at the same time. This may destroy one or both crystal diodes. Similarly, some spacing must be left so the armature is not frozen between the two fixed contacts—a slip of thin paper is a good test gauge.

Two 220-ohm resistors have been added in series with each latching diode to limit current in case the "Bantam" electrolytics become deformed due to idleness. The pilot lamp has been shown with two optional connections to either (but not both) fixed relay contacts. Employ whichever causes the lamp to remain lit during normal operation. Back voltage through an unlit lamp may influence operation of the latch.

The dial lamp may be used with either fixed contact. A 12-volt transformer with a 12-volt bulb is preferable to the 6-volt system shown because of the greater value of latching voltage available to buck out or augment the signal voltage in maintaining the latch either off or on.

In use, the circuit is adjusted with the pin plug not connected to any jack, in a manner similar to that used for the simple relays of Fig. 2. Then the pin plug is inserted into either the red or the black jack, as required: The red jack supplies a positive voltage to augment a positive voltage from the monitored source to hold the armature latched on. The black jack supplies a negative voltage to buck the supply to the relay coil to hold the relay off except with a very sudden following surge.

The added latching voltages are also

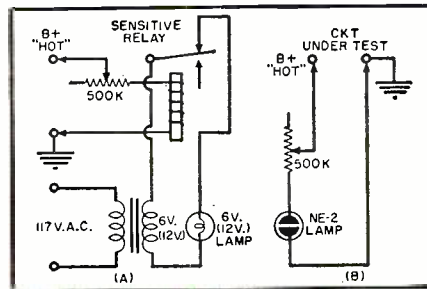

Fig. 2. (A) A relay-operated monitor, using a panel lamp as an indicator. (B) A neon lamp used as a voltage monitor.

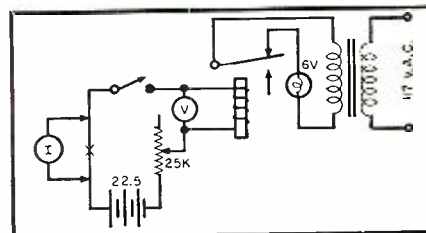
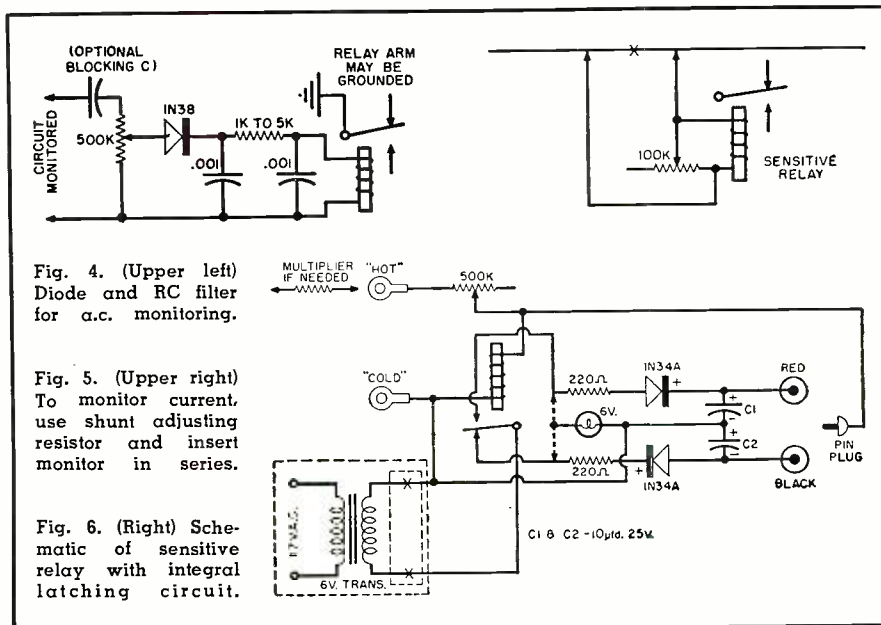

Fig. 3. This circuit is used to find critical operating values for a relay.

fed into the circuit under test through the series resistance. They may upset the operation of the equipment even though it is normal. The effect may be eliminated by unlatching the relay through removal of power to the transformer (pulling the plug) or by pulling the pin plug on the relay. Some leakage may still occur through one of the "Bantam" electrolytic capacitors, although this is slight.

The relay, its control, and the latch components have been made into one case so that a number of these may be driven from a common low-voltage a.c. latching current supply. The terminal strip facilitates connection of additional units.

As with the simple relay, the monitored voltage (if it is a.c.) may be rectified by a crystal diode and then applied to the relay coil through a rudimentary RC filter. -50-



Do you need a degree for success in Electronics?



"Not necessarily," says Dick Brani, Instructor in Project Sage at IBM—Kingston, New York. "Oh, sure—I'm aware of my limitations to design electronic equipment—that's the big advantage of a formal degree. But I am qualified to maintain it. The point is . . . there are many management positions in IBM for men like myself, and I'm convinced that comparable positions elsewhere would probably require an engineering degree."

Some years ago, IBM took the initiative with respect to technical training within its own organization. It realized, even then, that a great number of intelligent and capable men were falling by the wayside because they lacked 4 years of college engineering. Statistics indicated that because of financial difficulty or improper high-school preparation, close to 50% of the potential engineers in the country became lost in the educational shuffle. While some people ignored or bemoaned the fact, IBM did something about it. Consequently, men like Dick Brani now enjoy satisfying, more rewarding work than ever before.

Great Interest in Mathematics. While Dick was attending high school, his principal academic interest was mathematics. And, like many other young men of that time, Dick was realistic about his future. He decided his best bet might be business accounting. When Dick graduated, he accepted a position with a New York banking firm. It was not until he entered the Army that he had the opportunity to pursue a more advanced form of mathematics—an A.S.T.P. training program at Lehigh University. This all-too-brief experience convinced Dick that he should make his career in a field related to electrical technology

Postwar Education. Discharged with the rank of Staff Sergeant, Dick returned home to marry a girl he had met at Lehigh. During this period, he successfully supported



Dick trouble shooting
Magnetic Drum Frame.



He studies computer pluggable unit.



his family selling various lines of food. In the evening, however, Dick continued his study of radio, TV, and electronics at the Allentown Branch of the Temple Institute. In two years' time, he graduated and secured an F.C.C. license—his technical career began to take shape.

IBM Looks Especially Good. Glancing through an issue of *Time Magazine* one evening, Dick happened to read an article about Thomas J. Watson, Jr., the president of IBM. The story emphasized Mr. Watson's great faith in the future of electronic computers . . . the wonderful promise it holds for the ambitious, intelligent young man. Later, Dick spotted a classified ad describing IBM's association with Project Sage. That was all Dick Brani needed.

Asked to Become an Instructor. Three-quarters of the way through his nine-month computer systems course, Dick was invited to remain at Kingston as an instructor. "It was like a bolt out of the blue," he recalls. "I knew I'd enjoy teaching, but I always thought it was out of the question. I accepted all right. I can't tell you how much I've enjoyed helping these fellows and watching them grow within the organization. Right now, there's a fellow in my class whose education is limited to correspondence school. He's in the top third of his class, and has a real future with IBM—all because he has the native talent and is willing to work."

What Does Dick Brani Teach? "Actually, I teach three separate courses in field engineering. One is computer systems testing, which is for the more advanced student. It lasts for 33 weeks—a long time, perhaps, but it's well worth it. Another is a program of 24 weeks' duration that deals with computer input-output units. Finally, I teach a course in computer units displays. This also lasts for 24 weeks. Each one of these courses is an education in itself." Experience has shown that IBM's educational programing is most successful. Men accepted receive their training with no strings attached. Upon graduation the road to success is wide open in *all* divisions of the corporation.

Computer Analyzes All Air Traffic. "This computer is really fantastic. It contains approximately 1,000,000

parts, and it's housed in a building 4 stories tall. Information is filtered in from Texas towers, picket ships, reconnaissance planes—even ground observers. Every object in the sky is analyzed. Then it checks each object against available traffic data and identifies it as either friendly or hostile. It can make suggestions, but it can't send a Nike missile against a 'baddie.' Only authorized personnel can make that decision."

What About Dick's Future? "Well, right now, I'm doing work that most technicians couldn't touch with a ten-foot pole. I guess it's a matter of approach, but I know of few companies other than IBM where technicians are actually doing engineering work. Both kinds of companies will get the job done, but IBM prefers to think in terms of the man, encouraging him to grow into more responsibility. You might say that IBM gets more out of the man. In the final analysis, it seems a lot more efficient from the corporation's and employee's viewpoint. Personnel policy at all levels—management, engineering, or technical—is the same. The future is wide open."

Just recently, Dick bought a home in Saugerties, near Kingston, where his wife Betty and their three children, David, 9, Sharon, 7, and Paul, 3, enjoy a pleasant, contented life together. Occasionally, in the summertime, Dick plays softball with his co-workers. But his family is—and always will be—his predominant interest.

What About You? Permanent opportunities in the nationally important Project Sage program are still growing. If IBM considers your experience equivalent to an E.E., M.E. or Physics degree, you'll receive 8 months' training, valued at many thousands of dollars as a Computer Systems Engineer. If you have 2 years' technical schooling or the equivalent experience, you'll receive 6 months' training as a Computer Units Field Engineer, with opportunity to assume full engineering responsibility. *Assignment in area of your choice.* Every channel of advancement in the entire company is open. All the customary benefits and more. For more information, please write to: Nelson O. Heyer, Dept. 4306, IBM, Kingston, New York. You'll receive a prompt reply.



Dick explains computer logic to a Systems Class.



At the Operating Console.



At home Dick plays with one of his three children.

IBM

**MILITARY
PRODUCTS**

**BUILD THE BEST—
BUILD ALLIED'S OWN
knight-kits**

Here is a typical Knight-Kit value—available only from ALLIED—one of 45 great Knight-Kits you'll find in our special Supplement No. 165. Write for your FREE copy today.

**knight-kit HOBBYIST VALUE
10-CIRCUIT TRANSISTOR LAB KIT**

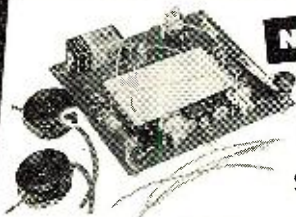

**Model
Y-299
\$15.45**

One of the most remarkable kits ever developed! You go from one exciting project to another... each circuit has a practical use, and helps to teach you how transistors work. One side of the printed circuit board is screen-printed to show where all components go—after you solder the basic parts in place, you change from one circuit to the next merely by inserting "plug-in" leads into the proper jacks on the board—no additional soldering! Makes any of these 10 circuits: 2-stage AM radio; photo-electronic relay; wireless broadcaster; code practice oscillator; electronic switch; audio amplifier; capacity-operated relay; electronic timer; voice-operated relay; electronic flasher. Includes all parts, 2 transistors, dual headphones (also serve as mike), relay, photocell, battery, "plug-in" circuit leads, guide cards, instruction manual. 3 lbs.

Model Y-299. Net, F.O.B. Chicago... **\$15.45**

OTHER knight-kit HOBBYIST VALUES



"SPACE-SPANNER" BC/SW
RECEIVER KIT
Y-243 **\$15.95**



"RANGER" SUPERHET
BROADCAST RECEIVER KIT
Y-735 **\$17.25**



TRANSISTOR
RADIO KIT
Y-765 **\$4.35**



2-STATION
INTERCOM KIT
Y-295 **\$14.75**

See our Supplement No. 165 for 12 other knight-kit hobbyist values

**free SUPPLEMENT
featuring knight-kits**



Send for our FREE Supplement No. 165 featuring 45 great Knight-Kits, including Test Instruments, Hi-Fi, Hobbyist and Amateur Kits. Write for your copy today.

**ORDER FROM
ALLIED RADIO**

Dept. (1-F-7, 100 N. Western Ave., Chicago 80, Ill.)

'Hi-Fi' Video Output Stages

By CHARLES ERWIN COHN

Poor picture quality, intercarrier buzz, and sync woes may disappear with a simple change.

THE VIDEO output stage of a TV receiver has a big job to do. For good contrast, it must deliver about 50 peak volts of signal to the picture tube; yet, to maintain good bandwidth, load impedance is limited to about 5000 ohms. This combination of conditions calls for a plate-current swing of about 10 ma.

In many TV sets, this job is assigned to the 6AU6 or some similar voltage-amplifier pentode. The required plate-current swings can be obtained from such tubes, but usually at the expense of driving them into the nonlinear portion of their characteristics. This can result in severe distortion of the whites (or blacks, depending on whether the grid or cathode of the picture tube is driven). In addition, this nonlinearity may cause considerable amplitude modulation of the sound carrier, resulting in intercarrier buzz, and undesired sync difficulties too, in some cases.

The remedy for these conditions would seem to be the choice of a video-output tube with sufficient current capabilities so that the required current swing could be obtained within the limits of linear operation. In casting about for a substitute that would provide a simple conversion, the 6AQ5 power pentode seemed a good choice. The particular conversion was carried out on a Meck XB-702 receiver, which showed the symptoms already mentioned and also provided a video-output circuit to work with that is used in many sets. This circuit is shown in the accompanying diagram.

The only component change required, other than that of the tube, was to replace the 10,000-ohm bias resistor by a 47,000-ohm unit. Here the bias was adjusted for maximum contrast. The extra current drawn by the 6AQ5 can easily be handled by the power supply of the receiver, since it is such a small fraction of the total receiver drain.

The only other problem that arose in this change involved the filament circuit. Where parallel filaments are used, there should be no difficulty. However, the series-filament arrangement of the receiver used made special consideration necessary. There were two filament strings, each carrying .3 ampere, converging into a .6-ampere string made up of the picture tube and a 6X5 rectifier. The 6AU6, with a .3-ampere filament, was in one of the .3-ampere strings. The 6AQ5, with a .45-ampere filament, was placed in the .6-ampere string in

parallel with a 47-ohm, 2-watt resistor. No other changes were made, as resulting voltage changes were evenly distributed among all tubes so that the effect on any one was very small.

As expected, considerable improvement was effected in the receiver's performance. The previously evident compression of the blacks was eliminated, making the picture almost photographic in quality. Intercarrier buzz, heretofore very annoying, was virtually eliminated.

The described conversion can be used for any set using this type of video-output stage. The substitution of a 6AQ5 for a 6AU6 is a happy one on several counts. For one thing, the same tube socket can be used with very few changed connections being required. For another thing, there is not sufficient difference in capacitances between the two tubes to cause any trouble. Also, since the two tubes are just about equal in transconductance, each provides about the same amount of gain.

In some cases, a little extra gain is required, since some improvement in available contrast is desired. This, too, can be provided with a little extra trouble. It is accomplished by using a 6CL6, which has twice the transconductance, or more, of the other two mentioned. This would require removing the 7-pin socket and enlarging the chassis hole to accommodate a 9-pin socket. However, since the 6CL6 has a .65-ampere heater, it should work well without additional complications in a .6-ampere heater string. -50-

Typical video-amplifier stage, showing two changes that improve performance.

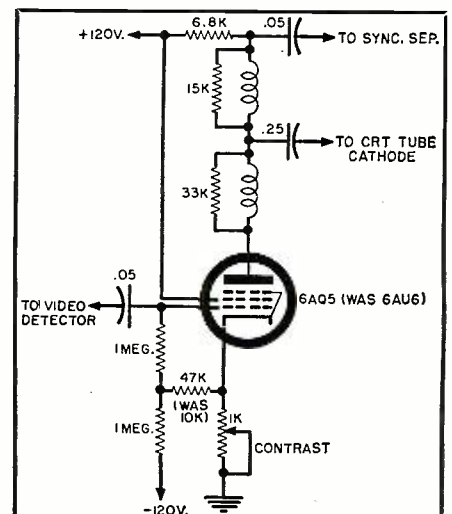

STANDARD LINE

MANUFACTURERS
ORDERS INVITED
EXPORT ORDERS
INVITED

Below Is A Partial List—Send For FREE Complete List and Order Form

QZ4	.42	5AT8	.79	6BK7	.75	7A4	.46	12J5	.39
1A7GT	.42	5J6	.79	6BL7GT	.74	7A5	.52	12L6	.59
1B3GT	.66	5T8	.79	6BN6	.57	7A6	.44	12S47	.47
1C5GT	.40	5U4G	.48	6BQ6GT	.79	7A7	.44	12S67	.54
1C6	.25	5U8	.79	6BQ7	.75	7A8	.44	12S7J	.44
1C7G	.25	5V4G	.79	6BY5G	.57	7A7	.69	12S7K	.47
1D5GP	.42	5V6GT	.49	6BZ7	.57	7A7	.43	12SL7GT	.59
1H4G	.45	5X8	.79	6C4	.36	7B5	.40	12S7GT	.56
1J6GT	.45	5Y3	.38	6CB6	.50	7B6	.41	12S7GT	.39
1L4	.54	5Y4G	.44	6CD6G	1.17	7B7	.42	12V6GT	.44
1L6	.55	5Z3	.56	6CU6	.47	7B8	.46	12W6	.59
1LA4	.46	6A7	.46	6D6	.43	7C5	.41	12X4	.36
1LA6	.58	6A8	.44	6E5	.36	7C6	.42	14A7	.44
1LB4	.48	6AB4	.66	6F5	.37	7C7	.44	14B6	.44
1LC5	.46	6AC7	.75	6F6	.37	7E5	.44	14Q7	.44
1LC6	.46	6AF4	.49	6G6	.47	7E6	.48	19T8	.69
1LD5	.56	6AG5	.68	6H6	.37	7E7	.58	19BGG	.17
1LE3	.56	6AG7	.69	6J4	1.59	7F7	.48	25BQ6GT	.84
1LH4	.46	6AH4G2	.70	6J5	.38	7F8	.65	25CA5	.79
1LN5	.49	6AH6	.53	6K6GT	.38	7G7	.74	25CD6	1.29
1NSGT	.49	6AK5	.41	6K7	.67	7N7	.58	25CU6	.99
1RS	.45	6AL5	.79	6L6	.59	7Q7	.64	25L6GT	.46
1S5	.50	6AM8	.79	6M7	.39	7Y4	.39	25W4GT	.42
1T4	.46	6AN8	.45	6N7	.39	7Y4	.39	25Z6	.36
1U4	.45	6AQ5	.47	6Q7	.39	7Z4	.59	27	.24
1U5	.70	6A55	2.25	6S4	.70	12A4	.40	35B5	.47
1V2	.66	6AS7G	.38	658GT	.47	12A5	.59	35C5	.47
1X2	.49	6AT6	.79	65B7Y	.75	12AB5	.49	35L6GT	.46
2A3	.54	6AT8	.79	65C7	.40	12AQ5	.40	35W4	.38
2A7	.54	6AT8	.79	65G7	.42	12AT6	.40	35Y4	.38
2D21	.50	6AU4GT	.60	65H7	.42	12AT7	.65	35Z3	.40
3A4	.50	6AU5GT	.42	65J7	.49	12AU6	.58	35Z5GT	.38
3A5	.52	6AU6	.79	65K7	.56	12AU7	.41	39/44	.25
3AL5	.52	6AU8	.64	65L7GT	.56	12AV6	.66	50A5	.47
3AU6	.57	6AV5GT	.38	65N7GT	.40	12AV7	.64	50B5	.47
3BZ6	.57	6AV6	.89	65Q7	.40	12AX4GT	.62	50C5	.47
3BC5	.57	6AW8	.65	65S7	.85	12AX7	.62	50L6GT	.44
3BN6	.57	6AX4GT	.56	6T4	.67	12AZ7	.67	80	.39
3CB6	.57	6AX5GT	.46	6T8	.54	12B4	.45	84/624	.45
3Q4	.55	6BA6	.49	6U5	.79	12BA6	.59	117L7GT	1.25
3Q5GT	.46	6BC5	.89	6U8	.79	12BA7	.45	117N7GT	1.25
3S4	.55	6BC8	.52	6V3	.45	12BE6	.59	117P7GT	1.25
3V4	.75	6BD5GT	.45	6V6GT	.39	12BH7	.63	117Z3	.36
4BQ7	.75	6BE6	.39	6W4GT	.52	12BY7	.59	117Z6GT	.61
4BZ7	.75	6BF5	1.17	6W6GT	.38	12CA5	.79		
5AM8	.79	6BG6G	.50	6X4	.38	12CU6	.79		
5AN8	.79	6BH6	.46	6X5	.74	12DQ6	.79		
5A95	.49	6BJ6	.46	6X8	.74				
		6BK5	.67						

Receiving Tubes Sent Parcel Post

FEATURING
FAMOUS FACTORY

TUBES

- INDIVIDUALLY BOXED!
- GUARANTEED ONE YEAR!
- FACTORY BOXED ● FACTORY IRREGULARS
- NEW JAN SURPLUS ● EQUIPMENT TUBES

**ALWAYS 1000
TYPES IN STOCK**

FREE POSTAGE! On All Orders
Shipped In U.S.A., Territories and
A.P.O.'s. Send 25c for handling on or
ders under \$5.00. Please send approx.
postage on Canadian and foreign
orders. Excess will be refunded.

Please Specify Console
or Table Model
When Ordering

Thousands of TRADE-IN TV's

Reconditioned By Factory Trained Technicians! Guaranteed To
Be In Working Condition When You Receive Them!

10"	\$25.00	19"	\$56.00
12"	\$30.00	20"	\$63.00
14"	\$35.00	21"	\$70.00
16"	\$42.00	24" (when available)	\$95.00
17"	\$49.00	27" (when available)	\$129.00

Get yourself a second set or buy some for re-sale!
FREE BONUS . . . two set coupler given with each set.
All TV's sent motor freight or Railway Express F.O.B. our warehouse.
Sorry, no A.P.O. shipments.

**Standard Line
PICTURE TUBES
Guaranteed One Year**

Any 10" Tube . . . \$10.75
Any 12" Tube . . . \$12.75
Any 14" Tube . . . \$14.75
Any 16" Tube . . . \$16.75
Any 17" Tube . . . \$17.75
Any 19" Tube . . . \$20.75
Any 20" Tube . . . \$20.75
Any 21" Tube . . . \$22.75

All Picture Tubes sent Railway Express F.O.B. our
warehouse. Sorry, no A.P.O. shipments.

**FREE
12" TV SET**
with every receiving
tube order of \$100.00
or more!

**FREE
16" TV SET**
with every receiving
tube order of \$200.00
or more!

FREE!
TWO SET COUPLER
WITH EVERY TUBE
ORDER OF \$8.50
OR MORE!!

Bonus TV sets
are shipped
complete with
cabinet and pic-
ture tube F.O.B.
our warehouse.
With slight adjust-
ments and mini-
mum labor they
can be restored
like new.

**REMEMBER—
You Buy Quality
When You
Buy Stand-
ard. Qual-
ity Never
Shouts—It
Always
Whispers.**

**We Are Not Selling
Price—We Sell
Only Quality**

Used Tubes, Electrically Perfect
Factory Seconds, Brand New
Factory Seconds and New and
Used Jan Surplus Tubes

STANDARD LINE

ELECTRIC COMPANY

432 HARRISON AVENUE, HARRISON, N. J. • Phone: HUmboldt 4-4997

Your choice of school
is highly important
to your career in



**INDUSTRIAL
ELECTRONICS**



**RADIO-
TELEVISION**



**ELECTRONICS
COMMUNICATIONS**

Become an

**ELECTRICAL
ENGINEER**

or an

**ENGINEERING
TECHNICIAN**

at

MSOE in Milwaukee

Choose from courses in:

ELECTRICAL ENGINEERING

Bachelor of Science Degree
in 36 months—
Communications or
Electrical Power.

ENGINEERING TECHNICIAN

Associate in Applied Science
degree in 18 months—
Electronics Communications or
Electrical Power.

MSOE—located in Milwaukee, one of America's largest industrial centers—is a national leader in electronics instruction—with complete facilities, including the latest laboratory equipment, visual aid theater, amateur radio transmitter—offers 93 subjects in electrical engineering, electronics, radio, television, electrical power, and electricity.

Advisory committee of leading industrialists. Courses approved for veterans. Over 50,000 former students. Excellent placement record. Previous educational, military, and practical experience is evaluated for advanced credit.



QUARTERS BEGIN JANUARY,
APRIL, JULY, SEPTEMBER

Choose wisely—your
future may depend on it.
Mail coupon today!

MILWAUKEE

SCHOOL OF ENGINEERING

Dept. RN-657, 1025 N. Milwaukee St.
Milwaukee, Wis.
Please send free illustrated career booklet
(please print)

I'm interested in.....
Name..... Age.....
Address.....
City..... State.....
Are you eligible for veterans educational
benefits?.....
Discharge date.....

MS-57

Radio Pill Broadcasts From Stomach

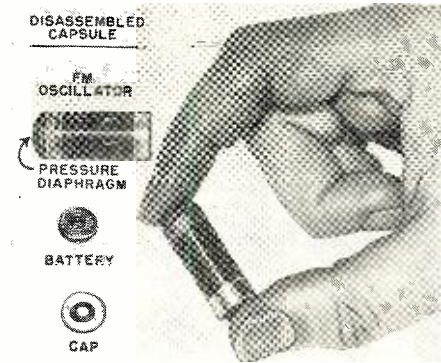

View of disassembled capsule is shown here.

Data from digestive tract sent by tiny FM transmitter.

A NEW radio broadcasting capsule which can be swallowed like a medicinal pill was demonstrated recently at the Rockefeller Institute. As it passes into the stomach and through the intestine, this world's smallest FM broadcasting transmitter signals the gastrointestinal pressures to an outside receiver. It has been developed and tested jointly by the Institute, the N. Y. Veterans Administration Hospital, and RCA. The pill was designed by Dr. Vladimir K. Zworykin, honorary vice-president of RCA, and his associates, after having been envisioned by Dr. John T. Farrar, chief of the gastro-enterology section of the hospital.

The little device permits pressure measurements to be made on internal organs with minimum disturbance to normal bodily functions. The new data is expected to be important in understanding gastro-intestinal disorders.

The pill is a plastic capsule measuring 1½ inches long and ¾ inch in

diameter containing a transistor oscillator powered by a tiny rechargeable battery which lasts about 15 hours before requiring recharge. At one end of the capsule is a pressure-sensitive rubber diaphragm through which the body's pressure variations are transmitted to a movable ferrite cup inductance core. This varies the inductance in the tuned circuit and results in frequency modulation of the oscillator, whose center frequency is about 1 mc.

The FM signal from the capsule within the body is picked up by an FM radio receiver by means of an antenna held close to the body. This signal is then recorded by a recording galvanometer or oscillograph, a cathode-ray oscilloscope, and a meter.

Plans are currently underway for recharging the battery from outside the patient's body. Also, it is planned to attempt to transmit information relating to temperature and acidity within the digestive tract.

-30-

Drs. Zworykin (left) and Farrar demonstrate radio pill. Diagrams on blackboard show circuit and parts placement. Receiver is on right side of table with recording oscillograph to left and oscilloscope to right. Pill is inside plastic bottle connected to manometer. Small antenna in front of bottle picks up the FM signal.

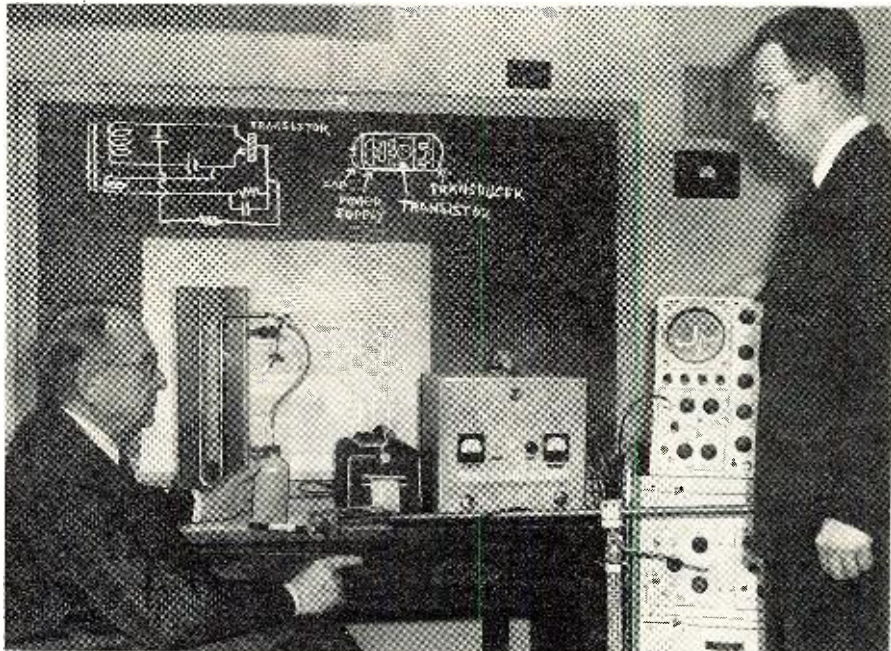

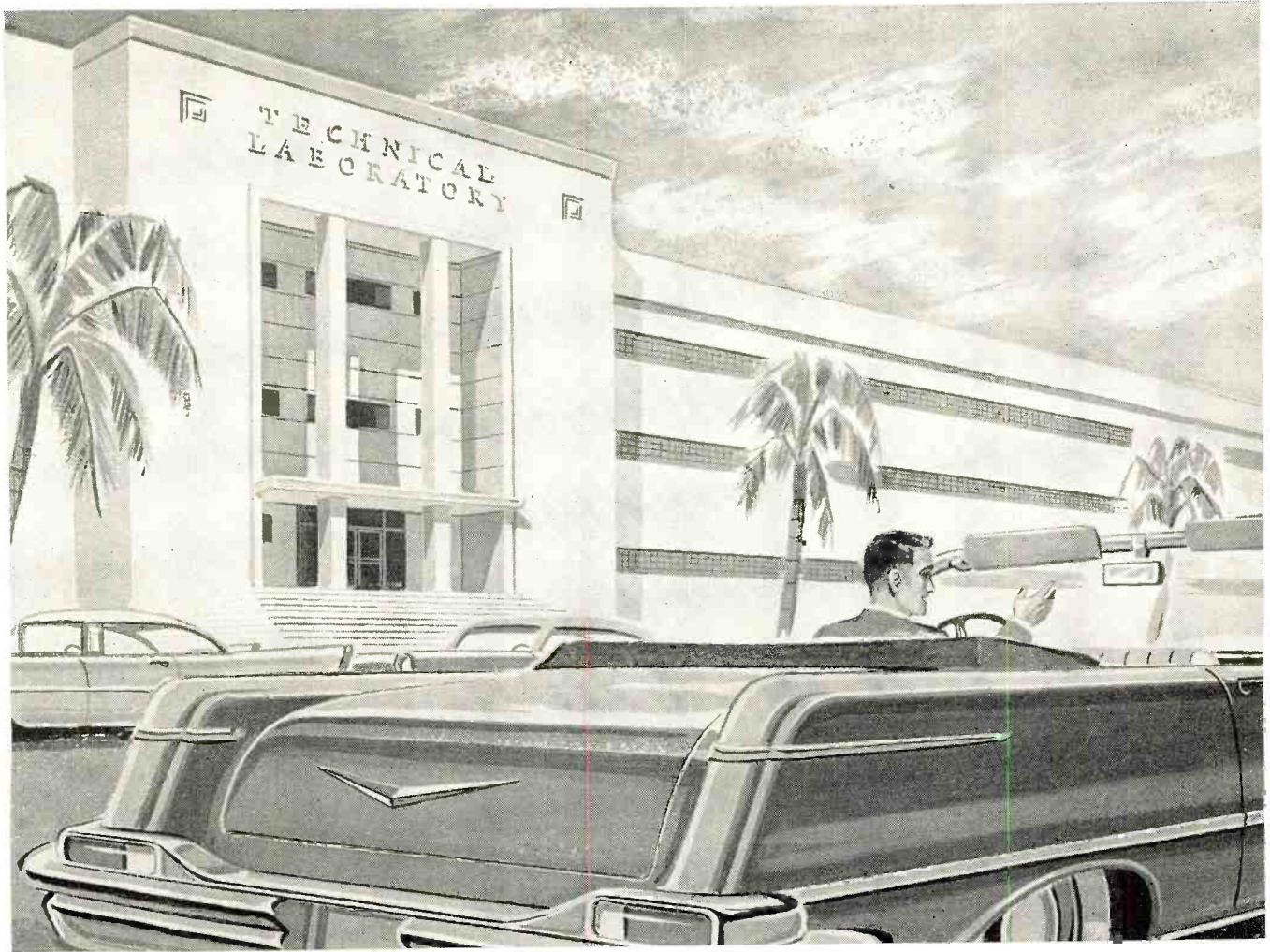

**It's Florida for the kind of missile work
only RCA can offer electronic technicians**



RCA careers are beginning for electronic technicians every day at the Missile Test Project at Patrick Air Force Base on Florida's central east coast. Each offers a unique opportunity to work on testing of all types of missiles now under development or planned. What's more, you can contribute to the Vanguard Satellite launching and tracking.

There's a broad range of RCA opportunity for technicians on all levels. A basic knowledge of electronics qualifies you for many of these openings. Complete facilities include latest electronic and optical data acquisition and transmission systems. Liberal RCA benefit program . . . relocation assistance, too. You'll live well in Florida.

Make *your* future in one of these field or shop assignments:

**RADAR—RADIO—TELEMETRY
TIMING—INSTRUCTING
ELECTRONIC TEST EQUIPMENT**

Mail the coupon for booklet which describes our Florida missile program and its advantages.



RCA SERVICE COMPANY, INC.

Mr. H. N. Ashby, Employment Mgr., Dept. N-16F
RCA Service Co., Inc., Missile Test Project
P. O. Box 1226, Melbourne, Fla.

Please send me brochure with the information on RCA employment advantages in Florida.

Name _____ Age _____ Married Yes No

Address _____ U.S. Citizen Yes No

Electronics Experience (Include Mil. Service & Tech. Schools) _____

Earliest Date Available _____

COMPLETE TRAINING FOR BETTER RADIO-TV SERVICE JOBS



Let these two world-famous Ghirardi training books teach you to handle all types of AM, FM and TV service jobs by approved professional methods—and watch your efficiency and earnings soar!

Completely modern, profusely illustrated and written so you can easily understand every word, these books have the way to fast, accurate service on any type of radio and TV set ever made. Each book contains the latest data on the latest methods and equipment—NOT a re-hash of old, out-of-date material. Each is co-authored by A. A. Ghirardi whose famous RADIO PHYSICS COURSE and MODERN RADIO SERVICING were, for 20 years, more widely used for military, school and home study training than any other books of their type!

THE NEW Ghirardi RADIO-TV SERVICE LIBRARY

Almost 1500 pages and over 800 clear illustrations show step-by-step how to handle every phase of modern troubleshooting and servicing.

1—Radio and Television Receiver TROUBLESHOOTING AND REPAIR

A complete guide to profitable professional methods. For the beginner, it is a comprehensive training course. For the experienced serviceman, it is a quick way to "brush up" on specific jobs, to develop improved techniques or to find fast answers to puzzling service problems. Includes invaluable "step-by-step" service charts. 820 pages, 417 illus., price \$7.50 separately. (Outside U.S.A. \$8.00.) See combination offer below!

2—Radio and Television Receiver CIRCUITRY AND OPERATION

This 660-page volume is the ideal guide for servicemen who realize it pays to know what really makes modern radio-TV receivers "tick" and why. Gives a complete understanding of basic circuits and circuit variations; how to recognize them at a glance; how to eliminate guesswork and useless testing in servicing them. 417 illus. Price separately \$6.75 (outside U.S.A. \$7.25).

New low price...you save \$1.25!

If broken into lesson form and sent to you as a "course," you'd regard these two great books as a bargain at \$50 or more! Together, they form a complete modern servicing library to help you work faster, more efficiently and more profitably. Completely indexed so you can look up needed facts in a jiffy.

Under this new offer, you save \$1.25 on the price of the two books—and have the privilege of paying in easy installments while you use them! No lessons to wait for. You learn fast—and you learn right!

STUDY 10 DAYS FREE!

Dept. RN-67, RINEHART & CO., Inc.
232 Madison Ave., New York 16, N. Y.

Send book(s) below for 10-day FREE EXAMINATION. In 10 days, I will either remit price indicated (plus postage) or return books postpaid and owe you nothing.

Radio & TV Receiver TROUBLESHOOTING & REPAIR (Price \$7.50 separately)

Radio & TV Receiver CIRCUITRY & OPERATION (Price \$6.75 separately)

Check here for MONEY-SAVING COMBINATION OFFER. Save \$1.25. Send both of above big books at special price of only \$13.00 for the two (Regular price \$14.25). . . you save \$1.25. Payable at rate of \$4 (plus postage) after 10 days if you decide to keep books and \$3 a month thereafter until \$13 has been paid.

Name

Address

City, Zone, State

Outside U.S.A.—\$8 for TROUBLESHOOTING & REPAIR; \$7.25 for CIRCUITRY & OPERATION; \$14 return privilege. Cash with order only, but same 10 day return privilege.



The 21CEP4 (right) has the same size screen as the conventional CRT (left).

First 21" 110-Degree CRT

RCA research cuts tube depth by nearly 6 inches, improves brightness, pix quality, and stability.

NOW under regular production at the RCA tube plant in Marion, Indiana, is the first commercial 110-degree picture tube in the 21-inch size, the 21CEP4. Its appearance marks the culmination of efforts initiated as far back as 1952, when this manufacturer began to investigate the practical feasibility of increasing the deflection angle beyond 90 degrees.

By July 1954, it was decided that an angle of 110 degrees was a realistic commercial objective; that is, a CRT deflecting through such an angle could be designed without requiring such alterations in associated circuits and components as to result in unrealistic receiver prices. Little more than two years later, in October 1956, the design now under production was incorporated in the 17BZ4.

The 21CEP4, weighing in at 22 pounds and measuring 14¾ inches long, incorporated several features developed over the years during which the project has been under way. In addition to the determination that 110 degrees was the optimum angle, 1½ inches had been selected some time ago as the optimum neck diameter by RCA engineers. Also, extensive work was done on determining the actual electron-beam paths in a picture tube, involving the use of some unique techniques. This research was necessary to arrive at a shape for the tube that would not obstruct the electron beam. Out of these investigations came the parabolic contour presently associated

with the new family of wide-angle cathode-ray tubes.

Other features found in the new line of picture tubes include a glass-button base, a straight electron gun that operates without an ion trap, and an aluminum backing on the screen of carefully controlled thickness.

The base of the tube combines the narrow pins used in miniature tubes with the plastic positioning key found on octal tubes. It should substantially reduce the number of otherwise usable picture tubes that must be replaced because of loose bases or poor base connections.

In using a straight gun, although ion burn can be avoided with proper aluminization, there is the additional danger of damage to the cathode with consequent shortening of tube life. A unique pre-focus lens, which gives superior focus and definition and is relatively insensitive to voltage variations, avoids contamination. In an extended-life test, 285 of the new tubes were subjected to 4000 hours of use. Results indicate average emission life superior to that of conventional tubes.

Costs to the manufacturer for the 17- and 21-inch sizes range about \$2 more than for 90-degree tubes. Since only about 15 per-cent more deflection power and "B+" power are required from the receiver, no additional power requirement is made on present conservatively designed sets. A 24-inch version is planned for commercial availability this month.

JUST RECEIVED! ASB-5 'SCOPE INDICATOR



BRAND NEW, including all tubes, together with 5BP1 'Scope Tube. Originally used in Navy Aircraft RADAR equipment. Easily converted for AC operation. VALUE \$250.00! OUR LOW PRICE **\$15.95**

ASB-5 RECEIVER FOR 420 Mc BAND!

As featured in "CQ" for October 1956. Easily converted, makes a marvelous receiver for 420 Mc band, with RF amplifier! Supplied complete with all tubes. OUR LOW PRICE. Tuning Knob for ASB-5 Receiver... \$1.29

\$1495

ASB-5 INDICATOR... \$16.95

MN26Y BENDIX DIRECTION FINDER

150-325 Kc; 325-695 Kc; 3.4-7 Mc. Complete with tubes, motor. BRAND NEW... \$26.95

Used, like new, incl. tubes and dynamotor... \$18.95

BENDIX DIRECTION FINDER

12-tube remote control Navigation Direction Finder and communications receiver. 150 to 1500 Kc in 3 bands, 28 V. DC input. Ideal for commercial navigation on boats and planes. Complete installation comprises: MN-26-C Receiver, used, with 12 tubes... \$16.50

MN-26-C With 12 Tubes, BRAND NEW \$24.95

MN-20-E Rotatable Loop... 4.25

MN-52 Azimuth Control Box... 2.95

All necessary accessories for above in stock.

TS-16/APN TEST SET, BRAND NEW

Complete with all cables... \$12.95

DETROLA BEACON RECEIVER

BC-1206A. A dandy little receiver for 200 to 400 Kc Band. Uses 135 Kc iron core IF's. Complete with six tubes: 6SK7, 6SA7, 6K7, 6SQ7, 2-25L6's. Used... \$4.99



NAVY RECEIVER TYPE ARB

Four Band. 195 to 9050 kc. Low Freq., Ship, Broadcast—40 to 80 meters. Includes tubes and dynamotor, for 24 volt operation. Easily converted for 110 V., 12 V., or 6 V. Schematic included. Excellent Condition. Overall: 8 1/4" x 7 1/4" x 15 1/4" Wt. 30 lbs. COMPLETE WITH ALL TUBES, Special... \$21.50

BC-906 FREQ. METER—SPECIAL!

Cavity type, 145 to 285 Mc. BRAND NEW in original factory packing, complete with antenna. Manual included. OUR LOW PRICE **\$8.88**

BC-221 FREQ. METER... \$129.50

BC-221 FREQ. METER CASE

Aluminum Case for BC-221 or TS-164 Freq. Meters. Shock Mounted. BRAND NEW... \$3.99

Original 1000 Kc Crystal for BC-221. BRAND NEW \$8.45

DYNAMOTOR VALUES!

Type	Input	Output	Used	BRAND NEW
DA-19-A	28V 11A	400V .400A	\$4.99	\$6.95
DM-28	28V	224V .07A	2.95	4.95
DM-32A	28V 1.1A	250V .05A	2.95	5.95
DM-33A	28V 5A	575V .16A		
	28V 7A	540V .25A	1.95	3.95
DM-34D	12V 2A	220V .080A	4.25	5.50
DM-37	25.5V 9.2A	625V .225A	5.95	8.95
DM-40	14V 3.4A	172V .138A	1.75	3.45
DM-53A	28V 1.4A	220V .080A	3.95	5.95
DM-64A	12V 5.1A	275V .150A		7.95
PE-73C	28V 20A	1000V .350A	8.50	11.50
PE-86	28V 1.25A	250V .050A	2.95	5.24

PE-103 6.75V Input, 500V @ 160 Ma output. With cables and plugs... \$24.50

2 VOLT BATTERY "PACKAGE"

1—2V. 20 Amp. Hr. Willard Storage Battery... \$2.45

1—2V. 7 prong Synchronous Plug-in Vibrator... 1.49

1—Quart Bottle Electrolyte (for 2 cells)... 1.45

ALL BRAND NEW! Combination Price... \$4.99

Willard 6-Volt Midget Storage Battery

8 Amp. Hour. BRAND NEW. 8 3/8" x 1-13/16" x 2 3/8". Uses Standard Electrolyte... Only \$2.22

Ham Special! Famous BC-645 XMITTER-RECEIVER



With MANUAL for Easy Conversion to CITIZENS' BAND!

Makes wonderful mobile rig for 420-500 Mc. Easy to convert for phone or CW 2-way communication. This swell rig originally cost over \$1000—yours for practically a song! You get it all, in original factory carton, BRAND NEW, complete with 17 tubes, less power supply. Conversion Instructions Included. \$29.50

PE-101C DYNAMOTOR for BC-645, has 12-24V input (easy to convert for 6V Battery operation) only \$7.95

UHF ANTENNA ASSEMBLY, for BC-645... \$2.45

Complete set of 10 Plugs for BC-645... \$5.50

CONTROL BOX for above... \$2.25

SOCK MOUNT for above... 1.25

CONVERSION BOOKLET. Instructions for most useful surplus rigs... \$2.50

ARC-5/R28 RECEIVER

2-meter Superhot. 100 to 156 Mc in 4 crystal channels. Complete with 10 Tubes. BRAND NEW... \$18.95

110 V AC Power Supply Kit for above... \$9.75

ARC-5/T-23 TRANSMITTER

100-156 Mc Includes 2-832A, 2-1625 Tubes. BRAND NEW... \$19.95

SPECIAL OFFER! Limited quantity ARC-5/T23 xmitters. BRAND NEW, less tubes... \$7.95

Excellent Used, less tubes... \$5.95

ARC-5 MARINE RECEIVER-TRANSMITTER

Navy Type Comm. Receiver 1.5 to 3 Mc. BRAND NEW with 6 tubes... \$16.95

Navy Type Comm. Transmitter 2.1-3 Mc. BRAND NEW with 4 tubes and Xtal... \$12.45

LORAN APN-4

FINE QUALITY NAVIGATIONAL EQUIPMENT

Determine exact geographic position of your boat or plane! Complete, BRAND NEW installation consists of: ID-6B/APN-4 Indicator; R-9B/APN-4 Receiver; PE-206 Inverter; Set of Plugs; Visor for Indicator; Operation manual. COMPLETE, BRAND NEW... \$129.50

SPECIAL APN-9A LORAN Receiver Indicator, less tubes, NEW (demilitarized) \$29.50

SCR-522 2-METER RIG!

Terrific buy! VHF Transmitter-receiver, complete with all components: 100-156 Mc. 4 channels. Xtal-controlled. Amplitude modulated voice. They're going fast! Excellent condition.

SCR-522 Transmitter-Receiver, complete with all 18 tubes. COMBINATION... Special \$33.33

Receiver Only, with all tubes... \$19.50

Transmitter Only, with all tubes... \$22.25

FREE! Schematic Diagram included FREE with each piece of equipment shown on this page. Schematics for any of these units also available separately at 50c each.

BRAND NEW SELSYNS

Operates from 37 1/2 volts, 400 cycles. New tested. Conversion diagram for 110 volts AC included. 2J1G1 Selsyn Control Transformer... \$2.95

2J1H1 Selsyn Differential Generator... Each 50c

I-95-M FIELD STRENGTH METER

Tunes 100 to 155 Mc. Made for Signal Corps. Like New... \$34.50

AN/ARR-2 RECEIVER

BRAND NEW—A Terrific Value! Tuning Range 234 to 258 Mc. Tubes: 7-9001, 3-6AK3, 1-12AG. Schematic included. Only a few at this low price! Complete... \$8.88

With 28 V 1.6A Dynamotor, complete... \$12.95

110 VOLT AC POWER SUPPLY KIT for above... \$9.75

WRITE FOR FREE CATALOG!

Please include 25% Deposit with order—Balance C.O.D. 50c Handling Charge on all orders under \$3.00 All shipments F.O.B. Our Warehouse, N.Y.C.

G & G Radio Supply Co. Telephone: CO 7-4605 51 Vesey St., New York 7, N. Y.

R24-ARG/5 NAVY TYPE (Similar to BC-946) BROADCAST RECEIVER



520 to 1500 Kc. 6 tubes: 3-12SK7, 12-12AG, 12K8. For dynamotor operation. Easily converted to 110 or 32 Volt. 2-IF stages. 3-gang tuning cond. Complete with all tubes, in original sealed carton. BRAND NEW... \$19.95

BC-457 TRANSMITTER—4-5.3 Mc. complete with all tubes and crystal. BRAND NEW... \$7.88

BC-458 TRANSMITTER—3 to 7 Mc. Complete with all tubes and crystal. BRAND NEW... \$7.88

BC-459 TRANSMITTER—7-9.1 Mc. complete with all tubes and crystal. BRAND NEW... \$11.95

ARC-5/T-19 TRANSMITTER—3 to 4 Mc. BRAND NEW complete with all tubes & crystal... \$8.88

110 VOLT AC POWER SUPPLY KIT

For All 274-N and ARC-5 Receivers

Can be assembled quickly and easily, on pre-drilled chassis. Plugs into the rear of any model 274-N receiver and delivers 24 volts as well as "B" voltage. Complete kit of parts with metal case, instructions. Factory wired, tested, ready to operate \$11.50

SPLINED TUNING KNOB for 274-N and ARC-5 RECEIVERS. Fits BC-453, BC-454 and others. Only 49c

SCR-274 COMMAND EQUIPMENT

ALL COMPLETE WITH TUBES Excellent Brand Type Description Used Used

BC-453 Receiver 190-550 KC... \$9.95 \$11.95 \$14.95

BC-454 Receiver 3-6 Mc... 7.19 8.29 11.95

BC-455 Receiver 6-9 Mc... 3.25 2.75 9.95

BC-456 Modulator... 2.24 2.75 4.24

BC-450 3-Receiver Control Box... 1.49 1.95

BC-451 Transmitter Control Box... 1.25 1.49

BC-608 Xmt 3-4-Mc (like new)... 6.95 8.88

BRAND NEW SPECIAL PURPOSE TUBES

Type	Each	Lots of 12	Lots of 100
JAN CRP-730A MAGNETRON, Raytheon	\$3.45	\$5.15	\$41.00
6J6W	.26	2.75	21.50
1626	.16	1.75	13.50
1629	.27	3.05	23.95
626	.44	4.95	39.50
2J724B	.35	3.95	29.50
VR105	.79	8.88	77.00
VR150	.79	8.88	70.00
8002R	.595		
RK65	.725		

NEW! Cathode Ray Tubes NEW!

3CP1... \$1.18 5BP4... \$2.22

3FP7... 1.18 5CP7... 2.45

5BP1... 2.22 5FP7... 1.44

9LP7... 1.88

BUBBLE SEXTANT

Made for U. S. Armed Forces by AGFA ANSCO. Actually worth \$150 or more! Has illuminated averaging disc for night-time use. Complete with carry-ing case. Only... \$9.95

DYNAMIC HANDMIKE, with "Press-to-talk" Switch, cord and plug—BRAND NEW, only \$2.95

DYNAMIC HEADPHONES, 600-ohm impedance, with large earphone cushions, cord and phone plug. BRAND NEW, special... \$3.95

HI-LO IMPEDANCE MATCHING TRANSFORMER for headphones, 600 ohms to 8000 ohms. With plug and jack, BRAND NEW 97c

HI-FI DYNAMIC HEADSET with Cushions Freq. Range: 40-14000 CPS. No Distortion. BRAND NEW... \$5.95

MICROPHONES

Model	Description	Used	BRAND NEW
T-17	Carbon Hand Mike	\$5.45	\$7.95
T-30	Carbon Throat Mike	.33	.69
T-45	Army and Navy Lip Mike		1.32
RS-38	Navy Type	2.45	4.95
T-24	Carbon Mike		5.95
TS-9	Handset		4.95

HEADPHONES

Model	Description	Used	BRAND NEW
HS-23	High Impedance	\$2.25	\$4.35
HS-33	Low Impedance	1.99	4.65
HS-30	Low Imp. (featherwt.)	1.49	2.25
H-16/U	High Imp. (2 units)	2.75	7.95
CD-307A	Cords, with PL55 plug and JK26 Jack		.99

BC-442 ANTENNA RELAY

Wonderful Value! Consists of 3/4 amp 2-1/2 RF Ammeter (antenna current indicator), 0-10 scale, Transmitter-Receiver Switching relay, in aluminum case with associated components. BRAND NEW... \$2.24



LAFAYETTE SENSATIONAL VALUES! IN COMPLETELY WIRED TEST EQUIPMENT at LESS than the PRICE of KITS!

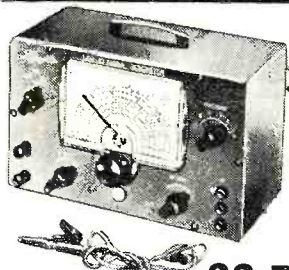

LAFAYETTE SIGNAL GENERATOR
NEVER BEFORE HAS A COMPLETELY WIRED AND TESTED INSTRUMENT OF SUCH ACCURACY AND QUALITY BEEN OFFERED AT SUCH A PRICE!

- FREQUENCY 120 KC TO 260 MC
- 120 KC TO 130 MC ON FUNDAMENTALS
- LABORATORY ACCURACY AND QUALITY

A completely wired and tested instrument not to be confused with units sold in kit form at almost the same price, but with a quality and accuracy of instruments 3 to 4 times its price. Six overlapping ranges generate signals of 120KC — 320KC, 320KC—1000KC, 1MC—3.2MC—11MC, 11MC—38MC and 37MC—130MC all on fundamentals with calibrated harmonics from 120MC to 260MC. Selector switch gives instant choice of ranges. Switch gives choice of internal modulation of 400 CPS or use of any external source at other frequencies. For audio testing the 400 cycle signal can be used separately. Outputs are unmodulated RF, modulated RF and 400 CPS audio. RF output is in excess of 100,000 microvolts and jacks are provided for choice of either high or low RF output. Stability is insured by special circuit design. Has a fine adjustment RF control. AF output is 2-3 volts, AF input is 4 volts across 1 megohm. Large clear 5 inch etched dial plate and pointer are protected by transparent plastic bezel. Common AF terminals for EXT-MOD input and INT-AF for audio tests eliminate need for special AF output connectors. Machine engraved panel lettering. Handsome gray metal case with carrying handle. Measures 6 1/2" x 10" x 4 1/2". Comes complete with pair of leads, AC line cord and plug. Operates on 105-125V 50-60 cycle AC. Shpg. wt., 8 lbs.

22.50

Outputs are unmodulated RF, modulated RF and 400 CPS audio. RF output is in excess of 100,000 microvolts and jacks are provided for choice of either high or low RF output. Stability is insured by special circuit design. Has a fine adjustment RF control. AF output is 2-3 volts, AF input is 4 volts across 1 megohm. Large clear 5 inch etched dial plate and pointer are protected by transparent plastic bezel. Common AF terminals for EXT-MOD input and INT-AF for audio tests eliminate need for special AF output connectors. Machine engraved panel lettering. Handsome gray metal case with carrying handle. Measures 6 1/2" x 10" x 4 1/2". Comes complete with pair of leads, AC line cord and plug. Operates on 105-125V 50-60 cycle AC. Shpg. wt., 8 lbs.

LAFAYETTE LSG-10 SIGNAL GENERATOR

22.50

NEW POCKET AC-DC VOM MULTITESTER
2,000 ohm per volt sensitivity on both DC and AC

160 ua 3" METER
1% PRECISION RESISTORS
SILVER CONTACT SELECTOR SWITCH

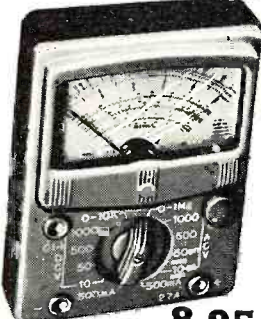

FULL SCALE RANGES
DC Volts: 0-10; 0-50; 0-500; 0-1000 Volts — AC Volts: 0-10; 0-50; 0-500; 0-1000 Volts—DC Current: 500 ua and 500 ma — Resistance: 0-10K; 0-1 Meg — Decibels: -20 to +22; +20 to 36 db (0 db = 0.775 V)—Capacity: 250 mmfd to .2 mfd—.005 mfd to 1 mfd—Output Ranges: 0-10; 0-50; 0-500; 0-1000 volts

8.95

Best Buy in America! A very accurate and sensitive VOM. This Multitester is a complete instrument (not a kit) with high quality and sensitive 160 microamp meter; 2000 ohm per volt on both AC and DC. Single selector switch, 1% accuracy and ruggedness, 3" meter. Features extreme versatility, with metal bottom for ruggedness and shielding. First capacity range requires 50 volt AC source. Second capacity range requires 10 volt AC source. Size 4 1/4" x 3 1/2" x 1 1/8". Complete with test leads and batteries. Shipping weight, 4 lbs.

RW-27A

Complete 8.95

NEW!

LAFAYETTE CAPACITANCE-RESISTANCE TESTER WITH "IN-SET QUICK CHECK"

COMPLETELY WIRED AND TESTED

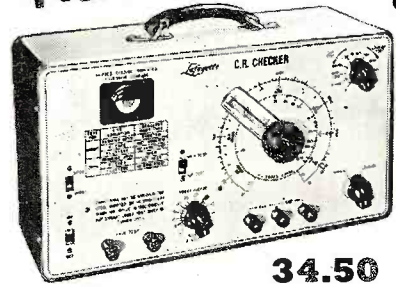

- TWO INSTRUMENTS IN ONE
- CHECKS ELECTROLYTIC, PAPER, MICA AND CERAMIC CONDENSERS
- 4 DIRECT READING CAPACITY SCALES FROM .00001 MFD TO 1000 MFD
- CHECK FOR OPEN SHORTS, LEAKAGE AND INTERMITTENTS
- 2 RESISTANCE RANGES FROM 100 TO 5 MEGOHM

Here is a "must" for servicemen and lab technicians. A completely self-contained AC operated capacitance and resistance bridge, plus a quick check for in the set testing. Large 5 direct reading scale has 4 ranges of .00001-.005 MFD, .001-.5 MFD, 1-50 MFD and 20-1000 MFD. Resistance ranges are 100;50,000 OHMS and 10,000 to 5 megohm. Quick check feature enables you to check capacitors for shorts, open or intermittent while in circuit—no need to remove them from the set. All you're sure they need replacement. Leakage test switch gives you choice of 25, 150, 250, 350 or 450 volts for checking leakage under correct potential. Separate power factor control with continuous settings from 0 to 50%. Operation is simple and accurate, using a magic-eye tube as the null detector. Attractively finished steel case with etched panel and rounded corners, measures 1 1/2" L x 8 1/4" H x 5" D. Shpg wt. 19 lbs.

34.50

you choice of 25, 150, 250, 350 or 450 volts for checking leakage under correct potential. Separate power factor control with continuous settings from 0 to 50%. Operation is simple and accurate, using a magic-eye tube as the null detector. Attractively finished steel case with etched panel and rounded corners, measures 1 1/2" L x 8 1/4" H x 5" D. Shpg wt. 19 lbs.

MODEL LC-4

NET 34.50

HIGH SENSITIVITY 20,000 OHM PER VOLT DC 10,000 OHM PER VOLT AC MULTITESTER

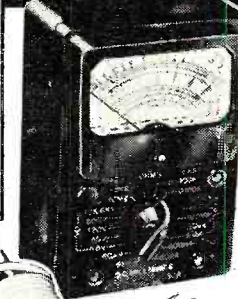

LOOK AT THESE FULL SCALE RANGES!
D.C. Volts: 0-6; 0-30; 0-120; 0-600; 0-1200; 0-6000 Volts — A.C. VOLTS: 0-6; 0-30; 0-120; 0-600; 0-1200 Volts — RESISTANCE: 0-10K; 0-100K; 0-1 Meg; 0-10 Megohms — D.C. CURRENT: 0-60 Microamp; 0-6; 0-60; 0-600 Milliamps — DECIBEL: -20 to +17 db (0 db = 0.774V) — CAPACITY: .0001-.01; .005-.15 mfd — INDUCTANCE: 20-2000 millihenry — OUTPUT RANGES: 0-6; 0-30; 0-120; 0-600; 0-1200 Volts

19.95

The new Lafayette high sensitivity Multitester is a complete instrument (not a kit). In addition to its unusual sensitivity of 20,000 OHMS PER VOLT ON D.C. AND 10,000 OHMS PER VOLT ON A.C., and the extraordinary number and scope of its ranges, it is packed with features that would make it highly made in this country. Uses 1% precision resistors, silver contacts on selector switch, 35 ua 3" meter. Dependable, rugged and accurate. Even the test leads are heavy duty with high voltage insulation. Voltage source required for low capacity range is 120V A.C., for high range capacity and inductance scale is 6V A.C. Attractive plastic front with metal bottom. Size 6 1/4" x 4 1/2" x 2 1/2". Complete with batteries and leads. Shipping weight 4 1/2 lbs.

RW-30A

Singly, Each 19.95 In lots of 8, Each 19.25

NEW!

LAFAYETTE CAPACITOR-RESISTANCE TESTER

COMPLETELY WIRED AND TESTED

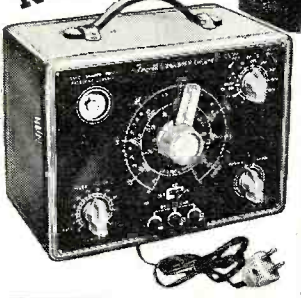

- COMPLETELY WIRED AND TESTED
- CHECKS ALL TYPES OF CONDENSERS FOR CAPACITY, LEAKAGE, OPEN SHORTS OR INTERMITTENT CONDITION
- DIRECT READING SCALES FROM .00001 TO 1000 MFD AND 100 TO 5 MEGOHMS

21.50

A stable and accurate bridge type circuit measures capacitance in 4 ranges of .00001-.005 MFD, .001 to .5 MFD, 1 to 50 MFD and 20 to 1000 MFD. Two resistance ranges of 100-50,000 and 10,000 to 5 megohms. Check leakage under actual load with choice of 25, 150, 250, 350 or 450 volts available by selector switch. Power factor control from 0 to 50%. Checks for leakage, open, short, or intermittent operation. All readings taken directly off scale, after setting magnetic null. Completely self-contained power supply. Attractively finished steel case with rounded corners and etched panel. Operates from 110V AC. Size 9 3/8" L x 7 1/8" H x 5 1/4" D. Shpg. wt. 10 lbs.

MODEL LC-15

NET 21.50

Lafayette Import Special! TRANSCRIPTION TYPE MANUAL PLAYER

- MAGNETIC BRAKE FOR FINE ADJUSTMENT OF EACH SPEED
- 4-POLE, HEAVY DUTY TRANSCRIPTION-TYPE MOTOR
- STYLUS WEIGHT ADJUSTMENT SCREW ON TONE ARM

Complete Turntable and Tone Arm Assembly at the lowest price Ever for Such High Quality

Here is a new manual player for the audiophile who wants noiseless, "wow-free" and rumble-free reproduction of recorded music at nominal cost. All the important features of professional transcription players have been incorporated in this precision turntable. The lightweight pickup arm is an integral part of the mounting plate and requires no installation. Player is equipped with a heavy duty, 4-pole, 3-speed motor for 78, 45 and 33 1/3 RPM records. An exclusive magnetic brake controlled by knob on the base plate, permits instantaneous fine adjustment of each speed. Stroboscope disc included with unit, checks speeds. Extremely smooth and quiet operation. No hum even with the most sensitive cartridges. Speed selector safety switch protects mechanism by making it necessary to pass through an OFF position when switching from one speed to another. Has automatic motor shut-off at end of record. 10" diameter, weighted cast iron turntable is supplied with a rubber traction mat for positive grip of record. Stylus pressure adjustment can be made easily and quickly with the conveniently located adjusting screw on the underside of the tone arm. Mounting plate is also equipped with pickup rest and ON-OFF switch. Dimensions of mounting plate: 12-15/16" left to right, and 10 1/2" front to rear. Requires 2 3/4" clearance below motor board and 3" above. Supplied with AC line cord, two plug-in heads, output cable for connection to amplifier and 45 RPM adapter. For 105-120 volts, 60 cycle AC. Shpg. wt., 12 lbs. Less cartridge. (NOTE: For protection in shipping, tone arm is separate. Just fasten to mounting plate.)



24.50

- PK-160 Manual PlayerNet 24.50
- PK-164. Same as above except equipped with genuine GE triple-play magnetic cartridge and dual diamond-sapphire stylus 36.50
- Wood base, cut out for PK-160 Manual Player. Top quality veneer attractively finished in mahogany or blonde (Specify).
- PK-162. Shpg. wt., 5 lbs.Net 3.95
- Unfinished mounting board only, cut out for PK-160 player. Strong, durable 3/4" gumwood, ready for stain or paint.
- PK-163. Shpg. wt., 1 lb.Net .95

LAFAYETTE RADIO DEPT RF1
JAMAICA 33, N. Y. 165-08 Liberty Ave. Write for FREE Bargain Packed Catalog!

100 SIXTH AVE., NEW YORK, N. Y.
BOSTON, MASS., 110 Federal St.
PLAINFIELD, N. J., 139 West 2nd St.
NEWARK, N. J., 24 Central Ave.
BRONX, N. Y., 542 E. Fordham Rd.

RADIO & TV NEWS

FREE! LAFAYETTE CATALOG



ELECTRONIC CATALOG PACKED WITH MONEY SAVERS

Packed with the largest selection of Electronic, Radio and T.V. Parts, and equipment, PA, Hi-Fi systems, tubes, antennas, Transistor Kits, parts and components, Test Equipment, new build your own kits, tools, books, Microscope, drafting equipment, Binoculars, Telescopes, All Radio, TV and Ham supplies — ALL AT GREAT SAVINGS — For the economy minded servicemen, dealer, engineer and technician. **CHUCK FULL OF BUYS! SEND FOR YOUR FREE COPY TO-DAY.**

PROFESSIONAL TRANSCRIPTION TURNTABLE AND VISCOUS-DAMPED TONE ARM THE FINEST TRANSCRIPTION TURNTABLE AND TONE ARM FOR THE PROFESSIONAL USER AND THE AUDIOPHILE



PK-300 TURNTABLE, PK-90 TONE ARM AND G.E. CART, RIDGE WITH GENUINE DIAMOND AND SAPPHIRE TYLI.

72.50

LATEST IMPROVED MODEL PK-300 TRANSCRIPTION TURNTABLE

New 3-speed instrument with built-in stroboscope and viewer for exact speed determination, and magnetic brake for instantaneous speed variation. Precision engineered to meet professional standards for wow, rumble and flutter content. Heavy 12" cast aluminum rim-driven turntable. Variable speed control permits adjustment of each speed within $\pm 7\%$ using efficient frictionless magnetic brake. Heavy-duty constant speed 4-pole induction motor freely suspended and isolated by shock-mountings to eliminate vibration transfer. R-C filter network suppresses "pop" in speaker. Truly a delight for the connoisseur. Size: 13 1/2" x 14" and requires 2 3/4" clearance above and 3 3/4" below motorboard. For 110-130V and 60/50 cycle AC. Power consumption 12 watts. Handsome hammertone gray finish. Shpg. wt., 20 lbs.

PK-300 Net **49.50**

ILLUMINATED BUILT-IN STROBOSCOPE & VIEWER

COMBINATION

DEAL



PK-90

PK-90 VISCOUS-DAMPED TONE ARM

This transcription arm assures dependable and stable operation, utilizing the "floating action" principle of friction. Damping is accomplished by a silicone fluid occupying the gap between a ball and socket. This damping control permits high compliance and negligible tracking error, and prevents damage to either record or stylus should the tone arm be accidentally dropped. Low frequency resonance, skidding and groove-jumping are likewise minimized. The tone arm accepts all records up to 12" and accommodates virtually all hi-fi cartridges by means of precisely engineered adapters which simplify installation and provide proper stylus pressure.

This tone arm is a quality companion to the PK-300 with matching finish. Shpg. wt., 2 1/2 lbs.

PK-90 Net **15.95**

New!



HIGH FREQUENCY TWEETER WITH ACOUSTIC LENS DIRECT IMPORTATION MAKES THIS PRICE POSSIBLE!

- FREQUENCY RESPONSE FROM 2000 CPS TO BEYOND AUDIBILITY
- LOUVERED ACOUSTIC LENS FOR UNIFORM SOUND DISPERSION
- HANDLES 25 WATTS OF POWER
- PRICED EXCEPTIONALLY LOW

14.95

New high frequency tweeter featuring a louvered acoustic lens for uniform sound dispersion and capable of handling up to 25 watts of distortion-free power. The directional tendency of high frequency notes is overcome by the natural wide dispersion angle of the short horn and the acoustic lens which disperses and radiates the high notes smoothly throughout the entire listening area. The lens is detachable for panel mounting, with a separate base for the tweeter furnished for external mounting where desired. Aluminum voice coil has 16 ohms impedance. Size: 4 1/4" long x 3" diameter, lens extends 2 1/2". Requires a crossover network, preferably one with a level control, such as the LN-2. With full instructions. Shpg. wt., 5 lbs.

HW-7 Net **14.95**

METAL-CASED CONE TYPE HI-FI TWEETER FREQUENCY RESPONSE 2000-16,000 CPS HANDLES 20 WATTS OF POWER

Highest quality cone type high frequency tweeter having a range from 2000 to 16,000 cycles. Especially efficient at higher end of audio spectrum where other cone type tweeters tend to lose clarity and volume. Entirely closed in a metal case with a base so that it can stand by itself or be mounted on a flat surface with mounting bracket supplied. Rated to handle 20 watts of power. A crossover network is required; the Lafayette LN-2 is ideal. Voice coil impedance 8-16 ohms. Size: 3 1/8" x 2 1/8" x 3" diam. Shpg. wt., 3 lbs.



HK-3 Net **5.95**

5.95 Net

CROSSOVER NETWORK • CAPACITIVE-INDUCTIVE NETWORK WITH CROSSOVER AT 2000 CPS • BUILT-IN LEVEL BRILLIANCE CONTROL



8.75

The frequencies above 2000 cycles are channeled to the high frequency tweeter by means of the high-Q inductance and capacitance comprising this efficient crossover network. The highs and lows are brought into acoustic balance by means of a continuously variable level-brilliance control. Control has a 2 1/2 ft. long cable for remote mounting. Network matches 8-16 ohm speakers with insertion loss reduced to a minimum. Enclosed in metal case 6" L x 2 3/8" H x 2 3/8" D. With full instructions. Shpg. wt., 5 lbs.

LN-2 Net **8.75**

3 WAY CROSSOVER NETWORK

Carefully designed and engineered to Lafayette's own specifications. Insertion loss is well below the acceptable minimum. Crossover is at 350 and 5000 cycles. Permits full enjoyment of any 3 way system. Properly balances woofer, mid range speaker and tweeter inputs. Complete with 2 continuously valuable "presence" and "brilliance" controls for tonal adjustment and full instructions. 8" L x 3 3/4" H x 2 3/4" W. Shpg. wt., 7 lbs.

LN-3 Net **14.95**



14.95

LAFAYETTE FM-AM TUNER KIT

Build Your Own Hi-Fi Tuner Kit and Save!



KT-100

- SIMPLIFIED DETAILED INSTRUCTION MANUAL
- MEETS FCC REQUIREMENTS FOR RADIATION
- GROUNDED GRID TRIODE AMPLIFIER
- ARMSTRONG FM CIRCUIT WITH FOSTER-SEELEY DISCRIMINATOR
- AFC DEFEAT CIRCUIT WITH FRONT PANEL CONTROL

The excellence of its design and the quality of its components combine to provide this compact high-fidelity FM-AM tuner with superb characteristics normally found in units costing several times as much, and with performance unbelievable at this low price. Features Armstrong FM circuit with limiter and Foster-Seeley discriminator. Simplified tuning with slide-rule dial and flywheel counterweighted mechanism. AFC defeat circuit combined with tuning control. Attractive etched copper-plated and lacquered finish.

SPECIFICATIONS

FREQUENCY RANGE: FM, 88-108 MC; AM, 530-1650 KC. **ANTENNA INPUT:** FM, 300 ohms; AM, Ferrite loopstick and high impedance external antenna. **CONTROLS:** 2—a function control for AM, FM, PHONO, TV and a tuning/AFC defeat control. **DISTORTION:** Less than 1% rated output. **FREQUENCY RESPONSE:** FM ± 5 db 20 to 20,000 cps; AM, ± 3 db 20 to 5000 cps. **SENSITIVITY:** FM, 5 μ v for 30 db quieting; AM, Loop sensitivity 80 μ v/meter. **SELECTIVITY:** FM, 200 KC bandwidth, 6 db down — 375 KC FM discriminator peak to peak separation; AM, 8 KC bandwidth, 6 db down. **IMAGE REJECTION:** 30 db minimum. **HUM LEVEL:** 60 db below 100% modulation. **TUBE COMPLEMENT:** 2-12AT7, 1-6BA6, 1-6BE6, 2-6AU6, 1-6AL5 plus 1-6X4 rectifier. **SIZE:** 5 1/2" high x 9 3/4" wide x 9 1/2" deep (excluding knobs). **CONSUMPTION:** 30 watts. For 110-120V 60 cycles AC. Less metal case. Shpg. wt., 9 lbs.

KT-100 kit, less cage Net **34.95**

ML-100—Metal cage for above, shpg. wt., 3 lbs. Net **5.00**

Lafayette
Radio
DEPT RF2

165-08 LIBERTY AVE.
JAMAICA 33, N. Y.

NAME _____
ADDRESS _____
CITY _____
ZONE _____
STATE _____

SEND
FREE
LAFAYETTE
CATALOG

CUT OUT AND MAIL TODAY!

The Amazing New

WUERTH SURGISTOR

\$1.85
LIST

Model 100-2 100-300 Watt Loads

SURGISTORS WILL:

1. More than triple tube life.
2. Keep no-load surge voltages off electrolytic capacitors.
3. Limit surge voltages in silicon rectifiers.
4. Reduce in-rush currents in power transformers.
5. Greatly increase pilot bulb life.
6. Provide a new standard of reliability for all electronic devices.

FOR USE ON:

1. Television Receivers, AC or DC, series or parallel heaters.
2. Hi-Fi Equipment
3. Public Address Systems
4. Juke Boxes
5. Electronic Organs



To Eliminate Destructive In-Rush Currents in Television & Radio Sets

A SURGISTOR is a new component combining the functions of a resistor and a relay. It is connected directly into the power line circuit of any electronic device. A SURGISTOR limits the in-rush current until the tube heaters are warmed sufficiently to accept the full voltage without damage. In addition, B plus voltages are temporarily held down to prevent cathode "stripping."

DISTRIBUTORS: Write today for full information.

WUERTH TUBE-SAVER CORPORATION

9125 LIVERNOIS AVE., DETROIT 4, MICH.

Repairing Shorts in Vacuum Tubes

By HYMAN HERMAN

OF THE many tubes discarded each year by service technicians, a surprising number could have been restored to useful service. Many tubes in otherwise good condition are ruled defective because of inter-electrode shorts. For years, it has been the practice to remove such shorts, where possible, in picture tubes. The same can be done with other tubes.

The circuit described here will determine whether such shorts exist and, if they do, between what elements. It will also remove many of these shorts. The device has enabled the author to salvage more than 15 per-cent of so-called "defective" tubes.

The three commonly used tube sockets are wired to two single-pole, 10-position switches so that all # 1 pins connect to the #1 switch positions, #2 pins to the 2# switch positions, and so on. Switch #1 is connected to "B+" and switch #2, through a 10-watt, 117-volt lamp, to "B-."

With the tube in its socket and the power switch on, switch #1 is progressively advanced through all positions. In each of its positions, switch #2 is rotated through all of its positions. In this way, all possible inter-electrode shorts are checked.

When a short completes the circuit, the lamp lights. Examination of the tube's basing diagram will show where continuity should legitimately be expected. When an unwanted short appears, current through the lamp will burn it out if it is caused by particles wedged between electrodes.

The limiting action of the lamp prevents burn-out of all except the 1.4-volt tubes used in portables. The latter should not be used with this device. A tube that has been restored with this device should be otherwise checked for quality before being returned to service.

-30-

Circuit of the tube short remover.

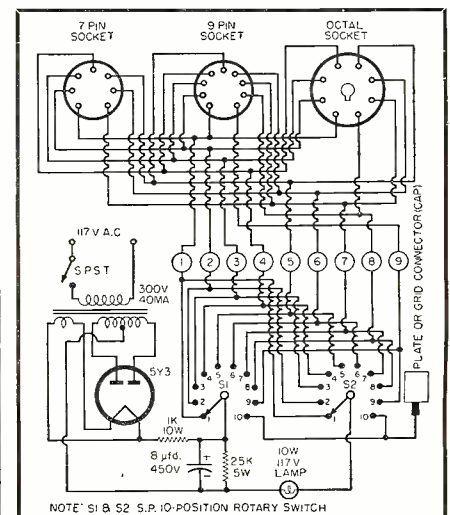

RADIO & TV NEWS

Build-it-Yourself..

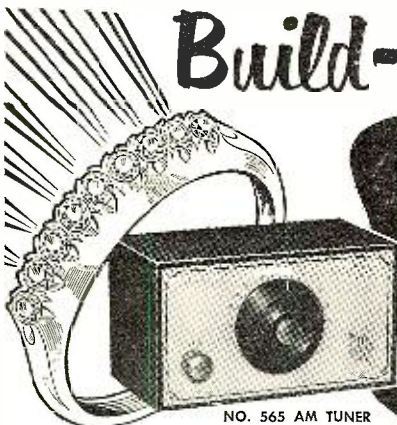

NO. 565 AM TUNER

the perfect mate

MILLER AM HIGH FIDELITY CRYSTAL DIODE TUNER

It's the perfect mate for your FM tuner... the Miller 565 Tuner Kit for the finest in AM reception. Designed and planned by master electronic engineers with over thirty years of manufacturing experience in quality radio components... the name Miller stands for the highest professional standards of quality and uniformity. Previously sold only as a factory assembled unit the most critical audiophiles have accepted the Miller 565 Tuner Kit for top performance when selecting a companion set or solo AM tuner. Only recently have materials become available which make possible the construction of extremely high "Q" coils. Coils used in this tuner have a "Q" in the order of 600. Assembly and wiring of this tuner have been so simplified that the novice may complete the unit in a matter of a few hours. Pictorial instructions as well as circuit diagrams are supplied with each kit.

COMPLETELY WIRED 595 AM TUNER ALSO AVAILABLE. PRICE \$19.50 plus Excise Tax

No Power Requirements • Selectivity (20 KC) • Low Cost • No Noise • Lifetime Trouble Free Operation • Sensitivity Gain Control • Small size 4" x 7" x 3 1/2" deep • Vernier dial • Nothing to cause distortion • Frequency 540 KC-1700 KC

The 565 AM Tuner Kit is fully guaranteed. Buy with confidence from your Radio and TV Parts Distributor. It is one of the lowest priced quality tuner kits on the market.

Net Price

\$14.70

J. W. MILLER COMPANY • 5917 So. Main St., Los Angeles 3, Calif.

"Pure Signal" CRT Eliminates TV Stage

This multi-beam picture tube can be driven directly by video detector.

A PICTURE tube now being shown both to receiver and CRT manufacturers can produce a full-contrast picture with no more drive than is obtainable from the video detector. A product of *Multi-Tron Laboratory*, the new display tube looks just like conventional CRT's. In fact, according to Nicholas Glyptis, president of *Multi-Tron*, its principle can be adapted to any bulb type now in use.

Distinctive feature of the new tube is its internal structure: it works on the multi-beam principle, rather than with a single electron beam. In operation, the spot on the screen is produced by the intersection of the beams. Spot brightness can therefore be controlled by modulating more than one beam. With more than one beam thus controlled, the sensitivity of the tube is increased to the point where only 5 to 10 volts drive, peak-to-peak, is necessary to produce an image of full contrast.

Since signal amplitudes of this order are common at the output of conventional crystal detectors in modern TV receivers, the need for a video-amplifier stage is at once eliminated. The accompanying illustration shows a detector stage designed to provide a.g.c. voltage, take-off points for the sync and audio i.f. stages, and drive to the picture tube. Elimination of the video amplifier means elimination of a stage that involves as many as 22 components. To the set manufacturer, this can mean a considerable saving in production costs. Aside from the tube used as the video amplifier and the usual group of resistors and capacitors for that stage, there are the peaking coils and other additional components needed to compensate the amplifier.

Designers of the tube report that retooling and redesign problems for those who manufacture the picture tubes or the sets are minor. Aside from the elimination of the video amplifier stage or stages, the receiver manufacturer will only be concerned with minor circuit rewiring. Since it is recommended that the receiver be operated at maximum sensitivity, removal of all a.g.c. voltage from the r.f. section is advised. The i.f. section will still be gain-controlled, but a.g.c. voltage to this strip should be reduced.

Quantity production of the tube should be no problem, according to *Multi-Tron*, as design tolerances meet the present standards of tube manufacturers. The multiple-beam CRT will also be of interest to those working toward a transistorized TV receiver. -50-

Detector drives CRT, sync. a.g.c., and audio i.f. circuits.

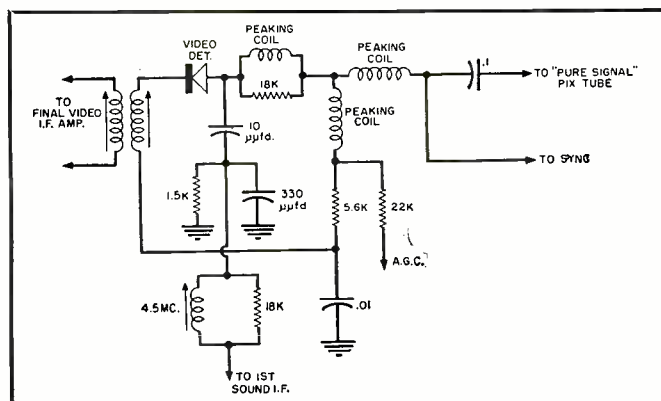

LOOK!

A General Electric GERMANIUM RECTIFIER specifically designed for TV replacements

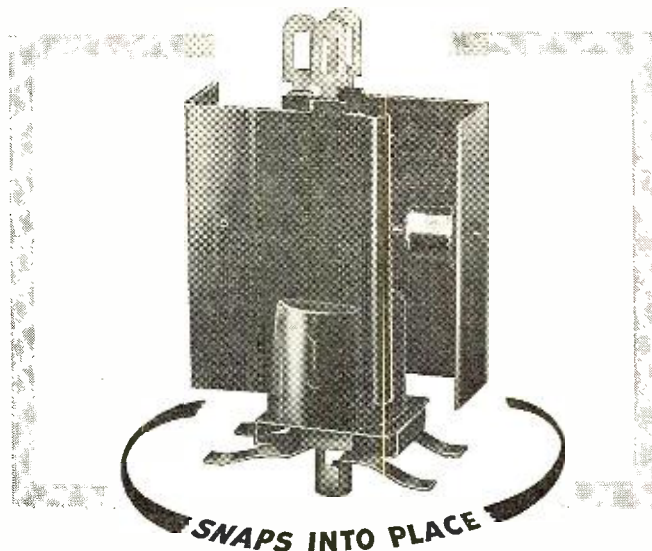

- ★ Snap-In Installation
- ★ Competitively Priced
- ★ Full Year's Written Warranty
- ★ Full Power Performance—no aging or fading

TV servicemen in the know are surging to General Electric's *proved* Germanium Rectifier. It's the new rectifier that goes in faster and easier, sustains full power and just about ends return calls on voltage troubles.

General Electric Germanium Rectifiers are backed by a record of more than six years of successful service in the field. The performance of these TV rectifiers has been checked in current television chassis by a leading independent testing organization.

Your outstanding advantage in General Electric Germanium Rectifiers is the ease of installation. They snap into place—faster than the old one comes out. No brackets to add, no drilling, reaming, or tapping to make them fit. And you don't have to install "heavy duty" or super-rated rectifiers to make sure of adequate voltage six months or a year later.

**FREE...
REPLACEMENT
GUIDE**

The General Electric Germanium TV Rectifier REPLACEMENT GUIDE tells you exactly which model fits your customer's set, and contains other useful data. Get your copy, free...at your G-E tube distributor now. Or, write directly to *General Electric Company, Semiconductor Products, Section S5867, Syracuse, New York.*

Progress Is Our Most Important Product

GENERAL  ELECTRIC

BUILD THE BEST—
BUILD ALLIED'S OWN
knight-kits

Here is a typical Knight-Kit value—available only from ALLIED—one of 45 great Knight-Kits you'll find in our special Supplement No. 165. Write for your FREE copy today.

knight-kit INSTRUMENT VALUE
5" GENERAL-PURPOSE SCOPE KIT



Model
Y-146
\$49.50

Feature for feature, the world's best scope kit value. Equal in performance to wired units several times its price. Ideal for radio and TV servicing, audio work and hundreds of other applications. Phantastron sweep circuit provides extreme sweep linearity; retrace blanking on all ranges eliminates retrace lines; vertical sensitivity is three times that of comparably priced scope kits. Printed circuit and laced wiring harness speed assembly. SPECIFICATIONS: *Vertical Response*—±3 db, 3 cps to 1.5 mc.; ±6 db to 2.5 mc. *Vertical Sensitivity*—.025 rms v/inch. *Sweep*—15 to 150,000 cps in 4 ranges. *Horizontal Sensitivity*—.07 rms v/inch. *Vertical Input Imp.*—3.3 meg shunted by 45 mmfd. *Calibrating Voltage*: 1 volt peak-to-peak, applied by push-button switch. Complete with 5" CRT, wire, solder, etc. 9 1/4 x 13 3/4 x 17 3/4". Shpg. wt. 28 lbs.

Model Y-146. Net, F.O.B. Chicago... **\$49.50**

OTHER knight-kit INSTRUMENT VALUES



5" WIDE-BAND SCOPE KIT
Y-144 \$69.00



VOLTAGE CALIBRATOR KIT
Y-136 \$127.5



HIGH-GAIN SIGNAL TRACER KIT
Y-135 \$26.50



TV-FM LINEAR SWEEP GENERATOR
Y-123 \$44.75

See our Supplement No. 165 for 18 other knight-kit instrument values

free SUPPLEMENT
featuring knight-kits



Send for our FREE Supplement No. 165 featuring 45 great Knight-Kits, including Test Instruments, Hi-Fi, Hobbyist and Amateur Kits. Write for your copy today.

ORDER FROM
ALLIED RADIO

Dept. 01-F-7 100 N. Western Ave., Chicago 80, Ill.

New Tube Tester Data

Settings for testing some of the newer tubes on two popular Triplett model tube checkers.

TRIPLETT MODELS 2413 & 3212

TUBE TYPE	KNOBS			LEVER POSITION	
	A Cir.	B Fil.	C Load	Up	Down
2B3 (Good tube reads 10)	3	2	100	1345678	2
2BN4 (Pins 2 and 7 also show short)	3	2	18	3	146
3CE5 (Adapt BX)	2	5	20	3	247
3DT6 (Adapt BX)	1	5	22	3	24
5AS4 (Test 1 & 2)	1-1	5-5	25-25	126-124	8-8
5BR8	2	5	20	46789	35
5BR8 (Test 2)	2	5	20	1234	58
5CG8	1	5	21	4679	358
5CG8 (Test 2)	1	5	21	124	358
5V3	3	5	25	135678	2
5V3 (Test 2)	3	5	25	134578	2
6BL4	5	6.3	18	2468	37
6BN4 (Pins 2 and 7 also show short)	3	6.3	18	3	146
6BR8	2	6.3	20	46789	35
6BR8 (Test 2)	2	6.3	20	1234	58
6BW4	5	6.3	20	123468	59
6BW4 (Test 2)	5	6.3	20	234678	59
6CB5A (Move pins 4 & 5 and pins 1 & 8 at same time on shorts test)	2	6.3	20	2	367
6CE5	2	6.3	20	3	247
6CG8	1	6.3	21	4679	358
6CG8 (Test 2)	1	6.3	20	124	358
6CH7	1	6.3	22	46789	35
6CH7 (Test 2)	1	6.3	22	1234	589
6CH8	2	6.3	22	23467	15
6CH8 (Test 2)	2	6.3	21	1489	56
6CU5 (Pins 2 and 5 also show short)	3	6.3	19	3	14
6DN6	3	6.3	18	1246	37
6DT6	1	6.3	22	3	24
12CU5 (Pins 2 and 5 also show short)	3	12.6	19	3	14
12DQ6	3	12.6	18	12369	78
12K5	1	12.6	22	3	14
5647	1	6.3	23	2	34
CK5694	1	6.3	24	2568	17
CK5694 (Test 2)	1	6.3	24	1234	78
5852	5	6.3	20	12456	78
5852 (Test 2)	5	6.3	20	12346	78
5915A	2	6.3	22	3	2457
5915A (Test 2)	1	6.3	44	3	124
CK5967 (Adapt. BW)	1	1.2	24	2678	45
CK5967 (Adapt. BW, Test 2)	1	1.2	24	1237	45
6145	3	6.3	18	15	78
6267/EFS6	1	6.3	23	247	35
CK6286	1	1.2	24	2	4
6386	2	6.3	22	15678	29
6386 (Test 2)	2	6.3	22	12345	89
6679	1	6.3	24	45	36789
6679 (Test 2)	1	6.3	24	45	12389
6680	2	6.3	25	10	345
6680 (Test 2)	2	6.3	25	10	458
6681	1	6.3	20	10	345678
6681 (Test 2)	1	6.3	20	10	123458

VACATION SPECIALS

WRITE FOR CONCORD'S CAMERA BARGAIN BULLETIN



SOLIGOR "45" 35mm Camera

Camera \$12.75
Case 4.50
Flash 5.50
TOTAL \$22.25

Complete Outfit \$19.95
\$31.90 VALUE

Shutter speeds from 1/25, 1/50, 1/100, 1/200 sec and B, built-in flash synchronization, optical viewfinder, standard accessory clip. Color corrected, coated 40mm f:4.5 Soligor lens in focusing mount with rapid-selector color-coded system. With case and Flash Gun Stock No. SOLIGOR-45 RN-6 Wgt. 2 Lbs.

COMPLETE SYSTEMS for your COTTAGE

Concord's 2 SPEAKER HI-FIDELITY SYSTEM

FULL 10 WATT OUTPUT 3 SPEED CHANGER IN FACTORY SEALED CARTONS

This combination will make all our competitors groan. We have selected the famous Concord 10 watt hi-fidelity amplifier with PP 6V6 output, the renowned VM 3 speed automatic changer with flip-over cartridge and two needles, a fine base for the changer, then we added a Rola 12" woofer PLUS a Utah tweeter with built-in crossover network. Best of all we cut the original price of \$112.50 by more than 50%. Don't hesitate on this one!

CONCORD'S FANTASTIC PRICE **\$55.95** COMPLETE

COMBINED VALUE OVER **\$112.50**

STOCK NO. BUDJ-COMBO-RN-6 Shipping Wgt. 35 Lbs.

10 WATT AUTOMATIC PHONO MUSIC SYSTEM #2

Latest 4 SPEED CHANGER

Famous brands include Bogen, Norelco, British BSR Monarch record changer. Concord goes all out in combining the finest units for their hi-fidelity combination system. No finer 10 watt music system available at any price!

Bogen hi-fidelity amplifier No. Amp-10. \$44.50
Imported British Monarch BSR 4 speed changer with flip-over cartridge. 46.50
Famous Norelco 8" twin cone hi-fi speaker. 16.50
REG. TOTAL. \$107.50

CONCORD'S AMAZING PRICE **\$69.95**

FAMOUS BRAND SAVE **\$37.55**
STOCK NO. COMBO-NO. 2-RN-6. Shipping Wgt. 30 lbs.

CRYSTAL MIKES !!!



MODEL 101-RN-5 Die cast case, baked on gray enamel finish. 6 foot shielded cable, stand adaptor. Response better than 60-7000 CPS. Output level 49 db. Shipping Wgt. 1 lb. Reg. Price \$9.95.

Concord's Closeout Price—Singly \$3.69

Lots of 3 \$3.95 Each

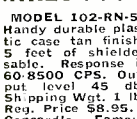

MODEL 102-RN-5 Handy durable plastic case tan finish. 5 feet of shielded cable. Response is 60-8500 CPS. Output level 45 db. Shipping Wgt. 1 lb. Reg. Price \$8.95.

Concord's Famous Price—Singly \$3.25

Lots of 3 \$2.95 Each



SHURE WIRE RECORDING HEAD

\$1.95

Regular \$15.00 Normally sold Mounted in hum-shielded case. Uniform Output. Excellent Frequency Response. Prong Contact. Stock No. WRH-RN-6 8 ozs.

RCA-VICTOR 45 RPM PLAYER

Famous Slide-O-Matic + 6 Best Selling Records

Concord Radio Offers the Finest! RCA-Victor Slide-O-Matic 45 RPM Player-Record Combination! Player PLUS 6 Top Seller 45 RPM Records. Brand New in Factory Sealed Cartons! Your Dealer Cannot Buy These at TWICE Our Price! Save Over 60% Off NET Prices! Reg. Combination.

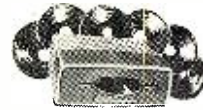

Value \$21.00

Fully Automatic Start and STOP! Famous Recordings by London, Columbia, MGM, Mercury etc.

Concord's Combination Price **\$7.99**

CROSLBY

Famous Transistor Book Radio



\$24.95

Concord's Buyers this hot item and your price is amazingly low! You will thrill at the fine tone of this radio. The handsome binding in genuine leather is made in a book form. A special automatic switch starts radio when cover is raised. Small enough to keep in your pocket.

Sold Nationally for \$54.50. CONCORD'S LOW, LOW **\$24.95** PRICE (Less Batteries) Stock No. BUK-RAD-RN-5, Shipping Wgt. 3 Lbs. Batteries for above—No. 415, \$1.75 (B). No. 423, \$1.68 (A).



3 WAY PORTABLE RADIO **\$17.49** Each

FEATURES
• 4 Tubes plus Rectifier. 1U4 1U5, 1R5, 3V4.
• Built-in Antenna.
• Sturdy Modern Plastic Case.
• Slide-Rule Dial.
• Powerful Circuits Enable Long Distance Reception.
• Lightweight. Weighs 4 Lbs. (Less Batteries).
• Latex Superhet. Circuit. Complete Set of Batteries for above \$3.25
STOCK NO. PRT-3-RN-6 SHIPPING WGT. 6 LBS.

TWO STATION INTER-COM SYSTEM

The Only 3 Tube Inter-Com at This Price

CONCORD EXCLUSIVE!

• Ideal for Offices • Nurseries • Beaches • Camping Trips • Shops • Stockrooms • Home or Office.
Ultra Sensitive
Optional: Additional remote station with push-button selector switch.
Stock No. ITCMR-1-C6
Special Net \$5.95
Additional: 3 cond. cable for above .03 per ft.



\$15.95

Value \$29.95

Stock No. ITCM-1-RN-6 Shipping Wgt. 10 lbs.

FULL 30-35 WATTS FAMOUS UTAH 15"

• HANDLES 35 WATTS.
• RESPONSE: 20-5,000cps.
• VOICE COIL IMPEDANCE 8 OHMS.
• MASSIVE FRAME CONSTRUCTION.
• ONE PIECE CONE.
Shipping Wgt. 13 Lbs.
STOCK NO. UTAH-15-RN-6 **\$27.50**



UTAH WOOFER-TWEETER COMBINATION

When used with companion Utah Tweeter you will have a Hi-Fidelity combination delivering a frequency response of from 20 cps to high frequency beyond audibility.
FREE! FREE! 9 SQ. FT. OF FIBRE GLASS WORTH \$2.95. Ship. Wgt. 16 lbs. Stock No. UT-15-TW-RN-6. **\$32.95**

MULTI-METER



MEASURES UP TO 10 MEGOHMS!
SENSITIVE 160 UA. 2" METER.
Your Complete Lab. Pocket Sized.
AT CONCORD **\$13.75**
EACH
REG. \$29.50

Unmatched performance in a factory wired multimeter. Loaded with features found only in instruments costing many dollars more. Measures resistance up to 10 megohms with internal 22.5 V. battery. Enclosed in durable plastic case. Complete with testprods and battery.
RANGES
Inductance: 0-1000 Henries
AC Volts: 10, 50, 250, 500, 1000 (@ 200 opv)
DC Volts: 10, 50, 250, 1000, 5000 (@ 4000 opv)
DC Current: 250 UA. 2.5 Ma, 25 Ma, 1/2 amp
Resistance: 0-10,000, 100,000, 0-1 Megohm, 10 Megohm.
DB: -20 to +36 DB.
Capacity: 250 MMFD. to .2 MFD.
Size: 3 7/8" x 5 3/4" x 2 1/4"
STOCK NO. TEST-CO-RN-6 Shipping Wgt. 4 Lbs.

CP-6 Pocket Multi-Meter

\$9.75

Each Complete with testprods and battery

Stock No. TEST-CP-6-RN-6

2000 OHM PER VOLT SENSITIVITY!
SENSITIVE 3" 140 UA. METER SILVER CONTACT SELECTOR SWITCH
RANGES
AC Volts: 6, 12, 60, 300, 1200.
DC Volts: 6, 12, 60, 300, 1200.
DC Current: 300 UA, 3 MA, 300 MA
Resistance: 0-10,000 Ohms, 0-1 Megohm.
Decibels: -20 to +17 DB.
Inductance: 0-1000 Henries.
Capacity: 250 MMFD. to .2 MFD.
Size: 3 7/8" x 5 1/2" x 1 3/4"
Shipping Wgt. 4 Lbs.

Your 1957 Catalog Is Ready . . . Write for Free Copy

CONCORD RADIO CORP.

45 Warren St., N. Y. 7, Dept. RN-6

RUSH THE FOLLOWING ITEMS:

1—..... 3—.....
2—..... 4—FREE CATALOG

I AM ENCLOSING \$.....
 SEND C.O.D. I ENCLOSE 20% DEPOSIT

NAME

ADDRESS

XCELITE Hand Tools
PREFERRED BY THE EXPERTS

**No. 99 s.m.
Service Master Kit**

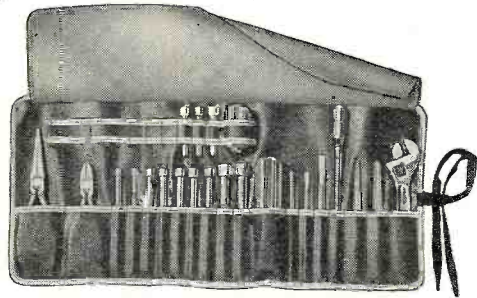

**FOR THOSE
WHO WANT
THE BEST!**

This amazingly compact new XCELITE "99 S. M." roll kit has all these quality XCELITE tools:

1. No. 52 Long Nose
2. No. 55 Side Cutter
3. Stubby Combination Handle with 1/4", 5/16" and 3/8" nut drivers
4. 6" chrome-plated adjustable wrench
5. Regular Combination Handle with
 - a. 9 nut drivers
 - b. 1 Phillips and 2 regular screwdrivers
 - c. 99-X10 Extension shaft (adds 6")
 - d. 3/8" and 1/2" chrome plated SUPREAMERS

Ask your distributor today!

XCELITE, INCORPORATED

Dept. E, Orchard Park, N. Y.

In Canada—Charles W. Pointon Ltd.
6 Alcina Ave., Toronto, Ont.

For Originality
LOOK TO XCELITE

college grads get ahead faster!

... have higher incomes ... advance more rapidly. Grasp your chance for a better life. Share rewards awaiting college-trained men. Important firms visit campus regularly to employ Tri-State College graduates. Start any quarter. Approved for Vets.

Bach. Sc. degree in 27 months

Complete Radio Eng. courses (TV, UHF, FM, Electronics). Also Mech., Civil, Elec., Chem., Aero., Eng. 36-months in Bus. Adm. (Gen. Bus., Acctg., Motor Transport Mgt.). Superior students faster. More professional class hours. Small classes. Enrollment limited to 1550. Beautiful campus. Well-equipped labs. Prep courses. Enter June, Sept., Jan., March. Earnest, capable students (whose time and budget require accelerated courses and modest costs) are invited to write Jean McCarthy, Dir. Adm., for Catalog and "Your Career in Engineering and Commerce."



TRI-STATE COLLEGE
1667 College Avenue Angola, Indiana

KOPELOVE SURPLUS BARGAINS

- BC-906D FREQUENCY METER**
140 to 240 mc. Cavity tuned, battery operated. Complete in wood transportation box. Only **\$6.95**
 - I-196B SIGNAL GENERATOR**
Used with BC-906D. Battery-powered oscillator. Complete with case. Used Only **\$3.50**
 - R-76/ARR-13 Aircraft Receiver**
200 to 400 kc. 12-volt model requires 12 and 200 vdc. New \$12.95. Used **\$7.95**
 - POWER TRANSFORMER** Pri. 110v, 60 c. Sec. 330. 0-330: 5.0 @ 2A.; 6.3 @ 7A.; 6.3 @ .3A. Only \$1.75 each. 3 for **\$5.00**
 - FILAMENT TRANSFORMER** Pri. 110v, 60 c. Sec. 6.3 @ .9A. 3 for **\$1.65**
- All items shipped f.o.b. our warehouse. Include 25% on C.O.D.'s. Ohio residents add 3% Sales Tax. All items subject to prior sale.

KOPELOVE ELECTRONICS CO.
Dept. RN-657, 1919 East First Street, Dayton 3, Ohio

"Operation Smoke-Puff"

By O. F. VILLARD, JR., W6QYT and
R. S. RICH, W6OPX
Radio Propagation Laboratory
Stanford Univ., Stanford, Calif.

AN EVENT of great interest to radio amateurs—in fact to all users of the ionosphere for long-distance communication—occurred on March 12, 1956. On that date an "Aerobee" rocket, fired from Holloman Air Force Base, N. M., into the E-layer of the ionosphere, apparently created a man-made cloud of ionization by releasing some 18 pounds of nitric oxide gas.

That an ion cloud appeared there can be no doubt, since it was detected simultaneously on the screens of at least two different radars. The fact that the cloud showed up shortly after the release of the gas is highly significant. The presumption is, therefore, that the experiment was successful. If ions can be produced in later tests, it will be possible to say that the March rocket firing represents the first time that man has ever created ionization in the ionosphere in an experiment expressly designed for that purpose.

The U. S. Air Force proposes to continue with tests similar to those performed last March and would like to invite radio amateurs and SWL's to participate in the task of determining: (a) whether ion clouds are really formed, (b) how large they are, and (c) what becomes of them after they are formed. All these things can be explored quite effectively simply by seeing to what extent the cloud is capable of reflecting radio waves.

Since the present assault is on the E-region of the ionosphere, the reflecting cloud will be at a height of approximately 70 miles. Owing to the earth's curvature, such a cloud will only be able to reflect signals between stations whose locations are indicated on the map of Fig. 1. This area is centered on the rocket's launching point at Alamogordo, N. M. and is deliberately made a bit generous to account for the possibility that some clouds may drift appreciably during their estimated lifetime of 10 or 20 minutes. The aim, as can be seen, is to generate an artificial patch of "short skip."

Stations at locations within this area wishing to participate in the tests, will be advised by mail of the expected dates and times of rocket firings. They may then listen to the range count-down station, which operates on 4870 kc. and should be audible over most of the area at most times of day. This station broadcasts the status of the test and gives the number of minutes until the expected firing time, followed (for a period) by the number of minutes after the rocket has gone off.

The best frequency band for getting a bounce from the cloud will depend on the time of day. Tests are planned for morning twilight, noon, and evening twilight, and some may be held at night. In general, the 14, 21, 30, 50, and 144 mc. bands may be useful. It is proposed to designate a particular frequency in each band as the one to be used by the stations participating in the test. All participants will be sent a list of each others' call letters so as to save time in checking to see if a station is within the area of the test.

A postcard to the authors of this ar-

TELEVISION

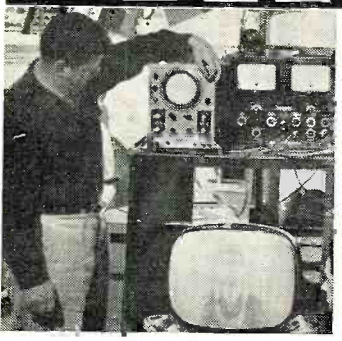

Industry needs Electronic Trained Men Now! Qualify for **BIG PAY JOB**, 9 short months. No other type of training can compare with actual shop practice you get at Healds under expert instructors.

Bachelor of Science Degree, 27 Months

- Electronics Engineering (B.S. Degree)
- Electrical Engineering (B.S. Degree)
- Television Technician (9 Months) Color TV
- Electronics Technician (12 Months)

Heald College ranks **FIRST** West of the Mississippi in "Who's Who in America"

Approved for Veterans

DAY AND EVENING CLASSES

Register Now. Write for Catalog.

(No Obligation.)

AT HEALDS YOU LEARN
BY DOING IN MODERN
ELECTRONICS LABORATORIES

HEALD
ENGINEERING COLLEGE

Van Ness at Post, RTN
San Francisco, Calif.

Your Name

Address

City

State

article who have been designated as coordinators of the amateur activities in connection with the project, in care of the Radio Propagation Laboratory at Stanford University, is all that is required of participants. If you live within the indicated area, your name will be placed on a mailing list and you will receive a questionnaire, some detailed suggestions, logs sheets, and information as to test times. You will also be advised, after each firing, whether the experiment went off as planned.

In order to make this project more enjoyable, it has been decided that each ion cloud test would be run as sort of ad hoc sweepstakes contest, wherein participants would exchange serial numbers and earn a score proportional to the number of stations contacted, the total number of contacts, and the number of bands used. Contestants on a given frequency band may contact each other more than once, but not more often than once every three minutes. The three highest scoring participants (phone, c.w., and SWL) in each rocket firing will receive certificates from the Air Force.

All participating stations should initially have their beams pointing in the direction of Alamogordo and the cloud. Transmission should open up more or less simultaneously. It will be best to start out at a relatively low frequency, say, 14 or 21 mc. As soon as the cloud-reflected signals are identified, an attempt should then be made to operate in the highest available frequency since the high frequencies may be expected to drop out first. A cloud-reflected signal will fade and this fading may help to distinguish such signals from ground wave or extended tropospheric propagation.

Hams and SWL's having tape recorders are asked to record the output of their receivers and send them in on the tape. The recordings will be analyzed for fading rates, etc. and will be quite valuable. Tapes will be transcribed and returned promptly.

Mexican ham and SWL participation is especially sought. Coverage south of the border is urgently needed. XE stations should have a definite advantage over the W's in this contest.

The proposed tests offer a real challenge to skilled ham operators and provides a chance to render an important service in furthering upper-atmosphere research. Here's a chance to make history and have fun too. Anyone for "Operation Smoke-Puff," gang? —30—

Fig. 1. General area in which communication by cloud reflection should be obtainable.



You Don't Need a Degree To Succeed in Electronics HELP YOURSELF THE EASY RIDER BOOK WAY

New release—a brilliant exposition

ENERGY

by Sir Oliver Lodge, F.R.S.

A remarkable book that examines and explains the fundamental forces about us. This classic non-mathematical exposition of this important subject by the eminent English physicist has been specially edited and illustrated for this long-awaited reprint. The subject of energy is presented in a crystal-clear fashion. The author's brilliant word pictures are amazingly thorough and generate complete understanding. Illustrated. Soft cover. 64 pp. #200.....Only \$1.25

coming July

BASIC TELEVISION

by Dr. Alexander Schure

A fabulous non-mathematical "Picture Book" course in 5 volumes covering black and white television from the ground up.

BASIC PHYSICS

by Alex. Efron, E.E., Ph.D.

A thoroughly readable, psychologically organized course, in two volumes, covering classical and modern physics at the intermediate level. It furnishes the background in physics required by all who desire to enrich their knowledge of science for individual and financial advancement. Every effort has been made to make the course self-teachable. Each illustration is carefully selected and executed. The books are rigorously correct technically, yet generate and maintain interest. Basic demonstration experiments are described and model problems are set up and solved. Coming soon.

coming June

CLOSED CIRCUIT TV SYSTEMS PLANNING

by M. A. Mayers & Rodney D. Chipp

This book is devoted to the applications of equipment and planning of closed circuit TV systems for use in factories, railroads, banks, schools, stores and many others.

GETTING STARTED IN AMATEUR RADIO

by Julius Berens W2PIX

Written for the individual who wants to get a license to own and operate his own amateur radio transmitter. It explains the license classes and requirements for each. Fundamentals of electricity and electronics explained in easy-to-understand language. Sample transmitting circuits. Stress placed on learning the International Morse Code, with a diagram of a code oscillator, and code memorization techniques. Numerous questions and answers given as an aid for license examinations. Explanation of the FCC regulations. #199, soft cover, 128 pp. (approx.) \$2.40

IF YOU WANT THE BEST IN TV SERVICE INFORMATION

PHILCO G E EMERSON
ADMIRAL R C A MOTOROLA
SYLVANIA ZENITH WESTINGHOUSE
HOFFMAN CROSLY PACKARD-BELL

Covers Production 1950-1956

RIDER'S NEW SDO

("single diagram only")

SERVICE

ONLY 50¢ PER CHASSIS
AT YOUR LOCAL JOBBER



Buy these and many other RIDER BOOKS at your electronics parts jobber, book store or department store book department. Look for the Rider Bookseller.

BASIC SERIES by

Van Valkenburgh, Nooger & Neville, Inc.

The fabulous picture-text books that teach faster and easier! The theory, principles, and practice of electricity, electronics, and synchros and servos are here presented in a manner that permits a rapid grasp of the fundamentals of these vitally important subjects. Over 2,000 specially prepared illustrations present, explain, and make every topic discussed picture-clear.

Basic Electricity

#169, soft cover, 5 vols., 624 pp., per set \$10.00

#169H, cloth bound in single binding...\$11.50

Basic Electronics

#170, soft cover, 5 vols., 550 pp., per set \$10.00

#170H, cloth bound in single binding...\$11.50

Basic Synchros and Servomechanisms

#180, soft cover, 2 vols., 270 pp., per set \$5.50

#180H, cloth bound in single binding...\$6.95

REPAIRING TELEVISION RECEIVERS

by Cyrus Glickstein

The most modern completely practical book, written by an expert with long experience in television receiver repair. Devoted to troubleshooting and repair techniques which are modern, yet down-to-earth. Covers the use of simple as well as elaborate test equipment of all kinds. Profusely illustrated. Soft Cover, 212 pp., 5 1/2 x 8 1/2", illus. #191.....Only \$4.40

PICTORIAL MICROWAVE DICTIONARY

by Victor J. Young & Meredith W. Jones

This pictorial dictionary, written by two acknowledged experts in the microwave field, presents with rigorous accuracy the microwave language. Derivation, explanation, definition, and illustration are combined in such fashion as to give the reader complete coverage of the microwave activity. Organization of the dictionary makes it easy to use... and very understandable.

Soft Cover, 5 1/2 x 8 1/2", illus.

#188.....Only \$2.95

ELECTRONICS TECHNOLOGY SERIES

edited by Alex. Schure, Ph.D., Ed.D.

An economically priced series of books explaining the basic concepts and principles of individual phases of electronics technology. Each book deals with a specialized subject.

- #166 RC & RL Time Constant Only \$.90
- #166-2 FM Limiters & Detectors Only \$.90
- #166-3 Frequency Modulation... Only \$.90
- #166-4 Crystal Oscillators Only \$1.25
- #166-5 A-M Detectors Only \$1.25
- #166-6 Limiters & Clippers Only \$1.25
- #166-7 Multivibrators Only \$.90
- #166-8 R-F Transmission Lines... Only \$1.25
- #166-9 Amplitude Modulation... Only \$1.25
- #166-10 Blocking Oscillators Only \$1.25
- #166-11 Wave Propagation Only \$1.25
- #166-12 Superheterodyne Converters & I-F Amplifiers Only \$.90
- #166-13 L-C Oscillators Only \$1.25
- #166-14 Antennas Only \$1.50
- #166-15 Inverse Feedback Only \$.90
- #166-16 Resonant Circuits Only \$1.25

FREE! FREE! Handsome genuine leather, gold-stamped bookmark, if you write today for FREE 1957 Spring-Summer Catalog RTN-6.

If your jobber, book or department store does not sell the Rider books you want, order direct by checking book desired in this ad. Add state and city tax where applicable. Canadian prices approximately 5% higher.

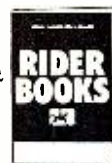

JOHN F. RIDER PUBLISHER, INC. 116 West 14th Street, New York 11, N. Y.

**BUILD THE BEST—
BUILD ALLIED'S OWN**

knight-kits

Here is a typical Knight-Kit value—available only from ALLIED—one of 45 great Knight-Kits you'll find in our special Supplement No. 165. Write for your FREE copy today.

**knight-kit AMATEUR VALUE
50-WATT CW TRANSMITTER KIT**

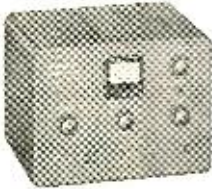

Model
Y-255
\$38⁹⁵

Here's top value for the Amateur—a band-switching transmitter kit for 80, 40, 20, 15 and 10 meters at a new low price. Conservatively rated at 50 watts—actually operates at up to 60 watts input on 80 and 40 meters. Oscillator is highly efficient 6AG7, final is reliable 807 transmitting tube. Pi-output matches 50-1200 ohms impedances—permits use with random length antennas—no need for external antenna tuner or coupler. Controls: Osc. Tuning; Bandswitch; Final Amplifier Tuning; Antenna Loading; Grid-Plate Meter Switch; Off-On Switch. Finest quality components—low-loss ceramic coil forms; RF-type coax connector; copper-finished steel chassis. Effective TVI suppression. Convenient jacks for crystal and external VFO on front panel. With step-by-step instructions. Less crystal and key. Shpg. wt., 19 lbs.

Model Y-255. Net, F.O.B. Chicago... **\$38⁹⁵**

OTHER knight-kit AMATEUR VALUES



SELF-POWERED VFO KIT
Y-725 **\$28⁵⁰**



RF Z-BRIDGE KIT
Y-253 **\$5⁸⁵**



100-KC CRYSTAL
CALIBRATOR KIT
Y-256 **\$10⁵⁰**



TRANSISTORIZED CODE
PRACTICE KIT
Y-239 **\$3⁹⁵**

free SUPPLEMENT
featuring **knight-kits**



Send for our FREE Supplement No. 165 featuring 45 great Knight-Kits, including Test Instruments, Hi-Fi, Hobbyist and Amateur Kits. Write for your copy today.

**ORDER FROM
ALLIED RADIO**

Dept. 01-F-7 100 N. Western Ave., Chicago 80, Ill.

FM "Musicasting" —a New Industry

By **WALTON N. HERSHFIELD**
President, Harkins Broadcasting Co.

One broadcast station's experiences with multiplexing and how it actually pulled the station out of the red.

ON MARCH 28, 1955, the Federal Communications Commission authorized multiplexing on commercial FM stations and created an entirely new industry.

Although faced by such technical problems as crosstalk, multi-path fading, and noise, an intrepid group of pioneers plunged undaunted into the business. In Jackson, Tucson, Phoenix, Cincinnati, Augusta, and many other American cities, salesmen ventured forth to tell American business and industry the story of FM "musicasting" and extol its benefits.

Day and night station and field service technicians worked; installing, aligning, and improving their new product. Daily, the confidence of the salesmen increased and the technicians became more familiar with this intriguing and unique science of transmitting three separate programs, simultaneously, on an FM carrier.

For those unfamiliar with multiplexing, the FM station transmits its regular 50 to 15,000 cycle audio program plus two supersonic tones (usually 41 and 67 kc.) which are above the range of human hearing and inaudible on a regular FM receiver. However, with a special receiver, the supersonic tone is amplified and detected to provide a separate program. This program is usually continuous background music, of constant volume level, without vocals or commercials. The industry has dubbed this service FM "musicasting."

The sales story for FM "musicasting" is one of quality coupled with economy. A simple receiver without moving parts is connected to a standard amplifier and continuous background music is available to the user—usually 19 hours a day, from 6 a.m. to 1 a.m.

The economy of this type of service is obvious since there are no telephone line charges to pay, no expensive record-player or tape recorder to buy, maintain, and operate. The musical variety is limited only by the total number of suitable recordings available at the station. At the author's operation there are 7000 selections, representing some 350 hours of programming without repetition. Only with central programming using eight hour tapes can this variety of selections be made available to the subscribers since few businesses not directly connected with the audio field could afford the

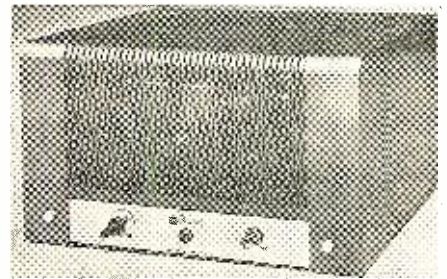

A typical FM "musicast" receiver.

space to store such a varied record collection.

Now for a quick look at the market potential for this type of service. When a group of hard-headed broadcasters leap into an unproven and untried field, you can be certain that there are some substantial incentives behind their decision. A look at any city population index will show that there are over 125 cities in the United States with a population in excess of 100,000. Each of these cities is capable of supporting one or more successful "musicasting" operations.

It is estimated that the average number of subscribers per town is 400. This figure varies, of course, from 100 sets in the smaller communities to 3000-4000 in cities the size of New York, Chicago, and Los Angeles. A little multiplication indicates that there is a potential market for almost 50,000 receivers. The average monthly charge for background music service of this type is \$25.00 per receiver. This means a monthly national rental income of \$1,250,000 or a brand-new industry grossing \$15,000,000 a year—which is not "chicken feed."

The next question that naturally arises is how much does it cost to enter the "musicasting" field. First, of course, you must have an FM station. At KTYL-FM our station was seven years old and had yet to show a nickel's profit. A study of our signal pattern indicated that the station should be able to cover the entire metropolitan area of Phoenix with its total population of 400,000. The market potential was estimated at some 400 receivers.

After careful thought, the station decided against installing and servicing the equipment and arranged with *Ra-Tone Electronics Co.*, a commercial sound distributor, to handle that phase of the operation.

On January 5, 1956 we threw the switch and commercial FM "musicasting" became available throughout the metropolitan Phoenix area. Our first installations, on a trial basis, were in a national chain clothing store, a grocery store, a bank, and one of the local night clubs.

Since that date, our salesmen have placed the service in over 100 establishments in Phoenix and we are adding new subscribers daily. But still more important, the FM station is operating in the black for the first time in its history. Listeners on the regular FM channel can enjoy daily programs of fine classical and semi-classical recordings—a service that the station could not have afforded to continue without the "musicasting" revenue.

Even if you don't own an FM station but still want to get into the "musicasting" field, there are some 600 such stations which could be approached. To date only about 30 FM stations are using their facilities for multiplex operation. Any sound distributor or TV service technician with the capital to invest in receivers (about \$100 per unit) would be welcomed by most FM broadcasters.

Our initial investment in transmitting equipment was about \$6000 including tape machines. Using regular bank financing, our initial capital outlay was only \$3000 for transmitting equipment and receivers. We are not only liquidating our indebtedness to the bank but making a profit. Our associated service organization is enthusiastic since this new venture represents an entirely new field of sound equipment sales to them.

If you are enterprising, have determination, and a little ready cash, a whole new industry is ripe for plucking. —30—

SOLDER GUN "HOLSTER"

By RAY HAWKSLEY

A SIMPLE and sturdy solder gun holder can be made from a piece of $\frac{3}{4}$ " pipe about $3\frac{1}{2}$ " long, fastened to the edge of the bench with an ordinary pipe strap.

This gets the gun off the bench when not in use, but makes it easy to pick up when wanted. The holster also prevents damage to the tip which might occur if the gun were hung up on a nail. —30—

"Holster" your solder gun for safety sake.

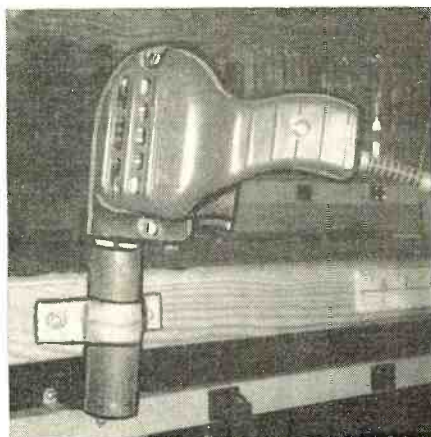

June, 1957

There's **BIG MONEY** in **CALEX** Self Service Tube Testers!



START SMALL . . . CONVINCE YOURSELF! Install the Calex tester of your choice in your shop, or in retail stores. See for yourself Calex sales magic at work . . . growing, steady new tube profits . . . mounting store traffic.

GROW AS FAST AS YOU WANT! Once you've seen the easy, steady income from Calex testers, you'll want to cash in on the tremendous potential all around you. You'll be amazed at the many letters from Drug Stores, Supermarkets and other retail stores actually asking for the Calex tester.

YOU CAN'T ARGUE WITH SUCCESS!

Take it from Servicemen and route operators coast-to-coast who have hopped on the Calex profit wagon

A. L., Filer, Idaho

"Since I set up a Calex tester, my store traffic almost doubled."

J. A., Boston, Mass.

"I now have a route of 30 testers. I actually make more money from these testers than in my service shop."

M. W., San Francisco, Cal.

"I was dead set against self service testers. A friend got me to try one . . . I'm glad I did."

WHY THE CALEX IS THE PREFERRED TUBE TESTER

Calex keeps up-to-date with new tubes. With over 120 sockets, this tester is designed for every popular tube base, and is kept up to date by simply substituting Calex's latest tube chart issued regularly. Now tests over 400 tube types, including radio, battery operated and car radio, series string filament tube types, and those in current model TV sets.

Calex is easy to use. Simple instructions on panel. Automatically tests for shorts when tube is plugged in; then one press of test button gives immediate GOOD-BAD reading on large 5" meter. No roll chart, no switches, no filament settings. Two pin straighteners on panel for customers' convenience.

Practically needs no service. No delicate components in circuit to wear out or change value. Heavy duty transformer. Fuse and grid cap cord replaceable by anyone when necessary.

Calex is accurate. Field tested for over two years. Automatically adjusts to line voltage variations. Proper load on tube simulates condition in receiver.

Calex gives you free promotional support. Attractive, colorful window streamer and other aids bring customers to you . . . sell on sight.

NOW YOU CAN HAVE A FAMOUS CALEX SELF SERVICE TUBE TESTER THE WAY YOU WANT IT!

Select the Calex Tester that suits you best!

- Counter Model \$139.50
 - Counter Model with attractive 3-dimensional flashing electric sign 169.50
 - Floor Model with deluxe 19" x 19" cabinet storing tubes in easy-to-read "egg crate" drawers 250.00
- In lots of 5 222.00 ea.

MAIL COUPON TODAY!

—with 25¢ for complete Sales Plan and Operating Manual. Tells you all you have to know to start and build a successful Self Service Tube Tester business. All forms included . . . no obligation.

CALEX MFG. INC.

3815 Martin Court
Seaford, L. I., N. Y.
CAstle 1-2777

Calex Mfg. Inc. (check one)
 Dept. RN I want to start {
 3815 Martin Court I want to expand route {
 Seaford, L. I., N. Y.
 Gentlemen: Please rush your complete Sales Plan and Operating Manual to me. I enclose 25¢ to cover postage and handling.
 NAME _____
 ADDRESS _____
 CITY _____ STATE _____

TIMELY SUMMER SPECIALS!

TRANSFORMER SPECIALS

No. 2289. 150 MA Power, 750 VCT. 5V @ 3A, 6.3V @ 5A. Upright Mt. Special \$3.95
 No. 10024. 200 MA Power, 800 VCT. 5V @ 3A, 6.3V @ 5A. Half Shell Mt. Special \$4.95
 No. 10026. 200 MA Power, 710 VCT. 5V @ 3A, 6.3V @ 5A. Upright Mt. Special \$4.95
 No. 3105. Audio Output. 8000 Ohm C.T. For PP 6L6 or equiv. 23 W. Output. 8 Ohm Sec. Special \$2.95
 No. 918-976. Filament. 117V 60 cy. Pri. 250V @ 4A Sec. Special \$1.95
 No. 918-664. Audio Output. 9000 Ohm C.T. 25W 8 or 16 Ohm Sec. Chrome finish. Special \$4.95
 Filament Transformer 117 Pri. 6.3V @ 1.5A. Sec. 2500V Ins. \$5.99
 50L6 Output Transformer. \$3.39
 Raytheon #25AX4 H. V. Chassis—Costs less than flyback alone! Complete with flyback, HV socket, HV leads, caps, condensers, resistors, condensers, etc. \$3.95
 Same as above with 3 tubes. \$7.95
 Raytheon A-294902 Front End—Complete front end section for 21" Raytheon. Includes tuner, I.F.'s resistors, condensers \$3.95
 Special Small Parts Bag—Over 300 usable radio and TV parts. This not a surprise package; no junk included. Many parts have been removed from new chassis and sub-assemblies, many are brand new. Contains condensers, resistors, knobs, sockets, switches, etc. A terrific value for only \$3.95 per asst.

ASSORTMENTS

100-100 assorted coils—Sec., R.F., I.F., Peaking, Antenna, etc.—etc. \$30.00 value = \$4.95
 Ceramics—100 asst. tubular and disc type ceramic cond. all Std. values. Stk. = 101. \$1.95 per asst.
 By-Pass—50 asst. paper tubular by-pass condensers. Wide range of std. values guaranteed fresh stk. = 102. \$1.95 per asst.
 Micas—50 asst. std. value mica condensers. Wide range of sizes. Stk. = 103. \$1.95 per asst.
 Resistors—100 asst. carbon 1/2, 1, 2 watt imported resistors. Stk. = 104. \$1.00 per asst.
 Resistors—100 asst. carbon 1/2, 1, 2 watt std. American mfg. AB, Stockpole, IRC, etc. Stk. = 105. \$1.95 per asst.
 Wire-Wound Resistors—50 asst. 5, 10, 20, 25, 50W in wide range of values. Stk. = 106. \$3.95
 Terminal Strips—100 asst. wide range of sizes and shapes from 1 lug to 8 lug. Stk. = 107. \$1.95
 Bathub Condensers—25 asst. Great for building hi-fi amps. & ham equip. Stk. = 108. \$1.95 per asst.
 Connectors—100 asst. battery plugs and small connectors. Stk. = 110. \$1.95 per asst.
 Tube Sockets—50 asst. 7 pin, 9 pin, octal, etc. Stk. = 115. \$1.95 per asst.
 Twist Lock Cond. 10 asst. twist locks. Sell one and get your investment back! Stk. = 114. \$1.95
 Toggle Switches—10 asst. Another great money saver for the builder. Stk. = 113. \$2.95 per asst.
 Knobs—50 asst. radio & TV Knobs. Stk. = 111. \$1.95 per asst.

TV ANTENNAS

In-Line Kit—Complete. Only a few wires needed to convince you this is a terrific buy. Famous design In-Line Kit includes:

- Pre-assembled 1/2" seamless aluminum tubing antenna
- Five foot mast
- Chimney mount—complete
- 5 stand-off insulators
- Twin lead. \$6.95 ea. Lots of 3: \$7.95 ea.
- Eight-Element Conical Antenna—Instant mount assembly, all aluminum eight element conical with high-frequency director bar. Stock up NOW! \$3.15 ea. Lots of 3: \$3.66 ea.

ANTENNA ACCESSORIES

Twin Lead Special 80 Mil/20 Ga. Wire. You get top quality, 80 Mil twin lead at the cost of thin, inferior wire. 1000' reel. Lots of 3 Mt. \$11.50
 Stock up on CHIMNEY MOUNTS—2" Type, galvanized strapping includes all hardware. In cases of 12 99c ea. Smaller Quantity \$1.29 ea.
 Stainless Steel Chimney Mounts—Snap in "Y" Type with stainless steel straps. Complete. In cases of 12 \$1.95 ea.; Smaller Quantities \$2.29 ea.

6x9 CO-AXIAL HI-FI SPEAKER

For cars, for the Hi-Fi enthusiast, for radio-TV use. Twin high frequency units cross over at 2500 cps. 2.15 oz. magnet, 4 watt output. \$8.07 ea. Lots of 6: \$8.95 ea.

6x9 REAR SEAT SPEAKER KITS

A deluxe kit at a really SPECIAL PRICE. Kit contains everything for a rear seat installation. Gray color metal baffle, 3 position switch, wired. \$3.95 ea. Lots of 6: \$4.25 ea.
 5 x 7 speaker and grille. \$3.75 ea. Lots of 6: \$3.95 ea.

STANDARD 6 VOLT, 4 PRONG REPLACEMENT-VIBRATORS

Covers 80% of your needs. Famous make—we buy them in bulk quantities and pass the savings on to you. Standard 12 volt replacement vibrator, 3 or 4 prong. \$1.35 ea. Lots of 10: \$1.50 ea.
 5" Speaker, Baffle—gray marbled plastic cover—Special \$1.95

AUTO ANTENNAS

TEAR DROP ANTENNA

For front or rear fender or rear deck installation. "Screw-Ball" mounting base assures speedy, effortless top mounting. No special tools needed. Three section—opens to 57", 48" cable provided. \$2.49 ea. Lots of 6: \$2.82 ea.

"SCREW-BALL" ANTENNA

Best for mounting ease. All metal, three section heavily chrome plated throughout. Ball base permits angular adjustment for every type of cowl or fender. Entire mounting from the top. Extends to 37", 36" cable included. \$2.49 ea. Lots of 6: \$2.82 ea.

ECONOMY MODEL

Two section chrome "screw ball" base antenna with 54" cable. Opens to 54". \$1.43 ea. Lots of 6: \$1.62 ea.

CONCEALED TYPE ANTENNA

Extends to 55" when raised and collapses to 1" when lowered—easily mounts from top. Adjustable to 40° sweep back. \$3.79 ea. Lots of 6: \$4.19 ea.

B & J ELECTRONICS INCORPORATED

5335 1/2 W. DIVERSEY CHICAGO, ILL. Phone BE 7-1660

Terms: F.O.B. Chicago, Ill. Cash with order or 25% deposit on C.O.D. orders. All merchandise subject to prior sale. Price tags may be changed without notice.

BARGAIN HUNTING? **TV SERVICEMEN!**
 Write for SENSATIONAL CATALOG
HENSHAW RADIO SUPPLY
 3619 TROOST KANSAS CITY, MO.

TAPE RECORDERS

Tapes—Accessories

Nationally Advertised Brands

UNUSUAL VALUES

Send for Free Catalog

DRESSNER

69-02 RA-174 St.

Flushing 65, N. Y.

MERITAPE

Low Cost, High

Quality Recording

Tape—

In boxes or

cans.

The newest hobby under the sun!

BUILD THIS SOLAR POWERED RADIO!

and many other sun-powered electronic, electrical and photometric devices featuring International Rectifier Corporation SUN BATTERIES!

Everyone—from the beginner with a basic understanding of electrical work to the experienced professional engineer—can build this pocket-size portable radio—powered by the sun! No batteries—not even an On-Off switch. All you need is sunshine! The basis for this radio is the International B2M Sun Battery. This unit is a scientific, accurate, precision-made photovoltaic instrument that directly converts light into electrical energy. This radio is just one of many devices you can build powered by solar energy. You have read about this new field of science. Be among the first in this newest hobby. Put the sun to work for you!

THIS NEW BOOK TELLS YOU ALL ABOUT SUN BATTERIES—PHOTOCELLS—AND HOW TO USE THEM. Packed with information and applications, this illustrated book shows wiring, diagrams and plans—every detail necessary to build many interesting devices. **\$150**

THIS IS THE FAMOUS B2M SUN BATTERY YOU'VE READ ABOUT. Widely used in experiments, this unit in bright sunlight (10,000 ft. candles) will deliver 2 milliamperes at 250 millivolts under optimum conditions; will last indefinitely with proper care. A \$2.50 value for only \$1.50

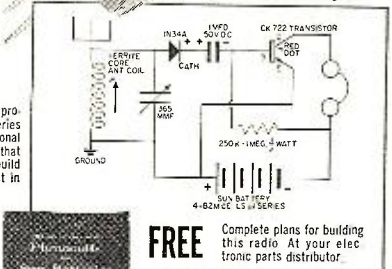
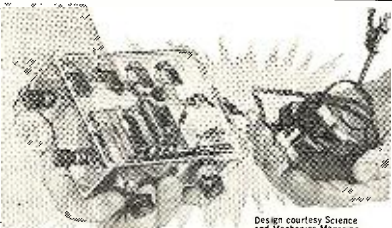

FREE Complete plans for building this radio. At your electronic parts distributor.

GET THE B2M SUN BATTERY AND ALL OTHER COMPONENTS REQUIRED AT LEADING ELECTRONIC PARTS DISTRIBUTORS EVERYWHERE. If your favorite distributor doesn't feature the B2M Sun Battery send check or money order to

International Rectifier Corporation
 El Segundo, California

SPECIAL OFFER, The book and the B2M Sun Battery for only \$2.85 at your distributor

Mac's Service Shop

(Continued from page 70)

"From what I've read, that's where trouble begins," Barney said with a grin.

"Possibly so, but that's what I want to find out. I'm just mule-headed enough to believe I can learn to do anything anyone else has done. This color set is going to be my guinea pig, and before I'm through I hope to be able to make every adjustment on it quickly, correctly, and confidently. It may take me a week to do a complete 'set-up' job on it the first time; but eventually I expect to cut this down to less than an hour. I'll say this: everything I've read about color sets and have heard in lectures takes on a new and much more 'real' meaning when I have a color set right in front of me; and it's mighty nice to know I can take all the time I want in making adjustments without having to worry about getting the set back to an impatient customer."

"I've been told you have to be constantly adjusting a color set. Right?"

"Not in my experience. Last night I tuned in on a color program at six-thirty and spent the first couple of minutes adjusting the hue, color, contrast, brightness, and fine tuning controls for what seemed to be the best color picture—and incidentally, every one of these affects the color—then I did not touch the set again until the end of the color programming at nine o'clock. You can, if you like, be messing with the controls constantly trying to compensate for slight differences existing between color cameras, studio lighting, and—in this fringe area—signal strength; but I'm about convinced that one of the most important controls in the enjoyment of colored television is self control. On a hunch, I ran a bunch of my prize slides through the projector last night, and in practically every one of them I felt I could make a marked improvement if I could just twist a 'hue' or 'color' knob a little this way or that!"

"Does noise interfere more with a weak color signal than it does with black and white?"

"I can't see that it does; but you do!"

"What do you mean by that crack?"
 "I never heard a peep out of you on my black-and-white set when you were operating seventy-five meters; but night before last you were coming in very loud and clear on the sound, even though you did not disturb the picture. I put a high-pass filter in the antenna lead, and that took care of you. It was a simple case of fundamental overload and actually has nothing to do with the set's being a color receiver."

"Outside of getting first-hand information on what can be expected in the way of color reception in this area and getting some experience in adjusting color sets, what else do you expect to gain by having a color set?"

"I want to know if the adjustments are stable over a long time or require touching up. I want to see for myself how much more service a color set is going to require than a black-and-white receiver. I want to know what components fail in a color set and how hard they are to locate when they do fail.

"Mostly, though, I want to prove something to myself. I've often noticed things that look terribly complicated and difficult from a distance lose much of this quality once you become familiar with them. While I'm not kidding myself that color TV service is going to be a snap, I still have a strong hunch it's not so bad as a lot of the technicians who go around scaring one another about it think. In other words, I'm going to become familiar with color TV. While in this case I do not expect familiarity to breed contempt, I do expect it to dissipate unreasoning fear."

"One final question," Barney said. "How does a black-and-white picture on a color set compare with the same picture on a black-and-white set?"

"That's one of the things I wanted to know, too; and that's why I arranged the sets side by side. The pictures are different. The color set picture has a slightly bluish tinge, but not any more than many black-and-white sets—and of course this tint can be changed. Also the dot structure gives the color set picture more of a 'satiny' look and actually makes it seem to have more detail than it does, for when I compared test patterns on both sets the detail was approximately the same. People who like an extremely high contrast picture prefer the black-and-white set; but those who like a softer, lower-contrast picture—and incidentally these seem to outnumber the others around here—for the color set picture.

"But why should I try to describe it. Bring Margie over this evening and see for yourself. The SRO spaces are only fifty cents each; but of course if you want to sit on the love seat, that will be an extra four bits a head."

"Reserve the love seat! We'll be there!" Barney exclaimed.

TV AND X-RAYS

By PROF. A. V. J. MARTIN

PERSISTENT rumors have been going around to the effect that television picture tubes emit harmful "x-rays". Many technicians have been queried about the possible danger of exposure with long viewing sessions.

A definite answer to this question has been provided by the Liege University in Belgium. Two geiger counters were used in making the test. The background count for one unit was 60 while for the second, more sensitive unit, the count was 90.

Four different television receivers were switched on and the counters held less than two inches away from the tubes. No difference was noted in the counts on the geiger units, indicating no radiation. The experimenters stress that there is no danger due to x-ray radiation from TV receivers.

BARGAINS - OUTSTANDING SURPLUS ELECTRONICS

60 WATT, 6 CHANNEL RADIOTELEPHONE

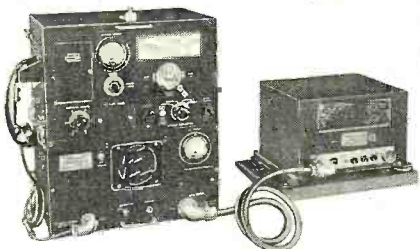

THE RADIOTELEPHONE BARGAIN all the Pleasure and Fishing Boats are talking about! This Transmitter-Receiver (RC-669, part of SCR-513) is beautifully and ruggedly built. Provides 6 fixed channels of crystal-controlled transmission and reception, in addition to manual tuning when desired for reception. Freq. range 1600 to 4500 KC, excellent FCC currently accepted 2-3 mc marine band. With recommended 12 V. DC (or 24 V. DC) dynamotor power supply will deliver 50-60 watts output. Supplied with instruction book, connecting cable, power supply constructional data, all tubes all tested and guaranteed. See our Ad in Oct. '56 Radio Telev. News for illustration and complete data, or send for descriptive bulletin!

50 W. RADIOTELEPHONE (RC-669 A, B, or C) USED-EXCELLENT, as described above. Shpg. wt. 183 lbs. **EACH** \$39.50
SAME AS ABOVE - NEW-UNUSED \$39.50
12 V. DC POWER SUPPLY, for above, has 2 Dynamotors, one for transmitter (540 V. at 450 ma.) and one for receiver. Produces 50/60 watts output. All series and tested. Each \$89.50
COMPLETE 12 V. DC POWER SUPPLY KIT, assemble and wire yourself. All material and diagram \$45.00
PE-110, A, B, or C POWER SUPPLY, for 110 V. 60 cycles AC operation. LIKE NEW condition. \$89.50
TS-11 HANDSET, with appropriate plug connector \$14.50

LORAN RECEIVING EQPT., APN-4, AT LOWEST PRICE EVER!!!

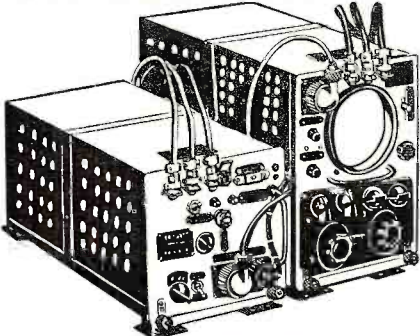

We made a "buy" on this popular model APN-4 Loran unit, used on Fishing and Pleasure boats and Aircraft for navigational purposes. All are Used but in Very Clean condition, complete with tubes and crystal. Each set consists of an R9/APN-4 Receiver and an I1-6/APN-4 Indicator. Originally sold in surplus for \$100.00 or more per set, it would be wise to buy an extra set for "Spare" while available at this real low price! Surplus accessories or inverter (80 to 115 V. AC, 400 to 2400 cycles required) supplied. (See "LIMITED QUANTITY" column for 400 cycle inverter special.)
PRICE PER SET (including one Indicator and one Receiver, as above. Not Tested. Excellent-Used. Shpg. wt. 80 lbs. \$29.95

15-600 KC RECEIVER

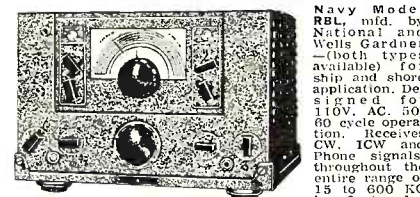

Navy Model RBL, mfd. by National and Wells Gardner - (both types available) for ship and shore application. Designed for 110V. AC 50-60 cycle operation. Receives CW ICW and Phone signals, throughout the entire range of 15 to 600 KC in 6 bands. Employs 7 modern metal tubes in TRF circuit with regeneration, plus two audio filters to allow choice of tone which is 800 or 1000 cycles at 20 db down with peak response occurring at 750 and 1000 cps respectively. Also incorporated audio limiter stage which reduces noise and interference. This is an excellent receiver for wireless operators, hams, and all others interested in the long and intermediate wave bands. Dim: 17 1/2" L. x 15 1/2" D. x 10 1/4" H. (less shock mounts) Supplied complete with tubes, instruction sheets and diagram. Shpg. wt. 135 lbs. **\$79.50**
PRICE, EACH, NEW-TINUSED \$39.95
PRICE, EACH, Used-Good Condition \$39.95

All Above Material Subject to Prior Sale. 25% Minimum Deposit with All C.O.D.'s. Min. Order \$5.00. All Prices F.O.B. Our Address.

TELEMARINE COMMUNICATIONS CO.

3030 W. 21st Street, Brooklyn 24, N. Y.
 Cable Address: Telemarine N. Y.
 Phone: ES 2-4300

NEW, HANDY-TALKY (BC-611) CHASSIS



Here's the chance to build your own real compact, lightweight Handy-Talky or Walky-Talky! Designed to transmit and receive on one crystal-controlled frequency between 3.5 and 6.0 mc., any real ham could revamp the coils for operation on higher frequency amateur phone bands. This will result in increased antenna power output and longer distance transmission. By building your own case for this chassis you will have space for larger batteries and increased B voltage, further increased power and longer service from batteries will result. These chassis are NEW, unused, complete with telescoping antenna but less tubes, coils, or crystals. Tubes required: 1-RF, 1-F5, 1-114, and 2-854. 2 miniature plug-in coils required (sold separately). 1-Antenna, and 1-RF Tank. Battery voltages required (original 1-1.5 volt "A" and 104.5 volts "B" battery, the latter may be increased to 135 or 167.5 volts to produce higher transmitter output. Supplied as specified, with Schematic diagram. Shpg. wt. 10 lbs. **\$12.95**

EACH - Chassis only \$12.95
PAIR OF COILS, for above, Ant. & RF Tank \$1.25

LIMITED QUANTITY BARGAINS

SENSATIONAL BARGAIN! TCS TRANSMITTERS, RECEIVERS AND ACCESSORIES

You've seen TCS Transmitters and Receivers priced so low! This communications "work horse" of the Navy and Coast Guard never sold in surplus for less than \$100 per set (Acq. cost \$200.00 per set). It's ideal for mobile or fixed station use; precise, trouble-free, and consistent. Excellent for Marine-Hand (2-3 mc) applications if certain front panel controls on Transmitter are removed, after precise tuning of frequencies, to meet FCC requirements. It will even meet FCC requirements regarding second harmonic radiation, since the transmitter uses a Buffer Amplifier (variable) link coupling between the final RF Tank and a pi-network which couples to the antenna, all of which reduces harmonic radiation to an minimum. Other features of TCS Transmitters and Receivers are: complete coverage 1.5 to 12.0 mc. all band-switching, 4-channel crystal-controlled, precision channel unit running in transmitter (precision VFO). Uses 1625 instant heating filament tubes (equivalent to Type 807) in RF Amp and Mod. sections of Transmitter. 100 watt drain. Rated for 100 V. AC and 20 watts phone output when transmitter plate voltage is 425 V., but this power can be easily doubled by using Transmitter's plate supply. Receiver designed to operate from either 12, 24, 110 V. DC, or 110/220 V. AC power supplies. Power Supply Diagrams furnished. Receiver is super-sensitive, superb, with excellent sensitivity, activity characteristics, and includes BFO circuit for CW reception. Units priced below are complete with tubes, good clean condition but untested.

TCS-5 (to 9) TRANSMITTER, with all tubes, schematic diagram and power supply diagrams, as outlined above. Shpg. wt. 60 lbs. **\$39.95**
PRICE, EACH \$39.95
TCS-9 (to 14) TRANSMITTER, same as above but has minor modifications which make these models more desirable. Shpg. wt. 60 lbs. **\$59.95**
TCS-5 (to 14) RECEIVER, complete with tubes and schematic diagram, as described above. Shpg. wt. 50 lbs. **\$69.95**
PRICE, EACH \$69.95

WRITE FOR PRICES ON OTHER TCS ACCESSORIES, 12 V. DC, 50 AMPS. GENERATOR, FOR BOATS OR HAM CARS. Having trouble with the car or boat battery running down due to heavy drain? Here's the answer! New-unused voltage-regulated 12.0 V. DC generator, which provides 50 amperes (600 watts), 85% voltage-regulation, at 2400 RPM. Generator is designed for clockwise rotation, is self-excited and measures 9" long by 8" dia., including voltage regulator. Shpg. wt. 35 lbs. **\$42.50**

PRICE, EACH \$42.50
22-30 V. DC, TO 110 V., 400 CYCLES AC MOTOR ALTERNATOR. For Fishing Boats or other craft with 24 to 32 V. DC power, for operating Loran, Radar, or other 400 cycle equipment. Output is 22.0-30.0 Volts DC at 75-65 amps., output 1.0 KVA at 115 volts (8.7 amps.), 1-phase, 400 cycles. Includes Navy type CRP 4002 Link gear attached. Used-excellent condition units, mfd. by Balentine. Shpg. wt. 50 lbs. **\$19.95**

LINK FM MOBILE TRANSMITTERS, 30-40 MC., 2.5 Watt FM Transmitters, single crystal-controlled channel, designed for 6 V. DC operation, Type 25 UPM-FB2. Contains all tubes, and 5.6 V. DC dynamotor (4002 Link gear attached). Used-excellent condition units, mfd. by Balentine. Shpg. wt. 50 lbs. **\$19.95**

PRICE, EACH, less Vibrator Power Supply (Shpg. wt. 30 lbs.) \$39.95

PRICE, EACH, with Vibrator Power Supply \$49.95

GENERAL ELECTRIC 10 KW RF POWER AMPLIFIER, model RP-3A, designed to increase RF power output of FM Transmitters (88-108 mc) to 10KW. Can be modified to operate on other frequencies. Available NEW, less Rectifier Power Supply and Tubes, **EACH \$795.00**
GCA 1P20 INFRA-RED IMAGE GENERATOR TUBE, used in American Sniperscopes and Sniperscopes. All NEW, UNUSED Condition. Shpg. wt. 8 lbs. **\$49.50**

CRYSTAL TYPE INFRA-RED IMAGE (SNOOPERSCOPE) TUBES. Used in British "Tabby" for seeing in the dark for "snooper" or "sniperscopes". Will detect objects not illuminated by 2 m. infra-red light rays. Requires power supply of 8000 to 4000 volts at a few microamperes. Screen size is 1 3/4" dia. All tubes checked before shipment. Price, for 100, **\$19.00**

FRONT END LENS ASSEMBLY. For above. Speed F1.9 f.1., 91.4 mm. Outside dia. at one end 60 mm. Length amount 67 mm. **EACH** \$7.00

FREQUENCY CALIBRATOR, 40-50 MC. Mfd. by Hazeltine. Permits checking accuracy of any signal, by beat frequency method, between 40 and 50 mc. Uses crystal-controlled oscillator operating 8-10 mc. into Freq. Multiplier, then into Buffer/Amplifier stage. Output is fed into mixer stage, along with signal being checked, demodulated, amplified and any resulting beat note determined by earphones. Includes built-in 110V. AC Power Supply, 8 tubes, and 10.0 mc crystal. Almost new condition. **\$29.95**

Shipping wt. 30 lbs. \$29.95

PRICE, EACH \$29.95
CRYSTAL-CONTROLLED, SINGLE CHANNEL, RACK MFG. RECEIVER 3-5.0 MC. Model RDE-1, mfd. by Communications Co., similar in design and physical characteristics to Wilcox CW-2 and F-3 receivers. Appearance to Wilcox CW-2 and F-3 receivers. Includes 110 V. AC (built-in) power supply, and coils (plug-in) for 3 to 5.0 mc. operation. By changing coil paddlers (internal in coils), frequency range can be raised or lowered. NEW condition. Shpg. wt. 50 lbs. **\$32.50**

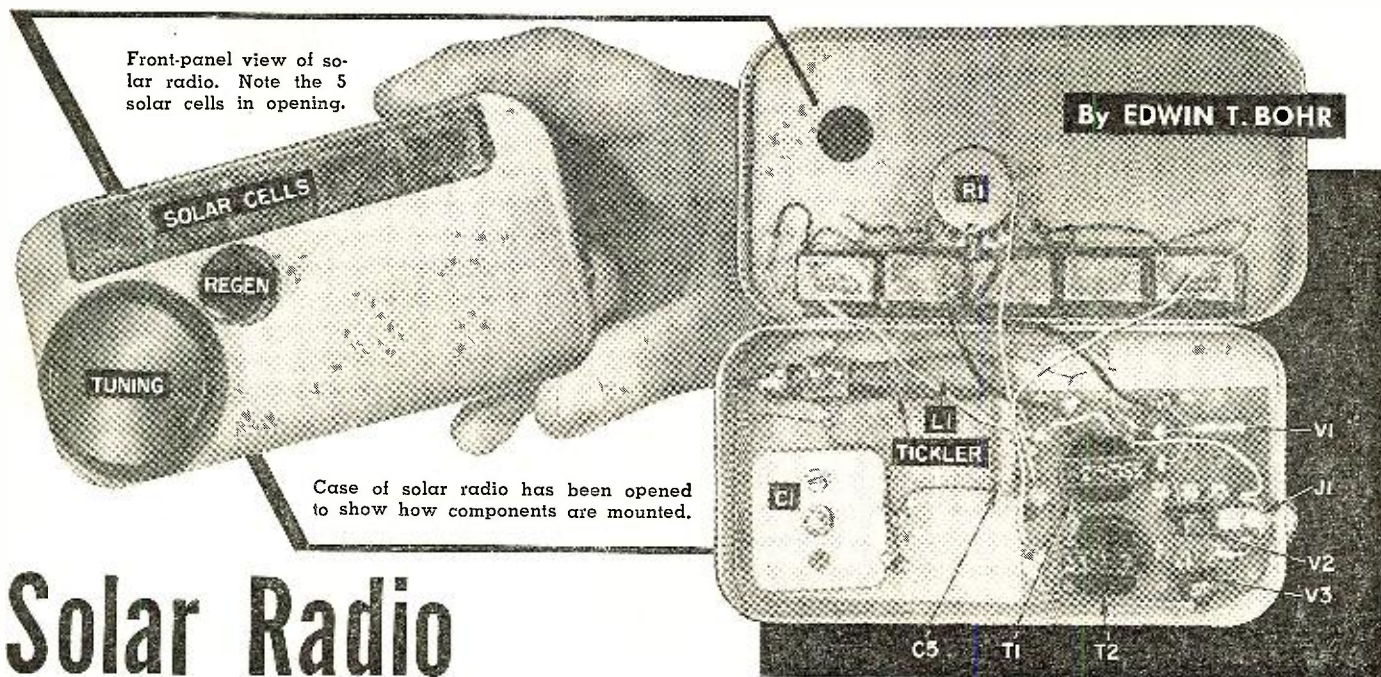

Solar Radio with Surface Barrier Transistor

Sensitive 3-transistor regenerative receiver operates from solar cells, uses new surface barrier transistor.

THE tiny solar radio to be described receives stations up to one hundred miles away without an external antenna! The styling is smart and attractive; and there is plenty of reserve volume for earphone operation.

Selectivity is very sharp, enough to separate even the most closely spaced local stations. All of the parts are easily obtained, no special items needed, and there is a minimum of necessary special drilling and cutting. The cabinet is a standard $4\frac{3}{8}'' \times 2\frac{1}{4}'' \times \frac{3}{4}''$ plastic case that costs only twenty cents.

Circuit

Although the circuit is not a super-het, it has plenty of zing and go. In fact, it has as good long distance reception as many four-transistor super-hets. Two *G-E* 2N107 transistors are used in the audio stages and a *Philco* SB-100 surface barrier transistor in the regenerative detector.

Only five inexpensive *International Rectifier* solar cells are necessary to power the entire three-transistor circuit. The high-efficiency surface barrier transistor makes this possible since it oscillates vigorously throughout the broadcast band with less power consumption than any other readily available transistor.

A type of regenerative surface barrier circuit, presenting an unusual degree of smoothness and freedom from spurious audio squeals, has been developed for the surface barrier tran-

sistor. Unfortunately, it could not be used in the solar radio, however, because of the power loss in the required biasing resistors. The circuit used is conventional.

One of the solar cells supplies the emitter bias through individual emitter resistors. This results in an exceedingly well stabilized circuit immune to the usual temperature effects, transistor aging, and individual transistor idiosyncracies. Many novelty transistor circuits employ less complicated circuits using fewer components, but these circuits are completely at the mercy of the foregoing effects.

The remaining four solar cells are connected in series to provide the collector voltage. Each transistor stage operates with a carefully apportioned amount of power. Since the collector current is almost exactly equal to the emitter current, the reader can ascertain the power level of each stage by noting the value of the emitter resistance. The audio output stage, of course, operates with the largest signal and has the smallest emitter resistance. The first audio stage has a larger emitter resistance because it handles a much smaller signal.

Although the detector amplifies a smaller signal than either of the audio stages, there is a certain minimum emitter current necessary for regeneration. Consequently, the detector consumes more current than the first audio stage, but less than the audio output stage. An approximate value

for the emitter current can be had by simply dividing the emitter supply voltage by the emitter bias resistor.

Construction

The problem of a suitable cabinet, cutting the holes, and mounting the components always consumes more time than wiring the circuit. Our solar radio, by design and short cuts, keeps such dull labor at a minimum. The cabinet is a *Lafayette* MS-160 plastic case which has been given a coat of *Krylon* spray. Possibly other brands of spray can be used, but with certainty we can say the *Krylon* produces a very beautiful finish.

Transparent tape masks the solar-cell area when the outside of the case is sprayed. Inside, where the solar cells will be cemented, should also be masked, since invariably some of the spray will reach the inside case surface. The *Krylon* will dry to the touch in a matter of minutes, but several hours are necessary for the spray to reach a completely hard, tough finish.

We suggest that you try your spraying skills on a scrap piece of plastic or box before spraying the solar radio case. *Krylon* is available in many beautiful colors. Chrome yellow is attractive and a recommended color.

The tuning capacitor is one of the new "solid dielectric" types. This capacitor is not mounted to the case front, instead, it is welded to the main body of the case. To do this, wet the back of the tuning capacitor with *General Cement* service solvent two or three times. Also, do the same thing to the inside of the case where the tuning capacitor will be mounted. Now press the back of the capacitor hard

against the case and, at the same time, twist it back and forth, finally positioning it in the proper place.

The solid dielectric tuning capacitor is now available with a flattened and tapped shaft that will fit most knobs, but some knobs will require a little more flat which a few file strokes will take care of nicely. To accommodate the knob shank, a large hole is required in the cover. To avoid cracking of the cover, drill a smaller hole and ream it to the necessary size.

Only two more holes are necessary, one for the regeneration control and another for the earphone jack.

The solar cells, ferrite antenna coil, and some of the internal wiring are cemented in place. Rigid leads from the earphone jack and cemented-in-place wires from the tuning capacitor are all that hold the circuit chassis in place. This is sufficient since the chassis is very light weight.

The "Sub-SubOuncer" audio transformers are held in place by pulling their leads through the terminal board and soldering them to the proper terminals. Again, this is satisfactory because of their light weight. It certainly would not do, however, with conventional electronic circuitry.

Of course, the lid must be securely attached to the case. Straight pins are used for this. Cut two pins to a 1/4" length, warm with a soldering iron, and push one in at each end of the cabinet through both the cover and case. Do not overheat the pin! The result is a very secure fastening that can be removed, if necessary, by prying with a fingernail or knife blade.

The parts used in this construction merit a few remarks. The ferrite antenna coil is one of the newer types which are tapped for transistor operation. A tickler is added by winding ten turns of wire near the terminal end of the antenna coil. The size of this wire is not too important, but it should be light and flexible.

The short antenna wire supplied with the ferrite antenna coil is wound around inside the case and cemented in place. After the tuning slug is adjusted for the proper tuning range, part of the adjusting screw must be cut off to reduce the over-all length.

The electrolytic emitter bypass capacitors are the very small type designed for transistor circuitry. The smaller DOT-1 (UTC) transformers may be substituted for the same company's SSO-3 transformers. In fact, almost any of the interstage transistor transformers are satisfactory. The earphone jack employed is a subminiature type.

Several wires are necessary between the chassis and lid. The excess flexible wire salvaged from the solar cells is excellent for this purpose.

Operation

With construction complete, plug in the earphones and hold the radio in direct sunlight. If any one of the five cells is covered the receiver will not operate, so be careful not to cover any

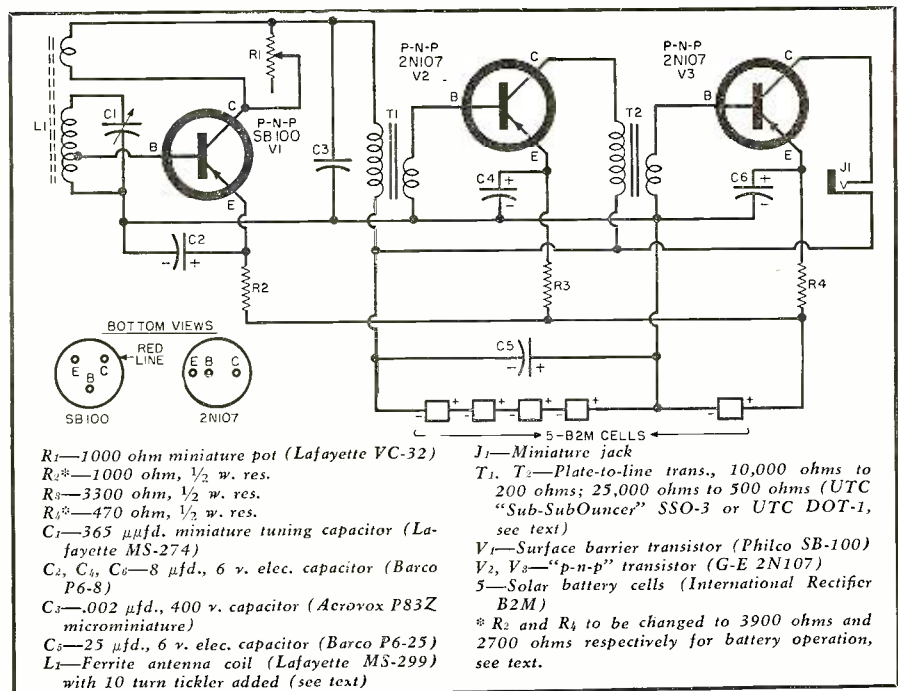

of the cells with your fingers. As the regeneration control is rotated back and forth, a putt-putt oscillation sound should be heard at one extreme of rotation. Now rotate the regeneration control until the oscillation just stops and you are ready to tune in stations. If it does not oscillate, swap the two leads from the tickler.

Local stations will come in without an external antenna and require a minimum of regeneration. Distant stations sometimes can be received without an external antenna, but the regeneration adjustment is critical. At night, operating the receiver under a strong electric light, stations four to six hundred miles away can be received. For greater sensitivity, an external antenna may be added to the short antenna coil wire.

Battery Operation

This receiver works exceedingly well with a simple battery supply. For bat-

tery operation, do this: Substitute a single mercury or dry cell for the bias solar cell and two cells in series to replace the four collector solar cells. Also change the emitter resistors to the values shown with the asterisks.

This radio, considering the simplicity of the circuit, performs well enough to be taken out of the novelty category. It has definite utility and shows just what can be accomplished with only two milliwatts of power supply.

We have used both standard earphones and the lightweight hearing-aid type without the earplug insert. Of the two, the regular earphones certainly are far superior in tonal quality, volume, and clarity. Too, they shut out more distracting noise. This accounts, in large part, for the better performance.

The builder may have trouble finding the surface-barrier transistors locally. Lafayette Radio catalogues these units and carries them in stock. —50—



View of underside of circuit subassembly on which is mounted all the components except controls, solar cells, and the ferrite-core antenna coil with tickler.

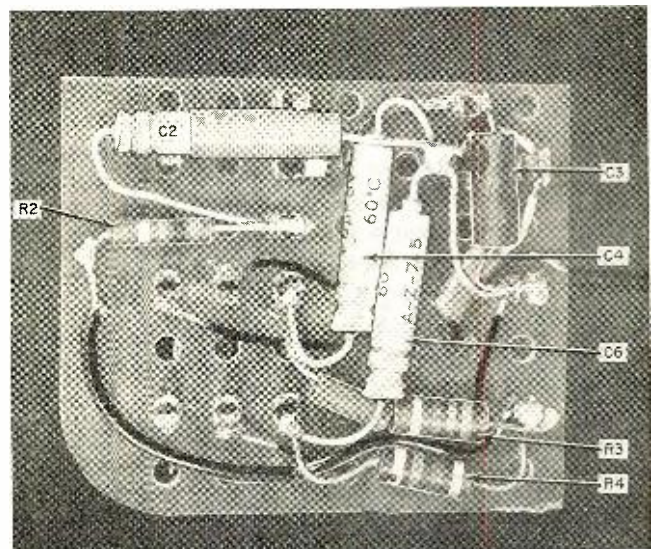

KLEINS

for the
ELECTRONICS
INDUSTRY

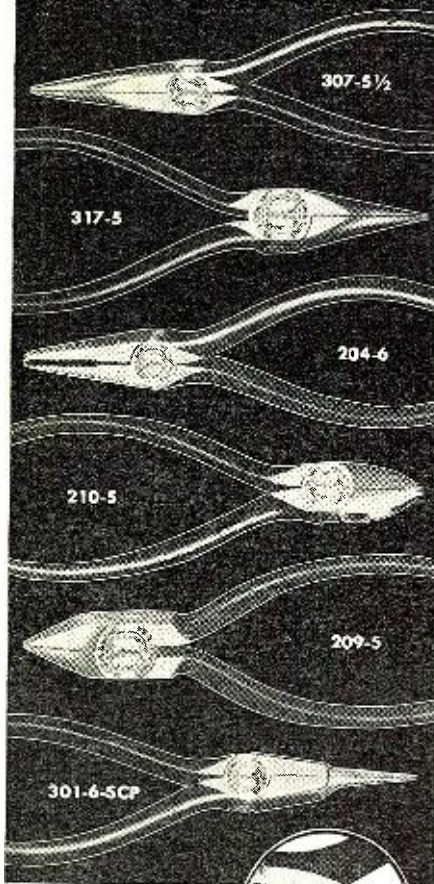

All pliers shown may be had with coil spring to hold jaws in open position. Spring guaranteed for the life of the plier.

Light in the hand... comfortable to use... points carefully matched... knives hand honed—all these features are yours with genuine Klein Pliers.

100 years of engineering skill and manufacturing experience are behind every pair of Kleins you buy.

You will be amazed at how much better a job you can do... how much faster you can do it... when the pliers you use are Kleins.

Ask Your Supplier



Write for your free copy of the Klein Pocket Tool Guide today.

Foreign Supplier

International Standard Electric Corporation, N. Y.

Mathias **KLEIN** & Sons
Established 1857 Chicago, Ill., U.S.A.
7200 McCORMICK ROAD • CHICAGO 45, ILLINOIS

Within the Industry (Continued from page 32)

announces the purchase of **WARREN PLASTICS CORPORATION**, and its subsidiary, **GROPP ENGINEERING DIVISION**. Both firms are wholly owned subsidiaries of the parent organization... Formation of **SYLVANIA-CORNING NUCLEAR CORPORATION** is announced by **SYLVANIA ELECTRIC PRODUCTS INC.**, and **CORNING GLASS WORKS**, joint owners of the company. The firm has been established for the purpose of expanded research, development, and production activities in the atomic energy field. Headquarters will be in Bayside, L. I. . . Preliminary plans have been completed for the **KAMA INSTRUMENT CORPORATION** to become a wholly owned subsidiary of **THE NARDA CORPORATION**.

* * *

JOHN M. KELLIE has been appointed controller of *Radio Condenser Company* . . . *Potter Instrument Company, Inc.* announces the election of **EDWARD D. GRAY** as vice-president . . . **JOSEPH P. BOUR** is now sales manager of the *Duotone Company* . . . **T. ROBERT BURNIGHT** has been appointed director of engineering for *The Maico Company, Inc.* . . . **DR. ARTHUR O. MCCOUBREY** has joined the *National Company, Inc.* as head of the organization's physics department . . . *International Resistance Company* announces the appointment of **FRANK G. DAVELER** as division manager, computer components division . . . **JAMES M. IGOE** has been appointed distributor sales coordinator for the operation sales services department of the *Raytheon Manufacturing Company* . . . *Electro-Pulse, Inc.* announces the election of **THOMAS C. RIDGWAY, JR.** as treasurer . . . The promotion is announced of **M. E. (MEL) KRUMREY** as manager of the jobber division of *Qiam-Nichols Company* . . . **SAM I. PICHEY** has been named sales manager for *Electrical Communications, Inc.* . . . *Ampex Corporation* announces the appointment of **PAUL O. FRINCKE** as director of video service engineering . . . The appointments of **A. K. MALLARD**, **R. W. FRISBEE**, and **R. K. JOSLIN** to new posts in the *RCA tube division* are announced by the company. Mr. Mallard is now manager, entertainment sales coordination, a newly created position; Mr. Frisbee is manager, industrial sales coordination; and Mr. Joslin is the new district manager of the Dallas territory . . . The newly organized *Tucson Instrument Corporation* has elected **FRANK R. PERIER** president and treasurer . . . **WILLIAM D. TASKER** is now production manager of *Microwave Associates, Inc.* . . . **NORMAN C. ANDERSON** is appointed vice-president, photoconductor-transistor division for *Electronics Corporation of America* . . . **ROBERT F. SIM, JR.** has been named manager of the distributor order service department for receiving and picture tubes, *Raytheon Manufacturing Company* . . . The promotion of **WILLIAM H. MADDEN** to dis-

tributor trades sales manager, magnetic products division, is announced by *Minnesota Mining & Manufacturing Co.* . . . *Sylvania Electric Products Inc.* announces the appointment of **ERNEST H. ULM** as general sales manager for the semiconductor division . . . The election of **THOMAS ALLINSON** as vice-president of marketing of *Daystrom, Inc.* is announced . . . **ORGAIN E. McCULLOUGH, JR.** is named as assistant to the president of *Clevite Corporation* . . . The promotion of **CHARLES PRAW-DZIK** to chief engineer, device development section, *General Transistor Corp.* is made known by the company . . . The appointments of **MURRAY ELLIS**, and **SAMUEL WIEGAND** as assistant managers in the sales department of *Datamatic Corp.* are announced by the firm . . . **WILLIAM SPANG** has been made quality control supervisor of the *Cambridge Thermionic Corp.* . . . **WARREN F. MORGAN** is elected vice-president in charge of customer relations for *Federal Electric Corp.*, service and maintenance organization of the *International Telephone and Telegraph Corporation* . . . **E. S. WILLIS** is now sales manager of the electro-mechanical division of *Erie Resistor Corporation* . . . **JERRY BADLER** is appointed to the post of purchasing agent for the *Aerovox Cinema Engineering Division* . . . The *Electronic Specialty Co.* announces the appointment of **WILLIAM R. MARTIN** as chief engineer and product manager of the r.f. systems and components division . . . **PAUL J. WEBER** is the newly appointed marketing manager for the instrumentation division of *Ampex Corporation* . . . **RICHARD D. HANSON** has been named manager of manufacturing for *Donner Scientific Co.* . . . **ERIC DYMOND** has been appointed assistant manager of electronic component sales of *Sangamo Electric Co.* Also, **R. R. WYLIE** has been named to the newly created position of marketing manager . . . **EDWARD W. ALLEN, JR.** is now manager of public relations at *Allen B. Du Mont Laboratories, Inc.* . . . **MICHAEL BALOG** has been appointed general manufacturing manager of the semiconductor division of *Sylvania Electric Products Inc.* . . . The appointment of **EDMOUR F. GI-GUERE** to the newly created position of manager, new market coordination, is announced by the *RCA components division* . . . **A. JOHN HINCK**, and **ALBERT STEADMAN**, the first employees of *Allen B. Du Mont Laboratories, Inc.* have received 25-year service pin awards.

-30-

STARVED ROCK HAMFEST

THE 11th annual hamfest of the Starved Rock Radio Club has been scheduled for June 9th (Sunday) at the LaSalle County 4-H Fairgrounds near Ottawa, Ill.

Almost 5000 hams and their families attended last year's gathering so the committee is making plans to accommodate an even larger number this year.

Midwest hams are cordially invited to attend this get-together. Contact George E. Keith, W9QLZ, club secretary, for additional details on this event.

-30-

RADIO & TV NEWS

Superior's New Model 770-A

The FIRST Pocket-Sized VOLT-OHM MILLIAMMETER



USING THE NEW "FULL-VIEW" METER 71% MORE SCALE AREA!

Yes, although our new FULL-VIEW D'Arsonval type meter occupies exactly the same space used by the older standard 2 1/2" Meters, it provides 71% more scale area. As a result, all calibrations are printed in large easy-to-read type and for the first time it is now possible to obtain measurements instead of approximations on a popular priced pocket-sized V.O.M.

- Compact — measures 3 1/8" x 5 7/8" x 2 1/4".
- Uses "Full View" 2% accurate, 850 Microampere D'Arsonval type meter.
- Housed in round-cornered, molded case.
- Beautiful black etched panel. Depressed letters filled with permanent white, insures long-life even with constant use.

Specifications — • 6 A.C. VOLTAGE RANGES: 0-15/30/150/300/1500/3000 Volts. 6 D.C. VOLTAGE RANGES: 0-7.5/15/75/150/750/1500 Volts. 2 RESISTANCE RANGES: 0-10,000 Ohms, 0-1 Megohm. 3 D.C. CURRENT RANGES: 0-15/150 Ma., 0-1.5 Amps. 3 DECIBEL RANGES: -3 db to +18 db, +14 db to +38 db, +34 db to +58 db.

\$15.85 NET

The Model 770-A comes complete with self-contained batteries, test leads and all operating instructions.

Superior's New Model TV-60

20,000 OHMS PER VOLT

ALL METER

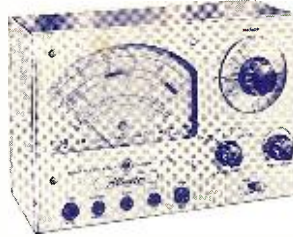

SPECIFICATIONS

8 D.C. VOLTAGE RANGES (At a sensitivity of 20,000 Ohms per Volt) 0 to 15/75/150/300/750/1500/7500/30,000 Volts.

7 A.C. VOLTAGE RANGES: (At a sensitivity of 5,000 Ohms per Volt) 0 to 15/75/150/300/750/1500/7500 Volts.

3 RESISTANCE RANGES: 0 to 2,000/200,000 Ohms, 0-20 Megohms.

2 CAPACITY RANGES: .00025 Mfd. to 30 Mfd.

5 D.C. CURRENT RANGES: 0-75 Microamperes, 0 to 7.5/75/750 Milliampers, 0 to 15 Amperes.

3 DECIBEL RANGES: -6 db to +58 db.

R.F. SIGNAL TRACER SERVICE: Enables following the R.F. signal from the antenna to speaker of any radio or TV receiver and using that signal as a basis of measurement to first isolate the faulty stage and finally the component or circuit condition causing the trouble.

AUDIO SIGNAL TRACER SERVICE: Functions in the same manner as the R.F. Signal Tracing service specified at right except that it is used for the location of cause of trouble in all audio and amplifier systems.

FEATURES

Giant recessed 6 1/2 inch 40 Microampere meter with mirrored scale. Built-in Isolation Transformer. Use of the latest type printed circuit and 1% multipliers assure unchanging accurate readings.

Model TV-60 comes complete with book of instructions; pair of standard test leads; high-voltage probe; detachable line cord; R.F. Signal Tracer Probe and Audio Signal Tracer Probe. Pliofilm bag for all above accessories is also included. Price complete. Nothing else to buy. ONLY

\$52.50 NET

Superior's New Model TW-11 STANDARD PROFESSIONAL

TUBE TESTER



- Tests all tubes, including 4, 5, 6, 7, Octal, Lock-in, Hearing Aid, Thyatron, Miniatures, Sub-miniatures, Novals, Sub-minars, Proximity fuse types, etc.
- Uses the new self-cleaning Lever Action Switches for individual element testing. Because all elements are numbered according to pin-number in the RMA base numbering system, the user can instantly identify which element is under test. Tubes having tapped filaments and tubes with filaments terminating in more than one pin are truly tested with the Model TW-11 as any of the pins may be placed in the neutral position when necessary.
- The Model TW-11 does not use any combination type sockets. Instead individual sockets are used for each type of tube. Thus it is impossible to damage a tube by inserting it in the wrong socket.
- Free-moving built-in roll chart provides complete data for all tubes. All tube listings printed in large easy-to-read type.

NOISE TEST: Phono-jack on front panel for plugging in either phones or external amplifier will detect microphonic tubes or noise due to faulty elements and loose internal connections.

SEPARATE SCALE FOR LOW-CURRENT TUBES—Previously, on emission type tube testers, it has been standard practice to use one scale for all tubes. As a result, the calibration for low-current types has been restricted to a small portion of the standard scale. The extra scale used here greatly simplifies testing of low-current types.

The Model TW-11 operates on 105-130 Volt 60 Cycles A.C. Comes housed in a beautiful hand-rubbed oak cabinet complete with portable cover.

\$47.50 NET

Superior's New Model TV-12 TRANS-CONDUCTANCE

TUBE TESTER



TESTING TUBES

- Employs improved TRANS-CONDUCTANCE circuit. An in-phase signal is impressed on the input section of a tube and the resultant plate current change is measured. This provides the most suitable method of simulating the manner in which tubes actually operate in Radio & TV receivers, amplifiers and other circuits. Amplification factor, plate resistance and cathode emission are all correlated in one meter reading.

- NEW LINE VOLTAGE ADJUSTING SYSTEM. A tapped transformer makes it possible to compensate for line voltage variations to a tolerance of better than 2%.

- SAFETY BUTTON—protects both the tube under test and the instrument meter against damage due to overload or other form of improper switching.

- NEWLY DESIGNED FIVE POSITION LEVER SWITCH ASSEMBLY. Permits application of separate voltages as required for both plate and grid of tube under test, resulting in improved Trans-Conductance circuit.

TESTING TRANSISTORS

A transistor can be safely and adequately tested only under dynamic conditions. The Model TV-12 will test all transistors in that approved manner, and quality is read directly on a special "transistor only" meter scale.

The Model TV-12 will accommodate all transistors including NPN's, PNP's, Photo and Tetrodes, whether made of Germanium or Silicon, either point contact or junction contact types.

\$72.50 NET

Model TV-12 housed in handsome rugged portable cabinet sells for only

SHIPPED ON APPROVAL NO MONEY WITH ORDER — NO C.O.D.

We invite you to try before you buy any of the models described on this and the following page. If after a 10 day trial you are completely satisfied and decide to keep the Tester, you need send us only the down payment and agree to pay the balance due at the monthly indicated rate. (See other side for time-payment schedule details.)

NO INTEREST OR FINANCE CHARGES ADDED!

CHARGES ADDED!

If not completely satisfied, you are privileged to return the Tester to us, cancelling any further obligation.

SEE OTHER SIDE!

Cut out and mail TODAY!

All prices net, F.O.B., N.Y.C.

FIRST CLASS
Permit No. 61430
New York, N. Y.

BUSINESS REPLY CARD

No Postage Stamp Necessary if Mailed in the U. S.

VIA AIR MAIL

POSTAGE WILL BE PAID BY —

MOSS ELECTRONIC DIST. CO., INC.

3849 TENTH AVENUE

NEW YORK 34, N. Y.

Superior's
New
Model

76

For the first time ever: ONE TESTER PROVIDES ALL THE SERVICES LISTED BELOW!

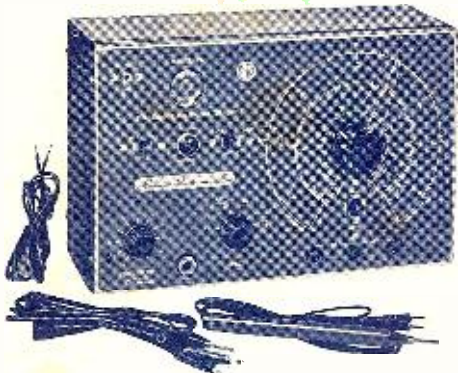

IT'S A CONDENSER BRIDGE

with a range of .00001 Microfarad to 1000 Microfarads (Measures power factor and leakage too.)

IT'S A SIGNAL TRACER

which will enable you to trace the signal from antenna to speaker of all receivers and to finally pinpoint the exact cause of trouble whether it be a part or circuit defect.

IT'S A RESISTANCE BRIDGE

with a range of 100 ohms to 5 megohms

IT'S A TV ANTENNA TESTER

The TV Antenna Tester section is used first to determine if a "break" exists in the TV antenna and if a break does exist the specific point (in feet from set) where it is.

S P E C I F I C A T I O N S

RESISTANCE BRIDGE SECTION

2 Ranges: 100 ohms to 50,000 ohms; 10,000 ohms to 5 megohms. Resistance can be measured without disconnecting capacitor connected across it. (Except, of course, when the RC combination is part of an RC bank.)

CAPACITY BRIDGE SECTION

4 Ranges: .00001 Microfarad to .005 Microfarad; .001 Microfarad to .5 Microfarad; .1 Microfarad to 50 Microfarads; 20 Microfarads to 1000 Microfarads. This section will also locate shorts, and leakages up to 20 megohms. And finally, this section will measure the power factor of all condensers from .1 to 1000 Microfarads. (Power factor is the ability of a condenser to retain a charge and thereby filter efficiently.)

TV ANTENNA TESTER SECTION

Loss of sync., snow and instability are only a few of the faults which may be due to a break in the antenna, so why not check the TV antenna first? The Model 76 will enable you to locate a break in any TV antenna and if a break does exist, the Model 76 will measure the location of the break in feet from the set terminals. 2 Ranges: 2' to 200' for 72 ohm coax and 2' to 250' for 300 ohm ribbon.

As Design Engineers, we the undersigned would like to say that the Model 76 is in our opinion the best combination unit of its kind we have been privileged to design. Although it is comparatively a low-priced tester, it will, after you become acquainted with its multiple services, be your most frequently used instrument.

S. LITT
L. MELENKEVITZ

SIGNAL TRACER SECTION

A built-in high gain pentode voltage amplifier, plus a diode rectifier, plus a direct coupled triode amplifier are combined to provide this highly sensitive signal tracing service. With the use of the R.F. and A.F. Probes included with the Model 76, you can make stage gain measurements, locate signal loss in R.F. and Audio stages, localize faulty stages, locate distortion and hum, etc. Provision has been made for use of phones and meter if desired.

Model 76 comes complete with all accessories including R.F. and A.F. Probes; Test Leads and operating instructions. Nothing else to buy Only

\$26⁹⁵
NET

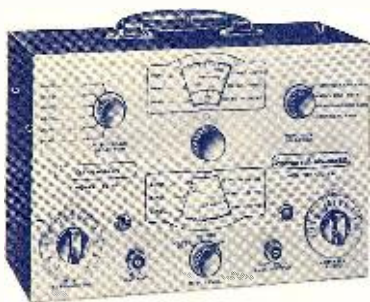

Superior's New Model TV-50

GENOMETER

A versatile all-inclusive GENERATOR which provides ALL the outputs for servicing:
A. M. Radio • F. M. Radio • Amplifiers • Black and White TV • Color TV

7 Signal Generators in One!

- ✓ R.F. Signal Generator for A.M.
- ✓ R.F. Signal Generator for F.M.
- ✓ Audio Frequency Generator

- ✓ Bar Generator
- ✓ Cross Hatch Generator
- ✓ Color Dot Pattern Generator
- ✓ Marker Generator

MARKER GENERATOR: The following markers are provided: 189 Kc., 262.5 Kc., 456 Kc., 600 Kc., 1000 Kc., 1400 Kc., 1600 Kc., 2000 Kc., 2500 Kc., 3579 Kc., 4.5 Mc., 5 Mc., 10.7 Mc., (3579 Kc. is the color burst frequency.)

R. F. SIGNAL GENERATOR: Provides complete coverage for A.M. and F.M. alignment. Generates Radio Frequencies from 100 Kilocycles to 60 Megacycles on fundamentals and from 60 Megacycles to 180 Megacycles on powerful harmonics.

CROSS HATCH GENERATOR: Genometer will project a cross-hatch pattern on any TV picture tube. The pattern will consist of non-shifting horizontal and vertical lines interlaced to provide a stable cross-hatch effect.

VARIABLE AUDIO FREQUENCY GENERATOR: In addition to a fixed 400 cycle sine-wave audio, the Genometer provides a variable 300 cycle to 20,000 cycle peaked wave audio signal.

DOT PATTERN GENERATOR (FOR COLOR TV): The Dot Pattern projected on any color TV Receiver tube by the Model TV-50 will enable you to adjust for proper color convergence.

BAR GENERATOR: Projects an actual Bar Pattern on any TV Receiver Screen. Pattern will consist of 4 to 16 horizontal bars or 7 to 20 vertical bars.

MODEL TV-50 comes absolutely complete with shielded leads and operating instructions. Only

\$47⁵⁰
NET

SHIPPED ON APPROVAL NO MONEY WITH ORDER — NO C. O. D.

MOSS ELECTRONIC DISTRIBUTING CO., INC.
Dept. D-347 3849 Tenth Ave., New York 34, N. Y.

Please send me the units checked. I agree to pay down payment within 10 days and to pay the monthly balance as shown. It is understood there will be no finance or interest charges added. It is further understood that should I fail to make payment when due, the full unpaid balance shall become immediately due and payable.

- | | |
|---|--|
| <input type="checkbox"/> Model 770-A Total Price \$15.85
\$3.85 within 10 days. Balance \$4.00
monthly for 3 months. | <input type="checkbox"/> Model TV-12 Total Price \$72.50
\$22.50 within 10 days. Balance \$10.00
monthly for 5 months. |
| <input type="checkbox"/> Model TV-60 Total Price \$52.50
\$12.50 within 10 days. Balance \$8.00
monthly for 5 months. | <input type="checkbox"/> Model 76 Total Price \$26.95
\$6.95 within 10 days. Balance \$5.00
monthly for 4 months. |
| <input type="checkbox"/> Model TW-11 Total Price \$47.50
\$11.50 within 10 days. Balance \$6.00
monthly for 6 months. | <input type="checkbox"/> Model TV-50 Total Price \$47.50
\$11.50 within 10 days. Balance \$6.00
monthly for 6 months. |

Name _____
Address _____
City _____ Zone _____ State _____

All prices net, F.O.B., N.Y.C.

We invite you to try before you buy any of the models described on this and the preceding page. If after a 10 day trial you are completely satisfied and decide to keep the Tester, you need send us only the down payment and agree to pay the balance due at the monthly indicated rate.

NO INTEREST OR FINANCE CHARGES ADDED!

If not completely satisfied, you are privileged to return the Tester to us, cancelling any further obligation.

SEE OTHER SIDE!

◀ Cut out and mail TODAY!

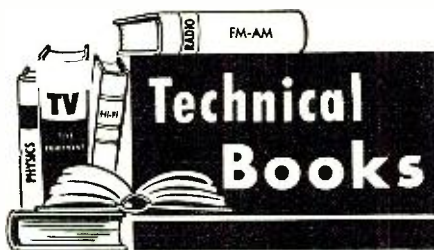

"AN INTRODUCTION TO JUNCTION TRANSISTOR THEORY" by R. D. Middlebrook. Published by *John Wiley & Sons, Inc.*, New York. 292 pages. Price \$8.50.

This book is for the electrical engineer who finds it advantageous to understand the physical processes in semiconductors as related to circuit properties of the junction transistor.

The author first deals with the physical qualities of semiconductors and the theory that applies to this type of component. The second and third parts of the book are devoted to actual circuit applications under various circuit parameters and special conditions.

The material, as presented, is thoroughly practical but the reader must have a strong mathematical background as the treatment is largely mathematical. An appendix listing the properties of germanium and silicon is included as are references at the end of each chapter for additional study. An excellent basic work for the engineer.

* * *

"THE ELECTRONIC MUSICAL INSTRUMENT MANUAL" by Alan Douglas. Published by *Pitman Publishing Corporation*, New York. 242 pages. Price \$7.50. Third Edition.

In revising this third edition the author points out that so many new circuits and techniques have been developed since the Second Edition made its appearance some three years ago, this new edition is justified.

As with the earlier volume, the text covers the electronic generation of music, describes conventional multi-note instruments; the production and mixing of electrical oscillations; amplifiers; tone controls and loudspeakers used with electronic musical instruments; commercial instruments; experimental methods; and, finally, provides schematic diagrams of circuits used in *Hammond*, *Solovox*, *Clavioline*, *Novachord*, *Conn*, and *Hammond* pedal instruments.

* * *

"HI-FI EQUIPMENT YEARBOOK—1957" edited by Sanford M. Herman. Published by *Herman & Stephens*, New York. 127 pages. Price \$1.95. Paper bound.

This is a listing of commercially available audio equipment with specifications, prices, physical size, and photographs (as supplied by the manufacturer) on amplifiers, tuners, phono equipment, speakers, cabinets, and tape recorders. The products of most of the well-known audio manufacturers have been included.

An introductory section entitled "The Presence of Distortion and the

June, 1957



Sell More Antenna Replacements with the new **CHANNEL MASTER®** TV Antenna Check-Up Kit

Who says antenna sales must slow down during the Spring and Summer months? Channel Master offers you a **brand new concept in antenna merchandising** that's sure to perk up your antenna business. It's the nationally advertised "TV Antenna Check-Up Kit" — designed to **build store traffic** for you by making present TV owners aware of their faulty antenna installations.

This 3-piece consumer literature kit includes:

- 16-page illustrated booklet "Better Pictures On Your TV Set"
- 10-point check-up folder "Spotting Antenna Trouble"
- Literature about the TW Antenna

Use these kits as free giveaways or mailing pieces to build store traffic.

CALL YOUR CHANNEL MASTER DISTRIBUTOR NOW! He also has Posters, Streamers, and Newspaper Mats to help you merchandise the "TV. Antenna Check-Up Kit."

Tie-In with Channel Master's High-Powered National Advertising in America's Leading Magazines



SERVICE ENGINEERS—Want a better position with a growth company?

We are looking for men experienced in electronic instrument building or repair to handle Field Service instrument work in one of the major industrial areas in the U.S. 3-6 weeks training Southern California. Write B. H. Holmes, Beckman Instruments, Inc., Fullerton, California. Ask for Career File #26.

STEREOPHONIC RECORD PLAYBACK HEAD IN-LINE MODEL TLD

For conversion, replacement, new equipment. Includes data, schematics for amplifiers, etc.

ORDER FROM:
NORTRONICS, INC.
1015 S. 6th Street
MINNEAPOLIS 4 MINN.

\$1950

ENGINEERING B.S. DEGREE in 27 MONTHS

Prepare for unlimited opportunities of the Electronic Age! Earn your B.S. degree in 27 months at Indiana Technical College. Intensive, specialized course. Comprehensive training in electronics, television, advanced radio theory and design, math and electrical engineering. Modern laboratories. Low rate. B.S. DEGREE IN 27 MONTHS in Aero., Chem., Civil, Elec., and Mech. Engineering; in 36 MO. in Math., Chem., Physics. Also preparatory courses. G. I. appr. Enter June, Sept., Dec., March. Earn part of your expenses in Fort Wayne while studying. Catalog.

INDIANA TECHNICAL COLLEGE
967 E. Washington Blvd., Fort Wayne 2, Indiana

Please send me free information on B.S. ENGINEERING DEGREE IN 27 MONTHS as checked.

Electronics Chemical Aeronautical
 Civil Mechanical Electrical

B.S. DEGREE in 36 MONTHS: Math. Chem. Physics

Name _____
Address _____

BUILD THE BEST— BUILD ALLIED'S OWN knight- kits

Here is a typical Knight-Kit value—available only from ALLIED—one of 45 great Knight-Kits you'll find in our special Supplement No. 165. Write for your FREE copy today.

knight-kit HOBBYIST VALUE 2-TRANSISTOR POCKET RADIO



NEW!

Model
Y-262
\$1465

It's fun to build this efficient pocket-size broadcast band radio. Entirely self-contained, complete with built-in antenna (no external antenna required), battery and earphone. Features reflex-type 2-transistor circuit. Printed circuit panel simplifies assembly. Has high-gain ferrite-core antenna; super-sensitive miniature dynamic earphone for excellent tone quality; variable capacitor for accurate tuning; months of dependable operation from single long-life alkaline cell battery supplied. Two simple controls—On-Off-Volume and Tuning. Handsomely styled leatherette carrying case. Fits coat pocket or may be worn from belt; only 4 x 3 3/4 x 1 1/4". Complete, with step-by-step instructions. Shpg. wt., 1 1/2 lbs.

Model Y-262. Net, F.O.B. Chicago... **\$1465**

OTHER knight-kit HOBBYIST VALUES



"10-IN-1" LAB KIT
Y-265 **\$1265**



"6-IN-1" LAB KIT
Y-770 **\$795**



3-WAY PORTABLE
RADIO KIT
Y-730 **\$1995**



"OCEAN HOPPER"
SW RECEIVER KIT
Y-740 **\$1795**

See our Supplement No. 165 for 12 other knight-kit hobbyist values

free SUPPLEMENT featuring knight-kits



Send for our FREE Supplement No. 165 featuring 45 great Knight-Kits, including Test Instruments, Hi-Fi, Hobbyist and Amateur Kits. Write for your copy today.

ORDER FROM ALLIED RADIO

Dept. 01-F-7, 100 N. Western Ave., Chicago 80, Ill.

"Distortion of Presence" is written by Peter Aczel, an ardent hi-fi fan.

* * *

"U.H.F. TUBES FOR COMMUNICATION" and MEASURING EQUIPMENT" by Electron Tube Division Staff. Published by *Philips Technical Library*, Eindhoven, Holland. 60 pages. Price \$1.50. Available from booksellers or from the publisher direct.

This handbook covers tubes designed to operate at frequencies of 300 mc. and up. Radio and radar gear, navigation equipment, two-way radio equipment, etc. are all shifting into the higher bands hence the need for information about the tubes designed to handle these u.h.f. and s.h.f. waves.

The text covers the *Philips* DC70, EC80, EC81, EC55, EC56, EC57, 2K25, 723A/B, K81A, K50A, and K51A tubes. Technical data, application notes, and other pertinent data is provided in the form of performance graphs and electrical and mechanical tabular material.

* * *

"TUBES FOR COMPUTERS" by Electron Tube Division Staff. Published by *Philips Technical Library*, Eindhoven, Holland. 51 pages. Price \$1.50. Available from booksellers or from the publisher direct.

The fast-growing computer field has focused the attention of engineers on various electronic tubes which have been designed for or are especially suitable for computer applications.

This compact handbook provides general notes on computer circuits and discusses the various tubes for use in high- and low-speed computers. The material covers tubes of *Philips'* manufacture but since many of these components are available in the U. S., the reader will find this discussion both interesting and useful.

* * *

"TUBE SELECTION GUIDE 1956-1957" compiled by Th. J. Kroes. Published by *Philips Technical Library*, Eindhoven, Holland. 124 pages. Price \$1.50. Paper bound. Available from booksellers or from the publisher direct.

This compact tube handbook, whose instructions are carried in English, French, German, and Spanish, is designed to assist electronic tube users in selecting the correct tube for the job at hand. The text is divided into various tables which list all tubes in the *Philips* manufacturing range or which can be replaced by suitable *Philips* equivalents, tubes by important properties, preferred tubes for new apparatus, tubes for replacement purposes only, and tubes which may be used for the replacement of obsolete types. Descriptions of type-number systems and data on several tube bases and tube holders are also included; an invaluable aid to engineers, technicians, and those who work with various electronic gear of European manufacture.

* * *

"PIN POINT TV TROUBLES IN 10 MINUTES" compiled by Coyne Staff. Published by *Coyne Electrical School*, Chicago and distributed by *Howard*

W. Sams & Co., Inc., Indianapolis. 299 pages. Price \$3.95. Spiral paper binding.

According to the compilers of this handbook some 700 receiver troubles will result in 70 basic types of faulty pictures. It is to help service technicians pin-point these circuit difficulties that this unique system for locating faults has been devised. Simple check charts, along with cross-references allow the rapid, accurate location of the most probable causes for each picture symptom. Having localized the fault to a specific section of the receiver, the technician should then be able to correct the trouble in minimum time and with little effort.

Although no single book can list all the ills that might beset a TV circuit, this volume has made an excellent stab at the problem. TV receiver circuits from 1953 on are covered in this presentation. Service technicians should find this a worthwhile investment as a time saver.

* * *

"HOW TO LISTEN TO THE WORLD" compiled by O. Lund Johansen. Published by *World Radio-Television Handbook*, Copenhagen. 54 pages. Price \$.60. Paper bound. Available from *Gilfer Associates*, P. O. Box 239, Grand Central Station, New York 17, N. Y.

This is a "how-to-do-it" book in which experienced SWL hands tell the beginner how to get the most out of his dialing. The text explains the principles of short-wave propagation, how atmospheric affect reception, how to pick the best bands, antenna systems, operating the receiver and identifying stations, QSL cards, how to describe reception, logging and reporting, DX-ing on medium waves, listening in on the hams, tips on DX-ing, how to identify languages, time differences, abbreviations, and QSL bureaus and their addresses. This book should answer a lot of "toughies" for the short-wave addict—both old and new.

* * *

"WORLD RADIO HANDBOOK" edited by O. Lund Johansen. Published by *O. Lund Johansen*, Copenhagen. 170 pages. Price \$2.00 plus 20 cents postage and handling. Paper bound. Eleventh Edition. Available from *Gilfer Associates*, P. O. Box 239, Grand Central Station, New York 17, N. Y.

Short-wave listeners will be happy to hear that the 1957 edition of this invaluable handbook is now available. As was the case with the earlier editions, the new volume carries a listing of standard frequency, long-, medium-, and short-wave stations throughout the world. The programs, station call letters, frequencies, and "best times to listen" are given for some 184 countries that maintain overseas services.

How to report reception, whether or not the station acknowledges such reports, and whether an IRC is expected are also given for each country, along with a section of musical themes where stations identify by such means.

For the serious SWL, hams, and others interested in tuning in on the world, this handbook is a "must"!

* * *

"TELEVISION EXPLAINED" by W. E. Miller, revised by E. A. W. Spreadbury. Published by *Iliffe & Sons Ltd.*, London. 175 pages. Price 12/6 plus postage. Sixth Edition.

It has been four years since the Fifth Edition of this text made its appearance and during that period many important changes have been made in British television. In order to cover both of the current systems now in use in England, the text material has been considerably revised and enlarged.

* * *

The author and reviser have assumed that the reader has a basic understanding of radio receiver circuitry but does not necessarily know anything about TV transmission and principles. The treatment is non-mathematical, written in simple language for the beginner or student. The circuits, equipment, and transmission standards discussed are British but the U. S. reader will find much basic material applicable to Stateside TV sets.

* * *

"BUILDING AN ENGINEERING CAREER" by Clement C. Williams & Erich A. Farber. Published by *McGraw-Hill Book Company, Inc.*, New York. 290 pages. Price \$4.75. Third Edition.

Since it looks as if engineering will

remain in the "most-in-demand" category for some time to come, many would-be engineers will welcome this over-all picture of their chosen profession.

The text material is divided into three major sections covering the education for engineering, the historical background of engineering, and, finally, the achievements in engineering. Chemical, civil, electrical, mechanical, mining and metallurgy are the engineering fields covered in the discussion.

As a source of basic information for the student deciding on a career, as a shot-in-the-arm for the man in the midst of his training, and for the practicing engineer who needs a revitalizing view of the "forest," surrounded as he is by the "trees," this book is recommended.

* * *

"FOUNDATIONS OF RADIO" by M. G. Scroggie. Published by *Philosophical Library*, New York. 338 pages. Price \$10.00 Sixth Edition.

The appearance of this new and completely revised edition of one of the best-known basic radio texts, will be welcome news to the author's many "fans" who appreciate and enjoy his lucid presentation of the subject.

In order that the complete tyro can use this text, the author has devoted an introductory section to an explanation of "radio shorthand" or electronic terminology. As a further aid to the non-British user, the U. S. publishers

have appended a listing of American equivalents for United Kingdom terms used in the text.

The author covers all the basic material so essential to an understanding of radio and then discusses tubes, transmitters, receivers, television and radar, antennas, power supplies, and transmission lines. Appendices covering symbols and abbreviations, circuit symbols, and decibel tables contribute to the "one-volume-library" concept.

* * *

"THE FIRST ONE HUNDRED AND FIFTY YEARS" by the House of Wiley. Published by *John Wiley & Sons, Inc.*, New York. 225 pages. Price \$7.50.

This is the history of a great publishing house during its first 150 years and a record of the people and events that contributed to its greatness.

Established in 1807, the firm has long been associated with the publication of technical books and its catalogue is, in reality a history of engineering progress. A number of engineers whose names are household words have contributed short pieces to this history which are, in effect, appreciations for the role of this dedicated publisher in advancing the frontiers of human knowledge.

* * *

"ANTENNAS" edited by Alexander Schure. Published by *John F. Rider Publisher, Inc.*, New York. 76 pages. Price \$1.50. Paper bound.

Volume 14 in this publisher's "Electronic Technology Series" covers both

Abraham Markus, co-author of famous best-seller "Elements of Radio" makes amazing offer!



TRY MY TV and RADIO REPAIR COURSE FREE FOR 1 MONTH

"If you haven't earned at least \$100 in spare time during that period you pay not a cent."

Here it is! The most amazing guarantee offered on any radio-TV course anywhere! We'll send you Abraham Marcus' course to use FREE for one full month! If in that time you haven't actually made \$100 fixing radios and TV sets, just return the books to us and pay not a penny!

Why do we make this sensational offer? First, because these books are so easy to use. They are written in the same clear, easy-to-understand language that made the author's "Elements of Radio" a 1,000,000-copy best-seller. Second, because these books get right to the point—tell you what to do in 1-2-3 fashion. For example, once you master the first few chapters of the TV book you are ready for business—ready to do service jobs in the field—jobs that account for over 80% of all service calls.

DON'T WAIT! You risk nothing when you send the coupon at right. You don't have to keep the books and pay for them unless you actually make extra money fixing radios and TV sets. Even when you decide to keep them, you pay on easy terms. Mail the coupon now.

WHAT YOU GET IN THESE 3 GIANT VOLUMES

ELEMENTS OF TELEVISION SERVICING. Analyzes and illustrates more TV defects than any other book, and provides complete, step-by-step procedure for correcting each. You can actually SEE what to do by looking at the pictures. Reveals for the first time all details, theory and servicing procedures for the RCA 28-tube color television receiver, the CBS-Columbia Model 205 color set, and the Motorola 19-inch color receiver.

RADIO PROJECTS. Build your own receivers! Gives you 10 easy-to-follow projects, including crystal detector receiver—diode detector receiver—regenerative receiver—audio-frequency amplifier—tuned-radio-frequency tuner—AC-DC superheterodyne receiver—etc.

RADIO SERVICING Theory and Practice. Here is everything you need to know about radio repair, replacement, and readjustment. Easy-to-understand, step-by-step self-training handbook shows you how to locate and remedy defects quickly. Covers TRF receivers; superheterodyne receivers; shortwave, portable, automobile receivers, etc. Explains how to use testing instruments such as meter, vacuum-tube voltmeters, tube checkers, etc., etc.



MAIL THIS COUPON

**Prentice-Hall, Inc., Dept. 5741-H1
Englewood Cliffs, New Jersey**

Please send me Abraham Marcus' TV & RADIO REPAIR COURSE (3 volumes) for 10 days FREE examination. Within 10 days I will either return it and owe nothing, or send my first payment of \$5.60. Then, after I have used the course for a FULL MONTH, if I am not satisfied I may return it and you will refund my first payment. Or I will keep the course and send you two more payments of \$5.60 a month for two months.

Name
Address
City Zone State

HARVEY has it... TELREX '56 Beam Antennas

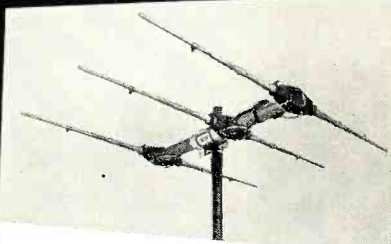

Commercial grade arrays at amateur prices; superior in performance, design and construction to any other antenna. Hair-pin resonated, precision tuned, matched and calibrated. Provide highest signal-to-noise ratio possible; 75% reduction in precipitation static.

FEATURES

- Extremely rugged elements of advanced sectional design; taper-swaged to reduce useless wind drag and silhouette by 55%.
- Special sturdy molded element support made of Borg-Warner "Cyclocac", a very high impact thermoplastic resin; holds, insulates and capacity-couples element to the boom for automatic dissipation of precipitation static.
- Stainless-steel airplane-type clamp, holds element sections firmly in exact position.
- Precisely constructed and the famous Telrex "Balun" help produce outstanding performance per element, clean-cut balanced pattern and minimum TVI.
- Single, heavy-wall aluminum boom is small in size, rugged in strength, and light in weight.
- Stainless steel "Hairpin" grounding lug provides element grounding at voltage node for lightning protection.

"SERIES 56" SPECIFICATIONS AND PRICES

Telrex No.	Meter Band	Elements No.	Gain db	Shpg. Wt. Lbs.	Amateur Net Each
3/4 M-15C	3/4	15	16.2	13	\$ 29.00
1 1/4 M-5C	1 1/4	5	11.9	3	6.95
1 1/4 M-15C	1 1/4	15	16.2	16 1/2	31.00
2M-3C	2	3	9.4	2 1/4	5.95
2M-5C	2	5	10.5	3	7.25
2M-6C	2	6	12.7	4	12.50
2M-8C	2	8	13.5	10	13.75
2M-808†	2	16	10.5	15	33.50
2M-15C	2	15	16.2	28	39.25
6M-3D	6	3	9.4	7	16.25
6M-4C	6	4	9.7	10	19.75
6M-6C	6	6	12.7	20	57.50
6M-56-135§	6	6	12.7	44	149.00
1030-S	10	3	7.0	9	36.50
10M-56-79‡	10	3	8.9	27	96.00
10M-56-120‡	10	4	10.1	33 1/2	144.00
10M-56-185§	10	5	11.2	77	220.00
10M-56-235§	10	6	12.7	93	290.00
15M-56-67‡	15	2	4.8	22	80.00
15M-56-99‡	15	3	8.9	32	117.00
15M-56-118‡	15	4	9.7	37	140.00
15M-56-198§	15	4	11.1	64	235.00
15M-56-245§	15	5	11.9	94	285.00
20M-56-79	20	2	4.8	26	89.00
20M-56-112‡	20	3	8.7	33	130.00
20M-56-149§	20	3	9.0	56	175.00
20M-56-168§	20	3	9.4	63	198.00
20M-56-235§	20	4	10.4	74	275.00
20M-56-265§	20	4	11.2	90	305.00
40M-56-180	40	2	3.4	66	180.00
40M-56-365§	40	3	8.3	130	365.00

‡Circular polarized †Deluxe Model
§Super Deluxe Model

Harvey has in stock
the New Tri-Band Antennas
for 10-15-20 Meters

MAIL ORDERS SHIPPED
SAME DAY AS RECEIVED

Include with payment an allowance for shipping charges. Prices subject to change without notice.

HARVEY Estab. 1927
RADIO CO., INC.

1123 Avenue of the Americas JU 2-1500
(6th Ave. at 43rd St.) N.Y. 36, N.Y.

the theory and practical application of antennas, transmission lines, input impedance, polarization, etc. and deals with antennas ranging in complexity from the basic dipole through parasitic arrays, long wires, and other varieties.

Practical antenna types are covered in some detail in the 5th and final chapter of this book. Service technicians, students, and practicing engineers will find this material of interest.

* * *

"EQUIVALENT RADIO TUBES—VADE-MECUM" edited by Dr. J. A. Gijzen. Published by P. H. Brans, Ltd., Antwerp. 342 pages. Thirteenth edition (1957).

This is the newest and most up-to-date version of the equivalent radio tube "bible" which is widely used wherever equipment incorporating tubes is used.

Instructions for using the comprehensive tables are given in eight languages and the tabular material made as simple yet complete as possible. A bookmark-symbol guide, in the language of the country in which the edition is distributed, makes it unnecessary to consult another source for the terminology. A master index of all the tubes covered refers the user to the pertinent section.

Those whose work involves the servicing, installation, or operation of non-American-built equipment would find this listing a time and trouble saver in making repairs, troubleshooting, or determining suitable American-made equivalents.

* * *

"RELIABLE ELECTRICAL CONNECTIONS" sponsored by the RETMA. Published by Engineering Publishers, G.P.O. Box 1151, New York 1, N. Y. 103 pages. Price \$5.00. Paper bound.

This is a compilation of the papers presented at the second RETMA conference on reliable electrical connections held last fall at the University of Pennsylvania.

Some 13 authors are represented and, in addition, the compilers have provided supplementary data and information supplied by 23 other experts on the subject. The material contained in this book is of particular interest to engineers, management personnel, and government agency representatives.

UNIONTOWN GABFEST

THE Uniontown Amateur Radio Club has scheduled its Eighth Annual Gabfest for Saturday, June 29th. The event will be held at the Club House on Old Pittsburgh Road, just off Route 51, 2 miles north of Uniontown.

The Club will open at noon with the prize drawing scheduled for 6:30 p.m. and movies after the drawing. This is a stag affair and hams are invited to come early and stay late. Registration fee is \$1.50. Refreshments will be available at nominal cost with coffee, pretzels, and side dishes free.

Contact the Club at P.O. Box 849, Uniontown, Pa. for further details or call W3PIE, the Club station.

Save Money with the Easy to Build NEW ERIE AUDIO-AMPLIFIER KIT Featuring

ERIE
"PAC"
PRE-ASSEMBLED COMPONENTS

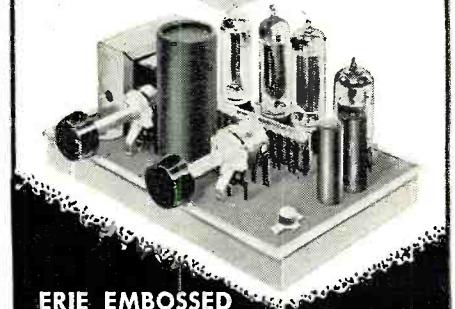

ERIE EMBOSSED WIRING BOARD

With these plug-in components: Tubes, Tube Sockets, Filter Capacitor, Volume Control and Switch, Tone Control, Capacitors.

This unique kit includes all components required to assemble a high quality, four tube, Push-Pull Audio-Amplifier, including tubes and output transformer.

The use of the ERIE "PAC" and the ERIE Embossed Wiring Board is a new concept in amplifier design which results in a compact, easy-to-assemble Kit. Complete instructions and recommendations for construction are provided.

SPECIFICATIONS

Frequency Response: 30 cycles to 12,000 cycles
±3.5 db.
Sensitivity: 0.56 volt RMS (input at 1 KC) for 4 watt output.
Power Output: 4 watts.
Input Impedance: 2 megohms.
Output Impedance: 4 ohms.
AC Power Consumption: 17 watts.
Overall Dimensions: 6-5/8" w. x 4-5/16" d. x 3-7/8" h.
Shipping Weight: 2 pounds.

\$12.95

F.O.B. BOSTON

20% deposit with C O D orders.

Cramer Electronics Inc.
811 BOYLSTON STREET, BOSTON 16, MASS.

NEW! 4-Transistor Pocket Radio!



Size of cigarette package. No external antenna needed. Brings in stations 800 miles away at night. Loud volume. Uses 12 1/2-cent flashlight battery that lasts 1500 hours. Printed circuit. Free literature.

Complete kit, \$23.50. Fully wired, \$29.50.

Send for yours today!

Order now from

GARDINER ELECTRONICS CO., Dept. 11
2545 East Indian School Road • Phoenix, Arizona

Motorola Color TV Sets

(Continued from page 48)

dynamic convergence set-up procedure is followed. This latter procedure is essentially the same as for other color sets using the 21AXP22 picture tube.

Service Hints

The *Motorola* color sets use two fuses. One is a 2-ampere, pigtail type which is located in the power-supply subchassis. To get at this fuse, the four mounting screws holding the subchassis in the cabinet must be removed and the cables going to the power supply disconnected. The second fuse is a $\frac{3}{8}$ -ampere, time-lag plug-in type located at the rear of the main chassis between the 6AU4 damper tube and the 6CM6 vertical-output stage. This fuse is accessible simply by removing the back cover of the cabinet.

Several separate test receptacles are available in these receivers. The five-pin plug on the rear chassis apron is used for checking a.g.c., video, and horizontal-oscillator operation. On the main chassis near the front of the set, the three picture-tube grid leads are plugged into a receptacle, and their signals can conveniently be checked there. The conventional mixer-grid test point is located on the tuner, and then there are two i.f. test points located on the main chassis near the first and third i.f.'s respectively. Individual test points are also provided for the color sync and color demodulator section.

Since the bell of the color CRT is made of metal, there is always the chance that one of the fields in the receiver may magnetize it. This will result in the inability to achieve proper color adjustment over one or more areas of the screen. Demagnetization is accomplished by placing next to the magnetized area a coil that is energized by a.c., then withdrawing it to a distance of about 10 feet before current is cut off.

The safety glass in front of the screen is removable for cleaning purposes. The h.v. should either be shorted out after the set is turned off or a "cooling off" period of at least 10 minutes should be observed before probing inside the set is undertaken. When the channel selector and fine-tuning knobs are pulled off, two screws become visible holding a circular insert. Remove the screws. Remove the five screws holding the metal molding trim at the bottom of the safety glass, as well as the four hex-head screws holding the metal glass retainer at the bottom. Finally, unscrew the five screws at the top of the screen, but be sure to hold the glass at this time to prevent it from falling out with the last screw. The glass has to be jiggled slightly to move it out, since it has to clear the flexible molding. When returning the glass be sure to attach the flexible molding at the top, bottom, and left side before inserting it into the frame again.

-50-

THE GREATEST VALUE IN TEST EQUIPMENT



MODEL
980 VOM

Only \$46⁷⁵/_{LIST}

A real value leader . . . accurate, compact, rugged, and low in cost. Has a combination of 28 functional ranges, simplified by a single dial. Ideal for radio and TV servicing, and for all 'round electronic and electrical measurement needs. At leading distributors, or write for literature. WESTON Electrical Instrument Corporation, Newark 5, N. J. A subsidiary of Daystrom, Inc.

WESTON test equipment
The Quality Line

ZYTRON "QUALITY BRAND"

RADIO & TV RECEIVING

TUBES

BRAND NEW

INDIVIDUALLY BOXED

Terrifically LOW PRICED!

Send TODAY for Complete Catalog

ZYTRON TUBE CORPORATION

220 West 42nd Street - New York 36, N. Y.



EASY TO LEARN CODE

It is easy to learn or increase speed with an Instructograph Code Teacher. Affords the quickest and most practical method yet developed. For beginners or advanced students. Available tapes from beginner's alphabet to typical messages on all subjects. Speed range 5 to 40 WPM. Always ready—no QRM.

ENDORSED BY THOUSANDS!

The Instructograph Code Teacher literally takes the place of an operator-instructor and enables anyone to learn and master code without further assistance. Thousands of successful operators have "acquired the code" with the Instructograph System. Write today for convenient rental and purchase plans.



INSTRUCTOGRAPH COMPANY

4711 SHERIDAN ROAD, CHICAGO 40, ILLINOIS

IMPORTANT NEWS FOR SERVICE TECHNICIANS



3rd SUPPLEMENT
to Howard W. Sams
"TELEVISION TUBE
LOCATION CHARTS"
available July 1st!

Thousands of subscribers have already received the first two Supplements and are now up-to-date with the Howard W. Sams Tube Location Guide Service.

SUBSCRIBE NOW—get *your* deluxe binder and all Supplements released to date. Remaining Supplements will then be mailed to you immediately as they become available. Here's what your subscription includes:

Current TV Model Coverage for One Full Year
 Complete Cumulative Indexing Service
 Deluxe Binder for Easy Filing

YOU GET A FULL YEAR'S
SUBSCRIPTION (4 ISSUES) \$3⁹⁵
PLUS BINDER FOR ONLY...

ORDER TODAY!

HOWARD W. SAMS & CO., INC.

Order from your Parts Jobber or mail to Howard W. Sams & Co., Inc., Dept. 1-FF7 2201 E. 46th St., Indianapolis, Ind.

Enter my order for _____ subscription(s) to the Howard W. Sams Tube Location Guide Service.

My (check) (money order) for \$ _____ is enclosed.

Name _____

Address _____

City _____ Zone _____ State _____

(outside U.S.A. priced slightly higher)

A High-Stability Oscillator Circuit

By **ROBERT J. ROPES**

Details on a ham circuit which oscillates vigorously and easily and tunes very well over a wide frequency range.

THE circuit to be described is a practical application of the circuit originally developed by Harris¹ as a "Q" multiplier, and recently suggested by Clapp² as having possibilities as a stable LC oscillator. This oscillator is exceptionally stable and its output possesses excellent waveform when the circuit is designed around the correct circuit constants.

The circuit can be called the "class A Colpitts," since it operates in class AB₁. As pointed out by Clapp,² the frequency coefficient of an oscillator is independent of the LC ratio of the oscillator tuned circuit if the operation of the circuit is *linear*; that is, class A, AB, or B. Since class A operation of an oscillator is, for all practical purposes, impractical, class AB or B operation must be used to give the necessary linearity of operation. Clapp has discussed³ several other oscillators in which the input and output circuits of the tube are connected across portions of the tuned circuits and in which the tube is operated in a linear manner. In an oscillator of this type, the greatest stability is obtained when the grid and plate circuits are connected to points on the tuned circuit of the lowest impedance which will sustain oscillation.

This "class A Colpitts" oscillator is somewhat reminiscent of the old Colpitts oscillator, but does not resemble it at all in operation. Since the oscillator operates in class AB₁, no grid current flows during any part of the oscillatory cycle, there is no "grid-leak" capacitor and no grid bias voltage is produced by grid current flow, as is the usual case in a class C oscillator.

In referring to the schematic, the large values of resistance in the cathode circuits are at once apparent. The resistance between the cathode and the tuned circuit "tap" insures adequate isolation between the cathode and plate circuits, their associated capacitances, and the tuned circuit itself. In addition, this resistance helps to maintain the operation of the tube in class AB₁. A tube should be chosen which has a very small input capacitance, with transconductance being a somewhat secondary factor. The large cathode resistance limits the plate current to a low value and assures a minimum of distortion in the waveform. The highest stability (and, incidentally, the lowest output) is obtained with a high grid-to-cathode capacity ratio in the tuned circuit. Ratios for C₃/C₂ on the order of 1/35 to 1/100 seems to be practical; ratios as low as 1/5 should not be used.

The circuit overcomes the distinct disadvantage of the Clapp series-tuned

oscillator—that of limited frequency coverage when used as a variable frequency oscillator. In many amateur installations, trouble is encountered with the Clapp series-tuned oscillator when attempting to cover a rather large frequency range. Since, as Clapp has stated, with constant circuit "Q," the value of transconductance required to maintain oscillation of the series-tuned oscillator tends to become very unstable at the high frequency end of the band being covered. The Clapp oscillator cannot be used for frequency changes greater than about 1.2 to 1 for this reason. W. B. Bernard⁴ has pointed out (and Clapp has admitted⁵) that "the series-tuned oscillator is no more stable than a high-C Colpitts having the same circuit 'Q' and the same impedances presented to the tube." Clapp goes on to state that the advantages of the series-tuned oscillator begin to deteriorate at high frequencies (although he does not state what the frequency limit of the circuit seems to be), but he indicates that "improvements in stability of from 10 to 100 times over conventional circuits are readily obtained." This last statement would seem to refer to fixed-frequency operation of the series-tuned oscillator at the lower radio frequencies.

The foregoing information is brought in by the author to attempt to show reasons why the so-called "Clapp series-tuned" oscillator has been disappointing to many amateurs who have built the circuit into variable frequency oscillators and exciters covering the high amateur bands, with the oscillator usually on 160 or 80 meters.

In constructing the "class A Colpitts" oscillator, the oscillator tank

Complete schematic of a stable oscillator.

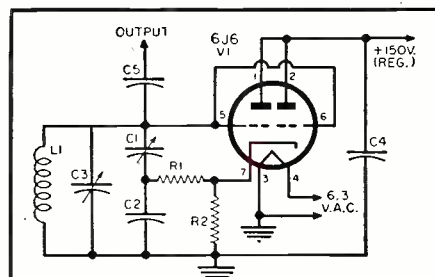

- R₁—1 megohm, 1/2 w. res.
- R₂—10,000 ohm, 1/2 w. res.
- C₁—100 μfd. variable capacitor (set at approximately 75 μfd. and used as "bandset" capacitor)
- C₂—5100 μfd. silver mica capacitor
- C₃—25 μfd. var. capacitor (covers 3.5 to 4 mc. with approximately 90% rotation)
- C₄—0.1 μfd., 400 v. capacitor
- C₅—100 μfd. mica capacitor
- L₁—21 μhy. coil, 24 t. #22 solid copper wire, closewound on 1/4" dia. form
- V₁—6J6 tube

coil should have a high "Q" and should be wound on a good form, preferably ceramic. The tuning capacitor should be of the double-bearing type and should be mounted rigidly to avoid mechanical vibration and modulation of the oscillator. All wiring should be direct and short, using heavy solid conductor wire. The extreme stability of this oscillator, coupled with the ease of tuning over a wide frequency range, should make this new circuit very popular with the amateur fraternity.

The author chose to use a 6J6 tube, because several were available and reasonably high transconductance with fairly low input capacity was obtained. There are numerous other tubes which are equally suitable. The circuit oscillates easily and vigorously.

The operating conditions of one oscillator built using this circuit were: Plate current—1.2 ma. (approx.), plate voltage—150 volts (regulated), grid voltage—0 volt, cathode voltage—12 volts, and frequency—2.5 mc.

The oscillator frequency would hover within a very few cycles per second of WWV for hours at a time and could be tuned over a wide band with but slight variation in plate current.

In conclusion, the author feels that the circuit qualities enumerated above along with the simplicity of the design should be enough incentive for having the amateur and experimenter give the oscillator a trial. We believe the results will fully justify our claims.



REFERENCES

1. Harris, H. E.: "A Simplified Q Multiplier," *Electronics*, May, 1951.
2. Clapp, J. K.: "An Inductance-Capacitance Oscillator of Un-usual Frequency Stability," *Proceedings of the IRE*, March, 1948.
3. Clapp, J. K.: "Frequency Stable LC Oscillators," *Proceedings of the IRE*, August, 1954.
4. Bernard, W. B.: Correspondence section of the *Proceedings of the IRE*, July, 1955.
5. Clapp, J. K.: Correspondence section of the *Proceedings of the IRE*, July, 1955.

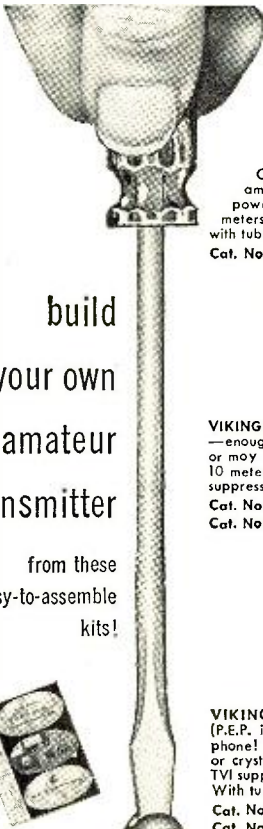
—30—



VIKING "ADVENTURER"—An ideal 50 watt CW transmitter for the novice or experienced amateur. Effectively TVI suppressed . . . built-in power supply . . . bandswitching 80 through 10 meters Easy to build and safe to operate. Complete with tubes, less crystal and key.
Cat. No. 240-181 Kit Amateur Net \$54.95

VIKING "RANGER"—Tops for operating convenience—enough power for world-wide contacts! Built-in VFO or may be crystal controlled. Bandswitching 160 thru 10 meters. 75 watts CW input—65 watts phone. TVI suppressed—with tubes, less crystals, key, microphone.
Cat. No. 240-161-1 Kit Amateur Net \$214.50
Cat. No. 240-161-2 Wired . Amateur Net \$293.00

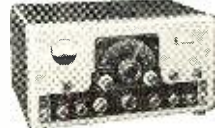

VIKING "VALIANT"—275 watts CW and SSB (P.E.P. input with auxiliary SSB exciter) 200 watts phone! Bandswitching 160 thru 10 meters. Built-in VFO or crystal control. Wide range pi-network output—TVI suppressed—high gain push-to-talk audio system. With tubes, less crystals, key and microphone.
Cat. No. 240-104-1 Kit Amateur Net \$349.50
Cat. No. 240-104-2 Wired . Amateur Net \$439.50

FREE CATALOG!
Write today for
your copy!



E. F. Johnson Company
3107 SECOND AVE. S.W. • WASECA, MINN.



THE REACH IS RIGHT AND TIGHT
with **KRAEUTER LONG NOSE PLIERS**

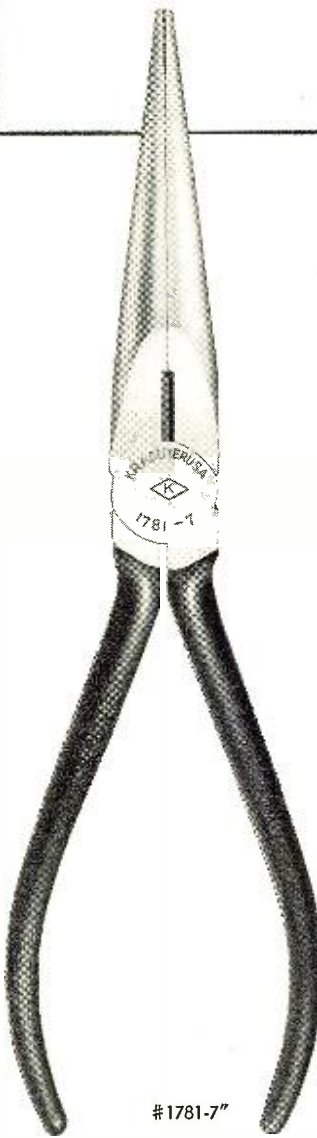

#1781-7"

You can depend on reachability and cutting power with Kraeuter's #1781 Long Chain Nose Pliers. And your reach will be tight and sure for those hard-to-get-at jobs with the extra long milled jaws of these pliers.

Buy the right line—It's the Kraeuter line for electronic and electrical work. Kraeuter tools are unreservedly guaranteed.

Send for catalog #25 illustrating complete Kraeuter line.

BUY THE FINEST
BUY KRAEUTER
BUY AMERICAN

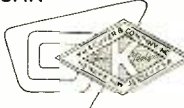

AS MODERN AS TOMORROW

kraeuter & co., inc

FOR 100 YEARS THE FINEST IN HAND TOOLS 1860-1960 • NEWARK, N. J.

**BUILD THE BEST—
BUILD ALLIED'S OWN**

knight-kits

Here is a typical Knight-Kit value—available only from ALLIED—one of 45 great Knight-Kits you'll find in our special Supplement No. 165. Write for your FREE copy today.

knight-kit HOBBYIST VALUE PHOTO-ELECTRONIC RELAY KIT



Model Y-702 \$1350

Build your own modern, dependable photo-electric system at low cost! System consists of relay kit and light source. Ideal as counter, announcer, burglar alarm (can be set to ring bell continuously when beam is broken) and for hundreds of other uses. An ultra-sensitive system, easy to assemble and capable of professional results.

Relay Kit Only. SPST contacts, rated 1 amp. Supplies 6.3 v. at 0.6 amps for alarm, counter, etc. Max. counting rate: 600 per minute. Uses sensitive cadmium selenide photocell. Usable distance from light source below: White, 250 ft.; deep-red filter, 125 ft. With 5696 thyratron tube. Size, 5 x 3 x 5". Shpg. wt., 2 1/2 lbs.

Model Y-702. Net, F.O.B. Chicago... \$1350

Light Source Kit Only. Sealed-beam bulb; capped filament; removable dark red filter. 6 x 6 x 4". Shpg. wt., 3 1/2 lbs.

Model Y-703. Net, F.O.B. Chicago... \$675

OTHER knight-kit HOBBYIST VALUES



WIRELESS BROADCASTER KIT
Y-705 \$950



50 W/SEC. ELECTRONIC PHOTOFLASH KIT
Y-244 \$2850



PHONO AMPLIFIER KIT
Y-790 \$895



PHONO OSCILLATOR KIT
Y-760 \$585

See our Supplement No. 165 for 12 other knight-kit hobbyist values

free SUPPLEMENT featuring knight-kits



Send for our FREE Supplement No. 165 featuring 45 great Knight-Kits, including Test Instruments, Hi-Fi, Hobbyist and Amateur Kits. Write for your copy today.

**ORDER FROM
ALLIED RADIO**

Dept. 01-F-7, 100 N. Western Ave., Chicago 80, Ill.

The Dyna-Box Checks Tubes (Continued from page 65)

S₂) to the number corresponding to the element which is the plate.

4. Set the "Grid Volts" switch, S₃, to zero.

5. On the tube tester, throw the switch corresponding to the number of the plate of the tube up to the N position. Also set up any other elements to the N position that are required by the TC-55 tube chart (if any) for that particular tube.

6. On the tube tester throw all switches corresponding in number to free grids of this tube, up to position P. This connects grids together.

7. Now flip the lever switch over to the "Power Output" position. With many tubes, you will get little or no reading, with zero grid volts. (Such tubes as the 6J6 and 6BK7A, however, will provide a reading.) Normally, increasing the grid volts to six will provide a reading which is recorded. Now switch to 20 volts (excepting for 6J6's, 6BK7A's and others that would read too high at this grid voltage), and record the reading.

An immediate comparison between two tubes of the same type can be obtained from these readings. Also, each section of a double tube can be compared, and tubes which require matching can thus be matched.

Just as the manufacturers of tube testers obtain the data supplied in their charts, users of the "Dyna-Box" must obtain such data from records kept on each tube tested. A suggested chart is shown in Table 1. Very soon, the user will have recorded information concerning new tubes or tubes known to be good, and, by comparison, can tell the condition of any tube tested. Because some tubes (such as the 6J6's mentioned before) may approach or exceed their maximum dissipation using 150 volts on the plates and 20 volts on the grids, tests are not made on 20 volts, if a high reading has already been obtained with 6 grid volts. Table 1, made in a few days use of the "Dyna-Box," is provided for information.

Before throwing away those old tubes out of your radio set, try them on the "Dyna-Box." You may find, as the author did, that some tubes eight years old, whose emission was down some, were as good as new, dynamically, and in some cases outperformed new tubes. And when you have tried to balance up a push-pull amplifier with tubes that check out on emission and with precision resistors in the circuit, the "Dyna-Box" may show why the balance isn't there.

Remember that a tube that tests really low on emission is certainly no good; but a tube that tests OK on emission is not necessarily a good tube. It may actually be so poor in performance that it is inoperative. These are the "dogs" that the "Dyna-Box" finds.

The ALL NEW "15-POUNDER" MYSTERY PACKAGE
of ELECTRONIC PARTS
Worth \$35.00
OUR PRICE
\$295
It's Another THRILLING SURPRISE. 15 pounds of BRAND NEW surplus. Perfect gift for Hams, etc.
NOTE: Send Envelope to Cover Mailing Costs. EXCESS REFUNDED.
SATISFACTION GUARANTEED

BUTTERFLY CONDENSERS
YOUR CHOICE
\$495
These units make the finest tuners for Ultra-high frequency transmitters, receivers, frequency meters, and oscillators.

TYPE A 4 1/4" Dia. TYPE A-100-320 MC. Antenna Type	TYPE B 4 3/8" Dia. TYPE B-130-400 MC.
TYPE C 2 1/2" Dia.	TYPE D 2 1/2" Dia.
TYPE C-300-1000 MC. Dist. 30589-1 tube	TYPE D-300-1000 MC. Clip for Kool Det.

RELAYS
3VDC 11-OHMS D.P.D.T.
3A. CONTACTS \$1.29
6VDC 24-OHMS D.P.S.T.
8A. CONTACTS \$1.95
110VAC 15A. CONTACTS S.P.S.T. \$1.75
TELEPHONE TYPE 7500-OHMS S.P.D.T. 2A. CONTACTS \$2.49

OIL CONDENSER
\$165
2 MFD. 3000 VDC. Pyranol Oil W/Mounting Bracket.
1-1 Mid. 3000 VDC. removed from equip. 4 1/2" x 4 1/2" x 2 1/2"

PHOTO ELECTRIC CELL
95¢
GE Vacuum Cell used in 2 M P R Q Sound Projector. Also useful for opening garage doors and Alarm Systems.

GE Pyranol Oil CONDENSER
32 MFD. 330 VAC. 60 Cy. Removed from equip. NEW. **95¢**

RCA Output Transformer
P.P. 6LE's 25 WATTS
Pri. 5000 ohms output SEC. = 1 500 ohms, = 2 600 ohms sidings 13 to 15,000 ohm. flat.

ALL-PURPOSE FIL TRANSFORMER
PRI. 117 v. 60 cyc. sec.
S4 V.12A
S4 V.10A
S4 V.8A
S4 V.6A
S4 V.4A
S4 V.2.5A

Hi Gain Dynamic Mike Kit
Uses UTC Transformer & Western Electric Mike. Ideal for Hams, PA., CAP. Recording Mobile Equip. -50 DB 80 to 7500 CPS. Diagram Furnished. **\$195**

SWING CHOKE \$595
2H-7H 550 MA. Thordarson T48003.

100 ASSORTED CRYSTALS
FT-243 FT-241A FT-171B Type Holders FREQ. RANGE 2015 KC to 38.1 MC.
Value \$50.00 **\$795**
HOTTEST BUY IN THE U.S.A.

AUDIO CHOKE 95¢
60H-1MA. 4,500 ohms. 15,000 turns of 44 wire. Size: 1 1/2" x 3/4" x 3/4". Ideal for radio control, planes, boats, etc.

ALLIGATOR CLIP
Piercing type with 5 Ft. cord and spade lug. Ideal for test clip. TL-137. **2 for 25¢**

TERMS: Cash with order or 25% DOWN—BALANCE C.O.D.
ALL PRICES NET F.O.B. DETROIT
MINIMUM ORDER \$2.00

HERSHEL RADIO CO.
TYler 8-9400
5249 GRAND RIVER Detroit 8, Michigan

GET INTO ELECTRONICS

Valparaiso Tech trains for top flight positions. Technical representative, field engineers, sales and specialists in communications, missiles, computers, radar, automation, color television. Basic and advanced theory and laboratory. Major companies visit school for our graduates. 21 months' course. High school grad. or equivalent. Dormitories—campus. Start Sept., Jan., April, July. G. I. approved. Write for Catalog.

VALPARAISO TECHNICAL INSTITUTE
Dept. RD Valparaiso, Indiana

Pocket CRT Checker

(Continued from page 63)

electrode glows because of the rectifier action in the picture tube, with the grid and cathode acting as a diode. The circuit is designed to indicate operable condition if the tube has a zero-bias emission of at least 100 ± 50 microamperes. There will be a broad tolerance because of the variations in resistors, neon lamps, and line voltage. This amount of current flowing through the 680,000-ohm resistor (R_1) develops sufficient voltage to cause one element of NE-2 lamp to glow. If the picture tube has enough emission to fire the NE-2 lamp, then it is also sufficient to illuminate the phosphor screen. This, then, tells the technician if a blacked-out screen is caused by a fault in the chassis or the picture tube. The amount of emission, however, may not be sufficient for satisfactory viewing. However, this latter factor can best be determined by observing brightness capabilities of the tube operated in its own TV circuit.

A "Grid No. 1-to-Cathode Short" will cause both neon elements to light. The electrodes appear to glow continuously because of the fast repetition of the applied a.c. voltage, which now goes straight through the short without rectification in one direction only.

If the picture tube base is loose, there may be a short in the flexible leads to the base that is not indicated by this checker. Grid No. 2, anode, or electrostatic-focus electrodes are not checked for opens or shorts. However, the percentage of tubes with these faults developing after they are in the home is small.

If the switch is depressed before emission begins, there is a positive peak of 75 volts on Grid No. 1. It is for this reason that the waiting period is recommended. After the emission starts to build up, Grid No. 1 and the cathode of the picture tube go into operation as a half-wave rectifier. The 220,000-ohm resistor then serves to limit current and acts as a voltage-dropping resistor, so that the positive-peak voltage on Grid No. 1 after warm-up will be less than one volt.

This picture tube checker can also be an asset in the service shop if it is used to check new tubes before they are installed in TV sets.

Construction

The technician can use his ingenuity in the assembly of the required components into a small case of his own choosing. The case the author used, already discussed, required no drilling or punching. The filament transformer was mounted to a molded stud on the case with a spring fastener. The NE-2 lamp was mounted behind the opening that appears on the front of the checker in Fig. 1. These standard components were easy to assemble. The completed tester has the advantages of simplicity and low cost. —30—

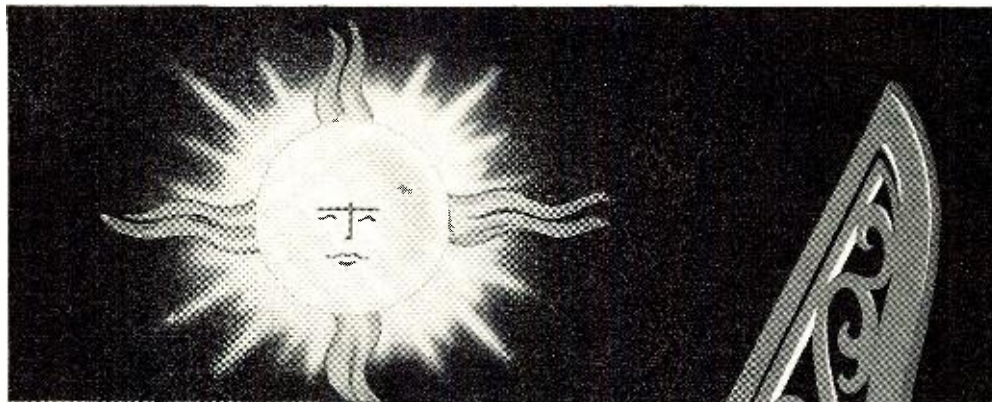

YOU SAVE TIME when you use STANCOR CONSERVATIVELY RATED EXACT REPLACEMENTS

No re-wiring, no circuits to change, because almost all STANCOR transformers are exact replacements, built for quality from original manufacturers' physical and electrical specifications. At better distributors everywhere. Write for your free catalog.

CHICAGO STANDARD TRANSFORMER CORPORATION

3505 ADDISON STREET • CHICAGO 18, ILLINOIS

Export Sales: Roburn Agencies, Inc., 431 Greenwich St., New York 13, N.Y.



LEARN HOW TO BUILD DOZENS OF HANDY DEVICES!



The ELECTRONIC EXPERIMENTER'S HANDBOOK will show you, via easy-to-follow, fully illustrated instructions, how to build exciting electronic devices such as:

- Your Own Hi-Fi AM Tuner
- Thermistor Fire Alarm
- Electronic Gardening Gadgets
- A Device That Kills TV Commercials
- Electronic Toys
- Geiger Counter
- Transistorized Light Meter
- Your Own Lie Detector

NOW ON SALE EVERYWHERE! Price: \$1.00

BUY DIRECT FROM FACTORY

TRANSVISION

Oldest Name in Electronic Kits

SPLIT/KITS

PAY AS YOU WIRE

INVEST SLIGHTLY MORE — but —
BUILD THE BEST!

- **A FEW DOLLARS GETS YOU STARTED:** Each Kit is "split" into a few packages, or stages, which you buy one-by-one as you wire.
- **EASIEST TO ASSEMBLE**
- **FREE educational aids**
- **Money-Back Guarantee**

A COMPLETE LINE OF

- **TV KITS**
- **INSTRUMENT KITS**
- **HI-FI KITS**
- **HI-FI Speaker Systems**
- **HI-FI CABINETS**

A wide assortment to house any make Hi-Fi units. Exquisitely styled, beautifully finished. Cannot be equalled anywhere.

Write for Complete Catalog



NEW!
Transistorized
VTVM—VOM KIT
\$3695 for Kit

Only \$10 gets you started. This covers the 1st stage. Balance in 2 stages; pay as you wire... Also, factory wired for \$69.

New TV KIT

Learn TV while building a DELUXE TV SET
Only \$15 gets you started. Balance in easy stages. Profit 3 ways: Learn by doing; save up to 50% on a DELUXE TV SET; prepare for COLOR TV.

FREE: A TV Course of Study with Kit. Prepared by a recognized educator, this course alone is worth many times the cost of the TV Kit.

TRANSVISION, INC., NEW ROCHELLE, N. Y.

TRANSVISION, INC., NEW ROCHELLE, N. Y. Dept. N

I'm enclosing \$ _____ deposit. Send the following: _____

Send FREE copy of your latest Catalog.

Name _____

Address _____

City _____ State _____

Adding "Volumatic Control"

By CHARLES ERWIN COHN

New Motorola circuit can be used with most auto radios.

SOME late-model Motorola car radios have incorporated a circuit development known as "Volumatic Control," which is claimed to give more effective automatic volume control and, thus, less volume fluctuation. This new circuit is simple enough to be added to any car radio.

The circuit, shown in Fig. 1, replaces the existing detector-first audio circuit and uses the 6CR6 (or 12CR6)—a tube developed especially for the purpose. Basically, the new departure consists of the application of a.v.c. voltage to the audio stage. To understand its operation, it is necessary to take a brief look at a.v.c. theory. In the conventional a.v.c. system, a d.c. voltage developed by the detector is applied to control the gain of the r.f. and i.f. stages which, in turn, feed the detector. Due to the fact that a closed loop exists here, the detector output can never be completely constant. In practice, it is roughly proportional to the logarithm of the input.

However, the situation is different with a.v.c. applied to the audio stage. Since this stage is outside the loop, it is possible for sufficient a.v.c. voltage to be applied to it such that the gain reduction will be proportional to detector output, resulting in an over-all output which is constant over a wide range of signal strengths. This is the ideal situation. In fact, if too much a.v.c. voltage is applied to this stage, it is possible to get too much gain reduction and thus have an output which actually decreases with increasing signal.

The circuit modifications are quite simple. First, the socket for the detector-first audio tube must be changed to a 7-pin miniature if it is not already such. If the existing socket is an octal, the easiest way to make the change is to enlarge the socket hole to 1-5/32" diameter if it is smaller and use the Amphenol 73-A7P adapter socket; then rewire.

With the modification completed, volume fluctuations caused by driving under a bridge, etc. should be greatly reduced or eliminated. In some cases, so much a.v.c. voltage might be applied that a decreasing output characteristic might be noted. In such a case, connect a resistor between the 6CR6 grid and ground. This will act with the grid resistor as a voltage divider. The value of this extra resistor should be determined experimentally.

Fig. 1. The "Volumatic Control" circuit.

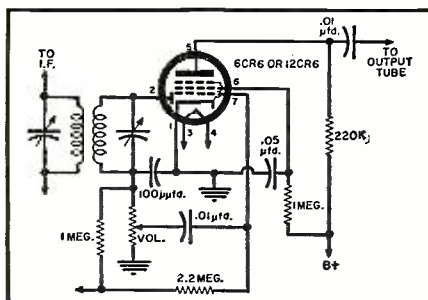

CROWN

Professional Tape Recorder

CROWN IMPERIAL

Tops in Performance!

Dual Track **\$449⁵⁰** Complete in case

Write for literature.
Address Dept. RN-6

Standard and Stereo models

INTERNATIONAL RADIO & ELECTRONICS CORP.
ELKHART, INDIANA

ELECTRONICS

PREPARE FOR A GOOD JOB!
BROADCAST ENGINEER
RADIO SERVICING AUTOMATION

TELEVISION SERVICING
BLACK & WHITE—COLOR

APPROVED FOR VETERANS AND SURVIVORS
OF VETERANS
BUILDING AIR CONDITIONED
SEND FOR FREE LITERATURE

BALTIMORE TECHNICAL INSTITUTE
1425 EUTAW PLACE, BALTIMORE 17, MD.

CODE SENDING SPEED

RECEIVING

Be a "key" man. Learn how to send and receive messages in International Morse code. Communicate with operators around the globe. Learn at home quickly through famous Candler System. Used by best operators. Qualify for Amateur or Commercial License. Write for FREE BOOK.

CANDLER SYSTEM CO.
Dept. 2-C, Box 928, Denver 1, Colo., U.S.A.

FOR THE HI-FI FAN:

THE WORLD'S MOST COMPLETE HI-FI GUIDE!

164 pages—
9 big chapters covering tuners, tapes, changers, tone arms, needles, amplifiers, preamplifiers, loudspeakers, enclosures—and much, much more.

Plus a helpful Yearbook Section which discusses the latest trends in high fidelity... lists outstanding records, artists, all FM stations, Hi-Fi shows, and includes a directory of free Hi-Fi literature.

NOW ON SALE AT YOUR FAVORITE NEWSSTAND! PRICE: 75¢

Sun	Mon	Tue	Wed	Thu	Fri	Sat
			2	3	4	5
CALENDAR of EVENTS						12
						19
						26

JUNE 8-12

Technical Personnel Recruiting Exposition. Sponsored by the Technical Career Conference. Hotel Sherman, Chicago, Ill. Further information available from Marcus W. Hinson, 19 S. LaSalle St., Chicago 3, Ill.

JUNE 10-11

Second RETMA Symposium on Applied Reliability. Sponsored by the Engineering Dept., RETMA. Hotel Syracuse, Syracuse, N. Y. Details and registration from RETMA Engineering Office, 11 W. 42nd St., New York 36, N. Y.

JUNE 11, 12, 13

Third Western Plant Maintenance and Engineering Show. Civic Auditorium, San Francisco. Full details from Clapp and Poliak, Inc., 759 Monadnock Bldg., San Francisco 5, Calif.

JUNE 12-14

Operations Research Conference. Sponsored by Illinois Institute of Technology. IIT Campus, Chicago, Ill. Additional information from R. D. Meade, Conference Coordinator, IIT, 3300 S. Federal St., Chicago 16, Illinois.

JUNE 17, 18, 19

1957 National Convention on Military Electronics. Sponsored by the IRE Professional Group on Military Electronics. Sheraton-Park Hotel, Washington, D. C. George Rappaport, % Emerson Radio & Phonograph Corp., 701 Lamont St., N.W., Washington 10, D. C., director of public relations for convention.

JUNE 17-21

1957 Annual Meeting of American Society for Engineering Education. Cornell University. Details from Society secretary, W. Leighton Collins, University of Illinois, Urbana, Illinois.

JUNE 24-28

Gaillard Seminar on Industrial Standardization. Sponsored by the American Standards Association. Engineering Societies Bldg., New York, N. Y. Further information from D. E. Denton, % ASA, 70 E. 45th St., New York 17, N. Y.

JUNE 27-JULY 1

Electronics in Automation Convention. Sponsored by the British Institution of Radio Engineers. University of Cambridge. Further information from the Institution's offices, 9 Bedford Square, London W.C. 1, England.

MOBILE-RADIO MAINTENANCE PAYS BIG MONEY!



Time Payment Plan Now Available!

LAMPKIN 105-B MICROMETER FREQUENCY METER. Price \$220.00 net.

LAMPKIN 205-A FM MODULATION METER. Price \$240.00 net.

Your regular test equipment plus these two Lampkin meters can put you in the business. There's plenty of opportunity close to your own home!

ACT NOW

Send coupon for free booklet "How to Make Money in Mobile-Radio Maintenance".

LAMPKIN LABORATORIES, INC. MFM Division, Bradenton, Florida At no obligation to me, please send

Free booklet Data on Lampkin meters.

Name _____

Address _____

City _____ State _____

LAMPKIN LABORATORIES, INC.

MFM Division BRADENTON, FLORIDA

TERADO Trav-Electric MOBILE POWER CONVERTERS



Give You **110 A.C. HOUSE CURRENT ANYWHERE** You Drive or Cruise

LIST

For 6 and 12 Volt Car Batteries—Capacities: 10 to 125 Watts **\$11.95 UP**

NO INSTALLATION

Just plug into cigar lighter on dash of car, truck, or boat—and away we go

- OPERATE PORTABLE TV.
 - SMALL DO-IT-YOURSELF
 - TOOLS WHEREVER NEEDED
- One of the great conveniences of our electronic age

101 USES



ALL ELECTRIC SHAVERS



PORT E TV



DICTATION



DO-IT-YOURSELF HOBBY TOOLS

SEE YOUR ELECTRONIC PARTS DEALER OR JOBBER

TERADO COMPANY

DESIGNERS & MFRS. OF ELECTRONIC EQUIPMENT SINCE 1927 1058 RAYMOND AVE., ST. PAUL 14, MINNESOTA

COYNE TRAINS YOU IN SPARETIME AT HOME

TELEVISION RADIO-COLOR TV

Only from famous COYNE do you get this modern up-to-the minute TV Home Training. Easy to follow instructions—fully illustrated with 2150 photos and diagrams. Not an old Radio Course with Television tacked on. Includes UHF and COLOR TV. Personal guidance by Coyne Staff. *Practical Job Guides* to help you EARN MONEY QUICKLY IN A TV-RADIO SALES AND SERVICE BUSINESS—part time or full time. COSTS MUCH LESS—pay only for training—no costly "put together kits."

SEND COUPON FOR FREE BOOK

SEND COUPON BELOW for Free Book and full details including EASY PAYMENT PLAN. NO COST OR OBLIGATION—NO SALESMAN WILL CALL.



B. W. COOKE, JR. PRES. **COYNE ELECTRICAL SCHOOL** FOUNDED 1899

A TECHNICAL TRADE INSTITUTE OPERATED NOT FOR PROFIT 500 S. Paulina Dept. A7-HT5 Chicago 12, Illinois

COYNE ELECTRICAL SCHOOL Television Home Training Div. 500 S. Paulina St., Chicago 12, Ill., Dept A7-HT5

Send FREE BOOK and details of your Television Home Training offer.

Name _____

Address _____

City _____ State _____

Antenna TOWERS

for TV-AMATEURS
COMMUNICATIONS

from Aermotor Company—since 1888 leaders in the manufacture of Steel Windmill Towers.

Check these features—
they're found in all
Aermotor Towers.

SELF SUPPORTING—no
cumbersome guy wires.

**HEAVILY GALVANIZED
AFTER FABRICATION**—
completely protected
against rust.

EASILY ASSEMBLED

STRONG—towers safely
sustain loads of 1500 lbs.
—safe in winds to 85MPH.

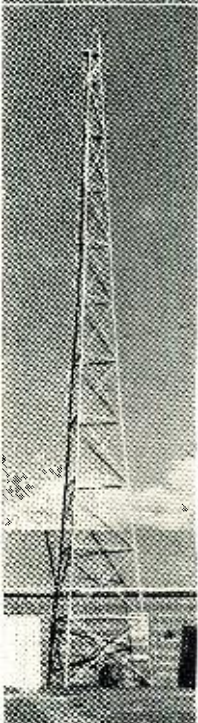

▲ TYPE MI-98

For TV Antenna up
to 6 square feet of
projected area.
Heights to 100'.

◀ TYPE MP-5

For Amateur Beams
up to 20 square feet
of projected area.
Heights to 97'3".

TYPE MP-9

(Not illustrated)

Meets "RETMA"
Standard TR-116
Specifications.
Heights to 123'5".

Write today for
complete information
on Aermotor
Steel Antenna Towers
and an Aermotor
Franchise in your
territory.

42

AERMOTOR COMPAY

2500 W. Roosevelt Road Chicago 8, Illinois
Dept. RTN-6

What's

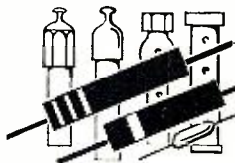

New in Radio

MOBILE RADIOTELEPHONE

Kaar Engineering Corp., Box 1320, Palo Alto, Calif., has added a new item to its line of communications equipment.

The new mobile AM radiotelephone, the TR-245, is a 50-watt, two-way unit specifically designed to handle field communications in oil exploration, mining, foreign construction, pipe lines, geological survey, and governmental applications. Easily installed in cars, trucks, jeeps, or other vehicles, the TR-245 permits these mobile units to keep in touch with each other and/or a base station.

Using a frequency range of 1.6-8 mc., the unit features strip chassis construction for easy maintenance, optional dual-channel operation, and 6 or 12 volt

provide for good resolution, utilizing multiple-decade ranges for pulse spac-

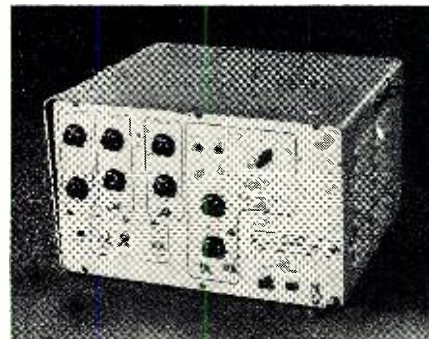

ing, delay, and width. Repetition rates from 10 cps to 100 kc., variable advance or delay operation from 0 to 100 μ sec., variable pulse width from less than .1 to 100 μ sec., and variable amplitude low-impedance output are provided.

Snap-off top and bottom plates provide complete accessibility. An overhanging light shield minimizes instrument panel glare.

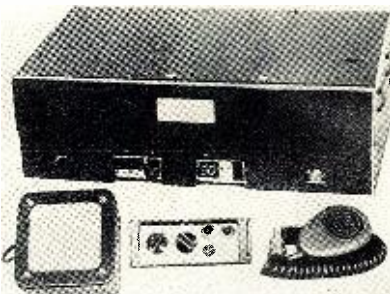

PANEL MODERNIZATION

Seco Manufacturing Company, 5015 Penn Ave., South, Minneapolis 19, Minn. is offering a new panel modernizing service to owners of its Model GCT-5 grid circuit tester.

The new panel, which is available from distributors for a nominal sum, lists a number of new tube types which can be handled by the tester. A small folder which pictures and describes the new panel service and lists a number of seldom used and industrial types that can also be handled by the instrument, is available from the company on request. Ask for the Model GCT-5 panel modernization folder when writing.

operation without modification. The entire unit measures 6" x 19" x 11" and weighs 27 pounds.

SNAP-IN SCREWDRIVER SHAFT

Xcelite, Incorporated, Orchard Park, N. Y., is now offering a new snap-in shaft extension which is designed to be used with the company's screwdrivers and nutdrivers.

The shaft, which is 8" long over-all, has winged prongs on one end to fit into the socket of the combination handles of the 99-PR and 99-JR sets. The other end of the shaft has a socket fastener like that in the handles to receive all the nutdriver shafts and single-end screwdriver shafts in the kits. The extension shaft provides an additional 6" reach for work in formerly inaccessible places.

Write the manufacturer direct for full details.

PULSE GENERATOR

Electro-Pulse, Inc., 11861 Teale Street, Culver City, Calif., is marketing a new pulse generator which has a wide range of laboratory and test applications.

The Model 2125B combines easily accessible internal design and simplified circuitry to provide fast rise time pulses at high repetition rates. The controls

DOUBLE-ENDED COIL FORM

The Cambridge Thermionic Corporation, 445 Concord Ave., Cambridge 38, Mass., has recently introduced a new double-ended miniature coil form that allows space for primary and secondary windings, with separate tuning slugs for the independent tuning of each section.

Designated the LS-14, the new unit is extremely compact and rugged. It is designed for applications where reliability is a "must." The form measures approximately $\frac{1}{2}$ " o.d. and $1\frac{3}{16}$ "

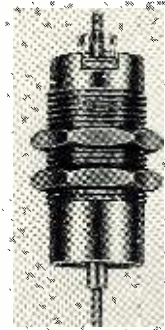

over-all length, excluding tuning slugs. It is available with up to six terminals and mounts by means of a threaded middle section. The interior of the LS-14 is made up of powdered iron components and the main housing is nickel-plated brass. The tuning cores are held in adjustment by means of built-in locking devices.

For additional information on these new units, write the manufacturer direct.

TINY FOIL ELECTROLYTICS

Cornell-Dubilier Electric Corporation of South Plainfield, N. J., has designed a new line of electrolytics especially for transistorized and printed circuits as well as other compact or miniaturized low-voltage d.c. gear.

Known as the "Electromite" Type NL, the new line is available in d.c. working voltages of 1, 3, 6, 10, 15, 25, and 50 volts in capacities from 1 to 200 μ f.d. and in sizes from $\frac{3}{16}$ " x $\frac{1}{2}$ " to $\frac{3}{8}$ " x $1\frac{1}{2}$ ".

The capacitors are compression-sealed and resistant to moisture and humidity. Terminal leads are tinned copper wire with the positive lead connected to the anode through a rubber bushing of the compression seal and the negative lead grounded to the aluminum can.

Bulletin No. 533 covering complete specifications on the "Electromite" line is available on request.

TINY POWER SOURCE

The General Electric Company's Specialty Electronic Components Department, West Genesee St., Auburn, N. Y., is in pilot production on a tiny new



power source, only $\frac{1}{35}$ th the size of a common flashlight battery, but with 60 times the voltage of such a battery.

Designed for highly specialized uses requiring small size, long life, and high voltage output, the new cylindrical, 1" long battery has a projected life of over 20 years. It can be used in such equipment as remote fire and radiation warn-

ing devices, deep well survey equipment, and electronic instruments.

The new battery produces 95 volts, weighs less than $\frac{1}{8}$ ounce, and measures less than $\frac{1}{8}$ inch in diameter. Although it is priced at \$12.50 now, the company believes mass production could eventually lower this to about one dollar.

VOICE-OPERATED RELAY

Minatel Incorporated, 1080 Dionne St., Saint Paul, Minn. has developed a new voice-operated relay which is designed to be used in program failure alarms, automatic programming, subcarrier keying, controlling transmitters, etc.

The new instrument has a maximum input level of +5 db; threshold level of -15 db \pm 3 db at 1000 cps; average energize time of 7 milliseconds within the operating range of -15 db to +5 db; and drop-out time independent of input level and adjustable from 1 to 5 seconds on the front panel.

The relay is housed in a standard $5\frac{1}{4}$ " rack mounting panel with an over-all depth of $5\frac{3}{4}$ ". A data sheet on the voice-operated relay is available from the manufacturer on request.

GARAGE DOOR OPENER

Packard Bell Electronics Corporation of Los Angeles, Calif., is now in production on a newly developed elec-

HANDSETS & MICROPHONES:

HANDSET with Retractable Cord—Butterfly Sw., PL-68 & PL-55 Plugs. H-22/U	New: \$4.95
TS-9 HANDSET—Push to talk Sw. No Plugs. Used: \$2.95	New: 4.95
TS-13 HANDSET—Push to talk Sw. w/PL-68 & PL-55. Used: \$3.95	New: 5.95
HANDSET HANGER—Rubber covered	1.50
F-1 BUTTON CARBON MIC.—High Gain—F/desk, car, hand use. Complete	New: 1.95
RS-38 CARBON MIC. with PL-68 Plug	U: 2.50
T-17 MICROPHONE—New: \$8.95	Used: 4.50

TRANSFORMERS and CHOKES

115 V. 60 CYCLE PRI. TRANS.:	
600 VCT/100 MA—6.3 V/5 A.; 5 V/3 A.	\$4.95
240 VCT/35 MA—24 V/9A.; 6.3 V/6 A.; 6.3 V/3 A.	1.75
1500 VCT/260 MA—6.5 V/3 A.—6.5 V/5 A.—5 V/4.5 A.	9.95
700 VCT/150 MA—5 V/3 A.; 6.3 V/4.5 A. CSD.	3.95
1090 V/12.6 MA—Tapper 2.5 V 2 A.	5.95
1180 V/80 MA—7.5 VCT/3.25 A. 2 A.	5.95
662 VCT/110 MA—6.3V/2 A.—5V/2 A.	3.95
16 Volt 35 Amp. 115/230	\$14.95; 24V—1 Amp 1.50
9 Volt CT—35 Amp.—Tapped 4.5 V.	7.95
12 Volt—Two separate windings—4 amp each.	5.95
5 V/2 A.; 5 V/2 A.; 5 V/2 A. & 5 V/6 A.	2.95
312 VCT/70 MA.; 6.3 V/2.1 A. & 5 V/3 A.	1.75
600-0-600 VAC—200 MA. 12.5 V. 2 A.; 12.5 V. @ 2 A.; 5 V. @ 3 A.—#H-108—Price	8.95
250-0-250 VAC—50 MA. 24 V. 1 A.; and 6.3 V. 1 A.—#H-109—Price	4.95

Choke—12.5 Hy/100 MA	\$1.95
Choke—8 Hy/150 MA—200 Ohm—Open Frame	1.25
Choke—5 Hy/150 MA—85 Ohm	1.50
Choke—10 Hy/250 MA—2 $\frac{1}{2}$ " x 2 $\frac{1}{2}$ " Potted	4.95
Choke—5 Hy/400 MA—4 $\frac{1}{2}$ " x 4 $\frac{1}{2}$ " x 5 $\frac{1}{2}$ "	4.95

FM RECEIVER—30 to 50 MC

• Government Surplus RECEIVER, converted to receive 30 to 50 MC FM. Continuous tuning and Push Button tuning on 10 Pre-set channels. With 10 Tubes, Speaker, Phone Jacks, Squelch Circuit, etc. Size: 1 $\frac{1}{2}$ " H x 6 $\frac{3}{4}$ " W x 12 $\frac{1}{2}$ " D. Power required 220 VDC 80 MA and 12 or 24 VDC. Stock No. **\$34.95** 3050. Used—Checked.

DYNAMOTOR—12 V for above: New: \$4.95—Used: \$2.95
AC POWER SUPPLY for the above: \$19.95

COAXIAL CABLE & CONNECTORS

CD-1071 CORD—With PL-259 Plugs each end. 50 ohm coax 2 Ft. long. Prices: 59¢ Each—Or in Lots of 10 @ 50¢ Ea.

PL-259—Plug. Ea. End & 32"—RG-54/U—58 ohm .50¢
SO-239 Chassis Conn. f/PL-259 (Removed) .3 for \$1.00
UG-21/U—Plug ea. end & 32"—RG-11/U—75 ohm .50¢
UG-22/U—With 4" Coaxial Cable.50¢

RETRACTABLE CORD—6 Ft.—6 for \$5.00—95¢ Each
CABLE—Rubber Covered, 7 Cond. #20 Shielded (2 separate shielded)—35 Ft. \$2.50

RT-19/ARC-4 REC.-TRANS.

144 to 148 MC RECEIVER-TRANSMITTER—Easily converted to 2 meters. Uses 2/6AC7, 3/12SJ7, 2/12SQ7, 2/12A6, 4/6N7, 2/6V6, 2/1614, 1/832, & 2/6L6 tubes. Conversion does not require all the tubes to be used. Power required 350 VDC & 12 VDC. Price—Less tubes and Dynamotor—with Schematic and conversion information **\$12.95**

POWER SUPPLY

110 V. For Army/Navy COMM. RECEIVERS
Eliminates set conversion. For use w/BC-453-454-455-946 or any sets requiring 24 V. @ 1 A. & 250 V. @ 50 MA. Ready to use: has 4" speaker, volume control, CW and on-off switches. Complete with cord and plug f/rec. Price...NEW: **\$18.95**

EE-8 FIELD TELEPHONE

Ideal for private telephone system for two or more phones, up to 17 miles. Hand ringer, generator with handset, carrying case. Uses 2 flashlight batteries. **\$14.95**
USED—Checked

WIRE—WeatherProof Twisted Pair: 500 ft. \$4.75—135 ft. \$1.00—2500 ft. \$19.95. Per Foot at 1 $\frac{1}{2}$ ¢.
COMBAT WIRE—Rubber covered W-130. \$.01 Per Ft.

SCR-625 Army MINE DETECTOR

• For Prospectors, Miners, Oil Companies, Plumbers, etc. An ideal portable unit for locating all types of buried metal objects up to 24" or more, depending on size and ground condition. Detection by means of a tone. Packed in a chest. Operating weight approx. 15 lb. Shipping wt. approx. 40 lbs. Complete with batteries. **\$39.95**

WRITE US YOUR REQUIREMENTS:

Whatever your needs in Generators, Blowers, Inverters, Motors, etc.—write us. Chances are we have it!

ANTENNA EQUIPMENT

MAST BASES—INSULATED
MP-22 BASE — (Illustrated) Ins. spring action; direction of bracket can be raised or lowered **\$2.95**
Wt. 9 lbs.
MP-48 BASE—Insulated type with heavy coil spring. Needs $\frac{1}{8}$ " mtg. hole. **\$4.95**
Wt. 11 $\frac{1}{2}$ lbs.
MP-35—Insulated type w/heavy coil spring and 5" dia. Ins. Requires 2" hole for mounting. **\$3.95**
Wt. 8 $\frac{1}{2}$ lbs.

SECTIONS FOR ABOVE BASES:
Tubular steel, copper coated painted, in 3 ft. sections, screw-in type. MS-53 can be used to make any length with MS-52-51-50-49 for taper. Any section @ 50¢ Each
Larger Diameter Section: MS-54. 75¢

WHIP ANTENNAS—5 Ft. w/Rigid Base \$1.50—6 Ft. No Base \$1.50—10 Ft. Throw Out \$1.50—94" Telescoping \$1.00—18 Ft. 3 Sections, Telescoping \$3.95—20" Telescoping (Chrome) 50¢.

DYNAMOTORS & GENERATORS:

INPUT VOLTS:	OUTPUT VOLTS:	STOCK NO.	USED:	PRICES:
12 VDC	220	DM-34	\$2.95	\$ 4.95
12	225	D-402	5.95	8.95
12	625	DM-35	9.95	
12	230	PE-133		4.95
12	540	DA-12		14.95
12	230	DA-14		8.95
14	220	DM-24	4.95	7.95
14	1030	260		
14	515	215	DM-42	4.95 9.95
14	250	50	DM-25	2.95 4.95
14	230	90	DM-21	6.95
24	250	60	DM-32	2.95 5.95
24	250	60	I2V/DM-32	4.95
12	250	60	PE-86	8.95
28	1000	350	PE-73	8.95
12 to 24 VDC PM	Dynamotor—Supplies 24 VDC 2 A. from 12 VDC, also 500 V 50 MA. @ 6 VDC will supply 12 VDC & 250 V 50 MA.			\$4.95
#0515				New:



METERS:

DC AMMETER HOYT—
In portable metal case, with Test Leads, 4 $\frac{1}{2}$ ", Fan Mirrored Scale 0-15 ADC. **\$3.95**

DB METER—10 to Plus 6—Westinghouse 3", NC-35 Imp. 600 ohms @ 1000 cycle. **\$4.95**
0-3 RF AMMETER IS-128; 2 $\frac{1}{2}$ " Rd. NEW: 2.95
0-8 Amp RF w/Thermocouple IS-89; 2 $\frac{1}{2}$ " Rd. 4.95
0-15 AC DC—2 $\frac{1}{2}$ " Rd.; IS-122. 4.95
0-500 MA DC—2 $\frac{1}{2}$ " Rd.; IS-22. 4.95

Address Dept. RN • \$5.00 Order Minimum, & 25% Deposit on C.O.D.'s • Prices are F.O.B. Lima, Ohio

FAIR RADIO SALES 132 SOUTH MAIN ST. LIMA, OHIO

BUILD THE BEST— BUILD ALLIED'S OWN knight-kits

Here is a typical Knight-Kit value—available only from ALLIED—one of 45 great Knight-Kits you'll find in our special Supplement No. 165. Write for your FREE copy today.

knight-kit INSTRUMENT VALUE PRINTED CIRCUIT VTVM KIT



Model
Y-125
\$24⁹⁵

Tops for stability, accuracy and value. Greatly simplified wiring—entire chassis is a printed circuit board. Uses low-leakage switches; 1% film-type precision resistors. Balanced-bridge, push-pull circuit permits switching to any range without adjusting zero set. SPECIFICATIONS: Easy-to-read 4 1/2" meter with sensitive 200 microamp movement. Zero-center scale and direct-reading db scale. Polarity reversing switch. Response, 30 cycles to 3 mc. Input resistance, 11 megs. Ranges: AC peak-to-peak volts, 0-4-14-40-140-400-1400-4000; AC rms v. and DC v., 0-1.5-5-15-50-150-500-1500; ohms, 0-1000-10K-100K; 1-10-100-1000 megs; db scale, -10 to +5. Complete, including battery and test leads. Size, 7 3/4" x 5 1/4" x 4 3/16". Shpg. wt., 7 lbs.

Model Y-125. Net, F.O.B. Chicago. . . . \$24⁹⁵

OTHER knight-kit INSTRUMENT VALUES



20,000 OHMS/VOLT
VOM KIT
Y-140 \$29⁵⁰



1000 OHMS/VOLT
VOM KIT
Y-128 \$16⁹⁵



TUBE CHECKER KIT
Y-143 \$29⁷⁵



RF SIGNAL
GENERATOR KIT
Y-145 \$19⁷⁵

See our Supplement No. 165 for 18 other knight-kit instrument values

free SUPPLEMENT featuring knight-kits



Send for our FREE Supplement No. 165 featuring 45 great Knight-Kits, including Test Instruments, Hi-Fi, Hobbyist and Amateur Kits. Write for your copy today.

ORDER FROM ALLIED RADIO

Dept. 01-F-7, 100 N. Western Ave., Chicago 80, Ill.

tronic garage door opener which will be marketed only on the West Coast for the present time.

The electronic opener, which is designed to operate any single or double residential overhead door, consists of three basic units: the transmitter, receiver, and garage door actuator. Features of the new system include a limit



switch which governs the travel of the door in either direction, a simple detaching latch in case of power failure, provision for extra push-buttons so the door may be operated from convenient locations around the house, and a hand-set thermal cut-out for protection from overload.

The device is being marketed with installation charges included in the purchase price. The firm's service personnel will handle the installations.

"LOW-OHM-METER"

Simpson Electric Company, 5200 W. Kinzie St., Chicago 44, Ill. has just introduced a new ohmmeter which features accurate measurements of low resistance values and utilizes low circuit currents.



The model 362 will give readings from .1 to 25 ohms with an accuracy of 3% of the full scale value. This accuracy is attained by using the expanded scale of the suppressed-infinity, shunt-type ohmmeter. The circuit current is only 5 ma. maximum which prevents damage to low-current components and promotes long battery life.

The circuit uses one self-contained battery and has two ranges, 0-5 ohms and 0-25 ohms. Over-all size of the instrument is 3" x 5 7/8" x 2 1/2".

NEW HAM RECEIVER

Radio Manufacturing Engineers, a division of Electro-Voice, Inc., Buchanan, Mich., has released a new, improved, medium-priced receiver designed especially for the radio amateur.

The Model 4350 features crystal controlled dual conversion on all bands, reducing images 54 db or more. A crystal filter gives crisp single-signal reception. The receiver covers only the ham bands, allowing maximum efficiency and wide bandwidth in areas where the ham intends to operate. To

BENDIX 100 WATT TRANSMITTER! FOUR SEPARATE ELECTRON- COUPLED OSCILLATORS!

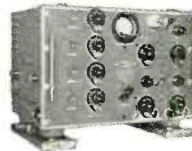

Can be easily converted to 10-20-40-80 meters. Crystal required for 10 meters. Each electron-coupled oscillator dial has 3,000 divisions enabling quick precision shifting. Constructed of highest quality parts with laboratory precision. Four separate output tanks; one 4-position selector channel switch has seven sections

which change the ECO, IPA and output tanks simultaneously! ALL controls mounted on front panel. The housing is cast aluminum, shields and case are sheet aluminum. 11" x 12" x 1 1/2". Ship. wt. 15 lbs. Complete with instructions and schematic. Uses and includes 3-807's and 4-12SK7's. Has 2-inch 5-amp R.F. output meter.

Only one knob (center) selects 10-20-40-80 meter bands. A complete coverage transmitter, for the new or experienced amateur. A TRUE HAM VALUE—COMPLETE WITH TUBES. Excellent condition. Cat. 3861TX15—

\$27.50

7 TO 27 MC SUPERHET RECEIVER BARGAIN

Spreads out into 5 big bands to give easy readable vernier-cranked tuning. This is the Navy Air Force's famous FAX Unit 3. TWO 12SK7 tuned RF amplifiers, 12K8 converter, THREE 12SK7 2.275 mc IF's, 12SR7 BFO & 2nd det., 12A6 output. 40-Meter & 20-Meter Amateur bands, commercial TTY bands, high-seas, Airline, foreign short wave—you get them all! No sweat to change 2 of the bands to 80 and 10. We furnish large schematic with parts values and alignment frequencies. Units are in excellent condition, with tubes, and only \$19.95

.2 TO 1.5 MC SUPERHET RECEIVER BARGAIN

Same as above, except freq. 200 to 1500 KC in 4 bands with schem. and align. \$19.95



We will pay \$\$\$\$ for an AN/ARN-6 or AN/ARC-3 or any of their components.

Also for AS-313 LOOP
Phone us collect on ABOVE ITEMS
Stanley 7-0406

SIMILAR FABULOUS PRICES FOR:

APR-9 ARC-1
ARN-7 ART-13 PARTS
BC-785-C I-152-C
LP-21-AM LM
MO-18A or MC-507 from these loops R-65/APN-9
TEST SETS 1-100, TS-117, -125, -147, -148, -488. What else have you???

FREE CATALOG!

If you're not on our mailing list—WRITE TODAY!

All shpts. FOB whse. Send 25% dep. with all COD orders. 10% min. sub. to prior sale & change of price without notice. Min. order \$2.50.

ARROW SALES, INC.

Western Mailing Address:
Box 3007-R NORTH HOLLYWOOD, CALIF.
Central Mailing Address & Sales-Showroom:
2441 S. MICH. AV., Dept. R, CHICAGO 16, ILL.
California Distributors' Stores
G. L. Electronics, Inc., 1632 Venice, Los Angeles
P.A.R.T.S., 8905 San Fernando Rd., Sun Valley

SCHEMATICS—CONVERSIONS FOR SURPLUS GEAR

NEW LIST DI MANY ADDITIONS!

Send stamped, self addressed envelope for List D. Add 25c for chart explaining AN nomenclature. DO IT TODAY!

R. E. BOX 1220
GOODHEART BEVERLY HILLS, CAL.

a TERRIFIC BARGAIN in a

SOLA CONSTANT-VOLTAGE TRANSFORMER
Ends fluctuating line voltage!
Big Discount Off . . .



the factory price at a 1-input 2,000 VA unit! And here's another bonus! This Air Forces 2,000 VA overstock, Sola Cat. No. 30768, has 4 inputs! 90-125 V., 190-250 V., 60 cy. or 50 cy. Isolated secondary is constant 115.0 V. ± 1% from no-load to full-load of 17.4 amp. So, if you choose, use it as a 220-115 V. step-down. And slash \$97.50 off the factory 1-input price!

Brand new in original wood box. 4 cu. ft. Ship. wt. 25.4 lbs. F.O.B. Pasco, Wash. Only

\$147.50

THE M. R. COMPANY
P. O. Box 1220-A Beverly Hills, Calif.

increase stability, the 4350 has triple spacing between tuning capacitor plates, a 6 pound die-cast front panel, welded chassis and case. Voltage regulation and temperature compensation



of thermal sensitive elements have further reduced the possibility of signal shift or drift, allowing retention of single-sideband signals for long periods without retuning.

Write the parent company for further details on this receiver.

GREGG SOLDERING GUN

Gregg Electric Co., 2 South Broadway, Lawrence, Mass. is now offering a new single-pole, instant-heat soldering gun, the "250".

According to the company, the gun will heat in two seconds, is the only single-pole, built-in transformer type gun that will handle deep-in work with its over 5-inch reach, and provides prolonged tip life due to instant soldering ability.

Tips can be changed in seconds. There is no need for set screws or wrenches as the tip simply unscrews with finger pressure. Changeable barrels are also available in standard and custom lengths. A pre-focused spotlight further enhances the convenience of the gun.

Write the company direct for a data sheet and full details on this new model.

"DWARF" RECTIFIERS

The Semiconductor Division of Radio Receptor Co., Inc., 240 Wythe Ave., Brooklyn 11, N. Y., is importing and stocking a new line of subminiature selenium rectifiers, the *Siemens* "Dwarf."

The new rectifier, about a fourth as long as an ordinary paper clip, weighs

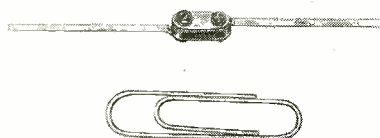

.015 ounce. Assembled in a black plastic body with flat pigtail leads, it is inexpensive and rugged and capable of withstanding vibration and shock.

While available only in half-wave, several units may be connected for other circuits, such as bridge arrangement and doubler. They can be used

FREE GIANT SUMMER FLYER
WRITE TO-DAY!



... SUDDENLY IT'S CHRISTMAS! UNTIL JUNE 25th—DUE TO FABULOUS SPECIAL PURCHASE DOUBLE BONUS OFFER!

The INDUSTRY'S BIGGEST PARTS GIVEAWAY... EVER!
FREE WITH EVERY \$10 ORDER

BONUS #1 Your Choice of ANY \$1 KIT FREE!	$\frac{1}{1}$	BONUS #2 \$15 assortment of RADIO PARTS FREE!	DOUBLE BONUS = Sixteen Dollars worth of parts free with \$10.00 order!
---	---------------	---	--

WORLD FAMOUS **KIT KING** DOLLARBUYS!

- 40 POPULAR BULBS. 1.1 to 6 V, screw & bayonet types, miniature. Reg. \$3.20. **\$1**
- EMERSON TUNER, HiQ, permeability tuned ANT. & Osc. coils, w/padders on 2 x 4" plate, variable tuning mech., 500 to 1600 kc. Reg. \$5. **\$1**
- 60 SUB-MINI RESIS-TORS. $\frac{1}{4}$ " long, 20 values; 15 ohms to 10 megohms. In poly box. Reg. \$5. **\$1**
- 30 POWER RESISTORS. WW, candohm, sand-coated vitreous. 15 values; 5 to 50W @ 35 to 11000 ohms. Wt. 2 lbs. Reg. **\$1**
- 10 IF XFMRs. Metal can, asstd. frequencies for radio, TV, hobby use. Wt. 3 lbs. Reg. **\$15**
- SUB-MINI SOLENOID, Guardian. 1 x 3/8 x 3/8". Changes elec. energy to mechanical. 12 VDC @ 300 ma. actuates plunger. Wt. 1 oz. Reg. **\$2.50**
- 40 TUBE SOCKETS, 4 to 14 prong. Transistor & printed circuit, 7 & 9's. octals, Ceramic & mica, too. Wt. 1 lb. Reg. **\$8**
- 15 ETCHED & PRINTED CIRCUIT SOCKETS, including mica-filled & shield types. Wt. 1 lb. Reg. **\$4**
- 15 VOLUME CONTROLS. Singles, concentric, TV, some w/switch. Std. shafts. Up to 1" meg. Some \$2.50 each!
- 20 AC-DC LINE CORDS for clocks, motors, etc. 2 cond. w/molded plugs. Wt. 1 lb. Reg. **\$5**
- 15 ROTARY SWITCHES, ceramic & bakelite; 1, 2, 3 gangs. Std. shafts. Shop must! Wt. 3 lbs. **\$1**
- 10 "POLY" BOXES, tested, hinged. Clear plastic, sized. w/snap locks. Reg. **\$2.50**
- 15-PC. TWIST DRILL SET. 1/16 thru 1/4" by 64ths. in graduated plastic holders. Reg. \$4. **\$1**
- G-E CONTROL SCOOP! Chassis incl. 3,000-ohm mini control relay, 115 to 6.3-1/2A flt. admtr., resistors, cond., pot, sockets. Wt. 2 lbs. **\$1**
- PC MOTOR DRIVER SET. Plastic handle, 3/16, 7/32, 1/4, 5/16, 11/32, 3/8, 7/16" steel socket wrenches in plastic case. Wt. 1 lb. \$3 value. **\$1**
- 3 OUTPUT XFMRs, single & P.P. tubes; 351.6, 50B5, 50L6 & 6Y8 to 3-4 ohm V.C. Wt. 2 lbs. **\$1**
- 15 PANEL SWITCHES. Push, momentary, power, thermal. Wide variety. Some \$2 ea. Wt. 2 lbs. **\$1**
- TRANSFORMER "OUN-STATE, 1 x 3/4 x 3/4". Int. 20. Impedance ratios unknown. 5 color-coded leads. Reg. **\$8**
- 000-999 COUNTER by Veeder-Root. Reset type; for all counting jobs. **\$1**
- 100 COIL FORMS. Wide variety sizes, insulation. Wt. 1 lb. Reg. **\$1**
- SUB-MINI TRANSISTOR, PNP. 1/2 size of pencil eraser; used in "name" portables. Orig. pack w/spec. sheet. **\$1**
- 100 CERAMIC CONDENSERS. Asstd. types; top mfrs; 30 values, color coded. Discs, too. Reg. **\$15**
- 3 AC-DC CHOKES, 800 ohms, 3H-50ma. Open frame mfg., for power supplies. Wt. 2 lbs. Reg. **\$1**
- 50 PLUGS, RECEPTACLES. Audio, power, chassis, panel & spkr. types. Wt. 2 lbs. **\$1**
- 2 MIKE TRANSFORMERS, carbon. Encased 200 ohms to hi-imp. gtr. w/leads. Wt. 1 lb. **\$1**
- 15 FERRITE COILS, adjustable. Asstd. types, sizes, frequencies. Wt. **\$1**
- 40 MOLDED CONDENSERS. 6S, 600. 1000V. up to 1000V. Brown, black ceramic cased. Wt. 1 lb. Reg. **\$8**
- 40 HI-Q CONDENSERS. Finest made! Ceramic tubular cased, asstd. popular values. Reg. **\$1**
- 40 PRECISION RESISTORS. Scoop! Carbon film, Wilkors, etc. 1%; wide variety values. 1/2 & 1w. Wt. 1/2 lb. Reg. **\$1**
- 100 RADIO PARTS—resistors, condensers, forms, etc. Wt. 2 lbs. Sold elsewhere \$5 to \$15; Guaranteed satisfaction. **\$1**
- 40 DISC CONDENSERS—transistor & printed circuit types. Reg. **\$1**
- 6 PILOT LITE ASSEMBLIES. Std. mfg., miniature bayonet. Reg. **\$1**
- 20 PRINTED CIRCUITS. Asstd. top makes, for transistor, radio, hobby circuits. Reg. **\$10**
- SUB-MINI CRYSTAL MIKE. Postage stamp size, 3/4" sq.; Styrene cased. High imp., clear crisp response to 8,000 cps. **\$1**
- WORLD'S SMALLEST RADIO KIT. 2 1/2 x 1 1/4 x 3/4". Permeability tuner, diode all parts. Instr. Reg. **\$3.50**
- MINI-METER BUY! 1 3/4" round, chromed. 0-3 amps. AC. For model railroad, power supplies, mobile. Reg. **\$3**
- 60 XFMRs, COILS, IF, RF, ant., slug-tuned coils, chokes, 25 types. Wt. 3 lbs. Reg. **\$15**
- 8 TRANSISTOR SOCKETs—for sub-mini tubes. Mica-filled. **\$1**
- 10 ELECTROLYTICS. Asstd. can types, up to 300 mf. Radio, TV, hobby. Wt. 3 lbs. Reg. **\$1**
- 2 TRANSISTOR LOOP-STICKS. Tapped, hi-Q ferrite adj. core. High selectivity & sensitivity. Wt. 1/2 lb. Reg. **\$3**
- 125 RESISTORS, 1/2, 1w, 40 values; 5 ohms to 10 megohms. 50% too. **\$1**
- 2000 Pcs. HARDWARE! screws, washers, etc. **\$1**
- G-E PRE-AMP KIT for magnetic cartridges. Chassis, parts, diagram. Lec. 65C7 (8pc. extra). Wt. 1 lb. Reg. **\$4.50**
- 175-FT. HOOKUP WIRE. 18, 24, 30, 36, 42, 48, 54, 60, 66, 72, 78, 84, 90, 96, 102, 108, 114, 120, 126, 132, 138, 144, 150, 156, 162, 168, 174, 180, 186, 192, 198, 204, 210, 216, 222, 228, 234, 240, 246, 252, 258, 264, 270, 276, 282, 288, 294, 300. Wt. 1 lb. Reg. **\$10.99**
- 70 TERMINAL STRIPS & boards. 15 types, 1 to 20 screw & solder pins. **\$1**
- 60 STANDARD KNOBS. Asstd. colors, bakelite & plastic. Set-screw types. Wt. 2 lbs. Reg. **\$1**
- 70 MICA CONDENSERS, 30 values, .0001 to .01 mf to 1000V. Silver, 5% included. Wt. 1 lb. Reg. **\$2**
- R/T SCOOP! Over 100 pop. radio parts; resistors, condensers on strips. Wt. 1 lb. Reg. **\$1**

VACATION SPECIAL!
POCKET-PERSONAL SUPERHET RADIO FULLY WIRED \$12.99

THE IDEAL VACATION COMPANION! Real big set performance w/built-in hearing aid phone and directional antenna. NO EXTERNAL CONNECTIONS. Attractive 5 1/2 x 3 1/2 x 1 1/2" ivory case. Volume & tuning controls. A sensitive, selective, factory-built unit sold elsewhere from \$20 to \$28. 3 miniature tubes.
 BATTERIES...\$2 extra

SUPER SOLAR BATTERY! Outperforms famed B2M many times... never wears out! 2 1/2 x 1 3/4 x 1 1/2" molded case w/glass window. Unusual power for all Sun Battery uses. Plug-in type. Reg. \$10... **\$2.98**

SUB-MINI SPEAKER. Only 1 1/2" sq. for transistor radios, etc. 1 oz. magnet, 4 or 10 ohm v.c. available. Reg. \$5... only **\$1.99**

TRANSISTOR DYNAMIC PHONE. 8,000 ohm; super-powered, sensitive (makes weak sigs loud). \$5 value. W/cord... **\$2.50**

HOW TO ORDER

Check items wanted. Return entire ad w/check or M.O., including sufficient postage, excess returned. C.O.D. orders, 25% down. Rated, net 30 days. Print name, address, amount money enclosed, in margin. (Canada postage 45c 1st lb., 28c ea. add. lb.).

MONEY BACK GUARANTEE

LEKTRON SPECIALTIES

133 Everett Ave. Chelsea 50, Mass.

YOUR COPIES OF RADIO & TV NEWS ARE VALUABLE!

Keep them neat... clean... ready for instant reference!

Order direct from:
JESSE JONES BOX CORP.
Dept. RN
Box 5120, Philadelphia 41, Pa.
(Established 1843)

Now you can keep a year's copies of RADIO & TV NEWS in a rich-looking leatherette file that makes it easy to locate any issue for ready reference.

Specially designed for RADIO & TV NEWS, this handy file—with its distinctive, washable blue Kivar cover and 16-carat gold leaf lettering—not only looks good but keeps every issue neat, clean and orderly.

So don't risk tearing and soiling your copies of RADIO & TV NEWS—always a ready source of valuable information. Order several of these RADIO & TV NEWS volume files today. They are \$2.50 each, postpaid—3 for \$7.00, or 6 for \$13.00. Satisfaction guaranteed, or your money back.

EXPAND YOUR PORTABLE TV SALES

WITH

ATR

INVERTERS

for changing your storage battery current to A. C. HOUSEHOLD ELECTRICITY

Anywhere...
in your own car!

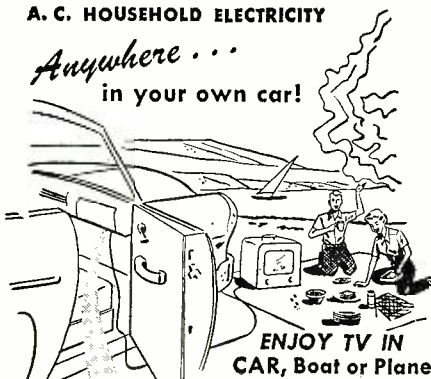

mounted out of sight under dash or in trunk compartment!

ENJOY TV IN CAR, Boat or Plane



EASY TO INSTALL
EASY TO OPERATE

ATR INVERTERS

especially designed for operating standard 110 volt A.C. portable TV sets

also

- TAPE RECORDERS
- WIRE RECORDERS
- DICTATING MACHINES
- ELECTRIC RAZORS

for

- EXECUTIVES
- SALESMEN
- PUBLIC OFFICIALS
- POLICEMEN
- FIREMEN
- OUTDOOR MEN
- REPORTERS
- FIELD INSPECTORS
- DOCTORS
- LAWYERS, ETC.

See your jobber or write factory

✓ NEW MODELS ✓ NEW DESIGNS ✓ NEW LITERATURE
"A" Battery Eliminators, DC-AC Inverters, Auto-Radio Vibrators



AMERICAN TELEVISION & RADIO CO.

Quality Products Since 1931

SAINT PAUL 1, MINNESOTA, U. S. A.

for test instruments, small power supplies, computers, control circuits, etc.

Full details on these components are included in Bulletin No. 242 which the company will supply on request.

NATIONAL RECEIVER

National Company of Malden, Mass., has recently introduced a new model general coverage receiver, the NC-109.

The receiver features an exclusive "Microtome" crystal filter and sepa-



rate product detector for c.w. and SSB reception. Also included are a big "S" meter; four-band coverage; phone, c.w., or SSB reception; a bandsread dial calibrated for 10, 11, 15, 20, 40, and 80 meter amateur bands; and an 11-inch indirectly lighted Lucite slide-rule dial.

The cabinet is of modern design in two-tone metal and measures 16 $\frac{1}{4}$ " x 10" x 10 $\frac{7}{8}$ ".

G-C TOOL KIT

General Cement Mfg. Co., 400 S. Wyman St., Rockford, Ill., is now marketing a new kit which contains the twelve most-often-used TV alignment tools in handy and compact form.

"The Top Twelve Tool Kit" contains both long- and short-reach aligners, *K-Tran* and soldering aids, and special

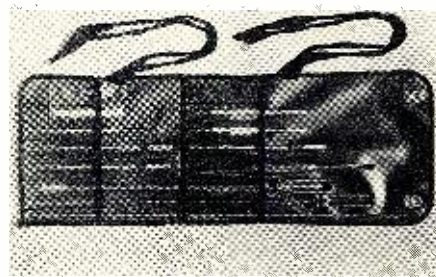

tools for *RCA* and *Zenith* sets. The set is neatly housed in a compact and durable plastic roll-up case.

Literature and other information on this tool kit are available from the manufacturer on request.

TINY SELECTOR SWITCH

Clarostat Mfg. Co., Inc., of Dover, N. H., is now offering a miniaturized rotary selector switch for applications in military and commercial assemblies such as guided missiles, aircraft electronics, mobile radio and radar, computers, range finders, pocket radios, and hearing aids.

The BHM series switches are rated at 50 ma. at 300 volts a.c. or d.c. and 500 ma. at 30 volts a.c. or d.c. All moving parts and contact mechanisms

are totally enclosed and the switch assembly is sealed for protection from dust and atmospheric conditions. Only $\frac{3}{8}$ " in diameter and $\frac{3}{4}$ " deep, including terminals, the new line is available in single-pole, 12-positions; double-pole, 6-positions; three-pole, 4-positions; and four-pole, 3-positions; and in either shorting or non-shorting versions.

This new line is being carried by the company's regular distributors or additional information can be obtained from the manufacturer direct.

METAL FILM RESISTOR

International Resistance Company, 401 N. Broad St., Philadelphia 8, Pa., has added two new types of metal film precision resistors to its line.

Available in two molded sizes, $\frac{1}{2}$ and 1 watt, these close-tolerance units have the metallic resistive film firmly bonded to a specially compound ceramic core. Designed to combine high accuracy and stability with low and controllable temperature coefficients, Types MEC and MEF resistors also provide low noise and negligible voltage coefficient and have low capaci-



tance and inductance which permits their use in high-frequency applications. Units for special requirements can be supplied.

A copy of Bulletin B-3, which is available without charge, provides complete specifications on these new components.

POCKET FM RECEIVER

The Commercial Electronic Products Division of *Radio Corporation of America*, Camden, N. J., has announced the development of the first commercial pocket-size FM radio receiver for mobile communication service.

The fully transistorized, 10-ounce receiver has been designed to provide ex-



tensions of several miles for radio systems now operating in the 150 mc. band.

It will be available to the public later this year after field tests have been completed.

The receiver is a single-channel device which will operate on any frequency in the 148-175 mc. band. The frequency is factory adjusted. The circuit incorporates an antenna and speaker which eliminates the need for an ear-piece. It measures 2 3/4" wide, 1" thick, and 6 1/2" high. It operates from mercury cells.

KNIGHT TWO-TRANSISTOR RADIO KIT

Allied Radio Corporation, 100 N. Western Ave., Chicago 80, Ill., has just released a new two-transistor pocket radio kit which is being marketed as the "Knight" No. 83-Y-262.

An efficient reflex circuit used in the design provides excellent reception of local broadcast stations without an external antenna being required, according to the company. Current drain is so low that months of operation are provided by the newly developed, long-life alkaline battery that comes with the kit. Printed wiring is used to cut assembly time. A simulated leather case, which may be carried or worn on a belt, houses the receiver.

A miniature dynamic earphone on a three-foot cord permits private listening. The set weighs 11 ounces.

TRANSFORMERS FOR TRANSISTOR CIRCUITS

Gramer Halldorson Transformer Corporation, 2734 N. Pulaski Rd., Chicago 39, Ill., has announced that it is prepared to supply a complete line of miniature audio transformers for transistorized circuit applications.

The new line consists of thirty-two items comprising two series: a 150-mw. series which measures 2 1/32" x 1 1/16" x 5/8" with mounting tab centers 1 3/16" at .6 ounce and a 300-mw. series measuring 1 3/16" x 1 1/8" x 1 3/16", weighing 1.1 ounces.

The units are supplied in individual plastic containers with complete installation instructions enclosed. Two charts, which allow selection of the proper transformer for the job at hand, are available on request.

-50-

Build 16 Radio

\$22.95

Only 22

CIRCUITS at Home
with NEW DELUXE
1957 PROGRESSIVE
RADIO "EDU-KIT"

A Practical Home Radio Course

- ★ No Knowledge of Radio Necessary
- ★ No Additional Parts or Tools Needed
- ★ Excellent Background for TV
- ★ School Inquiries Invited
- ★ Attractively Gift Packed



Reg. U.S.
Pat. Off.

Now Includes

- ★ TRANSMITTER
- ★ SIGNAL TRACER
- ★ SIGNAL INJECTOR
- ★ CODE OSCILLATOR

FREE SET OF TOOLS, PLIERS—CUTTERS, TESTER,
SOLDERING IRON, ALIGNMENT TOOL

WHAT THE "EDU-KIT" OFFERS YOU

The "Edu-Kit" offers you an outstanding PRACTICAL HOME RADIO COURSE at a rock-bottom price. Our kit is designed to train Radio & Electronics Technicians, making use of the modern methods of home training. You will learn radio theory, construction, servicing, basic Hi-Fi and TV repairs, code, FCC amateur license requirements.

You will learn how to identify radio symbols, how to read and interpret schematics, how to mount and layout radio parts, how to wire and solder, how to operate electronic equipment, how to build radios. You will receive a basic education in radio, worth many times the small price you pay, only \$22.95 complete.

THE KIT FOR EVERYONE

The Progressive Radio "Edu-Kit" was specifically prepared for any person who has a desire to learn Radio. The "Edu-Kit" has been used successfully by young and old in all parts of the world, by many Radio Schools and camps in this country and abroad. It is used for training and rehabilitation of

Armed Forces Personnel and Veterans throughout the world.

The Progressive Radio "Edu-Kit" requires no instructor. All instructions and parts are included. Every step is carefully explained. You cannot make a mistake.

PROGRESSIVE TEACHING METHOD

The Progressive Radio "Edu-Kit" is the foremost educational radio kit in the world, and is universally accepted as the standard in the field of electronics training. The "Edu-Kit" uses the modern educational principle of "Learn by Doing."

Therefore, you will construct radio circuits, perform jobs and conduct experiments to illustrate the principles which you learn. You begin by examining the various radio parts included in the "Edu-Kit." You then learn the function, theory and wiring of these parts. Then you build a simple radio. With this first set, you will enjoy listening to regular broadcast stations, learn theory, practice testing and troubleshooting. Then you build a more advanced radio, learn more advanced theory and techniques. Gradually, in a progressive manner, and at your own rate, you will find yourself constructing more advanced multi-tube radio circuits, and doing work like a professional Radio Technician.

Included in the "Edu-Kit" course are sixteen Receiver, Transmitter, Code Oscillator, Signal Tracer, and Signal Injector circuits. These are not unprofessional "breadboard" experiments, but genuine radio circuits, constructed by means of professional wiring and soldering on metal chassis, plus the new method of radio construction known as "Printed Circuitry." These circuits operate on your regular AC or DC house current.

In order to provide a thorough, well-integrated and easily-learned radio course, the "Edu-Kit" includes practical work as well as theory; troubleshooting in addition to construction; training for all, whether your purpose in learning radio be for hobby, business or job; progressively-arranged material, ranging from simple circuits to well-advanced topics in Hi-Fi and TV. Your studies will be further aided by Quiz materials and our well-known FREE Consultation Service.

THE "EDU-KIT" IS COMPLETE

You will receive all parts and instructions necessary to build 16 different radio and electronics circuits, each guaranteed to operate. Our kits contain tubes, tube sockets, variable, electrolytic and paper dielectric condensers, resistors, tie strips, coils, hardware, tubing, punched metal chassis, Instruction Manuals, etc.

In addition, you receive Printed Circuit materials, including Printed Circuit chassis, special tube sockets, hardware and instructions. You also receive a useful set of tools, a professional electric soldering iron, and a self-powered Dynamic Radio & Electronics Tester. The "Edu-Kit" also includes Code Instructions and the Progressive Code Oscillator, in addition to F.C.C.-type Questions and Answers for Radio Amateur License training. You will also receive lessons for servicing with the Progressive Signal Tracer and the Progressive Signal Injector, a High Fidelity Guide and a Quiz Book.

TROUBLE-SHOOTING LESSONS

You will learn trouble-shooting and servicing in a progressive manner. You will practice repairs on the sets that you construct. You will learn symptoms and causes of troubles in home portable and car radios. You will learn how to use the professional Signal Tracer, the unique Signal Injector and the Dynamic Radio & Electronics Tester. While you are learning in this practical way, you will be able to do many a repair job for your friends and neighbors, and charge fees which will far exceed the price of the "Edu-Kit." Our Consultation Service will help you with any technical problems you may have. J. Stataitis, of 25 Poplar Pl., Waterbury, Conn., writes: "I have repaired several sets for my friends, and made money. The "Edu-Kit" paid for itself. I was ready to spend \$240 for a Course, but I found your ad and sent for your Kit."

FREE EXTRAS

• SET OF TOOLS • RADIO AND ELECTRONICS TESTER • ELECTRIC SOLDERING IRON • TESTER INSTRUCTION MANUAL • MEMBERSHIP IN RADIO-TV CLUB • CONSULTATION SERVICE • HI-FI GUIDE • QUIZZES • TV BOOK • FCC AMATEUR LICENSE TRAINING • RADIO BOOK • PRINTED CIRCUITRY

ORDER FROM AD—RECEIVE FREE BONUS
RESISTOR & CONDENSER KITS WORTH \$7.00

- Send "Edu-Kit" Postpaid. I enclose full payment of \$22.95.
- Send "Edu-Kit" C.O.D. I will pay \$22.95 plus postage.
- Send me FREE additional information describing "Edu-Kit." Include FREE valuable Radio and TV Servicing Literature. No obligation.

Name
Address

PROGRESSIVE "EDU-KITS" INC.

497 Union Av.
Room 66E, Brooklyn 11, N. Y.

The NEW YEATS "Shorty" STATION WAGON & PANEL PICK-UP appliance dolly



YEATS Model No. 5
Aluminum alloy
Height 47"
Weight 32 lbs.



Only 47" tall, this new YEATS dolly is designed for TV and appliance men who make deliveries by station wagon or panel truck. No need to detach appliance for loading into the "wagon" or pick-up . . . the YEATS "Shorty" will slide into your vehicle with ease. Has aluminum alloy frame with padded felt front, quick fastening (30 second) strap ratchet, and endless, rubber belt step glide. New YEATS folding platform attachment, at left, saves back-breaking work handling TV chassis or table models. Call your YEATS dealer today!

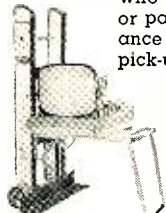

Folding platform is 13 1/2" x 24 1/2"
—attaches instantly. (Platform only) \$9.95.



"Everlast" COVERS & PADS

YEATS semi-fitted covers are made of tough water repellant fabric with adjustable web straps and soft, scratchless white flannel liners. All shapes and sizes—Write.

Furniture Pad

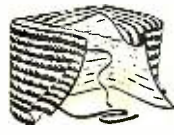

TV Cover

SEND postcard for full information on our complete line TODAY!

YEATS

appliance dolly

sales co.
Milwaukee 5, Wis.

2101 N. 12th St.

June, 1957

FRAM FREQ. METER
110 Volt—58-62 Cycles
with 9 reeds.....ea. **\$10.95**

REDMOND BLOWER

110V. 60 cyc. .3 Amp. 1600 Rpm. 3 3/4" Blower wheel—Outlet 2" Diameter. Suitable for cooling Transm. tubes, etc.ea. **\$7.95**
2 for \$15.00

SIGMA 5F RELAY

16,000 ohm in dual 8,000 ohm coils. (Can be paralleled) SPDT adjustable silver contacts. Adjustable armature tension. Operates on 500 microamperes or less. Ultimate in a sensitive relay. Ideal for precision control work.ea. **\$3.95**
Write for quantity prices.

G. E. RELAY CONTROL

(Ideal for Model Controls, Etc.)
Contains a sigma bridge, 5,000 ohm relay (trips at less than 2 MA), high impedance choke, bi-metal strip, neon pilot and many useful parts. The sensitive relay alone is worth much more than the total.ea. **\$9.25**
low price of... **\$1.10** ea. for

RELAYS

Sealed Claire SPST. Norm. closed 3000 ohm coil 4 ma.ea. **95c**
Claire Telephone Type 11300 ohm coil DPDT cont. 10 amp 125V. Sens. 4MA.ea. **\$3.95**
Cutler Hammer Contactor—110V 60 cy. 4 pole s.t. Norm. open 25 amp contacts.ea. **\$6.95**
Hermetically Sealed Relay Coil 110V AC 60 cy SPDT Contacts 5 Amps.ea. **\$1.85**
12 Volt DPDT DC Relay
Eachea. **\$1.35**
Cramer Time Delay Relay, 220V 60 cy. 45 sec. adj. 2 pole DT.ea. **\$6.95**
G.E. Plug in Relay 5 prong 2000 ohm coil 4 mil. SPDT (Sigma 4F).ea. **\$2.50**
Telephone type relay 12 V. DC @ 10 ma. triple pole single throw. Normally open.ea. **\$1.25**
Dynamotor Starting Relay, 12VDC 30 amp contactsea. **\$1.50**

OIL CONDENSER SPECIALS BRAND NEW

2 MFD 600 VDC .50	1 MFD 3000 VDC 1.85
4 MFD 600 VDC .75	4 MFD 4000VDC 14.95
6 MFD 600 VDC .85	6 MFD 4000VDC 16.95
8 MFD 600 VDC .95	1 MFD 6000 VDC 6.45
10 MFD 600 VDC 1.05	1 MFD 7500 VDC 1.49
12 MFD 600 VDC 1.15	2 MFD 10,000 VDC 39.95
2 MFD 1000 VDC .85	1 MFD 15,000 VDC 29.50
4 MFD 1000 VDC 1.35	1 MFD 25,000 VDC 49.50
1 MFD 1200 VDC .45	1 MFD 330 AC (1000 DC) .95
1 MFD 1500 VDC .75	20 MFD 330 AC 2.50
2 MFD 1500 VDC 1.10	8 MFD (2000 DC) 2.35
6 MFD 1500 VDC 1.95	
10 MFD 1500 VDC 3.50	
1 MFD 2000 VDC .85	
2 MFD 2000 VDC 1.35	
4 MFD 2000 VDC 1.85	
4 MFD 2500 VDC 4.95	

PANEL METERS

G.E., WESTINGHOUSE, W.E., SIMPSON, etc.

1 1/2" 0-5 Amps RF with Thermocouple. 3.95	3" METERS
2" METERS	0-50 Micro DC7.95
0-200 Micro DC4.95	0-100 Micro DC6.95
0-1 Ma (Scale 0-5 ma & 0-120 VDC)3.45	0-100 Micro5.95
0-1 Ma DC3.95	(Scale 0-3)5.95
0-15 Ma DC2.95	0-200 Micro DC4.95
0-35 Ma DC2.95	0-1 Mil DC4.50
0-50 Ma DC2.95	0-5 Ma DC (Scale 0-150)3.95
0-100 Ma DC2.95	0-5 Mil DC3.95
0-200 Ma DC2.95	0-5 Mil DC3.95
0-500 Ma DC2.95	0-10 Mil DC3.95
0-5 Amps DC2.95	0-50 Mil DC3.95
18-36 Volts DC2.49	0-100 Mil DC3.95
0-300 V. DC3.25	0-200 Mil DC3.95
0-150 Ma DC3.49	0-1 Amp DC3.95
0-3 Amps RF3.49	0-2 Amp DC3.95
0-4 Amps RF3.49	0-15 Amp DC3.95
0-9 Amps RF2.95	50-0-50 Amp DC4.50
0-15 Amps RF2.95	0-500 Volts DC4.50
0-15 Volts AC2.95	0-1 KV DC5.00
0-150 V. AC3.49	0-1.5 KV DC5.50
5 Meter3.95	0-7.5 V. AC3.95
	0-15 V. AC4.50
	0-130 V. AC4.50
	0-150 V. AC4.95
	0-5 Amps RF4.50
	110 V. 60 cy Running time meter
	0-9, 999.9 hrs. 10.50

CHOKES—FULLY CASED

10 HENRY 80 Mil (unshielded).....90c
8 HENRY @ 200 Ma.....\$1.95
10 HENRY @ 315 Ma.....3.50
3 HENRY @ 630 Ma.....3.50
6 HENRY 450 Mil.....4.95

Read 'n' Save Bargains

Precision Meter Multiplier—1 Megohm .1% tolerance\$1.49 ea.
IRC MPA 1 Meg Resistor 35 Watts85c
HEINEMANN CIR. BREAKER1.25
110 V. 60 cy. 20 amps. Curve 4.....1.25
.01 MMF 1000 VDC MICAS......5 for .95
.0004-250 VDC MICAS......5 for 1.50
1 MFD Oil Condenser 400 VDC, 20c ea. 10 for 1.50
Receiving element fits standard W.E. or Conn. telephone handsets65c
Globar non-inductive resistor, 6 watts 50 ohms25c

All merchandise sold on a 10 day money back guarantee basis

Min. Order \$3.00—25% with Order—F.O.B. New York

PEAK

ELECTRONICS COMPANY
66 W. Broadway, New York 7, N. Y., WO-2-5439

Sweep Generator Repair
(Continued from page 55)

changes faster as the plates come closer. If, for example, the oscillator operates at 170 mc. when the capacitor plates are farthest apart, it will be at 168 mc. when they are in mid-position, but when they reach the three-quarter point the increase in capacity will have changed the oscillator to something like 160 mc. At maximum capacity, it may be at 150 mc. This type of nonlinearity is overcome by modifying the waveshape of the signal driving the vibrator or by distorting the horizontal-sweep output so as to compensate for this apparent nonlinearity. In sweep generators using magnetic-type frequency changers, such as the *Knight*, *Heath* and *EICO* units, the problem of frequency linearity is much less probable. In either type of generator, it will be necessary to study the circuit carefully before troubleshooting this type of defect—but before frequency nonlinearity is suspected be sure to adjust the phasing and blanking controls properly.

The horizontal sweep signal in some generators is simply a portion of the 60-cycle sine wave from the power transformer, while in other units this signal passes through one or two stages of amplification and shaping. In the latter system, the loss of horizontal sweep is usually due to tube failure. Circuit tracing with the oscilloscope will locate the defect quickly.

Other defects likely to be encountered in sweep generators include various mechanical failures of the switches, gears, and potentiometers which form the channel tuning and the attenuator controls. The latter is occasionally subject to shorts or open circuits. Built-in markers can, of course, be lost if their crystals or the oscillator tubes become defective. In changing crystals, it is important to obtain the exact replacement part since differently cut crystals will not operate the same way.

Conclusion

The sweep generator is one of the most important and valuable tools in TV servicing, and its operation must meet certain minimum standards. Marginal or poor generator performance can give the appearance of TV receiver defects even though the set works perfectly. For this reason and also for the sake of efficient TV servicing, it is important to maintain and repair sweep generators from time to time. Minimum performance requirements, simple tests and most frequent trouble sources have been described here. It is hoped that they will enable readers to help themselves to some extent with their sweep generators. In some cases, the wisest course will be to return the unit to the manufacturer for repair and alignment, but there are many defects which the technician can spot and cure without losing the use of this important instrument for weeks. —30—

RAD-TEL'S
BIGGEST VALUES IN
15-YEAR HISTORY!

Thousands of satisfied customers over a 15-year period stamp us as always **RELIABLE, DEPENDABLE, TRUSTWORTHY!** Whether you buy one tube or hundreds of dollars in parts, all our merchandise is absolutely **BRAND NEW!**

2 FOR THE PRICE OF 1 KIT SALE

You get another identical kit absolutely free when you enclose this ad with your order. Applies only to same kit—no substitutions. **AD MUST ACCOMPANY ORDER.**

CERAMICON KIT

Kit of 50 assorted ceramic discs, biplates, tubular condensers. All condensers popular sizes, used in TV and FM sets. 2 lbs. total. **\$1.99**
Buy one. . . . Get another **\$1.99** kit **FREE** with this ad!

WIRE KIT

3 to 15 in. Stranded, solid-hook-up wire, plastic, cotton, etc. Covered ends cleaned and some tinned. All usable lengths. 1 lb 50¢
Buy one. . . . Get another kit **FREE** with this ad!

#48 BI-PASS CONDENSER KIT

Values .002 to .2, 200 to 1000 VDC. 99¢
Kit of 25.....
Buy one. . . . Get another 99¢ kit **FREE** with this ad!

#292 FILTER CHOKE 1.3 H., 260 ma., 60 ohms. 1 1/4 lbs., 49¢ ea.

Buy one. . . . Get one **FREE!**

Write Dept. RN-6 for **FREE** catalog of tubes and parts.

Rad Tel TUBE CO.

Not Affl. With Any Other Tube Mail Order Co.

No C.O.D.'s, please. Allow for postage. Subject to prior sale. No handling charge with this ad.

115 COIT ST., IRVINGTON 11, N. J.

"A Noteworthy . . . Satisfying Achievement"—THE **NEW YORK TIMES**

"Big, bold, beautiful!"—**CLEVELAND PRESS**

"Expertly presented . . . excellent"—*Irving Desfor, Associated Press Camera Editor*



Enthusiastic praise like this greeted the world's first **COLOR PHOTOGRAPHY ANNUAL** in 1956! It was a sellout at newsstands everywhere!

NOW—the big, second edition of the POPULAR PHOTOGRAPHY COLOR ANNUAL is on the way—featuring completely new portfolios and pictures by such master photographers as: Briggs, de Evia, Groebli, Haas, Halsman, Karsh, Penn, Sterns, Winquist and others.

PLUS • a strikingly illustrated, provocative debate on the **NUDE IN PHOTOGRAPHY**—Is it Art?

• a symposium by 15 famous photographers, critics and authors on **IS COLOR CREATIVE?**

• a complete handbook for the color photographer—with charts on filters for color, color temperature meters, instructions on color processing and printing!

• **AND** page after page of exquisite color reproductions—the largest collection of color photographs ever published in any single volume!

LOOK FOR THE 1957 POPULAR PHOTOGRAPHY ANNUAL! ON SALE NOW AT ALL NEWSSTANDS—ONLY \$1.00!





PHOTOCONDUCTORS

The Photoconductor-Transistor Division of *Electronics Corporation of America*, One Memorial Drive, Cambridge 42, Mass. has issued an 8-page bulletin describing its line of infrared-sensitive lead sulfide photoconductors for detection and guidance systems.

Technical specifications and ordering information is given for four general cell types having a wide range of performance characteristics. Charts for cell response as a function of both wavelength and source temperature are also given.

Applications for these devices include missile guidance, fire control, aerial mapping, data reduction, and spectroscopy.

CONTROL-RESISTOR DATA

Controls and resistors for practically all standard applications can be selected easily with the new condensed catalogue recently released by the Industrial Sales Dept. of *Clarostat Mfg. Co., Inc.*, Dover, N. H.

Essential facts and figures, together with photos and dimensional drawings, provide all the required information free from "sales pitches." Among the items listed are composition-element and wire-wound potentiometers in different sizes and wattages, power rheostats, a selection of switches, precision pots and encapsulated potentiometers, molded composition-element potentiometers, allied hardware, and a full line of all types and sizes of wire-wound power resistors.

HICKOK TEST EQUIPMENT

The *Hickok Electrical Instrument Company*, 10524 Dupont Ave., Cleveland 8, Ohio, is now offering, for a limited time only, copies of its new 8-page composite test equipment catalogue, Form SM-30.

This handy compilation lists twenty-five pieces of new test gear, two new color generators, and the new "Cardmatic" automatic tube tester. Each instrument is pictured, described in detail, and its special features outlined. Equipment for the service shop and laboratory is included in the new catalogue.

RIDER BOOKS CATALOGUED

A 32-page Spring-Summer catalogue describing the various publications currently available has been issued by *John F. Rider Publisher, Inc.*, 116 W. 14th St., New York 11, N. Y.

The catalogue describes the contents of each book and identifies approximately nineteen titles which are scheduled to be released later this season.

Copies of the listing are free and to

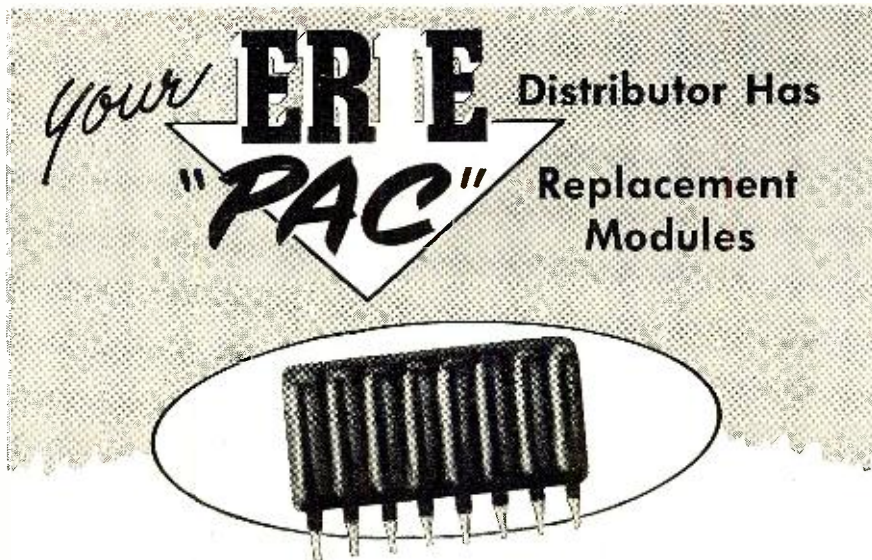

for Servicing 1957 Auto Radios

PAC is a group of interconnected capacitors and resistors, combined in a single-insertion unit. Several popular 1957 model automobile and truck radios employ this new concept in component packaging. When servicing these auto radios, a complete PAC (Pre Assembled Circuit) module can be quickly and easily replaced.

Your *ERIE* Distributor has PAC Replacement Modules in stock. See him for complete information and prices.



Another Sencore Time-Saver

Handy "36" R-C Substitution Unit

"36" Most Often Needed Components At YOUR Fingertips!

3 pole, 12 position switch individually selects one of the "36" components for direct substitution.

Contains:

- ★ 12-1 watt 10% resistor from 10 ohms to 5000 ohms
- ★ 12-1/2 watt 10% resistors from 10K ohms to 5.6 megohms
- ★ 10-600 volt capacitors Completely isolated from 100-mmf. to .5mf.
- ★ 1-10mf., 450V Electrolytic
- ★ 1-40mf., 450V Electrolytic
- ★ For Shop, Lab, or outside service

AVAILABLE AT ALL PARTS DISTRIBUTORS!

ONLY \$12.75 DEALER NET

POPULAR SENCORE PRODUCTS

- Transistor Tester
- Leakage Checker
- Filament Tester
- Voltage Regulator
- Bias Supply

SENCORE SERVICE INSTRUMENTS CORP.
171 OFFICIAL RD., ADDISON, ILL.

Cut out this ad now for further information.

F.C.C. LICENSE QUICKLY!

F.C.C. License—the Key to Better Jobs

An FCC commercial (not amateur) license is your ticket to higher pay and more interesting employment. This license is Federal Government evidence of your qualifications in electronics. Employers are eager to hire licensed technicians.

Grantham Training is Best

Grantham School of Electronics specializes in preparing students to pass FCC examinations. We train you quickly and well. All courses begin with basic fundamentals—NO previous training required. Beginners get 2nd class license in 8 weeks, 1st class in 4 additional weeks.

OUR GUARANTEE **FCC-TYPE EXAMS**

If you should fail the FCC exam after finishing our course, we guarantee to give you additional training at NO ADDITIONAL COST. Read details in our free booklet.

FCC-type tests are used throughout the Grantham course. Constant practice with these FCC-type tests helps you prepare for the actual FCC examination.

Learn by Mail or in Residence

You can train either by correspondence or in residence at either division of Grantham School of Electronics—Hollywood, Calif., or Washington, D. C. Our free booklet, "Opportunities in Electronics," gives details of both types of courses. Send for your free copy today.

MAIL NOW TO OFFICE NEAREST YOU

(mail in envelope or paste on postal card)

Grantham Schools, Desk 76-G
1505 N. Western Ave. 821-19th Street N. W.
Hollywood 27, Calif. Washington 6, D. C.

Please send me your free booklet, telling how I can get my commercial FCC license quickly. I understand there is no obligation and no salesman will call.

NAME

ADDRESS

CITY STATE

AIREX

THE HI-FIDELITY SUPERMARKET

WHERE THE PRICE IS ALWAYS RIGHT

RECORD CHANGER BARGAIN

LATEST WEBSTER AUTOMATIC CHANGER: Inter-mixes 10"-12 records. Automatic shut-off. CERX050A dual sapphire reluctance cart. Heavy duty 4 pole motor. With line cord. **\$29.95** and plugs. Base for above—**\$3.95**; Automatic 45 spindle—**\$2.49**.

NATIONALLY FAMOUS CASER RELECTANCE CARTRIDGE TYPE RPX 052A. Triple play .003 mil sapphire & .001 mil diamond. Clip-in Stylus. Stylus pressure 6-8 grams. **\$17.95**

NATIONALLY FAMOUS RELECTANCE CART TYPE 050A. Triple play sapphire needles for all records, clip-in stylus, stylus pressure 6-8 grams. **\$6.95**

NEW TECH-MASTER 60 WATT AMPLIFIER—PRE-AMPLIFIER KIT

Only unit of its kind on the market. Full 60 watts output. 120 watt peak. Frequency 20-20,000 cycles ± 1db at 60 watts. Intermodulation distortion less than 1% at 60 watts and less than 1% at 100 watt operating level. Output 4, 8, 16 OHMS, RIAA, AES, NAB, LP & 78 equalization. Input selector for auxiliary, tuner, TV & tape. Tape output from built-in cathode follower jack. Uses direct interstage coupling, special ultra linear output transformer, variable card load control. Uses 12AX7, 12AU7, 6AN8, 5U4GB, 2-6350. Bass & treble control. Separate selenium for bias supply. Full easy instructions. Size 10 1/2" D x 14" W x 5 1/2" H. **\$79.95**

COVER FOR ABOVE.....\$7.50



Grommes Hi-Fi Amplifier Kits

10 Watts, 18 watts peak. Resp. 20-20,000 cps 1 db. Preamp., 4 inputs. Hum—80 db. 2% Harm. Dist band width 8 DB down AM. Complete with detailed step by step instruction manual, all resistors, condensers, tubes, wire & solder. Easy to make. 2-12AX7, 2-6350, 5Y3. Bass & Treble boost. Limited quantity. **\$24.95**



New 20 watt Grommes amplifier kit, mdl. 61PGK, 30 watts peak. Response 20-20,000 cps ± 1/2 db. Hum—80 db, full equalization & compensation. Complete with cage, tubes, detailed instructions, wires and solder. **\$59.50**



FM-AM TUNER KIT

Easy to assemble. Professional quality performance. 3 double tuned IF stages. Foster-Seely discriminator, automatic frequency control & defeat. 7 tubes plus rectifier. Distortion less than 1% Hum level -70DB. Sensitivity 6 microvolts for 20 DB quieting on FM & 20 microvolts on AM. FM selectivity 20KC at 10 watts. Complete with detailed step-by-step instructions. **\$31.95**

FM TUNER ONLY—\$25.50 • COVER—\$3.95
These units are ideal in combination with any of the Hi-Fi Amplifier kits listed above.

MULLARD HI-FIDELITY TUBES

Type	Replaces	Price	Type	Replaces	Price
EL34	6CA7	\$4.35	6EC82	12AU7	\$2.20
EL37	6L6; 5881;	\$4.95	ECC83	12AX7	\$2.50
	KT66	\$3.50	EF86	2729;	\$2.75
EL84	6BD5	\$2.60	GZ32	5V4; 5U4	\$2.75
ECC81	12AT7	\$2.60			\$2.95

Nationally Known Utah Speakers

12" coaxial, exclusive built-in crossover network assures a frequency response from 35 to 17,500 cps; 12 watt cap. 8 OHMS impedance. Reg. \$24.95. **\$12.88**
15" woofer—response 30 to 8,000 cycles, 21.5 oz. magnet, 25 watt capacity, 1 1/2" voice coil. **\$19.95**
8 OHMS impedance. Reg. \$34.95. **\$7.95**
5" super tweeter—response 3000 to 19,500 cps, 25 watt capacity, 3/4" voice coil. OEM tubes impedance, with built-in crossover network. **\$7.95**

FAMOUS NORELCO SPEAKER

Model 9762M—12" twin cone coaxial type, full resonance speaker. Frequency range 35 to 18,000 without baffle. Flux density 11,000 GAUSS. 30 watt capacity. Impedance 8 OHMS. One of the finest quality speakers on the market today. **\$39.95**
Reg. list \$99.50.

EICO HI-FI AMPLIFIER KIT

60 watt ultralinear power amplifier with Acrosound TO-330 output transformer. 150 watt peak. Hum-90db. Response at 60 watt ± 1db. 15 cps to 35 KC. 4, 8 & 16 ohm taps. Push pull EL 34, EF 86 low noise voltage amplifier direct coupled to 6SN7GTB cathode coupled phase inverter. Output tubes operated with fixed bias. Sensitivity .55V for 60W. Damping factor 17. Inverse feedback 21db. Will work with any self-powered or external powered pre-amp. Send for complete EICO catalog. **\$72.95**

Standard Coil Cascode TV Tuner

Replacement for any type TV set. 41 MC. **\$7.95**
IF. Shaft length 4 1/4". In lots of 3, **\$6.49 each**
Knobs to match—69c.

Building Your Own Hi-Fi System? SEND US YOUR LIST OF COMPONENTS. We will give you a PACKAGED QUOTATION ON THEM. Hi-Fi Yearbook—\$1.95 (Refundable with purchase from Yearbooks).

All merchandise is brand new, factory fresh & guaranteed. Mail & phone orders on receipt of certified check or MO of 20% of items as a deposit. Balance C.O.D., F.O.B. factory N. Y. Prices & specifications subject to change without notice.

AIREX RADIO CORP.
64 Cortlandt St. N.Y. 7, N.Y. CO 7-2137

all who request the catalogue, the publisher will send, in addition and without charge, a genuine leather book-mark stamped in gold.

G-E REPLACEMENT GUIDE

A replacement guide to assist television technicians in using the new General Electric replacement germanium TV rectifiers has recently been issued by the company and is being offered without charge by the firm's tube and transistor distributors.

The guide contains a listing of TV sets and the particular germanium rectifier unit which may be used to replace the rectifier in the set. The sets of 32 TV receiver manufacturers are included.

NEW TRU-OHM CATALOGUE

Tru-Ohm Products, 2800 N. Milwaukee Ave., Chicago 18, Ill., has just issued an elaborate multi-color catalogue covering its complete line of resistors and rheostats.

The 22-page publication provides complete information on fixed enameled, adjustable enameled, oval, vitreous axial, "Tru-Rib," and caged resistors as well as the new printed circular resistors and the new Blue X-60 series resistors. A complete line of power rheostats is covered in text and illustration.

The company will supply copies of this new catalogue to those making their requests direct.

CENTRALAB CONTROL GUIDE

Centralab, a division of Globe Union, Inc., 900 E. Keefe Ave., Milwaukee 1, Wis., has announced the availability of a new edition of its popular "Pocket Control Guide."

This handy control cross-reference guide is published semi-annually to make the latest and most up-to-date replacement control information available. Hundreds of new listings have been included in the 106-page guide which has been designed to slip easily into the pocket or repair kit.

Copies of the guide may be obtained from the company's distributors or from the manufacturer direct. The price of Guide No. 5 is 20 cents a copy.

HOOK-UP WIRE BULLETIN

Philadelphia Insulated Wire Co., 200 N. Third St., Philadelphia 6, Pa., has issued a one-page data sheet on its new "Series 100" hook-up wire.

The wire features silver-plated copper conductor, extruded Teflon insulation, and is intended for continuous operation at 600 volts over a temperature range of from -60 to +200 degrees C.

Full specifications on the "Series 100" are given along with other pertinent mechanical and electrical data.

TRANSISTOR DATA

Lafayette Radio, 165-08 Liberty Ave., Jamaica 33, N. Y., has just issued a new four-page data sheet listing all the transistors and transistor transformers it carries in stock.

Of interest to experimenters, hobby-

ists, hams, and others engaged in building transistorized equipment, the listing includes transistors made by General Electric, Raytheon, Texas Instruments, Sylvania, Philco, Transitron, CBS, RCA, AmpereX, Clevite; and diodes made by Hughes, Raytheon, G-E, Sylvania, Texas Instruments, Transitron, and RCA; Veco thermistors and varistors are also listed along with the complete Argonne line of transistor transformers.

Copies of this reference data sheet are available from Dept. ST-1D of the company.

ALLIGATOR CLIP LINE

Mueller Electric Company, 1583H E. 31st St., Cleveland 14, Ohio, has recently issued a catalogue sheet which describes its new "70 Series" of streamlined alligator clips.

Design-simplified version of the company's standard "60 Series," the new line is described, specifications and prices given. The data sheet is available without charge upon written request to the manufacturer.

NEW RETMA STANDARDS

The Engineering Department of RETMA, 11 W. 42nd St., New York 6, N. Y., has announced the publication of three new standards of interest to the industry.

RS-181 covers iron core charging inductors and is available for 60 cents a copy. RS-182 deals with class A variable air capacitors and is priced at 30 cents each, while RS-183 covers standards for output transformers for radio broadcast receivers and is available for 25 cents a copy.

Any or all of these standards are available from the Engineering Department. Payment should accompany all orders.

RADIOACTIVITY TEST GEAR

Nuclear-Chicago Corporation, 229 W. Erie St., Chicago 10, Ill., has just issued a new 64-page, two-color catalogue which illustrates and describes over thirty new radioactivity measuring instruments introduced since the last catalogue was published.

Sections in the catalogue are devoted to nuclear scaling units, rate-meters, gamma-ray spectrometer systems, geiger and scintillation detectors, portable survey instruments for alpha-beta-gamma and neutron measurements, lead shields, personnel protection devices, counting systems, high intensity gamma and beta sources, and nuclear accessories.

TEST EQUIPMENT BULLETIN

Simpson Electric Company, 5200 W. Kinzie St., Chicago 44, Ill., is distributing without charge copies of its Bulletin No. 2058 which includes a representative selection of its line of test equipment.

The 6-page bulletin lists test equipment for servicing radio, television, and industrial electrical equipment as well as refrigeration, air-conditioning, appliances, and heating equipment.

Special emphasis has been placed on

the company's Model 362 low-ohm meter, its Model 382 in-circuit horizontal systems analyzer, and the Model 387 millivoltmeter for testing safety thermocouples on gas-fired equipment.

BATTERY GUIDE

Ray-O-Vac Company, 212 E. Washington Ave., Madison, Wis., is currently distributing copies of its 1957-58 portable radio battery comparative guide which lists its battery numbers and those of seven other major battery makers.

The guide is available free to anyone selling or handling portable radios and provides dealers with a handy reference source when servicing customer battery needs. The guide is in the form of a chart with a riveted hole for hanging on the wall, promoting customer self-service. All of the information contained in the guide is non-confidential and is simple so that anyone who reads can understand it.

The guide has a section on transistor batteries and provides the latest information on batteries for transistor sets as well as vacuum tube models and 100 standard type batteries. Details on the battery component of more than 600 models of portable radios, including 41 different brands, are also given.

Write Dept. 284 of the company for a copy of this new guide.

COLOR TUBE APERTURE MASK

Superior Tube Company, 1744 Ger-

mantown Ave., Norristown, Pa., has issued "Data Memorandum No. 5" describing and illustrating its line of aperture masks for color television picture tubes.

Of interest to set makers, this publication illustrates the principal steps in manufacturing the masks which are, in fact, paper-thin metal sheets into which are etched approximately a half million tapered holes that confine and guide beams from the three electron guns in the tube.

DRAWN CASES AND COVERS

Hudson Tool & Die Co., Inc., 18 Malvern St., Newark 5, N. J., has issued a four-page data sheet on its line of precision-drawn cases and covers designed specifically for the electronic industry.

Included is data on standard square, rectangular, and round cases; MIL-T-27 cases; cover assemblies; and custom closures. The company can supply these components in copper, brass, aluminum, Mumetal, steel, or stainless steel. Write the manufacturer for full details and a copy of the data sheet.

BETA TESTER DATA

Baird-Atomic, Inc., 33 University Road, Cambridge 38, Mass., is offering copies of its Bulletin TP-106-1, which describes its portable beta tester for transistor measurements.

The Model KT-1 is designed for the rapid measurement of basic transistor characteristics in quality control testing, circuit design, incoming inspection,

and troubleshooting. The data sheet explains these applications in addition to supplying complete electrical and mechanical data on this self-contained unit.

PERMANENT MAGNET DATA

The Magnetic Materials Section of *General Electric Company*, Edmore, Mich., has released a 12-page catalogue covering its line of both cast and sintered permanent magnets.

The new publication, PM-121, includes information on magnetic and mechanical properties, approximate tolerances, magnet assemblies, sales and service, in addition to information on how to order either cast Alnico 5 or sintered Alnico 2 magnets. The illustrations and engineering data provide the user with required information on the various available shapes.

BROCHURE ON WWV-WWVH

As a service to hams and others who use the National Bureau of Standards radio stations WWV and WWVH, the *Shasta Division of Beckman Instruments, Inc.*, P. O. Box 296, Station A, Richmond, Calif., is offering an 8-page, 2-color brochure describing the function, applications, and recent improvements in this service.

The brochure also describes the company's new Model 905 WWV receiver which was introduced earlier this year. Those desiring a copy of the bulletin are asked to specify "Data File #10."

-30-

We Have OVER 1000 USED TV SETS

At All Times In Our Huge Warehouse Buy one or more of these WORKING TVs to sell or use as your own second set! All Sets in GOOD WORKING condition!

Your Choice—Console or Table Model

10" ... \$23.00	19" ... \$58.00
12" ... \$28.00	20" ... \$64.00
14" ... \$33.00	21" ... \$72.00
16" ... \$40.00	24" ... \$99.00
17" ... \$46.00	

When ordering TV's, state whether table model or console is desired. Also preference on make of set. All TV's sent railway express F.O.B. Newark. On any quantity WIRE or CALL today!

FREE BONUS ANTENNA GIVEN WITH ANY TV SET ORDER!!

FREE RCA "CHEATER" CORD GIVEN WITH ANY TUBE ORDER OF \$7.00 OR MORE!!

FREE POSTAGE in U.S.A. and Territories on orders over \$5.00. 25¢ handling charge on orders under \$5.00. 25% deposit required on C.O.D.'s. Please send approximate postage or freight on Canadian and foreign orders. Subject to prior sale.

SEND for our **FREE** complete TUBE & PARTS LIST and order blank.

Brand New Factory Seconds! Electrically Perfect Factory Seconds! Used Tubes! New and Used Jan Surplus Tubes!

40¢
FOR ANY
TUBE
we will not be
undersold

Apology to Readers of Radio & TV News
Due to the tremendous response to our wonderful values in tubes, our buying staff at Video Electric Co. was unable to adhere to our Same Day Shipment policy. For this reason, some orders were delayed a number of days. We at Video wish to offer our profound apologies for any inconvenience caused our customers. We are attempting to remedy the situation at once.

PROMPT SHIPMENT ON ALL ORDERS
\$3700 Per Hundred
DON'T PAY MORE FOR SET TESTED LONG LIFE DEPENDABLE RADIO & TV TUBES • BUY VIDEO INDIVIDUALLY BOXED • ALL GUARANTEED FOR ONE YEAR OR YOUR MONEY BACK

Some Standard Brand—Others With Famous VIDEO Brand

0A2	5U4G	6HG6T	12A77
0A2	5U9	6J4	12A105
0A3	5V4	6J5GT	12AU7
0B2	5VE5T	6L6	12AV6
0C3	5V3	6N6GT	12AV7
0Z4	5Y4G	6P5	12AX4BT
1A7GT	6A34	6N7GT	12AK7
1C3GT	6AC7	6S4	12AZ7
1G4	6AG2	6Y6G	12BA7
1F4	6AF4	6CA7	12BJ6
1H4	6AM4GT	6B7Y	12BE6
1H5GT	6AM5	6B7GT	12BQ7
1J6GT	6AL5	6SF5	12BY7
1L4	6AM8	6BF7	12C08
1L6	6AN4	6B7	12CA7
1L5	6AN5	6H7	12CG7
1L5	6AN5	6SJ7GT	12SH7
1L4	6AQ7GT	6SK7GT	12SJ7GT
1L5	6AS5	6SL7GT	12SK7
1N5GT	6AS7G	6SN7GT	12SN7GT
1S4	6AT6	6S07	12SO7
1S6	6AU4GT	6S07	12V6GT
1T4	6AU5GT	6S07	12X4
1U4	6AU6	6L8	12A7
1U5	6BU5GT	6L8GT	14BE
1V2	6AV6	6U7G	14Q7
1X2	6AX4GT	6U5	14R66G
2A7	6A5GT	6V3	10T8
2D21	6BA6	6V6GT	2A4
2X2	6BC5	6W4GT	27A5GT
3A4	6BC7	6W6GT	27B9GT
3AR	6BE6	6X4	28C06G
3AL5	6BF5	6X5GT	28C06
3AL5	6AL5	6B06G	28GGT
12C5	6BH6	6Y6G	25W4GT
3CB6	6BJ6	7A5	25Z6GT
3Q4	6BK5	7A7	35L6GT
10RGT	6BR7	7B5	35L6GT
3S4	6BL7GT	7K7	35V4
3V4	6B8	7C7	35V4
4E27	6B06GT	7C8	35Z3
4B7	6B07	7C7	35X5GT
5AR6	6BY5G	7F7	50A5
5AN8	6B7	7F8	40B5
5A5	6C4	7F7	50C5
5A78	6CC4	7V4	50L6T
5AW4	6CC6C	7Z4	HO
5A24	6CF6	8A6	117N7GT
5L6	6CG6	12AH7GT	117P7GT
5T4	6CU6GT	12AT6	117Z3
5T8	6E5		

VIDEO ELECTRIC COMPANY
79 CLINTON PL. NEWARK, N. J.
Phone HUmboldt 4-9848

BUILD THE BEST—

BUILD ALLIED'S OWN

knight-kits

LOWEST COST because our giant buying power passes biggest savings on to you... you do the easy assembly, get professional results and **SAVE!**

knight-kits

EASIEST TO BUILD because KNIGHT-KIT "Step-and-Check" instruction manuals are marvels of clarity—it's just like having a good instructor at your side.

knight-kits

MONEY-BACK GUARANTEE: When properly assembled, KNIGHT-KITS fully meet published specifications, or we refund your money.

EASY TERMS AVAILABLE

knight-kit INSTRUMENT VALUE



EXCLUSIVE "IN-CIRCUIT" CAPACITOR CHECKER KIT

- ★ "In-Circuit" Checker
- ★ "Magic-Eye" Indicator
- ★ Save Almost 60%!

Model Y-119
\$1250

A tremendous aid to speedier, more profitable servicing—and you save almost 60% over comparable factory-wired units. Permits testing of capacitors while they are wired in the circuits! Simply press a button and the "magic eye" shows opens and shorts (not leakage). Checks by-pass, blocking, coupling and filter capacitors. Tests for opens and shorts on any capacitor of 20 mfd or greater capacity, even if it is in parallel with a resistance as low as 50 ohms. Tests for shorts can be made on any capacitor up to 2000 mfd, even when shunted by as low as 20 ohms. 7 3/4 x 5 1/4 x 5". With tubes, wire, solder. Shpg. wt., 5 lbs.

Model Y-119. Net, F.O.B. Chicago **\$1250**

See our Supplement No. 165 for 21 other knight kit instrument values

free SUPPLEMENT

featuring **knight-kits**

Send for our FREE Supplement No. 165 featuring 45 great Knight-Kits, including Test Instruments, Hi-Fi, Hobbyist and Amateur kits. Write for your copy today.



ORDER FROM

ALLIED RADIO

Dept. 01-F-7, 100 N. Western Ave., Chicago 80, Ill.

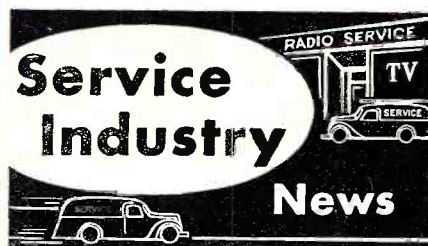

LICENSING continues to hold the service spotlight. The Council of the City of Long Beach, N. Y., recently passed an ordinance requiring the licensing of all TV distributors, dealers, and technicians serving that city. A bill was introduced in the Missouri State legislature to license all television, radio, and electronic service firms in that state. Municipal license ordinances are under consideration in Milwaukee, Wis. and San Francisco, Cal.

The Long Beach, N. Y., ordinance is the first licensing measure to be passed by a Long Island community. The bill defines six separate categories of TV activity, each of which carries a ten-dollar annual license fee and requires the posting of a \$5000.00 surety bond. The six divisions of the industry covered by the ordinance include: service contractors, service dealers, dealers, distributors, accredited TV technicians and accredited TV apprentices. The ordinance took effect May 1, 1957.

The Long Beach bill was endorsed by the Radio Television Guild of Long Island after it had been amended to include two representatives of the service industry on the administering board. The five-man Board of Examiners that will administer the law is made up of one member who is engaged in selling and servicing television, one member who services TV as a technician, an attorney, a science teacher from the local high school, and an electrical engineer with experience in electronic equipment.

The Missouri bill, which has the active support of the Television Service Association of Missouri, a NATESA affiliate, is opposed by the Television Electronic Association of Missouri, said to number in its membership more than 100 St. Louis area TV service technicians. Requiring all TV-electronic service firms and technicians to pay a \$50.00 annual license fee and to post a \$1000.00 surety bond, the Missouri license measure would be administered by a five-man commission with broad powers for rescinding or refusing licenses.

There are sharp differences of opinion among service dealers over the wisdom of encouraging political control of the consumer electronic service industry. Many firmly established service operators who have successfully weathered all types of unethical competition and business ups-and-downs have expressed concern over whether small service operators are not toying with economic suicide in supporting some of the license measures that are proposed.

158

SIG. CORPS EARPHONES

HI-IMPEDANCE DUAL HEADSET, COMPLETE WITH HEADBAND & CORD. **\$179** per set
USED. TERRIFIC VALUE. 2 for \$3.25

RAYTHEON VOLTAGE REGULATOR

Primary 95-130 Volts 60 cy. Output 115 V. 1 1/2% 500 watts. **\$4750**
BRAND NEW

ISOLATION TRANSFORMER

Pri. 105/115/125V.—Sec 115V. 1500 Watts Dual AC receptacle. Stancor **\$24.50** ea.

FILAMENT TRANSFORMER

Primary 115 V. 60 Cy. Sec. 24 Volts @ 3 Amps. Full case. BRAND NEW **\$2.49**

IMPULSE COUNTER TO 99,999

115V. 60 cy. operation...ca. **\$2.95**

FILAMENT TRANSFORMER

6.3V 10 Amp 115V-60cy Primary—Each **\$1.89**

WESTERN ELECTRIC

Stepping relay 44 steps, 6-12 Volt coil..... **\$4.95**

115 V AC RELAY

115 V 60 Cyc Coil DPDT, 10 Amp Contact...ca. **\$1.89**
3 for \$4.95

VEEDER ROOT COUNTER

5 Digit ratchet counter. Resettable. **\$2.95**

EIMAC VACUUM CONDENSER

32,000 VDC 12 MMF.....\$4.95
25 MMF.....5.95
50 MMF.....7.95

G. E. RELAY CONTROL

(Ideal for Model Controls, Etc.)

Contains a sigma midget 8,000 ohm, relay (trips at less than 2 MA), high impedance choke, bi-metal strip, neon pilot and many useful parts. The sensitive relay alone is worth much more than the total low price of..... **\$1.10** Each 10 for **\$9.25**

POWER SUPPLY KIT BARGAIN

Primary 115V, 60 Cy. Sec. 425-0-425V. @ 200 Ma., 6.3V @ 5 Amp., 5V. @ 4 Amp. Std. Mounting, plus 8 Hy. 200 Ma. choke and Dual **\$6.75** ea.
8 Mfd. 600VDC Oil Condensers.....

12-14 VOLT DYNAMOTOR

375 Volt at 150 Ma. with Filter... **\$4.95**

ANTENNA RELAY

12 Volt DC, DPDT plus extra SPST 10 amp contact. Low loss ins.ca. **\$1.39**

PANEL METERS

2" METERS	0-150 Ma.....\$3.95
0-1 Amp.....\$2.95	0-500 V. DC.....3.95
0-5 Amp RF.....3.95	200-0-200 V. DC.....3.95
0-150 V. AC.....3.95	0-2 Amps DC.....3.95
0-15 Ma.....3.95	0-2 Amps DC.....3.95
3" METERS	0-4 Amps DC.....3.95
0-5 Ma.....3.95	0-5 Amps RF.....4.95
	0-2 Amps RF.....4.95

OIL CONDENSER BARGAINS

1 mfd 600 VDCS .25	2 mfd 1000 vdc. .75
2 mfd 600 VDC .45	4 mfd 1000 vdc. 1.25
4 mfd 600 vdc. .75	4 mfd 1500 vdc. 1.75
8 mfd 600 vdc. .95	2 mfd 2000 vdc. 1.50
10 mfd 600 vdc. 1.10	4 mfd 2000 vdc. 2.95
1 mfd 1000 vdc. .60	1 mfd 3000 vdc. 1.85

BIG BARGAINS IN LITTLE TYPE

Kit of 25 WIRE WOUND RES. 5 to 50 watt. \$1.95
Kit of 10 TRANSMITTING MICAS..... 1.00
500 MMF CERAMIC CONDENSERS..... 10 for .50
15 MEG 1/2 METER MULTIPLIER..... 1.49
1 MFD 400VDC OIL COND..... 10 for .95

Min. Order \$3.00—25% with order F.O.B. New York
10 DAY GUAR. PRICE OF MDSE. ONLY

ADVANCE

ELECTRONICS COMPANY

6 WEST BROADWAY, NEW YORK 7, N. Y.

Phone REctor 2-0270



110V. AC POWER SUPPLY FOR 274N RECEIVERS

Just plug it into the rear of your 274-N RECEIVER... any model. Complete kit and black metal case, with ALL parts and diagrams. Simple and easy to build in a jiffy. Delivers 24 volts plus B voltage. No wiring changes to be made. Designed especially for the 274-N receiver. Only **\$8.95**. Filament trans. for 274N receivers. Pri. 110V. 60 cy. AC. Sec 24V @ 6A. An excellent buy at..... **\$1.95** ea.

SPINED TUNING KNOB FOR 274N RECEIVERS

An exclusive O-R item manufactured for us. Fits BC-453, BC-454 and other 274N receivers. This is a really hard-to-obtain item. Only **.89c** ea.



OFFENBACH-REIMUS

1564 Market Street, San Francisco, Calif.

RADIO & TV NEWS

Experienced service dealers point out that license measures are frequently aimed at part-timers who, in the mass, may account for a sizable chunk of the TV service business. However, the rigidly licensed plumbing and electrical industries have lost most of the consumer service market to part-timers and do-it-yourself home owners. If an extensive and expensive policing force is not created to search out and prosecute violators, part-time technicians will continue to operate without licenses, aided and abetted by a public that is very cost-conscious.

These dealers also feel that the registration of small shops as licensed service dealers will make them prime targets for jealous competitors and innately dissident set owners. The small-shop operator who is hard pressed for time to handle the current non-productive activities associated with his business could ill afford the loss of even more time in appearing before a board to explain the details surrounding a customer complaint.

Political jurisdiction over any business activity often leads to the extinction of the small businesses engaged in that field because they cannot afford the accounting and legal help they need to protect their interests. Such supervision tends to favor larger businesses, which have enough employees constantly engaged in income-producing work to carry the non-productive overhead burden of professional counsel.

Many dealers feel that, from a practical standpoint, small service operators have nothing to gain from licensing. The fact that a man is a licensed service dealer or technician will not inspire set owners to deal with them, these dealers feel. It will not lift the level of service charges nor relieve them of the necessity for competing for business in an open market. It will add to their costs of doing business while contributing no increase in their income.

Another approach to finding some answers to the numerous problems that beset the service industry was initiated in a recent meeting of service association officials with representatives of RETMA and NEDA. The electronic parts industry coordinating and educational committees have shown a keen interest in developing and sponsoring programs that would benefit the independent service industry. They have been stymied, however, in finding a satisfactory pattern for selecting a couple of representatives for the service industry to meet with these committees. Currently the coordinating committee is made up of 13 men who represent parts manufacturers and distributors. The problem is how to select about three men from service who would be accepted by the service industry nationally as their representatives on this and the educational committee.

Questionnaires were sent out to the officers of 333 service associations requesting each of them to submit the names of their choice of men to repre-

FIELD ENGINEERS:

HERE'S THE GOOD WORD—



Bendix Radio

IS CONTINUING ITS RAPID EXPANSION AND NEEDS YOU!

Bendix Radio, the leader in its field, has numerous, excellent opportunities for Field Engineering Personnel for both U.S. and overseas assignments. You will be responsible for the installation, overhaul and maintenance of long-range Bendix radar equipment.

ACT NOW! YOU'LL OBTAIN THESE IMPORTANT ADVANTAGES:

- ★ The prestige of representing the leader in its field.
- ★ Opportunity for professional development & advancement.
- ★ Excellent salary.
- ★ Overseas allowance.
- ★ Field allowance.
- ★ Relocation expenses.
- ★ Many other company benefits.

It is preferable that you have had a minimum of two years college, plus at least four years engineering experience in radar or communications systems.

Send resume to: MR. O. A. BOWMAN
Field Engineering
Dept. R

Bendix Radio

DIVISION OF BENDIX AVIATION CORP.
BALTIMORE 4, MARYLAND



WHY BEAT YOUR BRAINS OUT?

Merit exact replacement coils and transformers are always available at your nearest parts jobber—and they slide into chassis and circuit like a banana on ice!



MERIT

MERIT COIL AND TRANSFORMER CORP.
4427 N. CLARK ST., CHICAGO 40, ILLINOIS

LEARN

Television RADIO-COLOR-TV Electricity ELECTRONICS

IN THE GREAT SHOPS OF COYNE

TRAIN QUICKLY! OLDEST, BEST EQUIPPED SCHOOL of ITS KIND in U.S.

Veterans and Non-Veterans—Get practical training in top opportunity fields. Prepare now for a better job and a real future. Advanced education or previous experience not needed. Employment service to graduates.

Enroll NOW—Pay Later

Finance Plan and Easy Payment Plan. Also Part Time Employment help for students. *Training in Refrigeration and Electric Appliances can be included.*

FREE BOOK Clip coupon for Big Free Illustrated Book. No obligation and No Salesman Will Call. Act NOW.

B. W. Cooke, Jr., President

OPERATED
NOT FOR PROFIT
Established 1939
500 S. Paulina, Chicago
Dept. A7-85H

COYNE
ELECTRICAL SCHOOL

B. W. COOKE, Jr., Pres.
COYNE Electrical School
500 S. Paulina St., Chicago 12, Ill. Dept. A7-85H

Send FREE BOOK and full details on:

- TELEVISION-RADIO
- ELECTRICITY-ELECTRONICS

NAME.....

ADDRESS.....

CITY.....STATE.....

LM FREQUENCY METER

Heterodyne, crystal calibrated, modulated with calibration book \$49.50
125KC to 20,000KC—Exc. . . . ea.

LORAN APN-4 FINE QUALITY NAVIGATIONAL EQUIPMENT

Determine exact geographic position of your boat or plane! Complete, BRAND NEW installation consists of: 1D-6B/APN-4 Indicator; R-9B/APN-4 Receiver; PE-206 Inverter; Set of Plugs; Visor for Indicator; Operation manual; \$129.50
Brand New, Export packed. . . .

ID6B INDICATOR, R98 RECEIVER, \$69.50
Excellent. . . .

Write for Quantity Prices!

I-222-SIGNAL GEN. and Heterodyne wave-meter. 110VAC-60 cycle, 8-15MC and 135-230MC.
BRAND NEW. . . . \$39.50
Exc. . . . \$29.50

RM29 CONTROL UNIT

Containing ringer, 3 pos. locking type selector for monitor, direct or radio control. May also be used as portable battery operated telephone.

BRAND NEW, 6.95 2 for \$12.00
Used, 4.95 2 for 9.00
TS-13 HAND SET for above. exc. 5.95

DYNAMOTOR—12 volt for command ARC or ARA receivers.
BRAND NEW. \$4.95

COAXIAL CABLE

50 ohm—330 ft. lengths. New \$9.95
60 ft. lengths. New \$1.95 ea.
5CP1—Brand new. \$1.75 each

COMMAND ARC-5 TRANSMITTER

T-20. . . . 4 to 5.3 MC New
T-21. . . . 5.3 to 7 MC \$5.95

Used \$3.95
T-23 100-156 MC
New \$16.95
Used \$9.95
3 to 4 mc. like new. \$5.95
RECEIVERS Excellent
190-550 KC Used \$9.95
1.5-3.0 MC 7.95

RCA MOBILE TRANSMITTER

30-41 mc. AM Crystal Controlled. \$14.95 each.
DYNAMOTOR FOR ABOVE

6V DC Input-375 Volts 250 ma Output. \$9.95 each.

Sweet Oscilloscope Deals

INDICATOR UNIT: For conversion to test scope, panadapter, analyzer, etc. Double deck chassis. 5CP1 mounted in tube shield. Less small tubes and crystal, but complete with 5CP1. \$9.95
Exc. Cond. each

ASB-7 Radar Indicator Unit: For conversion to test scope or for use as modulation monitor. Has standard test-scope CR tube, H Cent. V Cent, Brill, Foc. Gain, and range selection switch. External power source was used. Tubes: \$9.95
4-6AC7, 3-6H6, Less 1-5BP1. New. . . .

UHF TRANSCIVER, APG-5

Cavity Only. New, less tubes. \$4.95 ea.
2500 Mc complete with 2C43, 2C40, 3E29, 1B27, VR105, 5Y8, 6AL5, 2 each \$39.50
2X2 and 8 each 6AK5.

\$45.00 Hi-Fi Headset

Uses annular grooved plastic fibre cones with voice coils as in speakers, and chamois ear pads to obtain spacing for correct acoustical load. GIVES FINEST MUSIC REPRODUCTIONS! Imp. 300 Ohms per unit or 600 Ohms when wire series.

USED, EXC. COND. \$4.95
WITH BRAND NEW CHAMOIS \$6.19
CUSHIONS

Radio Receiver 11-tube UHF tunable 234-258 MC receiver with schematic.
Complete with tubes, 3 ea. of 6AK5, 7 ea. of 9001, 1 ea. of 12A6, Like new
Less Tubes. \$2.95

MC-149F Inverter, 24 VDC input, 115AC, 400 cycles, 500 VA single phase. \$15.95
Exc.
Used \$9.95

RAX Navy Aircraft Receiver 200-1500 Kc. Used exc. \$14.95

WRITE FOR NEW BULLETIN
ALL ITEMS F.O.B. CHICAGO
25% Deposit required with orders

R W ELECTRONICS

2430 S. Michigan Ave., Chicago 16, Ill.
Dept. N, PHONE: CAIumet 5-1281-2-3

sent the service industry on these replacement industry committees. It was conceded, however, that it will be extremely difficult to select service representatives who will receive the approval of all service associations throughout the country, regardless of their affiliation or lack of such affiliation.

About 79 representatives of components manufacturers, distributors, and service groups convened in the joint meeting. It was the second meeting of its kind between representatives of NEDA and the service industry, but the first to include manufacturers. The first meeting with distributors was sponsored by the Eastern States District Conference of Service Associations, an informal organization which includes practically all service associations in the densely populated seven northeastern states.

The Eastern States District Conference of Service Associations was organized as a result of a series of conferences on a 20-point program designed to bring about more harmonious relations between parts distributors and the service industry. The major bone of contention between service associations and parts distributors has been the indiscriminate sale of replacement parts and equipment to all comers. Thousands of local parts distributors make a serious effort to restrict sales to bona fide dealers and technicians but the widespread distribution of electronic mail order catalogues tends to circumvent any local program for rigid control of distribution.

Henry E. Rogers, in an article titled "Wholesale Suicide" which appeared in the February issue of the "Guild News" (Radio-TV Guild of Long Island), called attention to a situation that "places the radio and service dealer in the embarrassing, if not untenable, position of paying more at wholesale for merchandise and many parts and components than the general public and part-timers pay for the same items at retail."

Referring to a recently published catalogue of a large electronic parts and equipment retailer, Mr. Rogers cited five products listed by brand name and part number which are offered to all comers at a lower price than a service dealer can buy them from a recognized electronic parts distributor who restricts his sales to legitimate accounts, preserving the clear-cut relationship between wholesaler and retailer.

The rugged competition in distribution poses as many problems for parts jobbers as the service dealer finds at the retail level. Parts distributors do have an effective national association that is able to combat sales plans that would make a shambles of the distributing activity. The service industry is still slowly groping its way toward the development of an effective united national force working in its behalf.

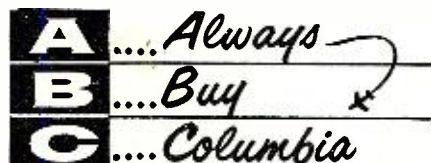

BC-605 AMPLIFIER GIVE AWAY!
Originally used in GI vehicle. Employs 2-1619 amplifier tubes. New cond. Complete with tubes AND schematic. BUY IT NOW! . . . 99c

LM FREQUENCY METER
195-20,000 Kc. Same as BC-221 only modulated. With original calibration book, crystal, etc. Excellent condition. . . . \$49.50

METERS! ALL EXCELLENT!
0-1 mi. 3-inch, round, W.E. Only. . . . \$2.99
0-150 V.A.C. 2-inch, round, G.E. . . . 2.99
0-2 mil 2-inch, round, General Electric. . . 2.45
0-5 amps. RF. 2-inch, round, Sparton. . . . 2.99
BEDE METER: 0-1 MA. 4" square. Cased in lucite. A beauty! Orig. cost \$18.00. \$7.95
Our clean-out price.

NEW TUBES! LATE DATE!
5Y3 65c 813 \$7.50
6AT6 85c 6CR6 90c
6BA6 85c 6X5 \$1.25
6BE6 85c 6V6 88c
4-65A \$10.95 12AT7 \$1.00
4X150A \$19.50 28D7 89c
4-400A \$34.95 15N7 88c

RAX RECEIVER
7-27 mc. 5 bands. Hi gain, very selective. Excellent cond. \$17.50
(We also have RAX Recvr. 200-1500 kc. \$14.95)

ATB TRANSMITTER
With proper tuning unit can cover 200-9000 kc. Has plug-in antenna tuning inductance unit. This particular set covers from 3000-9000 kc. Uses 2-815's (modulator and power). Like new. A Columbia monthly special! \$14.95

COMPLETE STOCK—WRITE FOR PRICES!
Just received complete sets of APR-4, ARC-27, ARC-11, ARN-6, ARN-7, ART-13, GRC, etc. Write for new, low-price prices!

FOR YOUR HAND-ITALKIE
Famous FT-501 ADAPTER. This gizmo enables you to use standard flashlight batteries \$9c

COMMAND GEAR—EXCELLENT COND.
BC-453 RECR. 19-35 MC Q 5'er \$12.95
BC-455 RECR. 6-9 MC. 40 meters. . . 4.95
BC-457 XMTR. 4-8 MC. Special. . . . 2.95
BC-458 XMTR. 5-8 MC. It's a steal! . . . 2.95
4-5.3 MC. XMTR. Brand new, boxed. Only \$4.95
5-7 MC. XMTR. Sparking new! Boxed. 4.95
BC-456 MODULATOR. Excellent cond. . . 4.95
BC-442 ANTENNA SWITCHING RELAY: with vacuum tube. Excellent price \$3.49
TRIPLE RECEIVER RACK. With shock mount 2.50
DOUBLE XMTR. RACK with shock mount 2.50
ALL PLUGS: For SCR-274N or ARC-5. Ea. 1.00
1625 TUBES: For spares. New, boxed. Ea. .25
TRIPLE RECEIVER CONTROL BOX. BC-450 95
TRANSMITTER CONTROL BOX. Only. . . 95
18 FT. FLEX CABLE TACH SHAFTS. To control receiver remotely. Special. . . 1.95
All orders FOB Los Angeles. 25% deposit required. All items subject to prior sale. MINIMUM ORDER \$3.00.

NEW CATALOG! Are you on our list for free copy?

All orders FOB Los Angeles. 25% deposit required. All items subject to prior sale. MINIMUM ORDER \$3.00.
OPEN MON. & FRI. NITES TILL 9 P.M.
TO EXPEDITE YOUR ORDER MAIL TO DEPT. R.

Columbia ELECTRONICS
2251 W. WASHINGTON BLVD.
LOS ANGELES 18, CALIFORNIA

LOST OUR LEASE!

Must Clear Warehouse! Sacrificing \$50,000 stock at 5¢ on Dollar!
Our Loss Your Gain!

GIANT KIT for Experimenters, Servicemen, Repairmen

40-50 lbs. of BRAND NEW, usable parts for ham transmitters and receivers. Consists of: Wire wound and metallized resistors; By-pass and filter condensers; Variable, padding, and trimming condensers; Input, Output, Power transformers; RF and Audio-filter Chokes; Volume Controls; Assorted Knobs; Hook-up Wire; Gang switches; Chassis; Voltage Dividers; Receiving and transmitting sockets, all sizes; PLUS MORE!
Total Retail Value over \$100.00

Only 200 kits at \$9.95
Freight or express shipments only, FOB Newark, NO COD, full amount must accompany each order.

Dept. RT
UNITED RADIO COMPANY
58 Market Street, Newark, New Jersey

Spot Radio News
(Continued from page 24)

can be made closer, making room for more stations.

A further improvement in single-sideband technique can be realized by making use of what is called suppressed carrier, so that the power of a station is concentrated in whichever sideband is being used and the station automatically shuts itself down between words, when the power is not needed. This is equivalent to a type of clean-up campaign to help rid the air of clutter caused by radiation of large amounts of wasted power. For example, such power is responsible for the undesirable byproducts such as the familiar whistling type of interference observed when two stations are on the same frequency.

The use of the split channels offers another means of obtaining greater use of the frequency space available. Because of the need for additional channels in the land mobile service, efforts have been made to develop equipment which requires less spectrum space and can, therefore, be operated in narrower channels. For example, ten years ago assignments could not be made closer than 60-kilocycles apart in one typical land mobile band, because of the width of the channel which the signal required. Through a combination of technical improvements in equipment design, manufacturers found that they could produce equipment which could operate in channels half as wide. As a result, many more assignments can now be crowded into a particular band of frequencies.

But the methods mentioned are not the only means of saving spectrum space. Ways to get more economical use of radio frequencies are now receiving the cooperative attention of industry and the FCC.

Commenting on the need for a constant study of the problem, FCC Headman George C. McConaughy said recently: "Spectrum-saving techniques of all kinds must now be given high priority in planning circles in both the government and industry . . . the most fertile and productive ground for research and development lies in the area of new techniques for compressing more and more intelligence into the narrower bandwidths, thus opening the way for more and better services of all types to the public."

THE EFFECTIVENESS of scatter techniques has won over the Canadian government: They have agreed to build a \$650,000 forward-scatter station near the famous Gander Airport in Newfoundland, as part of a new chain of radio stations.

The scatter program was proposed when it was found that scatter transmission could curb the frequent radio blackouts, which occur in the existing high-frequency radio-teletype circuits

As easy to use as a pencil

WALL
INDUSTRIAL
SOLDERING IRONS
give you

More BTU's . . .
Faster HEAT . . .
Higher HEAT CONTINUITY
than ANY OTHER soldering irons of equal tip size

Proved 4 times faster on the production lines of America's leading electronics firms. Complete range of sizes . . . scientifically designed . . . individually tested . . . for easier, surer precision work or heavy duty soldering. Operate on 110-120 volts, AC or DC! Model 18T illustrated, \$6.25 list.

Write for FREE Catalog

Exclusive THERMOSTATIC ACTION . . .

Guaranteed for the life of the iron!
Prevents excessive tip burning!



WALL MANUFACTURING CO.
Grove City, Pennsylvania
OVER 20,000,000 SOLDERING PRODUCTS SINCE 1864

BEWARE OF IMITATIONS

There Is Only One Original, Dependable **NO-NOISE TUNER-TONIC** with PERMA-FILM

Cleans, lubricates, restores all tuners, including water type. Won't change or affect capacities, inductance or resistance. Won't harm insulations or precious metals, nor attack plastics. Eliminates all noise, oxidation and dirt indefinitely. For television, radio and FM.

Non-toxic, non-inflammatory, insures trouble-free performance.

\$3.25

Extra economical because a small amount does the job!



Volume Control and Contact Restorer with Perma-Film

Cleans, lubricates, protects NOT A CARBON-TET SOLUTION! Still available in the new 6 oz. spray can. Net to servicemen . . . \$2.25



2 oz. bottle. Net to servicemen.

\$1.00

Also available in 8 oz. bottles and quart cans.

At Your Nearest Distributor.

ELECTRONIC CHEMICAL CORP.

813 Communipaw Avenue Jersey City 4, N. J.

TV TELLS HOW TO ANSWER RADIO T.V. QUESTIONS SERVICE LIBRARY



HERE IS LATE INFORMATION IN A HANDY FORM FOR RADIO AND TELEVISION REPAIRMEN, SERVICEMEN AND STUDENTS

AUDEL'S TV RADIO SERVICE LIBRARY—Over 1500 Pages—1085 Illustrations & Diagrams. 1001 Important Facts & Figures on Modern TV, Radio, Electronic Devices at your fingers' ends. Highly Endorsed.

INCLUDES TRANSISTORS and Transistor Circuits Rectifiers. Record Changers, P. A. Systems, Tape Recorders, Phonograph Pick-ups, P. M. Auto Radio, Radio Compass, Short Wave, Radar, etc.

ASK TO SEE IT! IT WILL PAY TO KNOW—

The Basic Principles—Construction—Installation—Operation—Repairs—Trouble Shooting. Shows How to get Sharp, Clear TV Pictures. Install Aerials—How to Test. Explains Color Systems. Methods of Conversion. Terms, etc. Includes Ultra High Frequency—Valuable for Quick Ready Reference and Home Study.

\$8 COMPLETE 2 VOLUMES

Get this Information for Yourself 7 DAY TEST—PAY ONLY \$2 MO.



MAIL ORDER

AUDEL, Publishers, 49 W. 23 St., New York 10, N. Y. Mail AUDEL'S T. V. RADIO SERVICE LIBRARY (2 Volumes) \$8 on 7 days free trial. If O. K. I will remit \$2 in 7 days and \$2 monthly until \$8, plus shipping charge, is paid. Otherwise I will return them.

Name
Address
Occupation
Employed by
 SAVE SHIPPING CHARGES! Enclose Full Payment With Coupon and We Pay Shipping Charges.

QUARTZ CRYSTALS

**Fast Service—
Unconditional Guarantee!**

Crystals ground and etched to your specified frequency at the lowest cost in the industry—supplied in popular FT-243 holders, 1/2" pin spacing, .093" pin diameter—also in DC-34 holders, 3/4" pin spacing, pin diameter .156 or FT-171 holders, pin spacing 3/4" with banana plug pins (fits 5-prong tube socket).



In FT-243 holders from 1005KC to 9000KC. In DC-34 or FT-171 holders from 1100KC to 8000KC (specify holder wanted).

Tolerance:	
.01%	1.50
.005%	2.50

NOW—hermetically sealed overtone crystals in HC6/U metal holders, pin spacing .486", pin dia. .050"—pin diameter .093" also available. Specify diameter wanted, otherwise .050 supplied.

3RD OVERTONE CRYSTALS

- 10 to 30 MC .005 tolerance \$3.85 ea.
- 30 to 54 MC .005 tolerance \$4.10 ea.

5TH OVERTONE CRYSTALS

- 55 to 75 MC .005 tolerance \$4.25 ea.
- 75 to 90 MC .005 tolerance \$5.50 ea.

(Write for quantity prices)

MARINE FREQUENCY CRYSTALS

- .005 Tolerance—available in FT-243 holders, or MC7 (pin spacing 3/4", dia. .125") holders.
- | | | | | |
|------|------|------|------|-------------------|
| 2009 | 2182 | 2670 | 2977 | |
| 2110 | 2406 | 2738 | 3021 | \$2.50 ea. |
| 2126 | 2637 | 2953 | 3093 | |
| 2174 | 2638 | 2961 | 3193 | |

SPECIAL! RADIO CONTROL CRYSTALS

- 27.255 MC sealed crystals, \$2.50 ea.

Novice Crystals 80 meter band within 1KC of specified frequency from 3701KC to 3749KC in 40 meter band from 7152KC to 7198KC within 1KC of specified frequencies 79¢; in DC-34, FT-171 or FT-243 holders (specify holder wanted) 79¢. (Add 5¢ per crystal for postage and handling.)

Stock crystals in FT-243 holders from 5675KC to 8650KC in 25KC steps 50¢.

FT-241 lattice crystals in all frequencies from 370KC to 540KC 50¢.

100KC Frequency Standard Crystals	4.50
200KC Crystals	2.00
455KC Crystals	1.00
500KC Crystals	1.00
1000KC Frequency Standard Crystals	3.50
Dual socket for FT-243 crystals	.15

Low frequency FT-241 crystals from 880.20KC to 1040.62KC in steps of 1040 cycles 75¢

(Write for complete listing.)

Texas Crystals

The Biggest Buy in the U.S.

8538 W. GRAND AVENUE · RIVER GROVE, ILL.
ALL PHONES—GLADSTONE 3-3555

Terms: All items subject to prior sale and change of price without notice. All crystal orders MUST be accompanied by check, cash or M.O. WITH PAYMENT IN FULL. NO C.O.D.s. Postpaid shipments made in U.S. and possessions only. Add 5¢ per crystal for postage and handling charge.

because of the sub-Arctic conditions.

Recommendation of the scatter chain came after the International Civil Aviation Organization's special jet age task force found that the . . . "world's outstanding case of immediate and compelling need for aviation improvement relates to air traffic control and communications in the North Atlantic region . . ." and predicted that, unless collective action is taken by all governments whose airlines fly the Atlantic, development of air traffic in this region will be more and more handicapped as the traffic continues to grow. The task force found that, in the summer of '56, more than half the flights across the North Atlantic suffered substantial difficulties in making contact with air traffic control services. It was felt, therefore, that a forward-scatter network would provide a partial answer to this problem.

IN COLORADO, at the Bureau of Standards Boulder labs, a short while ago, a group of scientists met to find out how to solve problems that still exist on the 3 to 300-kilocycle band; the region that is particularly suited for use in navigation systems, long-distance communication, and for the precise measurement of radio frequencies.

Commenting on radio reception difficulties experienced in a submerged submarine, one of the experts at the meeting pointed out that since propagation in sea water is nearly vertical (downward from the surface) the only operative types of antennas here are horizontal dipoles, electric and magnetic. The electric dipole, it was said, is coupled by resonance and the magnetic dipole by induction in a loop. The former has no resonance and nearly unlimited bandwidth, but fails when not submerged. The latter, by resonance, is able to present much greater interception area and available power. The magnetic interception area can be determined by the size of a radome and by the radian length or skin depth in the sea water; 2 meters at 15 kilocycles. And the radiation power factor (which is essential to bandwidth and efficiency), the scientists were told, is influenced by the size of the inductor and by the magnetic permeability of an iron core.

Thus, it was noted, it's necessary to resort to quite a bit of advanced engineering to come up with an antenna design that's adequate for subsurface reception.

A HISTORIC DECISION by an FCC examiner has brought together a university and a commercial TV operator who will share time on a v.h.f. channel.

The school—Michigan State University; the operator—TV Corporation of Michigan. They will operate jointly on channel 10, and will use separate call letters. The university will provide the transmitter, tower, and antenna, and the private company will use the physical facilities under a rental plan.

NATIONAL COMMUNICATIONS RECEIVER

RBL-5 15-600 KC, 6 Bands. Self contained 115V. 60 Cy. power supply. Gov't cost \$600. Brand new with Tech Man. \$59.95

NATIONAL HRO AC POWER SUPPLY

INPUT 115 VAC 60 Cy; OUTPUT DC 230 V. .075 A. Plus 6.3 VAC 3 A. standard rack panel mtg. \$19.95
Brand New

RCA INVERTER DYNAMOTOR ASSEMBLY TYPE SF25. Dual unit housed on 1 chassis with filter and relays. (Power unit for TRC-121.)

Inverter Input 115 VDC, 1 Amp.
Inverter Output 115 VAC, .50 Amp., 60 Cy.
Dynamotor Input 115 VDC 2 Amp.
Dynamotor Output 630 VDC .230 Amps.
Gov't. Cost \$795. \$79.95
Brand New

PINCOR ROTARY CONVERTER W910B. Input 115 VDC; Output 115 VAC 60 Cy. .0675 KVA. 3600 RPM. With Filter Network. \$24.95

WESTERN ELECTRIC RECTIFIER POWER SUPPLY KS 15093 11 Input 115/1/60; REGULATED OUTPUT 115/130 VDC .2 Amps. RACK PANEL MTG. \$39.95
6 Tubes NEW

IMPULSE KEYING UNIT MC163. INPUT LL5 V 60 Cy. 3 Oscillators, synchronous motor, automatic switching, freq. meter. Complete with tubes and instructions. \$59.95

TS 182/UP AN IDEAL SCOPE FOR THE HAM SHACK. BEING USED AT present for checking A1 Phone Xmters. To be assured of a good report use the scope section of this unit to adjust your rig's modulation. 115 VAC Operation. WITH SCHEMATIC, 6 A.C. cables, and probe. 50 lbs. \$24.95

ARC-5 COMPONENTS
Transmitter 3-4 Mc. Exc. \$5.95
4-5.3 Mc. Exc. 5.95
5-5.7 Mc. Exc. 4.89
RECEIVER 3-6 Mc. (autotune Head) 6.95
Modulator MD-7 Brand New 7.95

807W/5933—Ruggedized Version 807 New, Boxed, 5933, ea. \$1.59; Doz. \$15.00

1 1/2" MIRROR SCALE 4 1/2" Panel Meter 0-1 Mil. ROLLER SMITH \$9.95

200 Microamp 4 1/2" Panel Meter (HEATHKITVTVM Replacement) \$5.95

TEST SET TS-45 A/APN-3 NEW. \$29.95

TELEPHONE HANDSET TS-9 NEW W/cable. \$5.95

RELAY 6VDC SPST. ea. 69¢; 12 VDC DPDT ea. \$1.29

STANCOR Power Xformer PC 10167, 310-0-310 150 Ma., 6.3V. 3.5A, 5V., 3A. SPECIAL \$2.95

FILAMENT XFORMERS

5 VCT. 13 A. \$1.95

12 V. 4 A. 1.49

Isolation & Filament 115V. and 6.3V. (Small). SPECIAL \$1.00

CHOKO 10 Henry 150 Mils enclosed. 1.50

CARBON MIKE XFORM. MFGD. for Collins Comp.98

WESTON ANALYZER 772 Exc. Cond. 39.95

Molulation Xformer Mfgd. for Collins 20 Watts. 1.49

OIL CONDENSERS 2 MFD 1KV.69

3 MFD 1KV.98

REX RADIO SUPPLY

88 Cortlandt Street New York 7, N. Y.

When
Answering Advertisements
Say You Saw It in
RADIO & TV NEWS

ONE DOLLAR

Everything Brand New—Money Back Guarantee

- 15 - ASST ROTARY SWITCHES \$1
- \$9 INDOOR TV ANTENNA hi-gain 3 sec. \$1
- 100 - ASSORTED 1/2 WATT RESISTORS. \$1
- 70 - ASSORTED 1 WATT RESISTORS. \$1
- 35 - ASSORTED 2 WATT RESISTORS. \$1
- 1 - BEST 4" PM SPK. 1 oz. alnico #5 magnet. \$1
- 100 - TWIN LEAD-IN WR. 300Ω, heavy duty. \$1
- 50 - ASST. TUBULAR CONDENSERS 85°. \$1
- 400 - ASST. SCREWS, NUTS, WASH, RIVETS. \$1
- 10 - ASST. RADIO ELECTRO. CONDENSERS. \$1
- 35 - ASST. RADIO KNOBS screw and push-on. \$1
- 10 - 6 FT. ELEC. LINE CORDS with plug. \$1
- 5 - TV CHEATER CORDS with both plugs. \$1
- 3 - ELECTROLYTIC COND. 40/50-450V. \$1
- 3 - ELECTROLYTIC COND. 50/30-150V. \$1
- 4 - ELECTROLYTIC COND. 40/10-450V. \$1
- 3 - LOOPSTICK ANT. new ferrite, adjustable. \$1
- 10 - ASST. WIREWOUND RES. 5, 10, 20 watts. \$1
- 1 - 5" PM SPEAKER alnico #5 magnet. \$1
- 2 - \$2.50 SAPPHIRE NEEDLES 4000 playings. \$1
- 2 - SELENIUM RECTIFIERS 1-65ma. 1-100ma. \$1
- 200' - HOOK-UP WIRE & SOLDER KIT. \$1
- 12 - RADIO OSCILLATOR COILS 456kc. \$1
- 3 - 1/2 MEG VOLUME CONTROLS with switch. \$1
- 5 - DIODE CRYSTALS 2-IN21, 2-IN23, 1-IN64. \$1
- 50 - TUBULAR CONDENSERS .02-400v. \$1
- 50 - TUBULAR CONDENSERS .001-600v. \$1
- 25 - TUBULAR CONDENSERS .01-600v. \$1
- 20 - TUBULAR CONDENSERS .25-600v. \$1
- 25 - ASST. MICA TRIMMER CONDENSERS. \$1
- 1 - SET TV KNOBS standard type, incl. escutcheon. \$1
- 6 - SPIN TIGHT SOCKET SET 3/16" to 7/16" \$1
- 3 - TV ALIGNMENT TOOLS 7", 12", 18" \$1
- 1 - WIRE STRIPPER AND CUTTER. \$1

Send for Free Catalog of Amazing Bargains

CAPITAL ELECTRONICS
218 FULTON ST., N. Y. 7, N. Y. CO-7-7842

RADIO & TV NEWS

Elsewhere in the hearing rooms, grant action was slow, as usual, as the new-station listing on page 20 of this issue indicates.

ONCE MORE, the wonder tool of the century, electronics, has demonstrated its uncanny might.

Through an electronic control system on a hydraulic motor, coupled to an 11-ton telescope, it has become possible to guide the huge instrument through a single revolution in but 18 seconds.

At this terrific speed, a photographic resolution as high as 100 lines per millimeter has been obtained; a striking display of precision control, thanks to electronics. L. W.

WORLD-WIDE RADIO SETS

THE U. S. Information Agency has estimated that there are now 130,498,400 radio receiving sets in use throughout the world outside of the United States, its territories, and Canada.

The report shows an increase of almost 21,697,300 sets, or about 20 percent, over the last previous similar survey made in July 1954.

In addition to the almost 130½ million receivers, the Agency estimates there are also 24,747,500 wired radio speakers, most of them in Eastern Europe.

By areas, sets are as follows: Western Europe, 64,737,100; Eastern Europe, 17,200,000; Arabic countries, 2,141,500; non-Arabic Asia, 4,295,600; non-Arabic Africa, 1,158,100; Far East, 19,488,000; and Latin America, 21,478,100.

The Agency believes there are about 6,100,000 radio receivers and 20,000,000 wired speakers in the Soviet Union territories.

Thus, slowly but surely, the world is shrinking through wider contact with other peoples and civilizations. —50—

It took this Sikorsky helicopter just a brief three minutes to line up and lower a bulky directional antenna atop the 240-foot radio tower at the L. M. Ericsson Co. in Stockholm, Sweden, putting into operation Sweden's first permanent TV link. The country's only other TV transmitter is located on a water tower in Sodertalje, 15 miles away. Since it was physically impossible to assemble the parts on the tower, the helicopter was used to lift the 1300 pound antenna in place. The antenna was made to extremely exact tolerances which were held to within 1/20 millimeter per ten feet of the assembled unit. The new TV link is now in experimental service.



June, 1957

1957 PHOTOGRAPHY DIRECTORY

& BUYING GUIDE

Most Complete Handbook of Photographic products

See the exciting new products from all over the world

ON SALE NOW AT NEWSSTANDS AND PHOTO STORES ONLY!



\$1.00

ILLUSTRATED LISTINGS

LATEST MODELS

LATEST PRICES

Compiled by the editors of POPULAR PHOTOGRAPHY

Cameras . . . Lenses . . . Flashes & Speedlights . . .
Movie Equipment . . . Enlargers . . . Projectors . . .
Exposure Meters . . . Lighting Equipment . . .
Films & Papers . . . Stereo Equipment . . . Filters . . .
Tape Recorders, etc., etc.

NEW THIS YEAR in the 1957 PHOTOGRAPHY DIRECTORY & Buying Guide

Special 16-page section on HOW TO SELL YOUR PICTURES FOR CASH!

You'll profit from this money-making guide to the photo market—included as an extra bonus in this year's PHOTOGRAPHY DIRECTORY. This special section lists the name of newspapers, calendar & greeting card firms, trade journals and magazines interested in buying your photographs.

It's typical of the extra features that make the 1957 PHOTOGRAPHY DIRECTORY & Buying Guide bigger, better, more complete than ever.

BUY YOUR COPY TODAY—ONLY \$1.00

On sale now at your favorite newsstand or photo dealer

STAN-BURN

SPECIAL COMBINATION!

GARRARD-RC 121 4 SPEED HI-FI UNIT

Includes: GE RPX050A magnetic cartridge, BOGEN RR510C AM-FM-RECEIVER (tuner & amplifier on a single compact chassis. 10 watt amplif., flat freq. resp., low dist. Autom. Freq. Control for precise tuning includes volume, tuning, bass tone, treble tone, and function selection plus connections for a tape recorder), SP12B ELECTRO-VOICE 12" SPEAKER (40-50 cps, 20 watts, resp. 9.3, 0.0 cps, 16 ohm imp. Sens. rfg. 46 db. Grossover 4500 cps. 1 lb. Alnico V magnet 12 1/4" dia.). BASE REFLEX CABINET (Modern design, completely insulated, heavy plywood construction) and RECORD CHANGER BASE.

A \$250.00 VALUE— \$199.95
YOURS FOR ONLY.....

Specify BLONDE OR MAHOGANY FINISH desired. You may choose other components in place of above. Send us your list for lowest package price.

CATHODE RAY TUBE SPECIALS

ONE YEAR GUARANTEE

G.E.	Type	STAN-BURN	G.E.	Type	STAN-BURN
\$15.80	.10B4	\$10.00	\$30.75	.17CP4	\$20.50
19.10	.12LP4	13.95	33.90	.17GP4	21.50
18.75	.12UP4	15.00	37.00	.17IP4	21.50
20.75	.14CP4	13.75	28.35	.20CP4A	18.95
33.75	.15DP4	14.50	32.10	.20EP4A	21.95
32.20	.16DP4A	15.25	36.00	.21AP4	25.00
23.50	.16KP4	15.75	29.75	.21EP4A	20.15
27.20	.16KP4A*	18.75	33.50	.21IP4	22.00
33.75	.16GP4	18.75	30.90	.21FP4	21.15
31.50	.16LP4A	15.25	37.00	.21MP4	26.25
31.50	.16WP4	15.25	100.00	.24AP4	56.00
23.50	.17BP4	18.75	46.60	.24CP4A*	38.00
27.50	.17BP4B*	18.75	48.20	.24EP4A*	39.00

*Aluminized—Inquire for any tube not listed
Stan-burn CRT tubes RCA licensed—Mfd. by Lincoln
All orders of 6 or more STAN-BURN CRT subject to 10% additional discount
Prices subject to change without notice

\$20 WORTH OF ELECTRONIC PARTS IN GRAB-BAG

consisting of porcelain sockets, coils, speaker, trans resis. cond. ONLY \$1.98 (plus \$1.00 postage)

TAPE RECORDERS—Famous Brand

SPECIAL	SPECIAL
List Pr. \$249.95 \$169.00	List Pr. \$129.95 \$79.95
List Pr. 199.95 129.00	List Pr. 79.95 59.95

Write for illustrated details

RECORDING TAPE—TOP QUALITY

Plastic base—1200 Foot on 7" Reel—Freq. Response: 50-15,000 cps.
Red oxide base..... Lots of 12. ea. \$1.49
Same—600 foot on 5" Reel..... Lots of 12. ea. \$1.99
1800' MYLAR..... Lots of 12 rolls \$2.40 ea.
Single rolls..... \$2.70 ea.

KITS:

We stock the following manufacturers complete line of kits—see reference pages.

EICO.....	see pages 33,34	ARKAY.....	see page 95
QUALITY.....	see page 106	ELECTRO-VOICE.....	see page 11
		CABINART.....	see page 97

Bogen KDB-20 DF kits in stock
All domestic orders will be shipped prepaid for a limited time. Send us your list. Order by Manufacturer and Model Number of item.

VM 4 SPEED HI-FI CHANGER—Model 1210 with Ronette, Sonotone or Asiatic flip-over cartridge.....	\$22.95
RC 456 4-speed Collare, BRAND-NEW, Special 45 RPM SPINDLE for above.....	2.98
4 SPEED PORTABLE RECORD PLAYER with MONARCH CHANGER—Ronette cartridge—Two Tone Case.....	\$33.95
VM 4 SPEED portable changer ampl. with 2 tube amplifier.....	\$39.95
WEBSTER 4-speed "Magic Mind" automatic Ronette, Sonotone or Asiatic flip-over cartridge.....	\$22.95
MONARCH Model UASU 4 SPEED AUTO. INTERMIX CHANGER with crystal cartridge.....	\$22.95
Same with GOLD RING 500 S.S.....	25.95
Same with G.E. RPX050A.....	26.95
Same with G.E. RPX052A-Diam. Sapph.....	38.95
45 RPM SPINDLE.....	1.88
TU-8 MONARCH 3 Speed MOTOR & TURN TABLE UNIT (no arm) NEW LOW PRICE.....	3.95

HI-FI DIAMOND NEEDLES—1 Yr. Guar.

SINGLE DIAMOND NEEDLES.....\$9.49

DIA/SAPPH (Dual Needles)..... 11.49
Shipped PPD. (Specify cartridge make)

WHY PAY MORE?

HI-FI COMPONENTS • KITS
• RECORD PLAYERS • TAPE
RECORDERS • TUNERS
• AMPLIFIERS • SPEAKERS
• ELECTRONIC PARTS & TUBES
• Etc.

Top brand nationally adv. merchandise in this and other Radio & TV mags. is yours at low, low cost. Send us your list. Give Mfr's name and Model No. of item. Write for '57 catalogs to Dept. RN-6 today.

COMPLETE HIGH FIDELITY DEPARTMENT.

SEND US YOUR LIST FOR LOWEST QUOTATIONS ON ANY ITEM

We invite export inquiries and offers. Our export department will give special attention to expediting foreign orders at minimum commissions. We are authorized distributors for United Motors, All Delco and Gen. Motors Auto Radio parts in stock.
We also carry a complete line of popular makes of Radio Tubes at 50/10 discount. Also many other special purpose and transmitting types, and all electronic parts and equipment at lowest prices. Send us a list of your requirements for prompt quotations. Terms: 20% with order. Balance C.O.D. All prices F.O.B., NEW YORK Warehouse. Minimum order \$5.00. Write for our latest price list and Hi-Fi Catalog RN-6. All Prices Subject to Change Without Notice

STAN-BURN

RADIO and ELECTRONICS CO.
558 CONEY ISLAND AVE. • B'KLYN 18, N. Y.

Sales Aids

SCOTT KIT FOR DEALERS

Initiating a program for increased support of hi-fi dealers at the local level, H. H. Scott, Inc., is offering a comprehensive, practical kit to be used in cooperative advertising.

This kit enables the dealer to run effective hi-fi component ads in newspapers, other printed media, and on the radio. It gives practical pointers on in-store promotion, and tells how to garner publicity.

A 25-page loose-leaf brochure encompasses the basic fundamentals of good advertising and shows how these principles can be applied by the dealer. Sample newspaper ads (including layout-sets) are supplemented with information on the use of effective copy, how to place space, how to place radio time, and how to get the most out of the advertising dollar.

One minute, and ten-second scripts are included, plus a complete section on store publicity with sample publicity releases, and a book of newspaper mats covering the company's line.

Layouts, blocks of copy, headlines, mats of art, or photographs are separately supplied with directions for use. The kit is available from the company's sales representatives, or contact the firm at 385 Putnam Avenue, Cambridge, Mass., for details.

BASEBALL FACT BOOK

A handbook of baseball facts and figures containing complete major and minor league schedules for 1957 is now being made available by *Sylvania Electric Products Inc.* through television service dealers.

The 48-page booklet includes a section on "basic baseball strategy and plays" by the game's top experts. It also lists outstanding major league records for 1956, together with a 1957 outlook for both the American and National leagues.

The company's service dealers will provide this handy pocket-sized booklet to fans who want statistics "at hand" as they watch their favorites in action.

BATTERY PROMOTION

The inclusion of a new permanent dealer aid, the "Select-a-File," in RCA's 1957 portable radio battery promotion kit, has been announced.

The "Select-a-File" is a complete, illustrated, up-to-date source of battery replacement information for practically every portable radio now in use. Contained in a sturdy steel file box, a data card carries a photograph of a portable together with the manufac-

turer's name and model, plus the company's recommended battery complement.

The kit, which includes additional promotion material, is now available from all the company's battery distributors.

* * *

MERIT SALES CONTEST

Gail S. Carter of *Merit Coil and Transformer Corp.* (right) and Lee Smith of *American Airlines* (left), put the finishing touch on a rep sales contest which will send three winners to



Bermuda, Mexico City, or Havana, Cuba.

According to the company, the purpose of the contest, simply put, is to sell more of the firm's coil and exact replacement transformers.

If the contest winners elect to go on selling instead of taking a plane trip, the company will buy shares in the *Television-Electronics Fund, Inc.* of equal dollar value to the trip.

Winners will be the three rep agencies showing the highest sales percentage increase over the first seven months of 1956. The contest ends on July 31, 1957.

* * *

NEW SALES PROGRAM

CBS-Hytron has announced it will continue and expand its support of independent radio-TV service dealers across the nation in its 1957 sales promotion program.

The program calls for extensive national advertising augmented by concentrated local promotion aimed at attracting business into the shops of independent service dealers.

Suggestions from dealers throughout the nation indicate that the prime needs are for improved public relations in the dealer's local community, and to advertise and promote his services and products to potential customers. Among suggestions offered were both national and local advertising, direct mail campaigns, local meetings to stimulate cooperative action between dealers and distributors, and other activities aimed at enhancing the dealer in his local business community, and increasing his sales volume.

Along with national advertising, local promotion will include window displays, ad mats, etc., and an independent service dealer decal emblem which will identify the dealer to his customers. The emblem carries no company promotion. It is designed for the promotion of the dealer in his local community.

Selling Service
(Continued from page 52)

was used successfully by a southern service dealer several years ago. In this promotion, the dealer had some string tags cut in the shape of a four-leaf clover. These were die-cut, green-colored stock and were called "Good Luck Charms for Better TV Pictures."

The gimmick in this promotion was that the charm was worth fifty cents credit on the service call if the dealer's technician found it hanging some place on the TV set when he called to service it. Technicians reported that they found these charms hanging on rabbit ears, tuning controls and other places on sets where a string could be attached. It was a highly successful promotion.

Last year one of the business-form publishers developed a doorknob hanger for technicians to put on the doorknobs of homes close by those in which they serviced TV sets. The copy on it read, "We did it and we're glad. We just serviced your neighbor's TV set. Why not call us whenever your TV set needs service?" The dealer's name, address, and telephone number is imprinted on the hangers. One ingenious service dealer found it very successful during the first week he tried it. His men put the hangers on about sixty doorknobs a week. These cards brought in an average of two calls per week. This was about one call out of every thirty doors on which the hangers were placed.

This dealer concluded that, if he would arrange to place the doorknob hangers on sixty homes daily, he would pick up two additional service calls per day. As a result, he hired a high school student to work two hours every afternoon to systematically cover residential streets, putting the hangers on doorknobs. He said the plan proved highly successful.

Initiative, energy, and ingenuity will keep business flowing into any service shop without regard to seasons. —30—

PHOTO CREDITS

Page	Credit
40 (left), 41 (bottom) . . .	P. R. Mallory & Co., Inc.
40 (center)	National Carbon Co.
40 (right), 54, 55 (Fig. 6), 116	Radio Corporation of America
41 (top)	Ray-O-Vac
45	Simpson Electric Co.
46, 47, 48	Motorola Inc.
49	Sargent-Raymont
53 (top)	Hickok Electrical Instrument Co.
53 (center)	Precision Apparatus Co., Inc.
53 (bottom)	Electronic Instrument Co.
56, 57	Radio Craftsmen Inc.
58, 59	Designers for Industry, Inc.
63	General Electric Co.
114	The Rockefeller Institute
128	Harkins Broadcasting Co.
163	Sikorsky Aircraft Co.

ERRATUM

A printer's error on page 42 of the May issue has resulted in a lack of continuity in the text. The last line of the first column should read "gie's tests were carried out using head". Our apologies.

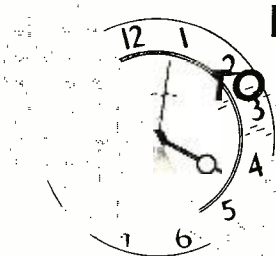

MONTHLY SPECIAL!
100 6SN7's
Individually Boxed In Units Of 100 Only
\$30
OFFER EXPIRES JUNE 30, 1957

FREE! 3-in-1 SCREWDRIVER SET
with every order regardless of size!

BRAND NEW TV PICTURE TUBES
RCA and DUMONT Licensed

10" Tube . . . \$10.95	17" Tube . . . \$17.95
12" Tube . . . \$12.95	19" Tube . . . \$20.95
14" Tube . . . \$14.95	20" Tube . . . \$20.95
16" Tube . . . \$16.95	21" Tube . . . \$22.95

Add \$4.00 to above prices for aminated tubes

TERMS: FREE POSTAGE on all prepaid continental U.S.A. orders on receiving tubes only. 25c handling charge on all orders under \$5. 25% deposit on all COP's. Picture tubes F.O.B. Passaic, N. J. via Railway Express.

NOW IS THE TIME . . . TO BUY FROM THE TUBE MART!

Pay Less For High Quality **RECEIVING TUBES**
Still Only **41¢**
Quantity Buyers!
100 Tubes \$38.00

Individually Boxed • Electronically Perfect
Factory Seconds

02A	6AUG	6SN7	12BA6
1B3GT	6AU5GT	6S7GT	12BE6
1M5GT	6AV5	6SK7GT	12A27
1LCS	6AV6	6SL7GT	12BH7
1LW6	6AW6	6SN7GT	12BR7
1M5GT	6AT6	6SQ7	12SA7
1Q5GT	6AH4GT	6SR7	12SC7
1R5	6BA6	6T8	12S7GT
1S4	6BC5	6U8	12S7GT
1S5	6BE6	6V8	12S7GT
1T4	6BG6G	6W4GT	12S7GT
1T5GT	6BJ6	6W4GT	12S7GT
1U4	6BK5	6W6GT	12S7
1U5	6BK7	6X4	19T8
1X2	6BL7GT	6X5GT	19BC6G
3Q4	6BQ6GT	6Y6G	25BQ6GT
3S4	6BQ6	7C5	25L9GT
3V4	6BV5G	7C6	2A25
5U4G	6BZ7	7E7	25Z6GT
5V4G	6C4	7F7	3B5B
6A8A	6CB6	7F8	3C5
6AC7	6CD6G	7N7	35L6GT
6AG5	6E6	8F6	35W4
6AG7	6E6GT	12A77	35Y4
6AF4	6E8GT	12AUG	35Z6GT
6AK5	6E6GT	12AUG	50A3
6AL5	6E6	12AV7	50B5
6AQ5	6E6	12AV7	50C5
6AS5	6E6GT	12AX4GT	50L6GT
6AT8	6SA7	12BY7	12T3



U.S. Crystals offers a complete line of guaranteed crystal frequencies for the novice, amateur, technician.
Send for catalog

SPECIAL FT-243 YOUR CHOICE 49¢ ea.

2015	2705	3145	4710	5950	6473	7125	7525	7830	8150	8470	
2017	2710	3150	4735	5955	6475	7140	7530	7833	8153	8473	
2020	2715	3155	4740	5960	6480	7145	7535	7836	8156	8476	
2023	2720	3160	4745	5965	6485	7150	7540	7840	8160	8480	
2025	2725	3165	4750	5970	6490	7155	7545	7845	8165	8485	
2040	2755	3190	4820	6000	6540	7225	7640	7950	8270	8600	
2055	2780	3175	4840	6006	6550	7240	7650	7960	8280	8610	
2060	2785	3200	4845	6025	6573	7250	7660	7970	8290	8620	
2065	2790	3205	4850	6040	6575	7255	7665	7975	8295	8625	
2090	2775	3210	4840	6042	6600	7275	7670	7980	8300	8630	
2105	2780	3220	4850	6050	6606	7275	7675	7985	8305	8635	
2125	2785	3225	4850	6073	6625	7300	7685	7995	8315	8645	
2130	2790	3230	4850	6075	6640	7308	7690	8000	8320	8650	
2135	2795	3235	4850	6100	6650	7315	7695	8005	8325	8655	
2140	2815	3240	4850	6106	6673	7325	7695	8010	8330	8660	
2195	2825	3290	4900	6125	6675	7333	7695	8010	8330	8660	
2200	2835	3035	4910	6140	6700	7340	7695	8010	8330	8660	
2305	2840	3320	5050			7606	7908	8220	8540	7	
2320	2845	3340	5127.5			7608	7910	8225	8540	7	
2350	2850	3340	5165			7610	7916	8230	8550	7	
2355	2855	3470	5160			7616	7920	8240	8560	7	
2360	2860	3470	5205			7618	7925	8245	8560	7	
2365	2865	3465	5235			7625	7930	8250	8570	7	
2370	2870	3525	5245			7630	7935	8255	8570	7	
2375	2875	3525	5275			7633	7940	8260	8575	7	
2390	2880	3655	5335			7640	7945	8265	8580	7	
2415	2885	3655	5385			7647	7950	8270	8585	7	
2430	2890	3700	5397.5			7650	7958	8273	8590	7	
2435	2895	3760	5435			7658	7960	8275	8591	7	
2440	2905	3800	5437.5			7658	7963	8275	8590	7	
2442	2910	3885	5485			7666	7970	8283	8606	6	
2456	2915	3940	5500			7670	7975	8290	8608	6	
2455	2920	3955	5545			7673	7975	8291	8610	7	
2560	2925	3980	5582.5			7675	7980	8300	8615	7	
2465	2930	3990	5617.5			7680	7983	8306	8620	7	
2470	2935	3995	5645			7683	7990	8308	8625	7	
2475	2940	4035	5660			7690	7991	8310	8630	7	
2480	2945	4045	5675	6147	6706	6	7311	7690	7991	8310	8630
2485	2950	4080	5687.5	6150	6725	7350	7700	8006	8320	8640	
2490	2955	4095	5700	6173	6740	7358	7706	8016	8325	8641	
2495	2960	4110	5706	6192	6750	7366	7708	8020	8330	8650	
2505	2965	4135	5725	6185	6773	7373	7710	8025	8340	8656	
2510	2975	4165	5740	6200	6775	7375	7715	8030	8350	8660	
2515	2980	4170	5740	6206	6800	7383	7720	8033	8358	8666	
2520	2985	4190	5760	6225	6806	7391	7725	8040	8360	8670	
2525	2990	4215	5760	6235	6815	7400	7731	8045	8366	8675	
2530	2995	4220	5773	6240	6825	7406	7735	8050	8370	8675	
2535	3005	4255	5785	6255	6835	7408	7740	8055	8376	8680	
2545	3010	4280	5780	6273	6850	7408	7730	8066	8380	8683	
2550	3015	4295	5826	6273	6873	7416	7733	8070	8383	8686	
2555	3020	4300	5835	6275	6875	7420	7740	8073	8390	8691	
2560	3025	4306	5806	6300	6900	7433	7741	8075	8391	8700	
2565	3030	4340	5820	6306	6906	7436	7745	8080	8400	8706	
2570	3035	4395	5825	6315	6925	7441	7758	8083	8406	8708	
2575	3040	4395	5840	6325	6940	7450	7760	8090	8408	8710	
2580	3045	4445	5850	6335	6945	7458	7767	8095	8410	8712	
2585	3050	4450	5865	6340	6973	7466	7780	8100	8416	8720	
2590	3055	4490	5880	6350	6975	7473	7783	8106	8420	8725	
2595	3060	4525	5885	6362	7000	7475	7790	8108	8425	8730	
2630	3065	4535	5875	6373	7006	7483	7791	8110	8430	8733	
2635	3070	4540	5880	6375	7025	7491	7796	8113	8433	8740	
2650	3075	4580	5892	6400	7040	7500	7806	8120	8440	8741	
2665	3095	4610	5900	6405	7050	7506	7808	8125	8441	8750	
2680	3110	4620	5905	6406	7073	7510	7810	8130	8450	8750	
2685	3130	4635	5907.5	6425	7075	7510	7816	8133	8458	3	
2690	3135	4680	5925	6440	7100	7516	7820	8140	8460	7	
2695	3145	4695	5940	6450	7106	7520	7825	8141	8466	7	

NUMBERS LISTED ARE FUNDAMENTAL FREQUENCIES IN KILOCYCLES

Include 5c per crystal for postage and insurance, Calif. add 4% Tax. No. C.O.D.'S. Prices subject to change, Ind. 2nd choice; substitution may be necessary. **Min. Order \$2.50.**

U.S. CRYSTALS, INC.

1342 So. La Brea Ave., Los Angeles 19, Calif.

WE DON'T NEED ENGINEERS

. . . but they write to us daily to order our **GENIAC Electric Brain Construction Kits**. So do TEACHERS, SCIENTIFIC AMATEURS, INDUSTRIAL FIRMS and schools. (See list below). **THOUSANDS OF SATISFIED CUSTOMERS** have bought **GENIACS** on a **7 DAY REFUND** guarantee. We are proud to offer our 1957 model, with up to the minute improvements for the thousands of new customers who can use them.

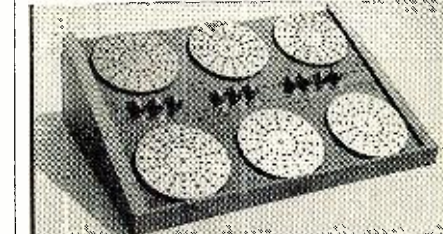

WHAT IS A GENIAC?
Here is a picture of the 1957 Model GENIAC in the display case (\$83.00) which comes with every kit. GENIAC stands for *Genius* Semi-Automatic Computer. A kit of specially designed switch decks and racks which perform the symbolic logic, reasoning, comparing, **PSYCHOLOGICAL TESTING** and **EXPERIMENT GAME PLAYING** circuits for tit-tat-toe and nlm. **ACTUARIAL ANALYSIS**.

SOME OF OUR CUSTOMERS
Allis-Chalmers • Remington-Rand • International Business Machines • Manual Missionary College • Barnard College • Westinghouse Electric • Phillips Laboratories • General Insurance • East of America • Lafayette Radio • Rohr Aircraft Co. • Albert Einstein Medical College • Naval Research Laboratory • Board of Education, Tecumseh, Nebraska • Los Angeles Public Schools • Jefferson Union High School • Oklahoma • M & M • Courtland Jr. High School • Bell Telephone Laboratories.

BOOKS-1. WHAT COMES WITH THE KIT?
1. SIMPLE ELECTRIC CIRCUITS AND HOW TO MAKE THEM . . . 64 page experiment manual.—NEW!
2. MINDS AND MACHINES . . . 200 page text on computers, automation and cybernetics.—NEW!
3. WIRING DIAGRAMS for basic GENIAC circuits.—NEW!
4. Beginners Manual for the person who has little or no familiarity with electric circuits.—NEW!
5. GENIAC study guide.—the equivalent of a full course in computer fundamentals, lists additional readings.
PARTS-PANELS, DISCS, RACK (for easy assembly and display). Hardware, wires, tools, battery, holder etc. for more than thirty machines.
SEND for your GENIAC now. At only \$19.95, a bargain, comes complete with over 400 parts and components. 5 books and manuals. We guarantee that if you do not want to keep GENIAC after one week you can return it for full refund.
Add 50¢ west of Miss. \$2 outside U. S. Mail Name and Address with check or Money Order to
OLIVER GARFIELD CO. Dept. RT67A
126 LEXINGTON AVE. NEW YORK 16, N. Y.

Classified

RATE: 50¢ per word. Minimum 10 words. August issue closes June 10th. Send order and remittance to: RADIO & TELEVISION NEWS, 366 Madison Ave., N. Y. C. 17.

RADIO ENGINEERING

COMPLETE radio, electronics theory & practice; television; broadcasting; servicing; aviation, marine, police radio. 18 or 21 months. Catalog. Valparaiso Technical Institute, Dept. N, Valparaiso, Ind.

FOR SALE

TRADE IN TV's—ship anywhere. 10 inch \$8, 12 inch \$11, 16 inch \$17, 17 inch \$22, 19 inch \$25, packing \$3. Justis Bros., Newport, Delaware.

RADAR publications. Practical circuits, theory, illustrations. Free descriptive list. Techbooks, B207, Ocean Springs, Mississippi.

NEW TG-34A Photoelectric Tape Code Practice Sets with manuals \$24.95; New BC-645's, with original and Citizen's Band conversion schematics, data, \$24.95. Engineering Associates, 430 Patterson Road, Dayton 9, Ohio.

216 INDIVIDUALLY cartoned tubes and 144 used tubes as removed from equipment. Lot price \$140.00. Express Collect. J. R. Davis, P.O. Box 9062, Knoxville 20, Tenn.

TELEPHONE Extension in your car. Answer your home telephone by radio from your car. Complete diagrams and instructions. \$1.25. Q. Carrier Co., 734-15th St., N.W., Washington 5, D.C.

TELEVISION, radio repair, service store, fully equipped, latest instruments, tools, busy Avenue Manhattan, fine-going, profitable business, established 25 years. Original Owner retiring. 1954 Chev Del Truck, Sacrifice, rare opportunity, valuable trade name included, taking offers. Classified Box 557, c/o Radio & TV News, 366 Madison Ave., New York 17, N. Y.

304TL TUBES, \$8.95 each. Four for \$29.95. Oldenburg, 764 Vann, Evansville, Indiana.

"COIL Winding Methods" Handbook 30¢. Laboratories, 328-H Fuller, Redwood City, California.

TV SETS—10 to 21"—\$12 Up, Catalog available others. Surplus Appliances RFD 2, Abele Park, Putnam Valley, N. Y.

BAKALITE And Fiber, Assorted Pieces, send \$2 to Lloyd Summers, 171 Somerton, Kenmore, N. Y.

MARINE Crystals Since 1933. Free brochure. Discounts. Airmail Service. C-W Crystals, Box 2065, El Monte, Calif.

PRINTED Circuits: Design and construct your own. Wonderful for transistor units. Copper boards, etching compound, and all instructions \$2.00. Dawntronic, SDM, 2051 Lansing, Denver 8, Colorado.

DIAGRAMS! Repair Information! Radios—amplifiers—recorders \$1.00. Televisions \$1.50. Give make, model, chassis. TV Miltie, Box 101RA, Hicksville, New York.

DIAGRAMS—Radios, Amplifiers, Changers, \$1.00 Each. Television Service Data \$2.00. Unknown Models, Give Tube Layout and Part Numbers. Kramer's Radio Service, Dept. 656, 36 Columbus Ave., New York 23, N. Y.

DIAGRAMS for repairing radios \$1.00. Television \$2.00. Give make, model. Diagram Service, Box 672-RN, Hartford 1, Conn.

TUBES—TV, Radio, Transmitting And Industrial Types At Sensibly Low Prices. New, Guaranteed, 1st Quality, Top Name Brands Only. Write For Free Catalog or Call Walker 5-7000, Barry Electronics Corp., 512 Broadway, New York 12N, N. Y.

COMPLETE Television Sets \$11.95. Jones TV, 1115 Rambler, Pottstown, Pa.

LARGE Stocks Bargain Priced Electronic TV, Hi-Fi, Radio Components. Chicagoland's Biggest Bargain Centers. Mid-America Company, 2412 S. Michigan, Victory 2-0702; 6101 N. Broadway, Rogers Park 4-3745.

WANTED

CASH Paid! Sell your surplus electronic tubes. Want unused, clean transmitting, special purpose, receiving, TV types, magnetrons, klystrons, broadcast, etc. Also want military & commercial lab test and communications gear. We swap too, for tubes or choice equipment. Send specific details in first letter. For a fair deal write, wire or telephone: Barry, 512 Broadway, New York 12, N. Y. Walker 5-7000.

WANTED: Short Wave & Communications Receivers. New or Used. All types Electronic Tubes. Highest Cash Prices Paid. Write or Phone: North Radio Co., 62 Cortlandt St., New York 7, N. Y.

CYLINDER and old disc phonographs. Edison Conqueror, Idelia, and Oratorio models. Berliner Gramophones and Zono-o-phones, Columbia cylinder Phonographs, and coin-operated cylinder phonos. Want old catalogues and literature on early phonos prior to 1919. Will pay cash or trade late hi-fi components. Box 50 % RADIO & TELEVISION NEWS.

WANTED: Receiver R5/ARN-7, MN-62A Transceivers, RT18/ARC-1, AN/ARC-3, BC-788C, I-152C, Collins, Bendix equipment. Test Sets, Dynamotors, Inverters. We pay highest prices. Advise quantity, condition, price first letter. Aircraft Radio Industries, Inc., 15 East 40th St., New York City, telephone LEXington 2-6254.

SELL Your Way to Wealth! Wanted: Surplus military and commercial aircraft electronics: ARN-6, ARN-6, ARN-6, AS-313, AS-313, AS-313, AS-13, ART-13, ART-13, ART-13, ARN-7, ARC-3, 51R-3, APN-9, BC-348, BC-788, I-152, MN-53, test equipment and All Vacuum Tubes. Top prices paid! For fattest checks—sell to Rex! Bob Sanott, W6REX, 1524 S. Edris Dr., Los Angeles 35, California. Phone: RPublic 5-0215.

WANTED: Signal Generators TS-403, TS-621, SG-3/U, TS-437, TS-510, TS-588, TS-608, etc.; TS-186 Frequency Meters, AN/APR-4 Tuning Units, other "APR" Receivers, ARC-3, other Surplus; also Hewlett-Packard and other laboratory quality equipment, Weston, etc. Instruments; technical manuals; for quick cash or swap for Zenith Transistor Portables, etc. LIT-TELL, Firhills, Box 26, Dayton 9, Ohio.

AN/APR-4, AN/APR-9, other "APR-," "ARR-," "TS-," ARC-1, ARC-3, ART-13, everything surplus: Tubes, Manuals, Laboratory equipment. Describe, price in first letter. Engineering Associates, 434 Patterson Rd., Dayton 9, Ohio.

PLATINUM Electronic Scrap. Highest prices. Estimates by mail. Satisfied customers from coast to coast. Ship with perfect confidence. Cash sent by return mail. Noble Metals Co., Box 1113, Santa Monica, California.

REPAIRS AND SERVICING

HIGH Fidelity Speakers Repaired. Amprite Speaker Service, 70 Vesey St., N. Y. 7, N. Y. Ba. 7-2580.

HELP WANTED

WANTED—instructor with a major interest in small transmitter service to teach in a two-year post high school service program. Write or call Jon P. Adams, Ferris Institute, Big Rapids, Michigan.

TAPE RECORDERS

TAPE Recorders, Tape. Unusual Values. Free catalog. Dressner 69-02 R, 174 St., Flushing 65, N. Y.

RECORDERS Wholesale! Tapes: 1200' \$1.39; 1800' \$1.85. Towers—155, Philadelphia 5.

DISCOVER our "Six-Unique Services" and Rock-Bottom prices on Hi-Fi; Stereo. Write the Silver Trumpet, 406R Walnut, Alexandria, Indiana.

HIGH FIDELITY

DISGUSTED of "Hi" Hi-Fi Prices? Unusual Discounts on all your High Fidelity requirements. Write now. Key Electronics Co., 120 Liberty St., New York 6, N. Y.

CORRESPONDENCE COURSES

USED Correspondence Courses and Books sold and rented. Money back guarantee. Catalog free. (Courses bought.) Lee Mountain, Pisgah, Ala.

INSTRUCTION

LEARN While Asleep! Details free. Research Association, Box 610-RT, Omaha, Nebraska.

DO you want to be a writer? No engineering background or writing experience required to be a technical writer. Our students earning over \$600.00 per month before completing course. Write Technical Publications Institute, 3022-L, Melrose, Los Angeles 46, California.

ENGINEERING Degrees, EE Option Electronics earned by home study. Residence classes also available. Pacific International University (American College of Engineering), 5719-C Santa Monica Boulevard, Hollywood 38, California.

MISCELLANEOUS

DECALS—Trademarks, Service, Sales, etc. Write Allied Decals, Inc., 8378 Hough, Cleveland, Ohio.

BUSINESS Cards. Free TV cuts. Raised printing. 1,000—\$4.50 postpaid. Polart Company, 20115 Goulburn, Detroit 5, Michigan.

HQ for the 5 TOP QUALITY brands of

TUBES

AT SENSIBLE PRICES!

- Individually boxed ● First quality only
 - Brand New ● 90-DAY RETMA guarantee
 - No rebrands ● No private brands ● No rejects
- WRITE FOR LATEST TUBE CATALOG FREE!

1835	.. \$ 3.35	6L299	.. 1.00	2051	.. .55
1Q22	.. 44.50	307A	.. .60	5S17	.. 1.35
6L-2	.. 10.00	355A	.. 1.10	5T46	.. 2.05
2B9	.. 1.95	377A	.. 14.00	5636A	.. 2.95
9C35	.. 2.00	371B	.. .75	5642	.. 1.00
9C39A	.. 11.00	403A	.. 1.20	5646	.. 1.40
2C4	.. 7.00	403B	.. 3.25	5651	.. 1.40
2C51	.. 2.25	404A	.. 12.50	5654	.. 1.40
2C53	.. 9.75	416A	.. 25.00	5675	.. 8.00
2E2	.. 2.44	416B	.. 39.50	5676	.. .85
4K45	.. 13.50	417A	.. 3.50	5687	.. 1.85
2K45	.. 35.00	417A/5842	.. 12.00	5691	.. 4.75
2K55	.. 15.00	450TH	.. 44.00	5693	.. 4.75
1B81	.. 1.95	KU-610	.. 3.50	5703WA	.. 4.75
1B24W	.. 4.75	WL/655/658	.. 12.00	5718	.. 4.00
1B29	.. 4.75	GL673	.. 12.50	5719	.. 2.00
1C23	.. 3.95	703A	.. 1.10	5726	.. .75
3C31	.. 1.00	717A	.. .90	5728	.. 1.25
3C45	.. 25.00	CK722	.. 5763	.. 1.25	
3K20000LK	.. 1.50	*750TL	.. 32.50	5764	.. 1.00
4-65A	.. Write	805	.. 2.00	5814	.. 1.00
4-125A	.. 30.25	805	.. 4.00	5819	.. 25.00
4-250A	.. 35.00	807	.. 1.10	5840	.. 2.50
4-400A	.. 40.00	807W/5933	.. 1.10	5876	.. 8.00
4B24/EL3C	.. 4.50	813	.. 9.50	5881	.. 2.05
4X500A	.. 75.00	814	.. 2.50	5910	.. .45
*4PR60A	.. 25.00	836	.. 1.00	5922	.. 1.00
5C2	.. 25.00	837	.. 1.25	6111	.. 4.95
6AK5W	.. 1.20	838	.. .70	6112	.. 4.85
6C21/450TL	.. 1.50	866A	.. 1.20	6120/3c45	.. 6.00
6J4	.. 1.30	917	.. 1.00	6161	.. 52.50
6L4	.. 1.75	917	.. 1.30	6201	.. 8.00
15E	.. 1.20	918	.. 1.10	6350	.. 10.00
FG52	.. 1.00	920	.. 1.00	6539	.. 9.00
*35TG	.. 2.00	930	.. 1.00	8008	.. 3.25
VC50/32V	.. 8.00	954	.. .40	8020	.. 1.00
RK-60/1641	.. 1.25	956	.. .35	9001	.. .75
		956	.. .35	9002	.. .50
		957	.. .35	9003	.. 1.35
		958	.. .35	9004	.. .30
		959	.. .25	9005	.. 1.60
		960	.. .35	9006	.. .20
		CK1005	.. .35		
		CK1007	.. .35		
		CK1028	.. 2.35		

and many others, over 1000 types in stock! WRITE! WE ARE FACTORY AUTHORIZED DISTRIBUTORS OF CBS-HYTRON, EIMAC, PENTA, etc.

2 COLOR TUBE CARTONS

Keeps your tube stock neat. New safety partition prevents tube breakage. Distinctively lithographed in glossy red and black. The most distinctive tube carton available today. Minimum quantity: 100 of any one size. Write for case lot prices.



SIZE FOR TUBE PER 100
Miniature... 6AU6, etc... 5.00
GT... 6SN7, etc... 1.25
Large GT... 1B3, etc... 1.50
Large G... 5U4G, etc... 2.00

WHITE GLOSSY BOXES

Completely blank. No printing or color. Otherwise same as above. Same high quality, same low prices. Specify "WHITE" when ordering. When color is not stated, 2 color cartons will be shipped.

TUBE STACKERS

White glossy only. Ministacker holds 10 Mini. tube cartons; "GT" stacker holds 10 "GT" cartons. SIZE PER EACH Ministacker... \$1.12/2 GT... \$1.02

\$10.00 Per Case of 100 FOB NYC. (All cartons & stackers free N.Y.C.)

● INVISIBLE INFRA-RED ● CL-2 LAMP \$10.00

Electronic Equipment Specials

- DUMONT 5" OSCILLOSCOPE, Model 274A. At less than 1/2 reg. price! Exc. cond. \$65.00
- RCA 5" OSCILLOSCOPE, Model W0-88A. A real good buy. Clean, v. gd cond. \$85.00
- RCA TV SWEEP GENERATOR, Model W-50A. In exc. cond. A bargain at only \$75.00
- DYNAMOTOR, V. compact, 12 VDC in. 420 VDC @ 250 ma. int. out. (160 ma. cont.) \$9.95
- Lots of 3, each... \$34.50
- FREQUENCY METER, Lavoie model 1055M (TS-127/U) 375 to 725 Mcs. Covers citizens band, color TV, etc. BRAND NEW in orig. packing! \$34.50
- IE-33-A UHF TEST SET. 4 major pcs. in wood chest. V. good \$25.00
- TS-35/AP SIGNAL GEN & POWER METER, 8700 to 9500 Mcs. Peak output power, 3 to 68 db. 0 to 68 db on CW. Excell. \$55.00
- PLATE XFMR. 3100-0-3100 v. @ 500 ma. 15000 v. ins. 98-123 v. tapped pri. 60 cy. 9"x8"x7 1/2". By Acme. Brand new, crated. \$34.50
- BC-457A XMTR. 4 to 5.3 Mcs. New, orig. ctngs. \$6.95
- BC-458A XMTR. 5.3 to 7 Mcs. Used. Excell. \$5.95
- MALLORY VIBRAPACK, 2 VDC input. std. nut. put. \$12.95
- MALLORY VIBRAPACK, 12 VDC input. Std. nut. put. \$9.95
- MALLORY VIBRAPACK, 6 VDC input. Std. nut. put. \$9.95
- LM FREQ. METER, Orig. box & stat. w/pow. sup. for 117 VAC op. & interconnect cable. Excellent condition \$35.00
- TUBE TESTER, Sylvania model 620, NEW! \$27.50
- VTVM POLYMER, Sylvania type 303, NEW! \$7.95
- VTVM POLYMER, Sylvania type 301, New! \$59.50
- VTVM DELUXE PLYMTR, Sylvania type 302, New! \$69.50

WRITE FOR "BARRY'S GREEN SHEET" FREE!

TERMS: 25% deposit with order, balance C.O.D. All merchandise guaranteed. F.O.B. N.Y.C. Subject to price variation and stock depletion MINIMUM ORDER \$10.00

TRADES ACCEPTED—OPEN MON. TO SAT.

BARRY ELECTRONICS CORP.
512 Broadway, Dept. RN, N.Y. 12, N.Y.
Phone: WALKER 5-7000

TUBE

SPECIALISTS to the WORLD

SELECT THE TUBES YOU NEED FROM ONE OF THE MOST COMPLETE TUBE INVENTORIES IN THE WORLD



First Quality — Fully Guaranteed — No Seconds

RECEIVING TUBES

TRANSMITTING TUBES

0A2	.69	GAD7G	1.50	6L6G	.98	12BF6	.60	0A3/VR75	.86	5JP2	6.35
0A4G	.95	GAFA	1.23	6L7	.95	12BH7	.89	0B3/VR90	.73	5JP5	9.95
0B2	.65	GAFA6G	.85	6N7	.89	12BK5	.95	0C3/VR105	.68	5LP1	7.40
0Z4	.49	GAG5	.72	6O7	.85	12BQ6GT	1.35	0D3/VR150	.68	5NP1	4.95
1A3	.68	GAG7	.98	6Q7GT	.79	12BY7	.90	1B22	1.25	6AC7W	1.45
1A7	.52	GAH4	.85	6R7	.85	12BZ7	.95	1B23	2.68	6AK5W	1.45
1AD4	1.20	GAM6	.85	6R7GT	.68	12C8	.69	1B24	3.85	6AL5W	1.95
1AE4	.92	GAJ5	1.49	6S4	.57	12CU6	1.35	1B27	12.95	6A05W	1.70
1AX2	.95	GAK5	.69	6S8GT	1.05	12H6	.69	1B35	3.45	6AS6W	2.69
1B3GT	.79	GAK6	.75	6S7	.79	12J5GT	.65	1B38	33.50	6BF7W	3.45
1C5GT	.62	GAL5	.58	6SA7GT	.79	12K7GT	.89	1B40	3.45	6C4W	6.75
1G4	.55	GAL7	.95	6S7Y	.87	12K8	.65	1B41	14.95	6C21	14.95
1G6GT	.49	CAM4	1.50	6SC7	.73	12Q7GT	.75	1C21	1.85	6F4	2.65
1HG6T	.58	GAM8	1.10	6SF5	.72	12SA7	.69	1N21	4.39	6JAWA	4.45
1J6GT	.69	GAN4	1.50	6SF5GT	.69	12SA7GT	.69	1N21B	1.45	6J5WGT	3.90
1L4	.74	GAN5	2.75	6SF7	.92	12SC7	.75	1N23	.68	6J6W	2.20
1L6	.79	GAN8	1.15	6SG7	.65	12SC7	.79	1N23B	1.40	6J6WA	3.90
1LA4	.79	GAQ5	.57	6SH7	.74	12SH7	.65	1N34	.42	6K4	2.20
1LA6	.85	GAQ6	.77	6SH7GT	.56	12SJT	.65	1N34A	1.45	65N7WGT	1.85
1LB4	.85	GAQ7	1.15	6SJT	.69	12TA7	.69	1P21	29.50	6X4W	1.20
1LC5	.79	GAR5	1.70	6SJTGT	.59	12S7	.85	1P22	13.25	6X5W	1.35
1LC6	.79	GAR6	2.15	6SK7	.64	12S7GT	.75	1P23	1.85	7BP7	4.45
1LD5	.85	GAS5	.70	6SK7GT	.59	12SQ7	.59	1P24	1.45	12DP7	14.95
1LE3	.79	GAS6	1.95	6SL7GT	.75	12SR7	.59	1P25	64.50	15P	1.45
1LC5	.85	GA57G	2.35	6SN7GT	.75	12V6GT	.77	1P28	8.95	15R	.49
1LH4	.85	GAS8	1.15	6SOT	.59	12W6GT	.83	1P30	1.95	2807	7.95
1LN5	.79	GAT6	.52	6S07GT	.59	12W6GT	.73	1P32	.95	100TH	6.25
1NSGT	.59	GAT8	1.05	6SR7	.55	14A4	.95	1P39	1.45	100TL	8.25
1QS6T	.95	GAU4	1.05	6SS7	.75	14A5	1.30	1P40	1.25	211	.45
1R4	.65	GAU5	1.10	6ST7	.95	14A7	.75	1P41	2.45	249B	2.95
1R5	.65	GAU6	.65	6T8	.95	14AF7	.95	1P42	2.35	249C	1.95
1S4	.65	GAU7	.85	6U5	.85	14B6	.69	2AP1	4.95	250TH	18.95
1S5	.65	GAU8	1.20	6U8	.95	14C7	.69	2B22	1.95	250TL	14.75
1T4	.65	GAU9	.53	6V3	1.25	14E6	1.05	2C21	.39	262B	4.45
1T5	.69	GAX4	.79	6V6	1.10	14E6	1.05	2C34	.25	274A	3.45
1U4	.67	GAX5	.69	6V6GT	.59	14E7	.85	2C36	21.50	274B	.85
1U5	.59	GB4G	.95	6W4GT	.65	14F7	.85	2C39A	10.95	304TH	9.95
1V	.65	GB8	.67	6W6GT	.79	14F8	1.10	2C40	9.45	304TL	12.50
1V2	.59	GBA6	.63	6X4	.48	14H7	.85	2C43	10.25	307A	1.10
1V6	1.49	GBA7	.85	6X5GT	.49	14N7	.85	2C52	2.95	350A	2.65
1X2A	.85	GB4C	1.50	6X8	.95	14Q7	.85	2C53	10.75	350B	2.35
2A3	.95	GB5C	.68	6V6G	.99	14R7	1.20	2D21	.65	371B	.85
2A6	.59	GB7C	1.20	7A4	.79	14S7	1.10	2D21W	1.95	393A	4.50
2X2	1.35	GBD7	1.35	7A5	.69	14W7	1.25	2E24	3.45	WL47A	2.95
2X2A	1.35	GBD6	.73	7A6	.78	14W7	1.25	2E24	2.40	417A/5842	1.20
3A3	1.08	GBE6	.65	7A7	.75	19BG6G	1.89	2E26	3.25	14.95	14.95
3A4	.50	GBF5	.82	7A8	.75	19T8	.95	2E30	1.55	434A	2.95
3A5	.64	GBF6	.68	7AD7	1.65	25AV5	1.25	2G21	2.45	450TH	47.50
3AL5	.65	GBGGG	1.75	7AF7	.89	25AX4	1.05	2J31	14.00	450TL	35.00
3AL5	.70	GBH6	.79	7B7	.95	25BK5	.95	2J32	17.50	55A	12.50
3AV6	.60	GBJ6	.69	7AH7	.95	25BQ6GT	1.25	2J33	14.00	70A	3.95
3B4	2.95	GBK5	.95	7B4	.75	25CDEGT	1.75	2J34	14.00	707A	4.95
3B7	.39	GBK7	1.05	7B5	.65	25CDEGT	1.75	2J36	14.95	707B	3.95
3BC5	.80	GBL7	1.05	7B6	.75	25CU6	1.30	2J51	97.50	715B	2.95
3BN6	1.05	GBN6	1.10	7B7	.75	25L6GT	.65	2J55	39.50	715C	10.95
3B6	.75	GBQ6GT	1.15	7B8	.85	25W4GT	.72	2J61	12.95	717A	.35
3CB6	.80	GBR7A	1.15	7C5	.75	25Z5	.75	2E24	2.40	750TL	65.00
3CF6	.85	GBX7	1.20	7C6	.75	25Z6	.62	2K23	15.25	723A/B	8.45
3D6	.39	GBY5G	1.25	7C7	.79	30	.65	2K25	11.95	725A	2.95
3FL4	.85	GBZ7	1.20	7E7	1.15	32L7	.85	2K28	27.50	726A	4.95
3Q4	.65	GC4	.38	7F7	.85	35A5	.69	2K33A	56.95	726B	32.50
3Q5	.75	GC5	.45	7F8	1.10	35B5	.68	3AP1	2.80	726C	32.50
3S4	.65	GC5GT	.46	7G7	1.10	35C5	.68	3B24	1.50	750TL	65.00
3V4	.69	GC6	.49	7H7	.79	35C5	.68	3B24W	4.95	801A	.38
4BQ7A	1.30	GC8G	.85	7J7	1.25	35L6	.65	3B25	4.95	802	4.95
4BZ7	1.35	GC8S	4.40	7K7	1.15	35W4	.44	3B26	7.45	803	1.40
5AM8	1.05	GC8E	.68	7L7	1.10	35Y4	.65	3B27	3.45	804	8.85
5AN8	1.10	GC9G	1.75	7N7	.85	35Z3	.65	3B29	5.95	805	3.95
5AQ5	.75	GC9E	.90	7O7	.95	35Z5	.59	3B31	2.45	806	4.85
5AS8	1.10	CCD7	.85	7R7	.95	41	.65	3C22	59.50	807	1.18
5AT8	1.10	CC6L	1.10	7V7	.95	41	.65	3C23	3.45	808	1.25
5AV8	1.15	CCM6	.85	7W7	.95	43	.79	3C24	1.48	809	2.20
5AW4	1.10	CC5E	.75	7X7	.95	50A5	.68	3C45	5.95	810	10.50
5AZ4	.60	CC1U	1.30	7Y4	.60	50A5	.68	3D21A	2.95	811	2.75
5B	.90	GD6	.59	7Z4	.65	50B5	.68	3E24	3.25	811A	3.25
5R4GY	1.45	GD6C	.95	12A4	.85	50C5	.68	3E29	9.00	812	2.75
5T4	.90	GE5	.75	12A6	.62	50L6	.62	4.65A	13.25	812A	3.25
5U4G	.58	GF5	.59	12A8GT	.79	50X6	.85	4.125A	22.50	813	10.50
5U8	1.10	GF6	.85	12AH7GT	1.05	50Y6	.78	4.250A	32.50	814	1.95
5V4G	.88	GF6GT	.69	12AL5	.65	50Y7	.75	4C27	8.95	815	1.95
5V6GT	.70	GF7	.85	12AQ5	.70	53	1.25	4C28	17.45	816	1.15
5W4GT	.65	GF8G	.72	12AT6	.48	53	1.25	4C35	13.45	826	.65
5X4G	.75	GG6G	.72	12AT7	.92	70L7	1.15	4E27	8.50	828	7.42
5X8	1.05	GH6	.59	12AUG	.62	75	.65	4X750A	22.45	829B	7.95
5Y3GT	.49	GH6GT	.49	12AU7	.75	77	.47	4X150G	31.95	830B	.65
5Y4G	.65	GJ4	2.55	12AV6	.52	78	.57	5B11	2.35	832	5.75
5Z3	.69	GJ5	.48	12AV7	.95	80	.59	5B14	1.95	833	7.95
5Z4	.89	GJ5GT	.47	12AW6	.95	81	1.85	5C22	27.50	833A	42.50
6A3	.95	GJ6	.68	12AX4	.85	83	1.19	5CP1	1.95	836	1.45
6A6	.82	GJ7	.82	12AX7	.78	83V	.95	5CP1A	8.45	837	1.25
6A7	.89	GJ7GT	.65	12AY7	1.15	84/GZ4	.49	5CP7	7.95	838	.69
6A8	1.05	GK6GT	.65	12AZ7	.85	117L/M7	2.45	5D21	7.45	845	4.85
6A1GT	.95	GK7	.75	12BA7	.85	117N/P7	2.45	5F7	1.20	851	8.95
6AB4	.59	GK7GT	.59	12BA6	.60	117N/P7	2.45	5H9	2.85	850	2.75
6AB7	.95	GK8	1.10	12BA7	.89	117Z3	.68	5J30	17.25	861	12.95
6AC5	1.05	GK8GT	.95	12BD6	.70	117Z4	1.05	5J33	6.95	866A	1.15
6AC7	.85	KL6	1.69	12BE6	.65	117Z6	.95	5JP1	12.45	872A	1.25

GRAND OPENING

Visit our newly opened BARGAIN STORE in our own warehouses. SEE FOR YOURSELF !! Forty thousand square feet of warehouse space loaded with a tremendous variety of resistors, condensers, chokes, test transformers, headsets, microphones, test sets, receivers, transmitters. EVERYTHING IN ELECTRONICS ROCK BOTTOM PRICES

ATTENTION ! ! ! !

Hundreds of hard-to-find tube types available in addition to this listing. Same low, low prices. We have one of the largest and most comprehensive tube inventories in the WORLD. If the tubes you want are not listed here, write to us and we'll answer by return mail.

876	.72	5687	2.65	6099	1.35
878	.48	5692	5.10	6101	1.45
884	.95	5693	4.65	6113	1.25
885	.95	5696	.90	6146	4.75
902	2.45	5702	1.95	6161	69.50
916	1.65	5703	1.25	6177	3.95
923	1.25	5704	1.85	6189	2.25
925	1.50	5718	2.75	6263	11.45
927	.95	5718A	4.75	6264	11.45
930	1.19	5719	2.15	6539	2.95
931A	2.95	5725	1.45	8005	4.75
954	.25	5726	1.95	8008	3.95
955	.35	5727	1.25	8012	.98
956	.35	5732	2.95	8013	2.65
957	.35	5744	1.75	8013A	3.75
958A	.35	5751	1.45	8014	67.50
959	1.32	5762	99.50	8020	1.25
991	.29	5763	1.25	8025	1.45
1603	2.95	5783	4.45	9001	.82
1616	.50	5787CK	4.05	9002	.60
1619	.30	5794	5.95	9003	1.20
1622	1.45	5812	2.70	9004	.35
1624	.95	5814	.95	9005	1.39
1625	.25	5819	32.50	9006	.25
1626	.19	5820	495.00	C1JA	10.95
1633	.85	5823	1.35	C6J	7.95
1635	1.48	5829	1.35	CK1005	.32
1641	1.35	5840	4		

SPECIFICATIONS

ALL VIKING RECORDERS

frequency response: 20 to 14,000 cps plus, at 7 1/2 ips, 40 to 7,000 cps plus, at 3 1/2 ips.
 signal-to-noise ratio: 60 db or better.
 flutter: 0.2 percent average.
 long term speed regulation: 1/2 of 1.0 percent.
 tape speed: 7 1/2 ips available by changing belt (smaller groove on motor pulley).
 maximum reel size: 10 inches

record/playback head characteristics: track width .090 inch, gap width .0015 inch. Impedance 2000 ohms at 10 cycles. Double coil hum bucking winding. Mu-metal shielded. Output 2.5 mv.
 recommended bias current: 8 ma. at 4 kc.
 erase head characteristics: track width .125 inch, double gap (each .005 in), inductance 53 mh. at 1 kc, erase 60% at 68 kc.

MORE PERFORMANCE PER DOLLAR

THESE ARE THE REASONS WHY:

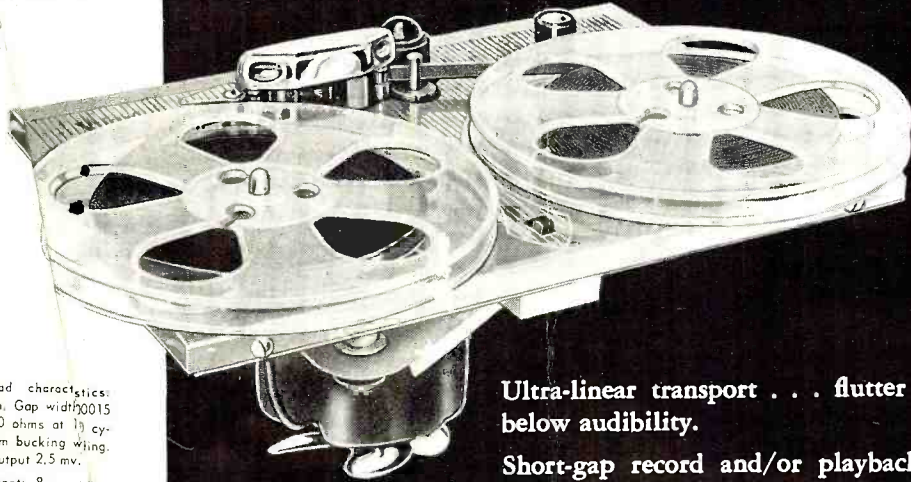

Ultra-linear transport . . . flutter and wow completely below audibility.

Short-gap record and/or playback heads for extended range . . . Double-coil (hum-bucking) record and playback heads for minimum hum. Double-gap erase heads for *dead quiet* erase.

The finest of bearings, and the ultimate in machining tolerances in capstan and drive members — *where precision counts.*

Rugged simplicity for enduring performance.

Physically independent amplifier components for increased flexibility and minimized hum pick-up.

Very high erase-bias oscillator frequency permits extended range recording without bias intermodulation.

NARTB equalization. Physical separation of mechanical and amplifier components, plus clean design, eliminates need for roll-off of lower (*bum*) frequencies.

SPECIFICATIONS

RP61 SERIES PREAMPLIFIERS

frequency response, playback: 30 to 14,000 cps \pm 2 db.
 frequency response, record-playback cycle: 30 to 12,000 cps \pm 3 db.
 distortion (tapes recorded 12 db below saturation): less than 2% within specified frequency range.
 internal signal-to-noise ratio: 60 db minimum all units.
 equalization: modified NARTB

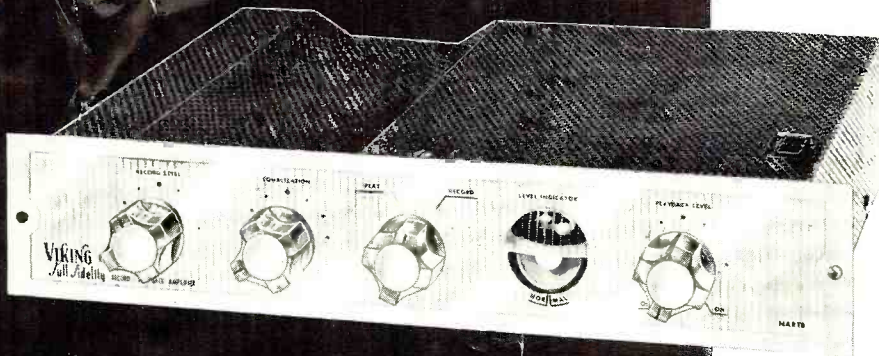

Ask your dealer for a Viking recording and playback demonstration before you buy any other recorder.



Viking OF MINNEAPOLIS

9600 Aldrich Avenue South, Minneapolis 20, Minnesota

EXPORT DIVISION: 23 Warren Street, New York City 7, New York
 Cable: SIMONTRICE, NEW YORK (All Codes)

recording channel gain: low level input. Requires .002 volt rms at 400 cycles for recording level 8 db below saturation. (High level input, .3 volts rms.)
 playback channel gain: 55 db.
 recording inputs: high impedance microphone (62 db overall gain) and high impedance radio or phono input (32 db gain).
 bias frequency: 68 kc.
 output: 1 volt, high impedance.
 tube complement: 1-12AX7, 1-12AU7A, 1-12AV7, 1-6X4, 1-6E5 Indicator.



Build *today's* profits with

MALLORY

Mercury BATTERIES

— the batteries of tomorrow !

The amazing mercury battery, pioneered by Mallory, helped make practical the remarkable new pocket-size transistor radios. Tiny, powerful, long-lasting, Mallory Mercury Batteries are the fast-growing line that will bring you profitable sales today . . . even greater sales tomorrow.

Mallory Mercury Batteries excel in long shelf life . . . in service life and economy in transistor portables. To help spark your sales, you get the backing of year 'round promotion and strong advertising in magazines like *The Saturday Evening Post*, *Time*, *Newsweek*, *Business Week* and *TV Guide*.

See your Mallory distributor today, and get full facts on the *full* line of Mallory Mercury and Zinc-Carbon Batteries.

For vacuum-tube portables,
sell Mallory Zinc-Carbon
Batteries . . . unsurpassed
for performance.

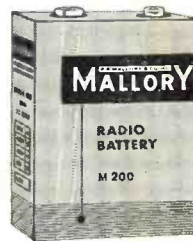

P. R. MALLORY & CO. Inc.
MALLORY

P. R. MALLORY & CO. Inc., INDIANAPOLIS • INDIANA

- Capacitors • Vibrators • Switches • Controls
- Resistors • Rectifiers • Power Supplies
- Filters • Mercury and Zinc-Carbon Batteries