

● OVER 30 PAGES ● ON HIGH FIDELITY

# RADIO & TELEVISION NEWS

ANC

NOVEMBER  
1956  
35 CENTS

*World's Leading Electronics Magazine*

**ALL-TRANSISTOR  
HI-FI AMPLIFIER**

**"DISTRIBUTED PORT"  
SPEAKER ENCLOSURE**

**HOW TO CHOOSE  
A TAPE**

**NEW RCA  
COLOR TV CIRCUITS**

**AIR RAID ALARM  
FOR HOME RECEIVERS**

**"THE ELECTRO-TACH"**

**COVER STORY**

(See Page 158)



# another Raytheon

# FIRST



**100% INTERCHANGEABLE TV TUBES  
THAT ELIMINATE SNIVETS\***



## 6DQ6 12DQ6 17DQ6

Thanks to an exclusive new Raytheon fin design, the Raytheon 6DQ6 is the first TV tube which eliminates SNIVETS that is 100% interchangeable — will work without special selection. It eliminates borderline performance, too, because its new design gives it additional and improved sweep characteristics not available in ordinary types.

Raytheon 6DQ6 tubes provide SNIVET free performance because they are individually tested for deflection operation and are given special tests under sweep amplifier conditions. Raytheon 12DQ6 and 17DQ6 Tubes incorporate this same fin construction and will provide the same superior, trouble-free performance.

An added bonus from the Raytheon 6DQ6 is that its interchangeability simplifies stocking. (It's an improved replacement for 6CU6 and 6BQ6GA series.)

Finally, the Raytheon 6DQ6 is another outstanding example of how Raytheon's superior engineering skill and production know-how have brought you still another tube that is first and finest in the field.

\* **SNIVET** — a vertical disturbance on the right hand area of the screen.

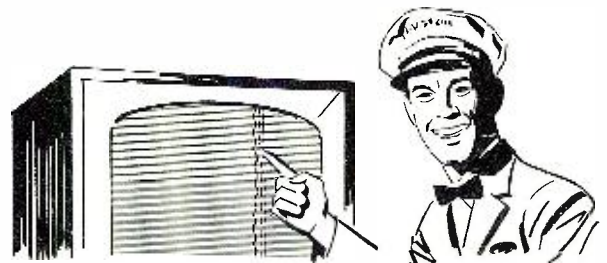

**RAYTHEON MANUFACTURING COMPANY**  
Receiving and Cathode Ray Tube Operations

Newton, Mass. • Chicago, Ill. • Atlanta, Ga. • Los Angeles, Calif.

Raytheon makes { Receiving and Picture Tubes, Reliable Subminiature and Miniature Tubes,  
all these } Semiconductor Diodes and Transistors, Nucleonic Tubes, Microwave Tubes.

  
*Excellence in Electronics*



AR 1 and 2

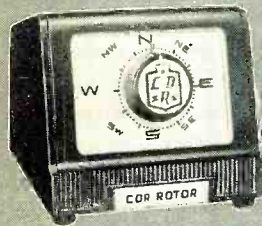

AR-22



TR-2



TR-4

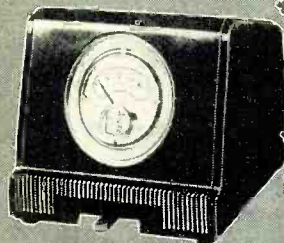

TR 11 and 12



Everything You Need for Profitable Rotor Sales

# CDR ROTORS

## have EVERYTHING

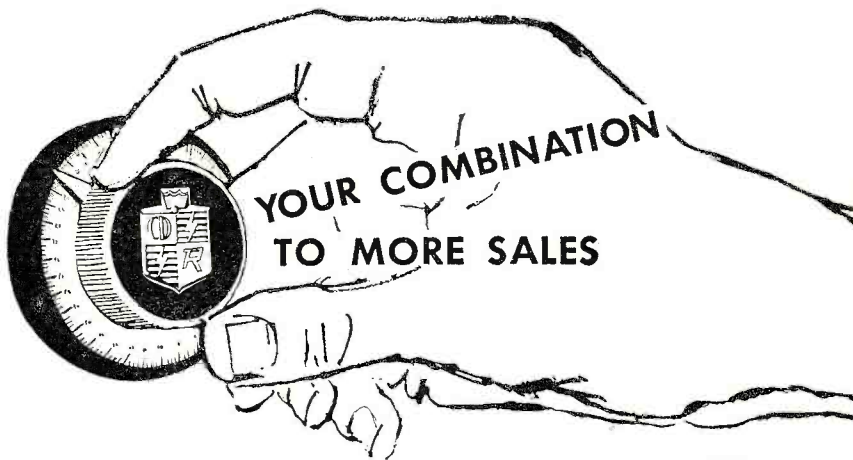

### THE COMPLETE LINE

... a model for every need... whatever the application there is a CDR Rotor that meets the situation best!

### PRE-SOLD FOR YOU!

The greatest coverage and concentration of full minute spot announcements on leading TV stations in every major rotor market is working for YOU...pre-selling your customers!



**CORNELL-DUBILIER**

SOUTH PLAINFIELD, N. J.



**THE RADIART CORP.**

CLEVELAND 13, OHIO

RADIO & TELEVISION NEWS is published monthly by Ziff-Davis Publishing Company, William B. Ziff, Chairman of the Board (1946-1953), at 64 E. Lake St., Chicago 1, Ill. Entered as second-class matter July 21, 1948, at the Post Office, Chicago, Ill., under the act of March 3, 1879. Authorized by Post Office Department, Ottawa, Canada, as second-class matter. SUBSCRIPTION RATES: Radio & Television News—one year U. S. and possessions, and Canada \$4.00; Pan-American Union countries \$4.50; all other foreign countries \$5.00.

Publisher  
**OLIVER READ, D.Sc., W1ETJ**

Editor  
**WM. A. STOCKLIN, B. 5**

Technical Editor  
**MILTON S. SNITZER**

Service Editor  
**CHARLES TEPPER**

Associate Editor  
**P. B. HOEFER**

Assistant Editor  
**J. JUSTER**

Television Consultant  
**WALTER H. BUCHSBAUM**

Art Editor  
**FRANK SAYLES**

Art Department  
**J. A. GOLANEK**  
**W. K. VAHSING**  
**JAMES A. ROTH**

Advertising Director  
**L. L. OSTEN**

Advertising Manager  
**MURRAY GOLDMAN**

Midwest Adv. Manager  
**JOHN A. RONAN, JR.**

Western Adv. Manager  
**JOHN E. PAYNE**



*First in radio-  
television-audio-electronics*

Average Net Paid Circulation 258,790

Radio News Trademark Reg. U. S. Pat. Office • Television News Trademark Reg. U. S. Pat. Office.

## CONTENTS

NOVEMBER, 1956

### EDITORIAL—INDUSTRY NEWS

For the Record.....	O. Read	8
Spot Radio News.....	Washington Correspondent	10
Picture-Phone Uses Telephone Lines.....		43
Designs of the Future.....		47
The "Wamoscope"—a Picture Tube That Includes Many Receiver Functions.....		105
New Call Letter Assignments.....		113
Radio Astronomers "Tune In" on Venus.....		116
Large Computer Keeps Signal Corps' Records.....		118
Longest Range Shipborne Radar.....		120

### HIGH FIDELITY AND AUDIO

The "Distributed Port" Loudspeaker Enclosure.....	Adelore F. Petrie	37
All Transistor Hi-Fi Amplifier.....	Hugh R. Lowry	44
Realistic High Fidelity—Horn Loudspeakers and Enclosures (Part 8).....	H. A. Hartley	51
A Volume Expander for Hi-Fi.....	J. W. Topham	54
How to Choose a Tape.....	Nat Welch	58
Certified Record Revue.....	Bert Whyte	62
New Technique for Loudspeaker Loading.....	Mort Wimpie	63
Tube Types for Audio Use.....	M. B. Knight	64
New Transformer Design for Power Amplifiers.....	Charles Graham	72
Distortion & Phase-Splitter Unbalance in Push-Pull Amplifiers.....	Nathan O. Sokal	142
Bandpass and Rejection Filters.....	Alvin G. Sydnor	148
New Hi-Fi—Audio Equipment.....		150
Our Cover.....		158

### SERVICING

#### Television-Radio

The "G-Line" Community TV System.....	Robert B. Gary	40
New RCA Color TV Circuits.....	Walter H. Buchsbaum	42
Factory Branch Servicing.....	William Leonard	67
New Emerson Color Receivers.....	Warren Philbrook	68
Mac's Service Shop.....	John T. Frye	76
Antenna News.....		126
Projection Tube Protection.....	Daniel Peters	136
Service Industry News.....		164

#### Test Equipment

A Test Instrument Calibrator for the Service Shop.....	Milton S. Kiver	48
Deflection Circuit Analyzer.....	Winston Starks	50
A Handy Troubleshooter.....	Jesse Dines	56
A Multi-Purpose Probe.....	Nels Mattson	57

### ELECTRONIC THEORY AND CONSTRUCTION

An Air Raid Alarm for Home Receivers.....	J. M. Jacobson & L. E. Tank	60
The "Electro-Tach".....	Harry B. Cordes	70
A Two-Tube Binaural Receiver.....	James J. Brophy	94
Useful Transistor Follower.....	Rufus P. Turner	166
Electronic "Organ" from Toy Piano.....	Alvin G. Sydnor	190

### DEPARTMENTS

Within the Industry.....	22	What's New in Radio.....	177
Manufacturers' Literature.....	132	Technical Books.....	185
Sales Aids.....	146	Calendar of Events.....	188



ZIFF-DAVIS PUBLISHING COMPANY  
WILLIAM B. ZIFF (1898-1953) FOUNDER  
Editorial and Executive Offices  
366 Madison Ave., New York 17, N. Y.  
MU 7-8080

VOLUME 56 • NUMBER 5



Member  
Audit Bureau of  
Circulations

© 1956 by Ziff-Davis Publishing Company. All rights reserved.

**SUBSCRIPTION SERVICE:** All communications concerning subscriptions should be addressed to Circulation Dept., 64 E. Lake St., Chicago 1, Ill. Subscribers should allow at least four weeks for change of address. Include your old address as well as new—enclosing, if possible, an address label from a recent issue of this magazine.

**CONTRIBUTIONS:** Contributors are advised to retain a copy of their manuscripts and illustrations. Contributions should be mailed to the New York Editorial Office and must be accompanied by return postage. Contributions will be handled with reasonable care, but this magazine assumes no responsibility for their safety. Any copy accepted is subject to whatever adaptations and revisions are necessary to meet the requirements of this publication. Payment covers all author's, contributor's, and contestant's rights, title, and interest in and to the material accepted and will be made at our current rates upon acceptance. All photos and drawings will be considered as part of the material purchased.

RADIO & TELEVISION NEWS



**JACK DEMPSEY**  
Former World's Heavy-weight Boxing Champion  
Long-time friend and supporter of DeVry Tech.

Jack Dempsey says:

**"Find Out TODAY How YOU MAY TRAIN AT HOME**

**For Great Opportunities in TELEVISION RADIO • ELECTRONICS**



**Nick Barton, Illinois,** a DTV grad, now has his own business and tells us he is "literally snowed with work."



**George D. Crouch, California,** was a retail store clerk. He took the DeVry Program, and today is in business for himself.

Get the Facts

**FREE** from

**DEVRY TECH**

See, too, How DeVry Tech Helps A Man Get Started in this Field



It costs you nothing to find out, and it may mean the turning point in your life. Let DeVry Tech tell you if you have the basic qualifications. Send in the personal rating chart today. Get the free leaflet, "89 Ways to Earn Money in Television-Radio-Electronics."

**Free Sample Lesson**



Let us give you without cost a Sample Lesson. See for yourself how easy it is to follow. DeVry Tech's down-to-earth instructions, practical training experiments, the test equipment you build and KEEP, the exclusive home training films... make learning simple and fast. Subject matter is broken down small enough and clearly enough for you to absorb it.

**Get These Added Benefits**

Whether you train at home or in our large, well-equipped, million-dollar Chicago Laboratories, you are not tied to a long-term contract... You have the privilege of canceling the program at any time.

ARE YOU DRAFT AGE? Mention it when you mail the coupon. We have valuable information for you.

Member of National Home Study Council



**DEVRY TECHNICAL INSTITUTE**

CHICAGO 41, ILLINOIS

FORMERLY

DEFOREST'S TRAINING, INC.

"One of America's Foremost Electronics Training Centers"

Fill Out This Chart and Mail with Coupon... No Obligation!

**PERSONAL RATING CHART**

- AGE**—If you are between the ages of 17 and 55, place the numeral 5 in the square at right. If above or below those ages, mark yourself 3.
  - EDUCATION**—If you have graduated from high school, mark 5 in the square at right. If you finished 8th grade, mark 3.
  - DEPENDENTS**—If you are free to come to Chicago, rate yourself 5. If you prefer to study at home and hold your present job, put down the number 3.
  - ABILITY**—If you've had any experience in handling a soldering iron or doing simple home wiring, rate yourself 5. If you feel you can follow simple "How-to-do-it" instructions, mark down 3.
  - AMBITION**—Are you interested in training for a real future in a promising field? Mark down 5. Or do you simply want to prepare for a better job with more money? Put down 3.
- If you are subject to military service, please mark "X" here.

**MAIL CHART AND COUPON NOW!**

DeVRY TECHNICAL INSTITUTE  
4141 Belmont Ave., Chicago 41, Ill., Dept. RN-11-M

I would like late facts about the many opportunities in Television-Radio-Electronics, including the 3 free publications, and how DeVry Tech may prepare me for my start in this billion-dollar field.

Name \_\_\_\_\_ Age \_\_\_\_\_  
Please Print

Street \_\_\_\_\_ Apt. \_\_\_\_\_

City \_\_\_\_\_ Zone \_\_\_\_\_ State \_\_\_\_\_

DTI's training is also available in Canada  
1049



"My interest is music—and I'm sensitive to distorted or uneven notes. I compared the sound, and then decided that the Garrard RC 121 gave better performance. The music comes over clean and clear...without wows, flutter, or rumble."

"We live on a budget

—and want the best our money can buy. The RC 121 Garrard gives us the 'top' in record changers at a price we can afford. It comes pre-wired, so easy to install that I did it myself."



"Radio service men have been waiting for the new Garrard RC 121. It's the first Garrard changer that fits into any cabinet. It will play for years, keep my customers satisfied. And parts are always available."

"I'm an engineer, and I can understand why the Garrard is called the world's finest record changer. It has heavy-duty steel construction, adjustable levers, a lot of quality playing features, and it is put together carefully."



"My friends at school all like the Garrard RC 121. When I'm alone and just listening, I play records one at a time, by hand. For dancing or background music while I'm studying, the changing and mixing features of the RC 121 are perfect."

"I'm an old hand at high fidelity. Being critical about sound, I like to experiment. I find that the new RC 121 won't hum with the most sensitive pickup, has the easiest adjustments for stylus pressure on any changer, and tracks without resonance or distortion."



There's something exciting for everyone in this entirely new

# GARRARD

World's Finest Record Changer

**RC 121**

"Renown"

\$42.50

one of 3

brilliant new

record changers



**HEAVY STEEL PRECISION TURN-TABLE:** A full inch high. Eliminates magnetic hum by strengthening motor shielding. Fly-wheel action. Silent, free-wheeling, ball-bearing turntable mount.

**GENUINE RUBBER TRACTION MAT:** Exclusive raised tread—adapts itself to contours of your records; protects grooves.

**TRUE-TURRET DRIVE:** Eliminates vibration, plays records at perfect, constant speed. Single turret, direct operation without belts.

**EXCLUSIVE SENSI-MATIC TRIP:** Sure operation even with tone arm set at lowest tracking pressures. Quiet, safe, gentle to records.

**4-POLE SHADED "INDUCTION SURGE" MOTOR:** Constant in speed, with minimum vibration. Smoothest, quietest, most powerful type. No hum, even with sensitive pickups. Self-aligning Oilite bearings. Exclusive dynamically-balanced rotor.

**FULL MANUAL POSITION:** Fingertip control adds to your automatic changer the advantages of a manual record player. Professional-type finger lift.

**STEEL MONO-BUILT UNIT PLATE:** Years of trouble-free service. Exclusive SNAP MOUNT springs mount changer instantly; can be levelled from top!

**EASIEST STYLUS PRESSURE ADJUSTMENT ON ANY CHANGER:** Protects delicate record grooves! Stylus Pressure set with easily-accessible knob on tone arm.

**Exclusive! TRUE-TANGENT TONE ARM OF ALUMINUM:** Plays better by eliminating resonance, providing greater rigidity, low mass, and lightness.

**INTERCHANGEABLE PLUG-IN HEADS:** Accommodate your choice of pickups. Fit all cartridges—crystal, ceramic, or magnetic; turnover, twist or plug-in types.

**READY FOR PLUG IN!** 6-ft. U-I approved electric cord and pickup cable, standard jack. No soldering, tools required.

**SIMPLI-MIX OPERATION:** You load records of any standard diameters in size order on fixed spindle. Automatic spindle for 45rpm records optional.



The Garrard-RC 121 "Renown" is everyone's quality record changer... engineered to bring you unmatched craftsmanship and features in a compact, economical unit. Whether you are assembling your first high fidelity system or rebuilding an old set, this fine Garrard changer meets every requirement. See it, test it — and you'll agree.

Now there's a GARRARD for every high fidelity system. Write for B.I.C. Plan Book.



301 Turntable \$89.00



RC 98 Super Changer \$67.50



RC 88 Deluxe Changer \$54.50



RC 121 Mixer Changer \$42.50



Model T Manual Player \$32.50

**GARRARD—A quality endorsed product of the B.I.C. group.**

BRITISH INDUSTRIES CORP., Dept. GS-46  
Port Washington, N. Y.  
Please send B.I.C. High Fidelity Plan Book.  
Name..... Address..... City..... State..... Zone.....

# HOW TO PASS Your FCC Commercial LICENSE EXAMS\*

**GET YOUR FCC LICENSE IN A HURRY!**

**We Guarantee\***  
to train you  
until you receive  
**Your FCC License**

\* See Free Catalog for complete details  
**Cleveland Institute training results in success  
with commercial FCC examinations  
.... easily .... and quickly**

**Here's Proof:**

Name and Address	License	Time
Walter Eggers, Pacific Grove.....	1st	12 weeks
Paul Reichert, West Salem, Ohio.....	2nd	10 weeks
Harold Phipps, LaPorte, Indiana.....	1st	28 weeks
John H. Johnson, Boise City, Okla.....	2nd	12 weeks
James Faint, Johnstown, Pa.....	1st	26 weeks

(Names and addresses of trainees in your area sent on request)

**Cleveland Institute training results in job offers like these:**

**Radio Operators & Technicians**

American Airlines has openings for radio operators and radio mechanics. Operators start at \$334.53 per month. Radio mechanic's salary up to \$1.99 per hour. Periodic increases with opportunity for advancement. Many company benefits.

**Electronic Technicians**

Convair Electronics Department: Radio and Radar Mechanics, Electronics Technicians, and Junior Engineers are wanted for a special program on fire control development and installation. Beginning rate: \$365 and up.

**And our trainees get good jobs**

**Electronics Technician**

"I am now employed by the Collins Radio Company as a Lab Technician. (This job was listed in your bulletin.) I have used the information gathered from your course in so many ways and I know that my training with Cleveland Institute helped me a great deal to obtain the job."

**Charles D. Sindelar, Cedar Rapids, Iowa Airlines**

"I replied to the Job Opportunities you sent me and I am now a radio operator with American Airlines. You have my hearty recommendation for your training and your Job-Finding Service."

**James H. Wright, Beltsville, Md.**

**CLEVELAND INSTITUTE OF RADIO ELECTRONICS**  
Desk RN-96, 4900 Euclid Bldg., Cleveland 3, Ohio.

We can train you to pass your License Exams if you've had any practical experience —amateur, military, radio servicing, or other. Our proven plan can help put you on the road to success.

\*Your FCC ticket will be recognized by employers as proof of your technical ability.

**MAIL COUPON NOW**

and get  
all 3 books  
**FREE**



Member National Home Study Council

**Cleveland Institute of Radio Electronics**

Desk RN-96, 4900 Euclid Bldg., Cleveland 3, Ohio.

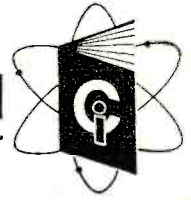

Please send Free Booklet prepared to help me get ahead in Electronics. I have had training or experience in Electronics as indicated below:

- |   |   |
|---|---|
| <input type="checkbox"/> Military           | <input type="checkbox"/> Broadcasting       |
| <input type="checkbox"/> Radio-TV Servicing | <input type="checkbox"/> Home Experimenting |
| <input type="checkbox"/> Manufacturing      | <input type="checkbox"/> Telephone Company  |
| <input type="checkbox"/> Amateur Radio      | <input type="checkbox"/> Other              |

In what kind of work are you now engaged? \_\_\_\_\_

In what branch of Electronics are you interested? \_\_\_\_\_

Name \_\_\_\_\_ Age \_\_\_\_\_

Address \_\_\_\_\_

City \_\_\_\_\_ Zone \_\_\_\_\_ State \_\_\_\_\_

Special Tuition Rates to Members of Armed Forces

**NOW-  
BROADCAST  
QUALITY**

For **P.A.**

**E-V 664**

**VARIABLE D\*  
CARDIOID**

**DYNAMIC MICROPHONE**

Every public address installation... every tape recorder... radio amateur rig... can have all the advantages of the E-V Variable D\* principle now used to give better quality in television and broadcast service. This new high-fidelity "664" has a uniform cardioid polar pattern at all frequencies. Provides such high front-to-back discrimination that unwanted sounds are reduced by two-thirds, without close-talking boominess... gives clear, natural reproduction of voice and music... almost doubles working distance from microphone. Exclusive E-V features make the "664" highly resistant to mechanical shock and climatic conditions... guarantee extra rugged service indoors and out. Can be used on floor or desk stand or carried in hand.

**Model 664. Variable D\* Super-Cardioid Dynamic Microphone.** Uniform response 40-15,000 cps. Output level -55 db. Impedance 150 ohms and Hi-Z. Exclusive Acoustalloy diaphragm. Breathblast filter. Pressure cast case, satin chrome finish. 18 ft. cable. List price .....\$82.50

\* E-V Pat. Pend.

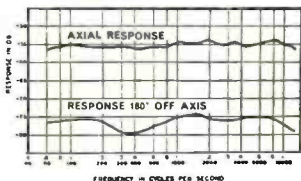

Smooth, peak-free response and high output permit higher sound level without feedback.

See your E-V Distributor or write for Catalog 124-N611

**Electro-Voice®**

ELECTRO-VOICE, INC. • BUCHANAN, MICH.  
Export: 13 E. 40th St. N.Y. 16, Cables: Arlab

*For the* **RECORD.**

**SHOW TIME**

**E**ARLY fall is traditionally the time of year when the Electronics Industry brings forth numerous products and reveals details on its new developments. The record-breaking attendance at the annual Wescon Show in Los Angeles serves to point up the steady growth of this industry, particularly in the engineering category. This show, which is attended principally by engineers, has once again illustrated the ever-increasing use of electronics in the industrial and automation fields.

Following close on the heels of the Wescon Show was the annual conference and exhibit sponsored by the Instrument Society of America. This annual conference is now recognized as the Automation Industry Show. While the characteristics are similar to those of other shows at the engineering level, there is found here a maze of gadgetry which serves to illustrate the tremendous strides made by electronics in the field of automation and control. Represented at this automation show was a model of a new mechanical governor, designed to replace conventional electrical type governors in gas-turbine locomotives, as developed by the *Woodward Governor Company*. An intriguing device was shown by *North American Philips* in the form of a gadget which liquefies gases in minutes by means of a machine of simple design and compact construction. A new heat detector or pyrometer produced by *Servo Corporation* detects, reports, and controls temperature variations without any interruption of process, and *Baird Associates* displayed a newly designed instrument called a "Turbistat" permitting continuous monitoring of turbidity in fluids and one permitting measurement of suspensions as low as 0.05 part in a million.

Another new device, consisting of a small turbine wheel encased in a small section of pipe and linked with an electrical coil, is designed to be connected to a computer to provide "flow-metering."

One of the larger companies had a huge trailer truck filled with a maze of exhibits. Other developments were instruments designed as part of systems of various types. *International Business Machines* showed its new automatic production recording system. This amazing device literally collects many sorts of production data and makes a permanent record for future use. Another new data processing system capable of analyzing hundreds of temperatures, pressures, and flows was displayed by *Beckman Instruments*. As soon as conditions fall outside of the

prescribed limits, the machine automatically shuts down the process. Other devices were demonstrated including a new lens, infrared gas and liquid analyzers, and an instrument developed by *Federal Telephone and Radio Company* known as a "tera-ohmmeter." These sensitive instruments are capable of measuring electrical resistances up to millions of megohms.

The most recent of the important fall shows was the 1956 Hi-Fi Show sponsored by the Institute of High Fidelity Manufacturers. All of the new developments in the high-fidelity field were displayed but the products, in contrast to those observed in other shows, were not as sensational. Increasing interest is now being shown in various designs of electrostatic loudspeakers and systems. The development of these devices points to their ultimate acceptance by the public for use in their hi-fi systems. Most of them were found to provide a tone quality characteristic of their very own. We particularly liked the dispersion of sound provided.

Audio amplifiers have steadily improved to the point where we sometimes wonder if further improvements are needed. Transistors have replaced the vacuum tube in several preamplifiers and in other components, and these new instruments provide reproduction free from any audible hum.

The editors of *RADIO & TELEVISION NEWS* played host to several thousand visitors at the Hi-Fi Institute Show. An authentic 1890 recording studio was reconstructed and placed on exhibit and, in addition to its historical significance, served to illustrate progress made since Mr. Edison invented the phonograph in 1877. Early battery-operated phonographs from this writer's historical collection, together with authentic recording horns used personally by early recording artists at the Edison studio, were included in this unique demonstration. Other historical machines displayed during the show served to illustrate the evolution of the phonograph "from tinfoil to hi-fi." We enjoyed meeting and talking with many of our readers during this show and we regret that it was not possible for more of you to visit our exhibits.

All of these various shows serve to illustrate the tremendous strides made by electronics and provide a common meeting ground for those having specific interests. The public, through the daily press, is more than ever cognizant of the contributions made by our industry and the effects of electronic wizardry on their daily lives. . O. R.



# free!

# ALLIED'S 1957 value-packed 356-page CATALOG



the only COMPLETE catalog  
for everything in electronics

*World's Most Complete Stocks*

- Latest Hi-Fi Systems and Components
- Super-Value KNIGHT-KITS • P. A. Systems and Accessories • Recorders and Supplies • TV Tubes, Antennas, Accessories • Amateur Receivers, Transmitters, Station Gear • Test and Lab Instruments
- Specialized Industrial Electronic Equipment • Huge Listings of Parts, Tubes, Transistors, Tools and Books...

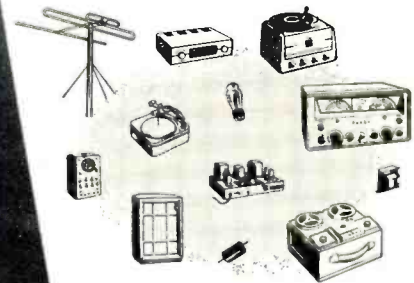

## FEATURING

**SUPER-VALUE knight-kits:** Finest electronic equipment in money-saving Kit form—Test Instruments, Hi-Fi kits, Hobbyist kits, Ham kits. Easiest to build and you SAVE MORE.

**EVERYTHING IN HI-FI:** World's largest selection of quality Hi-Fi components and complete music systems—available for immediate shipment from stock. Own the best in Hi-Fi for less!

**EASY-PAY TERMS:** Only 10% down, up to 18 months to pay. Available on orders over \$45. Fast handling—no red tape.

Get ALLIED's 1957 Catalog—it's complete, up-to-date—356 pages packed with the world's largest selection of quality electronic equipment at lowest, money-saving prices. Get every buying advantage at ALLIED: fastest shipment, expert personal help, lowest prices, guaranteed satisfaction...

send for the leading  
electronic supply guide



ALLIED RADIO CORP., Dept. 1-L-6  
100 N. Western Ave., Chicago 80, Ill.

Send FREE 356-Page 1957 ALLIED Catalog

Name .....

Address .....

City ..... Zone ..... State .....



*Our 36th year*

## ALLIED RADIO

World's Largest Electronic Supply House

November, 1956

# NEW

## THE Complete Line OF Electronics Hand Tools



### Look for this Bright New PROTO Display

PROTO offers a complete line of user-tested, professional tools for the electronics industries. This new self-service display offers you 109 PROTO Tools to choose from, including:

**Hex Nut Drivers • Pliers • Screwdrivers • Wire Strippers • Nippers • Snips • Ratcheting Wrenches • Midget Wrenches • All-Angle Drills • Grab-Alls and many other tools.**

Send 10¢ for catalog of entire line to **PROTO TOOLS**

2225 Santa Fe Ave., Los Angeles 54, Calif.  
Eastern Warehouse & Factory, Jamestown, N.Y.  
Canadian Factory, London, Ont.

5690



# Spot Radio News

\* Presenting latest information on the Radio Industry.

By RADIO & TELEVISION NEWS'  
WASHINGTON EDITOR

**ONE OF THE BOLDEST** moves in the legal history of TV hit the Commission during the closing weeks of summer. Colorado Governor Ed Johnson, who as a Senator served as chairman of the Senate Interstate and Foreign Commerce Committee, chose to defy the FCC's order shutting down unlicensed TV booster stations in his state, and issued a trio of executive orders which have the effect of *authorizing* continuance of booster operations in Colorado.

The Johnson order confounded the FCC's legal braintrust, who admitted that they'd have to accept the situation, until the courts decide who is right. At present, there is a test case pending in the U. S. Court of Appeals in Washington, and until the decision is made here, the FCC attorneys said that they are . . . "not going to tangle with Gov. Johnson."

In explaining his act, Gov. Johnson declared that he wanted to test the . . . arbitrary and incomprehensible action of the FCC to deny entertainment and education to the people of isolated areas."

**THE ALL-OUT PUSH** to upgrade the ultra-highs and develop a more effective high-band service will soon be on its way, according to FCC Chairman George C. McConaughy.

In an address before the broadcasters in White Sulphur Springs, Virginia, he said that all segments of industry are being invited to formulate means of organizing a research program that will place u.h.f. in its proper domain. Acknowledging the fact that the road ahead is not smooth, the Commission's headman said that the present plan and goal . . . offers the best hope on the horizon for facilitating the expression of this nation's TV service to the levels where ingenuity, spurred by active competition, can carry it."

Despite the size of the problem, the Commissioner added, he felt that the task would be completed, for the engineers are surely capable of finding the answers here, as they have found answers to more complex problems. "As a citizen of a country which can send its aircraft hurtling through the air at speeds approaching 2000 miles an hour," the government spokesman continued, "how can I doubt the ca-

capacity of the engineers of this industry to surmount the obstacles which until now have impeded progress in the utilization of the u.h.f. portion of the spectrum for effective TV broadcasting."

Noting that any changeover to the higher bands would have to be gradual, the FCC's chairman said that he wanted to emphasize the fact that . . . there is no thought of precipitous action which at a single thrust would obsolete v.h.f. receiving and transmitting equipment in which the public and broadcasters have made tremendous investments. But every receiver has a limited life span, and depreciation at permissible rates can meet the financial problems of v.h.f. broadcasters, who may at some future date be required to replace their present facilities with u.h.f. equipment."

Some in industry felt that the Commission should go a step further in their present probe and conduct an all-out study of the entire spectrum, to bring the present allocation table up to date with national requirements. Noting that in the fifteen years since the Commission made its first study, much has taken place on all of the bands, one expert said that . . . the expansion of the communications field and the electronics industry has been so rapid that future growth is being seriously curtailed by lack of spectrum space in many services. In addition to the TV problem, it was noted, communications systems used by police, fire, and other emergency services are seriously handicapped, because they cannot expand beyond the space that is presently being allocated for their operation.

"The spectrum space is not, in many cases, being used effectively," the specialist added. Comparing the situation to present-day traffic conditions faced by most cities, he said: "What a mess we could be in if our highways were limited to a plan originally developed in 1941."

Unfortunately, it was pointed out, the nation's communications system is in the same situation. "In some cases we are running up one-way streets when we should be on modern double-lane highways."

**PLANS TO CONSTRUCT** a multi-million dollar facility to test compo-

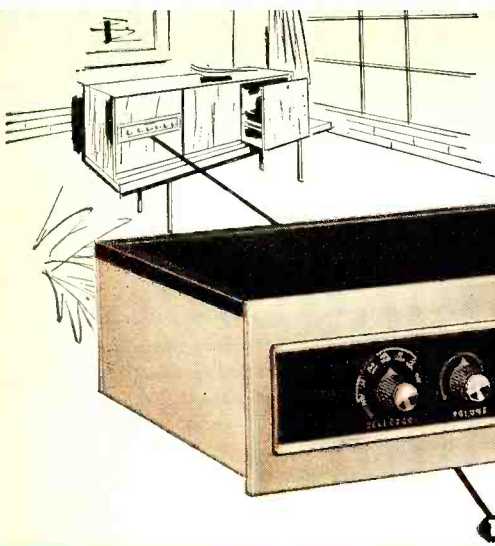

In **Electro-Voice** Amplifiers  
As in its Speakers...Superiority is the Standard

Electro-Voice superiority is superbly evident in its Model A20CL 20-Watt Circlotron Amplifier.

The E-V A20CL is a self-contained preamplifier, amplifier and music control center for use with any phonograph cartridge, AM/FM tuner, television and tape recorder. It features the Circlotron circuit and unique "Presence" control; Power: 20 watts rated, 40 watts peak output. Response, 20 to 20,000 cps  $\pm$  1.0 db. Distortion: Harmonic, less than 0.5%; I. M., less than 0.8%. Hum and noise: 75 db below rated output. Controls include (1) Playing Selector (tuner, 6-position phono equalizer, tape, TV, Auxiliary). (2) Volume. (3) Loudness. (4) Presence. (5) Treble. (6) Bass. Ceramic-Magnetic phono selector switch, Critical Damping. Output impedances: 4, 8, 16 ohms. High impedance tape recorder output. Net . . . . . \$124.50\*.

**THE E-V CIRCLOTROTON STORY**

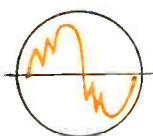

These are switching transients distorting a sine wave. Switching transients are inherent in all conventional push-pull circuits. They result from collapsing current in the output transformer. They cause Listening Fatigue.

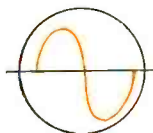

This is a sine wave from a Circlotron Circuit. There is no collapsing current in the output transformer. You get NO switching transients and NO Listening Fatigue.

**YOU CAN HEAR THE DIFFERENCE.**



**THIS IS A FREQUENCY RESPONSE CURVE.**

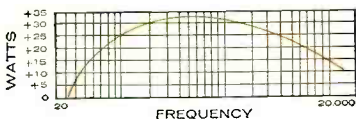

**THIS IS A POWER RESPONSE CURVE.**

Wide frequency response is easy to obtain and much advertised. Wide power response is difficult to obtain and not advertised at all. Conventional amplifier circuits rarely give their rated output at 20 cps or at 20,000 cps. In fact, measured at clipping level, ordinary amplifiers often give as little as 1/10th the power at 20 cycles that they produce at 1,000 cps.



This is the power response curve of an E-V Circlotron Amplifier. You get FULL rated power at 20 cps and FULL rated power at 20,000 cps.

**YOU CAN HEAR THE DIFFERENCE.**



**THIS IS A SINGER IN THE SPOTLIGHT.**



**THIS IS AN ACOUSTIC SPOTLIGHT.**



**THIS IS THE E-V PRESENCE CONTROL.**

The E-V Presence Control spotlights singers, separates them from the orchestra, lets you control the brilliance of your "concert at home." This Presence boost, in the 4,000 cps range, is a technique used by the motion picture industry to enhance the intimate quality of screen dialogue. And only Electro-Voice gives you amplifiers with Presence Control.

**YOU CAN HEAR THE DIFFERENCE.**

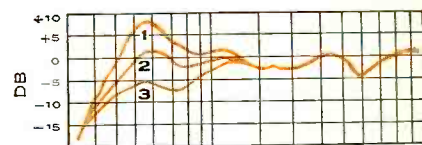

- 1 This is an underdamped speaker.
- 2 This is an E-V critically damped speaker.
- 3 This is an overdamped speaker.

Underdamping adds "muddy" bass to music by allowing too much movement of the speaker cone. Overdamping subtracts bass from the music by stopping the speaker cone too quickly. Critical Damping lets amplifier control speaker movement with precision . . . reproduces all the music—adds or subtracts nothing. Only Electro-Voice has Critical Damping.

**YOU CAN HEAR THE DIFFERENCE.**

**EACH E-V AMPLIFIER UNCONDITIONALLY GUARANTEED TO MEET OR EXCEED PERFORMANCE SPECIFICATIONS . . . AN EXCLUSIVE E-V GUARANTEE!**

**SEE YOUR E-V HIGH-FIDELITY DISTRIBUTOR OR WRITE FOR BULLETIN 222-N611**

\*Price slightly higher west of Rocky Mountains.

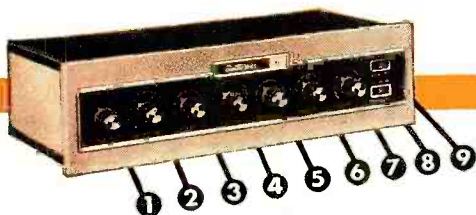

**E-V Model PC1 Music Control Center.** Beautiful preamplifier-equalizer unit for use with all amplifiers. Has self-contained, shielded, low-noise power supply. Controls include: (1) Power. (2) Playing Selector: tuner, tape, TV, Aux., 6-position phono-equalizer. (3) Volume. (4) Loudness. (5) Exclusive E-V Presence Control. (6) Treble. (7) Bass. (8) 3-position scratch filter. (9) 3-position rumble filter. Response  $\pm$  1 db 20 to 20,000 cps. Distortion: Harmonic, less than 0.3%; I. M., less than 0.5%. Hum and noise: 75 db below rated output. Net . . . . . \$99.50\*.



**E-V Model A30 Circlotron Amplifier.** An excellent companion unit to PC1 preamplifier. Power output: 30 watts rated, 60 watts on peaks. Response:  $\pm$  0.5 db, 20-75,000 cps. Harmonic distortion at rated output less than 0.3%. Intermodulation distortion at rated output less than 0.5%. Hum and noise level: 85 db below rated output. Output impedances: 4, 8, 16 and 70-volt line balanced. Feedback: 28 db negative. Controls include: (1) Power. (2) Critical Damping (adjustable between 0.1 and 15.) (3) Input Level. Net . . . . . \$108.00\*.

NO FINER CHOICE THAN

**Electro-Voice**

ELECTRO-VOICE, INC.  
BUCHANAN, MICHIGAN

Export: 13 East 40th Street,  
New York 16, U.S.A.

Cables: ARLAB

Canada: E-V of Canada Ltd.,  
1908 Avenue Road, Toronto, Ont.

**New Styling...  
New Features...  
A Completely New Line  
from H. H. Scott**

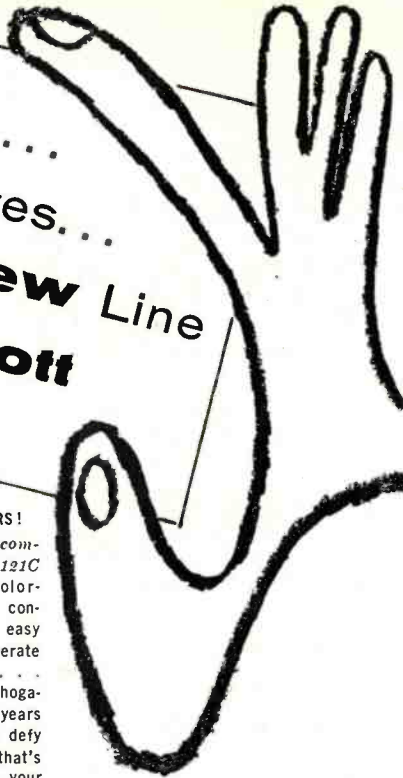

**210E**

**3 NEW FEATURE-PACKED AMPLIFIERS!**

(Models 99C, 210E complete amplifiers, 121C preamplifier) Color-marked Green Dot controls that make it easy for your family to operate your hi fi system . . . smartly designed mahogany cabinets . . . years ahead features that defy obsolescence . . . that's H. H. Scott for '57, your best dollar investment. See for yourself!



**330B**

**4 NEW SUPER-SENSITIVE TUNERS!**

(Models 330B, 331B AM-FM tuners; 311B, 310B FM tuners) For the first time AM that gives you audio response beyond 10 kc . . . FM with new wide-band circuitry that makes drift a thing of the past . . . AM-FM tuners equipped for Stereophonic (binaural) operation. That's H. H. Scott for '57. Hear for yourself!



**280**

**2 COMPLETELY REDESIGNED POWER AMPLIFIERS!**

(Models 240, 280) Exclusive Dynamic Power Monitor on Model 280 affords full output on music, yet protects expensive speakers against burnout . . . variable damping controls for perfect speaker matching . . . new exterior styling . . . clean distortion-free performance typical of all H. H. Scott components. Judge for yourself!

**ALSO SEE THE NEW 710A TURNTABLE**

**Visit your dealer or write today  
for complete technical specs.**

H. H. Scott Inc.  
385 Putnam Ave.  
Cambridge, Mass.



Please rush me your new catalog R-11 and complete technical specifications on H. H. Scott components for '57.

Name .....

Address .....

City .....

State .....

nents, which will make up the super high-power radar systems of the future, have been announced by the Air Research and Development Command.

The test quarters will be located at ARDC's Rome Air Development Center, Rome, N. Y., for use by Air Force engineers and industrial contractors engaged in developing such radar components as transmitters, tubes, diplexers, and waveguides.

The need for the super high-powered detection system is paramount in the ground environment of a defense against intercontinental ballistic missiles (ICBM's). The special checking unit to be built, which will serve as a proving ground, is expected to help in achieving the desired powers under controlled lab conditions.

According to ARDC, the facility should look like the combination of a large commercial power plant and a TV station; equipment will be housed in a completely shielded one and a half-story building, with 40,000 square feet of floor space.

**AS PART OF A PROGRAM** of radio-frequency power-standards development at the Bureau of Standards, an improved r.f. power-measuring bridge using only one thermistor has been designed and built by specialists of the high-frequency electrical standards section of the Bureau at the Boulder Labs.

The operation of a power-measuring bridge is based on the equivalent heating effect of direct-current power and r.f. power when both are dissipated in a purely resistive load. A temperature-sensitive resistor, such as a thermistor or a Wallaston wire, forms one arm of a Wheatstone bridge circuit which is biased with d.c. power until the bridge is balanced. When r.f. power is fed into the thermistor simultaneously with the d.c. bias power, the bridge becomes unbalanced and a quantity of d.c. power must be withdrawn to effect a rebalance. The quantity of d.c. power withdrawn can be equated to the r.f. power.

The approach used in the present improved design eliminates the previous difficulty by using a fixed total amount of direct current, furnished by a constant-current source, diverting the necessary part of this current from a bolometer bridge into a shunt resistor, where it can be measured directly. The more constant the current source, the greater the accuracy, especially at low power levels; thus the over-all usable range is increased.

A simple constant-current source can be improvised from a regulated lab d.c. power supply and a series resistor whose value is about 100 times that of the bridge resistance. The maximum change in the total current, due to load-impedance changes, will then be only about 1 per-cent. Accuracies on the order of 5 per-cent or better can be obtained with such a source and a 50-ohm single-thermistor bridge at power levels of about 1 to 100 milliwatts.

(Continued on page 112)

# ATTENTION: MEN 17 to 55



Handling Materials

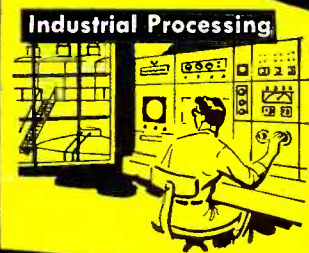

Industrial Processing

Does your present job offer advancement?

PREPARE NOW AT HOME FOR A PROFITABLE CAREER IN

# AUTOMATION ELECTRONICS!

PRACTICAL NEW TRAINING METHOD IS THOROUGH, DOWN-TO-EARTH!

In plant after plant, many machines are being designed to run themselves. This is called "Automation." The jobs of some men who used to run these machines are gradually disappearing. Every year sees more changes; more unskilled jobs being replaced. But it's making many new jobs too—good-pay, solid-future jobs in plants, offices and elsewhere—for men who are trained in Automation Electronics.

**NOW IS THE TIME TO GET YOUR TRAINING**  
The design, operation and maintenance of controls that regulate the new "automatic equipment," is a promising field of the future. It's still uncrowded. There's time to get in on the ground floor if you act now.

**NO PREVIOUS TECHNICAL TRAINING NEEDED**  
Many men 17 to 55, regardless of present job, even men without previous technical training or advanced education, can train for good jobs in Automation Electronics. DeVry Technical Institute offers effective training in your own home with movies, plenty of practical equipment and easy-to-read texts. Or get all of your training in DeVry's large well-equipped training laboratories in Chicago... one of the finest of its kind!

**WE HELP YOU GET STARTED IN THE FIELD**  
When you've completed the DTI training, you'll have the know-how—the practical training you need to hold down a good job in Automation. Our effective Employment Service will help you get

started toward many wonderful and exciting opportunities. You have nothing to lose—and much to gain. Send that coupon now so we can tell you about it.

**MANY SUCCESSFUL GRADUATES**  
For 25 years, DTI has been building men for better jobs. Our files contain many letters from men who have won success in electronics and who give much credit to their DTI training.

**GET INTERESTING NEW BOOKLET**

The interesting story of "Automation and YOU" is yours for the asking. Simply fill in... mail the coupon. See how DeVry's training programs may prepare YOU for a start in this coming new field.

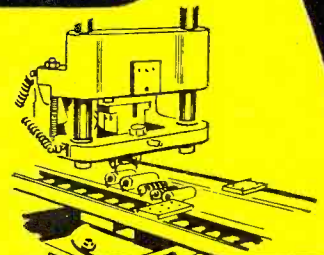

Making Electronic Devices



Recording and Billing

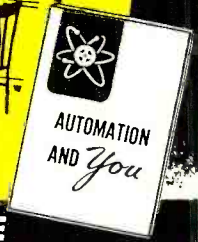

One of America's Foremost Electronics Training Centers

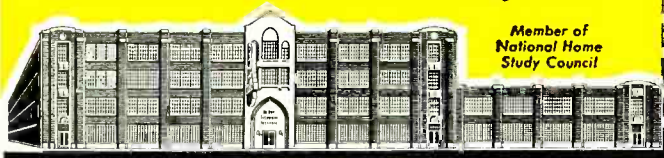

Member of National Home Study Council

**DEVRY TECHNICAL INSTITUTE**  
CHICAGO 41, ILLINOIS  
FORMERLY  
DEFOREST'S TRAINING, INC.

**GET THIS BOOKLET FREE**

DEVRY TECHNICAL INSTITUTE, Dept. RN-11A-M  
4141 Belmont Avenue, Chicago 41, Ill.

I would like further information about the newer Electronic opportunities in AUTOMATION, also facts on how you may help me to prepare.

Name \_\_\_\_\_ Age \_\_\_\_\_  
Please Print  
Street \_\_\_\_\_ Apt. \_\_\_\_\_  
City \_\_\_\_\_ Zone \_\_\_\_\_ State \_\_\_\_\_  
1040 DTI's training is available in Canada

# CHANNEL MASTER

## PUTS NEW SELL IN

DEALERS HAVE SOLD MORE *CHANNEL MASTER* T-W AND SHOWMAN ANTENNAS DURING THE PAST 30 DAYS THAN ANY OTHER ANTENNA DURING ANY 30 DAY PERIOD IN TV HISTORY!

*Isn't it time you called your Channel Master distributor?*

- ✱ Full-Color Ads
- ✱ 2-Page Spreads
- ✱ Full-page Ads



Month after month... all thru the prime TV buying months... this continuing series of sales-stimulating ads is creating loads of lively new prospects... right in your own selling area.

**55,000,000**  
ads building new  
customers and sales for you!

# NATIONAL ADVERTISING TV ANTENNAS!

## "Showman" INDOOR ANTENNA

This smartly styled antenna overcomes consumer objection to ugly "rabbit-ear" antennas. Exclusive "Metro-Dyne" electronic tuning brings in pictures sharp and clear on all VHF channels. Tuning knob with channel markings just like a TV set makes channel selection so easy. It's the most powerful indoor antenna ever developed . . . and it's backed with an **UNCONDITIONAL MONEY-BACK GUARANTEE**. Engineered for Black and White and **COLOR**.

model no.	description
3900	Mahogany & Gold
3901	Blond & Gold
3902	Ebony & Silver

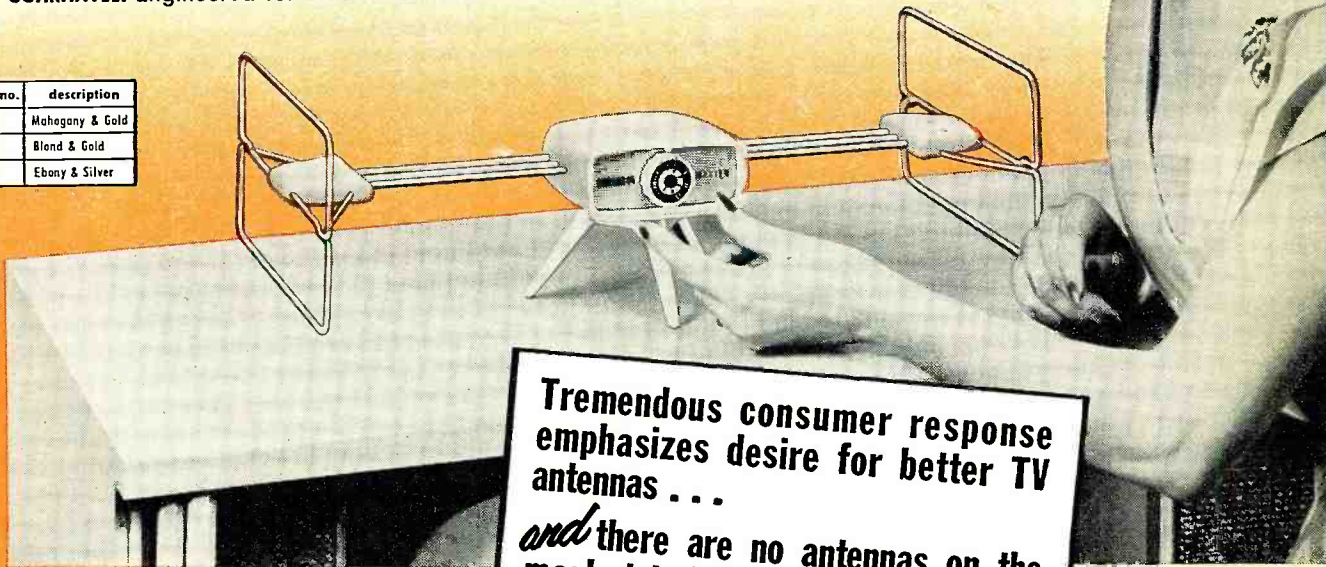

Tremendous consumer response emphasizes desire for better TV antennas . . .

*and* there are no antennas on the market today that compare with these fabulous new Channel Master models.

## T-W OUTDOOR ANTENNA

The revolutionary new T-W is the very first TV antenna to use the "Traveling Wave" principle. This unique design electronically *reinforces* signals . . . *eliminates* "ghosts" and "snow" . . . *rejects* all unwanted signals and interference. In gain, front-to-back ratio, and mechanical strength, the T-W is unequalled by any other Broad Band antenna. Engineered for Black and White and **COLOR**.

model no.	description
350	7-element
350-2	7-element stacked
351	5-element
351-2	5-element stacked
352	3-element
352-2	3-element stacked



**CHANNEL MASTER CORP.**

ELLENVILLE, N. Y.

WORLD'S LARGEST MANUFACTURER OF TV ANTENNAS AND ACCESSORIES

For Pride and  
Practicality . . .  
Specify

# FISHER Fidelity

Usually . . . when a music lover purchases a FISHER high fidelity product, he does so for pride, for quality, for personal satisfaction. On the other hand, it is gratifying to know that — if he preferred — he could have chosen FISHER, the leader in the field, purely on the basis of *economy*. For it has been proven time and again, that FISHER, with the best in technological advancement and beauty of style, is *most practical* to own.

FISHER Modules afford the most complete versatility for practical, step-by-step assembly of a high fidelity music system!

FISHER functional concept of unit-design offers the user the most *economical* means of achieving the ultimate in sound reproduction!

#### THE FISHER FM Tuner • Model FM-40

■ A beautifully designed instrument at moderate cost, for discriminating listeners. Stable circuitry and simplified controls make this remarkable tuner exceptionally easy to use. Meter for micro-accurate, center-of-channel tuning. Sensitivity, 3 microvolts for 20 db quieting. Can accommodate 72 or 300-ohm antenna systems. 8 tubes. Self-powered. CONTROLS: Power On-Off/Volume, Station Selector. OUTPUTS: Detector/Multiplex, plus cathode follower. SIZE: 12¾" x 8¾" x 4" high. WEIGHT: 15 pounds. CABINETS: Blonde (Model UN-B) and Mahogany (Model UN-M.)

\$99.50



FM-40

#### THE FISHER AM Tuner • Model AM-80

■ The high fidelity AM counterpart of the famous FM-80 Tuner. Combines the pulling power of a professional communications receiver with the broad tuning necessary for high fidelity reception. Designed to rigid standards; features a meter for micro-accurate tuning. Three-position adjustable bandwidth. Less than one microvolt produces maximum output. An excellent companion to the FM-80, for those who wish *binatural* reception. Three inputs, cathode follower output. 8 tubes. Self-powered. SIZE: 12¾" x 8¾" x 4" high. WEIGHT: 15 pounds. CABINETS: Blonde (Model UN-B) and Mahogany (Model UN-M.)

\$119.50

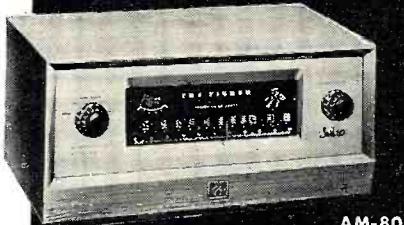

AM-80

#### THE FISHER FM-AM Tuner • Model 80-T

■ Unequaled among FM-AM tuners, Model 80-T is identical to the 80-R — but includes *complete* professional audio control facilities. For general specifications, see Model 80-R below. Model 80-T is the *first* FM-AM tuner with a separate tape head playback pre-amplifier (with NARTB equalization.) Pre-amplifier-equalizer has sufficient gain for lowest level magnetic cartridges. Six record equalization settings. Separate Bass and Treble Controls. DC on all audio tube filaments. Hum level non-measurable with Volume Control at minimum, better than 72 db below 2 volts at maximum position. On phono, better than 60 db below output with 10 millivolt signal. Four inputs. EIGHT CONTROLS: Selector, Variable AFC/Line Switch, Station Selector, Bass, Treble, Equalization, Volume, Calibrated Loudness Balance. SIZE: 12¾" x 8¾" (less knobs) x 6" high. WEIGHT: 21 pounds. CABINETS: Blonde (Model TB) and Mahogany (Model TM.)

\$199.50



80-T

#### THE FISHER FM-AM Tuner • Model 80-R

■ Acclaimed everywhere as the finest FM-AM tuner available. Works where others fail. America's first FM-AM tuner with *two* meters, for micro-accurate tuning. Extreme sensitivity — 1.5 microvolts produces 20 db of quieting. Separate FM and AM front ends, with adjustable AM selectivity and variable AFC for FM. AM sensitivity better than 1 microvolt. Response within 0.5 db from 20 to 20,000 cycles. Distortion below 0.04% for 1 volt output. Inherent hum so low as to be *non-measurable!* Super-smooth flywheel tuning. Shielded, shockmounted chassis. Multiplex, cathode follower outputs. SIZE: 12¾" x 8¾" (less knobs) x 4" high. WEIGHT: 16 pounds. CABINETS: Blonde (Model UN-B) and Mahogany (Model UN-M.)

\$169.50



80-R

#### THE FISHER FM Tuner • Model FM-90

■ *The Finest FM Tuner Made.* The FM-90 definitely sets the standards for the tuner of tomorrow . . . and outperforms *any existing FM tuner!* Micro-accurate tuning combined with extreme sensitivity and flexibility. Equipped with *two* meters, indicating signal strength and center of channel. Dual Dynamic Limiters operate on signals as low as *one* microvolt. Balanced antenna inputs for 72 and 300 ohms. Cathode follower and Multiplex outputs, Shielded and shock mounted. CONTROLS: Interchannel Muting, AFC/Power Switch, Station Selector, Input Level. Response within 1 db from 20 to 20,000 cycles. Sensitivity — 1½ microvolts for 20 db quieting. 10 tubes and 4 crystal diodes. SIZE: A compact 13¾" wide x 8¾" deep x 6½" high. Distinctively styled and housed in a smart metal case with handsome brass and plastic panel. WEIGHT: 16 pounds.

\$149.50

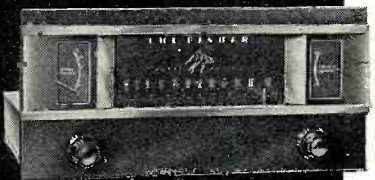

FM-90

Start Now With

# FISHER Fidelity

Depending on individual requirements — whether you are just beginning your high fidelity hobby, or whether you seek to improve an existing system — plan the first step with a practical view toward the future. Devote your budget to basic components. In that way, you can realize *immediate* listening satisfaction . . . with quality FISHER equipment. Moreover you can add to it later, with the same high level of quality.

If you start with phono — choose from the wide selection of FISHER quality amplifier models . . . later, add a tuner for FM, AM or both. Or . . .

If you start with radio — choose a professional tuner and amplifier from the wide range of FISHER models . . . later, add phono facilities, buying the best quality manual or automatic player your budget permits.

For the Best Present . . .  
and Future . . . Plan with FISHER

Free Individual Technical Bulletins are Available  
on All Models — Write Today



# FISHER Exclusives That Make a World of Difference!

Exclusive FISHER Features provide that added measure of control to satisfy all listening requirements. Here is flexibility that obsoletes old-fashioned hi-fi. Here is FISHER FIDELITY... it makes a world of difference.

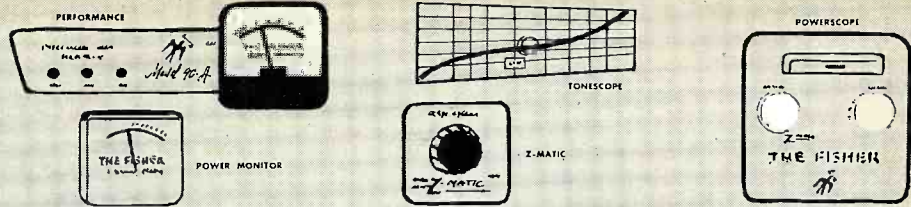

## Progressive Engineering At Its Superlative Best...

### THE FISHER 90-Watt Audio Amplifier

■ 90 watts of audio power, with less than 1/2% distortion at full output. Two power supplies assure optimum operation. FISHER Performance Monitor meter indicates correct adjustments of tube bias, screen voltage and output balance. Shows average power output in watts. Less than 1% IM distortion at 75 watts! Harmonic distortion at 50 watts 1/4 of 1%. Frequency response within 0.1 db, 20 to 20,000 cycles. Hum and noise better than 92 db below full output. 8 and 16-ohm speaker output impedances. Power socket supplies all necessary voltages for operation of unpowered auxiliary components. CONTROLS: Input Level, Speaker Impedance Switch, Meter Switch, Bias, Screen Voltage, Output Balance, Driver Balance, Z-Matic. TUBE COMPLEMENT: 1-12AU7, 1-12AX7, 4-EL34 (6CA7), 1-6Y6, 1-6AU6, 2-5R4GY, 2-NE16. SIZE: 14" x 11 1/2" x 8 3/4" high. WEIGHT: 55 pounds.

\$229.50



90-A



80-C

### THE FISHER Master Audio Control

■ This Master Audio Control matches any amplifier. Provides professional phono and tape-head equalization. Full mixing and fading facilities for from two to five channels. Seven inputs, including two Phono, Mic and Tape. Two cathode follower outputs. IM distortion virtually non-measurable. DC on all filaments. Separate equalization and preamplification directly from tape playback head. Four negative feedback loops, for excellent stability. CONTROLS: Bass, Treble, Master Volume, Two Phono/Tape Equalization, Calibrated Loudness Balance, Line Switch, Five Channel Selector Push Buttons, Five Input Mixer/Level. Self-powered. Three AC outlets. TUBE COMPLEMENT: 3-12AX7, 1-12AU7A. SIZE: 12 3/4" x 7 3/4" x 4 3/4" high. WEIGHT: 10 pounds. CABINETS: Blonde (Mod. CB), Mahog. (Mod. CM)

\$99.50

### THE FISHER 30-Watt Audio Amplifier

■ Incomparable FISHER amplifier with PowerScope, a visual Peak Power Indicator. More clean watts per dollar than any amplifier in its class. 60 watts peak! Three separate feedback loops, resulting in low internal impedance, extremely low distortion, and excellent transient response. Less than 0.5% distortion at 30 watts (0.05% at 10 watts.) IM distortion less than 0.5% at 25 watts. Uniform response within 0.1 db, 20 to 20,000 cycles. Within 1 db, 10 to 50,000 cycles. Hum and noise virtually non-measurable (better than 96 db below full output!) CONTROLS: Z-Matic, PowerScope, Input Level, 8 and 16-ohm output. TUBE COMPLEMENT: 1-12AT7, 1-12AU7A, 2-EL37, 1-5V4G, 1-PowerScope Indicator, 1-Regulator. SIZE: 15 1/4" x 4 1/4" x 6 7/8" deep. WEIGHT: 22 pounds.

\$99.50



80-AZ

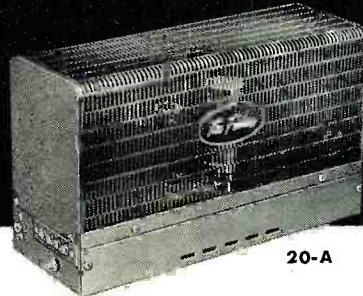

20-A

### THE FISHER 15-Watt Audio Amplifier

■ Low in cost, terrific in quality. It is the amplifier thousands of hi-fi enthusiasts have requested. Meets the most exacting requirements. Traditional FISHER workmanship, handsome appearance. Advanced design throughout. Response within 0.1 db, 20 to 20,000 cycles at 15 watts. Less than 0.7% distortion. IM distortion less than 1.5% at 10 watts. Hum and noise better than 90 db below full output! Internal impedance: 1 ohm for 16-ohm operation, giving damping factor of 16. Assures low distortion and superior transient response. Octal socket provides all necessary AC and DC voltages for operating unpowered auxiliary components. Output impedances 4, 8, and 16 ohms. TUBE COMPLEMENT: 1-12AX7, 2-EL84, 1-EZ80. SIZE: 13" x 4 1/4" x 6 3/4" high. WEIGHT: 13 pounds.

\$59.50

### THE FISHER 55-Watt Audio Amplifier

■ Plenty of power for your present—and any possible future needs. Less than 1% distortion at 55 watts. 110 watts peak. IM distortion below 2% at 50 watts. All-triode design. Exclusive FISHER Power Monitor, an illuminated meter to indicate average audio power and make possible correct adjustment of output tube bias. New Z-Matic Variable Damping Factor Control with three times the range of ordinary controls of this type. Frequency response ±0.1 db, 20 to 20,000 cycles. Hum and noise better than 92 db below full output! 8 and 16-ohm outputs. Minimum internal impedance 0.53 ohms at 16-ohm tap, giving maximum damping factor of 31. Input Level Control. Octal socket supplies all voltages for operating unpowered components. TUBE COMPLEMENT: 3-12AU7A, 2-6CL6, 2-6550, 2-5AW4. SIZE: 14 1/4" x 9 3/4" x 8 3/16" high. WEIGHT: 50 pounds.

\$169.50

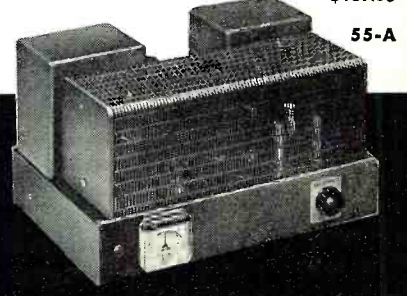

55-A

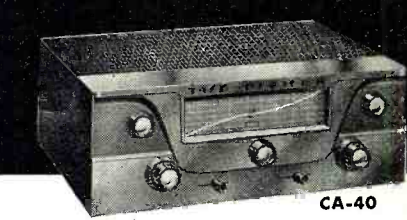

CA-40

### THE FISHER Master Control-Amplifier

■ Complete in every respect—the remarkable Model CA-40 Master Control Amplifier with ToneScope! A 25-watt amplifier with complete Audio Controls. Features ToneScope, an exclusive FISHER first that shows graphically the Bass and Treble Control settings on an illuminated panel. Response 10 to 90,000 cycles, within 0.5 db! Less than 1% distortion at 25 watts. IM distortion 1% at 15 watts. Hum and noise level better than 90 db. Six inputs. Direct tape-head playback and microphone preamp. Tape recorder output. Output impedances: 4, 8, and 16 ohms. CONTROLS: Volume, 4-Position Loudness Contour, Selector/Equalization, Power Switch, Bass, Treble, Rumble Filter, Noise Filter, Input Level. TUBES: 1-12AU7, 3-12AX7, 4-EL84, 2-6BW4. SIZE: 12 3/4" x 10 3/4" x 5" high. WEIGHT: 24 pounds.

\$139.50

## FISHER 'FIRSTS' - Milestones in Audio History

- 1937 FIRST High fidelity sound systems featuring a beam-power amplifier, inverse feedback, acoustic speaker compartments (infinite baffle and bass reflex) and magnetic cartridges.
- 1937 FIRST Exclusively high fidelity tuner, featuring broad-tuning 20,000 cycle fidelity TRF.
- 1937 FIRST Two-unit high fidelity system with separate speaker enclosure.
- 1938 FIRST Coaxial speaker system.
- 1938 FIRST High fidelity tuner with amplified AVC.
- 1939 FIRST Dynamic Range Expander.
- 1939 FIRST Three-Way Speaker in a high fidelity system.
- 1939 FIRST Center-of-Channel Tuning Indicator.
- 1945 FIRST Preamplifier-Equalizer with selective phonograph equalization.
- 1948 FIRST Dynamic Range Expander with feedback circuitry.
- 1949 FIRST FM-AM Tuner with variable AFC.
- 1952 FIRST 50-Watt, all-triode amplifier.
- 1952 FIRST Self-powered Master Audio Control.
- 1953 FIRST Self-powered, electronic sharp cut-off filter system for high fidelity use.

- 1953 FIRST Universal Horn-Type Speaker Enclosure for any room location and any speaker system.
- 1954 FIRST Low-cost electronic Mixer-Fader.
- 1954 FIRST Moderately-priced, professional FM Tuner with TWO meters.
- 1955 FIRST Peak Power Indicator in a high fidelity amplifier.
- 1955 FIRST Commercial Control-Chassis with mixing facilities.
- 1955 FIRST Correctly equalized direct tape-head playback preamplifier in tuners and master controls as well as a separate preamplifier.
- 1956 FIRST To incorporate Power Monitor in a home amplifier.
- 1956 FIRST All Transistorized Pre-Amplifier.
- 1956 FIRST Dynamic limiters in an FM tuner for home use.
- 1956 FIRST Performance Monitor in a high quality amplifier for home use.
- 1956 FIRST FM-AM tuner with two meters.
- 1956 FIRST 90-watt amplifier especially designed for home use.
- 1956 FIRST Complete visual indicator for bass, treble, filter controls and record equalization.

FISHER RADIO CORPORATION • 21-23 44 DRIVE • LONG ISLAND CITY 1, NEW YORK

# INDEPENDENT SCIENTIFIC SURVEY

## PRECISE MODEL #111 PROVED

### "BEST COMMERCIAL TUBE TESTER

### AT ANY PRICE" IN INDEPENDENT SURVEY



# precise

Model #111

## MUTUAL CONDUCTANCE AND EMISSION TUBE TESTER

An independent scientific survey conducted by an impartial testing laboratory confirms what purchasers already know: "The most advanced, the most complete tube tester and the best priced is made by PRECISE DEVELOPMENT CORP., Oceanside, N. Y."

### NOW YOU CAN CHECK TUBES THE MANUFACTURER'S WAY

- Checks both emission and mutual conductance
- Checks all tubes including hearing aid, miniatures
- Six different plate voltages
- Different grid signals
- Simplified Short check
- Gas check
- New type switches
- Deeply etched aluminum panel
- Three different screen voltages
- Latest roll chart
- Measures filament current
- Measures grid bias

# \$79<sup>95</sup>

111K (kit form)

**NOW ONLY**

111W (factory wired) ..... \$139.95  
Incl. carrying case and cover

Prices slightly higher in the West. Prices and specifications subject to change without notice.

### CHECK THESE ADDITIONAL 'specs' ... TALK TO YOUR JOBBER AND TO ANYONE WHO HAS THIS OUTSTANDING TUBE TESTER...

The Model 111 is the only single commercial tube tester that checks all tubes for both EMISSION and MUTUAL CONDUCTANCE separately. Filament current is measured directly on large meter when checking a VOLTAGE SAPPER tube. NEW, MODERN DESIGNED ROTARY SWITCHES allow you to check each tube element individually. NEW TYPE Single Rotary switch for complete short checks. The 111 makes all BIAS,

FILAMENT VOLTAGE, GAS, LIFE checks visually on large meter ... 5 individually calibrated ranges and scales for mutual conductance tests. NEWLY DESIGNED "NO BACKLASH" ROLL CHART lists all tubes including the new type 600 mil series tubes. Provisions are made for testing many color tubes. All CRT's can be checked with accessory adaptor, Model PTA.

SEE THE MANY MORE PRECISE INSTRUMENTS AND PROBES AT YOUR JOBBER TODAY!

# precise

THE FINEST KIT AND WIRED TEST EQUIPMENT

WRITE FOR CATALOG RN 11-6

DEVELOPMENT CORP. OCEANSIDE, NEW YORK, U.S.A.

# You Can Train at Home for Good Pay Jobs in RADIO-TELEVISION

**Fast Growing Industry Offers Good Pay, Security, Bright Future**

**LESSON AND CATALOG FREE MAIL CARD**

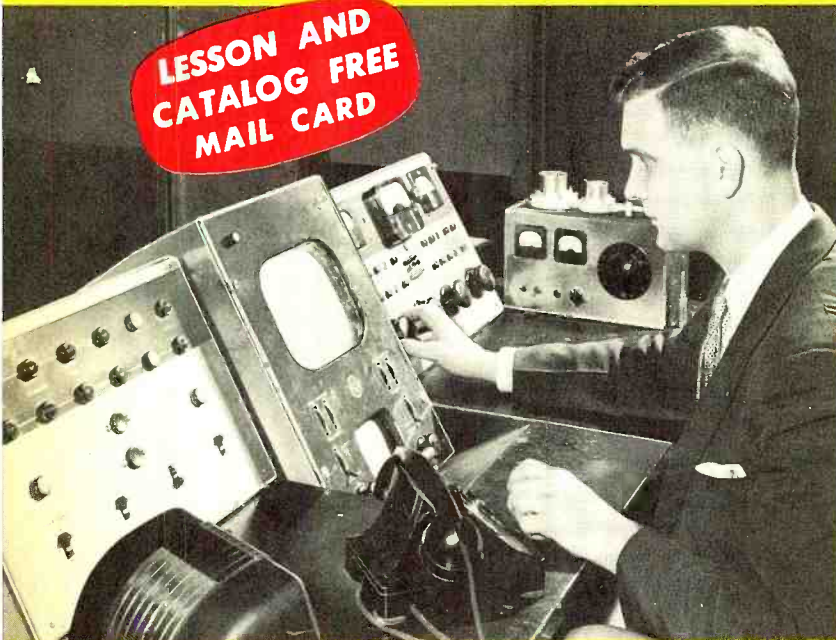

Training PLUS OPPORTUNITY is the ideal combination for success. Today's OPPORTUNITY field is Radio-Television. Over 125 million home Radios plus 30 million sets in cars and 40,000,000 Television sets mean big money, opportunity for trained Radio-Television Technicians. More than 4,000 Radio and TV Broadcasting stations offer interesting and important positions for technicians, operators. Color Television, portable TV sets, Hi-Fi, other developments assure future growth. Radio, Television are both growing. Need for trained technicians is increasing!



## Find Out What Oldest and Largest Home Study Radio-Television School Offers You

Since 1914—for more than 40 years—N.R.I. has been training ambitious men at home in spare time for Radio-TV. Thousands of successful graduates say N.R.I.'s 50-50 training method is a fast, easy, effective way to higher earnings, desirable jobs. Carefully planned experiments and practice with equipment supplied free of extra charge, bring basic principles, techniques to life right in your own home. Find out what dependable training can do for you.

## You Learn by Doing—Get Practical Experience with Kits N.R.I. Sends

Nothing takes the place of practical experience. As part of N.R.I. Servicing Course you build AC-DC Radio Receiver and Vacuum Tube Voltmeter shown below. Use them to make tests, conduct experiments, get practical experience. All equipment yours to keep.

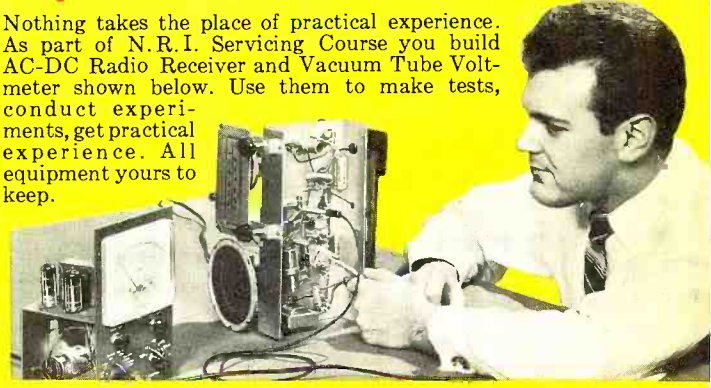

## Add to Your Income Starting Soon

**Make \$10-\$15 a Week Extra Fixing Sets in Your Spare Time**

Soon after enrolling, many N.R.I. students start earning extra money fixing neighbors' radio sets. Many earn enough extra to pay entire cost of course and provide capital to start their own full time Radio-TV business after getting N.R.I. Diploma. If you want a job with a future, find out how you can train at home for Radio-Television. Mail Postage Free postcard for Sample Lesson. See how practical it is to learn at home. Get 64-Page Catalog, too. See equipment you get, outlines of courses, facts about opportunities in this growing field. Prices of N.R.I. Courses are low, terms easy.



**See Other Side**

N.R.I. Training leads to good pay jobs like these. **BROADCASTING:** Chief Technician, Chief Operator, Remote Control Operator. **SERVICING:** Home and Auto Radios, P. A. Systems, Television Receivers, Electronic Controls, FM Radios, Hi-Fi. **SHIP AND HARBOR RADIO:** Chief Operator, Assistant Operator, Radiotelephone Operator. **POLICE RADIO:** Transmitter Operator, Receiver Serviceman. **GOVERNMENT RADIO:** Operator in Army, Navy, Marine Corps, Coast Guard, Forestry Service Dispatcher, Airways Radio Operator. **IN RADIO PLANTS:** Design Assistant, Transmitter Design Technician... **AND MANY OTHERS.**

## N.R.I. TRAINED THESE MEN

### Thanks N.R.I. for Good Start



"Right now I am doing spare-time repairs on Radios and Television. Going into full time servicing soon." **C. HIGGINS**, Waltham, Mass.

### Engineer with Station WHPE



"I operated a successful Radio repair shop. Then I got a job with WPAQ and now I am an engineer for WHPE." **VAN W. WORKMAN**, High Point, N. C.

### Quit Job to Start Business



"I decided to quit my job and do TV work full time. I love my work and am doing all right financially." **W. F. KLINE**, Cincinnati, Ohio

### N.R.I. Started His Way up



"I was a cab driver earning \$35 a week. Then I enrolled with N.R.I. Now tester with TV maker." **J. H. SHEPHERD**, Bloomington, Ind.

**CUT OUT AND MAIL CARD NOW**

# SAMPLE LESSON AND CATALOG BOTH FREE

**NO STAMP NEEDED!  
WE PAY POSTAGE**

This card entitles you to Actual Lesson on Servicing, shows how you learn Radio-Television at home. You'll also receive 64-Page Catalog.

**NATIONAL RADIO INSTITUTE, Dept. E  
Washington 9, D. C.**

Please mail me the FREE sample lesson and 64-Page Catalog. (No Salesman will call.)

Name ..... Age .....

Address .....

City ..... Zone ..... State .....

Approved Member, National Home Study Council

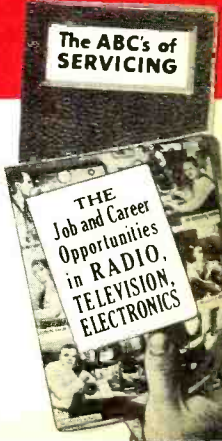

# Practice Servicing-Communications with Kits of Parts N.R.I. Sends



## YOU BUILD AC-DC Superhet Receiver

N.R.I. Servicing Course includes all needed parts. By introducing defects you get actual servicing experience practicing with this modern receiver. Learn-by-doing.

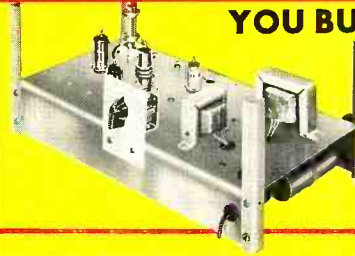

## YOU BUILD Signal Generator

You build this Signal Generator. Learn how to compensate high frequency amplifiers, practice aligning typical I.F. amplifiers in receiver circuits. Make tests, conduct experiments.

## YOU BUILD Broadcasting Transmitter

As part of N.R.I. Communications Course you build this low power Transmitter, learn commercial broadcasting operators' methods, procedures. Train for your FCC Commercial Operator's License.

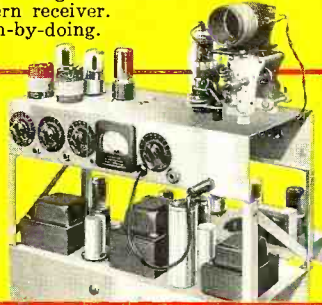

## YOU BUILD Vacuum Tube Voltmeter

Use it to earn extra cash fixing neighbors' sets; bring to life theory you learn from N.R.I.'s easy-to-understand texts.



# Radio-Television Can Give You a Good Job with a Future

## N.R.I. Graduates do Important Work — Get Important Pay



**Chief Engineer with Station**



**Paid for Instruments out of Earnings**



**Has Own Radio-TV Business**

"I am Chief Engineer of Station KGCU in Mandan, N. D. I also have my own spare time business servicing high frequency, two-way communications systems." R. BARNETT, Bismarck, N. D.

"I am doing very well in spare time TV and Radio. Sometimes have three TV jobs waiting and also fix car Radios for garages. I paid for instruments out of earnings." G. F. SEAMAN, New York, N. Y.

"We have an appliance store with our Radio and TV servicing and get TV repairs. During my Army service, N.R.I. training helped get me a top rated job." W. M. WEIDNER, Fairfax, S. D.

Here is a line of work that people respect—a vocation where you can advance, win a place for yourself, earn good pay and gain much personal satisfaction in what you are able to do. And you can learn at home in your spare time. Smart fellows everywhere are using their spare time to develop new knowledge, new skills. They know it is the trained man who gets ahead, gets the better job, drives the better car, is respected for what he knows and can do.

## Be a Skilled Technician

The technical man is looked up to. He should be. He does important work, gets good pay for it. Radio-Television offers that kind of work. There are more than 40 million Televisions, 150 million home and auto Radios. Millions more are sold each year. There are splendid opportunities for the man well trained in Radio-Television Servicing or Broadcasting. Micro-Wave Relay, Aviation and Police Radio, Two-Way Communications for buses, taxis, trucks, etc. are expanding—making more jobs, greater opportunity.

## You Can Train in Spare Time

Keep your job until you're ready for a better one. Learn at home. N.R.I. Courses are planned for men who can study only during spare time. You get many kits to build equipment, get practical experience. You work on circuits common to both Radio and TV. Equipment you build "brings to life" things you learn in N.R.I.'s easy-to-understand texts. Experienced N.R.I. instructors, technicians, specialists devote full time to making sure you get the best and simplest Radio-TV training. Train as fast or as slow as you like.

## Tested Way To Better Pay

N.R.I. Training is practical, thorough. You get the benefit of N.R.I.'s 40 years experience training men for success in Radio-Television. Most successful N.R.I. men start without any knowledge of Radio, many without a high school education. Find out what Radio-Television training can mean to you. Make a decisive move today toward becoming one of that select group—a Radio-TV Technician. Send for Actual Lesson and 64-Page Catalog, both FREE. NATIONAL RADIO INSTITUTE, Dept. E, Washington, D.C.

**See Other Side**

FIRST CLASS  
Permit No. 20-R  
(Sec. 34.9, P. L. & R.)  
Washington, D. C.

**BUSINESS REPLY CARD**

No Postage Stamp Necessary If Mailed In The United States

POSTAGE WILL BE PAID BY

**NATIONAL RADIO INSTITUTE**

16th and U Sts., N. W.

Washington 9, D. C.

**SAMPLE LESSON AND CATALOG**

**BOTH FREE**

**CUT OUT AND MAIL POSTAGE-FREE CARD**



here's how you  
can get more  
service calls  
...repeat  
customers

Garry Moore is advertising your special "Picture Tube Clean-Up" September 14 through November 23.

When your telephone rings and you're asked for the Garry Moore "Special Picture Tube Clean-Up," grasp the opportunity. Clean the picture tube faceplate and protective glass. Then check the set for any needed service. But be sure you have CBS tubes in your caddy. Your customer will want them if tubes have to be replaced.

CBS Tubes, through the Garry Moore "Special Picture Tube Clean-Up," get you into new television homes where you can check sets for necessary service. What's more, CBS is building "every-six-months check-ups" for you.

**NEW CBS PICTURE TUBE CLEANER**

In the handy easy-to-use squeeze bottle

Just S-Q-U-I-S-H it on and wipe it off! It's the perfect cleaner for the picture tube faceplate and protective glass. Quickly dissolves accumulated grime, dust and smoke. Gets glass clean. Leaves no annoying reflective film.

Just right for your caddy . . . won't break or leak. Now available in the big 6 oz. squeeze bottle at your CBS Tube distributor's.

6 oz. squeeze bottle only **39¢** net

Ask your CBS Tube distributor for your **FREE** trial bottle



**CBS-HYTRON**  
Danvers, Massachusetts

A Division of  
Columbia Broadcasting System, Inc.

See Garry Moore building new business for you . . . Fridays 10:30 to 10:45 A.M., EST, over the CBS Television Network. Tie in . . . get new business and more profits.

# Now, from Winegard

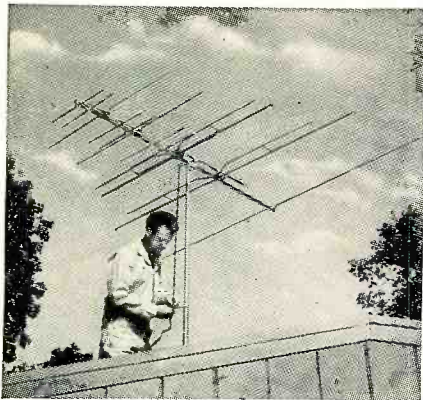

See it today **\$29.95**  
Only

The Incomparable

## Color'ceptor

### TV ANTENNA

for matchless Black-and-White TODAY  
and VIVID COLOR TOMORROW!

Sell the antenna "with a future" . . .  
the Color'ceptor.

Designed specifically to meet the critical demands of color TV, this fabulous Color'ceptor also ranks as the industry's outstanding antenna for top black and white reception.

Tested side by side with other makes by 50 independent service men—Color'ceptor walked away with performance honors in every single test category.

1. **MORE SENSITIVE!**—47% more gain on high band, 30% more on low band.
2. **PICTURE QUALITY!**—Color and black and white. All 12 channels.
3. **ABILITY TO REJECT CO-CHANNEL INTERFERENCE!**
4. **CONSISTENCY OF PERFORMANCE**—In spite of changing atmospheric conditions, even in extreme fringe areas.
5. **HORIZONTAL DIRECTIVITY**—The ability to reject multi-path signal reflections and ghosts.

And that's not all—Color'ceptor features Winegard's famous "umbrella-ease" snap-open design, the patented "electro lens"\*, gold anodizing for beauty and longer life. Available as an 11 element high performance, all-channel yagi unit at only \$29.95 list, or with added "Power Pack" as an 18 element unit at \$44.90 list.

#### EASIER TO SELL BECAUSE IT'S NATIONALLY ADVERTISED!

Your customers prefer Winegard Antennas because they know their quality. They see them advertised in leading national magazines, such as SATURDAY EVENING POST and others.

Join the "Winegard Team" and reap sales and profits with America's most advanced antennas!

For information, see your Jobber or write:

 **Winegard co.**

3000 Scotten Blvd., Burlington, Iowa

\*\* Pat. No. 2700105 \* Optional (\$14.95)

# Within the Industry

**NEAL W. TURNER**, chief audio engineer of the *Heath Company*, has been promoted to the post of merchandising manager for the Benton Harbor manufacturer of "do - it - yourself" electronic kits. In making the announcement, Robert Erickson, president of the firm, pointed out that Mr. Turner would be in charge of merchandising the firm's entire line of kits.



Before joining *Heath* in 1950, he was associated with *Hallcrafters Company* in Chicago, holding various engineering posts.

\* \* \*

**SCOTT HELT**, patent administrator at *Allen B. Du Mont Laboratories, Inc.*, passed away recently at the age of 49. He had been with the company since 1944 . . . **THOMAS O. MOORE** has joined the staff of *ORRadio Industries, Inc.* as chief electronic engineer . . . The post of general sales manager of the *Lansdale Tube Company* is being filled by **CYRUS H. WARSHAW**, manager of semiconductor sales for this *Philco* division . . . **HAROLD J. SCHULMAN** has been named assistant to the president of *Trav-Ler Radio Corp.* He will be in charge of marketing activities in addition to his other duties . . . **DR. JULIUS A. STRATTON**, Chancellor of M.I.T., has been named to receive the 1957 Medal of Honor awarded annually by the Institute of Radio Engineers.

The award will be presented at the society's annual banquet on March 20, 1957 during the organization's national convention in New York . . . **MORTON M. SCHWARTZ** is the new vice-president in charge of sales for *Olympic Radio & Television . . . Supreme Transformer Corp.* has named **PETER N. VOUGANAS** chief engineer . . . **PHILLIP L. GUNDY** has been elected vice-president of *Ampeex Corporation*. He will retain his present post of manager of the firm's audio division . . . The Institute of High Fidelity Manufacturers has appointed **WALTER STANTON**, president of *Pickering & Co.*, as secretary and **CHARLES FENTON**, head of *Fenton Company*, treasurer of the organization. The two men succeed **VINCENT ULRICH** who has resigned the dual post with the Institute . . . **RICHARD CHAMBERLIN** has been named manager of the newly established receiving tube department of *Eitel-McCullough, Inc.* . . . **DR. ERNEST WANTUCH** has been elected vice-president of *Airtron, Inc.* and will head the firm's new Cambridge Division . . . The appointment of **ROBERT THALMER** as chief engineer

of the radio and television division has been announced by *Sylvania Electric Products Inc.* . . . **ALLAN R. OGILVIE** has been elected vice-president of *Hancock Electronics Corporation* of Redwood City, California. He was formerly associated with *Remler Company* . . . **ALVIN B. POLLOCK**, a veteran of ten years' service with *Radio Corporation of America*, has been named manager of the Bloomington, Indiana plant of the firm's television division . . . **JOHN R. JOHNSON** has been named to head the sales and manufacturing operations of *Standard Coil Products Co. Inc.* . . . **DR. SAMUEL B. BATDORF** has joined *Lockheed Missile Systems* division's research branch as assistant director and head of the electronics division . . . **E. H. TAYLOR** has been appointed to coordinate the sales promotion and market development activities for the commercial sound division of *DuKane Corporation* . . . **HENRY K. KINDIG** has been upped to the post of plant manager of the Ottawa, Ohio TV picture tube plant of *Sylvania Electric Products Inc.* . . . **WEEMS E. ESTELLE** is the new manager of engineering for the *Edison Voicewriter* division of *Thomas A. Edison, Inc.* . . . The post of director of manufacturing at *Pyramid Electric Company* is being filled by **HERMAN J. SCHORLE**. He was formerly associated with *Micamold Electronics Manufacturing Corporation* and *Tobe-Deutchmann Corporation*.

\* \* \*

**L. J. BATTAGLIA** has been appointed to the post of manager, Marketing Department, *RCA Components Division*. He will be responsible for all marketing and sales activities of this newly formed division.



He joined the general office of *RCA* at Camden in 1941. In 1944 he was on the market research staff and a year later was transferred to the renewal sales group of the Tube Division. Five years later he was named field force manager in renewal sales and three years later was named manager of equipment and parts marketing, a post he held until his recent promotion.

He holds a Master's degree in Business Administration from the University of Pennsylvania.

\* \* \*

**THERMISTOR CORPORATION OF AMERICA** and **VIBRO-CERAMICS CORPORATION** have been merged with **GULTON MFG. CORP.** and the name of the combine changed to **GULTON INDUSTRIES, INC.** The merged firms will operate as

RADIO & TELEVISION NEWS

**RCA** offers you the  
 finest training  
 at home in  
 Radio-TV  
 electronics,  
 TV servicing,  
 Color TV

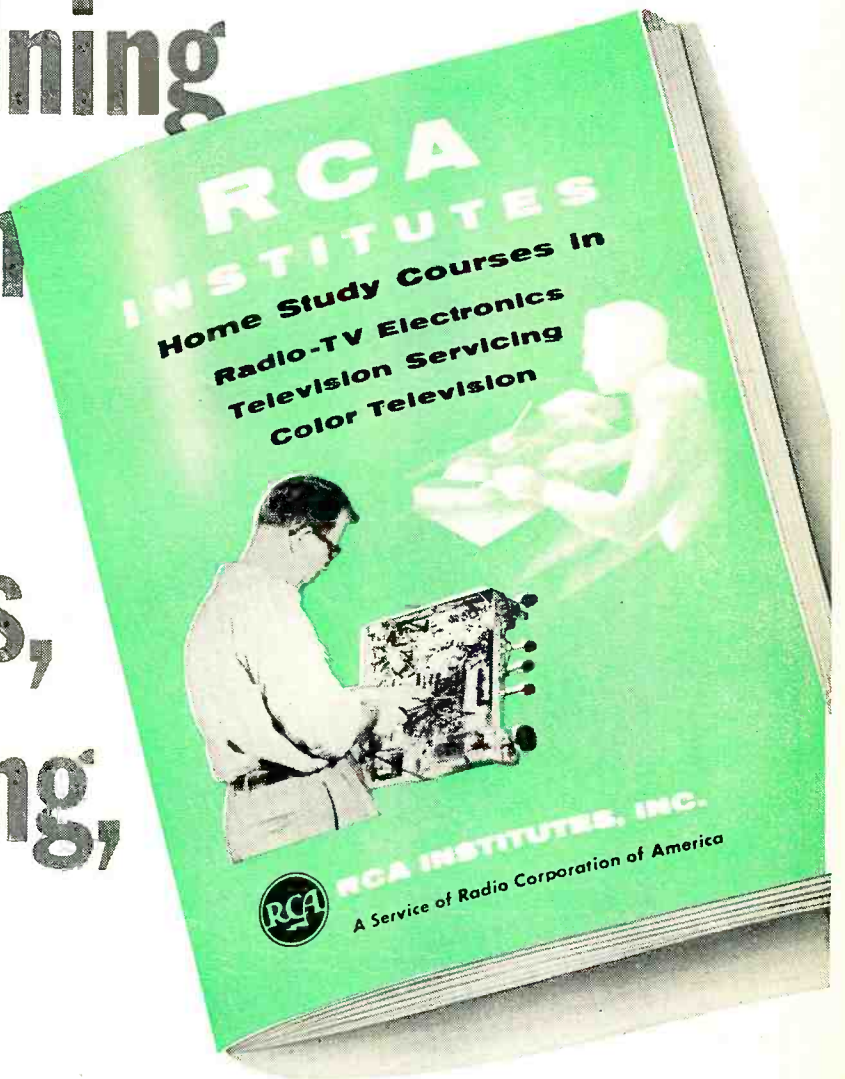

**SEND FOR THIS FREE  
 BOOK NOW!**

The instruction you receive and equipment you get (and keep) will start you on your way. Pay-as-you-learn. You pay for only one study group at a time. This 52 page book contains complete information on Home Study Courses for the beginner and the advanced student.



**RCA INSTITUTES, INC.**  
 A SERVICE OF RADIO CORPORATION of AMERICA  
 350 WEST FOURTH STREET, NEW YORK 14, N.Y.

RCA Institutes, Inc., Home Study N-116,  
 350 West Fourth Street New York 14, N. Y.  
 Without obligation, send me FREE CATALOG  
 on Home Study Courses in Radio, Television  
 and Color TV. No salesman will call.

Name .....  
 Please Print  
 Address.....  
 City..... Zone..... State.....

**VETERANS**  
 KOREAN G.I.  
 P.L. 550  
 CHECK HERE  
 ( )

# Cartridge replacements are a "Snap" with Sonotone

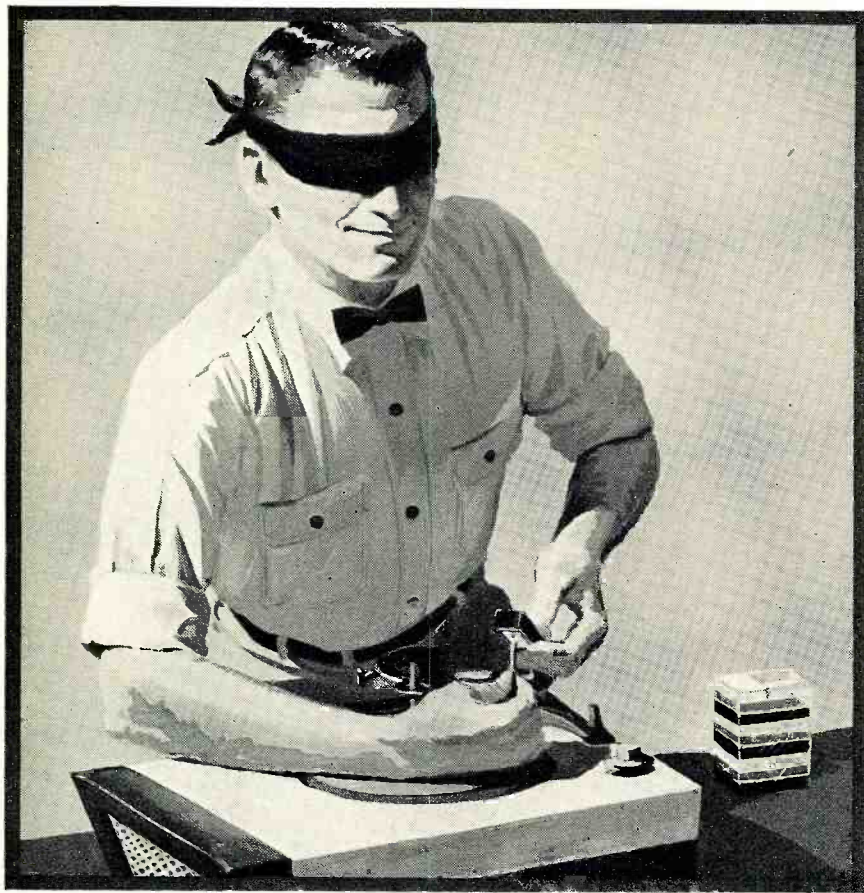

*Sonotone 1P and 2T mount the same way, take the place of up to 12 different models in other cartridge lines*

Time is money to you, so why be slowed down by handling a variety of different cartridges that mount various ways? Sonotone Ceramic 1P (single-needle) and 2T (turn-over) are all you need for over 90% of quality replacement jobs. They're a cinch to install in almost any arm — let you do the job *the same quick, easy way time after time.*

Stick to the Sonotone 2-model line and you'll find you cut installation time to an absolute minimum. Your customers will applaud for another reason — Sonotone cartridges, leader in the field, in virtually every case give *better* response than original equipment...enhancing your reputation for quality work.

#### **New standard of the phono industry**

In more than half the quality phonographs made today by leading manufacturers, you'll find one of these Sonotone cartridges. All the more reason why you should standardize on Sonotone.

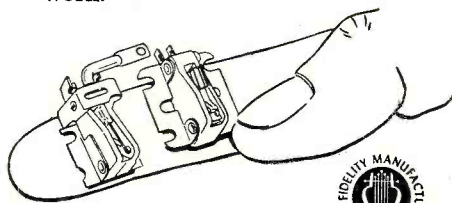

*Electronic Applications Division*



## **SONOTONE CORPORATION**

ELMSFORD, N. Y.

In Canada, contact Atlas Radio Corporation, Ltd., 50 Wingold Avenue, Toronto

a division of the new organization . . . **RAYMOND ROSEN ENGINEERING PRODUCTS, INC.** has changed its corporate name to **TELE-DYNAMICS INC.** No corporate or personnel changes are involved . . . **PLESSEY INCORPORATED** has been formed in the U. S. to further existing associations between **THE PLESSEY COMPANY LIMITED** of England and a number of American manufacturers. Headquarters are at 41 East 42nd Street, New York, N. Y. . . . **OXFORD ELECTRIC CORPORATION** has purchased all tools, dies, and inventory of the rear seat speaker line from **LOWELL MANUFACTURING COMPANY** of St. Louis . . . **LITTON INDUSTRIES** of Beverly Hills, California has purchased **TRIAD TRANSFORMER CORP.** of Los Angeles and its Indiana subsidiary, **UTRAD CORPORATION.** The parent firm now operates nine plants throughout the U. S.

\* \* \*

**BENJAMIN H. BALLARD, JR.** has been appointed to the post of sales manager for consumer products by the *National Company* of Malden, Mass.



He has served as the company's assistant sales manager and, recently, as manager of distributor sales. In his new post, he will be responsible for the sales management of all the consumer electronic products made by the firm including communications receivers, high-fidelity music systems, and various electronic components.

He joined the firm in 1954 after several years with *Westinghouse.*

\* \* \*

**STACKPOLE CARBON COMPANY** of St. Marys, Pa., celebrated its Fiftieth Anniversary early this fall.

Founded in 1906 as the *Stackpole Battery Company*, the name was changed to its present form six years later when carbon brushes and other carbon graphite specialties were added to the line.

The company has its main offices and two plants in St. Marys, three plants in Kane, Pa., and one in Johnsonburg, Pa. In 1953, electronic component manufacturing was begun by *Canadian Stackpole Limited* in a modern plant in Toronto.

\* \* \*

**WILFRED L. LARSON**, president of *Switchcraft, Inc.*, has been elected president of the Electronic Industry Show Corporation (formerly the Radio Parts and Electronic Equipment Shows, Inc.) and will head the association's 1957 Electronic Parts Distributors Show held in Chicago.



Serving with him will be Jerome M. Kirshbaum of *Precision Apparatus Company* as vice-president; William J.

(Continued on page 106)

**RADIO & TELEVISION NEWS**



# GET IN ON THE TV

# BOOM!



L. C. Lane, B.S., M.A.  
President, Radio-Television Training Association. Executive Director, Pierce School of Radio & Television.

## TRAIN FOR A TOP-PAY JOB AS A TELEVISION TECHNICIAN

**NO PREVIOUS EXPERIENCE NEEDED — study AT HOME in your SPARE TIME**

Next to the atom and hydrogen bombs, the biggest noise being made today is by the booming radio-television-electronics industry.

Now, while the boom is on in full force, is the time for you to think about how you can share in the high pay and good job security that this ever-expanding field offers to trained technicians.

Just figure it out for yourself. There are more than 400 television broadcasting stations operating right now

and hundreds more to be built; more than 34 million sets in the country and sales increasing daily. Soon moderately priced color television sets will be on the market and the color stampede will be on.

All these facts mean that good jobs will be looking for good men. You can be one of those men if you take advantage of my training now — the same training that has already prepared hundreds of men for successful careers in the radio-television-electronics field.

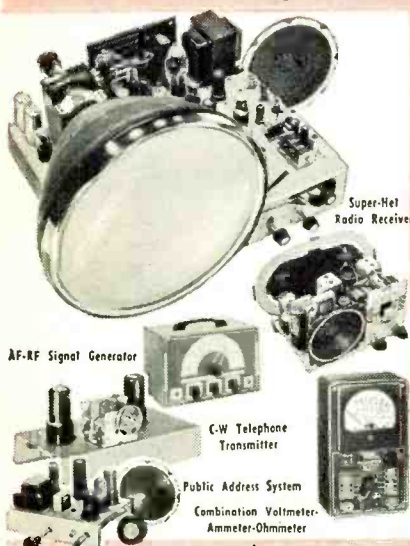

### LEARN BY DOING

As part of your training I give you the equipment you need to set up your own home laboratory and prepare for a BETTER-PAY TV JOB. You build and keep an Electromagnetic TV RECEIVER designed and engineered to take any size picture tube up to 21-inch, (10-inch tube furnished. Slight extra cost for larger sizes.) . . . also a Super-Het Radio Receiver, AF-RF Signal Generator, Combination Voltmeter-Ammeter-Ohmmeter, C-W Telephone Transmitter, Public Address System, AC-DC Power supply. Everything supplied, including all tubes.

**EARN WHILE YOU LEARN** Almost from the very start you can earn extra money while learning by repairing radio-TV sets for friends and neighbors. Many of my students earn up to \$25 a week . . . pay for their entire training from spare time earnings . . . start their own profitable service business.

**FCC COACHING COURSE** Qualifies you for Higher Pay! Given to all my students AT NO EXTRA COST. Helps you qualify for the TOP JOBS in Radio-TV that demand an FCC license! Full training and preparation at home for your FCC license.

## Radio-Television Training Association

52 EAST 19th STREET • NEW YORK 3, N. Y.

Licensed by the State of New York • Approved for Veteran Training

No experience necessary! You learn by practicing with professional equipment I send you. Many of my graduates who now hold down good paying technician jobs started with only grammar school training.

If you have previous Armed Forces or civilian radio experience you can finish your training several months earlier by taking my FM-TV Technician Course. Train at home with kits of parts, plus equipment to build YOUR OWN TV RECEIVER. ALL FURNISHED AT NO EXTRA COST!

After you finish your home study training in the Radio-FM-TV Technician Course or the FM-TV Technician Course you get two weeks, 50 hours, of intensive Laboratory work on modern electronic equipment at our associate school in New York City, Pierce School of Radio & Television.

**THIS EXTRA TRAINING IS YOURS AT NO EXTRA COST WHATSOEVER.** My courses are complete without this extra training, however. It is just an added opportunity for review and practice.

## VETERANS!

My School fully approved to train Veterans under new Korean G. I. Bill. Don't lose your school benefits by waiting too long. Write discharge date on coupon.

YOU GET THESE *free!*



### MAIL THIS COUPON TODAY!

Mr. Leonard C. Lane, President  
RADIO-TELEVISION TRAINING ASSOCIATION  
Dept. RT-11C, 52 East 19th Street, New York 3, N. Y.

Dear Mr. Lane: Send me your NEW FREE BOOK, FREE SAMPLE LESSON, and FREE aids that will show me how I can make TOP MONEY IN TELEVISION. I understand I am under no obligation.

(PLEASE PRINT PLAINLY)

Name \_\_\_\_\_ Age \_\_\_\_\_

Address \_\_\_\_\_

City \_\_\_\_\_ Zone \_\_\_\_\_ State \_\_\_\_\_

I AM INTERESTED IN:

- Radio-FM-TV Technician Course
- FM-TV Technician Course
- TV Studio Technician Course

**VETERANS!**  
Write discharge date

## USED EQUIPMENT BARGAINS

Hey! Now's your chance to get in on some of the best bargains in used ham equipment to come along in a long time. Our wild deals with our "Surprise" Trade-In Allowances have finally caught up with us - we find we're loaded with the used ham gear listed below. We have to move them NOW. So don't delay - order the unit you want TODAY. They won't last at these LOW prices. Give a first and second choice if possible. 20% required on C.O.D. orders. No equipment held without a deposit.

B&W 5100 Transmitter	\$299.50
B&W 5100S Transmitter	324.50
CENTRAL ELECTRONICS 10A Exciter	69.50
CENTRAL ELECTRONICS "A" Slicer	39.50
GONSET Standard 2-Meter Communicator	129.50
GONSET Deluxe 2-Meter Communicator	149.50
HALLICRAFTERS HT-18 VFO	42.50
JOHNSON VIKING I Transmitter	149.50
JOHNSON VIKING II Transmitter	229.50
JOHNSON VIKING VFO	29.50
MILLEN 90711 VFO	74.50
STANCOR ST-202 Transmitter	59.50

HEY!  
LOOK!



SAVE money on that new amateur gear. Let Walter Ashe make you one of his famous "Surprise" trade-in offers on your used (factory-built) test and communications equipment. Use the handy coupon and get your trade-in deal working today.

## NEW HAM GEAR

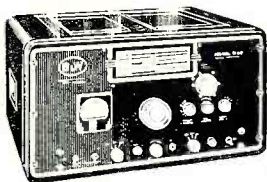

**B&W 5100-B TRANSMITTER**

Bandswitching, VFO or crystal controlled. All bands 80 thru 10 meters. 180 watts input on CW, 140 watts AM, 180 watts SSB when used with 51SB-B SSB generator. TVI suppressed. Net.....\$ 475.00



**COLLINS 75A-4 RECEIVER**

Less speaker. Net.....\$ 595.00



**NATIONAL NC-300 RECEIVER**

The "Dream Receiver" with super selectivity and sensitivity. For all bands 160 thru 1 1/4 meters (6, 2, and 1 1/4 meters with plug-in converters). Less speaker. Net.....\$ 399.00

## NEW JOHNSON VIKING TRANSMITTERS

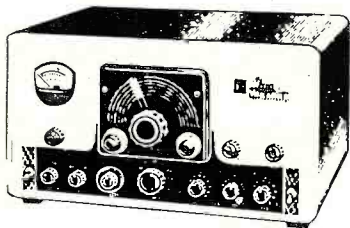

**"VALIANT"**

275 watts input CW, SSB (P.E.P. with SSB exciter). Built-in VFO. 160 thru 10 meters. Complete kit with tubes. Net.....\$ 349.50  
Wired and tested. Net.....\$ 439.50



**"PACEMAKER"**

SSB transmitter-exciter. 90 watts P.E.P. input SSB, CW, 35 watts AM. Upper and lower sideband selection. Built-in VFO. 80 thru 10 meters. With tubes. Wired and tested only. Net.....\$ 495.00



**NEW HALLICRAFTERS SX-101 RECEIVER.** Less speaker. Net.....\$395.00

WRITE FOR FULL INFORMATION  
ABOUT OUR TIME PAYMENT PLAN

All prices f. o. b. St. Louis • Phone CHestnut 1-1125

**Walter Ashe**  
**RADIO CO.**  
1125 PINE ST. • ST. LOUIS 1, MO.  
Our 34th Year

WALTER ASHE RADIO COMPANY  
1125 Pine Street, St. Louis 1, Mo.

RN-11-56

Rush my order for used equipment as follows:

(1st Choice).....  
(2nd Choice).....

Remittance for \$..... is enclosed.

Send free list of additional used equipment bargains.

Send new free 1957 Walter Ashe catalog.

Rush "Surprise" Trade-In offer on my.....  
for.....

(show make and model of new equipment desired)

Name.....

Address.....

City..... Zone..... State.....

# IF JOBS LIKE THESE ARE "ON YOUR MIND" ...

... but you can't qualify because you lack  
ADVANCED TECHNICAL KNOWLEDGE ...

## SEND NOW FOR CREI'S NEW FREE BOOKLET

It's crammed with facts and data—containing a tested plan to make you ready for the big jobs and a high-salaried career now being offered in

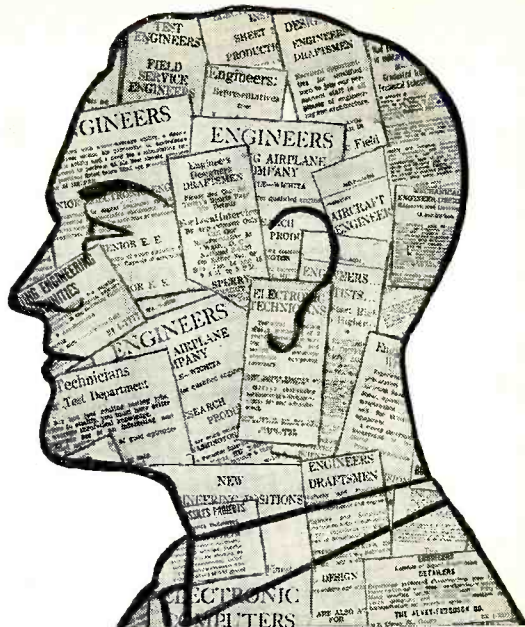

# RADIO—TELEVISION—ELECTRONICS

The want ads above are *real* ones ... they appear almost daily in magazines and newspapers—all over the country. They show how desperately the electronics industry needs *trained* men. On the other hand, they give you a good idea of what opportunities await you—if you get advanced technical training *now*. And no wonder trained men are needed! Look what's happening in just a few phases of the booming world of electronics:

40,000,000 TV sets already in use—430 TV stations on the air—more coming. Color TV is coming ahead fast. More than 125,000,000 radios in use. More than 97,000 radio-equipped police cars. At least 87,000 radio-equipped American ships. Top manufacturers sold billions of dollars worth of electronic equipment in 1955. By 1960, the radio-electronics industry should do no less than 15 billion dollars of business per year, not counting military orders.

*What do these figures mean to you? They mean that thousands of new electronic jobs have been added to the great, expanding field of electronics.*

### LITERALLY THOUSANDS ARE NEEDED!

You are needed—for development, research, design, production, testing, inspection, manufacture, broadcasting, telecasting, servicing. But you can qualify only if you take time to advance your knowledge ... if you take 2 minutes right now to write for the free CREI booklet, with no obligation.

### SHORTEST DISTANCE TO A GOOD CAREER IS CREI TRAINING

If you follow the plan outlined in our free booklet, you will be in line for promotion and pay increases in short order. Read what these typical CREI graduates have to say:

"In this time of less than two years, I have almost doubled my salary and have gone from wireman to engineering assistant and now to junior engineer. I have CREI to thank."—Frank A. Eckert, 22 Clover Lane, Levittown, Pa.

"I chose CREI training upon recommendation of two top engineers. Before I completed the course, I became transmitter chief of a 5 kw station. I am now employed as a technician at a 100 kw TV station and in spare time have a good TV sales and service business."—Archie D. Patton, 208 Burke Ave., San Antonio, Tex.

### CREI TRAINING—JUST WHAT INDUSTRY ORDERED

By method, experience, and personnel—CREI is equipped to teach you what you will need when

you translate your study into work. As proof that CREI knows what industry wants, many leading companies choose CREI to train their own technical staffs. Among them: United Air Lines, Canadian Broadcasting Corporation, Columbia Broadcasting System, Glenn L. Martin Co., All-America Cable and Radio, Inc.

### TOP FIRMS LOOK FOR CREI MEN

A CREI diploma itself is ample proof to many leading companies that a man is worth hiring. Moreover, employers contact *us* regularly for graduates to fill good jobs. Our placement bureau cannot keep up with the demands.

### Typical recent requests:

"In view of the fact that we have recently merged with the General Dynamics Corporation, we are entering a period of greatly expanded activity. Our need for the technical institute graduate is, therefore, greater than it has been, and we are interested in bringing our opportunities to the attention of your students."

Stromberg-Carlson Company  
Rochester 3, New York

"Just about four months have passed since I made my first recruiting trip to CREI. As a result of that visit Messrs. Kohls, Plante and Wenger are now members of the Laboratories and Mr. Kresge soon will be ... we have some openings now and will have others ..."—Bell Telephone Laboratories, Murray Hill, N.J.

### NAME YOUR FUTURE—GO AFTER IT—GET IT

What do you want? To pass FCC exams? Start your own business? CREI has helped others reach these goals, and can help *you*. Or, do you want to go after good-paying electronics jobs, secure, permanent careers like those advertised above? *Whatever* your choice, CREI can help you as it

has helped thousands of men—provided you have the ambition to follow the plan.

### NO COLLEGE DEGREE NECESSARY

If you have the equivalent of a high school education, and are good at mathematics, and have had some electronic experience—you can qualify for CREI and for the fruits which await you upon graduation.

### CREI ALSO OFFERS RESIDENCE TRAINING

CREI Residence School in Washington, D.C. offers training at same high technical level. Classes start at regular intervals. Qualified residence school graduates earn degree: "Associate in Applied Science." Check coupon if you prefer residence study.

### KOREAN WAR VETERANS:

If you were discharged after June 27, 1950, let the new G. I. Bill of Rights help you obtain resident instruction. Check coupon for full information.

### DON'T WASTE ONE MINUTE, INVEST TWO MINUTES ...

... and fill out the coupon—mail it right away. No obligation—you have nothing to lose but your present job in exchange for more money, a bright future and job security in a wide choice of electronics fields. Act today—and you'll receive your free booklet and the CREI plan by return mail. No obligation.

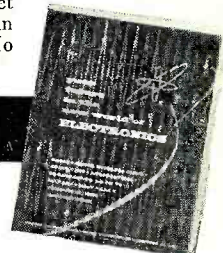

## MAIL THIS COUPON Today!

### CAPITOL RADIO ENGINEERING INSTITUTE

Accredited Technical Institute Curricula • Founded 1927

3224 16th St., N.W., Dept. 1111-C, Washington 10, D.C.

Please send me your course outline and FREE illustrated Booklet "Your Future in the New World of Electronics" ... describing opportunities and CREI home study courses in Practical Electronics Engineering.

### CHECK FIELD OF GREATEST INTEREST

- Practical Radio Electronics Engineering
- Broadcast Radio Engineering (AM, FM, TV)
- Practical Television Engineering
- Practical Aeronautical Electronics Engineering

To help us answer your request intelligently, please give the following information:

### EMPLOYED BY

.....

### TYPE OF PRESENT WORK

.....

### SCHOOL BACKGROUND

.....

### ELECTRONICS EXPERIENCE

.....

Name \_\_\_\_\_ Age \_\_\_\_\_  
Street \_\_\_\_\_  
City \_\_\_\_\_ Zone \_\_\_\_\_ State \_\_\_\_\_

CHECK:  Home Study  Residence School  
 Korean Veteran

# FOR THE FIRST TIME IN HI-FI HISTORY...

## cabinart

# pfK

## pre-finished Kits!

That's right! Now you can buy a loudspeaker enclosure in kit form whether you are a do-it-yourselfer or a don't-do-it-yourselfer. No more messing with shellac, furniture stain, varnish, wood putty, rags and the rest of the gookum... this time you really need only a screwdriver to assemble a superb piece of cabinet-work with that supremely professional "CABINART" finish. Each enclosure comes with every outside piece pre-finished in beautiful hand-rubbed korina or mahogany veneers. The assembled kits are absolutely indistinguishable from their world-famous factory-assembled "CABINART" counterparts. Best of all, the money you would otherwise spend on finishing tools and materials more than makes up the price difference between a pre-finished kit and an unfinished kit.



### Model PFK-120/150

(pfK=Pre-Finished Kit)

Pre-finished kit version of the REBEL 4, Paul Klipsch-designed CABINART corner horn for 12" or 15" speaker systems.

PFK-120, for 12" woofer drivers:  
Shipping Weight 42 lbs. \$48.00 net

Model K-12, unfinished kit \$36.00 net

Model KR-4/12, factory-assembled and finished version of same \$69.00 net

PFK-150, for 15" woofer drivers:  
Shipping Weight 48 lbs. \$58.00 net

Model K-15, unfinished kit \$42.00 net

Model KR-4/15, factory-assembled and finished version of same \$87.00 net

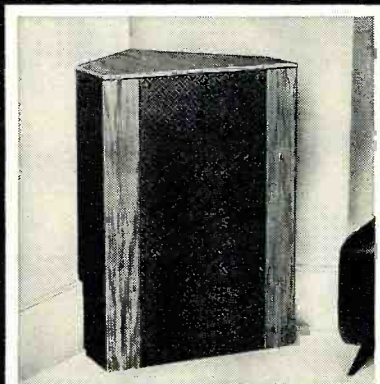

### Model PFK-300

(pfK=Pre-Finished Kit)

Pre-finished kit version of the REBEL 3, CABINART's famous Klipsch-designed corner horn for 15" speaker systems. Response down to nearly 30 cps.

Shipping Wt. 61 lbs. \$72.00 net

Model K-3, unfinished kit version of same \$49.50 net

Model KR-3, factory-assembled and finished version of same \$99.00 net

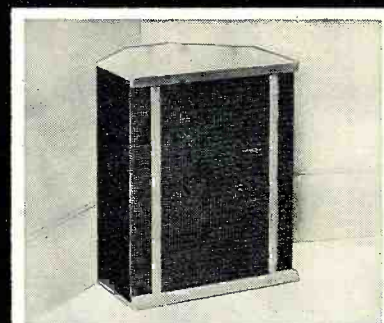

### Model PFK-500

(pfK=Pre-Finished Kit)

Pre-finished kit version of the REBEL 5, the extra-compact CABINART corner horn designed by Paul Klipsch for 8" and 12" speaker systems.

Shipping Weight 34 lbs. \$36.00 net

Model KR-5, factory-assembled and finished version of same \$48.00 net

Model K-5, unfinished kit version of same \$24.00 net

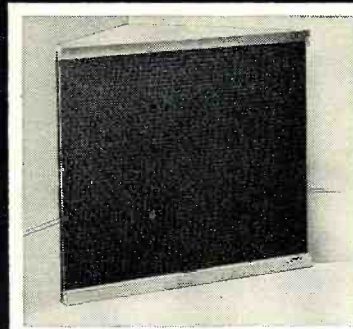

### Model P-610/630

Pre-finished versions of the CABINART Model 61/63 kits (folded corner horns) for 12" and 15" speakers, respectively.

P-610, for 12" speakers:  
Shipping Wt. 39 lbs. \$25.95 net

Model 61 unfinished kit version of same \$19.95 net

P-630, for 15" speakers:  
Shipping Wt. 39 lbs. \$29.95 net

Model 63, unfinished kit version of same \$23.95 net

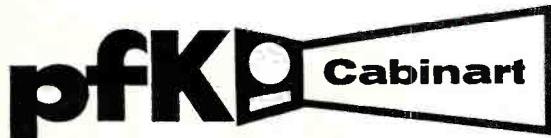

... and don't forget—

CABINART can supply you with 16 other hi-fi kits, 29 kinds of equipment cabinets, 4 matched speaker systems and 20 different hi-fi accessories.

## cabinart

Write For Complete cabinart '57 Catalog

CABINART FURNITURE IS MANUFACTURED BY G & H WOOD PRODUCTS COMPANY, 99 NORTH 11 ST., BROOKLYN 11, N. Y.

RADIO & TELEVISION NEWS

When only the best is  
good enough...

# Soundcraft

magnetic recording tapes on

magic "Mylar" <sup>\*</sup> base



Model's outfit by Mme. E. Grangé  
Car by Jaguar  
PLUS 50 by Soundcraft

For true high fidelity now — and from now on — choose **from**  
these Soundcraft tapes. All are made with Oscar-winning  
Soundcraft oxide on extra-strong "Mylar" base.

PLUS 50 — get 50% longer play

PLUS 100 — twice as much on a reel

"LIFETIME" — guaranteed for life

FOR EVERY SOUND REASON

REEVES **SOUND CRAFT** CORP.

10 East 52nd Street, New York 22, N. Y.



\*DuPont trademark

# 3 OBVIOUS REASONS

## why you should order a TECH-MASTER HI-FI KIT ... today!

- ① **TECH-MASTER** amplifier, preamplifier, tuner and radio kits represent the ultimate in modern electronic kit design—nothing is easier or more fool-proof to assemble; nothing gives finer performance once assembled!
- ② **TECH-MASTER** hi-fi kits carry the double guarantee of the Tech-Master Corporation, famous leaders in custom television and high fidelity since 1942, and of the **LOCAL** electronic parts distributor who fills your order and acts as your convenient, near-by source of expert information and advice. Ask him to demonstrate a Tech-Master kit when you are in his neighborhood—consult him again if you should ever need technical assistance, testing or service after you have purchased your kit!
- ③ **TECH-MASTER** hi-fi kits now offer you the unique convenience of simplified mail order from a **LOCAL** firm combined with the extra courtesy and sales backing you expect when dealing with a reliable parts-distributor.

### YOUR CHOICE OF FOUR HI-FI TECH-MASTER KITS:

#### TECH-MASTER TM-15A Ultra-Linear Williamson-Type 20-Watt Power Amplifier Kit

Flat response throughout the audible frequency range as well as considerably below and above it. Vanishingly low distortion at all normal listening levels. Not more than 1/2% intermodulation or harmonic distortion even at 15 watts output. Smooth, crisp, transparent listening quality. Superior transient response. Hum and noise level 70 db below rated output. 1.1 volts RMS input required for 20 watts output. Specially wound high-fidelity output transformer with 4, 8 and 16 ohm output impedances. Comes with sockets, terminal strips and connectors already mounted.

Model TM-15A (dimensions 9" x 12" x 6 1/2"; weight 27 lbs.) ..... \$49.95

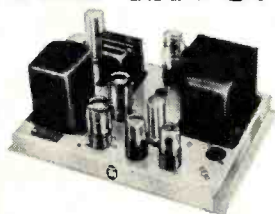

#### TECH-MASTER TM-16A De Luxe, Self-Powered Preamplifier-Equalizer Kit

Completely redesigned according to the latest techniques. Contains the most advanced features. 5-position phono equalizer (78 rpm, old 78's, RIAA, ffr, AES). Four input channels (one low-level, high-gain input for magnetic cartridges; three high-level; high-impedance inputs for AM, FM, or TV tuner, crystal or ceramic cartridge, high-output microphone, tape recorder, etc.). Loudness compensating control. Bass and treble controls with 15 db boost or cut at 20 cps and 20 kc, respectively. Cathode follower output. Smartly styled in handsome lacquered cabinet. Comes with sockets, terminal strips and connectors already mounted. Amazingly simple to assemble for trouble-free high-fidelity results.

Model TM-16SP (dimensions 9 7/8" x 3 3/8" x 4 1/2"; weight 4 lbs.) ..... \$24.50  
Matching gold escutcheon ..... 1.50



#### TECH-MASTER TM-17P Economy Preamplifier-Equalizer Kit

Same basic design as the Model TM-16SP, except for 3-position phono equalizer (78 rpm, RIAA, AES), standard true-taper volume control and provision to obtain power from the main amplifier or a similar external power supply (120 volts DC @ 6 ma, 6.3 volts AC @ 600 ma). Plug-in connection for TM-15A furnished. Cathode follower output. Gold-tone cabinet. Comes with sockets, terminal strips and connectors already mounted.

Model TM-16SP (dimensions 9 7/8" x 3 3/8" x 4 1/2"; weight 4 lbs.) ..... \$19.95



#### TECH-MASTER FM-18 Hi-Fi FM Tuner Kit

Designed for optimum reception and sound quality at minimum cost. Sensitivity 4 microvolts for 20 db quieting. IF bandwidth 200 Kc. Drift-free ratio detector. Automatic frequency control (AFC) with manual front-panel cutoff. Micro-vernier tuning. Both cathode follower and high-impedance outputs provided. Self-contained power supply. Very easy to assemble.

Model FM-18 (dimensions 4 1/2" x 8" x 6 1/4"; weight 6 1/2 lbs.) ..... \$29.95  
Model 18-C Cabinet ..... 7.50



#### ORDER NOW FROM YOUR NEAREST TECH-MASTER DISTRIBUTOR:

- California, Burbank  
Valley Electronic Supply  
1302 W. Magnolia Avenue
- California, San Francisco  
San Francisco Radio and Supply Company  
1284 Market Street
- Colorado, Denver  
Radio Products Sales Company  
1237 16th Street
- Connecticut, West Hartford  
Audio Workshop  
1 South Main Street
- District of Columbia  
Electronic Wholesalers  
2345 Sherman Avenue, N.W.
- Florida, Miami  
Flagler Radio  
1066 West Flagler Street
- Illinois, Chicago  
Musicraft  
48 East Oak Street  
Newark Electric Co.  
223 West Madison
- Indiana, Indianapolis  
Graham Electronics Supply  
102 South Pennsylvania St.
- Massachusetts, Boston  
Radio Shack Corp.  
167 Washington St.
- Missouri, Kansas City  
Burstein-Applebee Company  
1012 McGee Street
- New York, Albany  
Fort Orange Radio Distributors  
904 Broadway
- New York, New York  
Hudson Radio & TV Corp.  
48 W. 48th Street  
Terminal Radio Corp.  
85 Cortlandt Street
- North Carolina, Charlotte  
Shaw Distributing Co.  
205 W. First Street
- Ohio, Cleveland  
Progress Radio Supply Co.  
415 Huron Road
- Pennsylvania, Philadelphia  
Almo Radio Company  
412 North 6th Street
- Pennsylvania, Pittsburgh  
Cameradio Company, Inc.  
1121 Penn Avenue
- Tennessee, Memphis  
Bluff City Distributing Co.  
234 East Street
- Wisconsin, Milwaukee  
Acme Radio Supply Co.  
1009 N. Water Street
- Canada, Montreal  
Canadian Electrical Supply Co.  
275 Craig Street W.

TECH-MASTER CORPORATION



75 Front Street, Brooklyn 1, New York

# NATIONAL SCHOOLS

*proudly presents*

**FOR MEN  
WHO WANT  
TO EARN  
MORE MONEY**

## TELERAMA\* • ALL 8 BRANCHES OF TELEVISION • ELECTRONICS • RADIO IN ONE DYNAMIC, MODERN SHOP METHOD, HOME TRAINING COURSE

\*Registration applied for

Another great advance in **HOME STUDY TRAINING**. Let National Schools, of Los Angeles, a practical Technical Resident Trade School for over 50 years, train you at home by Shop-Method, for today's unlimited opportunities in **ALL 8 BRANCHES** of the Television, Electronics, Radio Industry.

Check all you receive in *One Master Course* at One Low Tuition

1. Television — Including Color TV
2. Radio — FM and AM
3. Industrial Electronics
4. Sound Recording and Hi-Fidelity
5. Preparation for FCC License
6. Automation
7. Radar and Sonar
8. Communications

ALL OF THIS MODERN, NEWEST, PRACTICAL EQUIPMENT IS YOURS TO KEEP!

- Parts to Build a modern TV set, including large screen Picture Tube.
- Parts to build a powerful Superhet Receiver, standard broadcast and short wave.
- Parts to conduct many experiments and build Continuity Checker, RF Oscillator, TV Circuits, Audio Oscillator, TRF Receiver, Signal Generator.
- Professional Multitester.
- These are a MUST for all technicians.

**YOU DO MANY PRACTICAL JOBS.**

You do servicing, circuit analysis and many other down-to-earth experiments. You build a modern TV set from the ground up . . . with equipment kits we give you, including a new large screen picture tube and professional Multitester, at no additional charge.

**EARN AS YOU LEARN!** Many of our students earn their entire tuition and more in Spare Time jobs we show them how to do while learning. **YOU GET GRADUATE ADVISORY SERVICE, TOO.**

**ALL YOURS  
TO KEEP**

**L. J. ROSENKRANZ**

President of NATIONAL SCHOOLS



This Master-Shop-Method course is completely up-to-date. Here in Los Angeles, the TV and Electronics center of the world, we are able to keep in constant touch with the industries' latest developments. As a student, you will quickly master all phases at home . . . in your spare time. Your earning power will grow with every lesson. Just as thousands of National Schools graduates do every day, you can handle servicing, manufacturing, repairing, hundreds of other jobs, or make good money in your own business. **SECURE YOUR FUTURE—NOW SEND COUPON BELOW.**



IN THESE MODERN TV STUDIOS, SHOPS AND LABORATORIES, your Shop Method Home Study Course was developed by experienced instructors and engineers. What an advantage that is to you at home — each lesson is tested, proved, easy to understand. You can master the most up-to-date projects, such as color TV set repair, printed circuits — even prepare for F.C.C. License and industrial electronics without taking a special course. **TAKE YOUR FIRST STEP NOW TO A TOP-PAY JOB IN TV, ELECTRONICS, RADIO. SEND COUPON BELOW TODAY**

**APPROVED FOR  
VETERANS  
AND  
NON-VETERANS**

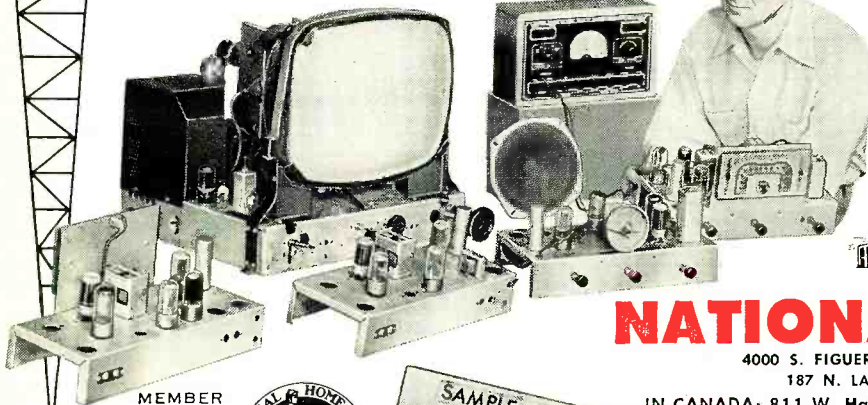

MEMBER



**FREE!**

Fully illustrated "CAREER" BOOK in TV, Radio, Electronics. AND actual Sample Lesson—yours at no cost; no obligation **SEND COUPON NOW—TODAY!**



## NATIONAL SCHOOLS

4000 S. FIGUEROA ST., LOS ANGELES 37, CALIF.

187 N. LA SALLE ST., CHICAGO 1, ILL.

IN CANADA: 811 W. Hastings St., Vancouver, B. C.

### NATIONAL SCHOOLS

TECHNICAL TRADE TRAINING SINCE 1905  
Los Angeles, California

**GET FAST SERVICE—MAIL NOW TO OFFICE NEAREST YOU!**

NATIONAL SCHOOLS, DEPT. RH-116

4000 S. FIGUEROA ST. OR 187 N. LA SALLE ST.

LOS ANGELES 37, CALIF. CHICAGO 1, ILL.

Rush free TV-Radio "Opportunity" Book and sample lesson. No salesman will call.

NAME \_\_\_\_\_ BIRTHDAY \_\_\_\_\_ 19 \_\_\_\_\_

ADDRESS \_\_\_\_\_

CITY \_\_\_\_\_ ZONE \_\_\_\_\_ STATE \_\_\_\_\_

VETERANS: Give Date of Discharge \_\_\_\_\_

# ELECTRICAL UNIFORMITY

*for dependable  
replacement in  
critical circuits*



A BASIC ENGINEERING FEATURE OF RCA RECEIVING TUBES

To cut down on "tube juggling" and circuit realigning, RCA controls the quality of your tubes for you—at the factory.

Take the RCA-6SN7-GTB, for example. Every single tube—not just one out of a batch—is subjected to no less than 11 tests for individual electrical characteristics. Before and during manufacturing, RCA closely controls such things as: (1) Cathode material to insure uniform cathode emission and minimize interface resistance, (2) Heater wire to assure even cathode temperature, (3) Grid dimensions and inside plate diameter to insure uniform transconductance, (4) Mica hole size and hole spacing to reduce microphonics.

Yes, you can rely on the electrical uniformity of RCA Receiving Tubes! Tell *your* distributor to fill *your* tube order with *RCA Tubes only!*



Just released: 28-page booklet, "RCA Receiving Tubes for AM, FM and TV." Up-to-date. Gives characteristics and socket connections for more than 600 types. See your RCA distributor for Form 1275-G, or write RCA, Commercial Engineering, Section E32X, Harrison, N.J.



**RECEIVING TUBES**

RADIO CORPORATION OF AMERICA, HARRISON, N.J.



# Join the NEL-KAYE Record Club and buy ANY LP Record at **DEALER'S COST**

(ANY LABEL — NO EXCEPTIONS)

A saving of **\$1.50** or more  
on each and every record.

Plus **Free** with your membership:  
any 10" or 12" record of your choice

As a member  
of this unique club  
you can get ANY LP  
ever recorded at DEALER'S  
COST; that's a saving of  
**38%** off the  
current list price.

If you are a true record collector, be it classical, pop  
or jazz this club was designed for you. If you  
usually purchase as few as one record a week you  
will save over **\$75.** a year.

The membership fee is **\$10**, for two years and  
entitles you to the following:

- 1** One 10" or 12" LP record absolutely **FREE**, **ANY** record — **ANY** label—the choice is entirely up to you. (the value of this **FREE** record alone is actually worth the greater part of your \$10. membership fee.
- 2** During the 24 month period of your membership, you may purchase as many or as few records as you wish.
- 3** There are no restrictions of any kind. You may order any LP record—any label, major or minor — RCA, Decca, Columbia, Capital, Mercury, London, Westminster, Urania, Vox,

Hayden Society, etc., any LP listed in any record Catalog. No exceptions—in short, any LP ever recorded.

- 4** Each month you will receive, absolutely **FREE**, a new record catalog worth 25¢, listing every LP ever recorded.

- 5** All records are guaranteed factory-new and in perfect condition assuring the highest standards of Hi Fidelity recording. Exchanges on any defective records are made immediately without charge.

**We do NOT manufacture records. You are not limited as to selection.**

## A Christmas Gift that's really different

Now . . . just in time for Christmas —

Give your music loving friends a two year club membership . . . simply send us their names and addresses together with a \$10. check for each membership. They will actually save many hundreds of dollars on their record purchases and will also receive any 10" or 12" record of their choice **FREE** plus all the other benefits of the Nel-Kaye Record Club as listed above.

### Special Offers at Dealer's Cost

will be made from time to time to club members on all accessories such as diamond needles, tapes, record racks, Hi-Fi phonographs etc.

### MONEY BACK GUARANTEE

Full membership fee (less cost of Free membership record) refunded within 60 days if not completely satisfied.

**JOIN TODAY**  
and save  
many, many dollars  
throughout the year.

Note: There is a few cents postage  
and handling charge on all orders.

Make checks payable to  
**NEL-KAYE RECORDS, Inc.** 1604 York Ave., New York 28, N. Y.

Dept. R-12

I am enclosing \$10  check or  money order covering two year membership in the "Nel-Kaye Record Club of the Year." This does not obligate me in any way. I may order as many or as few records of my choice as I wish.

My Free L.P. record choice is.....

NAME.....

ADDRESS.....

CITY.....ZONE.....STATE.....





**If it's worth Engineers' time . . .**



**. . . It's worth Engineered Cable**

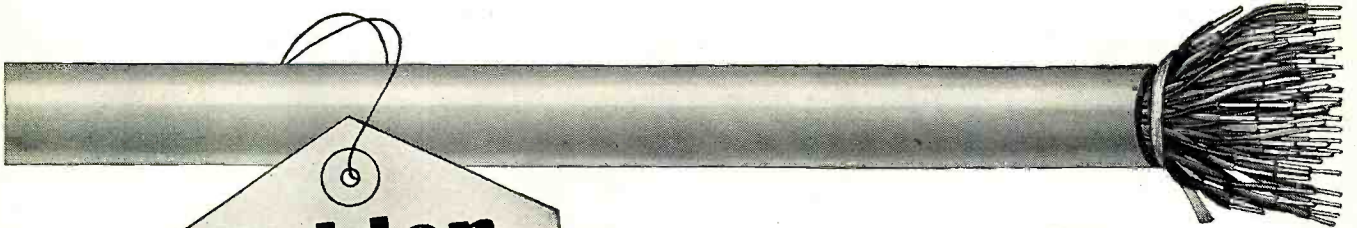

**Belden**  
**INTERCOMMUNICATING  
 AND  
 SOUND SYSTEM CABLES**

Indoor-outdoor, phones  
 or speakers—there is a  
 Belden engineered cable  
 to meet your needs for  
 a permanent, trouble-  
 free installation.

"Items from the  
 Complete Belden Line"

*Intercommunications systems in  
the Statler Hilton in Dallas,  
and other leading hotels  
with intercommunications  
systems, are wired by Belden.*

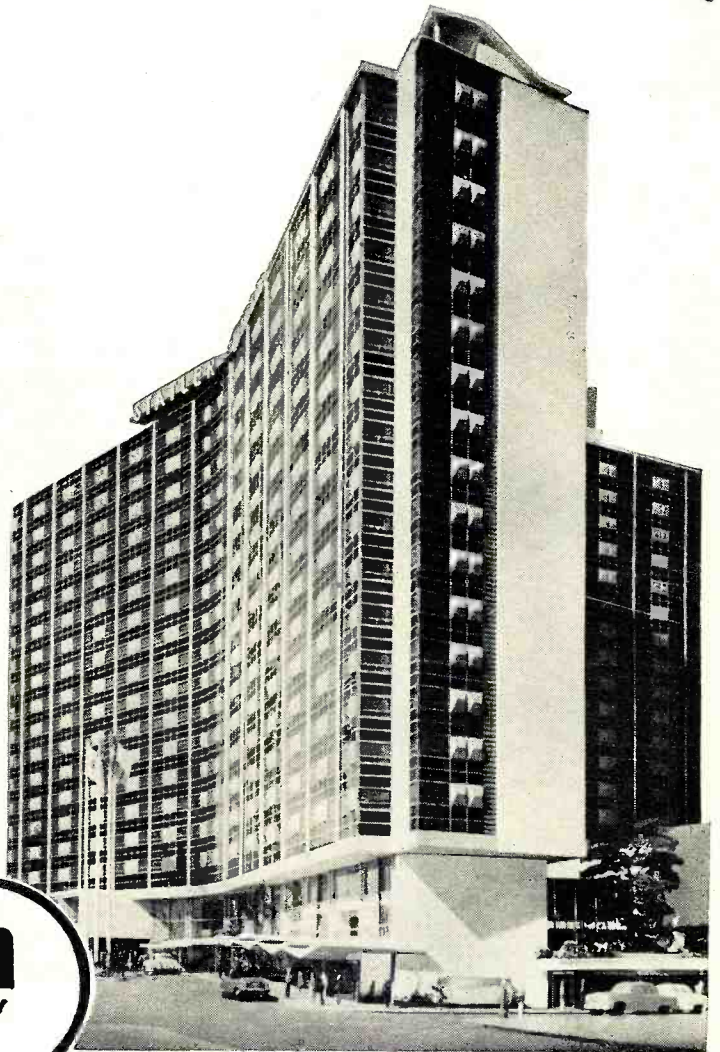

**Belden**  
**WIREFORMER FOR INDUSTRY**  
**SINCE 1902**  
**CHICAGO**

10-8

Magnet Wire • Lead and Fixture Wire • Power Supply Cords, Cord Sets and Portable Cord • Aircraft Wires  
Welding Cable • Electrical Household Cords • Electronic Wires • Automotive Wire and Cable

**NEW! COLOR and Black-&White  
LAB & TV 5" OSCILLOSCOPE #460  
KIT \$79.95. Wired \$129.50**

The FINEST professional 5 mc wide-band scope value. Ideal for research, h-f & complex waves, plus Color & Monochrome TV servicing. Flat from DC to 3.58 mc  $\pm 1$  db (color burst freq.), flat DC to 4.5 mc +1, -3 db. Vert. sens. 25 rms mv/in. Vert. Z 3 megs. Has the following outstanding features not found in scopes up to several times its price, kit or wired:

**VERTICAL AMPLIFIER:** direct-coupled (DC) thruout to eliminate l-f phase shift; push-pull thruout for negligible distortion; K-follower coupling between push-pull pentode stages for extended h-f resp. (minimizes h-f phase shift, extends useful resp. to 10 mc); full-screen undistorted vert. defl; 4-step freq-compensated decade step attenuator up to 1000:1. **SWEEP CIRCUIT:** perfectly linear sweeps, 10 cps - 100 kc (ext. cap. for down to 1 cps); pre-set TV vert. & hor. positions (30 & 7875 cps); automatic sync. ampl. & limiter eliminates sync amplitude adj. **PLUS:** direct or cap. coupling; bal. or unbal. inputs; edge-lit engraved lucite graph screen; dimmer; anti-glare filter; bezel fits std photo equipt. **OTHER IMPORTANT FEATURES:** High intensity trace CRT. Finest sq. wave resp. (.06 usec rise time). Push-pull hor. ampl., flat to 400 kc, sens. 0.6 rms mv/in. Built-in voltage calibration. Intensity mod. Sawtooth & 60 cps outputs. Astigmatism control. Retrace blank-

ing. Instant, drift-free full-screen vert. positioning & 2X full-screen hor. positioning. Bal., cal., astig. adj. externally accessible. 5U1 CRT, 2-6AU8, 2-6CB6, 1-12AU7A, 2-6J6, 1-6AX5, 1-1V2. Deep-etched satin aluminum panel, rugged grey wrinkle steel cabinet. Designed for easy building at home with no special equipment. 13" x 8 1/2" x 16". 30 lbs.

**SCOPE DIRECT PROBE\* #PD:** KIT \$2.75. Wired \$3.95. Eliminates stray-pick-up & signal re-radiation.

**SCOPE DEMODULATOR PROBE\* #PSD:** KIT \$3.75. Wired \$5.75. Demodulates AM carriers between 150 kc and 250 mc.

**SCOPE LOW CAPACITY PROBE\* #PLC:** KIT \$3.75. Wired \$5.75. For signal tracing in high frequency, high impedance & wide-band circuits (as in TV) without distortion from overloading or frequency discrimination.

for COLOR and Monochrome TV servicing

**New! PEAK-to-PEAK VTVM #232  
& UNI-PROBE (pat. pend.)  
KIT \$29.95. Wired \$49.95**

**UNI-PROBE:** exclusive with EICO! Terrific time-saver! Only 1 probe performs all functions—a half-turn of probe-tip selects DC or AC-Ohms.

The new leader in professional peak-to-peak VTVMs. Latest circuitry, high sensitivity & precision, wide ranges & versatility. Calibration without removing from cabinet. New balanced bridge circuit. High Z input for negligible loading. 4 1/2" meter, can't-burn-out circuit. 7 non-skip ranges on every function. 4 functions: +DC Volts, -DC Volts, AC Volts, Ohms. Uniform 3 to 1 scale ratio for extreme wide-range accuracy. Zero center. One zero-adj. for all functions & ranges. 1% precision ceramic multiplier resistors. Measure directly peak-to-peak voltage of complex & sine waves: 0-4, 14, 42, 140, 420, 1400, 4200. DC/RMS sine volts: 0-1.5, 5, 15, 50, 150, 500, 1500 (up to 30,000 v. with HVP probe, & 250 mc with PRF probe). Ohms: 0.2 ohms to 1000 megs. 12AU7, 6AL5, selenium rectifier; xfmr-operated. 8 1/2" x 5" x 5". Deep-etched satin aluminum panel, rugged grey wrinkle steel cabinet. 7 lbs.

**New! DELUXE PEAK-to-PEAK VTVM #249**

with 7 1/2" METER & UNI-PROBE (pat. pend.)  
KIT \$39.95. Wired \$59.95

All the advanced & exclusive features of #232—PLUS the extra convenience and readability of its big 7 1/2" meter. Your ideal bench instrument.

**VTVM RF PROBES\* #PRF-11 or PRF-25:**

KIT \$3.75. Wired \$4.95. Accuracy  $\pm 10\%$ . Use with any 11 or 25 megohm VTVM.

**VTVM HV PROBE #HVP-2:** Wired \$4.95. Complete with multiplier resistor. Measures up to 30 kv with any VTVM or 20,000 ohms/volt VOM.



Calibration without removing from cabinet.

\*Only EICO Probes have all these features: fully shielded; rugged terminal board parts mounting; shock-mounted floating construction; swivel-action; color-coding; easy parts accessibility.



These amazing EICO values are NOW IN STOCK at your nearest distributor. Examine them side-by-side with ANY competitor. You'll see for yourself why indeed EICO is your BEST BUY. Fill out coupon on reverse page.



150 kc to 435 mc  
with ONE generator!

**New! RF SIGNAL GENERATOR #324  
KIT \$26.95. Wired \$39.95**

for COLOR and Monochrome TV servicing

New wide-range, stable generator - better value than generators selling at 2 or 3 times its cost! Ideal for: IF-RF alignment, signal tracing & trouble-shooting of TV, FM & AM sets; marker gen.; 400 cps audio testing; lab. work. 6 fund. ranges: 150-400 kc, 400-1200 kc, 1.2-3.5 mc, 3.5-11 mc, 11-37 mc, 37-145 mc; 1 harmonic band 111-435 mc. Freq. accurate to  $\pm 1.5\%$ ; 6:1 vernier tuning & excellent spread at most important alignment freqs. Etched tuning dial, plexiglass windows, edge-lit hairlines. Colpitts RF osc., directly plate-modulated by K-follower for improved mod. Variable depth of int. mod. 0-50% by 400 cps Colpitts osc. Variable gain ext. mod. amplifier: only 3.0 volts needed for 30% mod. Turret-mounted coils slug-tuned for max. accuracy. Fine & Coarse (3-step) RF attenuators. RF output 100,000 uv; AF sine wave output to 10 volts. 50-ohm output Z. 5-way jack-top binding posts for AF in/out; coaxial connector & shielded cable for RF out. Tubes: 12AU7, 12AV7, selenium rectifier; xfmr-operated. Deep-etched satin aluminum panel, rugged grey wrinkle steel cabinet. 8" x 10" x 4 3/4". 10 lbs.

The specs are the proof...

**4 NEW BEST BUYS  
by EICO**

**COMPLETE  
with Preamp, Equalizer and Control Section  
New! 20-WATT Ultra-Linear Williamson-type  
HIGH FIDELITY AMPLIFIER #HF20  
KIT \$49.95. Wired \$79.95**

A low-cost, complete-facility amplifier of the highest quality that sets a new standard of performance at the price, kit or wired. Every detail, down to the etched, brushed solid brass control plate, is of the fine quality EICO is famous for.

Rated power output: 20 watts (34 w peak). IM distortion (60 cps: 6 kc/4:1) at rated power: 0.3%. Mid-band harmonic distortion at rated power: 0.3%. Maximum harmonic distortion between 20 and 20,000 cps at 1 db under rated power: approx. 1%. Power response (20w):  $\pm 0.5$  db 20-20,000 cps;  $\pm 1.5$  db 10-40,000 cps. Frequency response (1/4 w):  $\pm 0.5$  db 13-35,000 cps;  $\pm 1.5$  db 7-50,000 cps.

5 feedback equalizations for LP's & 78's including RIAA. Variable turnover feedback tone controls do not affect volume & permit large boosts or cuts at either end of audio spectrum with mid-freqs. unaffected. Loudness control & separate level set control on front panel. Low Z output to tape recorder. 4 hi-level switched inputs: tuner, tv, tape, auxiliary (xtal/ceramic phono or 2nd tuner); 2 low-level inputs for proper loading with all leading magnetic, FM & quality xtal cartridges. Hum bal. control. Extremely fine output transformer has interleaved windings, tight coupling, careful balancing & grain-oriented steel. 8 1/2" x 15" x 10". 24 lbs.

TURN PAGE FOR MORE EICO VALUES...



84 Withers Street, Brooklyn 11, New York

Prices 5% higher on West Coast.

**the specs are  
the test that tells  
who's best!**

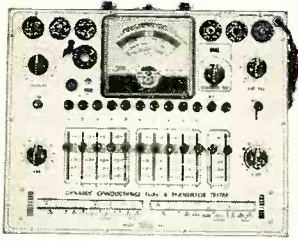

for COLOR & Monochrome  
TV servicing

**NEW! DYNAMIC  
CONDUCTANCE TUBE &  
TRANSISTOR TESTER #666**  
KIT \$69.95 WIRED \$109.95

Unexcelled testing thoroughness & accuracy. Checks transistor collector current & Beta using internal dc power supply. Tests all receiving tubes including subminiatures (& Color & Monochrome tv pic tubes with accessory adapter). Composite indication of mutual conductance, plate conductance, & peak emission. Simultaneous sel. of any 1 of 4 combinations of 3 plate, 3 screen, & 3 ranges of control grid voltage. Grid voltage variable over 3 ranges with 5% accurate pot. New series-string voltages for 600, 450 & 300 ma types. 5 ranges meter sens. with 1% precision shunts & 5% accurate pot. 10 SIX-position lever switches for free-point connection of every tube pin or cap. 10 pushbuttons for rapid insert of any tube element in leakage circuit & speedy sel. of individual tube sections. Direct reading of inter-element leakage in ohms. New gear-driven rollchart. Steel case with cover & handle. Sensitive 200  $\mu$ a meter.

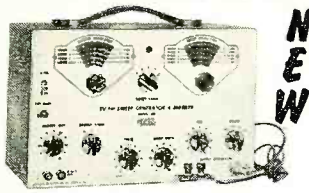

**NEW**

for COLOR & Monochrome  
TV servicing  
**TV-FM SWEEP GENERATOR  
& MARKER #368**  
KIT \$69.95 WIRED \$119.95

The **FINEST** service instrument of this type ever offered in either kit or wired form at ANY price! Outstanding ease & accuracy in FM & TV (including Color) alignment. Entirely electronic sweep circuit with accurately biased inductor: superb linearity on both sides of selected center freq. Newly-designed AGC circuit automatically adjusts osc. for max. output on each band with min. amplitude variations. Sweep range 3-216 mc in 5 OVERLAPPING FUND. BANDS. Sweep width continuously variable from 0-3 mc lowest max. deviation to 0-30 mc highest max. deviation. Variable marker gen. range from 2-75 mc in 3 FUND. BANDS plus a calibrated harmonic band (60-225 mc). Variable marker calibrated with int. xtal marker gen. 4.5 mc xtal incl. Ext. marker provision. Double pi line filter. Edge-lit hairlines eliminate parallax.

Turn page for other EICO ad



**FREE 1956  
EICO CATALOG!**

Tells you how to **SAVE 50%** on  
your test equipment costs!

**TUBE TESTER #625**  
KIT \$34.95  
Wired \$49.95

- tests 600 mil series string type tubes
- illuminated roll-chart

Pix Tube Test Adapter .....\$4.50

**New! GEIGER COUNTER #803**  
KIT \$19.95  
Wired \$29.95

(less batteries)  
Professional, all-electronic, sensitive, rugged—at lowest cost! Indicates by neon lamp & headphone clicks.

**5" PUSH-PULL OSCILLOSCOPE #425**  
KIT \$44.95  
Wired \$79.95

**7" PUSH-PULL OSCILLOSCOPE #470**  
KIT \$79.95  
Wired \$129.50

**VACUUM TUBE VOLTMETER #221**  
KIT \$25.95  
Wired \$39.95

**DELUXE VTVM : 214 (7 1/2" METER)**  
KIT \$34.95  
Wired \$54.95

**RF SIGNAL GENERATOR #320**  
KIT \$19.95  
Wired \$29.95

150 kc-34 mc, calibrated harmonics to 102 mc. Pure or mod. RF, & Colpitts osc. 400 cps sine outputs.

**NEW! REDI-TESTER #540**  
KIT \$12.95  
Wired \$15.95

Multi-range ac/dc voltmeter, ammeter, ohmmeter, wattmeter, leakage checker for home & auto repairs.

**#844 FLYBACK TRANSFORMER & YOKE TESTER**  
KIT \$23.95  
Wired \$34.95

- fast check all flybacks & yokes in or out of set.
- spots even 1 shorted turn!

Range 500 kc-228 mc on fund. Cont. sweep width control, 0-30 mc.

**KIT \$34.95**  
Wired \$49.95

**TV/FM SWEEP GENERATOR #360**  
5MC-4.5MC CRYSTAL .....\$3.95 ea.

1% accuracy on all 7 ranges. Range 75 kc-150 mc. Volt reg.

**KIT \$39.95**  
Wired \$59.95

**DELUXE RF SIGNAL GENERATOR #315**

Sep. volt-meter & ammeter

**KIT \$29.95**  
Wired \$38.95

**6V & 12V BATTERY ELIMINATOR & CHARGER #1050**

Sep. hi-gain RF & lo-gain audio inputs. Special noise locator. Calibrated wattmeter.

**KIT \$24.95**  
Wired \$39.95

**DELUXE MULTI-SIGNAL TRACER #147**

Reads 0.5 ohms -500 megs, 10 mmfd-5000 mfd. power factor.

**KIT \$19.95**  
Wired \$29.95

**R-C BRIDGE & R-C-L COMPARATOR #950B**

**HI-FI PREAMPLIFIER #HF-6**  
KIT \$24.95 Wired \$37.95. With Power Supply: KIT \$29.95. Wired \$44.95

Feedback circuitry thruout! Preamp-equalizer, tone controls, scratch & rumble filters, K-follower output.

20,000 Ohms/Volt  
**MULTIMETER #565**  
KIT \$24.95  
Wired \$29.95

1000 Ohms/Volt  
**MULTIMETER #536**  
KIT \$12.90  
Wired \$14.90

**VTVM PROBES**

Peak-to-Peak	KIT \$4.95	Wired \$6.95
RF	\$3.75	\$4.95
High Voltage Probe-1		\$6.95
High Voltage Probe-2		\$4.95

**SCOPE PROBES**

Demodulator	\$3.75	\$5.75
Direct	\$2.75	\$3.95
Low Capacity	\$3.75	\$5.75

For FREE 1956 catalog, mail coupon NOW!



84 Withers St. • Brooklyn 11, N. Y.

Prices 5% higher on West coast © 56  
and subject to change without notice.

**EICO, 84 Withers Street R-11**  
**Brooklyn 11, New York**

Send **FREE 1956 Catalog** and name of neighborhood EICO jobber.

Name.....

Home Address.....

City.....Zone.....State.....

Occupation.....

1945 to 1955: a decade of Know-How & Value Leadership in Kits & Instruments—over 1/2 million sold to date!

# The "Distributed Port"

## LOUDSPEAKER ENCLOSURE

By **ADELORE F. PETRIE**

Audio Products Engineering  
General Electric Company

**T**HERE are three main requirements that a loudspeaker enclosure should fulfill: (1) it should prevent interference between the front and back radiation from the loudspeaker, (2) it should improve low-frequency response, and (3) it should improve low-frequency power output capability.

A loudspeaker acts as a dipole radiator. The sound coming from the back of the loudspeaker is 180° out-of-phase with the sound coming from the front. This means that there will be cancellations and additions at various frequencies when a loudspeaker is operated without some sort of baffle. The amount of cancellation or addition depends on the difference in distance which the sound has to travel when coming from the back and front of the loudspeaker and the frequency involved.

In other words, a loudspeaker acts like the piston in an air pump. Without some sort of baffle around the piston (loudspeaker), the air displaced in front of the piston will merely circulate around to the back without building up any useful pressure. Fig. 1 shows what happens to the low-frequency response of a good 12" loudspeaker when it is operated without any baffle.

It is desirable that the low-frequency response of a loudspeaker system extend down to the lowest frequency that is contained in the program material normally fed into it. It is also necessary that the response be smooth so that the tonal balance of the program is maintained. A gentle slope in bass response is permissible since this may be offset by additional bass boost in the driving amplifier. However, this boosting wastes power and may severely limit power output.

It is not enough for a loudspeaker to have smooth response and wide range. Due to the fact that the ear is insensitive at low frequencies, a loudspeaker system must also have sufficient power output capability to make the frequencies it reproduces audible to the listener. For example, sounds

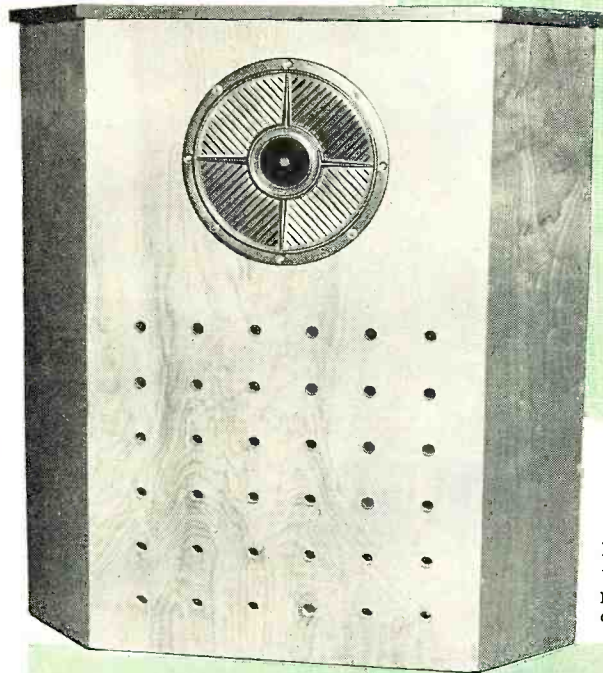

Laboratory model of enclosure with holes forming "distributed port" clearly visible. Commercial version is shown above.

*The performance of a "distributed port" enclosure is evaluated, along with useful general information on the low-frequency performance of quality loudspeakers.*

at 50 cycles-per-second must be 52 db louder than those at 1000 cycles-per-second in order to be heard. Therefore, it is necessary to check the low-frequency acoustic power output capability (sound pressure or intensity—not power input) of a loudspeaker system at a tolerable level of distortion to see if it is sufficient for application.

The acoustic power output capability of a loudspeaker is limited by the maximum sound pressure that the loudspeaker can produce without running into distortion. At low frequencies this pressure is determined by the maximum distance that the loudspeaker cone can move before it is limited mechanically or magnetically and by the enclosure used. It makes no difference in this discussion whether the cone movement is limited by magnetic distortion in the flux gap or mechanical distortion in the cone suspensions. The important fact is that every loudspeaker has some definite maxi-

mum cone movement. The amount of sound pressure this cone movement produces at low frequencies is determined by the characteristics of the loudspeaker enclosure. Because the acoustic power output capability in a given enclosure depends on cone excursion, it is interesting to note that the stiffness of the cone suspensions or the fundamental cone resonance of the loudspeaker has little effect on the power output capability of the loudspeaker system (providing the linearity of the stiffness is not changed).

### "Infinite Wall" Baffle

The previously mentioned interference problems may be completely eliminated simply by preventing the sound from the back of the loudspeaker reaching the front. One means of doing this would be to mount the loudspeaker in a hole in a large wall, see Fig. 2. This is known as an "infinite wall" type of enclosure. Because this is a simple enclosure which is comparatively easy to analyze and actually may be realized in practice, it can be used as a standard reference for comparison when evaluating other types of enclosures.

With this type of baffle, obviously there is no interference between the front and back radiation—they are separated by a wall "infinite" in size. The low-frequency response of a loudspeaker in this type of baffle depends on the size of the speaker, its efficiency, the damping factor of the

Fig. 1. Response of a typical high-quality 12-inch loudspeaker without any baffling.

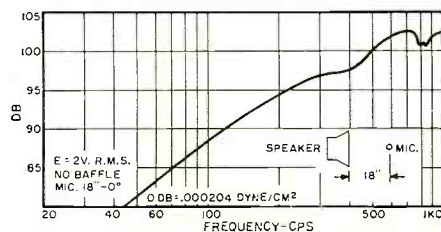

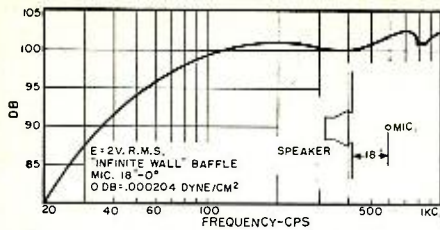

Fig. 2. Response of a typical high-quality 12" speaker in an "infinite wall" baffle.

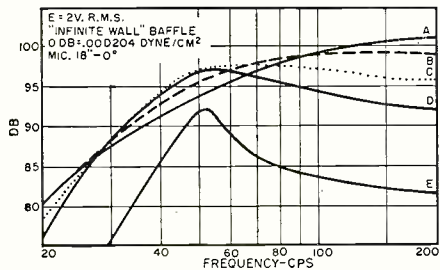

Fig. 3. Effect of magnet size on the response of a typical high-quality 12" loudspeaker (made by demagnetizing in steps).

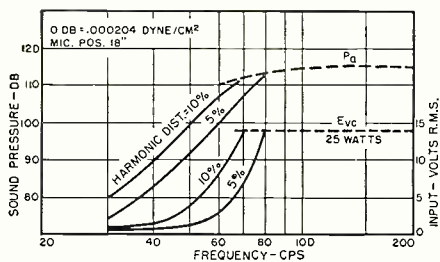

Fig. 4. Power output capability of a typical high-quality 12" loudspeaker in an "infinite wall" type speaker enclosure.

amplifier driving the speaker, and the low-frequency resonance of the loudspeaker in the baffle. Fig. 2 shows the response of a typical high-quality 12" loudspeaker in this type of enclosure. (Note: In order to eliminate the amplifier from this discussion, the frequency response curves shown in this article are plotted with a constant voltage input to the loudspeaker.)

This particular loudspeaker had a fundamental resonance of 50 cycles-per-second when mounted to the wall baffle. Note that this fundamental resonance was not apparent in the response curve. Instead of a resonant rise, the response was gently sloping off in the region around resonance. This is characteristic of all high-efficiency loudspeakers when driven from a feedback amplifier or other low impedance source. The electromagnetic coupling is so great that the amplifier shunts the resonant circuit, causing it to be overdamped (low "Q"). This makes for good transient response, but requires some sort of compensation to bring the low-frequency response up to where it should be.

In order to show the effect of efficiency on response, the efficiency of this loudspeaker, in an "infinite wall" type of baffle, was reduced by demagnetizing it in steps and thus plotting a family of response curves (Fig. 3). Curve A shows a high efficiency loudspeaker, curve E, shows a low-effi-

ciency loudspeaker. With similar construction, each time the 200-cycle response was reduced by 3 db, it was equivalent to reducing the magnet weight by one-half. This is the reason why loudspeakers of high efficiency often seem to lack bass response unless the bass end is compensated in some way (either in the amplifier or the enclosure).

Fig. 4 shows the acoustic power output capability ( $P_a$ ) of this loudspeaker in the "infinite wall" baffle for 5 and 10 per cent harmonic distortion. (Note: The average sound pressures that the loudspeaker systems shown in this article can produce throughout a typical living room are approximately 3 db below the recorded levels, which are measured 18" in front of the loudspeakers in a "dead" room.)

Fig. 4 also shows the corresponding electrical input to the voice coil ( $E_{vc}$ ). Note that the power at higher frequencies is limited, not by distortion, but by the maximum heat dissipation rating of the voice coil.

Note also that the electrical input to the loudspeaker must be greatly reduced at very low frequencies to prevent driving the loudspeaker into severe distortion. Rumble coming from the turntable and/or the record will often drive a loudspeaker into distortion, even though the rumble itself is too low in frequency and amplitude to be heard by the listener. To eliminate this difficulty it is usually desirable to have a sharp cut-off low-frequency filter somewhere in the system.

If the loudspeaker in Fig. 4 were less efficient, it would handle more electrical input at low frequencies; however the maximum acoustic output at low frequencies would be the same and, due to lower efficiency, the maximum acoustic output would be less in the region where the power is limited by the voice coil dissipation.

#### "Distributed Port" Enclosure

The "distributed port" enclosure is a reflex type of enclosure in which the back radiation is added to the front radiation at low frequencies. By this means it improves both the low-frequency response and the power output capability. It differs from most reflex enclosures in that the response and impedance characteristics are controlled by the addition of a specific amount of acoustic resistance.

There is no interference between

Fig. 5. Frequency response of a 12" speaker in several "distributed port" enclosures. The "infinite wall" response under same condition is shown for comparison.

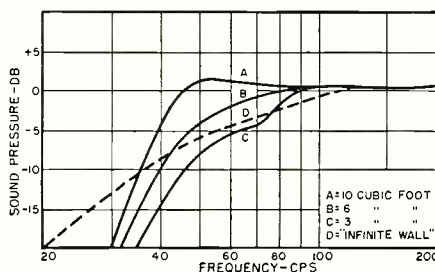

the front and back radiation at high frequencies due to the fact that the reflex action has an inherent high-frequency cut-off of back radiation. In the useful low-frequency range, a controlled amount of back radiation is added to the front radiation, increasing the output and power handling ability.

At very low frequencies (usually sub-audio) there is cancellation between the front and back radiation and air is merely pumped from the front to the back of the loudspeaker. This characteristic is common to all loudspeaker enclosures which utilize both front and back radiation, and makes it even more desirable to use a "rumble" filter, as mentioned previously.

Fig. 5 shows the low-frequency response of a typical high-quality 12" loudspeaker in three "distributed port" enclosures. Also shown, is the "infinite wall" response for comparison. Note the large increase in output and the smoothness of response at low frequencies, where the reflex action occurs. Adding the correct amount of damping in this design matches the impedance of the enclosure to that of the loudspeaker. This means maximum power output from the enclosure and broadband response (low "Q"). Putting this damping in the form of a "distributed port"—a fixed number of holes spread over a definite area—assures the permanent accuracy of the damping.

Fig. 6 shows the acoustic power handling ability ( $P_a$ ) of these same "distributed port" enclosures. Note the great increase in the undistorted sound pressure that these enclosures are capable of delivering at low frequencies. Note that, at some frequencies, the larger enclosures will handle less voltage input ( $E_{vc}$ ) than the smaller ones, although the sound pressure ( $P_a$ ) produced by the larger enclosures is greater. This is due to the fact that they are more efficient than the smaller enclosures at these frequencies.

#### Construction Data

Dimensions for constructing three "distributed port" enclosures are given in Fig. 7. (The 6-cubic foot unit is available commercially as the G-E A1-406 loudspeaker enclosure.)

The G-E A1-400 loudspeaker, used for all curves in this article, features a styled protective front plate, making the use of a grille cloth unnecessary in many installations. To take full advantage of this feature, the speaker should be mounted on the front surface of the speaker mounting board. If a grille cloth is required for styling purposes, the material used must not impair the transmission of high frequencies. Suitable materials are woven plastic or fabric having a light porous weave. The grille cloth should be mounted in a manner which will not allow vibration of the cloth against the cabinet. When grille cloth is used, the speaker is attached to the rear

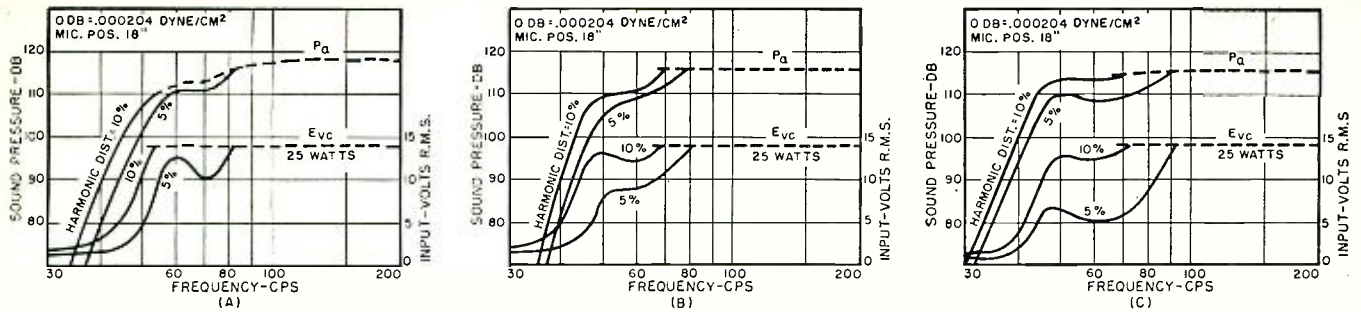

Fig. 6. Power output capability of a high-quality 12-inch loudspeaker in "distributed port" enclosures of various sizes. (A) 3-cubic feet, (B) 6-cubic feet, and (C) 10-cubic feet.

surface of the speaker mounting board.

Use plywood at least 1/2" thick for the 3- and 6-cubic foot sizes and at least 5/8" thick for the 10-cubic foot size. Preferred plywood thickness is 3/4". Line the back, bottom, and one side of the 3-cubic foot enclosure with 1" of Fiberglas or similar soft acoustic material. Line the bottom and two back sides of the 6- and 10-cubic foot enclosures with 2" of Fiberglas or equivalent. Glue all joints. Make front or back removable, if the speaker is to be mounted on the inside surface of the mounting board. The 2" x 4" brace is to keep the speaker from setting up vibrations in the front panel, which will subtract from the low-frequency output.

The shape of the enclosures may be altered to suit the needs of the user as long as the internal volume and the configuration of the front panel are maintained.

### Loudspeaker Characteristics

The curves presented here are accurate only when the loudspeaker used has characteristics which are similar to those of the G-E A1-400 loudspeaker. However, the general characteristics indicated are typical of all loudspeakers and must be kept in mind when choosing or designing a loudspeaker, or enclosure, or associated equipment.

The important characteristics of the A1-400 "woofer" for enclosure design include: Nominal diameter—12 inches; Effective cone diameter—10 3/4 inches; Free air resonance—60 cycles/second; Mass of moving system (exclusive of air load)—25 grams; BL (force constant)—12,000,000 gauss cm; and Magnet weight—14 oz. Alnico V.

Fairly similar types are the G-E 1201-A and 1203-A loudspeakers.

Using loudspeakers of larger diameter than 12" in these "distributed port" enclosures will, in general, improve the power handling ability but result in a poorer low-frequency response. A smaller loudspeaker will give correspondingly better low-frequency response and poorer power handling ability. A larger loudspeaker should not be used with the 3-cubic foot enclosure and a smaller loudspeaker should not be used with the 10-cubic foot enclosure.

### Room Effects

It should be noted that the curves presented in this article were taken

under conditions which did not include reflections and resonances usually found in the listening environment. This is desirable because the effect of a room on the performance of a loudspeaker system is usually independent of the system used. These same effects also color the music as the listener hears it when live performers are in the room and therefore are not necessarily harmful.

Every hard object of appreciable size in a room sets up reflections. The most important objects to be considered at low frequencies are the walls, ceiling, and floor. Standing waves are set up in a room at frequencies where the distances between parallel surfaces are equal to 1/2, 1, 1 1/2, 2, etc. wavelengths. These standing waves always build up high pressure points at the walls which cause them. The impedance match between the loudspeaker and the room is best at these high pressure points. For this reason, the best place for a loudspeaker system is the corner of the room where efficient coupling is made to all room resonances.

In most rooms, the only resonance which might be objectionable is the standing wave between the floor and ceiling, which usually occurs between 60 and 80 cycles-per-second. Coupling to this resonance may be reduced by placing the loudspeaker enclosure in

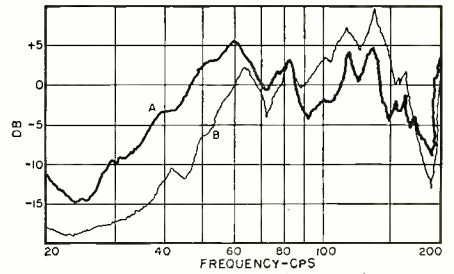

Fig. 8. (A) Response of a typical high-quality 12" loudspeaker in a 6-cubic foot "distributed port" enclosure in the corner of a "live" room, illustrating the effect of standing waves and reflections on response. (B) Response of a typical back-loaded folded corner horn enclosure of equal size measured under the same conditions as (A).

the corner, but off the floor (half way up the wall is best). This is usually objectionable appearance-wise. An equally good solution is to damp the resonance by applying sound absorbing material to the ceiling. To absorb these frequencies may require padding up to 8" thick, or hung 8" below the true ceiling.

Fig. 8A shows the response of a 6-cubic foot "distributed port" enclosure placed in a corner of a live room. Curve B shows the response of a typical back-loaded folded corner horn enclosure of equal size under the same (Continued on page 130)

Fig. 7. Mechanical details on three "distributed port" enclosures of (A) 10-cubic foot, (B) 6-cubic foot, and (C) 3-cubic foot volume. Refer to text and Fig. 6 above.

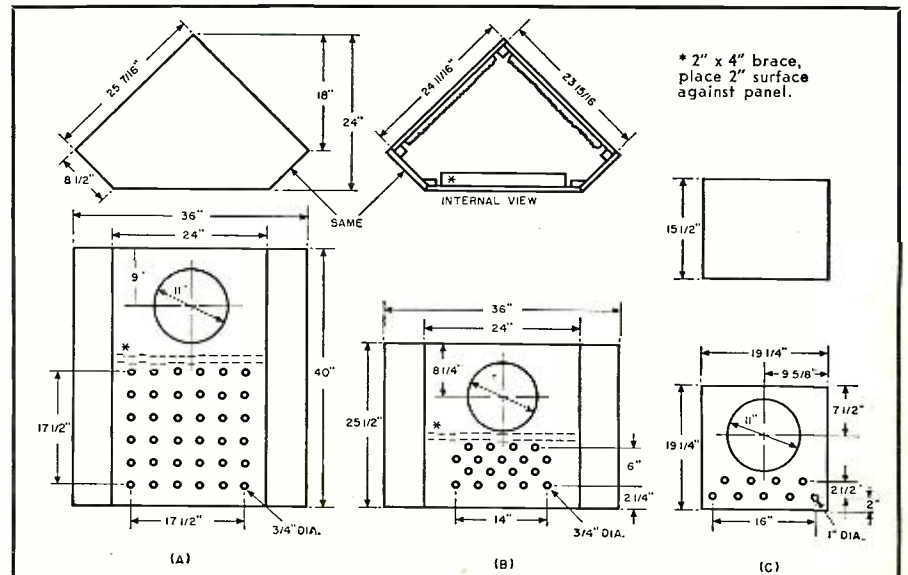
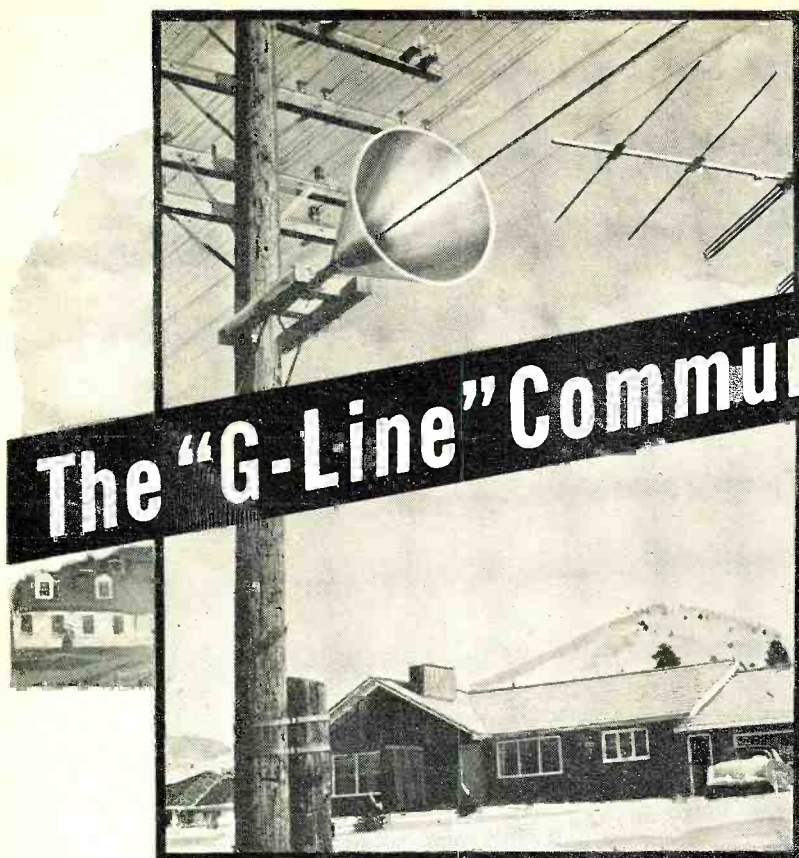

Fig. 1. TV reception by "radiation." One subscriber merely placed his yagi near the "G-Line" and picks up good signals.



# The "G-Line" Community TV System

By ROBERT B. GARY



*The use of a novel transmission line has cut the cost of system installation and maintenance at Helena, Montana.*

THE economics of most community TV installations dictate that the operator bring the TV signal from the antenna to the community before he can start collecting his installation fees. This means that the initial investment involves the cost of erecting the antenna and installing the transmission line and its associated amplifiers.

Maintenance of the system is largely confined to the servicing of the amplifiers and this item is, therefore, a direct function of the distance between the antenna and the community. This article will describe a new method of bringing the signal to the community, a method which is far more efficient and economical than the conventional cable systems.

Coaxial cable has an attenuation on the order of 20 db per 1000 feet on the lower TV channels. This means that for sound design at least two amplifiers are required per mile. In addition to the initial cost of the amplifiers and their maintenance, in many instances a special power cable must be strung to these amplifier sites. In some localities, therefore, consideration was given to a microwave relay to bring the TV signal from the mountain to the town. FCC regulations permit public utilities, like A. T. & T., to lease their microwave facilities to community TV systems but forbid the

community operator installing his own microwave link. As a result, many community TV installations remain paper projects.

Television reception is not possible in Helena, Montana, but only 15 miles away is McDonald Pass and the Continental Divide, and channel 13 can be picked up there from Missoula. By conventional coaxial cable methods the 15-mile haul would cost \$40,000 to \$50,000 just for the initial installation.

Helena was fortunate in having Bruce Hamilton, an alert engineer, in charge of its community TV project. He had read about the "G-Line" and realized that this technique might solve Helena's transmission problem. After some study and investigation, Mr. Hamilton started on the project of installing the first "G-Line" in a community TV system.

The "G-Line" is named after its inventor, Dr. George Goubau, who developed this single-wire line for the U.S. Signal Corps. (Details on this line were given in Leonard Lieberman's article, "The G-Line Antenna Lead-In," in the April 1955 issue of this magazine). Fundamentally, the characteristics of this line are those of a coaxial cable of fixed dielectric except that the outer conductor is placed at infinity. By choosing the proper relationship between the inner conductor and the surrounding dielec-

tric diameter, the mode of wave propagation is largely axial. It is only necessary that the single-wire line be fed from a coaxial system by means of a carefully designed "launcher." This is, effectively, a cone with the center conductor at its apex and the outer conductor making the transition from the coaxial cable to the infinite spacing.

Fig. 3 shows a typical "launcher" as used in the Helena installation. The "G-Line" has some remarkable properties. Its losses at the lower TV channels are on the order of 10 to 20 db per mile depending on the particular installation. The installation of the single-wire line is slightly tricky. When the line is about a half wavelength from the pole or other object, the loss at that point will be .05 db. Losses due to bends in the line become appreciable as the corner is made sharper. Theoretically, the db losses vary with the square of the bending angle and whenever bends are required they must be as gradual as possible. Another important characteristic of "G-Line" is that, theoretically, there is very little radiation. In actual practice Mr. Hamilton found that the radiation from the single-wire line was a maximum of 1.5 microvolts-per-meter at a distance of ten feet and this was at a point of greatest signal energy level. This factor is confirmed by the photograph of Fig. 1, which shows a rather unique method of tapping off a TV line. A home owner along the route of the "G-Line" simply placed his yagi antenna close to the wire and got good TV reception. This method has the operator's sanction since the regular rental fee is paid by this "radiation subscriber."

The channel 13 signal from Missoula is received by a conventional antenna array and amplified before it is converted down to channel 4. This conversion was suggested by the poor per-



formance of the channel 13 strip amplifiers which were tried first. The "G-Line" itself is more efficient at the higher frequencies but the amplifier considerations outweighed this feature. For channel 4 transmission, the maximum diameter of the "launcher" is 58 inches with a taper angle of 45 degrees. The inner conductor of the "G-Line" is #8 Copperweld and the dielectric is brown pigmented polyethylene with an outer diameter of .253 inch.

Although the theoretical distance from foreign bodies should be on the order of half a wavelength, for practical reasons the wire was suspended about 15 inches below the lowest crossarm of the telephone poles belonging to the Mountain States Telephone trunk line. In most straight sections the line is suspended by ¼-inch nylon rope as shown in Fig. 2. At some bends 15-inch polystyrene rods are used to brace the line horizontally. The telephone poles from McDonald Pass (altitude 6000 feet) to Helena (3000 feet) predate the road and therefore run along the road at only a few points. Distances between poles vary and the line crosses the new U.S. Highway 10 several times. Because power is not readily available at all points along the line, the line amplifiers are located at unequal intervals and the longest stretch of "G-line" is about 2.5 miles between amplifiers. On that stretch the total losses over 2.5 miles are only 53 db.

A total of nine line amplifiers is required to cover the 15-mile stretch. Mr. Hamilton found it necessary to space the receiving and transmitting launchers about 120-feet apart at the amplifier stations in order to avoid ghosts caused by feedback. Recent Signal Corps tests seem to indicate that "launchers" can be placed back-to-back without appreciable separation and it may well be that some mismatch exists in the Helena system

which causes this feedback problem. A typical horn and associated amplifier are shown in Fig. 4, and it is clearly apparent that the output of the "launcher" apex goes through the RG-11/U to the conventional line amplifier.

In Helena, the signal is distributed to over 500 homes by means of RG-11/U, double-shielded coaxial cable and conventional distribution amplifiers. A total of 70 miles of RG-11/U has been used to date in Helena just to hook up subscribers to the distribution amplifiers. The installation fee is \$125.00 with a monthly tariff of \$3.75. The major initial investment, as in all community TV projects, was the cost of bringing the signal down from McDonald Pass. While conventional coaxial cable and amplifiers would have cost at least \$40,000, the actual cost of installing the 15 miles of "G-Line," including the price of the wire itself, the amplifiers, antennas, power connections, etc., was only slightly over \$12,000.

The weather conditions at the Continental Divide are probably the most severe, with regards to snow and ice, in the country. During the past winter, however, the signal was lost for only half an hour when an inch of wet snow accumulated on large portions of the line. As soon as the snow had melted or fallen off, the signal was restored. Since there is no outer conductor, the problem of moisture seeping in or condensing between the outer conductor and the dielectric does not exist. The outer polyethylene jacket has, in other applications, proven to be almost impervious to weathering for a considerable time.

Helena TV Inc., the operator of this pioneer "G-Line" community TV system, is licensed by *Surface Conduction Inc.* of 521 Fifth Avenue, New York, the company which holds all commercial rights to Dr. Goubau's patents. So successful is the Helena installation that its owners are now intent on

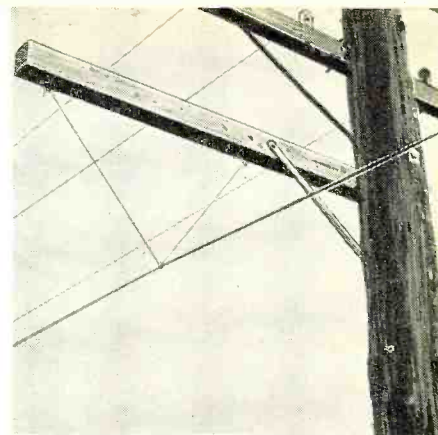

Fig. 2. The "installation" of the "G-Line" consists, for the most part, in suspending the line from the crossarm of a utility pole by a quarter-inch nylon rope.

tackling a 27-mile line in the area.

Other community TV systems which are planning to use the "G-Line" include the *Neighborhood TV Corp.* of Owen Sound, Ontario. Here the TV signal will be received at a suitable high point as close to Toronto (150 miles away) as possible and then transmitted to Owen Sound along the telegraph poles of the *Canadian Pacific Railroad*.

The most recent application of the "G-Line" to community TV was in September 1956 when an "open wire" transmission line was replaced by a single wire "G-Line" extending over 8000 feet in the Port Jervis community TV system. *Port Video Corporation*, owners of this system, found that this changeover resulted in improved performance.

This new "G-Line" installation extends (apart from poles belonging to *General Telephone and Rockland Light and Power*) over system-owned poles separated by 600 feet or more, thus showing the adaptability of the line to varied local conditions. -30-

Fig. 3. One of the "launchers" used in the Helena installation.

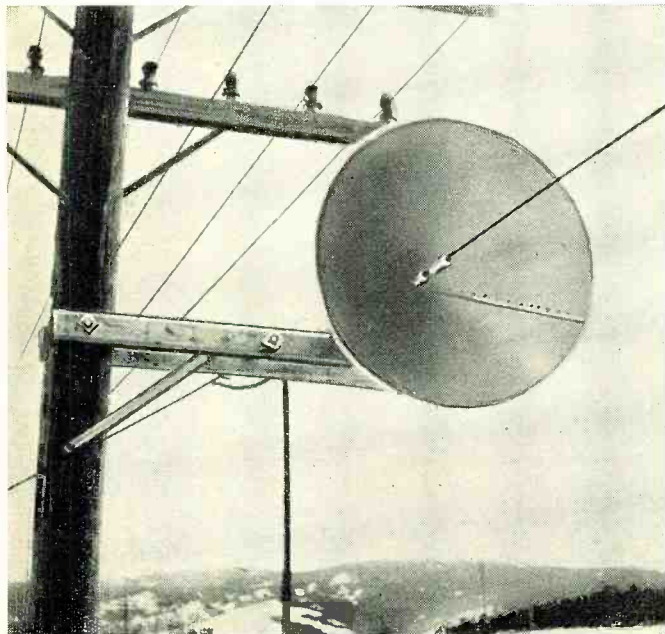

November, 1956

Fig. 4. Nine horns and amplifiers cover the 15-mile stretch.

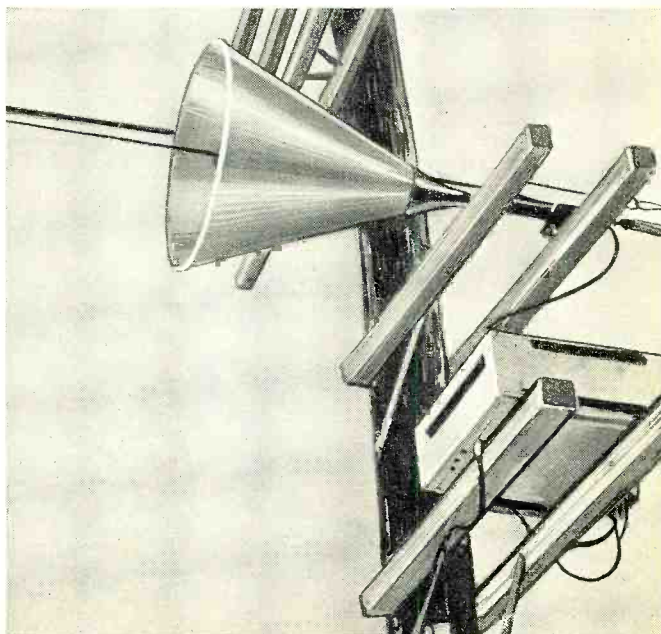

By  
**WALTER H. BUCHSBAUM**  
 Television Consultant  
 RADIO & TELEVISION NEWS

# New RCA Color TV Circuits

*The circuits described here are being used for the first time in color TV sets. Here, too, are installation hints.*

The color demodulator used in the "Special" and "Super" series of receivers is also new. Here (see Fig. 2) two dual triodes are used to provide all three color difference signals and directly drive the three kinescope grids. The color subcarrier and its sidebands are applied to all four triode grids while the color sync signal is applied to each cathode, with proper phase correction. One of the plate circuits produces the green and one the blue color difference signals while the red difference signal is the result of matrixing circuits between the plate voltages.

Since the demodulation occurs between grid and cathode, the tube also acts as an amplifier between grid and plate. This amplification of the color video signals makes it possible to go directly from the low level of the 3.58 mc. color subcarrier to the higher video signals required to drive the color picture tube grids. The cathodes of the color picture tube are driven by three Y signals, properly proportioned by means of a voltage divider network in the plate circuit of the second video amplifier.

The color demodulator circuit of the "Deluxe" line is patterned after the older pentagrid converter, synchronous detector system, and uses three output amplifiers which matrix directly into red, green, and blue difference signals.

The "Deluxe" chassis uses the triode section of a 6AW8 tube as a video noise inverter. A simplified diagram of this circuit is shown in Fig. 3. Video signals of the same polarity but at different amplitudes are applied to the grid and cathode of the first video amplifier and to the cathode of the noise inverter triode. These noise pulses are amplified in the noise inverter so that they are equal in amplitude, but opposite in polarity, to the noise pulses passing through the first video amplifier. This results in cancellation of noise pulses at the input to the first sync amplifier stage and the a.g.c. tube. To avoid cancellation of the sync pulse, the grid of the noise in-

*(Continued on page 78)*

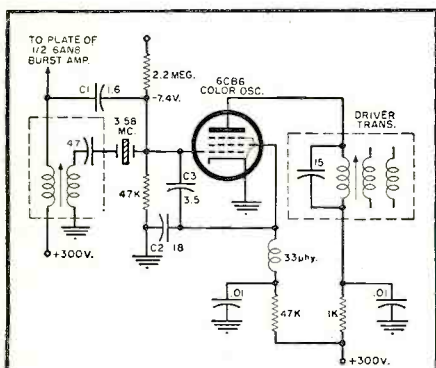

Fig. 1. Partial schematic diagram of the crystal-tube 3.58 mc. oscillator.

**T**HE new line of RCA color receivers is divided into three series. The "Special" and "Super" series use practically the same chassis. The "Deluxe" sets use a chassis which is considerably different. A total of 26 tubes plus the picture tube, two crystal diodes, and a 3.58 mc. oscillator are used in the "Special" chassis, CTC5 and CTC5A. The tuner is basically a v.h.f. type with u.h.f. attachment optional. Both video and intercarrier sound i.f. sections are conventional with one exception: separate second detectors are used for the sound and picture i.f.'s. This minimizes the possibility of 920 kc. interference. A single high-voltage rectifier is used to supply the 25 kilovolts for the ultor and a separate rectifier provides the focusing potential.

## New Circuits

The color sync section and the 3.58 mc. oscillator used in all new RCA receivers is considerably different from previously used circuits. A simplified circuit diagram of the 3.58 mc. oscillator is shown in Fig. 1. The burst amplifier provides a strong synchronizing burst signal which is applied to the 3.58 mc. crystal and, through  $C_1$ , to the control grid of the oscillator tube. Feedback from the screen grid of that tube through the divider network  $C_2$  and  $C_3$  causes continuous oscillation of a 3.58 mc. signal which is then furnished to the demodulators from the driver transformer. This circuit is quite a departure from previously used crystal oscillators which were controlled by a reactance tube and phase detector.

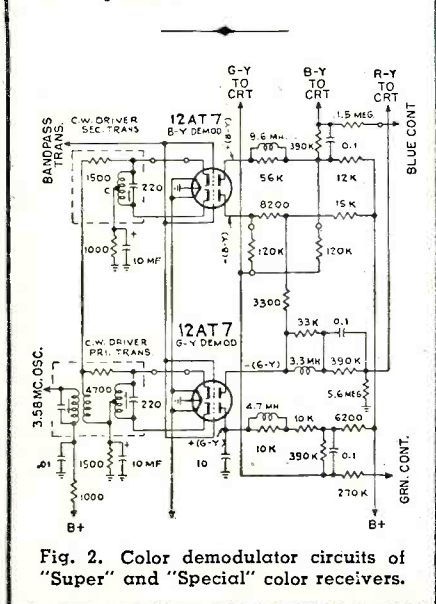

Fig. 2. Color demodulator circuits of "Super" and "Special" color receivers.

# Picture-Phone Uses Telephone Lines



W. E. Kock of Bell Telephone Laboratories shows how one experimental model of a Picture-phone would be used. Protruding above the picture screen is the camera lens. The knobs below the screen are for turning on the set and for defining the picture.



F. K. Becker, a Bell Telephone Laboratories engineer who is working on the development of a new Picture-phone system, demonstrates another one of the experimental models. The system makes Picture-phone transmission feasible after apparatus is fully developed.

SCIENTISTS and engineers at the Bell System's research and development organization have used an experimental "Picture-phone" system to transmit recognizable pictures over short and long distances, even as far as from New York to Los Angeles. Experimental pictures vary in size from 1 x 1½ inches to 2 x 3 inches, and are viewed from 1 to 2 feet away. Unlike television, a new picture is displayed every two seconds.

The Picture-phone is the first system of its kind to use a pair of ordinary telephone wires. This is what gives it promise of being commercially feasible. Only one other line, consisting of a pair of wires like the regular telephone line, would be installed on the customer's premises to carry the picture. It will be possible for a caller's picture to be "dialed" like an ordinary telephone call, provided the switch on the picture equipment is turned on at both ends of the line. If the switches are off, the telephone call will be completed without pictures. The picture can also be turned on after a conversation is underway.

The raster is made up of 60 lines, each of which may have a maximum of 40 dots. Thus each complete frame may be thought of as being made up of 2400 dots. Since one complete picture is transmitted every 2 seconds, a bandwidth of only 600 cps is required. Since the very low frequency components of this 600-cycle "video" band would be attenuated if sent over phone lines, the "video" signal amplitude modulates a 1200-cycle carrier. The sidebands (from 600 to 1800 cps) lie

*A telephone that transmits pictures along with sound has taken a big step towards commercial feasibility.*

within the range of optimum transmission exactly like a voice signal.

A conventional industrial-type Vidicon TV camera is used (see block diagram below), which produces a 60-line raster every 1/20 second. Of the 40 scans that are available every 2 seconds, one is arbitrarily selected and recorded during a single rotation of a magnetic drum. Gating and timing circuits allow the stored information to be picked off the drum faster than it had been recorded. Within 2 seconds, all the information from a single scan has been passed on to the modulator, and the drum is erased and made ready for the next picture. Sync data is then combined with the signal which then goes out over the telephone circuit.

Conventional techniques are used at the receiver, where the sync controls the sweep circuits and the picture in-

formation is presented to a pair of direct-view electrostatic-storage picture tubes, called Iatron. The picture is stored on an inner screen just behind the fluorescent coating on the tube screen, which remains dark during the storage. Then the picture is made visible by means of a flood of electrons from a second gun. The picture will last for several minutes or it may be erased by applying a voltage to one of the electrodes. By using two Iatrons with a half-silvered mirror, an image can be seen on either of the tubes when the other one is dark. Information is written into one tube while the other is being viewed, then the first tube is viewed while the other tube is having information applied to it.

The picture equipment is still undergoing development and evaluation and is not yet ready for manufacture or commercial use.

-30-

Block diagram of one of the systems being tried out that transmits narrow-band video.

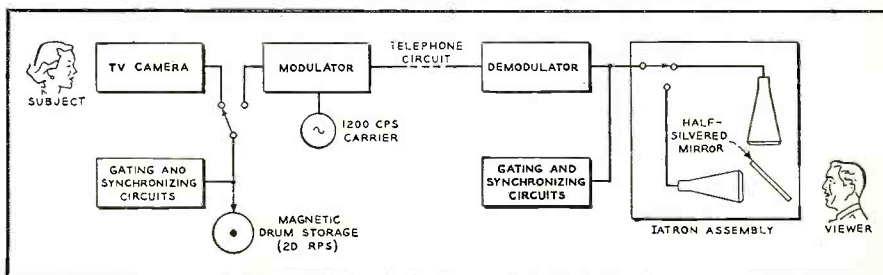
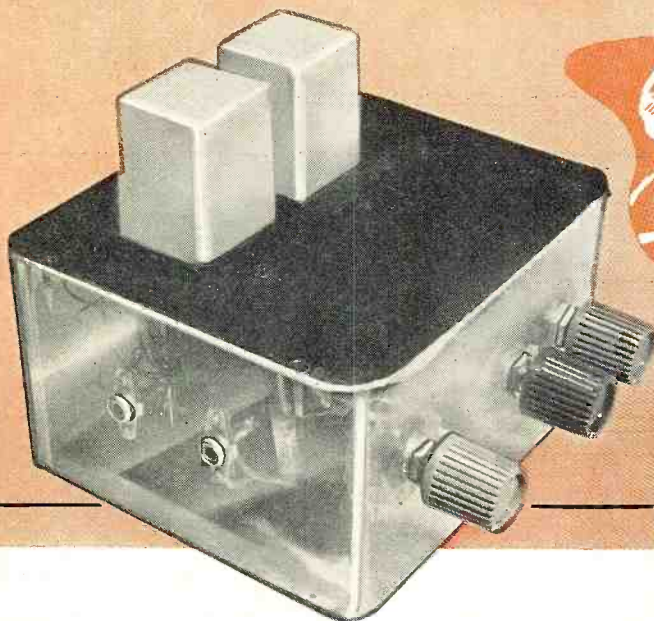

Fig. 1. The completely assembled transistorized amplifier housed in its Plexiglas case. From left to right the dials on the front control the volume, bass, and treble. The jacks, from left to right, are for output to an 8-ohm speaker system and input from a General Electric variable reluctance pickup cartridge.



# All Transistor Hi-Fi Amplifier

By

**HUGH R. LOWRY**

Application Specialist  
Semiconductor Products Dept.  
General Electric Company

Completely battery operated, this combination preamp, for magnetic cartridges, and power amplifier will provide quality reproduction. Although the power output is quite low, only about three-quarters of a watt, the unit's output is sufficient for ordinary home listening.

THE two most popular types of projects for the electronic hobbyist are those involving either transistors or high-fidelity equipment. Up until now however, transistors have been notorious for their lack of uniformity and transistor articles frequently contain statements like, "Resistor  $R_2$  should be selected for best results," or "It is advisable to try several transistors, and choose the one giving the best performance." For this reason, transistor applications in hi-fi equipment have been largely limited to preamplifiers that must be followed by conventional tube amplifiers so that the many advantages of transistors are not fully realized.

Recently the *General Electric Company* announced a complete line of low cost audio transistors with very close control on the parameters so that complete interchangeability is possible, even in push-pull output stages which formerly required high priced matched pairs. With these new transistors and present circuit design techniques, it is now practical to build a completely transistorized high-fidelity amplifier of sufficient output for ordinary home listening. The complete amplifier, including magnetic cartridge preamplifier and tone controls, is shown in Fig. 1. No attempt was made toward extreme miniaturization in the author's model, but the compactness typical of transistorized equipment is obvious. The circuit diagram of the complete unit is shown in Fig. 5.

One of the most popular pickups among high-fidelity equipment owners is the *G-E* "variable reluctance" unit and this preamplifier circuit was designed to work with it. To obtain proper high-frequency equalization, the manufacturer recommends that the cartridge be loaded down with 6200 ohms and that 18 db of bass boost be used to compensate for recording characteristics. This combination will compensate for the RIAA characteristic, which is used by virtually all record manufacturers, and be sufficiently close compensation to give acceptable performance with older recordings. In the case of this circuit, proper cartridge loading is accomplished by means of resistor  $R_1$ . This 3900-ohm resistor, operating in conjunction with the low input impedance of the first transistor,  $V_1$ , provides a circuit with proper response.

The preamplifier consists of two *RC*-coupled, grounded-emitter amplifiers with frequency selective feedback to give the required bass boost and turn-over frequency. There are many possible methods of biasing transistor amplifiers, each with its own advantages and disadvantages.

If a wide range of transistor current gains is to be tolerated with stable performance at high temperatures, it is necessary to use the circuit shown in Fig. 3A. In this type of biasing, the emitter current (and hence collector current) is essentially determined only by the voltage at the base and the resistance in series with the emitter.

Although this type of biasing is extremely stable, good low-frequency response requires a very large bypass capacitor around the emitter resistor, which adds considerably to the cost and little to the performance. Since this transistor hi-fi amplifier was not intended to be operated under extreme environmental conditions and the new *G-E* transistors have close control on current gain, it is possible to use a simpler form of biasing as shown in Fig. 3B. In this type of biasing the base current is determined by the collector voltage and the resistance between collector and base. This type of biasing is extremely degenerative. For example, consider the situation where the collector current increases, causing a drop in collector voltage. A decrease in collector voltage reduces the current flowing into the base which, in turn, reduces the collector current, thereby counteracting the original increase in collector current.

It might appear at first glance that this type of biasing would not only be degenerative for d.c. drifts, but would also degenerate the signal being amplified. This would be true if the a.c. load impedance was high in comparison with the 18,000 ohm collector resistor.

If the load is the input to another transistor, as is usually the case, the input impedance of the following transistor is low compared to the collector resistance and little a.c. degeneration takes place. Since tubes are voltage-operated devices, the usual method of bass boost is to use voltage feedback from the second plate to first cathode.

The input to the first transistor is almost a current source (low impedance cartridge plus large series resistance), and it is better to use current feedback rather than voltage feedback. A signal proportional to the output current is taken from the small resistor in the emitter of the second

transistor and fed back through a frequency sensitive network to the base of the first transistor. The performance of the preamplifier is shown in Fig. 2, and it can be seen that it is comparable in every respect to conventional tube preamplifiers.

As a matter of interest, the .05  $\mu$ f. capacitor was replaced with a 6  $\mu$ f. unit and the response of the preamp was found to be  $\pm 0.25$  db from 20 to 20,000 cycles. Over-all response to the voice coil jack was within about  $\pm 2$  db over the same frequency range.

### Tone Controls

It might be argued that perfect reproduction of music only requires that the amplifier compensate for recording characteristics and no additional frequency compensation is necessary. In practice, however, it is necessary to include tone controls so that differences in loudspeakers, room acoustics, listening levels, and individual preferences can be accommodated.

The tone controls used in this amplifier provide independent bass and treble control without interaction and both have a 1000 cycle turnover frequency. The action of the tone controls is easily understood if they are considered as current transfer networks rather than voltage transfer networks as in vacuum tube amplifiers. The output current from the second transistor goes to the volume control where part of it is shunted to ground and the rest goes to the junction of the 0.02  $\mu$ f. and 0.2  $\mu$ f. capacitors and the center arms of the potentiometers. At 1000 cycles the current is divided so that 10/11ths of the current is shunted to ground and 1/11th goes on to the next transistor. The low-frequency equivalent circuit for the "bass boost" condition is shown in Fig. 4B. With the movable arm of the potentiometer near the top, the 0.02  $\mu$ f.

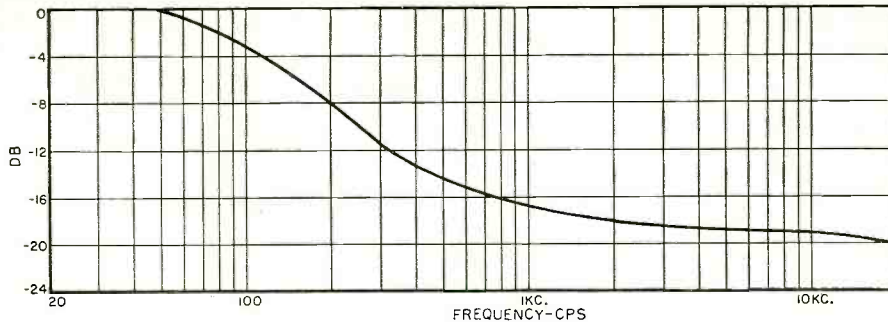

Fig. 2. The frequency response of the transistorized preamplifier unit.

capacitor is bypassed and more of the current is shunted into the 10,000 ohm resistor as the impedance of the 0.2  $\mu$ f. capacitor rises at low frequencies.

The high-frequency equivalent circuit of the tone control is shown in Fig. 4C for the "treble cut" condition.

Depending on the potentiometer setting, most of the higher frequencies will be shunted to ground as compared to a 1000 cycle signal. With the potentiometer arm at the top, the higher frequency current would bypass the 10,000 ohm resistor and a treble boost would be achieved. An exact analysis of this type of tone control is somewhat complicated since the performance depends on the volume control setting and the input impedance of the following transistor stage. Listening tests indicate that the performance is quite adequate and the frequency characteristics at an average volume control setting are shown in Fig. 6. It will be noted that the tone controls are not absolutely symmetrical but this is of little consequence since the extreme boost or cut settings are seldom used.

### Driver and Output Stages

The next three transistors comprise a linear amplifier and driver stage for the power amplifier. The biasing is much the same as for the preamplifier stage with the exception that the load

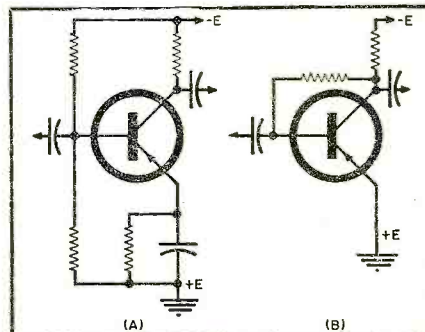

Fig. 3. (A) Biasing method suitable for extreme environmental conditions and (B) for use when unit is operated in normal places.

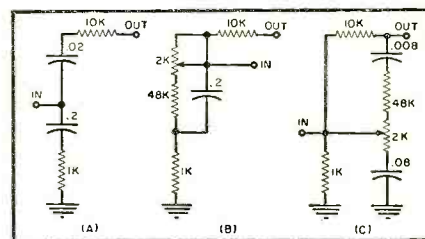
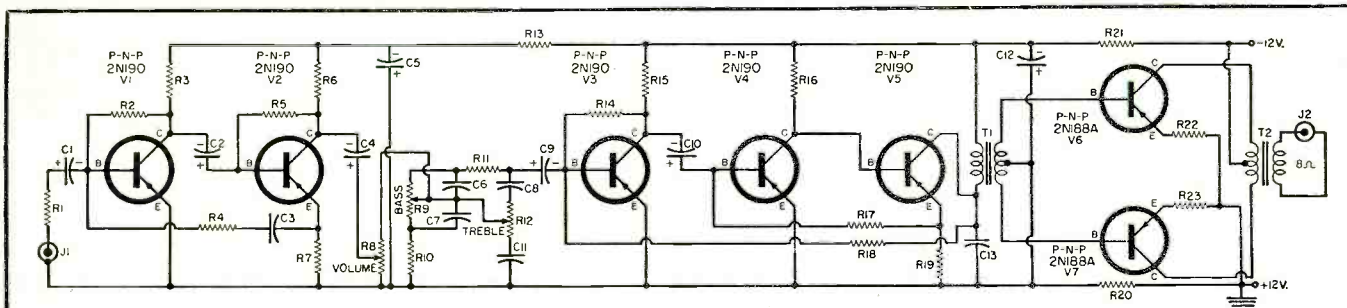

Fig. 4. (A) A 1 kc. equivalent circuit. (B) low-frequency equivalent circuit, and (C) the equivalent circuit at high frequencies.

resistances are lowered to accommodate the larger current swings at the collector. Negative feedback is used from the collector of the driver stage

Fig. 5. Complete schematic diagram of the transistorized amplifier-preamp unit. All parts are readily available at distributors.



$R_1$ —3900 ohm,  $\frac{1}{2}$  w. res.  
 $R_2, R_3, R_{15}$ —220,000 ohm,  $\frac{1}{2}$  w. res.  
 $R_4, R_5, R_{16}, R_{17}$ —18,000 ohm,  $\frac{1}{2}$  w. res.  
 $R_6$ —4700 ohm,  $\frac{1}{2}$  w. res.  
 $R_7$ —220 ohm,  $\frac{1}{2}$  w. res.  
 $R_8$ —100,000 ohm, 2 w. audio taper pot.  
 $R_9, R_{12}$ —50,000 ohm, 2 w. linear taper pot.  
 $R_{10}, R_{13}$ —1000 ohm,  $\frac{1}{2}$  w. res.  
 $R_{11}$ —10,000 ohm,  $\frac{1}{2}$  w. res.  
 $R_{14}$ —160,000 ohm,  $\frac{1}{2}$  w. res.  
 $R_{18}$ —5 megohm,  $\frac{1}{2}$  w. res.  
 $R_{19}$ —500 ohm,  $\frac{1}{2}$  w. res.  
 $R_{20}$ —5 ohm,  $\frac{1}{2}$  w. res.  
 $R_{21}$ —100 ohm,  $\frac{1}{2}$  w. res.

$R_{22}, R_{23}$ —10 ohm,  $\frac{1}{2}$  w. res.  
 $C_1, C_9$ —25  $\mu$ f., 12 v. elec. capacitor  
 $C_2, C_3, C_{10}$ —5  $\mu$ f., 12 v. elec. capacitor  
 $C_4$ —.05  $\mu$ f. capacitor  
 $C_5, C_{11}$ —50  $\mu$ f., 25 v. elec. capacitor  
 $C_6$ —.02  $\mu$ f. capacitor  
 $C_7$ —.2  $\mu$ f. capacitor  
 $C_8$ —.008  $\mu$ f. capacitor  
 $C_{12}$ —.08  $\mu$ f. capacitor  
 $C_{13}$ —.0047  $\mu$ f. capacitor

\*These are design values. .01  $\mu$ f. and .1  $\mu$ f. can be used for  $C_8$  and  $C_{11}$  respectively without seriously affecting performance.

$J_1, J_2$ —Phono jack

$T_1$ —Interstage trans., 5000 to 3000 ohms center-tapped (Argonne Transformer Type AR-500)

$T_2$ —Output trans., 125 ohms center-tapped to 8 ohms (Argonne Transformer Type AR-501)

$V_1, V_2, V_3, V_4, V_5$ —"p-n-p" junction transistor (General Electric 2N190)

$V_6, V_7$ —"p-n-p" junction transistor (General Electric 2N188A)

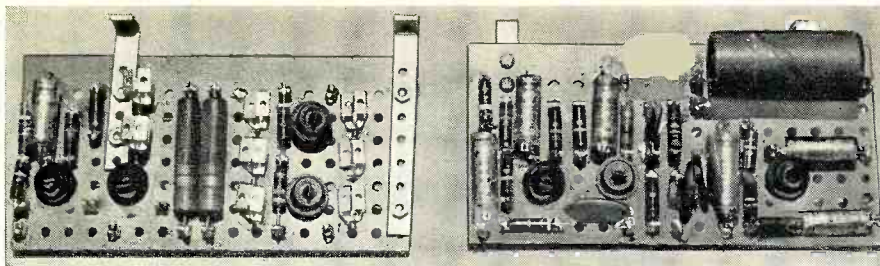

Top view of early version of amplifier (left) and preamp-tone control chassis (right).

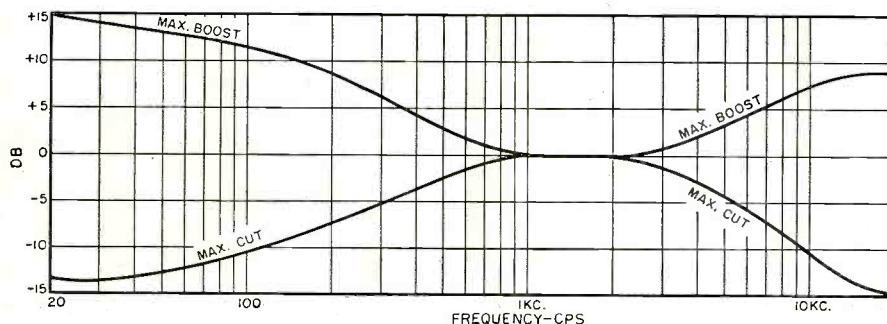

Fig. 6. Frequency response of the tone controls used with transistorized amplifier.

to the base of the third transistor. This type of feedback makes the output voltage proportional to the current flowing into the third transistor, which is precisely what is desired since the tone controls were designed from a current transfer basis. Feedback applied to the base also lowers the input impedance of the third transistor so that it is small compared to the 10,000 ohm resistor in series with the signal. A low input impedance, controlled by the feedback network, helps to make the amplifier performance independent of transistor variations.

The driver transformer acts as a phase inverter and impedance match for the push-pull output stage. In order to prevent crossover distortion in a transistor push-pull class B amplifier, it is necessary to supply a slight forward bias to the transistors. This bias is provided for by the currents of the various transistors flowing through  $R_{20}$ , a 5-ohm base biasing resistor. The 10-ohm resistors in the emitters of the transistors provide a slight amount of degeneration and also prevent thermal runaway due to heating of the transistors. Under "no-signal" conditions the current drain of the output stage should be 3 to 4 ma.

One aspect of transistor output stages that sometimes confuses de-

signers familiar with vacuum tube circuits is that no attempt is made to match the output transformer impedance to the transistors. A little thought will soon indicate the reason for this. If, as in this amplifier, it is desired to obtain undistorted peaks of two watts from a 12-volt supply, the peak current drawn by each transistor must be 333 ma. In order to get 333 ma. from a 12-volt source, the load on each transistor must be 12 volts/333 ma. or 40 ohms. The collector-to-collector load will be four times this, or 160 ohms. Therefore the impedance of the output transformer is determined only by the supply voltage and the desired output power.

If the transformer were designed to match the approximately 30,000 ohm output impedance of the transistors, maximum efficiency would be obtained but the undistorted output power would be limited to a few milliwatts.

The transistors used in the output stage are designed to have a gain which is constant from low collector currents up to collector currents of 0.2 or 0.3 ampere, so that there will be no distortion of the amplified signal. These transistors are measured and classified at the factory so that any two transistors with the same RETMA type number will give excellent performance in push-pull circuits.

Bottom view of chassis. Use of punched boards facilitates the wiring operation.

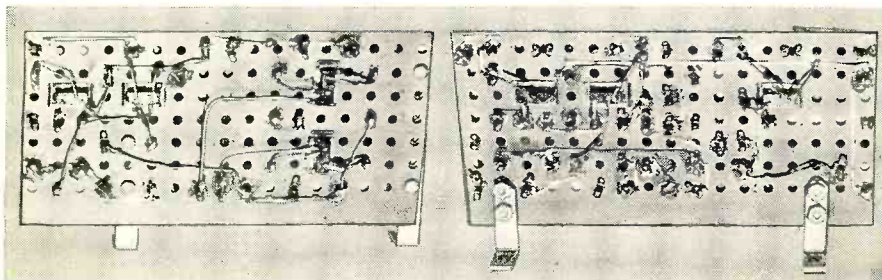

At the present time there are very few transformers on the market adequate for high-quality transistor amplifiers. Most so-called transistor transformers are designed with miniaturization as an objective so that the frequency response is severely limited. The driver and output transformers used in this amplifier were developed by the *New England Transformer Co.* (distributed by *Argonne*) specifically for this application, and these transformers (or those having equivalent quality) should be used for best results.

In a class B amplifier the current drain varies with the output signal so a well regulated power supply is a "must" for this amplifier. A very convenient source of 12 volts for experimental work can be obtained from a car battery or some of the miniature storage batteries now available. Alternatively, a regulated 12-volt supply working from the power line may be used.

### Construction

One extremely desirable feature of transistor circuitry is that the layout is noncritical since all circuits operate at a low impedance level and the transistors are small and can be mounted in any position. The author chose to construct the circuits using pre-punched terminal cards and ratchet terminals available from the *Alden Products Company*, Brockton, Mass. The components (including transistors) are mounted on one side of the boards and the wiring is done on the other side. All the circuits used in the amplifier were constructed on two 2½" x 4¼" punched terminal cards. These cards were fastened by brackets (also available from *Alden*) to the main chassis which holds the transformers and potentiometers. The advantages of this method of construction are that it is rapid, rugged, and the final chassis has the "professional" look of printed wiring. Transistor sockets were used in the original design, since it was desired to make interchangeability tests. Sockets are not really necessary, however, and the transistors might just as well be soldered directly into the circuit since each transistor is backed up by a full year's warranty when used within ratings.

Other possible methods of construction include conventional point-to-point wiring on a metal chassis, use of etched circuit boards, and wiring on terminal boards. The exact choice of layout and size will depend on the location of the amplifier. The compact size and negligible heat dissipation of this amplifier make it possible to install the amplifier in a speaker cabinet, bookshelf, or even in the base of a record changer.

Although small in size, this amplifier definitely is not small in performance. It may not be the amplifier to rattle the windows of the houses in the next block, but the output power and quality leave little to be desired for ordinary listening in your apartment or home.

# Designs of the Future

Right off the drawing boards at Westinghouse—here are some radio and TV ideas you may see soon.

TRANSISTORS and modules are making possible the design of radios which are smaller and can be used more flexibly than ever before. Some of the radio (and TV) designs shown here, which were developed by the radio and TV design department of the *Westinghouse Electric Corp.*, may never appear as finished products on the market, but, some of these ideas will undoubtedly be used. The compactness with which transistorized radios using modules can be made will allow them to be used in ladies' handbags where they will take up little space, be light, and blend well with the style. Also, because the basic receiver circuits take up so little room, more space will be allowed for the speaker (or speakers), resulting in better sound.

New TV receivers are emphasizing ease of use and the decorator's touch. The designs shown here advance this.

-30-

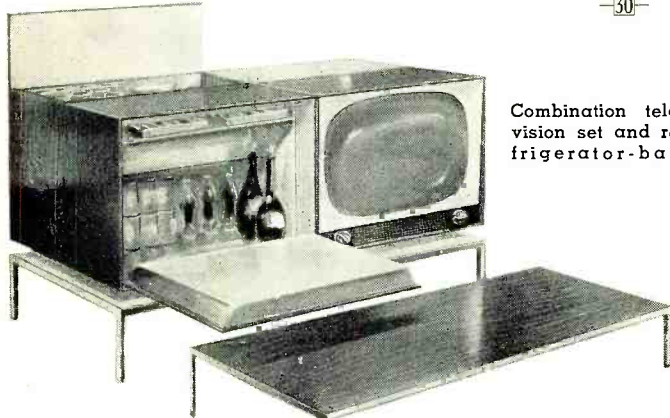

Combination television set and refrigerator-bar.

Shown below is TV set with wicker base for storage.

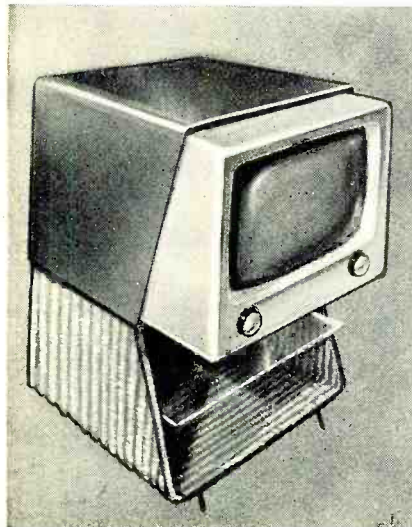

Patio model with blackboard for kids which becomes table top. Swinging plates hold drinks. Swivel-top TV set (lower right).

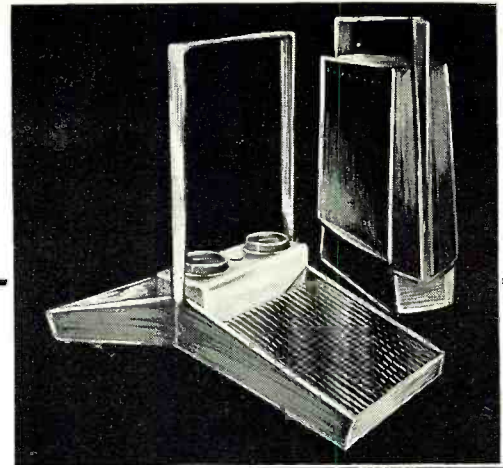
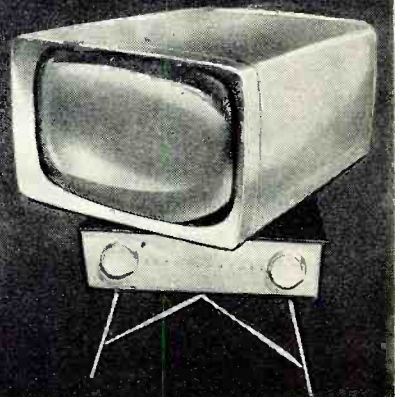
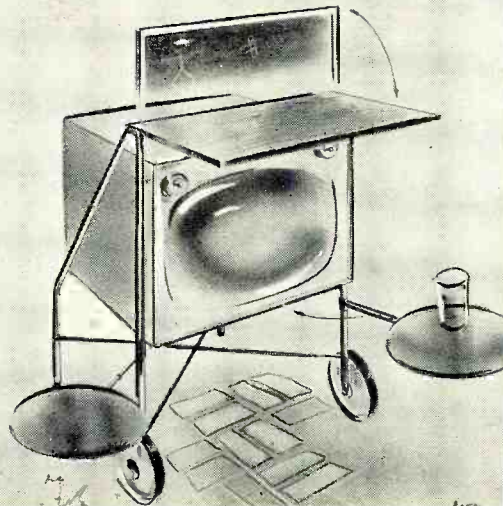

Portable radio with two large speakers. It folds compactly.



A ladies' handbag-portable radio with a slide-type tuner.

Attractive plastic handbag with transistorized radio.



Another portable radio handbag, this one all leather.

# A Test Instrument Calibrator

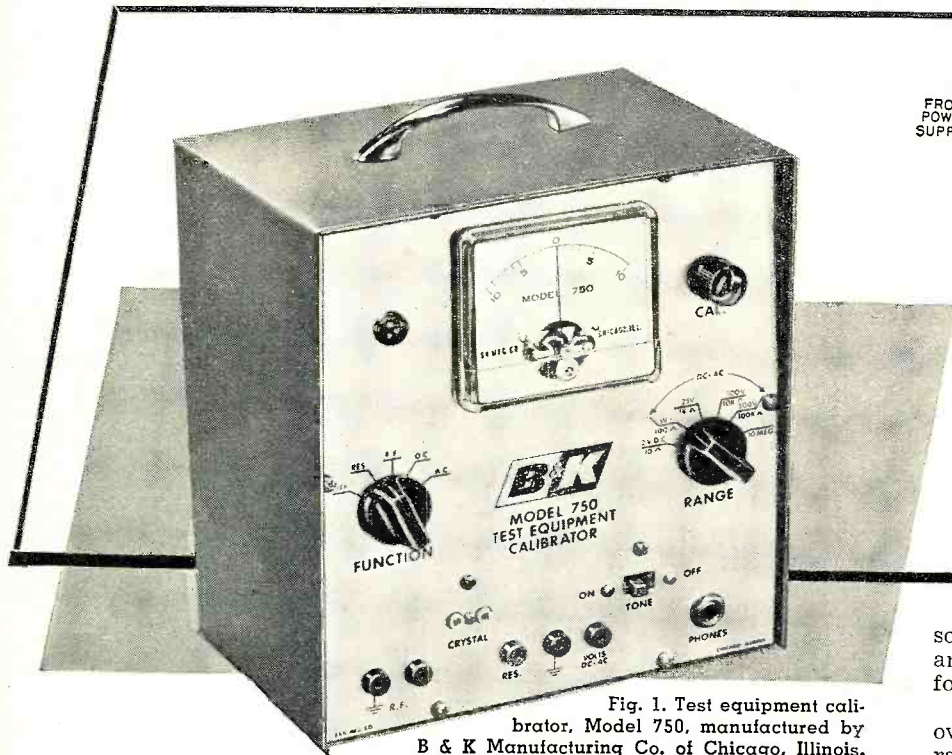

Fig. 1. Test equipment calibrator, Model 750, manufactured by B & K Manufacturing Co. of Chicago, Illinois.

*Now you can keep your v.o.m., v.t.v.m., and other test instruments at laboratory accuracy — inexpensively.*

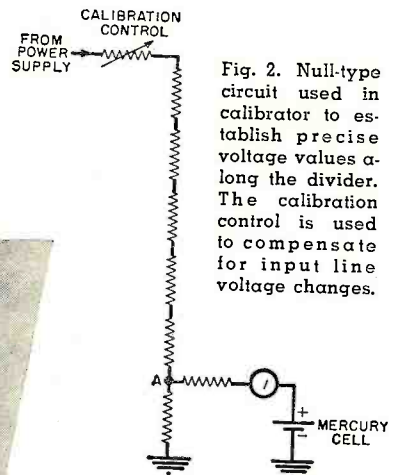

Fig. 2. Null-type circuit used in calibrator to establish precise voltage values along the divider. The calibration control is used to compensate for input line voltage changes.

solved by using high-wattage resistors and a well-designed power transformer.

One of the obstacles that must be overcome in achieving voltage accuracy of the order indicated (i.e.,  $\pm 1$  per-cent or better) is instrument protection against a.c. power line fluctuations. Obviously, conventional voltage regulators will not do since they are inherently less accurate than the level desired. The solution chosen relies upon the same voltage standard which sets the accuracy of the various a.c. and d.c. voltages themselves.

A mercury cell, whose value is known to be accurate to four significant figures, is connected in a nulling circuit of the type shown in Fig. 2. A center-reading microammeter is connected between the mercury cell and a voltage divider made of a string of precision resistors. One of the resistors in this string is made variable ("calibration control") and it is adjusted until the meter needle is positioned exactly over a very narrow hairline in the center of the scale. At this point, the voltage existing at point "A" on the voltage divider is exactly equal to the standard cell potential. The values of the other resistors in the string have been so chosen that the desired voltages are obtained at appropriate tap-off points.

The highest voltage value achievable in this manner is limited only by the value of the voltage which can be applied to the top of the divider. In the present instance, a top a.c. and d.c. reading of 300 volts is employed, this being deemed sufficient to check the high range of present voltmeters.

The same meter circuit will also serve as a continuous monitor whenever the instrument is set to deliver calibrating voltages. Any change in line voltage will be revealed immedi-

IF A service technician were asked what his most valuable servicing possessions were, nine times out of ten he would point to his test instruments. And yet, if that same man were asked just how accurate these units were, 95 per-cent of the time he could not give a definite answer. For the simple fact of the matter is that very few service technicians have this information, because very few men have the facilities for checking their test instruments.

As a simple illustration, suppose it is desired to check the accuracy of the d.c. ranges of a v.t.v.m. How could this be done? Someone might suggest a battery, but most batteries will vary by 10 to 20 per-cent of their indicated value. Or take a VR tube. This might appear to be a good way to establish a standard d.c. voltage but upon checking the specification sheets on these tubes, it is found that their voltage drops can range anywhere from 12 to 20 per-cent of the specified value. And so it goes. Practically every familiar source of what is thought to be reliably standard voltage, current, etc., turns out, on closer inspection, to possess enough normal variation to make it valueless from a standardizing point of view.

It was precisely such a situation, plus the common experience of seeing

technicians lose servicing time because they were relying on equipment which badly needed recalibration, that led to the design of the simple, low-cost test equipment calibrator shown in Fig. 1. With this unit, the accuracy of test instruments can be checked quickly and easily. If an instrument reading is off, the calibrator will not only tell how far off it is, but it will also help in the realignment of the unit so that it will function correctly.

Specifically, this test instrument calibrator can supply the following d.c. voltages to  $\pm 1$  per-cent, or better, accuracy: 5 volts, 25 volts, 100 volts, and 300 volts. These voltages allow checking of most of the d.c. voltage ranges of currently available volt-ohm-milliammeters and vacuum-tube voltmeters. In addition, the following a.c. voltages are furnished to  $\pm 1$  per-cent accuracy or better: 5 volts, 25 volts, 100 volts, and 300 volts. These voltages are used to check the a.c. ranges of v.o.m.'s and v.t.v.m.'s.

For these two functions, recognition was given to the fact that meter input impedances might vary from as low as 1000 ohms-per-volt to a hundred meg-ohms or more. This was taken into account by using appropriately low resistances in the calibrator voltage section. The problem presented by the resulting relatively large currents was



# for the Service Shop

By MILTON S. KIVER

ately by a shift of the meter needle from the center position. The user, noting this shift, can counteract its effect by adjusting the calibration control.

Another feature of v.o.m.'s and v.t.v.m.'s which this test instrument calibrator can check is the resistance ranges. A series of six precision resistors is available with values of 10, 100, 1000, 10,000, and 100,000 ohms, and 10 megohms. With these resistors, it is possible to check each of the resistance ranges found in present instruments. The values were so chosen that the check point would fall within the central region of each resistance range.

## R.F. Signal

Also available in the calibrator is a crystal oscillator which uses an external plug-in crystal and is capable of generating harmonics of the crystal frequency well beyond the v.h.f. region. For example, with a 5-mc. crystal, harmonic frequencies over 300 mc. can be obtained. With crystals possessing higher frequencies, the extent of the upper usable range is even greater.

These crystal frequency signals can be employed in two ways. If desired, they can be obtained at the "R.F." terminals and used as markers in setting up an alignment curve in radio and TV receivers, or, these crystal-generated signals can be employed to help the user calibrate (or check the calibration of) an AM signal generator. This is accomplished by feeding the signal generator voltage into the "R.F." terminals on the calibrator. The AM generator signal is combined with the crystal oscillator signal (fundamental plus harmonics) at a crystal diode mixer. The resulting signals are passed through a low-frequency pentode amplifier and applied to a front-panel phone jack to which a set of headphones may be connected. See Fig. 3. With a pair of headphones, zero beat is easily detected as the AM signal generator frequency is slowly varied.

If a 4.5-mc. crystal is used, a 4.5-mc. marker signal will be available for checking and aligning the audio i.f. system of television receivers.

To further increase the usefulness of the crystal-oscillator pentode-amplifier arrangement, a single-throw, double-pole switch is provided which will complete a feedback path and thereby generate an audio signal. This tone, available at the "Phones" jack on the front panel, can be employed to check audio amplifiers in AM, FM, or TV receivers. At the same time, an amplitude-modulated signal is available at the crystal fundamental and each of its harmonic frequencies. This modu-

lated r.f. signal can be obtained at the "R.F." terminals for external use and is a further aid in receiver alignment.

Note that the same crystal frequencies can also be employed to check the calibration of sweep generators when the sweep width controls of these instruments are turned to zero.

The precision of the a.c. voltages makes them ideally suited for measuring the peak-to-peak values of any waveform found in television receivers. Here is how this operation is performed: Apply the wave to be measured to the vertical input terminals of the oscilloscope and adjust the vertical attenuator and vertical gain control until the wave covers a reasonable height—say one-half the size of the screen. To facilitate the measurement, it is generally best to have the wave extend over a specific number of vertical squares on a screen mask. A simple figure to work with, in this respect, is 10 or 15 squares. (The wave in Fig. 4A covers 10 squares.) Whatever the figure, make a specific note of it.

Now, remove the signal and, without touching the vertical gain or attenuation controls of the scope, apply one of the a.c. voltages from the test instrument calibrator to the vertical input terminals of the oscilloscope. A sine wave will appear on the screen. Compare its height with that of the previous wave and if the two cover the same number of vertical squares, then both possess the same peak-to-peak value. Assume that this happens when the test instrument calibrator is providing 25 volts, a.c. Then both waves will have a peak-to-peak value of  $25 \times 2.83$  or 70.75 volts. The foregoing factor of 2.83 is the amount by which the r.m.s. figure of an a.c. wave must be multiplied to provide the peak-to-peak value.

Some service technicians like to turn down the horizontal gain of the scope until the calibration sine wave is only a vertical line. (See Fig. 4B.)

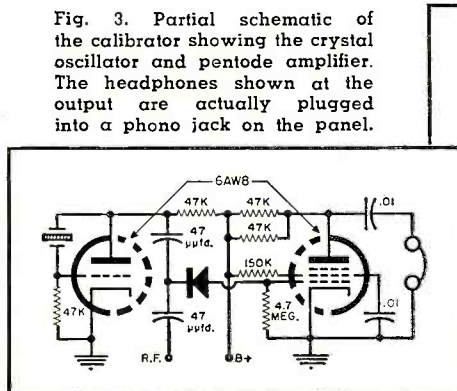

Fig. 3. Partial schematic of the calibrator showing the crystal oscillator and pentode amplifier. The headphones shown at the output are actually plugged into a phono jack on the panel.

They claim that such a line is easier to work with. Either method will give similar results since the horizontal spread of the wave is not important, only its height is.

The fortunate occurrence of both waves having the same peak-to-peak value is not likely to happen often. More often than not, the amplitudes of both waves will differ. Let us say that when the unknown wave is adjusted to cover a height of 10 squares, the calibrating sine wave, with the "Range" switch in the 25 volts position, covers only 8 squares. Then, to find the peak-to-peak amplitude of the unknown signal, set the ratio of the calibration voltage to the number of squares it covers, equal to the ratio of the unknown voltage to the number of squares it covers. The formula is as follows:

$$\frac{\text{calibration voltage}}{\text{vertical squares}} = \frac{\text{unknown voltage}}{\text{vertical squares}}$$

$$\text{Hence, } \frac{25 \text{ volts}}{8} = \frac{X}{10}$$

$$\text{and } 8X = 250$$

$$\text{or } X = \frac{250}{8}$$

$$X = 31.2 \text{ volts}$$

The peak-to-peak voltage is:

$$31.2 \text{ volts} \times 2.83 = 88.3 \text{ volts.}$$

(The same formula would be employed had the amplitude of the calibrating voltage been greater than that of the unknown wave.)

There are additional uses to which this instrument can be put, but its principal function is to provide the service technician (or even the engineer) with a calibration standard on which he can rely. It will pay for itself in reducing servicing time if used as little as two or three times a year. And, perhaps most important of all, it will give the technician a renewed faith in the accuracy of his test equipment.

-30-

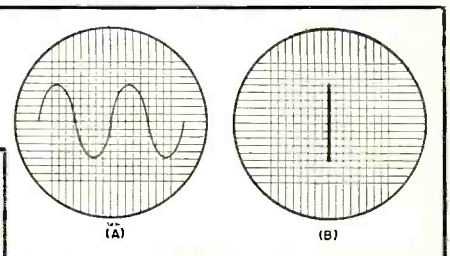
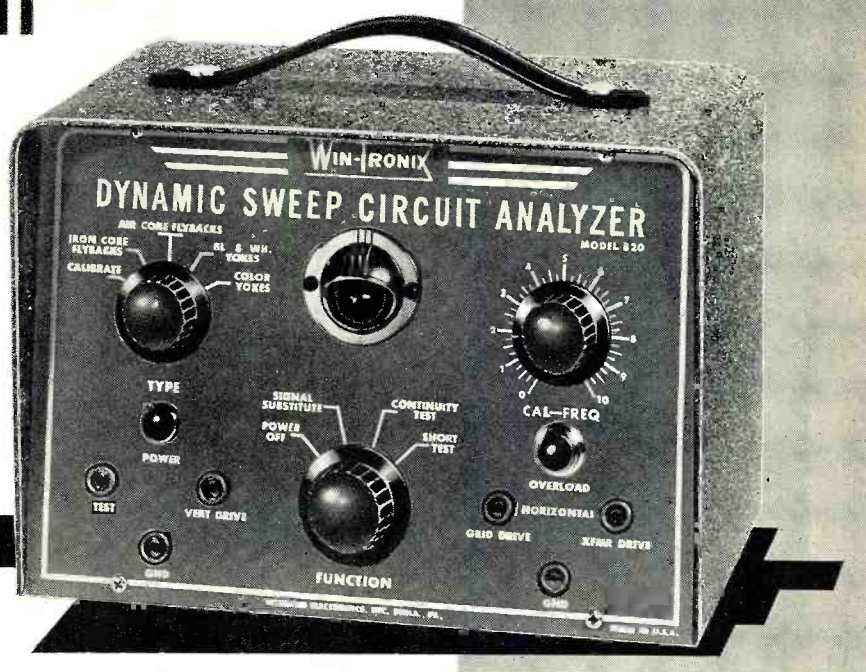

Fig. 4. The a.c. voltages of the calibrator can be used to measure peak-to-peak values of scope patterns. The full waveform may be displayed as in (A) or the horizontal gain may be decreased to zero (B).

# Deflection Circuit Analyzer

By  
**WINSTON STARKS**  
President, Winston Electronics, Inc.

Fig. 1. The Model 820 Dynamic Sweep Circuit Analyzer which furnishes horizontal and vertical sweep signals, tests flyback transformers and deflection yokes as well as continuity.



*A systematic approach to the troubleshooting of TV deflection circuits pays off in more profit.*

**T**HE special nature of the vertical and horizontal deflection circuits of TV receivers often makes it difficult to locate trouble in this section. Waveform analysis may indicate that something is wrong, but it will not usually tell what part is defective and, of course, cannot be used if there is no voltage to begin with. The use of component substitution and "cut and try" methods will often turn what

could be a very profitable job into a time consuming one.

A dependable method of troubleshooting deflection circuits is to substitute or inject the correct signal into the various key points in these circuits. Each stage, in sequence, receives what resembles its normal input signal and if the stage is good, its output will be correct. This is continued until the defective stage is located. This

method, troubleshooting by signal substitution, is easy to use and is a positive way of finding troubles. For example, if the trouble is no high voltage, injecting the proper high voltage causes the receiver to operate normally.

In order to troubleshoot the vertical and horizontal deflection circuits by signal substitution a generator is needed that will produce the correct 60 cps saw-tooth, 15 kilocycle saw-tooth, and horizontal output transformer drive voltages. An instrument which produces these waveforms and also incorporates a flyback and yoke tester is shown in Fig. 1. The schematic diagram of this instrument is shown in Fig. 2.

The circuit of this sweep section analyzer includes a horizontal oscillator, horizontal output tube, vertical sweep circuit, flyback and yoke tester, and 60 cps power supply. The first half of the 12AU7 serves as either the 15 kilocycle blocking oscillator or the flyback and yoke test oscillator. The second half of the 12AU7 operates either as a 60 cps saw-tooth amplifier or as a d.c. amplifier in the flyback test function. The 6BQ6 is the horizontal output tube which is used to drive the flyback transformer in the TV receiver under test. An oscillating neon bulb operates in a special circuit to produce a very sensitive shorted-turn tester.

When the instrument is used to test horizontal output transformers and yokes, the first half of the 12AU7 functions as a pulsed 500-cycle oscillator in a circuit that operates as a "Q" tester. When checking a flyback transformer or yoke with one or more

Fig. 2. Complete schematic diagram of the Dynamic Analyzer for sweep circuits.

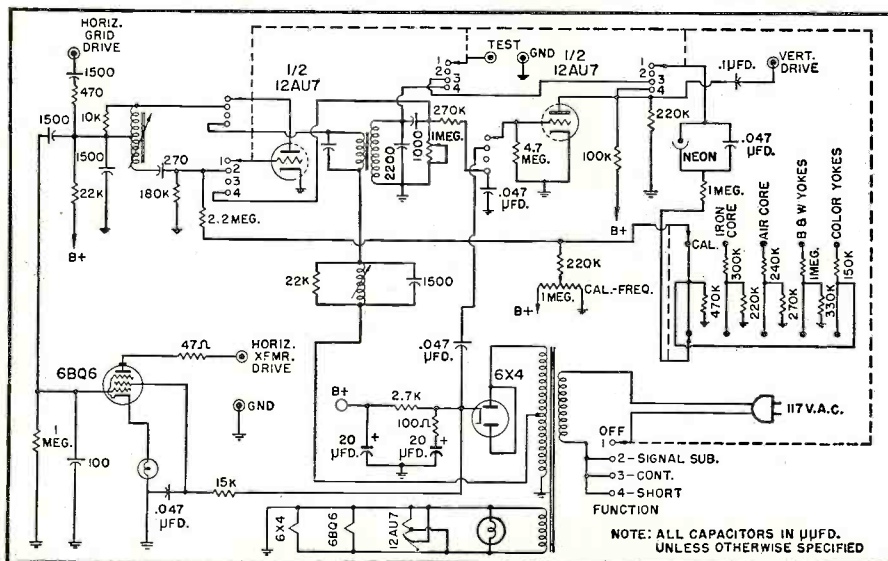

(Continued on page 108)

# Realistic High Fidelity

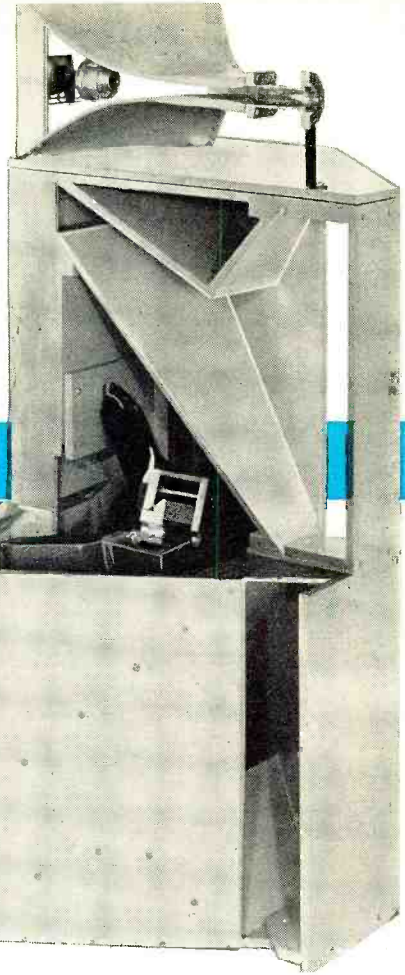

## Horn Loudspeakers and Enclosures

By **H. A. HARTLEY**  
Audio Consultant

*Part 8. A discussion of straight, folded, and corner horns used to load tweeters and mid-range drivers as well as load and enclose woofers.*

**A** HORN is fitted to a loudspeaker driver unit simply and solely to increase its electro-acoustic efficiency. A properly designed horn increases the acoustic loading on the diaphragm and this is bound to improve the efficiency since the diaphragm has something to work against. From this follows the obvious conclusion that a horn-loaded speaker requires less input than one using a flat baffle for a given sound output, and for a given size of diaphragm the horn-loaded speaker calls for less movement of the suspended system. From what you have learned in previous articles you can see, therefore, that the disadvantage of a small diaphragm for reproducing low frequencies—the large amount of free movement required—can be overcome to some extent, while retaining the advantages of the small cone for good high note response. Since the driver unit is subjected to smaller stresses, it would seem that fitting a horn instead of a flat baffle or box type enclosure is a great step forward. This supposition is correct. A properly designed horn-loaded speaker will give a wider and more linear response than any other type of loading, and when perfectly designed and without regard to "contingent liabilities" does not require the use of multi-channel systems. One unit will do the job. Yet almost every horn type speaker system you see has a tweeter; am I therefore talking nonsense? I mentioned contingent liabilities, and the innate cussedness of all loudspeaker problems is well to the fore in designing loudspeaker horns.

In this article I cannot possibly even attempt to classify the multitude of designs on the market. The good ones

Cutaway model Klipschorn corner loudspeaker system showing a folded horn used for the woofer and straight horns used for mid-range and tweeter.

are the result of technical know-how and intensive development work. The bad ones are non-scientific copies of good designs but without the knowledge necessary for modifying basically good designs. Some have resulted from the efforts of writers who profess to provide hi-fi for a few dollars. But it so happens that designing a good horn is not all that easy, and making it can be even more difficult. Here I shall explain the fundamental rules of the game, so that you can make your choice in an intelligent manner. But whereas there may be two schools of thought in speaker design, there can only be one in horn design, for the matter is simple enough—does the horn enclosure add distortion to the speaker unit's performance? If it does then it is a bad enclosure, and that is all there is to it.

The worst snag in adopting the horn as a speaker loading device is the size required for fidelity of reproduction. The diameter of the mouth of the horn, for perfection, should equal the wavelength of the lowest frequency it is desired to reproduce. The wavelength of a 50-cycle note is 22½ feet! Moreover, the rate of expansion from the throat (the narrow end) to the mouth, called the flaring constant, must conform to certain laws, so the length of our perfect horn for no cut-off at 50 cps would be about 70 feet. In this imperfect world we can afford to make some compromise, but you

can take it that a straight horn of proper design to reproduce down to 50 cps calls for a length of about 22 feet and a flare circumference of 24 feet, and that is not a thing you can get into an ordinary living room. Not only is the mouth as large as the sort of flat baffle you ought to have, but where are you going to put those 22 feet of length? As you can fold a baffle, so you can fold a horn, but with this added complication—that the highs don't like being pushed round sharp corners or along rough surfaces, and the lows, as in box baffles, set up vibration in the various parts of the assembly. Whereas the folded and curved horns of the brass section of the orchestra are resonant, to give the instrument its peculiar *timbre*, the horn of the reproducer must be inert and unable to impart coloration.

Probably the first superbly designed and engineered folded-horn speaker was the celebrated *Western Electric 555*. The speaker unit itself was made with very close tolerances to avoid loss of useful flux in the gap. The voice coil was wound with aluminum ribbon on edge, so that gap space was not wasted by a comparatively thick and rigid former, and the small aluminum diaphragm was properly ribbed to ensure stiffness (for it is important in a horn speaker that diaphragm breakup should not occur). This specialized unit then fed into a long folded horn

with the right flare constant, made of smoothly finished nonresonant material (at least down to the lower middle frequencies!), which terminated in a large rectangular mouth. The result was a fine speaker, but it was so big it could only be used in movie theaters.

Since that time we engineers have not increased our basic knowledge of horn design; we have made no discoveries that enable us to do things that couldn't be done 30 years ago. The mechanics of horns are perfectly straightforward and we can't do the impossible "even if it takes a little longer." Our efforts have been directed towards producing speakers that can be gotten into an ordinary living room, while retaining as many of the characteristics of the perfect horn as possible. In other words compromises have had to be made, and some compromises are very good and others are not.

### Design of Straight Horns

As no folded horn can be as good as a perfectly designed straight horn, it is necessary to determine the characteristics of the straight form to have some standard of reference. There are three main types: conical, exponential, and hyperbolic exponential. The only merit of the first is that it can be constructed out of flat sheets of material, and in case you wonder how a cone can be made out of flat material I should explain that what really matters is that the area of cross-section has to expand in a certain way. To all intents and purposes a square horn of pyramidal form is just as satisfactory as a truly conical one. By a conical horn I mean, therefore, one whose sides are a straight line, and by analogy I call an exponential horn one whose sides follow an exponential curve, whether the area of cross section is a square or a circle. The name hyperbolic exponential is usually shortened to "Hypex." Fig. 28 gives cross-sections of the three types.

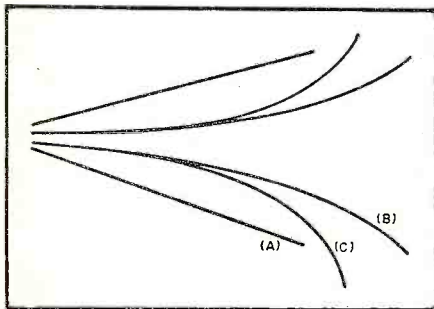
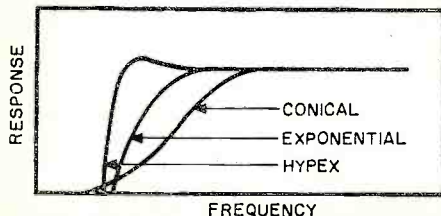
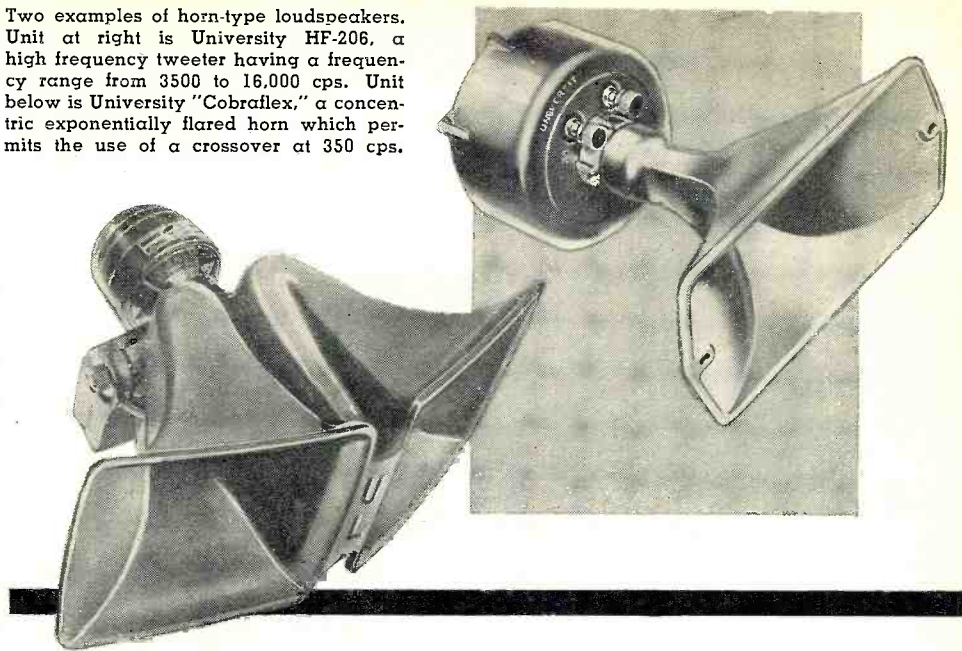

Fig. 28. The three types of straight horns: (A) conical, (B) exponential, and (C) Hypex.

Fig. 29. Cut-off characteristics of the three types of straight horns shown above.



Two examples of horn-type loudspeakers. Unit at right is University HF-206, a high frequency tweeter having a frequency range from 3500 to 16,000 cps. Unit below is University "Cobraflex," a concentric exponentially flared horn which permits the use of a crossover at 350 cps.



The conical horn is easy to design and easy to build. All that matters is that the narrow end should more or less fit the driver unit and that the length and mouth dimensions should be great enough to handle the lowest bass frequency it is desired to reproduce. The serious drawback of the conical horn is that its cut-off characteristic is not good.

In any high-fidelity system it is desirable that the wide frequency response should terminate with sharp cut-offs at bass and treble. A linear frequency response from 50 to 12,000 cps with very sharp cut-offs at each end will give truer reproduction than one linear from 60 to 11,000 with gradual roll-offs even if there is appreciable response at 40 and 15,000 cps. You may not believe this, but it is so. Now if you refer to Fig. 29 you will see that the conical horn has a roll-off whereas the exponential and Hypex horns have a cut-off, and the Hypex has the sharpest.

It is not difficult to understand why this should be so. In Part 1 I explained that a sound wave progresses through the air by setting up zones of compression followed by zones of rarification. The distance between successive zones of compression is the wavelength of the sound wave of that particular frequency. Now imagine such a sound wave passing through the horn. Obviously the horn must be as long as one wavelength otherwise part of the wave will be inside the horn and the rest outside and the only part to load the diaphragm with "horn efficiency" is the part inside. That is why inadequate length and mouth size give a bass cut-off.

In free air the speaker diaphragm produces a hemispherical propagation in front and when a conical horn is used this whole hemisphere has been collected into a cone but the general distribution throughout the horn is unaltered. When the wavelength is a substantial part of the horn length

there will be an instant when a zone of compression is inside the horn and a zone of rarification is at the mouth of the horn. Nature abhors a vacuum, so air at normal pressure around the circumference of the mouth rushes in and hinders the progress of the next pocket of compressed air. If there are several "cycles" inside the horn this doesn't matter; but at low frequencies the effect is very pronounced, and the interference pattern comes out like the curve in Fig. 29.

To take the Hypex as a contrast, the sound wave emerges from the mouth and not being confined by the straight line trend of the conical type progresses in a hemispherical manner. The air inside is protected by the shape of the horn mouth and by a hemispherical barrier of compressed air beyond the mouth. The description I have given is admittedly crude but it does account for the cut-off characteristic of the Hypex horn. In the Hypex, and to a lesser degree in the exponential, the cut-off is "pure" and determined solely by the horn dimensions.

Having vowed to keep higher mathematics out of this series I cannot give you the design data for these horns. Being exponential curves they involve mathematical exponentials which are reckoned highbrow; but the omission of this data is not a matter of great importance. Fig. 28 shows that the types cannot be confused, for the exponential increases quite gradually in a curved sort of way whereas the Hypex flares out quite suddenly near the mouth. And may I add a note about other wonder-working curves announced from time to time? We get paraboloids, catenoids (and some day we may get adenoids) all heralded as new achievements. Don't you believe it. These others "curves" are so near exponential that it couldn't matter less, and except for molded or cast horns, no folded bass horn is other than an approximation of an exponential curve, these fancy curves are just



Brociner 4C corner horn uses single 6-inch twin-cone driver as shown in Fig. 33.

approximations of approximations. Acoustic engineers are not swayed by emotional upsurges; the laws of horn design are quite straightforward, and the exponential and Hypex curves are two steps forward in good design. But they are difficult to make true to law.

No part of any type of exponential horn is flat, so it cannot be made of thick wood. The shaped panels are usually made of laminated or reconstructed wood and should be strongly braced with frames at fairly short intervals; the intervening areas should be covered with sound- and vibration-absorbing material or cement. This must be applied outside the horn, for the inner surfaces should be as smooth as possible to avoid air friction. The whole horn could be made of reinforced concrete, with a smooth cement finish inside, and super-enthusiastic high-fidelity fans have made such concrete monsters, with most impressive results. Of course the horn has to be built outside the house, so it is not very convenient for multi-story apartments. But it does show what has to be done to carry the horn to its logical conclusion.

### The Horn Throat

It would seem a simple enough matter to match a horn to any loud-speaker by making the throat (the narrow end) the same size as the speaker diaphragm, but this does not give the highest efficiency. Better acoustic loading is obtained by having the throat smaller than the diaphragm and including a sound chamber, as in Fig. 30A. At high frequencies this scheme does not work very well because the distance between the various parts of the diaphragm and the center of the throat can differ by several wavelengths, causing phase distortion. It is usually corrected by making the diaphragm concave and inserting a convex plug in the horn throat, as shown in Fig. 30B. This phase-correcting plug, as it is usually called, should

be a feature in any well-designed horn-loaded tweeter.

The throat itself causes 2nd harmonic distortion, varying directly with acoustic watts per unit area of throat and with the ratio between emitted frequency and cut-off frequency. For a given power input to the speaker, it follows that 2nd harmonic distortion will be smaller the larger the throat and the smaller the emitted frequency/cut-off frequency fraction. As the bass must be maintained, this fraction is kept small by removing the highs from the large throat speaker. This suits the general design very well since a large throat calls for a large diaphragm and a large diaphragm (subject to the special cases mentioned in Part 4) is not efficient for high frequencies. Then, since the first section of the horn has to be removed to provide the large throat, the removed part becomes the horn of the tweeter, so we quite logically arrive at the conclusion that, as far as horn speakers are concerned the tweeter-woofer combination is best. Whether my thesis that baffle-loaded speakers are best as single-channel systems is right or not, I cannot be accused of undue partisanship if I say that multi-channel systems are best with horn speakers.

### Folded Horns

In theory, as I have already pointed out, there should be no loss by folding a properly designed exponential horn. As far as the high frequencies are concerned there is very little loss due to reflections and interference in the concentric folded type shown in Fig. 31. A horn of this design is usually made up from metal spinnings, although it can be molded from non-metallic materials. The size required for adequate reproduction of low frequencies makes this type of horn very costly for wide-range reproduction, but it is an efficient horn for the frequency range 200 to 8000 cps.

In practice, a folded horn is usually made up as an assembly of flat wooden panels which can only be an approximation to the true exponential flare, so losses are inevitable (and "losses" includes distortion). As both sides of each panel usually form part of the horn acoustical lining and reinforcing battens cannot be used, so there must be some reverberation and cabinet resonance. To reduce this as far as possible the material used must be thick and rigid. The rate of flare does not conform to any law since the horn consists of a series of truncated pyramids, with the consequent disadvantages mentioned earlier. The shape, too, is bad for the transmission of high frequencies, but as it is normal practice to use a separate high frequency speaker unit, this is not a serious consideration.

Since, therefore, the folded horn is only an approximation to the ideal design there is almost no end to the ways in which this approach to perfection can be achieved. Reputable man-

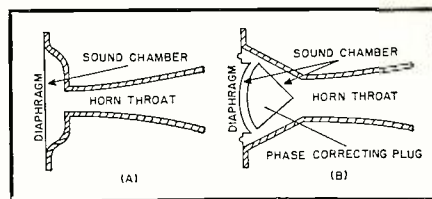

Fig. 30. Two designs of throat sound chambers without and with phase correcting plug.

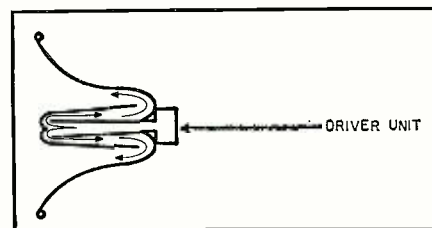

Fig. 31. Section of concentric folded horn.

ufacturers of speaker units have been forced to produce horn designs which are suitable for their products, and it can be supposed that some research has been carried out to evolve a good design. Other manufacturers of cabinets are equally interested in selling their wares, but in all this activity one thing can be emphasized—since no speaker has a perfectly linear response and since no cabinet imposes a constant load at all frequencies, the cabinet must be designed for the speaker selected.

Despite of all this, the curious fact remains that some combinations of units and horns that were not specifically designed for each other do sound extremely good, and there can be only one reason for this—luck. And good luck is not to be despised in the hunt for perfection. It is quite possible for a defective speaker to be housed in a defective cabinet so that the defects more or less cancel out, and it doesn't matter if such results came about through blind chance. What really matters is that the results are there. I have pointed out in an earlier part that speakers can't be designed by mathematics alone, nor,

(Continued on page 168)

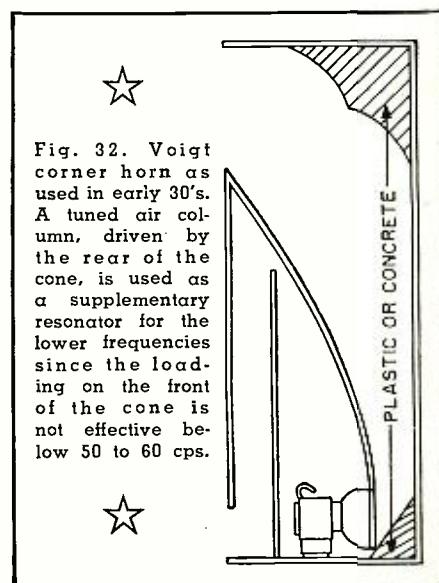

Fig. 32. Voigt corner horn as used in early 30's. A tuned air column, driven by the rear of the cone, is used as a supplementary resonator for the lower frequencies since the loading on the front of the cone is not effective below 50 to 60 cps.

# A Volume Expander for Hi-Fi

By J.W. TOPHAM



Fig. 1. Over-all view of remote control panel (left) and chassis housing expander and power supply (right). Controls on the panel are from left to right: master gain of complete system, power switch, eye tube, expansion switch, and the expansion set control. See diagram, Fig. 2.

*Construction details on a dynamic volume expander which has an attack time of less than 1 millisecond, releases in 2 seconds, and offers smooth and linear expansion.*

TO MOST audiophiles, "high fidelity" means as accurate a reproduction of the original score as possible, with regard to frequency response and dynamic range. Most of us have advanced our systems to a high degree of fidelity as far as frequency response goes. To afford good dynamics many of us have obtained high powered amplifiers allowing us to reproduce the ear-shattering crescendos much as they were originally played. To do this, it is necessary to advance the gain past the point where rumble and surface noises become objectionable.

It then becomes apparent that to reproduce a score satisfactorily, some means must be provided to increase the dynamic range of the program material. Many dynamic volume expander circuits have been developed but most fail to meet one or more of the following requirements: 1. Attack time of 1 millisecond or less, 2. Release time of approximately 2 seconds, 3. Intermodulation distortion less than 1%, 4. Unmeasurable harmonic distortion, 5. Smooth, linear expansion, 6. Fixed limit of expansion, and 7. Simplicity of operation.

If a volume expander meets these requirements, one would not be able to detect when the expander was being used except for the desired increase in dynamic range. The circuit presented meets these requirements and is truly a high-fidelity unit.

After extensive research it was decided to use plate load changes on the

push-pull output stage of a low-gain amplifier to give the required expansion. A second 12AU7 was connected in parallel with the 12AU7 output stage as shown in Fig. 2. The load seen by one output tube is made up of the parallel control tube and the output transformer. Now if a d.c. voltage, which is proportional to the input program signal, is developed and applied to the grid of the control tubes, the load offered by the control tubes will vary with the d.c. control voltage. If the polarity of the control voltage is negative, the voltage will tend to drive the control tubes to cut-off. When the control voltage cuts the control tubes off, the load seen by the output stage is only that of the output transformer. This load then is 15,000 ohms per tube. When the control voltage is zero, approximately 10 milliamperes will flow through each control tube giving an effective plate resistance of 6000 ohms per tube. The load seen by one of the output tubes is then  $15,000(6000)/(15,000 + 6000)$  or 4300 ohms. This change then from 15,000 to 4300 ohms in plate load as seen by each output tube governs the degree of expansion. Maximum expansion occurs when the control tubes are cut off or when the control tube grids are at -20 volts d.c.

It is interesting to note that the intermodulation distortion is at its lowest value when the output is fully expanded. If the input is kept below 3 volts peak-to-peak, the intermodula-

tion distortion will not exceed 1%. Harmonic distortion is unmeasurable irrespective of the degree of expansion.

The voltage required to cut off the control tubes was found to be -20 volts d.c. It was then necessary to develop a circuit which would produce a d.c. voltage of 0 to -20 volts proportional to the input signal over an input range of about 30 db. The rapidity with which this voltage is developed is known as the attack time. Tests have shown that an attack time of less than one millisecond is highly desirable. To accomplish this, the input signal is amplified and fed into a cathode follower. The grid of the cathode follower is biased to about +50 volts to prevent the tube from being cut off by large negative peaks. The output appears across the 10,000 ohm cathode resistor and is capacitively coupled to a 1N38 crystal diode. This diode serves to clamp the positive peaks to ground. The 40,000 ohm resistor bypassing the 1N38 along with the 25  $\mu$ fd. coupling capacitor gives a long time constant relative to the lowest frequency component of the signal. A 1N215 diode is used to rectify the a.c. signal to a d.c. voltage. The voltage is stored in the 1  $\mu$ fd. capacitor,  $C_{11}$ , and bled off by  $R_{23}$ . This RC combination gives a 2-second time constant for release time. The impedance of the cathode follower and 1N215 diode is about 680 ohms.  $C_{11}$  is then charged in 680 microseconds which is well under the 1 millisecond limit originally laid down.

Some visual means of setting the expander was required. An electron-ray tube was chosen so as to be free from the dynamic errors encountered when using meter type indicators. The eye tube is set to close when the voltage on the control tube grids is -20

*(Continued on page 163)*

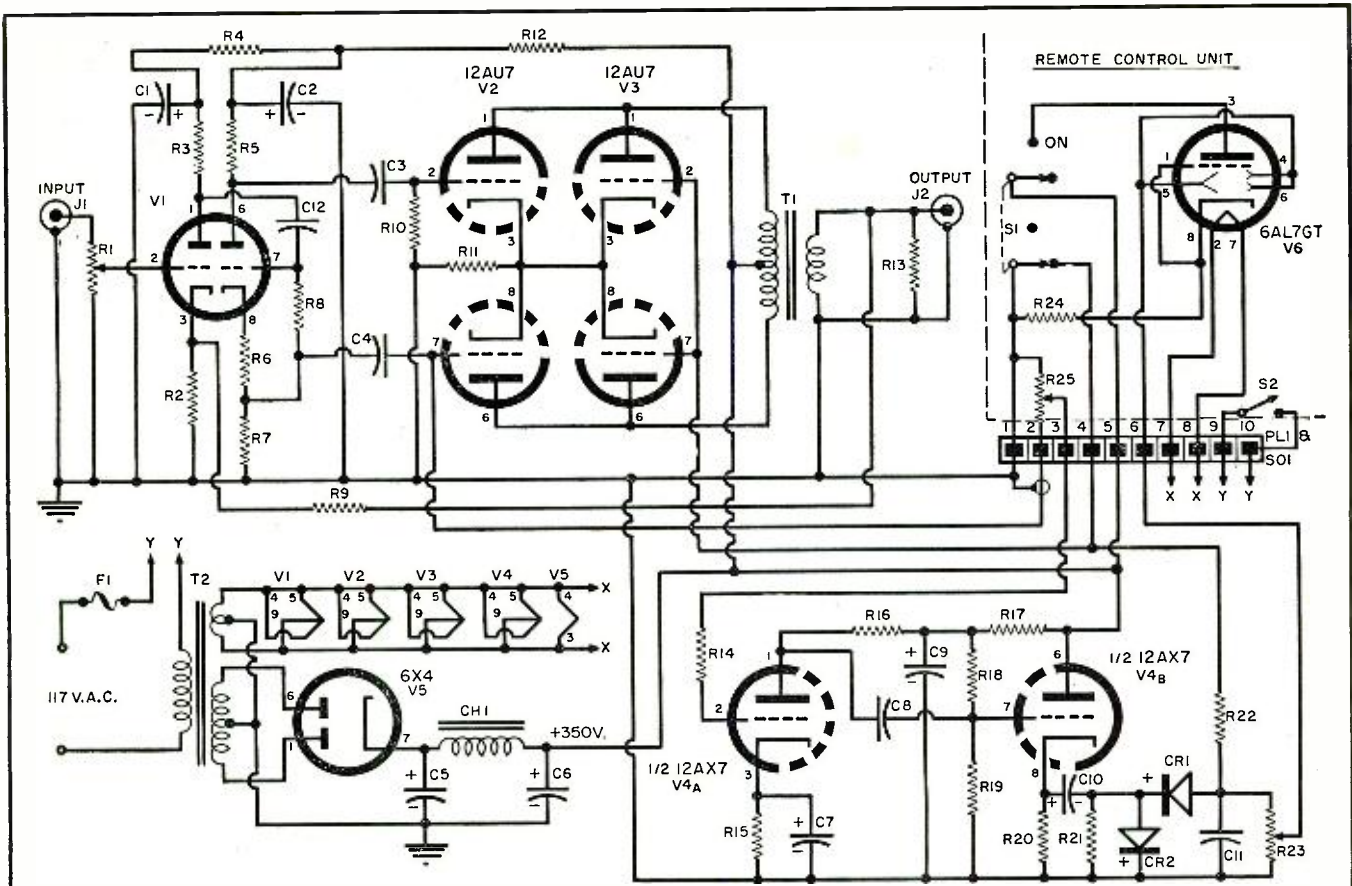

- R<sub>1</sub>—100,000 ohm audio taper pot ("Gain")
  - R<sub>2</sub>—750 ohm, 1/2 w. res.
  - R<sub>3</sub>—47,000 ohm, 1 w. res.
  - R<sub>4</sub>—33,000 ohm, 1 w. res.
  - R<sub>5</sub>, R<sub>7</sub>—47,000 ohm, 1 w. res. (matched ± 1%)
  - R<sub>6</sub>—1500 ohm, 1/2 w. res.
  - R<sub>8</sub>, R<sub>19</sub>—1 megohm, 1/2 w. res.
  - R<sub>9</sub>—150,000 ohm, 1/2 w. res.
  - R<sub>10</sub>—500,000 ohm, 1/2 w. res. (matched with R<sub>8</sub>)
  - R<sub>11</sub>, R<sub>12</sub>—510 ohm, 1 w. res.
  - R<sub>12</sub>—22,000 ohm, 1 w. res.
  - R<sub>13</sub>—2.2 megohm, 1/2 w. res.
  - R<sub>15</sub>—51,000 ohm, 1/2 w. res.
  - R<sub>16</sub>—120,000 ohm, 1/2 w. res.
  - R<sub>17</sub>—51,000 ohm, 1 w. res.
  - R<sub>18</sub>—2.4 megohm, 1/2 w. res.
  - R<sub>20</sub>—10,000 ohm, 1/2 w. res.
  - R<sub>21</sub>—40,000 ohm, 1/2 w. res.
  - R<sub>22</sub>—5 megohm, 1/2 w. res.
  - R<sub>23</sub>—2 megohm audio taper pot ("Eye Set")
  - R<sub>24</sub>—3300 ohm, 1/2 w. res.
  - R<sub>25</sub>—500,000 ohm audio taper pot ("Expansion Set")
  - C<sub>1</sub>—C<sub>3</sub>, C<sub>5</sub>—C<sub>7</sub>—20/20 μfd., 450 v. elec. capacitor
  - C<sub>8</sub>, C<sub>9</sub>—0.5 μfd., 400 v. capacitor
  - C<sub>6</sub>—40 μfd., 450 v. elec. capacitor
  - C<sub>7</sub>, C<sub>10</sub>—25 μfd., 25 v. elec. capacitor
  - C<sub>8</sub>—500 μμfd., 400 v. capacitor
  - C<sub>11</sub>—1 μfd., 100 v. paper or oil capacitor
  - T<sub>1</sub>—Output trans. 30,000 ohms plate-to-plate to 500/600 ohm sec. (UTC LS-51 or equiv.)
  - T<sub>2</sub>—Power trans. 300.0-300 v. @ 50 ma., 6.3 v. @ 2 amps.
  - CH<sub>1</sub>—7 hy., 60 ma. filter choke
  - J<sub>1</sub>, J<sub>2</sub>—Phono jack
  - PL<sub>1</sub>—10-contact plug
  - SO<sub>1</sub>—10-contact socket
  - S<sub>1</sub>—D.p.d.t. lever switch ("Expander")
  - S<sub>2</sub>—S.p.s.t. lever switch ("Power")
  - F<sub>1</sub>—2 amp., 250 v. fuse
  - CR<sub>1</sub>—1N215 or 6005 crystal diode
  - CR<sub>2</sub>—1N38 crystal diode
  - V<sub>1</sub>, V<sub>2</sub>, V<sub>3</sub>—12AU7 tube
  - V<sub>4</sub>—1/2 12AX7 tube
  - V<sub>5</sub>—6X4 tube
  - V<sub>6</sub>—6AL7GT electron-eye tube
- Note: CR<sub>1</sub> and CR<sub>2</sub> may be replaced by a 6AL5 tube.

Fig. 2. Complete schematic diagram of the high-fidelity volume expander. All component parts are standard jobber items.

Fig. 3. Graph of the input signal versus output signal showing the linearity of expansion. Refer to article.

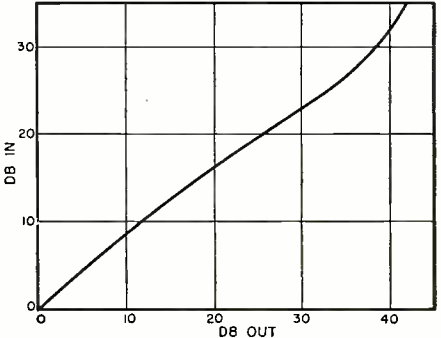

Fig. 4. Block diagram showing location of the expander in the over-all hi-fi system.

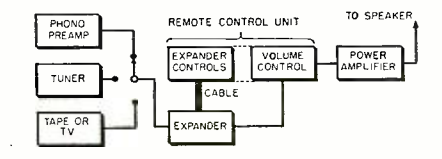

Fig. 6. Effect of feedback on the over-all frequency response of the unit.

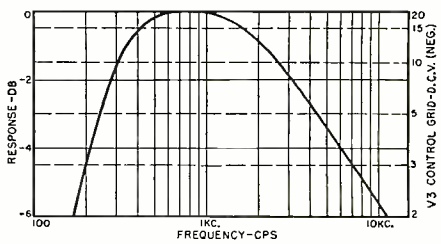
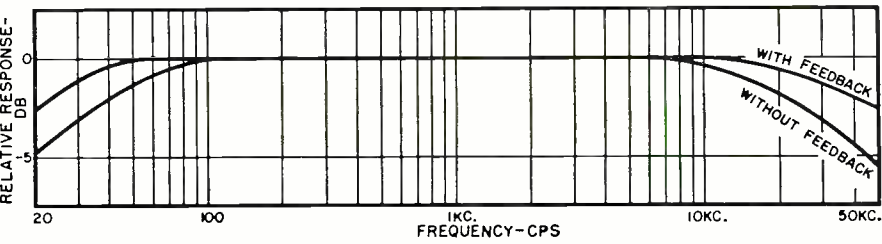

Fig. 5. The mid-band response of expander control circuit using the 12AU7 tube, V<sub>3</sub>.

# A Handy Troubleshooter

By  
**JESSE DINES**  
Ram Electronics Inc.

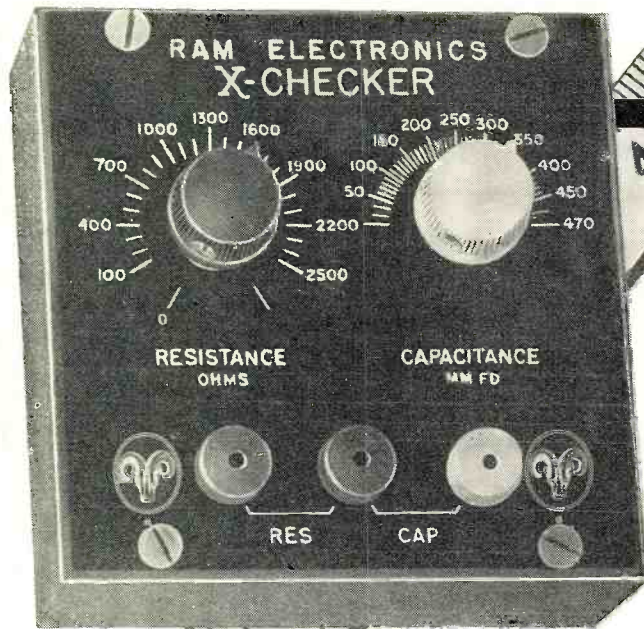
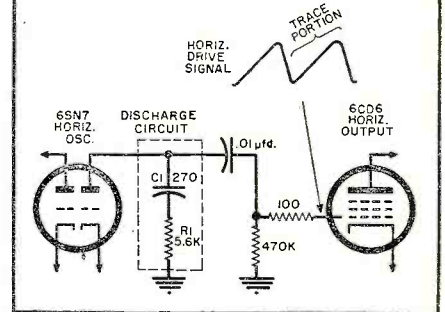

Fig. 1. The "X-Checker," shown here, consists of a small potentiometer and variable capacitor which may be connected in series, in parallel, or used separately.

Fig. 2. Partial schematic diagram of the output circuit of the horizontal oscillator in the Admiral TV chassis 21A3AZ. Note the critical waveshaping circuit C<sub>1</sub>-R<sub>1</sub>.



directly in a circuit for a resistor or capacitor which is suspected of being faulty; if the circuit works properly after the substitution, the original part is defective. It may also be used to determine what value of resistance and/or capacitance should be inserted in a circuit to compensate for parts deterioration.

Sometimes it is quite difficult to find a TV part that has changed value. Some of the troubles caused by deteriorated parts and how to eliminate these troubles by using a device like the "X-Checker" will now be discussed.

Improper horizontal linearity, brightness, or width may be caused by an improperly shaped drive signal which is fed to the horizontal output stage. The shape of the signal is determined by the RC discharge circuit (C<sub>1</sub>-R<sub>1</sub> in Fig. 2) connected at the output of the horizontal oscillator stage. If the value of either one of these two components has changed, the shape and magnitude of the waveform will change.

If the capacitance value of C<sub>1</sub> is incorrect, the curvature of the trace portion may be excessive, resulting in nonlinearity. If the value of R<sub>1</sub> is improper, the magnitude of the drive signal will either be too great, resulting in the production of excessive high voltage and too much brightness, or too small, resulting in insufficient high voltage and low brightness. Insufficient and excessive width, respectively, would also probably occur.

After deciding definitely that the trouble lies in this RC circuit, the substitution box may be used to determine whether the capacitor or resistor has changed value and what value of resistance and capacitance

(Continued on page 189)

*This small, rugged capacitance-resistance substitution box can help solve a multitude of servicing problems.*

THE device shown in Fig. 1 contains a variable capacitor with a range from 20 to 470  $\mu$ fd. and a variable resistor from 0 to 2500 ohms. These two elements may be used in series, in parallel, or separately and are especially useful for inserting resistance or capacitance in a circuit. The unit is called the "X-Checker" by its manufacturer, Ram Electronics Inc.

Three pin jacks serve as the circuit connecting points. To use the potentiometer, the test leads are inserted in the center and left jacks; to use the capacitor, the center and right jacks are employed. The right and left jacks are used when substituting the potentiometer and capacitor in series.

Essentially, this unit is substituted

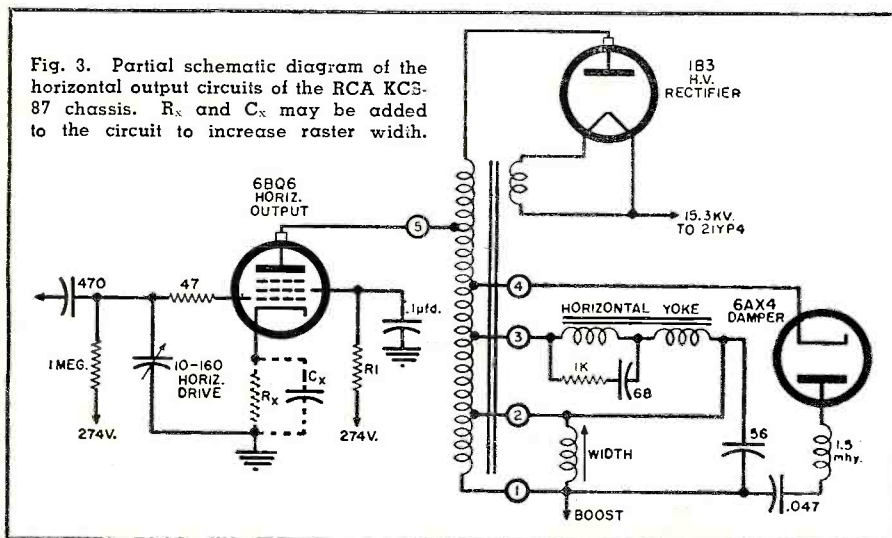
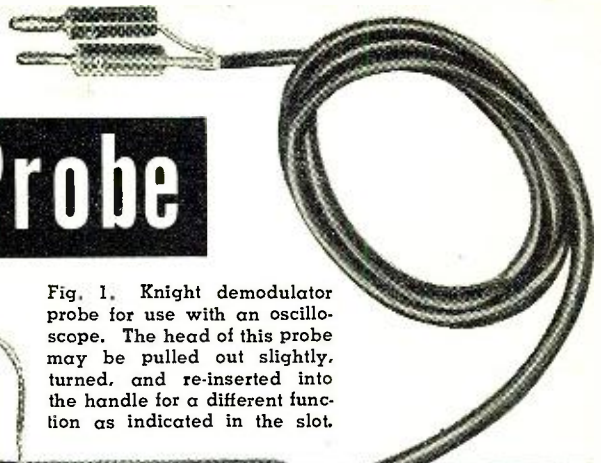

Fig. 3. Partial schematic diagram of the horizontal output circuits of the RCA KCS-87 chassis. R<sub>x</sub> and C<sub>x</sub> may be added to the circuit to increase raster width.



By  
**NELS MATTSON**  
 Knight Electronics

# A Multi-Purpose Probe



LABORATORIES, service shops, and experimenters constantly struggle with the problem of keeping workbenches free from the unsightly mass of test leads that are used for the various test instruments. This mass of leads usually frustrates the user when he attempts to make various tests and cannot untangle the proper test leads, and causes him to waste time. One answer is to combine several types of test leads into a single cable. Such is the multi-purpose probe and cable described here and designed to be used with a v.t.v.m. and/or oscilloscope. It is shown in Fig. 1.

The probe consists of two basic parts, one is a handle to which is attached the cable for connection to the test instrument. This handle contains a male plug with a single prong off center. The second part of the probe is a hollow plastic tube which contains the probe circuitry (at present, one of the three circuits shown in Fig. 2), probe tip, and female connector which mates with the male plug in the handle.

Fig. 3 is an exploded view of the probe. The over-all length of the assembled unit is five inches and the diameter is  $\frac{13}{16}$  inch. The handle is insulated tubular steel; the male plug is mounted in a molded plastic cable anchor which fits snugly into the steel tube. The center conductor of a coaxial cable (type RG 58/U or RG 59/U) is connected to the male plug, while the cable shield is bonded to a ground lead which then emerges from the cable anchor. This ground lead replaces a direct separate wire from the instrument.

The handle, with the recessed connector, serves as the receptacle for the hollow plastic probe head. One end of the probe head is fitted with a 3-pin socket which mates with the single-contact male plug in the handle. Since the male pin contact is molded on a

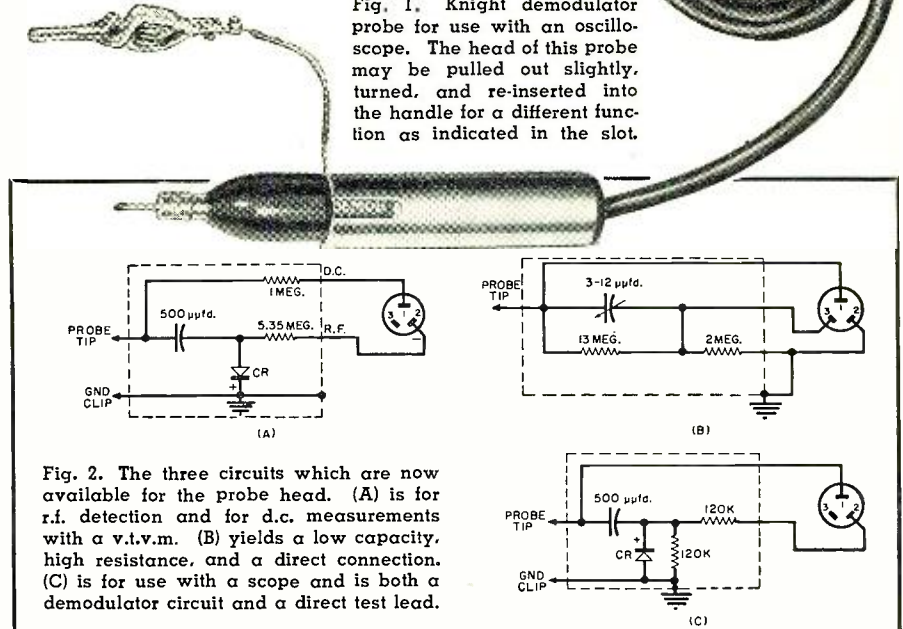

Fig. 2. The three circuits which are now available for the probe head. (A) is for r.f. detection and for d.c. measurements with a v.t.v.m. (B) yields a low capacity, high resistance, and a direct connection. (C) is for use with a scope and is both a demodulator circuit and a direct test lead.

*Unusual switch allows a single probe to be used for two or three different types of measurements.*

radius, the probe head can be inserted into the handle in three angular positions, corresponding to the location of the three female contacts. The circuit application being used is stamped on the plastic probe head and can be seen in the window slot of the handle when the head is inserted (see Fig. 1).

This hollow probe head provides for one, two, or three circuits, all having a common input *via* the phone tip plug, and with individual outputs on the 3-pin socket. The choice of circuits presently included in the probe is indicated in Fig. 2. The circuit shown in Fig. 2A allows the unit to be used as an r.f. detector or as a d.c. probe. The circuit of Fig. 2B enables

the probe to be used as a direct lead, or as a high resistance, low capacity scope lead. For demodulation, the circuit of Fig. 2C should be built into the probe head. This circuit also allows the probe to be used as a direct connector (pin 1).

The loading capacity of each crystal diode circuit is approximately 2 μfd. A smooth wide frequency range is obtained for the r.f. detector circuits by using a button capacitor at the input (see Fig. 3).

If the circuit incorporating a direct probe connection is used (Figs. 2B and 2C, pin 1), the probe may be used for a.c. and ohm measurements with a

*(Continued on page 193)*

Fig. 3. Exploded view of the probe shown in Fig. 1. The housing shield (B) normally contains the cable and plug housing (A). The probe head (D), when completely assembled, contains the female 3-pin socket with its circuits (C) and probe tip and nut.

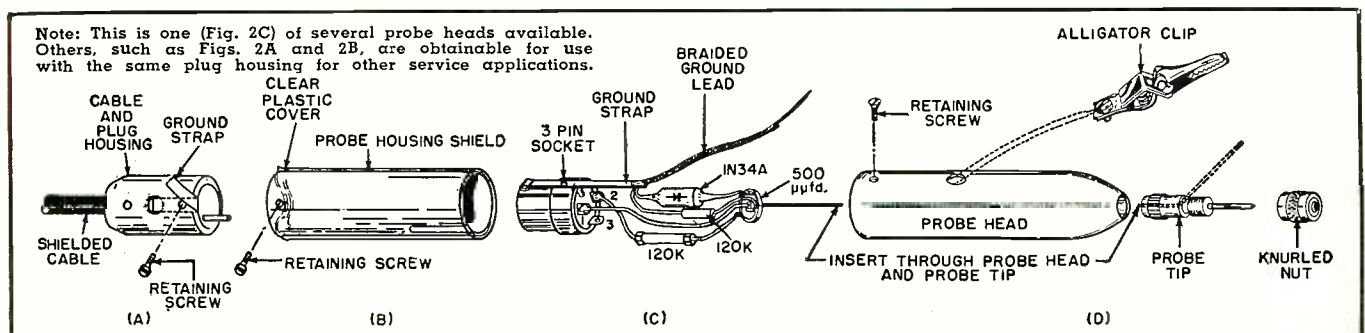

# How to Choose a Tape

By  
**NAT WELCH**  
Vice-President, "Irish" Tape



The tape "scratch test" which can be performed by the buyer. A length of tape is held in one hand while the tape surface is scratched with the other thumbnail. If, as shown in the close-up photo, oxide is deposited under the nail, it indicates that the abrasive deposit is inhibiting close contact between the tape and recording head, resulting in scratched tape.

*Factors involved in making your tape purchase and how the buyer can make a few simple checks on the tape quality.*

**H**OW much should I pay for tape?" This is a question that a recent convert to tape recording often asks a tape expert. And, there is no magic figure that you can quote in answer. Actually the tape enthusiast should expect to pay as much as necessary—and as little as need be. Because no matter what kind of tape recorder he may use, whether it's a slow-speed inexpensive machine or a high fidelity professional type, the quality and the type of the tape he selects may mean the difference between satisfaction and disappointment.

The question that should interest the tape recording fan is how to get the most pleasure from a tape recorder with the least maintenance trouble, not the price differential between one tape and another. "Quality" is the basic answer to satisfactory tape recording just as it is to many other audio products. And while an inexpensive record player may be adequate for a music-conscious vacationer at the beach, it wouldn't accomplish the same purpose as the professional turntable that is used to broadcast music. However, the beginner will soon find that there is far less spread in price between the least expensive and the most expensive tape than there is between record players.

You might start educating a beginner by establishing just what he wants to record on his tape recorder. If he plans to record nothing but speech,

all he requires is a budget-priced tape made on a plastic-base. A tape of this kind is adequate for speech or other applications where a wide frequency range is not involved. Why should a novice pay for premium quality professional tape when his investment won't bring one iota of better listening? But if, on the other hand, he is a music-lover, and he plans to record at 7½ ips or better, you may just as well tell him not to waste his time and money on anything less than the best premium tape on the market.

While purpose rather than price is the criterion to use in buying tape, the difference in cost between a good quality tape and an inferior brand is almost inconsequential when the re-use factor is considered. Certain minimum standards are essential and there are tests that will establish the presence of the necessary qualities or their absence. Even a veteran tape recording fan might use these tests to convince himself that he is not using tape that might actually be interfering with the listening pleasure he derives from his recorder. To make the first test, simply compare the surfaces of several tapes without regard to their price tags; then pick out those that look smoothest. The importance of smoothness in a recording tape may be explained to the newcomer in tape recording circles by showing him that a smooth surface is needed to insure close contact between the tape and the

recording head on the machine. The smoother the surface, the closer the contact. Frequency response depends on the closeness of this contact, and frequency response is just a high-fidelity man's way of describing the quality of the sound over a particular range between high and low pitched tones. For a novice, the best explanation is "close contact means good listening!"

Visible smoothness alone will not insure continuous, maintenance-free operation of a tape recorder. To prove that the smooth surface is permanent, suggest that he perform the "scratch" test and—you might like to try it yourself. The test is designed to reveal whether or not the base of the tape has been thoroughly impregnated with the magnetic oxide that is responsible for the sound. You test it the way a smart buyer of cotton fabrics rubs a piece of material between his fingers to see how heavily the cloth has been weighted with fillers. The filler rubs off on the fingers in a fine powder. In the same way, your fingers can determine the permanence of the bond of the oxide to the film. First stretch a piece of tape almost to the breaking point. Hold one end of the stretched tape between the thumb and forefinger of your right hand, (if you are righthanded), then run the thumbnail of your left hand down the length of the stretched tape. Be careful when you scratch the tape that you don't burn your finger. After scratching the tape look underneath your thumbnail. If it shows an accumulation of fine brown dust, you know that the magnetic oxide is not pro-

perly incorporated in the film. A reel of tape such as this deposits a layer of the fine oxide particles on the recording head as it passes, and fine though the dust may appear to the naked eye, it happens to possess the abrasive quality of jeweler's rouge. As the tape moves across a head where this deposit has accumulated it becomes scratched. In addition to scratching an often priceless tape, the accumulated dust acts as a separating factor between the head and the tape and obviously prevents the close contact required.

The novice can prevent this undesirable result by either cleaning his recording head incessantly (which is a nuisance and is probably too complicated for most neophytes) or by buying only tape that passes the scratch test. If your own tape didn't pass the test, you might clean the recording head on your own machine thoroughly before making fresh tapes. If your tape should shed enough of its oxide particles, the frequency response may also be adversely affected.

With the factor of quality established as the first requisite in selecting tape, the next step in helping a tape recording beginner to get the most pleasure from his hobby is to explain the different types of tape that are available and the properties of each.

Tape, in general, is manufactured to meet a variety of audio and physical standards for different applications.

#### Bases

The physical differences concern the strength and thickness of the base used on the tape; while the audio differences influence the fidelity of the sound reproduction. Of course the thinner the base, the more tape can be spooled on a reel. The bases most commonly accepted as suitable for both hobby and professional use are 1 mil Mylar and 1.5 mil acetate.

**Long Playing Tape:** This tape is adapted for use in recording lengthy musical compositions. Its base (usually 1 mil Mylar) enables a 7" reel to record for 45 minutes (at 7½ ips) on single-track tape instead of the normal 30 minutes. Yet this thinner base is as tough and durable as the thicker acetate base used in conventional types of tape. This long playing tape can be spliced with conventional tape without audible detection despite the different thicknesses of their base materials.

**Double-Play Tape:** This super-thin tape (½ mil Mylar) provides one full hour of recording time on a 7" reel, (at the same 7½ ips speed). This tape is indicated where long, uninterrupted recording is required and tape tension is not excessive.

**Bargain Tape:** If your novice friend is a gambler he might investigate unidentified tape in an unbranded box. Sometimes he may find acceptable tape on his bargain reel, or he might discover that the tape has been used, stretched, scraped, or otherwise damaged. These are a "let the buyer be-

REEL SIZE (in.)	TAPE LGTH. (feet)	PLAYING TIME FOR VARIOUS TAPE SPEEDS AND TAPE LENGTHS (TAPE SPEED—inches per second)				DUAL TRACK TIME	
		1⅞ ips	3¾ ips	7½ ips	15 ips	3¾ ips	7½ ips
		3	150	15 min.	7½ min.	3¾ min.	1⅞ min.
3	225*	22½ min.	11¼ min.	5⅞ min.	2 15/16 min.	22½ min.	11¼ min.
4	300	30 min.	15 min.	7½ min.	3¾ min.	30 min.	15 min.
4	450*	45 min.	22½ min.	11¼ min.	5⅞ min.	45 min.	22½ min.
5	600	1 hour	30 min.	15 min.	7½ min.	1 hour	30 min.
5	900*	90 min.	45 min.	22½ min.	11¼ min.	1½ hours	45 min.
7	1200	2 hours	1 hour	30 min.	15 min.	2 hours	1 hour
7	1800*	3 hours	90 min.	45 min.	22½ min.	3 hours	1½ hours
7	2400**	4 hours	2 hours	1 hour	30 min.	4 hours	2 hours
10½	2400	4 hours	2 hours	1 hour	30 min.	4 hours	2 hours
10½	3600*	6 hours	3 hours	90 min.	45 min.	6 hours	3 hours
14	4800	8 hours	4 hours	2 hours	1 hour	8 hours	4 hours
14	7200*	12 hours	6 hours	3 hours	90 min.	12 hours	6 hours

All tapes shown are standard tape (1½ mil film) except  
 \*Long playing tape (1 mil film)                      \*\*Double play tape (½ mil film)

Table 1. Playing time on various types and lengths of tape at different tape speeds.

ware" type of bargain, although a lucky customer occasionally might make a good buy.

**Tape for the Professional:** The resilience and breaking point of tape are two factors to consider in choosing the right tape for a certain purpose. It may take the ear of an experienced recordist to detect that a section of tape that has been recorded at 15 ips is being played back at a slight variation from the original recorded speed because the tape became stretched and failed to return to its original length. Mylar recording tape will stand much more tension than acetate tape before deforming. To a professional recording engineer, therefore, the ideal tape base is one that is practically un-stretchable as well as virtually unbreakable.

"Soundplate #220," a tape that Irish introduced years ago, is a super-tough tape intended for tape masters, recording under adverse climatic conditions, and high speed uses. It has 1.5 mil Mylar base. This tape is also indicated for radio programs where even a slight degree of stretching can cause a program to run over its allotted time and have its end commercial chopped off. The 1.5 mil My-

lar base tape is generally used for professional recording applications like making masters for subsequent duplicating or for special industrial and commercial purposes like telemetering, as noted previously, or where climatic conditions are a factor.

For less critical recording purposes, "Long Play" tape with its 1 mil Mylar base has satisfactory resilience and strength. "Double Play" tape with its ½ mil Mylar base is excellent for recording long musical efforts but it should not be employed where tape tension is extreme because it might stretch more easily than tape made with a thicker base film.

To clear up any confusion in the mind of a beginner about the length of time that he can record on his machine with any ordinary type of tape, a comprehensive chart is included. See Table 1. As a final word of advice to the newcomer in tape recording, the veteran might paraphrase Gilbert & Sullivan and suggest that he "make the tape fit the purpose." After all, there's nothing more unnecessary than office dictation on a professional-type premium tape recorded at 15 ips—unless it is a symphony recorded on ordinary budget tape at 1⅞ ips. —30—

Closeup view of rough and smooth types of recording tapes showing the difference in the surfaces. Both photographs represent an enlargement of 75 times.

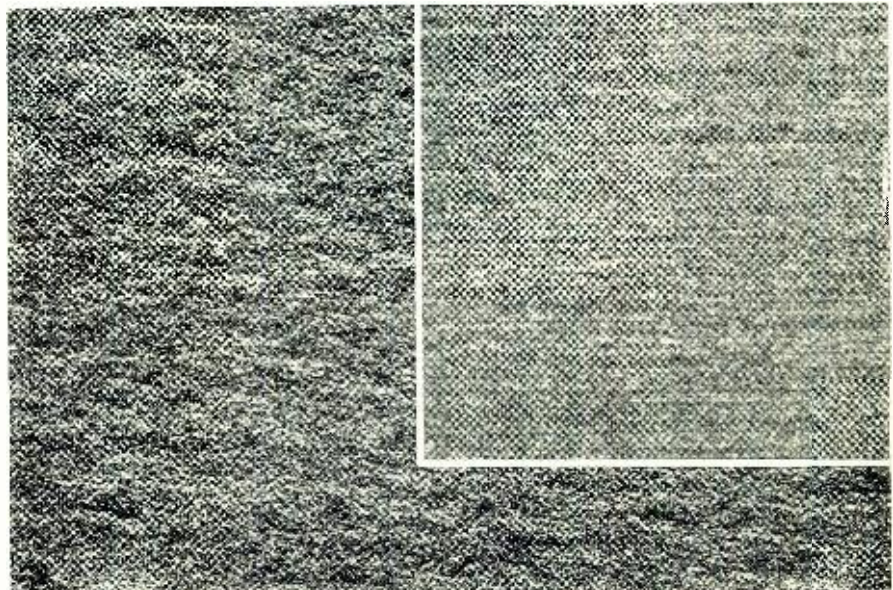

# An Air Raid Alarm for Home Receivers

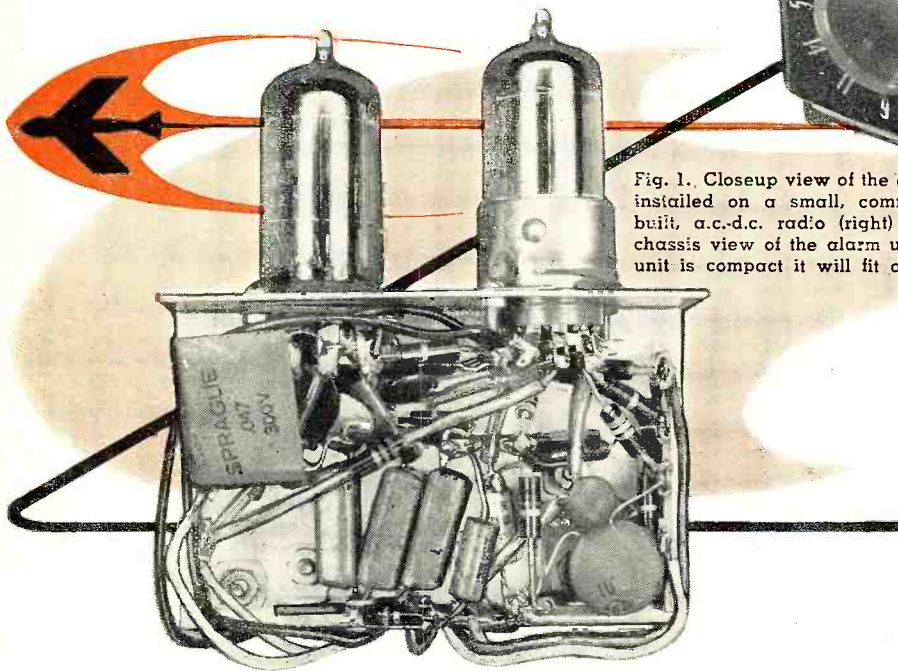

Fig. 1. Closeup view of the alarm installed on a small, commercially built, a.c.-d.c. radio (right) and under-chassis view of the alarm unit itself. Since unit is compact it will fit on most radio sets.



By  
**J. M. JACOBSON and L. E. TANK**  
Aircraft Armaments, Inc.

*FCC regulations require every radio amateur to have a Conelrad alarm system of some type. Here is an easily built and inexpensive (\$5.00) solution to the problem.*

**A**LTHOUGH a number of automatic monitoring circuits have been proposed to operate with the Conelrad Warning System, practically all of these circuits depend primarily upon the carrier break which occurs when the station goes off the air subsequent to the standard Conelrad warning. Since such a system would give a false alarm when the carrier is interrupted for any other reason, it would appear desirable to include additional portions of the "Radio Alert" sequence as a part of the automatic monitoring. This has been done in a comparatively simple circuit, which may be added to a standard a.c.-d.c. home receiver at a parts cost of five or six dollars without in any way disturbing the normal operation of the radio.

Although most readers are probably familiar with the Conelrad "Radio Alert" procedure, it might be well to summarize the characteristics of this system in order to more clearly understand the operation of the circuit. When a standard or FM broadcast station is notified to proceed with the Conelrad "Radio Alert" warning, it is required to follow these steps. (See Federal Communications Commission Manual BC-3.)

- a. Discontinue normal program.
- b. Cut the transmitter carrier for approximately 5 seconds.
- c. Return carrier to the air for approximately 5 seconds.
- d. Cut transmitter carrier for approximately 5 seconds.
- e. Return carrier to the air.
- f. Broadcast 1000 cycle steady-state tone for 15 seconds.
- g. Broadcast the Conelrad "Radio Alert" message—not to exceed 1 minute.
- h. Remove the transmitter carrier from the air for the duration of the alert or, if authorized, continue broadcasting Civil Defense information on a frequency of either 640 kc. or 1240 kc. as directed by Civil Defense.

The air raid alarm circuit to be described is operated by a combination of the 1000-cycle tone followed by a subsequent carrier break not over one minute later. The circuit will ignore the short preceding carrier breaks and will also ignore any carrier break not preceded by a 15-second 1000-cycle note. It provides, when attached to an a.c.-d.c. radio, a foolproof air raid early warning alarm without in any way affecting the normal receiver operation. No relays are required and

the alarm may be built in a small package approximately 4 inches square by 1½ inches deep which may be attached to the outside of the radio or inserted within if the particular model permits. Fig. 1 shows this attachment on a typical standard a.c.-d.c. model.

Fig. 2 is the circuit diagram of a typical a.c.-d.c. receiver. The circuit is identical to that used in practically all receivers of this class, the possible variation being in tube types. The air raid alarm has been designed to use two 12AX7 twin triodes although other dual triodes will probably work as well. The heater voltage for the alarm attachment is secured by cutting into the receiver series string at the ground end and inserting the 12AX7 heaters in series. To secure sufficient voltage for all heaters the 50C5 power output tube should be changed to a 35C5 which is identical except for the heater voltage. Plate voltages are also taken from the receiver supply, the additional current drain being negligible.

The radio receiver must be "on" at all times although the volume control may be turned down to its minimum level. The Conelrad 1000-cycle tone signal is taken from the diode detector at a point preceding the volume control while the broadcast station carrier "on-off" information is secured from the a.v.c. bus.

Fig. 3 is the circuit diagram of the alarm attachment. From point "A," Fig. 2, the received signal is passed to the grid of half a 12AX7 twin triode. A twin-T notch filter in this circuit forms a narrow bandpass amplifier which will pass only a 1000-cycle signal. It consists of resistors,  $R_2$ ,  $R_3$ , and  $R_4$  together with capacitors  $C_2$ ,  $C_3$ , and  $C_4$ . Adjustment may be accomplished by means of the variable resistor  $R_1$ . The other half of the twin triode,  $V_{12}$ , is connected as a diode

and receives the output of the narrow-band amplifier through capacitor  $C_6$ . The output of the diode rectifier,  $V_{1B}$ , charges  $C_7$ , in the timing network, (made up of  $R_9$ ,  $R_{10}$ , and  $C_7$ ) through  $R_9$ . This will cut the input to  $V_{2A}$  when capacitor  $C_7$  has been charged to a sufficient voltage by the existence of the 1000-cycle tone for a period of approximately 10 seconds. The resulting rise in potential at the plate of  $V_{2A}$  energizes a relaxation oscillator consisting of  $R_{12}$ ,  $C_8$  and  $NE_1$ . This oscillator, a neon tube, operates at a few hundred cycles-per-second. The signal from the relaxation oscillator at the plate of  $V_{2A}$  is superimposed, through  $C_{10}$ , on the grid bias of a gate tube,  $V_{2B}$ , forming the other half of the twin triode 12AX7. This grid bias is normally the a.v.c. voltage which has been taken off point "B" of the receiver, Fig. 2. As long as the a.v.c. voltage is present,  $V_{2B}$  will not pass the signal from the relaxation oscillator. As soon as the a.v.c. voltage drops to zero when the broadcast carrier is cut, an audio signal will appear through  $V_{2B}$ . The  $V_{2B}$  output from the cathode is coupled through  $C_{11}$  to the grid of the first audio tube in the receiver, point "C." Since this signal will pass through the audio amplifier and power output tube to the speaker beyond the volume control, it will cause a loud wail in the speaker irrespective of the volume control setting. The output of  $V_{2B}$  at the plate terminal is fed back through  $C_8$  to the plate of the diode rectifier section, tube  $V_{1B}$ , maintaining  $V_{2A}$  cut off and the relaxation oscillator in operation. The oscillator output in the speaker will therefore continue until the a.v.c. voltage returns.

It should be noted that because of the design of this circuit, it will maintain a loud alarm after triggering by the Conelrad "Radio Alert" warning until the owner recovers a carrier sufficient to return the a.v.c. voltage to normal. This would be done by retuning the set to either 640 kc. or 1240 kc. at which frequencies the Conelrad stations will be broadcasting.

Since some a.c.-d.c. radios have a volume level which is somewhat high even when the volume control is reduced as far as possible, it may be necessary to include the silencing switch,  $S_1$ , in series with resistor,  $R_{16}$ . This switch may be closed for night operation in order to avoid annoying background sounds in a quiet room with the set "on." During the times when the radio is being used as a receiver, this switch may be opened in order to secure full benefit of the volume control. However, the alarm circuit is operative whether or not the set is being used to receive signals in its normal manner and the silencing switch may be either opened or closed.

The "B+" voltages are obtained by connecting to points "D" and "E" of the receiver power supply. Heater voltage may be obtained from the a.c.-d.c. heater supply by changing the beam power pentode, which is usually

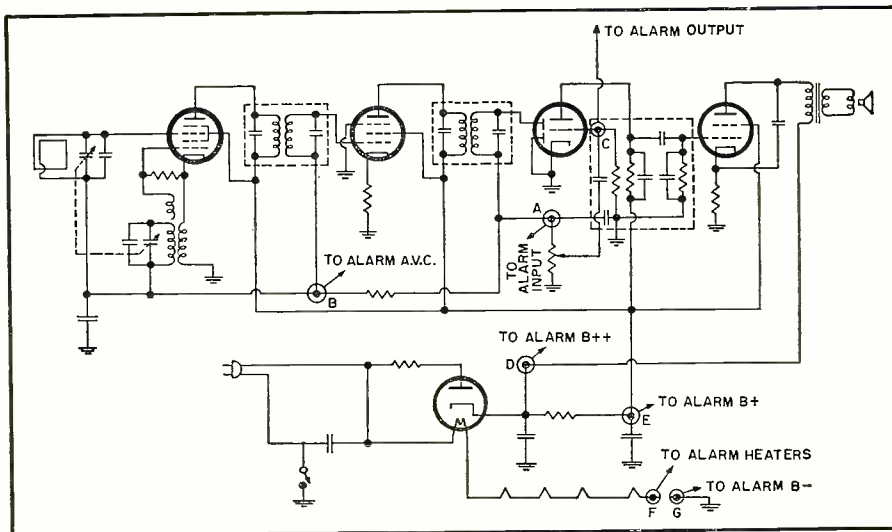

Fig. 2. Schematic diagram of a typical a.c.-d.c. radio receiver circuit. A few simple changes, involving tube substitutions, are all that is needed to adapt set.

a 50C5, to a 35C5 and inserting the heaters of the two 12AX7 twin triodes in series with the heater line. Although this will reduce the heater voltages somewhat, the operation of the set will be unaffected thereby. In sets using tubes other than the 50C5 a suitable change of the same nature will be required.

Fig. 1 shows the arrangement of the components in the alarm package. This arrangement may be modified as desired to fit the particular receiver to which it is being attached. A number of variations of the packaging have been designed and constructed. For use with a clock radio, the clock was removed and the alarm installed

in the space thus provided. The neon tube is located so that it projects through the front panel and thus gives a visible indication that the 1000-cycle note has triggered the alarm.

Another version provides a means for plugging the alarm into the a.c.-d.c. receiver without disturbing its wiring or changing the tube complement. This arrangement, however, requires a separate 117-volt a.c. power supply cord. Attachment of the alarm to the receiver is made by pulling out the detector-audio amplifier tube, inserting the adapter, and re-inserting the tube in the adapter. The adapter was made experimentally by soldering

(Continued on page 140)

Fig. 3. Schematic of alarm unit. No relays are used and circuit monitors continuously.

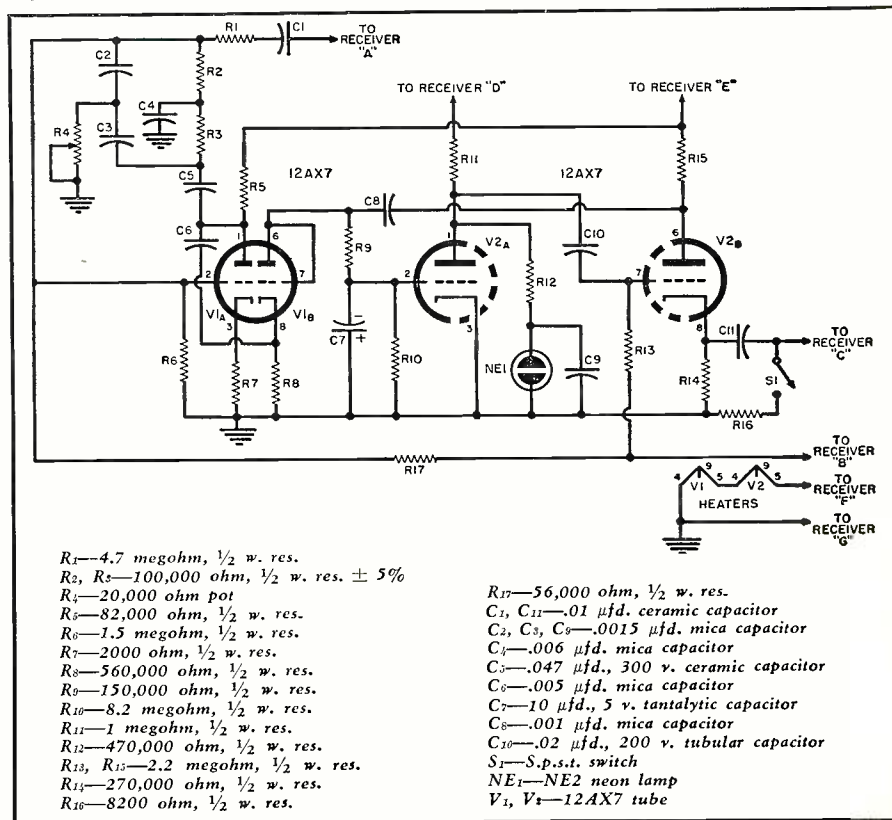

# Certified RECORD REVUE

By BERT WHYTE

The November edition of this column has always been a bit of a headache. Monthly magazine publishing being what it is, this November copy is being written at the end of hot and sticky August. While the record companies don't slack off very much during the summer, they nevertheless save their best new recordings for September release. The consequence is that when you receive your copy of the November edition, the Fall audio and record activity is at its height, but this column is bare of many of the "big" and important releases. It just can't be helped and all I can do is hope that enough "big" recordings arrive to make the December issue a worthwhile Christmas buying guide. To save the day for this issue, *Capitol Records* came to the rescue with the early arrival of the biggest Fall release in its history. So if there seems to be an unusual number of *Capitol* reviews you'll understand why. In addition to the *Capitol* stuff, we'll have a few items that were somehow overlooked and are deserving of your attention . . . and also do some jazz for a change as well as a few more tapes.

Equipment used this month: *Pickering* "Fluxvalve" in *Pickering* 190 arm, *Components Corp.* turntable, *Marantz* and *McIntosh* preamps, 2-*McIntosh* MC60 amplifiers, *Jensen* "Imperial" speaker, *Electro-Voice* "Georgian" speaker, *Ampex* monaural/stereophonic tape equipment.

## ELGAR

### SEA PICTURES OVERTURE: IN THE SOUTH

The London Symphony Orchestra conducted by George Weldon. *Capitol* P18017. RIAA curve. Price \$3.98.

The "Sea Pictures" is an LP premiere and a most welcome one. This is a facet of Elgar little known to the general public. No bombastic "Pomp and Circumstance" here . . . this is an Elgar who is surprisingly introspective, an Elgar in a soft pastel mood of nature consciousness. Five sea poems comprise the "pictures" and to these Elgar has set some exquisitely lovely music. Purportedly not programmatic, the glowing orchestration nonetheless evokes a stirring and graphic picture of the sea. The song texts are superbly projected by the late Gladys Ripley. Long famous for her oratorio work, these songs are a fitting memorial to this sensitive and gifted artist. Here her voice is rock-firm in pitch, her tone beautifully rich and resonant, her reading sincere and unforced. "In the South" overture has been committed to LP once before . . . a frightfully bad-sounding disc by *Urania* which reflected little credit on music, conductor, or orchestra. This overture is the Elgar of big and colorful orchestration and if you like his usual fustian genre, you will delight in this lively score. The result of an Italian holiday, this might be likened to

the Italian counterpart of his famous "Cockaigne" overture . . . his musical tribute to London.

In both the "Pictures" and the overture, conductor George Weldon contrives a fine orchestral balance and elicits some beautiful playing from the London Symphony. This is a vastly underrated fellow and he deserves more of a chance to show his wares. I had the pleasure of meeting Weldon briefly during the war in England and recall the memorable night he conducted the Birmingham Symphony in Rachmaninoff's "Rhapsody on a Theme of Paganini" with Benno Mosevitch as pianist. Glorious music inside the Birmingham Town Hall and outside the ghostly probing of the searchlights, occasionally lighting up the twisted iron skeleton of the burned-out department store, the torn arcade of the railway station, and other nearby ruins . . . and always the distant mutter of the ack-ack like some giant counterpoint to the music. Gadsfrey! Enough of that kind of reminiscence!

Soundwise this is the best so far of *Capitol's* new European series. Good clean string tone throughout both works, bright but not heavy brass, rather filmy woodwinds, excellent percussion of good impact and articulation, and above all, nice spacious acoustics to lend a pervasive liveness to the scores.

## BRAHMS SYMPHONY #1

Pittsburgh Symphony Orchestra conducted by William Steinberg. *Capitol* P8340. RIAA curve. Price \$3.98.

The 19th Brahms 1st symphony on LP and despite some very formidable competition, a version that is bound to become a best seller. Why? Well reason #1 may seem very strange and that is because of what I call Steinberg's "neutral" conducting. This is as straightforward a reading of this work as exists . . . there are no mannerisms, no tampering with the score, no striving for "effects," and yet it is not a dull reading, not something done by rote. The playing Steinberg gets from his men is exemplary, his balance and proportion nigh perfect. The attractiveness for many will be in this very simplicity of purpose, this hewing to the line of Brahms' intent. This is a reading for the student, the newly-minted hi-fi fan, the beginner in classical repertoire, not for the musicologist nor the musical dilettante, nor the veteran concert-goer. This is not meant as an insult to Steinberg but rather as a compliment for his restraint in letting the score stand on its own merits.

Reason #2 is that this is one of the biggest and best-sounding Brahms First Symphonies now on records. The famous opening

The opinions expressed in this column are those of the reviewer and do not necessarily reflect the views or opinions of the editors or the publishers of this magazine.

bars soar out beautifully, clean and unbridled. Throughout, the strings are sharp and incisive without the penalty of edginess. The brass is especially smooth and lustrous and the famous french horn theme is gorgeous in its mellow delineation. Woodwinds are very smooth and bright, vibrato easy to discern. Percussion was very good but I would have preferred somewhat more articulation from the tympani. Wide frequency and dynamic range coupled with spacious acoustics gave an over-all sheen to the sound and made for great "liveness." Those who own the Walter, Toscanini, or Kubelik versions will hardly replace them with this reading but they owe it to themselves to listen to an exceptional recording.

## GERSHWIN

### RHAPSODY IN BLUE AN AMERICAN IN PARIS

Leonard Pennario, pianist, with Hollywood Bowl Symphony Orchestra conducted by Felix Slatkin. *Capitol* P8343. RIAA curve. Price \$3.98.

This is a remake of the same coupling that appeared on *Capitol* several years ago. The pianist is the same but instead of Paul Whiteman's Orchestra we have conductor Felix Slatkin and the Hollywood Bowl Symphony. Net result is a definite upgrading in both sound and performance. Pennario has come a long way since the earlier version and he is now a much more assured and polished performer. Fortunately maturity has not robbed him of any spontaneity in his playing which was the outstanding characteristic in his reading of the "Rhapsody." Pennario has a good rhythmic sense and immense technical facility, two qualities which are musts in this work. In his ebullient perusal of the score, Pennario even outshines the fine effort of Katchen on the *London* label some months ago. I think the main reason for this is that Pennario has the advantage of an *American* orchestra and with their better handling of the feeling and syncopation of this work, he had a much more inspirational rapport than did Katchen with Mantovani.

The "American in Paris" was definitely needed . . . most of the other recordings in the catalogue were woefully inadequate in sound. Performance-wise however, I still like the incredibly fresh and saucy reading of Leonard Bernstein on an old *Victor*. Slatkin knows his way around this work, but makes the mistake of tempi which are too slow in the opening sections. Happily, about halfway through he comes to life and then things really start to move towards the boisterous climax.

Soundwise both the "Rhapsody" and the "American" leave the competition well behind although the *London* comes close at moments. Hi-fi fans will love the "American" in particular as there are some really spectacular effects here. Nice bright strings are much in evidence, as are those wonderful off-key trumpets, heard with startling clarity. There is very wide use of woodwind in this score and all are heard with exceptional purity of tone, and of course there is the busy clattering percussion, with the hard transients of the xylophone especially clean and articulate. The piano in the "Rhapsody" is the best yet from *Capitol*. Very smooth, liquid sounding, cleanly percussive when needed, but never subject to harsh ringing or other transient overload. Wide frequency range, wide dynamics and acoustics make for an outstanding recording.

## RIMSKY-KORSAKOV SCHEHERAZADE

Orchestra of the Vienna State Opera conducted by Mario Rossi. *Vanguard* SRV-103. RIAA curve. Price \$1.98.

(Continued on page 171)

# New Technique for Loudspeaker Loading

By **MORT WIMPIE**  
Rockbar Corporation

*Prefabricated port for bass-reflex enclosure reduces required cabinet volume and lowers resonant peaks.*

**T**HE last problem that must be met before the high-fidelity system is completely "housebroken" is the loudspeaker enclosure. Many attempts have been made to reduce its size and improve its appearance, and some of these have been moderately successful. All of them, to date, have represented some compromise with the performance in order to achieve the required "domesticity." This grows out of the fact that the loudspeaker cannot be separated from its enclosure. In order to achieve the sound desired from it, the speaker (or speakers) must be enclosed in an acoustically correct cabinet. There is really no problem in providing enclosures that will do a good job of matching the loudspeaker to the room in which it is situated, provided only that no thought is given to size, appearance, expense, etc. Unfortunately, there are few of us who can so completely disregard the feelings of our wives, the decor of our homes, or the size of our pocketbooks.

In order to justify its existence, the loudspeaker enclosure must do a number of things. It must first take the sound radiated from the back of the speaker cone and either completely absorb it, or turn it around so that it emerges, in phase, with the front radiation. Secondly, where possible, the enclosure should extend the bass response of the speaker at least one octave below the free air resonance of the speaker cone. In addition, the enclosure should not add resonances of its own making to the over-all system response and the speaker enclosure should apply loading in such a way as to control the cone velocity even below the speaker resonance.

One very simple enclosure that meets



some of these listed requirements is the bass-reflex or vented enclosure. There are many reasons for the widespread and well-deserved popularity of the bass-reflex enclosure. If properly tuned by use of the correct enclosure volume and port area for a given speaker, the enclosure provides excellent damping to the speaker cone at its resonant frequency where it is most needed. At some frequency below that of the cone resonance, the air mass in the vent and the mass of the cone resonate with the stiffness reactance of the cone suspension. Also, at some frequency above cone resonance, the

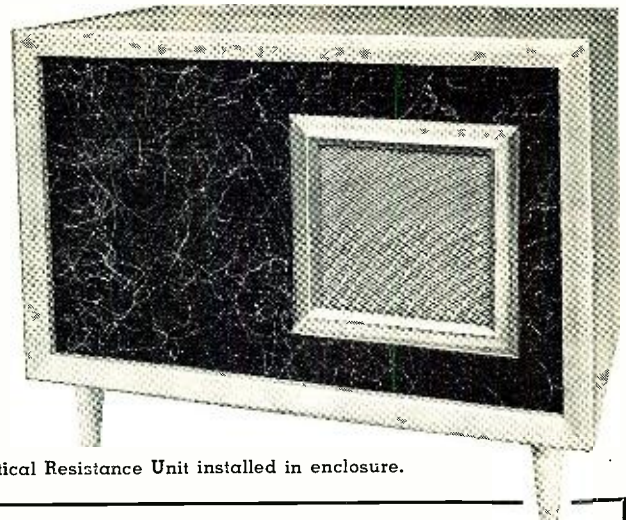
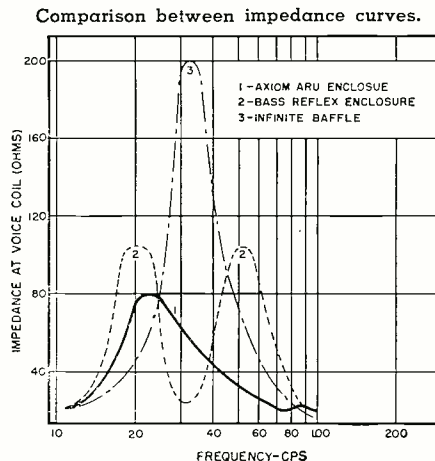

Acoustical Resistance Unit installed in enclosure.

## ENCLOSURE DATA FOR AXIOM-ARU ENCLOSURES

SPEAKERS	GOODMANS PROTOTYPES USED IN DESIGN	SPEAKER RES. FREQ. (in cps)	ENC. VOL. (cu. in.)	ARU MODEL	APERTURE FOR ARU (in.)
Single 12"	Axiom 22 MK II	35	7800	172	10½x10
Single 10"	Axiom 80	20	5900	180	12 x7
Single 15"	Audiom 80	35	9600	280	14½x10
Single 18"	Audiom 90	30	11,700	480	17½x13½
Two 12"	Axiom 22 MK II	35	11,000	Two 172	10½x10
Two 10"	Axiom 80	20	8300	280	14½x10
Four 10"	Axiom 80	20	11,700	480	17½x13½

Note: All volumes ± 10%. Enclosures fully lined with at least a one-inch thick acoustic baffling.

stiffness reactance of the enclosure becomes high and this will combine with the stiffness of the cone suspension and will then equalize the mass reactance of the cone. The result then is to produce two lower amplitude resonances—one below and one above that of the speaker alone or that of the speaker mounted in a true infinite baffle (refer to graph). The upper resonance is frequently responsible for a lack in smoothness of the low frequency response so that if very much bass boost is applied, the enclosure will tend to sound boomy.

Although the size of a properly tuned reflex enclosure is not as large as is required for some other types, its size does leave something to be desired when a low-resonant-frequency speaker is employed. For example, a 12-inch speaker with a cone resonance of 60 cycles would require an enclosure volume of just under 12,000 cubic inches (7 cubic feet) with a port area equal to the effective area of the speaker cone. A speaker with a lower cone resonance would require a proportionally larger volume. A number of techniques have been evolved to permit a reduction in the size of this type of enclosure while attempting to improve its performance by removing undesired resonances.

Mr. E. J. Jordan of *Goodmans Industries Ltd.* is responsible for one of  
(Continued on page 161)

# Tube Types

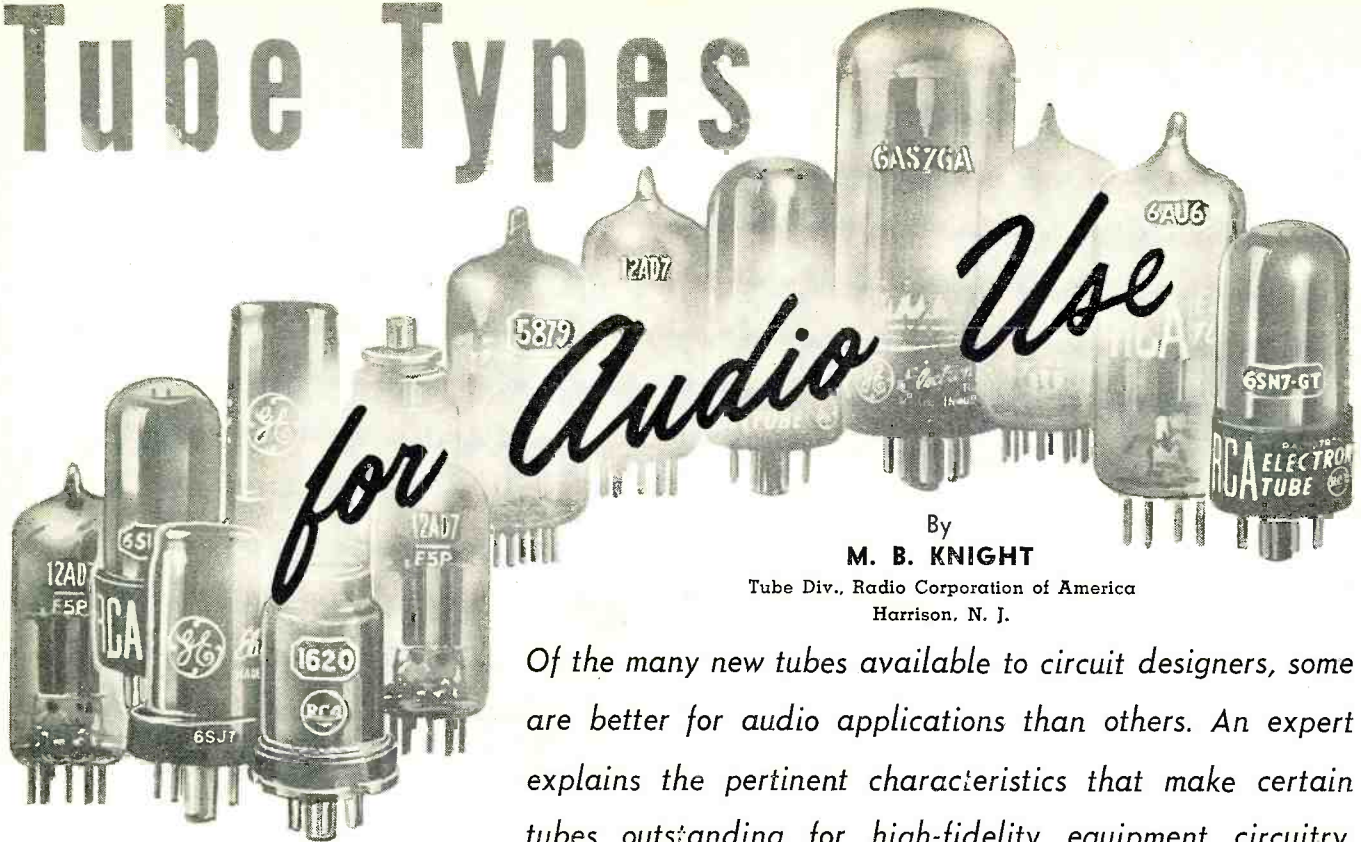

*for Audio Use*

By

**M. B. KNIGHT**

Tube Div., Radio Corporation of America  
Harrison, N. J.

*Of the many new tubes available to circuit designers, some are better for audio applications than others. An expert explains the pertinent characteristics that make certain tubes outstanding for high-fidelity equipment circuitry.*

**T**HE flood of new tube types which has appeared in recent years has brought both blessings and headaches to designers of audio equipment. The blessings lie in variety and in the fact that some of the new types incorporate improvements making them superior to older types for audio service. The headaches lie in the number of tubes which have similar characteristics, or which differ merely in heater ratings or basing, so that the choice of the most suitable type for a particular application is confusing.

The rapidity with which tube types continue to appear and disappear also poses a dilemma for the writer, because advice concerning a particular type may be worthless by the time it is published because the tube has already become obsolete.

The particular characteristics of a tube which most concern the designer of audio equipment depend on the relative position of the tube in the amplifier circuit. We shall begin with the characteristics most critical in low-level voltage-amplifier stages.

## Noise

The most important characteristic of low-level amplifier stages is noise. The useful sensitivity of an amplifier basically is limited by the "thermal" or "fluctuation" noise which appears at its input terminals. This noise (which is inescapable except at absolute zero temperature) is caused by the random motion of electrons in the conductors of the input circuit and signal source and appears across the input terminals of the amplifier as a

noise voltage proportional to the square root of the total input-circuit resistance and directly proportional to the system bandwidth. (Noise *power*, however, is independent of resistance.) To this input-circuit noise must be added the fluctuation noise, microphonic noise, and hum generated in the tube, all of which can be expressed in terms of equivalent voltages at the grid.

If the signal source is a high-impedance device such as a crystal microphone or pickup, the tube fluctuation noise is usually small compared with the noise generated by the source. On the other hand, if the signal source is a low-impedance device such as a tape head or magnetic pickup, the tube fluctuation noise will predominate unless the impedance level of the source is raised by means of a transformer. Because the cost of low-level input transformers having adequate magnetic shielding precludes their use in all but the most expensive equipment, the various types of tube noise must be considered in selecting types for use in many low-level input stages.

One of the sources of tube fluctuation noise is the random manner in which electrons are emitted by a thermionic cathode. The resulting noise, called "shot noise," appears in the plate current, and the equivalent noise voltage at the grid is inversely proportional to the square root of the effective transconductance. (Effective transconductance is the actual value obtained in the circuit and, in the case of a resistance-coupled amplifier, is usually substantially less than the value shown in the published data for

the tube.) In order to minimize shot noise it is necessary that the effective  $g_m$  be as high as possible, which means that the plate current of the tube must be as high as practical. In the case of a resistance-coupled amplifier these conditions are most easily achieved by the use of a relatively low value of plate-load resistance, usually between 50,000 and 100,000 ohms. The plate current under these conditions is usually about 1 milliamperere. In such cases the grid-voltage equivalent of the shot noise, assuming a 20-kc. bandwidth, is on the order of 1 microvolt, while the theoretical r.m.s. noise voltage developed across a 100,000-ohm resistance in a circuit having a 20-kc. bandwidth is 5.75 microvolts. Because there is not likely to be a difference of more than 2 to 1 in effective  $g_m$  between different tube types, choice of tube type from this standpoint is not particularly critical.

These shot-noise considerations apply only for space-charge limited emission, *i.e.*, when the tube is operated at rated filament or heater voltage. Because the shot noise produced under temperature-limited emission conditions is much higher, it is not advisable to operate low-level amplifier tubes at less than normal filament or heater voltage.

An additional type of fluctuation noise associated with cathode emission, called "flicker noise," is often observed. In contrast to shot noise, which is uniformly distributed throughout the frequency spectrum, flicker noise is greatest at low frequencies and may be much larger than shot noise below



a few hundred cycles. The causes of flicker noise are not well understood, and wide variations are observed even among tubes of the same type. The only safe choice from this standpoint is one of the special audio types, such as the 1620, 5879, 12AD7, or 12AY7, since these are specifically tested in order to eliminate tubes having excessive flicker noise.

Pentodes have an additional fluctuation noise component called "partition noise," caused by the random division of the cathode current between the plate and screen grid. As a result, the equivalent fluctuation noise voltage at the grid of a pentode is usually 2 to 3 times higher than that developed when the tube is operated as a triode. In critical applications, therefore, a triode is the better choice, particularly if the grid-circuit impedance is low.

Tube fluctuation noise can also be caused by defects, such as leakage or gas. Because these defects may occur in any tube type they need not be considered in the choice of a specific type.

### Hum

One of the common causes of tube hum is leakage in heater-cathode insulation. Although the resulting hum, called "heater-cathode" hum, has a low fundamental frequency (the power-line frequency) it can be troublesome even in "low-fi" amplifiers because of its high harmonic content.

The materials used for heater-cathode insulation have non-linear and often unpredictable resistance characteristics. For low heater-cathode leakage the heater temperature should be as low as possible and the heater insulation as thick as possible. Both of these considerations require that there be plenty of room inside the cathode, which means (1) a relatively large cathode, (2) relatively high heater power. Consequently, one should avoid types designed for high-frequency service, such as the 6BQ7A and 12AT7, in which the necessity for small inter-electrode capacitances leads to the use of small cathodes. For the same reasons it can be seen that the 6SN7GT family and the 6CG7 are preferable to the 12AU7. However, large variations are found between different tubes of the same type, and it is good practice, therefore, to use every circuit means practicable to minimize heater-cathode hum. In low-level stages, cathodes should be grounded directly or through low-impedance bypass capacitors; cathode followers and phase splitters should be used only in stages operating at fairly high signal levels. The heater circuit should be provided with a center tap at a.c. ground potential or, even better, should be shunted by a potentiometer of about 100 ohms resistance having its slider at a.c. ground potential so as to obtain an adjustable ground. It is also quite effective to bias the heater 20 or 30 volts d.c. positive with respect to the cathode.

Another common source of tube hum is heater-to-grid capacitance.

However, it is difficult to devise general rules for choosing a type from this standpoint, since differences between types otherwise suitable for low-level service are not large. Hum from this source can be most effectively minimized by good circuit design. The use of a heater supply circuit having a grounded center tap or adjustable ground tap, as described, is especially effective in reducing this type of hum. It is also advisable that the impedance of the grid-circuit at the power-line frequency be as low as possible. This consideration requires the use of a large coupling capacitance between the grid and the preceding stage or signal source. In cases where a reduction in low-frequency response is desirable to avoid motorboating, the large coupling capacitance should be retained and the change effected by a reduction in the value of the grid resistor.

Tube hum may also be caused by the magnetic field of the heater or of an external device such as a transformer, choke, or motor. Tubes having coiled heaters produce less hum from the heater field and are generally preferable to those having folded heaters (see Fig. 1). It is not practical, however, to fabricate coiled heaters for very small cathodes, and even tube types which have cathodes large enough to accommodate coiled heaters are often provided with folded heaters for economic or other reasons. One has the best chance of getting a coiled heater if the recommendations applying to the choice of types for low heater-cathode hum are followed.

Pentodes are more susceptible than triodes to magnetic hum. Even a relatively weak magnetic field may vary the division of current between plate and screen grid, and the resulting hum currents in the screen circuit will develop hum voltages which will be amplified. If external magnetic fields are a problem, screen grids should be bypassed with at least 0.5 microfarad of capacitance to minimize hum.

Operation of low-level amplifier tubes at less-than-normal heater voltage is sometimes helpful for minimiz-

Fig. 1. Cutaway views showing two types of heater construction. Coiled heater has a smaller external magnetic field and is, therefore, less likely to produce hum.

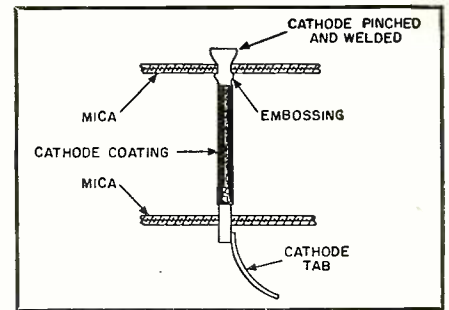
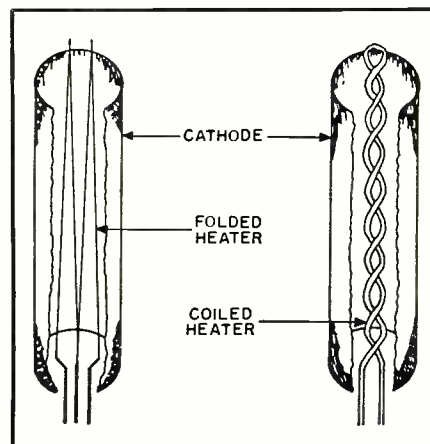

Fig. 2. Inverted-pinched-welded construction which insures a tight fit between a cathode and the supporting mica plates.

ing heater-cathode hum and magnetic hum, because it reduces both the temperature and the magnetic field of the heater. This expedient should be used with caution, however, because it usually causes a substantial increase in shot noise and may seriously impair tube life. Another method sometimes recommended is the use of d.c. heater supplies. However, with a proper choice of tubes and careful circuit design, the hum level of a wide-band audio amplifier using a.c. heater supply should not be more than about 2 db greater than that obtainable with d.c. operation.

Occasionally a baffling hum problem turns out to be caused by tube microphonics in conjunction with the vibration of a power transformer or choke. The choice of tube types from this standpoint is considered in the next section.

### Microphonic Noise

A tube will deliver electrical output if its interelectrode spacings are altered by shock or vibration. If mechanical resonances at audio frequencies exist in the tube, excitation from the loudspeaker may readily result in feedback or *sustained microphonics*. This problem is most serious in filament types, since a filament bears a dismaying resemblance to a guitar string. To minimize this type of microphonism, modern filament types employ "damper bars" which bear against the center of the filament, raising its resonant frequency and reducing the amplitude of vibration in the same manner as a finger on a guitar string. Even so, as resulting mechanical resonance is usually well inside the audio range, it is usually necessary to limit high-frequency response in equipment using filament-type tubes.

The most common microphonic difficulty with heater-cathode types is response to mechanical shock or *ballistic microphonics*. The sensitivity of a particular tube type to ballistic microphonics is largely determined by the interelectrode spacings employed, and by the tightness of the electrodes in the mica, and is thus related to basic tube design as well as to economic factors related to the difficulty of assembly. Tubes having smaller electrode spacings are more critical for microphonics. The principal vari-

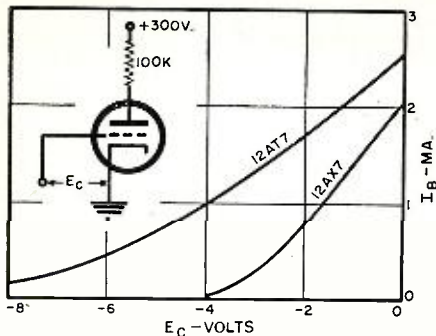

Fig. 3. Grid voltage vs plate current characteristics of the 12AT7 and the 12AX7.

able determining the tightness of fit attainable is the mechanical strength of the cathode; it is easier to obtain tight fit with a round cathode of relatively large diameter than with a small flat cathode. The relatively large-diameter round cathodes also make it possible to obtain tight fit by the use of the "inverted-pinched-welded" construction shown in Fig. 2. These considerations indicate that types designed for high-frequency use should be avoided. Fortunately, most of the basic design factors which result in low hum are consistent with the requirements for low microphonics.

Economic considerations affect microphonics simply because it costs less to construct tubes with loose-fitting elements. Thus the desires of both the tube manufacturer and the tube user are fulfilled if the internal fit of a tube is only as tight as it needs to be for its principal applications. The special audio types represent the extreme in this respect, because production speed is sacrificed in order to assure tight-fitting elements. In choosing from standard types, the user should seek those normally used in applications critical as to microphonics. Good examples of such types are the tubes of the 6SN7GT family and the 6CG7, which are used extensively in the highly critical horizontal oscillator circuits of television receivers.

A few types which are not carefully controlled for microphonics in manufacture, have, nevertheless, been found to be quite good in this respect because of particular construction features. One example is the 6SC7. However, the construction features which make the 6SC7 good for microphonics also give it a tendency to develop leakage noise with life. Measurements made by the author a few years ago showed the 6BF6 to be quite good for microphonics, but a hum-balance adjustment was necessary to obtain an acceptably low hum level.

The whole amplifier design may be related to the choice of tube type for the lowest-level stages. Although the special audio types give the best performance for minimum noise, hum, and microphonics, the more common types are often used for economy. In such cases it is highly recommended that the amplifier design be arranged to use the same type in higher level stages. This practice permits the se-

lection of the best of several tubes for the first stage, while using the remainder in less-critical sockets. There is no economy in discarding several low-cost tubes to get one good one.

### Distortion

The distortion produced by tubes is the result of the inherent nonlinearity of all grid-voltage-plate current characteristics. At moderate signal levels, tube distortion is principally second harmonic and is approximately proportional to grid-signal amplitude. At these levels, tubes having relatively low  $g_m$  and requiring relatively high heater power are usually preferable, because designs for high  $g_m$  with small cathode area, such as are employed for high-frequency types, lead to excessive nonlinearity. For example, the 6CG7, which requires higher heater power than the 12AU7, is better than the latter at low signal levels, although both types have approximately the same plate current,  $g_m$ , and  $\mu$ . Sharp-cut-off pentodes, such as the 6SJ7 or 6AU6, are also better than variable- $\mu$  types at low signal levels.

As signal amplitude is increased, a point is reached where tube distortion increases rapidly and contains substantial amounts of higher-order harmonics, the transition being caused by the signal swing reaching the cut-off or the grid-current regions. For this reason, the "maximum voltage output" values shown in the "Resistance-Coupled Amplifier Chart"<sup>1</sup> are usually determined by the points at which these higher-order harmonics appear. The fact that a particular tube type has higher maximum voltage output than another, however, is not necessarily an indication that it produces less distortion at moderate signal levels. For example, the 12AT7 has appreciably higher maximum voltage output than the 12AX7, but produces more distortion at moderate signal

levels. Fig. 3 shows output *versus* input characteristics of the two types; the greater curvature of the 12AT7 characteristics throughout the operating range is apparent. The tube-design factors responsible for this difference are shown in Fig. 4. The cross-section views, which are drawn to scale, indicate the closer spacing used in the 12AT7 in order to obtain good performance in v.h.f. mixer service.

Pentodes usually are capable of higher maximum voltage output than triodes of equivalent rating, but also generate slightly higher distortion at moderate signal levels. As a general rule, medium- $\mu$  triodes are capable of more voltage output than high- $\mu$  triodes. The correct choice of operating conditions is very important in obtaining maximum voltage output, and is simplified by the "Resistance-Coupled Amplifier Charts" which are published by most tube manufacturers<sup>1</sup>. These charts are usually optimized for voltage output.

### Power Amplifiers

**Triodes:** The science of designing power-amplifier triodes has been known for many years, and the older types, such as the 2A3, are still pretty good. Although several new triodes embodying improved construction techniques and having higher power sensitivity and power output than earlier types have appeared in recent years, most of these types have been designed for use as vertical-deflection amplifiers or voltage regulators. They are relatively poor audio amplifiers because the design factors which provide high output and high  $g_m$  usually result in highly nonlinear characteristics. In fact, the characteristics of practical vertical scanning circuits make it necessary to use nonlinear tubes in order to obtain linear deflection.

Most of the newer power triodes can be used successfully in audio service, however, by operating them in push-pull so as to obtain cancellation of the even-harmonic distortion. For example, the 6AS7G, which was designed for television damper service, has highly nonlinear characteristics but is capable of excellent performance as a push-pull audio power amplifier.

Triode-connected pentodes and beam-power tubes are generally not as linear as the best triodes, but are no worse in this respect than the vertical-deflection types and, consequently, can also be used successfully in push-pull circuits. Factors discussed in the next section which should be considered in the choice of a pentode or beam-power tube should also be considered when these tubes are connected as triodes.

From the standpoint of maximum power output the choice of a triode will depend principally on the plate-supply voltage available. When the plate-supply voltage is low, the characteristic desired is low plate resistance, which usually means low  $\mu$ . Maximum power output is usually reached while dissipation is still below

(Continued on page 162)

Fig. 4. Cross section showing, to scale, the differences in electrode geometries of the 12AT7 and 12AX7 tubes. Refer to text.

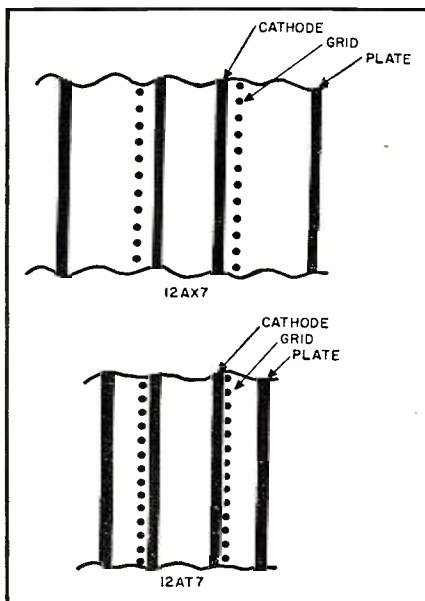

**W**HEN the *General Electric Company* announced recently that it was opening three factory service depots on a test basis to handle consumer service on *G-E* television and radio receivers, it sparked a wave of resentment in the independent service industry that swept across the country like a raging prairie fire. Some service associations looked for laws that could be used to stop *G-E* while others toyed with the idea of encouraging a boycott of the company's products.

In the opinion of many service industry spokesmen, this is an attempt to make the *General Electric Company* the whipping boy for the trend among manufacturers to provide consumer service on their products. The smouldering resentment against factory service had been growing in intensity as many manufacturers quietly expanded their consumer service activities in metropolitan areas. Explanatory statements from manufacturing service officials to the effect that their service activities were "in the interest of competent service shops" did not serve to reassure the independents, especially when factory service was heavily advertised and promoted.

After the first wave of resentment subsided a little, service association leaders settled down to get a rational analysis of the situation. They sought to determine the most logical and effective steps that could be taken by independent service shops to meet the competition of captive service. It was generally recognized that manufacturers have a legal right to provide service on the products they manufacture and if they operate their service depots without subsidization from sales, it is felt that independent service can compete against them successfully.

While most service technicians feel that manufacturers are going into the consumer service business to get a share of the billion dollar income it provides, there are other and even more important economic factors involved in manufacturers' interest in consumer service.

As the manufacturer sees it, his major business is to sell his products. Out of economic necessity, he must constantly strive to get an increasing share of the market for the things he produces. The growing complexity of consumer products has increased the importance of competent service as a factor in selling. In the main, the public feels that manufacturers should provide service on the products they sell. If one manufacturer provides factory service and uses it as a tool to sell his products, sooner or later competitive manufacturers must also make factory service available on their products.

The disadvantage for the manufacturer, however, is that his service operation is seldom as economical as that of competently staffed, independent service shops. This, many manufacturers admit, has kept them out of the service business. It seems that the overhead burden for supervision alone

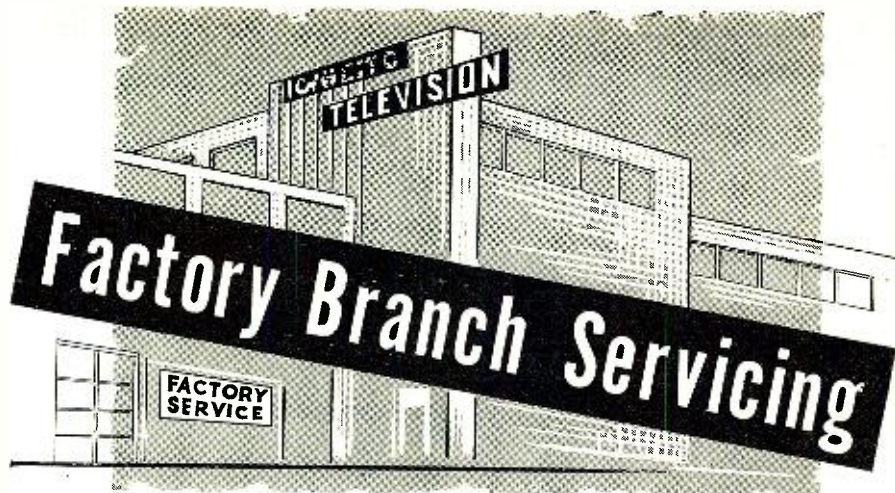

By **WILLIAM LEONARD**

### *Why is factory-controlled TV and radio servicing spreading? How can the independent shops survive?*

makes factory service more expensive than comparable independent service.

The controlling factor in whether independent shops or factory depots will dominate electronic service is the general public. The people who need service on TV or radio sets will decide.

Available case histories of set owner dissatisfaction with factory service reveal no instances where the customer was overcharged for the services performed. Customer dissatisfaction with factory service stems from the incompetence of the trainees sometimes employed to handle home service calls, long delays in providing service, and double talk on the part of the factory technician when several calls were necessary to correct a troublesome defect in a receiver.

On the other hand, the public's dissatisfaction with independent service is based upon downright cheating. The Better Business Bureaus estimate that the public was cheated out of better than fifteen million dollars last year by unscrupulous service shops. The public looks upon these shops as part of the independent service industry.

At the moment, there is no way for the public to know which shops are ethically operated and technically competent—except from experience. This can be very costly and discouraging to owners of TV sets. In their confusion they are inclined to turn to the big companies for brand-name service.

Service industry spokesmen say that any effort to publicize the independent electronic service industry or to develop publicity for its benefit, is stymied by the problem of identifying the ethical shops for the public. If an ad were to run in a national consumer magazine urging the public to patronize independent service shops, a reader who followed that advice and then received an unjustifiably large service bill from an unscrupulous service technician would become an implacable

enemy of all independent service shops.

The subject of factory service was uppermost in the minds of the hundreds of service dealers who attended the recent annual clinic and fair of the Texas Electronic Association in Houston, Texas. Top executives from most of the TV producers who are engaged in consumer service spoke during the clinic sessions and appeared on the panel on the closing day.

The conclusions reached by members of the TEA who attended the meetings, were that manufacturers have no intention of slowing down their consumer service activities. They feel that factory servicing of consumer electronic products will increase rapidly and will be supported by national advertising.

These service operators decided that the only way to compete with factory service is through national advertising and publicity on behalf of the ethically operated shops in the service business. By this means they hope to establish in the minds of the consumer the advantages of dealing with the ethically operated local service dealer. At the same time, they hope to identify these dealers for the public.

Not only the Texas group, but service organizations all over the country are interested in such programs. Some have been started; however, it will take a great deal of money and cooperative effort to make them work effectively.

One thought that seems to have been lost in the heat generated by this development is that there is no reason why independent service businesses cannot exist side-by-side with factory-controlled service. This situation exists today in the automotive repair business and many others. It is up to the independent to publicize and build up those parts of his operation which, for the customer, offer advantages over factory service.

# New EMERSON Color Receivers

By  
WARREN PHILBROOK



Fig. 1. The Emerson color TV console model C504A is shown here.

*Six models are available ranging from \$678 to \$914.  
All have the 21-inch color picture tube, new circuits.*

THE *Emerson Radio & Phonograph Corp.*'s current and recent color line consists of six different color TV models. Included are consoles, with and without doors, and consolettes. Two of the models are illustrated in Figs. 1 and 3. The least expensive color model carries a list price of \$678 while the most expensive console lists for \$914. The model C506A for \$678 (and the C507A for \$698, the u.h.f.-v.h.f. version) is the latest model in the line and is furnished in mahogany, blonde, or walnut. The models C502C and the C504A at \$894 and \$794 respectively (and C503C and C505A for \$914 and \$814, u.h.f.-v.h.f. versions respectively) are furnished in mahogany or blonde.

Some of the outstanding features of the new *Emerson* color sets are the provision for removal of the safety glass to allow easy cleaning of the picture tube screen, and the accessibility of the controls and chassis. In these sets, both the top and the rear cover are removable for servicing. All controls required for picture tube set-up are located at the front, so that it is not necessary to use a mirror during adjustments.

A complete operating instruction book for the receiver is included with every set sold. In addition, a service manual is available through the local *Emerson* distributor.

These sets have only two controls which may be used by the viewer during color TV reception; these are

the "Color Amp." and "Color Shading" controls. They are located behind the hinged panel on the front of the receiver. The "Color Amp." control can be adjusted to provide the color content of the picture from barely perceptible colors to vivid and bright. The "Color Shading" control is used to adjust the color balance to obtain correct skin tones and other familiar shades.

This receiver will automatically reproduce color programs when they are being broadcast without having to switch on any special control. However, the color pictures received may not always be the same because of differences at the studio, or transmitter, or even because of differences in program material. Therefore, it may be necessary to readjust the two viewer color controls from time to time. To do this during a color broadcast, just adjust the fine tuning control until the herringbone pattern disappears and the picture is clear. Then rotate the "Color Amp." control fully counterclockwise so that the picture is black-and-white. Next, adjust the brightness and contrast control for a good black-and-white picture. Rotate

the "Color Amp." control clockwise until the desired amount of color is obtained. Then, adjust the "Color Shading" control slowly so that the desired skin tones, etc., are viewed. It is important to keep the "Color Shading" control in the center of its range until it is used for the final touch up.

The picture tube is mounted directly on the chassis in all except models C506A and C507A, just as in most black-and-white TV receivers, so that the entire assembly can be removed at one time for servicing. A complete chassis of this type is shown in Fig. 2. The high-voltage cage contains a high-voltage safety interlock switch which is closed by an insulator on the rear cover of the cabinet. When the rear cover is removed, the two spring contacts of the switch make contact, shorting the high-voltage circuit to ground. Note the high-voltage cable connected to the picture tube "well."

For the models C506A and C507A, the picture tube is secured to the cabinet-mounted removable assembly.

From an electrical point of view, these color sets are conservatively designed and use circuits which have already had at least a year's field trials. These models do not use printed wiring nor any unconventional components—for color television, that is.

Four video i.f. stages and two stages of amplification for the intercarrier sound are used. Whereas some models use a total of 28 tubes (29 tubes for u.h.f. version) including the picture tube, some have only 27 tubes (28 for u.h.f.). The difference lies in the fact that the sets with 27 tubes use a single high-voltage rectifier tube while the

EDITOR'S NOTE: We have just been advised as we go to press that there is a change in the *Emerson* line of color TV receivers. Although some of the models shown here are still in the dealers' hands, present plans call for the marketing of model C506A at \$678 and model C507A at \$698 only.

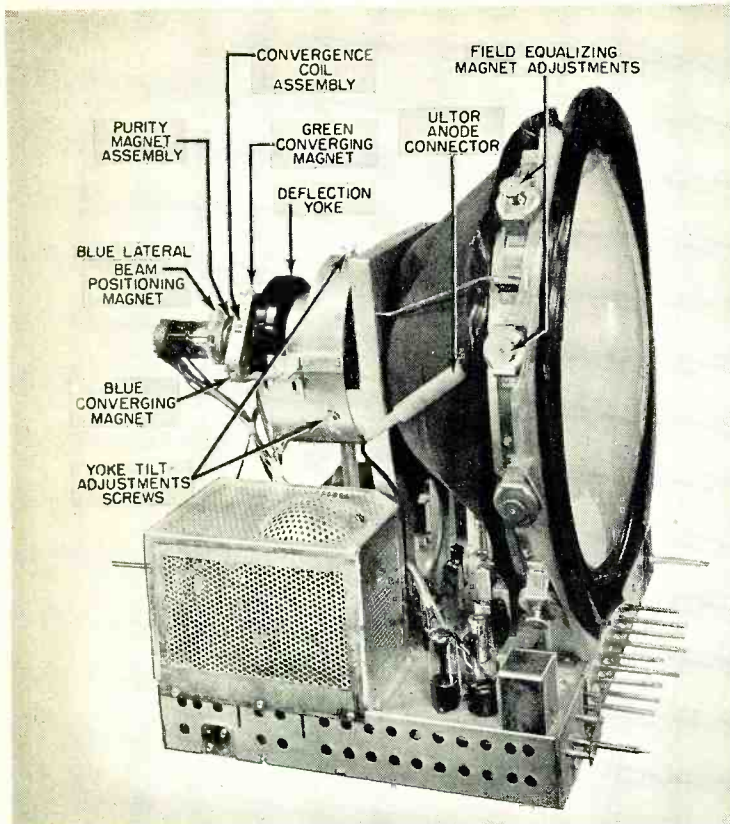

Fig. 3. The full door console is the model C502C. The nameplate covers the necessary color controls.

Fig. 2. Color TV chassis for the models C502C, C503C, C504A, and C505A. Note that the 21-inch color tube is fastened to the chassis and the entire assembly comes out of the cabinet together. All Emerson receivers are shipped completely assembled.

others use two tubes to produce the 25 kilovolts.

Also of interest is the fact that these receivers use a power transformer and four selenium rectifiers. Three crystal diodes and one oscillating crystal are used. The u.h.f. versions have an additional crystal diode. To provide maximum protection, two fuses are used in the "B+" secondary and two loops of No. 26 wire serve as fuses for the heater circuit. In an effort to reduce the disturbance created by motors or other arcing devices on the power line, the sets contain a line filter consisting of two capacitors and a resistor.

The chrominance or color circuits of these receivers resemble those of the RCA 21-CT-660 series, which have, more or less, served as the basic models for the industry. There are modifications of individual component values and even some of the circuitry, but these are minor. The RCA type high-level triode demodulators, tubeless convergence system, color sync, and color killer circuits are followed. However, the Emerson color laboratories have done a great deal of original development work and this is reflected in many of the modifications.

#### Service and Warranty

The factory guarantees all parts in the color TV sets for 90 days, and the picture tube itself is guaranteed for a full year. It has been Emerson's policy to encourage its dealers and distributors to perform all installations and service work on color as well as black-and-white TV receivers. Emerson has therefore conducted factory schools for its distributors and their key serv-

ice personnel. Attendance at the school is required before any color receivers will be shipped to a given distributor. A staff of area engineers is continuously travelling throughout the country and is giving distributor and dealer technical personnel training in color receiver theory, service, and adjustment.

In the New York metropolitan area, Emerson makes a factory service contract available to those customers who purchase their color sets from dealers who do not offer such a contract. A factory service contract for one full year costs \$98 at present. This includes the installation of the color receiver to an existing and usable antenna and provides all service work and parts for one year. If the antenna needs replacement, or if a two-set coupler is required, there is an extra charge based on labor and material.

If the cost of a one-year service contract seems high, it should be noted that the suggested list price for a three-gun, 21-inch color picture tube is \$160. Also, experience has indicated that color TV receivers require more adjustments and service calls than black-and-white sets do. Because of the circuit complexity and specialized parts used in color sets, it is expected that service costs may be higher for such sets.

#### Installation

Most of the picture tube components which may require adjustment during installation are indicated in Fig. 2. (It may be necessary to check the connection of the cable to the ultor anode in the picture tube "well" to assure

positive seating.) For most installations, only the purity and field equalizing magnets need adjustment and even these components usually need only be touched-up lightly in most instances.

The field equalizing magnets making up the ring-shaped assembly near the face of the picture tube are intended to offset any slight magnetic variations in the local magnetic field. Their effect may not always be very apparent. Only when purity of color is tested with a single color illuminating the screen, can the action of rotating the magnets be clearly observed. Each magnet interacts with its neighbors and, as a matter of fact, adjustment of the purity magnet may also require readjustment of these magnets.

The convergence coil assembly is adjusted both electrically through the various potentiometers and coils on the chassis, and mechanically at the three d.c. convergence magnets, two of which are identified in Fig. 2.

All 21AXP22 picture tubes require a blue lateral beam positioning magnet which is centered on the neck of the picture tube directly over the special pole pieces adjacent to the blue beam electron gun. The positioning of this magnet as well as the strength of the field it produces at the blue electron gun are critical. To adjust it, a small permanent magnet screw in the center of the lateral beam positioning assembly is turned. More detailed tube setup adjustments and installation procedures are given in the service data.

On the whole, the basic circuitry of the new Emerson receivers is very similar to that of other recently released models.

# The "Electro-Tach"

By HARRY B. CORDES

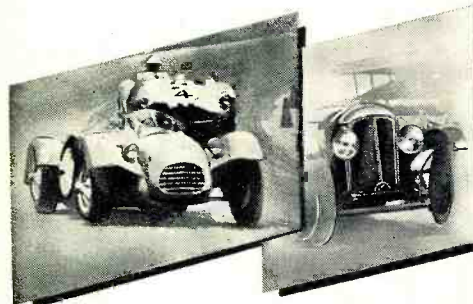

Close-up view of the thyatron box with the cover removed to show parts placement. The rpm indicator meter is also shown here. The indicator is a 0-1 ma. surplus aircraft instrument. It is mounted on a steering post mounting bracket. See text.

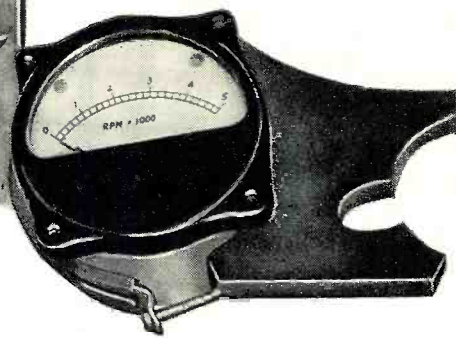
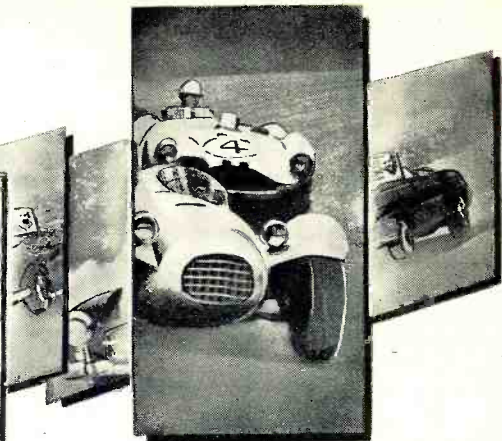
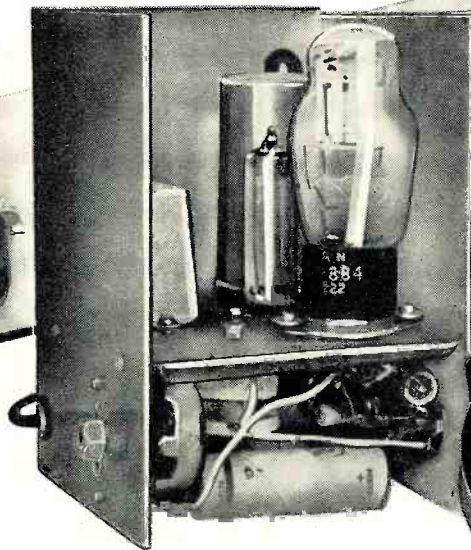

*Build this useful car accessory. This compact tachometer gives reliable indications up to motor speeds of 6000 rpm.*

**A**LTHOUGH a tachometer is not a necessity for driving an automobile, the mechanically minded motorist finds it an interesting and useful accessory. Sports car drivers use a tachometer as a reference for shifting gears to get optimum torque from the engine. It also provides a useful check on the electrical and oil pressure systems. In modern cars equipped with automatic transmissions, the driver often feels far removed from the engine and usually hasn't the faintest idea what is going on under the hood. A tachometer helps him pull optimum performance from his car, and also tells him how well the transmission is working.

There are several tachometers on the market at the present time, but they all leave something to be desired, either in terms of price, accuracy, or ease of installation. The unit described here was designed to give accurate and reliable readings, but at the same time retain features which make it easy to calibrate, install, and keep price fairly low.

## Principles of Operation

The circuit operates by sensing the firing of one of the engine's spark plugs. Each time the plug fires, a known current pulse is sent through a milliammeter. The meter averages the number of pulses per second and thus indicates the engine speed (Fig. 1). Since the unit detects the firing of only one plug (the engine goes through two revolutions for each spark) it may be used on any four-cycle engine irrespective of the number of cylinders. It may also be used

on two-cycle engines, but the calibration range must be doubled since a two-cycle engine fires each plug once for each revolution. The circuit, as shown in Fig. 2, may be used for speeds up to 6000 rpm with very good accuracy, although for standard American cars a maximum indication of 4500 to 5000 rpm is sufficient. The rpm readings of this instrument are independent of variations in the car's electrical or ignition systems.

The heart of this unit is a thyatron circuit which is quite similar to the familiar saw-tooth relaxation oscillator used in oscilloscopes; however, in this case the circuit is biased to prevent free running oscillations. The thyatron is normally in the "off"

condition and the capacitor  $C_1$  is charged to 105 volts through  $R_7$ ,  $RFC_1$ , and the meter circuit. When a pulse from the spark pickup is applied to the grid of the thyatron causing it to fire, the capacitor is rapidly discharged until the plate voltage of the thyatron falls below its extinction point. Conduction then stops abruptly and the capacitor recharges to 105 volts. This recharge current flows through the meter in the form of a short pulse. The meter circuit contains a large capacitor to smooth out these pulses and gives an average indication of pulses per second. Thus, the average current flowing through the meter will be proportional to the number of times per second the spark plug fires. If the spark plug firing rate doubles, the meter reading doubles; if it is tripled, the meter reading also triples.

In the usual saw-tooth sweep oscillator the plate resistor  $R_7$  has a high resistance. This limits the current flowing through the thyatron, to extinguish. In this circuit however, it is necessary to use a fairly large value for  $C_1$  so the recharge current will be sufficient to allow using a 1 ma. meter movement. And at the same time the time-constant of  $R_7C_1$  must be kept small so the circuit will have a short recovery time and pulses will not overlap at higher speeds. Therefore  $R_7$  turns out to be a value so small that it does not limit the current sufficiently to cause reliable extinction. For this reason the inductor  $RFC_1$  is placed in series with the capacitor to create a "ringing" reso-

Fig. 1. Exaggerated graphical relation between spark plug firing pulses and trigger current pulses through the meter which indicates proportional to average current. (A) Engine speed of 480 rpm (B) 960 rpm.

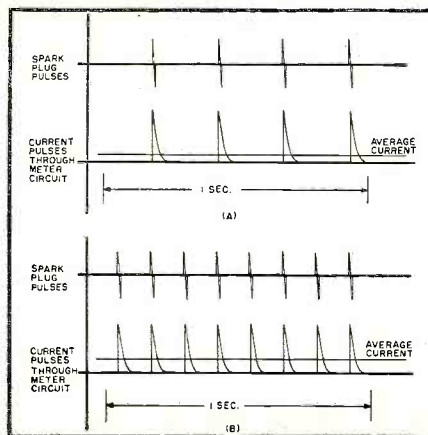

nant circuit. When the thyatron ignites, the voltage across  $RFC_1$  and  $C_1$  drops very rapidly. The ringing action of this resonant circuit causes the voltage drop to overshoot the minimum voltage required to keep the thyatron ignited and it extinguishes. The resistance of the  $RFC_1$  winding (350 ohms) also serves to limit the maximum current through the thyatron to a safe value.

The "B plus" voltage is obtained from a vibrator power supply which uses a 6.3 volt, 60 cps transformer wired in reverse. The output from the power supply is regulated with a 0B2 gas tube to prevent changes in the car's battery and generator voltages from influencing the tachometer readings.

### Construction

After considerable experimentation with various possible methods of detecting the firing of a spark plug, it was decided that a well shielded, capacitive type pickup was the best. The spark voltage from the ignition coil has a high-frequency character and a peak voltage of 10,000 volts or higher. This creates a difficult pickup problem and adequate shielding is necessary. With poor shielding, pickup from other spark wires will also trigger the thyatron and cause jerky and erroneous readings.

The details of the spark pickup and signal lead assembly are shown in Fig. 3. The pickup is a copper band about  $\frac{3}{4}$ " wide, which is clamped to the spark wire insulation about 4" from the plug itself. Before clamping the band on, a few layers of plastic insulating tape are wound over the spark wire insulation where the band is to be placed. After clamping the pickup band in place, four or five layers of tape are again wound over the band to insulate it from the spark wire shield. Next, the entire spark wire, from the distributor cap to the plug, is shielded with braid or aluminum foil taped in place. This shield is terminated about  $\frac{1}{2}$ " from the end caps of the spark wire to avoid arcover, and should be grounded either by a wire to an engine bolt or by running the bare shielding against the metal brackets and guides which hold the spark wires in place. The signal lead shield is terminated inside the spark wire shield and the two are electrically connected.

A word of caution; if the insulation on the spark wire is frayed or cracked there is a good possibility that arcover will occur to the shield. Use only spark wire which is new or in good condition.

The thyatron circuitry and power supply is housed in a 4" x 5" x 6" "Minibox." A sheet metal subchassis mounted about  $1\frac{1}{2}$ " from one end supports the tube sockets, transformer, and wiring. There is nothing critical about component placement or wiring, although an attempt should be made to arrange the components so that short wiring leads are maintained. The calibration

pot shaft is fitted with a shaft-lock to prevent accidental movement or creeping due to vibration.

The characteristics of the 884 thyatron can change appreciably with variations in heater voltage. In this circuit these variations cause only a very slight error. However, if the heater voltage is increased too much, the critical firing voltage can become less than 105 volts. Under this condition the circuit will become self-oscillatory, and a reading will be observed on the meter even if no input signal is present. In an automotive electrical system the voltage may rise as high as 7 to 7.5 volts with a high charging rate generator. To prevent the circuit from reaching this unstable condition the two parallel 1-ohm resistors were placed in series with the 6-volt power lead. If the unit is to be used with a 12-volt electrical system these two resistors may be replaced with a 5- to 6-ohm, 10 watt resistor. A voltage check should be made to insure that the voltage across the power supply and heater circuit never exceeds 6.9 volts.

The rpm indicator meter may be any 0-1 ma. D'Arsonval type movement with an internal resistance of 70 ohms or less. If the resistance of the movement is greater than 70 ohms, it will be necessary to use a higher resistance calibration pot.

The operation of this tachometer is such that the meter indication is perfectly linear with rpm, i.e., if 2 ma. on the meter is 1000 rpm, then 4 ma. is 2000 rpm, and .6 ma. is 3000 rpm. This greatly simplifies the layout of a new scale. The best scale range for ordinary automobile use is 0-5000 rpm, where the 5000 rpm point corresponds to 1.0 ma. on the original scale.

There are a number of methods for

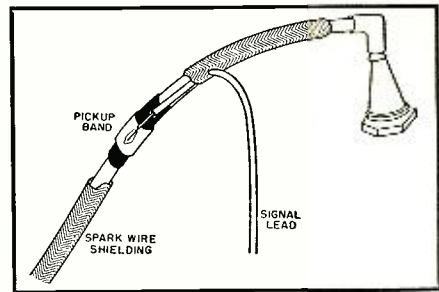

Fig. 3. Shield stripped away to show pickup band. Signal wire is soldered to band and then clamped in place. Band is then wrapped with tape to insulate it from the spark wire shield. Entire spark wire is then shielded. The signal wire is pulled through shield and the two shields connected. Signal wire is Belden #8431 cable.

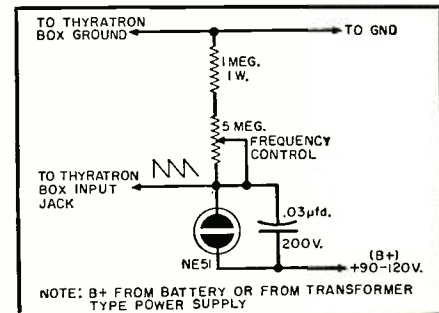
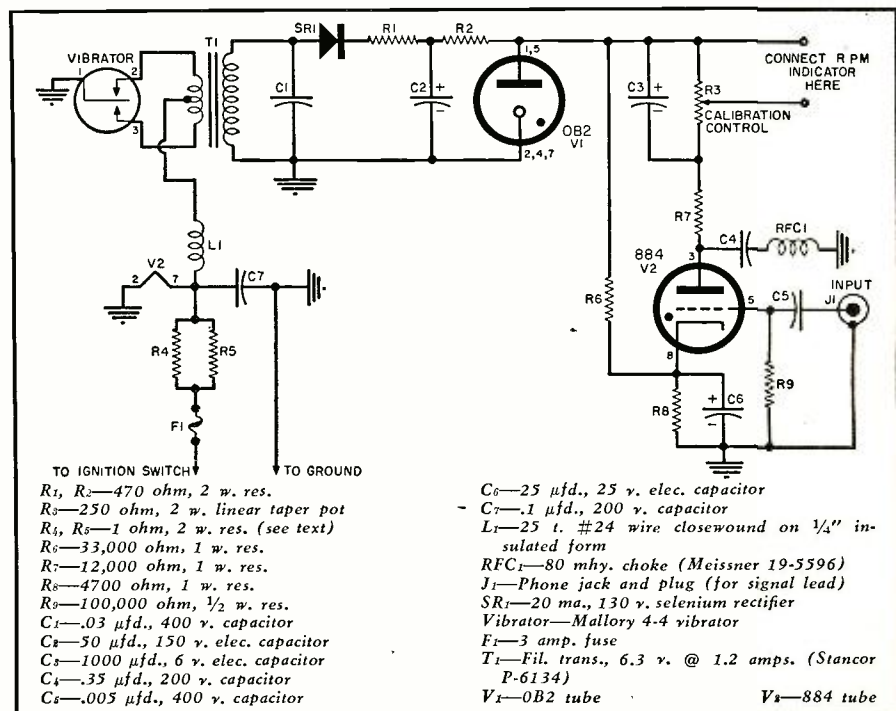

Fig. 4. Schematic of neon tube saw-tooth oscillator used to trigger thyatron box at known frequencies for calibration use.

calibrating a tachometer, such as comparison with another tachometer or by using a strobolight on the engine. However, the most accurate and straightforward way is by using the standard 60 cps line frequency as a reference. The neon tube circuit shown in Fig. 4 can be used to cali-

(Continued on page 124)

Fig. 2. Complete schematic diagram of the "Electro-Tach" unit. Parts are standard.



# New Transformer Design for Power Amplifiers

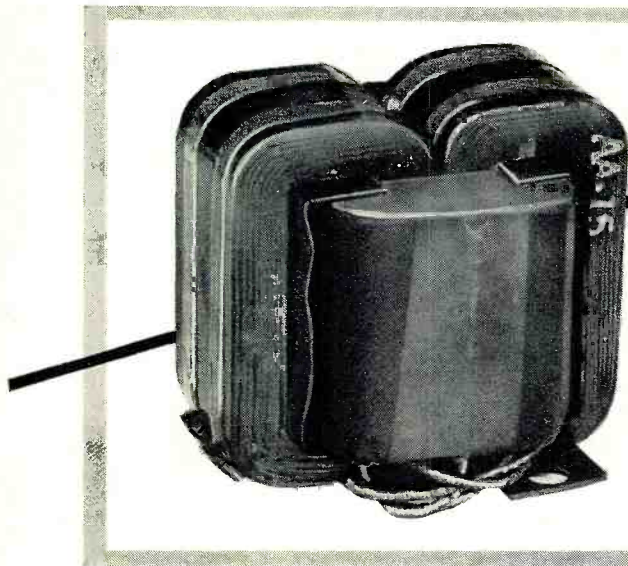

Fig. 1. Output transformer is shown removed from its shield can. This transformer is used in the Fairchild 275 amplifier shown.



By **CHARLES GRAHAM**  
Sales Engr., Todd Transformer Corp.

*Grain-oriented iron strip core material in high quality output transformer packs high power into minimum space.*

IT IS common knowledge among high-fidelity audio enthusiasts that when buying a power amplifier, it is best to look for the largest output transformer since it should provide the best low-frequency response. Today this is no longer necessarily true. For the last several years amplifier engineers have kept this popular conception in mind when designing power amplifiers. And advertising and sales departments have sometimes gone further; in some cases very large transformer "cans" have been employed to cover (hide) output transformers of very small size. That this notion regarding size of output transformer relative to high power is sometimes a fallacy is due to the increasing use today of *grain-oriented iron strip* as the core material of top

quality output transformers. See Figs. 1 and 3.

It is true that there is no substitute for a husky core of the highest possible saturation density, that is, one capable of the maximum number of flux lines per cubic inch. In other words, a big transformer may be good. But one whose core is of grain-oriented iron can be much better. It is important to bear in mind that larger cubic volume and/or greater maximum saturation density of core material relate only to the potential power delivery at the low-frequency end of the audio spectrum. Size is no help in getting good high-frequency response. That is controlled by several other factors.

When our transformer designers were given the project of designing the

output transformer to be described here, they knew that cost was not a first consideration. The objective was to come up with an output transformer to transfer the greatest possible amount of undistorted power at all audio frequencies, especially in the bass region, from a push-pull tube load of 3400 ohms to the conventional voice-coil impedances.

Although complexity of amplifier circuit design had not been ruled out by the amplifier manufacturer, the best circuit turned out to be a conservative, straightforward design. It is based on three outstanding features: the "Ultra-Linear" (screen-tapped primary) output configuration, which provides maximum power efficiency with lowest distortion, (2) the new *Tung-Sol* 6550 tubes in push-pull for high power handling capacity (made to handle up to 100 watts, they run easy in this amplifier), and (3) a specially designed output transformer which provides some of the unique characteristics of this amplifier. The simplicity of this circuit lends ease to service or adjustment, in addition to lessening the probability of either being frequently necessary.

The bass response, linearity, and power capability of an output transformer depend (other things being equal) on the core material. Most output transformers consist of punched iron laminations stacked in thin layers forming a core around which the coil is wound. In general, heavier cores (thicker cross-sections) provide more power, especially at low audio frequencies. Another way of increasing the low-frequency power handling capability is through use of grain-oriented strip-wound core material. Two well-

Fig. 2. (A) Single loop and (B) double loop C-core construction used in transformers.

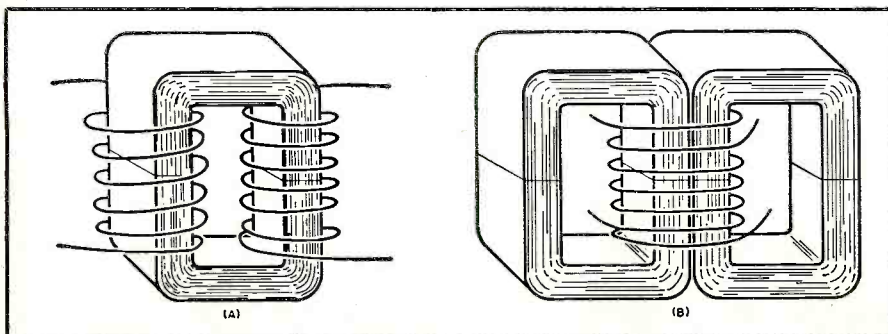



known brands of grain-oriented core materials are "Hypersil" and "Silectron."

This material is formed in prefabricated cores which are designated as "C-Cores" because of their shape. There are two types of "C-Core" transformer designs in general use for audio applications. The single core, which has two windings, is shown in Fig. 2A. A more useful shape for output circuitry is the double loop which is shown in Fig. 2B. This construction, see also Fig. 1, employs the greatest cubic volume of iron core relative to copper wire. It is a technique employed only in the most expensive output transformers. This particular method of building a transformer packs the maximum power handling capacity into the minimum space. Incidentally, construction of this sort results in a unit which weighs more per cubic inch of transformer volume than any other kind of output transformer.

The characteristics contributed by different kinds of core materials are graphically illustrated in Table 1 where the relative properties of cores using non-oriented iron in punched laminations and oriented material in strip-wound (C-type) cores are compared. This table shows that it is impossible to give a simple figure for the relative merit of these materials. In each case, the proportions determining the ratio of core to winding actually selected (third line in the Table) would be established by economic factors. Compared on a weight-for-weight basis, the new strip-wound cores win on all points. However, there are other factors which must be considered, such as cost and application, and except for these factors, all output transformers would use "C-Cores"!

The relative power rating figures in Table 1 need some explanation. From the figures it would appear that a transformer of comparable size and efficiency, using oriented material, would deliver ten times the power. While this is true, the principal advantage of grain-oriented material is in its ability to extend the frequency range downwards.

At the low-frequency end core saturation is the greatest problem. Thus it may be seen that there is no substitute for a husky core of the highest possible saturation density. It was found that by using the largest possible loops of oriented silicon steel strips in the double "C-Core" shape, the transformer would deliver 70 watts at below 20 cycles with extremely low distortion. This could not have been accomplished (with conventional circuitry) without a transformer many times larger, had punched laminations been used in the core.

The core must not offer a reactive load for the tubes since this might cause high distortion. At the high-frequency end, two types of reactance are involved; leakage inductance and winding capacitance. Both must be kept as low as possible. Typical values

PROPERTY	NON-ORIENTED IRON PUNCHED LAMINATIONS	GRAIN-ORIENTED STRIP ("C-CORE")
Saturation Density (in gauss)	10,000	17,000
Specific Gravity	7.7	7.6
Ratio of Core to Winding (Weight—normal proportions)	1.7-2.5	.25- .5*
Core Loss (per lb. at low frequency, 50 cps @ 10,000 gauss)	.63	.4 -1.0
Core Loss (per lb. at medium frequency, 1 kc. @ 2500 gauss)	4.8	.25 <sup>a</sup> .34 <sup>b</sup> 1.0 <sup>a</sup> 2.0 <sup>b</sup>
Maximum Density (relatively constant a.c. inductance)	5000 gauss	13,000 gauss
Inductance Factor (using same turns on core of same size)	1	3.5
Relative Loss Factor (assuming optimum efficiency on same core)	1	1.55
Relative Power Rating (using same size readjusted to optimum efficiency)	1	10

Notes: \*Applies for cores using a single "C" loop core and two windings. Other figure is for double-loop "C-Core" and one winding assembly.

(a) For strip wound core, strips .005" thick  
(b) For strip wound core, strips .013" thick

Table 1. Comparison of transformer with punched laminations and grain-oriented strip.

of leakage inductance across half the primary windings of this class of transformer must measure .004 henry or less! The correct proportions required to maintain low distortion output at high frequencies will depend on the loading condition of the tubes employed.

This company decided that although the use of grain-oriented "C-Core" strip for an output transformer is more expensive than would have been an even much larger core of regular transformer punched laminations, Fairchild's requirements in regard to low-frequency power delivery to the voice coil from the 6550 tubes called for the use of a double-loop "C-Core" if the transformer was to be kept to any sort of practical size to fit onto a chassis for home use. Even with this extraordinarily efficient core material, the transformer is physically as large as any transformer of ordinary laminated core material in current production for this sort of amplifier.

The transformer manufacturer produced several sample transformers,

first adjusting the primary inductance to produce a plate-to-plate load of 3400 ohms, then altering the gauge of the coil wire. Testing sample transformers indicated the correct size wire to allow just enough d.c. voltage loss from the "B plus" supply. One of the little-known, but important, details of audio transformer design is the extremely complicated interleaving of the coil windings. Windings next to the core have much smaller diameter (and consequently less wire length) than windings farther outside. The windings are, therefore, divided into numerous sections and alternated, interleaved, to help equalize the resistance in each half of the primary as well as the leakage inductance and distributed capacitance.

At the present writing there are a number of high-quality power amplifiers, in addition to the Fairchild Model 275 to be described, that use the grain-oriented "C-Core" strip material in their output transformers. Among such units are the Marantz 40-watt model, the Fairchild Model 255 (25

Fig. 3. Rear view of amplifier showing power (left) and output (right) transformers.

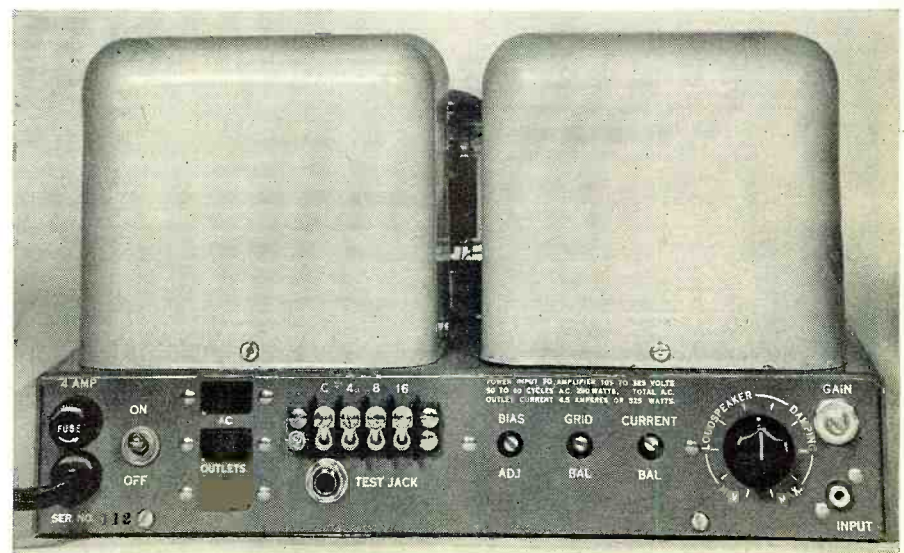

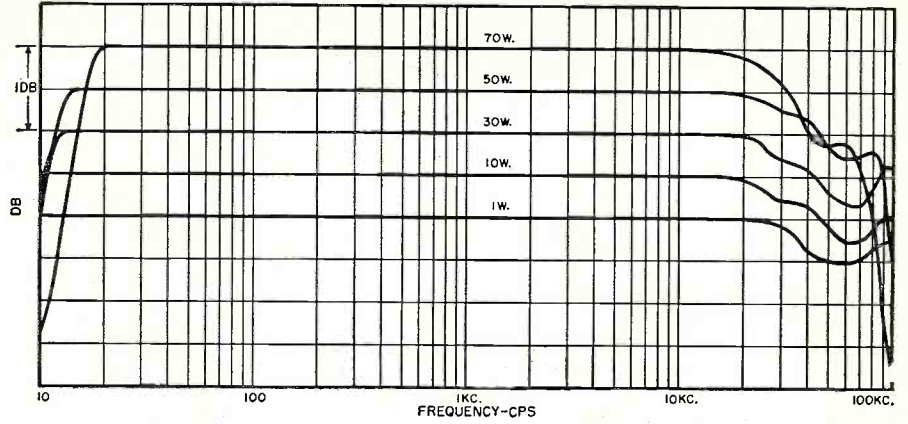
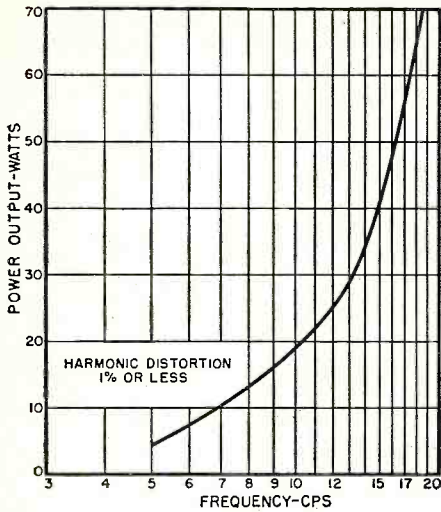

Fig. 4. Power response curves of amplifier at levels from 1 watt to 70 watts. Note that a full power of 50 watts is available down to 15 cps.

Fig. 5. Output at very low frequencies for 1 per-cent (or less) distortion.

watts), *Acro* (kit amplifiers), the *Dynakit*, *Interelectronics* 40-watt unit, and *Sonotone*. The future will almost certainly see increasing use of grain-oriented iron as output transformer requirements continue to become more stringent, particularly with reference to low-frequency power.

### The Amplifier

The Model 275 high power amplifier was designed around this special audio output transformer to provide full power from below 20 to above 20,000 cps. Each stage of the amplifier has conditions of operation well within tube specifications. Three class A tri-

odes precede the output stage, which employs the new *Tung-Sol* 6550 beam tetrode power tubes. Since these tubes are built to produce 100 watts of audio power they run easily at the 75 watts continuous which this amplifier produces. See Fig. 6.

Three types of feedback are employed, not including local feedback at voltage amplifier cathodes. They are (1) conventional negative voltage feedback from the 16-ohm tap of the transformer secondary, (2) negative current feedback, used in the variable damping circuit, and (3) screen grid feedback, through the employment of primary taps on the output transformer

for "Ultra Linear" operation of the 6550 tubes. These three types of feedback combine to produce the low IM distortion figures of under 0.5% at 65 watts with any combination of test frequencies. At levels of 10 to 35 watts the distortion figures are so low as to be incapable of being read accurately on standard measuring equipment.

The phase inverter-driver is one half of a 12AV7 with about 300 volts on the plate. The driving voltages for the grids of the 6550 output tubes are taken from the plate and the cathode of this split-load phase inverter. Matched-pair resistors are used here

(Continued on page 160)

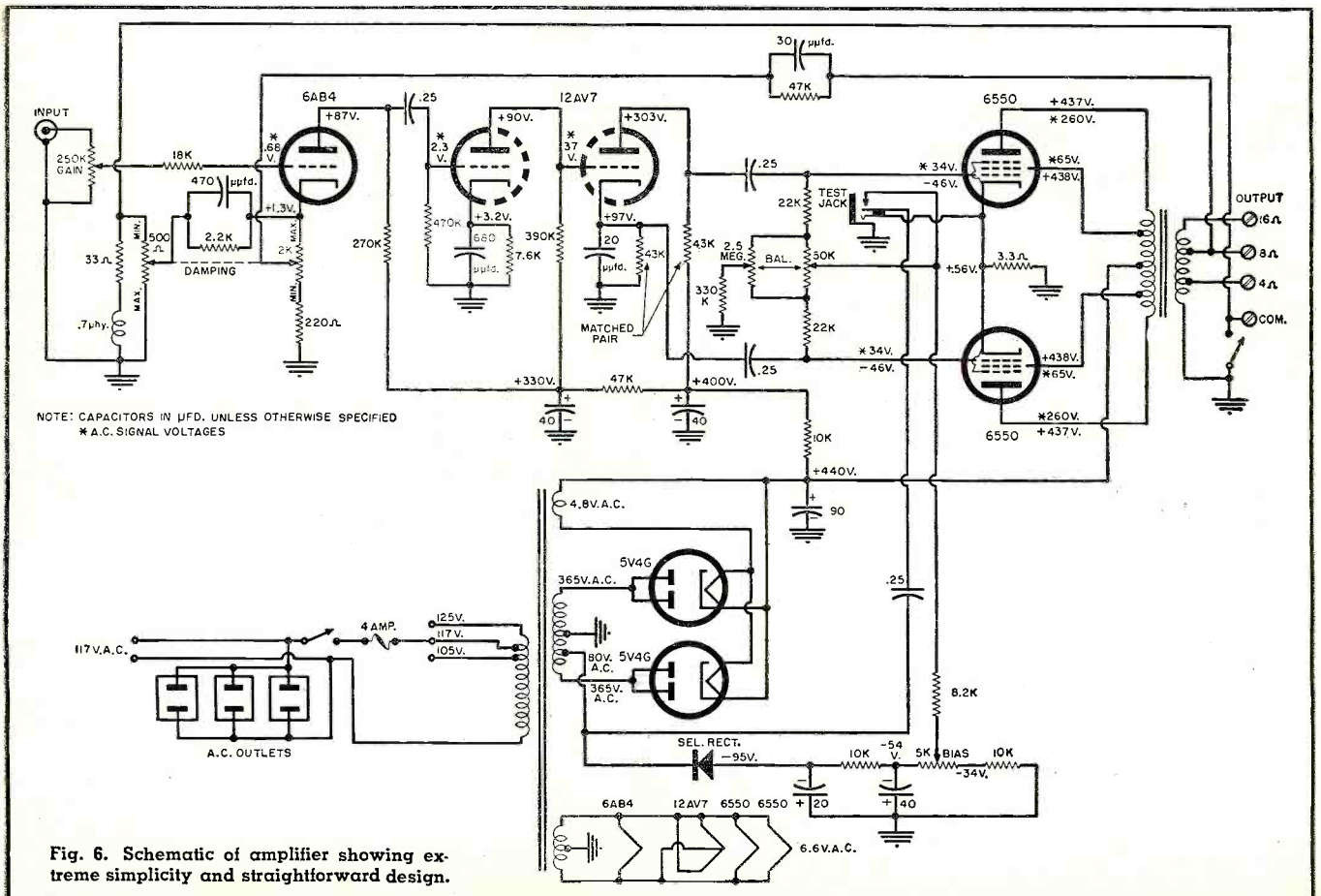

Fig. 6. Schematic of amplifier showing extreme simplicity and straightforward design.

THOUSANDS OF SERVICE DEALERS

SATISFY CUSTOMERS  
SAVE REPEAT CALLS

MAKE MONEY EVERY DAY with **B&K**



**DYNA-QUIK** MODEL 500  
DYNAMIC MUTUAL CONDUCTANCE TUBE TESTER

Tests over 95%

**OF ALL POPULAR TV TUBES\*— IN SECONDS**  
It's easy and profitable to check all the tubes in a TV set with DYNA-QUIK—on every service call. Cuts servicing time. Creates more on-the-spot tube sales. Saves repeat calls, protects service guarantee.

DYNA-QUIK 500 measures true dynamic mutual conductance, completely checks tubes with laboratory accuracy under actual operating conditions right in the home.

Tests each tube for shorts, grid emission, gas content, leakage, dynamic mutual conductance and life expectancy. One switch tests everything. No roll charts. No multiple switching. Makes complete tube test in as little as 12 seconds. Large 4½-inch plastic meter shows tube condition on "Good-Bad" scale or in micromhos on scales calibrated 0-6,000 and 0-18,000. Used in home or shop, DYNA-QUIK is a proved money-maker!

\*Including new 600 mill series tubes.

NET **\$109<sup>95</sup>**

Dyna-Quik 500. Easily portable in luggage-style carrying case. Size: 15¼ x 14½ x 5½ in. Weighs only 12 lbs. Has 7-pin and 9-pin straighteners on panel.

DELUXE—PORTABLE

**CRT** MODEL 400

Tests and repairs  
TV Picture Tubes

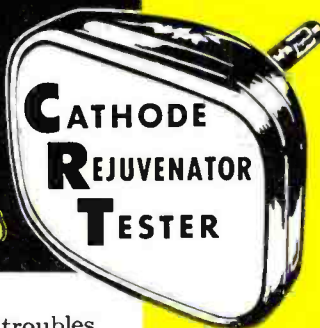

NET **\$54<sup>95</sup>**

Deluxe CRT 400. With 4½-in. plastic meter. Weighs only 5 lbs. Luggage style carrying case. Size: 11 x 7½ x 5".

Quickly spots and corrects picture tube troubles right in the home, without removing tube from set. Restores emission, stops leakage, repairs interelement shorts and open circuits. Life test checks gas content and predicts remaining useful life. Grid cut-off reading indicates picture quality customer can expect. Eliminates tube transportation, cuts service-operating costs. Also saves money on TV set trade-in reconditioning. Earns dollars in minutes—pays for itself, over and over again.

Proved in Use by Servicemen Everywhere.

See your B & K Distributor or send for facts on "Profitable TV Servicing in the Home" and Informative Bulletins 500-104-N.



**B & K MANUFACTURING CO.**  
3726 N. Southport Ave., • Chicago 13, Illinois

# Here's how to GET MORE WORK OUT OF YOUR Oscilloscope!

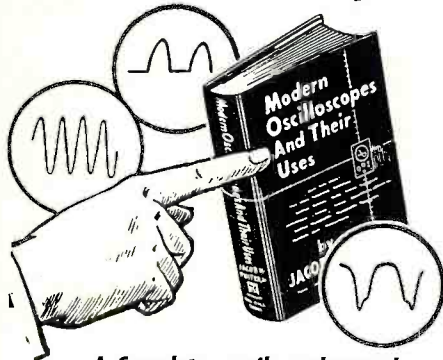

**A Complete, easily understood  
guide to using the handiest service  
instrument of them all**

## MODERN OSCILLOSCOPES AND THEIR USES

By Jacob H. Ruiters, Jr.

### Enlarged 2nd Edition

... contains the latest  
data ... everything  
you need to know  
about 'scopes!

### MORE THAN 30 NEW PICTURES

... plus 50 more pages  
on use of 'scopes in  
Color TV servicing ...  
Industrial Electronics ...  
Teaching ... even  
in Atomic Energy work.

It gets right down to  
how oscilloscopes operate. Then you learn exactly  
how to use them in lab work and on all types of AM,  
FM and television service—from locating troubles  
to handling tough realignment jobs.

### LEARN TO WORK EASIER, BETTER—AND FASTER!

Each operation is explained step by step. You  
learn to determine just where and how to use the  
'scope on specific jobs; how to make connections and  
adjust circuit components; how to set the controls;  
and HOW TO ANALYZE  
OSCILLOSCOPE PAT-  
TERNS fast and ac-  
curately.

370 illustrations includ-  
ing dozens of pattern pho-  
tos make things doubly  
clear.

No other type of specific  
service training can mean  
so much to you in boosting  
your efficiency and earning  
power! Send coupon NOW  
for 10-day FREE exami-  
nation!

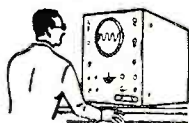

**'SCOPE EXPERTS  
get better jobs  
... bigger pay!**

### PRACTICE 10 DAYS—FREE!

Dept. RN-116, RINEHART & COMPANY, Inc.,  
232 Madison Ave., New York 16, N. Y.

Send MODERN OSCILLOSCOPES AND THEIR USES  
for 10-day FREE EXAMINATION. If book is satisfac-  
tory, I will then send you \$6.50 promptly in full  
payment. If not, I will return book postpaid in good  
condition and owe you nothing. (SAVE! Send \$6.50  
cash with order and we pay postage. Same 10-day  
return privilege with money refunded.)

NAME .....

ADDRESS .....

CITY, ZONE, STATE .....

OUTSIDE U.S.A. \$7.00 cash only. Money back if you  
return book within 10 days.



By JOHN T. FRYE

## THE SHOP HAS A VISITOR

**S**UMMER was over; Indian summer  
had come and gone; and now the  
bite of the chill wind whistling  
through the branches of the nearly  
naked trees told all too plainly that  
winter was close at hand.

But inside the service department  
of Mac's Service Shop all was cosy  
and warm. Only Barney, the Number  
Two Technician, was there, for Mac,  
the proprietor, was late to work—a  
most unusual circumstance. Just as  
Barney was starting out front to ask  
Miss Perkins, the office girl, if she  
knew anything of interest about Mac's  
tardiness, that worthy came through  
the door accompanied by another man  
whose lined, square-jawed face bore a  
striking resemblance to Mac's.

The resemblance between the two  
men was confined to their faces, how-  
ever. The other man was apparently  
a little older than Mac, and he had a  
much more stocky and powerful build.  
While Mac was rather on the lean and  
lanky side, the other man had a bar-  
rel chest, short arms whose muscles  
bulged the sleeves of his coat, and a  
pair of legs that looked like sections  
of telegraph poles.

"Barney," Mac said, "I want to in-  
troduce you to my brother, Paul. He  
is in the automobile repair business,  
and he got all those muscles you are  
admiring by yanking on wrenches.  
Paul, this is Barney, one of the most  
promising young electronic technicians  
in the business. He'll promise any-  
thing to get out of doing some work  
right at the moment."

Before Barney had a chance to re-  
ply to this slander, his hand was seized  
by Paul in a bone-cracking grasp of  
short and stubby fingers and pumped  
vigorously up and down with a motion  
that made waves run up his limp arm  
like loops cast on a rope.

"Glad to know you, son," Paul said  
with a wide and friendly grin. "And  
don't let what Pud here—that was his  
boyhood nickname, and it was short  
for Puddinghead—says bother you a  
bit. He's been boasting about what a  
smart young assistant he's got ever  
since we got here."

"Paul and his wife are visiting with  
us for a few days," Mac explained as  
Barney freed his hand from the vise-  
like grip and held it behind him while  
he gingerly and surreptitiously pried  
his fingers apart with the other hand.  
"I talked him into coming down and  
watching us work. I wanted him to  
see how men make an honest living."

"That's not what I hear about radio  
and TV technicians!" Paul exclaimed  
with a booming laugh. "In fact, a fel-  
low in my garage just a few days ago  
said that if you'd put a garage me-  
chanic and a radio repairman in a  
sack and shake them up, it'd be hard  
to guess which would come out first.  
That was his way of saying one is  
about as crooked as the other."

"No doubt we do have the same  
basic problems and come in for the  
same type of criticism and mistrust,"  
Mac commented as he shrugged his  
way into his shop coat. "Maybe you  
can make some suggestions that will  
help us. If you can, feel free to do so.  
We're always open to constructive  
criticism."

"A lot of people say that, but few  
people mean it," Paul observed as he  
perched himself on a high stool out of  
the way of the two at the bench.  
"But you two go right ahead and let  
me sit here and watch. If I see any-  
thing to yell about, you can bet I'll  
yell. Mac, as you call him, and I have  
been riding each other ever since we  
were kids, and I reckon we can both  
take it."

For a little while Mac and Barney  
worked in silence; then Mac had to  
remove a volume control nut, and he  
said to Barney: "Hand me that three-  
quarter-inch crescent wrench."

"Hand him that three-quarter-inch  
knuckle-buster is what he really  
means," Paul snorted. "Adjustable  
wrenches are makeshifts whose use is  
justified in an emergency, especially  
with odd-sized nuts; but there is no  
excuse for using them on nuts you  
must encounter as often as you do  
that size. Why in tarnation don't you  
have a complete set of good end-  
wrenches around this joint? When a

man makes his living with his hands, the least he can do is take care of those hands; and a good way to do that is to use wrenches that really fit nuts and will not slip off."

"Guess I can't argue with you there, Paul," Mac said, a little red around the ears. "I remember your telling me once that they call them 'monkey wrenches' because they're just good for monkeying around and rounding off the edges of nuts. I'll get some good wrenches tomorrow. We do have small end wrenches for working on speakers and holding small nuts, but we don't have wrenches that will catch volume control nuts, filter capacitor nuts, and so on."

While Mac was talking, Paul had gotten to his feet and was critically inspecting the other hand tools arrayed at the back of the bench. After carefully inspecting the points of several Phillips screwdrivers, he selected two and deliberately tossed them into the trash barrel.

"When one of those screwdrivers is worn out, junk it," he commanded. "All it is good for is to ruin screw heads and to slip out and mar the finish on a cabinet or do other damage. And while I'm on the subject of screwdrivers, most of these regular jobs are a sorry-looking lot. Don't you ever square up the bits? Half of these look more like wood-chisels than anything else. A screwdriver with a broken or worn or poorly-shaped bit is hard on screw-slots, hand-hide, and patience. I'll take these home with me and square them up on that little emery wheel you have in your basement; of course here's where that emery ought to be."

By this time Paul had really warmed to his work and was going through the drawer in which were kept drills, files, hacksaws, etc.

"You call these things drill-bits?" he asked contemptuously as he examined the cutting edges of the bits with a practiced eye under the bench light. "There's not a bit here but needs grinding. And I know you know how to grind a bit because I showed you myself."

"We've been pretty busy, and we don't use the drills so often," Mac began to explain lamely.

"A good mechanic is *never* too busy to keep his tools in tip-top shape," Paul brushed the explanation aside. "Good tools mean faster, better work; and that kind of work means more customer satisfaction and more business."

Barney, who was hugely enjoying seeing Mac on the pan—a position the youth usually occupied—blandly inquired:

"Are the rest of the tools *Pud* and I use OK?"

"Now I ask you, son: would you say this nearly smooth metal bar with a few faint markings on it was a hand tool?" Paul asked as he dangled a worn-out file in front of Barney's nose. "Most women carry a little piece of

(Continued on page 96)

... another  
**MALLORY**  
service-engineered  
product

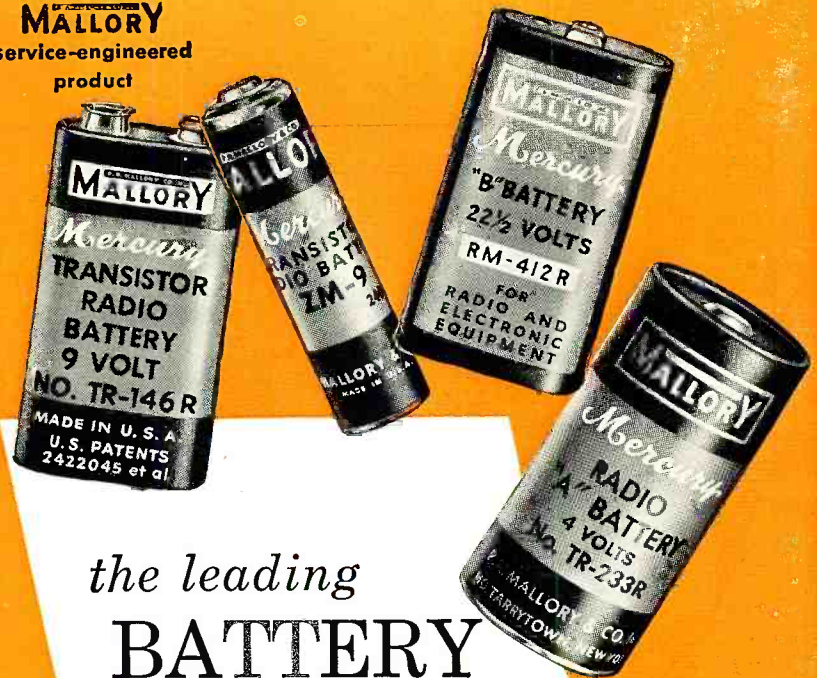

the leading  
**BATTERY  
LINE**  
for miniature  
transistor radios

**Mallory Mercury Batteries** are your best bet for the big new market offered by new "pocket-size" transistor portable radios—

**First in performance.** Mallory pioneered the mercury battery—the powerful, long-life power source that helped make these new radios possible.

**First in value.** Mallory Mercury Batteries cost less per hour of operation. They're fast-moving, good profit-makers for you . . . good value for your customers, too!

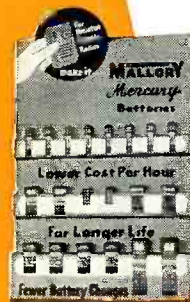

**SPECIAL INTRODUCTORY  
BATTERY MERCHANDISER**

Because of the remarkable shelf life of Mallory Mercury Batteries, now for the first time you can stock batteries without fear of inventory loss. This introductory assortment covers all popular transistor portables. No extra charge for the display unit! Order yours today!

P. R. MALLORY & CO. Inc.  
**MALLORY**

P. R. MALLORY & CO. Inc., INDIANAPOLIS 6, INDIANA

- Capacitors
- Vibrators
- Resistors
- Power Supplies
- Controls
- Switches
- Rectifiers
- Filters
- Mercury Batteries

**KITS • TOOLS**  
HI-FI  
Subminiature  
OPTICS  
PHOTO EQPT.

for  
Hams, Hobbyists,  
Repairmen &  
Industrial Firms

# FR ! Our Biggest Flyer Ever!

HUNDREDS OF BARGAINS,  
BONUS & GIFT ITEMS!  
Write for Your Copy Today!

FREE! ANY \$1 ITEM with  
EVERY \$10 ORDER!

FREE GIFT  
WITH EVERY ORDER!



LOOK!  
It's HERE!  
AND ONLY  
**\$13.98**

## A REAL POCKET-PERSONAL "SUPERHET" RADIO! COMPLETELY WIRED . . . NOT A KIT!

Here it is! A genuinely personal, completely portable superhet pocket radio . . . miniature in size—5½" x 3½" x 1¼"—yet providing true "big set" performance. Not a kit . . . comes completely wired! No external connections to antenna or ground. High impedance "hearing aid" crystal phone fits inconspicuously in ear, allows you to listen unobtrusively to any program . . . any time . . . anywhere. Has the volume, tone, selectivity and fidelity that only a vacuum tube superhet circuit can provide. Yet it weighs only 6 oz., fits easily in your pocket! Ideal for riding, walking, bicycling, of-heating. Perfect gift for the hospitalized and the hard-of-hearing. Completely self-contained, with built-in directional ferrite hi-Q antenna; 8 miniature tubes; sharply tuned miniature I.F.'s; miniature 2-gang variable tuning condenser. Painstakingly constructed by skilled craftsmen. Attractive and sturdy styrene case; ivory with ebony and gold "thumb control tuning knob," separate volume control with "ON/OFF" switch. You'll be amazed at the performance of this "pocket personal." And, in addition to our assurance of satisfaction, carries RMA guarantee. In mfrs. orig. cartons. Ship. wt. 1 lb. (less batteries).

BATTERIES FOR ABOVE . . . . . \$1.85

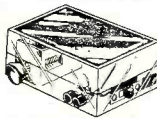

EXCLUSIVE!  
**3 IN 1** TRANSISTOR  
RADIO KIT

Sun-powered, Cell-powered or Dual-powered pocket radio kit. Sensitive, selective, with ample volume. Sun battery for daylight operation (runs from 100-watt lamp, too); "energy capsule" mercury cell for night operation, outlasts regular batteries 5 times! All parts mounted . . . MINUTES TO COMPLETE! Pre-drilled styrene cabinet; hi-gain transistor, loopstick, miniature var. cond., phone jacks, switch, knob, wire, hardware, step-by-step instructions. Ship. wt. 1 lb.

**\$7.88**

HIGH IMPEDANCE HEADSET . . . . . \$1.99



12" HI-FI SPEAKER

10 WATTS, 50-10,000 CYCLES. TOP MAKE. Regularly \$8.00.

**\$3.99**

ELECTRIC CLOCK-TIMER Reg. \$10  
Just a few! Tells time, shuts "Off" puts "On" appliances, lights, etc. within 12 hours. Less escutcheon & knobs. Instructions incl. Ship. wt. 2 lbs.

**\$2.50**

"KIT KING" KITS ARE SOLD ONLY BY

# LEKTRON

28 GARDNER ST. CHELSEA 50, MASS.  
Visit our salesroom, 131 Everett Ave., Chelsea

## Color TV Circuits (Continued from page 42)

verter is connected to a threshold control which varies the bias and, therefore, the conductivity of this tube. The bias is adjusted so that noise at a higher level than the sync tips is cancelled.

The RCA "Special" and "Super" models permit the color burst to pass the chroma amplifier and demodulator sections. This would ordinarily cause a yellow-orange stripe to appear at the left side of the picture and although, with proper centering and width adjustment, this would not be visible, its presence could be mistaken for parts of the actual picture. For this reason the triode section of the 6AW8 first video amplifier is used as a special blanking amplifier. Its purpose is simply to drive the screen of the second video amplifier negative and thereby cause the cathodes of the kinescope to cut all three electron beams off during the horizontal retrace time. The blanking tube is gated by a pulse from the horizontal flyback section; the blanking amplifier also supplies horizontal pulses to the burst keyer.

### Installation

The extent of the installation adjustments required may vary from simply unpacking the set and connecting it to the antenna and power line, to a full kinescope set-up procedure. Detailed instructions for complete color purity, convergence, and color background adjustments are included in the service manual for the receiver. Some useful installation pointers will be mentioned here.

The receivers are shipped with the color picture tube fastened to the front frame of the set and not to the chassis. The safety glass and mask can be removed quite easily but require that the rear cover of the set also be removed. Two spring hooks behind the small panel covering the controls on the front of the set must be pulled forward and down to release

Fig. 3. Simplified schematic diagram of the video noise inverter circuit of the "Deluxe" chassis. Notice how the noise pulse from the first video amplifier is bucked by an inverted pulse at the input to the first sync amplifier tube.

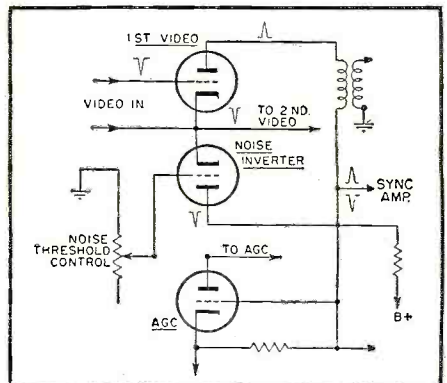

EARN BONUS CREDITS TOWARD FREE KITS!  
ANY PURCHASE ENROLLS YOU IN LEKTRON'S  
"CREDIT-BONUS PLAN"!

## FAMOUS "KIT KING" DOLLAR BUYS ONLY ONE DOLLAR EACH!

- 60 XFMR'S & COILS. IF, RF, ant., slug-tuned coils, chokes, 23 types. Wt. 3 lbs. Reg. \$15.
- DIODE RADIO KIT. Complete w/pre-drilled cabinet, germanium diode, loopstick tuner, instructions. All parts mounted. Wt. ½ lb. Reg. \$3.
- 15-PC. TWIST DRILL SET. 1/16th thru ¼" by 6ths, in graduated plastic holders. Reg. \$4.
- 25 VARIABLES. 15 sizes; singles, duals. Eric, ceramic, mica types. Wt. 1 lb. Reg. \$15.
- PHOTO-ELECTRIC CELL. Famous Western Electric photocell makes excellent sun battery; w/greater output than famed B2M. 1½" dia. Reg. \$5.
- 10 "POLY" BOXES. Assd. sizes clear plastic boxes; hinged w/snap lock. Hundreds of uses. Reg. \$2.50.
- 125 RESISTORS. Insulated & uninsulated. 30 values; 52 ohms to 1 meg. ½ to 2 w. 5%. too. Wt. 1 lb. Reg. \$19.
- 40 SUBMINIATURE RESISTORS. Exclusive! 20 popular values, 100 ohms to 1 meg. Only ¼" long. 1½ & 1½ w. In poly box. Reg. \$8.
- 8-PC. NUTDRIVER KIT. Plastic handle, 3/16, 7/32, ¼, 5/16, 1/2, 5/8, 7/16" steel socket wrenches in plastic case. Wt. 1 lb. \$3 value.
- 3 lbs. HARDWARE. 2,000 pcs. Ass'd. screws, springs, washers, etc. Hundreds of items! Reg. \$8.
- G-E PRE-AMP KIT. for magnetic cartridges. Complete w/chassis, parts, diagram. Less 6SC7 (88c extra). Wt. 1 lb. Reg. \$4.50.
- 30 TUBE SOCKETS. 4, 9, 6, 7, 8, 9, 11-prong. Miniature, octals, wafers, "zip-ins," molded. Tube shields, too. Wt. 2 lbs. Reg. \$7.
- 70 STANDARD KNOBS. Radio, TV, appliance, lab types. Ass'd. colors, bakelite & spg. Wt. 2 lbs. Reg. \$9.
- 30 PRECISION RESISTORS. WW & carbon. 30 values, 53 ohms to 1 meg. ½, 1 & 2 w. 5% tol. Some 5%. Wt. ½ lb. Reg. \$21.
- 20 AC/DC LINE CORDS. For clocks, motors, etc. Molded plugs, 2 cond. Wt. 1 lb. Reg. \$5.
- 70 MICA CONDENSERS. Famous makes, 30 values, .0001 to .01 mf. to 1000V. Silver, 5% included. Wt. 1 lb. Reg. \$5.
- 175-FT. HOOKUP WIRE. 25-ft. rolls; ass'd. colors, stranding, insulation. #18 to 24. Wt. 2 lbs. Reg. \$3.75.
- 75 CERAMIC CONDENSERS. ERS. Scoop! 35 ass'd. values, tubular & discs. 5 mf. to .01 mf up to 5 kv. Wt. ½ lb. Reg. \$11.
- 40 POPULAR BULBS. 1.1 to 6V. Screw & bayonet types; miniature. Wt. ½ lb. Reg. \$3.
- 65 RESISTORS. Insulated TIGs, Allen-Bradley, etc. 5 ohms to 10 megs. ½, 1 & 2 w; 1% & 5%. Wt. ½ lb. Reg. \$10.50.
- 10 ELECTROLYTICS, EP & twist, tubular, rect. Ass'd. sizes; multiples, too. 8 to 500 mf to 450V. Wt. 3 lbs. Reg. \$15.
- 4 SILICON DIODES. Sylvania 1N21, 1N22, 1N23, 1N105. Reg. \$8.50.
- 15 ROTARY SWITCHES. Wide ass't. ceramic & bakelite units; including multiple gangs. Wt. 3 lbs. Reg. \$14.
- 3 GERMANIUM DIODES. Most popular types: 1N34, 1N51, 1N69. Reg. \$4.
- 60 TUBULAR CONDENSERS. Popular makes, 30 types. .0005 to 0.5 mf to 1500 V. Wt. 2 lbs. Reg. \$12.
- 15 VOLUME CONTROLS. 10 types, values to 0.5 megs. Wt. 1 lb. Reg. \$9.
- 70 TERMINAL STRIPS & boards. 13 types: 1 to 20 screw & solder pts. Wt. 1 lb. Reg. \$5.
- 40 MOLDED CONDENSERS. Brown, black ceramic cased; .0001 to 0.1 mf up to 1000V. Wt. 1 lb. Reg. \$8.
- 2-TUBE AMPLIFIER KIT. complete except for 50L6 & 35Z5 tubes. Exc. tone, volume. Schematic incl. Wt. 1 lb. Reg. \$2.98.

HOW TO ORDER: Check items wanted. Return entire ad with check or MO. Include, sufficient postage, excess returned. C.O.D. orders, 25% down. Rated, net 30 days. Print name, address and amount money enclosed in margin. RN-11

## GET INTO ELECTRONICS

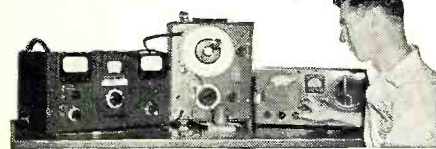

Valparaiso Tech trains for top flight positions. Tech. rep., field engineers, sales and specialists in communications, missiles, computers, radar, automation, color television. Basic and advanced theory and laboratory. Major companies visit school for our graduates, 21 months' course. High school grad. or equivalent. Dormitories—campus. Start Jan., April, July, Sept. G. I. approved. Write for catalog.

**VALPARAISO TECHNICAL INSTITUTE**  
Dept. RD Valparaiso, Indiana

HOW TO BE THE HAPPIEST CREATIVE ENGINEER IN CALIFORNIA

Engineers (E.E., M.E., Mfg., Sales) can have the kinds of jobs that creative men dream about. Top salaries and benefits. Suburban locations in Fullerton, Newport Beach, Richmond, or Palo Alto.

Write Beckman Instruments, Inc., 2999 W. 6th Street Los Angeles 5, California. Ask for Career File 211

## TAPE RECORDERS

Tapes—Accessories  
Nationally Advertised Brands  
UNUSUAL VALUES  
Send for Free Catalog

**DRESSNER**  
69-02 RA-174 St. Flushing 65, N. Y.

**MERITAPE**  
Low Cost, High Quality Recording Tapes—In boxes or cans.

the facemask. After this frame is pulled forward, release, from the rear of the set, the four clips holding the safety glass. Be sure to prevent the glass from falling.

Most of the adjustments are available from the front panel, only the vertical and horizontal centering, focus, and width controls are located at the rear of the chassis. The customer-operated controls are under the hinged panel, but by removing the whole cover, the remaining front controls become accessible.

After unpacking the receiver, check its appearance for obvious breakage. Remove the rear cover and check internally for proper tube seating, loose components, or any sign of breakage. After replacing the rear cover, connect the receiver to the antenna and the 117-volt a.c. power line. Turn on the set and tune to a color program. If it appears impossible to get horizontal locking and the image appears quite dark, adjust the a.g.c. control.

Next, adjust for a proper black-and-white picture by turning the color control fully counterclockwise until the "on-off" switch clicks. Vary the conventional black-and-white controls until the picture looks correct, then, advance the color control clockwise until the desired color intensity is achieved.

The hue control determines the correct color phase and its misadjustment will produce weird flesh colors.

It has been assumed that there was no difficulty in obtaining a good black-and-white picture without color impurity and without the primary colors appearing at the edges of picture elements. If either purity or convergence adjustments are required, the full set-up procedure should be followed.

-30-

### BLASTING IN FORD SET

BY JAMES A. McROBERTS

WHEN the Ford Model 2-MF auto receiver came into the shop the complaint was that strong signals blasted through while the weak signals were received quite satisfactorily.

A check showed that the a.v.c. line was about a half volt positive at pin 6 of the a.v.c. detector plate of the 6AT6 (V, on the service data).

Although not discernible as a leakage on the ohmmeter, the capacitor  $C_{11}$  ( $5 \mu\text{fd.}$ ) used for coupling the r.f. to the a.v.c. plate was leaking. A new capacitor for  $C_{11}$  proved to be the solution to this service problem.

-30-

Portion of circuit involved in "blasting."

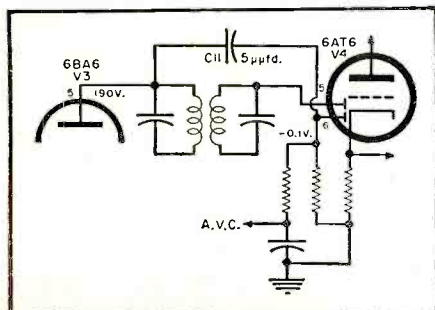

NEW

## PHAOSTRON PROBE-LITE

ILLUMINATED TEST PROBE  
SELF-CONTAINED  
SEE WHAT YOU ARE TESTING!

\$250  
LIST

It is just like having an extra hand. Simply insert the probe from your tester into the jack of the Probe-lite and the Probe-lite becomes alive to instantly give you a brilliant, pre-focus spotlight on the area that you are testing plus a long, extra slender, probe tip for making electrical contact in difficult places which previously were inaccessible. It could pay for itself the first time you use it.

Your distributor has them in stock, better call him today!

PHAOSTRON

PHAOSTRON INSTRUMENT & ELECTRONIC CO., 151 Pasadena Avenue, South Pasadena, Calif.

New



MODEL O-11  
Shpg. Wt.  
21 Lbs.

\$69<sup>50</sup>

- \* An improved model of what was already an outstanding instrument.
- \* Performance is unmatched in this price range.
- \* Incorporates the extra features required for color TV servicing.

*Extra!*

**A FULL YEAR TO PAY**

SEND FOR DETAILS OF HEATH  
TIME-PAYMENT PLAN.

**5  
BIG  
REASONS  
WHY**

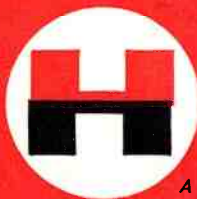

**HEATH  
COMPANY**

A SUBSIDIARY OF DAYSTROM, INC.

**BENTON HARBOR 15, MICH.**

**HEATHKIT ETCHED CIRCUIT, PUSH-PULL**

## 5" Oscilloscope Kit COLOR TV

The previous Heathkit oscilloscope (Model O-10) which was already a most remarkable instrument, has been improved even further with the release of the Heathkit Model O-11. It incorporates all the outstanding features of the preceding model, *plus* improved vertical linearity, better sync stability, especially at low frequencies, and much-improved over-all stability of operation, including less vertical bounce with changes in level. These improvements in the Model O-11 circuit make it even more ideally suited for color TV servicing, and for critical observations in the electronic laboratory. Vertical response extends from 2 CPS to 5 MC without extra switching. Response only down 1½ DB at 3.58 MC. The 11-tube circuit features a 5UP1 cathode-ray tube. Sync circuit functions effectively from 20 CPS to better than 500 kc in five steps. Modern etched circuit boards employed in the oscilloscope circuit cut assembly time almost in half, permit a level of circuit stability never before achieved in an oscilloscope of this type, and insure against errors in assembly. Both vertical and horizontal output amplifiers are push-pull. Built-in peak-to-peak calibrating source — step-attenuated input — plastic molded capacitors and top-quality parts throughout — pre-formed and cabled wiring harness — and numerous other "extra" features. A professional instrument for the serveshop or laboratory. Compare its specifications with those of scopes selling in much higher price brackets. You can't beat it!

**1 FEWER DOLLARS BRING MORE REAL QUALITY.**

- Factory-to-you sales eliminate extra profit margin.
- "Build-it-yourself" eliminates labor charge.
- Heath purchasing power cuts component costs.

**2 PERSONAL SERVICE ASSURES CUSTOMER SATISFACTION.**

- You deal directly with the manufacturer.
- We are interested in you before and after sale.

# Heathkits®

**ARE YOUR BEST BUY...**

**3 PROVEN DESIGNS MEAN RELIABLE PERFORMANCE.**

- Research and development efforts concentrated on kits only.
- All kits guaranteed to meet advertised specifications.

**4 EVERY KIT BACKED BY WORLD-WIDE REPUTATION.**

- The world's largest manufacturer of electronic equipment in kit form.
- Producer of more than a million electronic kits for the home workshop and industry.

**5 EASY TIME-PAYMENT PLAN TO FIT YOUR BUDGET.**



New **HEATHKIT ETCHED CIRCUIT**

# 5" Oscilloscope Kit

## GREATEST SELECTION . . .

Whether your particular special interest is in servicing, ham-radio, high-fidelity, or just experimenting—there are Heathkits to fill your needs. You can equip an entire service shop or lab, buy a complete ham station or high-fidelity system, or set up a really deluxe home workshop, by choosing from the more than 70 different "do-it-yourself" electronic kits by Heath. Just glance through the kits displayed in this ad, and you will get some idea of the tremendous array of low-priced, high-quality electronic equipment available.

- \* Brand new model with improved performance specifications.
- \* Full 5" scope for service work at a remarkably low price.
- \* Attractively styled front panel in charcoal gray with sharp white lettering.
- \* Easy to build from step-by-step instructions and large pictorials. Not necessary to read schematic.

This new and improved oscilloscope retains all the outstanding features of the preceding model, but provides wider vertical frequency response, extended sweep-generator coverage, and increased stability. A new tube complement and improvements in the circuit make these new features possible. Vertical frequency response is essentially flat to over 1 mc, and down only 1½ DB at 500 kc. The sweep generator multivibrator functions reliably from 30 to 200,000 CPS, almost twice the coverage provided by the previous model. Deflection amplifiers are push-pull, and modern etched circuits are employed in critical parts of the design. A 5BP1 cathode-ray tube is used. The scope features external or internal sweep and sync, one volt peak-to-peak reference voltage, 3-position step-attenuated input, adjustable spot-shape control, and many other "extras" not expected at this price level. A calibrated grid screen is also provided for the face of the CRT, allowing more precise observation of wave shapes displayed. The new Model OM-2 is designed for general application wherever a reliable instrument with good response characteristics may be required. Complete step-by-step instructions and large pictorial diagrams assure easy assembly.



MODEL OM-2

**\$42.50**

Shpg. Wt.  
21 Lbs.

### HEATHKIT LOW CAPACITY PROBE KIT

Oscilloscope investigation of high frequency, high impedance, or broad bandwidth circuits encountered in television requires the use of a low-capacity probe to prevent loss of gain, circuit loading, or waveform distortion. The Heathkit low-capacity probe may be used with your oscilloscope to eliminate these effects. It features a variable capacitor, to provide correct instrument impedance match. Also, the ratio of attenuation can be varied.

No. 342

**\$3.50**

Shpg. Wt. 1 Lb.

### HEATHKIT ELECTRONIC SWITCH KIT

This handy device allows simultaneous oscilloscope observation of two signals by producing both signals, alternately, at its output. It features an all-electronic switching circuit, with no moving parts. Four switching rates are selected by a panel switch. Provides actual gain for input signals, and has a frequency response of ± 1 DB from 0 to 100 kc. Sync output provided to control and stabilize scope sweep. Will function at signal levels as low as 0.1 volt. This modern device finds many applications in the laboratory and service shop. It employs an entirely new circuit, and yet is priced lower than its predecessor.

MODEL S-3

**\$21.95**

Shpg. Wt. 8 Lbs.

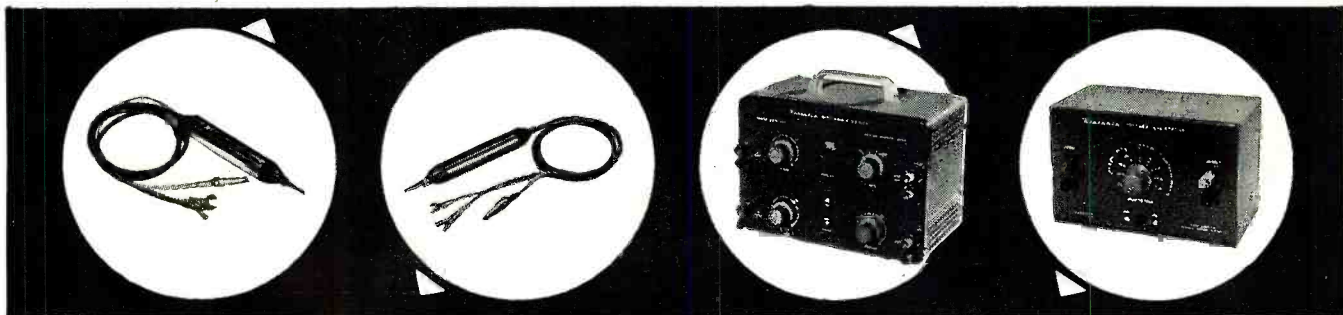

### HEATHKIT SCOPE DEMODULATOR PROBE KIT

Extend the usefulness of your oscilloscope by employing this probe. Makes it possible to observe modulation of RF or IF carriers found in TV and radio receivers. Functions much like an AM detector to pass only modulation of signal, and not the signal itself. Among other uses, it will be helpful in alignment work, as a signal tracer, and for determining relative gain. Applied voltage limits are 30 volts (RMS) and 500 volts DC. It uses an etched circuit board to simplify assembly.

NO. 337-C

**\$3.50**

Shpg. Wt. 1 Lb.

### HEATHKIT VOLTAGE CALIBRATOR KIT

This entirely new voltage calibrator produces near-perfect square wave signals of known amplitude. Precision 1% attenuator resistors assure accurate output amplitude, and multivibrator circuit guarantees good, sharp square waves, as distinguished from clipped sine waves. Output frequency is approximately 1000 CPS. Fixed outputs selected by panel switch are; .03, 0.1, 0.3, 1.0, 3.0, 10, 30, and 100 volts peak-to-peak. Allows measurement of unknown signal amplitudes by comparing to known peak-to-peak output of VC-3 on an oscilloscope. Will also double as a square wave generator at 1000 cycles for determining gain, frequency response, or phase-shift characteristics of audio amplifiers. Equally valuable in the laboratory or in radio and TV service shops.

MODEL VC-3

**\$12.50**

Shpg. Wt. 4 Lbs.

## HEATHKIT ETCHED CIRCUIT VACUUM TUBE



**\$24.50**

Shpg. Wt.  
7 Lbs.

- \* Easy to build — a pleasure to use.
- \* 1% precision resistors employed for high accuracy.
- \* Etched circuit board cuts assembly time in half.

# Voltmeter Kit

The fact that this instrument is the world's largest-selling VTVM says a great deal about its accuracy, reliability, and overall quality. The V-7A is equally popular in the laboratory or service shop, and represents an unbelievable test equipment bargain, without a corresponding sacrifice in quality. Its appearance reflects the performance of which it is capable. A large 4½" panel meter is used for indication, with clear, sharp calibrations for all ranges. Front panel controls consist of a rotary function switch and a rotary range selector switch, zero-adjust, and ohms-adjust controls. Precision 1% resistors are used in the voltage divider circuits and etched circuits are employed for most of the circuitry. This makes the kit much easier to build, eliminates the possibility of wiring errors, and assures duplication of laboratory instrument performance. This multi-function VTVM will measure AC voltage (rms), AC voltage (peak-to-peak), DC voltage, and resistance. There are 7 AC (rms) and DC voltage ranges of 0-1.5, 5, 15, 50, 150, 500, and 1500. In addition, there are 7 peak-to-peak AC ranges of 0-4, 14, 40, 140, 400, 1400, and 4000. 7 ohmmeter ranges provide multiplying factors of X1, X10, X100, X1000, X10K, X100K, and X1 megohm. Center-scale resistance readings are 10, 100, 1000, 10K, 100K ohms, 1 megohm, and 10 megohms. A DB scale is also provided. The precision and quality of the components used in this VTVM cannot be duplicated at this price through any other source. Model V-7A is the kind of instrument you will be proud to own and use.

### HEATHKIT Etched Circuit RF PROBE KIT

This RF probe extends the frequency response of any 11-megohm VTVM so that it will measure RF up to 250 megacycles within ± 10%. Employs printed circuits for increased stability and ease of assembly. Ideal for extending service and laboratory applications of your Heathkit VTVM.

No. 309-C  
**\$3.50**

Shpg. Wt. 1 Lb.

### HEATHKIT 20,000 OHMS/VOLT VOM KIT

Sensitivity of this instrument is 20,000 ohms-per-volt DC and 5,000 ohms-per-volt AC. Measuring ranges are 0-1.5, 5, 50, 150, 500, 1500, and 5000 volts for both AC and DC. Also measures current in the ranges of 0-150 microamperes, 15 ma, 150 ma, 500 ma, and 15 a. Resistance ranges provide multipliers of X1, X100, and X10,000, resulting in center scale readings of 15, 15,000, and 150,000 ohms. DB ranges cover from -10 db to +65 db. Housed in attractive black bakelite case with plastic carrying handle, this fine instrument provides a total of 25 meter ranges on its two-color scale. It employs a sensitive 50 microampere, 4½" meter and features all 1% precision multiplier resistors. Requires no external power, and is, therefore, valuable in portable applications where no AC power is available.

MODEL MM-1  
**\$29.50**

Shpg. Wt. 6 Lbs.

### HEATHKIT SCOPE DEMODULATOR PROBE KIT

This probe functions like an AM detector to pass only modulation of signal and not signal itself. Permits observation of modulation from RF or IF carriers in TV and radio receivers. Extends usefulness of your oscilloscope. Voltage limits are 30 V. rms. and 500 V. DC. Very valuable in service or laboratory applications.

No. 337-C  
**\$3.50**

Shpg. Wt. 1 Lb.

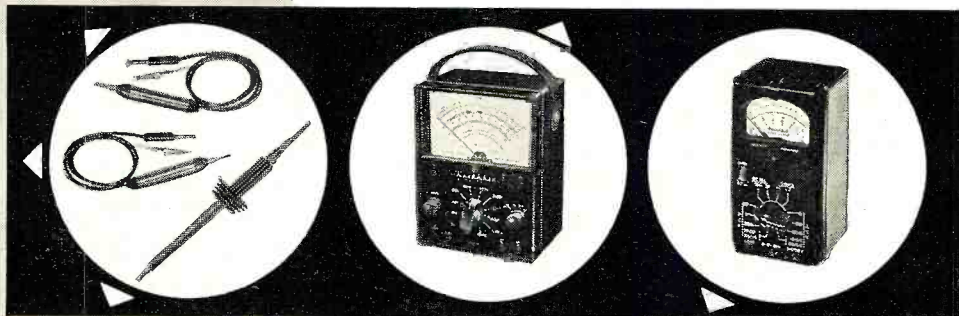

### HEATHKIT 30,000 VOLT DC HIGH VOLTAGE PROBE KIT

This probe provides a multiplication factor of 100 on the DC ranges of the Heathkit 11-megohm VTVM. Precision multiplier resistor mounted inside the two-color plastic probe body. Plenty of insulation for completely safe operation, even at highest TV potentials. Designed especially for TV service work.

No. 336  
**\$4.50**

Shpg. Wt. 2 Lbs.

### HEATHKIT HANDITESTER KIT

The Model M-1 measures AC or DC voltage at 0-10, 30, 300, 1000, and 5000 volts. Direct current ranges are 0-10 ma, and 0-100 ma. Ohmmeter ranges are 0-3000 (30 ohm center scale) and 0-300,000 ohms (3,000 ohms center scale). Uses a 400 microampere meter for sensitivity of 1000 ohms-per-volt. A very popular test device for the home experimenter, electricians, and appliance repairmen, and for use as an "extra" instrument in the service shop. Its small size and rugged construction make it perfect for any portable application. Easily slips into your tool box, glove compartment, coat pocket, or desk drawer. Top quality, precision components employed throughout.

MODEL M-1  
**\$14.50**

Shpg. Wt. 3 Lbs.



**HEATH COMPANY**  
A Subsidiary of Daystrom, Inc.  
BENTON HARBOR 15, MICH.

### CONTROLLED QUALITY . . .

Incoming parts inspection, and inspection of material coming off of our own production line assures you of the finest "build-it-yourself" kit that money can buy. Each kit contains all the components you need for assembly—and you can have confidence in the quality of the parts themselves. In addition to this inspection procedure, an extensive proof-building program for each new kit guarantees easy-to-follow instructions and reliable performance.

This brand new AC vacuum tube voltmeter emphasizes stability, broad frequency response, and sensitivity. It is designed especially for audio measurements, and low-level AC measurements in power supply filters, etc. Employs a cascode amplifier circuit with cathode-follower isolation between the input and the amplifier, and between the output stage and the preceding stages. An extremely stable circuit with high input impedance (1 megohm at 1000 CPS). Response of the AV-3 is essentially flat from 10 CPS to 200 kc, and is usable for tests even beyond these frequency limits. Increased damping in the meter circuit stabilizes the meter for low frequency tests. Nylon insulating bushings at the input terminals reduce leakage, and permit the use of the 5-way Heath binding post.

The extremely wide voltage range covered by the AV-3 makes it especially valuable not only in high-fidelity and service work, but also in experimental laboratories. AC (RMS) voltage ranges are 0-.01, .03, .1, .3, 1, 3, 10, 30, 100, and 300 V. Decibel ranges cover -52 DB to +52 DB. An entirely new circuit as compared to the previous model. Employs 1% precision multiplier resistors for maximum accuracy. Handles AC measurements from a low value of one millivolt to a maximum of 300 volts.

## HEATHKIT NEW AUDIO VACUUM TUBE

# Voltmeter Kit

- \* Brand new circuit for extended frequency response and added stability.
- \* Ten accurate ranges from 0-.01 to 0-300 volts.
- \* Modern, functional panel styling. "On-off" switch at both extreme ends of range switch.



MODEL AV-3

**\$29<sup>95</sup>**

Shpg. Wt. 5 Lbs.

### HEATHKIT AUDIO WATTMETER KIT

This instrument measures audio power directly at 4, 8, 16, or 600 ohms. Load resistors are built in. Covers 0-5 MW, 50 MW, 500 MW, 5 W, and 50 W full scale. Provides 5 switch-selected DB ranges covering from -10 DB to +30 DB. Large 4½" 200 microampere meter and precision multiplier resistors insure accuracy. Frequency response is ± 1 DB from 10 CPS to 250 kc. Functions from AC power line. Use in the audio laboratory or in home workshop.

MODEL AW-1

**\$29<sup>50</sup>**

Shpg. Wt. 6 Lbs.

### HEATHKIT AUDIO ANALYZER KIT

This multi-function instrument combines an AC VTVM, an audio wattmeter, and an intermodulation analyzer into one case, with combined input and output terminals and built-in high and low frequency oscillators. The VTVM ranges are .01, .03, .1, .3, 1, 3, 10, 30, 100, and 300 volts (RMS). Wattmeter ranges are .15 MW, 1.5 MW, 15 MW, 150 MW, 1.5 W, 15 W, 150 W. IM scales are 1%, 3%, 10%, 30%, and 100%. Provides internal load resistors of 4, 8, 16, or 600 ohms. A valuable instrument for the engineer or serious audiophile.

MODEL AA-1

**\$49<sup>95</sup>**

Shpg. Wt. 13 Lbs.

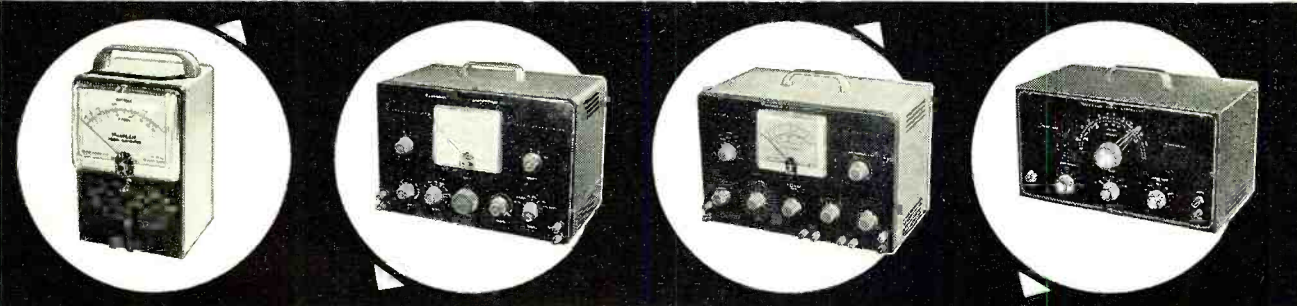

### HEATHKIT HARMONIC DISTORTION METER KIT

The HD-1 is equally valuable for the audio engineer or the serious audiophile. Used with a low-distortion audio signal generator, this instrument will measure the harmonic content of various amplifiers under a variety of conditions. Functions between 20 and 20,000 CPS, and reads distortion directly on the panel meter in ranges of 0-1, 3, 10, 30, and 100 percent full scale. Built-in VTVM for initial reference settings and final distortion readings has voltage ranges of 0-1, 3, 10, and 30 volts. 1% precision resistors employed for maximum accuracy. Features voltage regulation and other "extras". Meter calibrated in volts (RMS), percent distortion, and DB.

MODEL HD-1

**\$49<sup>50</sup>**

Shpg. Wt. 13 Lbs.

### HEATHKIT AUDIO OSCILLATOR KIT

Producing both sine waves and square waves, the Model AO-1 covers a frequency range of 20 to 20,000 CPS in three ranges. An extra feature is thermistor regulation of output for flat response through the entire frequency range. AF output is provided at low impedance, and with low distortion. Produces good sine waves, and good, clean square waves with a rise time of only two micro-seconds for checking square wave response of audio amplifiers, etc. Designed especially for the serviceman and high-fidelity enthusiast. A real dollar value in test equipment.

MODEL AO-1

**\$24<sup>50</sup>**

Shpg. Wt. 10 Lbs.

## HEATHKIT



MODEL  
AG-9

**\$34<sup>50</sup>**

Shpg. Wt.  
8 Lbs.

- \* *Less than 0.1% distortion — ideal for hi fi work.*
- \* *Large 4½" meter indicates output.*
- \* *Step-type tuning for maximum convenience.*

# Audio Generator Kit

This particular audio generator is "made to order" for high fidelity applications. It provides quick and accurate selection of low-distortion signals throughout the audio range. Three rotary selector switches on the front panel allow selection of two significant figures and a multiplier for determining audio frequency. In addition, it incorporates a step-type output attenuator and a continuously variable attenuator. Output is indicated on a large 4½" panel meter calibrated in volts and in db. Attenuator system operates in steps of 10 db, corresponding with the meter calibration. Output ranges are 0-.003, .01, .03, .1, .3, 1, 3, and 10 volts rms. A "load" switch provides for the use of a built-in 600 ohm load or an external load of higher impedance when required. Output and frequency indicators accurate to within ± 5%. Distortion is less than .1 of 1% between 20 cps and 20,000 cps. Total range is 10 cps to 100 kc. New engineering details combine to provide the user with an unusually high degree of operating efficiency. Oscillator frequency selected entirely by the switch method means that accurate resetability is provided. Comparable to units costing many dollars more, and ideal for use in critical high fidelity applications. Shop and compare, and you will appreciate the genuine value of this professional instrument.

### HEATHKIT RESISTANCE SUBSTITUTION BOX KIT

The RS-1 contains 36 10% 1-watt resistors ranging from 15 ohms to 10 megohms in standard RETMA values. All values are switch-selected for use in determining desirable resistance values in experimental circuits. Many applications in radio and TV service work.

MODEL RS-1

**\$5<sup>50</sup>**

Shpg. Wt. 2 Lbs.

### HEATHKIT CONDENSER SUBSTITUTION BOX KIT

This kit contains 18 RETMA standard condenser values that can be selected by a rotary switch. Values range from 0.00001 mfd to 0.22 mfd. All capacitors rated at 400 volts or higher. Capacitors are either silver-mica, or plastic molded.

MODEL CS-1

**\$5<sup>50</sup>**

Shpg. Wt. 2 Lbs.

### HEATHKIT AUDIO GENERATOR KIT

The Model AG-8 is a low cost, high performance unit for use in service shop, or home workshop. It covers the frequency range of 20 cps to 1 mc in five ranges. Output is 600 ohms, and overall distortion will be less than .4 of 1% from 100 cps through the audible range. Output is available up to 10 volts, under no load conditions, and output remains constant within ± 1 db from 20 cps to 400 kc. A five-step attenuator provides control of the output. Precision resistors are employed in the frequency determining network.

MODEL AG-8

**\$29<sup>50</sup>**

Shpg. Wt. 11 Lbs.

### HEATHKIT DECADE CONDENSER KIT

Precision, 1% silver-mica capacitors are employed in the Model DC-1 in such a way that a selection of precision capacitor values is provided ranging from 100 mmf (.0001 mfd) to 0.11 mfd (110,000 mmf) in 100 mmf steps. Extremely valuable in all types of design and development work. Switches are ceramic wafer types.

MODEL DC-1

**\$16<sup>50</sup>**

Shpg. Wt. 3 Lbs.



### HEATHKIT DECADE RESISTANCE KIT

The Model DR-1 incorporates twenty 1% precision resistors arranged around five rugged switches so that various combinations of switch positions will provide a total range of 1 ohm to 99,999 ohms in 1-ohm steps. Switches are labeled "units," "tens," "hundreds," "thousands," and "ten thousands." Use it for ohm-meter calibration in bridge circuits as test values in multiplier circuits, etc.

MODEL DR-1

**\$19<sup>50</sup>**

Shpg. Wt. 4 Lbs.

### HEATHKIT VARIABLE VOLTAGE REGULATED POWER SUPPLY KIT

This power supply is regulated for stability, and the amount of DC output available from the power supply can be controlled manually from zero to 500 volts. Will provide regulated output at 450 volts up to 10 ma, or up to 130 ma at 200 volts output. In addition to furnishing B-plus, the power supply provides 6 volts AC at 4 amperes for filaments. Both the B-plus output and the filament output are isolated from ground. Ideal power supply for use in experimental work in the laboratory, the home workshop, or the ham shack. Large 4½" panel meter indicates output voltage or current.

MODEL PS-3

**\$35<sup>50</sup>**

Shpg. Wt. 17 Lbs.



**HEATH COMPANY**  
A Subsidiary of Daystrom, Inc.  
BENTON HARBOR 15, MICH.

## HEATHKIT

# Signal Generator Kit

- \* No calibration required with pre-aligned coils.
- \* Modulated or unmodulated RF output.
- \* 110 mc to 220 mc frequency coverage.

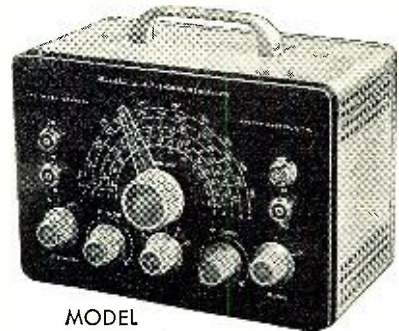

MODEL  
SG-8

**\$19<sup>50</sup>** Shpg. Wt. 8 Lbs.

### BONUS PERFORMANCE . . .

If a single word had to be selected to describe Heath Company advertising policy, it would be "conservative." By this we mean that the performance specifications and features are not exaggerated, and that the descriptions are accurate. We specify performance on the conservative side so you can be sure of equaling or exceeding our specifications. In almost every instance our kits will do more than we claim. Extra care in construction, and calibration against an accurate standard can extend performance well beyond advertised levels.

Here is an RF signal generator for alignment applications in the service shop or the home workshop. Thousands of these units are in use in service shops all over the country. Produces RF signals from 160 kc to 110 mc on fundamentals on five bands. Also covers from 110 mc to 220 mc on calibrated harmonics. RF output is in excess of 100,000 microvolts at low impedance. Output is controllable with a step-type and a continuously variable attenuator. Front panel controls provide selection of either unmodulated RF output or RF modulated at 400 cps. In addition, two to three volts of audio at approximately 400 cps are available at the output terminals for testing AF circuits. Employs a 12AU7 and a 6C4 tube. Built-in power supply uses a selenium rectifier.

One of the most outstanding features about the Model SG-8 is the fact that it can be built in just a few hours, even by one not thoroughly experienced in electronics work. Complete step-by-step instructions combined with large pictorial diagrams assure successful assembly. Pre-aligned coils make calibration from an external source unnecessary.

### HEATHKIT LABORATORY GENERATOR KIT

This laboratory RF signal generator covers from 100 kc to 30 mc on fundamentals in five bands. The output signal may be pure RF, or may be modulated at 400 cycles from 0 to 50%. Provision for external modulation has been made. RF output available up to 100,000 microvolts. Output controlled by a fixed step and a variable attenuator. Output impedance is 50 ohms. Panel meter reads RF output or percentage of modulation. Incorporates voltage regulated B+ supply, double shielding of oscillator circuits, copper plated chassis, and other "extras."

MODEL LG-1

**\$48<sup>95</sup>**

Shpg. Wt. 16 Lbs.

### HEATHKIT TV ALIGNMENT GENERATOR KIT

This improved sweep generator model provides essential stability and flexibility for work on FM, monochrome TV, or color TV sets. Covers 3.6 mc to 220 mc in four bands. Provides usable output even on harmonics. Sweep deviation from 0-42 mc, depending on base frequency. All-electronic sweep circuit eliminates unwieldy mechanical arrangements. Includes built-in crystal marker generator providing output at 4.5 mc and multiples thereof, and variable marker covering 19 to 60 mc on fundamentals and from 57 to 180 mc on harmonics. Effective two-way blanking.

MODEL TS-4A

**\$49<sup>50</sup>**

Shpg. Wt. 16 Lbs.

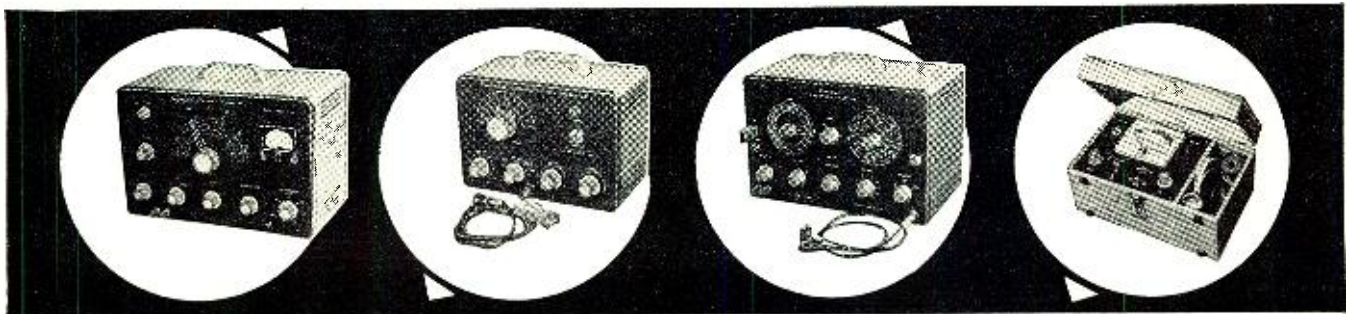

### HEATHKIT LINEARITY PATTERN GENERATOR KIT

This instrument supplies information for white dots, cross-hatch pattern, horizontal bar pattern, or vertical bar pattern. It feeds video and sync signals to the set under test, with completely controlled gain, and unusual stability. Covering channels 2 to 13, the LP-2 will produce 5 to 6 vertical bars and 4 to 5 horizontal bars. The dot pattern presentation is a *must* for the setting of color convergence controls in the color TV set. Panel provision made for external sync if desired. Use for adjustment of vertical and horizontal linearity, picture size, aspect ratio, and focus. Power supply is regulated for added stability. Essential in the up-to-date TV service shop.

MODEL LP-2

**\$22<sup>50</sup>**

Shpg. Wt. 7 Lbs.

### HEATHKIT CATHODE RAY TUBE CHECKER KIT

This instrument checks cathode emission, beam current, shorted elements, and leakage between elements in electro-magnetic picture tube types. It eliminates all doubt for the TV serviceman, and even more important, for the customer. Features its own self-contained power supply, transformer operated to furnish normal test voltages for the CRT. Employs spring-loaded switches for maximum operator protection. Large 4 1/2" meter indicates CRT condition on "good-bad" scale. Luggage-type portable case ideal for home service calls. Special "shadowgraph" test permits projection of light spot on screen. Also gives relative check of picture tube screen coating.

MODEL CC-1

**\$22<sup>50</sup>**

Shpg. Wt. 10 Lbs.

## HEATHKIT



MODEL  
TC-2

**\$29<sup>50</sup>**

Shpg. Wt.  
12 Lbs.

- \* Attractive counter-style cabinet.
- \* Wiring-harness simplifies assembly.
- \* Large 4½" meter with two-color "good-bad" scale.
- \* Separate tube element switches prevent obsolescence.

### HEATHKIT PORTABLE TUBE CHECKER KIT

This portable tube checker is identical, electrically, with the Model TC-2. However, it is housed in an attractive and practical carrying case, finished in proxylin impregnated material. The cover is detachable, and the hardware is brass plated. This rugged unit is ideal for home service calls or any portable application.

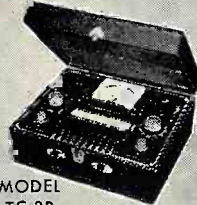

MODEL  
TC-2P

**\$34<sup>50</sup>** Shpg. Wt.  
15 Lbs.

### HEATHKIT DIRECT READING CAPACITY METER KIT

Operation of this instrument is simplicity itself. One has only to connect a capacitor to the terminals, select the proper range, and read the capacity value directly on the large 4½" meter calibrated in mmf and mfd.

Ranges are 0 to 100 mmf, 1,000 mmf, 0.01 mfd, and 0.1 mfd full scale. Precision calibrating capacitors supplied. Not susceptible to hand capacity effects. Residual capacity less than 1 mmf. Especially valuable in production line checking, or in quality control.

MODEL CM-1

**\$29<sup>50</sup>**

Shpg. Wt.  
7 Lbs.



**HEATH COMPANY**  
A Subsidiary of Daystrom, Inc.  
BENTON HARBOR 15, MICH.

## Tube Checker Kit

This fine piece of test gear checks tubes for quality, emission, shorted elements, open elements, and filament continuity. Will test all tube types normally encountered in radio and TV service work. Sockets provided for 4, 5, 6, and 7-pin large, rectangular, and miniature types, octal and loctal types, the Hytron 9-pin miniatures, and pilot lamps. Condition of tubes indicated on a large 4½" meter with multi-color "good-bad" scale. An illuminated roll chart is built right in, providing test data for various tube types. This tester provides switch selection of 14 different filament voltage values from 0.75 volts to 117 volts. Individual switches control each tube element. Close tolerance resistors employed in critical test circuits for maximum accuracy. A professional instrument both in appearance and performance.

The Model TC-2 is very simple to build, even for a beginner. It employs a color-coded cable harness for neat, professional under-chassis wiring. Comes with attractive counter style cabinet, and portable cabinet is available separately. At this price, even the part-time serviceman can afford his own tube checker for maximum efficiency in service work.

### HEATHKIT TV PICTURE TUBE TEST ADAPTER

Designed especially for use with the Model TC-2 tube checker. Use it to test TV picture tubes for emission, shorts, etc. Consists of 12-pin TV tube socket, 4 ft. cable, octal connector, and necessary technical data. Not a kit.



MODEL 355

**\$4<sup>50</sup>**

Shpg. Wt.  
1 Lb.

### HEATHKIT VISUAL-AURAL SIGNAL TRACER KIT

Although designed primarily for radio receiver work, this valuable instrument finds extensive application in FM and TV servicing as well. Features a high-gain channel with demodulator probe, and a low-gain channel with audio probe. Will trace signals in all sections of a radio receiver and in many sections of a FM set or TV receiver. Uses built-in speaker and electron beam eye tube for indication. Also features built-in wattmeter and a noise locator circuit. Provision for patching speaker and/or output transformer into external set.

MODEL T-3

**\$23<sup>50</sup>**

Shpg. Wt. 9 Lbs.



### HEATHKIT CONDENSER CHECKER KIT

The Model C-3 consists of an AC powered bridge for both capacitive and resistive measurements. Bridge balance is indicated on electron beam eye tube, and capacity or resistance value is indicated on front panel calibrations. Measures capacity in four ranges from .00001 mfd to .005 mfd, .001 mfd to .5 mfd, .1 mfd to 50 mfd, and 20 mfd to 1000 mfd. Measures resistance in two ranges, from 100 ohms to 50,000 ohms, and from 10,000 ohms to 5 megohms. Selection of five different polarizing voltages for checking capacitors, from 25 volts DC to 450 volts DC. Checks paper, mica, ceramic, and electrolytic capacitors. Indicates power factor of electrolytic condensers.

MODEL C-3

**\$19<sup>50</sup>**

Shpg. Wt. 7 Lbs.

### PIONEER DESIGN . . .

New and unique approaches to instrument and equipment designs are a Heath Company tradition. We concentrate all our development efforts on kit projects, since this is our prime activity—and not just a sideline. This logically results in more efficient, more reliable circuit designs—and you benefit from this constant engineering progress. Buying from the undisputed leader in the electronic kit field assures you of completely modern equipment, with outstanding advanced design features.

## HEATHKIT

# Impedance Bridge Kit

- \* ½% precision resistors and silver-mica capacitors.
- \* Battery-type tubes, no warm-up required.
- \* Built-in phase shift generator and amplifier.

The Model IB-2 is a completely self-contained unit. It has a built-in power supply, a built-in 1000 cycle generator, and a built-in vacuum tube detector. Provision has been made on the panel for connection to an external detector, an external signal generator, or an external power supply. A 100-0-100 micro-ampere meter on the front panel provides for null indications. Measures resistance from 0.1 ohm to 10 megohms, capacitance from 10 mmf to 100 mfd, inductance from 10 mh to 100 h, dissipation factor (D) from 0.002 to 1, and storage factor (Q) from 0.1 to 1000. ½ of 1% decade resistors employed for maximum accuracy. Typical accuracy figures are: resistance, ±3%; capacitance ±3%; inductance, ±10%; dissipation factor, ±20%; storage factor, ±20%. Employs a Wheatstone bridge, a Capacity Comparison bridge, a Maxwell bridge, and a Hay bridge. Special two-section CRL dial provides maximum convenience in operation. Use the Model IB-2 for determining values of unmarked components, checking production or design samples, etc. A real professional instrument.

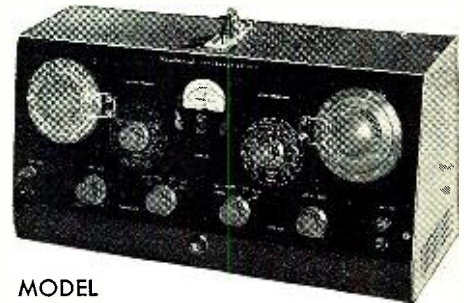

MODEL  
IB-2

**\$59<sup>50</sup>** Shpg. Wt.  
12 Lbs.

### HEATHKIT "Q" METER KIT

The Q Meter permits measurement of inductance from 1 microhenry to 10 millihenries, "W" on a scale calibrated up to 250 full scale, with multiplying factors of 1 or 2, and capacitance from 40 mmf to 450 mmf, ±3 mmf. Built-in variable oscillator permits testing components from 150 kc to 18 mc. Large 4½" panel-mounted meter is feature. Very handy for checking peaking coils, chokes, etc. Use to determine values of unknown condensers, both variable and fixed. Compile data for coil winding purposes, or measure RF resistance. Distributed capacity, and Q of coils.

MODEL QM-1

**\$44<sup>50</sup>**

Shpg. Wt. 14 Lbs.

### HEATHKIT ISOLATION TRANSFORMER KIT

This device isolates equipment under test from the power line. It is rated at 100 volt-amperes continuously, or 200 volt-amperes intermittently. AC-DC sets may be plugged directly into the IT-1 without the chassis becoming "hot." Additionally, since the IT-1 is fused, it is ideal for use as a buffer between the power line and a questionable receiver, or a new piece of equipment. Protects main fuses. Features voltage control, allowing control of the output from 90 volts to 130 volts. Panel meter monitors output voltage. A very handy device at an extremely low price.

MODEL IT-1

**\$16<sup>50</sup>**

Shpg. Wt. 9 Lbs.

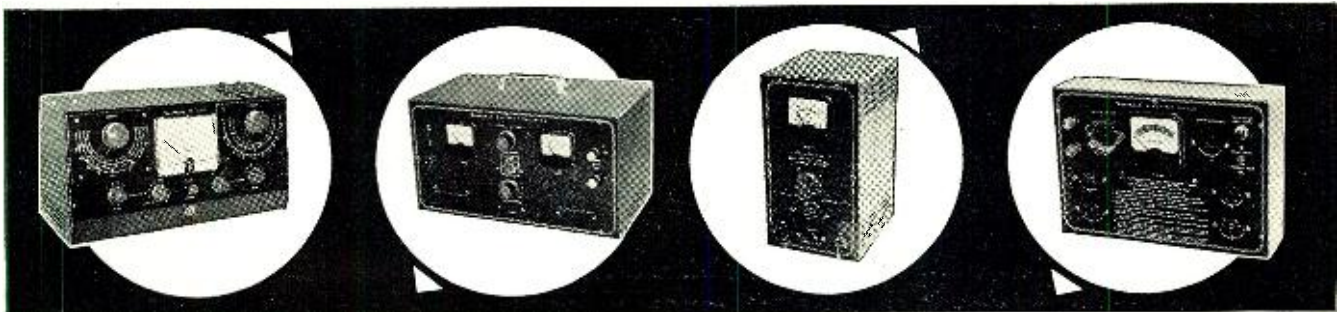

### HEATHKIT 6-12 VOLT BATTERY ELIMINATOR KIT

This completely modern battery eliminator will supply DC output in two ranges for both 6-volt and 12-volt automobile radios. The output is variable for each range, so that operating voltage can be raised or lowered to determine how the receiver functions under adverse conditions. Range is 0-8 volts DC or 0-16 volts DC. Will supply up to 15 amperes on the 6-volt range, or up to 7 amperes on the 12-volt range. Two 10,000 microfarad output filter capacitors insure smooth DC output. Two separate panel meters indicate output voltage or output current. Makes it possible to test automobile radios inside at the workbench. Will also double as a battery charger.

MODEL BE-4

**\$31<sup>50</sup>**

Shpg. Wt. 17 Lbs.

### HEATHKIT 6-VOLT VIBRATOR TESTER KIT

This instrument functions very much like a tube checker, to test auto radio vibrators. Vibrator condition is indicated on a simple "good-bad" scale. Tests for proper starting and overall quality of operation, of both interrupter and self-rectifier types of 6-volt vibrators. The model VT-1 is designed to operate from any battery eliminator capable of delivering continuously variable output from 4 to 6 volts DC at 4 amperes or more. It is an ideal companion unit for the Heathkit Model BE-4 battery eliminator. The construction book for the VT-1 contains vibrator test chart for popular 6-volt vibrator types. A real time saver!

MODEL VT-1

**\$14<sup>50</sup>**

Shpg. Wt. 6 Lbs.

## HEATHKIT DX-100 PHONE AND CW



**MODEL  
DX-100**  
Shpg. Wt.  
107 Lbs.

**\$189<sup>50</sup>**

Shipped motor freight unless otherwise specified.  
\$50.00 deposit required on c.o.d. orders.

- \* Phone or CW on 160, 80, 40, 20, 15, 11 and 10 meters.
- \* Built-in VFO, modulator, and power supplies.
- \* High quality components used throughout for reliable performance.
- \* Features 5-point TVI suppression.

# Transmitter Kit

The Heathkit DX-100 transmitter is in a class by itself in that it offers features far beyond those normally received at this price level. It takes very little listening on the bands to discover how many of these transmitters are in operation today. A truly amazing piece of amateur gear. The DX-100 features a built-in VFO and a built-in modulator. It is TVI suppressed, and uses pi network interstage coupling and output coupling. Will match antenna impedances from approximately 50 to 600 ohms. Extensive shielding is employed, and all incoming and outgoing circuits are filtered. The cabinet features interlocking seams for simplified assembly and minimum RF radiation outside of the cabinet. Provides a clean strong signal on either phone or CW, with RF output in excess of 100 watts on phone, and 120 watts on CW. Completely bandswitching from 160 through 10 meters. A pair of 1625 tubes are used in push-pull for the modulator, and the final consists of a pair of 6146 tubes in parallel. The VFO dial and meter face are illuminated, and all front panel controls are located for maximum convenience. Panel meter reads driver plate I, final grid I, final plate I, final plate voltage, and modulator current. The chassis is constructed of heavy #16 gauge copper-plated steel. Other high-quality components include potted transformers, ceramic switch and variable capacitor insulation, silver-plated or solid-silver switch terminals, etc. All coils are pre-wound, and the main wiring cable is pre-harnessed. The kit can be built by a beginner from the comprehensive step-by-step instructions supplied. It is a proven, trouble-free rig, that will insure many hours of "on-the-air" enjoyment in your ham shack.

## HEATHKIT COMMUNICATIONS TYPE ALL BAND RECEIVER KIT

This receiver covers 550 kc to 30 mc in four bands, and is ideal for the short-wave listener or beginning amateur. It provides good sensitivity and selectivity, combined with good image rejection. Amateur bands clearly marked on illuminated dial scale. Employs transformer type power supply—electrical bandspread—antenna trimmer—separate RF and AF gain controls—noise limiter—headphone jacks—

**MODEL AR-3**  
**\$30<sup>75</sup>**

and automatic gain control. Has built-in VFO for CW reception.  
**CABINET:** Fabric covered cabinet with aluminum panel as shown. Part 91-15A. Shipping weight 5 Lbs. \$4.95†

INCLUDING NEW  
EXCISE TAX†  
(Less Cabinet)  
Shpg. Wt. 12 Lbs.

## HEATHKIT VFO KIT

You can go VFO for less than you might expect. Here is a variable frequency oscillator that covers 160, 80, 40, 20, 15, 11, and 10 meters with three basic oscillator frequencies, that sells for less than \$20. Provides better than 10 volt average RF output on fundamentals. Plenty of drive for most modern transmitters. Requires a power source of only 250 VDC at 15 to 20 ma. and 6.3 VAC at 0.45A. Incorporates a regulator tube for stability. Illuminated frequency dial reads frequency directly on the band being employed. Temperature-compensated capacitors offset coil heating.

**MODEL VF-1**

**\$19<sup>50</sup>**

Shpg. Wt. 7 Lbs.

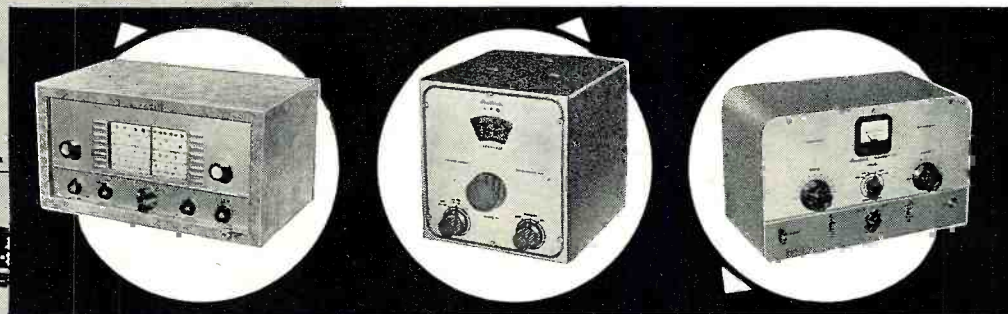

## EASY ON THE BUDGET!

You can buy Heathkits on an easy time-payment plan that provides a full year to pay. Write for complete details and special order blank.



**HEATH COMPANY**  
A Subsidiary of Daystrom, Inc.  
**BENTON HARBOR 15, MICH.**

## HEATHKIT CW TRANSMITTER KIT

This is the original low-priced Heathkit CW transmitter. Its reliable performance has been proven time and time again on the CW bands. Designed for crystal control, the Model AT-1 covers 80, 40, 20, 15, 11, and 10 meters. May be excited from external VFO. Plate power input up to 30 watts. Power supply built in. Panel meter indicates grid current or plate current for final. Incorporates pre-wound coils, copper-plated chassis, built-in line filter, profuse shielding, and top-quality parts throughout. Crystal socket and key jack on front panel. Built-in key-click filter, and single-knob bandswitching. 52-ohm coaxial output. Uses 6AG7 oscillator-multiplier, 6L6 power amplifier-doubler, and 5U4G rectifier.

**MODEL AT-1**

**\$29<sup>50</sup>**

Shpg. Wt. 15 Lbs.



### DOLLAR-SAVING ECONOMY . . .

There would be no particular achievement in selling inexpensive merchandise at a low price—although it is being done every day. However, there is something to crow about when, through tremendous purchasing power and factory-to-you distribution, Heath Company can offer top-quality equipment, using name-brand components, at such low prices. This is real economy, as opposed to the so-called "bargains". Needless to say, there is a big difference.

## HEATHKIT PHONE AND CW

# Transmitter Kit

- \* 6146 final amplifier for full 65-watt plate power input.
- \* Phone and CW operation on 80, 40, 20, 15, 11, and 10 meters. Pi network output coupling.
- \* Switch selection of three crystals — provision for external VFO excitation.



MODEL DX-35

**\$56<sup>95</sup>** Shpg. Wt. 24 Lbs.

The DX-35 features a 6146 final amplifier to provide 65 watts plate power input on CW, with controlled carrier modulation peaks up to 50 watts on phone. In addition, it is a most attractive transmitter. Modulator and power supplies are built-in, and the rig covers 80, 40, 20, 15, 11, and 10 meters with a single band-change switch. Pi network output coupling provided for matching various antenna impedances. A 12BY7 buffer stage provided ahead of the final amplifier for plenty of drive on all bands. 12BY7 oscillator and 12AU7 modulator. Provision for switch selection of three different crystals. Crystals reached through access door at rear. Front panel controls marked "off-CW-stand-by-phone", "final tuning", "antenna coupling", "drive level control", and "band change switch". Panel meter indicates final grid current or final plate current. A perfect low-power transmitter both for the novice, and for the more experienced operator. A remarkable power package for the price. Incidentally, the price includes tubes, and all other components necessary for assembly. As with all Heathkits, comprehensive instruction manual assures successful assembly.

### HEATHKIT ANTENNA IMPEDANCE METER KIT

This instrument employs a 100 microampere panel meter and covers the impedance range of 0-600 ohms for RF tests. Functions up to 150 mc. Used in conjunction with signal source, such as the Heathkit Model GD-1B grid dip meter, the Model AM-1 will determine antenna resistance and resonance, match transmission lines for minimum standing wave ratio, determine receiver input impedance, etc. Will also double as a phone monitor. A very valuable device for many uses in the ham shack.

MODEL AM-1

**\$14<sup>50</sup>**

Shpg. Wt. 2 Lbs.

### HEATHKIT "Q" MULTIPLIER KIT

The QF-1 functions with any receiver with an IF frequency between 450 and 460 kc that is not AC-DC type. Operates from the receiver power supply, requiring only 6.3 VAC at 300 ma. and 150 to 250 VDC at 2 ma. Simple to connect with cable and plugs supplied. Provides additional selectivity for separating two signals, or will reject one signal and eliminate heterodyne. A big help on crowded bands. Provides an effective Q of approximately 4,000 for sharp "peak" or "null". Tunes to any signal within the IF bandpass of the receiver, without changing main receiver tuning dial.

MODEL QF-1

**\$9<sup>95</sup>**

Shpg. Wt. 3 Lbs.

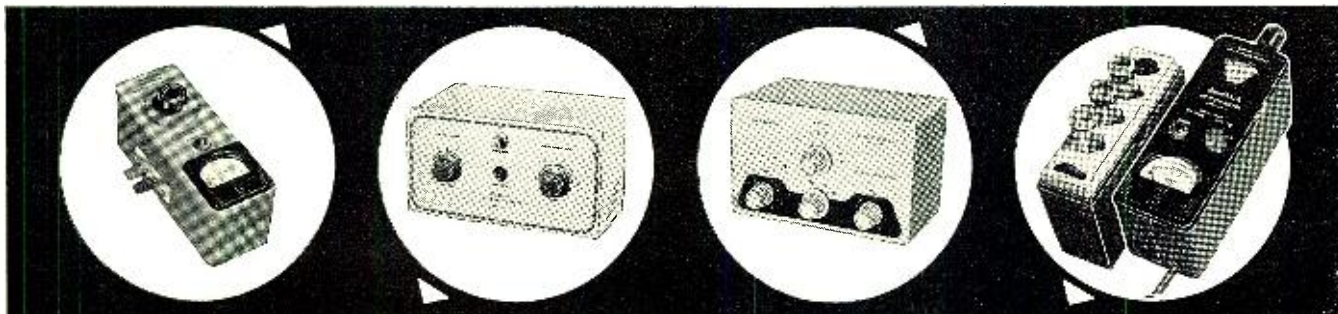

### HEATHKIT ANTENNA COUPLER KIT

This device is designed to match the Model AT-1 transmitter to a long-wire antenna. In addition to impedance matching, this unit incorporates an L-type filter which attenuates signals above 36 megacycles, thereby reducing TVI. Designed for 52 ohm coaxial input. Handles power up to 75 watts, 10 through 80 meters. Uses a tapped inductor and variable capacitor. Neon RF indicator on front panel. Copper-plated chassis—high quality components throughout—simple to build. Eliminates waste of valuable communications power due to improper matching. A "natural" for all AT-1 transmitter owners.

MODEL AC-1

**\$14<sup>50</sup>**

Shpg. Wt. 4 Lbs.

### HEATHKIT GRID DIP METER KIT

The grid dip meter was originally designed for the ham shack. However, its use has been extended into the service shop and laboratory. Continuous frequency coverage from 2 mc to 250 mc with pre-wound coils. 500 microampere panel meter employed for indication. Use for locating parasitics, neutralizing, determining RF circuit resonant frequencies, etc. Coils are included with kit, as is a coil rack. Front panel controls include sensitivity control for meter, and phone jack for listening to zero-beat. Will also double as an absorption-type wavemeter.

MODEL GD-1B

**\$19<sup>95</sup>**

Shpg. Wt. 4 Lbs.

## HEATHKIT BROADCAST BAND



**MODEL BR-2**

(Less Cabinet)

Shpg. Wt. 10 Lbs.

**\$19<sup>25</sup>**

INCLUDING NEW  
EXCISE TAX\*

### ATTENTION BEGINNERS . . .

This kit is an ideal "first project" if you have never built a Heathkit before. A good chance to "learn by doing."

- \* Miniature tubes and high-gain IF transformer.
- \* 5½-inch PM speaker.
- \* Rod-type built-in antenna. Good sensitivity and selectivity.
- \* Provision for phono jack.
- \* Transformer - operated power supply.

## Receiver Kit

You need no previous experience in electronics to build this table-model radio. The Model BR-2 receiver covers 550 kc to 1620 kc and features good sensitivity and selectivity over the entire band. A 5½" PM speaker is employed, along with high gain miniature tubes and a new rod-type built-in antenna. Provision has been made in the design of this receiver for its use as a phonograph amplifier. The phono jack is located on the back chassis apron. A transformer operated power supply is featured for safety of operation, as opposed to the usual AC-DC supply commonly found in "economy radio kits." Don't let the low Heathkit price deceive you. This is the kind of set you will want to show off to your family and friends after you have finished building it.

Construction of this radio kit is very simple. Giant size pictorial diagrams and detailed step-by-step instructions assure your success. The construction manual also includes an explanation of basic receiver circuit theory so you can "learn by doing" as the receiver is built. The manual even provides information on resistor and capacitor color codes, soldering techniques, use of tools, etc. If you have ever had the urge to build your own radio receiver, the outstanding features of this popular Heathkit deserve your attention.

**CABINET:** Proxilyn impregnated fabric covered plywood cabinet available for the BR-2 receiver as shown. Complete with aluminum panel, reinforced speaker grill, and protective rubber feet. Shipping weight 5 lbs., part No. 91-9A. . . . . \$4.95\*

### HEATHKIT PROFESSIONAL RADIATION COUNTER KIT

This sensitive and reliable instrument has already found extensive application in prospecting, and also in medical and industrial laboratories. It offers outstanding performance at a reasonable price. Front-panel meter indicates radiation level, and oral indication produced by panel-mounted speaker. Meter ranges are 0-100, 600, 6,000 and 60,000 counts per minute, and 0-.02, .1, 1 and 10 milliroentgens per hour. The probe, with expansion cord, employs type 6306 bismuth counter tube, sensitive to both beta and gamma radiation. It is simple to build, even for a beginner.

MODEL RC-1

**\$79<sup>95</sup>**

Shpg. Wt. 8 Lbs.

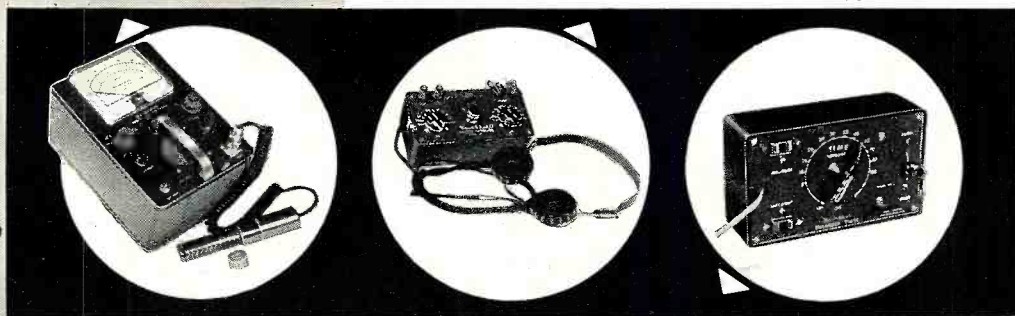

### HEATHKIT CRYSTAL RECEIVER KIT

The crystal radio of Dad's day is back again, but with big improvements! The Model CR-1 employs a sealed germanium diode, eliminating the critical "cat's whisker" adjustment. It is housed in a compact plastic box, and features two Hi-Q tank circuits, employing ferrite core coils and variable air tuning capacitors. The CR-1 covers the standard broadcast band from 540 kc to 1600 kc, and no external power is required for operation. Could prove valuable for emergency signal reception. This easy-to-build kit is a real "learn by doing" experience for the beginner, and makes an interesting project for all ages.

MODEL CR-1

**\$8<sup>75</sup>**

INCLUDING NEW  
EXCISE TAX\*  
Shpg. Wt. 3 Lbs.

- \* Amazing new circuit for high efficiency.

- \* Compact, portable and rugged.
- \* Stable circuit requires only one 67½ volt "B" battery and two 1½ volt "A" batteries.

### HEATHKIT ENLARGER TIMER KIT

The Model ET-1 is an easy-to-build device for use by amateur or professional photographers in controlling the timing cycle of an enlarger. It covers the range of 0 to 1 minute with a continuously variable, clearly calibrated scale. The timing period is pre-set, and the timing cycle is initiated by depressing the spring-return switch to the "print" position. Front panel provision is made for plugging in the enlarger and a safelight. The safelight is automatically turned "on" when the enlarger is "off". Handles up to 350 watts. The timing cycle is controlled electronically for maximum accuracy and reliability. Very simple to build in only one evening, even by a beginner.

MODEL ET-1

**\$11<sup>50</sup>**

Shpg. Wt. 3 Lbs.

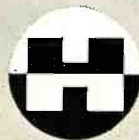

**HEATH COMPANY**  
A Subsidiary of Daystrom, Inc.  
BENTON HARBOR 15, MICH.

**HEATHKIT HIGH FIDELITY**

# Preamplifier Kit

## COMPREHENSIVE INSTRUCTIONS . . .

The step-by-step assembly instructions provided with each Heathkit are the finest available anywhere. Each manual begins at the beginning, and assumes no previous training or experience on the part of the kit builder. This means that our kits can be built successfully by anyone who can follow instructions. As a matter of fact, new manuals are tested by having the kit built by someone in our office who has had no previous experience in electronics. This is your guarantee of complete and thorough instruction material.

- \* 5 switch-selected inputs, each with its own level control.
- \* Equalization for LP, RIAA, AES, and Early 78's.
- \* Separate bass and treble tone controls, and special hum control.
- \* Clean, modern lines and satin-gold enamel finish.

Literally thousands of these preamplifiers are in use today, because the kit meets or exceeds specifications for the most rigorous high-fidelity applications, and will do justice to the finest available program sources. Provides a total of 5 inputs, each with individual level controls (three high-level and two low-level). Frequency response is within 1 DB from 25 CPS to 30,000 CPS, or within 1½ DB from 15 CPS to 35,000 CPS. Hum and noise are extremely low, with special balance control for absolute minimum hum level. Tone control provides 18 DB boost and 12 DB cut at 50 CPS, and 15 DB boost and 20 DB cut at 15,000 CPS. Cabinet measures only 12-9/16" W. x 3¾" H. x 4¾" D, and it is finished in beautiful satin-gold enamel. 4-position turnover and 4 position roll-off controls provide "LP," "RIAA," "AES," and "early 78" equalization, and 8, 12, 16, and 1 flat position for roll-off. Derives operating power from the main amplifier, requiring only 6.3 VAC at 1 ampere and 300 VDC at 10 MA. Easy to construct from step-by-step instructions and pictorial diagrams provided.

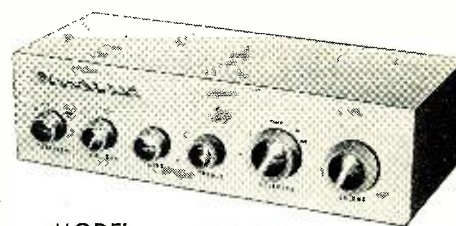

MODEL (With Cabinet)  
WA-P2 Shpg. Wt. 7 Lbs.

**\$19.75**

## HEATHKIT HIGH FIDELITY FM TUNER KIT

- \* Illuminated slide-rule dial covers 88 to 108 MC.
- \* Modern circuit emphasizes sensitivity and stability.
- \* Housed in attractive satin-gold cabinet to match WA-P2 and BC-1.

This amazing new FM tuner can provide you with real high-fidelity performance at an unbelievably low price level. Covering 88 to 108 MC, the modern circuit features a stabilized, temperature-compensated, oscillator, A.G.C., broadbanded

IF circuits, and better than 10 UV sensitivity for 20 DB of quieting. A high gain, cascaded, RF amplifier is used ahead of the mixer to increase overall gain and reduce oscillator leakage. It employs a ratio detector for high efficiency without sacrifice in high-fidelity performance. IF and ratio transformers are pre-aligned, as is the front end tuning unit. This means the kit can be constructed by a beginner, without elaborate test and alignment equipment. The FM-3A is designed to match the WA-P2 preamplifier and the BC-1 AM MODEL FM-3A

**\$26.95**  
INCLUDING NEW  
EXCISE TAX\*  
(With Cabinet)  
Shpg. Wt. 7 Lbs.

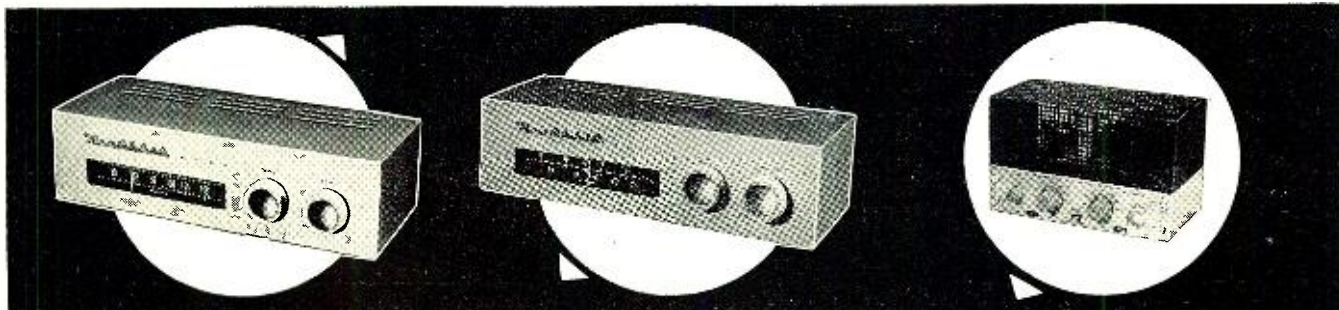

## HEATHKIT BROADBAND AM TUNER KIT

This AM tuner has been designed especially for high-fidelity applications. It incorporates a low-distortion detector, a broadband IF, and other features essential to usefulness in high-fidelity. Special voltage-doubler detector employs crystal diodes for low distortion. Sensitivity and selectivity are excellent. Audio response is ± 1 DB from 20 CPS to 2 kc, with 5 DB of pre-emphasis at 10 kc to compensate for station roll-off. Covers the standard broadcast band from 550 to 1600 kc. Incorporates a 10 kc whistle-filter and provides a 6 DB signal-to-noise ratio at 2.5 UV. RF and IF coils are pre-aligned, and power supply is built-in. Incorporates AVC, two outputs, and two antenna inputs.

MODEL BC-1  
**\$26.95**  
INCLUDING NEW  
EXCISE TAX\*  
(With Cabinet)  
Shpg. Wt. 8 Lbs.

## HEATHKIT ELECTRONIC CROSS-OVER KIT

This unusual device functions to separate low frequencies and high frequencies so that they may be fed to separate amplifiers and to separate speakers. This eliminates the need for conventional cross-over circuits, since the Model XO-1 does the complete job electronically. Cross-over frequencies of 100, 200, 400, 700, 1,200, 2,000 and 35,000 CPS are selectable with front panel controls on the XO-1, and a separate level control is provided for each channel. Minimizes inter-modulation distortion problems. Handles unlimited power, since frequency division is accomplished ahead of the power stage. Attenuation is 12 DB per octave, with sharp "knee" at cut-off frequency.

MODEL XO-1  
**\$18.95**  
Shpg. Wt. 6 Lbs.

## HEATHKIT ADVANCED-DESIGN



**MODEL W-5M**

Shpg. Wt. 31 Lbs.  
Express Only

**\$59<sup>75</sup>**

### MODEL W-5

Consists of Model W-5M plus Model WA-P2 pre-amplifier.

Shpg. Wt. 38 Lbs.  
Express only.... \$79.50

- \* Full 25 watt output with KT-66 output tubes.
- \* All connectors brought out to front chassis apron.
- \* Protective cover over all above-chassis components.

### HEATHKIT DUAL-CHASSIS—WILLIAMSON TYPE HIGH FIDELITY AMPLIFIER KIT

This 20-watt high-fidelity amplifier employs the famous Acrosound Model TO-300 "ultra-linear" output transformer and uses 5881 output tubes. The power supply is built on a separate chassis, and the two chassis are inter-connected with a power cable. This provides additional flexibility in mounting. Frequency response is  $\pm 1$  DB from 6 CPS to 150 kc at 1 watt. Harmonic distortion is only 1% at 21 watts, and IM distortion is only 1.3% at 20 watts. (60 and 3,000 CPS). Output impedance is 4, 8, or 16 ohms. Hum and noise are 88 DB below 20 watts. A very popular high-fidelity unit employing top-quality components throughout.

MODEL W-3M: Shpg. Wt. 29 Lbs. Express only..... \$49.75

MODEL W-3: Consists of Model W-3M plus Model WA-P2 pre-amplifier. Shpg. Wt. 37 Lbs. Express only..... \$69.50

### HEATHKIT 7-WATT AMPLIFIER KIT

This amplifier is more limited in power than other Heathkit models, but it still qualifies as a high-fidelity unit, and its performance definitely exceeds that of many so-called "high-fidelity" phonograph amplifiers. Using a tapped-screen output transformer of new design, the Model A-7D provides a frequency response of  $\pm 1\frac{1}{2}$  DB from 20 to 20,000 CPS. Total distortion is held to a surprisingly low level. Output stage is push pull, and separate bass and treble tone controls are provided. Shpg. Wt. 10 Lbs.

MODEL A-7E: Similar to the A-7D, except that a 12SL7 tube has been added for pre-amplification. Two inputs, RIAA compensation, and extra gain.

MODEL A-7D

**\$18<sup>65</sup>**

INCLUDING NEW EXCISE TAX\*

\$20.35\*

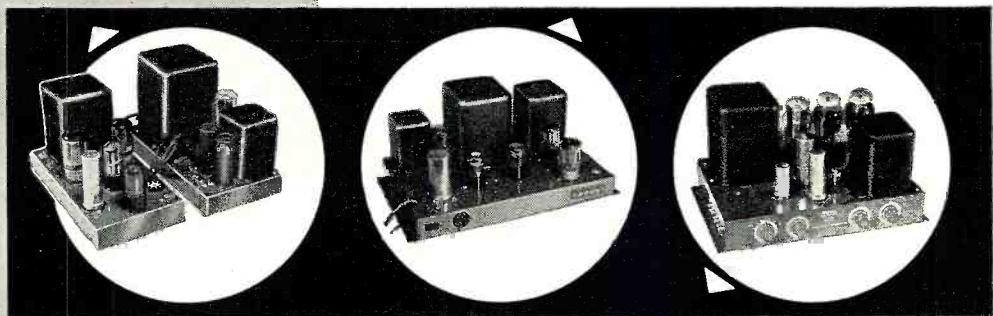

## HIGH FIDELITY

# Amplifier Kit

This 25 watt unit is our finest high-fidelity amplifier. Using a special design peerless output transformer, and KT-66 output tubes by Genalex, the Model W-5M provides performance characteristics unsurpassed at this price level. Frequency response is  $\pm 1$  DB from 5 to 160,000 CPS at 1 watt. Harmonic distortion is less than 1% at 25 watts and 1M distortion is less than 1% at 20 watts (60 and 3,000 CPS, 4 to 1). Hum and noise are 99 DB below 25 watts. Damping factor is 40 to 1. Input voltage for 5 watts output is 1 volt. Tubes employed are a pair of 12AU7's, a pair of KT-66's and a 5R4GY rectifier. Measures 13-3/32" W. x 8 1/2" D. x 8 1/4" H. Output impedance is 4, 8, or 16 ohms. Featured, also, is the "tweeter saver" which suppresses high frequency oscillation, and a new type balancing circuit requiring only a voltmeter for indication. This balance is easier to adjust, and results in a closer "dynamic" balance between output tubes. The Model W-5M provides improved phase shift characteristics, reduced IM and harmonic distortion, and improved frequency response. Conservatively rated high-quality components are used throughout to insure years of trouble-free operation. No technical background or training is required for assembly. Step-by-step instructions are provided for every stage of construction, and large pictorial diagrams illustrate exactly where each wire and component is to be placed. An amplifier for music lovers who can appreciate subtle differences in performance. Just ask the audiophile who owns one!

### HEATHKIT SINGLE CHASSIS—WILLIAMSON TYPE HIGH FIDELITY AMPLIFIER KIT

The 20-watt Model W-4AM Williamson type amplifier is a tremendous high-fidelity bargain. Combining the power supply and main amplifier on one chassis, and using a special-design output transformer by Chicago Standard brings you savings without a sacrifice in quality. Employing 5881 output tubes, the frequency response of the W-4AM is  $\pm 1$  DB from 10 CPS to 100 kc at 1 watt. Harmonic distortion is only 1.5% at 20 watts. Output impedance is 4, 8, or 16 ohms. Hum and noise are 95 DB below 20 watts.

MODEL W-4AM: Shpg. Wt. 28 Lbs. Express only..... \$39.75

MODEL W-4A: Consists of Model W-4AM plus Model WA-P2 pre-amplifier. Shpg. Wt. 35 Lbs. Express only..... \$59.50

### HEATHKIT 20-WATT HIGH FIDELITY AMPLIFIER KIT

This high-fidelity amplifier features full 20-watt output using push pull 6L6 tubes. Built-in preamplifier provides 4 separate inputs, selected by a panel-mounted switch. It has separate bass and treble tone controls, each offering 15 DB boost and cut. Output transformer is tapped at 4, 8, 16, and 500 ohms. Designed primarily for home installations, but also used extensively for public address applications. True high-fidelity performance with frequency response of  $\pm 1$  DB from 20 CPS to 20,000 CPS. Total harmonic distortion only 1% (at 3 DB below rated output).

MODEL A-9B

**\$35<sup>50</sup>**

Shpg. Wt. 23 Lbs.



**HEATH COMPANY**

A Subsidiary of Daystrom, Inc.

BENTON HARBOR 15, MICH.

All prices marked with a ‡ include a 10% federal excise tax that now applies to receivers, tuners and some amplifiers, even though they may be in kit form. Since the tax is in effect as of July 5, 1956, we have no choice but to reflect it in our kit prices. This note is just to let you know we are not increasing our prices on some kits, but merely including this new tax in them.

Thank you,  
HEATH COMPANY

HEATHKIT HIGH FIDELITY

Range Extending  
SPEAKER SYSTEM KIT

- \* High quality speakers of special design — 15" woofer and compression-type super-tweeter.
- \* Easy-to-assemble cabinet of furniture-grade plywood.
- \* Attractively styled to fit into any living room.
- \* Matches Model SS-1.

This range extending unit is designed especially for use with the Model SS-1 speaker system. It consists of a 15" woofer, providing output between 35 and 600 CPS, and a compression-type super-tweeter that provides output between 4,000 and 16,000 CPS. Cross-over frequencies are 600, 1,600, and 4,000 CPS. The SS-1 provides the mid-range, and the SS-1B extends the coverage at both ends of the spectrum. Together, the two speaker systems provide output from 35 to 16,000 CPS within  $\pm 5$  DB. This easy-to-assemble speaker enclosure kit is made of top-quality furniture-grade plywood. All parts are pre-cut and pre-drilled, ready for assembly and the finish of your choice. Complete step-by-step instructions are provided for quick assembly by one not necessarily experienced in woodworking. Coils and capacitors for proper cross-over network are included, as is a balance control for super-tweeter output level. The SS-1 and SS-1B can provide you with unbelievably rich audio reproduction, and yet these units are priced reasonably. The SS-1B measures 29" H. x 23" W. x 17½" D. The speakers are both special-design Jensens, and the power rating is 35 watts. Impedance is 16 ohms.



MODEL  
SS-1B

**\$99<sup>95</sup>**

Shpg. Wt. 80 Lbs.

HEATHKIT HIGH FIDELITY SPEAKER SYSTEM KIT



MODEL  
SS-1

**\$39<sup>95</sup>**

Shpg. Wt. 30 Lbs.

This speaker system is a fine reproducer in its own right, covering 50 to 12,000 CPS within  $\pm 5$  DB. However, the story does not end there. Should you desire to expand the system later, the SS-1 is designed to work with the SS-1B range extending unit — providing additional frequency coverage at both ends of the spectrum. It can fulfill your present needs, and still provide for the future. The SS-1 uses two Jensen speakers; an 8" midrange-woofer, and a compression-type tweeter. Cross-over frequency is 1,600 CPS, and the system is rated at 25 watts. Nominal impedance is 16 ohms. The cabinet is a ducted-port bass-reflex type. Attractively styled, the Model SS-1 features a broad "picture-frame" molding that will blend with any room decorating scheme. Pre-cut and pre-drilled wood parts are of furniture grade plywood. The kit is easy-to-build, and all component parts are included, along with complete step-by-step instructions for assembly. Can be built in just one evening, and will provide you with many years of listening enjoyment thereafter.

- \* Special design ducted-port, bass-reflex enclosure.
- \* Two separate speakers for high and low frequencies.
- \* Kit includes all parts and complete instructions for assembly.

HEATH COMPANY A Subsidiary of Dayton, Inc. BENTON HARBOR 15, MICH.

ORDER  
BLANK

NOTE: All prices subject to change without notice.

Enclosed find ( ) check ( ) money order for  
Please ship C.O.D. ( ) postage enclosed for \_\_\_\_\_ pounds.

On Express orders do not include transportation charges — they will be collected by the express agency at time of delivery.

ON PARCEL-POST ORDERS include postage for weight shown. ORDERS FROM CANADA and APO'S must include full remittance.

Name \_\_\_\_\_

Address \_\_\_\_\_

City & Zone \_\_\_\_\_ State \_\_\_\_\_

(PLEASE PRINT)

SHIP VIA

- Parcel Post
- Express
- Freight
- Best Way

QUANTITY	ITEM	MODEL NO.	PRICE

# KLEIN

THE THRILL THAT  
ONLY GOOD TOOLS  
CAN GIVE



The radio ham, serviceman or designer knows that the most important tools in his kit are Klein Pliers—long nose, oblique cutters, side cutters.

The quality of the work you do depends in no small measure on the quality of the tools you use. Your reputation as a craftsman is protected when your pliers carry the Klein trademark.



Write for your FREE copy of the Klein Pocket Tool Guide listing Klein equipment and giving valuable information.

Mathias **KLEIN** & Sons  
Established 1857 Chicago, Ill., U.S.A.  
7200 McCORMICK ROAD • CHICAGO 45, ILLINOIS

# A Two-Tube Binaural Receiver

By JAMES J. BROPHY

Build this inexpensive, two-tube receiver which provides an interesting "3-D" effect with AM-FM station simulcasts.

IN MANY cities regularly scheduled stereophonic sound programs are broadcast over standard AM stations for one channel and the station's FM affiliate for the other channel. Program listings in the local newspaper generally identify these broadcasts. Using such program material, the experimenter can easily experience the thrill of "3-D" sound with simple equipment costing far less than the two-channel tape systems now becoming popular.

Standard AM and FM receivers can be used if they are placed several feet apart facing the listener. For the maximum effect, however, earphones should really be used so that each ear

hears only one channel. If one does not care to provide earphone outputs on his receivers, the simple two tube set diagrammed can be constructed. While it is far from high fidelity, the "presence" generated by the stereophonic effect must be heard to be fully appreciated.

Wearing an inexpensive magnetic headset (ours dates from crystal set days), the listener can literally "point" to the various solo instruments in an orchestra, notice that the string section is down front, while the percussion group is in the rear, etc. Occasionally one gets the feeling that he is sitting in the middle of the orchestra itself. If the headset is reversed left

Complete schematic of receiver designed to be used with magnetic headphones to provide a true binaural effect. Author built his receiver using available junk box parts.

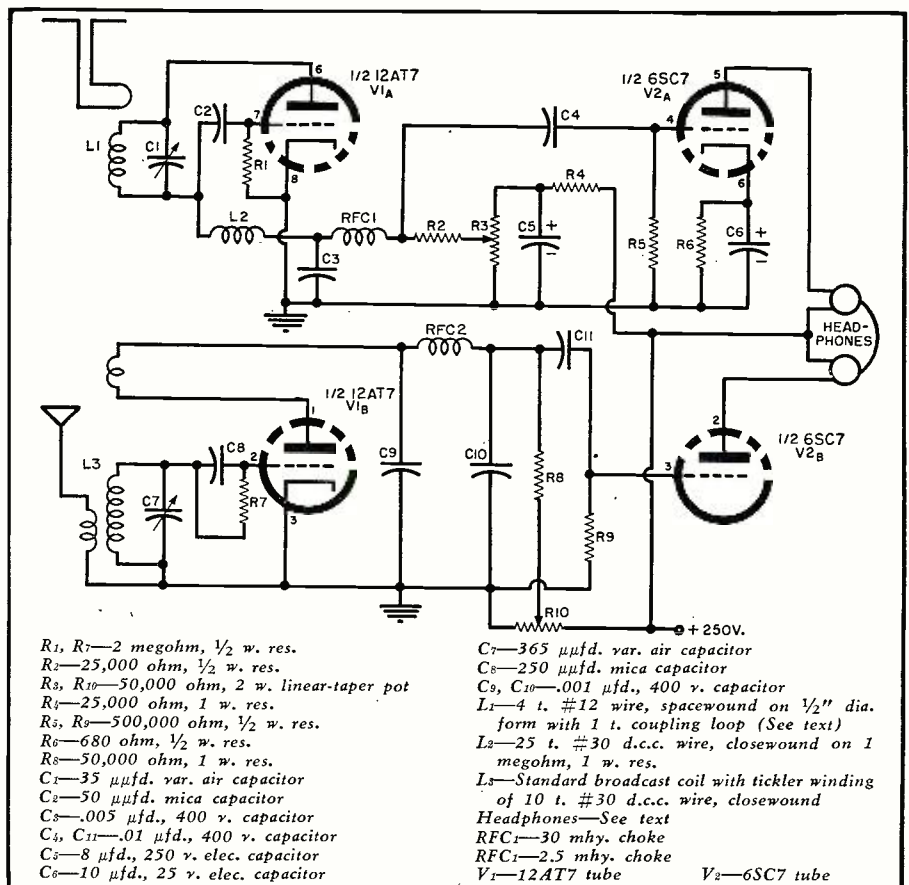

to right, the relative positions of the various instruments interchange. This "presence" effect gives the simple system a high-fidelity sound it can't possibly have.

As shown in the circuit diagram, the receiver employs a superregenerative slope detector for FM and a regenerative receiver for AM, each followed by a single stage of audio amplification. Dual triodes are used, so that the tube complement totals two, exclusive of power supply. The circuit is quite non-critical and reasonable departures from components and tube types given are permissible. Our set was constructed in its entirety from parts supplied by the junk box.

The circuit is conventional in every respect, except perhaps for the use of both a regenerative and superregenerative detector in the same envelope. We used this arrangement out of curiosity to see how well it might work and absolutely no difficulty was encountered. There is no apparent interaction between the two detectors and no interference between them. Obviously, separate tubes could be used to simplify the parts layout problem somewhat.

Superregeneration is controlled by variation of plate voltage of the detector. Some adjustment of the one-turn antenna coupling loop should be made to make this control operate smoothly. The set can be spotted in the FM band by squeezing or stretching the self-supporting coil. As usual, r.f. leads should be kept as short as possible, but all other wiring may be any convenient length. An outdoor dipole antenna is recommended for best results.

Plate feedback in the regenerative detector is supplied by a tickler winding on a standard broadcast coil. As usual, the proper polarity of feedback voltage must be obtained in order to make the detector oscillate. The tickler connections should be interchanged if proper operation is not achieved on the first try. Here, again, plate voltage variation controls regeneration. A short outside antenna will be sufficient in most instances.

The audio stages require little comment other than that magnetic earphones must be used in order to provide a d.c. path for the plate current. Individual volume controls in the grid circuits may be desirable to balance the sound levels of the two channels, but the regeneration controls accomplish this reasonably well. Another frill might be a switching arrangement in the outputs so that one could listen to either channel with both ears. Comparison of the effect obtained in this case with that given by the stereophonic connection is most remarkable.

Demonstration of this little set to both technical and non-technical listeners generally elicits some comment as "how can all that music come from two tubes?" The slight effort required to construct the receiver is more than repaid the first time the "3-D" effect is heard.

-30-

# TECHNICIANS

*Do your plans  
for a career include...*

- *Challenging work in electronics?*
- *An opportunity to grow in an expanding organization?*
- *A long established company?*

## **BELL TELEPHONE LABORATORIES**

... a leader in communications research and development now has openings for qualified technical aides in the fields of:

- **Communications**
- **Fire Control**
- **Radar**
- **Apparatus Development**
- **Computing Systems**
- **Guided Missiles**
- **Data Systems**
- **Specification Writing**

...and many others

## **CHECK THESE BENEFITS**

- *2 weeks paid vacation each year; 3 weeks starting with 15 years of service*
- *Liberal sickness benefits*
- *Company paid pensions*
- *Finest of facilities and equipment*
- *Recreational programs*
- *5-day normal work week*
- *Customary holidays*
- *Moving expense allowance*

If you have had a good basic science training at high school; applicable schooling in a technical institute, armed services school, or equivalent; and preferably 2 or more years of applicable industrial or military experience...

*Please send resume, phone or wire to*

Bell Telephone Laboratories  
General Employment Department R  
Mountain Avenue - Murray Hill, N. J.

You will be considered for openings at all of our laboratory locations including Whippany, N. J., New York, N. Y., Massachusetts, Pennsylvania, Maryland, Indiana and North Carolina.

**PLEASE STATE LOCATIONAL PREFERENCE**

## **BELL TELEPHONE LABORATORIES**

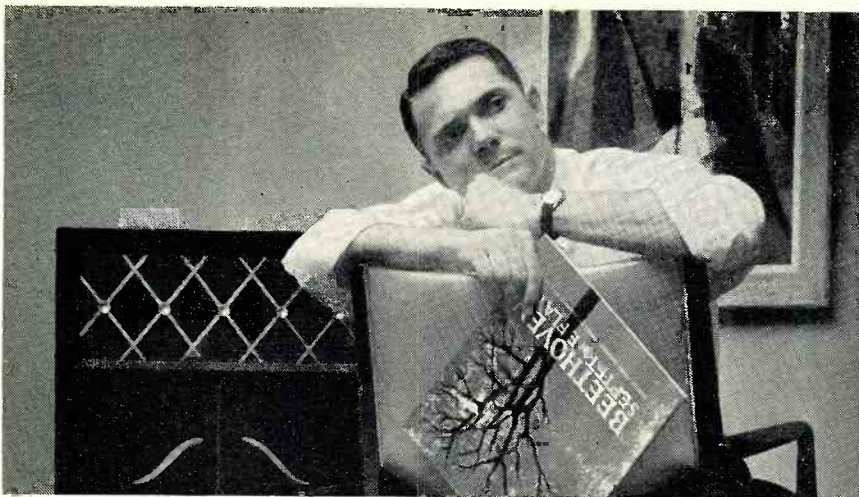

**Mac's Service Shop**  
(Continued from page 77)

emery-board in their purses for filing their nails that will cut faster than this sad thing. From what I've seen of your work, you guys should have a complete set of new and sharp flat, round, three-cornered, knife, and rat-tail files."

As he finished speaking, he absent-mindedly tossed the file into the trash barrel, for his eye had already lighted on the cheap hacksaws in the bottom of the drawer. He lifted them out and ran a critical and practiced finger along the teeth.

"Wouldn't cut hot butter," he muttered. "With a saw like that you don't cut something in two, you just rub it in two. From the size of the bill I get when I have my TV set worked on, I assume you fellows count your time as being worth something. Well, if it is, get yourself a really good hacksaw and keep sharp blades in it. You will save time for yourself and your customer, and still more important, you will get the satisfaction any mechanic worth his salt feels when he works with good tools."

The hacksaws were dropped into the trash barrel, too.

Mac watched his brother with an amused grin.

"Really pouring it on, aren't you, Paul?" he said with a chuckle. "And the heck of it is that I have nothing I can say in my own defense. I know that the hand tools we have are inadequate and in rather poor condition. At one time they were all right, but we've carelessly let them run down without replacing them. I guess the whole trouble is that we're just too electronic-minded. If a signal generator drifts off calibration, we're on it like a shot to bring it back to where it belongs; and if the scope develops a little trouble, everything comes to a grinding halt until it is working all right again. But for some reason it's hard for me to bear in mind that it's just as important to keep up one's hand tools as it is to keep up the test equipment."

"I know how it is," Paul admitted. "On my bench at the garage you'll still find a clumsy old-fashioned soldering iron instead of one of those handy solder guns you fellows use; and while I was talking I was making up my mind to buy one of those meters you use to measure a.c. or d.c. voltages or resistance. It will soon pay for itself if I only use it as a continuity meter for running down troubles in car wiring."

"Yes," Mac agreed, "I can imagine you would find a lot of uses for a good volt-ohmmeter around a garage."

"But getting back to your problems," Paul went on, "you ought to have a good little drill press sitting over there on the end of the bench. I know you've got electric hand drills, and they serve your purposes most of the time; but there surely are lots of

## Only planned high fidelity can give you true high fidelity!

Putting together a hi-fi system for your home *can be simple*—and it probably will cost a lot less than you think! Here at MusiCraft we offer the kind of information and guidance that will help you get started right and avoid mistakes.

As you may know, possible combinations of components are practically

limitless. We're happy to help you choose what will best suit your home and your budget. You can start small and add as you wish.

Stop in at MusiCraft soon or write us for further information. Let us help you plan the *kind* of high fidelity system that will give you *true* high fidelity.

Send your name and address if you would like to be on our mailing list for our announcements. Would you like a free copy of "Understanding High Fidelity"?



If you want to "build-it-yourself" and save—MusiCraft has a complete line of component parts in stock. The step-by-step directions are easy to follow—and you can feel free to call on us for any technical assistance you may need.

# MusiCraft

48 East Oak Street • Chicago 11, Illinois • DElaware 7-4150

Lowest Prices • Largest Component Selections • Complete Custom Installation Service

## WANTED



WANT Coronet (illustrated), Double Bell Wonder, Victor Types A, D, and O, Monarch Special, and Improved Monarch. Also Edison Idelia, Excelsior, and Treadle Phonographs. Want early Bell-Tainter, American Gramophones, Multiphone, Multinola, Scott Magazine Phonograph, Peerless, Sovereign, Wizard Phonograph, Regina Hexaphone, and Graphophones. Also catalogues or old literature on phonos made prior to 1906. Want unusual machines and coin-in-slot cylinder phonographs.

**A few duplicate Edisons and graphophones are now available for sale or trade.**

Send clear snapshot and full information to  
Box 50  
RADIO & TELEVISION NEWS  
366 Madison Ave., New York 17, N. Y.

**Willing to pay cash for Early Phonographs with outside horns**



# A TRIUMPH OF TELEPHONE TECHNOLOGY

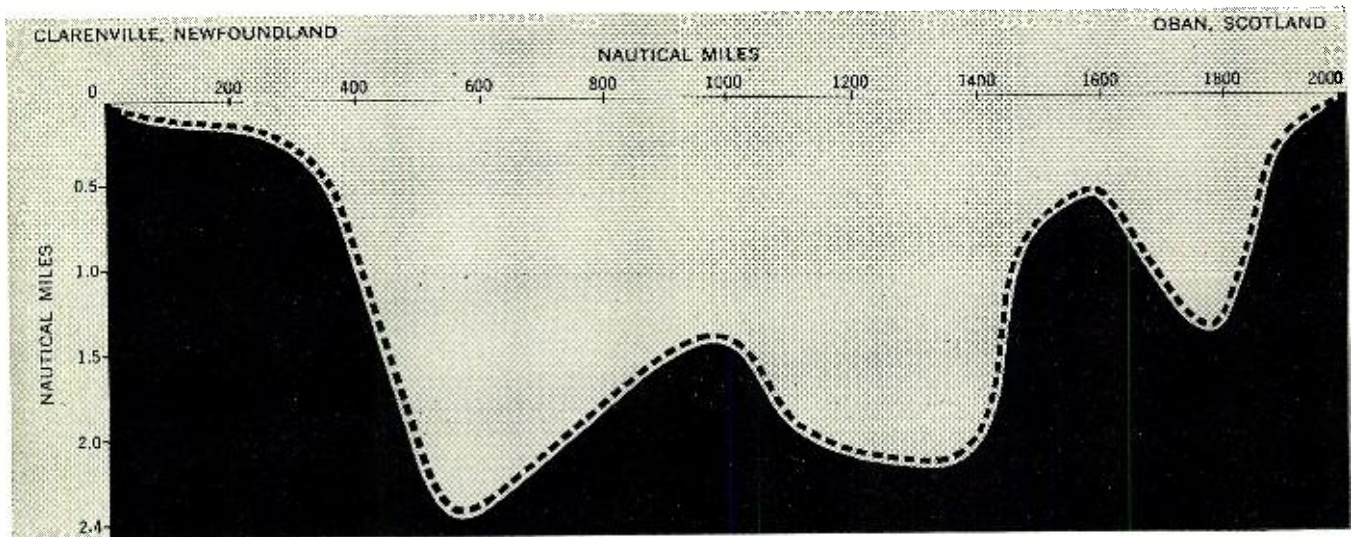

Contour of ocean bed where cable swiftly and clearly carries 36 conversations simultaneously. This is deep-sea part of system — a joint enterprise of the American Telephone and Telegraph Company, British Post Office and Canadian Overseas Telecommunications Corporation.

A great new telephone cable now links North America and Europe—the first transoceanic cable to carry voices.

To make possible this historic forward step in world communications, Bell Laboratories scientists and engineers had to solve formidable new problems never encountered with previous cables, which carry only telegraph signals.

To transmit voices clearly demanded a much wider

frequency band and efficient ways of overcoming huge attenuation losses over its more than 2000-mile span. The complex electronic apparatus must withstand the tremendous pressures and stresses encountered on the ocean floor, far beyond adjustment or servicing for years to come.

Here are a few of the key developments that made this unique achievement possible:

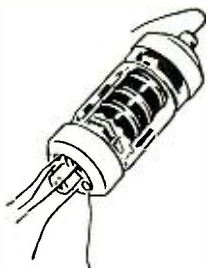

More than 300 electron tubes of unrivaled endurance operate continuously, energized by current sent from land.



Precisely designed equalizing networks and amplifiers compensate for the loss in the cable every 40 miles and produce a communication highway 144 kc. wide.



A unique triple watertight seal protects the amplifiers from pressures as high as 6500 pounds per square inch.

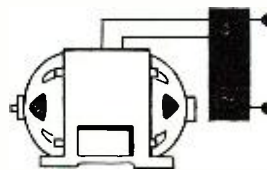

Power supplies of exceptional reliability send precisely regulated current along the same coaxial that carries your voice to energize the amplifying units.



**BELL TELEPHONE LABORATORIES**  
World center of communications research and development

ESPECIALLY FOR YOUR

# Christmas Package...

Leo. J. Meyerson  
WDCFO

## the new hallicrafters SX-101



Only  
**\$21<sup>53</sup>**  
PER MO.

Pay Just \$39.50 Down  
Cash Price: \$395.00

- ★ 7 ham bands on large slide rule dial; special 10 Mc. position for WWV; coverage of most MARS frequencies
- ★ Dual conversion receiver with exclusive Hallicrafters upper/lower sideband selection
- ★ Tee-notch filter
- ★ 50:1 tuning knob ratio
- ★ 5 steps of selectivity from 500-5,000 cycles
- ★ Illuminated, dual scale S-meter, functioning with AVC off
- ★ Direct coupled series noise limiter for improved operation and rectifier
- ★ 14 tubes plus voltage regulator and rectifier

OTHER HALLICRAFTER MODELS		
HT-30	\$26.98 per mo.	\$49.50 down
HT-31	21.53 per mo.	39.50 down
SX-100	16.08 per mo.	29.50 down
SX-99	11.92 per mo.	15.00 down
S-38D	5.00 per mo.	5.00 down

THE WORLD RADIO TRANSMITTERS		
WRL's Globe King (540 w. CW, AM, SSB)	\$36.78 per mo.	\$67.50 down
WRL's Globe Champ (300 w. CW, SSB, 250 fone)	\$21.75 per mo.	\$29.90 down
WRL's Globe Scout (65 w. CW, 55 w. fone)	\$7.95 per mo.	\$10.00 down
WRL's Globe Chief Kit (90 w. CW)	\$5.00 per mo.	\$5.00 down

Send for Our Latest Reconditioned Eqpt. List!

SAVINGS UP TO **50%**

**JUST OFF THE PRESS • NEW FREE 1957 CATALOG**  
Over 15,000 Bargains for the Amateur, experimenter, etc.  
Ask About WRL's new Globe King 500B, Globe Champ, Globe Chief



Please Rush Me:

Free Catalog, and info on items checked below:

SX-101     Other Hallicrafter Models

WRL's Xmtr. Series     Recond. Eqpt. List

Name: \_\_\_\_\_

Address: \_\_\_\_\_

City & State: \_\_\_\_\_

**a TERRIFIC BARGAIN in a**

**SOLA CONSTANT-VOLTAGE TRANSFORMER**  
Ends fluctuating line voltage!

**OVER 60% OFF...**

the factory price at a 1-input 2,000 VA unit! And here's another bonus! This Air Forces 2,000 VA overstock, Sola Cat. No. 30768, has 4 inputs! 90-125 V., 190-250 V., 60 cy. or 50 cy. Isolated secondary is constant 115.0 V. ± 1% from no-load to full-load of 17.4 amp. So, if you choose, use it as a 220-115 V. step-down. And slash \$147.50 off the factory 1-input price!

Brand new in original wood box. 4 **\$97.50**  
cu. ft. Ship. wt. 25.4 lbs. F.O.B. Pasco, Wash. Only

**THE M. R. COMPANY**  
P. O. Box 1220-A Beverly Hills, Calif.

**EASY TO LEARN CODE**

It is easy to learn or increase speed with an Instructograph Code Teacher. Affords the quickest and most practical method yet developed. For beginners or advanced students. Available tapes from beginner's alphabet to typical messages on all subjects. Speed range 5 to 40 WPM. Always ready—no QRM.

**ENDORSED BY THOUSANDS!**

The Instructograph Code Teacher literally takes the place of an operator-instructor and enables anyone to learn and master code without further assistance. Thousands of successful operators have "acquired the code" with the Instructograph System. Write today for convenient rental and purchase plans.

**INSTRUCTOGRAPH COMPANY**  
4711 SHERIDAN ROAD, CHICAGO 40, ILLINOIS

other occasions when a drill press would do a better job."

"Right again!" Mac agreed. "We're beginning to get into considerable custom installation of hi-fi systems, and that often calls for quite a bit of careful and precise panel drilling. If we had a drill press in which we could use hole saws, reamers, and so on, we could do faster, neater, easier work. We'll go down while you are here to help me pick out a good one and see what we can find. While we're down there, I think I'll buy your Christmas present a little in advance."

"What will it be?" Paul wanted to know.

"I think a new heavy-duty solder gun would just about fill the bill," Mac suggested.

"Well, what are we waiting on? Let's go!" Paul yelled.

### TV SETS IN PUERTO RICO

PUERTO Rico's two year old TV boom, with 130,000 sets now in use, is now big enough to justify local manufacture. Rico Electronics Inc., a Puerto Rican manufacturer of television parts, is currently investing \$200,000 in new machinery with the objective of meeting a major share of the island's growing picture tube replacement market.

The company expects the replacement market to reach an annual rate of 20,000 units by 1960 as television sets on the island climb to around 300,000. There are already 60,000 sets in San Juan, one for every two families in the metropolitan area. Although only 5100 new picture tubes were bought in 1955, a bumper crop is due by 1957 as many of the 130,000 sets now in operation require picture-tube replacement. Picture tubes generally require replacement after two to two and a half years. The average age of the sets on the island is 16 months.

Also important to the market is television "watching" time which is expected to rise sharply during the next 12 months as channels in operation increase from three to six.

Since 1952 Rico Electronics has been manufacturing electron guns on the island. Like other new manufacturers it does not pay federal taxes. The company is also completely exempt from Puerto Rican corporate income taxes for 10 years.

The new machinery, now being installed, will be used for screening, dagg-ing, evacuating, sealing, and testing picture tubes. Part of the present electron gun output will be absorbed in the picture tube operation.

The existing 12,000 square foot plant will continue to be used, but the work force will be increased from 80 to 120 workers. Because of the high degree of skill required in picture tube manufacturing, local workers will be under supervision of experienced continentals for about a year. Gradually, Puerto Ricans will take over supervisory tasks.

All picture tubes now in Puerto Rico are imported at an additional transportation cost of 20 per-cent of the selling price. It was said that the resultant savings will be passed on to the local consumer through lower prices.

Twenty manufacturers of communication equipment with net sales of over eight million dollars are now operating in Puerto Rico.

you get the most for your money in  
**ALLIED'S own knight-kits**

THE FINEST ELECTRONIC EQUIPMENT IN MONEY-SAVING KIT FORM

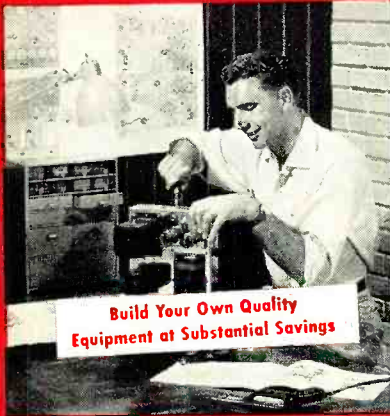

Build Your Own Quality  
 Equipment at Substantial Savings

**Buy With Confidence From the Pioneers in Electronic Kits**

**LOWEST COST**—our huge buying power means biggest savings for you. You do the easy assembly and your finished instrument is equal in performance and appearance to equipment selling for several times the remarkably low KNIGHT-KIT price.

**ADVANCED DESIGN**—months of research, development and field-testing go into each KNIGHT-KIT to bring you the latest advances in quality design. And to assure top performance, premium quality parts are supplied in each kit.

**EASIEST TO ASSEMBLE**—all chassis and panels are punched; all parts are clearly identified—resistors are mounted on cards and values are shown. Instruction manuals are a marvel of clarity, featuring "Step-and-Chek" assembly, "King-Size" diagrams and "Spotlight" pictorials. All you need are soldering iron, pliers and screwdriver.

**ALLIED stakes its 36-year reputation in the Electronics field on your complete success and fullest satisfaction with KNIGHT-KITS.**

TEST EQUIPMENT • HAM GEAR • HOBBYIST KITS • HI-FI KITS



LATEST  
 PRINTED  
 CIRCUIT

**NEW knight-kit LOW COST  
 GENERAL-PURPOSE 5" OSCILLOSCOPE KIT**

Model F-146

**\$49<sup>50</sup>**

Outstanding value in an all-new, highly versatile 5" oscilloscope kit. Perfect for visual display of all commonly encountered waveforms. Excellent for AM, FM and TV servicing, plus other high-frequency applications. An easy-to-build, easy-to-use, dependable performer that matches or beats commercially wired 'scopes selling at several times more. Up-to-the-minute kit design features printed circuit, laced wiring harness, and pre-cut wires for quick and easy assembly. Has 4 sweep ranges, 15-150,000 cps. High vertical sensitivity: 25 rms millivolts/inch; input impedance, 3.3 megs and 45 mmf; response down only 3 db at 700 kc. Horizontal sensitivity, 70 rms mv/inch; response, down only 3 db at 200 kc; input impedance, 2.2 megs and 30 mmf. Deluxe features include DC positioning controls for fast trace positioning; blanking circuit on all ranges to eliminate retrace lines; graph scope screen and internal, regulated calibrating voltage for highly accurate signal measurements; frequency-compensated vertical attenuator; provision for internal or external, positive or negative synchronization; Phantastron linear sweep generator; high 2nd anode voltage for high-intensity trace. Kit is complete with 5" CRT and all tubes—ready for assembly. Blue steel case with "disappearing" handle. Handsome panel in contrasting gray. Size, 14½ x 9½ x 16" deep. Shpg. wt., 40 lbs.

- Model F-146. Complete 5" Oscilloscope Kit. Net only. **\$49.50**
- F-148. RF Demodulator Probe Kit. Net only. **\$3.45**
- F-147. Low-Capacity Probe Kit. **\$3.45**

**EASY  
 PAYMENT TERMS**

If your total KNIGHT-KIT order is over \$45, take advantage of our liberal Time Payment Plan—only 10% down. Write for application form.



Model F-123

**\$44<sup>75</sup>**

**NEW knight-kit TV-FM  
 SWEEP GENERATOR KIT**

**Guaranteed Linearity • Fool-proof Calibration  
 Wide-Range Coverage • Electronic Blanking**

All-new; precision-designed for lab use, TV and FM servicing, production line testing. Covers 300 kc to 250 mc continuous on 4 bands (all fundamentals). Center frequencies of VHF TV channels appear on scales. Exclusive KNIGHT-KIT sweep circuit assures almost perfect linearity—RF sweep output in excess of 0.15 volts, flat within 1 db, is available on all bands. Sweep width continuously variable, 0-13 mc. Crystal-controlled marker oscillator with dual crystal socket and selector switch. Phase control provides blanking shift, 0 to 180°. Step-type and continuous output controls; separate marker amplitude control. Filter connected to 0-50 mc output jack provides 20 db attenuation of frequencies above 50 mc. to assure pure, fundamental output. 5-volt horizontal sweep voltage (for scope) available from front panel. Professional-looking blue-finish steel case with gray panel. Has "disappearing" handle. 8½ x 12 x 7½". With all parts, tubes, test cable, solder and multi-color pre-cut wire. Less crystal. Shpg. wt., 13½ lbs.

- Model F-123. TV-FM Sweep Generator Kit. Net only. **\$44.75**
- P-286. 4.5 mc Crystal (.005%). Net. **\$4.80**
- P-143. 5.0 mc Crystal (.02%). Net. **\$3.95**
- P-145. 10.7 mc Crystal (.02%). Net. **\$3.95**

ALL PRICES NET F.O.B. CHICAGO

order from **ALLIED RADIO**

100 N. WESTERN AVE., CHICAGO 80, ILLINOIS

SEE FOLLOWING PAGES



# ALLIED'S own knight-kits... better by far



## knight-kit 5" ALL-PURPOSE WIDE-BAND OSCILLOSCOPE KIT

2 Printed Circuit Boards • 5 Mc Width for Color TV

Model F-144

**\$69<sup>00</sup>**

Wide-band, 5" Oscilloscope; equals or betters the performance of commercially-wired 'scopes costing several times the price. Two printed circuit boards and laced wiring harness assure wiring accuracy and reduce assembly time. Ideal for lab use, color TV servicing and high frequency applications. Provides unusually wide sweep range—from 15 to 600,000 cps. Locks in at frequencies as high as 9 mc. Vertical response, 5 cycles to 5 mc. Response, down only 1 db at 3.58 mc color burst frequency; down only 3 db at 5 mc. High vertical sensitivity of 25 mv/inch. Input capacity 20 mmf and 3.5 megs. Outstanding features: cathode-follower vertical and horizontal inputs; 2nd anode provides 1400 volts high-intensity trace; push-pull vertical and horizontal amplifiers; positive and negative locking; faithful square wave response; frequency-compensated attenuator; Z-axis input for intensity modulation; one volt P-P calibrating voltage; astigmatism control; blanking circuit to eliminate retrace lines; DC positioning control. Complete with CRT, all tubes and parts. Handsome, professional, blue-finished steel case with "disappearing" handles. 14½ x 9½ x 16". Shpg. wt., 40 lbs.

Model F-144. Wide-Band 5" Oscilloscope Kit. Net only... **\$69.00**  
 F-148. Demodulator Probe. Net... \$3.45. F-147. Low Capacity Probe. 12 mmf. Net... \$3.45

## NEW knight-kit VOLTAGE CALIBRATOR KIT

Model F-136 **\$12<sup>75</sup>**



Permits the use of any scope as a precision peak-to-peak AC voltmeter. Provides a true square-wave voltage on scope screen. Range switch and calibrated potentiometer permit selecting any voltage between .01 and 100 volts, in 4 ranges. Fifth position of switch feeds external signal to scope for comparison. Constant output on line volt. variation from 80-135 v. ±6% on all ranges. Shunt capacitance only 15 mmf. Use any 20,000 ohms/volt VOM or a VTVM for initial calibration. Direct coupling of output provides ground reference for DC scopes. Portable case, 7¼ x 5¼ x 4¾". Ready to build. Shpg. wt., 5 lbs.

Model F-136. Voltage Calibrator Kit. Net... **\$12.75**



## knight-kit LOW COST RF SIGNAL GENERATOR KIT

Model F-145 **\$19<sup>75</sup>**

Build this wide-range extremely stable RF signal generator and save two-thirds the cost of a comparable wired instrument. Ideal for alignment of RF and IF stages in radio and TV sets, and for troubleshooting audio equipment. Delivers output on fundamentals from 160 kc all the way out to 110 mc; useful harmonics to 220 mc. Has built-in 400-cycle sine-wave audio oscillator for modulating RF; audio is also available externally. Features high-stability Colpitts circuit with precision-wound coils—no calibration necessary. Has input for external modulator. Maximum audio output, 10 volts. RF output, over 100,000 micro-volts. Step and continuous-type output attenuators. With all parts, tubes, wire and solder. Portable case, 7 x 10 x 5". Shpg. wt., 10 lbs.

Model F-145. RF Signal Generator Kit. Net only... **\$19.75**



Model F-135 **\$26<sup>50</sup>**

## knight-kit VISUAL-AURAL SIGNAL TRACER KIT

A remarkable value in an instrument which permits visual and aural signal tracing of RF, IF, video and audio circuits—has highest gain in its price class. Traces the signal from the antenna to the speaker. Reproduces signal at plate or grid connection of any stage. Identifies and isolates "dead" stages. Features: usable gain of 91,000; "magic eye" with calibrated attenuators for signal presence indication and stage-by-stage gain measurements; built-in 4" PM speaker; single probe with plug-in head gives instant choice of RF or audio tracing. Provides noise test; built-in watt meter calibrated from 25 to 1000 watts; provision for external scope or VTVM. Blue-finish steel case. Shpg. wt., 13 lbs.

Model F-135. Signal Tracer Kit. Net only... **\$26.50**

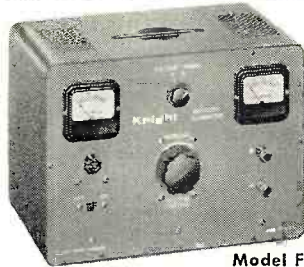

Model F-129 **\$37<sup>95</sup>**

## NEW knight-kit 6-12 VOLT BATTERY ELIMINATOR KIT

A valuable new unit for servicing auto radios, mobile gear, etc. Delivers continuously variable filtered DC output from 0 to 15 volts. Provides DC output at 0-8 volts or 0-15 volts. Continuous current rating: 12.5 amps at 6 volts, 10 amps at 12 volts. Can also be used as battery charger. Oversize rectifiers and transformer for better regulation and long life. Two meters provide simultaneous current and voltage readings; ranges: 0-15 volts DC; 0-20 amps DC. Doubly protected: fused primary and automatic-reset overload relay for secondary. Heavy-duty binding posts. Blue-finish steel case with "disappearing" handle. With all parts, solder and pre-cut wire. 9 x 12¼ x 7¼". Shpg. wt., 20 lbs.

Model F-129. Power Supply Kit. Net only... **\$37.95**



## knight-kit AUDIO GENERATOR KIT

Model F-137 **\$37<sup>50</sup>**

An ideal audio frequency source for checking audio circuits and speaker response. Covers: 20 cps to 1 mc in 5 ranges. Output voltage: 10 volts into 600 ohms impedance. Offers the flat response of a lab standard—±1 db to 1 meg. Generator imp., 600 ohms. Less than .25% distortion from 100 cps through the audible range; less than .5% when driving 600 ohm load at maximum output. Cont. var. step-attenuated output. 17 lbs.

Model F-137. Audio Generator Kit. Net only... **\$37.50**

## knight-kit RESISTANCE SUBSTITUTION BOX KIT



Model F-139 **\$5<sup>95</sup>**

Simplifies determination of resistor values needed in a circuit. 36 standard 1 watt resistance values between 15 ohms and 10 megohms with an accuracy of 10%. 18-position switch; also slide switch for multiplying values by 1000. Extra switch wafer serves as tie points, eliminating buss bar. 5 x 3 x 2". Complete with test leads and clips. 2 lbs.

Model F-139. Resis. Sub. Box Kit. Net... **\$5.95**

## knight-kit CAPACITANCE SUBSTITUTION BOX KIT



Model F-138 **\$5<sup>95</sup>**

Makes it easy to find capacitor values needed in a circuit. Provides 18 standard capacitor values from .0001 mfd. to .22 mfd., ±20%. Values are 600 volts, except .15 and .22 which are 400 volt. 18-position switch selects all values quickly and easily. In bakelite case, 5 x 3 x 2". Complete with all parts, test leads and clips. 2 lbs.

Model F-138. Cap. Sub. Box Kit. Net... **\$5.95**

QUALITY ELECTRONIC TEST EQUIPMENT IN MONEY-SAVING KIT FORM

...easiest to build...you get more...YOU SAVE MORE



4 1/2"  
Meter

Model F-128 **\$16<sup>95</sup>**

**knight-kit  
1000 OHMS/VOLT VOM KIT**

Exceptional accuracy and versatility at amazing low cost. Ideal for service shop, lab and Amateur use. Uses 4 1/2" meter (400 microamp movement) with separate scales for AC voltage and current, DC voltage and current, decibels and resistance. 38 ranges include: AC, DC and output volts, 0-1-5-10-50-100-500-5000 (1000 ohms/volt sensitivity); Resistance, 0-1000-100,000 ohms and 0-1 meg.; Current, AC or DC, 0-1-10-100 ma and 0-1 amps; Decibels, -20 to +69 in 6 ranges. Uses 1% precision resistors. 3-position function switch and 12-position range switch. Complete kit with bakelite case, (6 3/4 x 5 1/4 x 3 3/4"), battery, pre-cut wire, solder and test leads. Shpg. wt., 2 1/2 lbs.

Model F-128. 1,000 ohms/volt VOM Kit. Net only. **\$16.95**



Model F-140 **\$29<sup>50</sup>**

**knight-kit  
20,000 OHMS/VOLT VOM KIT**

Outstanding quality and performance at extremely low cost. Features 32 ranges; full vision 4 1/2" meter; accuracy ±2% of full scale; 50 microampere sensitivity for 20,000 ohms/volt input resistance on DC; front panel "zero adjust" Single switch selects function and range. Range: AC, DC and output volts, 0-2.5, 10-50-250-1000-5000; Resistance, 0-2000-200,000 ohms and 0-20 meg.; DC ma, 0-1-10-100; DC amps, 0-1-10; Decibels, -30 to +63 in 6 ranges. Uses precision 1% multipliers. Moisture-resistant film-type resistors. Complete kit with bakelite case (6 3/4 x 5 1/4 x 3 3/4"), batteries, pre-cut wire, solder and test leads. Shpg. wt., 5 lbs.

Model F-140. 20,000 ohms/volt VOM Kit. Net only. **\$29.50**

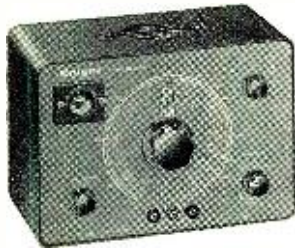

**knight-kit RESISTOR-CAPACITOR TESTER KIT**

Model F-124 Measures capacitance and resistance by accurate bridge method; checks for opens and shorts in paper, mica and ceramic capacitors; shows power factor of electrolytics. Large dial shows capacitance and

resistance at a glance; balanced-bridge circuit with "magic eye" null indicator measures power factor from 0-50%. Tests capacitors with rated voltages applied. 5 test voltages: 50, 150, 250, 350, 450. Capacity ranges: 10 mmf to 1000 mfd in 5 ranges. Resistance ranges: 100 to 50,000 ohms and 10,000 ohms to 5 megs. Accuracy, ±10%. Automatic discharge feature prevents after-test shock. Blue-finished steel case, 5 x 3 x 2". With tubes and all parts. Shpg. wt., 8 lbs.

Model F-124. Resistor-Capacitor Tester Kit. Net only. **\$19.50**

**NEW knight-kit TRANSISTOR & DIODE CHECKER KIT**



Model F-149 **\$8<sup>50</sup>**

Checks leakage-to-gain ratio and noise level of all junction, point contact and barrier transistors. Also checks diodes, forward and reverse current conduction of selenium rectifiers; useful for continuity and short checks. Easy-to-read meter. Features: spring-return leakage gain switch; calibration control; separate sockets for PNP and NPN transistors. Headphones or signal tracer may be used with checker for noise measurements. Case, 5 x 3 x 2". With 22 1/2 volt battery. 2 1/2 lbs.

Model F-149. Transistor Checker Kit. Net. **\$8.50**

**EASY PAYMENT TERMS:** If your total KNIGHT-KIT order is over \$45, take advantage of our liberal Time Payment Plan —only 10% down. Write for application blank.

**ALL PRICES NET F.O.B. CHICAGO**



**knight-kit VTVM KIT  
with Printed Circuit Board**

Model F-125 An extremely stable, and highly accurate VTVM. Greatly simplified wiring—entire chassis is a printed circuit board. Maximum convenience in arrangement of scales; 3X AC and DC scale design permits utilization of best portion of each scale for most accurate readings. Also measures peak-to-peak for FM and TV work. Ranges: AC

P-P volts, 0-4-14-40-140-400-1400-4000; AC rms volts and DC volts, 0-1.5-5-15-50-150-500-1500; resistance, 0-1000-10K-100K ohms and 0-1-10-100-1000 megohms; db scale, -10 to +5. AC response, 30 cycles to 3 mc. Low-leakage switches and 1% precision resistors. Balanced-bridge circuit. 4 1/2" meter, 200 microamp movement. Polarity reversing switch. Input res., 11 megs. Shpg. wt., 6 lbs.

Model F-125 Printed Circuit VTVM Kit. Net only. **\$24.95**

F-126. Hi-Voltage Probe; extends DC to 50,000 Volts **\$4.75**

F-127. Hi-Frequency Probe; extends AC to 250 mc. **\$3.45**

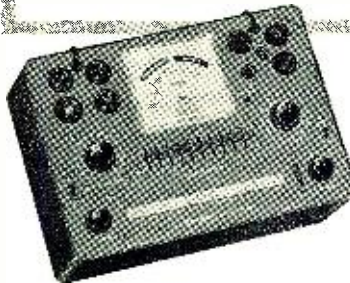

Model F-143

**knight-kit LOW-COST TUBE TESTER KIT**

**\$29<sup>75</sup>**

Offers high accuracy, top versatility and convenience at lowest cost. Tests 4, 5, 6 and 7-pin large, regular and miniature types, octals, loctals, 9-pin miniatures and pilot lamps. Features test for new 600 ma series string tubes. Tests for open, short, leakage, heater continuity and quality (by amount of cathode emission). 4 1/2" square meter with clear "GOOD-?-REPLACE" scale. With line-voltage indicator and line-adjust control. Choice of 14 filament voltages from .63 to 117 volts. Blank socket for future type tubes. Universal-type selector switches for any combination of pin connections. Single-unit, 10-lever function switch. Entire switch assembly is installed as a single unit—saves time and greatly simplifies construction. Illuminated roll chart lists over 600 tube types. Shpg. wt., 14 lbs.

Model F-143. Counter Model Tube Tester Kit. Net only. **\$29.75**

Model F-142. Portable Model Tube Tester Kit. Net only. **\$34.75**

F-141. TV Picture Tube Adapter for above. Net only. **\$3.75**



PORTABLE MODEL



Model F-119

**\$12<sup>50</sup>**

**knight-kit LOW-COST  
"IN-CIRCUIT" CAPACITOR CHECKER KIT**

Tests capacitors while they are still wired in the circuit! Saves time and bother; an essential instrument for the service technician. Just press a button and the "magic eye" instantly shows opens and shorts (not leakage). Tests opens and shorts on any capacitor of 20 mmf or greater capacity, even if it is in parallel with a resistance as low as 50 ohms. Tests for shorts may be made on any capacitor even when it is shunted by as low as 20 ohms. Blue-finish steel case, 7 3/4 x 5 1/4 x 5". With tubes, all parts, wire and solder. Easy to assemble. Shpg. wt., 5 lbs.

Model F-119. Cap. Checker Kit. **\$12.50**

order from **ALLIED RADIO** 100 N. WESTERN AVE., CHICAGO 80, ILL. →

# ALLIED'S own MONEY-SAVING knight-kits

FAMOUS knight-kits FOR HOBBYISTS & EXPERIMENTERS... FASCINATING, INSTRUCTIVE...



knight-kit  
"SPACE SPANNER"  
BAND SWITCHING  
RECEIVER KIT

Model S-243 \$15<sup>95</sup>

Thrilling Short Wave and Broadcast

Famous 2-band AC-DC receiver in easy-to-build kit form at a very low price. Pulls in thrilling short-wave (6 to 17 mc) and standard broadcast. It's fun listening to amateur, aircraft, police and marine radio. Features highly sensitive regenerative circuit. Bandswitch selects broadcast or short wave. Has 4" PM speaker and beam-power output tube for plenty of volume; headphone connectors for weak signal listening; slide switch cuts out speaker. Uses 12AT7 regenerative detector and audio amplifier, 50C5 power output, 35W4 rectifier. Six controls: Bandsread; Main Tuning; Antenna Trimmer; Bandswitch; Regeneration; Audio Gain. Includes tubes and all parts. 7 x 10 1/2 x 6". Shpg. wt. 4 1/2 lbs.

Model S-243. "Space Spanner" Receiver Kit. Net only..... \$15.95  
S-247. Matching Cabinet for above. 2 lbs. Net..... \$2.90



Model S-295 \$14<sup>75</sup>

## NEW knight-kit TWO-WAY INTERCOM KIT

New low-cost, easy to build intercom system kit. Ideal for use in home or office. Consists of Master unit and Remote unit, each with press-to-talk switch. Remote unit may be left "open" for answering calls from a distance, for "baby-sitting", etc. Remote may also be connected for "private" operation—cannot be "listened-in" on, but it can be called and can originate calls. Master unit includes high-gain 2-stage amplifier; each unit has 4" PM dynamic speaker. Complete with Antique White cabinets (4 3/4 x 6 1/2 x 4 3/8"), all parts, tubes and 50 feet of cable (up to 200 feet of cable can be added). For AC or DC. Shpg. wt., 7 lbs.

Model S-295. Two-Way Intercom Kit. Net only.. \$14.75

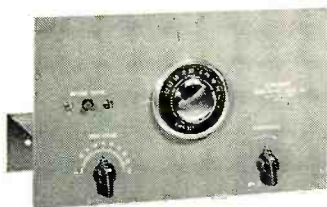

Model S-740 \$11<sup>75</sup>

knight-kit

## "OCEAN HOPPER" RECEIVER KIT

Tops for exciting broadcast, long wave and short wave reception. Highly sensitive regenerative-type circuit. Excellent headphone reception; can be used with 3-4 ohm PM speaker on strong broadcast band stations. Supplied with plug-in coil for standard broadcast; covers long wave and popular short wave bands with coils below. Pulls in thrilling foreign broadcasts, police, amateurs and aircraft. Controls: Main Tuning, Bandsread, Antenna Tuning, Off-On-Regeneration. With all parts and tubes (less extra coils and headset). AC or DC. Shpg. wt., 5 lbs.

Model S-740. "Ocean Hopper" Kit..... \$11.75

### EXTRA PLUG-IN COILS

S-741. Long Wave, 155-470 kc. Net..... 79¢  
S-742. Short Wave, 1.65-470 kc. } Net  
S-743. Short Wave, 2.9-7.3 mc. } each..... 65¢  
S-745. Short Wave, 7-17.5 mc. }  
S-744. Short Wave, 15.5-35 mc. }



Model S-735 \$17<sup>25</sup>

knight-kit

## "RANGER II" SUPERHET RADIO KIT

Thousands have built and enjoyed the "Ranger" Broadcast Band Receiver. Carefully engineered for easy construction and powerful, sensitive performance. Latest Superhet circuit; tunes 540 to 1680 kc; covers entire broadcast band and exciting police calls. Features automatic volume control, built-in preformed loop antenna, ball-bearing tuning condenser. Develops excellent tone quality from Alnico V PM dynamic speaker. Supplied with following tubes: 12SA7GT converter; 12SK7GT IF amp.; 12SQ7GT det.-AVC-audio; 50L6GT audio output; 35Z5GT rect. Complete with handsome brown plastic cabinet (6 x 9 x 5) tubes, speaker, all parts, and instruction manual. AC or DC operation. Shpg. wt., 8 lbs.

Model S-735. "Ranger II" Superhet Radio Kit. Net only..... \$17.25



Model S-730 \$19<sup>95</sup>

knight-kit

## 3-WAY PORTABLE RADIO KIT

A low-cost portable radio covering the full standard broadcast band from 535 kc to 1650 kc. Delivers excellent reception on AC or DC current or from self-contained batteries. Sensitive Superhet circuit features automatic volume control, economical operation. Includes powerful 5" Alnico PM dynamic speaker, efficient ferrite loop-stick antenna. Supplied with following tubes: 1R5 converter; 1U4 IF amplifier; 1U5 detector-AVC-audio; 3V4 audio output. Complete with attractive portable case (7 1/2 x 10 x 5 1/4"), tubes, speaker, all parts and instruction manual. Shpg. wt., 6 lbs.

Model S-730. 3-Way Portable Radio Kit (less batteries). Net. \$19.95

J-651. Battery Kit for above..... \$2.50

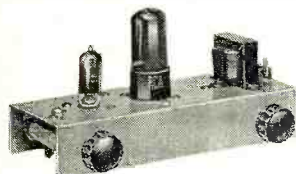

knight-kit LOW COST PHONO AMPLIFIER KIT

Model S-790 \$8<sup>95</sup>

It's easy to build this fine-performing, low-cost compact phono amplifier. Ideal for use in a portable phonograph—simply add any

record player and a 3 to 4-ohm speaker. Amplifier works with crystal or ceramic cartridges. Inverse feedback circuit for rich, clean tone quality. Delivers full 1 1/2-watt output with less than .25 volt input. Includes efficient tone control; has AC outlet, controlled from amplifier switch. Complete with tubes and all parts. Size only 4 1/2 x 7 x 4"—fits into almost any portable phono case. Shpg. wt., 3 lbs.

Model S-790. Phono Amplifier Kit. Net only..... \$8.95

## FAMOUS knight-kit CRYSTAL SET KIT

Model S-261

\$2<sup>15</sup>

Thousands of beginners have started in radio and electronics by building the KNIGHT-KIT crystal set. This feature-packed set delivers loud, clear reception of local broadcast stations. A germanium crystal diode detector assures high sensitivity and simple operation—no crystal adjustment required. "Hi-Q" coil boosts sensitivity. Ball-bearing variable capacitor for easy tuning. With all parts and simple-to-follow instructions. Shpg. wt., 1 lb.

Model S-261. Crystal Set Kit. Net only..... \$2.15

S-267. Accessory Kit. 2000-ohm headphones and all parts for outdoor antenna..... \$2.95



Buy with confidence from ALLIED—America's Pioneer in Electronic Kits

# finest quality electronic equipment in lowest-cost kit form

EASY-TO-BUILD HIGH PERFORMANCE KITS • WIDELY USED BY MANY LEADING TRAINING SCHOOLS



## NEW knight-kit ELECTRONIC PHOTOFASH KIT

**Model S-244**  
**\$28<sup>50</sup>**

New feature-packed photoflash kit—designed for top quality dependability—available at a money-saving low price. Ideal for black and white or color photography. Xenon-filled reflector-bulb assembly gives over 10,000 flashes at less than 1/2¢ each! 1/700-second flash freezes the fastest action. Has 50 watt-second output. Provides light approximating daylight in spectral quality; permits the use of outdoor-type film indoors. Film guide number for color (ASA10) is 45. Designed for "X" or "O" shutters only. Requires sync cable (available from any photo supply dealer) and either battery or AC supply listed below. Complete outfit with battery weighs only 3 1/2 lbs. Kit includes all parts, carrying case and easy-to-follow instructions. Shpg. wt., 3 lbs.

**Model S-244.** Electronic Photoflash Kit. Net.... **\$28.50**  
**S-246.** AC Power Supply Kit. Easy to assemble.... **\$3.75**  
**J-626.** Battery for above (Burgess U-200)..... **\$8.47**

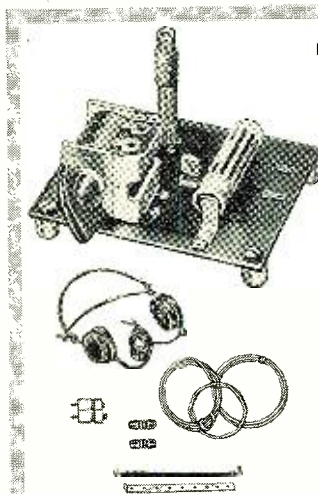

## knight-kit TRANSISTOR RADIO KIT

Printed Wiring • Works from Penlight Cell

**Model S-765** **\$4<sup>35</sup>** Smooth Variable Capacitor Tuning

Experiment with the marvel of transistors! Printed circuit requires no wiring—just assemble with a few solder connections and enjoy excellent reception over the full AM broadcast band. No tubes to burn out—no crystal. Compact—fits in the palm of your hand—operates for months from a single penlight cell. Transistor provides plenty of power for strong headphone reception. Complete with all parts, transistor and penlight cell. Shpg. wt., 8 oz.

**Model S-765.** Transistor Radio Kit **\$4.35**  
**S-266.** Accessory Kit. 4000-ohm headphones and all parts for outdoor antenna..... **\$3.15**

## FAMOUS knight-kit LAB KITS

### 6-IN-1 RADIO LAB KIT

**Model S-770**  
**\$7<sup>95</sup>** Build Any of 6 Electronic Projects

A fascinating and instructive kit. Enables you to build any one of the following projects: Standard Broadcast Receiver; Wireless Broadcast Receiver; Code Practice Oscillator; Code Practice Broadcaster; Signal Tracer; Sine Wave Generator. Perfect for beginners. Once basic wiring is completed, circuits may be changed without soldering. Safe to build and operate; only tools needed are screwdriver, pliers and soldering iron. The ideal kit for students and beginners in electronics. Kit includes mounting board, tube, all parts and easy-to-follow instruction manual. Less headphone (also serves as mike). Shpg. wt., 6 lbs.

**Model S-770.** "6-in-1" Lab Kit. Net only..... **\$7.95**  
**J-112.** Single 1000-ohm headphone for above..... **\$1.05**  
**C-100.** Antenna kit for above..... **\$1.05**

### 10-IN-1 LAB KIT

**Model S-265**  
**\$12<sup>65</sup>** Build Any of 10 Electronic Projects

A wonderfully instructive electronics kit. Ideal for experimenters, beginners—fun to build. Construct a sensitive Broadcast Receiver; Amplifier (for phono or mike); Wireless Phono Oscillator; Home "Broadcast Station"; Code Practice Oscillator; Capacity-Operated Relay, or any one of four other fascinating projects. Low voltages; safe to build and operate. Only tools needed are soldering iron, screwdriver and pliers. Perfect for self-instruction in circuit fundamentals, and packed with practical applications. Kit includes mounting board, tubes, all parts, hardware, microphone, and 12-page builders' manual. Shpg. wt., 10 lbs.

**Model S-265.** "10-in-1" Lab Kit. Net only..... **\$12.65**  
**J-112.** Single 1000-ohm headphone for above..... **\$1.05**  
**C-100.** Antenna Kit for above..... **\$1.05**

## knight-kit WIRELESS BROADCASTER KIT

**Model S-705**  
**\$9<sup>50</sup>** This fascinating unit makes it possible to "broadcast" with phonograph or microphone through any standard radio receiver up to 50 feet away—without any connection to the set. May be used with crystal or magnetic cartridge, or with microphone. Broadcasts a clear, full-toned signal. High-gain stage permits using magnetic cartridge without need for external preamp. Complete with all parts, tubes, wire and solder (less microphone). 4 1/2 x 5 x 6". Easy to assemble. Shpg. wt., 3 lbs.

**Model S-705.** Wireless Broadcaster Kit. Net only..... **\$9.50**  
**S-556.** Microphone for above with 5-ft. cable..... **\$3.95**

## knight-kit PHONO OSCILLATOR KIT

**Model S-760**  
**\$5<sup>85</sup>** This low-cost phono oscillator may be used with any crystal phonograph for "broadcasting" recorded music through any standard radio receiver up to 50 feet away. Requires no direct connection to radio set. Operates on any frequency between 600 and 800 kc. Has controls for adjustment of modulation level and selection of clear frequency on radio receiver. Uses 50L6GT tube and 35Z5GT rectifier. Complete with all parts, tubes and instructions. 4 1/4 x 4 1/4 x 4 1/2". Shpg. wt., 1 lb.

**Model S-760.** Phono Oscillator Kit. Net only..... **\$5.85**

## knight-kit CODE PRACTICE OSCILLATOR KIT

**Model S-239**  
**\$3<sup>95</sup>** Transistor Circuit—Powered by Penlight Cell



An ideal code practice oscillator. Uses transistor circuit. Extremely low current consumption—powered by single penlight battery. Provides crisp, clear tone (400 to 600 cps). Has input jack for earphone; screw-type terminal strip for key. In compact bakelite case (2 3/4 x 3 3/4 x 1 1/2") with anodized aluminum panel. Complete with all parts, transistor, battery and easy-to-follow instructions. Shpg. wt., 1 lb.

**Model S-239.** Code Practice Kit..... **\$3.95**  
See Next Page for Amateur Kits

ALL PRICES NET F.O.B. CHICAGO

order from **ALLIED RADIO** 100 N. WESTERN AVE., CHICAGO 80, ILL. →

# ALLIED'S own knight-kits give you the most for your money

## BUILD YOUR OWN QUALITY HI-FI AMPLIFIER!

**knight-kit**  
**BASIC 25-WATT**  
**LINEAR-DELUXE**  
**HI-FI AMPLIFIER KIT**

Model S-755  
**\$44<sup>50</sup>**

Williamson-Type Circuit  
 Printed Circuit Board  
 Chrome-Plated Chassis

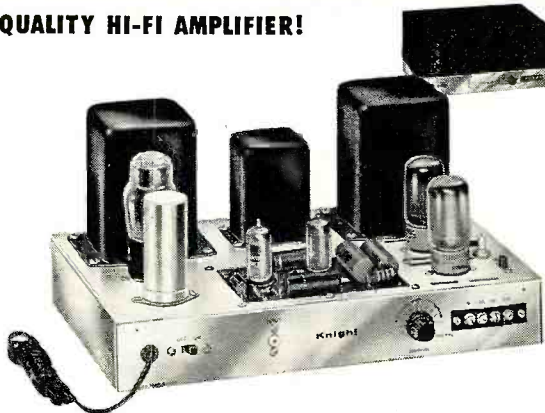

This super-quality hi-fi basic amplifier is designed to satisfy the most critical listener. Intended for use with tuners incorporating built-in preamp or with separate preamp. Incorporates latest Williamson-type circuit and has potted matched transformers. Delivers maximum output of 45 watts. Frequency response is:  $\pm 0.5$  db. 10 cps to 120 kc, measured at 20 watts. Harmonic distortion is only .15% right up to 30 watts. Intermodulation distortion is only .27% at 10 watts and only .4% at 20 watts, using 60 cps and 7 kc, 1:4 ratio. Hum level is -85 db below full rated output. Output impedance, 4, 8, 16 ohms. Input voltage for 25-watt output is 1.8 volts. Uses two 12AU7's, two 5881's, and a 5V4. Etched circuit is utilized in voltage amplifier and phase inverter stages to speed assembly. Has output tube balancing control, variable damping control, and on-off switch. Handsome chrome-plated chassis, 14 x 9 x 2". Overall height, 7". A deluxe true hi-fi amplifier equal in performance to amplifiers selling at over twice the price. Complete with all parts and tubes. Easy to assemble. Shpg. wt., 27 lbs.

Model S-755. Basic 25 Watt Hi-Fi Amplifier Kit. Net only ..... **\$44.50**  
 S-759. Metal enclosure for above; black finish. 3 lbs. Net. .... **\$4.25**

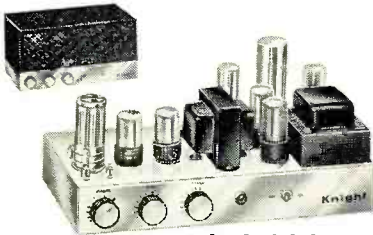

**knight-kit**  
**10-WATT HI-FI AMPLIFIER KIT**

Model S-753 Chrome-Plated Chassis  
**\$23<sup>50</sup>**

Famous for wide response and smooth reproduction at low cost. Only 0.5 volt drives amplifier to full output. Frequency response:  $\pm 1$  db, 30-20,000 cps at 10 watts. Harmonic distortion less than 0.5% at 10 watts. Intermod. distortion less than 1.5% at full output. Controls: on-off-volume, bass, treble. Input for crystal phono or tuner. Chromed chassis; punched to accommodate magnetic cartridge preamp. Matches 8 ohm speakers. Shpg. wt., 14 lbs.

Model S-753. Amplifier Kit. Net. . . **\$23.50**  
 Model S-235. Preamp Kit for above . . . **\$3.10**  
 S-757. Metal Enclosure. 3 lbs. .... **\$3.95**

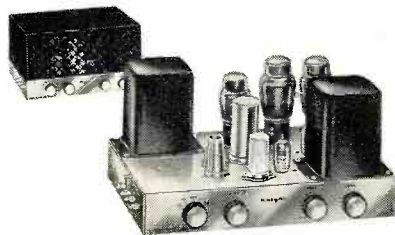

**knight-kit**  
**20-WATT HI-FI AMPLIFIER KIT**

Model S-750 Chrome-Plated Chassis  
**\$35<sup>75</sup>**

True hi-fi for less! Frequency response,  $\pm 1$  db, 20-20,000 cps at 20 watts. Distortion, 1% at 20 watts. Hum and noise level: tuner input, 90 db below 20 watts; phono 72 db below 20 watts. 4 inputs: magnetic phono, microphone, crystal phono or recorder, and tuner. Controls: Bass, Treble, Volume, Selector. With compensation positions for 78 and LP records. Built-in Preamp. Outputs: 4, 8, 16 and 500 ohms. 23 lbs.

Model S-750. 20-Watt Kit. Net . . . **\$35.75**  
 S-758. Metal Enclosure. 3 lbs. .... **\$4.15**  
 S-752. Chrome-plated escutcheon for cabinet installation of amplifier. Net. .... **\$1.40**

## LOW-COST TOP QUALITY KITS FOR THE HAM



**knight-kit**

Model S-255 **50-WATT CW TRANSMITTER KIT**  
**\$43<sup>75</sup>** Built-in Pi-Type Antenna Coupler

Check the features packed into this new transmitter kit and you'll see why it's one of the greatest Amateur values ever offered. Compact and versatile, it is the perfect low-power rig for the beginning Novice or seasoned veteran. Features: 50 watts input to 807 final; high-efficiency 6AG7 modified-Pierce oscillator takes crystal or VFO without circuit changes, bandswitching coverage of 80, 40, 20, 15, 11-10 meters; pi-section antenna output matches line impedances from 50 to 1200 ohms —permits use with any type of antenna; no separate antenna tuner required. Crisp, clean, cathode keying of oscillator and final. Power take-off plug supplies filament and B-plus voltages for other equipment. Copper-finished chassis and cabinet interior, filtering, shielding, bypassing, and coaxial SO-239 antenna connector provide excellent TVI suppression. Meter reads either plate or grid current of final. Jacks for VFO, crystal and key. Supplied with all parts and tubes. Less crystal and key. 8 $\frac{3}{4}$  x 11 $\frac{1}{4}$  x 8 $\frac{3}{4}$ ". Shpg. wt., 18 lbs.

Model S-255. 50-Watt Transmitter Kit. Net. . . **\$43.75**



**knight-kit**  
**SELF-POWERED**  
**VFO KIT**

Model S-725  
**\$28<sup>50</sup>**

Complete with built-in power supply! Careful design and voltage regulation assure high stability. Excellent oscillator keying characteristics for fast break-in without clicks or chirps. Full TVI suppression. Has plenty of bandwidth; separate calibrated scales for 80, 40, 20, 15, 11 and 10 meters; vernier drive mechanism. 2" chassis construction keeps heat from frequency determining circuits. Output cable plugs into crystal socket of transmitter. Output on 80 and 40 meters. With Spot-Off-Transmit switch for "no swish" tuning. Extra switch contacts for operating relays and other equipment. With all parts and tubes. 8 lbs.

Model S-725. Self-Powered VFO Kit. Net. . . **\$28.50**



**NEW knight-kit**  
**AMATEUR RF**  
**"Z" BRIDGE KIT**

Model S-253 Measures standing wave ratio (SWR) and impedance of antenna systems; also for adjusting antenna networks for optimum results. Any VOM may be used for null indicator. High accuracy with 20,000 ohm/v VOM Correction factor info supplied for other VOM's. With coax input and output connectors. Meters both input and bridge voltage. Calibrated dial gives direct impedance reading; includes 1% precision resistor for precise calibration adjustment. With all parts and handy plasticized SWR chart. 1 $\frac{1}{2}$  lbs.

**\$5<sup>85</sup>**

Model S-253. "Z" Bridge Kit. Net only . . . **\$5.85**

## ALLIED RADIO

100 N. WESTERN AVE., CHICAGO 80, ILL.

Our  
 36th year

ALLIED RADIO CORP., Dept. 01-L-6, 100 N. Western Ave., Chicago 80, Ill.

Ship me the following KNIGHT-KITS:

Quantity	Description	Model No.	Price

\$ \_\_\_\_\_ enclosed. For parcel post include postage (express is shipped collect).

Name \_\_\_\_\_

Address \_\_\_\_\_

City \_\_\_\_\_ Zone \_\_\_\_\_ State \_\_\_\_\_

← *order Today*



# The "WAMOSCOPE"—a Picture Tube That Includes Many Receiver Functions

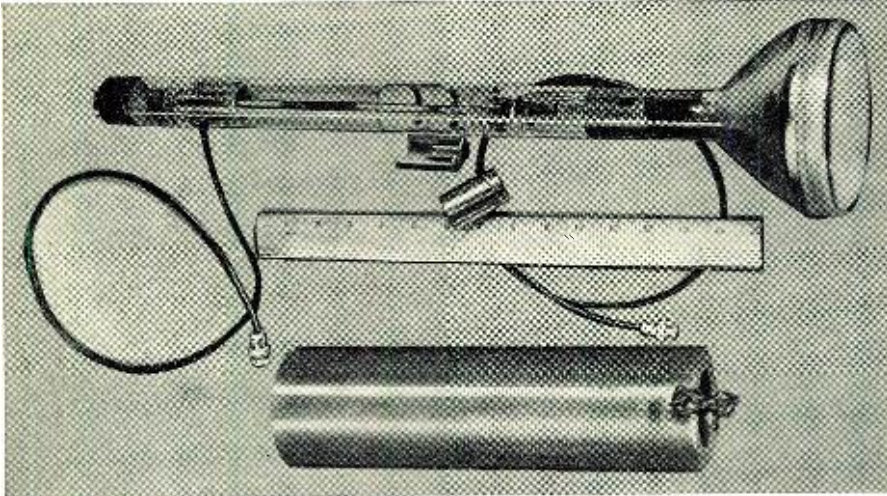

Type 6762 "Wamoscope" is shown with a 15-inch ruler to indicate its size. Also shown is the solenoid which fits over the tube to focus it along with the r.f. transducers.

*New development combines traveling-wave tube with cathode ray tube in single envelope. Operates in microwave range.*

A RADICALLY new type of cathode ray tube for radar, television, and other electronic display applications has been developed by *Sylvania Electric Products Inc.* in cooperation with the Naval Research Laboratory. The new electronic device is called the "Wamoscope," from "wave-modulated oscilloscope."

The new tube combines most of the essential functions of a microwave receiving set in a single tube envelope, eliminating many of the tubes and components required by conventional receivers. In a radar receiver utilizing the "Wamoscope," microwave signals go directly from the antenna into the tube, where, in a single envelope, the signals are amplified, detected, and displayed on the tube's fluorescent screen. Compared with a conventional radar receiver, this means that the local oscillator, mixer, intermediate frequency amplifier, detector, video amplifier, and their associated circuitry are eliminated. Another important feature is the wide selection of chan-

nels possible in the "Wamoscope," which operates over a microwave frequency band of 2000 to 4000 mc.

The operation of the tube is based upon velocity-sorting the electrons which emerge from the end of the helix of the traveling wave tube section. A d.c. beam is passed down the helix. With an r.f. input, the beam interacts with the r.f. fields on the helix so that the beam is velocity and current modulated in accordance with the amplitude of the r.f. signals. The velocity-modulated beam enters the region where the special electron-optical system is located. By applying a suitable bias voltage to an aperture here, the electrons whose velocity is greater than the d.c. velocity pass through the aperture and are allowed to impinge upon the screen of the cathode ray tube while the slower electrons are reflected.

Initial uses of the new wide-band tube will probably include special radars and military closed-circuit television applications.

-30-

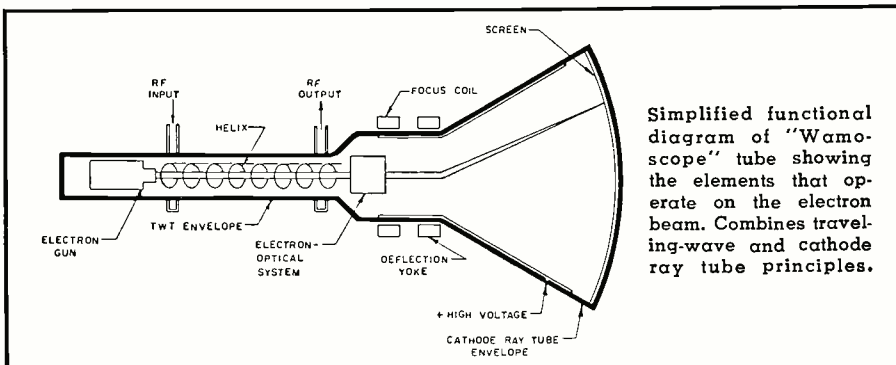

Simplified functional diagram of "Wamoscope" tube showing the elements that operate on the electron beam. Combines traveling-wave and cathode ray tube principles.

*Your choice of school is highly important to your career in*

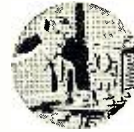

**INDUSTRIAL ELECTRONICS**



**RADIO-TELEVISION**



**ELECTRONICS COMMUNICATIONS**

*Become an*

**ELECTRICAL ENGINEER**

*or an*

**ENGINEERING TECHNICIAN**

*at*

**MSOE in Milwaukee**

*Choose from courses in:*

**ELECTRICAL ENGINEERING**  
*Bachelor of Science degree in 36 months. Communications option (radio-tv) Power option.*

**ENGINEERING TECHNICIAN**  
*Assoc. in Applied Science degree — 18 months.*

**Electronics Communications**  
**Electrical Power.**

MSOE — located in Milwaukee, one of America's largest industrial centers — is a national leader in electronics instruction — with complete facilities, including the latest laboratory equipment, visual aid theater, amateur radio transmitter — offers 93 subjects in electrical engineering, electronics, radio, television, electrical power, and electricity.

Advisory committee of leading industrialists. Courses approved for veterans. Over 50,000 former students. Excellent placement record.

TERMS OPEN JANUARY, APRIL, JULY, SEPTEMBER



*Choose wisely — your future depends on it. Write for more information today!*

**MILWAUKEE**

**SCHOOL OF ENGINEERING**  
Dept. RN-1156, 1025 N. Milwaukee Street  
Milwaukee 1, Wisconsin

Send FREE career booklet.

I am interested in.....

Name..... (Name of course)  
Age.....

Address.....

City..... Zone..... State.....

If veteran, give discharge date.....

MS-57

IT'S THE BIGGEST AND BEST EVER

# FREE THE GIANT ALL NEW 1957 BA CATALOG

A COMPLETE BUYING GUIDE FOR EVERYTHING IN . . .

## RADIO • TV ELECTRONICS

# 1957 BA

ANNUAL CATALOG NO. 571

- ✓ For faster shipment . . . for the fastest, easiest treatment . . . It's the "A" year "the stop" source for Everything in Electronics!
- ✓ Keep complete and up-to-date stock in 16 A's own warehouse combined with Shover mail-order "Sho-Stop" guarantee lightning speed shipment always!
- ✓ Every item customer—large or small—is important to us . . . BA employees are trained to speed every order on its way . . . (filled correctly) packed carefully . . . and shipped promptly!

COMPLETE INDEX PAGE 170

DEALERS, SERVICEMEN, SCHOOLS, THEATRES, S. PUBLIC, EXPERIMENTERS, ENGINEERS, LABORATORIES, AMATEURS

**BURSTEIN-APPLEBEE CO. SO.**

**BURSTEIN-APPLEBEE CO. Dept. M,  
1012-14 McGee St., Kansas City 6, Mo.**

Send Free B-A Catalog No. 571.

NAME \_\_\_\_\_

ADDRESS \_\_\_\_\_

CITY \_\_\_\_\_ STATE \_\_\_\_\_

**RUSH COUPON TODAY!**

**172 KING-SIZED PAGES**

**EVERYTHING IN RADIO TV AND ELECTRONICS**

**100'S OF NEW ITEMS LISTED HERE FOR 1st TIME**

**21 PAGES OF BARGAINS NOT IN ANY OTHER CATALOG**

Within the Industry  
(Continued from page 24)

Moreland of *Conrac, Inc.*, as secretary; and J. A. Milling, *Howard W. Sams & Co., Inc.*, as treasurer.

The Corporation sponsors the industry-wide show held in the late Spring in Chicago. The RETMA, Sales Managers Club, AEPEDA, and WCEMA cooperate in putting on this annual event.

\* \* \*

**WILLIAM G. TUSCANY** has been named to head sales of the newly created Semi-Conductor Section of *Centralab*.



The new section has been established to serve the growing transistor product field and will handle transistors and diodes together with other parts in complete assemblies or "packages" of electronic circuitry.

Mr. Tuscany, a Purdue University graduate, has been with the firm for the past five years. Earl Clemick, who will handle the sales of packaged electronic circuits, a post vacated by Mr. Tuscany's promotion, has been with the company for the past four years. He is a De Pauw University graduate.

\* \* \*

**SYLVANIA ELECTRIC PRODUCTS INC.'s** Radio and Television Division has transferred its operations from 254 Rano Street in Buffalo to Batavia, New York. The entire operation will be relocated in the new Batavia plant by the end of this year . . . **TELECTRO INDUSTRIES CORP.** has added 20,000 square feet of manufacturing space to its present plant at 35-16 37th Street in Long Island City, N. Y. The additional space will be used for manufacturing operations . . . **DALMO VICTOR CO.** has moved into its new 180,000 square foot plant at 1515 Industrial Way, Belmont, California. Operations of six separate plants in the San Carlos-Belmont area have now been consolidated in the new building . . . **WESTON ELECTRICAL INSTRUMENT CORPORATION** has opened a new Los Angeles branch office and warehouse at 2001 South Grand Avenue . . . The Parts Division of **SYLVANIA ELECTRIC PRODUCTS INC.** has purchased a 45,000 square foot plant in Titusville, Pa. The plant has been operating on a sub-contract basis for the past six years assembling electronic components for the TV and radio industry . . . **KURMAN ELECTRIC CO., INC.** formerly of Long Island City, has moved to new and larger quarters at 191-193 Newel Street in Brooklyn, N. Y. . . **HARMON-KARDON, INC.** has acquired an additional plant adjacent to its present location in Westbury, Long Island, N. Y. . . **CBS-HYTRON** has opened a modern 57,000 square foot plant on Mannheim Road in Melrose

RADIO & TELEVISION NEWS

## GO VERT TO COLOR TV

**COLORDAPTOR**—A simple 10 tube circuit and rotating color wheel converts any size black and white TV, direct view or projection, to receive compatible color TV. **COLOR-DAPTOR** is simply attached to TV set, does not affect normal operation, and can be built from parts experimenters have on hand.

Complete specifications including theory of operation, complete simplified construction plans, schematic, sample color filters. \$1.95.

Essential parts kit containing all special parts—coils, delay line, crystal, color filters—Up to 16" sets—\$19.75, 17" and larger—\$20.95.

All other **COLORDAPTOR** parts, kits, motors, etc. available. Write for information, prices.

**COLORDAPTOR** 3471 Ramona Palo Alto, Calif.

**BARGAIN HUNTING? TV SERVICEMEN!**

Write for SENSATIONAL CATALOG

**HENSHAW RADIO SUPPLY**

3619 TROOST KANSAS CITY, MO.

**RADIO and TELEVISION ELECTRONICS**

**RCA** in all Technical Phases New Classes (Day and Evening) Start 1st of Dec. Mar., June, Sept.

Free Placement Service for Graduates For Free Catalog write Dept. RN56

**RCA INSTITUTES, INC.**

A Service of Radio Corporation of America  
350 WEST 4TH ST., NEW YORK 14, N. Y.

For HIM for HER for you

**GENERAL ELECTRIC HI-FI MEANS  
ENDURING MUSICAL ENJOYMENT!**

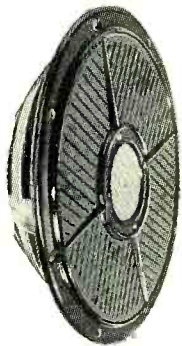

**G-E  
GOLDEN CO-AX**  
12-inch  
Dual Coaxial  
Loudspeaker

Combines a 12-inch woofer, a 2 3/4-inch tweeter, and built-in electrical-mechanical crossover system. Handles 25 watts of power. Distortion free response—40 to 15,000 cycles... **\$4495**

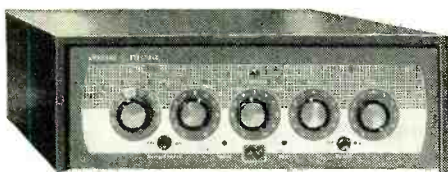

**G-E CONVERTIBLE**  
20-watt Amplifier and Pre-Amp

Dual chassis design for independent installation or use as a complete unit. This flexible, low-cost component provides 7 panel-mounted controls. **\$9995**



Loveliest of all—the gift of great music through the years. Awakened for you now in new splendor by the magic wand of General Electric Hi-Fi. Here are components for a lifetime of superb musical enjoyment. Ideal for anyone who appreciates the finest.

The incomparable General Electric cartridge puts new brilliance in your favorite recordings at modest cost. Ranging upward, you'll find General Electric speakers, the sensational 20-watt Amplifier and Pre-Amp, and other superb components each adding in its unsurpassed way to a quality of reproduction famous in professional circles. Fortunately, all General Electric components are sensibly priced. Examine them at your local dealer's, or write today for our free booklet of new Hi-Fi ideas. *General Electric Company, Special Products Department, Section R15116, Electronics Park, Syracuse, New York.*

*Progress Is Our Most Important Product*

**GENERAL  ELECTRIC**

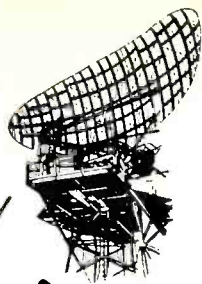

# FIELD TECHNICIANS

*Broaden the scope of your career with Bendix Radio!*

Get these BIG ADVANTAGES!

- Professional status
- The prestige of representing the leader in its field.
- Top salaries
- Liberal field allowances

If you have 5 or more years of electronics experience, you benefit many ways as a Bendix Radio Field Engineer. You will receive full pay while you go to our company-sponsored school in Baltimore. Then, you will be given a key assignment in the United States or overseas with responsibility of maintaining search and surveillance radar equipment made by Bendix Radio.

Write, call or wire EMPLOYMENT SUPERVISOR Dept. R

## Bendix Radio

DIVISION OF BENDIX AVIATION CORP  
Towson 4, Maryland  
(Phone VAlley 3-2200)

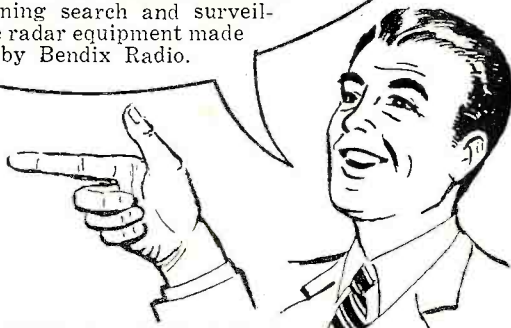

# \$500 per month?

mobile radio is bursting at the seams

That's a conservative income from mobile-radio maintenance!

equipment needs regular, careful maintenance

105-B MICROMETER FREQUENCY METER



Heterodyne type, measures crystal-controlled transmitters on the bench 0.1 to 500 mc. Price \$220.00 net.

205-A FM MODULATION METER

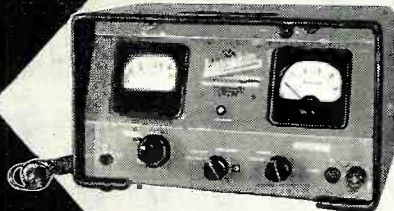

Measures peak deviation  $\pm 25$  kc. Tunable 25-500 mc. in one band. Small, rugged. Price \$240.00 net.

## LAMPKIN

test equipment is preferred by most mobile engineers!

Send for free booklet telling how you can earn money in mobile-radio maintenance.

**LAMPKIN LABORATORIES, INC.**  
MFM Division  
BRADENTON, FLORIDA

LAMPKIN LABORATORIES, INC.  
MFM Division, Bradenton, Florida  
At no obligation to me, please send  
 Free booklet  Data on Lampkin meters.  
Name \_\_\_\_\_  
Address \_\_\_\_\_  
City \_\_\_\_\_ State \_\_\_\_\_

Park, Illinois. The facility will be used to service the company's tube distributors in the Midwest . . . **SELECTRO CORPORATION** has moved into its own plant building at 610 Fayette Avenue, in Mamaroneck, New York. Some facilities are being retained at the firm's old quarters in New Rochelle, N. Y. . . . **ERIE RESISTOR CORPORATION** of Erie, Pa. is building a modern ceramic plant in State College, Pa. to be known as **TECHNICAL CERAMICS**. Completion is scheduled for late this fall . . . **APPLIED ELECTRONICS COMPANY, INC.**, manufacturer of marine and industrial communications equipment, has completed a 22,000 square foot plant in South San Francisco, California. . . . **UNIVERSAL WIRE & CABLE** of Chicago has opened a West Coast warehouse and sales branch at 5107 Telegraph Road in Los Angeles. The firm also operates a branch in Houston . . . **PACKARD-BELL COMPANY** has broken ground for a new service division and distributor headquarters on Figueroa Street just south of Washington Boulevard in downtown Los Angeles. The building will contain 30,000 square feet of floor space. A 22,000 square foot parking facility will be located adjacent to the structure. . . . **WHOLESALE RADIO PARTS CO., INC.** has opened a new electronic distribution center at 1650 Whiteford Road in York, Pa. Complete distribution services will be maintained for customers in the area. The firm's main location is in Baltimore, Md. -50-

### Deflection Circuit Analyzer (Continued from page 50)

shorted turns, the "Q" of the component will be low enough to load down the oscillator. The change in oscillator grid voltage will be amplified by the d.c. amplifier which, in turn, causes the neon bulb to stop glowing.

#### Using the Analyzer

In the event that trouble occurs in the horizontal deflection and high voltage sections, the horizontal oscillator, output tube circuit, flyback transformer, or deflection yoke will most often be at fault. To determine whether the trouble lies in the horizontal oscillator, the 15 kilocycle saw-tooth from the "Analyzer" is injected into the control grid of the TV receiver horizontal output tube (after removing the oscillator tube). The function switch is set to "Signal Substitute" and the signal is taken from the "Grid Drive" terminal. If a raster now appears, the set's horizontal oscillator is bad.

If a raster does not appear, check the output circuit. The plate cap is removed from the horizontal output tube and this cap is connected to the "Xfmr. Drive" jack of the "Analyzer." The function switch is set at "Signal Substitute." In this test, the 6BQ6 of the "Analyzer" supplies the signal to drive the flyback transformer and output circuit. If high voltage and raster are now produced, it is apparent that

the trouble is between the grid and plate of the output tube. In this case check the screen and cathode voltages of the output tube first. It is assumed that the tube has been replaced.

On the other hand, if no raster is produced by this test, the trouble must be in the output circuit made up of the damper tube, flyback transformer, deflection yoke, width coil, etc. An "Overload" pilot light on the front panel of the "Analyzer" is used for locating troubles in the output circuit. This pilot light should glow dimly when the "Analyzer" is connected to the plate cap of the TV receiver horizontal output tube. If the "Overload" bulb is excessively bright, too much current is being drawn in the output circuit, probably caused by a shorted component. The receiver should be turned off before damage can result. The next step is to disconnect components in the horizontal output circuit until the overload no longer exists. The last component disconnected before proper operation is restored is the defective one.

If the "Overload" indicator does not light, look for an open circuit in the output section. Replace the damper tube. With the receiver turned off, check the continuity of the "B+" circuit through the flyback transformer to the plate of the horizontal output tube with an ohmmeter or the continuity tester in the "Analyzer" (switch position 3).

If the previous tests have not located the trouble, check the flyback transformer. The presence of as little as one shorted turn in this transformer can keep the circuit from operating correctly. For this test, the "Function" switch of the "Analyzer" is set to "Short Test." The high voltage rectifier lead of the transformer goes to the "Test" jack on the instrument; the horizontal output tube lead of the transformer goes to the ground connector. If the neon bulb goes out, the transformer should be replaced. The deflection yoke is tested in the same manner.

The vertical deflection circuit in a TV receiver is somewhat simpler than the horizontal circuits. To check the vertical oscillator, set the "Function" switch to the "Signal Substitute" position and feed the signal from the "Vert. Drive" jack to the grid of the vertical output tube. If vertical deflection is produced when there was none previously, it is evident that the vertical oscillator is the cause of the trouble. On the other hand, if vertical deflection is not produced, the defect is probably in the output circuit. The vertical deflection yoke may then be tested in the same way as the horizontal section.

Servicing by use of a systematic procedure which divides the television circuit into its simple parts results in a great saving of time. The process of signal substitution described in this article can be applied to any part of the receiver although its greatest value as a time saver is in the troubleshooting of deflection circuits. —30—

for the exciting new

# COLOR ERA ..

here's the antenna that assures

**BETTER VIEWING...** the new **KAY-TOWNES K9 Antenna**

Even better than the famous BIG JACK and perfect in COLOR, too.

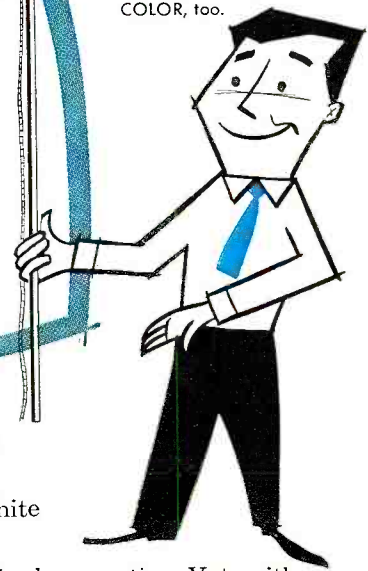
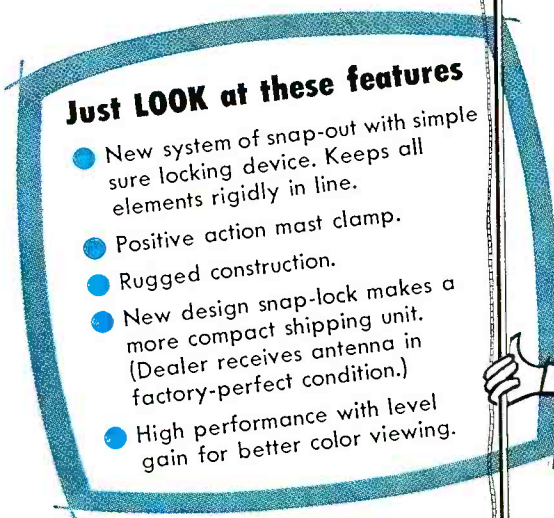

In color or in black and white it's the picture that counts, and for the best picture in either color or black and white Kay-Townes' new K9 offers the level gain performance so necessary to *good color reception*. Yet, with all this, it outperforms a 10-element yagi. Field-tested over the entire land under every weather condition, it bears the stamp of Kay-Townes engineering . . . guarantee of a quality TV antenna.

## K3 METROPOLITAN

Here's the all-round antenna *best suited* to metropolitan and primary areas where top performance, compact design and easy installation is desired—check it and you'll agree it's the finest metropolitan antenna available.

**IN STOCK AT BETTER JOBBERS**

**KAY-TOWNES**  
**ANTENNA COMPANY**  
 BOX 593 • ROME, GEORGIA



Superior's New Model TC-55



New!



# Streamlined TUBE TESTERS

FOR

The Experimenter or Part-time Serviceman, who has delayed purchasing a higher priced Tube Tester. The Professional Serviceman, who needs an extra Tube Tester for outside calls. The busy TV Service Organization, which needs extra Tube Testers for its field men.

Speedy, yet efficient operation is accomplished by: Elimination of old style sockets used for testing obsolete tubes (26, 27, 57, 59, etc.) and providing sockets and circuits for efficiently testing the new Noval and Sub-Minar types.

- You can't insert a tube in wrong socket. Separate sockets are used, one for each type of tube base.
- "Free-point" element switching system Any pin may be used as a filament pin and the voltage applied between that pin and any other pin, or even the "top-cap".
- Checks for shorts and leakages between all elements. Provides a super sensitive method of checking for shorts and leakages up to 5 Megohms between any and all of the terminals. Continuity between various sections is individually indicated.
- Elemental switches are numbered in strict accordance with R.M.A. specification. The 4 position fast-action snap switches are all numbered in exact accordance with the standard R.M.A. numbering system.

Model TC-55 comes complete with operating instructions and charts and streamlined carrying case.

**\$26<sup>95</sup>**  
NET

## PICTURE TUBE TESTER



Superior's New Model TV-40



- Tests all magnetically deflected tubes . . . in the set . . . out of the set . . . in the carton!!
- A complete picture tube tester for little more than the price of a "make-shift" adapter!!

The Model TV-40 is absolutely complete! Self-contained, including built-in power supply, it tests picture tubes in the only practical way to efficiently test such tubes; that is by the use of a separate instrument which is designed exclusively to test the ever increasing number of picture tubes!

### SPECIFICATIONS

Tests all magnetically deflected picture tubes from 7 inch to 30 inch types. • Tests for quality by the well established emission method. All readings on "Good-Bad" scale. • Tests for inter-element shorts and leakages up to 5 megohms. • Test for open elements.

Model TV-40 comes absolutely complete — nothing else to buy. Housed in round cornered, molded bakelite case. Only . . .

**\$15<sup>85</sup>**  
NET



Superior's New Model TV-11 Standard Professional

## TUBE TESTER

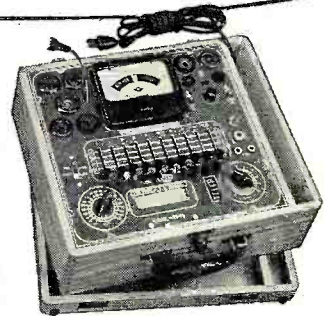

- ★ Uses the new self-cleaning Lever Action Switches for individual element testing. Because all elements are numbered according to pin-number in the RMA base numbering system, the user can instantly identify which element is under test. Tubes having tapped filaments and tubes with filaments terminating in more than one pin are truly tested with the Model TV-11 as any of the pins may be placed in the neutral position when necessary.
- ★ The Model TV-11 does not use any combination type sockets. Instead individual sockets are used for each type of tube. Thus it is impossible to damage a tube by inserting it in the wrong socket.
- ★ Free-moving built-in roll chart provides complete data for all tubes.
- ★ NOISE TEST: Phono-jack on front panel for plugging in either phones or external amplifier will detect microphonic tubes or noise due to faulty elements and loose internal connections.

**EXTRA SERVICE** — The Model TV-11 may be used as an extremely sensitive Condenser Leakage Checker. A relaxation type oscillator incorporated in this model will detect leakages even when the frequency is one per minute.

The model TV-11 operates on 105-130 Volt 60 Cycles A.C. Comes housed in a beautiful hand-rubbed oak cabinet complete with portable cover.

**\$47<sup>50</sup>**  
NET

## TRANS-CONDUCTANCE TUBE TESTER

Superior's New Model TV-12

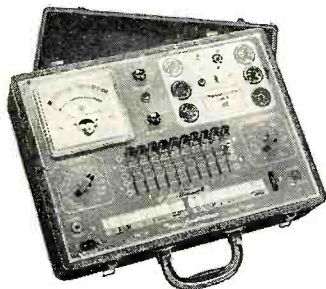

### TESTING TUBES

- ★ Employs improved TRANS-CONDUCTANCE circuit. An in-phase signal is impressed on the input section of a tube and the resultant plate current change is measured. This provides the most suitable method of simulating the manner in which tubes actually operate in Radio & TV receivers, amplifiers and other circuits. Amplification factor, plate resistance and cathode emission are all correlated in one meter reading.
- ★ NEW LINE VOLTAGE ADJUSTING SYSTEM. A tapped transformer makes it possible to compensate for line voltage variations to a tolerance of better than 2%.
- ★ SAFETY BUTTON—protects both the tube under test and the instrument meter against damage due to overload or other form of improper switching.

- ★ NEWLY DESIGNED FIVE POSITION LEVER SWITCH ASSEMBLY. Permits application of separate voltages as required for both plate and grid of tube under test, resulting in improved Trans-Conductance circuit.

### TESTING TRANSISTORS

A transistor can be safely and adequately tested only under dynamic conditions. The Model TV-12 will test all transistors in that approved manner, and quality is read directly on a special "transistor only" meter scale.

Model TV-12 housed in handsome rugged portable cabinet sells for only

**\$72<sup>50</sup>**  
NET

ALSO TESTS TRANSISTORS!

**EXAMINE BEFORE YOU BUY!**  
**USE APPROVAL FORM ON NEXT PAGE**

**New!**



# Superior's New Model 670-A SUPER-METER

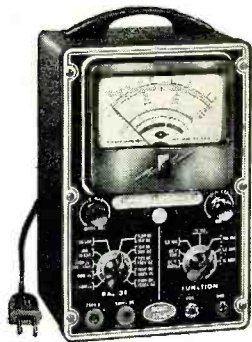

**SPECIFICATIONS**

D.C. VOLTS: 0 to 7.5/15/75/150/750/1,500/7,500 Volts  
 A.C. VOLTS: 0 to 15/30/150/300/1,500/3,000 Volts  
 OUTPUT VOLTS: 0 to 15/30/150/300/1,500/3,000 Volts  
 D.C. CURRENT: 0 to 1.5/15/150 Ma. 0 to 1.5/15 Amperes  
 RESISTANCE: 0 to 1,000/100,000 Ohms 0 to 10 Megohms  
 CAPACITY: .001 to 1 Mfd. 1 to 50 Mfd. (Good-Bad scale for checking quality of electrolytic condensers.)  
 REACTANCE: 50 to 2,500 Ohms 2,500 Ohms to 2.5 Megohms  
 INDUCTANCE: .15 to 7 Henrys 7 to 7,000 Henrys  
 DECIBELS: -6 to +18 +14 to +38 +34 to +58

**ADDED FEATURE:**

**Built-in ISOLATION TRANSFORMER** reduces possibility of burning out meter through misuse.

The Model 670-A comes housed in a rugged crackle-finished steel cabinet complete with test leads and operating instructions.

**\$28<sup>40</sup>**  
NET

**SHIPPED ON APPROVAL  
NO MONEY WITH ORDER  
NO C.O.D.**

**TRY ANY**  
of the instruments on this or  
on the facing page, for 10 days  
before you buy. If completely satisfied **then** send down payment and pay balance as indicated on coupon. **No Interest or Finance Charges Added!**  
If not completely satisfied return unit to us, no explanation necessary.

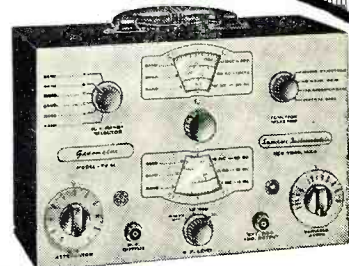

The new Model TV-50

## GENOMETER

A versatile all-inclusive GENERATOR which provides ALL the outputs for servicing:  
 A.M. Radio • F.M. Radio • Amplifiers • Black and White TV • Color TV

**R. F. SIGNAL GENERATOR:** Provides complete coverage for A.M. and F.M. alignment. Generates Radio Frequencies from 100 Kilocycles to 60 Megacycles on fundamentals and from 60 Megacycles to 180 Megacycles on powerful harmonics. • **VARIABLE AUDIO FREQUENCY GENERATOR:** In addition to a fixed 400 cycle sine-wave audio, the Genometer provides a variable 300 cycle to 20,000 cycle peaked wave audio signal. • **BAR GENERATOR:** Projects an actual Bar Pattern on any TV Receiver Screen. Pattern will consist of 4 to 16 horizontal bars or 7 to 20 vertical bars. • **CROSS HATCH GENERATOR:** Genometer will project a cross-hatch pattern on any TV picture tube. The pattern will consist of non-shifting horizontal and vertical lines interlaced to provide a stable cross-hatch effect. • **DOT PATTERN GENERATOR (FOR COLOR TV):** The Dot Pattern projected on any color TV Receiver tube by the Model TV-50 will enable you to adjust for proper color convergence. • **MARKER GENERATOR:** The following markers are provided: 189 Kc., 262.5 Kc., 456 Kc., 600 Kc., 1000 Kc., 1400 Kc., 1600 Kc., 2000 Kc., 2500 Kc., 3579 Kc., 4.5 Mc., 5 Mc., 10.7 Mc., (3579 Kc. is the color burst frequency.)

MODEL TV-50 comes absolutely complete with shielded leads and operating instructions.

**\$47<sup>50</sup>**  
NET

Only

**MOSS ELECTRONIC DISTRIBUTING CO., INC.**  
Dept. D-297, 3849 Tenth Ave.  
New York 34, N. Y.

Please send me the units checked. I agree to pay down payment within 10 days and to pay the monthly balance as shown. It is understood there will be no finance or interest charges added. It is further understood that should I fail to make payment when due, the full unpaid balance shall become immediately due and payable.

- Model TC-55.....Total Price \$26.95 \$6.95 within 10 days. Balance \$5.00 monthly for 4 months.
- Model TV-12.....Total Price \$72.50 \$22.50 within 10 days. Balance \$10.00 monthly for 5 months.
- Model 670-A.....Total Price \$28.40 \$7.40 within 10 days. Balance \$3.50 monthly for 6 months.
- Model TV-11.....Total Price \$47.50 \$11.50 within 10 days. Balance \$6.00 monthly for 6 months.
- Model TV-40.....Total Price \$15.85 \$3.85 within 10 days. Balance \$4.00 monthly for 3 months.
- Model TV-50.....Total Price \$47.50 \$11.50 within 10 days. Balance \$6.00 monthly for 6 months.

Name \_\_\_\_\_  
 Address \_\_\_\_\_  
 City \_\_\_\_\_ Zone \_\_\_\_\_ State \_\_\_\_\_

All prices net, F.O.B., N.Y.C.

# New IRC Dual Diodes

Spot Radio News  
(Continued from page 12)

**\$ 99** EA. NET

## Replacements for TV

The perfect replacements for dual diodes now being used in many TV sets instead of vacuum tube diodes. Full IRC quality . . . all exact duplicates of manufacturers' types.

## Three Types

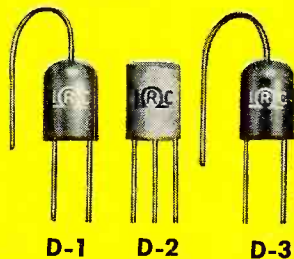

**D-1:** common cathode, dome-shaped type for GE, Hallicrafter and Muntz TV receivers.

**D-2:** common cathode, cylindrical-shaped type for GE TV receivers.

**D-3:** series type, dome-shaped diodes for Admiral and Magnavox TV receivers.

### "SKIN-PACKED"

Now at your IRC distributor on "skin-packed" perforated cards. "Skin-packing" protects dual diodes before you buy them . . . keeps them fresh after you buy them . . . type and style are clearly identified.

**99c EACH**

List Price: \$1.65

### SELENIUM DUAL DIODE

Stock No. D-1 for 27-226 SR-0006 K115J510-2

Hallicrafter Muntz G.E.

### SELENIUM DUAL DIODE

Stock No. D-1 for 27-226 SR-0006 K115J510-2

Hallicrafter Muntz G.E.

### SELENIUM DUAL DIODE

Stock No. D-1 for 27-226 SR-0006 K115J510-2

Hallicrafter Muntz G.E.

### SELENIUM DUAL DIODE

Stock No. D-1 for 27-226 SR-0006 K115J510-2

Hallicrafter Muntz G.E.

### SELENIUM DUAL DIODE

Stock No.

Hallicrafter Muntz G.E.

Wherever  
the Circuit Says



INTERNATIONAL RESISTANCE CO.

Dept. 483, 401 N. Broad St., Phila. 8, Pa.

In Canada: International Resistance Co., Ltd., Toronto, Licensee

Much better current regulation, as well as stability, can be obtained by using a well-designed constant-current source. The source in use at the Bureau (a special electronically regulated power supply) has a regulation of one part in  $10^5$  for a load variation of from zero to 100 ohms, while the stability is  $\pm$  one part in  $10^5$  per hour. Stabilities of  $\pm$  one part in  $10^6$  have been observed over periods of from five to ten minutes. With this source, r.f. power levels at the thermistor from 100 milliwatts down to 100 microwatts were measured with respective accuracies of .05 to 5 per-cent.

The design of this bridge circuit permits the inclusion of a self-balancing feature by having the amplified output of the bridge control the amount of shunt current. The improvement over present-day commercial bridges is about ten to one in the power range, and as much as 100:1 in the percentage accuracy, with the greatest improvement at low levels.

THE RECENT NATIONAL radio and television show in Great Britain revealed that a number of British TV set manufacturers are using electrostatic-type picture tubes. Portables with 9- and 12-inch screens are also the vogue, exhibits disclosed.

Many electronic robots were also on view. One device shown, an electronic random-number indicator, selects winning numbers of government premium bonds. Other exhibits included an electronic letter-sorting machine claimed to herald a revolution in the handling of mails; it enables a postman to divide mail into 120 divisions as against the normal 48 divisions of hand sorting. Also at the show were an electronic telephone switcher and the prototype of a speaking clock controlled by a quartz crystal which, it was said, gives a maximum error of 1/200th of a second in 24 hours.

One of the highlights of the affair was the FM trend. By the end of the year, over 84 per-cent of the population of the United Kingdom will be able to receive FM. As a result, industry in Great Britain is going all out for the replacement of old chassis operating only on AM.

SINCE THE ISSUANCE of the June FCC order on TV allocations, authorizations for stations have been side-tracked, and instead flurries of briefs with comments, counter-comments, appeals, and new requests have hit the Commission. Hundreds of such cases are now on the docks, and specific grant action has just about halted. The only TV activity in new station business was, as this column was written, in new-call assignments, as indicated on page 113 of this issue.

NEW ELECTRONIC DEVELOPMENTS have begun to have a decisive impact on our way of life.

During the recent convention in San Francisco, facsimile demonstrated its dynamic value when a New York daily used this photoelectronic method of transmission to publish California editions of convention papers, only hours after the stories were wired in. As the convention reporters phoned in their copy, the information was fed to linotype-machine operators, type was set, pages were made up and fed to facsimile machines linked to the coast. In San Francisco, the facsimile film was developed, sped by motorcycle to engravers, and four hours later complete editions were off the presses. Copy was transmitted at the rate of 175 square inches per minute; an entire issue took about a half hour to transmit.

Elsewhere, to aid in the solution of the increasingly complex problem of air-traffic control, a commercial version of the *charactron* shaped-beam tube, with a nineteen-inch screen, which has been used for some time in the Sage system of military aircraft surveillance, has been developed.

Instead of a blip on a radar screen that is sometimes surrounded by unwanted reflections from geographical

RADIO & TELEVISION NEWS



features or buildings, a moving diagram is provided by the system using the new tube. In addition to indicating the relative positions of the aircraft and showing movement across a map diagram, the system with the new tube actually prints letters and numbers to represent such information as flight number of the plane, speed, and altitude. All of this information is superimposed on a line-map diagram of the airfield area, eliminating all of the clutter or non-essential geographical shapes picked by raw radar.

Each cluster of numbers and letters moves on the map screen in relation to the airplane's movement in flight, and the numbers and letters in each cluster change as often as necessary to provide current information. Thus a control-tower operator engaged in directing air traffic can assimilate a tremendous amount of information from many radar sets, relating to a number of airplanes.

The *charactron* shaped-beam tube is essentially a device for displaying letters and numbers on a cathode-ray tube. The tube screen resembles that of a conventional television tube. In the tube, electrons are squirted or projected through a tiny stencil in which each opening is shaped like a letter or number to be reproduced. When the electron beams thus shaped strike the phosphor-coated screen, they reproduce a visible letter on the screen. The location of each character on the screen can be exactly controlled. The new tube, it is said, has a capability of reproducing letters and numbers, or specially-designed characters, at a rate in excess of 20,000 characters per second. Because each is formed by a carefully engraved or predetermined shape in the tiny stencil, the fidelity of reproduction of these characters is claimed to be uniformly high.

Also on tap in the busy electronic wonder world are radio units in traffic lights that can be used for public-address purposes to avoid panic during emergencies. Describing their operation, a traffic-communications expert said that voice messages could be given to motorists and pedestrians through traffic-light equipment, by using amplifiers mounted in the same cabinets containing intersection radio-tone control units.

At the Wright Air Development Center another exciting electronic development has made its appearance; an airborne TV system which may be used in jet aircraft reconnaissance by the U. S. Air Force.

Unlike the systems which have been used on occasion to relay TV signals from one ground point to another by way of a slow-circling plane, the modern method is a self-contained station. It is said to be so compact that it can be carried in a single-seat aircraft.

To cover a wide area, two unmanned TV cameras are used in a plane. Signals from the plane are transmitted to the ground control point where they are picked up by a receiver. There, the picture may be instantaneously photographed on 35-mm film which can be processed, it is claimed, in less than a minute. The picture can then be projected on life-size screens at the control point, or relayed to other locations. Also, pickups from slower moving aircraft may be observed, live, on standard fine-line monitors.

In addition, data, such as time and position, may be automatically printed on the film. And, according to the system's designers, it is also possible to slow or stop TV pictures, taken at high speeds, without a blur of ground movement.

Electronics is truly shaping our world, setting an exciting pattern for the future. . . . L. W.

### NEW CALL LETTER ASSIGNMENTS

STATE	CITY	CALL	CHANNEL
Conn.	Hartford	WTIC-TV	3
Minn.	Minneapolis	KMGH-TV	9
		(Formerly KEYD-TV)	
	St. Paul	KCTE-TV	2
N. Dak.	Williston	KUMV-TV	8
S. Dak.	Deadwood	KDSJ-TV	5
Tex.	Brownwood	KNBT-TV	19
Va.	Newport News	WACH-TV	33
		(Formerly WYOU-TV)	

# New IRC Fuse Resistors

**\$.45** EA. NET

## Easy To Use

IRC's new fuse resistors are rectangular-shaped, plug-in types for fast, easy replacement. Famous IRC quality in every respect.

## Two Types

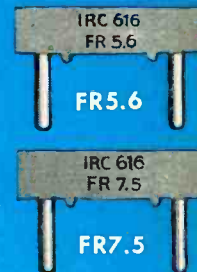

Popular values meet requirements of most sets. FR5.6 . . . 5.6 ohms. FR7.5 . . . 7.5 ohms.

### "SKIN-PACKED"

IRC fuse resistors are sheathed in protective plastic film from the moment they leave the IRC factory until you install them! Type and range are clearly identified on each card.

**45c EACH**

List Price: 75¢

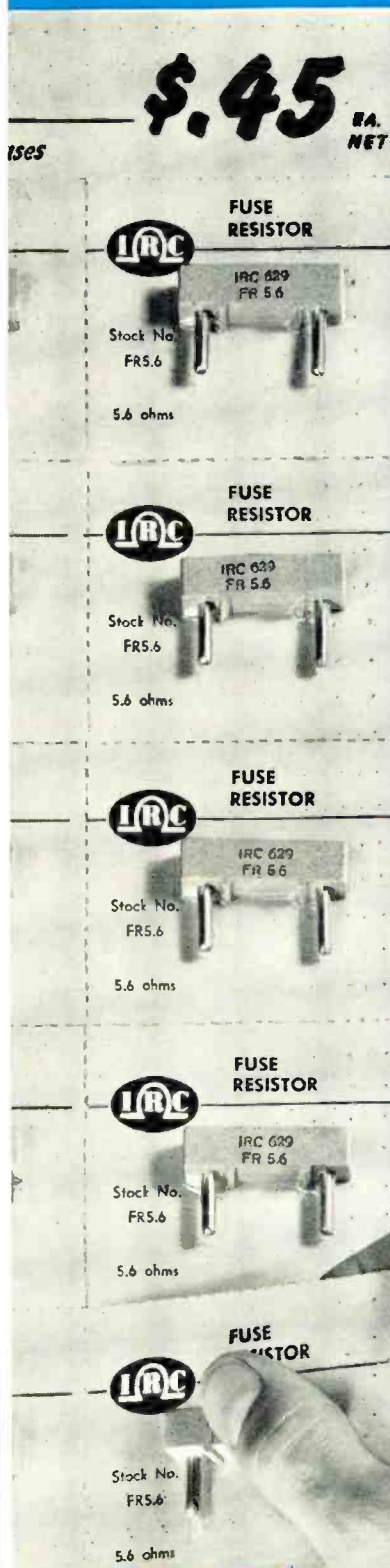

Wherever  
the Circuit Says



**INTERNATIONAL RESISTANCE CO.**  
Dept. 483, 401 N. Broad St.,  
Phila. 8, Pa.  
In Canada: International  
Resistance Co., Ltd.,  
Toronto, Licensee

# LAFAYETTE SENSATIONAL VALUES! IN COMPLETELY WIRED TEST EQUIPMENT AT LESS than the PRICE of KITS!

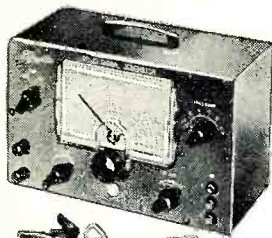

## LAFAYETTE SIGNAL GENERATOR

NEVER BEFORE HAS A COMPLETELY WIRED AND TESTED INSTRUMENT OF SUCH ACCURACY AND QUALITY BEEN OFFERED AT SUCH A PRICE!

- FREQUENCY 120 KC TO 260 MC
- 120 KC TO 130 MC ON FUNDAMENTALS
- LABORATORY ACCURACY AND QUALITY

A completely wired and tested instrument not to be confused with units sold in kit form at almost the same price, but with a quality and accuracy of instruments 3 to 4 times its price. Six overlapping ranges generate signals of 120KC—320KC, 320KC—1000KC, 1MC—3.2MC, 1MC—38MC and 37MC—130MC all on fundamentals with calibrated harmonics from 120MC to 260MC. Selector switch gives instant choice of ranges. Switch gives choice of internal modulation of 400 CPS or use of any external source at other frequencies. For audio testing the 400 cycle signal can be used separately. Outputs are unmodulated RF, modulated RF and 400 CPS audio. RF output is in excess of 100,000 microvolts and jacks are provided for choice of either high or low RF output. Stability is insured by special circuit design. Has a fine adjustment RF control. AF output is 2-3 volts. AF input is 4 volts across 1 megohm. Large clear 5 inch etched dial plate and pointer are protected by transparent plastic bezel. Common AF terminals for EXT-MOD input and INT-AF for audio tests eliminate need for special AF output connectors. Machine engraved panel lettering. Handsome gray metal case with carrying handle. Measures 6 1/2" x 10" x 4 1/2". Comes complete with pair of leads. AC line cord and plug. Operates on 105-125V 50-60 cycle AC. Shpg. wt., 8 lbs.

22.50

LAFAYETTE LSG-10 SIGNAL GENERATOR 22.50

## NEW POCKET AC-DC VOM MULTITESTER

2,000 ohm per volt Sensitivity on both DC and AC

- 160  $\mu$  3" METER
- 1% PRECISION RESISTORS
- SILVER CONTACT SELECTOR SWITCH

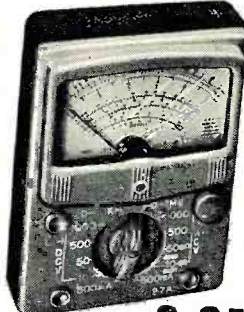

### FULL SCALE RANGES

DC Volts: 0-10; 0-50; 0-500; 0-1000 Volts — AC Volts: 0-10; 0-50; 0-500; 0-1000 Volts — DC Current: 500  $\mu$ a and 500 ma — Resistance: 0-10K; 0-1 Meg — Decibels: -20 to +22; -20 to 36 db (0 db = 0.775 V) — Capacity: 250 mmfd to 2 mfd — .005 mfd to 1 mfd — Output Ranges: 0-10; 0-50; 0-500; 0-1000 volts

8.95

Best Buy in America! A very accurate and sensitive VOM, high quality and sensitive 160 microamp meter; 2000 ohm per volt on both AC and DC. Features plastic front panel, precision resistors, 3" meter. Features extreme versatility, with metal bottom for ruggedness and shielding. First capacity range requires 50 volt AC source. Second capacity Complete with test leads and batteries. Shipping weight 4 lbs.

RW-27A

Complete 8.95

NEW!

## LAFAYETTE CAPACITANCE-RESISTANCE TESTER WITH "IN-SET QUICK CHECK"

COMPLETELY WIRED AND TESTED



- TWO INSTRUMENTS IN ONE
- CHECKS ELECTROLYTIC, PAPER, MICA AND CERAMIC CONDENSERS
- 4 DIRECT READING CAPACITY SCALES FROM .0001-.005 MFD, .001-.5 MFD, 1-50 MFD AND 20-1000 MFD.
- CHECK FOR OPEN SHORTS, LEAKAGE AND INTERMITTENTS
- 2 RESISTANCE RANGES FROM 100 TO 5 MEGOHM

Here is a "must" for servicemen and lab technicians. A completely self-contained AC operated capacitance and resistance bridge, plus a quick check for in the set testing. Large 6 direct reading scale has 4 ranges of .0001-.005 MFD, .001-.5 MFD, 1-50 MFD and 20-1000 MFD. Resistance ranges are 100-50,000 OHMS and 10,000 to 5 megohm. Quick check feature enables you to check capacitors for shorts, open or intermittent while in circuit—no need to remove them from the set till you're sure they need replacement. Leakage test switch gives you choice of 25, 150, 250, 350 or 450 volts for checking leakage under correct potential. Separate power factor control with continuous settings from 0 to 50%. Operation is simple and accurate, using a magic-eye tube as the null detector. Attractively finished steel case with etched panel and rounded corners, measures 14 1/2" L x 8 3/4" H x 5" D. Shpg wt. 19 lbs.

34.50

MODEL LC-4 NET 34.50

NEW!

## LAFAYETTE CAPACITOR-RESISTANCE TESTER

COMPLETELY WIRED AND TESTED



21.50

- COMPLETELY WIRED AND TESTED
- CHECKS ALL TYPES OF CONDENSERS FOR CAPACITY, LEAKAGE, OPEN SHORTS OR INTERMITTENT CONDITION
- DIRECT READING SCALES FROM .0001 TO 1000 MFD AND 100 TO 5 MEGOHMS

A stable and accurate bridge type circuit measures capacitance in 4 ranges of .0001-.005 MFD, .001 to .5 MFD, 1 to 50 MFD and 20 to 1000 MFD. Two resistance ranges of 100-50,000 and 10,000 to 5 megohms. Check leakage under actual load with choice of 25, 150, 250, 350 or 450 volts available by selector switch. Power factor control from 0 to 50%. Checks for leakage, open, shorts, or intermittent operation. All readings taken directly off scales after setting magic eye to maximum. Completely self-contained power supply. Attractively finished steel case with rounded corners and etched panel. Operates from 110V AC. Size 9 3/4" L x 7 1/8" H x 5 1/4" D. Shpg. wt. 10 lbs.

MODEL LC-15 NET 21.50

## HIGH SENSITIVITY 20,000 OHM PER VOLT DC 10,000 OHM PER VOLT AC MULTITESTER



### LOOK AT THESE FULL SCALE RANGES!

D.C. Volts: 0-6; 0-30; 0-120; 0-600; 0-1000; 0-6000 Volts — A.C. VOLTS: 0-6; 0-30; 0-120; 0-600; 0-1200 Volts — RESISTANCE: 0-10K; 0-100K; 0-1 Meg; 0-10 Megohms — D.C. CURRENT: 0-60 Microamp; 0-6; 0-60; 0-600 Milliamps — DECIBEL: -20 to +17 db (0.774V) — CAPACITY: .0001 to .005-.15 mfd — INDUCTANCE: 20-2000 millihenry — OUTPUT RANGES: 0-6; 0-30; 0-120; 0-600; 0-1200 Volts

19.95

The new Lafayette high sensitivity Multitester is a complete instrument (not a kit) in addition to its unusual sensitivity of 20,000 OHMS PER VOLT ON D.C. AND 10,000 OHMS PER VOLT ON A.C., and the extraordinary number and scope of its ranges, it is packed with features that would make it cost at least twice as much if made in this country. Uses 1% precision resistors, silver contacts on selector switch, 35  $\mu$  3" meter. Dependable, rugged and accurate. Even the test leads are heavy duty with high voltage insulation. Volt-ohm range required for low capacity range is 120V A.C., for high range capacity and inductance scale is 6V A.C. Attractive plastic front with metal bottom. Size 6 1/2" x 4 1/2" x 1 1/2". Complete with batteries and leads. Shipping weight 4 1/2 lbs.

RW-30A

Singly, Each 19.95 In lots of 3, Each 19.25

## 4 AND 6 TRANSISTOR SUPERHET KITS POCKET AND HOME RADIOS FOR SPEAKER AND EARPHONE OPERATION

POCKET SIZE: 4" L x 3-5/16" W x 1" D BUILT-IN ANTENNA! REQUIRES NO EXTERNAL ANTENNA OR GROUND!

Lafayette engineers have designed this fascinating 4-transistor superhet receiver kit in a unique and interesting form. It is, by itself, a completely self-contained, pocket sized personal portable set which operates a miniature earpiece so only you can hear; by plugging into the KT-96 kit listed below, it is instantly converted to a full 6-transistor home radio, complete with speaker for the entire family to enjoy. Circuit features use of 4 transistors (2 high frequency and 2 audio type) plus a germanium diode, 2 LC stages and built-in high gain ferrite core and antenna. The result is a sensitive, stable and selective set covering the entire broadcast band. Requires no outside antenna or ground connection. The kit is furnished complete with transistors and all parts, including battery and chassis already drilled and punched. The earpiece and carrying case are accessory items, not supplied. All necessary pictorial and circuit diagrams are furnished with simple, easy-to-follow instructions.

- KT-94 — Kit, shpg. wt., 2 lbs. Net 19.95
- MS-311 — Leather Carrying Case. Net 1.95
- MS-260 — Super power dynamic earpiece. Net 3.95

### 2 TRANSISTOR PUSH-PULL OUTPUT KIT WITH SPEAKER SELF-CONTAINED IN BEAUTIFUL PLASTIC CASE.

- CONVERTS 4-TRANSISTOR KIT INTO A 6-TRANSISTOR HOME RADIO WITH SPEAKER

Add a completely transistorized push-pull audio stage to your 4 transistor receiver. Complete stage including speaker and case measures only 3" H x 2 3/4" W x 1 3/8" D. Plugs right into 4 transistor kit above. Converts your 4 transistor set to a 6 transistor plus diodes superhet receiver. Performance equal or superior to commercially wired sets selling at more than twice the price. Kit includes 2 transistors, 2 transformers, 2 1/2" PM speaker, pre-punched chassis, speaker case to hold entire stage, battery, hardware, instructions and diagrams.

KT-96—Shpg. wt., 1 lb. Net 11.50

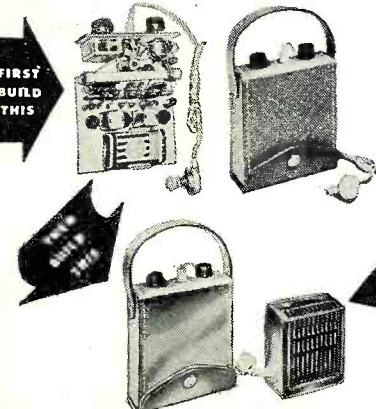

# LAFAYETTE RADIO DEPT RK-1

100 SIXTH AVE., NEW YORK, N. Y.  
BOSTON, MASS., 110 Federal St.  
PLAINFIELD, N. J., 139 West 2nd St.  
NEWARK, N. J., 24 Central Ave.  
BRONX, N. Y., 542 E. Fordham Rd.

JAMAICA 33; N. Y. 165-08 Liberty Ave. Write for FREE Bargain Packed Catalog!

# FREE! LAFAYETTE CATALOG



# ELECTRONIC CATALOG PACKED WITH MONEY SAVERS

Packed with the largest selection of Electronic, Radio and T.V. Parts, and equipment, P.A. Hi-Fi systems, tubes, antennas, Transistor Kits, parts and components, Test Equipment, new build your own kits, tools, books, Microscope, drafting equipment, Binoculars, Telescopes, All Radio, TV and Ham supplies — ALL AT GREAT SAVINGS — For the economy minded servicemen, dealer, engineer and technician. **CHUCK FULL OF BUYS! SEND FOR YOUR FREE COPY TO-DAY.**

## 35 WATT HI-FI AMPLIFIER KIT WITH METERED OUTPUT AND 4 PUSH-PULL PARALLEL NEW EL84 TUBES

New Lafayette high power amplifier kit with a host of features not in any other single amplifier. Calibrated output meter permits use as either a recording or reproducing amplifier. EL84 power pentodes provide high peak power and low distortion required for better audio quality. Features exceptional control versatility and ample inputs for all associated custom hi-fi equipment. DC operated preamp filaments and balancing adjustment to minimize hum. Meter can be switched to indicate either recording voltage or output level of amplifier. Features rumble filter, loudness control, separate bass and treble controls, silencing switch, speaker selector switch, output balancing adjustment and monitoring jack.



### SPECIFICATIONS

FREQUENCY RESPONSE:  $\pm 1$  db 20-40,000 cps. HUM: 85 db below rated output. POWER OUTPUT: 35 watts with 4% total distortion at full rated output. INPUTS: TV Sound, Radio, Magneto Phono, Crystal Phono, Tape. OUTPUT IMPEDANCE: 4, 8 and 16 ohms; high impedance for tape recorder. TUBE COMPLEMENT: 3-12AX7, 1-12AU7, 4-EL84, 1-5U4. FEEDBACK: Negative feedback loops virtually eliminate distortion. POWER: 117V, 60 cps, 80/150 watts with auxiliary power receptacles. Removable eucutcheon. Size 12 1/2" L x 9 3/4" D x 4 1/2" H. A combination of high power, high fidelity, gleaming beauty and advanced engineering features unmatched at even twice the price. Supplied in complete kit form with simplified easy-to-follow instruction sheets. Shpg. w., 25 lbs.

KT-115—Complete kit, .....Net 59.50

## LAFAYETTE'S FM-AM TUNER KIT

- SIMPLIFIED DETAILED INSTRUCTION MANUAL
- MEETS FCC REQUIREMENTS FOR RADIATION
- GROUNDED GRID TRIODE AMPLIFIER
- ARMSTRONG FM CIRCUIT WITH FOSTER-SEELEY DISCRIMINATOR
- AFC DEFEAT CIRCUIT WITH FRONT PANEL CONTROL

The excellence of its design and the quality of its components combine to provide this compact high-fidelity FM-AM tuner with superb characteristics normally found in units costing several times as much, and with performance unbelievable at this low price. Features Armstrong FM circuit with limiter and Foster-Seeley discriminator. Simplified tuning with slide-rule dial and flywheel counterweighted mechanism. AFC defeat circuit combined with tuning control. Attractive etched copper-plated and lacquered finish.

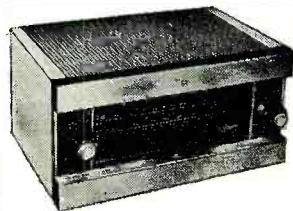

### SPECIFICATIONS

FREQUENCY RANGE: FM, 88-108 MC; AM, 530-1650 KC. ANTENNA INPUT: FM, 300 ohms; AM, Ferrite loopstick and high impedance external antenna. CONTROLS: 2—a function control for AM, FM, PHONO, TV and a tuning/AFC defeat control. DISTORTION: Less than 1% rated output. FREQUENCY RESPONSE: FM,  $\pm 5$  db 20 to 20,000 cps; AM,  $\pm 3$  db 20 to 5000 cps. SENSITIVITY: FM, 5  $\mu$ v for 30 db quieting; AM, Loop sensitivity 80  $\mu$ v/meter. SELECTIVITY: FM, 200 KC bandwidth, 6 db down — 375 KC FM discriminator peak to peak separation; AM, 8 KC bandwidth, 6 db down. IMAGE REJECTION: 30 db minimum. HUM LEVEL: 60 db below 100% modulation. TUBE COMPLEMENT: 2-12AU7, 1-6BA6, 1-6BE6, 2-6AU6, 1-6AL5 plus 1-6X4 rectifier. SIZE: 5 1/4" high x 9 1/2" wide x 9 1/2" deep (excluding knobs). CONSUMPTION: 30 watts. For 110-120V 60 cycles AC. Less metal case. Shpg. wt., 9 lbs.

KT-100 Complete kit, less cage, .....Net 34.95  
ML-10 — Completely wired, ..... Less metal case, .....Net 52.50  
ML-100—Metal cage for above, shpg. wt., 3 lbs., .....Net 5.00

New!

## HIGH FREQUENCY TWEETER WITH ACOUSTIC LENS DIRECT IMPORTATION MAKES THIS PRICE POSSIBLE!



14.95

- FREQUENCY RESPONSE FROM 2000 CPS TO BEYOND AUDIBILITY
- LOUVERED ACOUSTIC LENS FOR UNIFORM SOUND DISPERSION
- HANDLES 25 WATTS OF POWER
- PRICED EXCEPTIONALLY LOW

New high frequency tweeter featuring a louvered acoustic lens for uniform sound dispersion and capable of handling up to 25 watts of distortion-free power. The directional tendency of high frequency notes is overcome by the natural wide dispersion angle of the short horn and the acoustic lens which disperses and radiates the high notes smoothly throughout the entire listening area. The lens is detachable for panel mounting, with a separate base for the tweeter furnished for external mounting where desired. Aluminum voice coil has 16 ohms impedance. Size: 1 1/4" long x 3" diameter, lens extends 2 1/2". Requires a crossover network, preferably one with a level control, such as the LN-2. With full instructions. Shpg. wt., 5 lbs.

HW-7 .....Net 14.95

## METAL-CASED CONE TYPE HI-FI TWEETER

FREQUENCY RESPONSE 2000-16,000 CPS · HANDLES 20 WATTS OF POWER

Highest quality cone type high frequency tweeter having a range from 2000 to 16,000 cycles. Especially efficient at higher end of audio spectrum where other cone type tweeters tend to lose clarity and volume. Entirely closed in a metal case with a base so that it can stand by itself or be mounted on a flat surface with mounting bracket supplied. Rated to handle 20 watts of power. A crossover network is required; the Lafayette LN-2 is ideal. Voice coil impedance 8-16 ohms. Size: 3 1/8" x 2 1/8" x 3" Diam. Shpg. wt., 3 lbs.

5.95  
Net



HK-3 .....Net 5.95

## CROSSOVER NETWORK

• CAPACITIVE-INDUCTIVE NETWORK WITH CROSSOVER AT 2000 CPS • BUILT-IN LEVEL BRILLIANCE CONTROL



8.75

The frequencies above 2000 cycles are channeled to the high frequency tweeter by means of the high-Q inductance and capacitance comprising this efficient crossover network. The highs and lows are brought into acoustic balance by means of a continuously variable level-brilliance control. Control has a 2 1/2 ft. long cable for remote mounting. Network matches 8-16 ohm speakers with insertion loss reduced to a minimum. Enclosed in metal case 6" L x 2 1/2" H x 2 1/2" D. With full instructions. Shpg. wt., 5 lbs.

LN-2 .....Net 8.75

## 2 WAY SPEAKER SYSTEM 40-16,000 CYCLES



A modest budget need no longer limit your HI-FI aspirations. The system consists of the G.E. 12" woofer with heavy 14.5 oz. alnico V magnet and 1 1/4" aluminum voice coil rated at 25 watts; the new metal cased HK-3 cone type tweeter; and the LN-2 crossover network with level and brilliance control. Both tweeter and network are described on this page. The complete 2-way speaker system covers the frequency range 40-16,000 cycles. Shpg. wt., 16 lbs.

SY-87—Complete System, .....Net 27.50

SY-86—Complete System, same as above except the HW-7 Tweeter with acoustical lens is supplied instead of HK-3. Shpg. wt., 20 lbs., .....Net 36.50

Lafayette  
Radio  
DEPT RK-2

165-08 Liberty Ave.  
JAMAICA 33; N. Y.

SEND  
FREE  
LAFAYETTE  
CATALOG

NAME \_\_\_\_\_

ADDRESS \_\_\_\_\_

CITY \_\_\_\_\_

ZONE \_\_\_\_\_

STATE \_\_\_\_\_

CUT OUT  
AND MAIL  
TODAY!

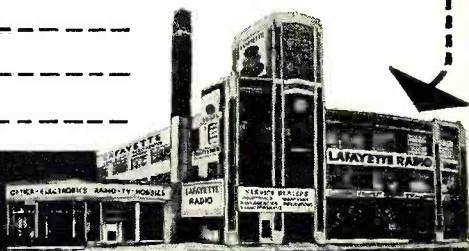

New! LAFAYETTE  
Mail Order Center

**AIREX**  
THE ELECTRONICS  
SUPERMARKET

**FALL PRICE SMASH RS**  
TOP QUALITY MERCHANDISE  
LOW... LOW... PRICES

**RECORD  
CHANGER  
BARGAINS**



**COLLARO RC54:** New 4 speed intermix, automatic shut-off, weighted turntable, manual position, plug-in head, 1 pole motor. **\$29.95**

**WEBSTER NEW 4 SPEED:** changer with Magic Mind. Automatically changes from 33 1/3 to 45 RPM as the record drops. New 16 RPM speed. With ceramic cart, dual sapphire styli. **\$24.95**

With 4 pole motor & GE RPX050A Reluctance cart & dual sapphire styli. **\$27.95**

**MONARCH MDL UAB:** British made, 4 speed, weighted turntable, intermix, automatic stop and shut off, heavy duty 4 pole motor, rubber turntable mat. Reg. \$49.95. **\$29.95** Less Cart.

**RECORD CHANGER BASES & BOARDS**

for the changers listed  
BASES... **\$3.89** MOUNTING BOARDS... **\$1.95**  
12" Ball Bearing Phono Slides... **pr. \$1.95**

**NATIONALLY FAMOUS GOLDEN CASED RELUCTANCE CART TYPE RPX052A.** Triple play .003 mill sapphire & .001 mill diamond. Clip-in Stylus. Stylus pressure... **\$17.95**

**NATIONALLY FAMOUS RELUCTANCE CART TYPE 050A.** Triple play sapphire needles for all records, clip-in stylus, stylus pressure... **\$6.95**

45 RPM SPINDLES GARRARD \$3.49 MONARCH \$2.95  
WEBSTER \$2.95 COLLARO \$3.75

**Grommes Hi-Fi Amplifier Kit**  
10 Watts, 18 watts peak, Resp. 20-20,000 cps, 1 db. Presamp., 4 inputs. Hum-80 db, 2% Harm. Dist at 10 watts. Complete with detailed step by step instruction manual, all resistors, condensers, tubes, wire & solder. Easy to make, 2-12AX7, 2-6V6, & 5Y3. Bass & Treble boost. Limited quantity. **\$24.95**

**FM-AM TUNER KIT**  
Easy to assemble. Professional quality performance. 3 double tuned IF stages, Foster-Seelye discriminator, automatic frequency control & defeat. 7 tubes plus rectifier. Distortion less than 1%. Hum level 70DB. Sensitivity 6 microvolts for 20 DB quieting on FM & 20 microvolts on AM. FM selectivity 200KC band width 8 DB down; AM S/C band width 5 DB down. 3 1/4" high x 9 1/2" wide x 3" deep. Complete with step-by-step instructions. **\$29.95**

**FM TUNER ONLY—\$23.95 • COVER—\$3.95**  
These units are ideal in combination with the Grommes Hi-Fi Amplifier.

**MULLARD HI-FIDELITY TUBES**

Type	Replaces	Price	Type	Replaces	Price
EL34	KT66; 6CA7	\$4.35	ECC82	12AU7	\$2.20
EL37	6L6; 5881;		ECC83	12AX7	\$2.50
	KT66	\$3.50	EF86	Z729;	
EL84	6BQ5	\$2.40	G232	5V4; 5U4	\$2.75
ECC81	12AT7	\$2.60			\$2.95

**FAMOUS UTAH 12" COAXIAL SPEAKER**  
LATEST DESIGN PARABOLIC WOOFER  
WITH 3 1/2" PARABOLIC TWEETER

This Utah 12" dual range reproducer compares in every respect with highly advertised \$50.00 units—yet COSTS LESS than most speakers. Exclusive built-in cross-over network ensures a frequency response from 35 to 15,000 cycles. The handling capacity is a full 12 watts. Ideal for any custom installation. Voice Coil impedance—8 ohms. Shipped in factory sealed cartons. Shipp. wt. 9 lbs. **\$12.88**

All merchandise is brand new, factory fresh & guaranteed. Mail & phone orders filled on receipt of certified check or MO of 20% of items as a deposit. Balance C.O.D., F.O.B. factory N. Y. Prices & specifications subject to change without notice.

**AIREX RADIO CORP.** 64 Cortlandt St., N.Y. 7, N.Y.  
Phone CO 7-2137

**DYNAKIT  
MARK II**

The most compact high fidelity 50 watt amplifier made. 100 watt peak. Intermodulation distortion less than 1% at 50 watts, less than .25% below 35 watts. Response 6-60KC ±.5db ±.1db 20-20Kc. Input 1.5 volts for 50 watt output, Damping factor of 15. 8 and 16 ohm taps. Uses 2-EL34, 6AN8 and 5U4GB. Complete with all components. Prewired XXXP circuit board. Only top quality parts used throughout. With bottom cover and **\$69.75** cage. 27 lbs.

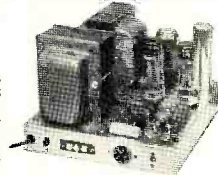

**Metzner  
Starlight  
Transcription  
Turntable**



Continuously variable speed from 16 to 83 R.P.M. Built-in illuminated stroboscope. Wow and flutter less than .40 db below recording level. Massive machined aluminum turntable with cork mat. Center drive, governor controlled motor. No belts, no pulleys, no cones. Mounting plate **\$49.50**  
12" x 13 1/2" .....  
Transcription base for turntable and arm... **\$14.95**



**NEW EICO 20 WATT  
HI-FI AMPLIFIER**

High quality ultra linear Williamson type circuit. Rated Power Output: 20 watts (34 watts peak). IM Distortion (60 cps; 6 kc/4:1) at rated power: 1.3%. Mid-band Harmonic Distortion at rated power: 0.3%. Maximum Harmonic Distortion between 20 cps & 20,000 cps at 1 db under rated power approx. 1%. Freq. Response at rated power ± 0.5 db 20 to 20,000 cps. Speaker Connection Taps: 4, 8, and 16 ohms. • 5 low-distortion feedback equalizations for LP's and 78's including RIAA. • Variable turnover low-distortion feedback tone controls do not affect volume & permit large amounts of boost or cut at either end of audio spectrum with mid-frequencies unaffected; "flat" positions at center settings. • Loudness control & separate level set control both on front panel. • Low impedance output to tape recorder. • 4 high level switched inputs: tuner, tv, tape, auxiliary (crystal/ceramic phono or 2nd tuner); 2 low-level inputs (not switched) for proper pickup loading & attenuation for all leading magnetic, FM & high quality crystal cartridges. • Hum balance control. **KIT, \$49.95 COMPLETELY WIRED, \$79.95**



**NEW EICO  
HI-FI PREAMP**

Response 12 to 50,000 cps ±.3 db; 6 inputs; hum & noise—75 db; total harmonic distort. 1%. 4 tube operation. Built-in scratch & rumble filter. Complete with cover.

Less Power Supply With Power Supply  
Kit ..... **\$24.95** Kit ..... **\$29.95**  
Wired ..... **\$37.95** Wired ..... **\$44.95**

**Radio Astronomers  
"Tune In" on Venus**

*Huge radio telescope tied in with electronic recorder picks up signals from outer space.*

**A**N Ohio State University radio astronomer recently reported receiving Morse code-like signals from a source presumed to be the planet Venus. Dr. John D. Kraus, director of the university's Radio Observatory, said that these signals often are accompanied by another type of emission from Venus—a crackling signal resembling static from thunderstorms. Whether or not Dr. Kraus was actually "tuned in" to Venus, often referred to as the earth's "twin," his dramatic report highlights advances being accomplished in the relatively new science of radio astronomy.

Radio astronomy, which traces back to the 1930's, is a new technique which supplements and extends the older visual astronomy methods. Four other institutions, in addition to Ohio State, are involved in this research. They include Harvard University, the California Institute of Technology, the Naval Research Laboratory, and the Carnegie Institution of Washington.

Radio waves are many times longer than light waves and can easily probe the huge clouds of dust in space that hide many objects from the conventional visual observations. For example, the experts tell us that one of the brightest objects in the sky would be the head-on collision of two entire galaxies some 200 million light years away. It would be so faint visually that it could only be photographed by long-range exposures with the largest optical telescope. If it were much farther away, even Mount Palomar's 200-inch telescope couldn't pick it up. Yet it could be easily "observed" through radio astronomy.

The key to radio astronomy is a "radio telescope." This consists of a huge, open-field based antenna, a receiver, and a special electronic recording instrument. The antenna, which gathers and focuses the radio waves like the lens of an optical telescope can be, as it is at Ohio State, a monstrous affair some 160 feet long and 22 feet wide. The entire antenna pivots on an east-west axis like a telescope.

The ultra-sensitive receiver and recording system is generally located in a nearby building. The electronic recorder at Ohio State, designed by Minneapolis-Honeywell's Industrial Division, does for the radio telescope what photo plates do for optical telescopes. Operating 24 hours a day, the instrument automatically records the celestial radio signals that provide the raw material which the scientists later study and analyze.

For All Your  
**HI-FI REQUIREMENTS**  
Write us first  
Complete stock of  
Tuners, Amplifiers, Speakers and Systems,  
Changers, Turntables, Cartridges, etc.  
Our Consultation Service is at your disposal.  
Write us today. Prompt Replies.  
Suggested Systems from \$150 and up  
We Ship Prepaid and Insured in the U. S.  
**SOUND MART UNLIMITED, INC.**  
Dept. N, 119 E. 59 St., New York 19, N. Y.

**L M B BOX CHASSIS  
OFFERS FREE  
inside LMB boxes**

10 tested kit diagram projects for the builder. Each one of these kit diagrams built by a recognized expert. Kit projects are complete in every detail. Circuit diagram, photo of project both front and rear photo. Rear photo shows wiring and parts. Detailed instructions for building, complete parts list and approximate cost. Complete to build exact part and your distributor can supply the parts. Ask your distributor for the list of LMB kit Diagram Projects. If he does not have them, write to

**L M B** 1011 Venice Blvd.  
Los Angeles, 15, Calif.

# Free.

## to Service Technicians Only

# THE NEW SAMS INDEX TO PHOTOFAC FOLDERS

### it keeps you up-to-the-minute on receiver coverage

PHOTOFAC Folders give you the world's finest Service data on TV and radio models just as soon as they hit the market. Now—with the new INDEX SYSTEM to PHOTOFAC, you locate the *latest* PHOTOFAC coverage *immediately*.

If you're a Service Technician, you can get the new Sams Index FREE. Here's how it keeps you up-to-date on receiver coverage: The Master Index (36 pages—issued twice yearly) is the complete reference to *all* PHOTOFAC Folders produced up to the date of its issue. In addition, you get an Index Supplement each month covering that month's releases of PHOTOFAC Folders. Thus, the Master Index *plus* the supplements keep you right up with current PHOTOFAC coverage. (The Index Supplements also appear each month in "PF Reporter" Magazine.)

It's easy to get your complete Index service to PHOTOFAC at NO COST TO YOU. If you're a Service Technician, just fill in the coupon and mail to us today. It will bring the Master Index direct to your shop, and monthly supplements will be mailed to you regularly thereafter. YOU'LL KEEP RIGHT UP-TO-THE-MINUTE ON PHOTOFAC COVERAGE—you'll be able to locate the data you need on over 30,000 models, as well as on CURRENT MODEL RELEASES.

Mail coupon today for your free subscription to the Sams Photofact Index

**HOWARD W. SAMS & CO., INC.**

Howard W. Sams & Co., Inc.  
2203 E. 46th St., Indianapolis 5, Indiana

Send me your FREE Master Index to PHOTOFAC Folders (twice yearly), and put me on your mailing list to receive all Index Supplements. My letter-head and/or business card is attached.

I am a Service Technician:  full time;  part time.

My Distributor is: \_\_\_\_\_

Shop Name \_\_\_\_\_

Attn: \_\_\_\_\_

Address \_\_\_\_\_

City \_\_\_\_\_ Zone \_\_\_\_\_ State \_\_\_\_\_

**Free!**  
TO SERVICE  
TECHNICIANS

TAKE THE RIGHT STEP TO TIME-SAVING PROFIT-BUILDING BUSINESS: Sign up with your Parts Distributor to get PHOTOFAC Folder Sets automatically each month.

**DO IT NOW!**

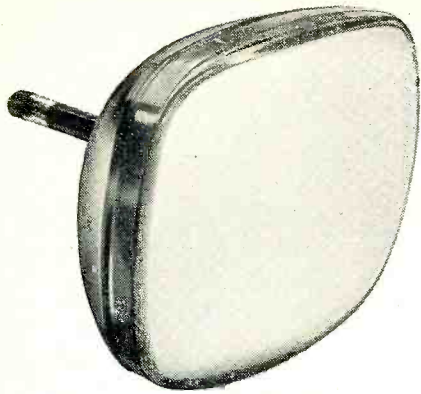

**BEST IN  
SIGHT**

**BEST IN  
SOUND**



Made to the highest requirements of leading set manufacturers, Tung-Sol Tubes are perfect replacements for all sets. Bank on Tung-Sol's brand of quality—tops in the industry. It's the sure way to avoid callbacks that eat into profits. Tell your supplier you'd rather have Tung-Sol tubes.

*Blue Chip Quality*

**TUNG-SOL®**

MAGIC MIRROR ALUMINIZED  
**PICTURE TUBES**  
**RECEIVING TUBES**

TUNG-SOL ELECTRIC INC., Newark 4, N. J. Sales Offices: Atlanta, Ga., Columbus, Ohio, Culver City, Calif., Dallas, Tex., Denver, Colo., Detroit, Mich., Irvington, N. J., Melrose Park, Ill., Newark, N. J., Seattle, Wash.

TUNG-SOL makes All-Glass Sealed Beam Lamps, Miniature Lamps, Signal Flashers, Picture Tubes, Radio, TV and Special Purpose Electron Tubes and Semiconductor Products.

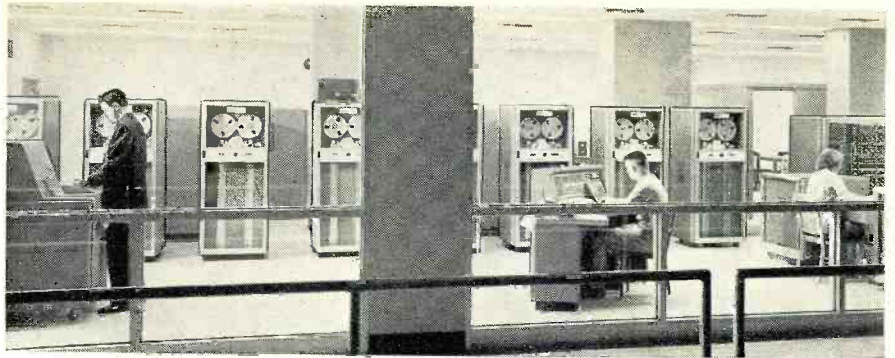

Over-all view of newly installed electronic computer-communications system that was formally put into operation recently at the Army Signal Supply Agency in Philadelphia.

## Large Computer Keeps Signal Corps' Records

*Army computer-communications system is now being used to provide high-speed control of global logistical operations.*

**A** GIANT electronic computer (IBM 705) recently went into formal operation as the electronic brain of the Army Signal Corps computer-communications system for signal supply management at The Army Signal Supply Agency in Philadelphia.

Designed by the *International Business Machines Corporation*, the computer is a key element of the electronic data processing network that handles requisitions, stock control, and other data pertaining to signal supplies for the entire U. S. Army. Installed at the focal point of these world-wide operations, it provides high-speed control of global logistical operations.

Working at incredible speeds, the computer proves a tireless worker—an electronic accountant providing an exchange of signal supply information needed to expedite the requisitioning, stock control, and distribution of signal equipment, parts, and components.

A major step in the field of automation for the Army Signal Corps, the electronic computer can make 30,000 logical logistical decisions per second; it can make 8400 additions or 1200 multiplications per second; and it can process 8000 tabulating machine cards a minute, thousands of times faster than by manual operation. The unit accounts for and controls the daily changing status of more than 150,000 items of signal communications equipment and supplies. These supplies are stored in depots in the U. S. and overseas. Daily supply information is provided on inventory changes, procurement, substitution of items, repair status, and other types of supply data.

Information made available to the computer is memorized and stored on magnetic tape and on ferrite core memory frames. This data is continuously available and can be reproduced at electronic speeds.

-30-

(Right) Central memory unit of the electronic computer. This unit contains a large number of tiny ferrite cores whose magnetization pattern is scanned to "read out" the information indicated by pattern.

(Below) Operators at master control panel of computer. This console supervises operations and permits communications between the operators and the entire system.

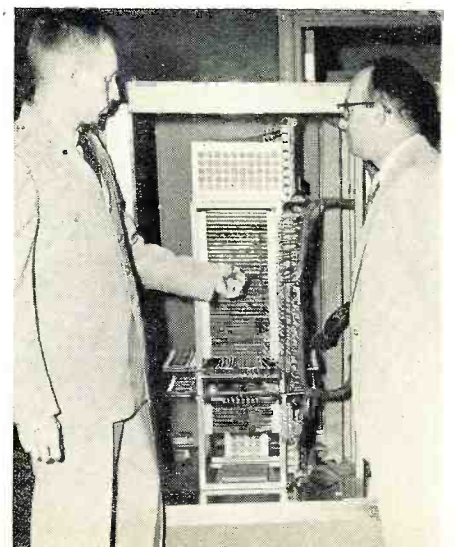

RADIO & TELEVISION NEWS

# RCA'S MISSILE TEST PROJECT



is attracting **Creative Engineers**  
and **Scientists** who are bound  
toward **success**

*Specific fields  
include:*

**TELEMETRY**  
**RADAR**  
**TIMING**  
**COMMUNICATIONS**  
**DATA PROCESSING**  
**OPTICS**

●  
*Request Your Interview **NOW...**  
RCA Engineering management  
will arrange an interview at the  
time and place you find most  
convenient. Please send complete  
resume of education and  
experience to:*

**Mr. H. N. Ashby, Technical Employment**  
**Missile Test Project, Dept N-16L**  
**RCA Service Company, Inc., P.O. Box 1226**  
**Melbourne, Florida**

**RADIO CORPORATION of AMERICA**

**MTP...** the Missile Test Project of the  
RCA Service Company, Inc. . . . at the Air Force  
Long Range Missile Test Center . . . is the largest  
missile-testing range and laboratory in the world!  
The responsibility for providing precision  
instrumentation for advanced stage missiles with a  
vast range of performance characteristics means  
new engineering and planning organizations and—  
real opportunity for rapid individual growth.

Here you will encounter instrumentation problems  
that challenge the state of the art and stimulate  
your creative ability in Aero, Ballistic and  
Space techniques.

Your rewards will include all the fascination,  
excitement and satisfaction of achievement  
in new frontiers of scientific knowledge . . .  
plus top salary.

What's more, you'll enjoy the pleasant climate  
and ideal living on Florida's central east coast,  
where Patrick Air Force Base, site of the MTP,  
is located.

RCA offers many additional advantages:  
Complete facilities . . . Planned advancement  
program . . . Professional recognition . . . Liberal  
program of company-paid benefits . . . Relocation  
assistance. You should have a Bachelor's or  
advanced degree in EE, ME, Physics or  
Mathematics and two or more years' experience.



Tmks. ®

# TRAN-KIT ELECTRONICS CO., INC.

Specialists in U-MAKE-IT transistor kits

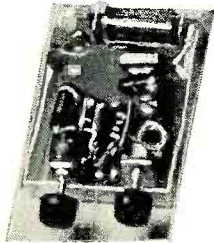

Two transistor regenerative kit complete with battery and case . . . less earphone

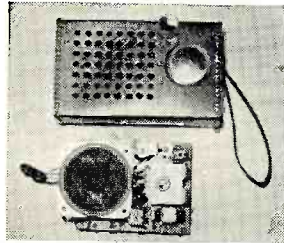

Four transistor super-het kit on P.C. board in simulated leather case . . . complete with speaker

## Super-sensitive high imp. dynamic phones available



Completely transistorized preamplifier kit for Hi-Fi application—wide frequency range on printed circuit board



Multi-purpose kit for building code oscillator, receiver, amplifier, etc.

Contact your local Distributor or Jobber

TRAN-KIT ELECTRONICS CO., INC. 467 So. Fifth Ave. Mount Vernon, N. Y.

# Longest Range Shipborne Radar

Uses 60-pound magnetron to deliver peak r.f. power of over ten million watts.

THE most powerful shipborne radar set ever put in service has been installed on the cruiser "Northampton," a Navy command vessel for directing the firepower of a task force. At the heart of this radar set is a magnetron designed and developed by the Westinghouse Electronic Tube Division. Nicknamed "Big Maggie," this tube delivers over ten million watts of peak r.f. power, enough to search out enemy planes over 400 miles away. This magnetron has a power capacity at least ten times that of existing World War II tubes. The tube itself, without the external connections, is about the size of a football and it weighs only about 60 pounds; its permanent magnet weighs some 300 pounds.

A major problem was the development of a cathode that could supply the enormous current required. The cathode had to operate at up to 3100 degrees F, greater than the temperature of molten iron from a blast furnace. A special vacuum-tight glass window is used to allow the release of the radar waves from within the magnetron. The window, saucer-size but very thin, withstands the intense heat from the cathode and total pressures as great as 400 pounds. The new magnetron operates as a sealed oscillator, employing water and mild forced-air cooling.

After successful laboratory tests, "Big Maggie" and its associated equipment underwent performance tests in the port of Boston. First tests surpassed expectations for distance-scanning. Radar operators monitoring a radar screen aboard a warship were said to be surprised when, to the south, they could observe air traffic arriving and leaving New York City's LaGuardia Airport, and to the north, the rugged coastal terrain of Nova Scotia.

At the heart of the longest range shipborne radar ever put in service is an ultra-powerful magnetron nicknamed "Big Maggie" by its designers. Enough power is generated to search out enemy planes over 400 miles away.



RADIO & TELEVISION NEWS

HOW TO BUILD data and theory in the 14th Edition

RADIO Handbook

Far more how-to-build it data on all kinds of amateur and other practical radio equipment than any other publication, plus extensive simplified theory and explanations. Greatest, largest, practical radio handbook ever published. 766 pages!

\$750 in U.S.A.

\*Plus any tax.

WORLD'S RADIO TUBES (BRANS' VADE MECUM). NEW 12TH EDITION. Lists over 15,000 tubes from every tube making country. Printed in 16 languages . . . \$5.00\*



BUY FROM YOUR DISTRIBUTOR Add 10% on direct mail orders to EDITORS and ENGINEERS, Ltd. Summerland 2, California

## 6 Volt DC AUTOMATIC RADIO

Conventional broadcast band superhet. Miniature components. Self contained speaker. Tube complement: 6X4, 6AS5, 6AV6, 6BA6, 6BE6. Neat appearance. Knobs and dial included. Mfgd. by Motorola. Brand New, ready to operate. Complete with tubes and vibrator. Size: 10 1/2 x 4 1/2 x 3 1/2. Weight: 7 1/2 lbs. . . . \$19.95

### COMPARE OUR TUBE PRICES

5933 (807W) Rugged improved version of 807, Sylvania, Boxed, New	each \$1.59, 2 doz \$3.00, dozen \$5.00
304TL—EIMAC—0 3KW Tube—Lab checked.	each \$9.95, 2 for \$19.00, dozen \$100.00
0B2—Mfr. VR Tube—New, Boxed.	each \$6.99, dozen \$7.00, 100 for \$55.00
6J6W—Twin Triode—New, Boxed.	each \$4.99, dozen \$5.00, 100 for \$45.00
1625—New, Boxed, SSB type . . .	dozen \$ 2.25
446B—UHF Triode—New, Boxed RCA	each \$1.00 . . . dozen \$ 10.00
872A H.V. GAS Rect.—New, Boxed.	each \$1.25 . . . dozen \$ 12.00
2E24—RCA Boxed, each \$2.25, 100 for \$200.00	
2C39A EIMAC (Bulk) or Machlett (Boxed), each . . . . .	\$ 9.50
2C43 G.E. (Bulk), each . . . . .	\$ 8.50

— ARC 5 COMMAND SPECIAL BUYS —  
Receiver—3-6 Mc. Exc. Cond. W/all tubes and Xtal. . . . . \$6.95

### TRANSMITTERS

5-3-7Mc.—Brand New . . . . .	\$4.89
3-6 Mc.—Exc. Cond. . . . .	\$5.95
3-6 Mc. Receiver with autotune device for manual or automatic channel selector—Exc. Cond. . . . .	\$8.95

DYNAMOTOR—12VDC input output—400VDC—200MA. Small, Compact, fits in average glove compartment. Mfd. by Hoover for RCA. Brand New . . . . . \$12.95

ECHO BOX TEST SET OBU-3—Near New	\$24.95
1-208 Crystal controlled Sig. Gen. 19-45 Mc. 115V-60 Cy. Good cond. . . . .	\$49.95
TS35AP—Sig. Gen. and Pow. meter 8700-9500 Mc. . . . .	\$49.95
TS6AP—Slotted Line—with meter, etc. 360-675 Mc. New . . . . .	\$49.95
TS146U/P—9285-9465 Mc. . . . .	\$49.95
TS-111CP—Wavemeter, New . . . . .	\$49.95

BATHTUB COND.—2MFD—600VDC Side Terminal. Various Mfgs.—New—CP . . . \$39. 100 for \$35.00  
STEPPING SWITCH—W. E. #D162768—SS-7 Oper. Volt 4.5-24VDC 4 Steps. New. Few left at \$4.95  
FILA. XFORM. 5VCT—13A. Thord T19F85 or equiv. . . . . \$2.95, 2 for \$5.00  
MOD. XFORMER—20 Watts—Chicago, Casco, Potted, 6LL, 807, etc. Similar to MD-7 Mod. Xformer—Small—\$1.95 . . . . . 3 for \$5.00  
NATIONAL RECEIVER—RBL-53 Bands—15-600KC—Self Contained power supply (115V-60Cy). Brand New Original Overseas Packed (100 lb.) 12 x 17 x 18 (size). Govt. cost \$700. With tech manual—Black Wrinkle Cabinet—Lim. Quan. . . . . \$59.95

### PANEL TYPE INSTRUMENTS (all new)

Sensitive Microammeter—0-50-UA. Her. Std. 2 1/2" Rd. . . . .	\$5.95
WESTON MICROAMMETER—0-200 UA (506) 2 1/2" Rd. . . . .	\$6.95
Freq. Meter—125V. 58-62 Cy. 7 Reed—3 1/2" RD. . . . .	\$7.95

Hearing Aid Phone (Crystal) New \$1.49, 10 for \$12.50

REX RADIO SUPPLY 88 Cortland St. New York 7, N. Y.



# AMERICA'S FINEST VALUES IN "LOW COST" HIGH FIDELITY

## ECONOMY 20 WATT AMPLIFIER \$22.95

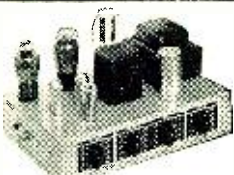

**NEW 1957 MODEL**  
**Push-Pull 6L6 Output Tubes**  
**Response 30-15,000 CPS**  
**Bass and Treble Tone Controls**  
**Input for Xtal or Dynamic Mike**  
**Input for Xtal or V.R. Phono**

With CU-14Y, 12" Coax Speaker... \$32.95  
 With P15-CR, 15" Coax Speaker... \$42.95  
 With Imperial IV System... \$39.95

With Imperial VI... \$48.95 With HF-33GE... \$69.95

A tremendous High Fidelity amplifier value. Response 30 to 15,000 cps. Electronic bass and treble boost by separate tone controls. Use this amplifier with any record changer having crystal or variable reluctance cartridge, radio tuner or high impedance crystal or dynamic microphone. 20 watts power output. Use with any 4 or 8 ohm speaker or 250 ohm line. Chassis size, 7 3/4" x 10 1/2" x 1 1/2" high. Complete with tubes; 2-6L6, 2-6CA, 12AX7 and 5U4G. This is a terrific value. A ready to use high fidelity amplifier at less than the cost of a kit. Ship. wt. 17 lbs. Model HF-20, 20 watt Hi-Fi amplifier. McGee's sale price, \$22.95.

## NEW "LOW-BOY" 3-WAY SPEAKER SYSTEM

15" COAXIAL SPEAKER  
 6" SPEAKER-CROSSOVER  
 30 to 17,000 CPS

SALE PRICE **\$29.95**

Low-Boy 3-way High Fidelity speaker system. Designed expressly for important size high fidelity. Available in mahogany finish cabinet only. Use with any high fidelity amplifier. Matches 8 ohm impedance. Equipped with a top quality 15" coaxial speaker and a 6" speaker or augmented midrange and high range response. All 3 models have genuine L-C crossover networks and variable brilliance controls. Only 2 wires to connect to the 4 or 8 ohm tap on your Hi-Fi amplifier. A fine speaker system to use with our Imperial 20, 30 and 34 high fidelity amplifiers, and all FM-AM chassis in our Radio & TV News offerings. Response with brilliant, middle and high range response. All 3 models have genuine L-C crossover networks and variable brilliance controls. Only 2 wires to connect to the 4 or 8 ohm tap on your Hi-Fi amplifier. A fine speaker system to use with our Imperial 20, 30 and 34 high fidelity amplifiers, and all FM-AM chassis in our Radio & TV News offerings. Choice of mahogany or mahogany finishes. Baffles are fully enclosed and acoustically lined. Small enough in size for the average room, yet large enough for proper baffling. 35" high, 19" front to back, 25" wide. Specify cabinet finish when ordering, otherwise we will ship mahogany finish. Take \$3.00 discount when you order with any of the Imperial amplifiers or Espey FM-AM chassis offered in this 3 page ad.

## 3 - 1957 MODEL HI-FI SPEAKERS

- COMPLETE SYSTEMS WITH 4 SPEAKERS
- ACOUSTICALLY LINED ENCLOSURES

The new 1957 Hollywood, 4 speaker high fidelity speaker systems are expressly designed to give realistic reproduction from your Hi-Fi amplifier or FM-AM radio. Juke box bass response with brilliant, middle and high range response. All 3 models have genuine L-C crossover networks and variable brilliance controls. Only 2 wires to connect to the 4 or 8 ohm tap on your Hi-Fi amplifier. A fine speaker system to use with our Imperial 20, 30 and 34 high fidelity amplifiers, and all FM-AM chassis in our Radio & TV News offerings. Choice of mahogany or mahogany finishes. Baffles are fully enclosed and acoustically lined. Small enough in size for the average room, yet large enough for proper baffling. 35" high, 19" front to back, 25" wide. Specify cabinet finish when ordering, otherwise we will ship mahogany finish. Take \$3.00 discount when you order with any of the Imperial amplifiers or Espey FM-AM chassis offered in this 3 page ad.

Model H-4H, Hollywood 4 speaker high fidelity speaker system, 20 watts, response 20 to 17,500 cps. Choice of blond or mahogany finish enclosure. Features a 12" General Electric 6.8 ohm Alnico V magnet, aluminum voice coil woofer, plus 6" mid-range and 2-5" tweeters. Built-in variable brilliance L-C crossover network. Model H-4H, Ship. wt. 55 lbs. Price \$39.95.

Model Y-4Y, Hollywood 4 speaker high fidelity speaker system, 25 watts, response from 18 to 17,500 cps. Choice of blond or mahogany finish enclosure. Features a 12" General Electric 14 oz. Alnico V magnet, aluminum voice coil woofer, plus 6" mid-range and 2-5" tweeters. Built-in variable brilliance L-C crossover network. Model Y-4Y, Ship. wt. 55 lbs. Sale price, \$44.95.

Model Z-4Z, Hollywood 4 speaker high fidelity speaker system, 25 watts, response from 18 to 17,500 cps. Choice of blond or mahogany finish enclosure. Features a 15" 2 1/2 oz. Alnico V magnet, heavy duty woofer, plus 6" mid-range and 2-5" tweeters. Built-in variable brilliance L-C crossover network. Model Z-4Z, Ship. wt. 57 lbs. Sale price, \$49.95.

## McGEE'S NEW 1957 MODEL 25 WATT 12" COAXIAL SPEAKER

- ★ 1 1/2 oz. G.E. 12" WOOFER—
- ★ 3 1/2" COAXIALLY SUSPENDED TWEETER—
- ★ BUILT-IN CROSSOVER—
- ★ ALUMINUM VOICE COIL WOOFER—

McGee's new 1957 model, GE-120XT, 12" 25 watt high fidelity coaxial PM speaker. No frills or dummy covers. It's all speaker value. Features a General Electric 12", 1 1/2 oz. Alnico V woofer with aluminum voice coil and exponential, molded seamless cone. The tweeter is a specially made 1.47 oz. Alnico V, 3 1/2" speaker which extends the high frequency response to 17,500 cps. It is electrically connected to accept only the upper register of audio. Only two wires connect this complete high fidelity speaker to any 8 ohm amplifier. Ship. wt. 8 lbs. Stock No. GE-120XT. McGee Sale price, \$18.95.

## McGee's Famous 12 AND 15 INCH COAXIAL P.M. HIGH FIDELITY SPEAKERS

Model CU-14Y, 12" high fidelity coaxial PM speaker. Response from 30 to 17,500 cps. Full 6.8 ohm Alnico V magnet in the 12" woofer. Special coaxially suspended high frequency tweeter. Built-in crossover network. Only two wires to connect to your radio or amplifier. Matches 3.2 to 8 ohm output. Don't confuse this speaker with many cheap speakers that are offered. This is a fine quality speaker. Stock No. CU-14Y. Sale price \$32.00 cash, two \$30.00.

Model P15-CR, 15" high fidelity coaxial PM speaker. Response down to 20 cps. and up to 17,500 cps. Full 2 1/2 oz. Alnico V magnet in the 15" woofer. Specially made, coaxially suspended 5" high frequency tweeter. Built-in crossover network. Only two wires to connect. Matches 3.2 to 8 ohm output transformer. A regular \$62.50 list price. Model P15-CR, McGee's Sale Price, \$23.95.

McGee's new 15" Junior coaxial PM speaker, 15" woofer has 6.8 ohm Alnico V magnet, 5" coaxially suspended tweeter with only two wires to connect to any 8 ohm radio or amplifier. Frequency response from 40 to 15,000 cps. Model No. M15-CR, 15" Junior coax PM speaker. Sale price, \$16.95.

## IMPERIAL 30 WATT AMPLIFIER \$29.95

**NEW 1957 MODEL**  
**Push-Pull 6L6 Output Tubes**  
**Response 15-20,000 CPS**  
**Bass and Treble Tone Controls**  
**Compensated Gain for G.E. Carl.**  
**Input for Xtal or Dynamic Mike**



With CU-14Y, 12" Coax Speaker... \$39.95  
 With P15-CR, 15" Coax Speaker... \$49.95  
 With Imperial IV Speaker System... \$46.95  
 With Imperial VI... \$55.95 With HF-33GE... \$76.95

New 1957 Model 30 watt High Fidelity audio amplifier. A \$100.00 list value for only \$29.95. Features a heavy 4 lb. specially wound high fidelity output transformer with 15% inverse feed-back; push-pull 6L6 output tubes and frequency response from 15 to 20,000 cps. Matches 8 or 16 ohm speakers. You can connect your own custom music system around this low cost 30 watt amplifier. This Imperial 30, 30 watt amplifier may be used with any radio tuner or record player. It will drive any speaker system that you may have. Use from one to ten 8" speakers or any 12" or 15" coaxial speaker or any 3-way speaker system. Tone compensated input for either a crystal phono pickup or a General Electric variable reluctance pickup. Also, has input for crystal or high impedance dynamic microphone, 4 controls and midrange, phono gain, treble tone and bass boost tone control. This amplifier weighs 21 lbs. net. Full size transformer components would cost you up to \$15.00 if purchased separately. Gold color chassis is 12 1/4" x 7 3/4" x 7 1/4" high. Complete with tubes; 6AT6, 12AU7, 6CA, 12AU7, 2-6L6, plus 5U4G rectifier. Stock No. IMP-30, 30 watt Imperial High-Fidelity amplifier, complete with tubes and diagram. Ship. wt. 23 lbs., Sale price only \$29.95.

## NEW IMPERIAL 24 WATT AMPLIFIER \$39.95

**PUSH-PULL EL-34 ENGLISH MADE MULLARD OUTPUT TUBES**  
**WILLIAMSON TYPE CIRCUIT**  
**RESPONSE 15-20,000 CPS**



With CU-14Y, 12" Coax Speaker... \$49.95  
 With P15-CR, 15" Coax Speaker... \$59.95  
 With Imperial IV Speaker System... \$56.95  
 With SP12125CR... \$65.95. With HF-33GE... \$86.95. Model IMP-34X

New, 1957 model Imperial 34X, 24 watt high fidelity amplifier for the audio enthusiast who wants McGee's finest amplifier. This amplifier features push-pull EL-34 English made Mullard output tubes in Williamson circuit. Heavy duty 6 lb. specially wound Williamson type ultra-linear output transformer in potted case has a response from 15 to 20,000 cps. Matches 8 or 16 ohm speakers. Amplifier has input for crystal pickup and built-in pre-amplifier for the popular General Electric and Goldring variable reluctance cartridges; as well as input for crystal or high impedance dynamic microphones. 4 controls are microphone gain, phono gain and separate variable treble and bass boost tone control with 15% inverse feed-back. Chassis size, 12 1/4" x 7 3/4" x 7 1/4" high. Complete with 7 tubes and diagram. Model IMP-34X, 24 watt high fidelity amplifier, ideal for use with any of our high fidelity coaxial or multiple speaker systems. Ship. wt. 26 lbs. Sale price, \$39.95.

## NEW IMPERIAL SPEAKER SYSTEMS

Imperial IV with 8" G.E. High Fidelity Speaker **\$19.95**

3-Way Imperial VI with 12" G.E. Speaker **\$29.95**

New 1957 Model IMPERIAL IV, High fidelity speaker system with General Electric 8" speaker. Housed in a high quality leatherette covered plywood cabinet 10" x 10" x 2 1/2" long. Fully enclosed; covered on all sides except back. Use as an auxiliary speaker or with any high fidelity radio, amplifier or home music system. The IMPERIAL IV contains a General Electric Model 850 or 8770 Norelco 8" extended range high fidelity 8" PM speaker with 6.8 ohm Alnico V magnet and curvilinear cone with 8 ohm voice coil and a 5" tweeter. Response 50 to 15,000 cps. Model IV Imperial 19.95.

1957 Model Imperial VI, 3-way speaker system. Baffle is of heavy wood, leatherette covered. Similar in appearance to the Imperial IV pictured above, except 4" taller and 1" deeper. Equipped with 3 matched speakers. A 12" G.E. Model 1203 with 9 ohm Alnico V magnet, plus 5 1/2" midrange and 3" tweeter. Simple to connect to any high fidelity amplifier. (8 ohm impedance). Stock No. IMP-VI, Sale price, \$29.95. Ideal for use with HF-20 and IMP-30 amplifiers described above.

## CONSOLE HI-FI SPEAKER SYSTEM \$49.95

12" G.E. PM WOOFER—10" PM MID-RANGE—8" G.E. MODEL 850 MID-HIGH RANGE SPEAKER AND 600 CYCLE L-C CROSSOVER NETWORK.

Have Juke Box tone quality in your own home. Strictly High Fidelity. Three speakers all connected to a 600 cycle frequency dividing network, so that only 2 wires feed the system from any 4 or 8 ohm radio or amplifier. A variable tone compensating control incorporated in the circuit makes brilliant highs or boomy lows to your own taste. Any amplifier that you now have will give you a much wider selection of acoustical arrangements with this speaker system. The 3-way system is shipped ready to connect to your amplifier or hi-fi radio. Equipped with a General Electric 12" woofer, an 8" famous G.E. 850 plus a 10" middle range speaker. Frequency response 30 to 15,000 cps. Take your choice of cabinets: blond or mahogany. (Specify finish desired when ordering) 37" high, 24" wide and 20" deep. Ship. wt. 75 lbs. Stock No. HF-33GE. Sale price, \$49.95.

Model HF-33GE, 3-way speaker system, same as above except has a heavy duty 12" G.E. PM Model 1201, plus 8" G.E. PM Model 850, 10" mid-range speaker and hard cone tweeter. Sale price, \$54.95. (Specify cabinet finish.) Model HF-33GE, 3-way speaker system, same as above except has HF-33GE described above, except has 15" 2 1/2 oz. Alnico V magnet woofer, 10" mid-range PM speaker and Model 4401 University horn type tweeter. All 3 speakers incorporate 600 cycle frequency dividing network with variable tone compensating control. Model HF-55GE, Sale price \$69.95 (specify cabinet finish).

## THEATER QUALITY HIGH FIDELITY SPEAKER SYSTEM \$39.95

15" WOOFER PLUS—ELECTRO-VOICE MODEL 847 MID-HIGH RANGE SPEAKER—600 CYCLE L-C CROSSOVER.

A theatre quality, powerful speaker system for homes and sound demonstration rooms. This speaker arrangement will connect to any high fidelity audio amplifier (8 ohm impedance) Features a 15" electro-dynamic heavy duty woofer which is equal to a PM speaker with up to 10 lbs. of Alnico V magnet. This woofer reproduces the low audio frequencies down to 20 cps. An Electro-Voice Model 847 horn type speaker is used for the middle range and high range of audio. These two speakers are connected to a 600 cycle inductive-capacity crossover network. Built in the network is the field of a transformer with a variable tone compensating control. Model HF-55GE, and not be this one. Stock No. EV-15847X. McGee's sale price, \$39.95.

# McGEE'S \$100,000 SALE! FM/AM CHASSIS-CHANGERS MONEY-SAVING VALUES

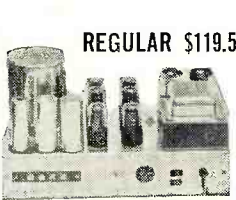
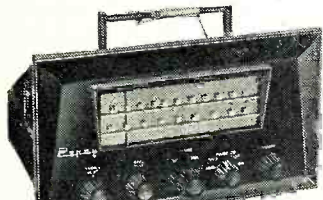

REGULAR \$119.50 VALUE **ESPEY 14 TUBE FM/AM TUNER** ON SALE **\$79.95**

24 WATT HIGH FI AMPLIFIER **\$39.95** EXTRA 34 WATT HIGH FI AMPLIFIER **\$54.95** EXTRA

McGEE'S FINEST VALUE EVER OFFERED

**YOU COULD SPEND MORE But Get NO BETTER**

McGee offers you for only \$79.95 Espey's regular \$119.50 14 tube Deluxe AM-FM tuner. (Separate audio amplifier required such as model 501G or 501E.) Prices above with 14 tubes including rectifiers. Tuner has its own built-in AC power supply. Your savings are almost \$40.00. Espey Model 700G performance features: Sensitivity 3mv on AM, 5mv on FM for 30db quieting. AM selectivity 10kc at 6db. FM 240kc at 6 db. Audio response flat from 20 cps. to 20,000 cps. with less than 1/2 percent distortion with one volt audio output. Chassis is 14" long, 8 1/2" high and 10" deep. Features a one-piece molded, gold-colored, plastic front which makes custom installation easy. Features full tuner RF stages—AFC on FM with defeating switch for easy FM tuning. Built-in pre-amplifier for GE variable reluctance phono cartridge, Pickering, etc. Three-position equalizer switch for—LP, AES or European phonograph records. Separate bass and treble tone controls with 23db. boost. Chassis is equipped with AC outlet jacks, auxiliary input jacks for tape recorder, etc. Built-in ferrite loop antenna for AM broadcast and 300-ohm input for FM band. The Espey 700G FM/AM tuner is second to none. It has all the features you might expect even if you paid up to \$200.00 for a tuner. This 700G FM/AM tuner chassis has all controls on the front which is desirable when you are using it with any good audio amplifier many of which are designed with no tone control or preamplifier circuits. We offer the 700G FM/AM tuner at only \$79.95. Shipping wt. 20 lbs. Espey 700G with Model 501G 8-tube Hi-Fi audio amp. both for \$119.90. Stock No. 700G-501G. Shipping wt. 42 lbs. Espey 700G with Model 501E 8-tube 34-watt Hi-Fi power amplifier, \$134.90.

Espey model 501G 8-tube ultra linear high fidelity 24 watt audio amplifier matching unit for use with model 700G tuner. Regular \$79.95 value—\$59.95 when purchased alone and \$39.95 when ordered with the Espey 700G tuner. This amplifier features less than 1/2 percent distortion with high fidelity audio frequency response from 10 cps. to 20,000 cps. Hum level so low it can be detected by electrical instruments only. Chassis size—12"x5"x8". Output tubes—4 6V6GT in push-pull Williamson high fidelity. Plus 6SN7 phase inverter and 2 5V4G rectifiers. Features an eight-pound potted case \$20.00 value output transformer with grain oriented iron core. Output impedance taps for 4, 8 and 16 ohms. Each **\$39.95**

Espey model 501E 8-tube 34-watt ultra linear high fidelity audio amplifier companion unit to be used with the Espey 700G tuner. Same appearance as model 501G. Equipped with 4 EL 37 English Mullard output tubes. Regular \$79.95 value—\$69.95 if purchased separately; \$54.95 if purchased with our 700G tuner. Each **\$54.95**

**ESPEY DEAL—1A**  
Espey 700G-501G tuner with 24 watt amplifier plus VM-956 GE 3 speed VM on metal base I Mill Diamond Needle \$10.00 extra. Net **\$144.95**  
If 34 watt amp is desired in place of 24 add \$15.00.

**ESPEY DEAL—2**  
Espey 700G-501G tuner with 24 watt amplifier plus new 456 Collaro 4 speed automatic record changer, less cartridge. Net **\$164.95**  
If 34 watt amp is desired in place of 24 add \$15.00.

**ESPEY DEAL—3**  
Espey 700G-501G tuner with 24 watt amplifier plus Garrard RC-98 equipped with a GE RFX-052A cartridge. Net **\$194.95**  
If 34 watt amp is desired in place of 24 add \$15.00.

**SPEAKERS RECOMMENDED**  
Order any of the following speakers with your Espey tuner and amplifier:  
12" coaxial PM, CU-14Y—\$10.00 extra  
12" coaxial PM, P15-CR—\$20.00 extra  
Imperial IV system—\$15.00  
Imperial VI system—\$25.00  
Norelco 676-12" regularly \$59.50 at \$30.00 extra.  
EV84-15W system—\$150.00 extra.

## BUY YOUR AUTOMATIC CHANGER AT McGEE



**4-SPEED COLLARO** Latest 1957 Model RC-456; Collaro 4 speed record changer. Plays all 4 speeds, 16, 33, 45 and 78 RPM both automatically and manually. Inter-mixes records of the same speed and shuts off after last record. Fast 6 second change cycle. Automatic disengagement of idler wheels eliminates flat spots that cause wow and flutter. All of the desirable features of the Model RC-532, plus 4 speed operation. Model RC-456 Collaro 4 speed automatic record changer, less cartridge. Sale price, \$34.50. RC-456 with G.E. variable reluctance cartridge with 3 mil sapphire and 1 mil diamond stylus. Sale price, \$46.95. Large spindle \$3.30.  
**MONARCH** Model UA6U—new, imported high fidelity 3 speed automatic record changer. Plays 7", 10" and 12" records, automatically. Inter-mixes records of the same speed in any order. Features a 4 pole high fidelity motor eliminating rumble and wow. Pickup automatically returns to rest and motor turns off after last record has played. Full size 10" turntable has molded rubber pallet for better record cushioning. Base size, 10 7/8" x 12 3/4". Tone arm is counter balanced to assure minimum record wear. Changer features, at no added cost the regular \$9.90 net value Goldring ±500 variable reluctance cartridge for the finest high fidelity record reproduction. Output 10 millivolts. Response, 20 to 16,500 cps. It requires the same gain as popular American variable reluctance cartridges. Model UA6U, Monarch automatic changer with Goldring cartridge, ship. wt. 15 lbs. Sale price, \$29.95. Large spindle for 45 RPM records, \$1.88 extra.  
**WEBCOR** Model 1642-1—popular 3-speed changer on metal base equipped with crystal cartridge. Sale price \$27.95.  
**WEBCOR 1642-21**. Same as above with base as pictured except with GE RFX-050 VR cartridge. Sale price, \$31.95.  
**NEW 1957 Garrard Model RC98**, "crown II," 3-speed super automatic changer, one of the world's finest. Provides the greatest combination of Hi-Fi features ever found in an automatic changer. Model RC98 changer, less cartridge—\$66.15. With VR cartridge, 1 mil diamond and 3 mil sapphire needles. RFX-052A—\$78.15. Large 45 rpm. center spindle \$3.43, extra.  
**Popular RC88 "Triumph"** Model with most of the features of the 98. RC88, less cartridge—\$53.41. With RFX-052A cartridge as above—\$65.41.

**8" NORELCO P14 \$7.95**  
Specially Priced at \$7.95 for this ad. Norelco imported from Holland 8" speaker. 15 lbs. Sale price, \$29.95. Large spindle for 45 RPM records, \$1.88 extra. Production from 75 cps to 19,000 cp—Imp. 466 ohms. Flux density 11,000 Gauss. Powerful Alnico Magnet. A fine addition to your Hi-Fi speaker collection. 2 for \$15.00

**6-TUBE, 6-VOLT AUTO RADIO \$19.99**  
WITH 6x9 SPKR. **6-TUBE 12-VOLT \$29.99**

Six-tube, 6 volt universal mounting auto radio. Thin neat construction lends itself to a nice looking underdash installation. Some auto dash panels have room to cut out for custom looking speaker is not built in. Set is furnished with the popular 6x9 size. Set dimensions—8 1/2" wide, 4 1/4" tall, 7 1/4" front to back. Dial is 5 1/2" x 2 1/2". Priced with tubes. Shipping weight, 12 lbs. Stock =AH-759. Made to sell for much more than our \$19.99 price.

**NEW 12-VOLT MODEL WITH SPEAKER \$29.99**  
Model AH-1259, 12 volt universal mounting auto radio. This is the same set as pictured above (AH-759), except made for 12 volt model 1955 and 1956 cars. Stock No. AH-1259 with 6x9" or 5x7" speaker, \$29.99.

**NEW 8 TUBE 6 VOLT PUSH-BUTTON MODEL \$37.95**  
New model SH-78555-X, 8-tube, 6-volt universal mounting auto radio with push buttons and 6x9 speaker. Made for Hudson cars, but their compact construction lends them to underdash installation. Has push-pull 6A05 high powered audio. Stock No. SH78555-X with 6x9 speaker—\$37.95. With 2—5x7 speakers—\$39.95; with 1—5x7 speaker \$37.95. Specify speaker size wanted. Three-section top cow mount antenna—\$2.29 extra.

**9-TUBE HI-FIDELITY**  
20 Watts Audio Dual Tone Controls **\$39.95** LESS SPEAKER  
Push-Pull Mullard EL 37  
RECEIVES BROADCAST 550 TO 1650 K.C.  
Jackson Model AM9A, 12 watt high fidelity audio amplifier and broadcast tuner combined, at less than you would normally pay for the amplifier alone. Push-pull EL37 output. Frequency response from 30 to 5,000 cps. Inputs for crystal or G.E. variable reluctance pickup and crystal or dynamic microphone. Separate bass boost and treble tone controls. Radio phono switch on front of chassis. Shielded output transformer matches 3.2 or 8 ohm speaker. Heavy duty 150 mill power transformer. R.F. stage and loop antenna. Receives broadcast 550 to 1650 kc. Sigsbee 13" long, 6" high and 9 1/2" deep. Complete with tubes: 2-6BA6, 6AUG, 6BE6, 6SN7, 6AT6, 2-EL37 and 5Y3 knobs, escutcheon, diagram and instructions included.  
Model AM9A, Hi-Fi amplifier and tuner. Ship. wt. 9 lbs. Sale price, \$39.95.  
Model AM9A with our CU-14Y 12" coaxial PM speaker, both for \$49.95.  
Model AM9A with our P15-CR 15" coaxial PM speaker, both for \$59.95.

**11-TUBE FM-AM HALLICRAFTERS**  
PLUS MONARCH RECORD CHANGER WITH RONETTE CERAMIC CARTRIDGE AND 12" COAXIAL PM SPEAKER  
**\$132.40 VALUE ALL FOR \$86.95**  
A COMPLETE HI-FI SYSTEM

McGee's best buy in a high fidelity home music system. You get the regular \$89.50 S-78A Hallicrafters 11 tube FM-AM chassis, Monarch model UA6U, 3 speed English made record changer with Ronette super high fidelity ceramic cartridge and our CU-14Y, 12" coaxial PM speaker all for only \$86.95. Hallicrafters chassis receives broadcast 540 to 1700 kc and FM 88 to 108 mc. AFC holds FM stations in perfect tune. Output transformer matches 500 ohm line as well as the 12" coax. High fidelity response 50 to 14,000 cps. Bass boost tone control. A full 11 tube transformer powered chassis with push-pull 6K6 audio. Size: 7 3/4" x 12 1/2" x 11" deep. Complete with tubes, knobs, escutcheon, diagram and instructions. High quality Monarch record changer plays 7", 10" and 12" records automatically. Inter-mixes records of the same speed in any order. Shuts off after last record has played. Features a 4 pole motor eliminating rumble and wow. Full size 10" turntable has molded rubber pallet to cushion records. Base size, 10 7/8" x 12 3/4". Tone arm is counter balanced to assure minimum record wear. Changer features the Ronette super high fidelity ceramic cartridge with separate sapphire stylus for microgroove and standard records with separate response to 13,500 cps. Our famous 12" coaxial PM speaker, model CU-14Y is described on the opposite page. Only two wires to connect speaker to chassis and plug pickup into phono input.  
S-78A chassis, CU-14Y speaker and UA6U changer, ship. wt. 45 lbs. All for only \$86.95. Separate large spindle for Monarch changer to play 45 RPM records automatically, \$1.88.  
S-78A, 11 tube Hallicrafters chassis only, ship. wt. 22 lbs. Special sale price, \$59.95.  
S-78A chassis with 12" coaxial PM speaker, ship. wt. 30 lbs. Both for only \$86.95.

**AIR KING FM-AM TUNER**  
SELF POWERED  
Use with any Audio Amplifier **\$24.99**  
SALE PRICE  
Air King factory built, 6 tubes self-powered FM-AM radio tuner. Receives broadcast 540 to 1620 kc and FM 88 to 108 mc. Use with any Hi-Fi audio amplifier or connect it to your TV set for FM-AM reception. Selector switch has 4 positions for TV-Phono-FM and AM 3 other controls are volume-off, tone and tuning. With tubes: 12AT7, 2-6A6, 6AL5, 6X4, 6X3, 6Y3 rectifier. Chassis size, 11 1/2" x 7 1/2" x 6 1/4" high. Illuminated slide rule dial 7 1/2" x 2 1/2", with escutcheon plate and knobs. Self-powered with its own power transformer. FM-AM tuner chassis No. 703 as used in Air King model 17K1C combination TV-Radio-Phono with power supply added. Note: separate audio amplifier is required to operate a speaker. Stock No. AIR-K6, self-powered FM-AM tuner, complete. Ship. wt. 10 lbs. Sale price, \$24.99.

**McGEE RADIO COMPANY** PRICES F.O.B. KANSAS CITY SEND 25¢ OR FULL REMITTANCE WITH ORDER. BAL. SENT C.O.D. TELEPHONE VICTOR 2-5092 1903 McGEE ST., KANSAS CITY, MISSOURI





**COMMAND  
ARC-5 TRANSMITTER**



T-20... 4 to 5.3 MC  
T-21... 5.3 to 7 MC  
New ..... **\$5.95**

Used ..... \$3.95  
3 to 4 mc. like new ..... **\$5.95**  
Receivers  
190-550 KC  
1.6-3.0 MC  
Excellent Used Brand New  
\$14.95 \$7.95 9.95

**TRANSMITTERS**

**T-23/ARC-5 UHF 2 METER TRANSMITTER**—This terrific command transmitter has turret switching coils for all stages. Uses 1625 Osc., 1625 Tripler, S32A Tripler, S32A Final. Range 100-156 mc. 4 Channels are provided using 4 separate coils in an automatic turret using 12 or 24V motor or a manually operated system. These coils can very easily be re-wound for 6 and 10 meters. Complete with all Tubes. Excellent condition, \$9.95. **\$13.95**  
Less tubes \$4.95. Brand New.....

**R-28**—Companion receiver for above. Used Excellent ..... **\$11.95**

**MN-26-C**—Remote Control Navigational Direction finder and communication receiver. Manual DF in any one of three freq. bands, 150 to 1500 KC. 24V. Self contained dynamotor supply. Complete installation, including receiver, control box, loop, azimuth control, Left-Right Indicator, plugs, loop transmission line and flex, shafts, oper. & main. manual. Ideal for use in boats, etc.

BRAND NEW..... **\$39.50**  
MN-20-E Loop. Brand New..... **4.95**  
MN-52 Crank Drive. New..... **2.50**  
MN-28-C Revr. New..... **6.95**  
MN-26-C Revr. New..... **19.95**  
MN-10-E Azimuth Indicator, New..... **9.95**  
DYNAMOTORS for above, 12VDC, MN-26 9.95

**RCA MOBILE RECEIVER**

30-41 mc. AM Crystal Controlled. **\$14.95** each.

**DYNAMOTOR FOR ABOVE**

6V DC Input-250 V DC Output. **\$9.95** each.

**RCA MOBILE TRANSMITTER**

30-41 mc. AM Crystal Controlled. **\$14.95** each.

**DYNAMOTOR FOR ABOVE**

6V DC Input-575 Volts 250 ma Output. **\$12.95** each.

ALL 4 ABOVE USED UNITS \$44.50

**R-23 (BC453) 190-550 KC COMMAND REC.** Complete w/tubes. **\$14.95**  
(Q 5-ER)

**RG54/U—50 OHM COAX CABLE.** **\$9.95**  
300 Ft. ....  
69 Ft. .... **\$2.69**

**APG 5 or 15 CAVITY**

10 Cm. 2C43 ose Nmitter, 2C40 Loc. Ose. Rec. 1B27 TR; tunes 2400 to 3000 MCS, less tubes. Price ..... **\$4.95**

**Radio Receiver 11-tube UHF tunable 234-258 MC** receiver with schematic. Complete with tubes. 3 ea. of 6AK5, 7 ea. of 9001, 1 ea. of 12A6. Like new ..... **\$6.95**  
Less Tubes ..... **\$2.95**

**AN/APR5A**—Airborne superhet radar search rec. Freq. range 1000 to 6100 MC. Rec. has a 10 MC IF band width operating from 80/115V AC, single phase 60 to 2600 cps, and one amp. at 26 VDC—complete with tubes ..... **\$149.50**

**FM WOBULATOR CAPACITOR**

Frequency modulation unit with a permanent magnetic field and a moving coil mechanism driving a metal diaphragm supported at the rim. This diaphragm sets as a moving plate of the frequency modulator capacitor. W/instructions. Build TV sweep sig. gen. BRAND NEW..... **\$2.75**  
2 for only ..... **\$4.95**  
**RT-7/APN Transceiver 420 Mc W/tubes and above** WOBULATOR..... Exc. **\$5.95** ea.

**Freq. Meter**—Cavity tuned—absorption type—110V AC 60 cycle 150 to 240 Mc. **\$14.95**  
Like New.....  
100 to 127 Mc—Like New..... **\$14.95**

**PE-109** Inverter 12VDC input, 115V, 1.5 amps., single phase, 400 cycle output. Brand New..... **\$39.50**

**SCR-522 VHF Transceiver**—100-156 Mc, 4 channels, crystal controlled, complete with tubes. Exc. .... **\$29.50**

**BC 442 Antenna relay**, Exc. .... **\$1.95** ea.  
with vacuum condenser. .... **\$3.95** ea.

**BC-357** Marker beacon receiver 68-80 Mc w/ tubes. **\$3.95**  
Exc. ....

**EE-8** Portable Army Field Telephone, complete in leather case. **\$15.95**  
Exc. like new.....

**BC929 RADAR, \$9.95**

**BC-929 A Radar Indicator Scoop.** This unit could be rebuilt into a fine test scope. It is an ideal size, 8x9x14 priced with tubes 2—6SN7, 2—6H6, 6G5, 6X5 and 2X2. This is a red hot buy. Scoop Price. New..... **\$9.95**

**RT-1/APN-2 TRANSCEIVER**

150-187 mc. Complete w/24 Volt Blower, 6 ea. 6AC7, 1 ea. 6H6, 1 ea. 6V6, 1 ea. 6SL7, 3 ea. 956, 1 ea. 2C26, 1 ea. 5W4 and 1 ea. 6SN7. Various other usable parts: Exc. **\$9.95** each.

**TS-170**—TEST OSCILLATOR—Battery operated, crystal controlled 3 frequency ranges, 332.6, 333.8 or 335.0 mc. **\$16.95**  
New.....

**LORAN APN-4**

**FINE QUALITY NAVIGATIONAL EQUIPMENT**

Determine exact geographic position of your boat or plane! Complete, BRAND NEW installation consists of: 1D-6B/APN-4 Indicator; R-9B/APN-4 Receiver; PE-206 Inverter; Set of Plugs; Visor for Indicator; Operation manual; Brand New, Export packed. **\$129.50**

**ID6B INDICATOR, R98 RECEIVER, \$69.50**  
Excellent.....

**A Sweet Oscilloscope Deal**

**INDICATOR UNIT.** For conversion to test scope, panadapter, analyzer, etc. Double deck chassis. 5CP1 mounted in tube shield. Less small tubes and crystal, but complete with 5CP1. Exc. Cond. .... **\$9.95**

**160 METER RECEIVER POWER SUPPLY**

Can be easily converted for 110 VAC. 60 cycle operation. complete with instructions, brand new. **\$5.95**  
loss tubes .....  
100 KC crystal, NEW..... ea. **\$2.95**  
Complete with 17 tubes, brand new..... **\$14.95**  
**1D6B/APN-4** Complete W/27 Tubes & 5CP1. **\$39.50**

Used..... **\$14.95**

**R9B/APN-4** Complete W/16 Tubes **\$14.95**  
Used.....

**U.S.N. 6 TUBE SHIP RECEIVER—MODEL RAL5**

The ideal commercial receiver for experimenters, hams, aviation, marine, etc. **\$29.95** Exc. with tubes

Two tuned RF stages—band switching panel—DB meter, AVC level control antenna and RF controls—audio tuning control—sensitivity controls including an AC-DC filament voltmeter with range of 10 volts. Frequency Range covers 300 KC to 23 MC.

**DYNAMOTORS**

Type	Input	Output	Excellent	New
BD-77	12 VDC	1000 VDC	350 MA	<b>\$14.95</b>
BD-83	12 VDC	375-150 MA		<b>1.95 \$4.95</b>
DM-35	12 VDC	625 VDC	225 MA	<b>9.95 19.95</b>
DM-37	24 VDC	625 VDC	225 MA	<b>6.95 9.95</b>
DM-64	12 VDC	275 VDC	150 MA	<b>3.95 5.95</b>
DM-34	12 VDC	220 V	80 MA	<b>2.95 4.95</b>
DM-65	12 VDC	440 VDC	400 MA	<b>14.95 19.95</b>
DA-1A	24 VDC	230 VDC	100 MA	<b>4.95</b>
DM-28	24 VDC	230 VDC	100 MA	<b>4.95</b>

**MOBILE HEAVY DUTY DYNAMOTOR:** 14 V. INPUT-output: 1030 VDC 260 MA. Tapped 515 V. 215 MA. use or 6 V DC INPUT-500 V. 175 MA. While they last—DM-12-Excel. Condition. **\$4.95**  
Brand New..... **\$9.95**

TS-76—Test Equipment. Exc. .... **\$14.95**

TS-45—Test Equipment. Exc. .... **19.95**

**HEADPHONES**

HS-23—2000 ohm. Brand New..... **\$5.45**

HS-33—600 ohm. Brand New..... **5.45**

CD-307 Ext. cord. .... **97c** ea.

Chamois ear cushions. .... new, **\$1.49** ea.

**SURPRISE PACKAGE**

20 lbs. of miscellaneous electronic equipment, worth much more than this low price of **ONLY \$1.95.**

**MG-149F** Inverter, 24 VDC input, 115AC, 400 cycles, 500 VA single phase. **\$15.95**  
Exc. ....

**R5-38** Navy Carbon Hand Mike... Exc. **\$2.45** ea.

**I-96A** Signal Generator 100-156 Mc. complete w/cords and cables, like new..... **\$69.50**

**Variac General Radio**—Model 200 BO-130V, 1 Amp. Brand new..... **\$5.95** ea.

**MS 3 ft. tapered mast sections**, exc. cond. .... **\$3.95**  
79c ea.  
6 for.....

**NATIONALLY ADVERTISED TUBES**

371 3BP1  
715A 3CP1 **\$1.95**  
2126 3EP1  
2131 3HP1  
417A 5AP1  
730A 5BP1  
720BY 5CP1 **4 for \$7.00**

39 211 12A6  
56 801 506  
58 446 884  
954 7193 1G4  
955 2X2 1G6  
957 EF50 1H4  
1625 1E1 1H6  
1626 1F4 6C4  
1629 1F5 6HG7 **10 for \$2.50**

6AG5 65H7 10 for  
6F8 65L7 **\$3.50**  
65K7GT 125K7  
25L6 6AK5  
6J6

6K7 6K6 10 for  
65K7 65N7 **\$5.00**  
125F7 2051  
125G7 2050  
VR105 9001  
VR150 6B4

**\$45.00 HI-FI Headset for only \$7.95**

Uses annular grooved plastic fibre comes with voice coils as in speakers, and brand new chamois ear pads to obtain spacing for correct acoustical load. GIVES FINEST MUSIC REPRODUCTIONS! Each capsule wired separately, with plug for binaural sound. Imp.: 300 Ohms per unit or 600 Ohms when wire series. **\$7.95**  
Brand new in original carton.....  
USED EXC. COND..... **\$4.95**

**BC 906** Cavity type freq. meter. 144 Mc to 235 Mc. Complete with antenna and operating manual. Brand new—Orig. factory pack..... **\$9.95** ea.

**OIL FILL CONDENSERS**

8 MFD @ 600 V..... **\$0.49**  
4X4 MFD @ 600 V..... **.39**

**TS-9** Handset—Complete with cord & Butterfly switch. Brand New Original Cartons..... **\$5.95**

**TS-13** complete with cord and Butterfly Switch, PL-68 & PL-55. Exc..... **\$5.95**

Used excellent..... **\$4.95; 10 for \$40.00**

**T-26** Mobile Chest Mike. Brand new..... **\$1.29**

**BC-1033** 68 to 80 MC receiver, less tubes, excellent..... ea. **\$3.95**

**FM RECEIVER, 30-42 Mc** complete w/tubes. Exc. .... **\$19.95**

Range Beam Filter—Navy Type—Similar to FL-8 and FL-30, 1020 Cycle Acceptance or Rejection w/PL-55 Cord and Plug for plugging into output of Rec. Also two output phomenent... New **\$1.69**  
Used ..... **\$1.29**

**AN/FGC**—Flux Gate Compass. A remote indicating earth inductor compass w/master indicator amplifier and gyro. Ideal for boats— **\$29.50**  
less power supply. Exc. Cond.....

**R.F. Head**—9500 Mc complete with magnetron 2J56, Klystron 2K25, 6AP6, 4 ea. **\$79.50**  
6AK5 & 0B2. Exc. ....

**UHF Transceiver**—2500 complete with 2C43, 2C40, 3E29, 1B27, VR105, 5Y3, 6AL5. 2 ea. 2X2 and 8 ea. 6AK5. **\$49.50**  
Exc. ....

**BC-924** Transmitter; 27-38 Mc. FM **\$19.95**  
Complete with tubes, new..... **\$19.95**  
12V Dynamotor for above.....  
**2 Meter Receiver**, part of SCR-522, complete w/tubes, exc..... **\$15.95**

**WRITE FOR NEW BULLETIN**

**ALL ITEMS F.O.B. CHICAGO**  
**25% Deposit** required with orders

**R W ELECTRONICS**

Dept. N  
2430 S. Michigan Ave., Chicago 16, Ill.  
PHONE: CAIumet 5-1281-2-3

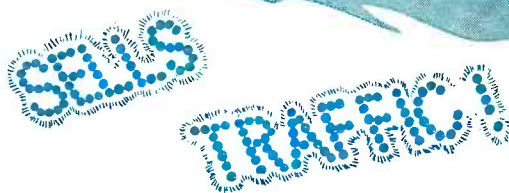

Capitalize on the growing two-set television market with this beautiful 5 color Telecoupler display.

Cash-in on the increased Christmas sales of both black & white and color tv sets by *displaying* and *selling* AMPHENOL's popular two-set coupler.



TELECOUPLER  
by AMPHENOL

see your



distributor



#### WING DIPOLE ANTENNA

Trio Mfg. Co., Griggsville, Ill., has just announced the addition of new models to its "Zephyr" line of TV antennas.

The "Zephyr Royal" features the new wing director which the company states increases the power and sensi-

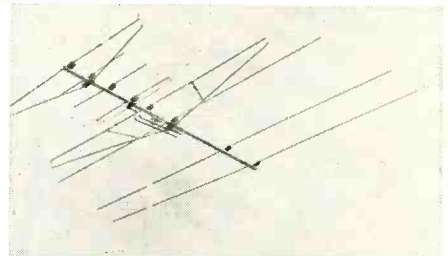

tivity of this antenna design. Rejector phasing is also incorporated to reduce side pickup.

The "Zephyr Mite," shown in the accompanying photo, uses stub matching and the stubs act as resonant dipoles on the high band, in addition to their normal function. Proper spacing of reflectors, high-band director, and the wing director gives the "Zephyr Mite" an extremely flat response over the v.h.f. band. The manufacturer claims that the variation in gain from channels 2 to 6 is only 1 db while for channels 7 to 13 the variation is only .5 db.

#### NEW SALES MANAGER

Medal Mfg. Co., Sharon, Pa., announces the appointment of G. M. Miller to head all sales and advertising activities for the antenna division.

#### FRINGE ANTENNA

Walsco Electronics Corp., 3225 Exposition Place, Los Angeles 18, Calif., has successfully completed a series of severe tests in remote fringe areas on the new "Super Wizard" TV antenna just made available. The manufacturer claims that this antenna fully overcomes the critical reception problems of difficult locations.

In the photo shown here, Walter L. Schott (left), president, and Jan Kob-

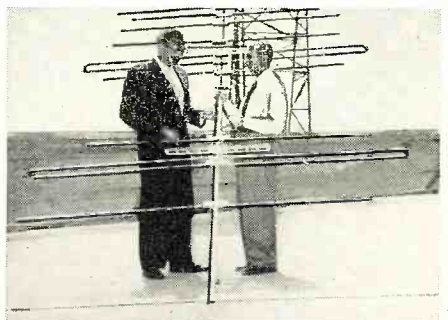

ler, chief antenna engineer, are shown inspecting the antenna after tests.

**MOST ACCEPTABLE**

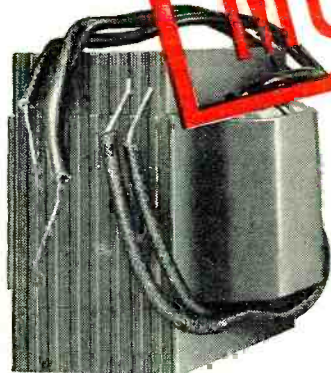

FROM DELCO RADIO

come the **transformers**  
with high acceptability.

You trust them...  
so do your customers!



Universal vibrator transformers, produced through the combined electronic skills of Delco Radio and General Motors, meet the requirements of nearly every model of auto radio. Each is designed for easy installation and complete customer satisfaction. Laminated core inserts are stamped out of low-loss silicon steel and heat treated to maintain correct magnetic properties. Coils are precision-wound on special machines. All models have ample leads. Your UMS-Delco Electronic Parts Distributor can supply you with all models. Call him today. Remember, the Delco Wonder Bar Radio is being nationally advertised in leading consumer publications... so you are tuned in on a constantly increasing service.

**Uncased Models 6055, 6065, 6067**  
do not include filter network

Cased Models 6060, 6064 and 6066 are made with "A" line filter network consisting of an "A" choke and .5 mfd. capacitor. Easy-mount drilling template, plus three self-tapping screws are included for your convenience.

**DELCO**



**RADIO**

DIVISION OF GENERAL MOTORS, KOKOMO, INDIANA



A GENERAL MOTORS PRODUCT—A UNITED MOTORS LINE  
Distributed by Delco Electronics Parts Distributors

A complete line of original equipment service parts from the  
**WORLD LEADER IN AUTO RADIO**

# KITS! KITS!

HERSHEL'S KITS ACCLAIMED BEST!

ALL KITS CONTAIN THE FINEST ASSORTMENTS. OVER 10,000 SOLD!

- 30 TUBE SOCKETS
- 2½-lbs of HARDWARE
- 15 ROTARY SWITCHES
- 10 Electrolytic Condensers
- 40 Radio & TV KNOBS
- 40 BY-PASS Condensers
- 60 CARBON RESISTORS
- 60 MICA CONDENSERS
- 100 SET SCREWS
- 8 1N22 XTAL DIODES
- 50 Ceramic Condensers
- 15 Variable Condensers (Air and Mica)
- 50 RF CHOKES
- 20 POWER RESISTORS
- 1 Phono Motor 115 Vac.
- 50 TERMINAL STRIPS
- 200 ft. HOOK-UP WIRE
- 1 TRANS. 6.3V-110 Vac.
- 5 Meissner Plug-In COILS
- 5 PILOT PANEL LITES
- 50 FUSES 3AG UP
- 1 Meter Rectifier O-1MA.
- 1 IGN. COIL 3V-15,000 VSEC.
- 25-Ft. Phono-Mike Cable
- 3 SELENIUM RECTIFIERS (65 MA. 110V.)
- 1 PHOTO Electric CELL

**YOUR CHOICE ANY KIT LISTED IN THIS AD 97c**

- 10 STRAIN INSULATORS
- 1 TELEGRAPH KEY
- 5 MICRO SWITCHES
- 75-Ft. 300 OHM TV LEAD-IN
- 25 TV STAND OFFS
- 24 SHOCK MOUNTS
- 1 PHONO XTAL with NEEDLE
- 1 PIX TUBE BRIGHTENER
- 3 CONDENSERS (500 MMFD 20,000 Volt)
- 100 Ft. of SPAGHETTI
- 1 RCA Flyback Trans.
- 10 BATHTUB CONDENSERS
- 10 GRAIN WHEAT LAMPS
- 5 RADIO-PHONO CHASSIS
- 4 LOOP ANTENNAS (RADIO)
- 1 PHANTOM ANTENNA A-62
- 100 SPRINGS (RADIO-PHONO)
- 5 RADIO NOISE FILTERS
- 25-Ft. RG-58/U COAXIAL CABLE with PLUGS
- 2 Powerful ALNICO 5 Magnets

## All New MYSTERY PACKAGE of ELECTRONIC PARTS



Worth \$40.00  
 Our Price **\$3.95**  
 It's the surprise of your life! 20 pounds of BRAND NEW usable GOVT. surplus. The ideal gift for trans, etc.

**OIL CONDENSER \$1.65**

2 MFD. 3000 VDC. w/Pyranol Oil Mounts & Brackets.  
 3-1 MFD. 3000 VDC. New, removed from equip. 4 3/4" x 4 3/4" x 2 1/2"

**ARC-5 COMMAND TRANSMITTER \$8.95**

7 to 8.1 Mc. New in Cartons, with 1 h tubes.  
 Hottest buy in the Country

TERMS: Cash with order or 25% DOWN—BALANCE C.O.D.  
 ALL PRICES NET F.O.B. DETROIT MINIMUM ORDER \$2.00

**HERSHEL RADIO CO.** TYler 8-9400  
 5249 GRAND RIVER Detroit 8, Michigan



Buy and use Christmas Seals... **Fight Tuberculosis!**

This antenna combines two driven elements with a special phasing harness to assure maximum gain, sharp directivity, and superior back and side signal rejection.

To suit varied reception requirements, the new TV antenna can be stacked. Constructed of high tensile aluminum alloys to withstand icing and gales, the "Super Wizard" (model 4240) carries a three-year guarantee.

### STATIC ELIMINATOR

Solar Mfg. Corp., E. 46th St. & Seville Ave., Los Angeles 58, Calif., has developed a coupler which links antenna lead-in lines to the input of TV receivers and bleeds off static charges. This unit is actually only 1/16 inch in diameter and 5/32 inch in thickness.



This unit consists of a high voltage ceramic capacitor shunted by a printed bleeder resistor. The capacitor serves as an r.f. coupling between the receiver and the antenna lines. Its dielectric withstands the 1500 volt a.c. test specified by the Underwriters' Laboratories. The resistor serves to bleed off static charges developed on the antenna system, keeping it effectively at ground potential. The most obvious source of such static charges is nearby lightning discharges. The unit is designated as the model DN-96-10.

### TRAVELING WAVE ANTENNA

Channel Master Corp., Ellenville, N. Y., announces a new antenna, the "T-W," which utilizes six new electrical features and embodies new structural ruggedness. It is claimed that a single bay of the fringe area model (No. 350) has higher gain than a wide-spaced, single-channel, 5-element yagi on each low-band channel and more than a stacked 10-element yagi on each high-band channel. In addition, it has a front-to-back ratio exceeding 10 to 1 relative voltage on each low-band channel with high-band front-to-back ratios from 5:1 to 12:1.

The new traveling wave principle of this antenna re-inforces picture signals

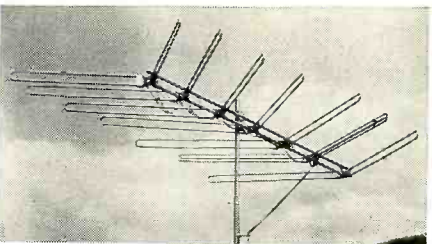

electronically providing for an equal flow of current in every dipole on each of the v.h.f. channels. All but one of the antenna's elements are driven elements. Hairpin or "fat" dipoles re-

place the conventional folded dipole—all elements are of this type including the reflector. The elements are vee'd forward at two different angles, and no two elements are of the same length.

Two braced crossarms and double trussing are used for extra strength. This antenna is available in three models: the model 350 7-element for deep fringe areas, the model 351 5-element for near fringe areas, and the model 352 3-element for suburban areas. All models may be stacked.

### COMMUNITY TV CABLES

Belden Mfg. Co., Chicago, Ill., is now producing two new community TV antenna system cables designed for low loss, long-service life, and maximum dependability. It is claimed that these new cables give essentially flat impedance with no peaks in attenuation to reduce the signal in either high or low TV signal channels. All cables are sweep tested before shipment.

For tap-off lead-ins, the No. 8232 double-shielded and double-jacketed cable is recommended. The No. 8233, also double-shielded and double-jacketed, is recommended for secondary leads.

### NEW INDOOR ANTENNA

JFD Manufacturing Co., Inc., 6101 16th Ave., Brooklyn 4, N. Y., is now marketing a new indoor antenna called the "Tuk-A-Tenna," designed to be used in portable TV sets as well as

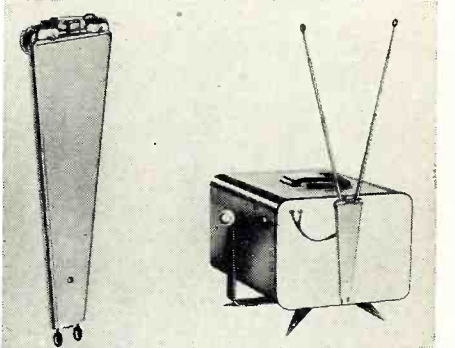

conventional table and console models. It is attached onto the back of the TV set, and when not in use, folds down behind an aluminum cover, out of sight, as shown in the accompanying photo. When in use, the dipole elements are pulled up and may be pivoted on individual swivel ball joints.

The "Tuk-A-Tenna" is available in four models, two 3-section models (TA142 and TA242), and two 4-section models (TA143 and TA243).

### CO-CHANNEL FILTER

Jerrold Electronics Corp., 23rd & Chestnut Sts., Philadelphia, Pa., is now distributing a high "Q" filter which electronically eliminates the "venetian blind" effects caused by co-channel TV interference. This filter is called the "Line-Out," and is available in two models: the model V-10, which eliminates 10 kc. interference, and the model V-20, which eliminates 20 kc. interference.



# Exclusive at **TERMINAL**... UNHEARD OF SAVINGS!

ALL BRAND NEW FACTORY SEALED



## SYLVANIA TEST EQUIPMENT

**LIMITED QUANTITIES! ACT NOW!**

Radio-TV Service Men — Industry — Laboratories  
This is your once-in-a-lifetime opportunity to acquire the world's finest test equipment at a fraction of its original cost.

**GUARANTEED** Brand new in original Sylvania factory sealed cartons, complete with detailed instruction sheets. Look at the amazing savings!

# Never Before! Never Again! Such SENSATIONAL LOW PRICES!

Type 620 SYLVANIA  
**TUBE TESTER**



New, portable tube tester tests all common receiving tubes, transmitting and industrial tubes, regardless of basing — also "600 ma" series string television tubes. In-line controls speed efficiency. Reads shorts and leakage directly in ohms — easy-to-read roll chart — gas test — easy switching for all tube bases. Best dollar buy. **Regular Price: \$149.50.**

**NOW ONLY \$89<sup>50</sup>**

Type 303 SYLVANIA  
**VTVM POLYMER**

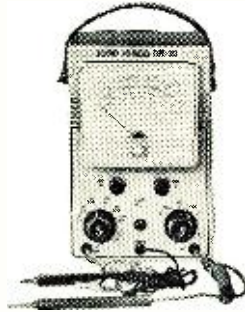

The ultimate in its price range — multi-purpose meter combining high accuracy with functional, smart styling to give "quick readings" under all conditions of ambient lighting. Measures AC and DC volts, and ohms over 6 ranges. **Regular Price: \$54.50.**

**NOW ONLY \$34<sup>50</sup>**

Type 405 SYLVANIA  
**5" SERVICE OSCILLOSCOPE**



The smallest 5" 'scope on the market... and the biggest value. Identical horizontal and vertical amplifiers with frequency response within 3 db from 2-700KC, 300 Millivolt sensitivity and 2.2 meg. input impedance. Linear sweeps from 16 to 50 KC. Extremely stable sync. **Regular Price: \$129.50.**

**NOW ONLY \$82<sup>50</sup>**

Type 506 SYLVANIA  
**COLOR-TV DOT GENERATOR**

Extreme sync stability, useful for linearity adjustments, positive gating circuit, wide range of dot spacing, practical dot size. Hard tube sync circuit and special Sylvania output adapter. Extremely compact unit. **Regular Price: \$129.50. NOW ONLY \$69.50**

Type 501 SYLVANIA MARKER GENERATOR  
Provides 2 separate signals for marking an oscilloscope trace of response curves. Accurate trap adjustment, freq. spotting, band width measurement and adjustment of popular 4.5 mc. intercarrier sound circuits. VFO covers 15 to 240 mc. range. **Regular Price: \$129.50. NOW ONLY \$69.50**

Type 600 SYLVANIA  
**LABORATORY TUBE TESTER**

Mutual conductance and emission test. Conversion transconductance test. Leakage test directly in megohms, gas test, and voltage regulator-thyratron tube test. Factory correlated readings, illuminated meter, roller chart. **Regular Price: \$469.50. NOW ONLY \$369.50**

Model 402 SYLVANIA SYNCHROSCOPE  
Continuously variable sweep speed 0.2 us/in. to 800 us/in. Internal trigger generator with rep. rate of 500, 1000, 2000, 4000 p.p.s. Positive pulse trigger output rising to 200 volts peak in 0.3 u sec. at amplitude of 100 volts for 3 u sec. Adjustable output trigger delay from 75 before to 25 u sec. after sweep start. Fixed sweep trigger delay at .90 u sec. **Regular Price: \$708.75. NOW ONLY \$490.00**

Model 402A SYLVANIA SYNCHROSCOPE  
Identical with model 402 but with an r-f detector and wide-band amplifier. **Regular Price: \$783.74. NOW ONLY \$540.00**

Model 402B **Regular price \$896.25. NOW ONLY \$602.00**

Type 228  
**SYLVANIA C.R.T.**

**TESTING ADAPTER**



Use with any Sylvania tube tester to check 85% of picture tube troubles without removing tube. Checks electromagnetically deflected types for emission, shorts, leakage, and open filaments. **Regular Price: \$7.60. NOW ONLY \$5.95**

Type 225 SYLVANIA  
**TV HIGH-VOLTAGE PROBE**

In conjunction with Sylvania types 301 and 302 polymeters this probe permits measurement of DC voltages up to 30 KV. **Regular Price: \$12.50. NOW ONLY \$6.95**

Type 301 SYLVANIA  
**VTVM POLYMER**



Features an inherently stable circuit from use of 2 Type 7N7 tubes in Sylvania-patented circuit. 1 Ma. meter movement, 6 AC and DC ranges read up to 1,000 volts and up to 30,000 volts DC with Sylvania Type 225 Voltage Multiplier Probe. Resistance measurements to 10,000 meg. True peak-to-peak readings up to 2,800 volts. 17 meg. input impedance. Illuminated meter and screw-on connectors. Shielded AC lead provides AC measurements from 20 cps. to 20,000 cps. with 2.7 meg. impedance. Measures DC current up to 10 amps. **Regular Price: \$109.50.**

**NOW ONLY \$69<sup>50</sup>**

Type 302 SYLVANIA  
**VTVM DeLUXE POLYMER**



6 AC and DC volt ranges 0-3, 10, 30, 100, 300, 1000. 6 peak-to-peak volt ranges. 5 RF volt ranges from 0 to 300. Ma in 6 ranges from 0 to 1000. 0-10 amp. DC. Ohms in 6 ranges to 1000 meg and db measurements in 6 ranges from -20 db to +61.4 db. Features new 7" Sylvania meter movement, patented linearity circuit, rf probe, high input impedance, shielded leads. **Regular Price: \$129.50.**

**NOW ONLY \$82<sup>50</sup>**

Type 403 SYLVANIA  
**7" TV SERVICE OSCILLOSCOPE**

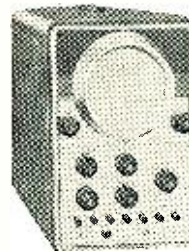

High quality 7" instrument with identical high-gain dc amplifiers on horizontal and vertical axes, plus advanced features of higher priced models of special value for TV service. Type 403 permits dc signal level measurements and phase relationship study. 2 preset TV sweeps. Vertical sensitivity 10 millivolts per inch rms. Freq. response flat to 500 kc within 2 db. **Regular Price: \$249.50.**

**NOW ONLY \$159<sup>50</sup>**

**All Items Subject to Prior Sale... FIRST COME... FIRST SERVED! ORDER TODAY!**

# Terminal Radio CORP.

85 CORTLANDT STREET, NEW YORK 7, N. Y. • WOrth 4-3311

**MAIL ORDERS FILLED**

All Prices F.O.B. New York City.  
Please send full remittance or 25% deposit, balance C.O.D.

The newest hobby under the sun!

# BUILD THIS SOLAR POWERED RADIO!

and many other sun-powered electronic, electrical and photometric devices featuring International Rectifier Corporation SUN BATTERIES!

Everyone—from the beginner with a basic understanding of electrical work to the experienced professional engineer—can build this pocket-size portable radio—powered by the sun! No batteries—not even an On-Off switch. All you need is sunshine! The basis for this radio is the International B2M Sun Battery. This unit is a scientific, accurate, precision-made photovoltaic instrument that directly converts light into electrical energy. This radio is just one of many devices you can build powered by solar energy. You have read about this new field of science. Be among the first in this newest hobby. Put the sun to work for you!

THIS NEW BOOK TELLS YOU ALL ABOUT SUN BATTERIES—PHOTOCELLS—AND HOW TO USE THEM. Packed with information and applications, this illustrated book shows wiring, diagrams and plans—every detail necessary to build many interesting devices. **\$150**

THIS IS THE FAMOUS B2M SUN BATTERY YOU'VE READ ABOUT. Widely used in experiments, this unit in bright sunlight (10,000 ft. candles) will deliver 2 milliamperes at 250 millivolts under optimum conditions; will last indefinitely with proper care. A \$2.50 value for only .....\$1.50



FREE Complete plans for building this radio. At your electronic parts distributor.

GET THE B2M SUN BATTERY AND ALL OTHER COMPONENTS REQUIRED AT LEADING ELECTRONIC PARTS DISTRIBUTORS EVERYWHERE. If your favorite distributor doesn't feature the B2M Sun Battery send check or money order to

International Rectifier Corporation  
El Segundo, California

**SPECIAL OFFER, The book and the B2M Sun Battery for only \$2.85 at your distributor**

## CUSTOM HI-FI TONE ARM

- ★ NEW—LOW MASS DESIGN Assures maximum performance of modern high-compliance cartridges.
- ★ NEW—INDIVIDUALLY CALIBRATED OFFSET ANGLE AND OVERHANG Assure correct tracking of LP records.
- ★ NEW—MICROMETER TYPE COUNTERBALANCE Assures accurate stylus pressures.
- ★ NEW—LONGER LENGTHS Assure lower tracking distortion.
- ★ 1-gram tracking
- ★ Low-friction nylon bearings
- ★ Custom hand-finished satin aluminum

CHOICE OF THREE LENGTHS

16" 18" 21" Overall

Available at better Hi-Fi dealers or write direct

*Volpar*

4404 W. 22 ST.  
PANAMA CITY, FLA.

**\$14.95**  
Any length

## LAM FLUX

### ALUMINUM SOLDERING FLUX

The miracle you have been waiting for. With this flux you solder Aluminum the same as other metals. You may use regular lead-tin solder. For 1 oz. send \$2.00 Cash, Check or M.O.—No C.O.D. Postpaid in U.S.A.—Available in quantity.  
**E. Lampe, P. O. Box 371, Lindenhurst, L. I., N. Y.**

## NEW & BETTER TEST CONNECTOR



Ask your jobber for the new E-Z-HOOK Test Probe. Patented hook design stays on . . . easier to use . . . safer. Ideal for scope and meters. Built-in Terminal Board saves time—money . . . easy to build own detector and special test assemblies. **The most for \$1.39!** E-Z HOOK TEST PRODUCTS. L.M. 1538 Woodburn Ave., Covington, Kentucky.

## NEW APPOINTMENT

*Snyder Mfg. Co.*, Philadelphia, Pa., manufacturer of auto radio and TV antennas, has promoted Jack Schweighauser to the position of national sales manager of the antenna division. This appointment comes simultaneously with the establishment of the antenna division. Mr. Schweighauser joined the company three years ago and was named assistant to Dick Morris, director of sales, in April 1955.

## "Distributed Port"

(Continued from page 39)

conditions. These curves were originally run to answer those who feel that horn enclosures have a "corner" on response in the corner of a room. However, it shows very nicely the effects of room resonances on two different loudspeakers.

## Conclusions

Loudspeakers are capable of handling very little input at extremely low frequencies. If the full capabilities of a loudspeaker are to be realized, low frequency rumble and the noise must be eliminated from a reproducing system.

High efficiency usually means less, rather than more bass response, unless a proper enclosure is used.

The use of a "Distributed Port" enclosure will improve the bass response and increase the low frequency power handling ability of moderately efficient loudspeakers similar to those mentioned in the text.

The use of a "Distributed Port" greatly complicates the design of an enclosure. However, this also makes it possible to optimize the design for range, response, or power handling ability in a given size.

# TELEVISION

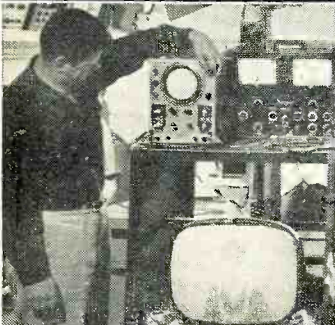

Industry needs Electronic Trained Men Now! Quality for BIG PAY JOB, 9 short months. No other type of training can compare with actual shop practice you get at Healds under expert instructors.

### Bachelor of Science Degree, 27 Months

- Electronics Engineering (B.S. Degree)
- Electrical Engineering (B.S. Degree)
- Television Technician (9 Months)  Color TV
- Electronics Technician (12 Months)

Heald College ranks FIRST West of the Mississippi in "Who's Who in America"

Approved for Veterans  
DAY AND EVENING CLASSES  
Register Now. Write for Catalog.  
(No Obligation.)

Your Name .....  
Address .....  
City .....  
State .....

AT HEALDS YOU LEARN  
BY DOING IN MODERN  
ELECTRONICS LABORATORIES

## HEALD ENGINEERING COLLEGE

Van Ness at Post, RTN  
San Francisco, Calif.

Co-channel interference, which results in a series of wide horizontal lines across the picture, is caused by the simultaneous reception of two TV stations broadcasting on the same channel. Such stations generally differ in transmitting frequency by 10 or 20 kc. per second. The 10 or 20 kc. frequencies beat with harmonics of the

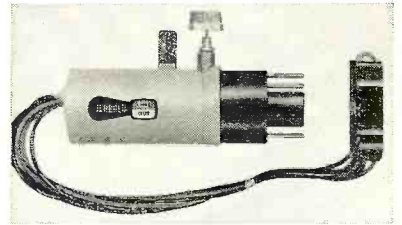

TV line frequency (15,750 cps), resulting in approximately 40 wide bars across the screen. The "Line-Out" filter eliminates the difference frequency. This unit is tunable over a 2 kc. range since the TV stations may vary plus or minus 1 kc. in carrier frequency.

The unit is mounted on the inside of the TV receiver's back cover.



AMERICAN TELEVISION &  
RADIO CO. ST. PAUL, MINN.

For those who  
want the finest!



Full Door Console  
Receiving Sets

UNSURPASSED  
IN BEAUTY

UNEQUALLED  
IN PERFORMANCE

UNMATCHED IN  
QUALITY  
CONSTRUCTION

exclusive  
profitable  
dealer  
franchises  
now available



designed  
with the  
Serviceman  
in mind  
... easy to  
get at



WRITE TODAY FOR COLORFUL  
BROCHURE SHOWING THE  
NEW LINE OF ATR TV SETS

ALSO MANUFACTURERS OF DC-AC INVERTERS,  
"A" BATTERY ELIMINATORS, AUTO RADIO VIBRATORS

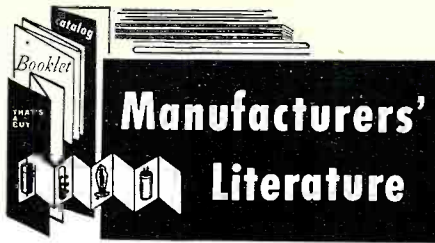

#### MOTOR SELECTOR CHART

Howard Industries, Inc., 1760 State St., Racine, Wis., has issued a handy fractional horsepower motor selector chart which should prove helpful to engineers and purchasing agents.

The characteristics and performance ranges of all fractional horsepower motor types are listed in detail on this binder-sized chart. Speed-torque curves for basic motor types are illustrated along with other valuable motor data.

#### COMPONENT CATALOGUE

Wells Sales, Inc., 833 W. Chicago Ave., Chicago 22, Ill., has issued a new 20-page catalogue which lists a wide variety of electronic components which the firm stocks regularly.

Included are miniature toggle and rotary switches, many types of capacitors, transformers, motors, dynamos and selsyns, and miscellaneous hardware, connectors, and insulators.

Write the company direct for a free copy of this publication.

#### SERVICE BOOK BULLETIN

Harry G. Cisin, Amagansett, N. Y., publisher of a complete line of television and radio service books, tube location guides, tube substitution guides, picture guide to TV troubles and rapid diagnosis of TV faults, etc., has announced the availability of Bulletin #R-11, which describes the books in some detail.

Copies of this bulletin are available without charge upon written request to the publisher.

#### HOFFMAN SERVICE GUIDE

The Hoffman Radio Division, 3761 S. Hill St., Los Angeles 7, Calif., has released a complete service guide covering all its commercial units produced during the period from 1948 to May 1956.

Containing 200 pages, this bound, 11" x 17" guide contains schematic diagrams, chassis parts lists, cabinet parts lists, and tuner data on all of the company's black-and-white and color television receivers, as well as on radios and phonographs. Television i.f. alignment, tuner alignment, lens size, and other useful information are also covered.

Distribution of the guide is being handled by the company's representatives. It is available for \$3.00 a copy.

#### NEW EICO ROLL-CHART

Electronic Instrument Co., Inc., 84 Withers St., Brooklyn 11, N. Y., has announced the release of a new 1956 tube tester roll-chart, #625-05.

Researched and compiled by the company's engineering department,

the chart contains hundreds of listings of the latest tubes as released by all of the leading tube manufacturers.

The chart is printed on a 6-foot long continuous sheet of durable high-quality white paper which is designed to withstand many years of daily use. It fits the Eico tube tester's roller mechanism. The roll chart is priced at \$1.00 and is obtainable from the firm's jobbers or from the manufacturer direct.

#### PICTURE TUBE GUIDE

The Tube Department of General Electric Company, 1 River Road, Schenectady, N. Y., has released a new edition of its "Quick Selectron Guide for Television Picture Tubes."

The new publication, ETD-1001C, is intended to help designers select a particular tube from the large number of types now on the market. It classifies each of the 211 tube types by size, bulb structure, and deflection angle, and lists the following information: whether the tube is aluminized or not, external conductive coating capacitance, type of ion-trap magnet, face dimensions, and style of anode terminal.

#### ALLIED'S 1957 CATALOGUE

Allied Radio Corporation, 100 N. Western Ave., Chicago 80, Ill., has released copies of its 1957 general catalogue, a 356-page manual listing over 27,000 items.

Designated as Catalogue No. 160, the new publication contains 160 pages of rotogravure, featuring the latest high-fidelity components, including 34 complete hi-fi systems; television chassis, boosters, rotators, and u.h.f. converters; table model and portable phonographs; professional and home recording equipment; p.a. amplifiers and complete systems; amateur receivers, transmitters, and other gear; industrial v.h.f. radio and radio-telephone equipment, in addition to components, books, tools, and hardware items of all types.

#### THERMISTOR MANUAL

The Metallurgical Products Department, General Electric Company, Detroit 32, Mich., has announced the availability of a newly revised, 53-page manual on thermistors.

This new publication, referred to as TH-13A, describes the latest general, material, and operating characteristics of the electronic semiconductors, as well as general types of applications. Besides basic data, it also includes details on thermistor assemblies, static and dynamic characteristic curves in addition to user information on how to order them.

#### ENGINEERING CRITERIA

The National Society of Professional Engineers' Subcommittee on Employment Practices has recently published a 23-page booklet covering employment practices criteria adopted by the Society.

Single copies of "Criteria for Profes-

RADIO & TELEVISION NEWS



# SHOW ANY PICTURE or PATTERN

at any time — ON ANY TV SET

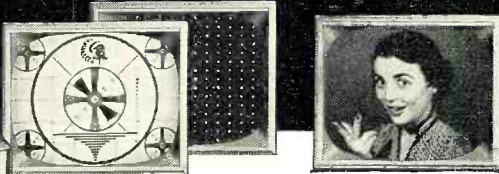

- For Servicing Black & White and Color TV
- For Merchandising and Advertising Promotions
- For Paging, Educational and Industrial Use

New  
MODEL 1000

## B&K DYNA-SCAN PICTURE AND PATTERN VIDEO-GENERATOR

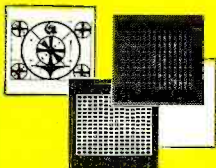

**3 SLIDE  
TRANSPARENCIES  
ARE SUPPLIED**

1. Indian Head Pattern
  2. White Dot Pattern
  3. White Line Crosshatch
- Plus One Clear Acetate

These are broadcast quality and assure high-definition TV images. You can also transmit slides of any subject you wish.



MODEL 950

See Your Distributor or Send For Bulletin 1000-N

Simplify and speed servicing with this unique, new, COMPLETE FLYING SPOT SCANNER. Produces composite video and sync signal that operates any standard VHF black and white or color TV receiver. Easily reproduces standard Indian Head test pattern or any other pattern—in home, shop or store—for proper TV set alignment; enables you to make all color TV static and dynamic convergence adjustments with stable White Dot and White Line patterns. Can be used with one or more standard TV receivers or fed into master antenna system. Reproduces from any film transparency. Transmits messages typed or written on clear acetate. Size: 16½ in. long, 10½ in. high, 9½ in. wide. Net wt. 28 lbs. . . . .

**\$199.95**  
NET

### Model 950 Dyna-Scan Pickup and RF Generator Only

Make your own picture and pattern generator. Just connect Model 950 to any properly modified 10-inch TV set which acts as your external flying spot scanner. Size: 3½ in. high, 10½ in. wide, 5 in. deep. Complete with 3 slide transparencies and 1 clear acetate. Net wt. 5 lbs. . . . .

**\$69.95**  
NET

**B & K MANUFACTURING CO.**

3726 N. Southport Ave. • Chicago 13, Illinois

Makers of DYNA-QUIK, CRT, CALIBRATOR and DYNA-SCAN



sional Employment of Engineers" are priced at 25 cents each. In quantity, the booklet is 20 cents each for from 10 to 49 copies, 15 cents each for 50 to 99 copies, and 10 cents each for 100 or more.

Printed in check-list format, the criteria cover specific categories of engineering career development. The criteria suggest the responsibilities of the employer to his professional employees, and the latter's responsibilities to the employer. Topics included are recruitment, indoctrination, professional development of the individual, salaries, engineering titles, personnel practices, and termination policies.

Write the Society at 2029 K St., N. W., Washington 6, D. C., for copies of the booklet.

### INDUSTRIAL TV CAMERA

General Precision Laboratory, Inc., 63 Bedford Road, Pleasantville, N. Y., has issued a one-page data sheet on its Model PD-152 ruggedized television camera.

The unit is capable of operating in extreme noise, shock, temperature, and vibration environments. These features are fully described in the literature along with information on the control equipment available with the camera.

Copies of Data Sheet ii-TV will be forwarded upon request to the manufacturer.

### WIRE CATALOGUE

A new catalogue which contains a complete listing of the firm's line of wire, ribbon, weld, and carbostrip products has been issued by the Parts Division of Sylvania Electric Products Inc., 12 Second Ave., Warren, Pa.

The catalogue, which supersedes one issued in October 1954, outlines the improved design characteristics of the new wire line. Wire and ribbon types in the line include alloy, clad, and plated.

Write the firm for a copy of this new catalogue. The company will issue supplementary data sheets for this catalogue as new information becomes available.

### SIGNAL GENERATOR DATA

An 8-page folder which illustrates and describes a new signal generator and control system has been published by Brush Electronics Company, 3405 Perkins Ave., Cleveland 14, Ohio.

The instrument described has been designed to meet the varied requirements of a signal source for electrical, electro-acoustical, and acoustic measurements. It will make a.f. response curve measurements, do high-frequency vibration testing, make calibration measurements, test sound insulation, and make acoustical and automatic distortion measurements.

The folder is illustrated and contains a detailed description of the instrument.

### PLASTIC UTILITY BOXES

Bradley Associates, Inc., 1650-58 N. Damen Ave., Chicago 47, Ill., has

RADIO & TELEVISION NEWS

**NEW! JUST OFF  
THE PRESS!  
Catalogue No. 110!**

Have you a copy? Are you on our mailing list? If not, write today!

#### THIS MONTH'S SPECIAL

0-1 MILLIAMPER METER: 270° indication. Just by-pass shunt and add scale. Used, good condition. . . . . **\$1.95**

J. J. GLASS ELECTRONICS CO.

1615 S. Main St. Los Angeles 15, Calif.

**BARGAIN HUNTING? TV SERVICEMEN!**  
Write for SENSATIONAL CATALOG  
**HENSHAW RADIO SUPPLY**  
3619 TROOST KANSAS CITY, MO.

**WANT A BETTER JOB? BECOME AN ELECTRONIC ENGINEER**  
ONLY 32 MONTHS TO EARN A BACHELOR OF SCIENCE DEGREE IN ELECTRONIC ENGINEERING  
Class enrollment limited to allow for individual instructions. Chartered by state of California. Nonprofit-nonsectarian. coeducational—established 26 years.  
**APPROVED FOR VETS—ENROLL NOW!**  
SEND FOR FREE CATALOG  
**PACIFIC STATES UNIVERSITY**  
1516 S. Western Ave., Dept. O, LOS ANGELES, CALIF.

issued a four-page data sheet which lists all of the plastic boxes the firm carries as stock items.

The data sheet lists the stock number, inside dimensions, and prices on various quantities. The boxes are illustrated by line drawings to facilitate the selection of the correct box for the job. The units are suitable for all types of miniaturized electronic construction as well as the packaging of component parts.

#### ICA CATALOGUE

*Insuline Corporation of America*, 186 Granite Street, Manchester, N. H., has issued an elaborate 80-page catalogue covering its line of equipment and parts for the electronic, television, radio, aviation, communications, and automotive industries.

Almost 200 items are pictured and described in detail in this colorful catalogue. Engineers and purchasing agents are invited to write on their company letterheads for copies of this catalogue.

#### STORY OF STANDARDS

*The American Standards Association*, 70 East 45th Street, New York 17, N. Y., has issued an interesting 20-page booklet which describes the three ways in which industry-wide standards become nationally accepted and approved.

The booklet, "How American Standards are Made," also tells who makes the standards and why and who uses them. It also explains the function of the Association and details these functions.

Copies of this informative booklet are available without charge from Dept. PR of the Association.

#### TRIPLETT DATA SHEET

*Triplet Electrical Instrument Co.*, Bluffton, Ohio, has issued a comprehensive panel instrument data sheet, Form 81556-T, which it is making available without charge.

The four-page form contains full-size scales of various types of panels as well as dimensional diagrams of round, rectangular, and special instruments on which panels are used. Typical external shunts, illustrated for the purpose of showing mounting dimensions, as well as illuminated meters are also included in the data sheet.

#### "EDU-KITS" BROCHURE

*Progressive "Edu-Kits" Inc.* of 497 Union Avenue, Brooklyn 11, N. Y., has issued an 8-page brochure describing its 1957 home radio course in kit form.

The booklet details the 16 printed circuit and metal chassis radio circuits which can be built with the new kit as well as a sample of the "quizzes" on radio theory which are part of each course.

Copies of this brochure are available without charge. Address all requests to S. E. Goodman in care of the company.

**STOP LOSSES due to inaccurate instruments**

**CHECK AND ADJUST**

Your Test Instruments  
with **LABORATORY ACCURACY**



Designed by  
**MILTON S. KIVER**  
Author of the Book  
"Servicing and Calibrating  
Test Equipment"  
Published by  
Howard W. Sams & Co., Inc.

**TEST EQUIPMENT**  
**New 750 B&K CALIBRATOR**

Calibrates VOM, VTVM and other meters, signal, sweep and marker generators and oscilloscopes.



Provides dc and ac voltages for checking voltage ranges of VOM, VTVM and other meters.



Standard resistances from 10 ohms to 10 megohms for checking reliability of each resistance range in VOM and VTVM.



Crystal oscillator generating harmonics over 300 mc for use as marker generator in all receivers, and to calibrate AM signal generator, and to align TV audio I.F. system.



Built-in tone generator for signal tracing amplifiers in all audio equipment. This tone also available at modulated RF.



Oscilloscope voltage calibrator in measuring peak-to-peak voltages of unknown waveforms.



#### Voltage Accuracy $\pm 1\%$ or Better

Avoid instrument errors that cause wrong decisions and time-killing rechecks in receiver testing. With the new, low-cost, laboratory-type Model 750 Calibrator you can quickly, easily check test equipment accuracy and make necessary adjustments.

Provides standard of  $\pm 1\%$  or better in all of its voltage sections—enables you to calibrate your test instruments like the labs do, and give better service at lower cost.

#### Model 750 Calibrator

Complete with 5 mc crystal. Operates on 110-120 v., 60 c. ac. Sturdy metal case. Size: 8 3/4 in. high, 8 in. wide, 5 1/2 in. deep. Net wt. 6 3/4 lbs.

**\$54<sup>95</sup>**  
NET

See Your Distributor or Send For Bulletin 750-N

**B & K MANUFACTURING CO.**  
3726 N. Southport Ave. • Chicago 13, Illinois  
Makers of DYNA-QUIK, CRT, DYNA-SCAN and CALIBRATOR



**THE NEW No-Noise TUNER-TONIC**

**Volume Control and Contact Restorer with Perma-Film**



Cleans, lubricates, protects not a carbon-tel solution. Still available in the new 6 oz. spray can. Net to servicemen—\$2.25

**1.00**

Also available in 8 oz. bottles and quart cans. At your nearest distributor.

with **PERMA-FILM**

Cleans, lubricates, restores all tuners including wafer type. Won't change or affect capacities, inductance or resistance. Won't harm insulations or precious metals; nor attack plastics. For television, radio and FM. Eliminates all noise, oxidation and dirt indefinitely. Non-toxic, non-inflammable, insures trouble-free performance. Extra economical because a small amount does the job!

**3.25**

Net to servicemen.

**ELECTRONIC CHEMICAL CORP.**  
813 Communipaw Avenue Jersey City 4, N. J.



# Electronic Technicians

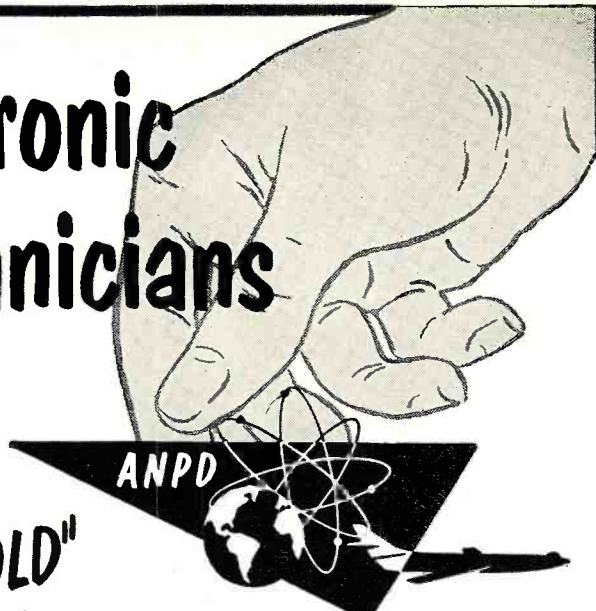

**"TAKE HOLD"**  
Of your future  
in the Atomic Energy Field!

Our organization offers unlimited possibilities for personal development and job advancement.

We seek technicians to assist in the development and prototype manufacture of electronic controls and instrumentation for the nuclear propulsion of aircraft. If you have military or civilian training and experience in electronics, fill out the coupon below and rush it to us at once.

## AIRCRAFT NUCLEAR PROPULSION DEPARTMENT

**GENERAL ELECTRIC**

P.O. BOX 132 CINCINNATI 15, OHIO

Dear Mr. Hoopes:  
I'm interested in full details about an opportunity at General Electric as an Electronic Technician. Please send me more information. I understand all replies are held in strictest confidence.

Mr. Robert H. Hoopes, Personnel Section, A.N.P.D.  
General Electric Co., P.O. Box 132  
Cincinnati 15, Ohio

NAME.....  
STREET.....  
CITY.....STATE.....

### ELECTRONIC TECHNICIAN EXPERIENCE *Check* LIST

Check items listed below indicating approximate months or years of Electronic Technician experience.

- |   | Yrs. | Mos. |   | Yrs. | Mos. |
|---|------|------|---|------|------|
| <input type="checkbox"/> High School .....                                      |      |      | <input type="checkbox"/> Printed Circuit Dev. & Fabrication ..... |      |      |
| <input type="checkbox"/> Correspondence School .....                            |      |      | <input type="checkbox"/> General - Laboratory Development .....   |      |      |
| <input type="checkbox"/> Technical School .....                                 |      |      | <input type="checkbox"/> Test - Construction .....                |      |      |
| <input type="checkbox"/> Military Service Schools .....                         |      |      | <input type="checkbox"/> Nuclear Reactor Controls .....           |      |      |
| <input type="checkbox"/> College .....  |      |      | <input type="checkbox"/> Servo-Controls .....                     |      |      |
| <input type="checkbox"/> Math.-Algebra-Trig. Calculus .....                     |      |      | <input type="checkbox"/> Radar - Sonar - Loran .....              |      |      |
| <input type="checkbox"/> Electrical Drawing .....                               |      |      | <input type="checkbox"/> Radio Communication Maintenance .....    |      |      |
| <input type="checkbox"/> Radio & TV Servicing .....                             |      |      | <input type="checkbox"/> I.F.F. - Fire Control Systems .....      |      |      |
| <input type="checkbox"/> Testing & Trouble Shoot Electronic Equipment .....     |      |      | <input type="checkbox"/> Magnetic & Dielectric Circuitry .....    |      |      |
| <input type="checkbox"/> Fabricate - Assemble - Wire Electronic Equipment ..... |      |      | Most Specialized In .....   |      |      |

## PROJECTION TUBE PROTECTION

By DANIEL PETERS

LIKE many TV service technicians, the author has had occasion to replace projection kinescopes which have acquired phosphor burns due to vertical or horizontal sweep failures and, like most of us, didn't give any thought to the matter of preventing future occurrences. It was not until this plague struck at home that it was decided some remedial action was needed.

The tube in the set, like most units of this type, depended on the conduction of the protection tube, when protection was needed, to prevent burnout. Since, in this instance, the so-called "protection tube" had an open filament its assigned function was effectively cancelled.

After experimenting with several circuits, the author came up with the one shown in the diagram. Its operation is as follows: Before sweep voltages are applied the current through  $V_2$  is limited by cathode bias so that relay  $RL_1$  does not pull in. The relay contacts are in series with the "B+" supply to the high-voltage power supply. When the horizontal sweep starts, the filament of  $V_1$  is lighted due to the induced voltage in  $T_1$  ( $T_1$  is a loop of wire around the core of the horizontal deflection transformer). The exact number of turns in  $T_1$  will depend on the tube selected for  $V_1$ .  $V_1$  can be any battery-type tube, wired as a diode (1S5, 1T4, 1U4, 1S4, 3V4, 3S4, 1G4, 3A4, etc. can be used). Generally, from one-half to one turn is right for the 1½-volt tubes and from one to two turns for the 3-volt tubes.

The position of  $T_1$  should be adjusted until the filament of  $V_1$  glows with the proper brilliance. This can be determined by using a tube lighted with the proper d.c. voltage as a visual reference.  $V_1$  will now rectify the vertical sweep voltage at the output of the vertical oscillator tube and supply a positive voltage to the grids of  $V_2$ , thereby closing  $RL_1$  supplying the "B+" to the high-voltage power supply.  $RL_1$  will stay closed only as long as both vertical and horizontal sweeps are present, and only as long as  $V_1$  and  $V_2$  are operating.

With the advent of color television many experimenters are obtaining and adapting projection sets for use with color wheels. Those who have such projects underway would do well to take another long look at the diagram—then take the vow to add it to their circuit—now!

Simple circuit which can be added to a TV set to protect the projection picture tube against phosphor burns on the tube screen.

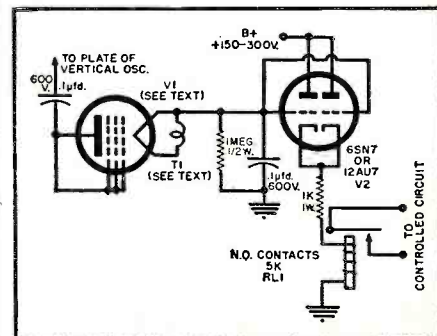



**LIFETIME  
GUARANTEED**

# TUBES

**SAVE**

**BRAND NEW  
PICTURE TUBES**

- RCA Licensed
- One Year Unconditional Guarantee

Type	Price	Type	Price
10BP4	\$11.90	17BP4	\$20.63
12LP4	\$14.38	19AP4	\$24.81
14BP4	\$16.86	21AP4	\$28.79
16RP4	\$19.38	21EP4	\$28.79
16LP4	\$19.38	24AP4	\$42.50

Picture Tubes shipped F.O.B. Harrison, N. J. Above types are most popular. However, you may order any equivalent size at the same price.

**HERE'S HOW LIFETIME GUARANTEED TUBES SAVE YOU MONEY!**

- We Guarantee to Replace ALL TUBES Purchased From Our Firm Forever
- Each Tube Individually Boxed and Guaranteed
- Over A Half Million Tubes Always in Stock
- Immediate Shipment
- Free Postage On All Orders With Full Remittance
- There are fewer "call backs"
- There are no "out of date" tubes
- "Peak Performance" testing in our fully equipped Testing Department before shipment guarantees quality

**SAVE**

**USED  
TV SETS**

Picture Tube Guaranteed To Work!

- Emerson
- RCA
- Philco
- GE
- Motorola
- Zenith
- Capehart
- Others

10" SET	Table Model . . . \$16.95	16" SET	Table Model . . . \$32.00
Console . . .	\$19.95	Console . . .	\$34.95
12" SET	Table Model . . . \$22.95	17" SET	Table Model . . . \$37.00
Console . . .	\$24.95	Console . . .	\$39.00
14" SET	Table Model . . . \$27.95		
Console . . .	\$31.00		

All prices F.O.B. Harrison, N. J. Prices on request for 19", 20", 21" and 24" sets.

**SAVE**

**NEW INDOOR ANTENNA**

Both UHF and VHF. Brings better reception than most outdoor antennas. Use on top of TV. List Price \$9.95

**YOUR PRICE**

3  
29  
\$3.99 each

**LOOK WHAT YOU GET FREE!**  
 • 1 RCA Cheater Cord  
 • 10 Assorted resistors  
 • 10 Assorted 2 color "blank" tube cartons

**FREE CLOCK RADIO**

With Every \$125 Purchase Within 30 Days  
 Sessions clock radio with famous brand for \$17.95. In ivory or rust.

0Z4 .43	3BN6 .70	6AV6 .39	6K8 .65	7C6 .43	14B6 .38
1A7GT .43	3CB6 .52	6AX4GT .60	6L6 .68	7C7 .45	14Q7 .50
1A7G7 .43	3Q4 .46	6AX5GT .57	6L7 .42	7E5 .45	19B6G6 1.15
1B3GT .65	3Q5GT .57	6B4G .52	6N7 .60	7E6 .55	19T8 .65
1C5GT .41	3S4 .47	6B8 .69	6Q7 .40	7E7 .70	24A .39
1D5GP .43	3V4 .47	6BA6 .47	6S4 .40	7F7 .59	25AV5GT .78
1E7GT .41	4BQ7 .89	6BA7 .58	6SA7 .45	7F8 .70	25BQ6GT .78
1G6GT .41	4BZ7 .95	6BC5 .47	6SC7 .48	7G7 .75	25L6GT .47
1H4G .43	5AW4 .75	6BC7 .80	6SG7 .41	7H7 .50	25W4GT .43
1H5GT .47	5BG6G 1.15	6BE6 .45	6SH7 .43	7J7 .75	25Z5 .37
1J6GT .47	5J6 .63	6BF5 .40	6SJ7 .43	7K7 .75	25Z6 .37
1L4 .45	5T4 .69	6BF6 .50	6SK7 .45	7L7 .75	27 .25
1L6 .55	5U4G .43	6BH6 .50	6SL7GT .55	7N7 .50	35A5 .46
1LA4 .57	5U8 .74	6BJ6 .47	6SN7GT .55	12AT6 .37	35B5 .50
1LA6 .47	5V4G .59	6BK5 .68	6SQ7 .39	12AT7 .66	35C5 .50
1LB4 .57	5Y3 .31	6BK7 .76	6SR7 .42	12AUG .41	35L6GT .47
1LC5 .49	5Y4G .36	6BL7GT .75	6SS7 .41	12AU7 .53	35W4GT .34
1LC6 .47	5Z3 .41	6BN6 .58	6T4 .95	12AV6 .35	35Y4 .34
1LD5 .57	6A7 .57	6BQ6GT .78	6T8 .68	12AV7 .67	35Z4 .39
1LE3 .57	6A8 .45	6BQ7 .78	6U8 .75	12AX4GT .65	35Z5 .34
1LG5 .57	6AB4 .43	6BY5G .58	6V3 .80	12AX7 .58	37 .29
1LH4 .64	6AC7 .67	6BZ7 .88	6V6GT .46	12AZ7 .63	50A5 .46
1LN5 .47	6AF4 .79	6C4 .37	6W1GT .39	12B4 .68	50B5 .50
1NSGT .50	6AG5 .50	6C5 .35	6W6GT .53	12BA6 .46	50C5 .50
1R5 .50	6AG7 .69	6C6 .49	6X4 .34	12BD6 .48	50L6GT .43
1S5 .42	6AH6 .69	6CD6G 1.15	6X5 .34	12BE6 .46	84/6Z4 .44
1T4 .50	6AJ5 .70	6D6 .48	6X8 .73	12BH7 .65	117L7GT 1.09
1U4 .47	6AK5 .54	6E5 .44	6Y6G .55	12BY7 .65	117N7GT 1.09
1U5 .42	6AL5 .39	6F5 .37	7A4 .45	12BZ7 .61	117P7GT 1.09
1V2 .65	6AQ5 .46	6F6 .38	7A5 .53	12CU6 .95	117Z3 .35
1X2 .51	6AR5 .46	6G6 .40	7A6 .45	12SA7 .45	117Z6GT .63
2A3 .65	6AS5 .48	6H6 .38	7A7 .43	12SJ7 .45	
2A5 .57	6AS6 1.70	6J4 1.79	7A8 .45	12SK7 .45	
2A7 .55	6AS7G 2.19	6J5 .39	7B5 .39	12SN7GT .56	
3A4 .51	6AT6 .39	6J6 .47	7B6 .42	12SQ7 .37	
3A5 .50	6AU4GT .65	6J7 .43	7B7 .41	12SR7 .45	
3AL5 .45	6AU5GT .59	6J8G .85	7B8 .45	12V6GT .45	
3AU6 .46	6AU6 .42	6K6GT .37	7C4 .39	12X4 .37	
3BC5 .54	6AV5GT .65	6K7 .39	7C5 .42	14A7 .42	

WE PAY ALL POSTAGE on receiving tubes orders shipped in USA, Territories and APO's. Send only purchase price of merchandise. Please include approximate postage on foreign shipments. All orders subject to prior sale. Add 25c handling on orders under \$5.00. Quantity users write for special discount.

Write for FREE Tube List—Order Blank—and FREE Sample Tube Carton. We want Y-O-U on Our Mailing List!

**SPECIAL SURPRISE**

Mention where you saw our ad and we will send you FREE three 6SN7's with any order of \$10 or more.

**FREE GIFT CERTIFICATE\***

worth \$5 toward the purchase of any of our merchandise on future orders will be sent with any order of \$50 or more.  
 \* Free Gift Certificate cannot be used to obtain another certificate unless order is \$55 or more.

# MAJOR BRAND TUBE CO.

Romano Bldg.

Harrison, N. J.  
ESsex 4-1106

WRITE DEPT. RN-11





# KESTER

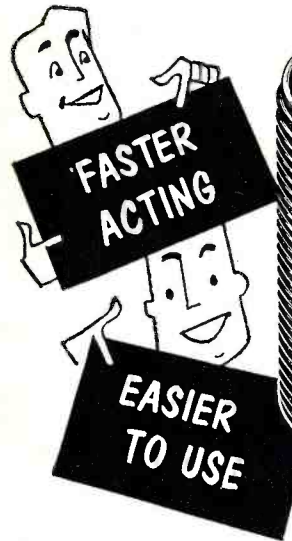

Absolutely non-corrosive and non-conductive, KESTER "RESIN-FIVE" CORE SOLDER contains an activated type of resin that gives you that fast, positive action on all your jobs . . . including the most difficult.



KESTER SOLDER COMPANY  
4235 Wrightwood Ave. • Chicago 39, Ill.  
Newark 5, N. J. • Brantford, Canada

# SOLDER

## LEARN TV

*'At the most practical school in the west'*

Work on late model sets—using modern equipment and service techniques; under qualified technician instructors. Short resident and correspondence courses—no unnecessary math or theory—also UHF and Color TV. APPROVED FOR VETERANS . . . day and nite classes.

Write for free literature, Dept. IA for residence—Dept. IAC for correspondence.

**V.S.I. TELEVISION SCHOOL** 4570 Firestone Blvd., Box 359  
South Gate, California

take your pick any assortment

**100**  
receiving  
**tubes**  
**\$38**

On orders of less than 100 tubes — 41¢ each

ALL TUBES UNCONDITIONALLY GUARANTEED FOR 1 YEAR

### BRAND NEW TV PICTURE TUBES

RCA and DUMONT Licensed

Partial Listing No dud required

Type	T.M. Price
10BP4	\$10.95
12LP4	12.95
12QP4	10.00
14CP4	15.25
15DP4	16.95
16DP4	18.50
16GP4	19.25
16KP4	17.00
16RP4	\$17.00
17BP4	19.00
17GP4	21.00
17LP4	18.00
19AP4	23.00
20CP4	24.00
21ALP4A	24.00
21EP4	24.00

Picture tubes  
F.O.B. PASSAIC, N. J.  
via Railway Express

### PRETESTED TUBES—INDIVIDUALLY BOXED

024	6AUG	6SH7	12BA6
1B3GT	6AUG5T	6S17GT	12BE6
1H5GT	6AV5	6SK7GT	12AZ7
1LCS	6AV6	6SL7GT	12BH7
1LNS	6AX4GT	6SN7GT	12BY7
1N5GT	6AT6	6SQ7	12SA7
1Q5GT	6AH4GT	6SR7	12SQ7
1R5	6BA6	6T8	12SJ7GT
1S4	6BC5	60B	12K7
1S5	6BE6	6V3	12SL7GT
1T4	6BG6G	6V6GT	12SN7GT
1T5GT	6B16	6W4GT	12S07
1U4	6BK5	6WG6T	12SR7
1U5	6BK7	6X4	19T8
1X2	6BL7GT	6X5GT	19BG6G
3Q4	6B06GT	6Y6G	25B06GT
3S4	6B07	7C5	25L6GT
3V4	6B15G	7C6	25Z5
5U4G	6BZ7	7E7	25Z6GT
5V4G	6C4	7F7	35B5
5Y3	6CB6	7F8	35C5
6AB4	6CD6G	7N7	35L6GT
6AC7	6F6	12AL5	35W4
6AC5	6HG6T	12AT7	35Y4
6AC7	6J5GT	12A06	35Z5GT
6AF4	6J6	12A07	50A5
6AK5	6K6GT	12AV6	50B5
6AL5	6L6	12AV7	50CS
6AQ5	6S4	12AX7	50L6GT
6AS5	6SR7	12AX4GT	117Z3
6AT6	6SA7	12BY7	

Free Postage on all prepaid continental U.S.A. orders. 25¢ handling charge on all orders under \$5.00. 25% deposit on all C.O.D. Subject to prior sale.

# TUBE MART

DISCOUNT HOUSE

PRcolt 3-0330

The Lokpot Bldg. Passaic, N. J.

## Air-Raid Alarm (Continued from page 61)

a wafer socket to a plug, however, an adapter developed for testing purposes may be used. Both the receiver and the alarm power cords must be plugged into the 117-volt outlet, however, the operation of the alarm is otherwise identical with that previously described. In this case no change of receiver tube type is needed.

In order to insure proper operation of the alarm circuit, it should be adjusted and tested in the following manner:

a. Apply a carrier between 600 and 1600 kc. modulated by a 1000-cycle tone, controlled as accurately as possible, with a sufficient amplitude to develop between 2½ and 3 volts a.v.c.

b. Tune the bandpass amplifier by adjusting potentiometer,  $R_{11}$ , for maximum voltage at the cathode of  $V_{1B}$ . An a.c. vacuum-tube voltmeter or an oscilloscope may be used as indicators. It is well at this point to mark the potentiometer setting with colored lacquer so that it may be reset if disturbed.

c. Remove the modulation and discharge the capacitor,  $C_7$ .

d. Modulate a carrier (about 75% at any frequency to which the set is tuned) with the 1000-cycle signal. After approximately 10 seconds the neon lamp,  $NE_1$ , should light showing that the relaxation oscillator has been triggered. Remove the modulation and permit the carrier to remain "on" for approximately 1¼ minutes after the modulation is removed. When the carrier has been cut, the alarm should operate.

e. While the alarm is sounding, re-apply the carrier. This should cut off the alarm.

In some a.c.-d.c. receivers with the alarm attachment a partial check of the alarm operation may be secured in the following manner:

a. Tune in a strong local station and allow the set to warm up completely.

b. By moving the tuning dial off station, eliminate the signal.

c. Turn the set "off" for approximately 10 to 15 seconds.

d. Turning the set "on" again will cause the alarm to sound.

e. It may be then eliminated by re-tuning the station. This check may be made at intervals during the life of the equipment to make sure that the alarm circuit is continuously operable.

A list of the component parts required to build the alarm is given in Fig. 3. The values of the resistors forming the twin-T network should be at least 5% tolerance, otherwise some padding may be needed. The total cost of all parts is approximately \$5.00, and the circuit is sufficiently non-critical to make it possible to construct it in a home workshop. A number of variations will suggest themselves to the experimenter.

# TEE-VEE Supply proudly introduces NEW SONIC RADIOS, PHONOS & COMBINATIONS Plus NEW HIGH FIDELITY UNITS



**MODEL 470**  
HIGH FIDELITY PHONOGRAPH

Deluxe 4-speed WEBCOR automatic record changer.  
Plays all size records intermixed.  
Two-speaker system produces true HIGH FIDELITY.  
Trouble-free PRINTED CIRCUIT chassis.  
Full range tone control.  
Handsome luggage cabinets—choice of British Tan or Rawhide— \$5445  
saddle stitched.



**CAPRI MODEL 440**  
E-X-T-E-N-D-E-D RANGE  
DUAL SPEAKERS

4-speed record player—16, 33, 45, or 78 RPM.  
Turnover High Fidelity pick-up equipped with 2 scientifically designed long-life needles.  
Cabinet handsomely bound and saddle stitched in British Tan or Rawhide.  
2 extra heavy, sealed Alnico 5 permanent magnet dynamic speakers.  
Full range tone control.

CAPRI MODEL 440 \$2250



**MODEL 450**

Deluxe 4-speed WEBCOR automatic record changer—plays all speed records intermixed.  
HIGH FIDELITY cartridge with dual needles.  
PRINTED CIRCUIT chassis.  
Full range tone control.  
Automatic shut-off for amplifier when record load is completed. Choice of two-tone grey or two-tone tan.

MODEL 450 \$3750  
MODEL 465

As above with 5-tube radio \$4850



**MODEL 490 SONIC HIGH-FIDELITY RADIO-PHONOGRAPH CONSOLE**

World famous GARRARD Deluxe 3-speed automatic record changer—plays all speed, size records intermixed with jamproof mechanism.  
High-fidelity cartridge with dual sapphire needles for finest performance—climatized—will resist temperature changes and humidity.  
Four speaker system employing cross over network for true high-fidelity responses from 50 to 15,000 cycles—2 12" and 2 8" P.M. speakers.  
Fool proof printed circuit chassis.

Mahogany \$12650 Blonde \$13440

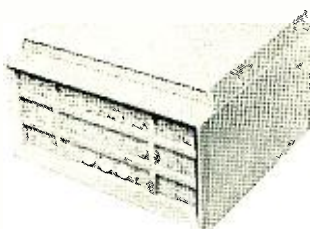

**MODEL 480 HI-FIDELITY**

World famous GARRARD Deluxe 3-speed automatic record changer—plays all speed, size records intermixed with jamproof mechanism.  
High-fidelity cartridge with dual sapphire needles for finest performance—climatized—will resist temperature changes and humidity.  
Three speaker system employing cross over network for true high-fidelity responses from 50 to 15,000 cycles—2 woofers and 1 tweeter.

Mahogany \$8995 Blonde \$9595  
Available with matching legs, \$14.95 extra.



**MODEL TR500**

1 Diode plus 4 Triode Transistors  
Full broadcast coverage 540-1620 K. C.  
3 Tuned I.F. stages  
Ferrite loop antenna  
Fool proof printed circuit  
Scuff-proof TEXON case in simulated Cowhide \$2697  
less batteries. ....  
\$1.45 for batteries.

SEND FOR NOVEMBER CATALOG OF PARTS SPECIALS!!

**TEE-VEE**  
Supply Co.

Send complete shipping instructions and 25% deposit. Balance C.O.D. and deduct 2% for check or money order in advance. Include sufficient postage for small items. Large items shipped via Railway Express collect.

3211-13 Washington Street  
Jamaica Plain 30, Mass.

**Examine FREE**



**Prentice-Hall  
ELECTRONICS &  
UHF LIBRARY**

Edited by **W. L. EVERITT**

**5 VOLUMES 1662 ILLUSTRATIONS**

Pay Easy Installments If You Keep the Set  
Turn to this new, up-to-date Library with complete confidence, for dependable facts on any phase of modern electronic theory and practice. These volumes, by outstanding authorities, give you thorough guidance—clearly written, logically arranged, profusely illustrated.

**Electronic Fundamentals and Applications**  
By Prof. John D. Ryder, Dean, College of Engineering, Michigan State University

Complete, logical, easy-to-follow treatment of (a) physical principles underlying electron tubes, (b) characteristics of vacuum tubes, (c) all basic tube circuits. Includes: Electron Ballistics. Cathode-Ray Tubes. Emission of Electrons. Space Charge in Vacuum Tubes. Diode Rectifiers. Triodes. Multi-Element Tubes. Small-Signal Amplifier Circuits. Audio-Frequency Amplifiers. Radio-Frequency Amplifiers. Oscillator Circuits. Modulation Systems. Wave-Shaping Circuits. Gaseous Conduction. Gas Diodes. Gas Control Tubes and Circuits. Photoelectric Cells. Solid-State Electronics.

**Electromagnetic Waves and Radiating Systems**

By Prof. Edward C. Jordan, Head, Dept. of Electrical Engineering, Univ. of Illinois

Covers entire field of electromagnetic engineering. Includes Propagation as well as radiation and transmission. Full treatment of UHF transmission lines, wave guides, antennas, slot antennas, radiation and diffraction, ground-wave and sky-wave propagation.

**Ultra High Frequency Engineering**

By Thomas L. Martin, Head, Dept. of Electrical Engineering, Univ. of Arizona

Theory and technique of ALL the new fields of electronic engineering: Radar. Telemetering. Electronic computing. Facsimile. Television. Blind landing systems. Pulse-time modulation. Ionosphere measurements . . . and the others.

**Networks, Lines and Fields**

By Prof. John D. Ryder, Dean, College of Engineering, Michigan State University

Network transformations and theorems. Resonance. Impedance transformation and coupled circuits. Filters. General transmission line. High-frequency line. Equations of the electromagnetic field. Radiation. Transmission and reflection of plane waves at boundaries. Guided waves between parallel planes. Wave guides.

**Elements of Television Systems**

By George E. Anner, Univ. of Illinois

Complete basic theory, plus current practice, covering: Closed TV systems. Commercial Teletcasting Systems. Color TV Systems. Gives clear exposition of all phases of picture transmission, including the new technique of dot interlace.

**SEND NO MONEY — EXAMINE FREE**

Just mail coupon below to get complete 5-Volume Set on 10 DAYS' FREE TRIAL. If not completely satisfactory, return in ten days and owe nothing. Or keep the set and pay only \$7.50 down and \$8 a month for five months until full price of \$47.50 is paid. Decide for yourself—without risk or obligation—just mail coupon to examine Library ten days free.

**Prentice-Hall, Inc., Dept. 5741-P1  
Englewood Cliffs, N. J.**

Send me the Prentice-Hall ELECTRONICS & UHF LIBRARY (5 Volumes) for ten days' free examination. If fully satisfied in ten days I will send you \$7.50 plus few cents postage and then \$8 a month for five months until full price of \$47.50 is paid. Or I will return the Library in ten days and owe nothing.

Name .....  
Address .....  
City and State .....

# DISTORTION & PHASE-SPLITTER UNBALANCE IN PUSH-PULL AMPLIFIERS

By **NATHAN O. SOKAL**  
Massachusetts Institute of Technology

*A discussion of the advantages which accrue by obtaining a.c. "balance" of output tubes as well as d.c. "balance."*

ALMOST all of the published material on high-fidelity audio amplifiers stresses the need for precise balancing of the phase splitter used in push-pull amplifiers. Various authors have their pet phase splitters; the one most commonly used is the split-load circuit shown in Fig. 1. The cathode and plate resistors,  $R_K$  and  $R_L$ , are usually matched within 1 per-cent, as are also the following grid resistors,  $R_{g1}$  and  $R_{g2}$ . The purpose of the matching is to get exactly equal a.c. voltages of opposite phase from the two outputs of the phase splitter. This precise balancing is quite useless and unnecessary—and even tends to defeat its own purpose. Why? Let us examine the reasons behind the balancing.

Push-pull connection of the output tubes cancels even-harmonic distortion generated by the tubes if their grid drives, plate loadings, and d.c. operating conditions are the same. This, then, is the reason behind the desire for equal drive on the tubes. However, the reasoning is based on the assumption that the output tubes have identical transfer characteristics. In actual practice, this is likely to be far from true. An idea of the range of characteristics from one tube to another of the same type can be had from the JAN specifications for the 6L6, a popular audio-output tube. A brand-new 6L6 can have a  $g_m$  between 5200 and 6800 micromhos (under standard test conditions) and the "end of life" is considered to be when the  $g_m$  drops to

Fig. 1. A widely used split-load phase splitter. The pairs of resistors are usually matched to within plus/minus one per-cent.

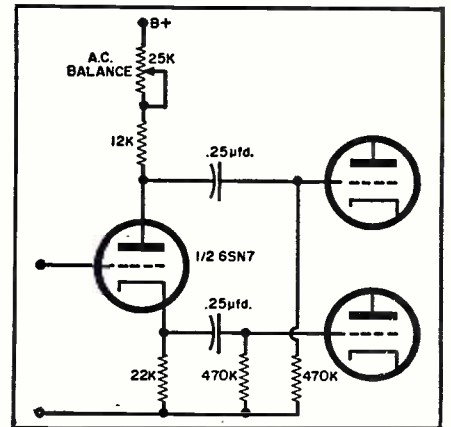
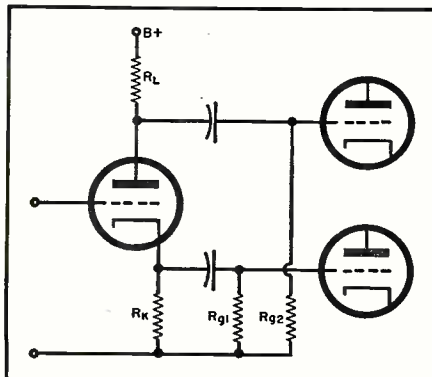

Fig. 2. Adjustable phase splitter. The "a.c. balance" potentiometer is set to give equal a.c. current in the output tubes.

4500 micromhos. There can be a difference in  $g_m$  of as much as 40 per-cent between two "good" 6L6's. Of course, they are not all that bad, but you get the idea.

It is true that d.c. balancing of the output tubes tends to equalize their characteristics, but this is only a partial correction. The result of the remaining difference between the tubes is simply that the even harmonics are not completely cancelled. (It should also be noted that for exactly the same reason, the driver tubes can add still more noncancellation to that caused by the output tubes.) The net effect of all this is that the "push" and "pull" halves of the amplifier can easily have gains differing by 50 per-cent. What, then, is the sense of equalizing the phase-splitter outputs to within 1 per-cent?

Now, if you want more nearly perfect cancellation of distortion (and it could be a moot point), what you can do is make the phase-splitter outputs enough unequal to compensate for the unequal gains of the "push" and "pull" halves of the amplifier. This can be done by making one of the phase-splitter loads adjustable, as shown in Fig. 2. The "a.c. balance" potentiometer is then set to give equal a.c. currents in the output tubes. (This is approximately the condition for best cancellation of distortion.) The results of this setup on an "Ultra-Linear Williamson"

*You're invited  
to a  
Launching!*

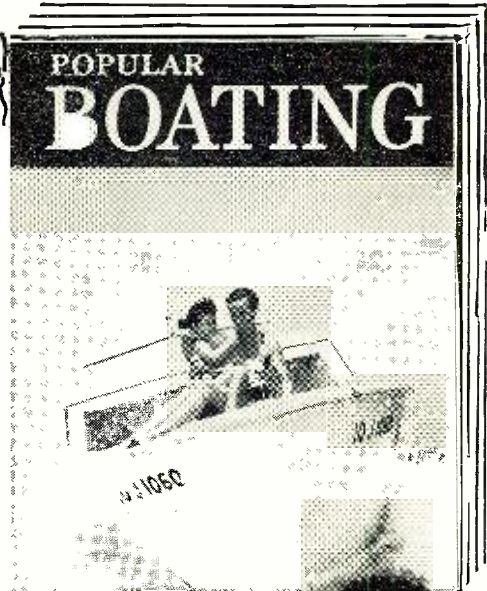
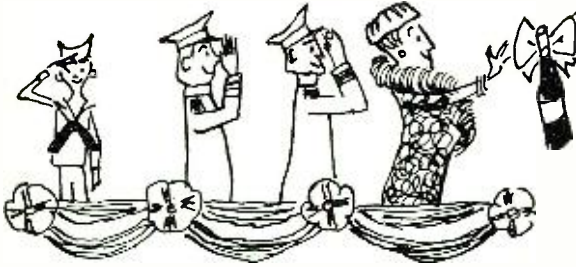

## SPECIAL OFFER TO READERS OF RADIO & TELEVISION NEWS

# 8 months of POPULAR BOATING only \$2.00

(a \$3.45 single copy value!)

This is your special invitation to "sign on" as a Charter Subscriber to POPULAR BOATING—the new Ziff-Davis monthly for *everyone* who enjoys life on the water.

Beginners and "old salts" . . . inboard, outboard and sailing enthusiasts and their families—all are finding POPULAR BOATING the most enjoyable magazine in the boating world. Copies of the first big issue, on sale only a few days, have become hard to find because of their tremendous demand.

POPULAR BOATING, the first new major boating magazine in more than a generation—brings a completely fresh approach to the entire world of boats—from dinghy to power cruiser.

Published by the same company that has made RADIO & TELEVISION NEWS tops in its field, POPULAR BOATING features money-saving how-to articles that point the way to more fun, greater safety afloat . . . new construction ideas . . . information on repairing, improving, fitting out your boat . . . monthly classes on seamanship and boat handling by expert boatmen . . . exciting boating yarns that will transport you to every corner of the world where there's fun and adventure on the water . . . regular features on new products, junior activities, maintenance, fishing, free aids to better boating, and much more!

Here are just a few of the exciting articles in POPULAR BOATING's first issue:

- **BREAKING THROUGH THE "WATER BARRIER"**—America's best-known racing writer, Hank Bowman, describes the perils of high speeds afloat.
- **SHOULD YOUR FIRST BOAT BE POWER OR SAIL?**—Two top boating writers defend their favorite craft in a hot debate.
- **OUTBOARDS UNLIMITED**—There's no limit to the fun outboarding offers. Here's how to enjoy it more fully!
- **GUY LOMBARDO'S GREATEST BOATING MOMENTS**—In this exclusive article, the famed musician and boatman recalls the most thrilling moments in his racing career.
- **ANN DAVISON'S NEXT BOATING VENTURE**—An exclusive first-hand report by the only woman ever to sail the Atlantic alone!

This first issue is already a complete sellout at many newsstands. How POPULAR BOATING offers readers far more than any other publication in the field . . . yet costs less. At regular rates, POPULAR BOATING sells for 35c on newsstands (Special Show Numbers: \$1.00) and \$4.00 a year by subscription.



**Welcome aboard as a  
Charter Subscriber!  
Fill out and  
mail this coupon TODAY!**

**POPULAR  
BOATING** 366 Madison Avenue, New York 17, N.Y.

### CHARTER SUBSCRIPTION ORDER FORM

Yes, please enter my Charter Subscription to POPULAR BOATING—at the special rate of eight months for only \$2.00. Also send me my Charter Subscription Certificate. My payment is enclosed.

Name.....

Address.....

City.....Zone.....State.....

- Please start my subscription with Volume 1, Number 1, if possible.  
 I've bought the first issue at a newsstand. Begin my subscription with the second (November) issue.

**A NEW MAGAZINE BY THE PUBLISHERS OF RADIO & TELEVISION NEWS**

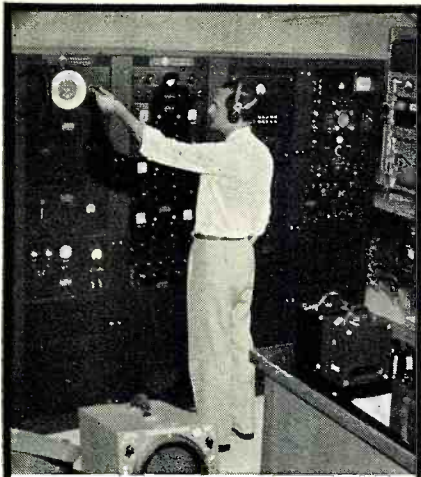

# STANDARDS

# ENGINEERS

for primary standards  
laboratory

At Hughes we are conducting fundamental research and development and production engineering in the fields of radar systems, guided missiles, digital and analog computers, microwave tubes, semiconductor products and other activities requiring use of many types of test equipment. This activity is supported by an outstanding Primary Standards Laboratory equipped for electrical, mechanical and physical certifications.

Those with extensive experience in the measurement of electrical and physical quantities to a high degree of accuracy and who wish to join in the establishment of new techniques to further increase the accuracy and application of such measurements will find a satisfactory outlet for these abilities at Hughes.

Scientific Staff Relations

## HUGHES

Research and Development Laboratories

HUGHES AIRCRAFT COMPANY

Culver City, California

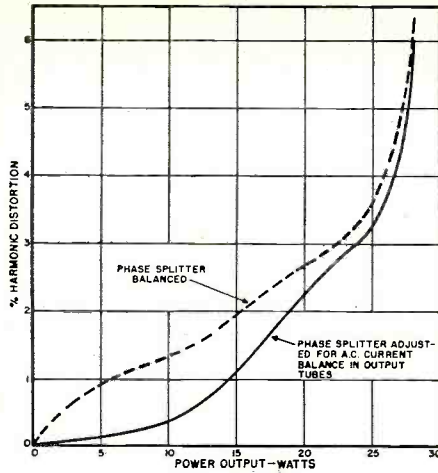

Fig. 3. Distortion vs power output for an "Ultra-Linear Williamson" with balanced and adjusted phase splitter. The feedback loop was opened in order to obtain data.

amplifier are shown in Fig. 3, where harmonic distortion of a 1 kc. input is plotted against power output for two conditions:

1. Equal resistors in the phase-splitter (dotted curve)
2. Potentiometer set for a.c. current balance in the output tubes (solid curve)

In both cases the direct currents were balanced. It can be seen that adjusting the phase-splitter reduced the distortion by as much as 700 per-cent.

The 807 tubes used in the amplifier might be considered a "matched pair". They both passed a tube-checker test, and indicated  $g_m$ 's were within 8 per-cent of each other. The feedback loop was opened to take the data, and a regulated power supply was used.

The "a.c. balanced" condition corresponds to a minimum alternating current in the common plate lead or common cathode lead of the output tubes. The easiest way to observe the condition is with an oscilloscope connected across a small resistor (say 100 ohms) in the common plate lead as shown in Fig. 4, and a sine-wave input to the amplifier. (Caution—the scope chassis will be "hot".) The waveforms for balanced and unbalanced conditions are shown in Figs. 5A and 5B; the input signal to the amplifier should be enough to drive the amplifier to medium-to-loud output.

Another way to observe the balance condition is to connect an a.c. meter or a headphone in the common plate

Fig. 4. A 100-ohm resistor is inserted in the common plate lead of the output tubes to observe the a.c. balance or unbalance.

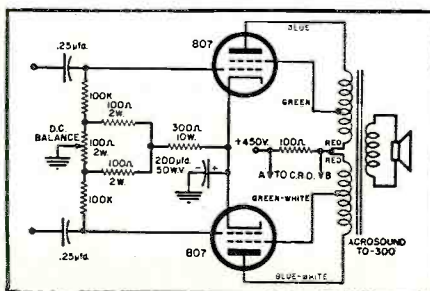

# H R → IT → IS!

## \$12.95 Oscilloscope

BC-929 is a 9-tube airborne scope indicator containing 3BP1 picture tube, 6SN7GT's, 6BD's, 6G5, 6X3 and 2X2. All usual controls on front panel (Positioning, focus, intensity). Has video amplifier. Easily converted to 115 V. 60 cy. with sawtooth generator. We give you schematic and instructions. Makes dandy little bench or portable scope. Like new... **\$12.95**

## FREQUENCY METER BARGAIN!

BC-906 is also a wonderful Grid Dip Meter and Relative Field Strength Meter! Frequency 144-225 mc. covers VHF communications and upper TV channels. You tune a silver-plated cavity to resonance with a large National Velvet Vernier dial. A probe in the cavity feeds the diode plate of a 1S5 and the rectified negative voltage applied to the grid of the same tube dips the plate current as shown on a 0-500 dc microammeter. The dial is individually calibrated with a curve showing 100 kc per dial division. The entire unit is in a compact carrying case only 12 1/4" x 8 3/4" x 6 1/2" with leather handle. Schematic is pasted inside. Includes plug-in antenna. Specs inside for one ea. 1.5 V. and 45 V. is like brand new and only... **\$7.95**

## ATTENTION! Engineers and Purchasing Agents—We are the largest suppliers of hard-to-get, technical electronics, tubes, test equipment, etc. If surplus can solve your problem, we have it! Send us your inquiries!

## the 2 HOTTEST RECEIVERS IN SURPLUS !!!

Extremely easy to make power supplies for both. Both come with schematics and instructions for the simple modifications required. Both are super-sensitive, super-selective superhets.

2 METERS: R-28/ARC-5, 100-150 mc. in excellent condition with all 10 tubes. 4-channel crystal control.

420 MC: CPR-46ACJ, double conversion, 2 IF's, 3 hightones, brand new with ALL 12 TUBES!

YOUR CHOICE **\$9.95** BOTH FOR **\$17.95**  
EACH..... ONLY.....

## THE BEST, HANDIEST CARBON MIKE

RS-38. Used in CAA towers. Fits in the palm of your hand! Has press-to-talk button on top, and a springy curled cord only 1 ft. long which stretches to 3 ft. With standard 3.5" microphone plug at other end. Like new and guaranteed. **\$2.95**  
Terrific buy at only..... **\$5.00**  
NEW—With hanger..... **\$5.00**

## ONE-WAY STREET FOR ELECTRONICS!

Operate Transistors, DC Relays, Meters, etc. From Your AC Line... Or Detect Radio Signals. New, exclusive... JANGermium Diode 1N70 stands 100 v peak and gives you up to 30 ma average current! A terrific buy gives you a new one guaranteed at the bargain rate of **8 for \$2.98** only.....

## RE-TUNE 30 W. TV XMTR TO 220 OR 440:

or start your own TV station! Four 8025 UHF triodes, two as 250-385 mc P-P osc. drive, two as PA which is grid-mod. by 3-tube video, and plate-mod. by 3-tube sync. amplifiers. New! With all tubes, schematic and instructions to make a powerful 420 MC Transmitter. **\$15.75** Only.....

## FREE! Big Bargain Catalog!

Send for your copy.

## COMMAND SET SPECIALS!

Receivers—with all tubes

1.5-3 mc. Excellent condition..... **\$9.95**  
3-6 mc. Excellent condition..... **4.95**  
100-150 mc. Excellent condition..... **9.95**

Transmitters—with all tubes

2.1-3 mc. Excellent condition..... **\$9.95**  
3-6 mc. Excellent condition..... **8.95**  
4-5.3 mc. Excellent condition..... **4.95**  
5.3-7 mc. Excellent condition..... **4.95**  
7.9-12 mc. Brand new..... **7.95**

12 VOLT DYNAMOTOR: For Command Receiver. With exact base to attach. **\$5.95**  
Special, Only.....

All shp'ts. FOB whse. Send 25% dep. with all COD orders. Item sub. to prior sale & change of price without notice. Min. order \$2.50.

## ARROW SALES, INC.

Western Mailing Address:  
Box 3007-R NORTH HOLLYWOOD, CALIF.  
Central Mailing Address & Sales-Showroom  
2441 S. MICH. AV., Dept. R., CHICAGO 16, ILL.  
California Distributors' Stores  
G. L. Electronics, Inc., 1632 Venice, Los Angeles  
P.A.R.T.S., Inc., 2005 Empire Ave., Burbank

## "magic memory" SYSTEM

### FOR LEARNING INTERNATIONAL RADIO CODE

GET A PACK OF  
McGEORGE  
CODE CARDS!  
MAKE A GAME OF  
LEARNING CODE **\$200** POSTPAID

Intnat'l. CODE FLAGS Included  
SEND CASH, CHECK OR MONEY ORDER TO  
**General Communications, Inc.**  
Marshall Building • Cleveland 13, Ohio



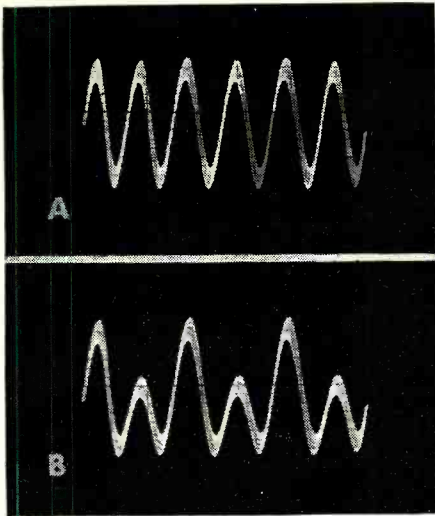

Fig. 5. Test waveforms. (A) Across A-B in Fig. 4 with proper a.c. balance. (B) Circuit with a.c. balance improperly adjusted.

lead through a step-up transformer, instead of the 100-ohm resistor shown in Fig. 4. Balance is indicated by minimum meter indication or minimum sound in the headphone.

In summary we can say: 1. If you are satisfied to accept the distortion likely to occur if the phase-splitter uses matched resistors—then you don't have to bother matching them, and 2. If you seriously want the lower distortion implied by the effort made to match the phase-splitter resistors—then you *should not* match them, but should make their ratio adjustable, as in Fig. 2.

The author wishes to thank Nicholas C. Vlahakis for obtaining the experimental data.

### CROSLY "SUPER V" HINT

By RUFUS P. TURNER

THE Crosley Model 431 "Super V" 21" TV receiver uses a series-parallel heater string. When the heater circuit opens and the set remains plugged in and switched on for a short time afterwards, the selenium voltage multiplier-type power supply continues to operate, but with no load.

The result is that the filter capacitors charge up and, since these capacitors "see" the power input circuit through the selenium unit, the two prongs of the power plug become d.c. "hot." When the plug is removed from the outlet, 125 volts or higher can be measured between the prongs. Because of the high capacitance of the filters (140  $\mu$ fd.), shorting the prongs does not remove the voltage immediately. Several repeated shorts are required to dissipate the charge completely.

Not only do these hot prongs deliver a biting shock, but the voltage raises Cain with an ohmmeter connected between the prongs to test for an open heater string.

If the set has gone completely dead—no picture, no sound—pull out the plug, keep the line switch on, and short the prongs several times with a screwdriver. The tell-tale sparks show that the heater string is open. Don't use your ohmmeter!

Heed this hint and save a valuable test instrument.

November, 1956

# \$100,000

Hi-Lo is covered by a \$100,000.00 insurance policy issued by one of the largest insurance companies.\*

## GUARANTEED PERFORMANCE

Each and every Hi-Lo is backed by a money back guarantee. For the best reception, unsurpassed clear pictures, specify Hi-Lo, with the exclusive highest gain, spiral designs which are covered by the following U.S. patent numbers: 2,495,579; 2,583,745, 2,724,773; 2,748,387; 2,755,466; and Canadian Patents 1951 and 1956; other patents pending.



**Hi-Lo** Model 505 — Channels 2-83  
The spiral antenna that is designed for maximum performance featuring the NEW TELESCOPING DIPOLES. This versatile antenna swivels on ball and socket in any direction. Gold spirals, plastic base blend with any room. LIST... \$14.95

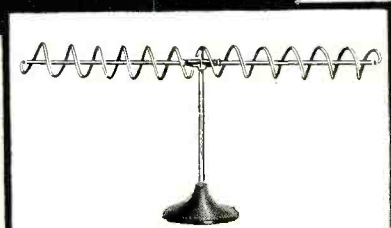

**Hi-Lo** Model 101 — Channels 2-13.  
The original and world famous antenna that is wanted, demanded and used for GUARANTEED FINEST RECEPTION. No rods to adjust. Provides clearest pictures faster. LIST... \$9.95



**Hi-Lo** Model 303 — Channels 14-83.  
The UHF ANTENNA with the highest signal gain that is specially designed for ALL UHF areas. Luxurious gold upright and crossbar. LIST... \$5.95

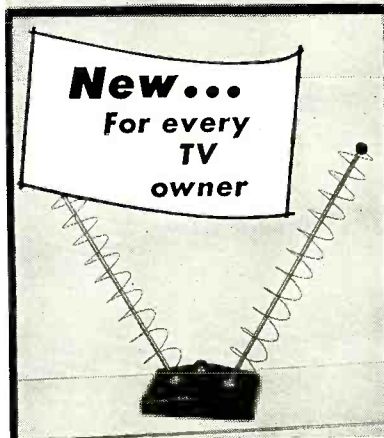

**Hi-Lo** Model 404 Channels — 2-83.  
NEW INDOOR ANTENNA that swivels with a gentle touch of your little finger. Dipoles swivel on ball and socket in every direction. Golden spirals and decorative plastic base blend with all furniture. RECEPTION IS GUARANTEED. LIST... \$12.95



**Hi-Lo** Model 202 — Channels 2-83  
PEAK PERFORMANCE which is unsurpassed is guaranteed with this antenna... for ANY and EVERY area. The gleaming gold upright, shiny spirals, bakelite base, aluminum bars, modern design

... all make this YOUR BEST ANTENNA BUY.

LIST... \$9.95

\*name upon request

INSIST ON THE GENUINE Hi-Lo Spiral Antennas!

Known and accepted everywhere, Hi-Lo is manufactured and GUARANTEED by the best antenna manufacturer in the world. Hi-Lo is consumer accepted and approved.

# Hi-Lo

**TV ANTENNA CORP.**  
3540 North Ravenswood Avenue  
Chicago 13, Illinois

# BUILD 16 RADIO CIRCUITS AT HOME

With the New Improved 1957 Progressive Radio "Edu-Kit" only **\$19.95**

**A PRACTICAL HOME RADIO COURSE**

Now Includes **SOLDERING IRON, TESTER, HIGH FIDELITY SIGNAL TRACER, CODE OSCILLATOR, PRINTED CIRCUITRY**



**FREE TOOLS**

- No Knowledge of Radio Necessary
- No Additional Parts or Tools Needed
- Excellent Background for TV
- Unconditional Money-Back Guarantee

**FREE** Hi-Fi, Radio & TV Servicing Manuals on Request. (See Coupon Below).

**WHAT THE "EDU-KIT" OFFERS YOU**

The "Edu-Kit" offers you an outstanding PRACTICAL HOME RADIO COURSE at a rock-bottom price. You will learn radio theory, construction and servicing. You will learn how to build radios, using regular schematics; how to solder and wire in a professional manner; how to service and trouble-shoot radios. You will learn how to work with punched metal chassis as well as the new Printed Circuit chassis. You will learn the principles of RF and AF amplifiers and oscillators, detectors, rectifiers, test equipment. You will learn and practice code, using the Progressive Code Oscillator. You will build 16 Receiver, Transmitter, Code Oscillator, Signal Tracer and Signal Injector circuits, and learn how to operate them. You will receive an excellent background for TV. In brief, you will receive a basic education in Electronics and Radio, worth many times the small price you pay, only \$19.95 complete.

**PROGRESSIVE TEACHING METHOD**

The Progressive Radio "Edu-Kit" is the foremost educational radio kit in the world, and is universally accepted as the standard in the field of electronics training. The "Edu-Kit" uses the modern educational principle of "Learn by Doing." You begin by building a simple radio. Gradually, in a progressive manner, and at your own rate, you construct more advanced multi-tube radio circuits, learn more advanced theory and techniques, and work like a professional radio technician.

**THE KIT FOR EVERYONE**

You do not need the slightest background in radio or science. The "Edu-Kit" is used by young and old, schools and clubs, by Armed Forces Personnel and Veterans Adm. for training and rehabilitation. The "Edu-Kit" is used in 79 countries throughout the world. Designed for universal use, the "Edu-Kit" operates on any voltage from 105 to 125 volts, AC and DC. For use in countries employing higher line voltages, a 210-250 Volt AC/DC model is available.

**THE "EDU-KIT" IS COMPLETE**

You will receive all parts and instructions necessary to build 16 different radio and electronics circuits, each guaranteed to operate. Our kits contain tubes, tube sockets, variable, electrolytic and paper dielectric condensers, resistors, tie strips, coils, hardware, tubing, punched metal chassis, Instruction Manuals, etc. In addition, you receive Printed Circuit materials, including Printed Circuit chassis, special tube sockets, hardware and instructions. You also receive a useful set of tools, a professional electric soldering iron, and a self-powered, dynamic Radio and Electronics Tester. The "Edu-Kit" also includes Code instructions and the Progressive Code Oscillator. You will also receive lessons for servicing with the Progressive Signal Tracer and the Progressive Signal Injector, a High Fidelity Guide, FCC Amateur License Reading Book, and a Quiz Book. All parts, components, etc. of the "Edu-Kit" are 100% unconditionally guaranteed, brand new, carefully selected, tested and matched. Everything is yours to keep. The complete price of this practical home Radio and Electronics course is only \$19.95.

**TROUBLE-SHOOTING LESSONS**

You will learn to trouble-shoot and service radios, using the professional Signal Tracer, the unique Signal Injector, and the dynamic Radio and Electronics Tester. Our Consultation Service will help you with any technical problems.

J. Stasaitis, of 25 Poplar Pl., Waterbury, Conn., writes: "I have repaired several sets for my friends, and made money. The 'Edu-Kit' paid for itself. I was ready to spend \$240 for a course, but I found your ad and sent for your kit."

**FREE EXTRAS**

- Radio Book • Radio and Electronics Tester • Electric Soldering Iron • Self-powered Tester Instruction Book • Hi-Fi Book • TV Book • Quiz Book • Membership in Radio-TV Club • Consultation Service • FCC Amateur Lic. Training • Printed Circuitry

**UNCONDITIONAL MONEY-BACK GUARANTEE**

**ORDER FROM AD—RECEIVE FREE BONUS RESISTOR KIT WORTH \$5**

"Edu-Kit", Postpaid. Enclose full payment of \$19.95.  
 "Edu-Kit", C.O.D. I will pay \$19.95 plus postage.  
 Send me **FREE** additional information describing "Edu-Kit". Include **FREE** valuable Hi-Fi, Radio & TV Servicing Manuals. No obligation.  
 (Outside U.S.A.—No C.O.D.'s. "Edu-Kit" for 105-125 V. AC/DC \$20.95; 210-250 V. AC/DC \$23.45.)

Name .....  
 Address .....

**PROGRESSIVE "EDU-KITS" INC.**  
 497 Union Ave., Room 59-E, Brooklyn 11, N. Y.



**EMERSON CAMPAIGN**

The largest and most comprehensive advertising and sales promotion campaign in the history of *Emerson Radio & Phonograph Corporation* has been scheduled for the ensuing year at a total cost in excess of eight million dollars.

The campaign will cover TV receivers, radios, phonographs, and air conditioners and will include national magazines, newspapers, trade papers, and extensive sales promotion materials.

The sales promotion phase of the campaign will include streamers, banners, displays, broadsides, direct mail, permanent fixtures, illuminated color outdoor-indoor signs, a six-way promotion on the firm's "Port-O-Rama," and many other sales devices and point-of-sale materials.

**NEW FUSE PACKAGE**

*Sightmaster Corporation* of New Rochelle, N. Y., is now packaging its replacement line of fuses in clear plastic boxes, ten fuses of an amperage to a box.

The plastic box is so designed that it will fit all conventional dispensers now being used in the trade. According to the manufacturer, the advantage of the plastic box is that the contents are immediately visible to the distributor and dealer as to the number of fuses remaining in the package. The plastic box is re-usable.

**CHRISTMAS PROMOTION**

*Arvin Industries, Inc.*, of Columbus, Ind., is making available to its dealers an attractive lithographed display designed to help promote its recently announced 1957 radio line for holiday giving.

The four-color piece is built around an ultra-modern Santa Claus and the

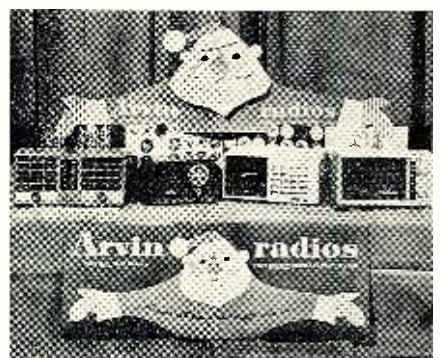

pine needles and snowflakes natural to the winter season. The display and accompanying banner can be used with three or four of the company's new table, clock, or portable sets and is in-

tended for window, counter, or floor applications.

**TAPE PROMOTION**

*ORRadio Industries, Inc.*, Opelika, Ala., manufacturer of "Irish" brand magnetic recording tapes, has launched its biggest advertising campaign to promote its entire line.

The program will utilize national publications, trade journals, and FM radio. Featuring the company's cartoon character "F. R. O'Sheen," the "Irish" leprechaun, and the "Seven Old Fashioned Villains of Tape Recording," the copy line will demonstrate how the "Ferro-Sheen" process can eliminate many of the problems that plague users of recording tapes.

**CHANNEL MASTER PROMOTION**

*Channel Master Corp.*, Ellenville, N. Y., is backing its two new television antennas with a \$500,000 national consumer advertising campaign.

Two-page spreads, full-color pages, and black-and-white full pages have

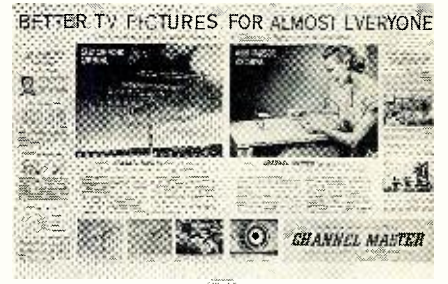

been scheduled for leading consumer books. The ads will run throughout the fall with a special spread for the Christmas season. The publications selected represent a combined circulation of 12,500,000 each issue and add up to 53,000,000 advertising messages concentrated within a three-month period.

Local sales promotions will be tied in with the national campaign using all media to blanket local areas.

**DU MONT "DEALER DERBY"**

Top winners in the *Allen B. Du Mont Laboratories'* recently completed "New Dealer Derby" have been announced by the TV Receiver Division. Four-door *Plymouths* were won by Alfred Caulk, *Eastern Wholesalers*, Baltimore; S. Joseph Mansker, *Du Mont-Florida*, Miami; I. W. Brayer, *G & W Distributing Co.*, Phoenix; Herbert L. Moore, *American Distributing Co.*, Charleston, S. C.; W. A. Cheever, *L. J. McAllister Co.*, Boston, and Harmond Barbour, *Sampson Distributing Co.*, Richmond.

Secondary prizes of mink stoles, diamond rings, and clothing gift certificates were also awarded.

**NEW RESISTOR PACKAGING**

The Electronic Components Division of *Stackpole Carbon Company*, St. Marys, Pa., is now offering new resistor package designs which pace the trend toward the automatic handling of these components on a production line basis.

The new packages, known as the

"Strip Pack," "Stack Pack," and "Reel Pack," are available for all of the company's 1/2-, 1-, and 2-watt fixed composition resistors. The "Strip Pack" holds the resistors neatly in a vertical position by means of small strips of corrugated cardboard into which one end of all resistor leads are inserted. In the "Stack Pack," the resistors are interleaved and horizontally stacked in layers. The "Reel Pack" features a single strip of plastic tape which secures the resistor bodies to the corrugated reel for feeding to automatic machines in a continuous string.

Dimensions for each package and further details are available on request to the company.

#### COLLARO CHANGER PROMOTION

Rockbar Corporation, Mamaroneck, N. Y., has launched an all-out campaign to promote the English-made Collaro record changer for which it is the U. S. distributor.

The new campaign consists of a series of seven different ads, each stressing a different Collaro feature. Each feature is illustrated by an off-beat, non-technical photograph designed to appeal to the average reader.

The firm estimates that there is a \$15 million a year market for record changers and that the replacement market represents a potential of about \$900 million.

The advertising will be carried in general consumer publications.

#### SERVICE AIDS DISPLAY

A complete line of sixty service aids, accessories, components, hardware, and specialty items is now being marketed by Dynamic Electronics-New York, Inc., in a new type of packaging designed for self-service impulse sales appeal.

With each assorted gross of items the company supplies free a three-color metal counter or wall self-service rack with 12 spokes to display any 12 of the 60 items in the line. The merchandise is packaged on 5" x 6"

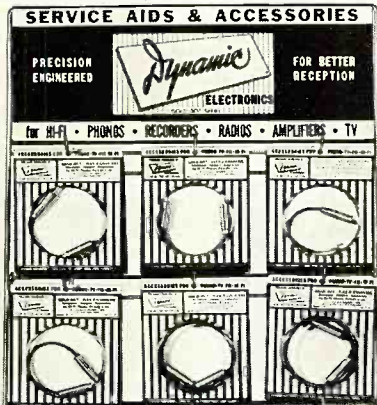

yellow, black, and white striped cards and the items are contained in a circular 3 1/2" transparent polystyrene blister on each card for clear visibility.

Details on the line and the free display rack are available from the company at 73-39 Woodhaven Blvd., Forest Hills, N. Y.



MODEL T-801  
\$417 LIST



MODEL T-811  
\$500 LIST

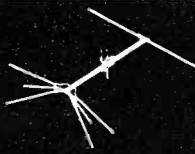

MODEL T-791  
\$444 LIST

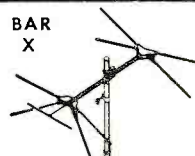

MODEL T-751  
\$556 LIST

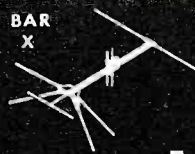

MODEL T-851  
\$472 LIST

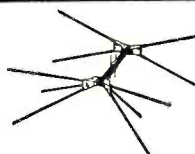

MODEL T-741  
\$529 LIST

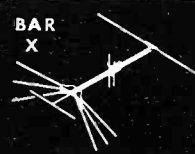

MODEL T-781  
\$556 LIST

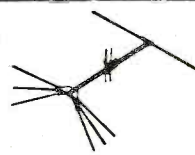

MODEL T-771  
\$500 LIST



OFFERS YOU FOR THE  
COMING SELLING SEASON

## America's Finest AND MOST COMPLETE LINE OF Conical Antennas

Nowhere else can you buy such a high quality, full size Antenna with as many practical, useable features at such low, down to earth prices. Here's what you get when you buy Tenna.

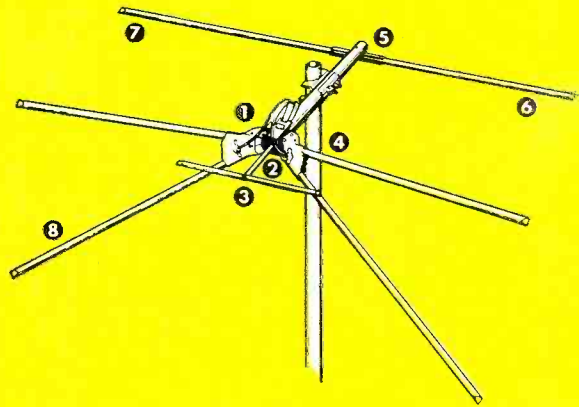

Check these Tenna features, feature by feature, with any or all other makes and you'll quickly agree that Tenna is truly the antenna for you . . . truly the king of all the conicals.

1. Completely pre-assembled. "Presto" Instant Mount Assembly opens as easily, quickly as an umbrella.
2. Now! Polyethylene Cable Anchor takes all tension off of terminals, prevents cable from breaking at terminals.
3. Models T-781, T-851 and T-751 are equipped with famous Tenna Director Bar to improve performance on higher channels.
4. Front Bracket made of heavy spring temper aluminum alloy with High Q molded plastic insulator.
5. Rear Bracket is made of heavy gauge aluminum to assure long life and resist strongest gales and heavy ice.
6. Arrays are full size in every respect and of all aluminum construction.
7. Aluminum elements are doweled to prevent whistling and provide greater strength.
8. Full line to select from; 8 single array antennas, 8 stacked antennas and 8 "Do-It-Yourself" antenna kits.

YOU BUY THE FINEST WHEN YOU BUY TENNA!

The **Tenna** Manufacturing Co.

Cleveland 25, Ohio

# The Finest UHF Converter Ever Designed



**B-T  
LABS**

UL approved

*Ultravertex*  
**OUTPERFORMS  
ALL OTHERS  
IN THE FIELD**

**\$39<sup>95</sup>**  
LIST

- ✓ Precise Impedance Match
- ✓ Higher Gain
- ✓ Lower Noise Factor
- ✓ Automatic 'on/off'
- ✓ Dual Speed Tuning

Check with your supplier today.  
Also ask about the Model '99'  
at \$19.95

... or write Dept. WL-4

**BLONDER-TONGUE LABORATORIES, INC.**  
Westfield, New Jersey

# Bandpass and Rejection Filters

By ALVIN G. SYDNOR

An easy way to design bridged-T circuits, using simple circuits and charts, rather than complicated formulas.

**M**UCH of the drudgery involved in designing and building bandpass and rejection filters for audio frequencies can be eliminated by using the simple circuits and charts presented in this article.

There was a time when the ham, experimenter, service technician, and design engineer avoided the bridged-T circuit because of its complexity. Now, however, the bridged-T is again coming into its own. One TV manufacturer's new color receiver uses the bridged-T filter to reduce cross-modulation. It is inserted between the tuner and the first video amplifier and is tuned to 41.25 mc.

The bridged-T is actually a resistor-capacitor filter network and, when used as shown in Fig. 1, it will cause the circuit to pass just a single frequency. In other words, even if there are many widely separated frequencies at the input terminals, only one of these frequencies would be passed providing the proper values are selected for the network.

Fig. 2 shows the same filter as in Fig. 1 except that it is in series with  $V_1$  and  $V_2$ . If we assume that there are many widely separated frequencies impressed on the grid of  $V_1$  and the values in the filter are correct, all frequencies impressed on the grid of  $V_1$  except the notch frequencies of the filter will appear at  $V_2$ . This type of filter circuit is customarily used as a scratch filter in phonograph amplifiers or as a heterodyne whistle filter in wide-band receivers. Usually for such a filter the notch or rejection frequency is 10,000 cps.

Fig. 1. Bandpass filter described in text.

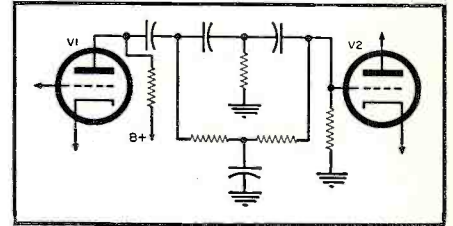
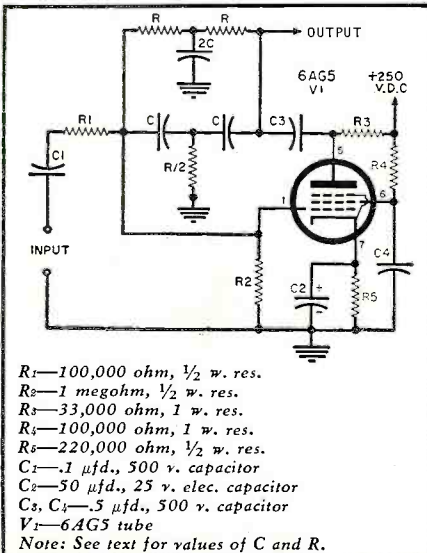

Fig. 2. The same filter as shown in Fig. 1 except that it is used for band rejection.

CPS	C- $\mu$ fd.	R-OHMS	2C- $\mu$ fd.	R/2-OHMS
60	.005	530K	.01	265K
120	.005	265K	.01	133K
400	.001	398K	.002	199K
1000	.0005	318K	.001	159K
5000	.00025	127K	.0005	63.5K
10,000	.0001	159K	.0002	75,500

Fig. 3. Common frequencies where filters are usually used. Refer to the article.

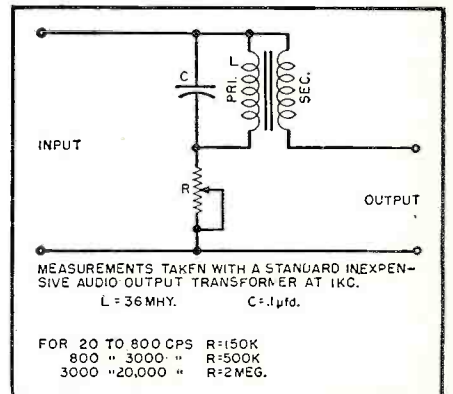

Fig. 4. A single frequency filter which provides up to 50 db attenuation at 1000 cps.

Fig. 3 is a chart of common frequencies where filters are usually used and can be used to design a filter. Assume that a 2000 cps filter is desired. The circuit of Fig. 1 would be suitable for this application. Since the 2000 cps frequency is not included on the chart of Fig. 3, we would select the next higher frequency, which is 5000 cps. The corresponding value of  $C$  is .00025  $\mu$ fd. From the basic formula:  $f = 1/(2\pi RC)$ , where  $C$  is the capacity in farads,  $f$  is the frequency in cycles-per-second, and  $R$  is the resistance in ohms, we can solve for  $R$ :

$$R = 1/(2\pi fC)$$

$$R = \frac{1}{(6.28)(2000)(.00025 \times 10^{-6})}$$

Thus,  $R = 318,000$  ohms (approx.),  $C = .00025$   $\mu$ fd.,  $R/2 = 159,000$  ohms, and  $2C = .0005$   $\mu$ fd.

The series-parallel resonant circuit

**ROUND, SQUARE, KEY and "D"**  
**OPENINGS QUICKLY MADE**  
 with Greenlee  
**Radio Chassis Punches**

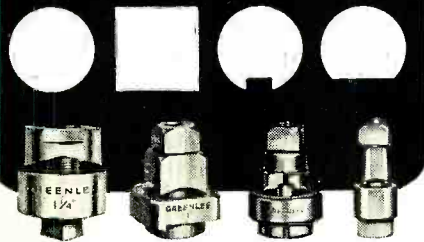

Save hours of hard, tedious work . . . cut accurate holes in chassis for sockets, plugs, controls, meters, panel lights, etc. with GREENLEE Punches. In 1-1/2 minutes or less make a smooth hole in metal, bakelite or hard rubber. Easy to operate . . . simply turn with ordinary wrench. Wide range of sizes. Write for details. Greenlee Tool Co., 1891 Columbia Avenue, Rockford, Ill.



**DON'T**  
**THROW**  
**OLD**  
**RADIOS**  
**AWAY!**

Here's the data you need to fix them FAST... and good as new!

Just look up the how-to-do-it data on that old radio you want to fix!  
 Four times out of 5, this giant, 3 3/4-pound, 744-page Ghirardi RADIO TROUBLESHOOTER'S HANDBOOK gives exactly the information you need to fix it in a jiffy. Tells what is likely to be causing the trouble . . . shows how to fix it. No useless testing. No wasted time. Handbook covers practically every radio receiver model made by 202 manufacturers between 1925 and 1942. Using it, even beginners can easily fix old sets which might otherwise be thrown away because service information is lacking. With a few simple repairs, most of these old sets can be made to operate perfectly for years to come.

**THE ONLY GUIDE OF ITS KIND!**  
 Cuts service time in half!

Included are common trouble symptoms and their remedies for over 4,800 models of old home, auto radios and record changers. Airline, Apex, Arvin, Atwater Kent, Belmont, Bosch, Brunswick, Clarion, Crosley, Emerson, Fada, G-E, Kolster, Majestic, Motorola, Philco, Pilot, RCA, Silver-tone, Sparton, Stromberg and dozens more. Gives how-to-do-it data on SPECIFIC jobs—NOT general theory. Includes hundreds of pages of invaluable tube and component data, service short cuts, etc.

-----TRY IT 10 DAYS . . . at our risk!-----  
 Dept. RN-116, RINEHART & CO., Inc.  
 232 Madison Ave., New York 17, N.Y.  
 Send Ghirardi's RADIO TROUBLESHOOTER'S HANDBOOK for 10-day free examination. If I decide to keep book, I will then remit the full price of only \$8.50 plus a few cents postage. Otherwise, I will return book postpaid and owe you nothing.  
 NAME \_\_\_\_\_  
 ADDRESS \_\_\_\_\_  
 CITY, ZONE, STATE \_\_\_\_\_  
 OUTSIDE U.S.A.—Price \$7.00 cash with order only.  
 Money back if book is returned in 10 days.

November, 1956

shown in Fig. 4 uses a standard audio output transformer. If we assume that the input frequency is equal to the resonant frequency of the tuned circuit, the signal appearing across the secondary winding will be 180 degrees out-of-phase with the input signal. Now, if we adjust *R*, the magnitude of the input and secondary voltages can be made equal, thus the output is zero.

A few audio frequency filters have been built that give up to 50 db attenuation for a single frequency using standard, easily obtainable audio output transformers.

Any change of input frequency away from resonance shifts the phase of the secondary voltage and a zero signal is no longer available.

These filters have some disadvantages arising from the limitations of the transformers. The filter frequency changes at high signal levels because of the core material. This effect can be eliminated by the use of powdered iron cores but at some sacrifice of input impedance and cost. The powdered iron core inductors, such as the *United Transformer Company* VIC series, will always work better than audio transformers, but for an economical filter the use of the audio type cannot be beat.

The inductance value of +85% —45% from mean value is obtainable in the VIC series by adjusting a set-screw in the side of the case. The *UTC* VIC series of variable inductors are obtainable in values from .0085 to 130 henrys.

Fig. 5 shows a 1000 cps narrow bandpass filter. The VIC-15 was used and measurements were taken with the values as shown in Fig. 5. The voltage gain was 30 times, output was measured at 10 volts r.m.s. The bandwidth was 10 cps at 1000 cycles. This type of transformer has a mean value of 5.4 henrys and a maximum current rating of 6 ma.

Fig. 5. Complete diagram covering a 1000 cps narrow bandpass filter. See article.

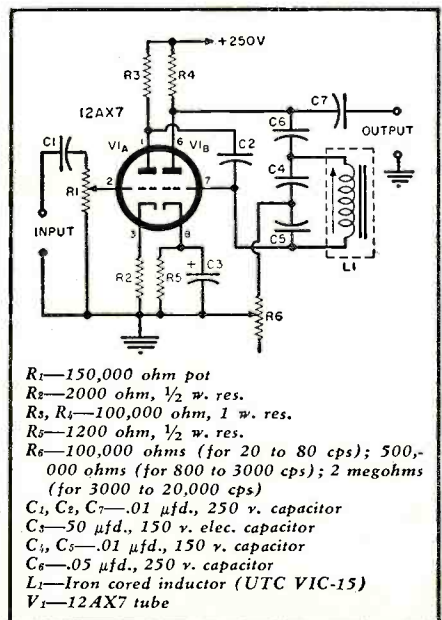

**YOUR**  
**BEST**  
**BUY**  
 in a UHF  
**Converter**



**B-T LABS Model '99'**

**OFFERS TOP**  
**PERFORMANCE**  
**AT LOW COST**

only **\$19.95** LIST

- Tuned Input—tracks with oscillator
- Precise Impedance Match
- One-Knob Tuning
- Drift-Free Performance

Check with your supplier today. Also ask about the Deluxe Ultraverter . . . or write Dept. XL-4

**BLONDER-TONGUE LABORATORIES, INC.**  
 Westfield, New Jersey.

the cartridge that scores **100%**

The Recoton-Goldring cartridge was acclaimed the best by a national independent research organization, because it passed all tests with flying colors!

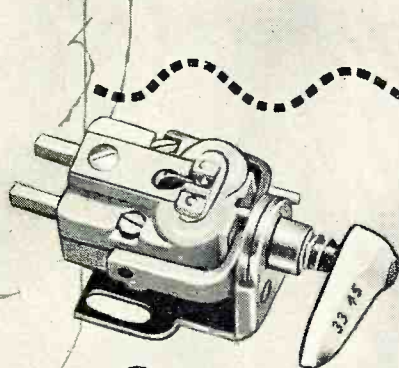

- Performance uniformly excellent.
- Cantilever - stylus - armature construction capable of rougher treatment than most moving-coil mechanisms.
- Will fit just about any American-made arm.
- Smooth and free of strain even on heavily recorded passages.
- Gives you more for your money. (Only \$9.90 including 2 synthetic sapphire styli).

Model 500 SD—Sapphire/Diamond  
Model 500 DD—Diamond/Diamond

**Recoton-Goldring**

**"500" MAGNETIC TURNOVER  
CARTRIDGE**

At leading hi-fi distributors,  
write for descriptive literature to

RECOTON CORPORATION, 52-35 Barnett Ave., Long Island City 4, N. Y.

Manufacturers of World-Famous Phonograph Styli.

...any arm can reach  
for good music

but...

A good arm delivers . . . and that's what audiophiles, audio-engineers, and music lovers are saying in words and by their purchases of Fairchild's excellent Model 280A plug-in transcription arm. The beauty of the finest recorded music stays in deep-freeze if the pickup arm is poorly designed. Check these points — they spell out the meaning of arm excellence, performance, of rugged construction:

- Fundamental resonance below audibility with any high quality cartridge.
- Perfect tracking on all records—arm offset and overhang carefully calibrated.
- No groove jumping, no skidding—arm laterally balanced.
- No delicate leveling required.
- Quick cartridge change. ("Less than 5 seconds dead interval"—Audio League.)
- Uses all standard cartridges including GE turnaround.
- No hum—remove cartridge slide, leave volume full on. Hum automatically cut out.

Net Prices: 280A (12") \$33.95  
281A (16") \$35.95

For further information on Fairchild professional arms or other High Fidelity components, write to:

**FAIRCHILD RECORDING EQUIPMENT CO. BTH** AVE. & 154 ST., WHITESTONE 57, N. Y.

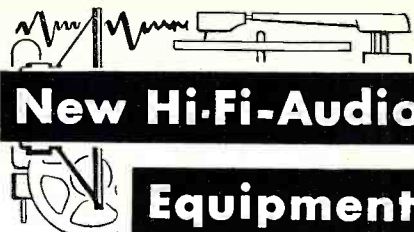

**New Hi-Fi-Audio**

**Equipment**

**NEW AUDAK TONE ARM**

Audak Company, 500 Fifth Avenue, New York 36, N. Y., is now offering a new and improved version of its high-fidelity tone arm in "assemble-it-yourself" form at reduced cost.

The "Audax" KT-12 is a 12" compass-pivoted tone arm on which the user can save almost \$10.00 by assembling it himself.

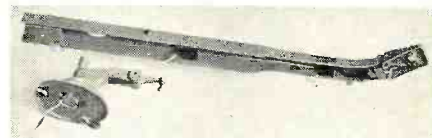

The only tool needed to perform this operation is a nail file or small screwdriver. The 16" version represents a saving of about \$13.00 over the factory assembled price. The KT-16 sells for \$17.55 net while the 12" version nets at \$14.55.

Full details on either the "kit" or assembled versions of the two tone arms are available from the manufacturer.

**FM-AM SYSTEMS FOR CARS**

American Elite, Inc., 7 Park Ave., New York, N. Y., is handling the U. S. distribution of the new Telefunken high-fidelity AM-FM receiver systems for automobiles.

Known as the "Blue Spot" line, the systems include extended-range high-fidelity speakers, built-in rear speaker plugs, full-range tone control, and separate power supply amplifier. The compact design of these receivers permits them to be installed in practically any car and transferred from car to car. The line is designed to be used with either 6- or 12-volt automotive systems.

The "Emperor Mark I" features the "Selecto-Magic" station finder and has

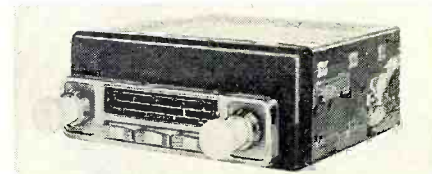

15 tuner circuits. The "Emperor Mark II," with push-button selector, has 11 tuned circuits.

Write the U. S. distributor for full details on either or both of these FM-AM tuners.

**E-V EQUIPMENT CONSOLE**

Electro-Voice, Inc., Buchanan, Mich., is making a special price on its new Model 890 equipment console for those purchasing the firm's PC2 preamp, A15 power amplifier, and 12TRXB

**RADIO & TELEVISION NEWS**

loudspeaker with "Aristocrat" enclosure.

The console enclosure measures 54" x 16" x 17 1/4" deep. The center storage compartment will accommodate any size line amplifier. The front panel of the compartment can be removed for conversion to record storage or for installation of an 8" speaker enclosure. The record changer drawer slides forward at a convenient operating height. The slotted bench, 6 feet by 2 feet, is

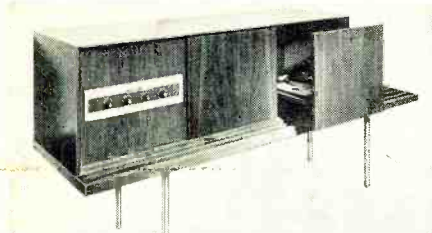

mounted on wooden legs with brass ferrules. The bench raises the equipment cabinet to a height of 17".

Write the company for details on the special price in effect on the console and information on the cost of the individual components comprising the "package."

#### WIDE-BAND AMPLIFIER

Altec Lansing Corp., 9356 Santa Monica Blvd., Beverly Hills, Calif., is marketing a new wide-band, low distortion general purpose amplifier which has been especially designed for public address and commercial sound system applications.

Total harmonic distortion of the 341A is less than .5% from 25 to 20,000 cps. Frequency response is  $\pm .5$



db from 5 to 50,000 cps. Load impedances are 8 ohms, 16 ohms, and 70 volt line. The amplifier is rated at 35 watts.

The unit is housed in a dark green hammertone finished cabinet adaptable to desk or rack mounting. Write Dept. RV-3 for full details on this instrument.

#### A.V.C. AMPLIFIER

Amplifier Corporation of America, 398 Broadway, New York 13, N. Y., has developed an automatic volume control amplifier which maintains constant output within  $\pm 1$  db with input changes of 30 db.

The Type B, Model 730, limiting amplifier consists of a two-stage push-pull circuit. The operating conditions of the input stage have been carefully determined so as to provide optimum limiter action with minimum distortion.

November, 1956

**Have fun-  
save  
money!**

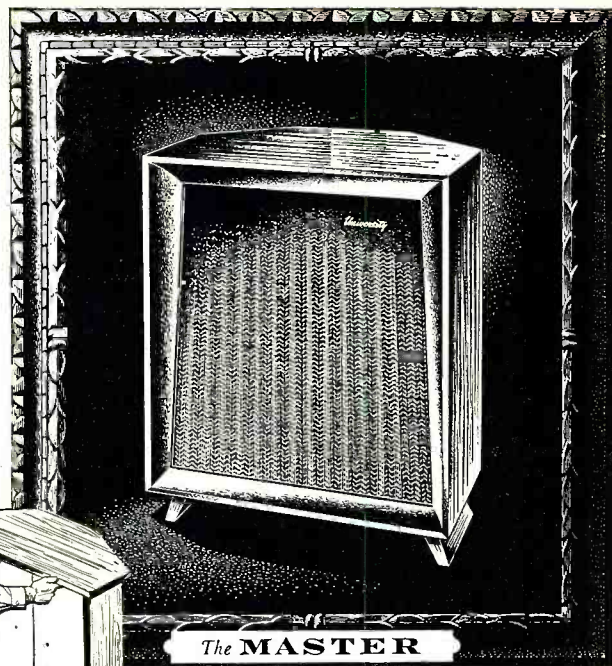

**The MASTER** is truly a masterpiece that can be seen and should be heard! The finest principles of acoustic engineering and the most tasteful elements of styling have been lavished on it. Each component of the MASTER is a gem which contributes to its overall magnificence. Just listen to the sonorous "big theatre" 13" woofer, the rich full-bodied middles produced by exclusive "reciprocating flare" horn with heavy duty compression driver and the crystal clear, natural highs emanating from the super-tweeter—all kept in perfect balance by the famous Acoustic Baton 3-way crossover network. A true cornerless-corner enclosure, it can be used flat against wall or in a corner. Unusually low price! Mahogany \$285.00, Blond \$290.00

## BUILD THIS MAGNIFICENT SPEAKER SYSTEM *It's so simple!*

**"DO-IT-YOURSELF" KWIKITS** — You can build your own version of the fabulous MASTER with a KwiKit, University's "do-it-yourself" enclosure kit. With this truly amazing kit, you don't end up with a "cheesebox"! You do end up with an enclosure as good as the finest factory-assembled enclosure, in construction and design.

The KEN-15 KwiKit is similar in every respect to the MASTER, except that the Kwikit employs a simplified front frame design. It's so easy to assemble . . . almost all you need is a screwdriver. 3/4" cabinet plywood used throughout. Finest 3/4" Birch hardwood used for all finishing surfaces. Kit contains: all pre-machined and pre-shaped wood sections; glue; hardware; plastic wood; sandpaper; easy-to-follow instructions. *If you like to build your own and save money then the KwiKit is made to order for you.* KEN-15 KwiKit \$49.75 net.

**THE EN-15 ENCLOSURE** is the exact enclosure used in the MASTER system; minus the speaker components. University makes this enclosure available for those who either have speakers or intend to build toward the MASTER in successive stages, via P-S-E. Mahogany \$125.00 net. Blond \$130.50 net. Unfinished \$102.00 net.

#### THE P-S-E STORY

P-S-E-Progressive Speaker Expansion plan (a concept first introduced by University) is the most revolutionary development in speaker history.

University speaker components, enclosures and networks have been so uniquely designed that it is possible to start an excellent basic system at low cost, and add to it later—while enjoying immediate listening satisfaction.

P-S-E makes it possible to build up to the MASTER (or any other fine system) in successive, inexpensive steps, using the KEN-15 KwiKit and EN-15.

*For the complete, fascinating story of P-S-E please send for FREE illustrated brochure.*



THE COMPONENTS THAT MAKE THE MASTER A MASTERPIECE



C15W



HF-206



4409



N-3

LISTEN

*University sounds better*



UNIVERSITY LOUDSPEAKERS, INC., 80 SOUTH KENSICO AVENUE, WHITE PLAINS, N. Y.

# AMERICA'S GREATEST TUNER BUY!

The Sensational

## Granco FM TUNER



Amazing Value... **\$39<sup>95</sup>** in walnut

Compare its performance with high priced tuners  
**PROVIDES ENDLESS HOURS OF STATIC-FREE  
AND DRIFT-FREE FM LISTENING PLEASURE**

The perfect addition to any HI-FI system,  
TV set, phonograph or tape recorder!

- Model T-160
- **Frequency Range:** 88-108 Mc.
  - **Selectivity:** 200 Kc at 3 db points.
  - **Audio Frequency Response:** 20 cps to 20,000 cps.
  - **Sensitivity:** 4 microvolts for 20 db quieting.
  - **Coaxial Tuner:** Exclusive Granco feature assures drift-free reception.
  - **Hum Level:** 70 db below 1 volt.
  - **Maximum Audio Output:** 2 volts.
  - **Antenna Input:** 300 ohms or built-in line cord antenna.
  - **Overall Dimensions:** 7" w. x 5" h. x 4 $\frac{3}{4}$ " d.

### ASK YOUR DEALER FOR A DEMONSTRATION

See and hear Granco's FM and FM-AM table radios  
and high fidelity radio-phonograph combinations

\*Price slightly higher  
in West and South

for name of your nearest dealer, write

## GRANCO PRODUCTS, INC.

36-07 20th Ave., Long Island City 5, N. Y.

World's only manufacturer specializing in FM

tion. The input may be connected directly either to a balanced 600 ohm line (with either or neither side grounded) or it may be bridged across a 600-ohm line without upsetting line impedance.

Used in conjunction with broadcast transmitters, telephone circuits, p.a.

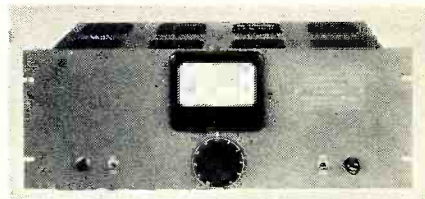

installations, wired music systems, etc., the amplifier can also provide automatic fading between two signals and for compression or expansion, or both, of any program material.

Write the manufacturer direct for full specifications on this unit.

### TWEETER WITH ACOUSTIC LENS

*Lafayette Radio*, 100 Sixth Ave., New York 13, N. Y., is now offering a new high-frequency tweeter which features a louvered acoustic lens for uniform dispersion. The unit will handle 25 watts of power.

The wide dispersion angle of the short horn, supplemented by the acoustic lens, defeats the directional quality of high-frequency notes. The highs are radiated throughout the entire listening area. The lens is detachable for panel mounting. A separate base for the tweeter is supplied in case external mounting is desired.

The aluminum voice coil has an impedance of 16 ohms. The over-all size of the tweeter is 4 $\frac{1}{4}$ " long, 3" diameter, and the lens extends 2 $\frac{1}{2}$ ". The

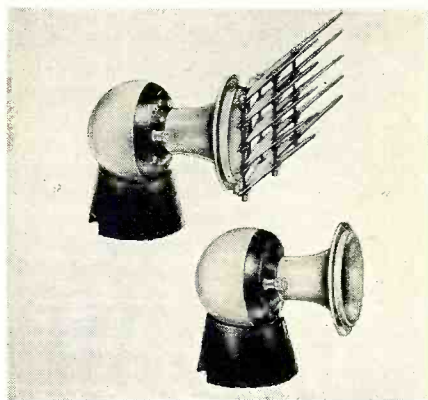

unit is catalogued as the HW-7 and additional information is available on request.

### NEW GOODMAN'S SPEAKERS

Two new speakers in the *Goodmans* line are now available from *Rockbar Corporation*, Mamaroneck, N. Y., U. S. distributor for these British-made components.

The "Midax" is a pressure type middle-range and high-frequency driver and exponential flared horn with frequency coverage up to 8000 cps. Its impedance is 15 ohms. The company recommends crossover frequencies of 750 and 5000 cps. The over-all length

**RADIO & TELEVISION NEWS**

for hi-fi  
and binaural  
listening...

### BRUSH CRYSTAL HEADPHONES

All models available with special cords for binaural listening. Brush Crystal Headphones are designed for exceptionally flat response through 10,000 cycles. Smooth air-tight fit for excellent bass response. Lightweight and comfortable. Sold by quality conscious dealers everywhere.

BRUSH ELECTRONICS  
DIVISION OF CLEVITE CORPORATION  
Cleveland 14, Ohio

BRUSH COMPANY



from the rear of the driver to the front of the horn is 20¼".

The "Trebax" is a tweeter with built-in horn. Its frequency response extends up to 15,000 cps. The recommended crossover is 5000 cycles. The impedance is 15 ohms and the over-all length from the rear of the driver to the front of the horn is 3¾".

Both units are designed to be used with the company's "Audiom" woofer to form a three-way speaker system. The "Trebax" may also be used with the firm's full-range "Axiom" speakers to form a two-way system.

#### STEPHENS ENCLOSURE KIT

Stephens Tru-Sonic, Inc. of Culver City, Calif. is now offering a "do-it-yourself" speaker enclosure in kit form.

The new kit features precision-cut, selected white birch plywood (¾" on three models and ½" on one model) acoustically engineered to fit together. Of the four models, three are designed to be set against a straight wall and one is a corner enclosure. Each kit contains the pre-cut pieces of wood, screws, glue, sound insulation material, deluxe woven Saran grille cloth in a neutral tone, and tacks. An illustrated booklet, containing step-by-

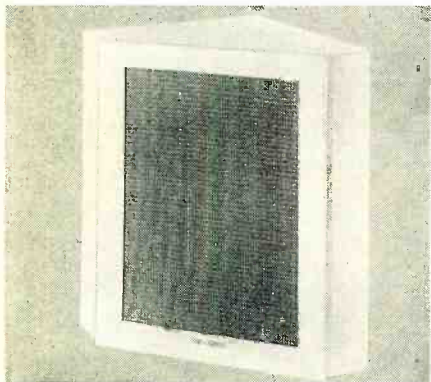

step instructions on how to assemble the cabinet, how to mount the speaker or speakers, and how to make all connections, comes with the kit.

#### NEW TONE ARM

Volpar, 4404 W. 22 St., Panama City, Fla., has developed a new tone arm which departs from conventional design in that it is lighter and longer than usual units.

The arm is currently available in three sizes: 16" over-all with a stylus-to-pivot length of 10"; 18" over-all with the distance between the stylus and pivot 12"; and a 21" unit with a stylus-to-pivot length of 14".

A data sheet giving complete specifications on this new line of tone arms is available on request. Such requests should be addressed to the attention of William E. Volk.

#### 25-WATT MOBILE AMPLIFIER

Newcomb Audio Products Co., 6824 Lexington Ave., Hollywood 38, Calif., is marketing a new 25-watt mobile amplifier which operates equally well from a 12-volt storage battery and a

# Miraculous!

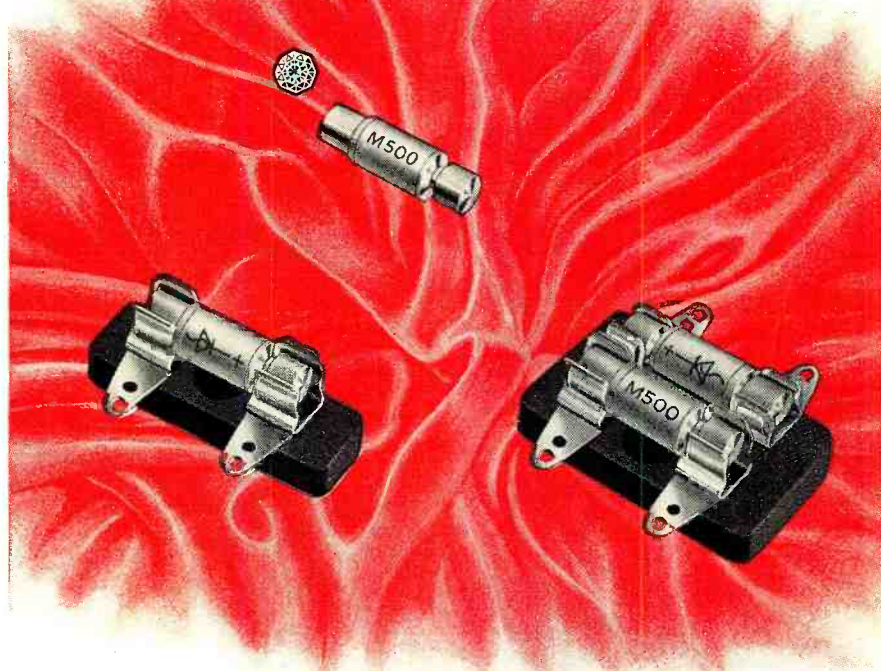

## SILICON RECTIFIERS

by

## SARKES TARZIAN

*For your future power supply in all radio, television, electronic devices and other rectifier replacements. Write for complete information.*



Patent Applied For

# Sarkes Tarzian, INC.

**RECTIFIER DIVISION**  
DEPT. N-2, 415 NORTH COLLEGE AVE., BLOOMINGTON, IND.  
In Canada: 700 Weston Rd., Toronto 9, Tel. Murray 7535  
Export: Ad Auriema, Inc., New York City

# ARKAY Kits . . . lead the field

new!

## ANOTHER ARKAY FIRST!!

### SPECIFICATIONS:

**ELECTRICAL RATING**—9-volt transistor energizer.

**OPERATING FREQUENCIES: TUNING RANGE**—540 to 1620 KC. I.F. AMPLIFIER—455 KC.

**POWER OUTPUT**—275 + milliwatts.

**SPEAKER**—large alnico V permanent magnet.

**TRANSISTOR COMPLEMENT:** X1 oscillator-converter; X2 1st I.F. amplifier; X3 2nd I.F. amplifier; D1 diode detector-AGC take-off; X4 class B driver; X5 class B output; X6 class B output.

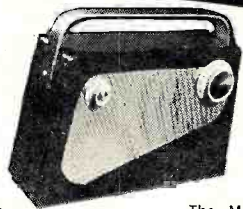

\$3750

Federal Excise Tax Included

## introducing

### ARKAY Model TR-6 TRANSISTORIZED PORTABLE SUPERHET RECEIVER

The Model TR-6 is a newly designed all transistor portable superheterodyne receiver with push-pull Class B output providing clear crisp output better than 275 milliwatts. Construction of the TR-6 is extremely simple because of the advanced engineering techniques employed in its design.

117-volt, 60-cycle a.c. power source. The new unit is designed for universal p.a. system operation in permanent installations or for battery-operated portable use.

Peak power is 40 watts with less than 3% harmonic distortion at 25 watts. Frequency response is 30 to 20,-



000 cps.  $\pm 2$  db. Hum level is 70 db below 25 watts. Inputs are provided for two microphone channels, phono, and tape. Controls include standby switch, power switch and treble-bass tone, phono, two microphones, phono motor control, and hum balance control.

### FOUR-SPEED CHANGER

The Theatre and Sound Products Department of *Radio Corporation of America*, Camden, N. J., has developed a four-speed high-fidelity automatic record changer which is designed for convenient plug-in use in home-assembled music systems.

Developed for use in combination with any arrangement of the company's electrically intermatched plug-in hi-fi electronic components, the new changer (SRC-62) provides hi-fi reproduction of all types and sizes of home phono discs.

The changer plays 7-, 10-, and 12-inch phonograph records, intermixes 10- and 12-inch discs of the same



speed, and provides automatic last-record stop for all speeds and sizes. Record-speed selection is controlled by a single rotatable selector switch.

Contact the manufacturer direct for full specifications on this new component.

### RADIO-INTERCOM UNIT

Fanon Electric Co., Inc., 98 Berrian St., Brooklyn, N. Y., is now marketing a packaged radio-intercom-door answering system which has been tradenamed "Musi-Talk."

From the master control, it is possible to converse with any of the remotes, answer the front door, or "baby sit" from any location in the house.

RADIO & TELEVISION NEWS



### ARKAY Model FL-10 Hi-Fi AMPLIFIER

A super lin. Williamson type 12-watt Hi-Fi amplifier with built-in pre-amp. Push-pull output with a frequency response of 40-15,000 cps. 4 controls including record equalization (LP, RIAA, EUR). Output impedances, 4, 8, & 16 ohms.

\$28.95



### ARKAY Model B-8 Hi-Fi Speaker System

Frequency Response: 10 to 20,000 cps. Crossover Frequency: 1600 cps. Power Rating: 25 watts. Impedance 16 ohms. Features a bass reflex, ducted port enclosure equipped with a low frequency speaker and a compression driven horn of special design. A variable balance control w/ network provides smooth continuous adjustment of the H/F speaker. . . . . \$35.95 fed. ex. tax incl.



### ARKAY Model FL-5 Hi-Fi Amp.

Full 5-watt amplification for true Hi-Fi performance in average rooms. Accepts tuner or phonograph of your choice and provides unusual tonal realism. Frequency response is 20-18,000 cps. at  $\pm 1.5$  db. Uses 4 miniature tubes for low hum and noise level.

Less Cover \$10.75  
Cover \$1.50  
Fed. Ex. Tax Incl.



### ARKAY Model HFT-7 Hi-Fi AM-FM Tuner

Excellent sensitivity and low noise characteristic. Automatic frequency control with provisions for AFC erase. Allows pinpoint, high selectivity tuning. Foster-Seeley discriminator, high efficiency AM loop stick antenna and temperature compensated oscillator circuit.

Less Cover \$32.00  
Model FM-6 (FM only) \$25.75  
Fed. Ex. Tax Incl.



## NEW!

### ARKAY Model FL-30 Hi-Fi AMP-PRE-AMP

**SPECIFICATIONS:**  
**POWER**—30 watts @ 1% IM.  
**FREQ. RESPONSE**  $\pm 1$  db.—10-40,000 cps.  
**HUM**—120 db. below rated output.  
**CONTROLS**—(6) Func. selector, loudness, bass, treble, level set, 5-position level compensation control.

Featuring a transistorized front end for use with a reluctance pick-up, this engineering masterpiece assures the finest in HI-FI reproduction. Record equalization for more than 30 labels (LP, RIAA, & EUR). Complete with rose gold panel and black cabinet.

\$49.95

Write today for full details on the remarkable units in the ARKAY line. You will receive our catalogue ABSOLUTELY FREE along with the name of your nearest dealer. Write today to Dept. RT-11.

PRICES 5% HIGHER WEST OF THE MISSISSIPPI

**ARKAY KITS, inc. · 120 Cedar Street · N. Y., N. Y.**



## wanted career men

Train for a career instead of a job. Demand for our graduates exceeds supply. Effective placement. Modest costs. Small classes. Well-equipped labs. Beautiful campus. Approved for Vets. Enter January, March, June, September.

### Bach. Sci. degree in 27 months

Complete Radio Eng. courses . . . TV, UHF, FM, Electronics. Also Mech., Civil, Elec., Chem., Aero. Eng. 36-month B.S. in Bus. Adm. (Gen. Bus., Acctg., Motor Transport Mgt.) . . . capable students faster. Prep courses. Write Jean McCarthy, Dir. Adm., for catalog and "Your Career in Engineering & Commerce."



## TRI-STATE COLLEGE

16116 College Avenue, Angola, Indiana



BARGAIN HUNTING?

## TV SERVICEMEN!

Write for SENSATIONAL CATALOG  
**HENSHAW RADIO SUPPLY**  
3619 TROOST KANSAS CITY, MO.

**CABINETS**  
**HI-FI—TELEVISION**  
CUSTOM-BUILT and STOCK

write for descriptive literature

**JACK CANTOR**

171A Washington St.—New York 7, N. Y.

## SCR-625 Famous ARMY MINE-DETECTOR

For Prospectors, Miners, Oil Companies, Plumbers, etc. Portable unit for locating all types of buried metal objects up to 24" or more depending on size and ground condition. Detection by means of a tone. Packed in a chest. Operating weight approx. 15 lbs. Shipping wt. approx. 40 lbs. Complete with batteries **\$39.95**

## CLASSIFIED ITEMS:

BC-212G Amplifier—2/6C5 tubes.....NEW: \$ 1.95  
 BC-216 Amplifier—6F7 & 39/44.....USED: 1.50  
 BC-229/429 Receiver—2500-7700 KC w/Coils. U: 6.95  
 BC-230 Transmitter—2500-7700 KC w/Coils. U: 8.95  
 BC-347 Amplifier—1/6F8G tube.....N: 1.95 U: 2.95  
 BC-357 Beacon Rec.—75 MC.....N: \$4.95; U: 2.95  
 BC-367 Amplifier—2/6V6 tubes.....N: \$4.95; U: 2.95  
 BC-375 Transmitter.....USED: 29.95  
 Tuning Units 1/BC-375; PU-5-6-7-8-9-10-26.....U: Ea. 3.95

Cables 1/BC-375/BC-191, PL-61, 64 or 59.....each end: Ea. 2.75  
 BC-442 Antenna Relay Box—w/Cond.....New: 2.95  
 BC-603 Receiver FM—20-28 MC.....Used: 29.95  
 BC-604 Trans. FM—30 Watt, 20-28 MC.....Used: 18.95  
 BC-500 Trans. & Rec.: 25 Watt, 20-28 MC.....New: 39.50  
 BC-654 Transceiver: 3800 to 5800 KC.....Used: 34.95  
 BC-709 Amplifier—Battery Operated.....New: 1.95  
 BC-745 Transceiver: 3 to 6 MC.....Used: 14.95  
 BC-924 Trans. FM—30 Watt, 27-38.9 MC.....New: 24.95  
 BC-966 IFF—160-211 MC, 13 tubes.....Used: 5.95  
 BC-1158 Trans.: 50 Watt, 53.3-95 MC.....New: 39.95  
 IB-60/APA-10 Panoramic Oscilloscope.....New: 39.95  
 CD-874 Cord—f/HS-30—Low Imp., w/PL-55 U: .59  
 CD-515 Cable for BC-669.....2.75  
 CD-605 Cord—F/HS-30—High Imp. w/PL-54......79  
 CD-307 Cord—w/PL-55 & JK-26......59  
 CD-318 Cord—1/PL-68, JK/48, & SW-141.....U: .89  
 GN-45 Handcrank Generator w/Legs & Seat..... 9.95  
 R-1/ARR-2 Receiver—234—258 MC. w/Tubes.....U: 4.95  
 R1/ARR-1 Receiver—Converts to 2 or 6 Meters..... 2.95  
 RT-7/APN-1 Altimeter—140 MC.....Used: 9.95  
 RT-34/APS-13 Transcevr. Comp. less tubes.....U: 3.95  
 R-74/CRW-2 Receiver—53-88 MC—6 Tubes.....N: 9.95  
 TG-34A Keyer: 115/230 V 50-60 cy. w/Tubes.....N: 16.95  
 TG-10 Keyer: Complete w/Tubes.....Tested U: 14.95  
 T-121 Transmitter—3.4 MC with Coder..... 7.95  
 Range Beam Filter, Navy Type: \$1.95; FL-8..... 1.49  
 RM-12 Radio-Telephone. Remote Control.....Used: 19.95  
 RM-13 Telephone, Remote Control.....N: \$24.95; U: 19.95  
 RM-21 Remote Control Box for BC-669..... 4.95  
 SCR-625 Mine Detector—Reconditioned..... 39.95

SCR-522 Transceiver: 100-156 MC.....Used: \$34.95	Rec. Chassis only.....w/Tubes: 19.95
	Less Tubes: 9.95
Trans. Chassis only.....w/Tubes: 22.50	Less Tubes: 9.95
Schematic & Conversion Information only..... 2.50	

BD-72 Portable 12 Line Switchboard.....Used: 39.95  
 Sound Powered Head & Chest Set—Checked..... 3.95  
 Sound Powered Head & Handset w/Mark II.....Used: 2.95  
 TS-9 Handset w/switch. No Plugs: New: 5.95  
 Used: 3.95  
 TS-13 Handset w/switch. PL-68 & PL-55.....Used: 5.95  
 HS-30 Headset—Hearing Aid Type.....L. N.: 1.50

### WRITE US YOUR REQUIREMENTS:

Whatever your needs in Generators, Blowers, Inverters, Motors, etc.—write us. Chances are we have it!

# FAIR RADIO SALES 132 SOUTH MAIN ST. LIMA, OHIO

## PRACTICE CODE TAPE:

**SETS:** INKED PAPER TAPES—For Code practice and training—For Radio Operators, Hams, Amateurs, Beginners, and Telegraphers. 15 lessons to a Set, on 16mm 400 ft. reels that can be reproduced on TG-34A and TG-10 Keyers. Price: SET of 15 Reels in wood **\$18.95** case

**REELS**—Lesson Reels available individually. Order specific number 1—15 desired. Price Each: \$2.00  
 3/4" BLANK PAPER TAPE: 30 Rolls \$3.00; 60 Rolls .....\$5.00

## TAPE PULLER MX-333

Used with code practice equipment to reel 3/4" paper tape as it is passed through the recorder. AC induction motor with friction drive for varying speed. Operates on 110 V 60 cycle. **\$12.95** Used: **\$9.95**  
 New

## BC-1158 TRANS. & MODULATOR:

Frequency coverage 53.3 to 95 MC. 50 Watt. RF Doubler, Amplifier and Modulator Sections, using 4/815 and 10/12SN7 Tubes. Can be converted to 2-6-10- or 20 Meters. Complete with Tubes, Meter, Blower, etc.....NEW: **\$39.95** Used: **\$29.95**

## RA-20 POWER SUPPLY

110 V 60 cycle output 230 VDC 90 MA @ 12.6 @ 2A. Size: 3/4" x 5/2" x 6/2". **\$9.95**  
 Used, Checked.....

## NOW—OPERATE BEACON RECEIVER FROM 12 VOLT

BC-1206CM BEACON RECEIVER: 200-400 KC, 5 Tubes, 135 KC IF, operates from 24 VDC—**\$9.95**  
 New.....  
 Used.....\$5.95  
 For 12 Volt operation, use this PM DYNAMOTOR—12 VDC input, output 24 VDC. Size: 2 1/2" x 4" **\$4.95**  
 7" Dyn.....Only  
 Combination: New BC-1206 & Dynamotor.....\$12.95

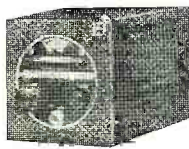

## DYNAMOTORS & GENERATORS:

INPUT VOLTS:	OUTPUT VOLTS:	STOCK NO.	PRICES USED:	NEW:
12 VDC	220	DM-34	\$2.95	\$4.95
	225	D-402	5.95	8.95
12	225	DM-35	9.95	
12	230	PE-133	4.95	6.95
12	540	DA-12		14.95
12	230	DM-14		8.95
14	220	DA-24	4.95	7.95
14	1030	260		
14	515	215	DM-42	4.95 9.95
14	375	150	BD-83	3.95
14 VDC	330	150	BD-87	3.95 5.95
14	250	50	DM-25	6.95 8.95
14	1000	350	BD-77	14.95 29.95
24	250	60	PE-86	8.95
28	1000	350	PE-73	8.95

12 to 24 VDC PM Dynamotor—Supplies 24 VDC 2 A. from 12 VDC, also 500 V 50 MA. @ 6 VDC will supply 12 VDC & 250 V 50 MA. **\$4.95**  
 #0515.....New:

## NATIONAL DIAL TYPE "N"

Precision 4" divided scale with decimal vernier drive 5:1 ratio. Planetary drive fits 1/4" shaft 100-0 scale. 3 for \$5.00 Each: **\$1.95**

## 110 V. POWER SUPPLY

For Army or Navy COMM. RECEIVERS:

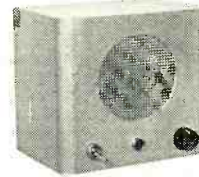

Just Plug In—And Turn On... That's All!

Completely assembled unit which eliminates conversion of set; for use with BC-453-454-455-946 or any other Sets requiring 24 V @ 1 Amp and 250 V @ 50 MA. Has 4-inch Speaker, volume control with On-Off switch and C W Switch. Complete with cord and plug to fit rear of receiver. Gray hamer-tone finish. Wt. 8 lbs. Brand NEW—Price.....Only: **\$18.95**

## TRANSFORMERS—115 V. 60 Cycle Pri. (and Chokes)

600 VCT/100 MA—6.3 V/5 A; 5 V/3 A.....\$4.95
240 VCT/35 MA—24 V/9 A; 6.3 V/6 A; 6.3 V/3 A.....1.75
1500 VCT/260 MA—6.5 V/3 A.—6.5 V/5 A.....9.95
5 V/4.5 A.....
700 VCT/150 MA—5 V/3 A.; 6.3 V/4.5 A. CSD.....3.95
2500 V/0.15 A.; 2.5 V/175 A.; 6.3 V/6 A.....5.95
1890 V/12.6 MA—Tapped 2.5 V 2 A.....5.95
1100 V/80 MA—7.5 VCT/3.25 A.....5.95
720 VCT/50 MA—6.3V/2.5 A—5V/2 A.....2.50
662 VCT/110 MA—6.3V/2 A—5V/2 A.....2.50
800 VCT/300 MA—12.6V/10 A—5V/3 A.....6.95
16 Volt CT—5 Amp. 115/230.....\$24.95; 24V—1 Amp 1.50
9 Volt CT—35 Amp.—Tapped 4.5 V.....7.95
12 Volt—Two separate windings—4 amp each.....5.95
5 V/2 A.; 5 V/2 A.; 5 V/2 A.; & 5 V/6 A.....2.95
6.3 V/2.1 A. and 5 V/3 A.....1.75
600-0-600 VAC—200 MA. 12.5 V. 2 A.; 12.5 V. @ 2 A.; 5 V. @ 3 A.—#H-108—Price.....8.95
250-0-250 VAC—100 MA. 24 V. 1 A.; and 6.3 V. 1 A.—#H-109—Price.....4.95

Choke—12.5 Hy/100 MA.....\$1.95  
 Choke—8 Hy/150 MA—200 Ohm—Open Frame.....1.25  
 Choke—5 Hy/150 MA—85 Ohm.....1.50  
 Choke—10 Hy/250 MA—2 1/2" x 2" x 3" Potted.....4.95  
 Choke—5 Hy/400 MA—4 1/2" x 4" x 5 1/2".....4.95  
 "A" Choke—1 Hy @ 1 A. 7 ohm. Size: 2 1/4" x 2 1/4".....Price: 1.95

**EE-8 FIELD TELEPHONE**—Ideal for private telephone system up to 15 miles, for two or more phones. Has internal ringer & handset. Requires 2 flashlight batteries. With carrying case & shoulder strap. Used, Checked.....**\$14.95**

## METERS:

### WESTON AC AMMETER:

(Pictured) In portable leather case, with Test Leads, 2 1/2", 0-15 AC and 0-3 AC Scale.....**\$5.95**



DC AMMETER HOYT: In portable metal case, with Test Leads, 4 1/2", Fan Mirrored Scale 0-15 ADC.....\$4.95  
 DB METER—10 to Plus 6, Westinghouse 3", NC-35 Imp. 600 ohms @ 1000 cycle.....4.95  
 0-1 MA Weston 505; 2 1/2" Rd.....3.95  
 0-3 RF AMMETER IS-128; 2 1/2" Rd.....NEW: 2.95  
 0-8 Amp RF w/Thermocouple IS-89; 2 1/2" Rd.....4.95  
 0-15 AC-DC—2 1/2" Rd.; IS-122.....4.95  
 0-500 MA DC—2 1/2" Rd.; IS-22.....4.95  
 0-150 V. 60 cycle; Simpson; 3 1/2" Rd.....3.95  
 0-250 MA DC—DeJury, 3" Sq.....3.95  
 OUTPUT—5 Ranges, 4000 ohm Imp.—Used.....4.95

Address Dept. RN • \$5.00 Order Minimum, & 25% Deposit on C.O.D.'s • Prices are F.O.B. Lima, Ohio

## YOUR TAPE RECORDER CAN MAKE MONEY FOR YOU

Make tape recordings of PARTIES • MEETINGS • SCHOOL CONCERTS & EVENTS • WEDDINGS and transfer to high-fidelity permanent records for very little cost. Then resell at your own price!

- Records Imprinted With Your Copy
- Large or Small Quantities
- Exceptionally Low Rates
- All Speeds and Sizes

## CREST RECORDS, INC. Dept. R-11

220 Broadway, Huntington Sta. 6, N. Y.

Please send me brochure and rates on transferring tape to records.

NAME.....

ADDRESS.....

CITY.....ZONE.....STATE.....

**MAIL TODAY FOR BROCHURE AND RATES**

## BE QUALITY WISE... BUY QUAL-KITS!



### HI-FI AMP. KIT

Complete 6 tube-10 watt amplifier. Push-pull beam power output, built-in pre-amp, 5 position selector switch, 3 position record equalization, LP, RIAA, Eur. Response 1/2 db. 20-20,000 cps. Output 10 watts at less than 2% IM. Low noise level and harmonic distortion. **\$28.50**  
 Add 10% Fed. Tax  
 Every kit complete with 28 page fully illustrated instruction and assembly manual. Cover and legs optional.



### HI-FI AM-FM TUNER KIT

Advanced 7 tube circuit plus Rectifier for full sensitivity and selectivity. Distortion less than 1%. Sensitivity is 5 uv for 30 db quieting on FM. 25 uv AM. Armstrong FM Circuit with limiter, Foster-Seeley Discriminator. 20-20,000 cps response. Full AFC control—no drift. Easy assembly. **\$28.95**  
 Add 10% Fed. Tax  
 Write for FREE catalog and name of nearest dealer carrying these remarkable units.

## QUALITY-ELECTRONICS

319 Church St. Dept. 111 New York 13, N. Y.

SERVICEMEN WHO PUT PRIDE IN THEIR WORK "ALWAYS SPECIFY STANCOR"

**CHICAGO STANDARD TRANSFORMER CORPORATION**

3505 Addison Street • Chicago 18, Illinois

# HARVEY's famous hi-fi consultants RECOMMEND



## ...the DYNAKIT MARK II 50-Watt Power Amplifier Kit

Because of the enormous demand for DYNAKITS (everybody who has heard one seems to want one), they have been in short supply this past summer. Now HARVEY has enough of them in stock to end the drought. Any random sample of the DYNAKIT will deliver a minimum of 50 watts with astonishingly low distortion — and that means not just harmonic and intermodulation distortion but phase shift, square-wave ripple, and low-frequency bounce and flutter as well. Construction time? Three or four hours—with no special skill. Listening quality? "The Greatest!" say the audiophiles. The price? Still only.....\$6975

**NOW BACK  
IN STOCK!**



## ...and the SHERWOOD S-2000 High-Fidelity FM-AM Tuner

Here's one of those rare top-quality tuners designed with just as much attention to audio quality as to RF circuit refinements. At 100% modulation, the specified intermodulation distortion is less than 1.5% and the harmonic distortion at 400 cps less than 1% — meaning very superior sound indeed. Specified FM sensitivity is also tops among commercially available tuners — 0.95  $\mu$ v for 20 db quieting, made possible by the special 6BS8 cascode input stage and balanced antenna input transformer. Add to that a very low-distortion wide-band AM section, and you have a tuner that's hard to beat at any price—and unbeatable at only.....\$13950

(Slightly higher with tooled leatherette covers.)  
S-3000: An FM-only tuner containing the FM section of the S-2000 plus new-type tuning eye and LOCAL-DISTANCE switch for suppression of cross-modulation images on strong signals.....\$99.50

**MAIL ORDERS SHIPPED  
SAME DAY AS RECEIVED**

Include with your payment a generous allowance for shipping charges — the excess will be promptly refunded.

**HARVEY RADIO CO., INC.** Estab. 1927

1123 Avenue of the Americas JU 2-1500  
(6th Ave. at 43rd St.) N.Y. 36, N.Y.

The intercom can be used to monitor one or more rooms from any one or more locations. In addition, each remote can originate a call to the master or to any other remote.

The radio portion of the system can be used simultaneously with the intercom. A neon pilot light indicates when

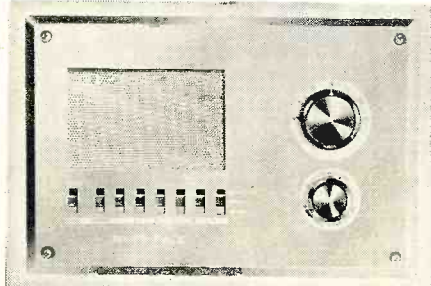

the system is in operation. The package consists of one master control (10 $\frac{3}{4}$ " x 7"), one weatherproof door speaker (5" x 5"), four indoor speakers (4 $\frac{1}{2}$ " x 6"), and 200 feet of wire. The units are housed in brushed copper cabinets to harmonize with any decor.

### EQUIPMENT CABINET

The *Cabinart Division* of *G & H Wood Products Co.*, 99 N. 11th St., Brooklyn, N. Y., is offering a combination equipment and speaker cabinet in a modern, low-boy design.

The model is available either unfinished in smooth sanded birch veneer ply or finished in a choice of blonde or cordovan mahogany on selected birch ply. When open, the drop front doors reveal a tuner-amplifier compartment which measures 16 $\frac{5}{8}$ " wide, 10 $\frac{3}{8}$ " high, and 14 $\frac{1}{2}$ " deep and a changer compartment 15 $\frac{1}{4}$ " wide, 14 $\frac{1}{2}$ " deep, and 6 $\frac{3}{8}$ " above the player base. Below the drop-

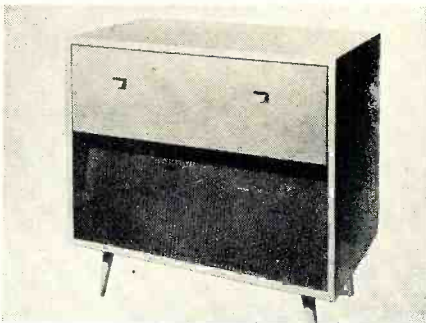

front door is a bass reflex speaker enclosure 13 $\frac{1}{4}$ " high, 34" wide, and 15 $\frac{1}{4}$ " deep with a baffle area of 4.1 square feet.

Over-all dimensions of the cabinet are 32 $\frac{1}{2}$ " high by 35 $\frac{1}{2}$ " wide by 16 $\frac{1}{4}$ " deep. Shipping weight is 68 pounds.

### "AMPLICALL" INTERCOM

*Rauland-Borg Corporation*, 3515 W. Addison St., Chicago 18, Ill., is currently introducing a new line of intercom systems under the tradename "Amplicall."

Featuring new styling throughout, the units are housed in compact cases of "Sharonart" steel finished in a unique simulated embossed leather effect. A complete selection of basic systems is available to provide any desired intercom service.

**INTRODUCING**

## AN ALL NEW ELECTROSTATIC TWEETER (MODEL 5-20)

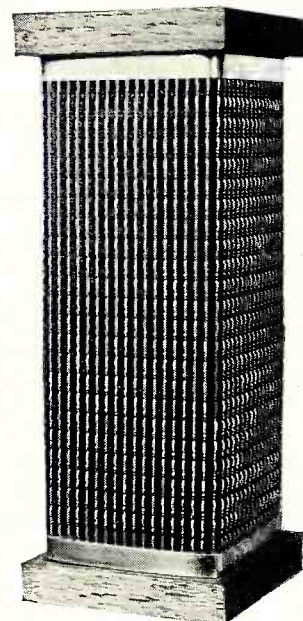

**REMARKABLE VALUE**

**AT ONLY \$29.<sup>50</sup>**

Combine this all New Electrostatic Tweeter with your present speaker system and realize the full capabilities of your Hi Fidelity System.

### FEATURES

- Plug in combination with your present speaker system
- Built in crossover network and matching transformer
- Smooth response from 5000 to beyond 20,000 cycles
- Excellent transient response
- Uniform distribution of sound
- 360 horizontal omni-directional sound.
- Dimensions: 4 $\frac{1}{2}$ " x 4 $\frac{1}{2}$ " x 12"
- Hand rubbed cabinet in mahogany or blonde
- Radiating assembly guaranteed for 2 yrs.

Manufactured in the U.S.A.  
Available at all leading Hi-Fi dealers. If your dealer can not supply, write  
DEPT. R.

*Pampa*

ELECTRONICS CORP.  
7354 FRANKFORD AVE.  
PHILA. 36, PA.

DEALER'S INQUIRIES  
INVITED. WRITE DEPT. R.

**RADIO & TELEVISION NEWS**

The new 4400 Series features a universal master with station signal lights and chime signal. Calls remain registered and identified during the absence



of the person signalled. Facilities are available for up to 30 buttons and lights.

For full details on the entire line, write the manufacturer direct.

#### SMALL TAPE RECORDER

Tandberg, 10 East 52nd Street, New York 22, N. Y., is now marketing a compact two-speed tape recorder and playback unit which is said to be able to record music at 1 7/8 ips with no audible wow or flutter.

The circuit incorporates an exceptionally heavy flywheel, a flutter and wow-proof belt drive, and a close-gap record-playback head. Low hum level is achieved by using Mumetal shielded heads and a unique retractable tape carriage which fully shields the tape when recording or playing back.

The Model 2 and the Model 2F (with foot attachment for remote control)



both record at 1 7/8 and 3 3/4 ips. Both incorporate a Goodmans heavy-duty 5" x 7" speaker, and use four tubes plus selenium rectifier. The instruments are housed in walnut cabinets which measure 15" long, 11 1/2" wide, and 6 5/8". A carrying case is available for easy portability.

Write the manufacturer for a data sheet containing full specifications.

#### FM-AM TUNER KIT

Lafayette Radio, 100 Sixth Avenue, New York 13, N. Y., recently released a new FM-AM tuner in kit form.

Known as the KT-100, the kit incorporates an Armstrong FM circuit with limiter and a Foster-Seely discriminator. The a.f.c. can be disabled to allow tuning weak stations. The front end consists of a grounded grid triode amplifier and separate mixer and oscillator. The circuit uses seven tubes and a selenium rectifier.

The AM superheterodyne section

November, 1956

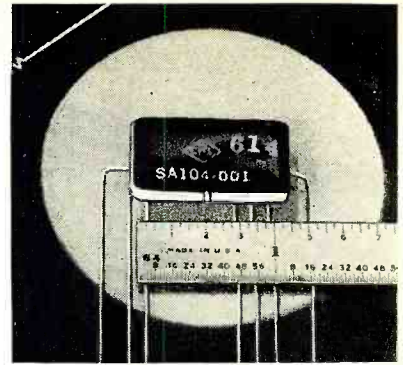

Model TA-11  
Measures only  
1/2" x 1" x 1/4"

# TALK ABOUT FUN!

It starts here, with this

## New Centralab Four-Stage Transistor Amplifier

- ◊ You can use it in building all sorts of pocket-size radios and recorders, test equipment, computers, other projects where an ultraminiature, low-power, high-gain, dependable audio amplifier is desired.
- ◊ The most advanced form of Packaged Electronic Circuit. Includes four special transistors, in addition to five capacitors, 12 resistors, and wiring.
- ◊ Gain, 75 db. Supply voltage, 1.3v. Signal to noise ratio, 38 db. nominal.
- ◊ Ask your Centralab distributor for Model TA-11. Send coupon for Bulletin EP-75 containing complete information, schematics, and curves.

# Centralab

A DIVISION OF GLOBE-UNION INC.  
910K East Keefe Avenue, Milwaukee 1, Wisconsin

Y-5624

Send me free Bulletin EP-75.

Name.....

Company.....

Address.....

City..... Zone..... State.....



\*Trademark

THE FINEST TELEVISION AND  
FM ACCESSORIES by

*Dynamic*  
ELECTRONICS

FOR BETTER RECEPTION Tested and specifications  
certified by New York Testing Laboratories, Inc.



Designed especially for Tape, Wire  
and Disc Recorders & Play Backs  
and Disc Recorders & Play Backs.  
HIGH FIDELITY, PHONOS, AMPLIFIERS,  
FM & AM TUNERS and TELEVISION RECEIVERS.  
Guaranteed elimination of noise picked up  
through the line caused by motors, ignition, neon,  
diathermy, lighting & heating equipment, trans-  
mitters and electrical appliances.  
• DUAL FILTER ACTION.  
• PASSES ALL FREQUENCIES ABOVE 10 KC.  
• AUTOMATIC ATTENUATION ABOVE 10 KC.  
Model DF200 Introductory Price \$6.95



Guaranteed complete suppression and elimina-  
tion of disturbances in antenna system caused  
by ignition, diathermy, X-ray, industrial RF,  
appliances, fluorescences above 40 mc.  
• Passes all frequencies above 40 mc.  
• Rejects all frequencies below 40 mc.  
Model T121 Introductory Price \$4.95

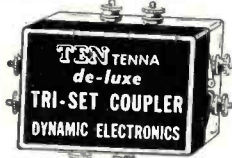

For highly efficient operation of any com-  
bination of 2 or 3 TV sets or FM Receivers  
from 1 Antenna of any type—absolutely  
no interaction.  
• Less than 6db insertion loss.  
• 40 to 50db rejection ratio.  
Model T130 Introductory Price \$5.45



Assures removal of overload in strong  
signal areas... will improve and  
Remedy faulty AGC circuits in TV & FM  
Receivers regardless of cause.  
• Eliminates ghosts and image tearing.  
• Reduces audio and video distortion.  
Model T115  
Introductory Price \$4.95

**FREE!**  
An 8-page  
booklet packed  
with every "Dy-  
namic" acces-  
sory. "How to  
recognize and  
remedy your TV  
and FM prob-  
lems".

Frequently  
poor reception  
occurs even  
though the  
receiver is  
in good  
condition and  
operating to  
the accepted  
standards of  
the manufacturer.  
In such cases,  
the problem can  
often be rectified and  
reception improved by using a  
properly designed external accessory.

There is a Dynamic accessory  
or service aid for practically  
every need. Satisfaction  
guaranteed or your money back!

Available at leading parts distributors

Manufactured By...

**DYNAMIC ELECTRONICS-NEW YORK, INC.**  
Forest Hills, Long Island, N. Y.

features a.v.c., a ferrite core antenna,  
and a high impedance terminal for  
external antenna. Tuning is flywheel  
counterweighted. The kit includes all

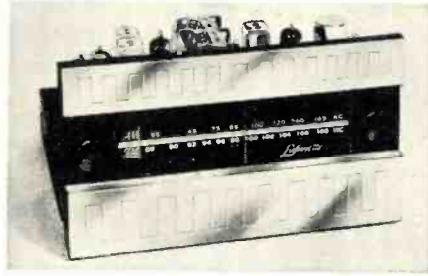

parts and easy-to-follow instructions.  
Write the company direct for full  
details on this tuner.

#### RECORDER WITH CONTROL

*Wilcox-Gay Corporation*, 743 N. La-  
Salle Street, Chicago, Ill. is now in  
production on the "Recordio Coronet,"  
a tape recorder that will automatically  
take off-the-air or microphone pick  
ups by means of a clock-radio control.

The unit has a built-in eight-tube  
superhet radio and *Telechron* clock  
with automatic time switching facili-  
ties. This model has seven speakers,

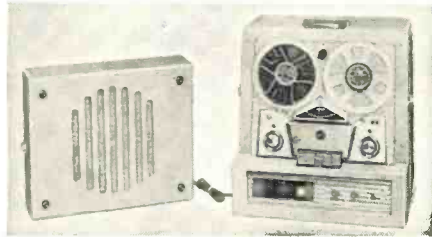

one of which is a 12" p.a. type on a  
removable baffle for hanging on the  
wall.

Other features include two record-  
ing speeds, an 8-watt wide-range pow-  
er amplifier, dual level indicators, and  
a tone control.

#### PORTABLE DISC RECORDER

*Presto Recording Corporation*, Para-  
mus, N. J., is now offering two new  
units in its line of audio components.

The first item is a portable disc re-  
corder, the K-11, which the company

claims will cut discs of broadcast  
quality. The unit comes in a compact  
carrying case and weighs 40 pounds.  
The mechanism can be mounted in an  
existing home hi-fi system if desired.  
Complete instructions for such an in-  
stallation are included with the unit.

The second unit is the PB-17A re-  
producer with subsonic tone reversal.  
The instrument will play 16 hours  
without repeating the program ma-  
terial by use of a tandem operation.  
With Mylar-based tape, the playing  
time with this form of operation can  
be increased to 24 hours.

Write the company for full details  
on either or both of these units.

#### TRANSISTORIZED AMPLIFIER

*Lafayette Radio*, 100 Sixth Avenue,  
New York 13, N. Y., is now offering a  
5-transistor audio amplifier kit which  
has been especially designed for the  
experimenter or student of electronics.

Utilizing the new *General Electric*  
2N189 and 2N186A transistors, the cir-  
cuit provides a 3/4 watt output and a  
response of 30 to 10,000 cps. The cir-  
cuit is class B push-pull output and  
employs inverse feedback for reduction  
of linear and non-linear distortion.

There are three inputs, crystal, mag-  
netic, and tuner; separate bass and  
treble controls, and transformer-cou-  
pled driver and output stages. The kit  
comes complete with all parts, pre-  
punched chassis, knobs, transistors,  
etc. plus detailed, simple diagrams and  
assembly instructions.

#### AUDIO CATALOGUES

##### SHURE CATALOGUE

*Shure Brothers, Inc.*, 222 Hartrey  
Ave., Evanston, Ill., has announced  
the immediate availability of its "Gen-  
eral Catalogue 56" covering micro-  
phones, microphone cartridges, mike  
accessories, phono pickup cartridges,  
and magnetic recording heads.

Technical data and general informa-  
tion have been prepared with the end  
user in mind. Questions have been  
anticipated so that persons buying the  
products described will find the kind  
of information they need to evaluate  
the usefulness of a given model.

The company's authorized distrib-

## Our Cover

Pat Gregory, popular West Coast entertainer,  
uses the hi-fi system in her home to try out her  
new program material. She depends on her  
Concertone tape recorder to give her a true  
picture of her voice when the tape is played  
through the Stephens speaker system. For re-  
laxation, she enjoys listening to other artists'  
presentations, using her Fisher tuner which  
feeds into the same speaker system. Pat thus  
uses her hi-fi system both professionally and  
personally as so many people in the entertain-  
ment world are doing.



utors will supply copies on request or readers may write direct to the firm.

#### TRANSISTOR DATA FOR AUDIO

The Semiconductor Products Department of *General Electric Company*, Electronics Park, Syracuse, N. Y., has prepared a new package of brochures for the designer of transistorized radios, phonographs, and other audio amplifiers.

The package contains complete specification information on the company's standard, high-performance entertainment transistors and application notes on transistor audio amplifiers.

The information is designed to assist engineers in selecting the proper transistors, either *n-p-n* or *p-n-p*, for any degree of performance desired in a four-, five-, or six-transistor radio.

Performance curves showing typical power gain of the transistors for class A and class B amplifiers using six-, nine-, and twelve-volt power supplies are included.

When writing for this package of brochures, specify publication number GP-71.

#### PHONO-RECORDER CHART

*Walsco Electronics Corporation*, 3225 Exposition Place, Los Angeles 18, Calif., is offering a new wall chart which lists its complete line of phono-recorder replacements.

Designed especially for service technicians, the chart is designed to speed repairing of almost all domestic and imported record players and recorders since it indicates at a glance the exact drive wheel, belt, spring, or tire required.

The chart measures 30" x 22" and is sturdy enough for wall mounting. It is obtainable either from the company's distributors or from the manufacturer direct.

#### LAFAYETTE AUDIO GEAR

*Lafayette Radio*, 100 Sixth Avenue, New York, N. Y., has issued a four-page brochure describing and picturing its line of audio gear.

Included are FM-AM tuners, speakers, crossover networks, bass reflex enclosures, complete speaker systems, and FM-AM receivers and receiver chassis models for custom installations.

Copies of this brochure are available without charge from the company.

#### JENSEN SPEAKER CATALOGUE

*Jensen Manufacturing Company*, 6601 South Laramie Ave., Chicago 38, Ill., has just released a new catalogue, No. 1070, covering its line of "Professional Series" loudspeakers for commercial, industrial, institutional, and p.a. applications.

The catalogue contains 24-pages of definitive information on all the equipment in the line including the "Hypex" projectors, rectangular horns, transformers, as well as the "Speech Master," high-fidelity, "Weather Master," and "Viking" lines.

Write the manufacturer direct for a copy of this catalogue. Please specify No. 1070.

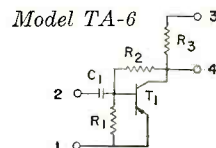
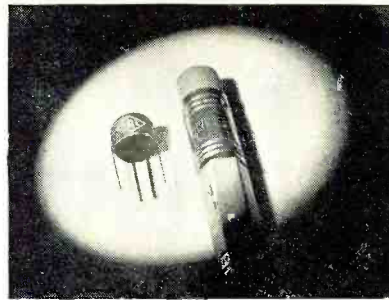

# A PRIZE TROPHY

for miniaturized audio amplification

*No closed season... no limit... to its applications*

## New Centralab Single-Stage Transistor Amplifier

- ◆ High-gain, low-power transistor amplifier can be used by itself in microphones and other miniature circuit designs. Or, you can combine several units, to get a multiple-stage unit for other audio applications.
- ◆ This is a complete amplifier housing capacitance, resistance, transistor, and wiring. Gain, 24 db. Noise level, less than 1/2 millivolts. Supply voltage, 1.35 v.
- ◆ As small as an eraser on an ordinary lead pencil.
- ◆ Ask your Centralab distributor for Model TA-6— or TA-7. Send coupon for Bulletin EP-75 containing complete information, schematics, and curves.

# Centralab

A DIVISION OF GLOBE-UNION INC.

910K East Keefe Avenue, Milwaukee 1, Wisconsin

Y-5625

Send me free Bulletin EP-75.

Name.....

Company.....

Address.....

City..... Zone..... State.....



NEW \$70.00

**SHURE SLENDYNE**

**OMNIDIRECTIONAL  
DYNAMIC  
PROBE  
MICROPHONE**

IS **5**  
**Microphones**  
IN **1**

Model  
"535"  
List  
Price  
**\$70<sup>00</sup>**



*For Public Address  
Remote Broadcast  
Theater-Stage  
Sound Systems*

A completely versatile probe microphone of excellent frequency range (60-13,500) that combines ruggedness, beauty and reliability.

**Versatility:** Can be used (1) on a floor stand; (2) on a desk stand; (3) quickly removed for use as a hand-held microphone; (4) furnished with lavalier cord for wearing around the neck; (5) impedance switch permits use as high or low impedance microphone. Accessory on-off switch requires no wiring.

**Ruggedness:** Built to withstand hard usage and extremes of temperature and humidity.

**Beauty:** Slender, convenient shape, finished in brushed satin chrome.

**Reliability:** High efficiency magnetic materials and circuits assure years of consistent high quality performance. Shure quality control techniques result in an exceptionally high degree of uniformity for microphone interchangeability and multiple use.

**SLENDYNE Model "530"**

This deluxe version of the Slendyne has a frequency range of 50-15,000 cps and is furnished with a Cannon XL-3-11 broadcast connector. Strikingly attractive non-reflecting black and gold anodized finish. LIST PRICE \$110.00

*The Mark of Quality*

**SHURE SHURE BROTHERS, INC.**

210 HARTREY AVENUE • EVANSTON, ILLINOIS

**Fairchild Amplifier**  
(Continued from page 74)

to provide equal signals to the following grids. The cross-coupled phase inverter was rejected because its high-frequency response does not nearly match its low-frequency performance, and it is extremely complicated, non self-balancing, and liable to age out of adjustment. The split-load phase inverter is subject to none of these liabilities, and it provides the smallest amount of phase shift at both ends of the frequency spectrum. It has inherently low distortion due, in large part, to the local (current) feedback that occurs across the large cathode resistor which is an integral part of this circuit.

With the exception of the negative current feedback connection in the first stage, the voltage amplifiers are quite conventional. The circuit constants were selected to give more than adequate gain without sacrificing the very wide bandpass essential for good transient response.

The power transformer is equipped with three taps: 117 volts, 100-105 volts, and 125 volts, eliminating the necessity for a voltage regulator in high or low voltage areas. Thus the rated output of the amplifier is not altered by substantial variations in line voltage.

Another feature which will interest many audiophiles is the provision for variable damping. By means of an exclusive damping control, the stability of the amplifier does not change when the damping factor is changed. Similarly the frequency response distortion and gain remain unchanged. The damping factor is continuously adjustable from .1 to 10. This gives a source resistance at the output terminals which is adjustable from .4 ohm to 160

ohms and on the 16 ohm tap alone from 1.6 to 160 ohms.

**Specifications**

Frequency response (+0 -5 db) is 20 to 20,000 cps at any level to 70 watts. The unit's sensitivity is less than .7 volt r.m.s. required for the rated output as against a 1 volt minimum output delivered by most signal sources.

Figs. 4 and 5 show the response of the amplifier. Fig. 5 is especially interesting in that it shows the very low frequency performance. According to Fig. 7, a power output of about 65 watts is available at under 0.5% IM distortion, while about 75 watts is available at 1.5% IM distortion. Square wave performance of the amplifier is shown in Fig. 8.

The input impedance is 250,000 ohms which matches all modern signal sources whether or not cathode follower output is employed. Output impedances of 4, 8, and 16 ohms are provided.

Hum and noise are better than 90 db below rated output (less than 1 mv. on the 16-ohm tap). Six controls are provided for this amplifier: "on-off," gain, dynamic balance adjust, static plate-current balance adjust, damping factor adjust, and bias adjustment of the output stage plus test jack. There are six tubes: a 6AB4, a 12AV7, two 6550's and two 5V4G's. The unit draws 290 watts and will operate over a voltage range of 105-125 volts at either 50 or 60 cycles.

The entire amplifier is housed in a beige and gold cabinet which has been styled by *Raymond Loewy Associates* to match the *Fairchild* preamplifier-equalizer and other of the company's power amplifiers. It is quite heavy, weighing 32 lbs. Over-all dimensions are 8 3/4" x 13" x 7" high. The audiophile net price is \$213.00. -30-

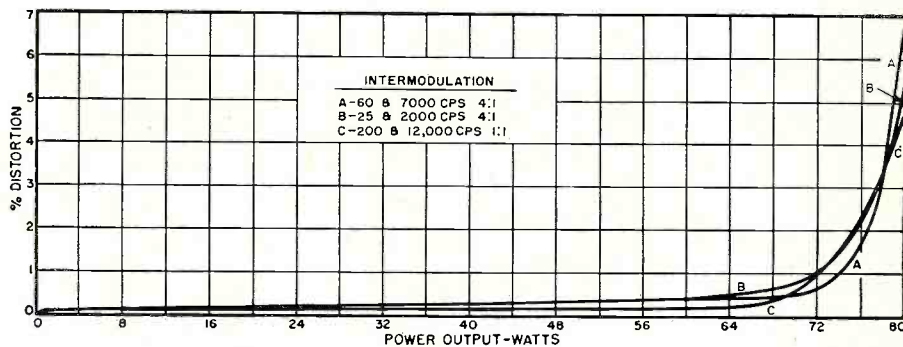
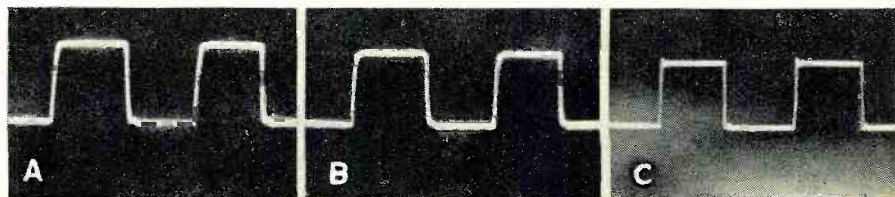

Fig. 7. IM distortion of amplifier at three different input signal mixtures.

Fig. 8. Response of amplifier with 6 kc. square wave input. (A) was taken at 70 watts output, while (B) was at a 40-watt output level. Variable damping has been used in both cases to eliminate a bare trace of ringing visible in (C), which was also taken at 40 watts output with variable damping at minimum.





## Loudspeaker Loading

(Continued from page 63)

the newest of these approaches. Full credit must be given to Mr. Jordan for the development of the technique and items to be described.

What was done was to establish the criteria for an ideal enclosure and then, starting from the concept of the vented box, proceed to modify it so as to approach the ideal. The design criteria are as follows: (1) frequency response extended down to at least 20 cps; (2) complete absence of resonances above this frequency; (3) small size; (4) low distortion; and (5) efficiency as high as possible in keeping with these desiderata. In practice, the problem evolved down to a technique for inserting the various constants into the enclosure such that the resulting performance is as required. If it were possible to add equivalent mass (acoustic inductance) to the speaker cone, then it would be possible to reduce the volume required for the enclosure. This can be done by loading the cone by means of a restricted orifice or vent. Also, if it were possible to add losses or leakage (acoustic resistance), then resonances would be damped out. This can be done by inserting a controlled amount of leakage in the form of a number of very narrow slits in one of the enclosure walls or by covering a relatively large aper-

ture with a material of suitable porosity. The above requirements are combined and met in the Acoustical Resistance Unit.

This unit consists of a framed panel covered with a metal grille and flanged to fit an oversized port of a reflex enclosure. The unit is made up of a restricted orifice along with a larger area filled with thick felt-like damping material. It is then only necessary for the user to build an enclosure to the recommended volume, cut two holes—one for the loudspeaker (or speakers) and one for the ARU—screw these units into place, and end up with an enclosure that comes close to meeting the ideals originally outlined earlier in this article.

Reference to the curves will indicate how an enclosure of this type compares to a standard (and larger) bass-reflex and to an infinite baffle. The table of volumes shown previously will indicate that these enclosures are of extremely moderate size, especially considering the low cone resonance of the speakers employed.

It should be remembered that these ARU's were designed around constants determined from particular speakers manufactured by *Goodmans Industries Ltd.* There is no reason why they cannot be modified (or used as is) for other speakers of equal or similar characteristics. If speakers with higher resonant frequencies are employed, however, the bass extension will be reduced.

-30-

# HICKOK

## Model 605A



DYNAMIC MUTUAL  
CONDUCTANCE

# Tube Tester

Handy Size Portable

- Popular—Accurate—Dependable.
- Large 5" easy-to-read meter.
- Accurately tests tubes in micromhos.
- Built-in 20,000 ohms per volt DC multimeter measures capacitance, inductance, volts, current and decibels.
- Write for technical details...

THE HICKOK ELECTRICAL INSTRUMENT CO.

10524 Dupont Avenue • Cleveland 8, Ohio

Just Out

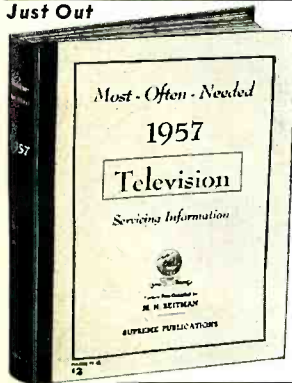

# New SUPREME 1957 TV Manual

## AMAZING BARGAIN

The new 1957 TV manual is the scoop of the year. Covers all important sets of every make in one giant volume. Your price for this mammoth manual is only \$3. This super-value defies all competition. Other annual volumes at only \$3 each. Factory service material simplifies repairs. Includes all data needed for quicker TV servicing. Practically tells you how to find each fault and make the repair. More pages, more diagrams, more service data per dollar of cost.

## TELEVISION SERVICING COURSE

Let this new course help you in TV servicing. Amazing bargain, complete, only \$3, full price for all lessons. Giant in size, mammoth in scope, topics just like a \$200.00 correspondence course. Lessons on picture faults, circuits, adjustments, short-cuts, UHF, alignment facts, hints, antenna problems, trouble-shooting, test equipment, picture analysis. Special, only **\$3**



## Companion RADIO COURSE, Introduction to TV

Here is your complete radio training in 21 easy-to-follow lessons. Covers fundamentals, fault finding, use of test equipment. Everything in radio. Introduction to TV. Self-test questions. New edition. Special, only **\$2.50**

Newest

## RADIO DIAGRAMS

Here is your complete source of all needed RADIO diagrams and service data. Covers everything from the most recent 1956 radios to pre-war old-timers; home radios, auto sets, combinations, changers, FM, and portables. Sensational values. Only \$2 for most volumes. Every manual has extra large schematics, all needed alignment facts, parts lists, voltage values, trimmers, dial stringing, and helpful hints. Volumes are large in size, 8 1/2 x 11 inches, about 130 pages. See coupon at right for a complete list of these radio manuals. →



## COVERS ALL POPULAR SETS

Here is your service data for faster, easier TV repairs. Lowest priced. Best by comparison. *Supreme TV* manuals have all needed service material on every popular TV set. Helpful, practical, factory-prepared, data that will really make TV servicing and adjustment easy for you. Benefit and save with these amazing values in service manuals. Only \$3 per large volume. The choice of wise servicemen.

## SIMPLIFIES TV REPAIRS

These giant TV manuals have complete circuits, needed alignment facts, curves, service hints, all factory production changes, voltage charts, waveforms, and double-page schematics. Here are your authentic service instructions to help you do expert work quicker; and priced at only \$3 per large yearly manual. Repair **any TV model** ever made by having in your shop all 11 volumes as listed in coupon. Your special price for all, only \$30. Or try the new 1957 TV manual to see what an amazing bargain you get for \$3. Send no-risk trial coupon today.

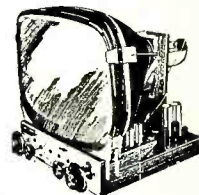

The repair of any television set is really simple with *Supreme TV* service manuals. Every set is covered in a practical manner that will simplify trouble-shooting and repair. This is the help you need to find toughest faults in a jiffy. Each \$3 TV volume covers a whole year of service material. New *Television Servicing Course* will aid you in learning TV. Be wise, buy *Supreme Manuals* only once each year instead of spending dollars every week.

## NO-RISK TRIAL ORDER COUPON

SUPREME PUBLICATIONS, 1760 Balsam Rd., Highland Park, ILL.

### Radio Servicing Manuals

- Most-Often-Needed Series
- 1956 Radio Manual, \$2.50
  - 1955 Radio Manual, only \$2
  - 1954
  - 1953
  - 1952
  - 1951
  - 1950
  - 1949
  - 1948
  - 1947
  - 1946
  - 1942
  - 1941
  - 1940
  - 1939
  - 1926-1938 Manual, \$2.50
  - Radio and TV Master Index, 25c
- These annual RADIO volumes specially priced at only **\$2.50** each.
- THIS GROUP ONLY \$2 EACH**

Rush today TV manuals checked  below and Radio manuals at left. Satisfaction guaranteed.

- New 1957 Television Servicing Manual, only **\$.33**
- 1956 Television Manual, **\$3.**  Early 1955 TV, **\$3.**
- Additional 1955 TV, **\$3.**  1954 TV Manual, **\$3.**
- 1953 Television Manual, **\$3.**  1952 TV, **\$3.**
- 1951 Television Manual, **\$3.**  1950 TV, **\$3.**
- 1949 TV Manual, **\$3.**  1948 TV Manual, **\$3.**
- New Television Servicing Course, complete... **\$3.**
- Companion Radio Course (all 21 lessons) **\$.250**

- I am enclosing \$..... Send postpaid.
- Send C.O.D. I am enclosing \$..... deposit.

Name: .....  
Address: .....

# Supreme Publications

November, 1956

161

help yourself  
to the  
handiest  
plier  
ever  
designed



CHAN NEL LOCK

No. 420

GRIPS LIKE  
A PIPE  
WRENCH

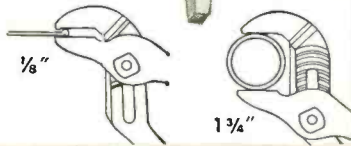

No other plier does so many jobs so well as a CHANNELLOCK No. 420. Grips anything from a small cotter pin to a 1 1/4" hex nut. And what a grip! Just like a pipe wrench. What's more, CHANNELLOCKS are streamlined... easy to use in hard-to-get-at places. Ask your hardware man for a CHANNELLOCK plier. You'll soon agree with thousands of other craftsmen... CHANNELLOCK is the handiest plier of them all.

BE SURE IT'S A GENUINE CHANNELLOCK



CHAMPION DEPARTMENT TOOL CO. MEADVILLE, PA.

Tube Types for Audio  
(Continued from page 66)

ratings. When plate-supply voltage is high, the tube characteristics have less effect on maximum power output and tube dissipation ratings are usually the limiting factors. Power sensitivity is usually better with higher- $\mu$  tubes. If both high power sensitivity and high power output are essential, the tube must have high  $g_m$ , which, in turn, means that it must have a large-area cathode and high heater power.

**Power Pentodes and Beam-Power Tubes:** Quite a few new pentode and beam-power tube designs have been brought out specifically for audio applications and should be useful to builders of audio equipment. It is generally advisable to ignore the multitude of types developed for television deflection circuits. These tubes are designed primarily to provide high peak currents at low plate voltage, and they develop considerable distortion when used in audio circuits. Another disadvantage of these types is the low screen voltages at which they are designed to operate. These voltages must generally be obtained from the plate supply through large series resistances or voltage-dividers making it difficult to obtain good screen-supply regulation.

Most beam-power tubes designed for audio use have comparable knee voltages and differ principally in power-output capabilities in accordance with their ratings. It is convenient to select a type which can be operated with screen-grid voltage approximately equal to the available plate-supply voltage. If the plate-supply voltage is relatively low, a suitable tube usually has low triode  $\mu$ . The 6W6GT is one example. Power sensitivity is primarily a function of  $g_m$ . Some of the new types, such as the 6BK5, have exceptionally high power sensitivity, which is desirable for some receiver applications, but also produce relatively high distortion. The best all-around choice is usually a beam-power tube designed for audio use, such as the 6L6, 5881, 6V6GT, 6AQ5, and 6CM6.

REFERENCE

1. "RCA Receiving Tube Manual," RC-17.

PORTABLE U.H.F. GROUND PLANE

By EDMUND H. MARRINER

**RC** model builders and hams can have an efficient ground plane antenna by using a UG-SO-239 coax fitting. For 144 mc. four 19-inch pieces of heavy wire or brazing rod can be soldered on the plug base for radials. The vertical part of the antenna is a piece of 19-inch copper wire or rod soldered in the pin.

The antenna will now fit a PL-259 plug on the end of the coax line. The antenna is set up on location by taping the coax to any stick. A more portable unit may be made by soldering banana plugs on the radials and the sockets soldered on the UG-SO-239.

**RAD-TEL**  
for HIGHEST QUALITY  
TUBES

Pkg. of 100 \$11.89 Your Choice 29c ea.

1A4	1F7	6A4	7E7	30	71A
1A4P	1G4	6AC5	12A5	31	76
1A6	1G5	6B4	12C8	32	79
1B4	1G6	6C8	12F5	33	81
1B4P	1H4	6F8	125F7	34	82
1B5	1I6	6L5	12Z3	35	85
1B7	1P5	6P5	14A4	36	89
1C6	1N6	65T7	14A5	37	96
1C7	2A7	65V7	14E7	38	117Z4
1D5	2B7	6Y7	14H7	39	615
1D7	2C26	6U7	14I7	45/VT25	954
1E5	2E5	6Z45	14N7	46A	1626
1E7	3A8	7A5	14X7	49	1629
1F4	3B7	7AD7	25A	50	719A
1F5	3C6	7AM7	25Y5	55	9006
1F6	5X4	7E6	15	57	

5BP1

CATHODE RAY TUBE

Replace your present less efficient tube with this value-packed bargain—or, use it for a much needed spare!

Reg. Value \$15 **\$1.80**

\$1.95 ea. Lots of 3, 1.80 ea.



Write Dept. RN-11 for free Tubes & Parts Catalog.

EXPORT INQUIRIES INVITED

TERMS: 25% deposit must accompany all orders—balance C.O.D. All shipments F.O.B. Irvington warehouse. Orders Under \$5.00, \$0.00 Handling Charge.



PLEASE send full remittance. Allow for postage and save C.O.D. charges. Unused money refunded. Subject to prior sale.

115 COIT ST., IRVINGTON II, N. J.

GET INTO ONE OF THESE  
TOP OPPORTUNITY FIELDS

**ELECTRICITY**  
— Electronics or  
**TELEVISION**  
— Radio-Color TV

TRAIN IN THE GREAT SHOPS OF

**COYNE** OLDEST, BEST EQUIPPED  
SCHOOL OF ITS KIND IN U. S.

**Veterans and Non-Veterans**—Prepare for a better job NOW that offers a real future, too! Get practical training in TELEVISION—RADIO—ELECTRICITY—ELECTRONICS—(Refrigeration & Electric Appliance Repair can be included). Learn on real equipment—no advanced education or previous experience needed. Lifetime employment service to graduates.

**Finance Plan**—enroll now, pay most of tuition later. Part time employment help to students.

**FREE BOOK** Clip coupon for Big Free Illustrated Book. No salesman will call. Act NOW.

B. W. COOKE President FOUNDED 1899

**COYNE ELECTRICAL SCHOOL**  
A TECHNICAL TRADE INSTITUTE OPERATED NOT FOR PROFIT  
500 S. PAULINA ST., CHICAGO, Dept. 86-85H  
ELECTRICITY • TELEVISION • RADIO • REFRIGERATION • ELECTRONICS

B. W. COOKE, Pres., COYNE ELECTRICAL School

500 S. Paulina St., Chicago 12, Ill., Dept. 86-85H

Send FREE BOOK and details on:

- TELEVISION-RADIO
- ELECTRICITY-ELECTRONICS

NAME.....

ADDRESS.....

CITY..... STATE.....

RADIO & TELEVISION NEWS

Volume Expander  
(Continued from page 54)

volts d.c. This is adjusted by  $R_{23}$  and need not be re-adjusted once set. A vacuum-tube type voltmeter should be used to measure the control grid voltage.

The bandpass of the control circuit was limited to the mid-band of audio frequencies to prevent the expander from operating on low-frequency rumble or high-frequency clicks and surface noise. (See Fig. 5.) It is this mid-band which determines the effective loudness so it was a logical choice.

Actually, the circuit used provided about 15 db of expansion. Various tests indicated that 8 db was the most satisfactory value for nearly all types of orchestral program material. A 7 db feedback loop was added to reduce the maximum expansion to 8 db and to improve the frequency response and to reduce distortion. (See Fig. 6.) The feedback loop also helped to linearize the expansion slope of the amplifier as shown in Fig. 3.

The expander must be used intelligently if high-fidelity reproduction is to be the end result. It should never be used on solo instruments or voices. This type of material is seldom compressed by the record manufacturers so expansion would be unrealistic. With orchestral, organ, and choral works it can be used on nearly all recordings with excellent results. Wide dynamic range recordings, surprisingly, often are the most impressive when expanded. When using the expander the expansion switch is turned to "on" and the eye set to close on the loudest passages of the recording by means of  $R_{25}$ .

The author chose to locate the power switch ( $S_2$ ), expansion set ( $R_{25}$ ), the eye tube ( $V_6$ ), and the expansion switch ( $S_1$ ) on a remote control panel. A cable connects this panel with the main chassis. (See Fig. 1.) The gain control of the over-all system must be located after the expander unit so that it cannot affect the setting of the expander if the volume level is varied.

-30-

## PRESERVING WIRING

By CHARLES ERWIN COHN

**WHEN** a piece of electronic equipment is used for a long time, the chassis wiring deteriorates due to slow oxidation of the insulation, causing it to be crumbly and weak.

This can be prevented when the equipment is new by spraying the wiring with a spray lacquer such as "Krylon." This lacquer seals the insulation and other parts against air and thus prevents the destructive oxidation.

Keep this "kink" in mind when you buy or build a new piece of electronic gear. It will save untold headaches and eliminate a lot of needless troubleshooting time if this one source of equipment failure can be immediately eliminated from consideration.

-30-

# IBM WANTS ENGINEERS AND TECHNICIANS FOR PROJECT SAGE

*(Continental air defense for  
165,000,000 Americans)*

Project SAGE, America's air defense warning system, offers opportunities to challenge your ability. Equipped with more than 50,000 vacuum tubes, the SAGE computer is the result of the most advanced electronic concepts. Make your own career with SAGE, and the world's largest computer.

## SYSTEMS ENGINEERS

You will be responsible for the performance, evaluation, reliability testing, and maintenance of the entire system.

**Requirement:** Degree or equivalent with emphasis in electronics.

## FIELD TECHNICIANS

Actual maintenance and component analysis. Assume high-level responsibility.

**Requirement:** Two-year technical school training in electronics, or equivalent.

## NOW is the time to investigate

- Permanent Employment
- Full Employee Benefits
- Training at Full Salary
- Relocation Expense Allowance

## Assignments in:

- Portland, Me.
- Richmond, Va.
- Syracuse, N. Y.

## ... and other desirable locations

Write, giving details of education and experience, to:  
Nelson O. Heyer, IBM, Department 4311A,  
Military Products Division, Kingston, New York

**IBM**  
®

INTERNATIONAL  
BUSINESS MACHINES  
CORPORATION

DATA PROCESSING  
ELECTRIC TYPEWRITERS  
TIME EQUIPMENT  
MILITARY PRODUCTS

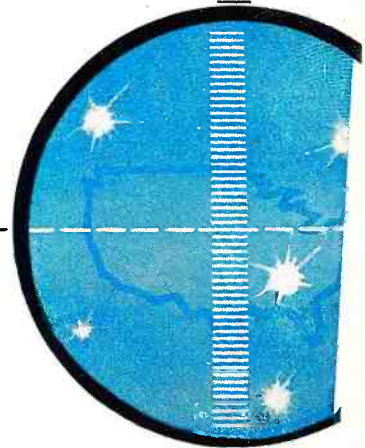

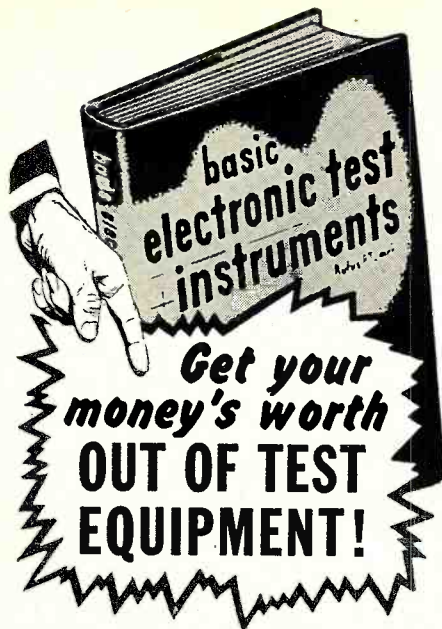

**WORK BETTER, FASTER WITH FEWER INSTRUMENTS!**

No sooner do you buy one new test instrument than another type comes along that is said to be even better and more useful. You soon realize you've got to draw the line somewhere!

The answer is to really learn about instruments . . . to KNOW exactly what each type CAN and CANNOT do. Actually, you can do first class work with only a few basic instruments. You can save hundreds of dollars by learning to use old instruments more fully.

Remember! It isn't so much the instruments you use . . . it's the instrument "KNOW HOW" that counts! And that's where this famous book can be worth its weight in gold!

**GET MORE WORK OUT OF YOUR OLD INSTRUMENTS**

BASIC ELECTRONIC TEST INSTRUMENTS by Rufus Turner covers instruments and test equipment from a practical, on-the-job standpoint. No useless theory! In 255 pages and with more than 170 illustrations it shows you how to select the right instruments and how to use them on all kinds of jobs.

It shows how to modernize old types and use them in new ways. It helps you avoid buying unnecessary instruments; teaches you work-saving testing short cuts; shows how to evaluate instrument readings fast and accurately.

**COMPLETE WORKING DATA ON OVER 60 INSTRUMENT TYPES**

Over 60 types . . . from the latest TV sweep, marker and linearity pattern generators to grid-dip oscillators, special purpose bridges and all the old standbys from V-O-M's and signal generators to oscilloscopes and dozens more . . . are fully covered.

Written especially for servicemen, students, amateurs and experimenters, BASIC ELECTRONIC TEST INSTRUMENTS is the only book of its kind. It saves you money . . . helps you earn more money! Price only \$4.00 (\$4.50 outside U.S.A.)

**10-DAY FREE TRIAL**

- Dept. RN-116 Rinehart & Co., Inc.
- 232 Madison Ave., New York 16, N. Y.
- Send Turner's 255-page BASIC ELECTRONIC TEST INSTRUMENTS book for 10-day FREE EXAMINATION. If I decide to keep book, I will then remit \$4.00 plus postage. Otherwise I will return book postpaid promptly and owe you nothing.
- (Send \$4.00 with order and we pay postage.)
- Same money-back guarantee.)
- Name . . . . .
- Address . . . . .
- City, Zone, State . . . . .
- OUTSIDE U.S.A.—Price \$4.50 cash only. Money back if book is returned in 10 days.



IN REVIEWING the subject matter emphasized in the service meetings and clinics sponsored by service associations through the years, the steady increase in the interest in business management subjects is very impressive. In the early days of television, technical lectures would attract large crowds of service technicians whereas business lectures drew only a handful of service shop owners.

The heavy mortality rate among small shops during the past few years has served to emphasize the inadequacy of superior technical skill as the sole requirement for running a service shop successfully. The man who opens a service shop today without a definite plan for both short- and long-range promotions for business has two strikes against him at the very start. Many technicians who have left the employ of large shops to strike out for themselves with a good list of customers they handled for their former employer soon find that the average customer's memory is short-lived.

The program of business lectures given at the annual NATESA convention typifies the wide range of business operating subjects that are of deep interest to service businessmen today. The subjects covered at the NATESA convention included: methods for determining costs of doing business, advertising a service business, getting new customers, how to hold old customers, telephone answering techniques that keep old customers and win new ones, keeping service records, inventory systems for an electronic service business, and accounting and personnel training.

One of the biggest problems that faces independent service shops at this time is the lack of competent men. Most service operators realize they should build up their organizations to the optimum size of four men, but they are stymied in their efforts to hire the right kind of men to add to their organizations. In many areas, operators of one- and two-man shops are merging their businesses and incorporating them as single operating companies. To accomplish the mergers and gain the benefits from the economies they provide, the combined businesses are moved into a better located, larger building and the individual shops are closed. The savings that can be accomplished through the merger of three or four small shops into a single operating unit are amazing.

The subject of shop mergers was of deep interest to the service dealers who attended the fourth annual clinic and fair sponsored by the Texas Elec-

tronic Association. Forrest L. Baker, former president of T. E. A., and Al Niehaus, clinic chairman for the 1955 convention, are two of the principals in the merger of five shops in San Antonio, Texas, into a single operating company.

Service dealers recognize that the rapidly increasing competition from factory service depots will require more efficient management and operating practices for independent service businesses to survive. They also recognize that it is becoming increasingly more difficult for one man to spread his time over the many varied jobs required in a small business.

Another factor that is of deep concern to service associations is that of curbing the activities of the incompetents and gyps who are responsible for the cloud of suspicion that hovers over the independent service industry. The thirty radio and television service shops in the area of Hickory, N. C., that make up the Catawba Valley Radio and Television Association, recently appointed a committee to investigate customer complaints that they have been defrauded on TV service or that they were given inadequate service. Melvin Jones is president of the Catawba Valley Radio and Television Association. Other officers include Howard Stutts of Newton, vice-president; Donald Bennison of Hickory, secretary-treasurer; and Calvin Underwood of Newton, sergeant-at-arms.

In reporting to members of his local association about the progress of the California State Electronics Association, Ray Warthen, president of the North Bay Radio and Television Association, said:

"CSEA, after many months of hard work, has become an organized statewide body that has built the foundation on which it will be possible to have an effective, powerful association that will benefit all of California's servicemen. This was accomplished through the unselfish efforts of the Board of Directors who on their own time met on an average of once a month over the past nine months. These men represented every part of the state where the television industry is particularly centered. The CSEA was finally incorporated early this year. Plans were made to carry out the first annual convention, which incidentally was a considerable success.

"Some 22 of the 29 local associations in the State of California have endorsed CSEA. The membership of the CSEA has grown considerably and will continue to grow. The CSEA's first official job will be to put through state

licensing bills and to continue to watch carefully the attempts of manufacturers' service companies who are obviously expanding in this state."

Indications that the independent electronic parts distributors are beginning to realize that they must cooperate with their customers in the service industry to survive, were evident in a talk made recently by Herbert V. Hedeem, executive officer of the National Electronic Distributors Association. Mr. Hedeem pointed out that service performed by factory depots meant the loss of this parts and replacement tube business to the independent parts distributors. He said that the future of the independent electronic parts distributors is tied to that of the independent electronic service industry. Because of that, parts distributors are deeply interested in cooperating with service associations in programs for their mutual benefit.

Many parts distributors who have felt that industrial and commercial electronic products would cushion the effect of the loss of replacement parts and tube business to captive service depots now find that national service organizations have been set up to handle industrial and commercial products. Service companies of national magnitude will bypass the local parts jobbers in purchasing their tubes, parts, and supplies. Parts distributors will eventually feel the squeeze for business when they are faced with the competition of factory service outlets for both consumer and industrial service business.

### Massachusetts Anniversary

A recent dinner celebrating the 25th anniversary of the Radio Television Technicians Guild of New England was attended by more than 200 members and guests. Installation of new officers for the Boston Chapter also took place. Officers include Leonard Appel, president; Gilbert Clark, vice-president; Lawrence McEvoy, secretary; Hyman Leve, treasurer; and Albert C. W. Saunders, director of education. In his acceptance speech, the new president emphasized the Guild's preference for persuasion and voluntary action over coercion and pressure.

-30-

## Build your own amateur transmitter

... from these  
easy-to-assemble kits!

KIT  
ONLY!



VIKING

### "ADVENTURER" TRANSMITTER

Complete to the last detail, the Viking "Adventurer" is the ideal CW transmitter for the beginning amateur... the perfect standby transmitter for the experienced amateur. Effectively TVI suppressed—professional in appearance and design—easy to assemble and operate! 50 watts input—single knob bandswitching on 80, 40, 20, 15 and 11-10 meters. Packs enough power for world-wide radio contacts with just a simple antenna. Wide range pin-network output tuning—no antenna tuner needed. Kit is furnished complete with built-in power supply, tubes, cabinet, wiring instructions and antenna suggestions.

Cat. No. 240-181-1. Viking "Adventurer" Kit, less crystal, key...\$54.95



VIKING

### "RANGER" TRANSMITTER

Tops for operating convenience—enough power for world-wide contacts. Built-in VFO or may be crystal controlled. Bandswitching 10 through 160 meters. 75 watts CW input, 65 watts phone. Drives most kilowatt amplifiers including the Viking Kilowatt. TVI suppressed—easy to build—professional in appearance. With timed sequence (break-in) keying system. Kit or wired and tested.

Cat. No. 240-161-1. Viking "Ranger" Kit with tubes, less crystals and key...\$214.50

Cat. No. 240-161-2. Wired \$293.00

For detailed information see your distributor or write to:

**E. F. Johnson Company**

3134 SECOND AVE. S.W., WASECA, MINNESOTA

November, 1956

# Mullard AUDIO TUBES DESIGNED FOR HIGH FIDELITY

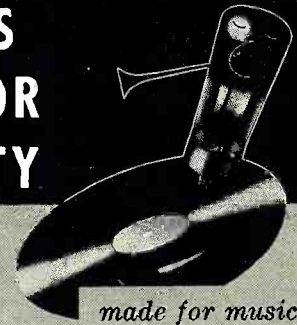

Many years of research and development have been spent in producing a range of Audio Tubes to meet the

requirements of High Fidelity sound

reproduction in all respects. This is why MULLARD Audio Tubes are accepted in Great Britain as a standard by which others are judged, and why leading High Fidelity manufacturers in the United States also use MULLARD tubes in their equipment.



**EL-34**—Recognized as the finest high power output pentode, up to 100 watts in push-pull. Exceptionally linear, requires low input voltage.



**EL-84**—9-pin miniature AF power pentode, combining high gain and linearity. Up to 18 watts in push-pull.



**\*EL-37**  
Specialized manufacture of Mullard High Fidelity tubes, particularly the EL-37 assures longer life and increased balanced power output. Equivalent to 6L6, 5881, KT66.



**\*ECC83/12AX7**

**\*ECC82/12AU7**

**\*ECC81/12AT7**

Mullard quality double triodes with low hum, noise and microphonics.

\*Maximum levels specified and guaranteed



**\*EF-86**—High gain pentode with low hum, noise, and microphonics. Especially designed for input stages of tape recorders and pre-amplifiers. Equivalent to the Z739 and the 5879.



**\*GZ34** — Indirectly heated full-wave rectifier with 5v, 1.9 amp heater, 250 ma output. Equivalent to 5U4G/GA without circuit changes with the advantage of lower tube voltage drop due to unipotential cathode.

MULLARD TUBES are available at leading audio distributors throughout the United States. For detailed technical data and application information, write to:

**INTERNATIONAL ELECTRONICS CORP.**

81 Spring Street, New York 12, N. Y.

TRADE MARK MULLARD, LTD., LONDON



**MULLARD TUBES DEVELOPED FOR HIGH FIDELITY**

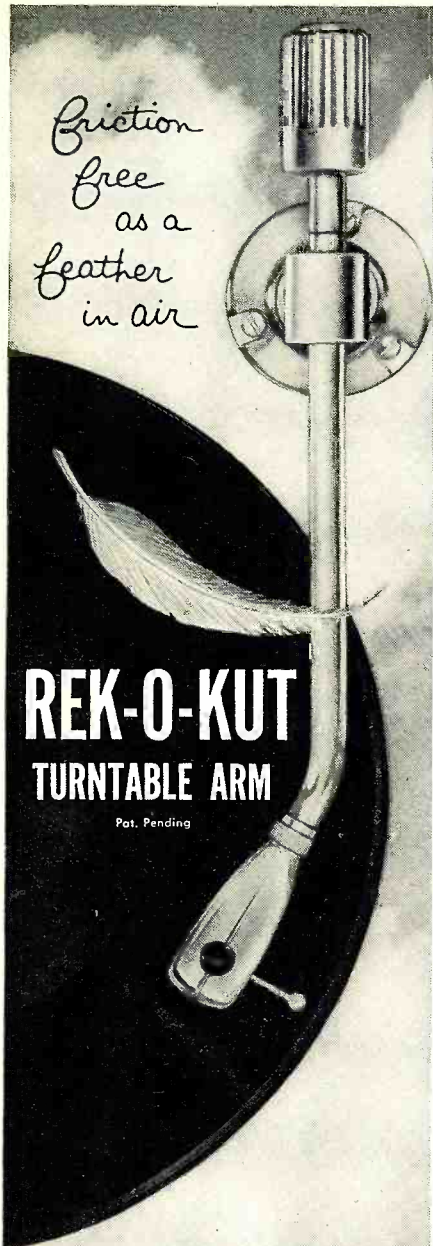

Friction  
free  
as a  
feather  
in air

# REK-O-KUT TURNTABLE ARM

Pat. Pending

A-120 for records up to 12" \$26.95  
A-160 for records up to 16" \$29.95  
slightly higher west of Rockies

LATERAL FREEDOM FROM FRICTION  
achieved by unitized sealed-in  
twin-bearing pivot.

FRICTION-FREE VERTICAL SUSPENSION  
between 1 mm chrome-steel  
bearings... sealed in cross-shaft!

ENDS NEED FOR STYLUS PRESSURE  
GAUGE! With cartridge mounted  
and arm in state of balance...  
turn micrometer-action counter-  
weight to build up stylus pressure.



See your dealer or write:

**REK-O-KUT**  
COMPANY, INC.

38-01 Queens Blvd., Long Island City 1, N. Y.

EXPORT: Morhan Exporting Corp., 458 B'way, N. Y. 13  
CANADA: Atlas Radio Corp., 50 Wingold Ave., Toronto 10

# Useful Transistor Follower

By RUFUS P. TURNER

A circuit which can be used as a coupler or an input stage to provide higher input impedance to other gear.

IT IS often said that one thing wrong with the transistor is its low input impedance. However, the common-collector transistor amplifier circuit does have high input impedance (up to 1 megohm in most practical setups) and can provide power gain equal to about 40 per-cent of that obtainable with the more familiar common-emitter circuit. The common-collector is similar to the vacuum-tube cathode follower in its features of high input vs low output impedance, absence of phase reversal, less than unity gain, and good frequency response.

Fig. 1 shows a common-collector stage which has a measured input impedance of around 500,000 ohms. It may be used as a coupler, like the cathode follower, or simply as an input stage to provide higher input impedance for other transistorized gear. A CK725 transistor is used, since this type has high collector resistance. Since the CK725 has an output impedance of 20,000 ohms in a common-collector circuit, a miniature coupling

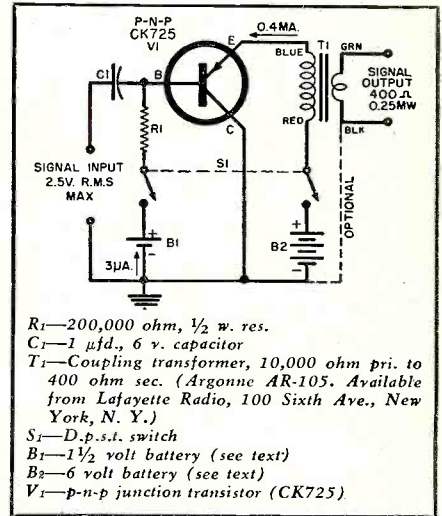

- R<sub>1</sub>—200,000 ohm, 1/2 w. res.
- C<sub>1</sub>—1 µfd., 6 v. capacitor
- T<sub>1</sub>—Coupling transformer, 10,000 ohm pri. to 400 ohm sec. (Argonne AR-105. Available from Lafayette Radio, 100 Sixth Ave., New York, N. Y.)
- S<sub>1</sub>—D.p.s.t. switch
- B<sub>1</sub>—1 1/2 volt battery (see text)
- B<sub>2</sub>—6 volt battery (see text)
- V<sub>1</sub>—p-n-p junction transistor (CK725)

Fig. 1. Schematic and parts list covering the "transistor follower." Refer to text.

transformer is employed for 400-ohm output.

A power gain of 12 db is provided

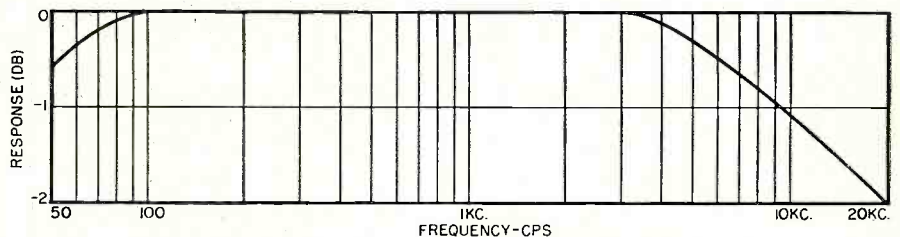

Fig. 2. Frequency response of the "transistor follower." See article for details.

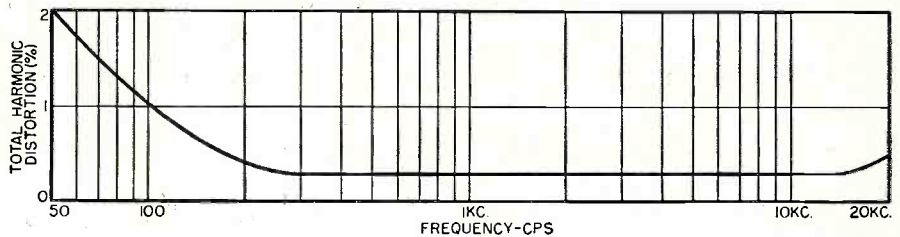
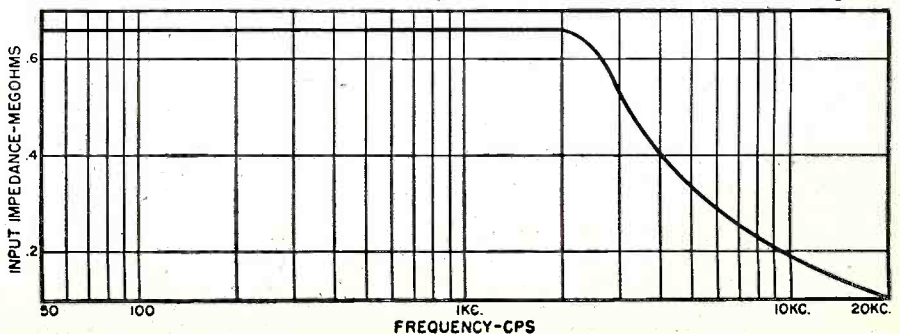

Fig. 3. Distortion characteristic of circuit. Higher levels are due to transformer.

Fig. 4. Graph showing how the input impedance of the circuit varies with frequency.



by the circuit. Maximum power output is 0.25 milliwatt in a 400-ohm resistive load. Maximum input signal level, corresponding to 0.25-mw. output, is 2½ volts r.m.s. The d.c. drain from battery  $B_1$  is 3 microamperes, and from battery  $B_2$  0.4 milliamperes. The two voltages of opposite polarity may be obtained from a miniature, 7½-volt, tapped battery, such as Burgess 5540.

Figs. 2, 3, and 4 give measured performance data. From Fig. 2, the frequency response is seen to be flat between 100 and 3000 cycles, within 0-1 db from 50 to 9000 cycles, and within 0-2 db from 50 to 20,000 cycles. Fig. 3 shows the total harmonic distortion throughout the frequency range. The higher levels are due to the transformer. Fig. 4 shows how the input impedance varies with frequency. From this curve, the impedance is seen to hold at 0.66 megohm from 50 cycles to 2 kc., and then to decrease to 0.1 megohm at 20 kc. Higher input impedance (up to 1 megohm with selected transistors) may be secured by omitting the base bias circuit,  $B_1R_1$ . Without the bias, however, stability of the operating point will be lost and the maximum input signal voltage, before severe distortion, must be reduced.

-30-

## TEST INSTRUMENT TROUBLES

By JAMES McROBERTS

### PRECISION SERIES ES-500 SCOPE

Leakage of blocking capacitor  $C_{12}$ , .5  $\mu$ fd., which couples the vertical signal from the 6AK5 vertical amplifier to the 7AD7 vertical output amplifier will cause a loss of grid bias on the latter tube and can easily result in overdriving of this output tube. Test by replacement is preferred if the scope suddenly displays evidence of a cut-off of the peaks of a waveform. The new replacement should be molded paper with a 600-volt rating.

### RCA "VOLTOHMYST"

If the pointer persists in drifting from the zero position, and if this drift can be corrected by a re-adjustment of the "Zero Adjust" control on the panel, the cause is usually a gassy 6K6GT tube in the differential amplifier. To test, interchange the 6K6's, and note if the drift is in the opposite direction. If so, replace first one and then the other 6K6GT until the pointer no longer drifts.

If, upon interchanging tubes, the drift is still in the same direction, the grid resistance of the circuit has probably increased. The most frequent offenders are the 3.3-megohm resistors in the grid circuits of the 6K6GT tubes.

### TRIPLETT MODEL 3432 GENERATOR

The high-frequency oscillator of this AM signal generator uses a 6SJ7 connected in a Hartley circuit. The cathode is connected to the center tap of the appropriate coil ( $L_1$  to  $L_5$ ) through the switch  $S_1$ . Eventually, a nonconducting film or layer may form on the switch contacts, reducing or stopping the flow of cathode current, resulting in no output. The remedy, clean the switch contacts with carbon tetrachloride and burnish lightly with any small, smooth steel rod at hand.

-30-

# NOW HEAR THIS!

## Stereophonic Sound

### WITH NEW Bell 3-SPEED TAPE RECORDER

## AND... YOU NEED NOTHING ELSE EXCEPT YOUR RADIO, TV OR AMPLIFIER

Bell, famous name in Hi-Fidelity, offers plenty that's new and STEREO too, in this inexpensive, easy-to-operate Tape Recorder.

- TRUE FIDELITY  
... 30-12,000 cycles
- THREE SPEEDS  
... 7½, 3¾, 1½ ips
- DUAL TRACK RECORDING  
... Monaural only
- PLUS STEREO PLAYBACK  
... staggered (offset) heads
- RECORDED STEREO TAPE  
... with each recorder
- ALL FOR ONLY \$189.95  
... slightly more in West

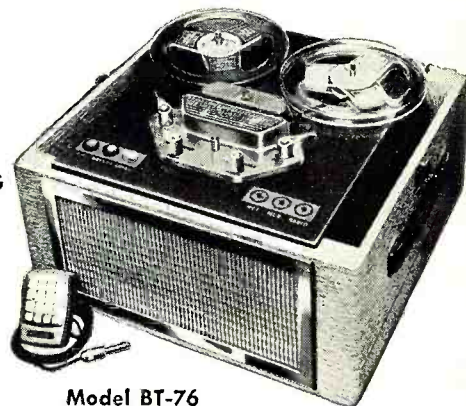

Model BT-76

Bell's new BT-76 Tape Recorder is masterfully engineered, ruggedly built and handsomely cased, with outstanding features usually found only on expensive professional equipment. As a recorder, or when used for either Monaural or Stereophonic playback, it is a magnificent instrument. Its staggered (offset) heads feed

equalized, pre-amplified signals from Head #1 into Recorder Amplifier, from Head #2 into any Radio, TV, or other amplifier system equipped with phono input (connecting cable furnished), guaranteeing true Stereophonic Sound. Now being demonstrated at leading Department Stores and Hi-Fidelity Dealers. Now hear it now!

## OTHER BELL TAPE RECORDERS AS LOW AS \$139.95

**MODEL BTK-1—Conversion Kit**—To add Stereophonic Playback to any RT-75 when desired. Includes second head, pre-amp, hardware, simple instructions, **\$16.95**

**MODEL RT-75—Tape Recorder**—Same as BT-76, above, identical appearance and operation but without Stereophonic playback ..... **\$174.95**

**MODEL RT-88—Tape Recorder**—Two speeds, Piano-Key controls, three separate motors, True Fidelity, Dual Track Recording, Lightweight..... **\$139.95**

Prices shown subject to change; are slightly higher West of the Rockies.

## BELL SOUND SYSTEMS, Inc.

A SUBSIDIARY OF THOMPSON PRODUCTS, INC.

557 MARION ROAD COLUMBUS 7, OHIO

Bell Tape Recorders are sold by leading Department Stores and High Fidelity Sound Dealers everywhere. Write . . . we'll send you complete literature and your nearest dealers' name.



for  
changer  
convenience  
and  
turntable  
performance

the direct-drive

**THORENS**

CD-43



the only changer with  
complete published  
wow, flutter, rumble  
performance figures

**RUMBLE:** for E 53 N motor mounted on CD-43, CBA-83, CB-33 and E-53PA units. (Reference level: 2.6 cm/sec., 1000 cps.)

	Total rumble level	100 cycle rumble	low frequency rumble
Best units.....	-52 db.	-53 db.	-55 db.
Average.....	-50 db.	-51 db.	-53 db.
Lower limit for all units equipped with E 53 N motors	-48 db.	-49 db.	-52 db.

**FLUTTER:** Less than 0.1%.

**WOW:** Less than 0.3%. Tests made with the standard 12" turntable weighing 2½ lbs.

These measurements are minimum quality control standards which must be met or exceeded by every THORENS RECORD CHANGER, PLAYER AND TURNTABLE!

ask your dealer to  
demonstrate **THORENS**

Write for Thorens Catalog.

**THORENS**



Music Boxes  
Hi-Fi Components  
MADE IN SWITZERLAND  
Spring-Powered Shavers  
Lighters

NEW HYDE PARK NEW YORK

Realistic High Fidelity  
(Continued from page 53)

for that matter, can cabinets. Marrying the two is best done by practical experiment.

Corner Horns

There is some dispute as to who first thought of a corner horn, by which I mean a device which uses the adjacent walls as part of the horn system. Sandeman, in U. S. Patent No. 1,984,550 of 1929, refers to a sound generator working into the literal corner of a room formed by the meeting of two walls and the ceiling. There is a later device, the small Ephraim corner horn, extended by the same three plane surfaces. But the first high-fidelity job I met was the Voigt in the early thirties. A section is given in Fig. 32, and the section line is from the middle of the front of the housing (it is not an enclosure) into the actual corner of the room. The loading on the front of the diaphragm is not effective below about 50 to 60 cps, so a tuned air column is used as a supplementary resonator for lower frequencies, driven by the back of the diaphragm. The whole device, while it works very well, is rather ugly and clumsy and has been superseded, at least in the U. S., by the Brociner housing shown in section in Fig. 33. This design is unusual in so far as it postulates a single wide-range speaker unit with no separate tweeter.

The Klipsch design inaugurated a new era in corner horns. First described in 1941 it has the outstanding merit of being able to reproduce lower

Fig. 33. Cross-section of Brociner Model 4 horn showing curved front horn for highs and mid-range and long folded rear horn for lows.

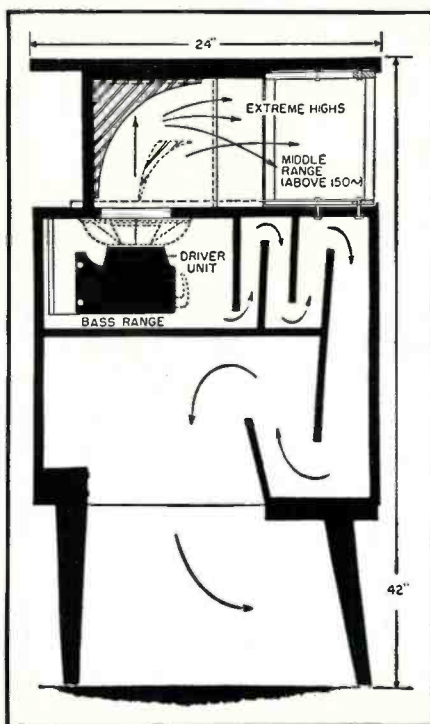

ALL NEW  
BIGGER THAN EVER!



FREE

**NEWARK'S**  
Complete  
**ELECTRONICS**  
Catalog No. 65

Here's everything in Industrial  
Electronics, High Fidelity,  
Radio, TV and Amateur  
Equipment

Write  
today

**NEWARK**  
ELECTRIC COMPANY

Mail Order Division . . . Dept. R-11  
223 W. Madison St., Chicago 6, Illinois  
4736 W. Century Blvd., Inglewood, Calif.

Now! RCA Victor Hi-Fi  
"Mylar"\* tape—super-  
strength, extra-long play!



Sells on length alone! Not 1200', but 1800' on a 7-in. reel! Extra-thin—superstrong! Also available: new RCA Victor acetate tape with full frequency performance—to be sold at a special low price! And new RCA Victor acetate tape with full High Fidelity response—same tape used for professional recordings. Sell RCA Victor—and you'll sell more tape!

\*"Mylar" is a registered Dupont trademark for its polyester film.

**RCA VICTOR**  
RADIO CORPORATION OF AMERICA

CAMDEN 8, NEW JERSEY  
RADIO & TELEVISION NEWS



frequencies than those determined by the flare cut-off of the horn. This is done by allowing the back of the diaphragm to work into a closed air chamber having a natural resonance of a frequency equal to the cut-off of the horn. The enclosure is designed in such a way that the adjacent walls form part of the horn. Making allowance for the fact that the horn is not a true exponential (since flat surfaces are used to form it), that the transition from the horn proper to the wall-horn (if I may so call the external part) is not smooth, and that the reactance of the air chamber is not a true equivalent of a larger horn, the design gives exceptionally good bass response.

The Klipsch design, as indeed with any other design of folded horn, only gives the results the designer anticipated when very solidly made to avoid cabinet resonances. This adds to the cost and the extra cost must be faced if the best results are wanted. If you are offered a Klipsch type of horn at a very low price, you can be sure it won't sound like the original full-sized design. The design is quite complicated and cannot be made cheaply, but having been very carefully worked out to give very good results it is not unreasonable to insist that the designer's specification be adhered to exactly. An important point to be noticed is that the woofer horn is not expected to work above 500 cps, so the tweeter must be able to handle 15 watts (the input for the system) at that frequency, and a lot of tweeters won't do that. A number of corner horn outfits have a much higher crossover frequency, and you may well pause to consider if this is good practice.

### What Is the Answer?

You have seen that a good folded horn enclosure must conform to certain standards. The flare constant for the horn must approximate closely the exponential or Hypex law. It must be solidly constructed from acoustically inert material, and cutting corners to lower the cost can only result in poorer performance. The crossover frequency must be selected with a due regard to the design of the woofer horn, which imposes certain requirements on the tweeter. How can all this be checked?

I think the only answer is that you test what is offered to you. Get the system into your own room. Connect it to your amplifier. Feed your amplifier with the linear sine-wave output of an audio oscillator. As you gradually run down the scale from the extreme highs to the lowest bass, listen very carefully and note how close to apparently equal sound output at all frequencies the whole system behaves. Listen particularly carefully for resonances in the bass. Listen also to the character of the sound output. A sine wave sounds very dull and uninteresting, because it has no harmonics to give it musical color. That is what you



## CHAMPION CARTRIDGE

*There is only one champion in the fine phono cartridge field: the ESL. After impartial testing of nineteen leading pickups, the authoritative Audio League continues to report:*

"By a practically unanimous decision, our listening panel considers the ESL Professional and Concert Series cartridges to be by far the finest phonograph reproducing instruments we have heard.

"In A-B comparisons with its closest competitors, even persons who had never previously been exposed to high fidelity reproduction were struck by the superior definition of the ESL."

"The smoothness and clarity of these cartridges are unique. ...For sheer naturalness and undistorted ease, ESL has no peer."\*

*Is your pickup obsolete? No matter how respected nor how recent it may be, you're missing plenty if you don't have the world's most advanced cartridge: the ESL. Write today for free information.*

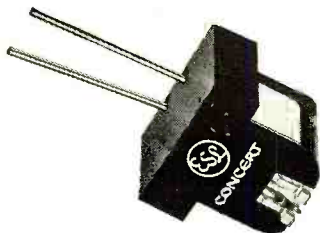

FOR LISTENING AT ITS BEST

**Electro-Sonic Laboratories, Inc.**

Dept. R, 35-54 Thirty-sixth St. • Long Island City 6, N.Y.

Soloist Series from \$14.95 • Concert Series \$35.95 • Professional Series arm and cartridge \$106.50

\*Authorized quotation No. 51. Please consult The Audio League Report, Vol. 1, No. 6-7 (March-April 1955) for the complete technical and subjective report. Additional information in Vol. 1, Nos. 10 & 12. Subscription: 12 issues \$4, from P. O. Box 262, Mt. Vernon, N. Y.

## NOT EVERYONE APPRECIATES THE HARTLEY

It is a proven, scientific fact that musical sounds *DISCRIMINATE*. They give more listening pleasure to one person than any other, due to the ability of some blessed ears to hear true pitch. Those of you who belong to this fortunate group will truly understand and appreciate the greatness that is the Hartley 215 Speaker system.

### THE SPEAKER THAT PRODUCES NO SOUND

Whether it be a fanfare of trumpets or the roll of a drum, the sound of the instruments — nothing else — comes through the Hartley Speaker system. It is free from resonance — free from distortion. Laboratory tests confirm this statement.

### REALISTIC HIGH FIDELITY

Substitute a Hartley 215 in any system and immediately you will hear the amazing difference. Designed by H. A. Hartley, famous audio consultant, it will provide you with the best sound reproduction possible, outperforming speakers of larger size.



### Hartley 215 Speaker Systems

The renowned Hartley Baffle with one, two, three or four drivers. Prices start at \$115.75 for the complete system. At franchised dealers or write for details:

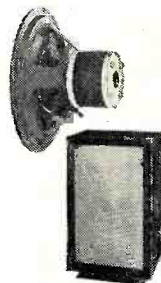

## HARTLEY PRODUCTS CO.

DEPT. 20 • 521 East 162nd Street  
New York 51, N. Y.  
LUdlow 5-4239

Now available at:

#### Emmons Audio Equipment

12608 Ventura Blvd.  
Studio City, Calif.

#### Herbice & Mathews

3109 West Chester Pike  
Larchmor,  
Newton Square, Pa.

#### Vic's Phono Shop

766 Elmwood  
Jackson, Mich.

#### Whitney's Audio Services

3402 Wilson Blvd.  
Arlington 1, Va.

want from your speaker, so at no point in the frequency range should there be any edge to the sound, for that would indicate spurious harmonics. Above all reject a system which has a pronounced boom at one bass frequency, for in time that becomes unbearable; better to have a slightly higher bass cut-off.

Of course you won't get perfect response, and if you have made your own enclosure it may sound pretty bad; but the oscillator test is a good one for your own experimentation, for when you hear a resonance you can go hunting for it with a stethoscope, track it down, and rectify it. There are very few, with enough experience in sound reproduction to be able to diagnose a fault by listening to musical reproduction for a few minutes. What I have suggested may be highly unpopular with the poor harassed owner of an audio store, but I don't know any other way of finding out how a complete speaker assembly and its housing will behave in your own listening room.

(To be continued in January issue)

## NASH SET BLOWS FUSES

By JAMES A. McROBERTS

**W**hen the Model AC152 auto radio used in Nash cars blew fuses repeatedly and the r.f. choke ( $L_6$  in the service data) would smoke, the following servicing procedure was employed.

Since  $L_6$  is in the d.c. power supply line, the short circuit was evidently beyond this component. Disconnection at the set side of the switch into separate lines and replacement of the fuse showed that the short circuit was in the leg running to the speaker field or fields.

The trouble was further localized to the spark plate,  $M_5$ , which had small metal filings grounding its hot side (of the speaker leg) to the chassis. Removal of these filings cured the trouble. —30—

## ADMIRAL SERVICE HINT

**T**he customer complained of picture jitter on his Admiral Chassis 21B, both horizontally and vertically, at intermittent intervals.

Monitoring the sync section with an oscilloscope revealed the defect occurred subsequent to the sync separator and clipper, a 12AU7 ( $V_{403}$  in the service data). A substitution procedure was instituted after ohmage and voltage readings failed to reveal any significant discrepancies.

The replacement of capacitor  $C_{108}$ , .02  $\mu$ fd., (see diagram) cured the trouble. Inspection of the removed capacitor with a capacitance bridge and by leakage tests failed to reveal the cause of the trouble insofar as this capacitor was concerned.

—30—

Portion of Admiral 21B schematic. See text.

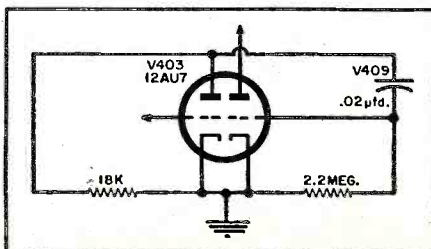

HI-FI  
**Fen-tone**  
IMPORTS



**Fen-tone** REX AA  
Expulsion Ejector

Selected by all HI-FI authorities as the most perfect intermix record changer ever built. Americanized version of world-famous Rex A changer. Patented intermix—plays 10 in any size between 6" and 12" without pre-setting. RUMBLE WOW and FLUTTER are practically non-existent. Short spindle supplied for use as HI-FI record player. Plug-in shells for all make cartridges. Truly the greatest HI-FI value ever!

Audiophile Net \$59.50  
(45 rpm spindle—Net \$3.50 add'l.)

Send for FREE complete Fen-tone Hi-Fi catalog

## FENTON COMPANY

15 Moore St.

New York 4, N. Y.

Sold through better  
Audio Distributors.  
See yours today!

West of Rockies,  
prices slightly  
higher.

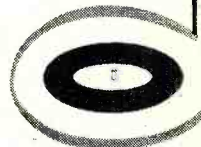

## DUOTONE IN LIFE

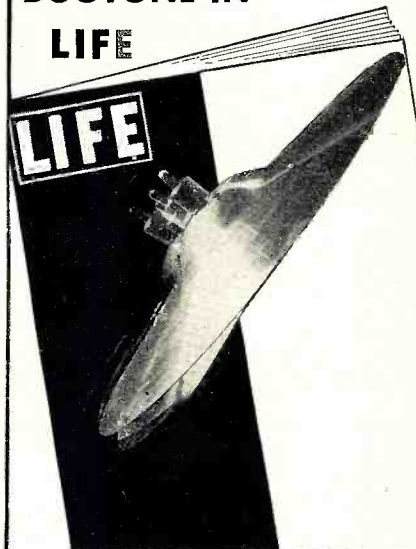

**THE BIG NEWS IS DFF**—"Duotone's Fidelity Focus" goes into "Life" and tells millions about the most sensational needle ever designed. DFF brings recorded music out of the shadows, into clear focus. Life readers will make the demand for DFF big. Send for free DFF promotional material today. Especially Duotone's home Needle-Tester. Don't delay. Demand will be great. Get free DFF kit and test cards, today.

**THE DUOTONE COMPANY, Keyport, N. J.**

**Certified Record Revue**  
(Continued from page 62)

The 22nd version of this warhorse among warhorses should hardly be cause for rejoicing, yet one must pay attention to this or any other work when it comes billed as a special demonstration record. *Vanguard* has been putting out a series of special recordings as demonstrators to sell at \$1.98 initially and then revert to the regular catalogue at regular \$3.98 price. Well what have we got here? The work itself is, of course, ideal for demonstration material and *Vanguard* has made the most of its opportunity.

One of the few small companies whose recorded sound is equal and often superior to the best output of the major record companies, *Vanguard* has endowed this "Scheherazade" with a sound which is sheer orchestral opulence. String tone, brass, woodwind, percussion . . . all is magnificently clean and undistorted, projected in a fabulous acoustic liveness that is one of *Vanguard's* real achievements. Now here I'm going to say something that may seem strange. For all the splendor of this sound, I have heard other *Vanguard* recordings, not designated as demonstration discs, which have sound as good and in some cases better than this present recording. Maybe it's the repertoire, or something else, but that's my opinion.

Performance-wise Rossi does a good job except for tempi which are too slow in several sections. He manages a nice blending of the lyrical and rhythmic elements and never oversentimentalizes. Yes, a fine performance but this reviewer still savors the near definitive Dorati performance on *Mercury*. Aside from that, this is certainly worth the attention of anyone interested in upgrading his library or those who are making a first purchase. At the regular \$3.98 this would rate as a great buy. At \$1.98 it's a steal!

**DEBUSSY**  
**LA MER**  
**IBERIA**

L'Orchestra du Theatre des Champs-Elysees conducted by D. E. Inghelbrecht. Ducretet-Thomson DTL93017. RIAA curve. Price \$3.98.

Two great Debussy works, by a great Debussy interpreter. The whole story here is performance. Inghelbrecht is one of the most astute conductors of Debussy and his reading of these scores is strictly in the classic mold. His "La Mer" does not have the incandescence of Toscanini's, nor his "Iberia" the drive of Ansermet . . . but he is probably closer to the way in which Debussy would have wanted his works performed. This is conducting of great refinement. No phrase is carelessly turned, no break is ever perceived in the inflexible beat. His dynamic shadings are precise, but never studied. He is at one and the same time a master of lyricism and a champion of rhythm. If this recording had sound to match the performance, this would be truly sensational. As it is the sound is fair enough, but is lacking in terms of frequency and dynamics, low distortion, and orchestral definition. Good acoustics save the day, however, and despite the shortcomings, a very enjoyable record.

**THE MARCHES OF SOUSA**

The Band of the Grenadier Guards conducted by Major F. J. Harris, M. B. E. London LL1229. RIAA curve. Price \$3.98.

Here is another sizzling record of Sousa Marches. This time our British friends in the Grenadier Guards are whooping it up and



COURTESY NORTH AMERICAN AVIATION

Another reason why today's fastest selling high fidelity record changer is **Collaro**

\* Accurate Speeds—

factory pre-set and tested for less than 0.25% rms wow and flutter content measured at 33 1/3 rpm... specifications unmatched in the field.



For other features and new popular price, see your hi-fi dealer or write Dept. TL-4  
**ROCKBAR CORPORATION** 650 Halstead Avenue, Mamaroneck, N. Y.

ANY ONE of these recorded OPERAS **LA TRAVIATA**  
**FREE** **CARMEN**

To PROVE to you the remarkable value and amazing high fidelity of our recordings, take CARMEN or TRAVIATA or FIGARO—yours as a FREE GIFT! Superb performances in exciting concert versions. World-renowned singers and orchestras. Noise-free, pure vinyl recordings. What's more, when you get your free sample opera, you also become eligible to audition free ANY or ALL of the twenty glorious operas listed below!

Absolutely no obligation to buy. Pay only for those you decide to keep at low membership prices (see below). 50% off usual retail cost. Buy nothing unless you wish; the free gift is yours in any case. Limited quantities. Mail coupon without money NOW!

- Violetta Valery . . . . . Margit Opawsky  
Alfred Germont . . . . . Leo Larsen  
Georges Germont . . . . . Henk Driessen  
Annina . . . . . Catharina Hessels  
and other outstanding artists
- CARMEN**
- Carmen . . . . . Cora Canne Meyer  
Don Jose . . . . . Leo Larsen  
Escamillo . . . . . Gerard Holthaus  
Micoela . . . . . Corry van Beckum  
and other outstanding artists
- THE MARRIAGE OF FIGARO**
- Figaro . . . . . Siemen Jongstma  
Susanna . . . . . Anneke van der Graaf  
Il Conte Almaviva . . . . . Henk Driessen  
Le Conte . . . . . Margit Opawsky  
and other outstanding artists



**THE OPERA SOCIETY, Dept. RT-II**

45 Columbus Avenue, New York 23, N. Y.

Send me as a FREE GIFT (check one) your high fidelity 33 1/3 RPM recorded performance of

CARMEN  LA TRAVIATA  FIGARO

Also deliver for a 5 day free home trial the long-playing selections I have NOT crossed off at the right, about one a month. I will be billed only for those I keep—at low membership prices shown at the right—saving 50%. I may return any recording, and pay nothing. I may cancel my Trial Membership at any time. Free Gift is mine to keep in any case.

Records are not listed in order of release.

Name . . . . .  
Address . . . . .  
City . . . . . Zone . . . . . State . . . . .  
Canada: 105 Bond Street, Toronto 2, Ont.

(Cross out those you do not want to audition FREE)

1. \* LA TRAVIATA (Verdi), 2. \* MARRIAGE OF FIGARO (Mozart), 3. \* DIE FLEDERMAUS (Strauss), 4. \* CARMEN (Bizet), 5. \* THE CORONATION OF POPPEA (Monteverdi), 6. \* THE BARBER OF SEVILLE (Rossini), 7. \* QUEEN OF SPADES (Tchaikovsky), 8. \*\*\* DON GIOVANNI (Mozart), 9. \*\* RIGOLETTO (Verdi), 10. \*\* OBERON (Weber), 11. \*\* FAUST (Gounod), 12. \*\* THE GYPSY BARON (Strauss), 13. \*\* BORIS GODUNOV (Mussorgsky), 14. \*\* MESSIAH (Handel), 15. \*\* THE PEARLFISHERS (Bizet), 16. \* IL TROVATORE (Verdi), 17. \*\* THE ABDUCTION FROM THE SERAGLIO (Mozart), 18. \* ORFEO AND EURIDICE (Haydn), 19. \*\* LE BELLE HELENE (Offenbach), 20. \*\*\* LOHENGRIN (Wagner).

SPECIAL MEMBERSHIP PRICES  
\* One 12" disc (approx. 1 hour) . . . . . \$2.95  
\*\* Album of two 10" discs (approx. 1 1/2 hours) . . . . . \$3.75  
\*\*\* Album of two 12" discs (approx. 2 hours) . . . . . \$5.50  
plus a few cents shipping expenses.

# A NEW CONCEPT IN SPEAKER DESIGN

## ...From Altec Lansing Laboratories

Exceeding the expectations of even those engineers who worked on the design and development of Altec Lansing's new Biflex speakers, the principle of "multiple concentric compliances" has provided almost unbelievable new performance at very nominal cost. By separating a single cone into two segments with a flexible connection, Biflex speakers achieve a smoother and more extended frequency range than any other single cone loudspeaker.

To convince yourself of the truly remarkable performance of Biflex speakers selling for as little as \$27.00, you have only to listen for yourself. Only by hearing the Biflex can you believe that so much high fidelity can be yours for so little.

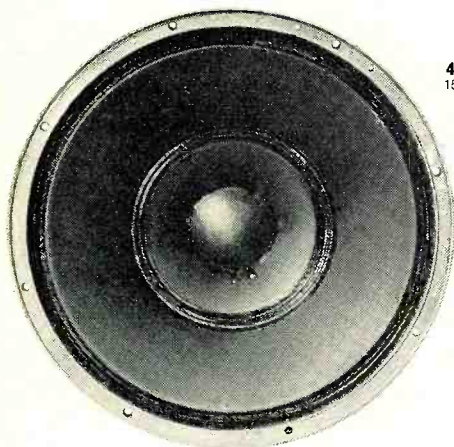

**415A**  
15", 25 watts, 30-14,000 cycles, \$63.00

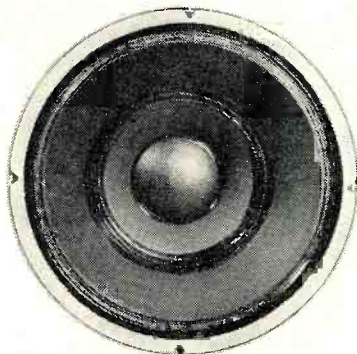

**412A**  
12", 20 watts, 40-15,000 cycles, \$48.00

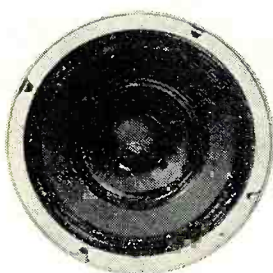

**408A**  
8", 15 watts, 60-16,000 cycles, \$27.00

These guaranteed frequency responses, measured in Altec's anechoic chamber, are minimum specifications and will be met or exceeded by the Biflex speaker you buy.

ALTEC FIDELITY IS HIGHEST FIDELITY



Dept. 11 T  
9356 Santa Monica Blvd., Beverly Hills, Calif.  
161 Sixth Avenue, New York 13, N. Y.



a mighty sound they make! This record of course invites comparison with the recent and notable band music on *Mercury*. The Grenadier Guards are definitely the more military-sounding . . . a coarser, more "oompah" type sound. Frankly, the *Mercury* group is without parallel in the band world as none can match the precision of this special hand-picked symphonic band. But if the Grenadier Guards lack the snap precision of the Eastman group, they make up for it in verve and spirit.

If the good Major had quickened his tempi a bit, this would be a very American-sounding aggregation. The sound is magnificent to say the least. Huge sonorous weighty brass, sharply detailed woodwind, and percussion of tremendous impact and accuracy. All is very wide in frequency with really exceptional dynamics. Distortion was virtually nil and the over-all effect is one of sheer power. Owners of big speaker systems will have a ball with this recording!

### DEBUSSY

**PRELUDES (BOOKS 1 AND 2)**  
Friedrich Gulda, pianist. London LL-1289/90. RIAA curve. Price \$7.96. Two discs.

This is the story of a young man and a very difficult subject. It is to the credit of Gulda, a sensitive and perceptive artist, that *London* has enough faith in him to let him tackle Debussy "Preludes." Here is a set of seemingly simple piano exercises but most pianists avoid them like the plague. The demands of color, phrasing, dynamics, tempi are extreme. Inevitably, if one is brash enough to take on the "Preludes" he must face squarely the heroic figure of Gieseking. These "Preludes" are virtually his property after a lifetime of development and it will take some doing to supplant his reading. That young Gulda comes as close as he does is high praise indeed. It is not a question of steel-fingered technical proficiency—which Gulda has in abundance—but of questing insight, temperament, and feeling, self analysis and stern discipline. All these things are, alas, the province of mature wisdom and age. Young Gulda is just that . . . too young. However, if his reading is not of the noble proportions of a Gieseking, it is none the less exceptionally well done and entirely acceptable and if one brings in the factor of sound it has much to command. This is, in fact, the first recording of the "Preludes" that can qualify as really modern wide-range hi-fi sound. For all his mastery Gieseking's discs are rather ineffectual soundwise and it is a pleasure to hear these pieces with such splendid sound as the *London* engineers have afforded.

This is close-up recording that allows all the subtleties and nuances of performance to come through cleanly and well detailed. Yet they have managed to wrap the piano in an acoustic perspective which allows for an uncanny illusion of presence. Transient response is superb and throughout one can hear and appreciate Gulda's firm well-rounded tone. Highly recommended to those of an inquiring and open mind.

### MILSTEIN MINIATURES

Nathan Milstein, violinist, accompanied by Leon Pommers, pianist. Capitol P8339. RIAA curve. Price \$3.98.

This is the sort of record to delight the thousands of Milstein admirers. A potpourri of violin pieces, some very well known and others intriguingly off-beat, this shows the polished Milstein of the violin recital. In a program that varies from parts of Smetana's "From My Homeland" to the ubiquitous "Flight of the Bumble Bee" he displays his violinist's bag of tricks that have made him world famous. Double bowing, harmonics, the pizzicato and spiccato, and other feats

RADIO & TELEVISION NEWS

of virtuosity can be heard. More important however is the way his meltingly sweet, fabulous big tone comes through. The engineers have given him a supremely good example of violin recording. The tone is always full, never subject to screech or scratch. This is sharply detailed close-up recording, mercilessly revealing of faults and extolling of virtues. All is clean and undistorted and with clever use of acoustics, a fine illusion of presence is maintained.

#### GYPSEY

**The Hollywood Bowl Symphony Orchestra conducted by Carmen Dragon. Capitol P8342. RIAA curve. Price \$3.98.**

Man, you can smell the garlic and hear the creak of the gypsy wagons when you hear the music on this disc. Or you might expect to have a waiter sidle up to you with a flagon of Tokay ready to pour and the strolling fiddlers din a Czardas in your ear! If its Geep-sy music you want you'll certainly get your fill on this disc. Carmen Dragon and the orchestra put forth some very hi-fi versions of such pop favorites as "Hora Staccato" "Zigeunerweisen," "Two Guitars," "Dark Eyes," etc., as well as such items as Brahms "Hungarian Dance #6" and Dvorak's "Slavonic Dances #8 and 10." The playing is very expert, spirited and gay, the "fi" is very "hi" indeed. Strings get the big play here and all are heard with smooth clean precision. All other elements are equally well reproduced and cornball though it may be, I predict a brisk sale on this album!

#### FOLK SONGS OF THE OLD WORLD

**The Roger Wagner Chorale. Capitol PBR 8345. RIAA curve. Price \$7.96. Two discs.**

This is a magnum sampling of the incomparably good work of the Roger Wagner Chorale. This group has come to the fore recently as the best of contemporary choral groups. Their previous albums for Capitol have been best sellers and this should be no exception even though this is the first two-record Capitol FDS album I can recall.

As the title implies this is a collection of Folk Songs from Europe. Many are old familiar favorites like "Loch Lomond," "Flow Gently Sweet Afton," "Greensleeves," "The Minstrel Boy," "O Tannenbaum," etc., while others from France, Spain, Norway, Denmark, Sweden, and Holland are off the beaten track. As usual with this group all is beautiful tone, superb sharp attacks and release, carefully modeled phrasing, incredibly integrated balance between choirs. Their intonation and inflection, their articulation and intelligibility are a joy to the ear. This is certainly their outstanding album to date and I can sincerely recommend to all who enjoy beautiful singing.

#### Jazz Corner

#### KENTON IN HI-FI

**Stan Kenton and his orchestra. Capitol W724. RIAA curve. Price \$3.98.**

The only proper word for this is sensational! I hereby give you fair warning . . . if you live in an apartment don't even try to play this at full room volume! The Kenton records that have come down to us over these past few years were loud enough, but when consciously and deliberately his music is given the full hi-fi treatment, the effect is literally paralyzing. This represents a collection of numbers that have made Kenton a famous and controversial figure in jazz over the last decade. Such choice items as "Artistry Jumps," "Intermission Riff," "Southern Scandal," "The Peanut Vendor," "Concerto to End All Concertos," and others are on this disc.

As played by this virtuoso orchestra, the excitement they generate is incredible. The effect of the Kenton massed brass is truly

November, 1956

# Still the finest!

## ...DUPLEX SPEAKERS BY ALTEC LANSING

Duplex speakers by Altec Lansing are still the finest loudspeakers made—still the outstanding choice of professional engineers. Without truly outstanding performance, their long record of leadership could not be maintained.

Duplex speakers are the finest because they represent the ultimate development from the sound laboratories that are responsible for the famous stereophonic speaker systems of Cinerama, Cinemascope and Todd-A-O. Until you hear the efficient reproduction of sound throughout the frequency range of 30 to 22,000 cycles which is available only in *tested* and *guaranteed* Duplex speakers by Altec Lansing, you have not realized the true potential of your high fidelity installation.

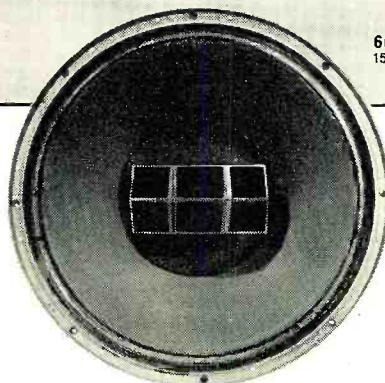

**604C**  
15", 35 watts (50 peak), 30-22,000 cycles,  
\$165.00 incl. network

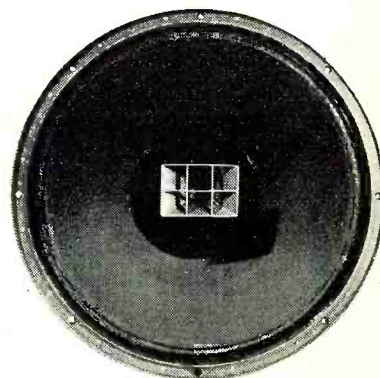

**602A**  
15", 25 watts (35 peak), 30-22,000 cycles,  
\$126.00 incl. network

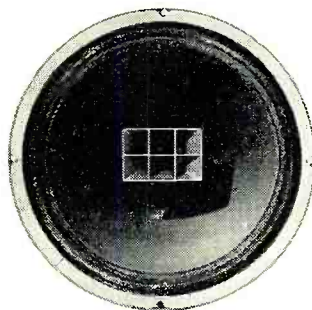

**601A**  
12", 20 watts (30 peak), 30-22,000 cycles,  
\$108.00 incl. network

These guaranteed frequency responses, measured in Altec's anechoic chamber, are minimum specifications and will be met or exceeded by the Duplex speaker you buy.



**ALTEC**  
LANSING CORPORATION

ALTEC FIDELITY IS HIGHEST FIDELITY

Dept. 11-T  
9356 Santa Monica Blvd., Beverly Hills, Calif.  
161 Sixth Avenue, New York 13, N. Y.

# FULL FIDELITY MUSIC ENJOYMENT

TWIN-CONES IN A SINGLE

*F.R.S.* SPEAKER  
COVER THE  
AUDIBLE RANGE

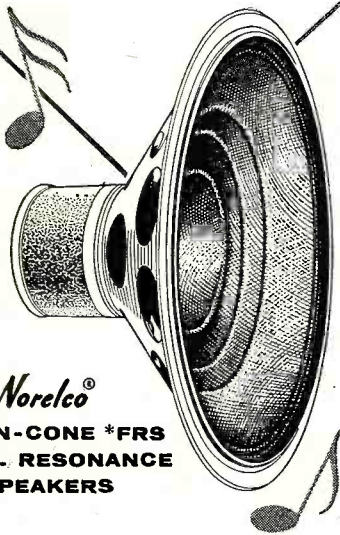

**Norelco®**

**TWIN-CONE \*FRS  
\*FULL RESONANCE  
SPEAKERS**

In a single speaker, Norelco has created an unusually efficient sound radiator. These twin-cone speakers incorporate a small cone for reproducing high frequencies and a large cone for lower frequencies. Both cones operate in conjunction from a single voice coil—producing balanced sensitivity and uniform sound for all ranges. Arrangement of both cones reflect and diffuse the sound while moving in phase to provide even sound distribution.

A deep air gap within a homogeneous magnetic field provides unusually large movement of the voice coil resulting in distortion-free reproduction over the entire frequency range. Impedance does not diminish with higher frequencies and volume is practically constant throughout the whole audible range.

Send today for your catalog on Norelco \*FRS Twin-Cone Speakers. It contains specification data, sound distribution curves, frequency characteristics on these speakers as well as the new Norelco Speaker Enclosures.



Send to Dept. G11 for more details

**North American Philips Co., Inc.**  
100 East 42nd Street  
New York 17, N. Y.

awesome, as can be imagined with six trumpets and five trombones going full tilt, to say nothing of the six saxes, the guitar, bass fiddle, drums, and Stan on the piano! The engineers have collaborated with Stan to produce just about the cleanest big band sound I've heard yet.

The Kenton technique of course exploits every instrument's resources to the utmost, aided and abetted by some of the top drawer jazz men of today. Maynard Ferguson is there to blow the trumpet section clear out of sight with his stratospheric screeches, and his buddies Peter Candoli and Sam Noto are in there pitching too. For the soaring trombone solos that Stan so dearly loves we have the incomparable Carl Fontana, and to shape the melodic line in these Kenton scores we have the facile sax of Vido Musso. One listen to this recording convinces you of one thing . . . for dynamic punch this Kenton group is about the tops and even if you don't like his music, I suggest you listen to it as a strictly hi-fi experience. The transients of those massed brasses are a severe test even for the best sound systems!

### SONGS FOR SWINGIN' LOVERS

**Frank Sinatra. Capitol W653. RIAA curve. Price \$3.98.**

What a "swingin' lover" is can only be imagined. But you do not have to belong to this group in order to enjoy the highly stylized vocalizing of Frankie. This boy is very much like gin and tonic . . . you either like it or ugh! I must confess I get a kick out of his really incredible phrasing. Sinatra can do more to put a song "over" by clever emphasis on phrasing or even a certain inflection in his voice than most top ballad singers can do with their whole armamentarium of vocal tricks. The "swingin'" in the title refers to the fact that these are not the agonizingly slow, "blues" type of ballads Sinatra made famous with the screaming teenagers. Rather he is on a definite up-beat here . . . the tempi are on the quick side . . . everything is gay and light.

In fifteen numbers ranging from "I've got you under my skin" and "Old Devil Moon" to things like "Makin' Whoopee" and "Anything Goes," Sinatra does some of his best work yet. Of course as I've said before . . . more than a large part of the success of Sinatra on records, and especially the recent issues by *Capitol* is due to the superb recording he gets from the engineers. Here one can detect every change of inflection every subtle nuance of his delivery as well as appreciate the rich smoothness of the voice and the absolutely first class background accompaniment, which is heard in wide range low-distortion sound. And last, but hardly least, Sinatra always enjoys the fabulously quiet surfaces of the *Capitol* recordings which add the final fillip of realism.

### Tape Review

#### STRAVINSKY L'HISTOIRE DU SOLDAT

**Vienna State Opera Orchestra conducted by Mario Rossi. AV-Vanguard 152-3B, monaural tape, 5" reel, 7½ ips, double track. Price \$8.95.**

Ever since the *Audio Video* tape and *Vanguard Record* alliance was summated, I've been looking forward to the release of this great Stravinsky work, which was so successful on record. After a listen to this tape I have not changed my opinion about the performance and my appreciation of the sound has been considerably heightened. This is still about the best performance of this work available. Authentic or not—I still do not like the incredible speeded-up tempi of Stravinsky's own version on *Columbia*. Here Rossi takes things at a reasonable pace that makes for much dramatic emphasis in this colorful score and, throughout, his adroit handling of

all other elements is a joy to the ear. Sound-wise the recording was a superb job. On the tape, everything comes in fuller measure. The famous trumpet part is ever more dazzlingly bright and sharply detailed, the strings and especially the solo part have a beautiful sheen and plenty of bite and incisiveness without the penalty of edginess. The percussion has still more impact and sharper articulation. And as for the acoustic perspective, here is an odd little thing that clearly shows the superiority of the tape over the disc . . . when I was listening to the disc I savored the fine spacious "liveness" the hall afforded, but I kept hearing a peculiar low rumbling sort of sound every now and then, which try as I might I just couldn't identify. After hearing it on the tape it finally became apparent what the "rumble" was . . . believe it or not a bus or truck outside the hall! You can hear the initial revs of the motor and then it takes on an ascending pitch as it pulls away! Buses aside, this is one of the finest offerings yet in the *AV-Vanguard* releases and this is most highly recommended.

### Stereophonic Tape

#### BERLIOZ

#### SYMPHONIE FANTASTIQUE

**Boston Symphony Orchestra conducted by Charles Munch. RCA Victor GCS6, "stacked" stereophonic. 7" reel, 7½ ips. Price \$18.95.**

When I reviewed the disc of this work by the same group, I noted that it was one of the best performances available despite some mannerisms of Munch which may be distracting. I also said it was a pretty good recording although not "tops" by any means. Now here is the stereo version and again we come to the inescapable fact that this is such a fabulous medium that it colors one's viewpoint and it is hard to be dispassionate about something which is so sonically exciting. Here in the glory of stereosound the Munch "Fantastique" seems ever so much more attractive! And by golly there is just no bones about this . . . it really is a fabulous experience. All the parts before the "March to the Gallows" and the "Witches Sabbath," which frankly are overlooked by hi-fi nuts, take on a new dimension and are sonically much more rewarding than the same section in the disc. This is principally due to the much greater orchestral definition afforded by the stereosound. All the wonderful scoring for strings and woodwinds becomes newly articulate and with the plus of depth and directionality the effects are breathtaking. Needless to say the "March" and "Witches" sections of the roaring finale are loaded with hi-fi sensationalism . . . here is where the stereo makes an incredible difference. Low percussion in the disc did not seem overly clean nor detailed. Here there is still less than one could prefer, but it is far beyond the disc and the impact is tremendous by comparison. The famous bell in the last movement is altogether stunning, although one would think that since the mike was practically thrust into the bell that stereo would not make much difference . . . but it does, probably less transient overloading and better distribution of sound.

Boy, will the hi-fi nuts flip when they hear the trumpets and trombones of the last movements! The tremendous brazen weight, the gigantic sonority the trombones generate is truly awesome! All the usual effects of stereo are easily apparent too . . . the directionality is generally good throughout the score, depth effect is greater than most . . . the "hole in the middle" phenomenon is minimal here, dynamic range seems fantastically wide and much enhanced over the disc. Yet, this is a fabulous recording and about the only sour note I can interject is that this stereo of *Victor* and several others in this same release has a higher background hiss level than the earlier *Victor* releases. I don't know whether

# 40

FOR ANY

# TUBE



we will not be undersold

PROMPT SHIPMENT ON ALL ORDERS

**\$37.00**  
Per Hundred

DON'T PAY MORE FOR SET TESTED LONG LIFE DEPENDABLE RADIO & TV TUBES • BUY VIDEO INDIVIDUALLY BOXED • ALL GUARANTEED FOR ONE YEAR OR YOUR MONEY BACK

**FREE POSTAGE** in

U.S.A. and Territories on orders over \$5.00. 25c handling charge on orders under \$5.00, 25% deposit required on C. O. D.s. Please send approximate postage or freight on Canadian and foreign orders. Subject to prior sale.

**We Have OVER 1000 USED TV SETS**

At All Times In Our Huge Warehouse Buy one or more of these WORKING TVs to sell or use as your own second set! All Sets in GOOD WORKING condition! Your Choice—Console or Table Model

10" . . . . . \$23.00	19" . . . . . \$58.00
12" . . . . . \$25.00	20" . . . . . \$64.00
14" . . . . . \$35.00	21" . . . . . \$72.00
15" . . . . . \$40.00	24" . . . . . \$99.00
17" . . . . . \$46.00	

When ordering TVs, state whether table model or console is desired. Also preference on make of set. All TVs sent railway express F.O.B. Newark. On any quantity WIRE or CALL today!

SEND for our **FREE** complete TUBE & PARTS LIST and order blank.

**FREE BONUS ANTENNA GIVEN WITH ANY TV SET ORDER!!**

**FREE RCA "CHEATER" CORD GIVEN WITH ANY TUBE ORDER OF \$7.00 OR MORE!!**

Some Standard Brand—Others With Famous VIDEO Brand

0A2	2X2	6AC7	6BK5	6SG7	7F8	12V6GT
0A3	3A4	6AG5	6BK7	6SH7	7N7	12X4
0A4	3A5	6AF4	6BL7GT	6SJ7GT	7Q7	12X4
0B2	3AL5	6AH4GT	6BN6	6SK7GT	7Y4	14B6
0C3	3AU6	6AK5	6BQ6GT	6SL7GT	7Z4	14Q7
0Z4	3BC5	6AL5	6BQ7	6SN7GT	12A6	198B6G
1A7GT	3CB6	6AM8	6BY5G	6SQ7	12AH7GT	19T8
1B3GT	3Q4	6AN4	6BZ7	6S7	12AT6	24A
1C7G	3Q5GT	6N8	6C4	6SV7	12AT7	25AV5GT
1F4	3S4	6AQ5	6CB6	6T8	12AUG	25BQ6GT
1H4	3V4	6AQ7GT	6CD6G	6U4GT	12AU7	25CD6G
1H5GT	4B27	6A55	6CF6	6U7G	12AV6	25OU6
1J6GT	4B97	6AS7G	6C5G	6U8	12AX7	25L6GT
1L4	5AN8	6AT6	6CU6GT	6V3	12AX4GT	25W4GT
1L6	5AN8	6AU4GT	6E5	6V6GT	12AX7	25Z6GT
1LA6	5AQ5	6AU5GT	6HG6T	6W4GT	12A27	35L6GT
1LQ5	5AT8	6AU6	6H6	6W6GT	12B4	35W4
1LH4	5AW4	6BUS6T	6J5GT	6X4	12BA6	35Y4
1LNS	5AZ4	6AV6	6J6	6X5GT	12BE6	35Z3
1N5GT	5J6	6AX4GT	6K6GT	6X8	12BH7	35X5GT
1S4	5T4	6AK5GT	6L6	6Y6G	12H7	50A5
1S5	5T5	6A6	6N7GT	7A5	12CUG	50B5
1T4	5U4G	6BC5	6S4	7A7	12SA7	50C5
1U4	5U8	6BC7	6S7G	7B5	12S67	50L6GT
1U5	5V4G	6BE6	6SA7	7B7	12S7H	80
1V2	5V6GT	6BF5	6SB7Y	7C5	12S17GT	117N7GT
1X2	5V3	6BG6G	6SC7	7C6	12S7GT	117P7GT
2A7	5Y4G	6BH6	6SF5	7C7	12SN7GT	117Z3
2D21	6AB4	6BJ6	6SF7	7F7	12SQ7	

# VIDEO

**ELECTRIC COMPANY**  
79 CLINTON PL. NEWARK, N. J.

Phone HUmboldt 4-9848

## HIGH-PAY CAREERS

IN ELECTRONICS — TELEVISION — RADIO

### Await Men with COMPLETE Training!



Nationally-recognized, accredited Central training is designed to get you into high-paying career positions in the shortest possible time. In addition, Central's "Progressive Plan" is so arranged that each phase of training you complete qualifies you for a more important, better-pay position. In just a few short weeks you are qualified for certain basic jobs. Then, with every additional training phase that you complete, you qualify "up the ladder" for more advanced types of positions. Central offers complete Electronics-TV-Radio training leading to an Associate of Science degree, and qualifying you as an *Electronics Engineering Technician!*

Thousands of Central graduates have been placed at almost every technical level in the electronics industry. Free nation-wide placement service.

### 3 PROVEN TRAINING PLANS

(Choose the one that fits your requirements)

- 1. HOME STUDY COURSE** (with 9 kits of equipment) —Qualifies you for diploma, FCC license, and a variety of electronics jobs (or transfer into advanced resident training).
- 2. HOME STUDY-RESIDENT COURSE** (with 9 kits of equipment)—Home study, followed by short period of resident training. Qualifies you for diploma, FCC license, and a wide variety of Electronics-TV-Radio positions (or continue with advanced resident training). An accredited technical institute curriculum.
- 3. FULL RESIDENT COURSE**—Qualifies you for Associate of Science (A.S.) degree and top-pay employment opportunities as Electronics Engineering Technician. Part-time employment opportunities available for students while training. An accredited technical institute curriculum.

Don't limit yourself! Get the facts on Centrals complete training that can take you just as far as you want to go in the electronics technician field. Send coupon today for FREE brochure on your opportunities in Electronics.

**VETERANS!** Central offers courses approved under G.I. Bill

### CENTRAL TECHNICAL INSTITUTE

Dept. W-116, 1644 Wyandotte St., Kansas City 8, Mo.

Tell me more about how you can qualify me for a high-pay Electronics career.

Name \_\_\_\_\_ Age \_\_\_\_\_

Address \_\_\_\_\_

City \_\_\_\_\_ State \_\_\_\_\_

If Korean veteran, give approximate discharge date \_\_\_\_\_

**Take the advice of experts:  
Do a Better Service  
Job . . . Get a Better  
Price with KRYLON®**

... spray high voltage connections to prevent corona, and arcing caused by moisture.

... spray bell part of picture tube to repel dust and arcing.

... spray antennae to prevent rust, corrosion, pitting, signal loss.

... insulate and moisture proof lead-in connections.

**KRYLON RUST RELEASE**

... unlocks rusted, corroded, "frozen" parts, etc. Loosens rusted antennae and outside connections. Giant 16.2-oz. can.

**KRYLON DULLING SPRAY**

... kills glare and reflections from objects in T-V studios, simplifies lighting and arranging problems. Giant 16.2-oz. can.

**KRYLON SPRAY ENAMELS**

... for maintenance and touch-up ... renew tube bells, loud speaker grids, hardware, etc. 18 colors. Giant 16.2-oz. can.

Order from your T-V Parts Jobber or write

**KRYLON, INC., NORRISTOWN, PA.**

**KRYLON GOES FARTHER IN NEW GIANT CAN . . .  
35% More Product at No Extra Cost to You**



**WANT TO BUY!**

**BC-224, BC-348 RECEIVERS**

**ARC-3 BC-788 R5/ARN-7**

Cash or trade. Immediate action.

**HARJO SALES CO.**

503 N. Victory Blvd. Burbank, Calif.

**TAPE RECORDERS**

**TAPES (in Boxes or Cans) & HI-FI**

EXCEPTIONAL VALUES

NATIONALLY ADVERTISED BRANDS

WRITE FOR FREE CATALOG

**CARSTON**

215A E. 88 St.  
New York 28, N. Y.

**FIDELITONE  
DIAMOND  
PHONOGRAPH NEEDLES**



**QUALITY and DEPENDABILITY BACKED**

**by 27 YEARS of DESIGN LEADERSHIP.**

**PE O, INC.**

**Chicago 26**

they've changed tape brands, or changed their dubbing set-up in some manner or whatever . . . it is just not as quiet as it should be . . . and I hope they remedy this quickly. Stereo aside, this reading is good, sound good, but one could have preferred a greater leaven of each. But consider and listen to the same thing with the stereo and all one can do (at least at this stage of newness of stereo) is submit gracefully, lean back and appreciate the next best thing to being at Symphony Hall in Boston at a performance. -30-

**TV SET RADIATION**

By **STAFFORD E. DAVIS, W5HDM**  
Staff Engr., Station WFAA-WBAP

**M**ANY articles have been written concerning cures for TVI. This type of interference is caused by the TV set receiving a signal from an amateur station or other source that interferes with either the sound or picture of the TV set. Cures vary from the use of low- and high-pass filters to asking the amateur to get off the air.

Very little is heard, however, about the many cases of AMI (amateur interference) caused by incorrectly operating TV sets. These receivers not only cause trouble in the short-wave receivers used at ham stations but interfere with reception of broadcast stations on standard home receivers.

The author's set was especially plagued by such interference. Within a block of his home, he could start picking up interference on his car radio from the household TV receiver. This interference took the form of various oscillations up and down the broadcast band.

On the short-wave receiver interference was especially bad on the 75-meter band where oscillations occurred about every 15 kc. on the dial. Knowing that these oscillations were produced in the horizontal section of the TV set, the author set about trying to get rid of these unwelcome signals. Complete shielding of the horizontal oscillator-discharge tube and the horizontal output tube and circuits had absolutely no effect.

Next a regular a.c. line filter was used on the a.c. plug with the same results. A good ground was also tried. Then quite by accident the author brought his hand near the wires going to the horizontal and vertical deflection yoke coil while his other hand was touching the chassis. This brought about a very slight decrease in the signal being radiated by the TV set.

This was the answer to the problem! Taking a long length of plastic covered wire, one end was grounded to the picture tube support while the rest of the wire was wound around the wires leading to the yoke coils. After covering the wires completely with the plastic covered wire, the other end was grounded to the TV chassis. This completely cured the trouble.

There are no more unwanted signals. The undesirable signals were being radiated from the one-foot cable of wires leading to the yoke coils. Of course, a braided shield could have been used but the system adopted was quicker, cheaper, and simpler.

A new regulation has been formulated by the FCC concerning undesirable radiation from home appliances and TV sets. Meanwhile, it is hoped that this suggestion will be helpful to others who have TV sets that are radiating unauthorized signals. -30-



# What's New in Radio

## BUTTON HEARING AID

Busse Electronics Company, 1133 E. Lawson Ave., St. Paul 6, Minn., is now marketing a miniature, self-contained, one-piece hearing aid which incorporates several interesting electronic features and employs the latest sub-miniature assembly techniques.

The unit is transistorized and is powered by the miniature battery shown in the foreground of the photograph. A control on the base of the amplifier permits the user to set the level of his choice. No electronic tone control has been incorporated in the

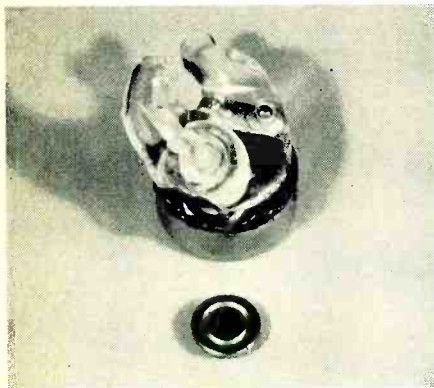

instrument although such variations are possible by selecting receiver response and by varying the size of the hole through the mold.

Mounting of the hearing aid onto the custom ear mold is included in the retail price which runs approximately \$100.00.

Write the manufacturer direct for additional details on this unit.

## TELEPHONE PICKUP

Lafayette Radio, 100 Sixth Ave., New York 13, N. Y., is now offering a four-transistor telephone pickup which features class "B" push-pull output for efficient speaker operation.

Catalogued as the KT-95 kit, the circuit is designed with transformer

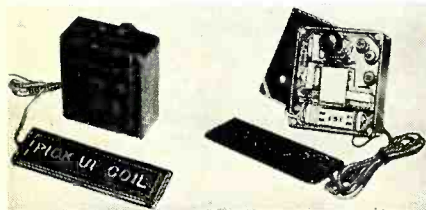

coupling between input, driver, and push-pull output stages for maximum efficiency. The unit may also be used as a portable amplifier for magnetic and crystal phono inputs as well as microphone crystal and magnetic inputs. The unit, when assembled, measures 3 1/8" x 2 3/4" x 1 1/8". The kit comes

November, 1956

RADIO • TELEVISION • INDUSTRIAL ELECTRONICS

# THIS professional TRAINING IS THE KIND THAT Really Pays Off!

... and it costs only a fraction of what you might expect to pay!

**FIX ANY RADIO OR TV SET EVER MADE...easier...better...faster**

Backed by the how-to-do-it methods so clearly explained in this one big 822-page book, you'll be prepared for fast, accurate service on any radio or television receiver ever made.

Radio & Television TROUBLESHOOTING AND REPAIR by Ghirardi & Johnson is far and away the world's most modern, easily understood guide. Step by step, it takes you through each service procedure... from locating troubles with less testing to repairing them promptly by fully-approved professional methods... the kind that enable you to handle tough jobs as slick as you now do the easy ones.

Best of all, the cost is only \$6.75 (or see money-saving combination offer in coupon).

## COMPLETE SERVICE TRAINING

For beginners, this giant book is a complete training course. For

experienced servicemen, it is an easy way to "brush up" on specific jobs; to develop better methods and shortcuts and to find fast answers to tough jobs.

Here are just a few of the subjects covered: Components and Their Troubles; Basic Troubleshooting Methods; "Static" and "Dynamic" Testing; Practical Troubleshooting Tips and Ideas; AC/DC, 3-way Portable and Battery Set Troubleshooting Problems; Servicing Communications Receivers; a Complete Guide to Television Service; AM, FM, and TV Realignment Made Easy; Resistor, Capacitor, Inductor and Transformer Problems; Servicing Tuning, Selector and Switching Mechanisms; Loudspeakers; Servicing Recorders and Record-playing Equipment... and dozens more! 417 illustrations. Read TROUBLESHOOTING AND REPAIR for 10 days AT OUR RISK!

**LEARN BASIC CIRCUITS FULLY... and watch service "headaches" disappear**

It's amazing how much easier and faster you can repair radios, television sets and even industrial electronic equipment when you know all about circuits and what makes each one "tick."

You locate troubles in a jiffy because you know what to look for and where to look.

You make repairs lots faster, better and more profitably!

Actually, there are only a comparatively few BASIC circuits in modern equipment. Radio & Television RECEIVER CIRCUITRY AND OPERATION by Ghirardi and Johnson gives you a complete understanding of these as well as their variations. It teaches you to recognize them... to understand their peculiarities and likely "troubleshooting"... and shows how to eliminate useless testing and guesswork in making repairs.

## LEARN MORE—EARN MORE!

Throughout, this 669-page book with its 417 clear illustrations gives you the kind of above-average professional training that fits you for the better, big pay jobs in either servicing or general electronics.

Covers all circuits in modern TV and radio receivers, amplifiers, phono-pickups, record players, etc.

Price only \$6.50... or see money-saving offer in coupon. Examine it 10 days at our risk!

The books that REALLY SHOW YOU HOW!

More radio-TV technicians have trained from Ghirardi books than any others of their kind! Almost 1300 pages and over 800 pictures and diagrams in these two new books explain things so clearly it's next to impossible for you to go wrong. Each book is strictly up-to-the-minute... NOT a re-hash of old, out-moded material.

**FREE EXAMINATION...easy terms!**

Dept. RN-116, RINEHART & CO., INC.  
232 Madison Ave., New York 16, N. Y.

Send books indicated for FREE EXAMINATION. In 10 days, I will either remit price indicated plus postage or return books postpaid and owe you nothing.

Radio & TV TROUBLESHOOTING AND REPAIR (Price \$6.75)  Radio & TV CIRCUITRY AND OPERATION (Price \$6.50)

COMBINATION OFFER... Both books only \$12.00 (Regularly price separately \$13.25... you save \$1.25)

(Combination offer is payable at rate of \$3 (plus postage) after 10 days if you decide to keep books, and \$3 a month thereafter until \$12 has been paid.)

Name.....  
Address.....  
City, Zone, State.....  
OUTSIDE U.S.A. \$7.25 for TROUBLESHOOTING & REPAIR; \$7.00 for CIRCUITRY & OPERATION; \$13.00 for both books; Cash with order, but money refunded if you return books in 10 days.



**SAVE \$1.25**  
Make your training library complete! Get both these big books at the low price of only \$12.00 for the two (you save \$1.25).

**POWER TRANSFORMER BARGAIN**

Primary 115 V. 60 cy. Sec. 425-0-425V  
 @ 200 ma., 6.3 V. @ 5 amp., \$3.99  
 5 V. @ 4 amp. Standard mounting, 2 for \$7.50 ca.

**POWER SUPPLY KIT TRANSFORMER**

as described above plus 1-shielded 6  
 Hy. 200 MA choke and 2 oil condens-  
 ers 10 MFD, 600 VDC. \$6.75 ca.

**G.E. MIDGET POWER SUPPLY**

115V. 60 cy. input. Delivers 135 VDC  
 @ 50 MA and 6.3 V. @ 1 amp. Well fil-  
 tered. Ideal for B eliminator for port-  
 ables, pre-amps, etc. Complete with rec-  
 tifier and line cord. \$3.95 ca.

**OIL CONDENSER** .001 15,000 VDC  
 4x4x4 MFD Ceramic Condenser  
 600 VDC. \$95c Low-loss 2 for 99c

**WESTERN ELECTRIC** FREQUENCY METER  
 Stepping relay 44 steps, DUAL, 58.62 CPS. 48-  
 6-12 Volt \$4.95 52 CPS \$14.50  
 coil. 3"

**6 VOLT DYNAMOTOR** 6 VOLT DYNAMOTOR  
 400 Volts @ 175 Mills out. 600V @  
 Small size. \$9.95 150 ma. \$9.95

**2 Mfd 4000 VDC** 0-50 MICROAMP METER  
 Oil Condenser Ceramic Ins. 2" Round BRAND NEW. \$4.95  
 \$2.95 ea. 2 for \$5.90

**115 V. 60 CY. SELSYNS**  
 High torque. BRAND NEW in original  
 wrappings. Made for Western Electric. \$5.95  
 2 for \$9.50

**4" SQUARE METER**  
 0-25 Microamperes, illuminated, VSWR scale.  
 BRAND NEW. \$9.95  
 GOVT. SURPLUS. ea. \$9.95  
 As above 25-0-25 microamps 3" \$9.95 ea.

**VISIT OUR STORE FOR UNLISTED BARGAINS**

**G. E. RELAY CONTROL**

(Ideal for Model Controls, Etc.)  
 Contains a sigma midget 8,000 ohm. relay (trips at  
 less than 2 MA), high impedance choke, bi-  
 metal strip, neon pilot and many useful parts. The  
 sensitive relay alone is worth much more than the  
 total low price of \$1.10 Each 10 for \$9.25  
 FREE Model Control Book with Purchase of 10.

**COAX ANTENNA SWITCH**

RF relay with low loss ins. Switches to either of 2  
 type 831R coax receptacles. Latching device re-  
 moves voltage after actuated, permitting operation  
 from 12 volts DC to 115 AC. Mounted in 14-95  
 aluminum case. Terrific Value. \$1.95  
 2 for \$3.50

**12-14 VOLT DYNAMOTOR** 12 VOLT DYNAMOTOR  
 375 Volt at 150 Ma. 425 Volts @ 200  
 with Filter \$4.95 Ma. Cont. \$9.95  
 Duty.

**MOBILE DYNAMOTORS**

5.5 to 6 VOLT DC INPUT  
 INT. CONT. DUTY FILTER PRICE  
 OUTPUT DUTY DUTY FILTER PRICE  
 400 VDC 275 Mills 175 Mills with \$19.95  
 400 VDC 300 Mills 200 Mills less 14.95  
 425 VDC 375 Mills 275 Mills less 24.50  
 11.5 to 12 VOLT DC INPUT  
 400 VDC 275 Mills 175 Mills with 12.95  
 625 VDC 225 Mills 175 Mills less 11.75

**PANEL METERS**

**WESTON, G.E., SIMPSON, etc.**  
 2" METERS 3" METERS  
 0-100 Microamp. \$4.95 0-10 Milliamp. \$2.95  
 150-0-150 Microamp. 4.95 0-150 Milliamp. 3.95  
 0-150 Microamp. 4.50 0-200 Milliamp. 3.95  
 0-1 Milliamp. 3.95 0-300 Milliamp. 3.95  
 0-1.5 Milliamp. 2.95 0-500 Milliamp. 3.95  
 0-5 Milliamp. 2.95 10-0-10 Amp DC. 2.95  
 10-0-10 Amp DC. 2.95 0-15 Volts AC. 4.95  
 D8 0 to +15. 2.95 0-15 Amps DC. 2.95  
 0-300 Volt AC. 3.95

**OIL CONDENSER BARGAINS**

1 mfd 600 VDC .25	8 mfd 1000 vdc. \$1.35
2 mfd 600 VDC .45	12 mfd 1000 vdc. 1.59
4 mfd 600 vdc. .75	6 mfd 1500 vdc. 1.95
8 mfd 600 vdc. .95	2 mfd 2000 vdc. 1.50
10 mfd 600 vdc. .95	3 mfd 2000 vdc. 2.25
1 mfd 1000 vdc. .60	4 mfd 2000 vdc. 2.95
2 mfd 1000 vdc. .75	1 mfd 3000 vdc. 1.85
4 mfd 1000 vdc. 1.25	2 mfd 10KV DC. 27.50

**BIG BARGAINS IN LITTLE TUBE**

Kit of 25 WIRE WOUND RES. 5 to 50 watt. \$1.95  
 Kit of 10 TRANSMITTING MICAS. 1.00  
 1 amp. MERCURY SWITCH 59c ea. 2 for 1.00  
 500 MWF CERAMIC CONDENSERS. .10 for .50  
 15 MEG 1% METER MULTIPLIER. 1.49  
 1 MFD 400VDC OIL COND. .10 for .95

Min. Order \$3.00—25% with order F.O.B. New York  
 10 DAY GUAR. PRICE OF MDSE. ONLY

**ADVANCE**

**ELECTRONICS COMPANY**  
 6 WEST BROADWAY, NEW YORK 7, N. Y.  
 Phone WOrth 4-2526

complete with all parts except the in-  
 duction coil.

**VOLTAGE CALIBRATOR KIT**

Heath Company, Benton Harbor, Mich., has engineered a new voltage  
 calibrator which is being offered in kit  
 form as the Model VC-3.

The new instrument produces near-  
 perfect square wave signals of known  
 amplitude. Precision 1% attenuator



resistors insure accurate output ampli-  
 tude while the multivibrator circuit  
 guarantees good, sharp square waves,  
 as distinguished from clipped sine  
 waves.

The output frequency is approxi-  
 mately 1000 cps. Fixed outputs, se-  
 lectable by means of a front panel  
 switch, are: .03, .1, .3, 1, 3, 10, 30, and  
 100 volts peak-to-peak. The instru-  
 ment allows measurement of unknown  
 signal amplitudes by comparing the  
 known peak-to-peak output of the unit  
 on an oscilloscope.

Write the manufacturer for full  
 specifications and price on this new  
 kit.

**TV REMOTE CONTROL**

The Alliance Manufacturing Com-  
 pany, Inc., of Alliance, Ohio, has re-  
 cently introduced a compact, portable,  
 and easy-to-connect remote control  
 tuner which is designed to fit prac-  
 tically any make of TV receiver.

Tradenamed "It," the new unit  
 comes complete with all necessary



parts, housed in a self-display carton.  
 There are no wires to connect and no  
 tools are required. "It" changes chan-  
 nels and tunes each channel. It will  
 operate up to 20 feet away from the  
 set. Pressure on the channel selector  
 and tuning bar switches stations.

The unit, which is housed in a non-  
 breakable plastic case, is electrically  
 powered by a d.c. reversible motor

which turns the channel switch in  
 either direction. Current is supplied  
 by leakproof, long-life batteries.

Write the company direct for details  
 on this fully-guaranteed, inexpensive  
 accessory unit.

**HALF-INCH CAMERA TUBE**

The Tube Division of Radio Corpora-  
 tion of America, Harrison, N. J., is  
 now distributing developmental sam-  
 ples of its new one-half-inch vidicon  
 camera tube for use in lightweight,  
 miniature transistorized TV cameras,  
 to manufacturers of such camera de-  
 vices.

The tube, which is 3" long and 1/2" in  
 diameter, has greater sensitivity to  
 light than the standard 1" vidicon cam-  
 era tube used in present industrial TV  
 systems and TV film cameras. This is  
 due, in part, to its improved light sen-  
 sitive photoconductive layer. In addi-  
 tion, the tube has been designed with  
 a heater that minimizes battery drain  
 in order to meet the requirements of  
 small experimental transistorized bat-  
 tery-operated TV cameras.

**COMMUNICATIONS RECEIVER**

Gonset Co., 801 S. Main St., Bur-  
 bank, Calif., has designed a completely



new communications receiver especial-  
 ly for amateur mobile applications.

The G-66 covers six bands, including  
 standard broadcast, each amateur  
 band being individually calibrated and  
 spread across the easy-to-read, slide-  
 rule-type dial scale. A rotating drum  
 exposes only the dial scale for the  
 band selected.

The bands included in the receiver  
 are .54-2 mc.; 3.5-4 mc.; 7-7.3 mc.;  
 14-14.35 mc.; 21-21.45 mc.; and 28-29.7  
 mc. Operating voltages are 6 or 12  
 volts d.c. or 115 volts a.c. The power  
 supply is factory set for specified 6 or  
 12 volt operation.

The receiver measures 4 1/2" high,  
 6 1/2" wide, and 9" deep. The power  
 supply measures 4 1/2" high, 6 1/2" wide,  
 and 4 3/8" deep. Write the company di-  
 rect for full electrical specifications.

**"ARMCHAIR HAMSHACK"**

Morrow Radio Manufacturing Co.,  
 2794 Market St., Salem, Ore., is mar-  
 keting a new triple-duty amateur rig  
 which is equally at home in the living  
 room, automobile, or in portable appli-  
 cations.

Less than one cubic foot of space is

required for all three pieces of equipment comprising the rig. The company has built the unit into a modern step-shelf and table which is available in a

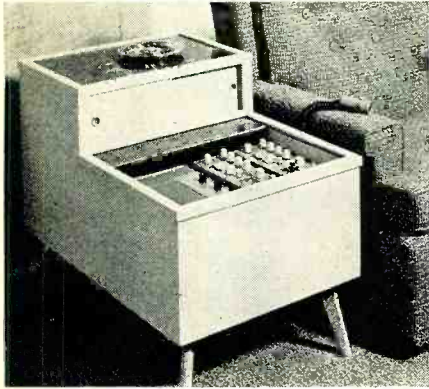

variety of furniture finishes. The sliding top can be closed when the equipment is not in use. A separate compartment under the shelf has been provided for a Conelrad monitor. This space also provides room for the station log and microphones.

The transmitter is the company's MB-560A, the receiver is the MBR-5, while the speaker and power supply unit has been designated as the RTS-600S.

Write the company direct for specifications on the complete package or the individual components comprising the rig.

#### MINIATURE TV CAMERA

*Majestic International Corporation*, 743 N. LaSalle St., Chicago 10, Ill., is handling the U. S. distribution of the West German-built miniature television camera which is being marketed as the "Peepsqueak."

The new cigar-shaped camera is less than 6" long and measures only 1 7/8" in diameter. Its miniature size permits thorough inside inspection of previously inaccessible areas. Equipped with two sets of spring-loaded guide rollers, it can travel through pipes, tubing, walls, etc., that have an inner diameter of 2 3/8" or more and a bending radius of a mere 14".

This remote controlled unit contains a mini-resistor and a number of sub-miniature tubes that serve as ampli-

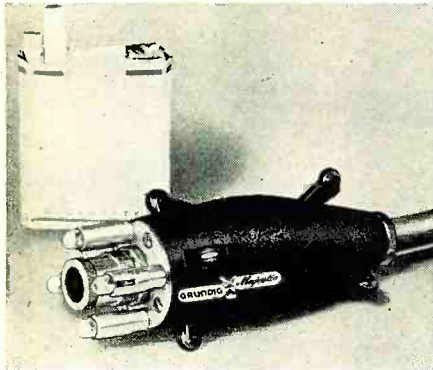

fying elements. A conical mirror accessory may be mounted 3/4" ahead of the lens combination to reflect the image of the inside walls. The image received can be magnified up to 20

November, 1956

# BEST BUY IN HI-FI

## Grommes



### 10PG 10 Watt High Fidelity Amplifier

Here is new styling with a full set of controls providing exceptional flexibility in a moderately priced amplifier. A simple efficient flat compact design features modern feedback circuitry, record compensator, loudness control, wide range bass and treble controls, rumble and scratch filters, and six inputs, including one for tape head. Frequency Response:  $\pm 0.5$  DB. 20 to 20,000 CPS. Distortion: 2% harmonic and 3% intermodulation at 10 watts.

Net Price to user.....57.50

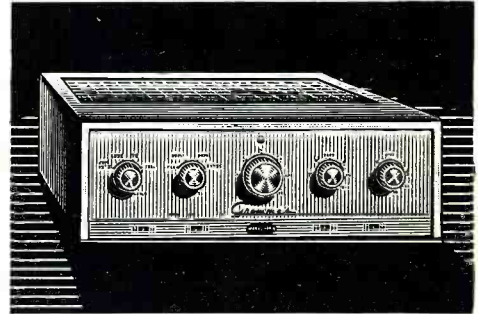

### 15PG 12 Watt High Fidelity Amplifier

The best buy in the medium priced field. The all new deluxe 15PG features the most advanced circuitry, the highest quality components and greater flexibility of controls. It features feedback throughout, separate turnover and roll-off record compensators, new loudness control, wide range bass and treble controls, rumble and scratch filters, and six inputs including tape head. Frequency Response:  $\pm 0.5$  DB. 20 to 30,000 CPS. Distortion: 1% harmonic and 2% intermodulation at 12 watts.

Net Price to user.....69.50

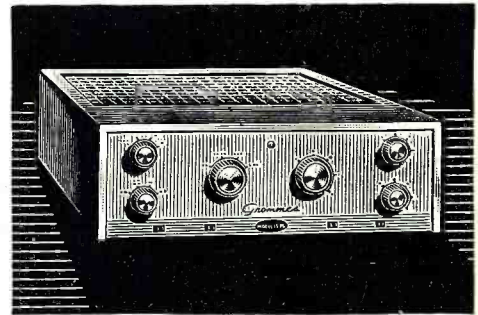

### 20PG 20 Watt High Fidelity Amplifier

An all new amplifier featuring new styling, advanced circuitry and greater control flexibility. The 20PG incorporates feedback throughout and has all the new features of the deluxe 15PG plus higher power in the output stage. Frequency Response:  $\pm 0.5$  DB. 15 to 30,000 CPS. Distortion: 1% harmonic and 2% intermodulation at 20 watts. Cabinet in charcoal gray with brushed brass trim and front panel.

Net Price to user.....89.50

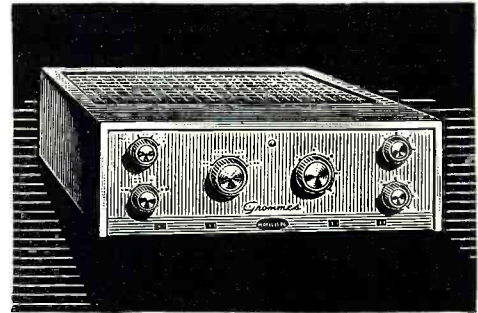

**GRT-3 HIGH FIDELITY FM-AM TUNER**—A matching FM-AM Tuner for Grommes amplifiers and pre-amplifiers. Tuning is simplified by flywheel drive, tuning meter and AFC on FM. Circuit consists of tuned RF stage on FM and AM, dual limiters, wide band IF coils with high sensitivity and cathode follower audio stage. Net Price to user.....129.50

See the Grommes Hi-Fi Dealer in your area or write

Ask your dealer to also show you the Grommes Premier 212, a new deluxe equalizer pre-amplifier control center and the Premier 260, a new 60 watt basic amplifier. If your dealer cannot help you, write for complete details and where to buy.

**Grommes** Div. of Precision Electronics, Inc.  
Dept. R-11, 9101 King Avenue  
Franklin Park, Illinois

Send Free Hi-Fi Equipment Brochure.

Name.....

Street.....

City.....Zone.....State.....

# CRYSTAL Manufacturing Headquarters

Over 11,000,000 quartz blanks in stock —let our experienced technicians grind and etch to your exact frequency needs.



Our laboratory contains the latest equipment, including General Radio Primary Frequency Standard and electronic counters to insure accuracy as specified below.

## SPECIAL CRYSTALS

In FT-243 holders with 1/2" pin spacing. From 1500 to 9500 kc.  
 .05% tolerance \$1.35 ea. .01% tolerance \$1.50 ea.  
 .005% tolerance \$2.50 ea.  
 In DC-34 holders with 3/4" pin spacing. From 1100 to 8500 kc.  
 .05% tolerance \$1.35 ea. .01% tolerance \$1.50 ea.  
 .005% tolerance \$2.50 ea.

## NOVICEBAND

80 meters within 1 kc of specified frequency—3701 to 3749 kc in DC-34 or FT-243 holders—(specify holder wanted) **79¢**

## STOCK CRYSTALS

In FT-243 holders—5675 kc to 8650 kc in 25 kc steps each, **50¢**

## FT-241 LATTICE CRYSTALS

In all frequencies from 370 kc to 540 kc. . . . **50¢**  
 500 kc Crystals. **\$1.00** 455 kc Crystals. **\$1.00**

## STOCK CRYSTALS

Send postcard for free list of frequencies. FT-241, DC-34, FT-243, FT-171, each **50¢**

## 40 METERS

From 7152 to 7198 kc within 1 kc of specified frequency in FT-243 holders only **79¢**

2-6-10-15-20-40-80 Meter Ham Bands in DC-34 or FT-243 holders (specify holder wanted) **79¢**

## JOBBER & MANUFACTURERS

Write For Quantity Prices & Catalog

# Texas Crystals

The Biggest Buy in the U.S.

8538 W. GRAND AVENUE · RIVER GROVE, ILL.  
 ALL PHONES — GLADSTONE 3-3555

Terms: All items subject to prior sale and change of price without notice. All crystal orders MUST be accompanied by check, cash or M.O. WITH PAYMENT IN FULL. NO C.O.D.s. Postpaid shipments made in U.S. and possessions only. Add 5¢ per crystal for postage and handling charge.

times since focal length of the lens system is only 1/2".

## ETCHED-CIRCUIT SCOPE KIT

Heath Company of Benton Harbor, Mich., has improved its popular Model O-10 oscilloscope kit and is now offering the new version as the Model O-11.

The new unit incorporates all of the features of its predecessor model plus improved vertical linearity, better sync

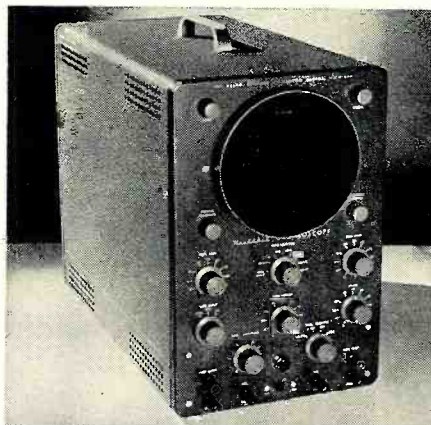

stability (especially at low frequency), and improved over-all stability of operation (including less vertical bounce with changes in level).

These circuit improvements make it ideally suited for color TV servicing and for critical observations in the electronic laboratory. Response is down only 1 1/2 db at 3.58 mc. The 11-tube circuit features a 5U1 cathode-ray tube. The sync circuit functions effectively from 20 cps to better than 500 kc. in five steps.

Modern etched circuit boards cut assembly time, insure excellent circuit stability, and precludes errors in assembly.

## "LITTL-LYTICS" AVAILABLE

Sprague Products Company, 51 Marshall St., North Adams, Mass., is now marketing its hermetically sealed aluminum electrolytic capacitors through electronic parts jobbers to accommodate the replacement field.

The "Littl-Lytics" were originally developed for military and computer equipment. They are ideal for replacements in transistor radios, hearing

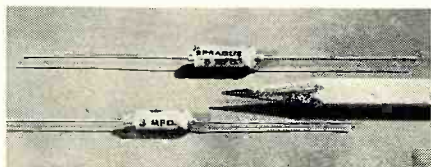

aids, pocket-sized wire recorders, and all other miniature electronic units.

The capacitors range in size from 3/16" diameter by 3/16" long to 3/8" diameter by 7/8" long. All have ultra-low leakage current and exceptionally long shelf life, according to the company. Values range from 1 µfd. to 200 µfd. in voltages from 1 to 50 volts d.c.

## FLYBACK-YOKE TESTER

Radio City Products Co., Inc., Center & Glendale Sts., Easton, Pa., is now in production on a new flyback

Give  
your  
friends

RADIO &  
TELEVISION  
NEWS

this  
Christmas!



What more thoughtful gift to friends than a subscription to RADIO & TELEVISION NEWS this Christmas!

You'll be giving 12 full months of enjoyment . . . all the excitement of the wonderful world of electronics.

For no other magazine covers the field more completely, more authoritatively than RADIO & TELEVISION NEWS. No wonder it's the leading electronics magazine in the world . . . read by over a half-million technicians, amateurs, and advanced electronics hobbyists each month.

No gift is more practical . . . more thoughtful than one that keeps arriving every month. Make that gift RADIO & TELEVISION NEWS this year!

## SPECIAL GIFT RATES

First 1-year gift subscription . . . . . \$4.00  
 Second 1-year gift subscription . . . . . \$3.00  
 Each additional 1-year gift . . . . . \$2.00

Each gift subscription will be announced by an attractive card naming you as donor.

Fill in and return the prepaid, self-addressed envelope facing this page for your own and gift subscriptions. List additional gift orders on an extra sheet of paper.

(Your own new or renewal subscription may be included.)

## RADIO & TELEVISION NEWS

366 MADISON AVENUE  
 NEW YORK 17, N.Y.



RADIO & TELEVISION NEWS

transformer and yoke tester with a capacitor tester feature included.

Five easy reading scales include a separate scale for yokes and one for capacitors. The instrument will test all flybacks, yokes, and capacitors without disconnecting them from the



circuit or tests them individually. Tests are made at operating conditions of about 200 volts of pulsed power. All TV flybacks used in color sets can also be tested.

The illuminated meter-picture frame type steel case measures 10" x 6" x 5" and weighs 8 pounds. The unit comes with tube, leads, and complete operating instructions.

#### SOLID ELECTROLYTE BATTERY

Ray-O-Vac Company of Madison, Wis., has developed a new solid electrolyte dry battery which is recommended for applications in instruments that require high voltage with low current drains. Dosimeters, Geiger counters, and other radiological instruments would be naturals for this battery.

The new battery provides a current of one-one-hundred millionths of an ampere. It can be furnished in practically any voltage and its compactness can be demonstrated by the fact that the 50-volt version measures only 3/8" by 2". Even smaller sizes will be available.

Shelf life of the solid electrolyte battery is estimated at more than 10 years. Leakage is eliminated and stable operating voltages are maintained over a temperature range of minus 65 degrees to 165 degrees F.

#### DIAL-ILLUMINATOR KIT

National Company, 61 Sherman St., Malden 48, Mass., has recently introduced a new version of its MCN dial which is available with a dial illuminator kit as optional equipment.

The illumination feature adds to the utility of the MCN, which is scaled down for use in mobile installations and small converters and tuners. The illuminator is bracket-mounted to the output coupling so that the 6.3 volt #51 panel light rotates behind the scale with the pointer over the dial face. Thus the pointer is constantly illuminated for easy, accurate reading.

The dial features three blank calibrating scales and a 0-100 logging

November, 1956

## THE NEWEST, MOST COMPLETE BOOK ON

# TRANSISTORS AND THEIR USE

## "TRANSISTOR CIRCUIT HANDBOOK"

by Louis E. Garner, Jr.

The complete, authoritative book on Transistors. Clearly presented in four sections: Part I—"Laboratory Practice"—covers Transistor types, construction, characteristics, etc.; techniques for wiring and testing, tools and test equipment required, etc.; components for use with Transistors. Part II—"Basic Circuits"—covers amplifiers, oscillators and dozens of special purpose circuits. Part III—"Circuit Applications"—audio, R.F., test instruments, and a wide variety of controls and gadgets. Part IV—"Reference Data"—Transistor characteristics charts; manufacturers; definitions and design formulas; special techniques and new developments; complete bibliography. The outstanding book on Transistors. 430 pages; profusely illustrated; 5 1/2 x 8 1/2" case bound. Order today, postpaid only . . . . . \$4.95

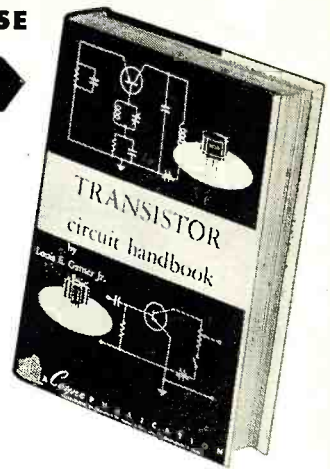

**SAMS BOOKS**  
keep you ahead in  
**ELECTRONICS**

### USE HANDY ORDER FORM BELOW

Sams books cover every phase of Electronics for the service technician, engineer, student or experimenter. Listed below are a few of the many valuable Sams books available at electronic parts distributors and leading book stores.

### USE THIS ORDER FORM

#### TRANSISTOR CIRCUIT HANDBOOK . . . . . \$4.95

- Color TV Training Manual.** Prepares the Technician for Color TV service work. Covers principles of the Color TV system; Color receiver circuits; installation and servicing sets. Includes color blocks outlining the use of color test equipment. 260 pages; 8 1/2 x 11"; 300 illustrations. . . . . \$6.95
- TV Test Instruments.** Revised and enlarged to include latest data on instruments used in Color TV servicing. Tells clearly how to operate each type of test instrument used in TV service work. 180 pages; 8 1/2 x 11"; illustrated. . . . . \$3.50
- Key Checkpoints in TV Receivers.** Prepared by the Howard W. Sams engineering staff. Provides many applications for general TV service work, including time-saving information on how to make quick tests at key points to determine where trouble lies, and how to check overall performance of the receiver after repair, to insure against callbacks. 182 pages; 5 1/2 x 8 1/2"; illustrated. . . . . \$2.00
- Analyzing and Tracing TV Circuits.** Presents a new approach to TV servicing. 168 pages, 8 1/2 x 11" . . . . . \$3.00
- Photofact Television Course.** Gives a clear complete understanding of TV principles, operation, practice. Used by thousands of students. 208 pages, 8 1/2 x 11" . . . . . \$3.00
- Radio Receiver Servicing.** Covers the basic receiver types—gives time-saving hints for solving basic troubles, such as dead set, weak set, noisy set, etc. 192 pages; 5 1/2 x 8 1/2" . . . . . \$2.50
- TV Servicing Guide.** Explains how to apply proper trouble-shooting procedures based on analysis of symptoms (most of which are illustrated by picture-tube screen photos). Shows how to locate and eliminate trouble in every section of the receiver. 132 pages, 8 1/2 x 11" . . . . . \$2.00

- Tape Recorders—How They Work.** Explains recording theory, tape characteristics, motorboard mechanisms, drive motors, amplifiers, magnetic heads, volume indicators, equalization circuits—covers everything you want to know about recorders. 176 pages; 5 1/2 x 8 1/2". . . . . \$2.75
- Servicing AGC Systems.** Describes the operation and circuit variations of the various types of AGC systems and explains the servicing techniques that can be applied. Illustrated by actual case histories and photographs of symptoms. 132 pages; 5 1/2 x 8 1/2"; illustrated. . . . . \$1.75
- Servicing & Calibrating Test Equipment.** Shows you how to keep your test instruments in reliable working order, how to determine proper operation and avoid erroneous indications. Explains calibration procedures; gives method for performance record-keeping; shows simple ways to check instrument accuracy; describes proper maintenance and servicing of instruments. 192 pages, 5 1/2 x 8 1/2" . . . . . \$2.75
- So You Want to Be a Ham.** Tells you what you need to know about getting your license and acquiring equipment. Covers such subjects as: Conquering the Code; Getting Your Ticket; Going on the Air; Electronics as a Career; etc. 196 pages; 5 1/2 x 8 1/2"; illustrated. . . . . \$2.50
- Servicing TV Sweep Systems.** Describes the operation, circuit function and circuit variations of vertical and horizontal sweep systems common to most TV receivers. Tells how to analyze circuits; trouble-shoots for you. 212 pages; 5 1/2 x 8 1/2"; illustrated. . . . . \$2.75

There is an authoritative Sams book on virtually any Electronic subject in which you're interested. Check below for FREE Book List describing all Sams books.

Send Book List



### HOWARD W. SAMS & CO., INC.

Order from your Parts Jobber today, or mail to Howard W. Sams & Co., Inc., Dept. 1-L6 2201 East 46th St., Indianapolis 5, Indiana.

Send books checked above. My (check) (money order) for \$ . . . . . is enclosed.

Name . . . . .

Address . . . . .

City . . . . . Zone . . . . . State . . . . .

(outside U.S.A. priced slightly higher)

Look for  
**SAMS BOOKS**  
on the  
"Book Tree"  
at your Parts  
Distributor

We're looking  
for...

**ENGINEERS**  
**OPERATIONS  
CONTROLLERS**  
**ELECTRONIC  
TECHNICIANS**

to train for  
guided missile operation  
control positions

Intensive training course in co-ordination of guided missile launch operations will be given successful applicants.

Qualified applicants should have experience or knowledge in one of the following fields: Aircraft Operation, Communications or Flight Control, Radar, Telemetry, Timing, GCA or Navy C.I.C.

Positions located in Florida and outside continental limits of the U.S.A. on the Air Force Missile Test Range.

Starting salary \$6500-\$7500 per annum, 30% bonus if selected for out of country assignment. Relocation expenses allowable.

Send resume to: Technical Manager, Industrial Relations



**PAN AMERICAN WORLD AIRWAYS, INC.**  
GUIDED MISSILES RANGE DIVISION  
PATRICK AIR FORCE BASE, FLORIDA

scale. Over-all measurements of the dial with illuminator are 3 7/8" wide, 2 3/4" high, and 1 1/4" behind the panel. Full information may be obtained from the manufacturer direct.

**TRANSISTOR RADIO KIT**

A "do-it-yourself" transistorized radio kit is now being marketed by *Sylvania Electric Products Inc.* especially for the hobbyist, experimenter, and those interested in constructing their own radio gear.

The kit contains six of the company's transistors, a crystal diode, and a 40-page manual including instructions for making the radio and 20 other practical items such as amplifiers, oscillators, broadcast receivers, ham radio components, test instruments, etc.

The kit has three 2N35's, three 2N94's, and one 1N34A crystal diode. When used in connection with the recommended parts, a variety of circuits can be constructed.

**TRANSISTOR TESTER KIT**

*Kit-Tronics*, 2315 Hendola Drive, N. E., Albuquerque, N. M., is now offering a transistor tester which is available in either kit or wired-and-tested form.

The Model TT-2 features a 4 7/8" two per-cent meter and  $\pm 1\%$  precision components. The ranges include current gain *beta* 0-100 and 0-300, an expanded *alpha* scale .50 to .99, and leakage. The unit measures *p-n-p* and *n-p-n*

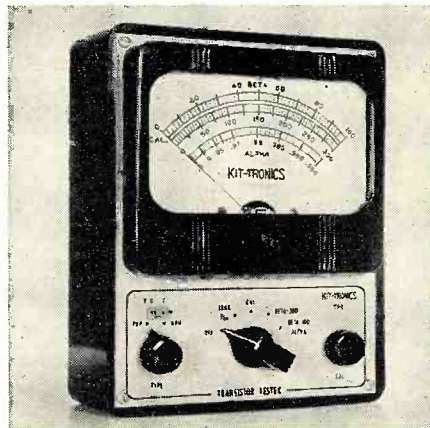

transistors as well as crystal diodes. It is self-contained, self-calibrating, and operates on inexpensive flashlight batteries.

In kit form the panel comes punched, lettered, and finished. Completed step-by-step, easy-to-follow assembly instructions plus operating procedures are included in a 17-page manual which accompanies the kit.

Write the company for full information on the tester in either kit or wired form.

**CAR RADIO TRANSISTOR**

*Sylvania Electric Products Inc.* has introduced a new hermetically sealed power transistor which has been especially designed for auto radio receiver applications.

Designated as the 2N242, the new transistor is competitively priced with

**COAXIAL CONNECTORS**

83-1AP	.. \$0.30	83-1SPN	.. \$0.50	UG-58/U	.. \$0.65
83-1B	.. 1.10	83-1T	.. 1.30	UG-88A/A	.. .75
83-1H	.. 12	83-168	.. 1.30	UG-280/U	.. .75
83-1J	.. .73	83-185	.. 1.12	UG-260/U	.. .65
83-1K	.. .40	UG-218	.. .85	UG-278/U	.. 1.95
83-1P	.. .40	UG-238U	.. 1.10	UG-280/U	.. .65

**SWISS PRECISION JEWELERS  
SCREWDRIVER SET**

6 Sizes from 3 to 8 (2 1/2"-3 1/4") Each has swivel top. Set of six. **\$1.69**

**MIDGET PRECISION JEWELERS PLIERS**

Five types—flat, round, & snipnose. Diagonal cutters & end nippers. Sizes 4" to 4 3/4". Complete set in plastic Tool Roll. Imported. . . . per kit **\$4.95**

**LITTLE GIANT FIRE EXTINGUISHER.** Ideal for workshop, car or home. Safe for Electrical fires. Aerosol Pressure Can, push button action. 4 for \$5.00; ea. **\$1.49**

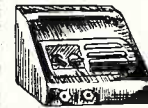

**ICA Deluxe  
SIGNA-TONE**

Model 4300  
Brand New Audio Oscillator & Code Practice Set. Reg. **\$7.95**  
net \$15.75... Our Price

**6 Volt DYNAMOTORS Mfd. by Westinghouse** or G.E. Removed from Equip. Guaranteed like new condition.

Input 5.6VDC Output 600V @ 155MA. . . . \$14.95  
Input 5.5VDC Output 380V @ 340MA. . . . \$16.95

**SIGMA 4F 8000 OHM SENSITIVE RELAY.** Pulls in at 1.6 MA release at .75 MA & SPDT 2 AMP contacts removed from new equip. guaranteed. . . . \$4.75 ea.

**0-500 DC MICROAMMETER 2 1/2" Rd. Sun Mfg.** \$4.30 ea.

**0-1 MA DC MILLIAMMETER 3 1/2" Rd. DeJur Model 310.** Scale 0-4KV. \$4.95

**0-800 MA DC MILLIAMMETER 3" Rd. DeJur Model 310.** \$3.35

**BRAND NEW TUBE SPECIALS Guaranteed**

0B2	.. \$0.95	VR-150	.. \$0.85	807	.. \$1.25
5BP1	.. 3.25	211	.. 1.75	807W	.. 1.75
5FP7	.. 1.85	WE249B	.. 3.75	866A	.. 1.25
6J6W	.. .59	WE249C	.. 3.75	872A	.. 2.75
6SN7GTB	.. .79	802	.. 2.25	8020	.. 1.50

**FL-8-A FILTER—1020 Cycle—like new.** \$1.95

**10 HY 400 MA Choke Herm. Sealed.** \$4.88

**NT-6 Storage Battery 6V. 4 Amp Hrs. ea.** \$1.95

**BB-54A Storage Battery 2V. 20 Amp Hrs. ea.** \$1.95

**SEND FOR FREE BARGAIN BULLETIN**

TERMS: Cash with order or 25% deposit—balance C.O.D. Net 10 days to rated accts. All prices net F.O.B. warehouse. Market 7-3999

**ELECTRONIC DISTRIBUTORS**  
**727-29 ARCH STREET**  
**Philadelphia 6, Pa.**

**A U D I O T V TELLS HOW TO ANSWER RADIO T.V. QUESTIONS**  
**3 SERVICE LIBRARY**

HERE IS LATE INFORMATION IN A HANDY FORM FOR TELEVISION AND RADIO REPAIRMEN, SERVICEMEN AND STUDENTS

**AUDELS T.V. RADIO SERVICE LIBRARY—** Highly Endorsed—Over 1500 Pages—1048 Illustrations & Diagrams. 1001 Important Facts & Figures on Modern Television, Radio, Electronic Devices at your finger ends.

**INCLUDES TRANSISTORS & Transistor Circuits, Record Changers, Rectifiers, P.A. Systems, Tape Recorders, Phonograph Pick-ups, F.M., Auto Radio; Radio Compass, Short Wave, Radar, etc.**

**ASK TO SEE IT! IT WILL PAY TO KNOW—** The Basic Principles—Construction—Installation—Operation—Repairs—Trouble Shooting. Shows How to get Sharp, Clear T.V. Pictures. Install Aerials—How to Test. Explains Color Systems, Methods of Conversion, Terms, etc. Includes Ultra High Frequency—Valuable for Quick Ready Reference and Home Study.

**\$6 COMPLETE 2 VOLUMES** Get this Information for Yourself.

**7 DAY TEST—PAY ONLY \$1 A Month**

**MAIL ORDER**  
AUDEL Publishers, 49 W. 23 St., N.Y. 10, N.Y.  
Mail AUDELS T.V. RADIO SERVICE LIBRARY (2 Volumes) \$6 on 7 days free trial. If O.K. it will remit \$1 in 7 days and \$1 monthly until \$6 is paid. Otherwise I will return them.

Name \_\_\_\_\_  
Address \_\_\_\_\_  
Occupation \_\_\_\_\_  
Employed by \_\_\_\_\_

the components it replaces. Its use eliminates the vibrator, power transformer, and associated components in auto sets. Operating at 12 volts, the 2N242 provides 2½ watts of class A output with less than 5 per-cent harmonic distortion.

The transistor also has applications in servo-amplifier and communication equipment where high-powered transistors are required and in military and industrial control equipment.

### RECHARGEABLE BATTERY SET

The Radio Receiver Division of General Electric Company, 1285 Boston Ave., Bridgeport, Conn., has just released a new all-transistor pocket radio which is available with rechargeable batteries good for 10,000 hours of use.

Featured with the recharger carrying case as an accessory are two nickel-cadmium rechargeable cells which fit into the radio in place of standard mercury or carbon penlite batteries and can be re-energized as many as 200 times, simply by plugging into an a.c. house outlet overnight. The radio will operate while recharging, if desired, and will play an average of 50 intermittent hours per charge at medium volume level for a total of 10,000 hours.

The set measures 6¼" x 3½" x 1½" and weighs only 20 ounces including batteries. It uses six transistors, which will drive a speaker at good volume or can be used with earphones for private listening.

### LOW-RANGE OHMMETER

Chicago Industrial Instrument Co., 865 N. Sangamon St., Chicago 22, Ill., is now offering a portable instrument capable of measuring extremely small values of resistance.

The Model 55 "Centi-Low" ohmmeter can be used for detecting shorted windings in transformers, motors, and generators; for locating faulty solder



connections; poor switch and relay contacts; poor grounds; and other low resistance circuit troubles.

There are two ranges in this instrument: .01 ohm low, 5 ohm center, and 5 ohms high; and .02 ohm low, 5 ohms center, and 50 ohms high. Power is supplied by an internal dry battery or in continuous service the instrument

November, 1956

# SAVE WITH "STANDARD" ON RADIO & TV RECEIVING TUBES you can trust!

• INDIVIDUALLY BOXED IN HANDSOME GARTON

We're specially geared to supply the needs of small and large service organizations and dealers, as well as manufacturers of electronic equipment. Our tubes are tested with extreme care. Every tube we ship is GUARANTEED to read "GOOD" even on supercritical new automatic "Do-it-Yourself" Tube Testers! That's why every "STANDARD" tube you buy can be TRUSTED to give dependable, long lasting performance that avoids costly callbacks and builds good will!

GUARANTEED FOR ONE YEAR

Type	Each	Type	Each	Type	Each	Type	Each	Type	Each	Type	Each	Type	Each
0A2	\$.89	3BE6	.51	6AR5	.43	6F6GT	.65	7AD7	1.05	12B4	.68	25AV5	.95
0B2	.88	3BN6	.99	6AS5	.55	6H6GT	.56	7AF7	.64	12BA6	.50	25BQ6GT	
0C3	.94	3BY6	.55	6AS7G	4.50	6J5GT	.44	7AG7	.64	12BA7	.66		1.06
0D3	.90	3BZ6	.55	6AT6	.42	6J6	.68	7AH7	.64	12BB6	.52	25L6GT	.53
1A5	.49	3CB6	.60	6AU4GT	.74	6J7	.70	7AJ7	.70	12BE6	.52	25W4GT	.53
1A7GT	.67	3CF6	.64	6AU5GT	.85	6K6GT	.45	7B4	.54	12BF6	.50	25Z5	.64
1A4E	.90	3CS6	.56	6AU6	.47	6K7	.70	7B5	.52	12BR7	.72	25Z6GT	.46
1B3GT	.79	3LF4	.76	6AV5	.94	6K8	.75	7B6	.52	12BQ6	1.03	30	.64
1H4	.41	3Q4	.66	6AV6	.42	6L6G	.88	7B7	.58	12BY7	.77	32L7	.91
1H5GT	.51	3Q5GT	.72	6AX4	.72	6L6GA	.88	7C4	1.05	12BZ7	.76	35A5	.55
1J6	.93	3S4	.62	6B4	.60	6Q7GT	.54	7C5	.56	12CA5	.59	35B5	.54
1L4	.62	3V4	.62	6B8G	.93	6R7	.75	7C6	.50	12J5GT	.48	35C5	.54
1L6	.66	4BQ7A	.92	6BA6	.50	6S4	.52	7C7	.58	12J7	.50	35L6GT	.52
1LA4	.83	4BZ7	1.09	6BA7	.65	6S8GT	.75	7E5	.85	12L6	.58	35W4	.43
1LA6	.80	5AM8	.59	6BC5	.58	6SA7GT	.57	7E6	.65	12Q7	.62	35Z4	.48
1LB4	.82	5AN8	.94	6BC7	.78	6SC7	.63	7E7	.85	12SA7GT	.57	35Y4	.48
1LC5	.79	5AQ5	.51	6BD5GT	.98	6SD7	.55	7F7	.69	12SF5GT	.65	35Z4	.48
1LC6	.79	5AT8	.90	6BD6	.54	6SF5GT	.65	7F8	.97	12SF7	.75	35Z5GT	.43
1LD5	.79	5AV8	.90	6BE6	.52	6SF7	.75	7G7	.85	12SG7	.59	39/44	.59
1LE3	.79	5BK7A	.98	6BF5	.66	6SG7	.55	7H7	.62	12SH7GT	.67	42	.47
1LG5	.79	5J6	.68	6BF6	.43	6SH7GT	.52	7J7	.85	12SK7GT	.55	43	.58
1LH4	.79	5R4GY	1.00	6BG6G	1.47	6SJ7GT	.52	7K7	.85	12SL7GT	.66	45	.55
1LN5	.79	5T8	.85	6BH6	.64	6SK7GT	.56	7L7	.85	12SN7GT	.59	45Z5	.55
1N34	.89	5U4G	.49	6BJ6	.53	6SL7GT	.68	7N7	.62	12SQ7GT	.46	46	.71
1N5GT	.64	5U8	.86	6BK7	.97	6SN7GT	.59	7Q7	.62	12SR7	.50	50A5	.55
1N48	.50	5V4G	.82	6BL7GT	.94	6SQ7GT	.46	7R7	.70	12V6	.52	50B5	.52
1N64	.75	5V6GT	.52	6BN6	.98	6SR7	.46	7S7	.90	12W6	.63	50C5	.52
1R4	.86	5X8	.83	6BQ6GT	1.03	6T8	.85	7V7	.92	14A7	.58	50L6GT	.56
1R5	.62	5Y3G	.42	6BQ7	.93	6U4GT	.61	7X7	.99	14F7	.68	50X6	.56
1S4	.67	5Y3GT	.43	6BY5G	.85	6U5	.72	7X6	.62	14B6	.50	55	.52
1S5	.52	5Y4G	.43	6BZ6	.55	6U8	.86	7Y7	.80	14B8	.70	56	.52
1T4	.62	6A8GT	.68	6BZ7	1.09	6V3	1.09	7X4	.45	14C5	.84	56	.52
1U4	.62	6A8A	.51	6C4	.41	6V6GT	.50	7Z4	.50	14C7	.69	57	.62
1U5	.52	6AC5GT	.81	6C5GT	.60	6V8	.85	12A6	.60	14E6	.69	58	.64
1V	.48	6AC7	.90	6CB6	.57	6W4GT	.50	12AL5	.44	14E7	.84	71A	.65
1V2	.46	6AF4	1.10	6CD6G	1.50	6W6GT	.63	12AQ5	.52	14F7	.69	75	.51
1X2A	.79	6AG5	.59	6CF6	.65	6X4	.40	12AT6	.53	14F8	.99	77	.59
2A7	.69	6AH4	.69	6CG7	.65	6X5GT	.40	12AT7	.75	14H7	.66	76	.49
2B7	.79	6AH6	.89	6CL6	.96	6X8	.81	12AU6	.47	14J7	.85	78	.49
2X2	1.42	6AK5	1.05	6CM6	.70	6Y6G	.64	12AU7	.62	14N7	.76	80	.49
3A4	.51	6AL5	.46	6CN7	.70	6ZY5	.60	12AV6	.42	14Q7	.63	83V	.75
3A5	.90	6AL7GT	.99	6CS6	.56	7A4/XXL		12AV7	.87	14R7	.85	85	.61
3A8GT	.95	6AM8	.95	6CU6	1.15		.58	12AW6	.85	14S7	.81	117Z3	.43
3AL5	.47	6AN8	.95	6D6	.62	7A5	.70	12AX4	.72	19BG6G	1.53	117N7	1.30
3AU6	.51	6AQ5	.52	6DE6	.58	7A6	.56	12AX7	.67	19T8	.86	117Z6GT	.74
3AV6	.42	6AQ6	.46	6E5	.71	7A7	.58	12AY7	2.14	24A	.40	807	1.10
3BC5	.59	6AQ7	.75	6F5GT	.54	7A8	.56	12AZ7	.77				

FREE POSTAGE We'll pay shipping charges on all orders anywhere in U.S.A., accompanied by remittance in full. Please include 25% deposit with C.O.D. orders. Minimum order \$5.00.

Latin Note: SE HABLA ESPAÑOL

## STANDARD ELECTRONIC TUBE CO.

286 Fifth Avenue, New York 1, N. Y.

Phone: LAckawanna 4-7677

OVER 97,000 TECHNICIANS HAVE LEARNED HOW TO GET THE MOST OUT OF BASIC TEST EQUIPMENT for AM FM-TV

### 'Servicing by Signal Substitution'

A BEST SELLER FOR OVER 13 YEARS!  
(NEW, UP-TO-DATE, 14th EDITION)

The Modern, Simplified, Dynamic Approach to all Receiver Adjustment & Alignment Problems

- ★ Nothing complicated to learn
- ★ No extra equipment to purchase
- ★ Universal... non-obsolete
- ★ Employs only Basic Test Instruments

Ask for "S.S.S." at your local Radio Parts jobber or remit 40¢ in small stamps or coin directly to factory.



ONLY 40¢  
103 pages. Invaluable information that will help you redouble the value of your basic test equipment.

PRECISION APPARATUS COMPANY, INC.  
70-31 84th STREET, GLENDALE 27, L. I., N. Y.



**20  
YEARS  
OLD!**

*He's already an*  
**ELECTRONICS  
ENGINEERING  
DESIGNER**

Out of high school just 2 years ago, this young man has already started a fascinating, highly rewarding career in electronics engineering. No matter whether you are now 18 years old—or 28—a 26-month Embry-Riddle education will prepare you for a quick start in this lucrative professional field.

Electronics Engineering Design course concentrates on essential technical studies and practical projects. With the aid of top flight Embry-Riddle instructors you'll master many absorbing fundamentals - - - Microwaves and Radar, Servomechanisms, Industrial Electronics and Television, to mention a few of the subjects.

The demand for trained engineers is greater than the supply—and will be for years! So take the first step now—mail this coupon. And remember, study and play in Miami's perfect year-round climate is stimulating and exciting.

FOUNDED 1926



MAIL THIS COUPON TODAY

DEAN OF ADMISSIONS, Dept. 77  
Embry-Riddle School of Aviation, Miami 30, Fla.

Without obligation, please send FREE and postpaid full particulars.

- ELECTRONICS ENGINEERING DESIGN
- AERONAUTICAL ENGINEERING DESIGN

Name.....Age.....

Address.....

City.....State.....

I am a (check one)  veteran  non-veteran

can be powered by an external power supply.

The instrument measures 7" x 5½" x 3¾". Full details are available on request.

**MATCHED MIDGET PLIERS**

Plomb Tool Company, 2205 Santa Fe Ave., Los Angeles 54, Calif., has added six matched midget pliers to its "Proto" line of service tools. The new units were developed especially for electronics workers; radio, television, and electric technicians; hobbyists; and experimenters.

The pliers are forged from special steels. The cutting edges are induction-hardened and the jaws have been narrowed for reaching into restricted places. Matched, wide-opening handles are shaped to fit snugly into the palm of the hand and provide high leverage and good "feel." All six of the pliers have red plastic "Handeze" grips. Lengths range from 4" to 4¾".

**EMC TRANSISTOR CHECKER**

Electronic Measurements Corporation, 280 Lafayette St., New York, N. Y., has recently added a low-cost transistor checker to its line of test equipment.

The Model 210 is housed in a rugged, molded Bakelite case. It will check all p-n-p and n-p-n transistors, measures gain in three ranges, and measures leakage on a two-color "poor-good" scale. The instrument will also check crystal diodes.

The unit comes complete with batteries. It is currently available in both

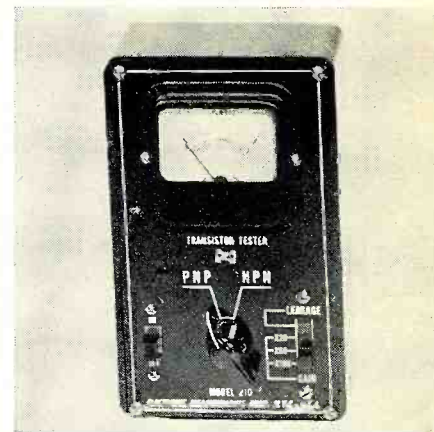

kit and wired-and-tested form. Write the manufacturer direct for prices and additional information on this instrument. -30-

**SCOPE CALIBRATION GRID**

BY JAMES F. SUTHERLAND

IF, LIKE the author, you have ever experienced difficulties with warped and loose fitting plastic calibration grids on your scope, perhaps the following idea will be of interest.

The author recently assembled a Heathkit Model O-10 scope and was not satisfied with the way the green plastic calibration screen was expected to retain its shape and position throughout the life of the instrument without some means of rigid suspension. Since wood is non-magnetic and can be easily cemented to plastic, it was decided that a wooden embroidery hoop could be cut to size and bonded to the screen for a press fit into the felt-lined CRT front support. The hoop, which can be purchased at most dime stores, was measured and cut as shown in the diagram to the right.

Since the temperature changes and the absorption of moisture by the plastic will cause the screen to pull away from

the ring if they are not securely bonded together, a generous amount of Duco cement should be used. After the glue has dried for two or three days, the screen can be painted with flat black paint to make it inconspicuous, and then be pressed into place with the wooden ring toward the inside.

The photographs show the inside face of the screen with the attached wooden ring and the completed job. It cannot twist or warp when mounted in this fashion. Try it out! -30-

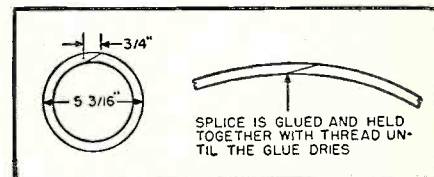

Details for making screen retaining ring.

Plastic grid with wooden retaining ring.

The re-inforced screen in place on scope.

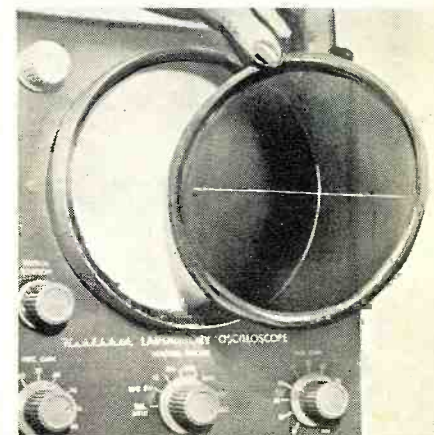



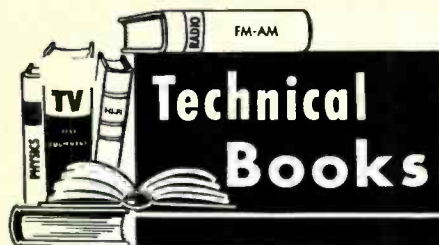

"CORRECTING TELEVISION PICTURE FAULTS" by John Cura & Leonard Stanley. Published by *Iiffe & Sons Ltd.*, London. 66 pages. Price 3s 6d (approximately 60 cents plus postage). Paper bound.

This book contains over 150 "Tele-Snaps" showing various faults as reflected on the screen of the picture tube. The various types of faults are dealt with under sectionalized headings. The cause of each fault is clearly explained, first in simple non-technical language and then in greater detail for the professional technician.

Although the authors are writing of the British system, practically all of the material in this little book is applicable to U.S.-built television receivers as well.

\* \* \*

"INVERSE FEEDBACK" by Alexander Schure. Published by *John F. Rider Publisher, Inc.*, New York. 47 pages. \$90. Paper bound.

This is the 15th book in this publisher's "Electronic Technology Series" and deals with the principles and applications of inverse feedback as applied to various electronic devices.

The text material is written for the student, technician, and engineer. Review questions throughout the text make the book suitable for home study.

\* \* \*

"INTRODUCTION TO OPERA" edited by Mary Ellis Peltz. Published by *Barnes & Noble, Inc.*, New York. 332 pages. Price \$1.65. Paper bound.

This guidebook, sponsored by the Metropolitan Opera Guild, contains plot summaries and titles of the leading arias for some forty well-known operas. Of particular interest is the list of opera recordings and an evaluation by C. J. Lutens as to the acceptability of the performance and the technical quality of the recording.

Most of the operas included in the Met repertoire in recent years are covered.

\* \* \*

"ELEMENTS OF PULSE CIRCUITS" by F. J. M. Farley. Published by *John Wiley & Sons, Inc.*, New York. 143 pages. Price \$2.00.

Here is another one of *Methuen's* "Monographs on Physical Subjects," this one addressed primarily to physicists and research workers who wish to obtain an introduction to such subjects as integration and differentiation of waveforms, limiting, square-wave generators, trigger circuits, time base generators, and pulse amplifiers. A familiarity with ordinary tube circuits and radio practice has been assumed.

November, 1956



GUARANTEED PERFORMANCE

# CROWN

## Professional Tape Recorder

CROWN  
meets more  
top professional  
standards than any  
other tape recorder!

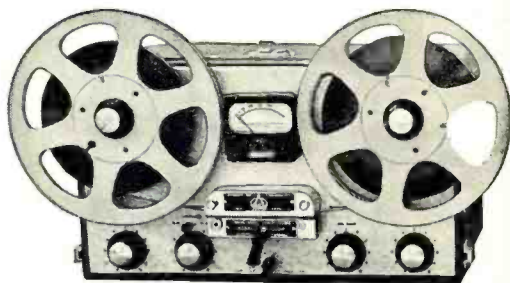

# CROWN IMPERIAL

Breaks Sound Barrier! Breaks Price Barrier!  
Breaks Service Barrier!

## A COMPLETE HI-FI PACKAGE

3-Speed Recorder 10" Reel Facility  
20-Watt Micro-Linear Amplifier  
2 Channel Mixer Monitor Speaker  
Exponential Curve Equalizer

Dual or Full Track **\$449<sup>50</sup>** complete with case

Write for literature.  
Address Dept. RN-11

*Specifications . . .* "MICRO-LINEAR" HEADS • THREE

SPEEDS • THREE MOTORS • MEETS NARTB STANDARDS •

"MICRO-SYNC" TIMING • STRAIGHT LINE THREADING • 4" DUAL LIGHTED METER

• MAGNETISM BRAKING • PERFECT ERASURE • CATHODE FOLLOWER OUTPUT

## INTERNATIONAL RADIO & ELECTRONICS CORP.

ELKHART, INDIANA



**BARGAIN HUNTING?**

**TV SERVICEMEN!**

Write for SENSATIONAL CATALOG

**HENSHAW RADIO SUPPLY**

3619 TROOST KANSAS CITY, MO.

### BRAND NEW RECEIVING TUBES

Top Quality—Individually Boxed  
**Terrifically LOW PRICED!**

Send TODAY for Complete Catalog

**ZYTRON TUBE COMPANY**

220 West 42nd St., New York 36, N. Y.

### LEARN TV SERVICING UHF—COLOR—VHF

Master the latest, up-to-the-minute TV and Color TV developments.

You can Earn to \$5,000-\$10,000 a year in TV servicing after a few short months. Education or age is no barrier. Find out how you can EARN WHILE YOU LEARN in our big Shops and Laboratories. You work with the latest equipment. Waste no time with Non-Essentials, Math or Design Theory. Complete information in our new FREE booklet. Address Dept. 11-56-R. Approved for veterans. Free Placement Service.

**WESTERN TELEVISION INSTITUTE**  
341 W. 18th St. Los Angeles, Calif.

Dept. 11-56-R  
Mail me information about training.  
Name .....

Address .....



The "TV and Radio Tube Substitution Guide," which sells for 50 cents, covers various direct replacements that can be made in TV and radio circuits. The "Admiral TV Trouble-Indicating Tube Location Guides" covers this manufacturer's receivers from 1948 through 1956. The book sells for \$1.00.

The final two volumes deal with troubleshooting techniques. "Rapid TV Trouble Shooting Method" at \$1.00 covers the methods devised by the author to facilitate locating the trouble—some of which involve no test equipment. The second book, "Shoot TV and Radio Trouble Fast," sells for \$1.50 and covers radio receiver circuitry as well as television circuit faults.

\* \* \*

"COMMUNICATION ENGINEERING" by W. L. Everitt and G. E. Anner. Published by McGraw-Hill Book Co., Inc., New York. 644 pages. Price \$9.00. Third Edition.

This book is noted for its clear, step-by-step analyses of the major problems confronting the communications engineer. In this edition, emphasis is placed on the area which must precede the study of all other divisions of communication, namely, the fundamentals of linear network analysis and synthesis, including the use of unilateral elements. In order to demonstrate the design requirements which are imposed on the linear portions of communications systems networks, the book develops both an analysis of various types of modulation and the transformation of transients from the time to the frequency domain.

\* \* \*

"THE INTERNATIONAL DICTIONARY OF PHYSICS AND ELECTRONICS" edited by Walter C. Michels, et al. Published by D. Van Nostrand Co., Inc., Princeton, N. J. 1004 pages. Price \$20.00.

Here in one big volume, prepared by an international group of distinguished scientists and educators, are definitions of most of the principal terms used in classical and modern physics, useful not only to physicists but also to scientists and engineers in diverse fields who have need for information about terms used in physics. The terms defined include laws, relationships, equations, basic principles and concepts, as well as the most widely used instruments, apparatus, and their components. For those who do not have an extensive mathematical background, both explicit and discursive statements and entries are given, as well as definitions of the more common mathematical terms encountered in present-day physics. All definitions, wherever possible, which have been established or recommended by professional groups are included.

\* \* \*

"SIMPLIFIED RADIO SERVICING BY COMPARISON METHOD" by M. N. Beitman. Published by Supreme Publications, Highland Park, Ill. 91 pages. Price \$1.50. Paper bound.

This is a newly revised edition of one of the author's most popular servicing handbooks. The author outlines the simple tests that can be run in order to obtain electrical, visual, and other reactions from radio parts and circuits and explains how to determine if the indications thus obtained are correct for that particular part or stage.

A comprehensive tube data section has been included so the user is independent of other reference works. Schematics are provided on commercially available equipment and it is this material that is used to demonstrate the techniques advocated by the author.

The text itself is written in an informal and easy-to-understand form. Beginning technicians and those interested in stepping up their service output will find this manual of particular interest.

\* \* \*

"AMPLITUDE MODULATION" edited by Alexander Schure. Published by John F. Rider Publisher, Inc., New York. 55 pages. Price \$1.25. Paper bound.

This is the ninth book in this publisher's "Electronic Technology Series" dealing with the fundamental concepts of electronic circuitry.

The text covers both the basic principles of amplitude modulation and some of the methods used to accom-

# NEW FABULOUS MODULAR RADIO KIT

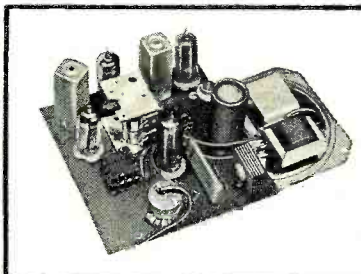
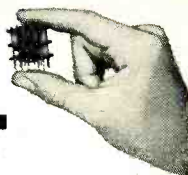

ONLY \$17<sup>50</sup>

Complete Kit with Tubes, Loudspeaker and Ivory Molded Cabinet

Assemble this sensitive AC-DC Table Model Super Heterodyne Radio Receiver in less than 1/2 hour

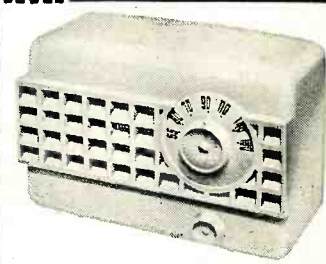

NO WIRING

NO SPECIAL TOOLS

Only a Soldering Iron Required

You have read about the Navy's 'Project Tinkertoy.' You have heard about 'Module' construction in military electronic applications.

This remarkable new pre-fab technique is now available to you — for the first time — in the first civilian product to feature both: PRINTED CIRCUITRY and MODULAR COMPONENTS.

Here is an exciting opportunity to work with one of the latest developments in modern electronics and learn about the new, fabulous module technique.

In years to come, every radio, TV receiver, test instrument — in fact, every electronic device — will be modular constructed.

Be among the first to assemble a modular radio-broadcast receiver!

Use this convenient order form

**ACT NOW!** Send your check or money order today! 10% required on C.O.D.

R & D Electronics Laboratories Inc. Dept. RN-11  
21-28 45th Road, L.I.C. 1, N.Y.

Send..... Modular RADIO KIT(S) at \$17.50

I enclose  check;  money order in the sum of \$.....

In full payment — postage prepaid.

As 10% deposit for C.O.D. — I pay all charges.

NAME.....

ADDRESS.....

CITY..... ZONE..... STATE.....

All Parts Unconditionally Guaranteed



## Handy Troubleshooter

(Continued from page 56)

will produce the best linearity, brightness, and width. To do this, insert (in series or parallel) the components of the checker with  $C_1$  and  $R_1$ . Adjust the checker for the best picture, shut off the power, and insert into the circuit fixed components whose values match those indicated on the checker in combination with  $C_1$  and  $R_1$ .

The high voltage in some sets may be too high, resulting in excessive picture brightness and insufficient height and width; or too low, resulting in insufficient picture brightness and excessive height and width. These troubles may be overcome by changing the horizontal drive capacitor (10-160  $\mu$ fd. in Fig. 3) and/or the screen grid dropping resistor or cathode resistor of the horizontal output tube. Substituting the checker for the horizontal drive capacitor and increasing or decreasing the capacitance will decrease or increase, respectively, the high voltage. Substituting the variable resistor of the checker for the 6BQ6 screen grid dropping resistor ( $R_1$  in Fig. 3) not only checks this resistor but also indicates the value of the fixed resistor that should be inserted for optimum high voltage.

Actually, the circuit of Fig. 3 does not normally have a resistor in the cathode of the 6BQ6 tube. However,

one may be inserted to decrease the high voltage output. If a resistor is inserted, it should be paralleled by a capacitor—the values should be about 100 ohms for the resistor and 1  $\mu$ fd. for the capacitor. The best values are found by using a substitution box. (Insert a 1  $\mu$ fd. capacitor across the capacitance terminals of the checker to begin with.)

Before making any of the preceding changes, a milliammeter must be inserted in series with the 6BQ6 cathode to make sure that the normal tube current is not exceeded. Generally speaking, a current of 100 milliamperes or less is required for the 6BQ6 and other horizontal output tubes; the lower the current, the better.

Ringling in a yoke is noted by the appearance of dark and light vertical bands on the left side of the raster which gradually diminish in strength as they approach the center of the screen. It is caused by the absence of, or an incorrect, yoke resistor-capacitor network. It may also be a decrease in yoke or flyback transformer efficiency or faulty damper tube.

To eliminate ringling originating in the horizontal yoke, substitute the variable capacitor of the checker for the yoke balancing capacitor (68  $\mu$ fd. in the yoke circuit of Fig. 3) and insert the potentiometer in series with it. Vary both components for minimum ringling and substitute fixed components when the optimum values are determined.

## for everything in hi-fi GET THE MONEY-SAVING 1957 ALLIED CATALOG

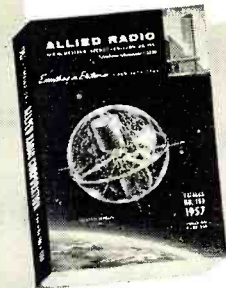

featuring the world's largest stocks of systems & components

**free!**  
SEND FOR IT

Here's your complete money-saving guide to Hi-Fi. Shows you how to select a custom Hi-Fi music system for your home at no more than the cost of an ordinary phonograph. Tells you what to look for and how to save money. Offers the world's largest selection of complete Hi-Fi systems as well as individual amplifiers, tuners, changers, speakers, enclosures and accessories. Want to build-your-own?—see the famous Hi-Fi KNIGHT-KITS. For everything in Hi-Fi—for everything in Electronics, get the FREE 1957 ALLIED Catalog.

### ALLIED RADIO AMERICA'S HI-FI CENTER

ALLIED RADIO CORP. Dept. B-116  
100 N. Western Ave., Chicago 80, Ill.

Send FREE 1957 ALLIED Catalog

Name \_\_\_\_\_  
Address \_\_\_\_\_  
City \_\_\_\_\_ Zone \_\_\_\_\_ State \_\_\_\_\_

## COYNE QUALITY TELEVISION RADIO-COLOR TV Home Training at Unbelievably Low Cost



The future is YOURS in TELEVISION!  
A fabulous field—good pay—fascinating work—a prosperous future in a good job, or independence in your own business!

Coyne brings you MODERN-QUALITY Television Home Training; training designed to meet Coyne standards at truly lowest cost—you pay for training only—no costly "put together kits." Not an old Radio Course with Television "tacked on." Here is MODERN TELEVISION TRAINING including Radio, UHF and Color TV. No Radio background or previous experience needed. Personal guidance by Coyne Staff. Practical Job Guides to show you how to do actual servicing jobs—make money early in course. Free Lifetime Employment Service to Graduates.

**COYNE ELECTRICAL SCHOOL**  
A TECHNICAL TRADE INSTITUTE OPERATED NOT FOR PROFIT  
500 S. Paulina Street, Chicago 12, Dept. 86-HT5

B. W. COOKE, Jr.,  
President



Coyne—the Institution behind this training... the largest, oldest, best equipped residential school of its kind. Founded 1899.

## Send Coupon for Free Book

and full details, including easy Payment Plan. No obligation, no salesman will call.

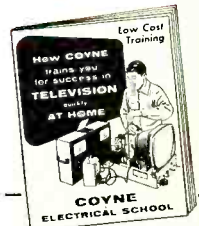

### COYNE Television Home Training Division

500 S. Paulina St., Chicago 12, Ill.  
Dept. 86-HT5

Send Free Book and details on how I can get Coyne Quality Television Home Training at low cost and easy terms.

Name \_\_\_\_\_  
Address \_\_\_\_\_  
City \_\_\_\_\_ State \_\_\_\_\_



C <sub>1</sub>	R <sub>1</sub>
.005 $\mu$ fd.	16,000 ohms
.01 $\mu$ fd.	1.2 megohms
.0015 $\mu$ fd.	.01 $\mu$ fd. in parallel
.005 $\mu$ fd.	1.5 megohms
.001 $\mu$ fd.	
.005 $\mu$ fd.	15,000 ohms
.005 $\mu$ fd.	.005 $\mu$ fd.
.001 $\mu$ fd.	56,000 ohms
.005 $\mu$ fd.	5600 ohms
.01 $\mu$ fd.	33,000 ohms
.005 $\mu$ fd.	
.001 $\mu$ fd.	47,000 ohms

Table 1. Various combinations of R<sub>1</sub> and C<sub>1</sub> as used in the author's construction.

lation. At any other frequency the negative feedback voltage is larger than the positive so that the resultant degeneration of the amplifier suppresses these frequencies.

Even though most textbooks show a lamp in the cathode of V<sub>1</sub>, the author used a 30-ohm resistor. There was no noticeable change in output as the frequency was changed. Actually, the lamp is not needed in this circuit because we are not interested in any variation of amplitude or distortion.

For those who want to experiment with the circuit for different tones, here's what the lamp does. If the amplitude of the oscillator increases, there will be more current flow through the lamp. When this current reaches a certain value, the lamp filament begins to get hot, making its resistance increase, thus a larger voltage drop is developed across the higher resistance. Therefore, we will have more degeneration which will reduce the gain of V<sub>1</sub> and cause the output to stay constant. A 3-watt, 120-volt lamp will suffice.

Because of space limitations, a 3" PM speaker and a salvaged output transformer from a small portable radio were used. Output was sufficient to be heard over two large rooms.

The exact values of resistor-capacitor combinations have to be determined by experiment. Any desired note may be obtained by applying the proper value of resistor and capacitor combinations.

Notes below the range of the device can be synthesized by depressing combinations of keys simultaneously.

In the author's organ, only twelve notes were covered, involving the combinations of resistors and capacitors as shown in Table 1. The small ceramic disc type capacitors were used.

The oscillator and power supply were built on a 1½" x 7" x ½" aluminum strip with two "L" brackets for mounting.

In building this unit, be sure to get

Fig. 2. Wooden key modifications so that they serve as s.p.s.t. switches in unit.

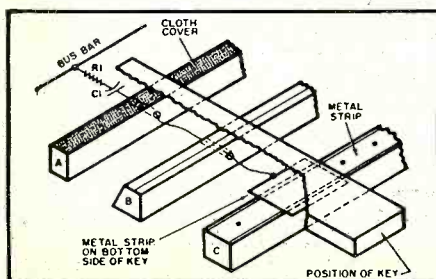

November, 1956

HENRY HAS IT FIRST  
HENRY HAS IT FIRST  
HENRY HAS IT FIRST  
HENRY HAS IT FIRST

YES HENRY HAS ALL THE  
NEW EQUIPMENT FIRST!

hallicrafters

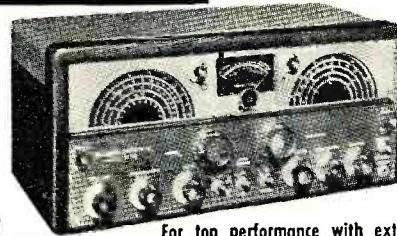

NEW  
SX100

For top performance with extra pull power and ability to tune in stations.

\$29.50 Down  
20 monthly payments of \$14.65

\$295.00 Cash Price

A few items in stock for immediate shipment are:

Model	Cash Down	20 Monthly Payments	CASH PRICE
S38D	5.00	2.47	\$ 49.95
S53A	9.00	4.45	89.95
S85	12.00	5.94	119.95
SX99	15.00	7.42	149.95
SX96	25.00	12.37	249.95
SX62A	35.00	17.32	349.95
R46B speaker			17.95
HT30	49.50	24.50	495.00
HT31	39.50	19.55	395.00
S94-S95	6.00	2.97	59.95
S-102	6.00	2.97	59.95
S-106	6.00	2.97	59.95

Write, wire, phone or visit either store today.

Butler 1, Missouri  
Phone 395



Granite 7-6701  
11240 West Olympic Blvd. Los Angeles, 64

Bob Henry,  
W0ARA  
Butler, Mo.



Ted Henry,  
W6UOU  
Los Angeles



"World's Largest Distributors of Short Wave Receivers."

### SCHEMATICS—CONVERSIONS FOR SURPLUS GEAR

#### NEW LIST DI MANY ADDITIONS!

Send stamped, self addressed envelope for List D. Add 25c for chart explaining AN nomenclature. DO IT TODAY!

R. E. BOX 1220  
GOODHEART BEVERLY HILLS, CAL.

#### \*\*\* ATTENTION \*\*\*

#### HAMS—SERVICEMEN—EXPERIMENTERS

#### BIG \$1.00 SALE—LIMITED TIME ONLY

100 Famous brand insul'd carbon resistors only \$1.00  
100 Ceramic disc & tubular Capacitors . . . only \$1.00  
Fine assmt of resistors (unused) 5-10-20%, ½-1 watt, 10 ohms to 4.7 meg., (30 to 40 values) \$18.00 value pkg. Fine assmt of disc & tubular capacitors (unused) .5 to 1000mmf, 1000 volt rating (15 to 20 values) \$25.00 value. So Hurry—Send Now—Money Back Guarantee.

L & W PRODUCTS, P. O. Box 266, Taunton, Mass.

### ENGINEERING

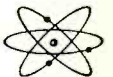

#### B.S. DEGREE in 27 MONTHS

Prepare for unlimited opportunities of the Electronic Age! Earn your B.S. degree in 27 months at Indiana Technical College. Intensive, specialized course. Comprehensive training in electronics, television, advanced radio theory and design, math and electrical engineering. Modern laboratories. Low rate. B.S. DEGREE IN 27 MONTHS in Aero., Chem., Civil, Elec., and Mech Engineering; in 36 MO. in Math., Chem., Physics. Also preparatory courses. G. I. appr. Enter Dec., March, June, Sept. Earn part of your expenses in Fort Wayne while studying. Catalog.

#### INDIANA TECHNICAL COLLEGE

9116 E. Washington Blvd., Fort Wayne 2, Indiana

Please send me free information on B.S. ENGINEERING DEGREE IN 27 MONTHS as checked.

Electronics  Chemical  Aeronautical  
 Civil  Mechanical  Electrical

Name \_\_\_\_\_  
Address \_\_\_\_\_

# DON'T JUST SAY CAPACITORS

Ask For Sprague By Catalog Number

Know what you're getting . . . get exactly what you want. Don't be vague . . . insist on Sprague. Use complete radio-TV service catalog C-610. Write Sprague Products Company, 51 Marshall Street, North Adams, Massachusetts.

# SPRAGUE®

WORLD'S LARGEST CAPACITOR MANUFACTURER

a toy piano with wooden keys. The ones with plastic keys will not work since such instruments have a metal rod instead of a triangle stud as shown at "B" in Fig. 2.

Remove the bottom cover with all keys and hammers as is. Start laying out the speaker, filament, and output transformer.

Next drill all of the holes, including a series of holes for the speaker. Then the resonant rods are removed and the hammers from each key removed.

The triangular strip "B" was removed and a small hole drilled through it for each key, as shown in Fig. 2. A small strip of thin metal was tacked on the bottom of each key (directly above block "C") and a separate wire soldered to each strip.

The soft cloth originally glued on strip "C" is removed and a strip of metal the same length and width is tacked on, leaving about 1/4" on one end so that the lead from the grid of  $V_1$  (pin 2) can be soldered.

No. 27 enamel-covered wire was used from the key to strip "A" where a 4-40 machine screw with a solder lug on each end was used as a tie point for each key. Located between the oscillator chassis and strip "A" is a bus bar which runs across the bottom cover. Make sure you have enough room for your resistor-capacitor combinations between this bus bar and each screw in strip "A." The common bus bar is connected through  $R_2$  to pin 3 of  $V_1$ .

Considering the small amount of time required to build this "organ", it is truly a satisfying project. -30-

## VERTICAL LINEARITY

By R. J. CARMICHAEL

**A MAJORITY** of today's television receivers incorporate a built-in device which permits a sure and simple vertical framing adjustment without the use of additional equipment.

The method consists of tuning the set to an operating channel then advancing the brightness control and adjusting the contrast control until the vertical retrace lines are visible on the screen.

Next adjust the vertical height and vertical linearity controls for equal spacing of these vertical retrace lines. Finally, return the brightness and contrast controls to normal.

The picture in now correct vertically, your customer is happy, and the job has taken only a few seconds. -30-

## MOTOROLA AUTO SET HINT

By JAMES A. McROBERTS

**A Motorola Model 801 auto set** was reported "dead" but vibrator buzzes and normal voltage appeared to be present.

First test for audio buzz at the output tube grids. If OK, try touching the hot side of the muting switch which is frequently the cause of the trouble.

Check to see that it (the muting switch) does not permanently mute the audio due to bad spring leaves.

Hope this hint will prove a time saver and eliminate needless searching for other, more serious, troubles. -30-

# don't be vague...

insist on SPRAGUE

# Twist-Lok<sup>\*</sup> 'lytics



\*Trademark

# SPRAGUE

NORTH ADAMS, MASS.

# F.C.C. LICENSE QUICKLY!

## F.C.C. License—the Key to Better Jobs

An FCC commercial (not amateur) license is your ticket to higher pay and more interesting employment. This license is Federal Government evidence of your qualifications in electronics. Employers are eager to hire licensed technicians.

## Grantham Training is Best

Grantham School of Electronics specializes in preparing students to pass FCC examinations. We train you quickly and well. All courses begin with basic fundamentals—NO previous training required. Beginners get 2nd class license in 8 weeks, 1st class in 4 additional weeks.

## OUR GUARANTEE

If you should fail the FCC exam after finishing our course, we guarantee to give you additional training at NO ADDITIONAL COST. Read details in our free booklet.

## FCC-TYPE EXAMS

FCC-type tests are used throughout the Grantham course. Constant practice with these FCC-type tests helps you prepare for the actual FCC examination.

## Learn by Mail or in Residence

You can train either by correspondence or in residence at either division of Grantham School of Electronics—Hollywood, Calif., or Washington, D. C. Our free booklet, "Opportunities in Electronics," gives details of both types of courses. Send for your free copy today.

## MAIL NOW TO OFFICE NEAREST YOU

(mail in envelope or paste on postal card)

### Grantham School, Desk 6-C

1505 N. Western Ave. OR 821—19th Street N. W.  
Hollywood 27, Calif. OR Washington 6, D. C.

Please send me your free booklet, telling how I can get my commercial FCC license quickly. I understand there is no obligation and no salesman will call.

NAME .....  
ADDRESS .....  
CITY ..... STATE .....

RADIO & TELEVISION NEWS

Sandy Says!  
Be Modern with an

## Anchor V-500-VTVM!

- Simpler to operate
- Easier to maintain
- No battery

SIZE: 6 1/2" x 9 1/4" x 4 1/2".

Latest type tubes and circuitry. Single control selects range and function. Has 4 1/2" full view meter, separate 3-volt AC scale, zero centering for TV and FM alignment, DB scale and burnout proof meter circuit, housed in durable carrying case. Completely factory wired, tested and warranted.

only **\$47.50** net  
AT YOUR  
DISTRIBUTOR

**anchor products co.**  
ELECTRONIC COMPONENTS  
2712 W. Montrose • Chicago 18, Ill.



**Multi-Purpose Probe**  
(Continued from page 57)

v.t.v.m. However, for most v.t.v.m.'s, a separate jack is used on the front panel for these measurements (as distinct from the d.c. jack) so a minor revision is needed to allow the single probe cable to be used for all measurements, eliminating the extra test lead. All that is required in some v.t.v.m.'s is to connect a wire internally from the a.c.-ohms jack to the d.c. jack. All v.t.v.m. measurements can then be made from the probe head. Careful study of the v.t.v.m. switching circuit will indicate the best way to make the required modification for any particular instrument.

A high voltage probe head is also available for this unit. This head has a standard multiplier resistor, two high voltage guard discs, and a triple-contact female connector so that it can be plugged directly into the handle. Another head includes a low-capacity, high-voltage divider for use with an oscilloscope to display the voltage waveform at the plate of TV horizontal output tubes and high voltage rectifiers.

At present the probe is marketed in kit form by *Allied Radio* as part of the *Knight Electronics* kit line. —50—

**PHOTO CREDITS**

Page	Credit
37, 44, 46	General Electric Company
40, 41	Helena TV Inc.
42, 78	Radio Corporation of America
43	Bell Telephone Laboratories
47, 120	Westinghouse Electric Corp.
48	B & K Manufacturing Co.
50	Winston Electronics, Inc.
51	Klipsch & Associates
52	University Loudspeakers, Inc.
53, 168	Brociner Electronics Corp.
56	Ram Electronics Inc.
57	Knight Electronics
58, 59	ORRradio Industries, Inc.
60	Aircraft Armaments, Inc.
63	Rockbar Corporation
68, 69	Emerson Radio & Phonograph Corp.
72, 73, 160	Todd Transformer Corp.
105	Sylvania Electric Products Inc.
118	U. S. Signal Corps Photo

**ADDENDUM**

In the article "A Portable Ultrasonic Protection System" which appeared on page 52 of our July 1956 issue, an incorrect source of supply was indicated for the ultrasonic transducers. We have since learned that Harris Transducer Corp., Woodbury, Conn., will supply these units in quantity. Write the company direct for full information and prices.

*For the finest in sound...*

**ACROSOUND**  
**ULTRA-LINEAR**

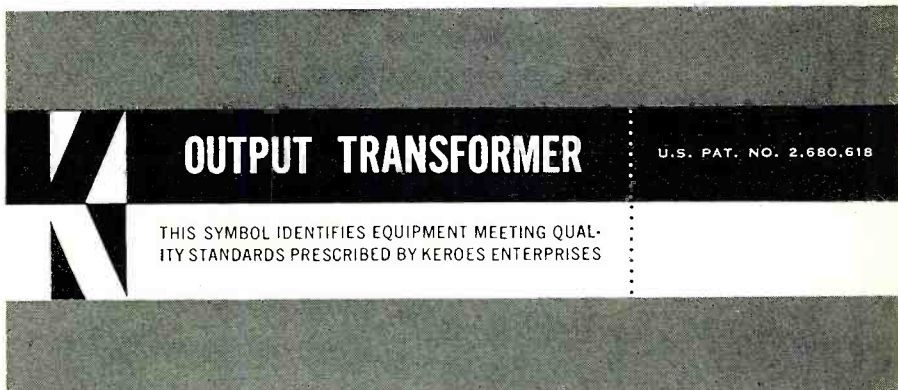

THIS SYMBOL IDENTIFIES EQUIPMENT MEETING QUALITY STANDARDS PRESCRIBED BY KERES ENTERPRISES

Acrosound transformers with the black and gold "K" symbol are correctly tapped for top performance in Ultra-linear circuits. Enjoy the finest in sound . . . with the transformer that assures best Ultra-Linear results. Write for our free 16 page catalog

**ACRO PRODUCTS COMPANY**  
369 SHURS LANE • PHILADELPHIA 28, PENNSYLVANIA

**"PIC-PROBE" by Radionic . . .**

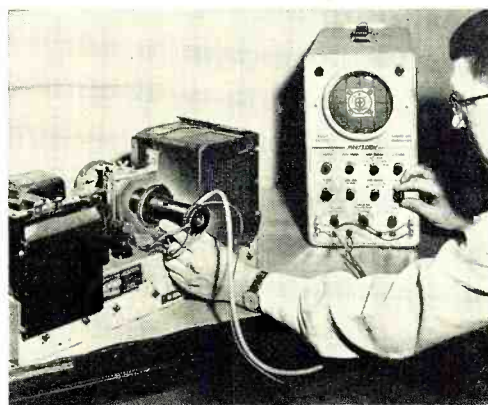

**the most valuable test instrument ever developed for TV servicing**

**DESIGNED FOR ALL TV SETS USING NO. 2 OR NO. 11 PIN FOR BEAM MODULATION.**

**ADAPTER ALSO DESIGNED FOR USE WITH "PIC-PROBE" ON SERIES FILAMENT SETS.**

**Actual Picture on Scope**

**Enables You to Check Accurately**

- Yolk
- Trap Azoital
- Yolk Distortion
- Barrelling
- Vertical Linearity
- Horizontal Linearity
- Width
- Height
- Pincushioning
- Pattern Distortion

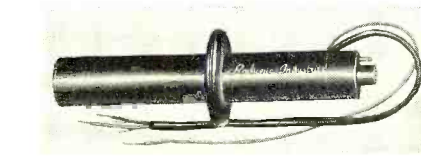

- ★ Tells immediately if the tube is bad or causing faulty operation.
  - ★ Checks all picture adjustments on the TV set without the need of a picture tube.
  - ★ Don't have to interpret scope wave forms —what you see on the TV, you see with Radionic's "Pic-Probe."
  - ★ No breakage or implosion as from a small picture tube.
- ★ Compact—dynamic in performance . . . durable.

Available through recognized distributors

**RADIONIC** Division of **RAVEN ELECTRONICS MANUFACTURING CO.**  
Sales Office: 3215 W. NORTH AVENUE CHICAGO 47, ILL. | Plant: 8859 S. KEDZIE AVE. EVERGREEN PARK, ILL.



# Classified

RATE: 50¢ per word. Minimum 10 words. January issue closes November 9th. Send order and remittance to: RADIO & TELEVISION NEWS, 366 Madison Ave., N. Y. C. 17.

## RADIO ENGINEERING

COMPLETE radio, electronics theory & practice; television; broadcasting; servicing; aviation, marine, police radio. 18 or 21 months. Catalog. Valparaiso Technical Institute, Dept. N, Valparaiso, Ind.

## FOR SALE

BUY Surplus transmitters, receivers, radar & electronic equipment. Direct from Government. List \$1.00. Box 1842BW, Hartford 1, Connecticut.

DIAGRAMS! Repair Information! Radios—amplifiers—recorders \$1.00. Televisions \$1.50. Give make, model, chassis.—Norelco-Philips and Ampere tubes in stock! TV Miltie, Box 101 RA, Hicksville, New York.

DIAGRAMS for repairing radios \$1.00. Television \$2.00. Give make, model. Diagram Service, Box 672-RN, Hartford 1, Conn.

TUBES—TV, Radio, Transmitting And Industrial Tubes At Sensibly Low Prices. New, Guaranteed, 1st Quality, Top Name Brands Only. Write For Free Catalog or Call Walker 5-7000, Barry Electronics Corp., 512 Broadway, New York 12N, N. Y.

DIAGRAMS—Radios, Amplifiers, Changers, \$1.00 Each. Television Service Data \$2.00. Unknown Models, Give Tube Layout And Part Numbers. Kramer's Radio Service, Dept. 656, 36 Columbus Ave., New York 23, N. Y.

COMPLETE Television Sets \$11.95. Jones TV, 1115 Rambler, Pottstown, Pa.

SERVICE time cut in half with Trouble Shooting Test Instrument made from old Television. \$2.00. Sterling, 129 West Long Ave., New Castle, Pa.

BUILD 3"—Square 4-Transistor Radio! Speaker! No Outside Antenna! Plans: \$3.00. Details: D. W. Bush, 2345-N So-101, San-Clemente, California.

6—MOTOROLA FMTU30 Mobile Phones—WE106A Selectors—41A Controls—WJ Channel Crystals Approved FCC & Tel. Co.—Reliable Service Co., 204 N. Jefferson St., Richmond, Va.

SURPLUS Radar, transmitters, receivers, walkie-talkies. Fantastic bargains. Picture catalog 5¢. Meshna, Malden, Mass.

HEAD Sets HS-30 New. Lightest Weight. Most Natural Tone. Best For Hard Of Hearing. Sold Only With Pitch Transducer. \$3.50 Post Paid. Hearing Aids, 3966 Lansdale Rd., Cleveland 18, Ohio.

TUBES—4D32 \$13.95, 715A \$1.75, 725A \$1.75, 706AY \$1.75, 6-11 Ballast 100 @ \$10.00, GL299 \$1.75, new, original boxes in quantity. Allied Electronics, 111 North 41, Omaha, Nebraska.

REPAIR broken or cracked plastic parts and restore original finish with the Rayther Plastic Repair Kit. \$3.00 prepaid. Free information. Rayther Co., Box 262A, Station B, Toledo, Ohio.

TRANSISTOR Kits. Free information. Transit Electronics, Box 15-N4, Aiden Manor, N. Y.

TELEVISIONS. Used Rebuilds, from 25.00. All Sizes. New Television Kits With Cabinets 69.00. Excel Television Sales, 891 Bank, Ottawa, Canada.

HERMETICALLY Sealed Power Transformers, Ideal For Williamson Type Amplifiers To 20 Watts!!! Freed, 60 cycle, 105/115/125 primary, 800 VCT, 200 MA, 6.3 V. at 3.0 Amps., 5.0 V. at 3.0 Amps., 6.3 V. at 6.0 Amps. New \$4.95 each, F.O.B. Los Alamos. E. Grothus, Box 795, Los Alamos, N. M.

## WANTED

CYLINDER and old disc phonographs. Edison Conqueror, Idelia, and Oratorio models. Berliner Gramophones and Zono-ophones, Columbia cylinder Gramophones, and coin-operated cylinder phones. Want old catalogues and literature on early phones prior to 1919. Will pay cash or trade late hi-fi components. Box 50 % RADIO & TELEVISION NEWS.

TUBES and equipment bought, sold, and exchanged. For action and a fair deal write B. F. Gensler, W2LNI, 56 Crosby St., N. Y. 12N, N. Y.

AN/APR-4, AN/A1R-9, other "APR-" "ARR-" "TS-" ARC-1, ARC-3, ART-13, everything surplus; Tubes, Manuals, Laboratory equipment. Describe, price in first letter. Engineering Associates, 434 Patterson Rd., Dayton 9, Ohio.

WANTED: Receiver R5/ARN-7, MN-62A Transceivers, RT18/ARC-1, AN/ARC-3, BC-788C, I-152C, Collins, Bendix equipment, Test Sets, Dynamotors, Inverters. We pay highest prices. Advise quantity, condition, price first letter. Aircraft Radio Industries, Inc., 15 East 40th St., New York City, telephone LExington 2-6254.

ART-13/T47A Transmitters, \$175.00; ART-13/T47 Transmitters, \$125.00; BC-788 C Altimeters, \$175.00; ARC-3 Transceiver Complete, \$325.00; R5/ARN-7 Radio Compass, \$175.00; BC-348 Rec'r Modified, \$25.00; BC-348 Rec'r Unmodified, \$50.00; ARC-1 Transceiver, \$300.00; BC-342 Rec'r, \$50.00; BC-312 Rec'r, \$40.00; I-152-C Indicator, \$50.00. Ship. Via Express, C.O.D. Subject To Inspection To H. Finnegan, 49 Washington Ave., Little Ferry, N. J.

BC221's WANTED—Highest cash price for BC-221's paid even more if the unit has modulation and hasn't been tampered with. Original Book needed. Write giving Model No. to Bolton Laboratories, Inc., Bolton, Mass.

SELL Your Way To Wealth! Wanted—Surplus Military And Commercial Aircraft Electronics: BC-788, I-152, ARN-7, ARC-1, ARC-3, transmitters, receivers, test equipment, etc.! Wanted—Electronic Tubes: Broadcast, transmitting, receiving, Magnetrons, Klystrons, miniature, sub-miniature, ruggedized, etc.! Top Prices Paid! For Fastest Checks—Sell to Rex! Write or phone description for immediate action. Bob Sanett, W6REX, 1524 S. Edris Drive, Los Angeles 35, Calif. Phones: REpublic 5-0213, CRestview 1-3856.

AUTHORS: Want to buy Home Study Radio and Television course, copyrighted or capable of being copyrighted. Massey Institute of Radio and Television, P.O. Box 1527, Jacksonville, Florida.

WILL buy auto radios and parts, new or old. State model number, condition, and asking price. Nelson Bros., 228 N. 2nd St., Phoenix, Arizona.

## REPAIRS AND SERVICING

HIGH Fidelity Speakers Repaired. Amprite Speaker Service, 70 Vesey St., N. Y. 7, N. Y. Ba. 7-2580.

## TAPE RECORDERS

WHOLESALE! Recorders. Tapes. Phonographs. Radios. Catalogue 10¢. Towers-155, Philadelphia 5.

TAPE Recorders, Tape. Unusual Values. Free Catalogue. Dressner 69-02 R, 174 St., Flushing 65, N. Y.

RECORDERS, Tape, Hi-Fi. Wholesale Prices. Catalogue. Klarston, 215 E. 88th St., N. Y. C. 28.

PRE-RECORDED Tapes, Low price recording tape, Accessories, Catalogue. Efsco Sales, 270E Concord, West Hempstead, New York.

## RECORDS

PHONOGRAPH Records Cheap. Catalogue. Paramount, ND-313 East Market, Wilkes-Barre, Penna.

## CORRESPONDENCE COURSES

USED Correspondence Courses and Books sold and rented. Money back guarantee. Catalog free. (Courses bought.) Lee Mountain, Pisgah, Ala.

## INSTRUCTION

STUDY at home for Commercial Radio Licenses. Free Sample lesson, very reasonable fee. Write Radio License Aid's, 275 Dayless, Ft. Worth, Texas.

ENGINEERING Degrees earned by home study. Residential courses also available. American College of Engineering, Box 27724-C, Hollywood 27, California.

## MISCELLANEOUS

LETTERHEADS, Repair Orders, Tags printed. Samples, prices free. Howprint, 723-K Eunice, Webster Groves, Missouri.

WE construct any type electronic device. Kits wired. Ham gear built. Electronic Engineers, Poteau, Okla.

THREE Line rubber stamp with automatic inking pad \$1.00. Billingsley, 4403 Magnolia, Chicago 40, Ill.

HQ for the 5 TOP QUALITY brands of

# TUBES

AT SENSIBLE PRICES!

• 90-Day RETMA guarantee • Brand New  
• Individually boxed • First quality only

WRITE FOR LATEST RECEIVING AND TV TUBE PRICE LIST, FREE!

1B35	..\$3.50	GL299	..\$3.00	1620	..\$3.00
1Q22	..\$5.00	304TH	.. 8.75	1624	.. 1.25
CL-2	..10.00	304TL	..10.50	1625	.. .30
2C35	.. 2.00	307A	..20.50	2050	.. 1.00
2C39A	.. 9.75	355A	..12.00	2051	.. .65
2C51	.. 3.25	357A	..10.00	5517	.. 1.35
2C53	.. 9.95	403B	.. 1.25	5636	.. 2.95
2E24	.. 2.75	403B	.. 2.75	5636A	.. 2.95
2K25	..19.75	404A	..12.50	5642	.. 1.00
2K25	..19.75	416B	..29.00	5643	.. 5.00
2K55	..15.00	416B	..39.00	5646	.. 4.50
3B24W	.. 5.00	417A	.. 2.75	5651	.. 1.40
3B29	.. 5.50	417A	.. 2.75	5656	.. 4.50
3BP1	.. 1.40	450TH	..45.00	5670	.. 1.00
3C23	.. 4.50	KU-610	.. 3.50	5675	.. 1.00
3C31	.. 1.40	658	..90.00	5687	.. 2.75
3C45	.. 6.00	GL1673	..13.00	5689	.. 5.00
3D1A	.. 9.95	701A	.. 2.75	5692	.. 5.00
3D1	.. 3.00	703A	.. 1.10	5693	.. 4.75
3J30	..30.00	717A	.. 3.50	5703WA	.. 4.50
4-65A	..16.50	723A	.. 7.85	5718	.. 4.50
4-25A	..30.25	725A	.. 3.50	5719	.. 2.00
4-250A	..35.00	750TL	..50.00	5725	.. 2.75
4-400A	..58.50	800	.. 8.00	5749	.. 1.25
4B24	.. 4.50	802	.. 2.25	5744	.. 1.25
EL3C	.. 4.50	803	.. 2.00	5749	.. 1.25
4C35	..13.50	805	.. 1.20	5812	.. 1.00
4E27	..15.00	805	.. 1.20	5812	.. 1.00
*4PR60A	..50.00	807W	.. 9.95	5814	.. 8.00
5C22	..19.10	813	.. 2.85	5840	.. 6.00
5R4WV	.. 1.40	833	.. 2.65	5840	.. 6.00
6AK5W	.. 1.40	814	.. 4.00	5871	.. 2.35
6C4	.. 2.00	815	.. 2.00	5910	.. .45
6C21	..15.00	816	.. 1.50	5915	.. 4.50
6E6	.. 1.90	836	.. 1.50	5915	.. 4.50
6J6W	.. 1.00	837	.. 1.25	6111	.. 4.95
1SE	.. 1.50	838	.. 1.00	6112	.. 4.95
*357G	.. 4.50	845	.. 5.00	6130	.. 6.00
VC50	.. 2.45	866A	.. 1.25	3C45	.. 6.00
3-13V	.. 8.00	889A	..125.00	6146	.. 4.55
RK60	.. 1.35	917	.. 1.50	6161	.. 70.00
RK65	.. 7.50	918	.. 1.50	6189	.. 2.50
NY65	.. 2.50	927	.. 1.50	6201	.. 3.00
RKR72 or 73	.. 40	930	.. 1.50	6350	..10.00
1F12A	.. 5.00	955	.. .35	954	.. 9.00
VXR-130	.. 1.75	956	.. .35	8008	.. 3.95
371B	.. .90	957	.. .35	8020	.. 2.00
203A	.. 2.50	958A	.. .35	9001	.. .85
250R	.. .50	991/NE2	.. .25	9002	.. .65
250R	.. 2.95	CK1005	.. .35	9003	.. 1.35
*250TL	.. 14.00	CK1007	.. .35	9004	.. .50
HK253	.. 5.00	CK1026	.. 2.35	9006	.. .20

... and many, many others. Over 1000 types in stock! WRITE!

## 2 COLOR TUBE CARTONS

Keeps your tube stock neat. New safety partition prevents tube breakage. Distinctive lithographed in glossy red and black. The most distinctive tube cartons available today. Minimum quantity: 100 of any one size. Write for case list prices.

FOR TUBE PER 100  
Miniature . 6AU6, etc. . . \$1.00  
GT . . . 6SN7, etc. . . 1.50  
Large GT . . . 6X4, etc. . . 2.00  
Large G . . . 5U4G, etc. . . 2.00

WHITE GLOSSY BOXES  
Completely blank. No printing or color. Otherwise same as above. Same high quality same low prices. Specify "WHITE" when ordering. When color is not stated, 2 color cartons will be shipped.

TUBE STACKERS  
White glossy only. Mistacker holds 10 Mini tube cartons; "GT" stacker holds 10 "GT" cartons.  
SIZE PER EACH  
Mini-stacker . . . . . 1 1/2¢  
GT . . . . . 2¢



## TEST EQUIPMENT BARGAINS!

ABSORPTION WAVEMETER. GEN'L. Radio type 758A (Worth \$40.00) NEW! \$ 12.50  
5" OSCILLOSCOPE. Dumont 274A. Vg. good. \$ 75.00  
5" OSCILLOSCOPE. Dumont 200B. Vg. good. \$ 110.00  
5" OSCILLOSCOPE. Dumont 304H. L. New! \$ 250.00  
5" OSCILLOSCOPE. RCA WO-88A. Vg. good. \$ 95.00

EXTRA SPECIAL!  
TEKTRONIX 5" OSCILLOSCOPE model 541, with 53/54K fast rise plug-in pre-amp unit. NEW! (Worth \$150.00) \$1095.00  
TEKTRONIX 5" OSCILLOSCOPE model 545, with 53/54K plug-in pre-amp unit. NEW! \$1295.00  
\$1,600.00  
TV XTAL 13 CHANNEL MARKER. Key "Mega-marker" incl. all 13 xtals. Vg. good. \$49.50  
VTVM. Ballantine 305. Rack mtd. L.N. \$235.00  
SQUARE WAVE GEN. Measurements Corp. model 71. Excellent cond. \$165.00  
MEGACYCLE (GDO) METER. Measurements Corp. model 59. Rack mtd. with probe and all coils. Like New! \$125.00  
PULSE GENERATOR. Hewlett-Packard model 212A. Rack mtd. w/dust cover. L. New! \$450.00  
"EPUT" (EVENTS PER UNIT TIME) METER. Berkeley model 554. Five digit, high speed counter. (Worth \$1,000.) New! \$690.00  
UHF SIGNAL GENERATOR. Hewlett-Packard 616A \$180.00  
VTVM. Hewlett-Packard 410B. L. NEW! \$180.00  
SIGNAL GENERATOR. Measurements Corp. model 80. 0-400 Mcs. Vg. good. \$350.00  
SIGNAL GENERATOR. Measurements Corp. model 78FM. 86-110 Mcs. 30 Kc. deviation. Excellent condition \$175.00

## TRANSFORMER SPECIAL!

3100-0-3100 volts @ 1/2 amp!  
PRIMARY: tapped for 98-104-110-116-123 volts, 60 cycles AC.  
SECONDARY: 3100 volts each side of center @ 500 ma. 15 KV impregnated mica insulation. Conservatively rated. Meas. 9" L x 8" H x 7 1/2" W. \$34.50  
New, guaranteed. Shpg. wgt. 6 lbs.

WRITE FOR "BARRY'S GREEN SHEET." FREE!

TERMS: 25% deposit with order, balance C.O.D. All merchandise guaranteed, F.O.B. N.Y.C.

# BARRY ELECTRONICS CORP.

512 Broadway, Dept. RN, N.Y. 12, N.Y.  
Call Day or Night—24 Hour Phone Service  
Phone: Walker 5-7000

When you order by mail . . .

please print your name and address clearly, be specific in your order, enclose proper amount, allow ample time for delivery.

# TUBE SPECIALISTS to the WORLD

SELECT THE TUBES YOU NEED FROM ONE OF THE MOST COMPLETE TUBE INVENTORIES IN THE WORLD



## RECEIVING TUBES

0A2	.69	6AD7G	1.50	6L6G	.98	12BF6	.60
0A4G	.95	6AF4	1.23	6L7	.95	12BH7	.89
0B2	.65	6AF6G	.85	6N7	.89	12BK5	.95
0Z4	.49	6AG5	.72	6Q7	.85	12BQ6GT	1.35
1A3	.68	6AG7	.98	6Q7GT	.79	12BY7	.90
1A7	.52	6AH4	.85	6R7	.85	12BZ7	.95
1AD4	1.20	6AH6	.85	6R7GT	.68	12C8	.69
1AE4	.92	6AJ5	1.49	6S4	.57	12CU6	.95
1AX2	.95	6AK5	.69	6S8GT	1.05	12H6	.59
1B3GT	.79	6AK6	.75	6SA7	.79	12J5GT	.65
1C5GT	.52	6AL5	.58	6SA7GT	.79	12K7GT	.85
1G4	.65	6AL7	.95	6SB7Y	.87	12K8	.69
1G6GT	.49	6AM4	1.50	6SC7	.72	12Q7GT	.75
1H5GT	.58	6AM8	1.10	6SF5	.72	12SA7	.69
1J6GT	.69	6AN4	1.50	6SF5GT	.69	12SA7GT	.69
1L4	.74	6AN5	2.75	6SF7	.92	12SC7	.75
1L6	.79	6AN8	1.15	6SG7	.65	12SG7	.79
1LA4	.79	6AQ5	.57	6SH7	.74	12SH7	.65
1LA6	.85	6AQ6	.55	6SH7GT	.59	12SJ7	.65
1LB4	.79	6AR5	1.50	6S7	.69	12SK7	.69
1LC5	.79	6AR6	2.15	6SK7GT	.64	12SL7	.85
1LD5	.85	6AS5	.70	6SK7GT	.59	12SN7	.75
1LE3	.79	6AS6	1.95	6SL7GT	.75	12SQ7	.59
1LH5	.85	6AS7G	2.35	6SN7GT	.75	12V6GT	.75
1LG4	.85	6AS8	1.15	6S7	.59	12W6GT	.87
1LH5	.85	6AT8	1.05	6S7GT	.59	14A4	.95
1NSGT	.59	6AT8	1.05	6S7GT	.59	14A5	1.30
1Q5GT	.95	6AU4	1.05	6S57	.75	14A5	1.30
1R4	.65	6AU5	1.10	6ST7	.95	14A7	.75
1R5	.65	6AU6	.65	6T8	.95	14AF7	.95
1S4	.65	6BA7	.85	6U5	.85	14B6	.69
1S5	.65	6AV5	1.20	6U8	.95	14C7	.95
1T4	.65	6AV6	1.50	6V3	1.25	14E6	1.05
1T5	.69	6AX4	.95	6V9	1.10	14E7	1.15
1U4	.67	6AX5	.69	6V6GT	.59	14F7	.85
1U5	.59	6B4G	.95	6W4GT	.65	14F8	1.10
1V	.65	6B8	.67	6W6GT	.79	14H7	.85
1V2	.59	6BA6	.63	6X4	.49	14N7	.85
1V6	1.49	6BA7	.85	6X5GT	.49	14Q7	.85
1X2A	.85	6BC4	1.50	6X8	.95	14R7	1.20
2A3	.95	6BC5	1.68	6Y6G	.69	14S7	1.10
2A6	.59	6BC7	1.20	7A4	.79	14W7	1.25
2X2	.49	6BD5	1.35	7A5	.69	19B6GG	1.89
2X2A	1.35	6BD6	.73	7A6	.78	19T8	.95
3A3	1.08	6BE6	.65	7A7	.75	25A5V5	1.25
3A4	.50	6BF5	.82	7A8	.75	25A7	1.05
3A5	.85	6BF6	.62	7AD7	1.65	25AK5	.95
3AL5	.65	6BG6G	1.75	7AF7	.89	25BQ6GT	1.25
3AU6	.70	6BH6	.79	7AG7	.95	25CD6G	1.75
3AV6	.60	6BJ6	.69	7AH7	.95	25CU6	1.30
3B4	2.95	6BK5	.95	7B4	.75	25J5	39.50
3B7	.39	6BK7	1.05	7B5	.65	25J6	12.95
3BC5	.80	6BL7	1.05	7B6	.75	25J7	15.25
3BN6	1.05	6BN6	1.10	7B7	.85	25K23	15.25
3BY6	.85	6BQ6GT	1.15	7B8	.85	25K25	11.95
3CB6	.80	6BQ7A	1.15	7C5	.75	25K26	17.50
3CF6	.85	6BX7	1.20	7C6	.75	25K33A	56.95
3D6	.39	6BY5G	1.25	7C7	.79	3AP1	2.90
3FL4	.85	6BZ7	1.20	7E7	1.15	3B24	.95
3Q4	.65	6C4	.38	7F7	.65	3B24W	4.95
3Q5	.75	6C5	.48	7F8	1.10	3B25	4.95
3S4	.65	6C5GT	.46	7G7	1.10	3B26	7.45
3V4	.69	6C6	.49	7H7	.79	3B27	3.45
4BQ7A	1.30	6C8G	.85	7J7	1.25	3B29	5.95
4BZ7	1.35	6CB5	4.40	7K7	1.15	3BP1	2.45
5AM8	1.05	6CB6	.68	7L7	1.10	3C22	59.50
5AN8	1.10	6CD6G	1.75	7N7	.85	3C23	3.45
5AQ5	.75	6CF6	.90	7Q7	.95	3C24	1.48
5AS8	1.10	6CC7	.85	7R7	.95	3C43	5.95
5AT8	1.10	6CL6	1.10	7V7	.95	3D21A	2.95
5AV8	1.15	6CM6	.85	7W7	.95	3DP1	3.25
5AW4	1.10	6C5G	.75	7X7	.90	3E29	9.00
5AZ4	.60	6CU6	1.30	7Y4	.65	4-65A	13.25
5I6	.90	6D6	.59	7Z4	.85	4-125A	18.95
5R4GY	1.45	6DC6	.95	12A4	.85	4-250A	29.50
5T4	.90	6E5	.75	12A6	.57	4C28	17.45
5U4G	.58	6F5	.59	12A8GT	.79	4C35	13.45
5U8	1.10	6F6	.59	12AH7GT	1.05	4E27	7.95
5V4G	.88	6F6CT	.69	12AL5	.65	4X150A	22.45
5V6GT	.70	6F7	.85	12AQ5	.70	4X150G	31.95
5W4GT	.65	6F8C	.72	12AT6	.48	5BP1	2.35
5X4G	.75	6G6G	.72	12AT7	.92	5B2A	1.95
5X8	1.05	6H6	.59	12AU6	.62	5C22	27.50
5Y3GT	.49	6H6GT	.49	12AU7	.75	5CP1	1.95
5Y4G	.65	6J4	2.55	12AV6	.52	5CP1A	8.45
5Z3	.69	6J5	.48	12AV7	.95	5DP7	7.95
5Z4	.89	6J5GT	.47	12AW6	.85	5D21	7.45
6A3	.95	6J6	.68	12AX4	.85	5FP7	1.20
6A6	.82	6J7	.82	12AX7	.85	5J29	29.50
6A7	.89	6J7GT	.65	12AY7	.85	5J30	17.25
6A8	1.05	6K6GT	.65	12AZ7	1.15	5J33	6.95
6ABGT	.95	6K7	.74	12B4	.85	5JP1	12.45
6AB4	.95	6K7GT	.59	12BA6	.60		
6AB7	.95	6K8	1.10	12B7	.99		
6AC5	1.05	6K8GT	.95	12BD6	.70		
6AC7	.85	6L6	1.69	12BE6	.65		

## TRANSMITTING TUBES

0A3/VR75	.86	5J2	6.35	876	.72	5687	2.65	6099	1.35
0B3/VR90	.73	5J5	9.95	878	.48	5692	5.10	6101	1.45
0C3/VR105	.68	5LP1	7.40	884	.95	5693	4.65	6113	1.25
0D3/VR150	.68	5NP1	4.95	885	.95	5696	.90	6146	4.75
1B22	1.25	6AC7W	1.45	902	2.45	5702	1.95	6161	69.50
1B23	2.68	6AK5W	1.45	918	1.65	5703	.95	6187	3.95
1B24	4.85	6AL5W	.95	923	1.25	5704	2.95	6189	2.65
1B27	12.95	6AQ5W	1.70	925	1.50	5718	2.75	6263	11.45
1B35	3.45	6A56W	2.69	927	.95	5718A	4.75	6264	11.45
1B38	33.50	6BF7W	3.45	930	1.19	5719	2.15	6539	2.95
1B40	3.45	6C4W	6.75	931A	2.95	5725	1.45	8005	4.75
1B41	3.75	6C21	14.95	954	.25	5726	.60	8008	3.95
1P21	1.89	6F4	2.65	955	.35	5727	1.25	8012	.98
1P22	.39	6J4WA	4.45	956	1.61	5732	2.95	8013	2.65
1N21B	1.45	6J5WGT	3.90	957	.35	5744	1.75	8013A	3.75
1N23	.68	6J6W	2.20	958A	.35	5751	1.45	8014	67.50
1N23B	1.40	6J6WA	3.90	959	1.32	5762	99.50	8020	1.25
1N34	.42	6K4	2.20	991	.29	5763	1.25	8025	1.45
1N34A	.48	6SN7WGT	1.85	1603	2.95	5783	4.45	9001	.82
1P21	29.50	6X4W	1.20	1616	.50	5787CK	4.05	9002	.60
1P22	13.25	6X5W	1.25	1619	.30	5794	5.95	9003	1.20
1P23	1.85	7BP7	4.45	1622	1.45	5812	2.70	9004	.35
1P24	1.45	12DP7	14.95	1624	.95	5814	.95	9005	1.39
1P25	64.50	15E	1.45	1625	.29	5819	32.50	9006	.25
1P28	8.95	15R	.49	1626	.19	5820	495.00	C1JA	10.95
1P30	1.95	28D7	.95	1633	.85	5823	1.35	C6J	7.95
1P31	.95	300TH	6.25	1635	1.48	5829	1.25	CK1005	.32
1P39	1.45	100T	8.25	1641	1.35	5840	4.40	CK1006	3.45
1P40	1.25	111	.45	1654	1.75	5841	7.40	CK1007	.65
1P41	2.45	249B	2.95	2050	1.25	5844	.95	CK1038	4.70
1P42	2.35	249C	1.95	2051	.65	5851	3.45	CK1039	4.70
2AP1	4.95	250TH	18.95	5516	6.45	5876	12.50	F123A	2.75
2B22	1.95	250TL	14.75	5517	1.65	5879	1.25	F127A	22.50
2C21	.39	262C	4.95	5634	6.95	5881	2.95	F128A	14.95
2C34	.25	274A	3.45	5636	2.90	5886	3.25	FG17	4.95
2C36	21.50	274B	.85	5637	4.95	5894	15.95	FG27A	10.90
2C39A	10.95	304TH	7.95	5638	7.45	5896	4.45	FG32	3.95
2C40	9.45	304TL	9.95	5639	8.95	5899	3.95	FG95	17.50
2C43	10.25	307A	1.10	5641	5.95	5902	5.95	FG105	12.95
2C52	2.95	350A	2.65	5642	1.95	5905	8.75	FG172	17.95
2C53	10.75	350B	2.35	5643	5.95	5906	1.45	HF100	6.95
2D21	.65	371B	8.55	5647	3.95	5908	7.85	HF200	9.95
2D21W	1.95	393A	4.50	5651	1.35	5932	3.95	HF300	17.50
2E22	3.15	WL417A	2.95	5654	1.25	5933	2.25	WL616	47.50
2E24	2.40	417A/5842		5656	7.90	5963	5.45	RK65	7.50
2E26	3.25		12.45	5670	1.10	6021	4.45	RK72	.50
2E30	1.95	434A	2.95	5675	10.95	6080WA	7.95	RX21	5.50
2G21	2.45	460TH	47.50	5676	1.25	6096	1.45	TZ40	3.50
2J31	14.00	450TL	35.00	5678	1.25	6097	1.45		
2J32	12.50	575A	9.95	5686	1.95	6098	1.85		
2J33	14.00	705A	.68						
2J34	14.00	707A	4.95						
2J36	14.95	707B	3.95						
2J37	9.50	715B	2.95						
2J55	39.50	715C	10.95						
2J61	12.95	717A	.35						
2J62	12.95	721A	.65						
2K23	15.25	723A/B	8.45						
2K25	11.95	725A	2.95						
2K26	17.50	726A	4.95						
2K33A	56.95	726B	32.50						

# ACTUAL SIZE

complete with selector switch...

## TRIPLETT

ELECTRICAL INSTRUMENT CO.  
Bluffton, Ohio

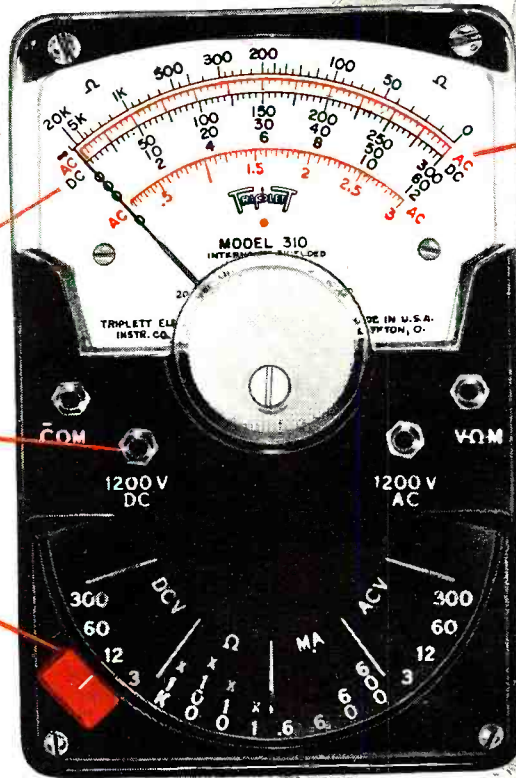

• 5,000 ohms per volt. A.C.

• 20,000 ohms per volt. D.C.

• BANANA-TYPE JACKS—positive connection and long life.

• EXCLUSIVE SELECTOR SWITCH speeds circuit and range settings. The first and only miniature VOM with this exclusive feature for quick, fool-proof selection of all ranges.

• SELF-SHIELDED FOR CHECKING IN STRONG MAGNETIC FIELDS. Self-shielded, rugged, higher-torque Bar-Ring instrument movement (exclusively Triplet).



### CARRYING CASE

Handsome leather carrying case with adequate space for Model 310 tester and accessories. Trouser belt slips through loop on back of the case for out-of-the-way carrying. MODEL 369 CASE—U.S.A. Dealer Net ..... \$2.90

### LOOK AT ALL THESE RANGES

DC VOLTS: 0-3-12-60-300-1200 at 20,000 Ohms/Volt.  
AC VOLTS: 0-3-12-60-300-1200 at 5,000 Ohms/Volt.  
DC MICROAMPERES: 0-600 at 250 Millivolts.  
DC MILLIAMPERES: 0-6-60-600 at 250 Millivolts.  
OHMS: 0-20,000-200,000 (200-2000 at center scale).  
MEGOHMS: 0-2-20 (20,000-200,000 Ohms at center scale).  
OUTPUT: Convenient chart in instruction book.

SEE IT AT YOUR JOBBER  
AND IT'S ONLY ONE OF TRIPLETT'S MIGHTY NINE VOM LINE!

## Model 310 MIGHTY MITE

# the only complete miniature V-O-M (AC-DC)

ONLY \$29<sup>50</sup> Dealer Net



- 631**  
Combination  
V-O-M—VTVM
- 630-NA**  
For Best Testing  
Around The Lab,  
Production Line  
or Bench
- 630**  
The Popular  
All-Purpose  
V-O-M
- 630-A**  
A Good Lab and  
Production Line  
V-O-M
- 310**  
The Smallest  
Complete V-O-M  
With Switch
- 630-T**  
For Telephone  
Service
- 666-MR**  
Medium Size  
For  
Field Testing
- 625-NA**  
The First V-O-M  
With 10,000  
Ohms/Volt AC

BURTON BROWNE ADVERTISING

...another  
**MALLORY**  
service-engineered  
product

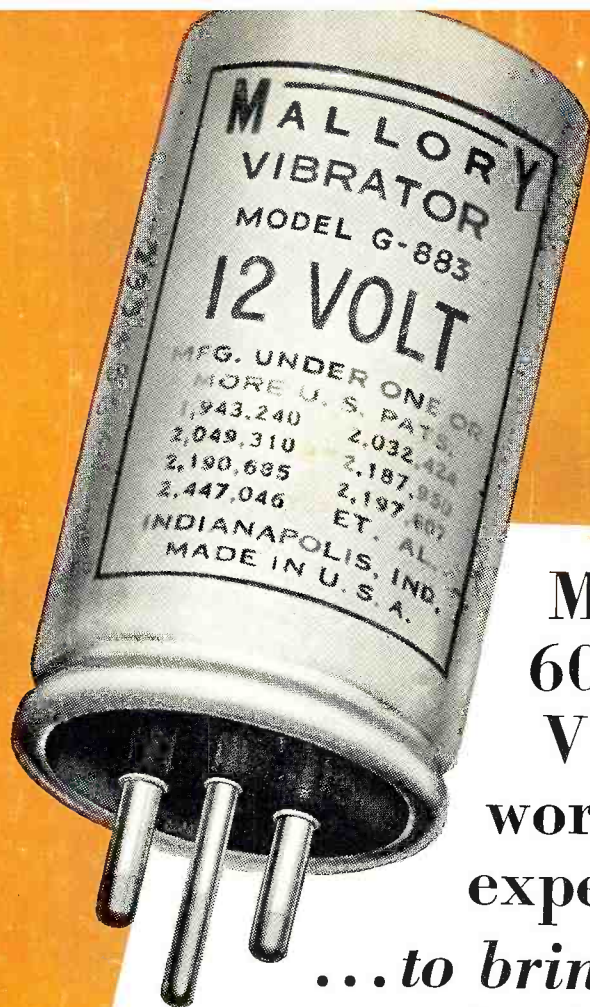

More than  
60 Million  
Vibrators  
worth of  
experience  
...to bring you  
the best!

Yes, it has taken 26 years of pioneering development . . . plus the manufacturing know-how gained by making more than 60 million vibrators—60 million units worth of experience—to bring you Mallory's long-lived, premium performance vibrators.

Unique Mallory features have reduced mechanical hum to levels thought impossible a few years ago. They have extended vibrator life, and established new standards of reliability and service.

As in the past, Mallory will continue to lead the vibrator field in design and development . . . bringing you the finest in performance . . . the utmost in economy and efficiency.

Give your customers *the best*.  
Be certain you order Mallory from  
your distributor.

P. R. MALLORY & CO. Inc.  
**MALLORY**

P. R. MALLORY & CO. Inc., INDIANAPOLIS 6, INDIANA

- Capacitors • Vibrators • Resistors • Controls • Switches
- Rectifiers • Power Supplies • Filters • Mercury Batteries