

HI-FI CERAMIC CARTRIDGES

RADIO & TELEVISION NEWS

MAY
1956

35 CENTS
in U.S. and Canada

World's Leading Electronics Magazine

IN THIS ISSUE

TRANSISTORS IN INDUSTRY

SATELLITE TV

COMMERCIAL ASPECTS OF
SINGLE-SIDEBAND

NEW TV ANTENNA UNITS

REALISTIC HIGH FIDELITY
Your Listening Room

AN EXPERIMENTAL
U.H.F. OSCILLATOR

TRANSISTOR RADIOS

QUICK CHECKS FOR
TUBES IN SERIES

TRANSISTORIZED
R.F. CAPACITANCE METER

COVER STORY

(See Pg. 41)



your source of finest TV and Radio Tubes is

first in transistors...



Raytheon's pioneering in the research, development and production of Transistors has resulted in many important "firsts" — firsts that give Raytheon an unchallenged lead in the field. Here are some of these firsts:

FIRST in commercial production. Raytheon was the first company to commercially produce and sell junction transistors. These first transistors set high performance standards as they revolutionized the hearing aid industry.

FIRST in RF Transistors. Raytheon scored another important first by leading the way in RF Transistors, too. The first commercially produced RF Transistors — Raytheons — are revolutionizing the portable radio industry, and are being used in computers and communication equipment. Many major manufacturers of portable radios use these Raytheon RF Transistors and all "hybrid" portables use either Raytheon Transistors, Raytheon Subminiature Tubes or a combination of both.

FIRST in PNP Silicon Transistors. Raytheon alone makes a line of PNP Silicon Transistors that fills the need for transistors that will operate at high temperatures.

FIRST Major Manufacturer to Break the Dollar Barrier. A most important first to you — Raytheon is the first major supplier to achieve such high production and product acceptance of their transistors that one of the line could be priced at less than a dollar — Raytheon quality transistors range in price from 99¢.

At Raytheon more than 100 engineers and scientists, plus nearly 1400 other employees are devoted to a single task — the design, development and production of the finest and best in transistors and diodes. To help them work more efficiently, and to meet increasing production schedules Raytheon recently added facilities totaling three acres of engineering and manufacturing space to its Semiconductor Division.

Raytheon Tube Distributors from coast to coast stock and recommend Raytheon Transistors.



ACTUAL SIZE

This huge plant (3 acres of floor space) has just been added to Raytheon's Semiconductor Division — to help meet the ever increasing demands for Raytheon Transistors.

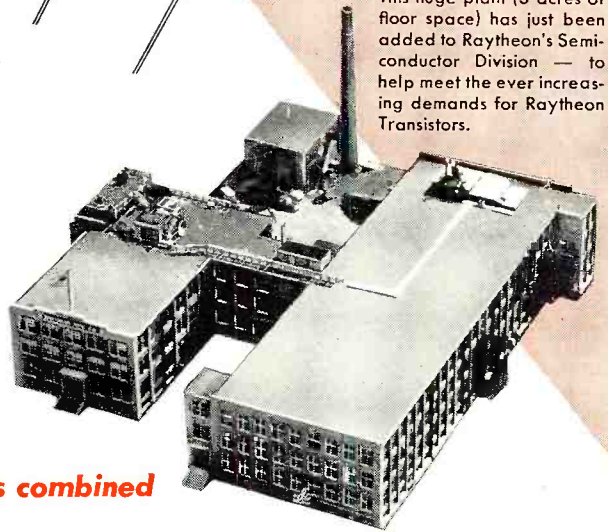

RAYTHEON TRANSISTORS

more in use than all other makes combined



RAYTHEON MANUFACTURING COMPANY

Receiving and Cathode Ray Tube Operations

Newton, Mass. • Chicago, Ill. • Atlanta, Ga. • Los Angeles, Calif.

Raytheon makes all these: { Receiving and Picture Tubes, Reliable Subminiature and Miniature Tubes, Semiconductor Diodes and Transistors, Nucleonic Tubes, Microwave Tubes.



I WILL TRAIN YOU AT HOME FOR GOOD PAY JOBS IN RADIO-TELEVISION

J. E. SMITH has trained more men for Radio-Television than any other man. OUR 40th YEAR.

America's Fast Growing Industry Offers You Good Pay—Bright Future—Security

I TRAINED THESE MEN



"Started to repair sets six months after enrolling. Earned \$12 to \$15 a week in spare time."—Adam Kramlik, Jr., Sunneytown, Pennsylvania.

"Up to our necks in Radio-Television work. Four other NRI men work here. Am happy with my work."—Glen Peterson, Bradford, Ont., Canada.



"Am doing Radio and Television Servicing full time. Now have my own shop. I owe my success to N.R.I."—Curtis Stath, Ft. Madison, Iowa.

"Am with WCOC. NRI course can't be beat. No trouble passing 1st class Radio-phone license exam."—Jesse W. Parker, Meridian, Mississippi.



"By the time I graduated I had paid for my course, a car and testing equipment. Can service toughest jobs."—E. J. Streitenberger, New Boston, Ohio.

AVAILABLE TO **VETERANS** UNDER G. I. BILLS

Training plus opportunity is the PERFECT COMBINATION for job security, good pay, advancement. In good times, the trained man makes the BETTER PAY, GETS PROMOTED. When jobs are scarce, the trained man enjoys GREATER SECURITY. NRI training can help assure you more of the better things of life.

Start Soon to Make \$10, \$15 a Week Extra Fixing Sets

Keep your job while training. I start sending you special booklets the day you enroll, that show you how to fix sets. Multitester built with parts I send helps you make \$10, \$15 a week extra fixing sets while training. Many start their own Radio-Television business with spare time earnings.

My Training Is Up-To-Date

You benefit by my 40 years' experience training men at home. Well illustrated lessons give you basic principles you need. Skillfully developed kits of parts I send (see below) "bring to life" things you learn from lessons.

You Learn by Practicing with Parts I Send

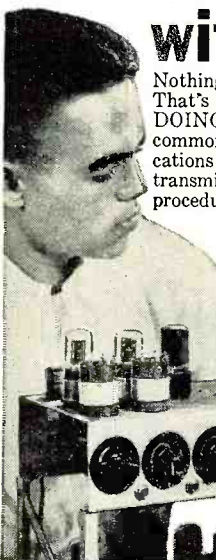

Nothing takes the place of PRACTICAL EXPERIENCE. That's why NRI training is based on LEARNING BY DOING. You use parts I furnish to build many circuits common to Radio and Television. As part of my Communications Course, you build many things, including low power transmitter shown at left. You put it "on the air," perform procedures required of broadcasting operators. With my Servicing Course you build modern Radio, etc. Use Multitester you build to make money fixing sets. Many students make \$10, \$15 week extra fixing neighbors' sets in spare time while training. Coupon below will bring book showing other equipment you build. It's all yours to keep.

The Tested Way To Better Pay!

2 FREE BOOKS SHOW HOW MAIL COUPON



Television Making Good Jobs, Prosperity—Even without Television, Radio is bigger than ever. 115 million home and auto Radios to be serviced. Over 3000 Radio broadcasting stations use operators, technicians, engineers. Government, Aviation, Police, Ship, Micro-wave Relay, Two-Way Radio Communications for buses, taxis, trucks, etc., are important and growing fields. Television is moving ahead fast.

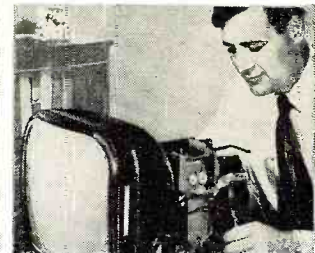

About 200 Television stations are now on the air. Hundreds of others being built. Good TV jobs opening up for Technicians, Operators, etc.

25 million homes now have Television sets. Thousands more are being sold every week. Get a job or have your own business selling, installing, servicing.

Radio-TV Needs Men of Action—Mail Coupon

Act now to get more of the good things of life. Actual lesson proves my training is practical, thorough. 64-page book shows good job opportunities for you in many fields. Take NRI training for as little as \$5 a month. Many graduates make more than total cost of training in two weeks. Mail coupon now. J. E. SMITH, President, National Radio Institute, Dept. 6EE, Washington 9, D. C. OUR 40TH YEAR.

Good for Both—FREE

MR. J. E. SMITH, President, Dept. 6EE.
National Radio Institute, Washington 9, D. C.
Mail me Sample Lesson and 64-page Book, FREE.
(No salesman will call. Please write plainly.)

Name..... Age.....
Address.....
City..... Zone..... State.....

VETS write in date of discharge.....

The ABC's of SERVICING
How to Be a Success in RADIO-TELEVISION

RADIO & TELEVISION NEWS is published monthly by Ziff-Davis Publishing Company, William B. Ziff, Chairman of the Board (1946-1953), at 64 E. Lake St., Chicago 1, Ill. Entered as second-class matter July 21, 1948, at the Post Office, Chicago, Ill., under the act of March 3, 1879. Authorized by Post Office Department, Ottawa, Canada, as second-class matter. SUBSCRIPTION RATES: Radio & Television News—one year U. S. and possessions, and Canada \$4.00; Pan-American Union countries \$4.50; all other foreign countries \$5.00.

Assistant Publisher
Editorial Director
OLIVER READ, D.Sc., WJETI
Editor
WM. A. STOCKLIN, B. S.
Technical Editor
H. S. RENNE, M. S.
Service Editor
CHARLES TEPFER
Associate Editor
P. B. HOEFER
Assistant Editor
J. JUSTER
Television Consultant
WALTER H. BUCHSBAUM
Art Editor
FRANK SAYLES
Draftsmen
J. A. GOLANEK
W. K. VAHLING
Advertising Director
L. L. OSTEN
Advertising Manager
MURRAY GOLDMAN
Midwest Adv. Manager
JOHN A. RONAN, JR.
Western Adv. Manager
JOHN E. PAYNE



*First in radio-
television-audio-electronics*

Average Net Paid Circulation 229,357

Reg. U. S. Pat. Off. Radio News Trademark Reg. U. S. Pat. Office • Television News Trademark Reg. U. S. Pat. Office.

CONTENTS

MAY, 1956

EDITORIAL—INDUSTRY NEWS

For the Record.....O. Read 8
Spot Radio News.....Washington Correspondent 24
The Transistor in Industry.....Frank M. Dukat 39
Cover Story..... 41
Satellite TV.....John B. Grund 50
New TV Grants Since Freeze Lift..... 158

HIGH FIDELITY AND AUDIO

The Ceramic Cartridge and Equalization.....Herman Burstein 43
Realistic High Fidelity (Part 2).....H. A. Hartley 46
A Tape System You Can Build—Stereophonic Operation
(Part 4).....John L. MacAllister 56
Transistor Intercom Amplifier.....Edwin T. Bohr 58
Evolution of the Phonograph (Part 6).....Oliver Read & James Riley 72
Certified Record Revue.....Bert Whyte 74
Germanium Diode Broadcast-Band Tuner..... 76
New Hi-Fi-Audio Equipment..... 106

SERVICING

Television-Radio

Clearing Up TV Interference.....John B. Ledbetter 48
New TV Antenna Roundup.....Walter H. Buchsbaum 62
Transistor Radios (Part 3).....Milton S. Kiver 68
Mac's Service Shop.....John T. Frye 78
Quick Check for Tubes in Series.....Matthew Mandl 100
Antenna News..... 118
Radio-TV Service Industry News..... 175

Test Equipment

An Experimental U.H.F. Oscillator.....Louis E. Garner Jr. 53
Transistorized R.F. Capacitance Meter.....L. Fleming 65
A Transistorized Scope Calibrator.....Joseph Chernof 102
Wide-Range Spike Generator.....Rufus P. Turner 111
Using Your Test Equipment.....Mel Byron 130
New Tube Tester Data..... 138
Using the 5AXP4.....Lloyd B. Hust 152

AMATEUR AND COMMUNICATIONS

Commercial Aspects of Single-Sideband (Part 1).....Jack N. Brown 59
1955 Edison Radio Amateur Award Winner..... 80

ELECTRONIC THEORY AND CONSTRUCTION

Magic Earphones.....Irving Gottlieb 70
Battery-operated Cathode Follower.....Rufus P. Turner 126

DEPARTMENTS

Within the Industry..... 32 Technical Books 132
Manufacturers' Literature 120 What's New in Radio..... 140
Sales Aids 146



COVER PHOTO: Operator at Raytheon's Semiconductor plant in Newton, Mass., "grows" a crystal from silicon in a crucible containing molten silicon at 2650 degrees F. How this is done is explained on page 41, this issue. (Ektachrome by George E. Meyers)

ZIFF-DAVIS PUBLISHING COMPANY

President
B. G. DAVIS

Vice-Presidents
H. J. MORGANROTH
M. H. FROELICH

Secretary-Treasurer
G. E. CARNEY

Circulation Manager
M. MICHAELSON

BRANCH OFFICES

CHICAGO (1)
64 E. Lake St., AN 3-7700
LOS ANGELES (14)
Starliner Center, 900 Wilshire Blvd., Mich. 5956



ZIFF-DAVIS PUBLISHING COMPANY
WILLIAM B. ZIFF (1898-1953) FOUNDER
Editorial and Executive Offices
366 Madison Ave., New York 17, N. Y.
VOLUME 55 • NUMBER 5



Member
Audit Bureau of
Circulations

© 1956 by Ziff-Davis Publishing Company. All rights reserved.

SUBSCRIPTION SERVICE: All communications concerning subscriptions should be addressed to Circulation Dept., 64 E. Lake St., Chicago 1, Ill. Subscribers should allow at least four weeks for change of address. Include your old address as well as new—enclosing, if possible, an address label from a recent issue of this magazine.

CONTRIBUTIONS: Contributors are advised to retain a copy of their manuscripts and illustrations. Contributions should be mailed to the New York Editorial Office and must be accompanied by return postage. Contributions will be handled with reasonable care, but this magazine assumes no responsibility for their safety. Any copy accepted is subject to whatever adaptations and revisions are necessary to meet the requirements of this publication. Payment covers all author's, contributor's, and contestant's rights, title, and interest in and to the material accepted and will be made at our current rates upon acceptance. All photos and drawings will be considered as part of the material purchased.

Amazingly effective
HOME TRAINING in

AUTOMATION ELECTRONICS TELEVISION RADIO ELECTRONICS

YOU CAN
BUILD A 21-INCH
TV SET IF YOU
WISH

LEARN
BY
DOING

THE ELECTRO-
LAB* CERTAINLY
MAKES IT
SIMPLE

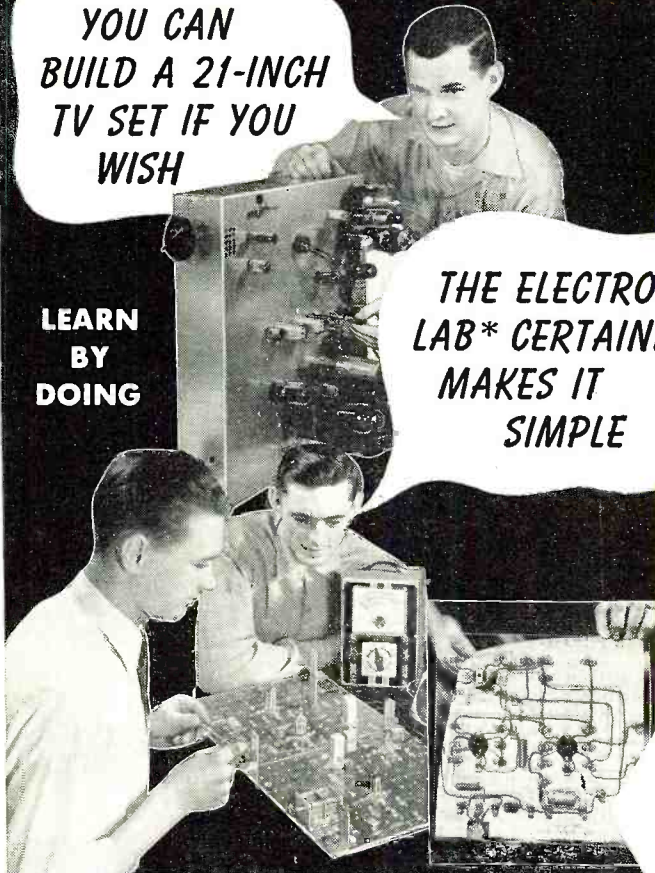

Television, Radio, Electronics, has created a great variety of good jobs; jobs with money, respect, position; jobs you may choose among—if you only had training. DeVRY Training is modern, thorough, practical—followed by a real Employment Service. Thousands have stepped into good pay—why not you? No need to leave home; no need to quit your present job; no special preliminary training required. Fill out coupon below and get the full story. Men 17 to 55 preferred.

YOUR OWN HOME MOVIES

Movies are a remarkable feature of the D T I System. You use a movie projector and many reels of films. Run off each film as often and as slowly as you want. A wonderful aid to help make important points crystal-clear. Get the full story! Send in that coupon.

Member of National Home Study Council

HOME MOVIES



"One of America's Foremost
Electronics Training
Centers"



DEVRY TECHNICAL INSTITUTE
CHICAGO 41, ILLINOIS
FORMERLY
DEFOREST'S TRAINING, INC.

USE AND KEEP all of this practical
Quality Commercial Type Equipment

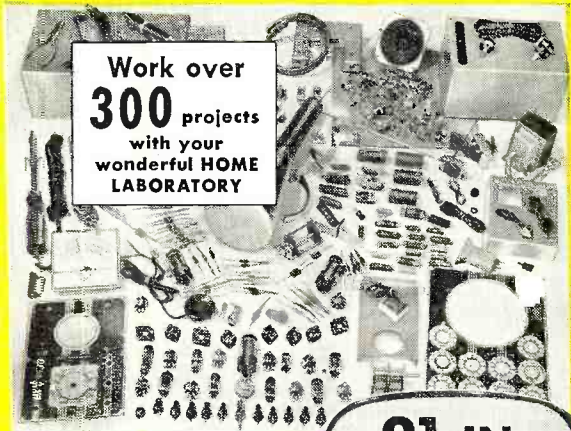

Work over
300 projects
with your
wonderful HOME
LABORATORY

NEW STYRENE ELECTRO-LAB* SPEEDS LEARNING

Simply place a pictorial diagram under transparent Styrene base. Follow the diagram. Wiring is tremendously simplified. Work over 300 learn-by-doing projects — a wonderful way to get experience. *Trade-mark

21-IN.

Build and keep
DTI's NEW 21 Inch
TV Set—ideal for
custom installation.
(DTI also offers
hometraining with-
out the TV set.)

BUILD AND KEEP

A quality Oscilloscope—almost a necessity for Television servicing. Helps you earn while you learn.

BUILD AND KEEP

A Vacuum Tube Voltmeter—a highly versatile test unit you can use when you are ready to make real money! IF PREFERRED, you may get all your preparation in DTI's big Chicago training laboratories—among the finest. (See building pictured below.)

Valuable information for men
subject to military service.



MAIL COUPON TODAY

DeVRY TECHNICAL INSTITUTE
4141 Belmont Ave., Chicago 41, Ill. Dept. RN-5-M

I would like complete facts including "89 Ways to EARN MONEY in Television-Radio-Electronics."

Name _____ Age _____
Street _____ (PLEASE PRINT) Apt. _____
City _____ Zone _____ State _____
1019 DTI's training is available in Canada.

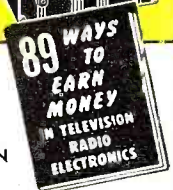



*exclusively
for
you!*

a mile of tape . . . a mile of pleasure!

5280 feet on every 10½" reel of PLUS 100

Thanks to its extra thin—extra strong magic Mylar® base, Soundcraft Plus 100 magnetic recording tape on a single 10½ inch reel gives you 5280 feet of clean, rewarding *professional* sound. Even on a conventional 7 inch reel, you take advantage of 2400 feet . . . the recording length that puts you on a par with the professionals.

With a 5 inch reel, Plus 100 gives you a full 1200 feet of recording pleasure.

The tape recorder expert who really *knows* his equipment will insist on Soundcraft Plus 100 magnetic recording tape—the *EXTRA, EXTRA* long-play quality tape. Ask for it wherever you buy hi-fi equipment.

*DuPont Polyester Film



FOR EVERY SOUND REASON

REEVES SOUNDCRAFT CORP.

10 East 52nd Street, New York 22, N. Y.

RADIO & TELEVISION NEWS

An Invitation...

To men who want to "go places" in TV SERVICING

Find out about this NEW, ALL-PRACTICE WAY of becoming a Professional TV SERVICEMAN

If you have some Radio or Television experience, or if you know basic Radio-Television principles but lack experience—NRI's new Professional Television Servicing course can train you to go places in TV servicing. This advertisement is your personal invitation to get a free copy of our booklet describing this training in detail.

Learn-by-Doing "All the Way"

This is 100% learn-by-doing, practical training. We supply all components, all tubes, including a 17-inch picture tube, and comprehensive manuals covering a thorough program of practice. You learn how experts diagnose TV defects quickly. You see how various defects affect receiver performance—picture and sound; learn causes of defects, accurately, easily, and how to fix them. You do more than just build circuits. You get practice recognizing, isolating, and fixing innumerable troubles.

You get actual experience aligning TV receivers, diagnosing the causes of complaints from scope patterns, eliminating interference, using germanium crystals to rectify the TV picture signal, obtaining maximum brightness and definition by properly adjusting the ion trap and centering magnets, etc. There isn't room on this or even several pages of this magazine to list all the servicing experience you get.

UHF & COLOR TV Making New Boom

Installing front-end channel selector strips in modern UHF-VHF Television receivers and learning UHF servicing problems and their solution is part of the practice you get. To cash in on the coming color TV boom you'll need the kind of foundation in knowledge and experience this training gives.

Get Details of New Course Free

Once again—if you want to go places in TV servicing, we invite you to find out what you get, what you practice, what you learn from NRI's new course in Professional Television Servicing. See pictures of equipment supplied, read what you practice. Judge for yourself whether this training will further your ambition to reach the top in TV servicing. We believe it will. We believe many of tomorrow's top TV servicemen will be graduates of this training. Mailing the coupon involves no obligation.

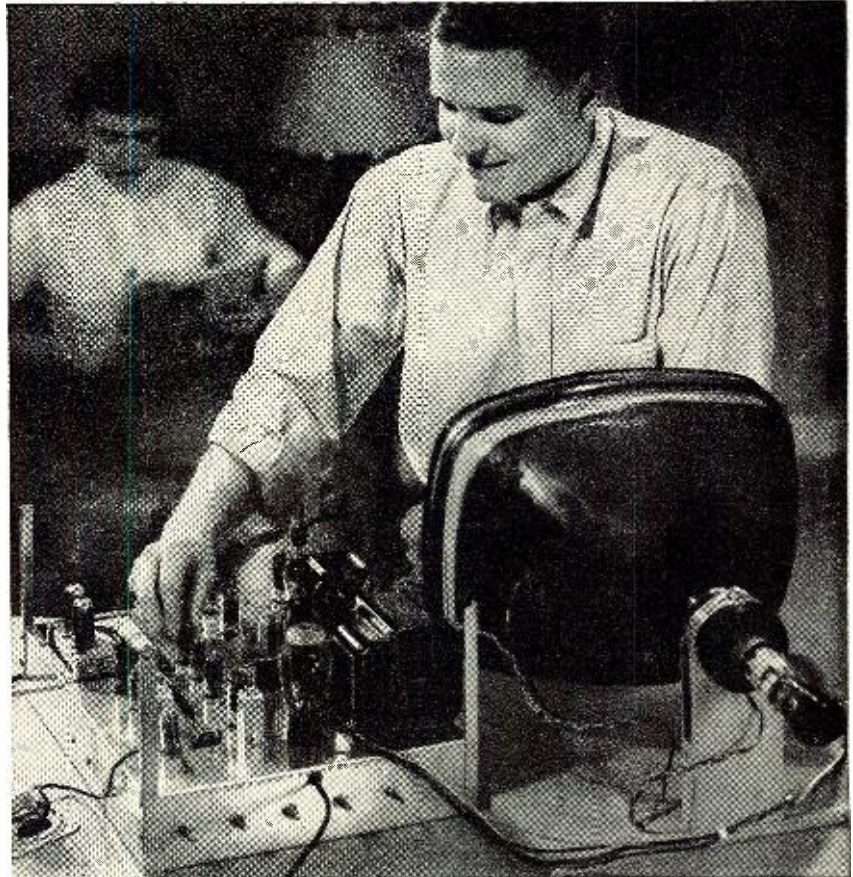

Train at home easily, quickly, for TV's top servicing jobs. NRI's Professional Television Servicing course includes a 17-inch picture tube and all other tubes and components to build a complete TV Receiver, Oscilloscope, Signal Generator, H.F. Probe. Complete training, including all equipment, available now for a low introductory price—under \$200 on easy terms.



National Radio Institute, Dept. 6EET
16th and U Sts., N.W., Washington 9, D. C.

Please send my FREE copy of "How to Reach the Top in TV Servicing." I understand no salesman will call.

Name..... Age.....

Address.....

City..... Zone..... State.....

APPROVED MEMBER NATIONAL HOME STUDY COUNCIL

NOW WITH Slide Clamp FOR EASIER USE

E-V 655C
Slim Trim
DYNAMIC
 for TV and BC



**Choice of Stations
 COAST TO COAST**

The famous 655 is now equipped with removable clamp-on stand mount. Microphone simply slides on or off. Extra rugged—praised for its dependability. Response 40-20,000 cps—widest range of any commercial microphone. Output level -55 db. High signal-to-noise ratio. Blast-proof grille. Omnidirectional. Easily concealed in studio props. Exclusive Acoustalloy diaphragm. Impedance 50 ohms easily changed to 150 or 250 ohms. Cannon UA-311 connector. TV gray 20 ft. cable.

Model 655C. List Price \$200



MODEL 654

Response 50 to 16,000 cps. Omnidirectional Output -55 db. Recessed selector gives 50 or 250 ohms impedance. Swivel stud Cannon XL-3 connector. 18 ft. cable. List. \$95

Available from Authorized E-V Distributors. Normal trade discount applies. Write for Catalog 122-N65

NO FINER CHOICE THAN
Electro-Voice
 ELECTRO-VOICE, INC. • BUCHANAN, MICH.

For the **RECORD.**

BY THE EDITOR
COLOR TV NEEDS MORE EXPOSURE

IT IS with mixed emotions that I look back to the initial excitement of having a color television receiver in my home. This was just two years ago, in March, 1954. My decision to install the set was based on a personal curiosity to find out just how well (or not so well) a commercial television receiver would stand up in daily service under typical home conditions.

Through the cooperation of *Westinghouse*, I obtained the loan of an 840CK15 color set from their regular production line for use in my experiment. In my editorial (June, 1954), I reported the results and observations made during the first months when the set was in daily service. One of the principal objections was the limited amount of color telecasting available at that time. With the exception of an occasional daytime color program, there was little to look forward to in the evening during principal viewing hours. We also recall that one of the leading manufacturers, in an attempt to stimulate sales, had offered to rent color TV sets to the public at a cost of \$100 per month. Based on the cost comparison between black-and-white and color, we figured that at the time, it would cost 54 times as much to enjoy color (per hour) than black-and-white.

Picture quality, during 1954, left much to be desired. After living with color TV for many months, it became obvious that tremendous improvements were needed at the source, that is, in the TV studio itself. Through no fault of the receiver, skin tones would vary throughout the spectrum from red to yellow, and it was necessary to continuously compensate at the set.

During the past year, great improvements were made (especially in camera techniques, makeup, and lighting) which have overcome many of the faults noted during 1954. The color picture during 1955 ranged from good to excellent. The cost per hour to the color set owner dropped considerably as more color programs became available. Industry had finally made the decision to "put the horse before the cart." And we heartily agree with Leslie Hoffman, president of the Radio-Electronics-Television Manufacturers Association, who recently said that "the breakthrough of color TV, both in manufacturing and broadcasting, was the most significant merchandising development of 1955. Sales of the large-screen color sets during the fall and early winter indicate that exposure to color programs and such, rather than price, is the determining factor in public acceptance of this exciting new medium."

We have seen many fine color shows on our latest TV sets with its 19-inch screen. Our friends no longer imply that we should have our heads examined for having a color TV set in the house when there was practically no color to see. Reactions have now gone from the ridiculous to the sublime and, almost without exception, our friends and neighbors express sheer amazement and delight when they see quality color television for the first time. These reactions are due—first, because of tremendous improvements made in the transmission of color beginning at the camera and ending at the home screen—and second, because we now are using a set equipped with one of the recently-developed color picture tubes. The combination of tube, circuitry, and studio techniques and control all contribute to the upgrading of the television picture many times over.

As far as technical performance is concerned, only one visit from a service technician (on our new set) was required. In spite of the fact that we had purchased a service contract with the distributor and his service organization, it took seven days of pleading by phone before the technician showed up. If this is an example of color TV servicing, then we shudder to think what will happen in days to come when the public begins purchasing color sets on a grand scale.

In our opinion, the time is not too far away when the buying public will accept color TV enthusiastically based largely upon word-to-mouth advertising by the present owners. But if other viewers, like ourselves, have to wait a full week for service, then industry is in for a real headache.

We were told by the service technician that there were (at that time) about 80 color sets in his territory. Most service calls involved "educational" services to show Mrs. Jones how to tune a color signal properly. The remaining troubles appeared to be minor and usually involved a simple tube replacement. In our case, this was so—the high voltage regulator had burned out after some 90 days of service.

You may ask, "Why didn't you service this set yourself?" The answer to that question is: I wanted to learn first-hand what our service contractors were doing to take care of their customers. It took a full week to find out! An independent full-time service shop would never tolerate such delay.

I sincerely hope that mine is not a typical "case history." If it is—then our service profession is either undermanned or is doing a poor selling job—or both. O. R.

Free

ALLIED'S 1956 value-packed 324-PAGE CATALOG

the only **COMPLETE** catalog for everything in TV, Radio, Hi-Fi and Industrial Electronics

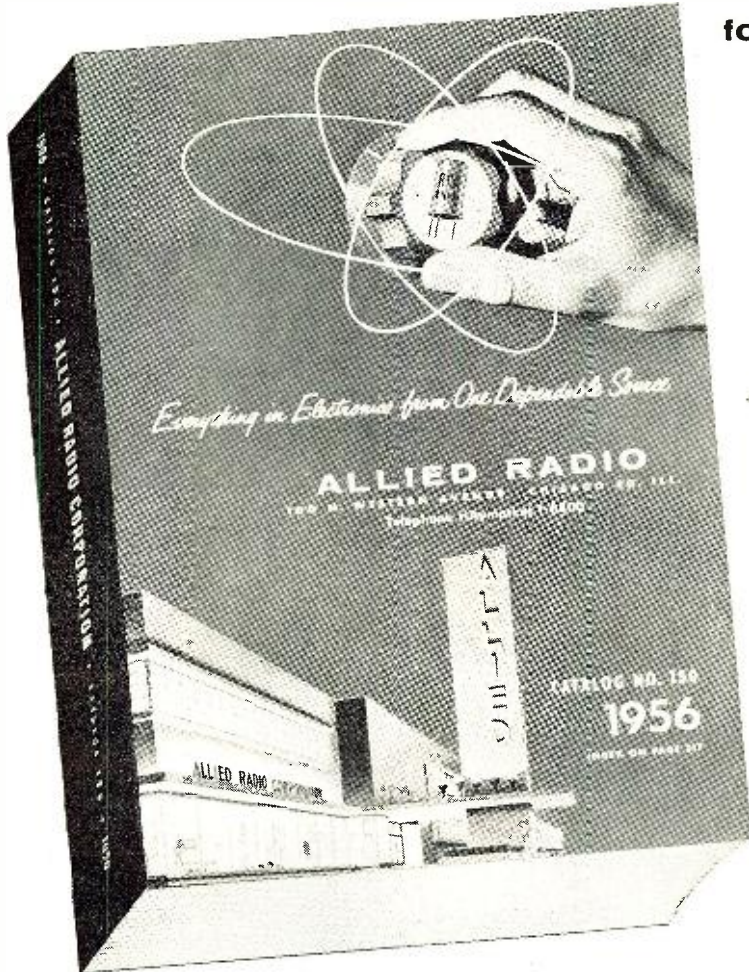

Get ALLIED'S 1956 Catalog—it's *complete*, up-to-date—324 pages packed with the world's largest selection of quality electronic equipment at lowest, money-saving prices. Get *every* buying advantage at ALLIED: fastest shipment, expert personal help, lowest prices, assured satisfaction. Send today for your **FREE** copy of the big 1956 ALLIED Catalog.

World's Most Complete Stocks

- Latest Hi-Fi Systems and Components
- P.A. Systems and Accessories
- Recorders and Supplies • TV Tubes, Antennas, Accessories • Amateur Receivers, Transmitters, Station Gear
- Specialized Industrial Electronic Equipment • Test and Lab Instruments
- Huge Listings of Parts, Tubes, Transistors, Tools, Books

Featuring Super-Value Knight-Kits—
top quality electronic equipment
in precision-designed kit form
BUY DIRECT AND SAVE

EASY-PAY TERMS

Use our liberal Easy Payment Plan—only 10% down, 12 months to pay—no carrying charges if you pay in 60 days. Available on Hi-Fi and P.A. units, recorders, TV chassis, test instruments, kits, Amateur gear, etc.

HI-FI SPECIALISTS

To keep up with the latest and best in High Fidelity, look to ALLIED. Count on us for *all* the latest releases and largest stocks of Hi-Fi equipment. We specialize, too, in TV supply—and are foremost in the field of Builders' Kits.



send for the leading electronic supply guide

ALLIED RADIO CORP., Dept. 1-E-6
100 N. Western Ave., Chicago 80, Ill.

Send **FREE** 324-Page 1956 ALLIED Catalog.

Name _____

Address _____

City _____ Zone _____ State _____

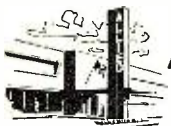

ALLIED RADIO

World's Largest Electronic Supply House

Master TV Systems

by **JERROLD**

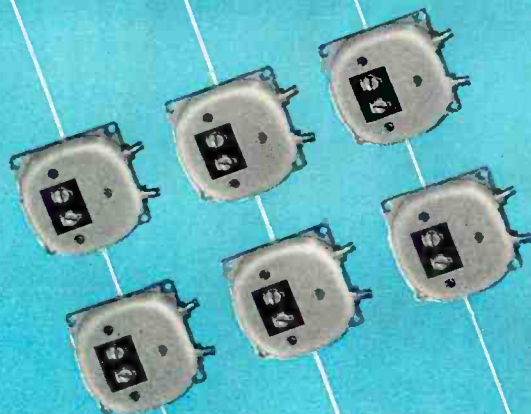
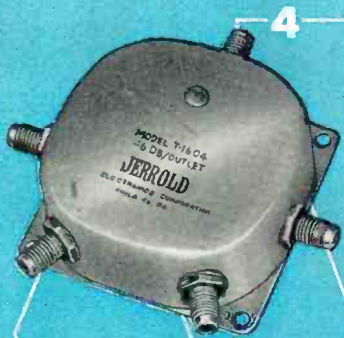

World's Largest Manufacturer of Amplified Master Television Equipment

1. Antenna-Top UHF CONVERTERS—Convert any UHF channel to any VHF channel right at the antenna . . . avoid losses of long UHF lead-ins. Have voltage regulated oscillators and Teflon trimmers for drift-free performance.

2. Lo-Noise PRE-AMPLIFIERS—Mount at the antenna to amplify the signals, not the snow. Models for all-channel (2-13), low-band (2-6), or single-channel operation. Amazingly low noise level and high gain for perfect pictures where conventional "boosters" fail.

3. Hi-Gain DISTRIBUTION AMPLIFIERS—Sensitive, 5-tube cascade circuit distributes snow-free all-channel VHF signals to 5, 10, 20, or more receivers. Noise figure approaches theoretical minimum—only 6 db.

4. Passive LINE SPLITTERS—Simplify complicated building layouts. Divide amplifier output 2 or 4 ways to feed low-noise coax distribution lines in various wings. No tubes, cannot overload.

5. Line Tap IMPEDANCE MATCHERS—Quick, easy way to connect TV sets to distribution lines. Match 300 ohm receivers to coax line, suppress interaction between sets, compensate for line response tilt.

PLUS Powerful sales aids to help you sell, install, and service any Jerrold system more profitably.

See your nearest Electronic Parts Distributor or write direct to:

**JERROLD
ELECTRONICS
CORP.**



2214 Chestnut Street, Philadelphia 3, Pa.

In Canada: Jerrold Electronics (Canada) Ltd., 50 Wingold Ave., Toronto 10, Ont.

ACCEPT THIS

FREE

OF ALL THESE

10 MASTERPIECES

COMPLETE ON TWO LONG PLAYING 33 1/2 R. P. M. DISCS.

Long
Playing



And

YOU MAY BE OUR GUEST ON A LUXURIOUS

FREE TRIP TO EUROPE!

17 Thrilling Days for TWO...

IN ENGLAND, FRANCE, ITALY, SWITZERLAND!

or if you prefer, take **\$2,500.00** IN CASH

NO OBLIGATION TO BUY ANYTHING—NOW OR EVER

THOUSANDS OF OTHER PRIZES

Including 1 Super Hi-Fi installation with AM-FM Radio, Phonograph and color TV; 1 color TV Set; 10 super High Fidelity Phonographs; 20 portable super Hi-Fi Phonographs; 150 complete Recorded Opera Sets; 250 deluxe sets of Handel's Messiah; 1000 Concert Hall Society Limited Edition Recordings; 3000 High Fidelity 12" Long Playing Records!

TOTAL VALUE OVER \$25,000.00

BEETHOVEN

Piano Sonata No 24 in F Sharp, Op. 78
Grant Johannesen, Pianist

BACH

Tocatta and Fugue in D minor
Alexander Schreiner at the Organ of the Tabernacle, Salt Lake City

DUKAS

Sorcerer's Apprentice
Utrecht Symphony, Paul Hupperts, cond.

CHOPIN

Fantaisie-Improvisation
R. Goldsand, Pianist

BERLIOZ

Roman Carnival
Netherlands Philharmonic, Walter Goehr, cond.

MOZART

Symphony No 26 in E Flat
Netherlands Philharmonic Orchestra, Otto Ackermann, conducting

BRAHMS

Academic Festival Overture
Utrecht Symphony, Paul Hupperts, conducting

WAGNER

Meistersinger Prelude, Act 1
Zurich Tonhalle Orchestra, Otto Ackermann, conducting

VIVALDI

Concerto in C for Two Trumpets
H. Sevenstern and F. Hausdoerfer, Trumpeters, Netherlands Philharmonic Orchestra, Otto Ackermann, conducting

MUSSORGSKY

Night on Bald Mountain, Netherlands Philharmonic Orchestra, Walter Goehr, cond.

In this unique musical game

EVERYONE IS A WINNER!

because you get 10 FREE High Fidelity Masterpieces as an IMMEDIATE GIFT!

This Coupon Expires June 30th

THE MUSICAL MASTERPIECE SOCIETY, INC., Dept. 47-5
43 West 61st Street, New York 23, N. Y.

In Canada: 105 Bond St., Toronto 2, Ont.

I have a long-play phonograph. Please enter my name in your musical game to win a FREE Luxury TRIP TO EUROPE for Two (or \$2,500.00 in cash, if preferred), or any one of the other \$25,000.00 worth of prizes! It is understood that I need never buy a record from the Society, unless I wish. Also send ABSOLUTELY FREE, the TEN MASTERPIECES on long-play (33 1/2 R.P.M.) high fidelity discs, and enroll me as a Trial Member of the Society.

I may keep these recordings, whether or not I buy any of the future selections, all of which will be described to me in advance. I may reject any recording before or after receiving it, and cancel my membership at any time. For future selections I decide to keep, I pay only the Member's low price of \$1.89 (plus a few cents for shipping) per long-playing disc. A saving of 40% off the usual retail price! I enclose 25¢ to help cover shipping expenses of the 10 masterpieces.

NAME..... (PLEASE PRINT)

ADDRESS.....

CITY..... ZONE..... STATE.....

LIMIT: One entrant per family. If you are ALREADY a member, do NOT send this coupon. You will hear from us by mail how you may participate in this Contest.

Contest will be judged by a nationally-known certified independent organization.

HERE'S YOUR CHANCE to win a LUXURY TRIP to Europe - for TWO - including visits to Paris, Rome and London... with all expenses paid by the famous Musical Masterpiece Society! Or you can pocket a small fortune in cash, if you prefer! Thousands of other valuable prizes worth over \$25,000.00 will be given to make new friends for the Musical Masterpiece Society!

YOU WIN FROM THE START for if you just mail the coupon below now, you are already an immediate WINNER - because we will give you all 10 MAJOR WORKS of Music described at the right, on high fidelity long-play records - ABSOLUTELY FREE! There is no obligation to buy anything or pay anything except 25¢ to help cover shipping expenses on these 10 valuable masterpieces!

We make this extraordinary offer because we want to acquaint you with the remarkable High Fidelity... and the magnificent performances... that distinguish the Musical Masterpiece Society's recordings! There's no better way for us to demonstrate the advantages our members enjoy, than actually to place these records in your hands - as a GIFT. And to make sure that

INTERNATIONAL PRAISE!
"The recording is of such perfection it seems to bring the artists into your living room!"
-Glorious Sounds, Amsterdam, Holland
"The discs can be recommended without reservation to record owners!"
-The Action, Zurich, Switz.
"Uncommonly fine, even for these days of technical advancement!"
-Los Angeles Examiner, Calif.

© 1956, Musical Masterpiece Society, Inc., N. Y.

as many people as possible hear them, we offer the huge prizes listed above!

You don't have to write any elaborate essays - or solve any tricky puzzles to be a winner. You can win the Grand Prize... or any of the hundreds of other Awards... by simply filling out the official entry blank that comes with your Free Recordings. You don't need a knowledge of music. You don't have to buy or pay anything. In fact, there has never been a contest easier to enter, or more fun than this!

FREE TRIAL MEMBERSHIP, TOO!

Along with your FREE recordings, we will also give you, immediately - without cost or obligation on your part - a Trial Membership in the Society. This Membership (which may be cancelled at any time) is valuable, because it entitles you to audition - Free of Charge, in your own home - any of the Society's future selections. Each will be described to you in advance, and you may reject any recording either before or after receiving it. You are not required to buy any records, but you may keep those you want, simply by paying only \$1.89 per long playing disc containing up to 40 minutes of music - a saving of 40% off the usual retail price! Just imagine the record collection you can build, almost for pennies!

NO STRINGS ATTACHED

You incur no obligation to buy anything. Simply mail coupon at once. We'll send your FREE recordings of these TEN MAJOR WORKS - and put your name down as eligible to win a luxury Tour of Europe - or any one of the other valuable prizes! However, to be eligible, your coupon must be in the mail before June 30th. Mail it today!

Revolutionary News in Receiving Tubes

A man in a uniform and cap, smiling broadly, holds a large sign. The sign is white with a black border and contains the text '6 MILLION HOUR FIELD TEST' in large, bold, black letters. The background of the advertisement is a bright yellow, textured surface.

**6 MILLION
HOUR
FIELD TEST**

—now, Sylvania tests every important TV tube type under actual set conditions to give you "time-tested" protection against call-backs

—6 million hours! To date that's the grand total of tube-testing in Sylvania's newest and biggest attack against common tube troubles and costly call-backs. To simulate "home operation" Sylvania tubes were taken from inventory and tested in 139 stock TV sets of leading manufacturers.

The "6-million-hour field test" is an important part of Sylvania's continuous design and development program to give you the most dependable tubes available for servicing all TV makes and models.

By giving Sylvania tubes rugged and dynamic tests at

accelerated line voltages, the common tube troubles of modern "hard working" circuits are corrected before they start digging into your profits.

Design improvements resulting from these tests give you superior replacement tubes, which often out-perform original equipment designs.

Look for the yellow and black carton—it represents a new kind of tube dependability backed by the 6-million-hour field test.



 **SYLVANIA**[®]

LIGHTING • RADIO • ELECTRONICS • TELEVISION • ATOMIC ENERGY

SYLVANIA ELECTRIC PRODUCTS INC.
1740 Broadway, New York 19, N. Y.
In Canada: Sylvania Electric (Canada) Ltd.,
University Tower Bldg., Montreal

damaged, weather-worn, obsolete!

6 out of 10 need replacement now!

replace them with
CHANNEL MASTER
TV ANTENNAS

**FIVE ALL-CHANNEL FAVORITES —
TOPS FOR REPLACEMENT!**

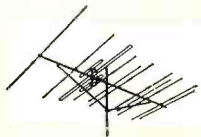

SUPER RAINBOW model no. 331
Still the most sensitive all-channel antenna model! Other popular Rainbow models also available.

"K.O." model no. 1023
(broad band)
Knocks out "venetian blinds" with the highest front-to-back ratios ever recorded!

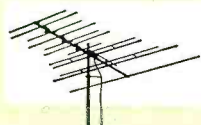
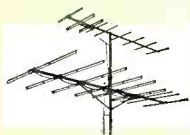

TRAILBLAZER model no. 335
Extra elements provide extra performance at no extra cost!

New LANCER model no. 337
Popular fringe-area installation — new rugged powerful design. Also available: Super Lancer, and new economy "Challenger" model.



SUPER FAN model no. 313A
The finest of Fan-antennas — superior both electrically and mechanically!

Here's the greatest profit opportunity in TV today!

The "Golden Age" of antenna replacement is here! Time has finally caught up with millions of older TV antennas that no longer provide good reception.

A national survey shows that 65% of all TV set-owners in established areas are not getting the picture quality they *should* be getting. **THEY NEED NEW ANTENNAS!** And you can profit in a big way by replacing now with a powerful, new CHANNEL MASTER installation!

YOUR BEST REPLACEMENT BUY is Channel Master, America's most widely advertised and merchandised antenna line. Channel Master provides you with the most advanced electrical designs, the soundest construction, the easiest, fastest installation.

See your Channel Master distributor



CHANNEL MASTER CORP.

ELLENVILLE, N. Y.

WORLD'S LARGEST MANUFACTURER OF TV ANTENNAS AND ACCESSORIES

Something

NEW

has

Centralab

Wirewound and carbon units
snap together — **in just seconds!**

Snap wirewound unit...

(with outer shaft cut to length)



To carbon unit...

(with blue shaft cut to length)



Snap on switch...

(from Fastatch KB series)



Add the knobs...

— and there's your wire-carbon combination



been added to

Centralab's Fastatch® Custom-Control system!

has wirewounds

RATED 5 WATTS

Size of a 2-watt...
price of a 2-watt...

*The first really new development
in wirewound controls in 15 years*

*Now your Centralab distributor can give you the right
replacement for practically any dual-control custom — carbon,
wire-carbon, auto radio*

Why risk irritating a customer, because you have to wait for an exact replacement before you fix his TV, radio, or auto set? It's not necessary at all.

Chances are, you can find just what you're looking for, in Centralab's complete line of Fastatch duals. You can get more than 5,000 different combinations of resistance and taper, to duplicate exact electrical characteristics.

You don't have to do the manufacturer's job — there are no loose parts . . . no lugs to bend . . . no tricky assembling. Fastatch units — both wirewound and carbon — are assembled, tested, and guaranteed by Centralab.

Have your Centralab distributor show you Fastatch wirewound and carbon duals. Then, try them on your next jobs.

Send coupon for bulletin 42-218R.

Tear out coupon and mail today!

Centralab
®

A DIVISION OF GLOBE-UNION INC.

910E E. Keefe Avenue • Milwaukee 1, Wisconsin

Send me free bulletin 42-218R.

Name.....

Company.....

Address.....

City..... Zone..... State.....

PROFIT COMES BACK!

to phono cartridge and needle market with

Electro-Voice®

**POWER-
POINT**

(THE CARTRIDGE WITH
JEWEL* PLAYING TIPS)

CUT INVENTORY COSTS

Power-Point Replaces over 90%
of All Popular Phono Cartridges

REPLACE CARTRIDGE AND NEEDLE IN SECONDS

(Just Slip Out—Slip In)

E-V Power-Point actually gives you more working capital by cutting, drastically, the number of different cartridges and different needles you need in stock to do an adequate replacement business. Power-Point *alone* replaces over 90% of all popular phono cartridges. You save valuable time, troublesome service calls . . . you can replace Power-Point in less time than it takes to read this sentence! Remember too, almost a million Power-Points are now in use, and the number is growing fast. Additional millions will be demanded by the replacement market!

What is Power-Point?

A nylon-encased unit combining ceramic cartridge and two jeweled* playing tips. A Power-Point cartridge can be changed in seconds, replaces virtually all popular phono cartridges, costs less than two needles alone. It has low inertia, superior tracking ability, wide range, low distortion, minimum needle noise and record wear. It is non-inductive, hum-free, unaffected by moisture or temperature. It actuates all changer mechanisms.

*Superior synthetic sapphire or natural diamond.

Four Power-Point Types, each \$3.95 list

Model 51-1 (Red): two 1-mil sapphire tips.

Model 52-2 (Green): two 2-mil sapphire tips.

Model 53-3 (Black): two 3-mil sapphire tips.

Model 56 (Blue): turnover mounted 1-mil and 3-mil sapphire tips

Three Mounting Mechanisms

Model PFT-1 Power-Point Fixed Mount, 50c list.

Model PT-1 Power-Point Turnover Mount, \$1.00 list.

Model PT-2 Power-Point Turnunder Mount, \$1.00 list.

MAIL COUPON TODAY!

Electro-Voice

ELECTRO-VOICE, INC., BUCHANAN, MICHIGAN

Send me complete information about Electro-Voice Power-Point cartridges, sales-aids and display.

Company _____

Address _____

City _____ State _____

Signed _____

Let me send you FREE
the entire story

Just fill out the coupon and mail it. I will send you, free of charge, a copy of "How to Pass FCC License Exams," plus a sample FCC-type Lesson, and the amazing new booklet, "Money-Making FCC License Information."



CARL E. SMITH, E.E.
President

I can train you to pass your FCC License Exams in a minimum of time if you've had any practical radio experience—amateur, Army, Navy, radio servicing, or other. My time-proved plan can help put you, too, on the road to success.

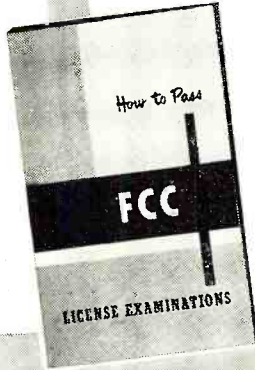

FREE

Tells where to apply and take FCC examinations, location of examining office, scope of knowledge required, approved way to prepare for FCC examinations, positive method of checking your knowledge before taking the examination.

How to Pass FCC COMMERCIAL Radio Operator License Exams

GET YOUR FCC TICKET IN A MINIMUM OF TIME

Get this Amazing Booklet FREE



An FCC License Can be Your Guarantee of Success in Electronics

TELLS HOW

HERE IS YOUR GUARANTEE

If you fail to pass your Commercial License exam after completing our course, we guarantee to continue your training without additional cost of any kind, until you successfully obtain your Commercial license.

WE GUARANTEE

TO TRAIN AND COACH YOU AT HOME IN SPARE TIME UNTIL YOU GET

YOUR FCC LICENSE

If you have had any practical experience—Amateur, Army, Navy, radio repair, or experimenting

TELLS HOW

Our Amazingly Effective JOB-FINDING SERVICE

Helps CIRE Trainees Get Better Jobs

Here are a few recent examples of Job-Finding results

ELECTRONICS TECHNICIAN

"I am now employed by the Collins Radio Company as a Lab Technician. (This job was listed in your bulletin). I have used the information gathered from your course in so many ways and I know that my training with CIRE helped me a great deal to obtain this job."

Charles D. Sindelar, Cedar Rapids, Iowa

AIRLINES

"I replied to the job Opportunities you sent me and I am now a radio operator with American Airlines. You have my hearty recommendation for your training and your Job-Finding Service."

James A. Wright, Beltsville, Md.

INDUSTRIAL ELECTRONICS

"Upon my discharge from the Navy I used your Job-Finding Service and as a result I was employed by North American Aviation in electronic assembly (final checkout)."

Glen A. Furlong, Fresno, Calif.

Your FCC ticket is recognized by employers as proof of your technical ability.

TELLS HOW

Employers make

An Approved Member



JOB OFFERS Like These to Our Graduates Every Month

Transcontinental Airline: "American Airlines is very much interested in receiving applications from CIRE trainees. We have immediate need for technicians in many cities."

West Coast Manufacturer: "We are currently in need of men with electronics training or experience in radar main-

tenance, and we would appreciate if you will refer interested persons to us."

Letter from nationally-known Manufacturer: "We have a very great need at the present time for radio-electronics technicians and would appreciate any helpful suggestions that you may be able to offer."

These are just a few examples of the job offers that come to our office periodically. Some licensed radioman filled each of these jobs . . . it might have been you!

HERE'S PROOF FCC LICENSES ARE OFTEN SECURED IN A FEW HOURS OF STUDY WITH OUR COACHING AT HOME IN SPARE TIME

Name & Address	License	Time
A/1C Ronald H. Person, St. Louis 20, Mo.	1st Class	25 Weeks
Milton L. Geisler, ET3, FPO, San Francisco, Calif.	1st Class	26 Weeks
Marvin F. Kimball, Lafayette, Ind.	2nd Class	21 Weeks
L. M. Bonino, Harlingen AFB, Tex.	2nd Class	16 Weeks
John E. Hutchison, Bluefield, W. Va.	1st Class	27 Weeks

CLEVELAND INSTITUTE OF RADIO ELECTRONICS

CARL E. SMITH, E. E., Consulting Engineer, President
Desk RN-90 — 4900 Euclid Bldg., Cleveland 3, Ohio

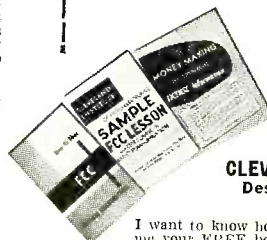

Get All 3 FREE

MAIL COUPON NOW

CLEVELAND INSTITUTE OF RADIO ELECTRONICS
Desk RN-90, 4900 Euclid Bldg., Cleveland 3, Ohio

(Address to Desk No. to avoid delay)

I want to know how I can get my FCC ticket in a minimum of time. Send me your FREE booklet, "How to Pass FCC License Examinations" (does not cover exams for Amateur License), as well as a Sample FCC-type lesson and the amazing new booklet, "Money-Making FCC License Information."

PLEASE PRINT CLEARLY

NAME..... AGE.....

ADDRESS

CITY..... ZONE... STATE.....

FOR PROMPT RESULTS SEND AIR MAIL
Special tuition rates to members of the U. S. Armed Forces
Electronic Training Available to Canadian Residents

TEST 5 TUBES in 4 SECONDS EACH...ACCURATELY!

WITH THE NEW ADVANCED ENGINEERED

precise MODEL 116

Gm. & Em. **ULTRAFAST**
TUBE & TRANSISTOR TESTER



**COMPLETELY
NEW!**

PRECISE MODEL 116K in kit form..... **\$69.95**
PRECISE MODEL 116W factory wired\$119.95

Servicemen know the Precise Model 111 (the winner in an independent survey) easily rates "the finest tube tester in the field" at any price, BUT FOR AN ON THE JOB QUICK-TEST . . . the fastest, most accurate is the PRECISE Model 116. What's more you test tubes the foolproof method inherent in the famous Precise Model 111.

Did you ever wish you could plug in 5 of the same type tubes at once and check each one individually by rotating a switch? YOU CAN WITH THE PRECISE MODEL 116—Plug in 5 IF tubes and let them heat up at once and then check each one separately by rotating the TUBE BANK switch. ACTUALLY CHECK 5 TUBES IN 20 SECONDS, 4 SECONDS PER TUBE.

The Precise Model 111 taught the lesson that IF amplifier tubes (like the 6BC5 or 6AU6) should be tested for Gm (mutual transconductance) while the power amplifiers (like the 6L6) should be tested for Em (emission)—that's ULTRAFAST Model 116 test! It checks each section of each tube separately . . . by rotating the FUNCTION SWITCH . . . each triode of a dual triode is checked individually . . . each diode and the triode of a duo-diode-triode is separately tested and not lumped as in other testers . . . and a pentode is tested as a pentode—not a diode. TRANSISTORS, SHORTS, GAS, LIFE, Em, Gm etcetera can be tested with the PRECISE Model 116.

You can inexpensively extend the Precise Model 116 to test filament current, etc. The Model 116 gives an accurate, ultra-fast (3 basic knobs for testing) check of television tubes!

No Surplus—An etched panel—beautiful Moleskin covered wood carrying case and cover and specially simplified instructions makes the PRECISE MODEL 116 THE FINEST FAST-CHECK TUBE TESTER AND DOLLAR EARNING TRAVELING COMPANION A TV SERVICEMAN EVER HAD.

Not yet at your distributor. Order NOW to insure early delivery.
SEE YOUR LOCAL DISTRIBUTOR FOR PROOF OF WHAT WE OFFER — OR WRITE US FOR DOCUMENTARY RESULTS OF AN INDEPENDENT SCIENTIFIC SURVEY.

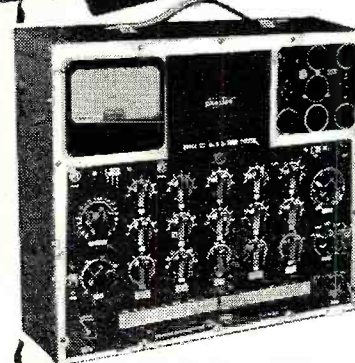

THE FAMOUS MODEL #111
111K **\$79.95**
111W \$139.95
INCL. CARRYING CASE & COVER

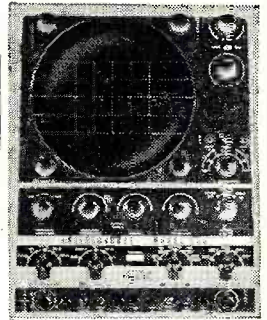

THE FIRST LOW PRICED
7" COLOR SCOPE
300K **\$99.95**
300W \$199.95



LOW PRICED 5" SCOPE
315K \$49.95
315W \$84.95

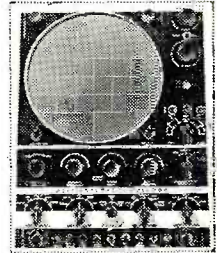

THE FIRST AND ONLY
8 1/2" COLOR SCOPE
308K **\$129.50**
308W \$229.50



LOWEST PRICED
WIRED 4 1/2" VTVM
909K \$25.98
909W **\$37.50**

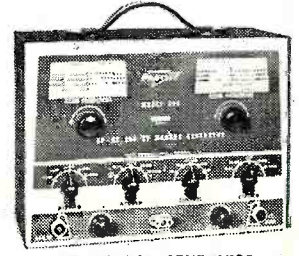

RF-AF-BAR GENERATOR
with pre-assembled* head
630K \$33.95
630KA* \$38.95
630W **\$53.95**

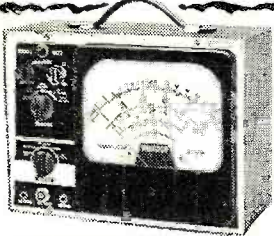

THE FINEST VOLT, REG,
7" VTVM KIT
9071K \$35.95
9071W **\$49.95**



LOW PRICED RF SIGNAL GENERATOR
"BEST BUY" IN GEN. FIELD
610K \$23.95
610KA pre-assembled head..... \$28.95
610W **\$39.95**

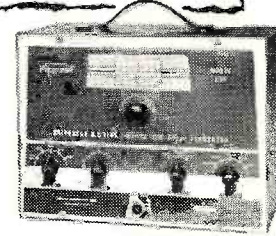

UNIV. AF, SINE, SQ, & PULSE GEN.
635K \$33.50
635W **\$52.50**

Prices slightly higher in the West. Prices and specifications subject to change without notice.

PTAK ..\$2.95
PTAW ..\$4.25

WRITE FOR CATALOG RN 5-6

SEE THE MANY MORE PRECISE INSTRUMENTS AND PROBES AT YOUR DISTRIBUTOR TODAY!

precise DEVELOPMENT CORP. OCEANSIDE, NEW YORK, U.S.A.

Leadership is a *distinction*.

And in a growing, competitive, specialized

field...it is an *achievement*

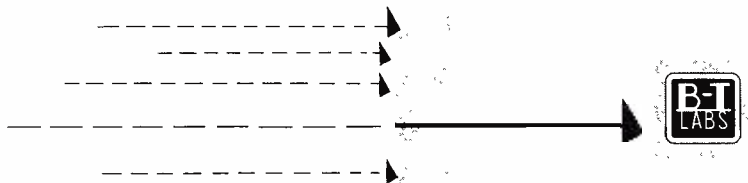

BLONDER-TONGUE LABORATORIES, INC. has, since its inception, devoted all of its facilities to the study and the advancement of the techniques and equipment used in TV signal amplification, distribution and wired transmission. This has resulted in many product developments which have gained wide and enthusiastic acceptance among the professional technicians in the field.

On the following pages are some of these B-T products... products that have proved their quality, worth and reliability in tens of thousands of installations across the nation. But, this is only the beginning. The number of multi-set users is growing daily — and the application of TV to industry and science is just coming to life.

B-T products are engineered specifically for master TV and closed circuit TV. By design, they are the key to these rapidly growing markets. They can assure your own profit future in the field.

BLONDER-TONGUE products are sold by electronic equipment distributors from coast-to-coast — and are used by service-technicians and commercial installers — everywhere.



OBSERVER

Model TVC-1
Industrial TV Camera

A new crystal-controlled camera for use in industry, education, science and other closed circuit applications. Complete unit includes Vidicon tube, coated f1.9 lens, control generator and 25 feet of control cable. The control generator may be located up to 500 feet from the camera. It provides two RF outputs and one high definition video output.

Image may be viewed on standard TV sets located up to one mile from the camera, before preamplification is required. The camera uses fully interlaced, 525-line scanning for maximum resolution. Traverse control permits camera to be focused from 2 inches to infinity.

Complete \$1995⁰⁰ list

CONVENIENT EFFECTIVE TV INSTALLATION TOOLS

2-SET COUPLER Model TV-42

Resistive network provides 12 db isolation between two TV or FM sets fed from a single antenna. Also mixes two amplifiers or antennas. Response from 0 to 900 mc.

\$295 list

ROTARY CABLE STRIPPER Model S-1

A rotary cutter and stripper of coax cable and non-metallic tubing up to 1/2" in diameter. Calibrated for measuring lead and shield length required. Ideal for use with B-T Cable Connectors.

\$375 list

TV SET MATCH Model TM

An impedance-matching transformer designed for use at the TV set to match 75-ohm cable to 300-ohm TV input. Cable plug supplied to fit jack permits easy connect and disconnect. Heavy duty output leads with spade lugs.

\$325 list



FAMOUS LINE OF ALL-CHANNEL UHF CONVERTERS AND VHF AMPLIFIERS

ANTENNA BOOSTER

Model AB with Remote Control
More than 25 db gain. Broad-band antenna amplifier in weatherproof housing with mast-mounting bracket. Remote control power supply may be located near set. Furnishes either 24 or 110 volts to amplifier, as desired. Matched 300-ohm input and output terminals on both units. Single line carries power 'up' and signal 'down'. 'On-off' is automatic with TV set.

\$9500 list



HOME BOOSTER Model HA-3

Provides more than 16 db gain. Automatic 'on-off' operates through TV set. No tuning. Features low-noise, push-pull, broadband circuits. Self-powered.

\$4700 list

CLASS A Model 99

Ideal all-channel UHF converter for 'Class A' signal areas. Direct-drive ganged tuning provides precise tracking of input and oscillator. VHF output on channel 4, 5 or 6. Precise, 300-ohm impedance match.

\$1995 list



ULTRAVERTER Model BTU-2

Tunable, all-channel UHF converter — the most powerful in the field — with high-gain, low-noise triode amplifier. Has dual-speed channel selector. VHF output on channel 5-6. Automatic 'on-off' with TV.

\$3995 list



ADD-A-UNIT TV SYSTEM COMPONENTS



COMMERCIAL ANTENNASIFIER Model CA-1

A popular broad-band VHF amplifier for antenna and line applications. Gain: 26 db on low band and 24 db on high band. Low noise circuit. 75 ohms and 300 ohms at input and output. Gain control. Self-powered.

\$7950 list



RADIATION-PROOF HOUSING

Model MRH-A

Weatherproof and radiation-proof outdoor enclosure for master TV equipment. Has perforated mounting surface and adjustable support bracket. Maximum ventilation, front-opening sealed door and sturdy hasp. Iridite-finished, cadmium-plated steel.

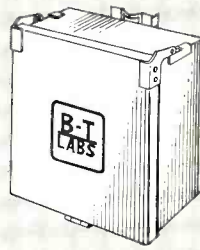

\$4950 list

LINE SPLITTERS

Model LS4-1, 2, 3 and 4

Model LS4-1
Four 75-ohm lines from one 75-ohm line.
Model LS4-2
Four 75-ohm lines from one 300-ohm line.
Model LS4-3
Four 300-ohm lines from one 75-ohm line.
Model LS4-4
Four 300-ohm lines from one 300-ohm line.

each \$950 list



MASTERLINE TV SYSTEM COMPONENTS



VHF SINGLE CHANNEL AMPLIFIER with AGC—Model MCS

Gain in excess of 38 db on low band and in excess of 35 db on high band. Features automatic level and manual gain controls. Has high rejection of adjacent channels. Input and output 75-ohm coax fittings. Two outputs and all-channel mixing network. Self-powered.

\$11750 list (specify VHF channel)

VHF CONVERTER-AMPLIFIER Model MVC

Converts a specified VHF 'high' channel to a specified VHF 'low' channel. Crystal controlled. Gain: in excess of 33 db \pm 1/2 db. Input and output 75-ohm coax fittings. Two outputs and all-channel mixing networks. Self-powered. Available on special order only.

\$30000 list (specify input and output channels)



VHF AMPLIFIER Model MLA

Powerful all-channel VHF cascade amplifier with more than 37 db gain. Has variable gain controls for equalizing high and low bands. Output on each band: 1.25 volts RMS, flat to within 2 db. Self-powered. Input and output 75-ohm coax fittings. When used with MAGC maintains constant output level.

\$12400 list

AUTOMATIC GAIN CONTROL Model MAGC

A plug-in unit for use with MLA amplifier to maintain constant output level over 20 db input range. Output flat within 1.5 db. Effective with over 14,000 microvolts MLA input signal. Compensates for AC line variations. Input and output 75-ohm coax fittings. Obtains power from MLA.

\$7100 list



OUTDOOR TAP-OFF Model MTO-11

Spliceless, weatherproof tap from RG-11/U cable. Uniform 17 db resistive isolation with only 0.6 db insertion loss. Lowest shunt capacity. Positive electrical protection thru blocking condenser. Supplied with installation tool.

\$750 list



ISOLATED TAP-OFFS

SPICELESS CABLE TAP-OFFS

RESISTOR OUTLET BOX Model RO1-B

Indoor tap-off from RG-11/U or RG-59/U line. Coax jack and plug supplied for RG-59/U TV cable. VHF and UHF isolation: 17 db with only 0.6 db loss.

\$500 list

ISOTAP PLATE Model ISO-1B

Basic isolation network of RO1-B less plastic box. For use in standard electrical box. Supplied with wall plate.

\$400 list

INDOOR TAP-OFF Model MTO-59

Spliceless tap from RG-59/U cable. Uniform 17 db isolation with only 0.6 db insertion loss. All-channel reception outlet for apartments, hotels, motels, etc. Supplied with wall plate and installation tool.

\$750 list

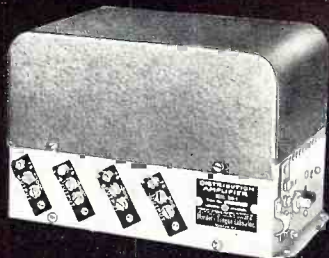
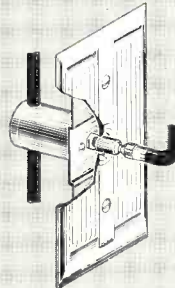

DISTRIBUTION AMPLIFIER Model DA8-B

Provides eight isolated TV set outlets from one 75-ohm or 300-ohm input. Each outlet handles 75-ohm or 300-ohm line, and delivers 10 db gain on all VHF channels. Gain control covers 20 db range. Self-powered.

\$8950 list

MIXER AMPLIFIER Model MA4-1

A versatile unit consisting of broadband mixing circuits and built-in power supply for up to four plug-in VHF channel strips or two UHF converter strips (see CS-1 and UC-1). Precise 75-ohm and 300-ohm impedance match at all terminals. May be used in series.

\$6415 list



VHF CHANNEL STRIP Model CS-1

Single channel amplifier strip for MA4-1. Gain: 20 db on low channels and 17 db on high channels. Input terminals for 75-ohm or 300-ohm line. Draws power from MA4-1. \$2700 list (specify VHF channel)

UHF CONVERTER STRIP Model UC-1

Designed for use with MA4-1. Converts a specified VHF channel to a specified UHF channel. Gain: more than 15 db. 300-ohm input. Draws power from MA4-1. \$9000 list



'EXACT-MATCH' TV ACCESSORIES

BALUN Model MB

Precise impedance match between 75-ohm coax and 300-ohm antenna line. Has 75-ohm coax fitting and 300-ohm screw terminals. Weather-protected.

\$8⁰⁰ list

DIRECTIONAL COUPLER

Model MDC-2

Two isolated outlets for TV sets or branch lines. Only 3 db forward loss. Minimum isolation: 14 db. One 75-ohm input and two 75-ohm output fittings. Weather-protected.

\$13⁰⁰ list

DIRECTIONAL COUPLER

Model MDC-4

Four isolated outlets for TV sets or branch lines. Only 6 db forward loss. Minimum isolation: 20 db. One 75-ohm input and four 75-ohm output fittings. Weather-protected.

\$26⁰⁰ list

DUPLEXERS

Pair remotely controls TV amplifiers or permits two-way audio or AM transmission. One line for VHF TV, plus AC, AM or audio (0 to 2 mc). Weather-protected.

Model MDX-300 (300 ohms) pair

\$22⁵⁰ list

Model MDX-75 (75 ohms) pair

\$25⁰⁰ list

FM WAVE TRAP Model MWT-1

Eliminates FM interference at the antenna, in the line or at the TV set. Attenuates any FM channel more than 25 db. 75-ohm coax fittings. Weather-protected.

\$23⁰⁰ list

ALL-CHANNEL EQUALIZER

Model ME-1

Graduated attenuation from 17 db on Channel 2 to 1 db on Channel 13. Balances signals through 1000 ft. of RG-11/U or 500 ft. of RG-59/U. 75-ohm coax fittings, in and out. Weather-protected.

\$15⁵⁰ list

LOW-BAND EQUALIZER

Model ME-2

Graduated attenuation from 9 db on Channel 2 to less than 1 db on Channel 6. Balances signals through 2000 ft. of RG-11/U or 1000 ft. of RG-59/U. 75-ohm coax fittings, in and out. Weather-protected.

\$15⁰⁰ list

POWER LINE FILTER

Model MLF

Provides 60 db RF isolation between amplifier and power line. Two AC power outlets, one BX input connector. Mounts in MRH-A.

\$16⁶⁵ list

VHF ATTENUATOR Model MAT

Uniform all-channel attenuation from 0 to 45 db in steps of 3 db. 75-ohm coax fittings, in and out.

\$22⁵⁰ list



CABLE CONNECTORS

COMING SOON

A Complete Line of Closed Circuit TV, Master TV and Industrial TV Equipment . . . including:

PROJECTION TV

VIDEO ADAPTOR-AMPLIFIER

Makes any TV set a Video Monitor

FIELD STRENGTH METER

Continuous Tuning (54-216 mc)

CABLE COUPLER Model MC

Correct 75-ohm match in splicing, adapting or terminating RG-11/U and/or RG-59/U cable. Thru-connection for Model MRH-A. Used with B-T Connectors and Terminating Plug.

\$2⁵⁰ list

TERMINATING PLUG Model MTP-75

Correctly terminates cable fitted with Model MC Cable Coupler.

\$2⁵⁰ list

NEW SOLDERLESS CONNECTORS

Model P-11S

Matched 75-ohm male fitting for use with RG-11/U size cable.

each **\$1³⁰** list

Model P-59S

Matched 75-ohm male fitting for use with RG-59/U size cable.

each **\$1³⁰** list

BLONDER-TONGUE LABS, INC.

Dept. 4

Westfield, New Jersey

For detailed information on B-T products — or for free, expert sales engineering services to assist you in planning any master TV or industrial TV system, write:

**WANTED
200,000 TV
SERVICE MEN!**

**VETERANS
NON-VETERANS**



**GET IN ON THIS
2 BILLION DOLLAR PLUM!**

200,000 — That's how many service men will be needed to handle television-radio-electronics industry requirements in the next few years. That's the figure given by the director of product service for CBS-Columbia — a man in a position to know.

2.7 billion dollars to be spent just for service and installation of TV sets in American homes by 1957! That's the figure given by one of the top men in the entire industry — the president of Radio Corporation of America.



L. C. Lane, B.S., M.A.
President, Radio-Television
Training Association.
Executive Director, Pierce
School of Radio & Television.

Think What This Means For YOU!

Here is a field still in its infancy — New jobs with top pay and a secure future are being created every day — Here is a chance for you to get into a growing field with unlimited opportunity for advancement — Here is your chance to set up your own business and be your own boss — Here is your opportunity to get in on a 2 billion dollar plum by becoming a Television Technician.

**LEARN TELEVISION AT HOME
IN YOUR SPARE TIME**

Trained men get the top jobs. You can qualify for one without giving up your present job or social life. My lessons are especially prepared for you to study at home — even if you have absolutely no experience in this field.

CHOOSE FROM THREE COMPLETE COURSES
covering all phases of Radio, FM and TV

1. Radio, FM and Television Technician Course — no previous experience necessary.
2. FM-TV Technician Course — previous training or experience in radio required.
3. TV Cameraman and Studio Technician Course — advanced training for men with Radio or TV training or experience.

EXTRA TRAINING IN NEW YORK CITY AT NO EXTRA COST!

After you finish your home study training in Course 1 or 2 you can have two weeks, 50 hours, of intensive Lab work on modern electronic equipment at our associate resident school, Pierce School of Radio & Television. THIS EXTRA TRAINING IS YOURS AT NO EXTRA COST WHATSOEVER!

FCC COACHING COURSE — Important for BETTER-PAY JOBS requiring FCC License! You get this training AT NO EXTRA COST! Top TV jobs go to FCC-licensed technicians.

LEARN BY DOING

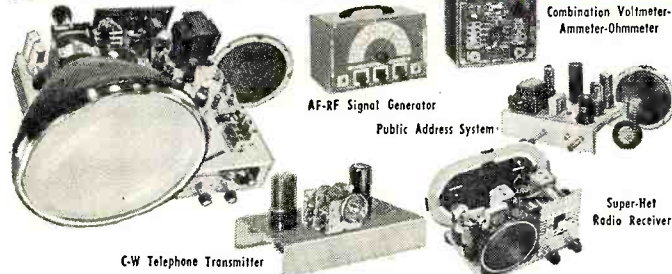

VETERANS

My School fully approved to train Veterans under new Korean G. I. Bill. Don't lose your school benefits by waiting too long. Write discharge date on coupon.

As part of your training, I give you the equipment you need to set up your own home laboratory and prepare for a BETTER PAY TV JOB. You build and keep a professional TV RECEIVER complete with big picture tube (designed and engineered to take any size up to 21-inch) . . . also a Super-Het Radio Receiver, AF-RF Signal Generator, Combination Voltmeter-Ammeter-Ohmmeter, C-W Telephone Transmitter, Public Address System, AC-DC Power Supply. Everything supplied, including all tubes.

EARN WHILE YOU LEARN

Almost from the very start of your course you can earn extra money by repairing sets for friends and neighbors. Many of my students earn up to \$25 a week . . . pay for their entire training with spare time earnings . . . start their own profitable service business.

FREE!

I'll send you my new 40-page book, "How to Make Money in Television, Radio, Electronics," a Free sample lesson, and other literature showing how and where you can get a top-pay job in Television.



Mr. Leonard C. Lane, President
RADIO-TELEVISION TRAINING ASSOCIATION
Dept: T-53, 52 East 19th Street, New York 3, N.Y.

Dear Mr. Lane: Send me your NEW FREE BOOK, FREE SAMPLE LESSON, and FREE aids that will show me how I can make TOP MONEY IN TELEVISION. I understand I am under no obligation.

(PLEASE PRINT PLAINLY)

Name _____ Age _____

Address _____

City _____ Zone _____ State _____

I AM INTERESTED IN:

- Radio-FM-TV Technician Course
- FM-TV Technician Course
- TV Cameraman & Studio Technician Course

VETERANS!
Write discharge date

Radio **T**elevision **T**raining **A**ssociation

52 EAST 19th STREET • NEW YORK 3, N. Y.

Licensed by the State of New York • Approved for Veteran Training

May, 1956

MAIL THIS COUPON TODAY!

International

presents

"AIRKORE"

a new selenium replacement
rectifier so outstanding it

Outperforms them all!

- 12° to 15° lower core temperature.
- Overload capacity 7 times normal rating.
- 20% less aging.
- Maximum air flow in any vertical mounting position (regardless of degree of rotation).
- Increased efficiency throughout life.

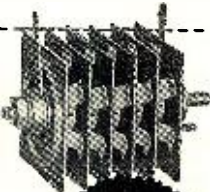

NO BURN IT'S
guaranteed
for 1 year!

AirKore provides these outstanding advantages without sacrificing the basic design of proven superiority—"center-support" construction!

Compare any other rectifier with the new AirKore. Guaranteed for a full year, this new design assures increased efficiency...will help cut costly "call-backs." For products of the highest quality, manufactured under the most rigid standards in the industry, look for the name International.

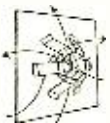

This exclusive device provides greater contact area—uniform temperature rise across the plates—increased efficiency.

AirKore design permits maximum circulation of air around the plates, through the core and spring itself.

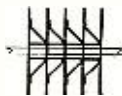

A WORLD OF DIFFERENCE
...THROUGH RESEARCH

International Rectifier

C O R P O R A T I O N

El Segundo, California • Phone ORegon 8-6281
In Canada: Atlas Radio Corp., Ltd.,
50 Wingold Ave. W., Toronto, Ontario • RU 1-6174

THE WORLD'S LARGEST SUPPLIER OF
INDUSTRIAL METALLIC RECTIFIERS



* Presenting latest information on the Radio Industry.

By RADIO & TELEVISION NEWS'
WASHINGTON EDITOR

THE HARD-HITTING probe of TV by the Senate's powerful Interstate and Foreign Commerce Committee, now in full swing, under the chairmanship of Senator Warren G. Magnuson, may well result in a general overhaul of the present channel plan. Witness after witness has testified that the allocation scheme as it stands now is out-moded and is ripe for a complete change.

Specifically, the investigating group was told that the Commission must resolve three basic questions: should more very-high channels be made available at the expense of other services; should co-channel separation be reduced so as to squeeze more stations in the same spectrum space; and should certain areas be assigned ultra-high operation only, providing de-intermixture of the area?

Witnesses declared that there is no use in trying to readjust the present twelve very-high channels; to provide an adequate telecast system of national effectiveness, more channels must be added. A number of those testifying said that greater antenna heights and cross-polarization (discussed in this column on several occasions) would help substantially in solving the problems.

Reviewing the proposed addition of channels to the very-high bands, experts pointed out to the committee that such channels would have to come from military, and certainly strong opposition could be expected to such a move. It was generally admitted that an additional group of three or possibly six channels would be extremely helpful in minimizing the problem.

The ultra-high broadcasters were especially critical of the Sixth Report, which had set the pattern for the allocation schedule. Said they: If Congress or the Commission doesn't act quickly and come to their rescue, u.h.f. will just become a dismal bust; a story of complete disillusionment.

Reporting on his ultra-high experiences, WGBS-TV (Miami) president George Storer said that his 1000-foot 185-kw. (visual) station was putting out a satisfactory, if not superior, signal to the entire area, plus coverage of some seventy miles south of Miami. Ultra-high transmitters operating in flat-terrain constant-foliage condition country, as his station, the committee

was told, can easily equal very-high service and surpass it in performance, insofar as man-made interference is concerned, since diathermy and similar radiating machines do not affect the u.h.f. signals. In rugged country, as in Portland, Oregon, u.h.f. may have to have a lift, Storer pointed out, and this could come from satellites.

The prexy of the U.H.F. Industry Coordinating Committee, Harold Thoms, who also operates WISE-TV in Asheville, North Carolina (Channel 62), scored the Commission for market-straddling, which he claimed has driven u.h.f. stations out of existence. The Senators were bluntly told that the... "time is long past for the FCC and Congress to stop talking and promising, and to come forth with a sharp knife and cut up the spectrum pie."

The Commission, continued Thoms, has... "delayed unreasonably even in proposing a solution... and it devolves upon the Congress to direct the way"... for a solution.

An eight-point resolution should be offered to the FCC, the Senators were told, calling for... de-intermixture, reduction of present limits of power, reduction of present limits of antenna heights, reduction of v.h.f. mileage separations, confinement of TV stations to their home communities, directional antennas, elimination of cost differentials for all-band sets, and reduction of common carrier cable and microwave relay costs.

THE PRESENT DILEMMA of the ultra-high operators and prospective owners prompted the FCC to relax its deadline rules for construction. A six months' dispensation was entered on the books for all u.h.f. interests with construction permits; this moved the deadline up from January 16 to July 16. After that date, it will be necessary to show a *bona fide* indication that building will begin as soon as practical.

A NEW RESEARCH device which measures the effectiveness of three methods now in use for airborne radar observation (side-by-side, super-positioning, and successive comparison methods), has been developed by the Aircraft Observer Research Laboratory, Mather Air Force Base, Califor-

RADIO & TELEVISION NEWS

RCA offers you the
 finest training
 at home in
Radio-TV
 electronics,
TV servicing,
Color TV

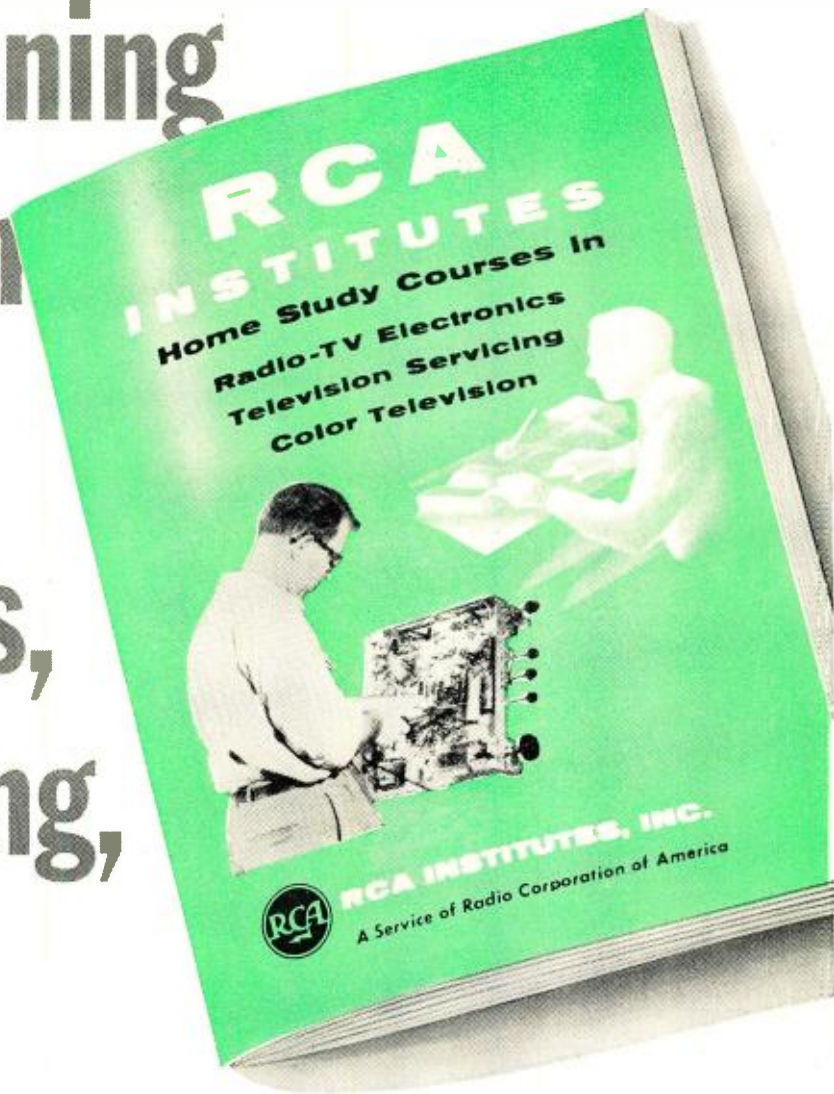

**SEND FOR THIS FREE
 BOOK NOW!**

The instruction you receive and equipment you get (and keep) will start you on your way. Pay-as-you-learn. You pay for only one study group at a time. This 52 page book contains complete information on Home Study Courses for the beginner and the advanced student.



RCA INSTITUTES, INC.
 A SERVICE OF RADIO CORPORATION of AMERICA
 350 WEST FOURTH STREET, NEW YORK 14, N.Y.

RCA Institutes, Inc., Home Study N-56,
 350 West Fourth Street New York 14, N. Y.
 Without obligation, send me FREE CATALOG
 on Home Study Courses in Radio, Television
 and Color TV. No salesman will call.

Name.....
 Please Print
 Address.....
 City..... Zone..... State.....

IMPORTANT
 Be sure to write
 for RCA Institutes
 catalog before
 signing up for any
 Radio-TV course

H. H. SCOTT . . . A SOUND INVESTMENT

nia. The unique equipment compares the methods employed while using the airborne radar images with visual reconnaissance materials during flight.

Various types of comparator radar are contemplated in the future and thus the results of these tests should indicate which method is most valid under certain conditions. Consequently, the results should give important information to engineers in the design of future bombardment radar equipment.

In addition to its research capability, the device can be used as an effective training aid for bombing and navigation systems. Information received from the results of the testing device will be relevant to briefing and target study procedures, selection and utilization of reconnaissance photographs and prediction material, and the training of observers for optimum equipment utilization.

A MICROWAVE RELAY station, including a 100-foot magnesium tower, that can be transported to a site by helicopter and put into operation within two hours, has been developed by the Air Research and Development Command Air Development Center at Rome, N. Y., in conjunction with an electronics manufacturer in Chicago.

Adaptabilities of the station are said to provide for remote radar set control and use in ground-controlled landing approaches. Voice communication can also be transmitted.

Total equipment weight is 1900 pounds. This includes a shelter, radio equipment, and antenna mast with adjustable reflector. It is light enough to be transported by a *Piasecki* H-19 type helicopter.

The tower, which telescopes into a 12-foot package, can be erected by a crew of eight men in less than an hour.

AN AMAZING EXHIBITION of electronic progress was placed on view during a *guest week* at the Bureau of Standards some weeks ago. Over eight hundred guests, leaders from science, industry, education, and government, who attended at the invitation of Secretary of Commerce Sinclair Weeks and Dr. Allen V. Astin, Director of the Bureau, were taken on guided tours involving the work of fourteen laboratories. They saw an exhibition of the new forward scatter method of broadcasting radio and TV signals, a recently-developed analogue computer for instantaneous determination of radioactive fall-out patterns, an automatic hurricane weather station, and a freezing-point oven for maintaining crystal oscillators at a very constant temperature.

The guests were shown, by actual demonstration, how the Bureau derives the absolute electrical units from the basic standards of length, mass, and time. The demonstration experiment was then extended to give the mass of the electron in terms of these basic standards.

(Continued on page 157)

TUNING METER FOR BOTH AM AND FM

Now you can tune distant stations perfectly. Helps you adjust your antenna for best reception.

PLANETARY DRIVE TUNING

Edge lighted lucite tuning dials with separate logging scales. Big easy to read numbers. Quick or vernier tuning on both FM and AM sections.

FM RF SECTION

Highly sensitive cascade front end and heavy copper plated chassis gives 3 microvolts sensitivity for 20 db quieting.

SUPER SELECTIVE FM IF'S

Such sharp tuning that you can separate stations so close together ordinary tuners would pass them by.

WIDE BAND FM DETECTOR

Radically new design makes drift a thing of the past. Stations stay in tune. Strong and weak signals can be tuned with equal ease.

NEW AM DETECTOR

Exclusive H. H. Scott design means distortionless reception even if stations modulate to 100%. High frequencies come through perfectly. Conventional detectors distort AM above moderate modulation percentages, and distort high frequencies.

BINAURAL OUTPUT JACKS

from the completely separate FM and AM sections. Monaural output also provided.

WIDE-RANGE AM

3 position adjustable bandwidth including 'Ultra-Wide-Range' position for receiving the full 10 kc frequency range broadcast by the better AM stations. Perfect reception under any signal conditions.

Inside story on the
**MOST ADVANCED
AM-FM TUNER
EVER DEVELOPED**

Engineered by the same H. H. Scott team that has won every important High Fidelity award, this sensational tuner not only looks different . . . it sounds different — better than any tuner you've ever heard.

The AM side features radically new detector design . . . it's the first really wide-range AM tuner on the market . . . you actually get fine AM sound to 10 KC! The FM side has 3 microvolt sensitivity . . . you pull in stations you've never heard before.

**"The Professional"
Model 330 AM-FM
(Binaural) Tuner**

Styling and dimensions provide a perfect match to the 99-B and 210-D complete amplifiers. **\$199.95***

*Slightly higher west of Rockies

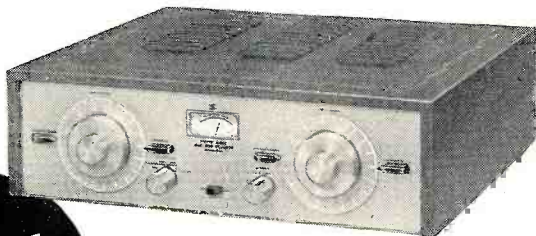

FREE!

New H. H. Scott Catalog and Hi-Fi Guide. Just off the press. Write for your free copy.



H. H. Scott, Inc., Dept. R5, 385 Putnam Ave., Cambridge, Mass. Export Dept.: Telesco International Corp. 270 Park Ave., N. Y. 17

NATIONAL SCHOOLS

proudly presents

FOR MEN WHO WANT TO EARN MORE MONEY

TELERAMA • ALL 8 BRANCHES OF TELEVISION • ELECTRONICS • RADIO IN ONE DYNAMIC, MODERN SHOP METHOD, HOME TRAINING COURSE

*Registration applied for

Another great advance in **HOME STUDY TRAINING**. Let National Schools, of Los Angeles, a practical Technical Resident Trade School for over 50 years, train you at home by Shop-Method, for today's unlimited opportunities in **ALL 8 BRANCHES** of the Television, Electronics, Radio Industry.

Check all you receive in *One Master Course* at One Low Tuition

1. Television — Including Color TV
2. Radio — FM and AM
3. Industrial Electronics
4. Sound Recording and Hi-Fidelity
5. Preparation for FCC License
6. Automation
7. Radar and Sonar
8. Communications

ALL OF THIS MODERN, NEWEST, PRACTICAL EQUIPMENT IS YOURS TO KEEP!

- Parts to Build a modern TV set, including large screen Picture Tube.
- Parts to build a powerful Superhet Receiver, standard broadcast and short wave.
- Parts to conduct many experiments and build Continuity Checker, RF Oscillator, TV Circuits, Audio Oscillator, TRF Receiver, Signal Generator
- Professional Multitester
- These are a MUST for all technicians.

YOU DO MANY PRACTICAL JOBS.

You do servicing, circuit analysis and many other down-to-earth experiments. You build a modern TV set from the ground up... with equipment kits we give you, including a new large screen picture tube and professional Multitester, at no additional charge.

EARN AS YOU LEARN! Many of our students earn their entire tuition and more in Spare Time jobs we show them how to do while learning. **YOU GET GRADUATE ADVISORY SERVICE, TOO.**

ALL YOURS TO KEEP

L. J. ROSENKRANZ

President of NATIONAL SCHOOLS



This Master-Shop-Method course is completely up-to-date. Here in Los Angeles, the TV and Electronics center of the world, we are able to keep in constant touch with the industries' latest developments. As a student, you will quickly master all phases at home in your spare time. Your earning power will grow with every lesson. Just as thousands of National Schools graduates do every day, you can handle servicing, manufacturing, repairing, hundreds of other jobs, or make good money in your own business **SECURE YOUR FUTURE—NOW SEND COUPON BELOW.**



IN THESE MODERN TV STUDIOS, SHOPS AND LABORATORIES, your Shop Method Home Study Course was developed by experienced instructors and engineers. What an advantage that is to you at home — each lesson is tested, proved, easy to understand. You can master the most up-to-date projects, such as color TV set repair, printed circuits — even prepare for F.C.C. License and industrial electronics without taking a special course. **TAKE YOUR FIRST STEP NOW TO A TOP-PAY JOB IN TV, ELECTRONICS, RADIO SEND COUPON BELOW TODAY**

APPROVED FOR VETERANS AND NON-VETERANS

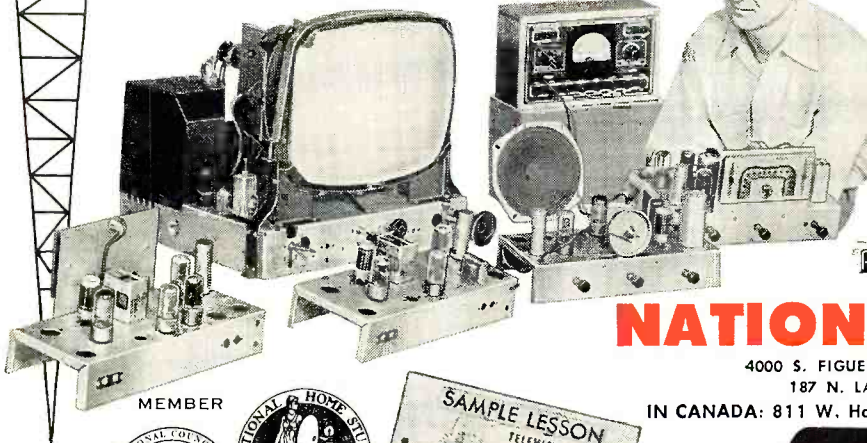

MEMBER



FREE!

Fully illustrated "CAREER" BOOK in TV, Radio, Electronics. AND actual Sample Lesson—yours at no cost, no obligation **SEND COUPON NOW—TODAY!**



NATIONAL SCHOOLS

4000 S. FIGUEROA ST., LOS ANGELES 37, CALIF.
187 N. LA SALLE ST., CHICAGO 1, ILL.

IN CANADA: 811 W. Hastings St., Vancouver, B. C.

NATIONAL SCHOOLS
TECHNICAL TRADE TRAINING SINCE 1905
Los Angeles, California

GET FAST SERVICE—MAIL NOW TO OFFICE NEAREST YOU!

NATIONAL SCHOOLS, DEPT. RH-56
4000 S. FIGUEROA ST. OR 187 N. LA SALLE ST
LOS ANGELES 37, CALIF. CHICAGO 1, ILL
Rush free TV-Radio "Opportunity" Book and sample lesson No salesman will call.

NAME _____ BIRTHDAY _____ 19__

ADDRESS _____

CITY _____ ZONE _____ STATE _____

VETERANS: Give Date of Discharge _____

Belden 8411

If it's worth an engine r's time . . .

Belden 8422

. . . it's worth an Engineered Cable

Belden 8412

Belden microphone cables

Whatever the installation,
whatever the requirements,
there is an accurately
rated Belden Microphone
Cable built for the job.



Belden
WIREMAKER FOR INDUSTRY
SINCE 1902
CHICAGO

4-8

1001 WIRES FOR EVERY ELECTRONIC NEED

Get this FREE Booklet Today!

THE DATA THAT LAUNCHED THOUSANDS OF CAREERS IS YOURS FREE TO SHOW YOU HOW TO BE SUCCESSFUL IN **RADIO-TV-ELECTRONICS**



"YOUR FUTURE IN THE NEW WORLD OF ELECTRONICS"—contains a proved plan for your successful career in:

- ★ **BROADCASTING**
- ★ **TELEVISION**
- ★ **MANUFACTURING**
- ★ **COMMUNICATIONS**
- ★ **SERVICING**
- ★ **AERONAUTICAL ELECTRONICS**
- ★ **ARMY, NAVY, AIR FORCE, COAST GUARD ELECTRONICS**

A PROVED CAREER-PREPARATION PLAN THAT WORKS!

This free book has brought success home to thousands of men just like you! They are now enjoying responsible jobs, good pay and the good things of life. So can you! In less time than you think! We tell you how you can carve out a bigger better-paying job. Our proved career-preparation plan works because it was written by authorities who know exactly what the varied electronic industries want, need and expect from you!

ELECTRONICS' FUTURE CAN BE YOUR FUTURE

You can't keep up with the tremendous changes in the electronic industries. What's predicted for next year becomes outdated in a few months! All phases of the electronic industries are experiencing phenomenal growth. There are thousands of career openings, big ones. Industry can't find enough trained manpower to fill them—in manufacturing, testing, servicing, broadcasting and telecasting.

TAKE TV FOR EXAMPLE!

Over 430 TV stations are on the air! Many more are building or in the plans

stage; there are over 35 million TV sets in use. Color TV is coming alive! This same phenomenal growth picture is repeated in every phase of business employing electronics—crime prevention, aeronautics, fire-fighting, communications, to name but a few. CREI has the plan to keep you moving upward, to help you assume your rightful place!

CREI GRADS ARE IN DEMAND!

The big companies know CREI men have what it takes! CREI grads are at work in America's biggest corporations, in positions ranging from technicians to engineers to top management. Companies such as United Air Lines, Canadian Broadcasting Corporation, Trans-Canada Airlines, Sears-Roe-

THOUSANDS LIKE YOU HAVE SUCCEEDED WITH CREI'S PLAN! "CREI TRAINING IS BEST"



"I chose CREI training upon recommendation of two top engineers. Before I had completed the course I became transmitter chief of a 5 KW station. I am now employed as a technician at a 100 KW TV station, and in spare time have a good TV sales and service business. Anyone interested in his electronic future should have CREI training." . . . —Arlie D. Patton, San Antonio, Texas

"I know of no case in which a man who applied himself and completed the CREI course failed to better himself through promotion and increase in salary." . . . —Wendell L. Fraser, San Diego, Calif.

"CREI has raised me to professional status as a radioman. Thanks to your instructors who always gave me needed help."—Victor Mentzer, Wilmington, Del.

"I have been in radio and electronics for 24 years. I fully recommend CREI as the best school I have seen."—L. McManus, Montreal, Canada

CAPITOL RADIO ENGINEERING INSTITUTE

Accredited Technical Institute Curricula

Founded in 1927
3224—16th Street, N.W.
Washington 10, D.C.

CREI also offers resident instruction at the same high technical level, day or night, in Washington, D.C. New classes start frequently during the year. If this type of instruction meets your requirements, check the coupon for Residence School catalog. Qualified residence graduates may earn the degree of Associate in Applied Science.

INFORMATION FOR VETERANS

If you were discharged after June 27, 1950—let the new G.I. Bill of Rights help you obtain resident instruction. Check the coupon for full information.

MAIL THIS COUPON Today!

CAPITOL RADIO ENGINEERING INSTITUTE

Dept. 115-C, 3224 16th St., N. W., Washington 10, D. C.

Please send me your course outline and FREE Illustrated Booklet "Your Future in the New World of Electronics" . . . describing opportunities and CREI home study courses in Practical Electronics Engineering.

- CHECK FIELD OF GREATEST INTEREST
- Practical Radio Electronics Engineering
 - Broadcast Radio Engineering (AM, FM, TV)
 - Practical Television Engineering
 - Aeronautical Electronics Engineering

Name

Street

City Zone..... State.....

CHECK: Home Study Residence School Korean Veteran

To help us answer your request intelligently, please give the following information:

EMPLOYED BY

TYPE OF PRESENT WORK

SCHOOL BACKGROUND

RADIO ELECTRONIC EXPERIENCE

IN WHAT BRANCH OF ELECTRONICS ARE YOU MOST INTERESTED?



RADIART features
the complete line of new
COMMUNICATION VIBRATORS
in 6 Volt and 12 Volt Series
that outlasts all others

These Ten Types Offer Complete Replacement for ORIGINAL Communication Equipment, the PROPER VOLTAGE for Each Application.

Old No.	New No.	
	6 volt	12 volt
5515	5715	6715
5518	5718	6718
★	5721	6721
★	5722	6722
★	5725	6725
5605	5805	6805
5620	5820	6820
5621	5821	6821
5622	5822	6822
★	5824	6824

For Specific Applications See Latest Radiart Vibrator Guide

Again because of SUPERIOR ENGINEERING and CONSISTENTLY INCREASED QUALITY, Radiart offers you communication vibrators that are DEPENDABLE! The RIGHT vibrator... for EACH application! See for yourself... You're RIGHT WITH RADIART.

SUBSIDIARY OF



THE **RADIART** CORPORATION
CLEVELAND 13, OHIO

TV ANTENNAS • AUTO AERIALS • VIBRATORS • ROTORS • POWER SUPPLIES



3447 N. Oakland Ave.
Milw. 11, Wis.
Dec. 9, 1955

Dear Mr. Moore:

On your morning show you say that CBS tubes are the best and I'll buy that! I've always had tube troubles and no matter how expensive an instrument we owned its performance was mediocre. Maybe we were too critical but a television picture is either good or it is not. When our picture tube gave up the struggle our serviceman at the Ace Electric Co. installed a CBS picture tube. We are delighted with the ultra bright and shadow clear picture we are receiving. I wanted you to know that we are glad we took your advice and believe me when the time comes to buy a new set it will be a CBS if they make them. (Do they?)

Sincerely
Mrs. Ruth Svensson

CBS-HYTRON

Danvers, Massachusetts

A DIVISION OF COLUMBIA BROADCASTING SYSTEM, INC.

HERE'S PROOF

**your
customers
want
CBS tubes**

Since Garry Moore has been selling CBS tubes over the CBS Television Network, most service technicians have had women customers ask them for CBS tubes. And not just once in awhile.

Every day more and more women are requesting CBS tubes. We hear stories like Mrs. Svensson's often.

It all adds up to these important facts. You build good will . . . cut call-backs . . . and profit more when you install CBS tubes . . . the tubes with the Good Housekeeping Guaranty Seal.

Is your caddy well stocked with CBS tubes?



Show her the CBS carton with the Good Housekeeping Guaranty Seal. See Garry Moore sell your expert service over the CBS Television Network.

Within the Industry



TUBES FOR THE
FINEST IN HI-FI

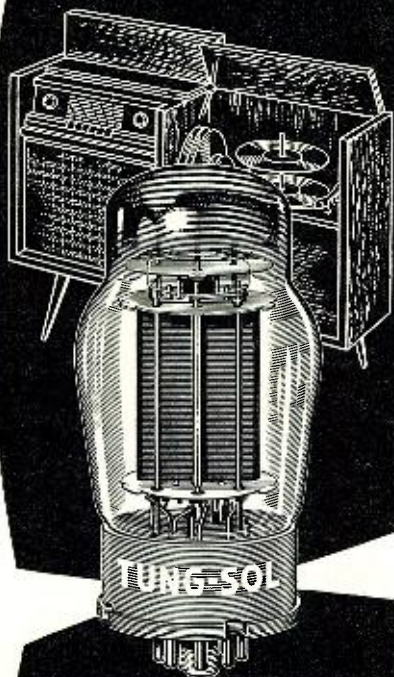

Almost without exception, makers of the finest high-fidelity sets depend upon Tung-Sol Audio Amplifier Tubes to help deliver the performance expected of their products.

Through these tubes—the "5881" and the "6550"—Tung-Sol clearly demonstrates its ability to meet and maintain high-fidelity's critical design requirements in volume production.

This achievement is indicative of the quality and dependability of Tung-Sol Hi-Fi, Radio and TV Tubes . . . products of America's largest independent electron tube manufacturer. Tung-Sol Electric Inc. Newark 4, N. J.

TUNG-SOL
ELECTRON TUBES

Tung-Sol Automotive & Electronic Products

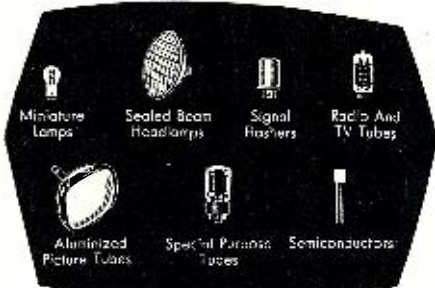

HERBERT C. GUTERMAN has been elected chairman of the board by directors of *National Company, Inc.* of Malden, Mass.



He has a wide background of industrial operating experience in the electronics field, having held executive posts with such companies as *General Electric* and *Emerson*.

During World II, he served as a Commander with the Navy and was head of the electronics components group of the Production Division of the Bureau of Aeronautics. He also saw active duty with the Signal Corps in World War I.

He is a member of the AIEE, a senior member of the IRE, and several other professional groups. He holds an E.E. degree from Columbia.

* * *

MAGNAVOX COMPANY of Fort Wayne, Indiana, has purchased substantially all the assets, properties, and good will of **SENTINEL RADIO CORPORATION** as a going concern. Operation of the new division will continue in Evanston, Illinois . . . **INTERNATIONAL TELEMETER CORPORATION** has established a new subsidiary, **TELEMETER MAGNETICS AND ELECTRONICS CORPORATION**, which will develop and produce special purpose data processing machines, etc. . . .

NARDA MANUFACTURING CORPORATION has been established as a wholly-owned subsidiary to manufacture u.h.f. and microwave test equipment and detecting elements for its parent firm, **NARDA CORPORATION** . . . **PLOMB TOOL COMPANY** has acquired certain assets of **TUBING APPLIANCE COMPANY, INC.** including essential machinery, tooling, patents and inventories of "Tac" ratchet wrenches . . . The *Trumbull Components Department* of **GENERAL ELECTRIC COMPANY** has announced the formation of a subsidiary corporation, **CARIBE GENERAL ELECTRIC, INC.** to operate a plant in Palmyra, Puerto Rico for the manufacture of low-voltage electrical distribution protective and disconnect devices . . .

MEASUREMENTS CORPORATION of Boonton, New Jersey, has acquired the instruments division of **LINEAR EQUIPMENT LABORATORIES, INC.** of Copiague, New York. Plans are to move operations to Boonton in the near future . . . **KARET-MARGOLIN, INC.** has been organized as a representative firm with offices and warehouse at 13 W. Hubbard Street, Chicago 10, Illinois. A branch office has been established at 4418 Huron Circle

in South Bend, Indiana . . . **ASTRON CORPORATION** has purchased all the outstanding stock of **SKOTTIE ELECTRONIC CORPORATION, INC.** of Peckville, Pa. . . . **LINEAR EQUIPMENT LABORATORIES, INC.** of Copiague, New York, which recently sold its instruments division, has changed the name of the firm to **LEL, INC.** and will devote all of its efforts to its expanding i.f. amplifier division. . . . **SIEGLER CORPORATION** has purchased the assets of **HUFFORD ELECTRONICS COMPANY** of West Los Angeles firm, and will operate it as a part of its **HALLAMME ELECTRONICS DIVISION** . . . **ALLIED RECORD MANUFACTURING CO.** of Hollywood and **BART MANUFACTURING CORPORATION** of Belleville, N. J. have formed **AMERICAN SOUND CORPORATION** for the production of custom pressings, matrices, tape duplications, and the milling of all types of record biscuits and materials. A new plant is being built in Belleville to accommodate the operation . . . **ZENITH** has established **ZENITH RADIO RESEARCH CORPORATION OF CALIFORNIA** in Redwood City, California. A new building at 841 Warrington Avenue will house the laboratory.

* * *

FRED GLUCK has been appointed director of engineering by *The Astatic Corporation* of Conneaut, Ohio. He was formerly chief engineer of *Fada Radio*.



In his new post he will direct and coordinate the various engineering activities of the company. While at *Fada*, he was responsible for all engineering activities involved in the design of that company's line of TV and radio receivers and with its extensive military electronics program. His duties also included liaison and contract administration work with various government agencies.

Mr. Gluck, a senior member of the IRE, was previously in engineering and sales administration with the *Radiart Corporation* and during the war was with the Navy Bureau of Ships as a design engineer.

* * *

WORLD RADIO LABORATORIES is adding 17,000 square feet to its plant at 3415 W. Broadway in Council Bluffs, Iowa. The plant itself was completed in the spring of 1954 but the firm has already outgrown these facilities . . . **MERIT COIL & TRANSFORMER CORP.** has established a new warehouse at 312 7th Street in San Francisco to service the firm's customers in Cali-

TOP performance for TV anywhere!

Federal's "ALL-STAR" LEAD-IN TEAM

*Urban, fringe or distribution system...
heat, rain, dust, snow, ice, salt spray,
polluted air... whatever the conditions
you'll find a winner in these dependable
Quality-Controlled Cables by "FTR"*

North, East, South, West... wherever there are TV customers... Federal's "All-Star" Lead-in Team can be depended upon to deliver *championship performance*...!

These six popular types are outstanding examples of the quality, ruggedness, efficiency and long life built into every foot of Federal Cable. Whatever the run requirements or local weather conditions the Federal "All-Stars" will score high in satisfaction... with you and your TV customers.

Federal lead-ins can be installed with utmost confidence, because they are engineered and manufactured by a *pioneer* cable maker... and "Certified by a World of Research"... through the International Telephone and Telegraph Corporation.

Check the high points of Federal's "All-Star" Team...check your stock of TV lead-ins...get in touch with Federal now for prompt shipment of your needs!

*"America's leading producer of
solid dielectric cables"*

Federal



High Volume-Low Price TV Lead-in



Economical and Efficient

TV-1190—300-ohm heavy-duty lead-in with 90 mil. web. Has 7/#28 copper strands. Economical and highly efficient. Insulated with Federal-developed "silver" polyethylene for long life. Also available in brown.



Another Low-cost Leader

TV-2000—300-ohm dumbbell-shaped lead-in with 55 mil. web. Has 7/#30 copper strands. A high-value, low-cost type for the average installation. Cinnamon-brown color is protection against ultra-violet.

"Quality-Controlled" TV Lead-in & Cable



Heavy-duty Type

TV-1182—300-ohm deluxe type heavy-duty long life lead-in with 7/#28 copper strands, 100 mil. web. Available in "silver" or brown polyethylene. Resists weather, heat, sun. Very low line loss in fringe areas.



Quality plus Economy

TV-1184—300-ohm dumbbell-shaped, standard, economy type lead-in with 7/#28 copper strands, 70 mil. web, for urban areas with no unusual conditions. Cinnamon-brown color is highly effective in resisting ultra-violet.



Rotor Lead-in

TV-1188—Rugged, dependable, long-life rotor lead-in. Weather-resistant. Insulated with "silver" vinyl. Three 7-strand conductors of .0121 AWG soft bare and one conductor of .0121 AWG tinned soft bare.

Community TV Lead-in



Secondary Lead-in

59/U Type—73-ohm coaxial lead-in. Highly efficient as a Community TV pole-to-house tap-off. Meets all needs wherever a high-grade installation is a must. Ideal for use with unbalanced input TV receivers.

For data on other types, write Dept. D-445

Federal Telephone and Radio Company

A Division of INTERNATIONAL TELEPHONE AND TELEGRAPH CORPORATION
COMPONENTS DIVISION • 100 KINGSLAND ROAD • CLIFTON, N. J.

In Canada: Standard Telephones and Cables Mfg. Co. (Canada) Ltd., Montreal, P. Q.
Export Distributors: International Standard Electric Corp., 67 Broad St., New York

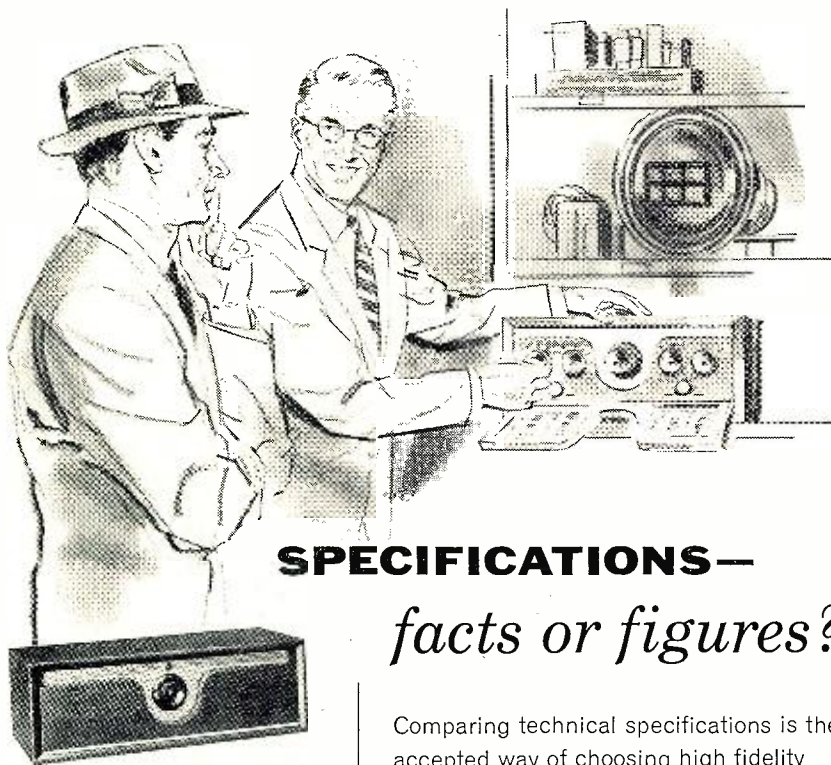

SPECIFICATIONS— *facts or figures?*

440B Control Preamp

maximum flexibility with 12 controls, 25 record crossover combinations • five inputs; three high level, two low level • noise level at maximum volume better than 95 db below 1.5 volts output • 1,000 ohms cathode follower matched to 340A power amplifier • mahogany or blond hardwood cabinet*...\$149.00

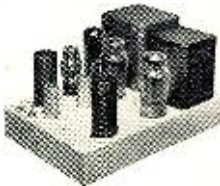

340A Power Amplifier

highest power; 35 watts at less than 1/2% thd, 30-15,000 cps • frequency response ± 1 db, 5 to 100,000 cps • noise level -40 dbm: 85 db below rated output • heavy duty tube complement; 1-12AY7, 1-12AU7, 2-6550, 1-5U4GB, 1-0A3/VR75 simplified circuitry for exceptional stability and long life...\$159.00

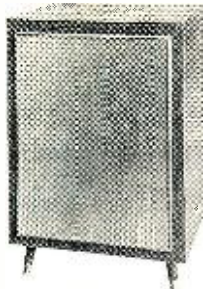

824 Iconic Speaker System

professional quality in a complete plug-in home unit • guaranteed frequency response 50-22,000 cycles • 12" woofer • high frequency driver and horn • 3000 cycle dividing network with balancing facilities • no corner necessary • mahogany or blond hardwood cabinet*...\$180.00

*All Altec Lansing fine furniture cabinets bear the seal of the Hardwood Association

Comparing technical specifications is the accepted way of choosing high fidelity components, but these comparisons are meaningless when the specifications are unsubstantiated by the manufacturer. Ask your dealer why Altec Lansing's exclusive "Performance Guarantee" is more important to you than pages of impressive specifications that do not carry a warranty. As an expert on high fidelity, he can tell you the difference between performance you hear and specifications you can only see. After your Altec dealer has explained why engineering integrity, skilled craftsmanship and strict product testing allow Altec Lansing to guarantee the published specifications of each component they build, you will know why Altec is the finest name in sound. This exclusive "Performance Guarantee" is your assurance that every Altec home music component you buy will meet or exceed its published technical specifications. See your Altec dealer soon for a demonstration of this or other Altec Lansing high fidelity systems priced from \$324 to \$1180.



ALTEC FIDELITY IS HIGHEST FIDELITY
Dept. 5-TM
9356 Santa Monica Blvd., Beverly Hills, Calif.
161 Sixth Avenue, New York 13, New York

California, Washington, Oregon, Idaho, Montana... **UNIMAX SWITCH DIVISION** has established new and enlarged facilities in Wallingford, Conn., in order to meet production requirements of its line of precision snap-acting switches... **AXEL ELECTRONIC DIVISION** has moved its administrative, laboratory, and production facilities to a recently-purchased modern five-story plant at 134-20 Jamaica Avenue in Jamaica, New York... **DONNER SCIENTIFIC COMPANY** is building a modern, open-plan, air-conditioned plant on a 10 acre site in Concord, California. The new 22,000 square foot plant will be ready for occupancy in June... **JOHN E. FAST & COMPANY** has purchased a new building at 3580 Elston Ave., Chicago, which will add 115,000 square feet of manufacturing space for its line of electrostatic capacitors... **CARTER MOTOR COMPANY** has begun construction on a new factory at 2711 West George Street in Chicago. The new plant will double the firm's production capacity... Ground has been broken at Anaheim, California, for a new 60,000 square foot plant of **HALLAMORE ELECTRONICS DIVISION**. June 1st is the scheduled completion date... **INTERNATIONAL RECTIFIER CORPORATION** of El Segundo, California, has moved its New York branch office to 132 East 70th Street. Arno Nash is in charge... **HARVEY RADIO COMPANY, INC.** has opened an "Audio-torium" at 1123 Avenue of the Americas at 43rd Street in New York. The new 10,000 square foot store is devoted exclusively to the needs of the hi-fi shopper and is organized "department-store" style for shopping ease.

* * *

JON B. JOLLY is the new sales manager of *CBS-Hytron's* Semiconductor Department in Danvers, Mass.



Before joining the company, he was district manager, semiconductor products, covering the greater metropolitan New York area for *General Electric Company*. Prior to that he was in the steel construction business.

Mr. Jolly received his bachelor of electrical engineering degree at Georgia Institute of Technology and is a member of the IRE.

* * *

C. R. (CAP) KIERULFF has been named president and general manager of *Kierulff Electronics, Inc.*, and *Kierulff Sound Corp.* of Los Angeles, California... **NORMAN S. KORNETZ** is the new manager of engineering for *Westinghouse's* Television-Radio Division at Metuchen, New Jersey... *Oxford Electric Corporation* of Chicago has named **FRED BOECKER** to the post of plant manager of its transformer division... **THEODORE G. BECKHARDT** has joined the staff of *Eastern Precision Resistor Corp.* as assistant to the president... The Television and Radio Division
(Continued on page 82)

RADIO & TELEVISION NEWS

YOU PUT THIS TUBE IN AND...
 YAP... YAP... YAP... BLAH... BLAH... BLAH
 ...AND I MISSED MY FAVORITE PROGRAM



... IT'S **YOUR** REPUTATION!

Serviceman, at this point you are on your own! Your customer holds only **you** responsible if the picture tube goes bad because it was **your** selection. If your selection for replacement was a high quality brand, chances are your reputation for quality work wouldn't be under the gun like this.

When you use Du Mont picture tubes your reputation is backed by the pioneer commercial cathode-ray tube manufacturer of the country. The Twin-Screen Hi-Lite* alumi-

nized picture tube is a product of the finest engineering, design, and production features assembled in 25 years of commercial manufacturing. Your confidence is definitely assured because you **know** that the guarantee on Du Mont picture tubes is good—as it has always been.

Your reputation for high quality work is established when you use high quality products. You have a reliable **partner** when you use Du Mont picture tubes.

*The ultimate in aluminized picture tubes

IT'S DEALERS CHOICE

make it...

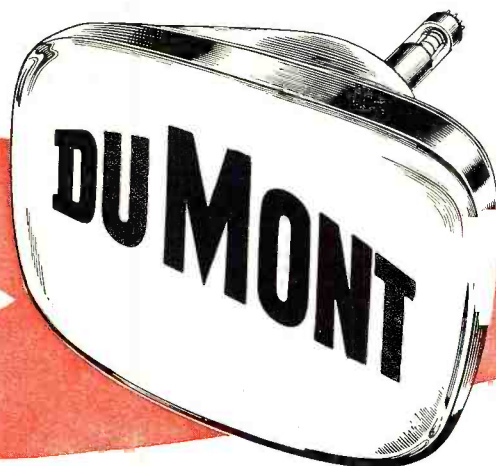

Cathode-Ray Tube Division

ALLEN B. DU MONT LABORATORIES, Inc., 750 Bloomfield Avenue, Clifton, N. J.

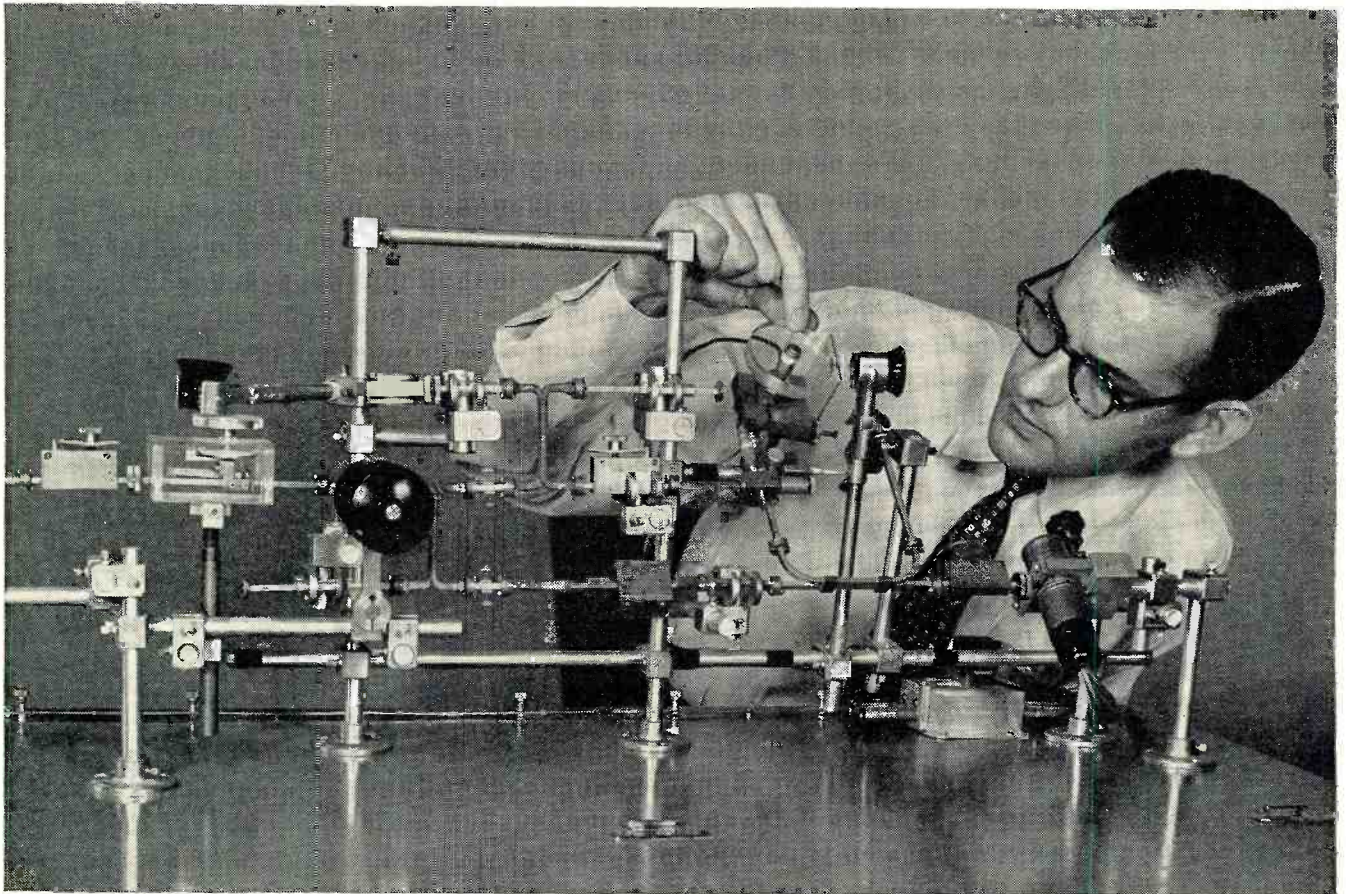

Physicist G. K. Farney checks the frequency of Bell's new klystron, which is located at far right. Tube's output is about 20 milliwatts.

Sixty billion vibrations per second

A great new giant of communications—a waveguide system for carrying hundreds of thousands of voices at once, as well as television programs—is being investigated at Bell Telephone Laboratories.

Such a revolutionary system calls for frequencies much higher than any now used in communications. These are provided by a reflex klystron tube that oscillates at 60,000 megacycles, and produces waves only 5 mm. long.

The resonant cavity that determines the frequency is smaller than a pinhead. The grid through which the energizing electron beam is projected is only seven times as wide as a human hair, and the grid "wires" are of tung-

sten ribbon $3/10,000$ inch in width.

G. K. Farney, University of Kentucky Ph. D. in nuclear physics, is one of the men who successfully executed the development of the klystron. Dr. Farney is a member of a

team of Bell scientists whose exciting goal is to harness the immense bandwidth that is available with millimeter waves . . . and to make certain that your telephone system remains the best in the world.

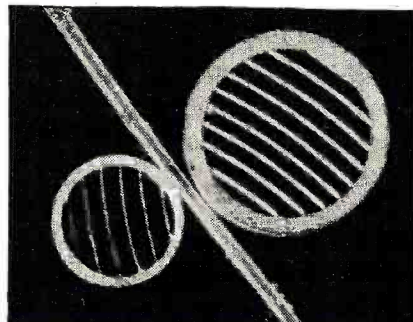

Grids in new tube, enlarged 30 times, with human hair for comparison. Electronic beam passes through smaller, then larger, grid.

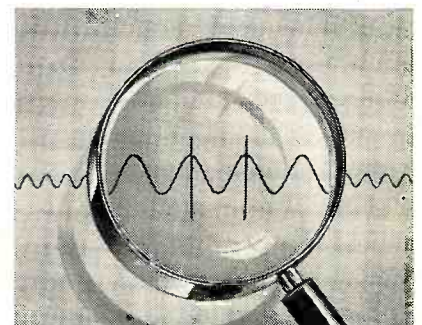

Wavelengths produced by the klystron tube are only .2 inch long— $1/15$ that of the transcontinental radio relay system.

BELL TELEPHONE LABORATORIES

WORLD CENTER OF COMMUNICATIONS RESEARCH



RADIO & TELEVISION NEWS

**NEW! COLOR and Black-&White
LAB & TV 5" OSCILLOSCOPE #460
KIT \$79.95. Wired \$129.50**

The **FINEST** professional 5 mc wide-band scope value. Ideal for research, h-f & complex waves, plus Color & Monochrome TV servicing. Flat from DC to 3.58 mc ± 1 db (color burst freq.), flat DC to 4.5 mc +1, -3 db. Vert. sens. 25 rms mv/in. Vert. Z 3 megs. Has the following outstanding features not found in scopes up to several times its price, kit or wired:

VERTICAL AMPLIFIER: direct-coupled (DC) thruout to eliminate l-f phase shift; push-pull thruout for negligible distortion; **K-follower** coupling between push-pull pentode stages for extended h-f resp. (minimizes h-f phase shift, extends useful resp. to 10 mc); full-screen undistorted vert. defl; 4-step freq-compensated decade step attenuator up to 1000:1. **SWEEP CIRCUIT:** perfectly linear sweeps, 10 cps - 100 kc (ext. cap. for down to 1 cps); **pre-set TV vert. & hor. positions** (30 & 7875 cps); automatic sync. ampl. & limiter eliminates sync amplitude adj. **PLUS:** direct or cap. coupling; bal. or unbal. inputs; edge-lit engraved lucite graph screen; dimmer; anti-glare filter; bezel fits std photo equipmt. **OTHER IMPORTANT FEATURES:** High intensity trace CRT. Finest sq. wave resp. (.06 usec rise time). Push-pull hor. ampl., flat to 400 kc, sens. 0.6 rms mv/in. Built-in voltage calibration. Intensity mod. Sawtooth & 60 cps outputs. Astigmatism control. Retrace blank-

ing. Instant, drift-free full-screen vert. positioning & 2X full-screen hor. positioning. Bal., cal., astig. adj. externally accessible. 5U1P CRT, 2-6AU8, 2-6CB6, 1-12AU7A, 2-6J6, 1-6AX5, 1-1V2. Deep-etched satin aluminum panel, rugged grey wrinkle steel cabinet. Designed for easy building at home with no special equipment. 13" x 8 1/2" x 16". 30 lbs.

SCOPE DIRECT PROBE* #PD: KIT \$2.75. Wired \$3.95. Eliminates stray-pick-up & signal re-radiation.

SCOPE DEMODULATOR PROBE* #PSD: KIT \$3.75. Wired \$5.75. Demodulates AM carriers between 150 kc and 250 mc.

SCOPE LOW CAPACITY PROBE* #PLC: KIT \$3.75. Wired \$5.75. For signal tracing in high frequency, high impedance & wide-band circuits (as in TV), without distortion from overloading or frequency discrimination.

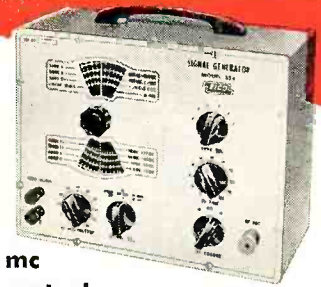

**150 kc to 435 mc
with ONE generator!**

**New! RF SIGNAL GENERATOR #324
KIT \$26.95. Wired \$39.95**

for **COLOR** and Monochrome TV servicing

New wide-range, stable generator - better value than generators selling at 2 or 3 times its cost! Ideal for: IF-RF alignment, signal tracing & trouble-shooting of TV, FM & AM sets; marker gen.; 400 cps audio testing; lab. work. 6 fund. ranges: 150-400 kc, 400-1200 kc, 1.2-3.5 mc, 3.5-11 mc, 11-37 mc, 37-145 mc; 1 harmonic band 111-435 mc. Freq. accurate to $\pm 1.5\%$; 6:1 vernier tuning & excellent spread at most important alignment freqs. Etched tuning dial, plexiglass windows, edge-lit hairlines. Colpitts RF osc., directly plate-modulated by K-follower for improved mod. Variable depth of int. mod. 0-50% by 400 cps Colpitts osc. Mod. gain ext. mod. amplifier: only 3.0 volts needed for 30% mod. Turret-mounted coils slug-tuned for max. accuracy. Fine & Coarse (3-step) RF attenuators. RF output 100,000 uv; AF sine wave output to 10 volts. 50-ohm output Z. 5-way jack-top binding posts for AF in/out; coaxial connector & shielded cable for RF out. Tubes: 12AU7, 12AV7, selenium rectifier; xfmr-operated. Deep-etched satin aluminum panel, rugged grey wrinkle steel cabinet. 8" x 10" x 4 3/4". 10 lbs.

for **COLOR** and Monochrome TV servicing

**New! PEAK-to-PEAK VTVM #232
& UNI-PROBE (pat. pend.)
KIT \$29.95. Wired \$49.95**

UNI-PROBE: exclusive with EICO! Terrific time-saver! Only 1 probe performs all functions—a half-turn of probe-tip selects DC or AC-Ohms.

The new leader in professional peak-to-peak VTVMs. Latest circuitry, high sensitivity & precision, wide ranges & versatility. **Calibration without removing from cabinet.** New balanced bridge circuit. High Z input for negligible loading. 4 1/2" meter, can't burn-out circuit. 7 non-skip ranges on every function. 4 functions: +DC Volts, -DC Volts, AC Volts, Ohms.

Uniform 3 to 1 scale ratio for extreme wide-range accuracy. Zero center. One zero-adj. for all functions & ranges. 1% precision ceramic multiplier resistors. Measure directly peak-to-peak voltage of complex & sine waves: 0-4, 14, 42, 140, 420, 1400, 4200. DC/RMS sine volts: 0-1.5, 5, 15, 50, 150, 500, 1500 (up to 30,000 v. with HVP probe, & 250 mc with PRF probe). Ohms: 0.2 ohms to 1000 megs. 12AU7, 6AL5, selenium rectifier; xfmr-operated. 8 1/2" x 5" x 5". Deep-etched satin aluminum panel, rugged grey wrinkle steel cabinet. 7 lbs.

**New! DELUXE PEAK-to-PEAK VTVM #249
with 7 1/2" METER & UNI-PROBE (pat. pend.)
KIT \$39.95. Wired \$59.95**

All the advanced & exclusive features of #232—PLUS the extra convenience and readability of its big 7 1/2" meter. Your ideal bench instrument.

VTVM RF PROBES* #PRF-11 or PRF-25: KIT \$3.75. Wired \$4.95. Accuracy $\pm 10\%$. Use with any 11 or 25 megohm VTVM.

VTVM HV PROBE #HVP-2: Wired \$4.95. Complete with multiplier resistor. Measures up to 30 kv with any VTVM or 20,000 ohms/volt VOM.



Calibration without removing from cabinet.

*Only EICO Probes have all these features: fully shielded; rugged terminal board parts mounting; shock-mounted floating construction; swivel-action; color-coding; easy parts accessibility.

The specs are the proof...

**4 NEW BEST BUYS
by EICO**

**COMPLETE
with Preamplifier, Equalizer and Control Section
New! 20-WATT Ultra-Linear Williamson-
type HIGH FIDELITY AMPLIFIER #HF20
KIT \$49.95. Wired \$79.95**

A low-cost, complete-facility amplifier of the highest quality that sets a new standard of performance at the price, kit or wired. Every detail, down to the etched, brushed solid brass control plate, is of the fine quality EICO is famous for.

Rated power output: 20 watts (34 w peak). **IM distortion** (60 cps: 6 kc/4:1) at rated power: 1.3%. **Mid-band harmonic distortion** at rated power: 0.3%. **Maximum harmonic distortion** between 20 and 20,000 cps at 1 db under rated power: approx. 1%. **Power response** (20w): ± 0.5 db 20-20,000 cps; ± 1.5 db 10-40,000 cps. **Frequency response** (3/4 w): ± 0.5 db 13-35,000 cps; ± 1.5 db 7-50,000 cps.

5 feedback equalizations for LP's & 78's including RIAA. Variable turnover feedback tone controls do not affect volume & permit large boosts or cuts at either end of audio spectrum with mid-freqs. unaffected. Loudness control & separate level set control on front panel. Low Z output to tape recorder. 4 hi-level switched inputs: tuner, tv, tape, auxiliary (xtal/ceramic phono or 2nd tuner); 2 low-level inputs for proper loading with all leading magnetic, FM & quality xtal cartridges. Hum bal. control. Extremely fine output transformer has interleaved windings, tight coupling, careful balancing & grain-oriented steel. 8 1/2" x 15" x 10". 24 lbs.

These amazing EICO values are **NOW IN STOCK** at your nearest distributor. Examine them side-by-side with ANY competitor. You'll see for yourself why indeed EICO is your **BEST BUY**. Fill out coupon on reverse page.

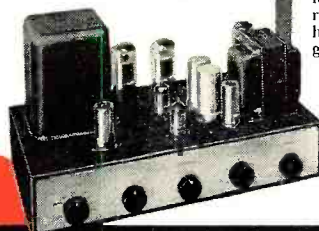

TURN PAGE FOR MORE EICO VALUES...

84 Withers Street, Brooklyn 11, New York

Prices 5% higher on West Coast.

Do you OVERPAY for QUALITY instruments?

EICO's mass purchasing and world-wide distribution, together with advanced electronic design, produce values never before possible . . . to give you Laboratory Precision at Lowest Cost!

GET the MOST for YOUR MONEY! Don't buy ANY test instrument till you put the EICO INSTRUMENT (kit or wired) equivalent before you—and . . .

Compare advanced electronic design: see the latest in circuitry and features.

Compare finest components: see the famous brands you know and trust, such as GE, Centralab, Mallory, etc.

Notice ease of construction and operation: Exclusive "Beginner-Tested" Manuals make assembly and operation step-by-step, quick, crystal-clear. "You build them in one evening—they last a lifetime!"

Check 5-Way Guarantee: Only EICO gives you this exclusive complete protection! EICO guarantees components, instructions and satisfactory operation — AND guarantees service and calibration for the LIFETIME of the instrument, at less than cost of handling.

Compare feature for feature, dollar for dollar.

There's an EICO distributor right nearby in your own neighborhood — over 1200 coast-to-coast. EICO planned it that way so that you can easily examine EICO BEFORE YOU PUT DOWN ONE CENT OF YOUR MONEY!

COMPARE any of EICO's 46 models SIDE BY SIDE with ANY competitor. Then YOU judge who's giving you the MOST for your money.

Over 500,000 EICO instruments in use . . . You'll agree EICO gives you LABORATORY PRECISION AT LOWEST COST.

Turn page for other EICO ad



FREE 1956 EICO CATALOG!

Tells you how to SAVE 50% on
your test equipment costs!

TUBE TESTER #625
KIT \$34.95
Wired \$49.95

- tests 600 mil series string type tubes
- illuminated roll-chart

Pix Tube Test Adapter\$4.50

New! GEIGER COUNTER #803
KIT \$19.95 Wired \$29.95

(less batteries)

Professional, all-electronic, sensitive, rugged—at lowest cost! Indicates by neon lamp & headphone clicks.

5" PUSH-PULL OSCILLOSCOPE #425
KIT \$44.95
Wired \$79.95

7" PUSH-PULL OSCILLOSCOPE #470
KIT \$79.95
Wired \$129.50

VACUUM TUBE VOLTMETER #221
KIT \$25.95
Wired \$39.95

DELUXE VTVM #214 (7 1/2" METER)
KIT \$34.95
Wired \$54.95

RF SIGNAL GENERATOR #320
KIT \$19.95
Wired \$29.95

150 kc-34 mc, calibrated harmonics to 102 mc. Pure or mod. RF, & Colpitts osc. 400 cps sine outputs.

CATHODE RAY TUBE CHECKER #630
KIT \$17.95 Wired \$24.95

Easy, fast test of all types & sizes TV pix & scope CR tubes, in set or carton.

#944 FLYBACK TRANSFORMER & YOKE TESTER
KIT \$23.95
Wired \$34.95

- fast check all flybacks & yokes in or out of set.
- spots even 1 shorted turn!

Range 500 kc—228 mc on fund. Cont. sweep width control, 0—30 mc.

KIT \$34.95
Wired \$49.95

TV/FM SWEEP GENERATOR #360
5MC-4.5MC CRYSTAL\$3.95 ea.

1% accuracy on all 7 ranges. Range 75 kc—150 mc. Volt reg.

KIT \$39.95
Wired \$59.95

DELUXE RF SIGNAL GENERATOR #315

Sep. voltmeter & ammeter

KIT \$29.95
Wired \$38.95

6V & 12V BATTERY ELIMINATOR & CHARGER #1050

Sep. hi-gain RF & lo-gain audio inputs. Special noise locator. Calibrated wattmeter.

KIT \$24.95
Wired \$39.95

DELUXE MULTI-SIGNAL TRACER #147

Reads 0.5 ohms—500 megs, 10 mmfd—5000 mfd. power factor.

KIT \$19.95
Wired \$29.95

R-C BRIDGE & R-C-L COMPARATOR #950B

New! BATTERY TESTER #584
KIT \$9.95
Wired \$12.95

Tests A & B portable radio, hearing-aid, lantern, other batteries—in or out of equipment.

20,000 Ohms/Volt MULTIMETER #565
KIT \$24.95
Wired \$29.95

1000 Ohms/Volt MULTIMETER #536
KIT \$12.90
Wired \$14.90

VTVM PROBES

Peak-to-Peak	KIT \$4.95	Wired \$6.95
RF	\$3.75	\$4.95
High Voltage Probe-1		\$6.95
High Voltage Probe-2		\$4.95

SCOPE PROBES

Demodulator	\$3.75	\$5.75
Direct	\$2.75	\$3.95
Low Capacity	\$3.75	\$5.75

For FREE 1956 catalog, mail coupon NOW!



84 Withers St. • Brooklyn 11, N. Y.

Prices 5% higher on West coast and subject to change without notice. ©55

EICO, 84 Withers Street
Brooklyn 11, New York

Send FREE 1956 Catalog and name of neighborhood EICO jobber.

Name.....

Home Address.....

City.....Zone.....State.....

Occupation.....

1945 to 1955: a decade of Know-How & Value Leadership in Kits & Instruments—over 1/2 million sold to date!

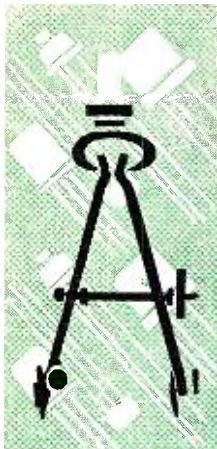

This apparatus grows single crystals of germanium. Eight years ago a single crystal of any metal was a scientific curiosity. Today large single crystals of both germanium and silicon are routinely grown as part of the normal transistor production process.

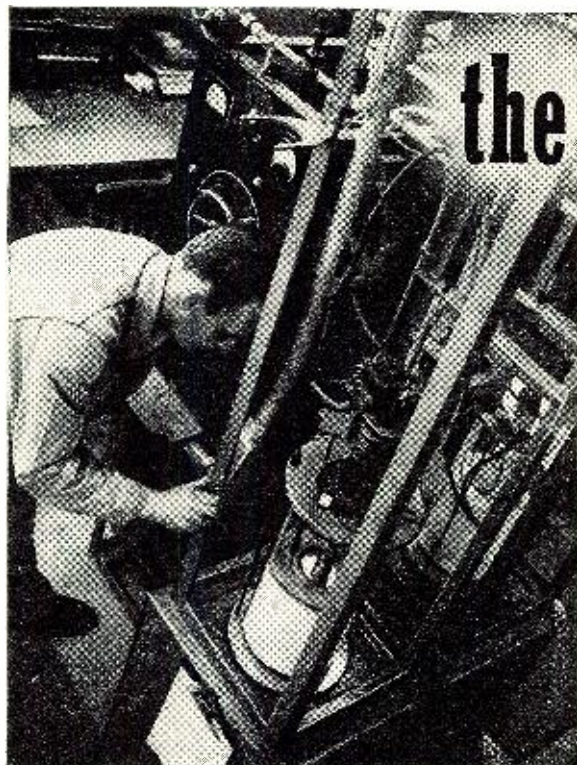

the Transistor in Industry

By **FRANK M. DUKAT**

Transistor Engineering & Product Manager
Semiconductor Division
Raytheon Manufacturing Company



IT IS NOW nearly eight years since Bardeen and Brattain of *Bell Telephone Laboratories* announced the invention of semiconductor amplifiers or transistors. The progress to date is remarkable and is a fitting tribute to the thousands of engineers and scientists in over sixty companies who have been instrumental in the development and production refinement of semiconductor devices. At times progress has seemed slow, but one must remember that invention is only the first step along the hard road to an engineering performance level which is consistent with price; but when this final step has been achieved, then transistors become commercial realities and their acceptance, as such, is indicated by an increased rate of use. Industry figures now clearly show this.

For 1953 information is unavailable, but total sales were probably somewhat less than one million units. Industry figures show over a million units sold in 1954. In 1955 sales were over three million units and in 1956, with the advent of new portable and hybrid auto sets, total sales could double. See Table 1 on page 41 for report on sales. Still this is only a small percentage of the total tube market which has averaged about 250 million units for new entertainment equipment alone over the last five years. It is, therefore, appropriate at this time to review the present status of the transistor to see what problems remain and what solutions are at hand.

The field of application for transistors is very large indeed since, in addition to their use in conventional and well known circuitry now using tubes, they possess certain inherent characteristics which open up applications in areas where the tube has been unable to compete with more efficient mech-

In eight years, the transistor industry has grown to be a potential giant. Here are some of the facts on what is in store for us, performance-wise, in the near future.

anical devices. In the former category are, of course, communication equipment, computers, servo systems, and the like. In the latter are many relay and switching applications; for example, the use of transistors makes a completely automatic telephone switchboard feasible with mechanical switching replaced by electronic methods.

It is beyond the scope of this article to consider more than a small portion of the field. Therefore, we will concentrate primarily upon communication devices used for entertainment. In so doing, many other applications are covered, for entertainment equipment today covers about as wide a frequency and power range as most applications in other more specialized fields.

Very early in transistor history it was recognized that the advantages of the transistor lay in its small size, low power requirements, mechanical strength, and freedom from microphonics. Potentially, it had better reliability and lower cost than a tube. At the same time high noise, poor high-frequency performance, and restricted temperature ranges were then considered limitations. However, since that time continued transistor development has removed many of these initial restrictions.

In the case of noise there are many readily available audio transistors today that have a better output signal-to-noise ratio in typical preamplifier

circuits than a tube doing the same job. This advantage is over and above the elimination of microphonic and hum problems. As an example, consider the performance of a 2N133/2N132 preamplifier (Fig. 1) for use with a reluctance pickup as compared to a typical 6SC7. The transistor has an output signal-to-noise ratio 6 db better than the tube. But the transistor is not always quieter than a tube. In the audio circuit described the tube is at a disadvantage because it is operating as a voltage amplifier with a poor transconductance/plate current ratio. At radio frequencies transistor noise has not

Fig. 1. A transistor phono preamplifier which exceeds tube performance from the hiss standpoint as well as eliminating all hum and microphonic difficulties. The frequency response is compensated for use with a reluctance type pickup.

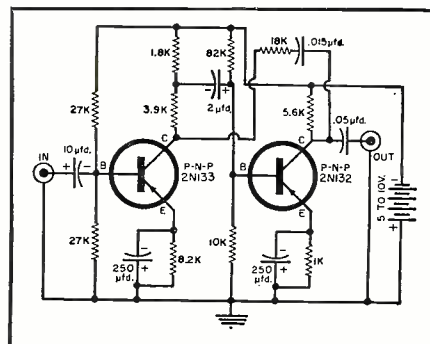

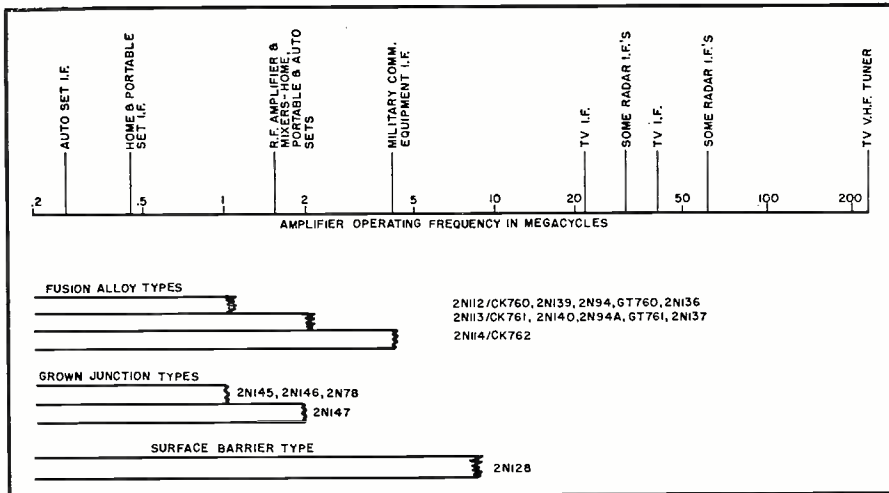

Fig. 2. Operating range of commercially-available transistors to an approximate twenty per-cent (20%) alpha cut-off frequency criterion. It should be realized here that the extreme ends of the operating range are not by any means exact.

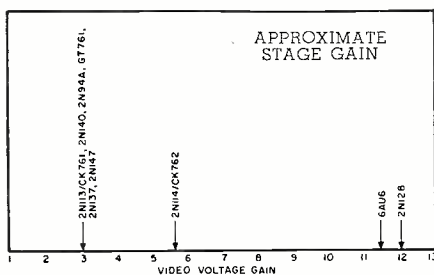

Fig. 3. Comparison of transistors and tubes in a 3.5 video amplifier.

been too thoroughly investigated but is close enough to a tube in the broadcast band so that transistorized portable receivers of good sensitivity are comparable to tube sets.

Temperature

All semiconductors by their very nature have temperature limitations. Actually there are two maximum and minimum junction temperatures to consider. One pair is the maximum and minimum junction temperature that

causes destructive or irreversible effects to occur, while the other pair represents the extremes of the range over which the application may be expected to operate satisfactorily. The high temperature end of the former is generally a point somewhat below the melting point of the solder used to make connection to the transistor elements. The term "somewhat below" is used because transistors, like tubes, must be baked out during processing at temperatures in excess of any which they may encounter in service. In well designed germanium transistors the maximum rated temperature, often called storage temperature, is at least 185° F. On the other hand, there are few circuits that can be made to operate satisfactorily at junction temperatures of 185° F because the change in characteristics of the transistor from low temperatures to 185° F cannot be adequately compensated. Hence, the application sets an upper limit on temperature range more than the transistor itself. For an average application of germanium (other than power transistors) 150° F is a reasonable figure. At the low temperature end few destructive effects are apparent unless the enclosure opens up as the result of mechanical stresses. But, from the application standpoint, low temperatures limit performance, although little trouble in this regard should be encountered in the usual "entertainment" circuitry.

In military applications performance over a wide range of temperatures is mandatory and it is here that silicon transistors play their most important role, particularly at the high temperatures, for their low-temperature performance is worse than that of germanium. Presently available silicon transistors can be operated with junction temperatures of 350° F with no destructive effects, but, again, as a practical matter, the average application limits their maximum junction temperature to about 275° F. It is unlikely that they will be used extensively in the entertainment market for two reasons. First, germanium transistors seem to have the advantage over silicon in all respects except the ability to operate at high temperatures. Second, unless someone finds a way to purify silicon cheaply, the inherent cost of silicon transistors will always be more than germanium.

It is ironic that silicon, one of the most common elements, is so difficult to purify to the degree needed for transistors that it cannot compete with germanium which, although about as costly as gold, is extremely easy to purify. Actually, the value of purified silicon and purified germanium is about the same; the basic problem is that of recovery of waste material during transistor manufacture. Waste germanium can be so successfully recovered at low cost that not much more than that necessarily contained in the finished transistor is lost. In the case of silicon, the cost of recovery is so high that it is just as



For use in transistors, germanium must be pure to the order of one part in a billion, a degree of purity not detectable by chemical means. Electrical methods are, therefore, employed where the impurity concentrations are measured by a determination of the resistivity of the sample. The resistivity apparatus shown here plots a contour of the resistivity along the bar of refined germanium on the chart recorder shown in the background. Upon completion of the run the unusable portions of the bar are marked and cut off. Refer to text.



well to start with new raw material.

Frequency

Frequency limitations in transistors have certainly restricted their use. The basic problem in today's transistor is that carriers injected into the base region of the transistor are not accelerated by a field as they are in a tube, but must wander over to the collector in a slow random motion called diffusion. One way of determining the consequences of such slow motion is by a measurement of *alpha* cut-off frequency or the frequency at which the common base current amplification falls to .7 of its low-frequency value.

How well transistors work in high-frequency circuits is complicated by many factors, and it is beyond the scope of this article to consider more than a few of them, but there are some rough and ready rules we can apply to the *alpha* cut-off frequency that are useful in predicting the suitability of transistors for a given application. One of these is, that, to obtain engineering performance which approaches the power gains of tubes, *i.e.*, gains of at least a thousand or so, the maximum operating frequency should be about 20% of the *alpha* cut-off frequency. The circuit employed will be common emitter because common base circuits, even at audio frequencies, are hard put to make 1000 times gain. Applying this rule, it appears that minimum *alpha* cut-off frequencies of at least 2-2.5 mc. are needed for portable and home set i.f.'s which operate at 455 kc. For mixer operation across the broadcast band, the 20% criterion would indicate an *alpha* cut-off frequency of 8 mc. or so, and a television v.h.f. amplifier operating at 200 mc. would need a 1000 mc. *alpha* cut-off, although at this point conventional tube performance is so degraded that one could get away with less. The *alpha* cut-off frequency can be increased by making the base of the transistor thinner. Accordingly the development of high-frequency transistors has been a continuing search for means of reducing the thickness of the base.

The collector base capacitance also causes trouble at high frequencies because it constitutes a feedback path to the input circuit which must be neutralized to maximize performance.

In theory, any reasonable value of collector capacitance can be neutralized, but, in fact, it must have a value consistent with the frequency of the application and have low variation. Another approximation for which the *alpha* cut-off frequency concept is useful is in video amplifiers. Here the voltage gain bandwidth product is about equal to the *alpha* cut-off frequency on the assumption that collector capacitance is reasonable. In television video amplifiers about 3.5 mc. bandwidth is required. For example, a tube like the 6AU6 has a gain bandwidth product of 40, so that voltage gains of 11 per stage are realizable in TV video amplifier service.

Some rough technical requirements having been set up, let us now consider how well present commercial transistors meet the requirements. From Fig. 2 it is immediately apparent that many commercial transistors satisfy the requirements for home, portable, and auto sets, but none can handle the TV set front end or i.f. to complete satisfaction. As proof of the pudding, transistors are, in fact, being used in portable and home sets, but not being considered to any degree for TV.

Fig. 3 indicates that at least one transistor equals the 6AU6 for gain bandwidth, but this isn't the whole story. To drive a 21" picture tube we need a voltage swing of over 100 volts from the video amplifier. This swing is beyond the voltage rating of any present-day commercial transistor that is capable of meeting the gain bandwidth requirement. This is a consequence of the fact that in transistors there is a space charge region around the collector junction whose width is a function of the voltage between collector and emitter. As the voltage is raised the space charge region expands into both the base and the collector with the relative expansion somewhat proportional to the resistivities of the two regions. In abrupt junction transistors (surface barrier and fusion alloy) the resistivity of the collector is so low compared to the base that the entire expansion of the space charge is into the base. For small expansions this is all to the good because it reduces the base width, thus increasing the frequency of *alpha* cut-off. However, when the space



THE operator is growing a crystal of silicon from a crucible containing molten silicon at a temperature of 2650° F. A solid seed of silicon is placed into the molten pool and the temperature distribution so arranged by control of the induction heater that freezing begins to take place onto this seed. The seed is then pulled from the melt, taking with it solid silicon. The temperature is so controlled that the seed widens into a crystal over one inch in diameter during growth. Such a crystal can potentially produce over 2000 transistors.

By virtue of going through this procedure, the solid is made in single crystal form with an orientation which is that of the seed. For silicon or any material merely randomly frozen out of a melt, hundreds of crystals of random orientation would result in the rod. This machine makes it possible to confine the solid material to only one crystal. Single crystal material is necessary for either semiconductor diodes or transistors.

A feature of this furnace, which is particularly interesting, is that it is designed for the growing of silicon where in previous years such furnaces were used only for germanium crystal growth. With the coming of high temperature devices such as silicon rectifiers and silicon transistors it has been necessary to evolve this type of furnace design to cope with the extremely high melting point and chemical activity of silicon. For example, a tendency for silicon to dissolve its own crucibles has been solved here.

The specific function being performed by the operator in the cover photo is to check on the temperature of the liquid pool of silicon with an optical pyrometer. The optical pyrometer shown works on the principle of comparing the color of a glowing hot filament with the color of the object being observed. The dial reading is a measure of the amount of current needed to heat the filament and is calibrated in degrees of temperature.

TABLE 1. MANUFACTURERS' TRANSISTOR SALES

Manufacturers' sales of transistors in 1955 were nearly three times as large as they had been a year earlier.

Factory sales of transistors totaled 3,646,802 units last year compared with 1,317,327 sold in 1954.

The 1955 sales were valued at \$12,252,741 at the factory level compared with a 1954 value of \$5,122,266.

The report was estimated by the RETMA Statistical Department on the basis of information supplied by transistor manufacturers throughout the country. It reflects total industry activity and includes those transistors which are sold for use in both entertainment and non-entertainment types of electronic equipment.

charge region touches the emitter, transistor action ceases, in fact, there exists a direct short circuit between collector and emitter, and the transistor will destroy itself unless the current flow is limited. Typically, in abrupt junction units with an *alpha* cut-off frequency of 30-40 mc. this punch-through voltage occurs around 10 volts.

In the rapidly moving field of transistors limitations do not seem to last for long and today there is in development a diffused base transistor that promises to overcome, to a large extent, the problem of restricted frequency range and voltage and power limitations at high frequencies. In this unit, shown in Fig. 4, the base is formed by diffusing *n* type material from a vapor into a *p* type chip. The process of diffusion from vapor is much more easily controlled and very narrow base widths are feasible. The emitter is a small dot of *p* material laid down in a "nonpenetrating" manner on the base. The connection to the collector (which is, in reality, the original chip) is simply made by penetrating *p* material through the *n* type skin, while the base connection is made directly to the skin itself. Transistors made in this manner have been reported with *alpha* cut-offs of 500 mc. which would make them usable as amplifiers at v.h.f. television frequencies. In addition, gain bandwidth products have been reported that are superior to tubes. In these units the collector junction is not abrupt—there is no space charge expansion into the base region and, as a result, operation is no longer limited to very low voltages. Furthermore, the impurity concentration can be made to vary through the base in such a manner that a built-in field is created to accelerate carriers toward the collector. This effect increases the *alpha* cut-off frequency for a given base width by about five times.

Power

The development of power transistors with acceptable engineering performance levels at acceptable costs is a most interesting subject. The advantage of transistors in auto sets is, of course, obvious, for with them an auto set may be made which will operate directly off the car battery without need for a vibrator-type power supply which not only takes up space but also, through the years, has been a reliability problem. Strangely enough, the problem of the power transistor in auto sets has not been entirely one of power and temperature effects, but rather one of obtaining adequate gain. A minimum power output level of about 3 watts is needed in an auto set. A single transistor operating class A then must be capable of dissipating about 7 watts allowing for the no-signal conditions and some inefficiency in the output transformer. With a 14 volt nominal supply the collector current is .5 ampere and the peak collector current 1 ampere. At these current levels early power tran-

sistors gave such low gains that a medium power unit was needed as a driver.

Design engineers working on hybrid auto receivers with a transistor output stage and all other stages using tubes operating with 12 volts on their plates soon discovered that high gain power transistors were also needed here because of the limited power available from a driver tube operated with 12 volts on its plate.

More gain in the power transistor was mandatory and again transistor development research solved the problem. The low gain was due primarily to reduced emitter efficiency at high current densities. The emitter had to be made of even lower resistance material than indium to correct the situation. Gallium was suitable, but this metal becomes soft at 100° F. Fortunately it was found that discrete amounts of gallium mixed with indium would accomplish the trick. As a result there are now power transistors capable of gains up to 1000 times. Power drive requirements are only about 3.5 milliwatts for the application discussed, which is easily available from the 12 volt tube, thus making possible the hybrid auto set.

Cost

But why a hybrid—why not an all-transistor set? The answer, of course, lies in the fact that one potential advantage of the transistor has not yet been realized; namely, low cost. The use of a transistor is, therefore, restricted to those applications where its advantages outweigh its increased cost. In 1953 they replaced tubes in hearing aids despite a unit price of over \$8.00, because of the enormous advantages they offered in this application. In 1955 their use began to multiply in portable receivers, despite a price that averaged several times that of a tube, again because they possessed inherent advantages which were valuable in portable receivers.

However, it is not quite so easy to justify higher costs in auto sets. The consumer is not concerned with reducing the power requirements or the size of his auto set, but the auto set designer is concerned with these things—hence the hybrid receiver, which

saves space and battery current without materially running up the price tag.

In the case of television set applications of transistors there is a variation of the same problem. Here the space saving feature of the transistor is unimportant. The reduced power consumption would be, except that most of the power consumed goes into the deflection system, and there is no transistor today that can handle the job. The situation here seems to be entirely one of cost. When the transistor can compete directly with the tube costwise, it will appear in television sets.

Reliability

Any discussion of transistors must include some comment on their reliability. Early transistors were encapsulated in a plastic. In many applications this encapsulation was adequate, as is well demonstrated by the plastic encapsulated transistors which are still in use in hearing aids today after over three years of service. However, plastic units did not stand up well at high temperatures, nor could they survive under extreme moisture conditions. As a result, extensive effort has been directed toward the development of hermetically-sealed enclosures. Two problems arose; first, some units (presumably hermetically sealed) were subject to abrupt failures in varying percentages because of simple leaks. Second, some that were truly sealed died slowly as the result of the gradual release of internal contaminants. Today these problems seem to be practically eliminated. It is not easy to present definite proof for the simple reason that chemical reactions play a large part in a transistor's life. These may begin the day the transistor is encapsulated and, in general, go on whether the unit is being operated or not. Hence, in a sense, a transistor is always on life test as compared to a tube where life, in general, only is used up while operating. Accelerated life tests at high temperatures are, therefore, used to predict transistor life under more normal conditions. Today such tests predict long and useful transistor life, although it will take years to accumulate exact information under normal storage conditions.

Conclusion

The conclusion to be reached on the status of transistors is inescapable. Early reliability problems are over, costs are dropping, and the engineering performance level is rising. Furthermore, the development of the diffused base transistor seems destined not only to overcome frequency obstacles, but even to point to a high-frequency performance level superior to tubes. The trend to transistors, already evident in portable radios, will gradually encompass the auto and home set field and within a few years begin to establish itself even in some TV set designs.

Fig. 4. The diffused base type transistor.

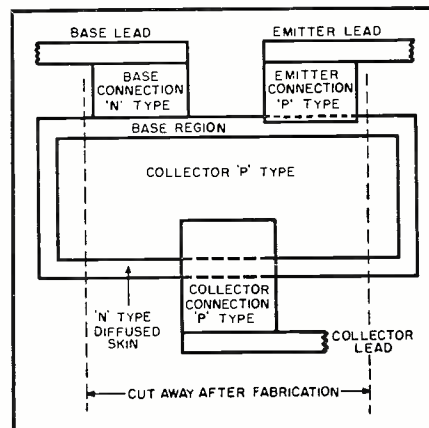

The Ceramic Cartridge and Equalization

By HERMAN BURSTEIN

Typical ceramic cartridges, suitable for high-fidelity applications. Clockwise are units by Sonotone, Electro-Voice, Shure, Webster Electric, American Microphone, and Astatic. At the present time these six firms are believed to be the only producers of ceramic cartridges in the United States.

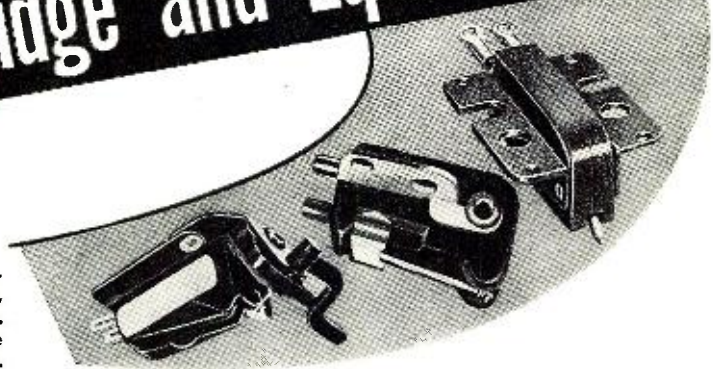

UNTIL a relatively recent date the common piezoelectric phonograph cartridge, which mainly took the form of a Rochelle salt crystal, seemed completely out of contention for high-fidelity use. Its treble response was poor, compliance low, resistance to heat and humidity inadequate, etc. In the last few years, however, improvements in the piezoelectric cartridge have made it suitable for high-fidelity reproduction. Much of the improvement has been due to use of a ceramic element, barium titanate, in place of Rochelle salt. At the same time, improved Rochelle salt cartridges, such as those of *Ronette* and *Fenton*, have also appeared on the market. Highly impervious to heat and

Hi-fi performance is now possible with piezoelectric cartridges. Although the author's discussion is more or less confined to ceramic units, all data presented applies equally as well to crystal-type cartridges.

humidity, the modern piezoelectric pickup compares well with magnetic types in terms of frequency response,

have the advantage of much higher output than magnetic ones, about 5 to 1 volt on a recording made at the

EDITOR'S NOTE: Like most topics on hi-fi reproduction, there are always pros and cons to the subject. It is a known fact that both ceramic and crystal cartridges can be designed to provide extremely good hi-fi performance, comparable in many respects to magnetic units. On the other hand, needle talk on some is greater than magnetics and, because of their high impedance, are not as likely to be used with transistor circuits as the magnetic type, with its low impedance. Both types of piezoelectric cartridges, utilizing built-in compensation, do not require any special preamplifier and while the crystal cartridge has a greater output than the ceramic type, both can be operated directly into a power amplifier requiring one-half volt for full output. Ceramic cartridges today are much alike in regard to quality performance. However, crystal units vary widely between different manufacturers.

Although most of the technical data used in Figs. 4 through 9 is based on the Sonotone 3T-S ceramic cartridge, all facts and figures can be applied, in principle, to all other ceramic and crystal units.

N A R T B standard recording level of 7 cm. per second peak velocity, thus eliminating the need for preamplification and thereby reducing problems of hum and turntable rumble. Magnetic pickups only produce from 2 to 3 millivolts up to about 50 millivolts. Hum is also less of a problem with piezoelectric pickups because, unlike mag-

compliance, tracking pressure, and distortion.

In addition, piezoelectric cartridges

produce from 2 to 3 millivolts up to about 50 millivolts. Hum is also less of a problem with piezoelectric pickups because, unlike mag-

Fig. 1. The RIAA recording characteristics widely used today.

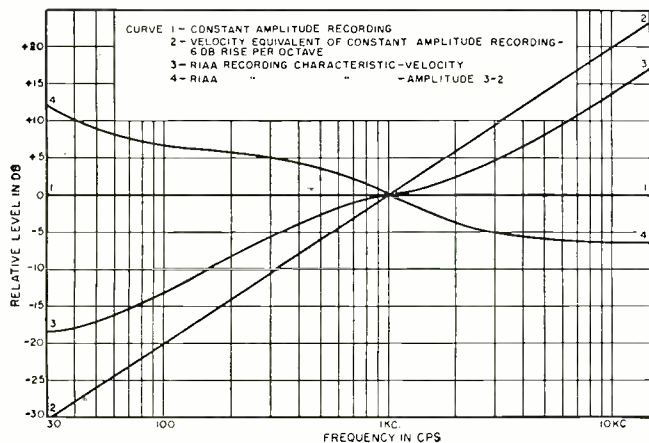
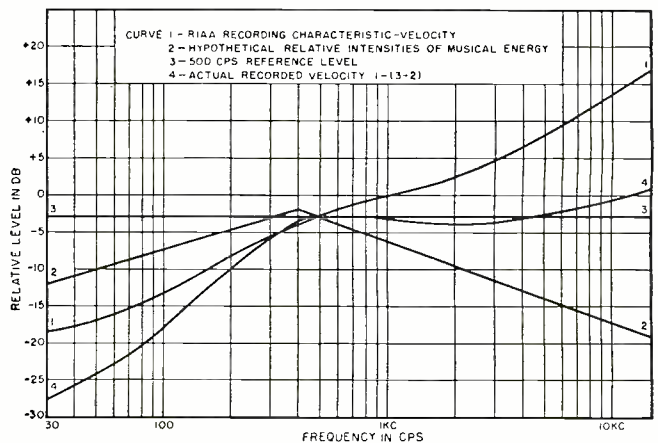

Fig. 2. An approximation of actual recorded velocity. See text.



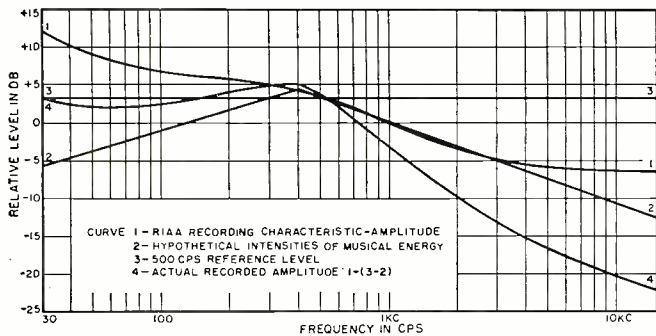

Fig. 3. Approximation of actual recorded amplitude. Curve 1 represents RIAA recording characteristic in terms of amplitude.

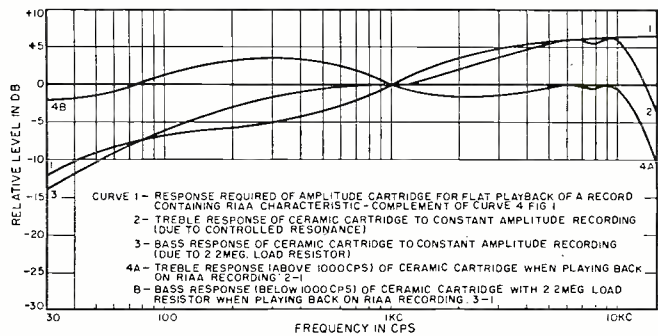

Fig. 4. Response of ceramic cartridge to RIAA recording. Curves 2, 3, and 4 were made using the Sonotone 3T-S ceramic unit.

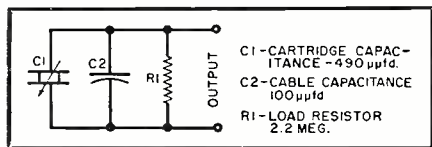

Fig. 5. Electrical values for ceramic cartridges having the response characteristics shown in Fig. 4. A Sonotone 3T-S is used here. Cartridges from other manufacturers may vary somewhat in capacitance and may thus require different loading.

netic ones, they contain no inductance and therefore are not sensitive to hum fields.

Although preamplification is no longer necessary, low-frequency equalization is still required, as in the case of magnetic cartridges. The type of equalization used, however, is entirely different than for magnetics, as well as being simpler on the whole. The output of a high-fidelity piezoelectric cartridge can be fed directly to an amplifier input intended for a high level source such as a tuner, TV set, or tape recorder. While the low-frequency response obtained in this way may be tolerable, it may be made more uniform by proper loading.

The purpose of this article is to explain why these pickups require low-frequency equalization and how this is achieved; and to discuss high-frequency equalization in connection with such cartridges. The discussion is based on the premise that the pickup is used on discs recorded according to RIAA standards, now quite generally employed in the United States. For clarity and complete understanding, it is first necessary to review the nature of the RIAA curve and the significance of the terms "velocity" and "amplitude" in disc recording.

For constant voltage input, the mag-

netic-type cutter of a disc recording machine, without equalization, operates at the same velocity for all frequencies. Inasmuch as velocity (V) is proportional to groove amplitude (A) times frequency (F), that is, $V = 2\pi AF$, amplitude declines as frequency goes up. However, this is wasteful of groove space at high frequencies. Also, at high frequencies the small signal excursions become comparable in the record groove, which constitute noise. Therefore, as an approximation, the recording process should use equalization which produces constant amplitude over the audio range for constant signal input, as depicted by Curve 1 in Fig. 1.

From the relationship $V = 2\pi AF$, it is apparent that velocity varies directly with frequency when amplitude is held constant. Therefore the constant amplitude characteristic, Curve 1, corresponds to a velocity characteristic rising 6 db-per-octave, as shown by Curve 2.

Curve 3 shows the RIAA velocity characteristic, which, for reasons that appear in the last two paragraphs of this section, rises less than 6 db-per-octave. In other words, this is the frequency equalization generally used in the recording process. When a magnetic cartridge is employed in playback, the required playback equalization is the complement of Curve 3, providing bass boost and treble droop. This is so because the magnetic pickup, being an inductive device, produces a voltage proportional to velocity.

The piezoelectric pickup, on the other hand, responds not to velocity but to recorded amplitude. The amplitude of the RIAA recording curve is shown by Curve 4 and is obtained by subtracting Curve 2 from Curve 3.

Thus Curve 4 is the amplitude characteristic corresponding to the RIAA velocity characteristic.

It is sometimes stated that modern discs have constant velocity above 500 cps and constant amplitude below 500 cps. This statement initially seems at odds with Fig. 1, which shows a rising velocity above 500 cps and a rising amplitude as frequency goes below 500 cps. The explanation lies in the fact that Fig. 1 depicts the equalization used in recording, while the statement referred to concerns the actual recorded level at various frequencies, which depends upon the relative intensities of sound energy over the frequency spectrum as well as upon the equalization used. This can be made clear by reference to Figs. 2 and 3.

The RIAA recording characteristic in terms of velocity is repeated as Curve 1 in Fig. 2. Curve 2 shows the hypothetical intensity of sound energy at various frequencies produced by a musical source. It is known that, generally speaking, audio energy is greatest around 400 cps and declines below and above this frequency. For a specific source, the actual curve would doubtless have different slopes than those of Curve 2 and would be marked by peaks and valleys. Nevertheless, it would bear a family resemblance to Curve 2, which is adequate for explanation purposes.

Curve 2 has been drawn so that the treble slope goes through 500 cps, which is taken as a reference level, depicted by Curve 3. The net result of frequency equalization per Curve 1 and varying intensity of sound at different frequencies is Curve 4. This is obtained by subtracting Curve 1 from Curve 3. It may readily be seen that actual recorded velocity, as illustrated by Curve

Fig. 6. The effect of load resistor upon response of a ceramic cartridge to RIAA disc. Curves 1, 2, 3, 4 are with Sonotone unit.

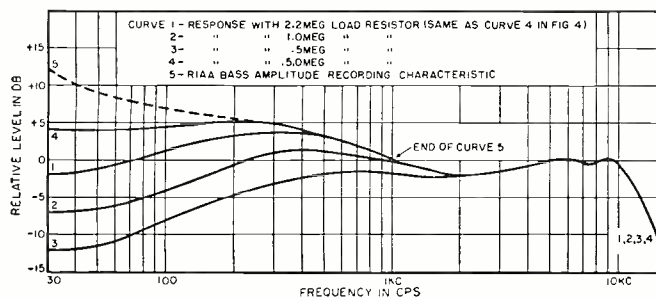
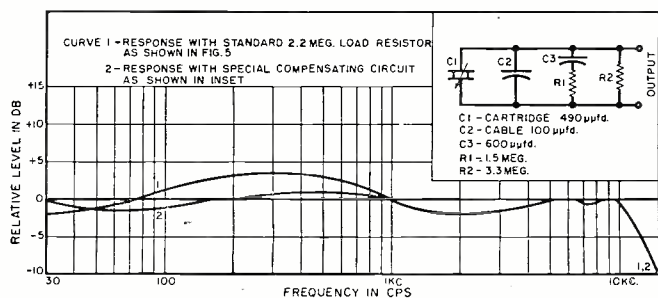

Fig. 7. Effect of a compensating circuit upon response of a ceramic cartridge to RIAA recording. All with Sonotone unit.



4, tends to be fairly constant above 500 cps. Hence the designation "constant velocity recording" for frequencies above 500 cps.

The RIAA recording characteristic in terms of amplitude is repeated as Curve 1 in Fig. 3. Curve 2, intensity of audio energy, is the same as in Fig. 2 and is drawn to pass through the reference level of 500 cps. The net result of Curves 1 and 2 is Curve 4, which represents actual recorded amplitude. Below 500 cps, Curve 4 substantially lives up to the description "constant amplitude recording."

RIAA recording equalization was designed with a careful view to the relative intensity of audio energy at various frequencies, as produced by typical sources of music and other sound. Although it would be advantageous from the viewpoint of signal-to-noise ratio to have rising recorded velocity in the treble range (note that the reference here is to recorded level, not equalization) an increase in velocity is limited by the ability of the playback stylus to track properly. Excessive velocity produces excessive acceleration forces (proportional to frequency times velocity) which would cause the stylus to lose contact with the groove walls when the tone arm is adjusted for reasonable vertical pressure, resulting in distortion.

Below 500 cps, it is necessary to impose a limit on recorded amplitude to prevent the disc cutter from cutting excessively wide grooves, which would result in cross-modulation between adjacent grooves and produce distortion. On the other hand, it is necessary to consider the playback problems that arise for a magnetic pickup if velocity drops as frequency declines. A magnetic pickup requires bass boost in playback which is complementary to the RIAA velocity recording equalization shown by Curve 3 in Fig. 1. To the extent of this boost, the reproduction of hum and rumble is increased. It is therefore desirable to limit the velocity droop due to recording equalization as much as possible so as to reduce the corresponding need for playback boost when using a magnetic cartridge. Translating this requirement into terms of amplitude, it is de-

sirable that recorded amplitude be kept as high as feasible below 500 cps. The RIAA curve, taking into account the variation of sound energy with frequency, is therefore a compromise between the need for high recording amplitude to minimize magnetic cartridge playback problems and the need for restricted amplitude to avoid excessive groove excursions. This compromise results in approximately constant recorded amplitude below 500 cps, and is effected by bass recording equalization that falls moderately in terms of velocity and rises moderately in terms of amplitude with declining frequency.

Playback Equalization

In the following discussion it should be noted that all references to recording characteristics pertain to the RIAA (or other) characteristic; they do not pertain to actual recorded velocity or amplitude as determined by the distribution of audio energy.

Curve 1 in Fig. 4 shows the playback equalization required to achieve flat response when playing an RIAA recording with a hypothetical pickup that produces a voltage directly proportional to amplitude. This curve is the complement of the RIAA amplitude characteristic, shown as Curve 4 in Fig. 1.

In the case of a piezoelectric cartridge, the required treble boost can be achieved physically, by proper design, in the cartridge itself through resonance. The required bass droop can be achieved electrically by means of a suitable load resistor, which acts as part of a frequency-discriminating voltage divider.

Curve 2 in Fig. 4 shows the treble response of an actual high-fidelity piezoelectric pickup, with a ceramic element, when playing a constant amplitude recording. (The pickup used to obtain the data of Figs. 4 through 9 is the Sonotone 3T-S ceramic unit.) The rising characteristic is achieved by means of several damped mechanical resonances built into the vibratory system of the cartridge. High-frequency response of all types of cartridges is limited by resonance of the effective mass of the stylus and the

compliance of the disc material. Response falls rapidly at frequencies above resonance. Furthermore, the high-frequency droop of Curve 2 is partly due to "playback losses" that normally occur when a typical 33½ rpm 12" vinyl record is played. These losses affect all types of cartridges.

In the case of magnetic cartridges, the manufacturer tries to prevent a rise in response at the resonant frequency by means of damping. The manufacturer of the high-fidelity piezoelectric pickup, however, uses resonance to achieve the required treble boost, with reference to constant amplitude recording, as indicated by Curve 1. By proper physical design and damping of his cartridge, he locates resonances in the portion of the audio spectrum where they will do the most good and regulates their amplitude and spread. Curve 4A, obtained by subtracting Curve 2 from Curve 1, shows the resulting treble response to an RIAA recording obtained through controlled resonance.

Curve 3 in Fig. 4 pictures the bass droop of the ceramic pickup, with reference to a constant amplitude recording, when loaded by a 2.2 megohm resistor. Fig. 5 indicates the electrical values of the ceramic cartridge in question, together with its cable and load resistor. This particular cartridge has a capacitance of 490 $\mu\text{mfd.}$, while cable capacitance is assumed to be 100 $\mu\text{mfd.}$, a reasonable average value. The time constant of R_1 , C_1 , and C_2 determines the shape of Curve 3 in Fig. 4. The difference between required and actual bass droop, respectively represented by Curves 1 and 3, determines bass response, as shown by Curve 4B.

It is important that for a given piezoelectric cartridge the correct load resistor be used. Too low a value produces inadequate bass response; too high a value, excessive bass. This is illustrated in Fig. 6 for the cartridge discussed here. It may be seen that a 2.2 megohm resistor provides the closest approach to flat response. If the pickup in question is fed into a .5-megohm load such as commonly found at amplifier inputs intended for

(Continued on page 165)

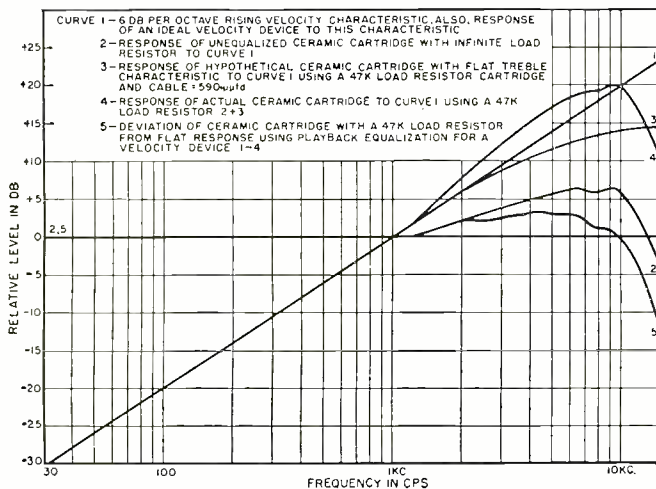

Fig. 8. Response of a ceramic pickup when equalized to produce an output proportional to velocity. Curves 2, 5 Sonotone unit.

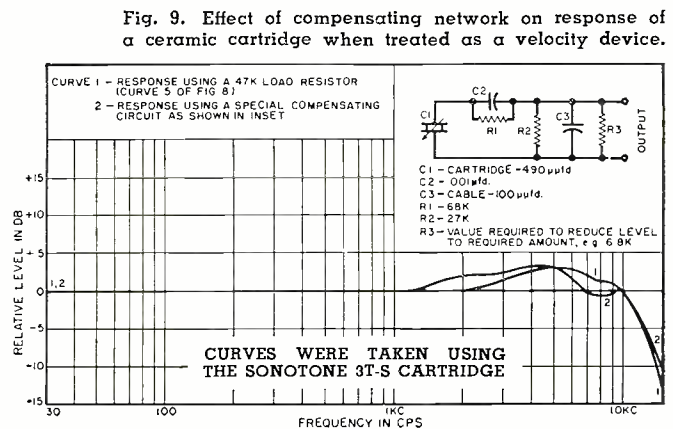

Fig. 9. Effect of compensating network on response of a ceramic cartridge when treated as a velocity device.

Realistic High Fidelity



IN PART 1 of this series I explained that A-B testing of audio products in a dealer's store might enable you to assess the differences between various competing products as heard in that store, but did very little in guiding you as to which would sound best in your own home. You have also seen how sound waves behave in unenclosed air and in chambers having reflective containing walls. Reflections seem to be undesirable, so it would seem a simple matter to hang draperies all over the walls and ceiling, put a thick carpet on the floor, and conceal the naked wood of the furniture with the hideous tablecloths, tasseled drapes, and even leg frills of the worst of the Victorian period of stuffiness; then get a good speaker and housing from the dealer and set it up in this acoustic morgue. Unfortunately it isn't as easy as that, for experiment will show that without reflection the musical reproduction has no life. But as soon as we do introduce reflections and echoes we also introduce complications.

Our rooms do reflect sound in varying degrees and the amount of reflection is determined not only by the furnishings but by the frequency of the sound waves being reflected. The size of the room as well as its shape has a bearing on what is actually heard; the position of the speaker can alter everything; the very nature of the music being reproduced has some bearing on the way it is heard in the auditorium. Given unlimited wealth and resources the way to solve the problem is to hire an architect who is an expert in acoustics and get him to build a music-listening auditorium somewhere on the grounds of your estate, with enough seats in the thing to accommodate the many people who will come to hear the nearly perfect. But most of us aren't like that. We are ordinary folk and have to use what we have, for better or worse. Let us try and work out how to do it for the better.

First of all is the size of the room. No doubt you have read over and over again that you will get loss of bass if the room isn't big enough, because to reproduce a low-frequency sound the room must be at least as long as the wavelength you wish to reproduce. Fig. 5 is a chart showing the wavelengths of various frequencies of sound waves, and from this you will see that, according to the textbooks, a room which will reproduce a 50-cycle note must be at least 24 feet long, and one to reproduce 30 cycles would have to be at least 38 feet long. Sometimes you are told that if the speaker is in one corner it will sound better, for the diagonal of the room is obviously longer

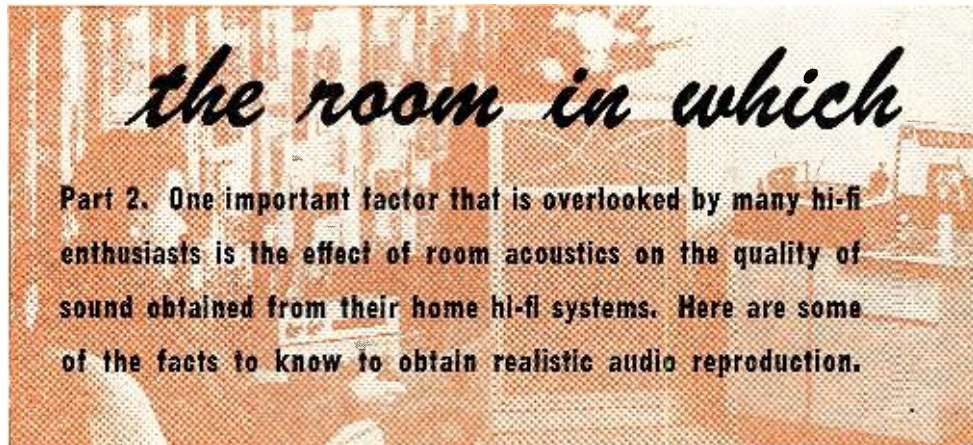

than one side, so all you have to do is to sit in the opposite corner and there you have it! But if you don't want to put the speaker in one corner and don't want to sit in the opposite corner, what are you to do? My suggestion is that you put the speaker where you want to put it and sit where you want to sit. And you will still hear the bass, in spite of the textbooks!

I don't want to decry the efforts of my fellow writers, but it is a fact that a lot of textbooks are just a rehash of material that has appeared in print before, and if someone many years ago came out with a "law," or a "principle," or an "axiom" it is likely enough that it will be repeated over and over again, without its alleged validity being questioned. Being a difficult and unbelieving person myself I very often don't accept these laid-down principles, and as I can hear exceedingly well reproduced low notes in my own room which isn't anywhere near as big as the minimum size laid down by the experts, it follows that there must be some other explanation of what is going on.

As has been explained, a sound wave progresses in ever-growing spherical zones of compression followed by zones of rarefaction; a human ear in the path of the sound wave will be acted on by the compressed and rarified air. If there is only one sound wave the eardrum will be affected only once, but if the sound is continuous then the eardrum will be affected every time a zone of compression and decompression passes it, at a frequency determined by the frequency of the original sound. If it is a 50-cycle note the ear will be affected 50 times a second, and the fact that the wavelength, the distance between successive spheres of compression, happens to be 24 feet has nothing to do with your hearing the sound in any way at all. You could hear the 50-cycle

sound in the open air or in a pair of headphones (if these are capable of reproducing a 50-cps note) or in any room between these extremes. *But*, and it is a big but, reflections from the walls of the room have a great deal to do with what happens.

Without considering any factors other than reflection, let a 50-cycle sound be sent out from a speaker in a room which is 30 feet long. According to the textbooks this room is large enough for you to hear the sound properly because it is big enough to contain a whole wavelength. But if you walk about the room while the sound is emerging from the speaker you will find that there are points where you hear no sound at all. This is due to the reflections from the walls. If you refer back to Fig. 1 (Part 1) you will see that reflectors on the nodes produce cancellation of the sound and those on the antinodes do not. If a whole wavelength and a bit have emerged from the speaker and the bit is reflected from a wall in such a way that a zone of rarefaction meets an equal and opposite zone of compression the result will be nothing at all. Such a condition is called a standing wave, because it is a "wave" having no energy. Of course it is not a wave at all, it is a zone of no wave, but the term conveniently describes the condition. Standing waves exist in terms of frequency, room dimensions, and the nature of the reflecting surfaces, and it is an instructive experiment to feed an amplifier with the output of an audio oscillator and listen to the speaker in various parts of the listening room. There are acoustically blind spots all over the room, and just outside of these acoustical blind spots the sound can be heard at full strength.

With great patience a map of the room could be drawn for each fre-

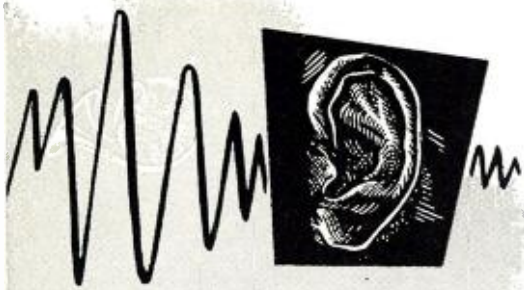

you listen

By **H. A. HARTLEY**
Audio Consultant

quency showing the location of the blind spots, but as the sounds used for the map are pure and sustained tones, which very rarely occur in real music, the value of a set of such maps seems to be very doubtful.

Independent of the frequency of the sound wave there are two factors which determine the behavior of the sound wave once it is injected into the room—resonance and reverberation. Sometimes these terms are used interchangeably but they are two quite distinct effects. As in an open or closed organ pipe any enclosed body of air resonates at its natural frequency, an effect, we shall discover in due course, which has a direct bearing on the design of a speaker housing. The air in a room has its own natural resonant frequency determined solely by the volume of the enclosed air; it will follow that if the volume is such as to create a resonance within the normal audible range then any notes emitted by the speaker of the same frequency will be augmented. In practice this doesn't matter very much because the effect is generally negligible; but the effects of reverberation are much more serious, an unduly long reverberation period affecting the whole gamut of frequencies and making speech and music quite unintelligible.

In the absence of absorbing material on the walls and ceiling of the auditorium the sound waves proceed from the source, are reflected by the walls on to the ceiling and from the ceiling on to the walls (and floor, if it is bare). Further reflections occur until the sound is echoing backwards and forwards. If part of the auditorium has curved surfaces, such as a domed or curved ceiling, the scattering of reflections becomes emphasized. The time of reverberation is easily measured, for a transient pulse of sound can be

generated and the recurring echoes heard until their magnitude is negligible; the decay in intensity must necessarily occur since the walls and ceiling are not perfect reflectors, and a little is lost with each reflection. The time in seconds required to reach practical audibility is called the reverberation period.

Before it was treated, a lecture room at Harvard University which was used in some of the earlier experiments in architectural acoustics had a 5.5 second period for an ordinary human voice; obviously even a slow speaker could utter several syllables in this time, so the result was simply a jumble of sounds if the room was fairly empty. Adding cushions to the seats improved matters, the more cushions the greater the reduction in reverberation time, and the further addition of a packed audience brought the time down to a period when a speaker could be heard very well indeed. These somewhat primitive and nowadays obvious results did at least start proper investigations into room acoustics, and it can be taken as a simple generalization which always works that if you stand in the middle of your listening room, clap your hands, and hear that "the melody lingers on," then conditions are not right for high-fidelity reproduction and sound absorbing material must be introduced.

These properties of various materials can be arranged in a simple table. If the coefficient of absorption is unity, representing complete absence of reflection, then the coefficients for various substances are as given in Table 1.

As far as the usual room accessories are concerned, unglazed bookcases fairly full of books are good sound absorbers, but if glazed the coefficient becomes that of glass; unupholstered furniture can be taken as equal to pine boards. Wallpaper is more effective than paint on plaster but there is not much improvement by using it. Thickly upholstered furniture is much more absorbent than modern functional designs; a fitted carpet provides a more manageable listening room than one with a polished wooden floor and rugs. Picture windows without curtains are almost impossible to correct or compensate; if you have one of these quite admirable features in your music room, your listening will have to be done

→ Fig. 5. Wavelengths of sound waves, in feet, at frequencies up to 100 cps.

↓ Fig. 6. Absorption coefficients of acoustic tiles at various frequencies.

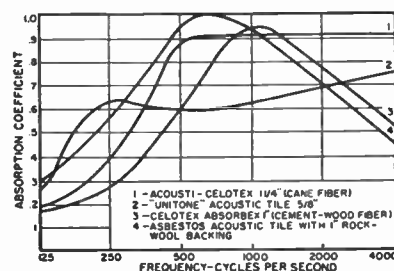

Open window	1.00
Audiences	0.96 to 0.44
Felt 1 inch thick (varying density)	0.80 to 0.50
Cork 1/2 inch thick	0.32
Insulating panels	0.70 to 0.25
Rugs and carpets (varying thickness)	0.30 to 0.20
Unglazed oil paintings	0.28
Velvet curtains	0.25 to 0.20
Cretonne curtains	0.15
Linoleum	0.12
Pine boards	0.06
Plaster on laths	0.034
Glass	0.027
Bricks and hard wall plaster	0.025
Cheesecloth and similar material	0.02 and less*

*Lace and nylon curtains are almost completely transparent to sound, so their presence in front of various wall materials has no effect on the absorption coefficients of those materials; drapes to be effective must be of velvet, cretonne, art jute (burlap), or similar substantial material.

Table 1. Absorption properties of various materials found in the average living room.

after dark, and the curtains must be substantial. Uncased radiator's and wall heating panels can be very troublesome, as can be a piano, either upright or grand.

Controlled absorption can be set up by the use of acoustical tiles. These are usually recognized by their perforated appearance. Usually the front portion is of compressed asbestos pierced with a regular pattern of small holes; this is backed with a layer of rock wool from a half-inch to one-inch thick. The tiles are not fastened directly to the wall but to battens fastened to the wall; alternatively the rock wool can be obtained as separate cushions to be laid between the battens, the front tiles being fastened to the battens. Other tiles, cheaper and much lighter in weight, consist of compressed sugar-cane fiber; others, again, are made up of exploded mica granules cemented to shape. Typical absorption curves for tiles of these various types are shown in Fig. 6, and it will be seen that maximum absorption usually occurs in the frequency band 700 to 1500 cps. Manufacturers of these tiles will supply the absorption curves on request.

The acoustical treatment of rooms intended for music listening has to be considered from two aspects—insulation from external sounds which would interfere with enjoyment of the music, and removal of reflections in the room, particularly in the reduction of re-

(Continued on page 148)

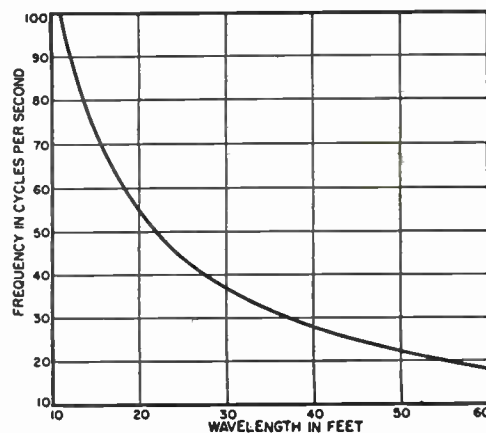

Clearing Up

TV Interference

By JOHN B. LEDBETTER

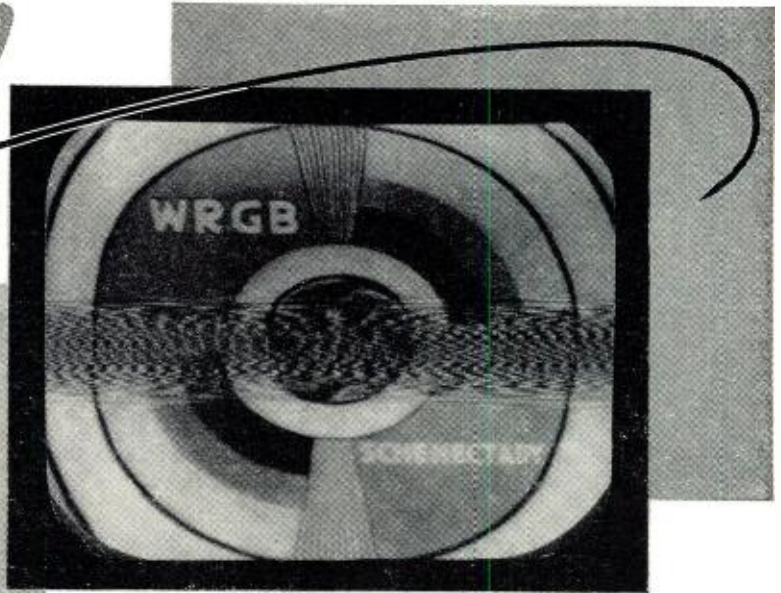

Fig. 1. The interference shown here is not caused in the TV set itself but originates in a long-filament type electric bulb in the vicinity of the receiver.

Many TV picture troubles are due to interference arising in the TV receiver itself. Here are sources and cures.

MOST TV viewers and many service technicians think of interference primarily in terms of signals from other receivers, power lines, and other external sources. Actually, there are interference sources within a TV receiver itself which are equally as bad. The horizontal sweep signal frequently causes picture troubles on the TV set. High-voltage arcing is another such source of internal interference. This article will attempt to enumerate some of these and will give informa-

tion for the cure of typical troubles. The first two cases described are not in the same category as the others but are so common that they may be reviewed with profit.

Type: Spurious oscillation

Effect: Single horizontal stripe (resembling a barber pole), drifting up and down the screen (Fig. 1). This type of interference may affect only one channel.

Source 1: Old-fashioned long-filament light bulbs. Many of these are still used in attics, closets, hallways, cellars, porches, basements, etc.

Remedy: Replace with a standard bulb, whether the old type is causing interference at the moment or not.

Source 2: Poor contact between a standard-type light bulb and the lamp socket, a defective bulb, or arcing in the socket switch.

Remedy: Turn off each light until the defective one is found. Try a new bulb. If the trouble remains, disconnect the lamp and sandpaper the socket contacts. Tighten loose connections or replace socket if necessary.

Type: Interference to nearby radio receivers

Effect: Whistles, squeals, "birdies," high-pitched "beeps," r.f. hash, sharp-tuning buzzes, "bloops," or background noises every 15.75 kc. on the broadcast receiver's dial. (Strong interference may cover or "blanket" the entire AM dial.)

Source: TV receiver

Reasons: Radiation from an unshielded or poorly-shielded high-volt-

age power supply. Defective horizontal damping tube. Improperly adjusted drive control. Unshielded horizontal or vertical sweep circuit. (Large picture tubes are worse in this respect.)

Remedies: 1. Disconnect the lead-in from the TV receiver. If interference on the AM set drops or disappears, it is being distributed via the TV antenna or lead-in. Install a simple high-pass filter or $\frac{1}{4}$ -wave open stub at the TV receiver antenna terminals.

2. If disconnecting the lead-in had no effect on the interference, it is being radiated from the TV chassis or through common coupling in the a.c. power circuits. Bypass each side of the power line to chassis with a .01 to .05 μ fd. capacitor. Experimenting may be necessary in some cases to find the most effective value.

3. See that all side or back covers of the high-voltage power compartment are in place.

4. Check or replace the damper tube. It may be slightly defective and contributing to the interference.

5. Check the small spring straps or hairpin loops which ground the outer coating of the picture tube to the yoke assembly frame. Bend slightly to increase contact pressure, or insert several thicknesses of tinfoil between each spring and the tube coating.

6. Line the inside of the cabinet with tinfoil. Line the bottom with copper screening or use a copper or aluminum plate.

Type: Intercarrier buzz (sync buzz, audio buzz)

Effect: 60-cycle hum which varies with fine tuning or contrast-control adjustments. (This may appear only on one particular station or during scene changes.)

Source 1: Improper setting of the contrast or fine-tuning control.

Fig. 2. To reduce signal overload at the antenna input terminals make an attenuator using the circuit shown here. The table lists the component values to use for the attenuation desired in the pad.

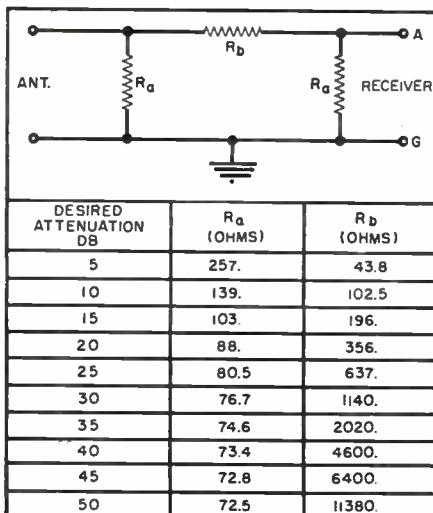

Remedy: Always adjust the fine tuning away from the buzz. Set the contrast as low as possible to still obtain the desired shading. (Setting it too high will produce buzz even in a properly-adjusted receiver.)

Source 2: Improper alignment (r.f. or video i.f. stages). This is indicated if the best picture and best sound do not coincide or are not reasonably close on the fine-tuning adjustment.

Remedy: Align carefully with a scope, video generator, and manufacturer's instructions.

Source 3: Improper sound discriminator alignment. First, try a new discriminator tube to clear suspicion in this direction. (6AL5's are common offenders and will often check good on a tube tester but fail to balance properly in the discriminator or settle down in sync a.f.c. circuits.) If this tube is good, align both the primary and secondary of the discriminator transformer. In some receivers, alignment will require test equipment; in others, a simple ear check will suffice.

Source 4: Receiver overloading, caused by too strong a signal or over-modulation of white level at the transmitter. This may not affect dual-channel receivers but may cause a buzz in intercarrier sets. If the signal is strong enough, it may overload a video i.f. or video amplifier, or sync separator stage (or the mixer-oscillator in some receivers).

Remedies: Overloading is indicated if disconnecting one or both lead-ins stops the trouble. If the trouble has always been present, try one of the following:

1. Install a resistance pad in the lead-in. (See Fig. 2.) Use good-grade noninductive resistors. Mount in a shielded, well-grounded can.

2. Check grid and cathode voltages in the video i.f., video, and converter stages for overloading (use a high-frequency probe with a v.t.v.m. or a scope). Change the values of the cathode or grid-loading resistors if required to prevent overloading or incorrect voltages.

3. If the buzz appears suddenly and the set previously has operated satisfactorily, look for a leaky or shorted tube in the r.f., oscillator, video i.f. or video amplifier stages, or an open decoupling or filter capacitor common to several of these circuits.

Source 5: Audio wiring in the receiver too close to the vertical blocking transformer, vertical output transformer, or deflection yoke. This can produce strong 60-cycle pickup.

Remedies: Re-route the wiring away from all parts (or wiring) associated with the sweep circuits. Shield the transformers (and possibly the wiring) in these circuits. (This is particularly effective in less-expensive sets where little or no shielding is used.)

Suggestions: In most cases, especially in well-designed sets, sound discriminator alignment will eliminate the buzz. In older and some inexpensive receivers, some of the other changes may be necessary. (In certain

↓ Fig. 3. Corona discharge and arcing at the high-voltage components will cause the type of interference shown here.

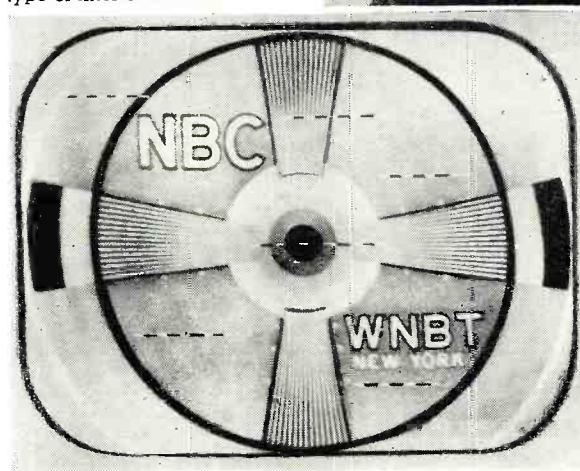

↑ Fig. 4. One wide black bar indicates a 60-cycle interference, frequently due to power supply hum in the video.

receivers, an open or defective filter capacitor will cause hum very similar to intercarrier buzz. This source should be checked before extensive alignment or wiring re-routing is undertaken.)

Type: Arcing and corona discharge

Effect: Light interference lines in the picture (similar to electrical interference). See Fig. 3. Brightness may vary, accompanied by mechanical frying or sizzling sound which may or may not be heard in audio.

Source: Low-resistance path to ground in high-voltage power supply.

Remedies: Cut all bench illumina-

tion and make a careful visual examination of the second anode connector, rectifier socket connections, and all points in the high-voltage circuit for a tiny, bluish arc. Straighten out all sharp bends in the high-voltage leads. Make sure the second anode connector is making firm contact in the picture tube. Re-solder all connections on the high-voltage rectifier socket, horizontal output transformer, etc. Examine or disconnect fiber terminal boards in the high-voltage bleeder circuit. (In several models, these terminal boards or strips have broken down internally

(Continued on page 150)

→ Fig. 5. Picture tearing, such as shown here, can be caused by 60-cycle hum getting in the video i.f. circuit via a cathode-to-heater short in an i.f. tube.



↓ Fig. 6. The two vertical lines on the left of the raster shown here are caused by Barkhausen oscillations in the horizontal output tube. A single-magnet type ion trap is often slipped around the tube to eliminate this trouble.

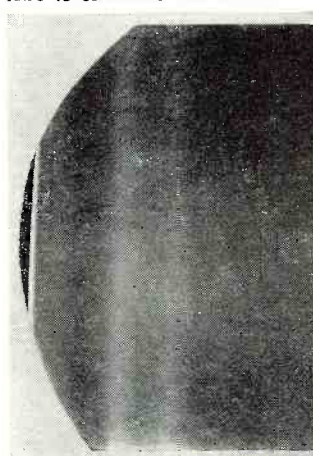

→ Fig. 7. The beat-type interference pattern shown here, often due to external signal sources, may be caused in the receiver by a faulty oscillator.

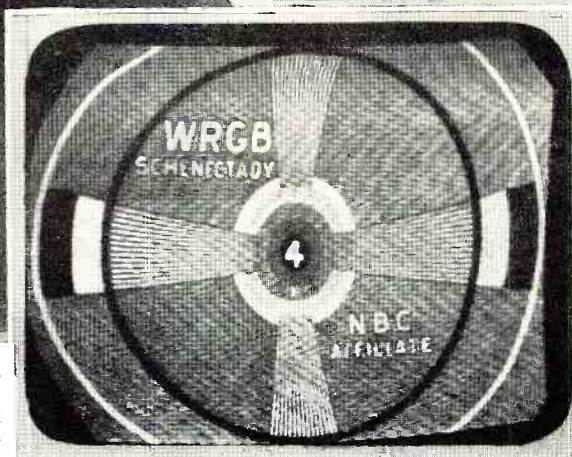

Satellite TV

By **JOHN B. GRUND**
Advanced Applications Engineer
Sylvania Electric Products Inc.

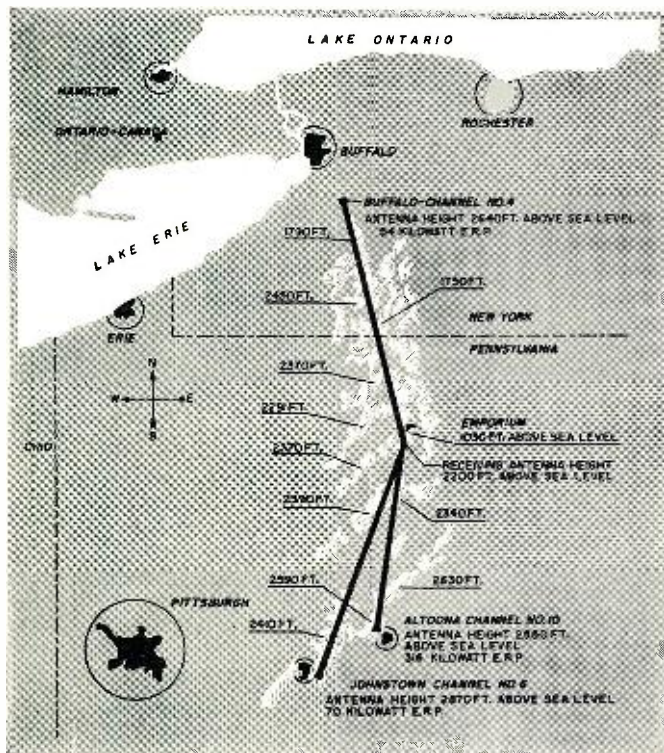

Fig. 1. Emporium, Pa. where the satellite stations described in this article are located, is a small town situated in a valley blocked from surrounding v.h.f. TV stations by relatively low mountains. Direct station signals are unavailable.

Various types of booster and satellite TV transmitters are under consideration for improving u.h.f. and v.h.f. TV reception. Here are experimental results from three.

HOW can a small town situated in one of the narrow valleys of Northwestern Pennsylvania, 65 miles from the nearest commercial television station, have the highest concentration of television receivers of any community in the United States? Satellite television is the reason.

In 1951 *Sylvania Electric Products Inc.* obtained a license for an experimental u.h.f. TV station to provide an "off-the-air" test signal for field testing u.h.f. tuner tubes and equipment then under development. Another objective was to investigate the feasibility of unattended satellite operation as a means of economically supplying TV coverage to remote areas not receiving signals from established stations. Emporium, Pennsylvania, is in just such a remote area. The town is situated deep in a valley in the Allegheny Mountains at an elevation of about 1050 feet above sea level. The

surrounding hills rise sharply, 1000 feet or more above the valley. While television signals are received sporadically in the valley, consistent reception from several television stations is possible on the hilltops. Fig. 1 shows the location of Emporium relative to cities with v.h.f. television stations.

The original transmitter site was chosen to fulfill three objectives: provide line-of-sight reception at the *Sylvania* plant and most of Emporium; provide acceptable reception of available v.h.f. signals; and be readily accessible by road. The site selected was 1100 feet above and 1.7 miles southwest of the center of Emporium. Fig. 2 shows the tower site in the foreground located on top of a hill overlooking the town.

Systems in Operation

There are now two experimental u.h.f. television systems in operation in Emporium as shown in Fig. 3. In

Fig. 2. View of Emporium, Pa., from the air. The u.h.f. satellite TV transmitter antenna site is in the clearing in the foreground, on a mountain south of town.



system 1, the channel 6 v.h.f. signal is picked up from the Johnstown station 88 miles distant, demodulated, and re-transmitted on u.h.f. channel 22. Because one area of the town is shadowed from the u.h.f. transmitter by an intervening hill, the signal from the u.h.f. transmitter on the hill is picked up in the valley, amplified, and re-radiated on the same channel to provide coverage in this shadowed area. In system 2, the v.h.f. television signal is received at the hilltop location, relayed by microwave to a central location in the valley, demodulated, and rebroadcast on channel 82.

All transmitters operate automatically and are unattended. The stations are monitored at all times and in the event of any malfunction of equipment, the stations are turned off until corrective measures have been taken. The channel 22 station on the hill is remotely controlled by microwave control equipment.

One of the hilltop towers is shown in Fig. 4. The main tower is 98 feet in height. Mounted on it are the channel 6 receiving antenna, the transmitting colinear arrays for channel 22, and microwave transmitting and receiving antennas. Another mast, not shown, supports channel 4 and channel 10 ten-element yagi antennas. The top of this 65-foot mast is only a few feet above the trees bordering the clearing.

A concrete block building houses receivers, transmitters, and associated equipment. Because of the isolated location, there are no windows in the building. The necessary ventilation is supplied by air vents and exhaust fans.

Fig. 5 is a photograph of the transmitting equipment. The pattern generator with custom-built monoscope tube for station identification is in the rack on the left. The sync and timing generators for the monoscope are mounted in the next rack. Since the photo was taken, microwave receiving and control equipment has also been installed. Power supplies for the microwave transmitter are on top of this same rack. The center rack houses the channel 22 sound transmitter. The picture transmitter is in the rack beside it. The rack on the right contains monitoring equipment. The tape recorder used for automatic aural station identification can be seen on top of the rack on the right.

The transmitters are turned on and off by two clocks, one for weekday operation and another for weekends. Other time clocks control the receiv-

er and insert visual and aural station identification at regular intervals. A running-time meter on the equipment has recorded over 20,000 hours of operation.

On-Channel Booster

As previously mentioned, one section of Emporium is shadowed from the hill-top transmitter by intervening hills. An on-channel booster station was constructed to redirect the signal into this shadowed area and, at the same time, provide additional technical data on the problems associated with this type of transmission.

Isolation of the receiving and transmitting antennas was the first problem encountered. Unless the two antennas are properly separated and oriented, the amplified signal from the transmitter will again be received at the receiving antenna resulting in feedback. Placing the directional antennas about 75 feet apart and directing them at right angles to each other gave an isolation of about 93 db between them. The received signal is, of course, horizontally polarized but it is re-radiated with vertical polarization. The cross polarization gave very little added isolation between transmitting and receiving arrays; however, use of cross polarization permits a viewer to choose between reception from primary station or booster station to eliminate ghosts. With horizontal polarization of both signals severe ghosts were a problem in the areas where signals from both primary and booster stations were of equal intensity. Vertical polarization of the retransmitted signal corrected this difficulty.

The transmitter of the on-channel booster station consists of several stages of 6AN4 tubes operated grounded-grid and stagger-tuned to give the required 6 mc. bandwidth. The output stage uses a pair of 5876 tubes in a grounded-grid, push-pull circuit. Voltage gain of the amplifier or booster is about 68 db.

The on-channel booster has been operated more than 6000 hours. Color programs have been received over it with no apparent degradation of the signal, so cross modulation has not been a problem. The use of a booster transmitter to supply a TV signal to a shadowed area has been quite successful. To obtain a signal from KG2XDU in the area equivalent to that received from the booster KG2XFZ, would require raising the transmitter average power by 16 times. This is 1000 times the power of the booster transmitter and illustrates the saving which can be obtained by the use of low-powered boosters to cover small shadowed areas.

Will the best television signal coverage of an urban area be obtained by locating the transmitter on a hill overlooking the area and using a directional antenna, or by installing the transmitter in the center of the area and employing an omni-directional antenna system? To answer this question and to compare tube performance at

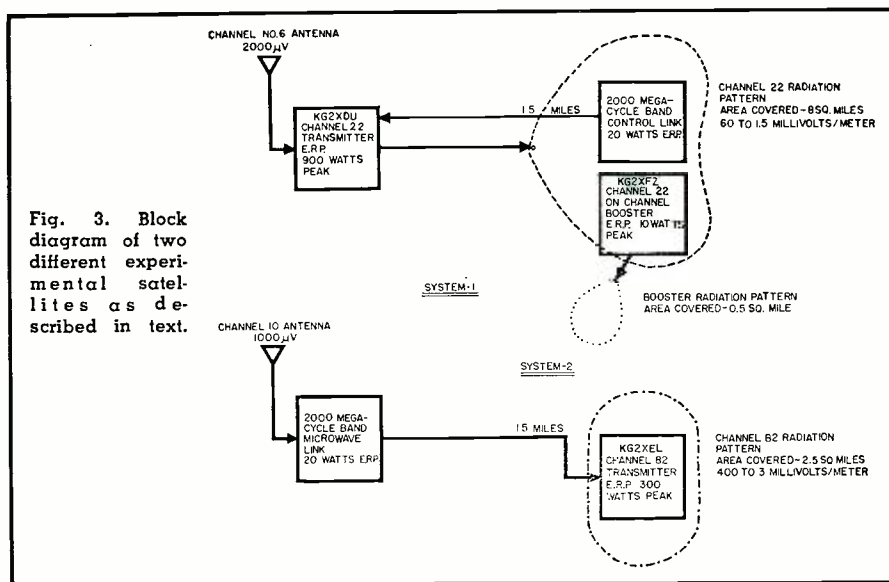

the high frequency end of the u.h.f. TV band, a channel 82 transmitter was constructed and put in operation in the valley near the center of Emporium.

Except for an additional doubler stage between triplers and final amplifiers, and the use of the tube type 4X150G in the power amplifier stages, the channel 82 transmitters (sound and picture) have the same tube line-up as the channel 22 transmitters. Program material is relayed from the hilltop location to the satellite transmitter in the valley by a microwave link operated in the 2000 mc. band. Both sound and picture are micro-

waved, the FM sound being transmitted on a 6 mc. subcarrier.

The tower in the valley which supports the channel 82 transmitting array, the on-channel booster corner-reflector transmitting antenna, and the two microwave antennas with associated equipment, is pictured in Fig. 6. The channel 82 transmitting antenna is designed to radiate an elliptical pattern to conform to the shape of the valley.

Although the measured signal strength from KG2XEL on channel 82 is as great or greater than that from KG2XDU, channel 22, reception

Fig. 4. (Left) Closeup view of tower and building located at the hilltop site.

Fig. 5. (Right) Transmitting equipment for the channel 22 satellite transmitter, KG2XDU, and microwave and transmitting equipment contained in the hilltop building. Shown here are monoscope pattern, sync, timing generators, and transmitters.

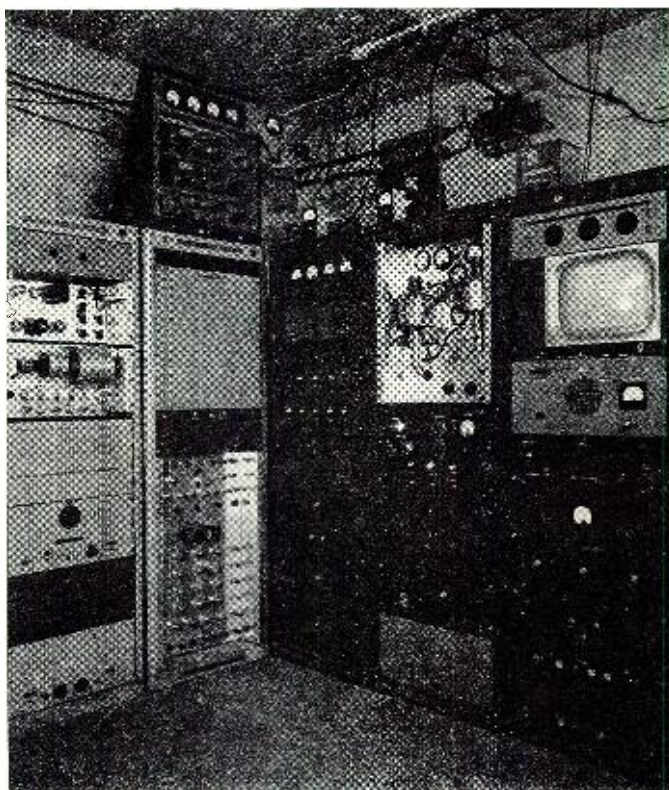
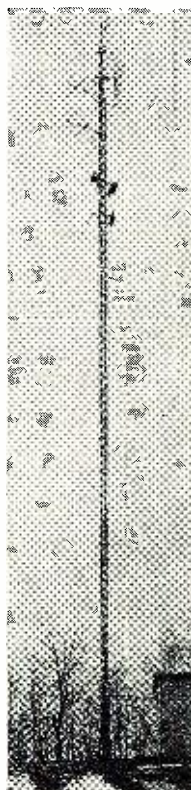



← Fig. 6. Tower and transmitting antenna for channel 82 satellite located in town of Emporium, Pa. The channel 22 booster corner reflector antennas and parabolic antennas for microwave links are also shown.

generally is not as good. The higher frequency of transmission, which makes the shadowing effect of trees and buildings much more pronounced, and the lower antenna height—the transmitting antenna is only 70 feet above ground level—coupled with the generally poorer performance of u.h.f. tuners and converters at the high frequency, limit the channel 82 coverage much more than was anticipated. Reflected signals seem to be more bothersome at channel 82 than at the lower channel as well.

Future of Satellite TV

The Federal Communications Commission has recognized the need to extend television coverage to communities too distant to receive signals from established stations and too small to support a television station. On August 1, 1955, the FCC reduced the minimum power requirements of commercial TV stations to 100 watts at any antenna height. Public Notice FCC 54991 of August 5, 1954, invited applications for stations which do not propose to originate local programs. These rule changes are the first step in the Commission's efforts to provide each community with at least one television station.

As a result of Public Notice 54991 several stations are now being operated as satellite stations, rebroadcasting programs received by off-the-air pickup from other TV stations. Technical operating requirements of these stations, however, are the same as regular commercial TV stations except for the programming. Two TV stations thus operated are KTRE-TV in

Lufkin, Texas, rebroadcasting programs from KPRC-TV, Houston, 125 miles away; and KDLO-TV, Florence, South Dakota, rebroadcasting programs from station KELO-TV, Sioux Falls, South Dakota, 100 miles distant.

Probably the best example of low-power television stations in operation at v.h.f. is afforded by the Armed Forces Television Service which operates five low-power (less than 100 watts e.r.p.) stations at isolated military bases. It is too early to see what effect the reduction of minimum power requirements will have on the establishment of commercial TV stations in the smaller communities. It is difficult to predict whether or not the financial advantage gained by lower first cost will be great enough to compensate for the lower income obtainable in a small community. Further relaxation of the present rules is required to stimulate the growth of a commercial low-power satellite service. A committee of the RETMA has studied the problem extensively and made recommendations. These recommendations and comments from other interested parties are now being studied by the FCC.

A comparison of unattended satellite stations and community antenna systems as a means of providing a TV signal to a small remote community is presented in Table 1. Advantages and disadvantages are listed—some are of more concern to the viewer, others are applicable to the operators of the systems.

Because relaxed rules applicable to commercial unattended satellite stations have not yet been adopted by the FCC, little station equipment is available commercially. It has been estimated by the manufacturers of related equipment, that such a station should be obtainable in the future for from \$10,000 to \$50,000. —30—

TABLE 1. COMPARISON OF SATELLITE STATION WITH COMMUNITY ANTENNA SYSTEM

SATELLITE STATION ADVANTAGES

1. No cost to the viewer.
2. Most economical way to provide service to a number of viewers.
3. Provides service to isolated viewers living out of the urban area.
4. Does not interfere with the signals of the originating station.
5. All the equipment is in one spot for easy maintenance.
6. Viewer requires only a simple antenna.
7. Offers opportunity to grow into a full fledged station with locally originated programs.

DISADVANTAGES

1. A satellite station can only broadcast one program signal at a time, as is the case for regular TV stations.
2. Requires an FCC license, and rules for commercial operation of unattended satellites have not yet been provided.
3. Expenses must be defrayed by popular subscription, or advertising.
4. Requires some frequency spectrum space but this is available in the u.h.f. band.

COMMUNITY ANTENNA ADVANTAGES

1. Several programs may be provided.
2. Requires no FCC authorization, but will have to meet FCC signal radiation limits in the future.
3. Provides a captive audience which may be billed monthly to defray the expense of the operation.
4. Requires no frequency spectrum space, if radiation is suitably controlled.
5. Electronic equipment required is not complex.
6. Viewer requires no antenna installation.

DISADVANTAGES

1. Requires an extensive cable distribution system, with attendant local franchise and utility pole rental contracts.
2. May interfere with the signals of the originating stations, if radiation is not carefully controlled.
3. Electronic equipment is scattered throughout the system, complicating maintenance.
4. Unlikely to grow into a local TV station with locally originated programs. However, some do or intend to originate local programs.

An Experimental

U.H.F.

Oscillator

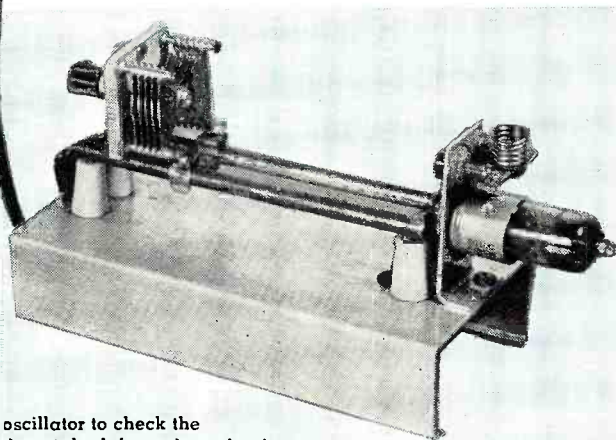

By **LOUIS E. GARNER, Jr.**

Fig. 1. Using a u.h.f. oscillator to check the operation of an experimental u.h.f. receiver circuit.

WITH the growing importance of the higher radio frequencies and the increasing use of u.h.f. equipment, both by amateur and commercial operators, there is a developing need for a compact, inexpensive, and reliable u.h.f. oscillator. Such an instrument might be used by service technicians as a low-powered transmitter for "checking out" receivers and antenna systems or for qualitative tests of receiving installations. It might be used by home experimenters, students, and schools for laboratory experiments demonstrating the principles of u.h.f. And it might be used by design engineers as an auxiliary signal generator, for checking out receiver designs, for "breadboard" tests of experimental equipment, as a substitute local oscillator when checking new receiver circuits, as a signal source for determining transmission line characteristics, and in many similar applications.

The basic specifications of such a u.h.f. oscillator might be itemized as follows:

- (a) The instrument should be compact; easily used on the workbench.
- (b) It should be self-contained, having a built-in d.c. power supply.
- (c) The unit should be reliable and require no tricky adjustments.
- (d) It should be capable of supplying a reasonably strong signal.
- (e) The instrument should be capable of operating over a moderate band of frequencies and, further, should be easily changed to cover other ranges if desired for special applications.
- (f) It should be inexpensive, as well as easy to build and to use. Remembering that the instrument is to serve as

an auxiliary to, not as a replacement for, a standard signal generator, it need not incorporate features generally reserved for expensive laboratory-type instruments. Such features as an output attenuator, precise calibration, and a constant output level may be eliminated in the interests of a simpler and less expensive circuit.

The u.h.f. oscillator shown in the photographs, originally designed for use in checking production u.h.f. receivers, meets the general specifications outlined on most counts. In addition, it incorporates facilities for checking the oscillator's d.c. grid voltage, permitting the instrument's use as a grid dip oscillator. Equally important, a straightforward circuit is employed, with only standard components used in its construction, thus permitting the instrument to be duplicated quite easily by any ham, home experimenter, student, or technician of moderate skill.

Circuit Description

In order to keep component cost to a minimum, a commercial receiving-type

triode vacuum tube has been used in the basic oscillator circuit instead of an expensive special-purpose u.h.f. tube, such as is generally used in u.h.f. instruments. The 6AF4 is an excellent high frequency oscillator, and has been used as the local oscillator in many commercial u.h.f. TV front-ends and converters. With care in circuit design and construction, it may be used at frequencies up to and exceeding 900 megacycles.

Referring to the schematic diagram given in Fig. 2, the 6AF4 triode is connected as a conventional Colpitts oscillator, with inductance L_1 and the split-stator "butterfly" tuning capacitor C_0 serving as the primary tuning elements. Some tuning is also provided by distributed wiring capacities, by the interelectrode capacities of the vacuum tube, and by the residual inductance of leads. The net effect of these added capacities and inductances is two-fold. (1) They place an upper limit on the frequency of operation (about 650 mc. with the layout and wiring shown in the photographs), and (2) they limit the tuning range of capacitor C_0 for

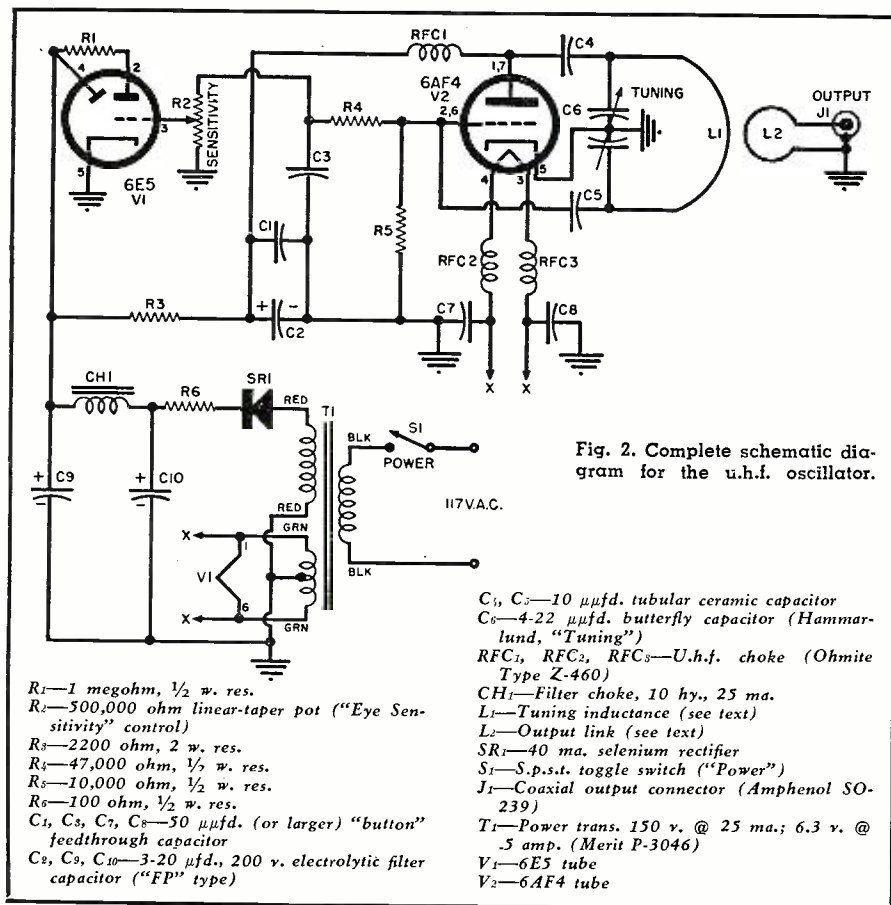

any given inductance L_1 . The "tank" circuit, L_1 - C_6 is isolated from the tube electrodes by blocking capacitors C_4 and C_5 , hence there is no d.c. on the tuning elements. Output loop L_2 is inductively coupled to tuning inductance L_1 and serves to pick up the r.f. signal and to feed it to the coaxial output connector J_1 .

The d.c. plate voltage is supplied through u.h.f. choke RFC_1 ; heater voltage through chokes RFC_2 and RFC_3 . Carbon resistor R_5 serves as the grid leak. Silver mica "button" capacitors C_1 , C_3 , C_7 and C_8 are used as bypass capacitors for the oscillator stage and keep r.f. signals more or less isolated in the vicinity of the oscillator tube, minimizing stray radiation and feedback over the power line cord. C_3 , in conjunction with isolating resistor R_4 , provides r.f. filtering action for the d.c. voltage fed to the tuning eye tube; C_1 and RFC_1 provide r.f. filtering in the "B" supply circuit; and C_7 and C_8 , with RFC_2 and RFC_3 , respectively, provide filtering for the heater supply.

In order to provide an indication of oscillation intensity, a 6E5 tuning eye tube is used as a d.c. voltmeter. This tube is connected in a conventional manner, with a 1 megohm resistor (R_1) between the triode plate and target anode. A d.c. control voltage is obtained from the grid of the 6AF4 oscillator tube and fed through the r.f. filter network C_3 - R_4 to potentiometer R_2 . The setting of R_2 determines what proportion of the available d.c. voltage is applied to the grid of the 6E5 and thus R_2 serves as an "eye sensitivity" control.

As the oscillator's grid bias voltage changes, the tuning eye's shadow angle increases or decreases. The eye closes with an increase in grid bias (indicating an increase in oscillation intensity) and opens with a decrease in bias voltage (indicating a decrease in oscillation intensity).

The power supply is conventional. The d.c. is obtained from the half-wave selenium rectifier SR_1 , powered, in turn, by the high-voltage secondary winding of transformer T_1 . A dual section "pi" filter is employed to remove ripple, with the first section consisting of inductance choke CH_1 and electrolytic capacitors C_{10} and C_9 ; the second section consists of resistor R_3 and capacitors C_6 and C_2 C_6 is common to both sections of the filter. The d.c. for the 6E5 tuning eye tube is taken off between the first and second sections of the filter network. Resistor R_6 is not part of the filter network, but serves to prevent damage to the selenium rectifier by limiting the charging current surge to C_{10} . Heater voltage is supplied by a center-tapped filament winding on T_1 . A s.p.s.t. toggle switch, S_1 , serves as the "off-on" switch.

Construction Hints

The general layout used by the author is apparent from the below and above chassis views of the model, given in Figs. 3 and 4, respectively. Except for the 6AF4 oscillator stage itself, layout is not especially critical and another builder might follow the general layout shown or might make up a new one to fit his own requirements.

As far as the power transformer, T_1 , filter choke, CH_1 , and filter capacitor, C_2 , C_6 , C_{10} , are concerned, the mounting holes for these components may be located simply by holding the parts on the chassis and marking the hole locations with a scribe.

Layout of the 6AF4 oscillator stage is fairly simple as long as good u.h.f. wiring practice is followed. All signal connections must be kept as short and direct as possible. To facilitate this, the tube socket is mounted *upside down*, about $\frac{1}{4}$ " above the chassis on brass spacers. The tube itself passes through a hole in the chassis. A steatite (ceramic) tube socket should be used to minimize high frequency losses. The four button capacitors (C_1 , C_3 , C_7 , C_8) serve as terminal points for the three r.f. chokes (RFC_1 , RFC_2 , RFC_3) and the isolating resistor (R_4). These are located around the tube socket in such a way as to permit short, direct connections to the tube socket pins, and so that none of the components overlap. Spacing should be such that minimum lead length is left on each component (chokes and resistor).

The commercial chassis and cabinet used by the author has an over-all covering of black wrinkle enamel. In order to solder the button capacitors in position and to make direct connections to chassis ground, it was necessary to remove all enamel in the vicinity of the 6AF4 tube socket. This was accomplished by the liberal application of solvent, steel wool, and elbow grease—especially the latter.

Once the machine work on the front panel is completed, controls may be labeled. The author used special decals for labeling the model. If unavailable locally, they may be purchased from the Tekni-Labels Company, 232 No. Glenoaks Boulevard, Burbank, California. After the decals are applied, they should be protected with at least two coats of clear plastic spray. Since only two low-power tubes are used, no venting is necessary, even if the unit is to be left on for several hours at a time. Eliminating vent holes and louvers not only simplifies the mechanical work, but also improves the electrical performance of the instrument by reducing stray r.f. radiation.

Except for the cable to the 6E5 tube socket, all r.f. wiring is above chassis and all d.c. and low-frequency a.c. wiring below chassis. As mentioned earlier, the r.f. wiring should be short and direct. . . . component leads should be kept as short as is practicable. . . . and lead wires, where used, should be either heavy bus bar (#14 or #12 ga.) or tinned copper braid or strap. Below chassis wiring is non-critical and the builder may follow his own inclinations.

Inductance coils L_1 and L_2 are made from #14 ga. tinned bus bar. Their exact size and shape may be determined by experiment to fit the individual needs of the builder. The frequency range covered will depend on the size of L_1 , of course, but the maximum frequency possible with the general lay-

out shown is in the neighborhood of 650 megacycles. Because of the large effects of individual variations in wiring, exact sizes for L_1 and L_2 cannot be specified for particular frequency coverage. However, in the author's model, with L_1 consisting of $\frac{1}{2}$ turn (semicircle) 1" in diameter, with $\frac{5}{8}$ " legs (forming a large "hairpin"), the frequency ranged from a minimum of 195 megacycles to a maximum of 320 megacycles as C_6 was adjusted. To reach extremely high frequencies, the tuning coil (L_1) may consist of only a small arc of bus bar . . . in fact, several "coils" may be connected in parallel to obtain a still greater reduction in inductance. In the author's model, L_2 consists of a $\frac{3}{4}$ turn coil, $\frac{3}{4}$ " in diameter, spaced $\frac{3}{8}$ " from L_1 and self-supported by its own leads.

Calibration

After the wiring has been completed and checked, the tubes may be inserted in their sockets and the instrument turned "on" and allowed to warm up. To check for oscillation, adjust the "eye sensitivity" control (R_2) to see if the tuning eye can be made to "close." As long as the eye can be closed, it indicates that a negative grid bias voltage is being developed across grid leak resistor R_6 —a sure sign of oscillation. If the eye shadow angle does not change with the adjustment of the "sensitivity" control, it indicates trouble . . . recheck all wiring, check tubes, and check both plate (d.c.) and heater voltages. The failure of the tuning eye tube to develop a green

glow generally indicates a lack of "B plus," assuming all wiring to be right.

Where the completed u.h.f. oscillator is to be used simply as a general purpose u.h.f. signal source, it may not be necessary to calibrate the instrument, other than to check the maximum and minimum operating frequencies, and to adjust L_1 to cover the desired range. Typical applications of an uncalibrated oscillator may be in school work . . . a good "project" would be the calibration of the instrument . . . and in general experiments with transmission line systems, where the frequency may be measured as a routine part of the tests.

On the other hand, where a calibrated instrument is needed, several techniques are available to the worker. Before attempting calibration, the instrument should be left "on" for at least five to ten minutes to permit all components to reach their normal operating temperatures. In addition, the worker should remember that the dial covers a 180° range but that a "butterfly" type tuning capacitor, as used in the instrument, changes capacity only over a 90° range. He should choose the portion of the dial he wishes to use for calibration, and adjust the capacitor and dial position accordingly.

The basic technique for calibration is to determine the operating frequency at a discrete number of dial positions, later plotting these values on a graph to form a smooth "calibration curve" or chart. Two standard methods may be used for determining actual frequency at any dial setting, as follows: (a) "zero beat" method; or (b) the

Lecher wire frequency measurement.

To use the "zero beat" technique, the worker should have a receiver (a simple detector will be satisfactory for most applications) and a standard signal generator. The outputs of the u.h.f. oscillator and of the standard signal generator are fed together into the receiver (or detector). The u.h.f. oscillator is set to the first position to be checked and the signal generator carefully adjusted until an audible "beat signal" is obtained from the receiver's loudspeaker (or detector's headphones). It is presupposed that the receiver has been tuned to pick up the signal from the u.h.f. oscillator and is capable of operating over the desired frequency range. The signal generator is carefully adjusted until the audible beat disappears, with a low frequency note appearing on either side of "zero" beat. At zero beat, the signal generator and u.h.f. oscillator are both set at the same frequency. This method is repeated at each check point to obtain a series of readings for calibration. When using this technique, a receiver is preferred to a simple detector, to avoid misleading "zero" beats between harmonics of the signal generator and the u.h.f. oscillator.

To use the Lecher wire technique, a Lecher frame must be prepared. This consists of two tightly stretched parallel wires, shorted at one end and open at the other, with a total length between five and seven feet. A movable slider or "shorting bar" is provided to short the two wires at any point. The
(Continued on page 151)

Fig. 4. Above chassis view of the u.h.f. oscillator. Note that the tube socket for the 6AF4 is mounted upside down.

Fig. 3. Below chassis view—all major parts are identified.

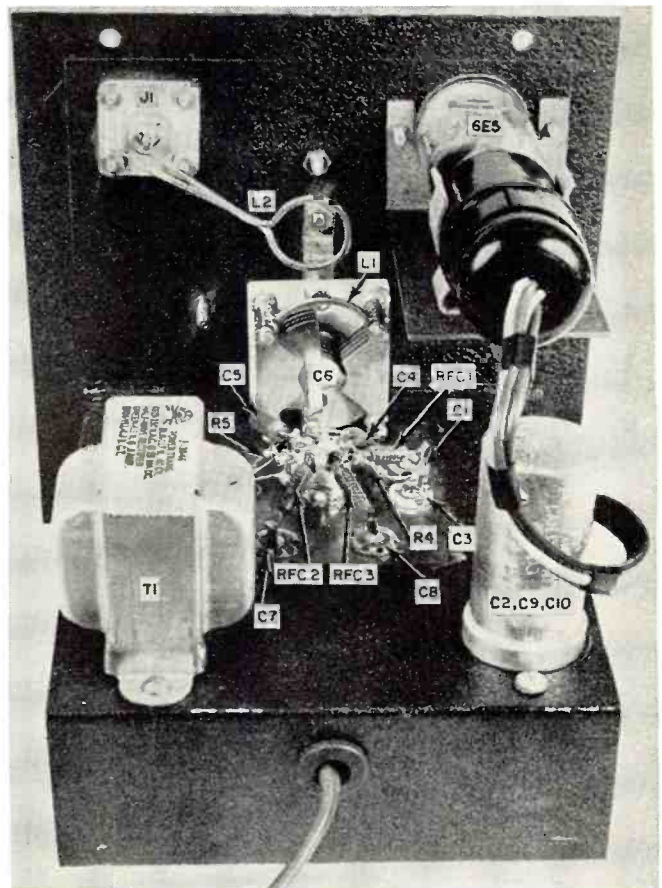
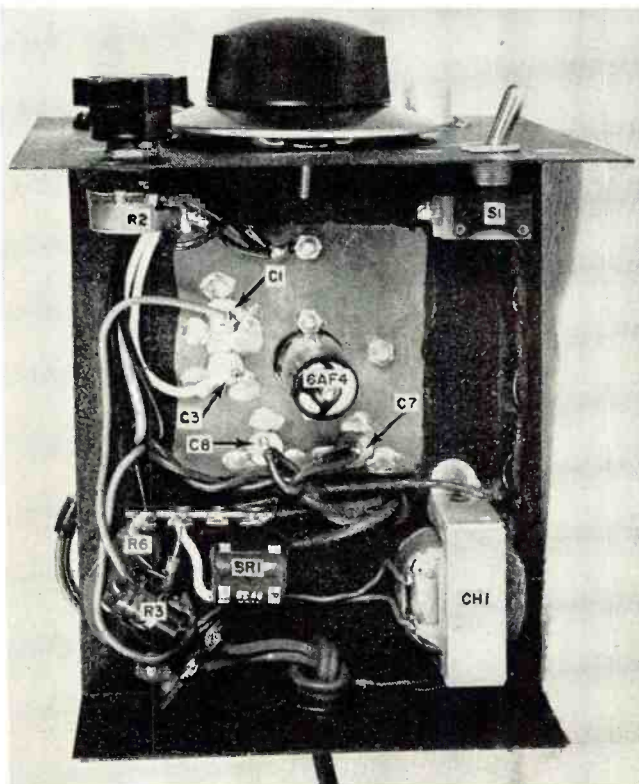

By **JOHN L. MacALLISTER**
Viking of Minneapolis

A Tape System You Can Build

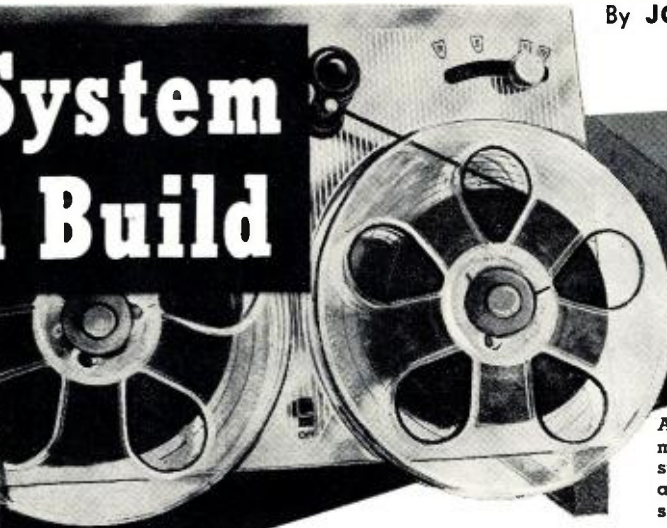
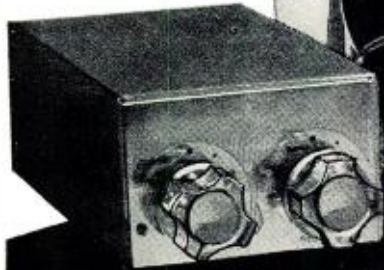

Any binaural or stereo setup must consist of a dual-channel system, including playback pre-amp, power amplifier, and loudspeaker, for each channel.

Stereophonic Operation

Part 4. Concluding article covers conversion of basic deck to permit recording and reproduction of stereophonic tape.

BASED on questions asked at various Audio Fairs and stereo sound demonstrations, any discussion of stereophonic sound should begin with a clarification of the terms "stereophonic sound" and "binaural sound," which are often used interchangeably. Actually, they represent slightly different recording techniques. Through common usage, however, one generic term "stereophonic sound," is rapidly becoming applicable to either.

Specifically, binaural recording applies to recordings wherein two microphones are spaced a distance equivalent to that separating the human ears, and separated by a disc or sphere roughly equivalent to the size of the human head. In many cases, coupling equivalent to the auditory coupling between the human ears is actually introduced between the microphones in an effort to obtain the truest binaural effect. A binaural system in this strict sense of the word is shown in Fig. 1A. As will be seen, the output of the left-hand and right-hand microphones is recorded on separate tracks, is played back in turn through separate amplifiers, and is listened to using independent earphones powered by the left-hand and right-hand amplifiers respectively. Thus, it is apparent that the left and right ears, respectively, will hear the program material with the exact time-relationship and balance with which it arrived at the microphones.

A binaural tape recorded in this manner can be played back over a dual-channel amplifier system, but using speakers spaced at some given distance instead of the earphones shown, and much of the same listening quality will be preserved. In other words, bin-

aurally recorded tapes are adaptable for use with stereophonic loudspeaker systems.

A complete stereophonic system is diagrammed in Fig. 1B. In stereophonic recording the microphones are spaced fairly far apart, the exact distance depending upon the size of the musical group being recorded and, to some extent, the hall acoustics and other factors. The audio channels are kept entirely separate as in binaural recording, and spaced speakers are used for playback. Here again, earphones can be used for playback without adversely affecting the program reproduction, although there is no valid reason for doing so since the recording process did not involve this discrete spacing.

Whether a given recording is binaural or stereophonic in origin makes little difference in the end result. Music so recorded and played back through separate high-quality music systems, takes on an auditory depth or spatial effect which lends amazing presence and realism. This is particularly true with respect to orchestral groups or symphonies having widely dispersed sound sources. It is evident even in the reproduction of single source instruments, such as piano and voice, because of the reflections which, to an extent, fortify the sound as we normally hear it in an auditorium or concert hall.

Both stereophonic and binaural sound are terms which, loosely used, have become somewhat interchangeable. For the sake of brevity, both recording modes will be grouped together and considered as "stereophonic" throughout this article.

Tape is ideally suited to the record-

ing and reproduction of stereophonic material. Present recording practice calls for the recording of two 90 mil tracks along either side of a standard $\frac{1}{4}$ " tape. In monaural recording, one of these tracks is recorded in either direction. In stereophonic recording these two tracks are recorded simultaneously.

Either binaural or stereophonically recorded tracks can be mixed by paralleling the two stereophonic pickup heads or the output of the preamplifiers, applying the mixed signals to a single amplifier and speaker. Played through a single music system, such a tape effectively becomes a monaural music source, in every way equivalent to a standard monaural recording.

Conversely, a monaural tape can be played through a stereophonic system using both amplifier channels, providing what can be considered as "pseudo-stereophonic" performance, but it will not provide any of the directional sense or depth which characterizes stereophonically recorded tape. The gain, such as it is, is merely the elimination of the single-point sound source.

"Staggered" and "Stacked" Modes

Stereophonic tape recordings are commonly available in either of two types of recording. Fig. 2B shows the head configuration used for so-called staggered recording. Here ordinary single record or playback heads are spaced exactly $1\frac{1}{4}$ " apart, one covering the upper half of a standard $\frac{1}{4}$ " tape, and the other the lower half of the same tape. It follows logically that if the same head arrangement and the exact spacing of heads is employed in playback as was used in recording the material, the two channels will be heard in their original balance and time relationship. With in-line heads, as shown in Fig. 2C, the same condition applies, except that the heads instead of being

separated by a finite spacing are located one above the other.

Champions of both the stacked and staggered modes of stereophonic recording and playback are not lacking. It is argued that slight differences in spacing between a given playback head assembly and that used in the original recording process will destroy the balance of the program material. Actually, the very slight difference encountered is roughly equivalent to that of moving three or four seats one way or the other in the concert hall. A perfectly valid objection to the staggered head style of recording is the fact that cut-and-splice editing of staggered tapes is almost impossible.

Stacked or, if you prefer, in-line heads, on the other hand, have one fundamental disadvantage. Because of the unavoidable close coupling between heads, the stacked head provides a very high degree of crosstalk, i.e., a signal voltage appearing at a given instant in either head, sets up a ghost image in the adjacent head. This is no disadvantage in stereophonic recording or playback since the program material in both heads is almost identical. It does, however, set up an immediate obstacle to use of either one of the stacked heads for monaural recording or playback.

The actual crosstalk ratio can be minimized with effective *Mumetal* shielding, but is a considerable factor in any case; usually on the order of 30 to 45 db signal ratio. Thus, in recording, the signal impressed on the desired channel would appear as an unwanted ghost track on the adjacent channel. Similarly, in using one head section for playback from a standard half-track dual recorded tape, the program material from the adjacent channel would appear in the output at a level approximately 30 to 45 db down from the desired material.

Because of this crosstalk characteristic inherent in stacked heads, it is

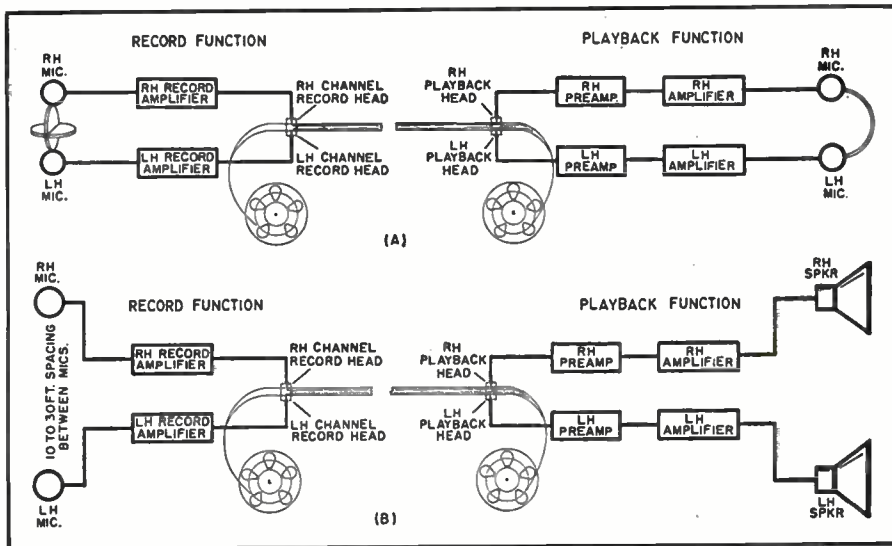

Fig. 1. Binaural (A) and stereophonic (B) systems of recording and playback.

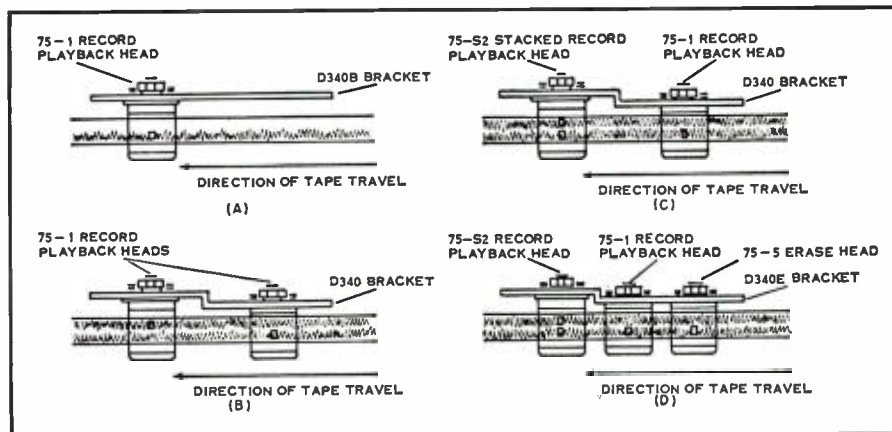
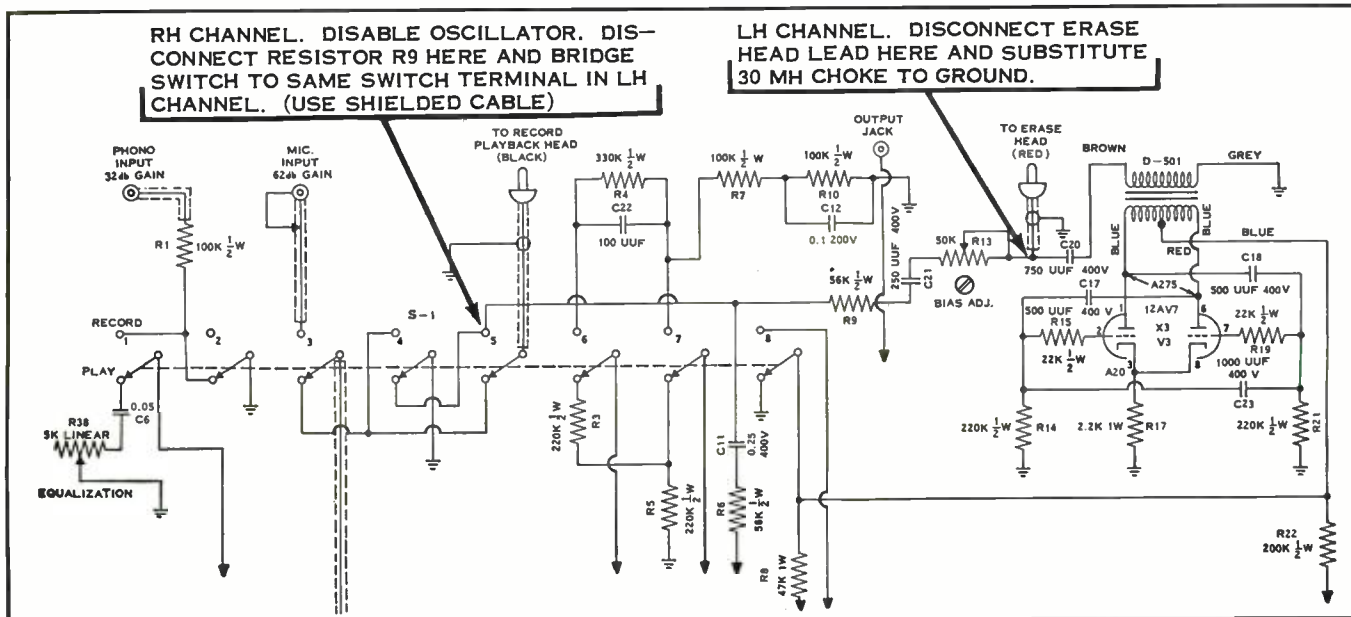

Fig. 2. Basic monaural head assembly and stereophonic derivations. See text.

normal practice to provide an additional single-track head for use with monaural tapes. In the *Viking* "universal" stereophonic head assembly this additional head is placed on the lower track and spaced at the standard stag-

gered head spacing of 1 1/4" as shown in Fig. 2C. Thus it serves not only for the recording and playback of monaural tapes, but for playback of staggered stereophonic tapes as well. Such (Continued on page 123)

Fig. 3. Partial schematic of record-playback preamp (described in April issue) showing circuit changes for stereo recording.



Transistor Intercom Amplifier

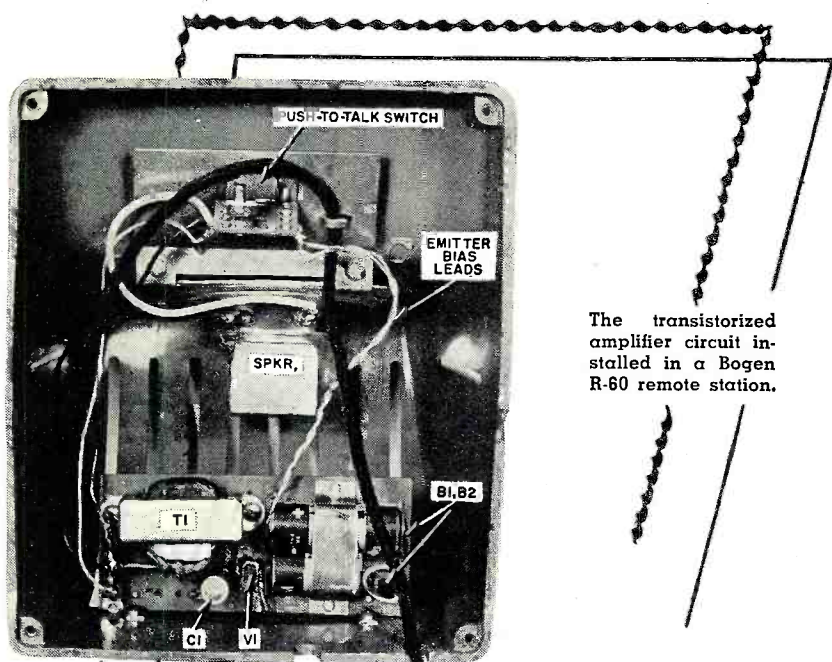

The transistorized amplifier circuit installed in a Bogen R-60 remote station.

Reduce noise and hum pickup on long intercom runs by adding an amplifier to each of the remote stations.

By EDWIN T. BOHR

Fig. 1. (A) Complete schematic of the simple transistorized amplifier circuit which can be added to any remote station. (B) Circuit installed in a Bogen R-60 intercom.

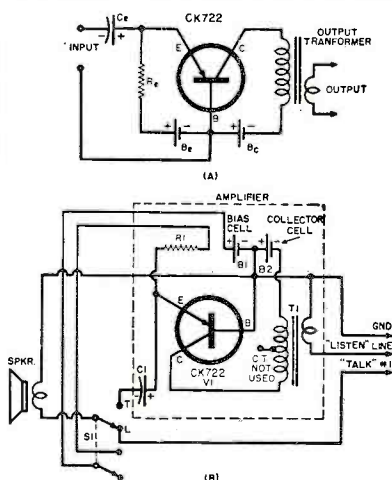

R_1 —3300 ohm, $\frac{1}{2}$ w. res.
 C_1 —50 μ d., 3 v. elec. capacitor
 S_1 —D.p.d.t. switch
 T_1 —Output trans., 25,000-ohm pri. to 4-ohm sec. (See text)
 B_1, B_2 —1.3 volt mercury cell (Mallory RM12R)
 V_1 —“p-n-p” junction transistor (Raytheon CK722)

REMOTE intercom stations feed a very low-level signal that must be amplified by the master. Even though the impedance is low, 50 ohms or less, there is still noise and hum pickup on long lines and particularly on runs through industrial and shop areas. Since the master is always in the listen position, this line pickup is continually amplified and over a period of time can become extremely annoying.

To solve the problem, we simply install a battery-powered transistor pre-amplifier in the remote, thus raising the signal fed to the line. This amplifier, mounted directly inside the remote, operates indefinitely from a built-in battery supply without external power connections or extra wiring. By indefinitely, we mean it should operate at least for two years from one set of two mercury cells. Furthermore, the battery supply assures a hum-free circuit. Certainly, this is a point that can not be overemphasized.

Circuit

The amplifier circuit is the essence of simplicity; more easily understood and constructed, in fact, than most vacuum-tube circuits. Because of its more favorable impedance match, the grounded-base transistor circuit is used rather than the grounded-emitter configuration.

Grounded-base stages have low input impedance, very high output im-

pedance, and a current gain of less than one, usually about .95. Unless coupling transformers or special circuits are used between stages, it is impossible to obtain gain from grounded-base junction transistors in cascade. Even with transformer coupling the gain is somewhat less than a grounded-emitter circuit.

The gain of the grounded-emitter circuit is higher, but if we calculate the outputs from grounded-emitter and grounded-base circuits when each is fed directly from a 4-ohm voice coil, we find the grounded-base circuit produces the larger output signal. This is true because the grounded-base circuit utilizes more of the sound power from the voice coil. To put it differently, the 75-ohm input impedance of the grounded-base circuit matches the voice coil impedance better than the 1000-ohm input impedance of the grounded-emitter circuit, therefore more than compensating for the lower gain.

There are other advantages in using the grounded-base circuit. First, inexpensive transistors are every bit as good in this circuit as the expensive high- α units. Use any p-n-p transistor that is available. Secondly, the circuit is almost independent of transistor temperature effects.

Transistor circuits are often suggested for the advanced constructor—well not this one! Anyone can construct it with no trouble at all if a moderate amount of care is exercised.

Stripped of all the gingerbread work, the basic circuit is shown in Fig. 1A. One cell, B_e , supplies the emitter bias voltage and the other cell, B_c , the collector voltage. The polarities are shown for a p-n-p transistor, for example, the CK722. Reverse both cell polarities for an n-p-n transistor.

The resistor, R_e , adjusts the emitter bias current to the desired value and keeps it relatively independent of the particular transistor plugged into the socket. For example, we wanted an emitter current of about .4 ma. for this particular circuit, so we considered the transistor emitter a short circuit and calculated what value of resistance, connected across a mercury cell, would give us this current.

An emitter current of .4 ma. is more than necessary to accommodate the signal swing. However, it was purposely made high, bringing down the input impedance of the amplifier. Since the current gain is almost unity, the drains on both the emitter and collector cells are about the same, hence they should expire at the same time.

Capacitor C_e blocks the emitter bias from the speaker. This capacitor must have a very high capacitance in order to couple any energy into the low impedance input. The amplifier low-fre-

(Continued on page 99)

Commercial Aspects of Single-Sideband

By
JACK N. BROWN
Engr., Barker & Williamson

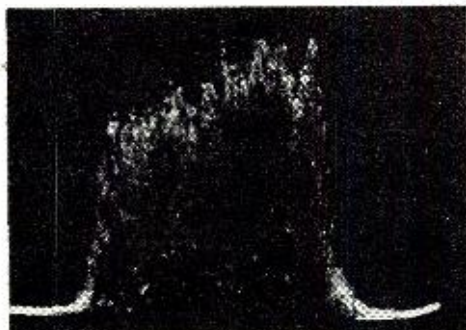
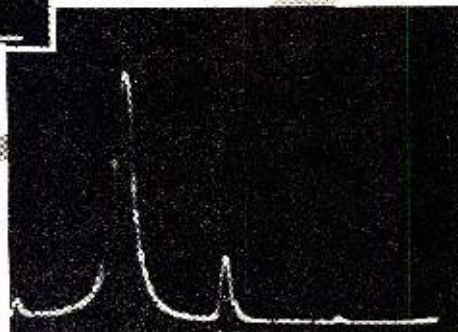
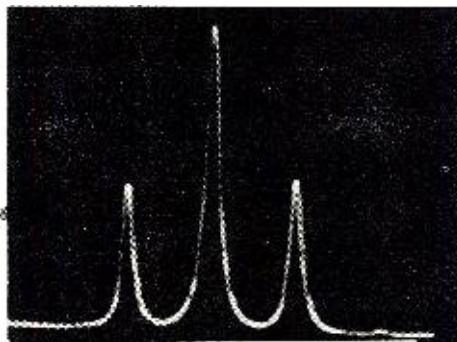

Actual scope screen photographs of the patterns shown diagrammatically in Figs. 3, 4, and 5.

Part 1. A three-part series — although directed to the commercial services who have or may go to SSB operation, most of the technical aspects of this series will also be of interest to radio amateurs.

IT IS becoming increasingly apparent that single-sideband is destined for more widespread use in the commercial services. In view of the recent FCC action in Docket 11513, it would appear that single-sideband will eventually become mandatory for all commercial services below 25 mc. The reason for the recent FCC action is, of course, spectrum conservation. There are other advantages to be gained by changing to single-sideband but these will be outlined later.

Historical Background

Single-sideband for radiotelephone has been in fairly common use since the mid-1920's. The first commercial application of this technique was a joint experiment by RCA and A. T. & T. on a circuit that spanned the Atlantic from New York to London. Prior to that time single-sideband had been used only on carrier-current telephone circuits for land-line service. It soon became apparent that the system offered decided advantages over the previously attempted double-sideband AM circuits. At that time the generation of single-sideband was a fairly complex matter and required some unusual techniques for the radio art at that stage of its development. From 1927 until World War II the only commercial use that was made of single-sideband was by *American Telephone & Telegraph Company* in its transoceanic commercial telephone service. There is considerable material in the literature^{1,2} justifying the use of single-sideband rather than double-sideband AM transmission.

With U. S. entry into World War II it became increasingly apparent to the military services that additional radio channels were required. The cooperation of A. T. & T. was enlisted in furnishing single-sideband circuits for radiotelephone as well as multi-channel radioteletype. The first circuits used by the military were leased from A. T. & T. but as the war progressed the military services themselves procured single-sideband equipment and trained teams of military personnel to operate it.

Today the bulk of military point-to-point communication is handled by single-sideband with as many as two channels of radiotelephone transmitted on one sideband and up to twelve teletype circuits handled on the other sideband. Thus a total of fourteen communication circuits is available between two given points from a single transmitter. The economy of such a method is evident and the actual operational success of this technique is daily becoming more apparent. Since World War II the military services have continued their expansion of single-sideband circuits.

The major growth in single-sideband activity has, of course, been among the radio amateurs of this country. Circuit developments since World War II indicate that a single-sideband signal can be generated with simpler equipment than heretofore thought possible. The principal drawback to single-sideband prior to World War II was the difficulty in maintaining the frequency stability required for such a system. Recent technical

developments leading to improved oscillator stability, the availability of better and higher frequency filters, wide-band audio and radio-frequency phase-shift networks, and newer tubes make single-sideband generation and transmission more practical. It is the intent of the author to outline for the prospective commercial user of single-sideband just what the system has to offer, its advantages and disadvantages, and the economics of changing from an existing AM system to a SSB system.

Nature of Single-Sideband

To understand single-sideband it is desirable to start with something known, *i.e.*, an amplitude-modulated, double-sideband signal. One step still further toward the elementary would be to consider an unkeyed c.w. carrier at the input of the receiver. This unkeyed, unmodulated c.w. signal occupies no bandwidth whatever. It can be visualized as an infinitely thin line drawn at a specific frequency where a plot of frequency along a horizontal axis is one dimension and the height of the carrier is merely a measure of its amplitude. See Fig. 1. If anything at all is done to the c.w. carrier, *e.g.*, if it is interrupted at some finite keying rate, modulated with either AM, FM, or phase modulation, there are other radio-frequency components present besides that of the carrier itself. If an oscilloscope is connected to the output of the transmitter, the pattern shown in Fig. 2 would be seen for a single frequency fed into audio stages of the transmitter.

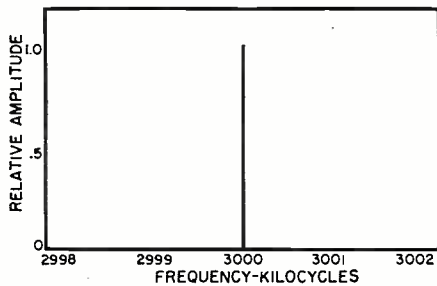

Fig. 1. A spectrum representation of a continuously keyed (3000 kc.) unmodulated carrier. Note that there are no extra sidebands present and the carrier "width" is infinitely thin. See discussion in text.

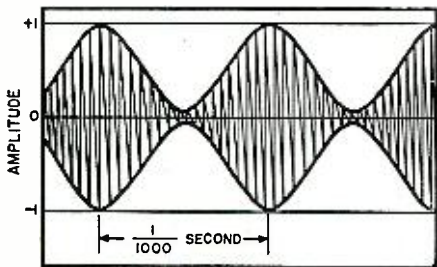

Fig. 2. Sketch of an oscilloscope trace made by a 100% modulated AM transmitter when modulated by a tone of 1000 cps.

It should be noted that 100% modulation occurs when the negative peaks of modulation meet at the center line of the pattern. If we were to look at the signal on a spectrum analysis basis as was just done with the c.w. carrier we would see the following: The carrier would be present at its original frequency; however, there would be two other radio frequency signals present at the output of the transmitter which are directly dependent upon the audio modulation frequency fed into the transmitter. If the audio frequency fed into the transmitter is 1000 cps, the two additional signals present at the transmitter output would be exactly 1000 cycles above and below that of the carrier frequency. If the audio modulation frequency is changed from 1000 cycles to 3000 cycles, the two sideband signals would move from 1000 cycles either side of the carrier frequency to 3000 cycles either side of the carrier frequency. Similarly, if the audio frequency is changed to 300 cycles, the sideband signals would move closer in frequency to that of the carrier, i.e., to within 300 cycles of the carrier. Thus it can be seen that for each single audio frequency fed into the microphone of an amplitude-modulated transmitter there are two sideband signals present at the output of the transmitter, each carrying the exact same intelligence, namely, that of the distance by which it is separated from the carrier signal and its relative amplitude.

When the signal appears at the second detector of the communication receiver the carrier frequency is heterodyned with the two sideband signals. The two separate, but identical, audio signals are recovered and combined in the audio system of the receiver.

These two signals add in-phase to

produce intelligible audio at the receiver loudspeaker terminals. Fig. 3 shows the AM signal as obtained from a *Panoramic Radio Products, Inc.*, spectrum analyzer, Model SB-8A. This shows the two sideband signals 1000 cycles either side of the carrier. It will be noted that the carrier voltage is two times greater than that of each individual sideband signal if the vertical scale is a linear plot of voltage. Thus it can be seen that for a 100-watt AM transmitter the maximum power that can be realized in either sideband is 25 watts peak. This nets an effective 50 watts peak power when the two sidebands are recovered at the receiver. The carrier, meanwhile, has been transmitted along with the two sideband signals and has accomplished only one thing, that is, demodulating or heterodyning the sideband intelligence back into the audio-frequency range. The carrier itself has contributed nothing to the actual intelligence transmitted. It has neither "carried" nor enhanced the intelligence transmitted in any way. Thus for an average power of 100 watts and an intermittent power of 150 watts being transmitted by our hypothetical AM transmitter we have, at the distant receiving station, a signal attributed to only 50 watts of the actual transmitted power. This would not appear to be the most economical means of transmission.

The Single-Sideband Case

If we take the AM signal, just discussed, and perform a couple of basic operations to produce a single-sideband suppressed-carrier signal we must then examine just what we have accomplished power- and economy-wise.

The first, and incidentally the easiest, operation to perform on the AM signal is to get rid of the carrier. This is accomplished most simply by using a balanced modulator in one of the early radio-frequency stages of the transmitter so that sidebands are still produced but no carrier is present. One point that must be made at this time to clear up what seems to be one of the most difficult things to grasp about single-sideband is that for a single-sideband suppressed-carrier signal there is no carrier under any conditions of modulation, that is, when speech is impressed upon the single-sideband transmitter the carrier itself does not appear. The r.f. energy appearing at the transmitter output is *not* carrier, but is sideband energy. The second, and far more difficult, operation that must be performed on our double-sideband signal is that of eliminating one of the two sidebands present in the transmitter output.

The two systems that are currently available for performing this sideband suppression or cancellation will be discussed in Part 2 of this series. Let it be assumed that one of the sidebands is suppressed. We then have a signal with a *suppressed carrier frequency* identical to that of our former AM

signal but one whose sideband frequencies, derived from the originating audio frequencies, lie to only one side of the carrier frequency. If a *lower* sideband signal is being generated, the sideband signal representing a 1000 cycle audio tone would lie exactly 1000 cycles *lower* in frequency than the suppressed-carrier reference frequency of the transmitter.

This is illustrated in Fig. 4. This pattern was taken from a spectrum analyzer where the right hand "pip" is the suppressed carrier, the largest "pip" just to the carrier's left is the *lower* sideband signal and the small signal to the extreme left is the second harmonic of the 1000 cps audio tone fed into the SSB transmitter. Note that the vertical scale is logarithmic and reads directly in db. If a complex audio waveform, such as that represented by the human voice, is fed into the transmitter, there will be many frequencies present at the transmitter output, each of which represents its corresponding audio-frequency input. For the typical male voice the maximum energy is concentrated in the lower audio frequencies, below 800 cycles, with a decreasing amount of energy in the higher audio frequencies up to approximately 3000 or 4000 cps. Such a signal is shown in Fig. 5. This spectrum analysis was made on an actual single-sideband transmitter and shows that all the intelligence lies to one side of the carrier frequency. It would appear that we have successfully confined the intelligence transmitted by the radiotelephone transmitter to a spectrum which is one-half that used by the previously considered double-sideband transmitter.

Receiving the Signal

Receiving SSB signals is not as simple as receiving AM signals. Since the single-sideband signal no longer has a carrier against which the sideband signals can be heterodyned in the receiver, the receiving station has the problem of furnishing an artificial carrier. The most rigid requirement that the artificial carrier must meet is that of frequency stability. The artificial carrier, whether furnished by the beat-frequency oscillator or some other detection system to be considered later, must be within very close frequency limits of the original transmitted suppressed carrier. Many commercial single-sideband transmitters transmit a residual (not totally suppressed) carrier signal so the detection of the proper carrier re-insertion frequency may be accomplished or so that automatic frequency control equipment may be used. If the artificially furnished carrier in the receiving system is within approximately 50 cps of the transmitted carrier frequency, the voice frequencies received will retain all of the natural sound and, in most cases, will be recognizable as that of the transmitting operator. For frequency deviations greater than 50 cps, an error in the frequency relationship of the audio frequencies in

the demodulated signal will be present. The farther away the artificial carrier is from the transmitted sideband signal the higher the voice of the transmitting operator will seem. If the carrier is too close to the sideband signal the recovered audio speech will appear to be very guttural and muffled and, in some cases, completely unintelligible. Thus the first stringent limit is placed upon the single-sideband equipment to be considered. A tuning tolerance of ± 50 cycles must not be exceeded. If this tolerance is divided evenly between transmitting and receiving facilities it means that the transmitter and receiver must not drift from their assigned frequencies by more than ± 25 cycles.

This imposes strict limitations on any single-sideband equipment if manual tuning is prohibited at the receiving equipment. Translated into more usual terms, a 25 cycle frequency tolerance is considerably more stringent than the .01% frequency tolerance permitted under present FCC regulations. The current FCC tolerance limit represents one part in 10^4 frequency deviation, while the 25 cps deviation for a single-sideband system represents a frequency tolerance at 10 mc., for example, of 2.5 parts in 10^6 . This is almost two orders of magnitude greater. This might at first appear to be unattainable with present-day equipment; however, crystal oscillators, when used with ovens, can provide frequency stability of one part in 10^6 . As can be seen with a fixed frequency tolerance of ± 25 cycles, the higher the frequency of operation the more rigid becomes the percentage deviation that must be met. Twenty-five cycles deviation at 2.5 mc., therefore, is equivalent to a deviation of one part in 10^5 frequency stability.

System Gains

If we again consider the power distribution of sideband and carrier of Figs. 2 and 3 versus that of Figs. 4 and 5 for the single-sideband case it can be seen that considerable economy of power can be effected by first eliminating the carrier from the transmitted signal and then by eliminating one sideband. The power capabilities can then be used to transmit a higher powered sideband signal in a decreased portion of the spectrum. This amounts to nothing more than literally "putting all our eggs in one basket."

The exact decibel advantage a single-sideband system has over a comparable AM system has been discussed and evaluated in many different ways. It can be stated, however, that the advantage of single-sideband over AM will vary with operating conditions, that is, with signal-to-noise ratio. When the AM and single-sideband signals being compared are well above interference and local noise levels the advantage of single-sideband over AM will generally be in the neighborhood of 3 db. As conditions become progressively worse, however, the advantage of single-sideband over its AM

counterpart becomes increasingly great. Some experimenters report that in extreme circumstances where the signal-to-noise ratio is very poor, system gains of up to 16 db have been observed under actual operating conditions. A generally accepted figure for normal operating conditions with a moderate signal-to-noise ratio is between 6 and 9 db improvement over an equivalent AM transmitter. This discussion, of course, assumes that narrow band single-sideband receivers are used at the receiving locations.

If the maximum benefits of a single-sideband system are to be derived, the receivers used in this system must have a bandwidth equal to that of the transmitted signal. If a 3 kc. audio spectrum is transmitted at the single-sideband transmitter, the single-sideband receiver must be capable of receiving a 3 kc. bandwidth to the exclusion of all other frequencies. This means that some sort of intermediate frequency filtering must be used to produce a selectivity characteristic which will sharply discriminate against adjacent channel interfering signals and successfully pass all of the sideband components that the desired signal is transmitting.

Economic Considerations

One of the important points to a prospective user of single-sideband would be the initial cost of such a system and whether or not it would be possible to salvage any of the existing AM equipment. First let's consider the installation of completely new single-sideband equipment versus the cost of currently obtainable AM equipment. Fig. 6 shows an estimated relationship between the cost of new single-sideband equipment and new AM equipment of current design for various output powers between 50 watts and 5 kilowatts. The power comparison between the two systems is such that the carrier power of the AM transmitter is equal to the peak envelope power output of the single-sideband transmitter. This appears to be a fair comparison and the only logical one that can be made in view of power measurement methods with single-sideband signals. As can be seen in Fig. 6, for transmitters with less

than 100 watts output the initial cost of a single-sideband transmitter is greater than its AM counterpart. At the 50-watt level it is estimated that the cost of a single-sideband transmitter would be approximately twice that of the 50-watt AM transmitter. At the 100-watt level, however, the cost would just about equal that of the AM transmitter. At the 1-kw. level the best estimates indicate that the AM transmitter would cost almost twice as much as a single-sideband transmitter. As the power rating increases the difference in AM and SSB equipment costs becomes greater. This curve can best be explained by the fact that a certain minimum amount

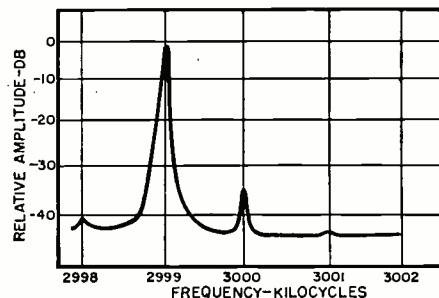
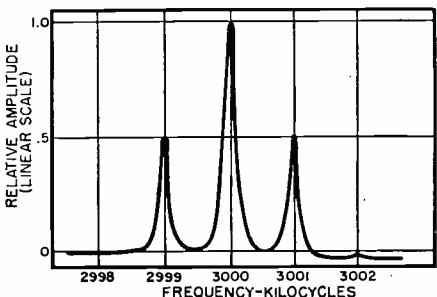

Fig. 4. Chart showing lower sideband, suppressed carrier generation. The carrier is at 3000 kc., the lower sideband of a 1000 cps tone is at 2999 kc. with the 1% audio distortion second harmonic appearing at 2998. The residual upper sideband appears at 3001 kc. at a level of -45 decibels.

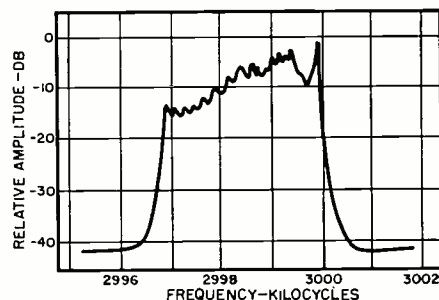

Fig. 5. Chart showing envelope of a single sideband signal transmitting a sustained vowel sound. The suppressed carrier is at 3000 kc., the lower sideband extends lower in frequency to approximately 2997 kc. Note that the maximum energy of a male voice is in the lower audio frequencies which are nearest the carrier. See text.

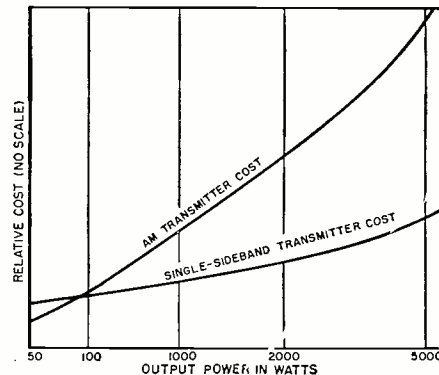
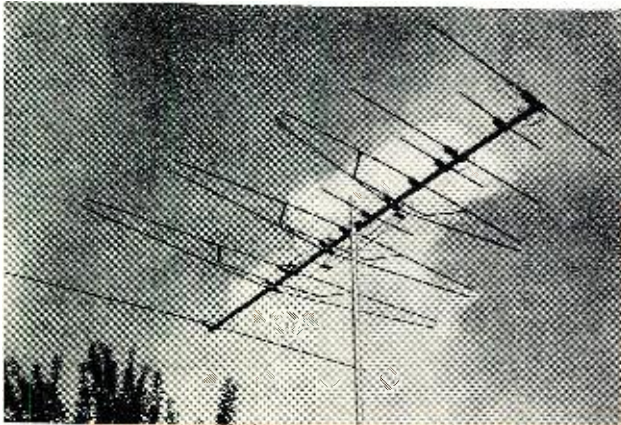

Fig. 6. Plot of estimated cost of AM and SSB transmitters versus the output power. (AM carrier = peak envelope power of SSB.)

than 100 watts output the initial cost of a single-sideband transmitter is greater than its AM counterpart. At the 50-watt level it is estimated that the cost of a single-sideband transmitter would be approximately twice that of the 50-watt AM transmitter. At the 100-watt level, however, the cost would just about equal that of the AM transmitter. At the 1-kw. level the best estimates indicate that the AM transmitter would cost almost twice as much as a single-sideband transmitter. As the power rating increases the difference in AM and SSB equipment costs becomes greater. This curve can best be explained by the fact that a certain minimum amount

(Continued on page 112)

New TV Antenna Roundup



By **WALTER H. BUCHSBAUM**
Television Consultant
RADIO & TELEVISION NEWS

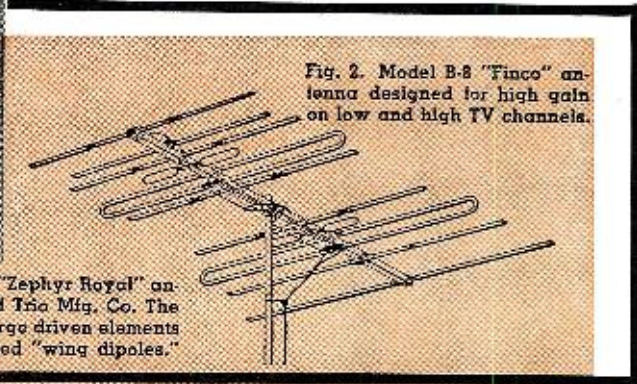

Fig. 2. Model B-8 "Finco" antenna designed for high gain on low and high TV channels.

Fig. 1. "Zephyr Royal" antenna of Trio Mfg. Co. The three large driven elements are called "wing dipoles."

Review of the new design trends in TV antennas with helpful hints on how to choose one for fringe areas.

THE present TV station allocation pattern has produced many areas where reception is quite problematical and where the antenna installation makes the difference between usable pictures and no reception at all. Such conditions place a special responsibility on the service technician since the choice of antenna is entirely in his hands.

It is important to appreciate the various considerations which govern the choice of antenna. The major reception considerations are listed below:

1. Single-channel reception. Signal strength is the major criterion here. Is the signal weak, extremely weak, or does it suffer from reflection?

2. Multi-channel reception from one direction. Again the signal strength is important, particularly for the weakest station. Is it possible to use a single antenna, broadband probably, for all channels? Are several antennas required? How should they be stacked? How connected?

3. Multi-channel reception from different directions. This may require a number of antennas oriented individually, or else a rotator may be used.

4. Color TV. Bandwidth and freedom from reflections are vitally important for color reception. Other criteria may include good impedance match and optimum gain.

The antenna's radiation pattern, which indicates its directivity, lobe width, and immunity to certain types of interference, may be important in some locations. Narrow-beam antennas

often have insufficient bandwidth for color reception and their impedance matching ability is sometimes very poor.

All of the preceding factors may enter into the considerations leading to the selection of a particular antenna type. Unfortunately, the highly competitive antenna manufacturing industry is given to strong claims and often confusing technical descriptions. Tradenames are sometimes mistaken for actual type names. This is especially true where some of the characteristics of a standard antenna type are modified by the addition of portions of some other antenna type. The basic antennas used for commercial TV reception at the present are still the dipole, folded dipole, conical or "V" type, and yagi.

Many variations of these basic antennas appear as modified element shape and combinations of two or more different types or of the same type, cut to different wavelengths. These modifications are designed to alter some particular reception characteristic. For example, intermixing of different wavelengths of yagi ele-

ments results in a broader bandwidth. The addition of phase reversing networks to the elements may improve the impedance match at higher channels, etc. Modifications and their effects are discussed at greater length later in this article.

Antenna Characteristics

Before deciding on a particular antenna type the various antenna reception characteristics should be clearly understood and considered carefully. The standard definitions and measurement units are as follows:

Gain. This is invariably expressed as the apparent or relative power of an antenna as compared to the power delivered by a simple dipole. In other words, 3 db power gain for a certain antenna type means that this antenna will pick up twice as much r.f. power as a simple dipole would in its place. It is always assumed that both the dipole and the other type are tuned to the same frequency, have perfect impedance match, and work into the correct receiver input impedance.

Bandwidth. This represents the frequency response of an antenna and is usually stated in terms of megacycles between the 3 db or half-power points. For satisfactory color TV reception the antenna should have less than 1 db loss over the entire 6-mc. channel being received. Again, the bandwidth figure is valid only if proper impedance match exists at both the antenna and receiver.

Characteristic impedance. This is the impedance value with which the antenna should be terminated to effect maximum power transfer. In the case of a simple dipole, the impedance at the center is at the minimum. As the spacing between the feedpoints is in-

Fig. 3. Current distribution along a half-wave dipole antenna. Different output impedances exist along the antenna, as shown.

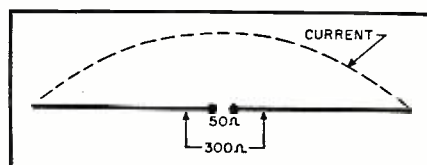

creased, the impedance also increases as shown in Fig. 3. This is analogous to tapping down a tuned inductance.

The impedance of the antenna is affected, among other things, by the action of reflecting, directing, and other elements near the driven element. Stacking or paralleling reduces the impedance as does the addition of other elements.

Directivity. This characteristic describes the antenna signal sensitivity from different directions. A simple dipole has a horizontal directivity pattern that can be described as two circles, one on each side of the antenna. When a reflector is added, the reception from the rear is greatly reduced, as shown in Fig. 5. The arrangement of various directors and reflectors commonly used in yagi and similar types of antennas serves not only to reduce reception from the rear, but also narrows the beam greatly. This reduces reception of unwanted multipath signals which may cause ghosts.

The ideal antenna for most applications would have great apparent gain, flat response across the full TV band, and an extremely narrow directivity pattern coupled with exact 300-ohm impedance which would be constant for all TV channels. However, each of these characteristics depends on the other. An antenna designed to give high gain usually also has, as a result, narrow bandwidth. Good directivity reduces bandwidth as well as characteristic impedance. Most commercially available antennas represent the optimum combination of these features, arranged to serve particular conditions rather than to be useful in all applications.

Something needs to be said about stacking antennas and about the value of antenna height in increasing gain. The signal increase obtained by stacking two equal antennas is always less than double. In other words, if a certain antenna in a given location delivers 10 microwatts to the receiver, stacking a second one above it will not result in 20 microwatts. As a matter of fact, the addition of more and more antennas to an array results in a progressively smaller increase. Stacking of antennas is advised only in deep fringe areas and only with the proper stacking-bar arrangement. Stacking bars are tuned elements which assure proper phasing at the resonant frequency.

Height is another factor which is often overrated. Once the antenna is raised beyond obstructing structures, additional height may not substantially increase the signal strength. It is hardly possible, in areas where the curvature of the earth limits reception, to raise antenna structures the hundreds of feet required to overcome this type of obstacle. Locating the antenna on natural elevations like hills, etc., and using antenna masts which clear obstructing buildings or low ridges will, of course, improve reception. But once the obstacle is

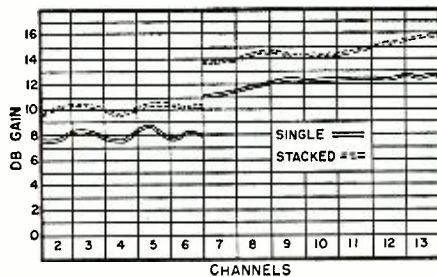

Fig. 4. Frequency response curves for a single bay and for two bays stacked. (Winegard Co. "Interceptor" Model L-4)

cleared, further height does not usually result in increased signal strength.

Typical Fringe Antennas

The various TV antennas shown here are typical of the newer commercially available units for fringe area application. There are many other popular and accepted models on the market; however, those shown are sufficient to indicate the recent trends in antenna design.

An example of a broadband fringe area antenna is the "Zephyr Royal" (Trio Mfg. Co.) shown in Fig. 1. Its idealized frequency response as submitted by the manufacturer, is shown in Fig. 6. This antenna uses "wing dipoles" tuned to different frequencies in combination with directors and a single reflector. Each of the "wing dipoles" is $3/2$ -wavelengths long at a particular high-channel frequency, combining the effect of $1/2$ -wavelength folded dipoles at the low channels with three-element antennas at the high channels. One of the "wing dipoles" is about 9 feet long, which is $1/2$ wavelength at channel 2. At the same time, this is approximately $3/2$ wavelengths for channel 7. The other two "wing dipoles" are similarly cut for channels 4 and 10, and 6 and 13.

Uniform bandwidth and good gain recommend this antenna for weak signal areas where several high- and low-band TV stations are received from the same direction. This antenna can be used with a rotator to receive stations from different directions. The addition of reflector and directors also

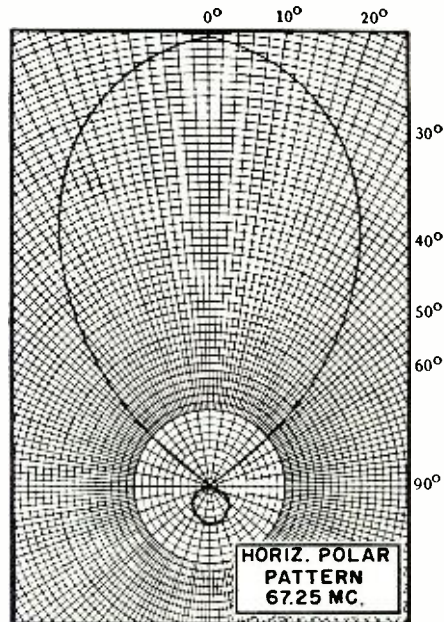

Fig. 5. Horizontal polar pattern of a particular antenna showing a strong front lobe, or area of reception, and a relatively weak one from behind the antenna.

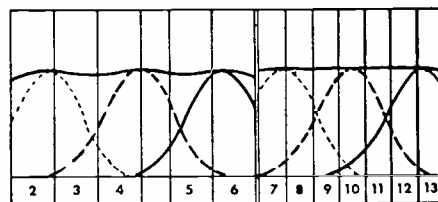

Fig. 6. Response curve of the Trio "Zephyr Royal" antenna. Each "wing dipole" is tuned to one low- and one high-band channel. All curves combine to give a flat response.

gives a high front-to-back ratio and a fairly narrow beam.

Another instance of a broadband antenna is the "Interceptor" Model L-4 (Winegard Co.) featuring a host of dipole elements of different lengths. Basically, the stagger-tuned principle and the use of $3/2$ wavelengths for the high channels is also employed here. The manufacturer's relative gain figures for this antenna in single bay and stacked versions are shown in Fig. 4.

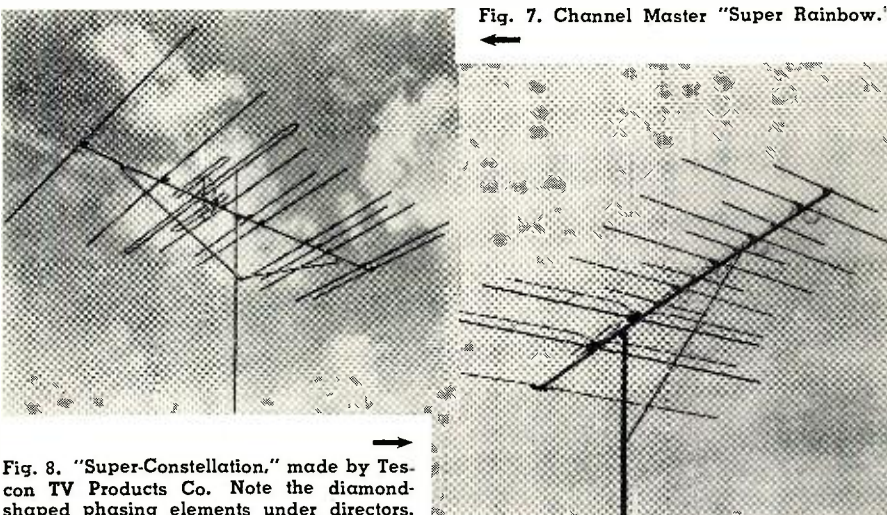

Fig. 8. "Super-Constellation," made by Tescon TV Products Co. Note the diamond-shaped phasing elements under directors.

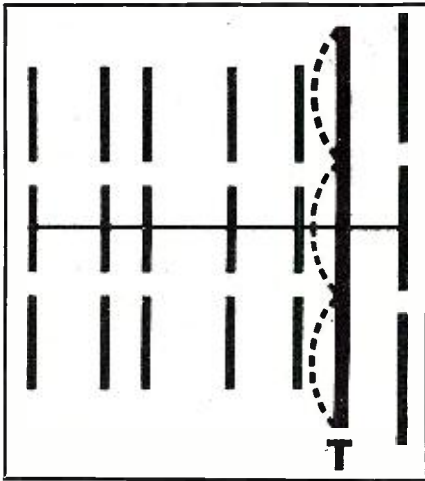

Fig. 9. On the high v.h.f. band, the Channel Master "Super Rainbow" antenna behaves like three yagis, as shown here.

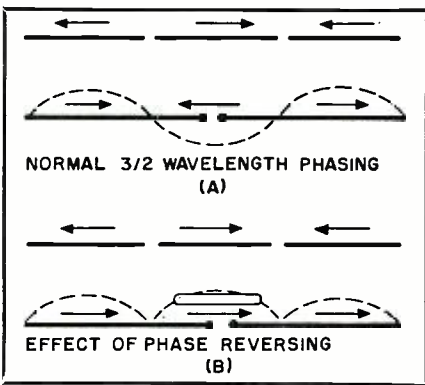

Fig. 10. Action of a phase reversing element on the high v.h.f. band when operating with a $3/2$ -wavelengths element. The antenna without the phase reverser is shown in (A), with phase reverser in (B).

The "Finco" Model B-8 (*Finney Co.*) shown in Fig. 2, combines two folded dipoles which are "tripoles" at the high channels, with an array of parasitic elements designed to provide maximum directivity while maintaining the gain inherent in folded-dipole yagis. The outstanding feature of this antenna is its very sharp beam and high front-to-back ratio. Bandwidth and gain appear sufficient for most fringe areas.

A variation of the in-line combinations previously shown is the "Super Rainbow" (*Channel Master Corp.*), illustrated in Fig. 7. This antenna is admittedly a yagi type cut basically for the low channels. At the high channels, the two smaller folded dipoles add their gain to that of the larger dipole. To get optimum operation at the high band there are separate directors and reflectors which consist of three elements side-by-side. These high-band reflectors and directors are interspersed with the low-band elements for minimum interference on either band. Fig. 9 shows the effect of this arrangement as three high-band yagis operating side-by-side. A very narrow beam results from this arrangement. The bandwidth of this antenna is good enough for color TV, but its main feature is the narrow beam on the high channels.

Still another of the broadband antennas supplied with parasitic elements for high and low frequencies is the "Super Constellation" (*Tescon TV Prod. Co.*) shown in Fig. 8. The directors tuned to the low band have a special diamond-shaped phasing element to make them effective as $3/2$ -wavelength elements on the higher channels.

Other means for obtaining broadband coverage and fairly high gain are used for the antennas in Figs. 11 and 12. The model 3D of *Fretco, Inc.*, makes use of different-diameter elements to obtain maximum bandwidth and uniform impedance match on high and low channels. Its beam width at the low channels is much wider than at the high end. The antenna shown in Fig. 12 uses phase reversal to assure good gain at $3/2$ -wavelengths reception. The operation of this phase-reversing element on the "Wizard" antenna (*Walsco Electronics Co.*) can be understood by referring to Fig. 10, which shows the effect of phase reversal at the center of the $3/2$ -wave antenna.

The various broadband, high-gain, and sharp-beam antennas currently on the market are designed primarily for weak-signal areas where a number of high and low channels are received. Basically each of these antennas is a broadband yagi type with special parasitic elements added to obtain more gain at the high channels.

When the manufacturer's gain figures are inspected, their actual meaning must be carefully considered. A 6 db voltage gain relative to a simple dipole is equivalent to a 3 db power gain, and merely means that twice as much signal is received—not six times as much. When the literature states that a certain antenna is equivalent to three 10-element yagis, this does not mean that its gain is three times that of a 10-element yagi, but that it can be expected to perform somewhat better than a single yagi antenna.

The difference between a 5- or 10-element yagi is not very great in db relative gain; however, beam width is affected greatly by the addition of elements. Where reflected signals or other interference signals arrive at an angle from the main signal, the directivity of an antenna may be more important than its gain and in such an instance a large number of elements in a yagi antenna are genuinely useful.

While some yagis cut to a single channel might not be broadband enough for color TV, many, like the *RCA* five-element yagi shown in Fig. 13, are designed to provide maximum gain and directivity on a single channel as well as at least a 6 mc. wide flat bandwidth.

A rather new antenna system that should be particularly useful where strong reflections or interference signals are encountered is shown in Fig. 14. Each individual antenna is a partial exponential conical and can be used that way. When ghosts or other interference patterns are encountered, the use of the complete "Expo-I.R.I.S." antenna system consisting of two antennas, a rotator, and a special stacking harness, is suggested by the manufacturer, *Holloway Electronics Corp.* This antenna system is designed to reject interference from almost any desired angle.

In operation, one antenna is fixed
(Continued on page 156)

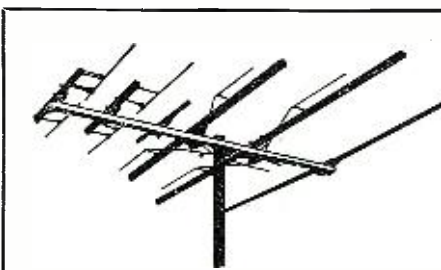

Fig. 11. Fretco model 3D, using different-diameter elements for a wide band.

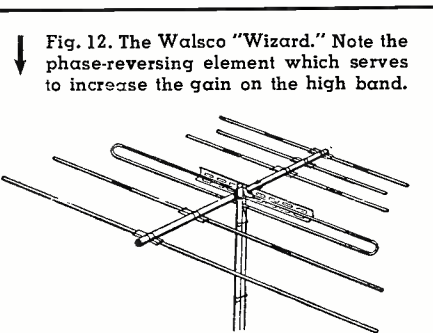

Fig. 12. The Walsco "Wizard." Note the phase-reversing element which serves to increase the gain on the high band.

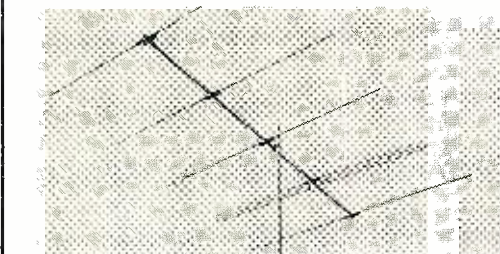
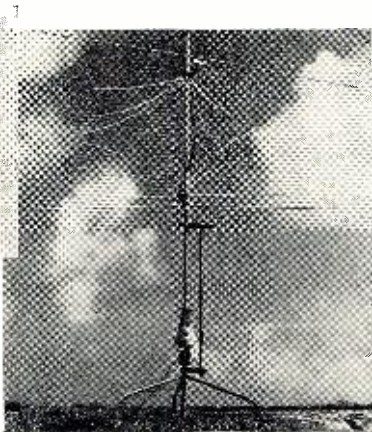

Fig. 13. RCA 5-element single-channel yagi.

Fig. 14. Holloway Electronics Corp. "Expo-I.R.I.S." antenna system. The lower antenna is fixed in direction while the upper one is mounted on a rotator and oriented for maximum interference rejection.



Transistorized

By L. FLEMING

THE r.f. capacitance meter is a handy and accurate instrument for measuring small capacitances. It supplements the more common bridges and meters by yielding good clear readings down to as low as $1 \mu\text{fd}$. The meter described here has two ranges: 0-80 μfd . and 0-1000 μfd ., like the commercial version which was announced by *General Radio* in 1948¹.

The "active" part of the circuit, a fixed-frequency r.f. oscillator, is easily transistorized. Only one transistor is required; the commercial instrument uses only one tube, a 117L7. The transistor used in the author's model is a 2N107, made by General Electric and lists at about \$1.25. Any type having a rated *alpha* cut-off frequency greater than about 600 kc. should be satisfactory.

Capacitance meters, like most bridges, are devices that are used on an occasional or "spot" basis, rather than being left on for long periods. In such cases transistor operation is a real convenience because the usual waiting for warm-up is entirely eliminated. Battery drain, about 1.5 milliamperes, is so small that with ordinary occasional use the batteries should last over a year.

Basic Circuit

Fig. 1 is a simplified schematic of an r.f. capacitance meter. The idea is simply to connect the unknown capacitance so that it detunes a tuned circuit, then find out how much of a known capacitance must be removed to get the circuit back into its original resonance.

A fixed-frequency r.f. oscillator is loosely coupled, by means of a link, to a tuned LC circuit across which the unknown is connected. A pickup coil coupled to coil *L* is connected to a crystal diode and a microammeter, to indicate when the tuned LC circuit is in resonance with the oscillator.

Tuning capacitor *C* is calibrated backwards. Normal resonance, with nothing connected across the "unknown" terminals, is with tuning capacitor *C* at maximum capacitance. The dial at this point is marked "0". If, say, 10 μfd . is connected to the "unknown" posts, we will have to reduce the tuning capacitor *C* by 10 μfd . in order to get resonance again. So the dial is marked "10" where the tuning capacitance is 10 μfd . down from maximum, and so on.

With ordinary tuning capacitors, this type of application produces dial scales that are crowded at the wrong end. The circuit, however, can be and

Over-all view of the transistorized r.f. capacitance meter. Meter and dial scale sizes preclude miniaturization of unit.

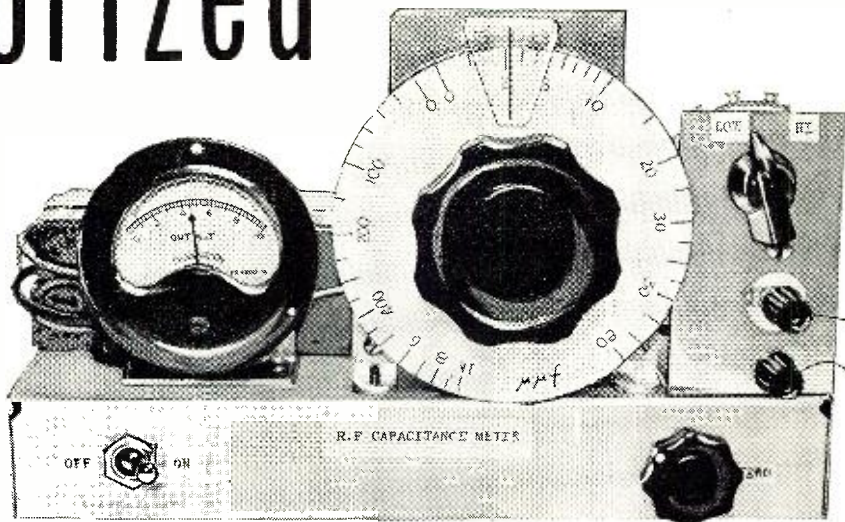

R.F. Capacitance Meter

Construction details on a versatile unit which measures capacitance from 1 to 1000 μfd . in two separate ranges.

is designed to get around this and produce a scale law that is approximately logarithmic without using a special capacitor. More about this later.

Application

The first 2 μfd . on the "low" capacitance scale covers about $\frac{3}{4}$ inch of scale length, and the first 10 μfd . some 2 inches around the 4-inch diameter dial. Capacitances to ground of tubes, sockets, binding posts, and wiring are very readily measurable. Nestling in the bottom of many a junk-box is a collection of small mica and ceramic capacitors, unmarked or bearing the mysterious spots of non-standard color codes. Identification with the capacitance meter takes less time than does the necessary marking, with ice pick or India ink.

As equipment becomes smaller and frequencies go higher, the trend toward

slug-tuned coils and fixed capacitors continues. Many coils in FM, TV, and other v.h.f. and u.h.f. service use only the tube and stray circuit capacitance for tuning. Experimentation and design in this field is made much easier if these stray capacitances can be measured. The procedure is the same as for capacitors—connect to the "X" terminals and twirl the dial until the microammeter reads a maximum—but some care is necessary with the connecting leads. The ground lead to the capacitance meter post can be any old piece of wire or clip lead. Flexible test-lead wire is, however, too big and limp and full of its own capacitance to ground to use for the "hot" side. If measuring, say the capacitance from a tube socket pin to ground, use an ordinary clip lead to the chassis but use a piece of about No. 20 bare wire from the "hot" capacitance meter terminal to the socket pin being measured. Bend this stiff wire into position so that it comes within $\frac{1}{4}$ inch or so of the pin, then zero the capacitance meter. Now the lead capacitance is pretty well taken care of. Then tack-solder the end of the lead to the pin and take the reading.

A little practice in measuring the capacitance to ground of various lead wires will give one a feeling for what is expected, and engender confidence in the method.

Some examples of common values of strays: An ordinary binding post at-

Fig. 1. Simplified schematic diagram of an r.f. capacitance meter. See Fig. 2.

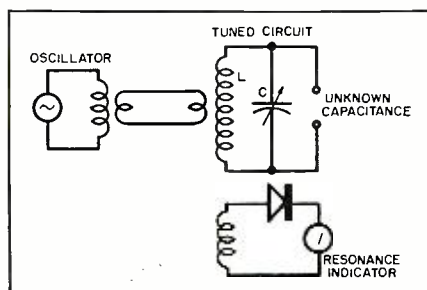

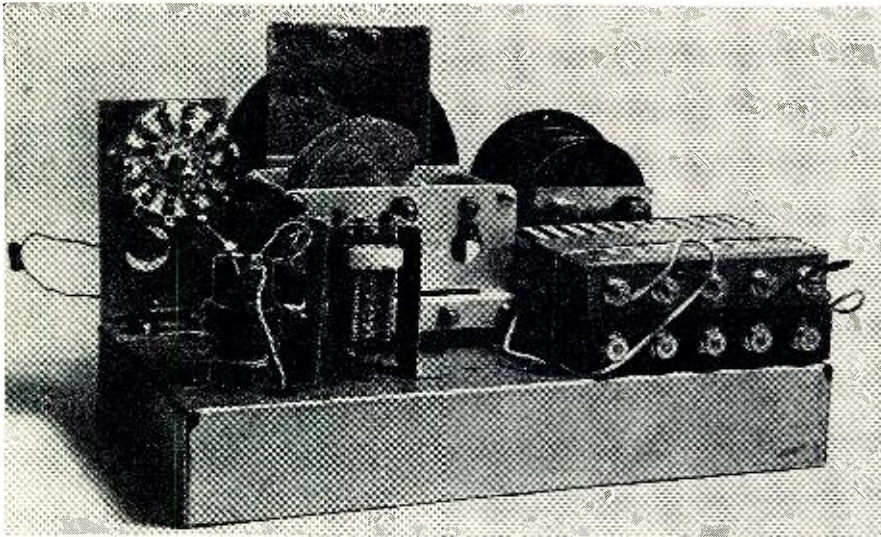

Rear view of meter. No cabinet was used in construction but may be added if desired.

tached to a metal panel with regular thin fiber washers measures about $9 \mu\mu\text{fd}$. An "interstage," i.e., two miniature wafer sockets with a coupling capacitor wired from the plate terminal of one to the grid terminal of the other, and with plate and grid resistors, is around $6 \mu\mu\text{fd}$. without any tubes in place. Two short pieces of No. 22 plastic-insulated hookup wire twisted together for an inch measure around $1 \mu\mu\text{fd}$. Two metal plates 1 cm square and 1 mm apart approximate $1 \mu\mu\text{fd}$. Hookup wire covered with shielding braid is quite variable, depending on how tight the braid fits, but often runs as high as $100 \mu\mu\text{fd}$. per foot.

Mechanical Layout

The model shown in the photographs was built on a standard $5" \times 9\frac{1}{2}" \times 1\frac{1}{2}"$ chassis without any cabinet. While this is admittedly a lazy man's layout, it makes no concessions on the score of operability. A cabinet is desirable to keep the internal adjustments from being disturbed. The size cannot be cut down much because panel space is required for a decent-sized dial, a meter, a zero-adjustment trimmer, two switches, and the terminals. The oscillator itself is of negligible size, stuck underneath the chassis as seen in the bottom view. Largest items physically are the dial, tuning capacitor, meter, and batteries. Too-small batteries are not advisable because of their limited shelf life.

The only precaution necessary is to lay out the tuning capacitor, coil, and trimmers about as you would in a 10-meter or 20-meter transmitter stage—bare hookup wire run "through the air" to keep wiring capacitance low and stable. Stray coupling to the oscillator should be avoided, because the coupling *via* the link must be very loose. Aside from this there is quite a free choice in choosing the chassis, cabinet, and location of parts.

Complete Circuit

Fig. 2 is the complete schematic. The oscillator must be fairly stable

and have a low L/C ratio, considerably lower than the other tuned circuit. The coil L_1 used in the model is a "Loopstick." The frequency being fixed, a Colpitts-type circuit is feasible and no taps are required on the coil. A high "Q" is desirable. A good broadcast-type antenna coil should be satisfactory, particularly one from a defunct auto radio, since the small antenna on a car makes a high-"Q" antenna coil necessary. A suitable home-made coil would be about 100 turns of No. 30 enamel wire on a 1-inch diameter Bakelite tube. Frequency is 500 kc. The *General Radio* 1612-A Capacitance Meter operates at 1 mc.; the factors governing choice of frequency are complicated but far from critical, and 500 kc. was chosen here out of regard for the limitations of available low-cost transistors.

The oscillator feedback ratio C_1/C_2 is about $1/16$. C_1 should be silver mica. Plain mica is satisfactory for C_2 . Operating current is determined by the emitter resistor R_1 and by the voltage (3 v.) to which R_1 is returned. It is about 1.4 milliamperes. The r.f. voltage across the tuned circuit depends mainly on the collector supply voltage. It is best to have plenty of spare power to operate the resonance indicator meter M_1 . About 12 volts is OK.

In general the oscillator must be "stiff," i.e., not loaded down much by the other circuitry that is coupled to it. Hence the low L/C ratio and the high-"Q" coil. The coupling link L_{1A} is a piece of solid No. 20 hookup wire bent around the lower end of the winding of L_1 . A half-turn or less is sufficient. Experimentation is necessary.

If the coupling is too tight, the tuned circuit L_2-C_6 will pull the oscillator frequency a bit as it is tuned through resonance. This will show up as an odd double-hump in the resonance indicating meter. When the dial is turned through resonance, say clockwise, the meter will read peak at a different capacitance setting than when the dial is turned counterclockwise. Loosen the link coupling until this effect is no longer noticeable.

The tuned circuit coil L_2 is a high-"Q" inductance removed from an old, high-quality 455-kc. i.f. transformer. Inductance is about 1 millihenry. High "Q" is particularly important here, because it determines the sharpness of the resonant peak. With a "Q" of 100 or better (the one used measured 120) the resonance meter reading will drop about 50 per-cent when the circuit is detuned by $1 \mu\mu\text{fd}$. With a "Q" as low as 50 the sharpness of the peak is too low to resolve these small capacitance changes nearly as well.

This particular coil is wound of Litz wire in four pies, on a $\frac{3}{4}"$ form, air-core. Any air-core coil to be suitable must be of Litz wire. Iron-core i.f. coils should have a high enough "Q" if they are of comparatively large size—not the kind from midget transformers. A satisfactory home-made coil with adequate "Q" will be 175 turns of No. 28 enamel or Formvar wire on a 2-inch diameter form, single-layer. Winding length is about 2.3 inches.

The oscillator-coupling link L_{2A} is merely two turns of hookup wire wound around the low end of the coil. Coupling coil L_{2B} for the resonance meter circuit was 12 turns of No. 20 magnet wire bunch-wound and stuffed inside the form of L_2 . With a different coil than the one shown, some experimentation will be necessary. If L_{2B} has too many turns, the meter circuit will load down the tuned circuit, lower the "Q," and hence the meter reading. Best results, a peak reading of around half-scale on the meter, are found with an optimum number of turns, although the pickup coil L_{2B} is not critical.

Panel trimmer C_4 is a $15 \mu\mu\text{fd}$. variable, used to set the circuit for resonance when the main dial is set at zero. Part of its function is to compensate for the capacitance of connecting leads to the unknown being measured; the other part to make up for general drift.

The main tuning capacitor used was a *National* EMC-250, $250\text{-}\mu\mu\text{fd}$. unit with straight-line-wavelength cut plates. This item just happened to be on hand. The requirements, however, are a bit unusual if we are to get a convenient scale shape. More about this later. As part of the scale-shaping design, a series padder is required, C_7 and C_8 . Screwdriver-adjusted $100\text{-}\mu\mu\text{fd}$. trimmer C_7 is visible in the photograph, in back of the main tuning capacitor.

On the low capacitance range of the instrument, $0\text{-}80 \mu\mu\text{fd}$., the unknown is connected directly across the coil L_2 . To get the high range of $0\text{-}1000 \mu\mu\text{fd}$., it was found best to connect the unknown across C_6 through a fixed $300\text{-}\mu\mu\text{fd}$. padder C_8 . Range switch S_2 should be a low-capacitance type. A rotary wafer switch was used, in spite of its size.

The crystal diode rectifier arrangement is conventional, with a $.01 \mu\text{fd}$. capacitor across the meter for an r.f. bypass. Physical location of parts is not fussy, because of the low impedance of the circuit.

Capacitor Scale

It is highly desirable to have the capacitance scale of a roughly logarithmic shape, spread out at the low end. If the tuning capacitor C_4 were, for example, an 80 $\mu\text{fd.}$ unit of straight-line capacitance (semicircular plates) type, the scale would be linear and the first 1 $\mu\text{fd.}$ on the scale would occupy only about .07 inch of space. Five times this spread is actually obtained in the completed instrument.

It turns out that a good way to get a good taper on the scale is to use a series padder. The commercial capacitance meter¹ uses a 500 $\mu\text{fd.}$ semicircular-plate tuning capacitor in series with a fixed padder of about 100 $\mu\text{fd.}$, giving about 80 $\mu\text{fd.}$ maximum for the combination. The effect is this: near maximum capacitance of the tuning capacitor, a given per-cent variation in its capacitance makes relatively little difference percentagewise, in the capacitance of the series combination; near minimum capacitance, it makes much more difference. This can be checked by a little application of the formula for series capacitors. Roughly the effect is that the scale is spread out about 5 times as much, in terms of capacitance removed from the circuit, at the "low" end of the scale (maximum capacitance) as at the "high" end.

Unfortunately, stock variables of this capacitance and plate shape are rather hard to find. An ordinary broadcast receiver type capacitor is tapered in the wrong direction for this kind of use.

Fig. 3 shows a stunt that can be used if we have a tapered-plate (e.g., straight-line-frequency) tuning capacitor without end stops, that will rotate in either direction. Fig. 3A shows the rotor plates, diagrammatically, fully meshed with the stator. Fig. 3B shows the reverse rotation, not normally used. This direction of rotation gives the opposite law from the usual: capacitance is reduced slowly at first, from maximum, then more rapidly as the plates open out. This direction is used in the present instrument for the low range, although the capacitor used has a relatively mild taper. A little series padding is used too, to help things along. Fig. 3C shows the plates opening out in the usual direction. Capacitance is removed rapidly at first, then more slowly. This direction is used for the high range, because the circuit otherwise gives too much "taper."

Generally, any tuning capacitor on hand that will rotate the full 360 degrees is adaptable to this type of instrument. The series padder, about 160 $\mu\text{fd.}$ for the low range, is used in conjunction with a 250 $\mu\text{fd.}$ variable in reverse rotation. The variable used has "straight-line-wavelength" plates, with some taper but not enough to give the desired scale spread without a little series padding to help it along.

Calibration

To calibrate the low range, a hand-

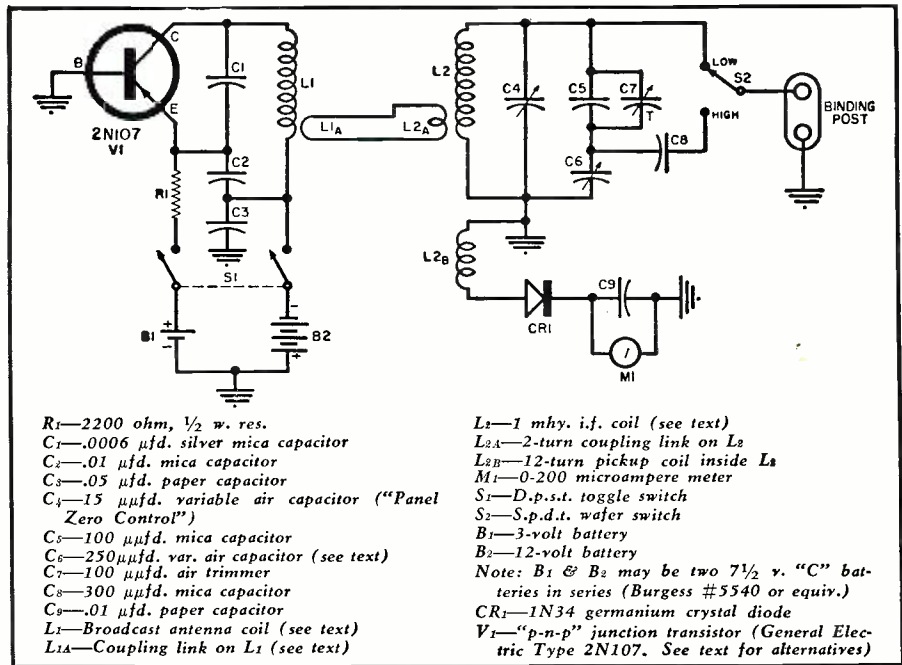

Fig. 2. Schematic of r.f. capacitance meter using a transistor oscillator. The meter measures 1 $\mu\text{fd.}$ readily and has ranges of 0.80 $\mu\text{fd.}$ and 0-1000 $\mu\text{fd.}$

ful of small fixed mica or ceramic capacitors is needed. Or if a low-range bridge is available, a couple of mica trimmers with 1-inch leads soldered on will make a good transfer standard. On the high range a decade box, if available, is convenient.

First step is to get the L_2 tuned circuit in resonance with the oscillator. A start can be made by shorting out C_7 - C_5 and twirling the dial of C_6 until the meter reads a peak. Then adjust the link coupling until the double-hump effect is gone. Try adjusting pickup coil L_{2B} for maximum meter response consistent with sharp tuning. Then unshort C_7 - C_5 and adjust C_5 until the meter shows resonance at the maximum setting of tuning capacitor C_6 .

Just to be on the safe side, the zero

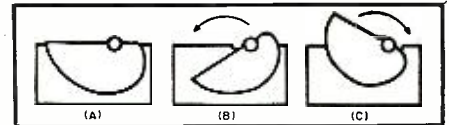
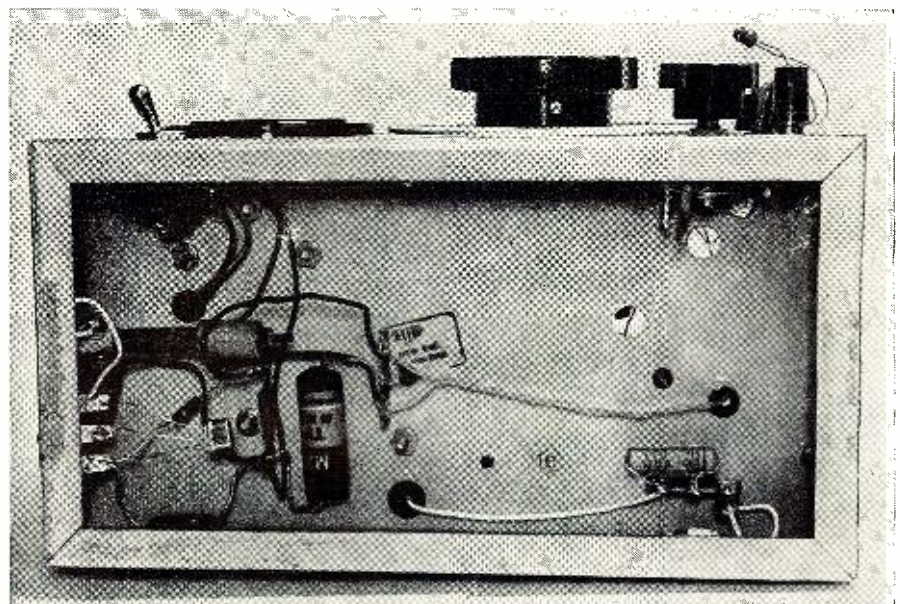

Fig. 3. Rotation of C_4 for two ranges of instrument. (A) plates fully meshed, (B) "reverse" rotation for low-range (0.80 $\mu\text{fd.}$), and (C) normal rotation for the "high" range (0-1000 $\mu\text{fd.}$) of the meter.

end of the low scale was marked on the dial at a point where the capacitor plates were unmeshed just a trifle; zero for the high range is marked where the plates are unmeshed a bit in the opposite direction.

Oscillator frequency adjustment may be necessary, either by slug-tuning or by up to a few hundred $\mu\text{fd.}$ of padding.
 (Continued on page 153)

Bottom view of the capacitance meter. Transistors are mounted with full lead length.



Transistor Radios

By MILTON S. KIVER*



Fig. 1. The Zenith Model 500 7-transistor portable weighs 19 ounces with batteries.

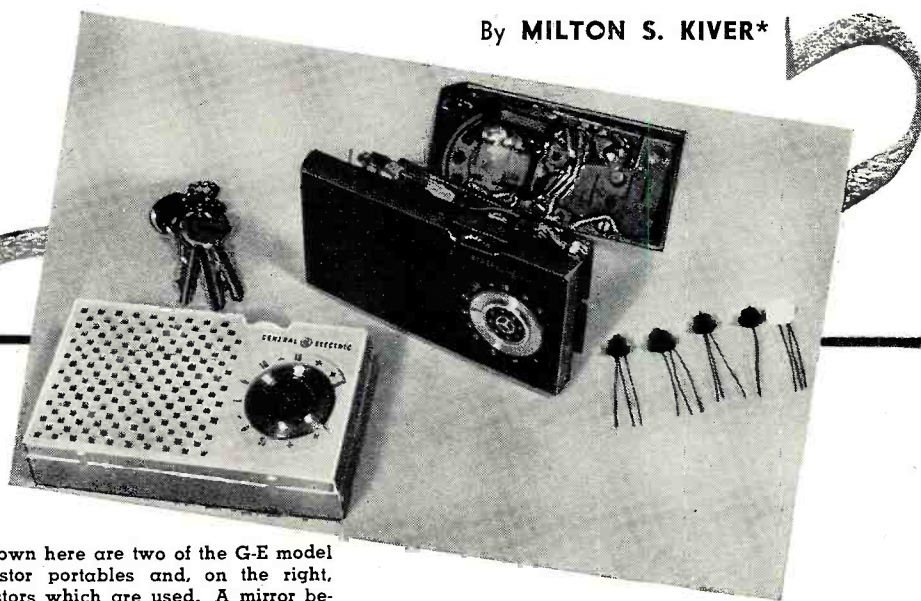

Fig. 2. Shown here are two of the G-E model 675 transistor portables and, on the right, the transistors which are used. A mirror behind the black radio reveals its back view.

Part 3. G-E and Zenith transistor radios are analyzed in this concluding article. These personal-type radios use no vacuum tubes and feature low battery drain.

WITHIN recent months several new transistor radios have appeared and it may be of interest to examine them to see what new features they possess. One of these receivers is the *General Electric Model 675* shown in Figs. 2 and 3. This contains a 2N136 converter, a 2N137 1st i.f., a 2N135 2nd i.f., a 2N78 transistor detector, and a 2N44 for power output. A 13.5-volt battery is used, with a tap at 4.5 volts. Power output is 40 milliwatts at 10 per-cent distortion, with a maximum output of 60 milliwatts.

Much of the receiver circuitry is similar, in basic form, to the transistor radios discussed in the January and February, 1956 issues of *RADIO & TELEVISION NEWS*. Some of it is different, however, and it is these sections which will be discussed here.

One circuit of interest is the a.g.c. network. In the detector stage, V_4 , the emitter bias is received from the battery through R_{12} . The transistor used is an *n-p-n* type, which means that electrons, in effect, flow from the battery, through R_{12} to the emitter and then from the emitter to collector, down through R_{11} to ground and back to the positive side of the battery. This flow of current produces a voltage drop across R_{12} which bucks the battery and therefore reduces the negative potential at point "A."

Now, V_4 operates as a class B detector, which means that no current flows through the unit until a signal is received. Therefore, with no signal,

the voltage drop across R_{12} is created only by the current drawn by the converter and i.f. stages. When a signal is received, V_4 draws current proportional to the strength of the signal and the voltage drop across R_{12} will increase. This serves to lower the "B—" voltage at point "A" and, also, the negative bias at the bases of the converter and two i.f. stages. All these prior transistors are of the *p-n-p* variety and in each instance, the more negative the base is with respect to the emitter, the more current will flow through the unit and the greater the amplification accorded the signal. On the other hand, if we decrease the applied negative voltage to each base, then the current flow through the transistor will decrease and the amplification will be reduced. It is this latter action which occurs when the signal level increases and V_4 draws more current. This behavior, of course, is desired.

The effect of the bias reduction will be greatest on V_2 because its emitter is returned to a fixed voltage, here -4.5 volts. On the other hand, the converter (V_1) and 2nd i.f. (V_3) will be controlled only slightly since the bias on all elements of these transistors change in unison.

On weak signals, the current drawn by V_4 drops, resulting in a lower volt-

age drop across R_{12} and leaving more "B—" voltage at point "A" for the other transistors. The i.f. amplifier gain will then be greater.

Another interesting feature of this receiver is the manner in which the battery life is extended through the regulated current drain of the 2N44 power output stage. Since a single stage is being used here, it is class A and ordinarily current would be flowing at all times irrespective of the strength of the signal. In the present arrangement, however, an entirely different method is employed to circumvent this difficulty. The collector of V_4 connects directly to R_{11} , the volume control, and this resistor also serves the base of V_5 . When no signal is being received, V_4 is cut off (or very close to it) and practically no current flows through R_{11} . This places the base and emitter of V_5 at the same potential which, in a transistor, is equivalent to a cut-off condition. (For current to flow from emitter to collector in this transistor, the base would have to be negative with respect to the emitter.) Under no-signal conditions then, V_5 is cut off and draws no power from the battery.

When a signal is received, V_4 starts passing current; the electrons flow from the collector to the variable tap on R_{11} and through the bottom portion of R_{11} to ground. This produces a negative voltage across R_{11} which is the correct polarity to cause current to flow through V_5 . This voltage across R_{11} will be proportional to the setting of the volume control and the strength of the received signal. By the same token, the power output stage will draw current directly proportional to the strength of the received signal and the volume control setting; therefore,

* Author of "AM-FM Servicing Short Cuts" (Howard W. Sams & Co.), "TV and FM Receiver Servicing" (D. Van Nostrand Co.), and other books.

the lowest volume setting will give the longest battery life.

It is possible to operate in this manner with transistors because their characteristic curves are linear to very small voltages. With vacuum tubes, the curvature of the characteristic curves under the same conditions would lead to excessive distortion.

Provision is also made in this receiver for private earphone reception through the use of a low-impedance earphone which replaces the loudspeaker when a miniature plug is inserted into the jack, which is accessible through a hole in the back of the cabinet. This silences the speaker and allows the user to hear radio programs under conditions of high ambient noise or situations in which the operation of the speaker is not desirable.

Zenith Model 500

The Zenith Model 500 transistor receiver (Fig. 1) contains seven separate transistors. As may be expected from such an array, the power output is fairly high for this type of device, being 100 milliwatts of undistorted power and a maximum power capability of 180 milliwatts.

The schematic diagram of this receiver is shown in Fig. 4. Separate oscillator and mixer stages are used, with the oscillator signal reaching the mixer base via *C₁*. The incoming signal is captured by a ferrite-rod antenna and transferred inductively to the same element of the mixer. The two signals then beat together and the resultant i.f. is transferred from the collector circuit to a two-stage i.f. system.

Both i.f. stages are closely similar,

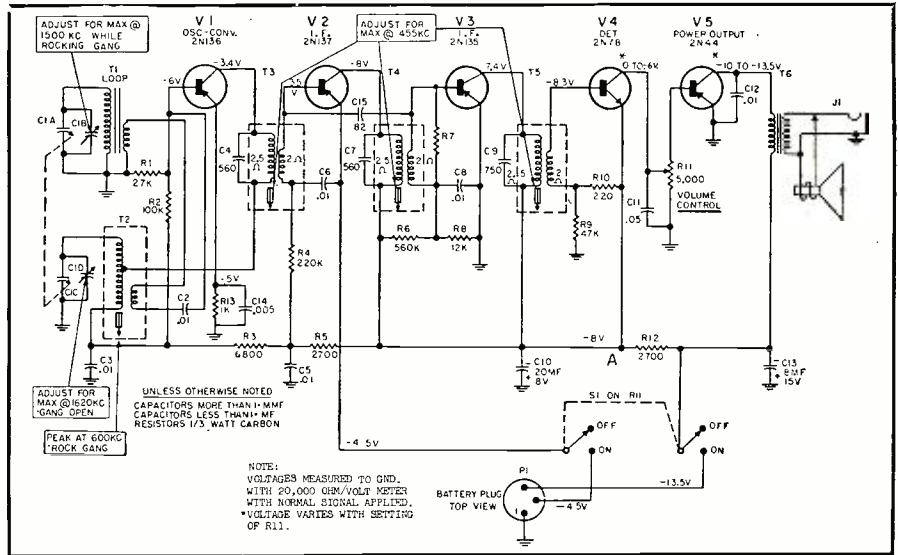

Fig. 3. Diagram of the G-E Models 675 and 676 transistor portable radios.

the only significant difference being that one stage, the first, is a.g.c. controlled while the second stage is not. This a.g.c. voltage is obtained from the second detector and its polarity is negative. When the signal level rises, the a.g.c. voltage becomes more negative. This works counter to the positive bias voltage on the bases of the mixer and 1st i.f., reducing the value of this bias voltage and thereby lowering the current through these transistors. As a result, signal amplification drops. (All transistors are of the *n-p-n* variety, requiring the base to be positive with respect to the emitter. The collector potential is positive.)

A germanium diode is employed as the second detector, feeding the de-

modulated signal to *R₁*, a 2000-ohm volume control. The average d.c. voltage developed across *R₁* by the incoming signal is negative and it is this slowly fluctuating signal which is employed in the a.g.c. system.

The stage beyond the detector is called the driver and it serves two purposes. First, it drives the class B push-pull output stages. Second, it amplifies the signal supplied from the detector enough so that an earphone, plugged into the collector circuit of this stage, will have sufficient volume. An interesting feature of this earphone circuit is that it neatly prevents the output stage from wasting power when the earphone is in use. The class

(Continued on page 131)

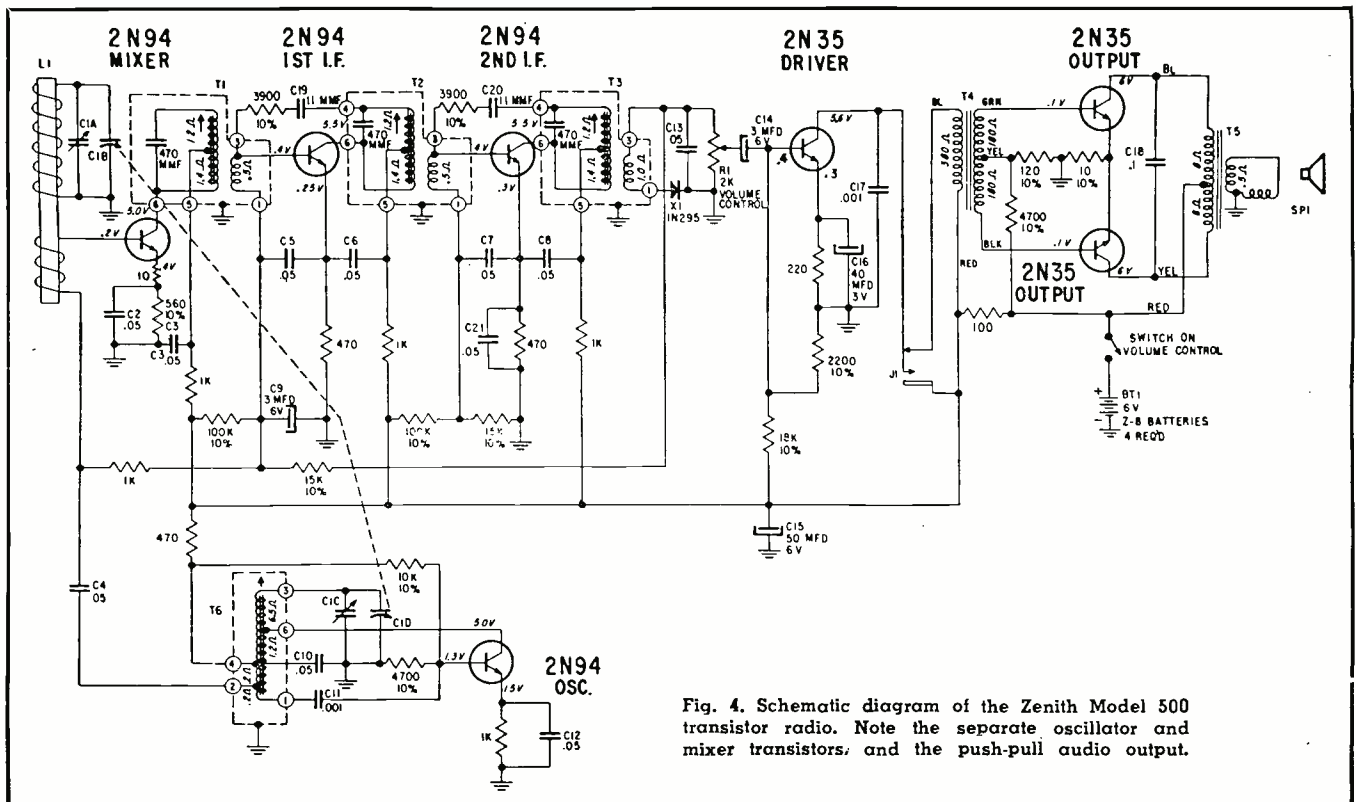
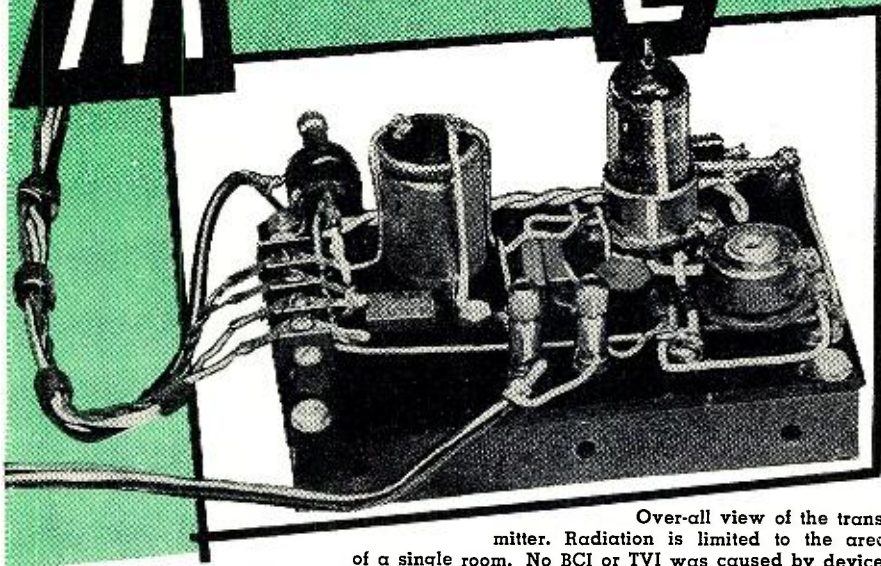

Fig. 4. Schematic diagram of the Zenith Model 500 transistor radio. Note the separate oscillator and mixer transistors, and the push-pull audio output.

Magic Earphones

By IRVING GOTTLIEB



Over-all view of the transmitter. Radiation is limited to the area of a single room. No BCI or TVI was caused by device.

Free your listening of phone cords. Build this midget two-way unit which uses inductor field within the room.

FOR many radio activities, earphones offer several advantages over loud-speaker reception. Radio amateurs and short-wave enthusiasts have found that the use of earphones is a help in spotting weak signals or those subjected to strong interference. The use of earphones also provides requisite privacy and spares "non-participants" unnecessary annoyance. Finally, phones offer a feeling of "presence." This may not be due to a true "binaural" effect, but a life-like quality is imparted to the reception. These reasons combine to make the manufacture of earphones a profitable business notwithstanding the availability of modern multi-watt amplifiers and speaker systems.

We sometimes allow ourselves to become immunized to obstacles and irritants because, to our knowledge, they have always existed. Consider the case of the earphone cord. It confines the listener to the immediate vicinity of the receiver. A potential danger exists should a ham attempt to adjust his transmitter while wearing his phones. The cord itself invariably becomes twisted and snarled and always seems to be resting on the writing pad.

Extending the length of the cord still isn't the final solution since there is always a chance that loose objects will become entangled in the cord and get brushed onto the floor. The cord has long been the "villain of the piece" but, as will be shown, it need no longer be considered a necessary evil.

Recently, the author repaired a hearing aid, the nature of the malfunction-

ing being that broadcast stations were being received. The defect was due to non-linearity in the input circuit resulting from a gassy tube. Although replacing the tube remedied the situation, this did not terminate matters, for the seed of an idea was sown by the experience. Could the same principle be employed to eliminate the ohmic connection between a receiver and headphones? If so, one could walk about unhampered, unchained to the receiver. It was realized that certain requirements would have to be met in order to make such a device worthy of construction. First, the volume should be constant, or very nearly so within the area of the operating room. This also takes into account both standing and sitting positions. Secondly, no critical adjustments should be needed and there should be no effects from body capacity. In the third place, the device should be inexpensive.

Early in experimentation, it was found that high frequencies did not lend themselves to the requirement for constant signal strength. Also, critical tuning adjustments were difficult to avoid. The solution was found in the employment of a low frequency and the transference of energy by induction. A small transmitter is modulated by the output of the radio receiver. The energy from the transmitter is picked up and demodulated by a simple lightweight receiver attached to the headband. The loop antenna for the transmitter, actually the oscillatory tank coil, consists of five turns of wire

pinned to the molding which, in most rooms, forms the junction between wall and ceiling. The receiving antenna is essentially a smaller version of the transmitting loop. It should be recognized that the geometrical relation of the two loops is the same as that commonly used to couple the output of a transmitter to an antenna pickup coil. In contrast, true "loop" antennas are oriented with their edges lined up. The directive properties possessed by this method of energy transfer precludes its use for our purpose. On the other hand, when a small coil is moved across the cross-sectional area of a large coil carrying alternating current, the voltage induced in the small coil changes very little with respect to its position providing the planes of the two coils are kept parallel. This is precisely what the doctor ordered, and is the basic principle contributing to the success of the "Magic Earphones."

The schematic diagrams of the transmitter and receiver are shown in Figs. 1 and 2. The dimensions of the author's room are ten by twelve feet. Five complete turns of wire resulted in a transmitter frequency of 470 kc. There is nothing sacred about this value, but it should be below the broadcast band in order to prevent interference to standard radio receivers.

By the same token, it is well to avoid frequencies in the vicinity of 450 to 460 kc. which corresponds to the passband of i.f. amplifiers in most radios. These are precautionary measures. Actually, the radiation from a low-frequency horizontal loop located a minute fraction of a wavelength above ground is feeble. This was proved by employing smaller capacitors than finally used in order to tune the loop to a frequency within the broadcast band. A small five-tube superhet was used to explore the general pattern of the field strength outside of the room containing the equipment. At distances of ten or fifteen feet, the volume control had to be fully advanced in order to produce ordinary listening volume.

Insofar as the receiver is concerned, the resonating capacitor C_1 should not be much less than about 200 μfd . Below this value, the receiving tank circuit tends to become susceptible to the tuning effects of body capacity. An upper limit of about 500 μfd . should be observed in order to maintain a fairly high "Q." The author used the lid of a cardboard box measuring 5 x 6 inches. The energy intercepted by the receiving loop diminishes rapidly as

the area is reduced, so the constructor should not deviate too far from these dimensions. A larger loop would be suitable electrically but would then become physically awkward. In any event, if cardboard or wood is used, the form should be first heated in the oven in order to drive off absorbed moisture. Immediately after the heat treatment, a coating of clear varnish should be applied to render the material impervious to moisture.

The polarity of the transistor battery indicated in Fig. 2 is correct for the *p-n-p* junction transistor. The polarity should be reversed in the event an *n-p-n* junction transistor is used. It will be observed that a separate battery is not employed to energize the collector electrode, and also that an output transformer is not used. It was found that, in the interest of weight reduction, these two components could be dispensed with. Very little degradation of performance results from these simplifying measures.

The circuit of the transmitter is shown in Fig. 1. A single type 12AU7 tube provides the two triode sections required for oscillator and modulator. The first triode section, V_{1A} , comprises the oscillator, which is a "hot cathode" Colpitts. The inductive component of the oscillatory tank circuit is furnished by the ceiling loop antenna. The plate of V_{1A} is at r.f. ground potential. This helps keep r.f. out of the audio portion of the transmitter and makes it easy to obtain clean modulation.

The other triode section, V_{1B} , functions as a Heising modulator. The audio frequency choke, CH_1 , constitutes the common impedance which couples the modulator to the oscillator in this scheme of modulation. The audio frequency excitation for the modulator is obtained from the output stage of the radio receiver. The right-hand circuit of Fig. 1 illustrates the manner in which this is accomplished. A high-resistance potentiometer, R_5 , is connected across the primary winding of the audio output transformer. Also, a s.p.d.t. toggle switch is provided to enable selection of speaker or "Magic Earphone" operation. This switch can be mounted either on the chassis or the panel of the radio receiver. The value of R_5 is high enough so that it produces very little effect during speaker operation.

Filament and "B" voltage are obtained from suitable points in the radio receiver. The "B" voltage can be between 180 and 250.

It is a worthwhile precaution to use shielded wire or coaxial cable for the antenna lead-in to the radio receiver. This is to prevent entry of transmitter energy into the radio receiver, a condition which can result in "singing around the loop," which is similar to the sustained audio frequency oscillation often heard when speaker and microphone of a p.a. system participate in the feedback of energy from output to input of the system. It is also best to place the transmitter two or three feet from the antenna terminals of the radio receiver,

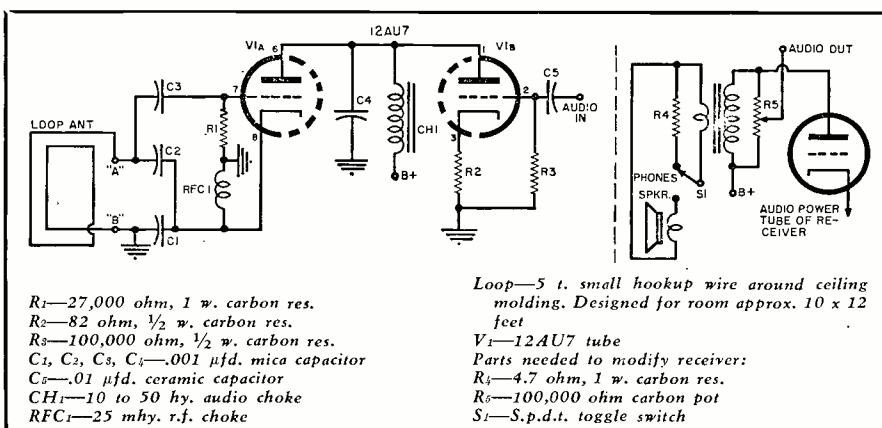

Fig. 1. Complete schematic of transmitter. Method for obtaining the modulating voltage from the station receiver is shown in diagram at right. Refer to article.

To place the system in operation, a scope should be connected to terminals "A" and "B" of the transmitter. Oscillation will be indicated by a solid pattern. It is not necessary for the oscilloscope to resolve the individual cycles of the r.f. envelope. If a scope is not handy, oscillation can be determined by connecting a voltmeter through a 1N34 diode to terminals "A" and "B."

Turn the audio volume control of the radio position half way up. Next, adjust the potentiometer, R_5 , so that the average modulation index appears to be between 30 and 60 per-cent. The exact adjustment will be made later while listening to the "Magic Earphones." For the present, the detection of r.f. energy which varies in amplitude in response to audio frequency is a pretty good indication that the transmitter is operative. (When observing the modulation envelope, be certain that S_1 is switched to "phones.")

Next, the receiving loop must be made resonant to the frequency generated by the oscillator. Place the "Magic Earphones" on a table several feet from the transmitter. Connect a 25 μ fd. capacitor from the "top" side of C_1 to terminal "A" of the transmitter. One should have at hand the following selection of capacitors: 25 μ fd., 50 μ fd., 100 μ fd., 200 μ fd., and 300 μ fd. Find the parallel combination

which results in the loudest reception. This is not difficult to do because tuning is not critical. The two or several capacitors may be used as such, or may be replaced by a single capacitor of equivalent value.

After this has been done, it should be possible to walk about the room, receiving signals by means of electromagnetic induction. The "Magic Earphones" should fit the head in such a way that the receiving loop is approximately horizontal for the ordinary position of the head. The volume control of the radio receiver, and perhaps R_5 , can now be adjusted for best performance.

When first enjoying the freedom afforded by the "Magic Earphones," one must overcome the psychological expectation of suddenly having earphones jerked from the head by a taut cord. It is much the same as the first experience with an automobile having automatic transmission. There is a strong apprehension that the motor will be killed after applying the brakes for a full stop. Such, of course, is not the case. Within a short time, one stops and starts with nary a worry. In like fashion, following a short period of adaptation, the "Magic Earphones" will be found to provide operating convenience that makes the old way appear primitive.

—50—

Fig. 2. Schematic of the miniature receiver and a photo showing how the receiver is mounted on the headphone band. The unit is light enough to cause no difficulties.

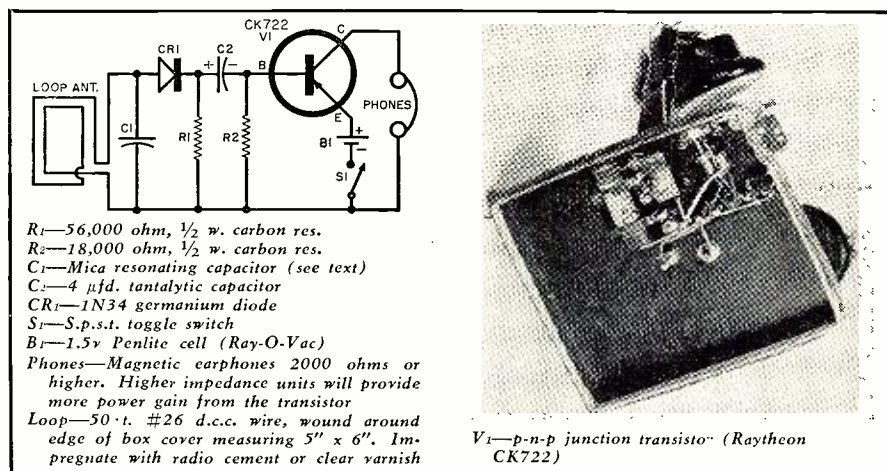

EVOLUTION of the PHONOGRAPH

By **OLIVER READ**
Editor, **RADIO & TELEVISION NEWS**
and
JAMES RILEY



Thomas A. Edison listening to his "Triumph" phonograph in his laboratory. This photograph was taken in 1906.

Fig. 2. Edison's "Fire-side" unit played both 2- and 4-minute cylinders and came with a dual-stylus reproducer.

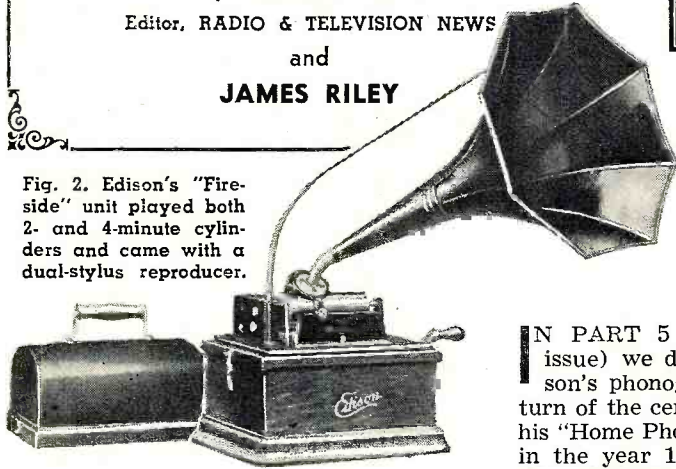

Part 6. More on development of early Edison phonographs including data on maintenance.

IN PART 5 of this series (March issue) we described several of Edison's phonographs made before the turn of the century. Among these was his "Home Phonograph" first produced in the year 1896. Following publication of this article we have been literally deluged with requests for information as to the availability of parts and for information on repair techniques for his early models. Many of our readers are in possession of Edison's "Home" and "Standard" models. These were the two best sellers in their day and many thousands of these were produced. Original instruction books have been lost through the years and without this information the phonograph collector is greatly handicapped when attempting to restore his cylinder machine.

The following is from an original instruction book published in 1898 "for the Edison Home Phonograph." Because his "Standard" model is very

similar, the maintenance techniques will apply to the "Standard" as well as the "Home."

The detailed sketch of the model "A" Home Phonograph (Fig. 1) with its index of parts shows all of the essential components comprising the phonograph:

"Before winding or starting the machine, see that all working parts are free, particularly that there is no dirt or packing in the gear wheels, and that all set screws are tight. Sometimes these screws work loose from shock.

"The Phonograph, like every other good mechanism, should be clean and free from dust. Instructions as to oiling will be found later in these directions.

"See that knife adjusting screw (22) is screwed entirely back, or until the stop pin rests against the casting of the speaker arm, as it always should do except when shaving. This screw



↑
Fig. 3. The Model K "combination" sound box or reproducer. Refer to article.



←
Fig. 4. Two separate sapphire points are coupled to the diaphragm. See Fig. 3.

Fig. 5. The 4-minute sapphire in playing position. It has a tip radius of .0045".

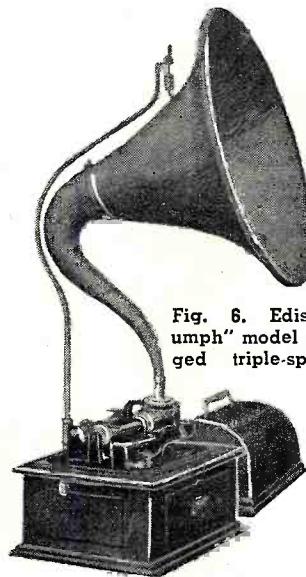

Fig. 6. Edison's "Triumph" model was a rugged triple-spring unit.



Fig. 7. Edison's "Standard" was popular. It had a "cygnet" horn.

INDEX OF PARTS

Fig. 1. Sketch shows details of the Edison "Home Phonograph" Model A, circa 1896. Parts are identified in legend at right.

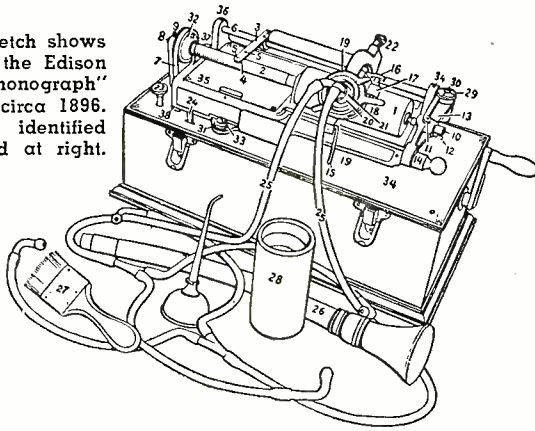

- | | |
|---|---|
| 1. Brass Mandrel to hold wax cylinder (Assembled with Main Shaft) | 19. Speaker Clamps |
| 2. Main Shaft (Assembled with Brass Mandrel) | 20. Speaker |
| 3. Feed Spring | 21. Tube Plate |
| 4. Feed Nut | 22. Knife Adjusting Screw |
| 5. Feed Nut Screws | 23. Speed Adjusting Screw |
| 6. Back Rod | 24. Start-and-Stop Switch |
| 7. Drive Belt | 25. Hearing Tube |
| 8. Main-Shaft Center | 26. Speaking Tube |
| 9. Main-Shaft Center Set Screw | 27. Chip Brush |
| 10. Swing-arm Center | 28. Wax Cylinder, or Blank |
| 11. Swing-arm Center Set Screw | 29. Swing-arm Spring Washer |
| 12. Swing-arm Center Adjusting Screw | 30. Spring-Washer Set Screw |
| 13. Swing Arm | 31. Body-holding Screw Washers (metal and rubber) |
| 14. Lock Bolt | 32. Main-Shaft Pulley |
| 15. Lift Lever | 33. Body-holding Screw |
| 16. Speaker Adjusting Screw | 34. Top Plate |
| 17. Speaker Adjusting Screw Lug | 35. Home Phonograph Body |
| 18. Speaker Lever | 36. Back-rod Set Screws |
| | 37. Main-Shaft Pulley Set Screw |
| | 38. Body Cushions |

controls the shaving knife, and draws it away or forces its cutting edge against the wax cylinder.

"As a precautionary measure, it is well to look to the belt (7), the shaft (2), and the speaker arm, before starting the machine. All machines are completely adjusted before shipment from the factory. They will sometimes, though not often, become disarranged in transit. The tension of the belt (7) should be moderate, and the belt-tightening idler pulley (not shown in engraving but easily found on the machine) should be in proper place against the belt. The main shaft (2) turns on centers (8 and 10), between which it should run easily. If centers are too tight they will bind the shaft, while, if too loose, the end-shake will destroy the accuracy of the reproduction. There should be no end-shake here. The shaft adjustment is regulated by the adjusting screw (12) on the swing arm center. A simple test is to throw off the belt with the hand, and see if the shaft will spin freely without noise. The main shaft pulley (32) should of course be tight on the shaft. Its set screw (37) regulates this. The

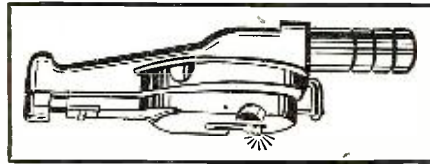

Fig. 8. The original diamond stylus reproducer used in early Edison machines.

main shaft centers are regulated by set screws (9 and 11), as shown in the drawing. Care should be taken that the large end of the mandrel (1) does not touch the center lug of the body casting. The thickness of a piece of paper between the lug and mandrel is sufficient clearance. The speaker arm or carriage of the machine should work free on the back rod (6).

"All bearings should be oiled, as mentioned before, and to obtain the best results from the motor the gears must be kept clean, particularly the fine-toothed gear which engages the governor pinion. The governor disc (the flat metal plate against which the horseshoe rocker works) must be oiled occasionally. If necessary to adjust the governor, see to it that there is a

slight play between centers. If too tight there, regulation is impaired and efficiency is diminished.

"Under no circumstances should the governor disc, described above, touch the adjacent gear.

To Reproduce

"The first operation will undoubtedly be reproducing. Raise lift lever (15) to its highest point. Push speaker lever (18) to its highest point, against speaker adjusting screw lug (17). Throw down lock bolt (14) and open swing arm (13) wide. Slip the wax cylinder (28), beveled end foremost, upon the tapering brass mandrel (1), and press it firmly, but not too forcibly, into place. Close swing arm and re-lock it. Now place hearing tube (25), or horn, on the speaker tube (reproducer) plate (21), slide speaker arm to point where record appears to begin, and drop lift lever (15), after having first thrown start and stop switch (24) to the left.

"With the Automatic Speaker (type C reproducer) the following adjustment is unnecessary, as the reproducer (Continued on page 168)

Fig. 9. The last of the "Home" phonograph series was this model with its "cygnet" horn. This particular model, a popular one, is discussed in detail in article.

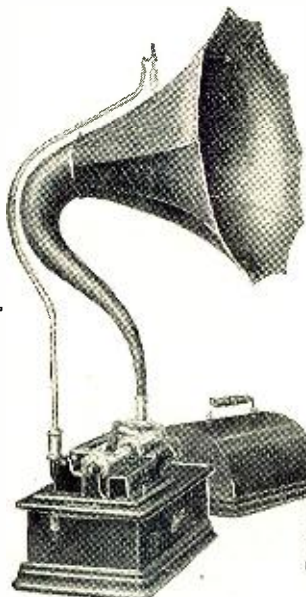
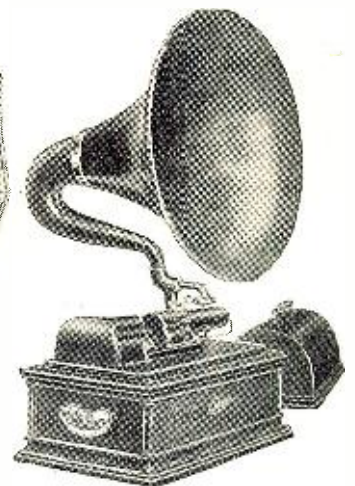

Fig. 11. A deluxe phonograph was this Edison "Opera" model with its diamond reproducer, big horn.



Fig. 10. A favorite with collectors is this small "Gem" model phonograph with its "Fireside" horn.



Certified RECORD REVUE

By BERT WHYTE

FIRST thing on the agenda this month is to thank the many readers who wrote me expressing their approval of my equipment report on the New York Audio Fair. I am quite grateful for the nice response, naturally, but I am also just a bit surprised. I did not think such a superficial report on the new hi-fi equipment would arouse such reader enthusiasm. As most hi-fi fans are aware, there is a great deal of pro and con about equipment reports. Some magazines have equipment reports as a regular monthly feature, other magazines avoid them like the plague. Certainly, these reports must have value to a great many people or they would not continue to be published. However, many people also feel that the elaborate reports published in certain magazines are biased in favor of the manufacturer because of advertising pressure. To this charge, I will resort to the classical political answer . . . "no comment."

I assure you that it is not the intention of this writer to turn the introductory part of this department into an equipment report section. There are too many other audio subjects that require discussion to even consider such an action. However, I am bound to say that these letters have shown that there is a definite need for an occasional word about equipment. It would seem that there are many people who simply are not located near any hi-fi emporiums and, perforce, must buy their equipment by mail. Naturally, they would like to have as much prior information about a given piece of equipment as possible, before they make their purchases. This will be the function of this department when equipment is concerned, mainly to inform, report, and if I have actually used the equipment in question, offer any pertinent comments on performance. No oscilloscopes or oscillators, no graphs and charts, just a few observations which I hope will be of value to Joe Doakes, music lover.

Having clarified my position, I want to pass along some information about a new product that made its debut at the Fair. I refer to the *Fairchild* "Turromatic" turntable, which impressed me at the Fair as a very attractive and cleverly designed product. Unfortunately, like so many new audio products, production on these units has been slow and none has been available for evaluation. As far as I know, I received the first unit which was released for test, and this will probably be the first report on it to appear in the hi-fi press. The *Fairchild* turntable will be available in three models, differing only in the type of drive motor. The standard unit has a regular 4-pole induction motor, then there is the deluxe model with a hysteresis synchronous motor, and a third model with a special heavy duty *two-speed* synchronous motor.

The operating principle of the turntable is coming in for a lot of attention these days: endless plastic belt driving a turntable of great mass, the drive motor being well iso-

lated from the turntable by extremely careful shock-mounting. The *Components Corp.* turntable was the first of the belt type and *Fairchild* the second, but from what I can gather, not the last! Several other belt types are reported to be well past the planning stage. The *Fairchild* has refinements of design that should appeal to many people. The turntable is actually a two-piece assembly, the steel "sub-table" being covered by a closely fitting aluminum shell. This shell serves a number of purposes. It is, of course, non-magnetic and effectively shields magnetic cartridges from any pull the steel sub-table might exert. It is also the record playing surface and is covered with a very soft polystyrene-like plastic foam. And last, but not least, it serves to hide the driving belt and sub-table. The sub-table itself has most of its considerable mass concentrated near the rim. The effect of this is that when the table is revolving, the centrifugal force is increased and theoretically the mass of the table becomes still greater.

The drive belt system is unique. The motor shaft drives a rubber puck of prescribed diameter and a pulley is mounted on top of this puck, and it is on this pulley that the plastic belt rides in a groove and connects with a similar groove in the sub-table. There are three of these puck-pulley assemblies, one each for 33 $\frac{1}{3}$, 45, and 78 rpm. By means of a special bracket and a control knob any of the speeds can be selected, without stopping the motor. Both the sub-table shaft and well and all of the pulleys are fitted with poured babbitt metal bearings. As is well-known from automotive use, babbitt bearings become quieter and smoother as they "wear in." The puck-pulley setup allows a decoupling stage between motor shaft and belt drive so as to avoid vibration.

Another cute trick that will be a boon to some of our forgetful readers, is that the motor shaft assembly is controlled by a d.c. solenoid. When the current is on, the motor shaft engages the puck, when the current is turned off, the motor shaft is automatically withdrawn from contact with the puck. Thus it is impossible to form a "flat" on a puck or idler in this turntable, whereas in conventional units if one forgets to manually disengage the drive shaft, you will get that awful cyclic "thump-thump" typical of an idler with a flat. Well, that pretty well describes this unusual table. As far as performance was concerned, it was what you might expect of such a well thought out design. A check with a strobe disc showed it to be right on the button on all three speeds. Best of all, I could not discern any wow or flutter, nor (Glory be!) any rumble, even though the unit was used with a system capable of reproducing sound below 30 cycles. If the *Fairchild*

The opinions expressed in this column are those of the reviewer and do not necessarily reflect the views or opinions of the editors or the publishers of this magazine.

people can meet this performance in their regular production models, (and they assure me they can) this turntable should meet with a great deal of sales success. Oops! . . . almost forgot to tell you why there is a *two-speed* synchronous motor model of this turntable. Well, at regular motor speed of 1800 rpm, this with the reduction afforded by the puck-pulley-sub-table ratio allows the normal 33 $\frac{1}{3}$, 45, and 78 rpm speeds. By turning a switch the other motor speed of 900 rpm is obtained with, of course, the resultant halving of the available speeds. The reason for all this is *Fairchild's* curtsy toward the possible future of 16 $\frac{2}{3}$ rpm records. This is the speed at which the new "Highway Hi-Fi" records revolve and the speed has also been used in making the "talking books" for the blind. My own opinion is that there are many formidable technical problems to be licked to make 16 $\frac{2}{3}$ rpm records of as high a quality as current LP's, to say nothing of the fact that the record industry is prospering too well to risk upsetting their economic appercept by the introduction of a new speed. The two-speed feature is *Fairchild's* thoughtful precaution against obsolescence and, as such, will be appreciated by careful buyers. Needless to say the halving of speed also gives you 22 $\frac{1}{2}$ and 39 rpm . . . so in case some wild-eyed engineer dreams up something at these speeds, you've got him whipped!

Some months ago, I reported to you on the introduction by *Pickering* of a half mil stylus for LP. I commented at the time that specialized styli by other manufacturers would probably be forthcoming. A new *Fairchild* cartridge makes use of an elliptical stylus rather than the conventional round type, and *Pickering* has made a slight modification in its half mil stylus. As soon as I get more information and clear up some other matters, I'll bring you up to date on these developments.

Before swinging into the reviews, one other thing requires comment and that is the long expected flowering of recorded tape as an important media for music reproduction. Heretofore a tiny trickle of material of indifferent quality, we are finally getting tapes of superior musical and technical quality, and while quantity-wise there is no flood, there is a steady and growing stream of new releases. In the past few months we have seen the introduction of tapes on the *Berkshire* label, which utilizes the catalogues of the *Haydn Society* and *Urania Records*, *Sonotapes* made from *Westminster* masters, *Phonotapes* using the *Vox* and *Philharmonia* catalogues, and others. Stereotapes are really booming, with releases due from the aforementioned sources, a half dozen new tapes from *Victor*, big name pioneer in stereotapes who is going to release at least one new stereotape every month from now on, the imminent release of *Angel* stereotapes with monaural also on the agenda, and strong and persistent rumor has it that before the year is out, we will have stereo from *Columbia*, *Capitol*, *London*, and *Mercury*! To which we can all shout Hallelujah! As soon as I have anything more concrete on these developments, I'll shoot you the word.

Equipment used this month: *Weathers* arm, cartridge, and oscillator, *Fairchild* "Turromatic" turntable, *Marantz* audio consolette, *Scott* 70-watt amplifier, *McIntosh* 60-watt amplifier, *Jensen* "Imperial" and *Electro-Voice* "Georgian" speakers, *Ampex* 600, and *Ampex* 612 (stereo) tape equipment.

GUITAR MUSIC OF LATIN AMERICA

Laurindo Almeida, guitarist. Capitol 8321. RIAA curve. Price \$3.98.

Lovers of the classical guitar will welcome this new recording by talented Laurindo Almeida, whose previous "Guitar Music of (Continued on page 160)

NO. 57

PYRAMID

technical

bulletin

THERE IS MORE TO A CAPACITOR THAN ITS DESIGN FORMULA:

$$C = \frac{K D}{A}$$

Pyramid's production and life tests of their capacitors are among the most stringent in the industry. Production test for voltage breakdown, capacitance, power factor, insulation resistance and seal are performed on 100% basis. In consisting of life, temperature and immersion cycling, vibration, and corrosion where applicable. These serve to guarantee that the capacitors you purchase are consistently as represented to be.

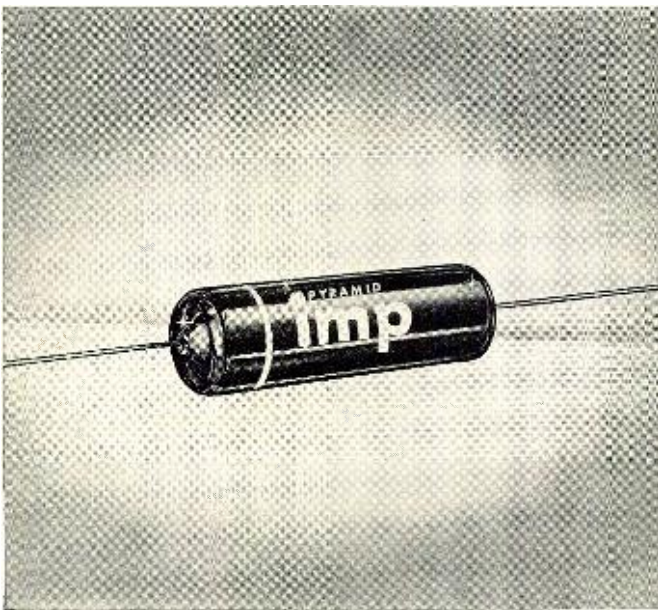

Pyramid capacitors also owe their exceptional performances to the type of materials used in their manufacture and the production methods which Pyramid engineers have devised. For example, in the new Pyramid IMP capacitor, a new, exclusive plastic molding technique was developed which bonds casing, impregnated element, and tinned copperweld leads into one compact assembly capable of withstanding severe physical abuse. In addition, this unit is heat and moisture resistant withstanding the RETMA humidity-resistance test to a remarkable degree. In another capacitor, type MT metallized paper units, vacuum impregnation is employed and the ends of the capacitor are sealed with plastic. Then, as a final step, the entire unit is completely coated with a highly moisture resistant wax. It is production techniques such as these which, in conjunction with high quality papers, impregnants (such as Halowax, Mineral Oil, or Silicone Base Synthetic Oil), and metals, that account for the excellent stability and long life that Pyramid capacitors exhibit.

Pyramid capacitors, particularly electrolytic capacitors, are specifically designed for long shelf life. To achieve this goal requires that the various materials and chemicals used in the manufacture of these units possess a high quality and long term stability. Another contributing factor to long shelf life is the care which is taken to provide maximum protection against the corrosive effects of chemicals in the atmosphere. This necessitates a container which is well insulated against the intrusion of moisture, i.e., one which is air tight and hermetically sealed.

* * * *

The number of different types of capacitors that Pyramid manufactures is extensive. Included in this line are the following:

1. Electrolytic capacitors, type TD, with each unit sealed in a metal tubular case. Available in single sections, dual sections, and triple sections.
2. Electrolytic capacitors in screw base metal containers, type MC. Available in single and dual sections.
3. Twist-Mount electrolytic capacitors, type TM. Available in single, dual, and triple sections. Different sections may have different working voltages.
4. HI-TEMP Twist-Mount Electrolytic capacitors, type TWH. Designed for 100°C operation.
5. Dry Electrolytic capacitors in wax-filled, impregnated cardboard tubes, type CDB. Available in single, dual, and triple sections. Sections may possess individual leads or share a common negative terminal.
6. Plug-in Electrolytic capacitors, type DO, provided with 4 pins on standard octal base.
7. High-capacitance, low voltage electrolytic capacitors, type PFB.
8. Molded tubular paper capacitors, type IMP.
9. Miniature tubular paper capacitors. Type 85LPT.
10. Ceramic-cased tubular paper capacitors, type CT.
11. Bathtub-Type Oil-Paper Capacitors, types PDM, PDMT, PDMB.
12. Metal-tubular Oil-Paper capacitors, types PTIM, PTDMV, 4PTIM, 4PTIMV, 7PTIM.
13. Small-base oil-paper capacitors, types PKM, PKMF, PKMS, PKMT, and PKMB.
14. High-voltage oil-paper capacitors, types PLM, PLMF, PLMS, PLMU, PLMR.
15. Kraft-tube metallized paper capacitors, type MT.
16. Metal-can metallized paper capacitors, types MPKG, MPGM.
17. Metal-tube metallized paper capacitors, types MPTIK, MPTIM.
18. "Glasseal" subminiature paper tubular capacitors, and many others.

Pyramid capacitors are competitive in price because of the modern production methods that are employed throughout every phase of capacitor production. Whenever possible, automation techniques are being applied so that more uniform high quality may be achieved. Much of Pyramid's success is due also to the aggressiveness of Pyramid engineers in pioneering new products.

PYRAMID ELECTRIC CO. North Bergen, New Jersey



FOR COMPLETE DATA SEND FOR ENGINEERING BULLETIN—FORM IMP-2

SEE US IN BOOTH 213
AT THE MAY PARTS SHOW

PYRAMID IS THE BIG NAME IN CAPACITORS AND SELENIUM RECTIFIERS TODAY!

www.americanradiohistory.com

Your choice of school is highly important to your career in



INDUSTRIAL ELECTRONICS



RADIO



TELEVISION

Become an
ELECTRICAL ENGINEER
or an
ENGINEERING TECHNICIAN
at

MSOE in Milwaukee

Choose from courses in:

ELECTRICAL ENGINEERING
Bachelor of Science degree in 36 to 42 months with a major in electronics or electrical power.

ELECTRICAL TECHNOLOGY
Engineering Technician certificate in 12 months in electronics, radio, or electrical power;

Associate in Applied Science degree in 18 months in radio and television.

TECHNICAL SERVICE

Service certificate in 6 months in electricity; in 12 months in radio and television.

MSOE — located in Milwaukee, one of America's largest industrial centers — is a national leader in electronics instruction — with complete facilities, including the latest laboratory equipment, visual aid theater, amateur radio transmitter — offers 93 subjects in electrical engineering, electronics, radio, television, electrical power, and electricity.

Advisory committee of leading industrialists. Courses approved for veterans. Over 50,000 former students. Excellent placement record.



TERMS OPEN JULY, SEPTEMBER, JANUARY, APRIL

Choose wisely — your future depends on it. Write for more information today!

MILWAUKEE

SCHOOL OF ENGINEERING
Dept. RN-556 1025 N. Milwaukee St.
Milwaukee 1, Wisconsin

Send FREE career booklets on:

Electrical Engineering Radio-Television

I am interested in..... (Name of course)

Name..... Age.....

Address.....

City..... Zone..... State.....

If veteran, give discharge date.....

MS-31

Germanium Diode Broadcast-Band Tuner



Although basically a crystal receiver, it is one of the best to date. Its broad bandpass, with no tube noise or a.c. hum, makes it adaptable to many applications. It is ideally suited for recording AM broadcasts off-the-air.

IN THESE days of multi-tube and multi-stage radio receivers, the simple germanium-diode b.c. tuner recently introduced in kit form by J. W. Miller Company, 5917 S. Main St., Los Angeles 3, California is of interest.

Designed to be used with a high gain amplifier or preamp, the receiver is most effective when used with a 75-ft. long-wire antenna. Although some extremely distant reception has been reported, the set operates best on stations within a 25 mile radius.

The No. 565 tuner can be used with an earphone, if desired, but in this case a good ground connection is required.

The kit includes all parts and instructions for assembly. It sells for \$14.70 at radio and TV parts distributors throughout the country. It is easily assembled and the results justify the effort involved.

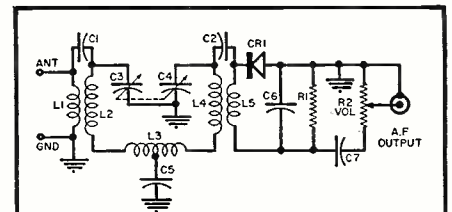

- R₁—100,000 ohm, 1/2 w. res.
- R₂—1 megohm volume control
- C₁—15 μfd., 100 v., coupling capacitor (antenna)
- C₂—10 μfd., 100 v. coupling capacitor (r.f.)
- C₃, C₄—2-gang vernier capacitor (Miller #565-8)
- C₅—.1 μfd., 100 v. capacitor
- C₆—200 μfd., 100 v. capacitor
- C₇—.05 μfd., 100 v. capacitor
- L₁—250 μhy. loading coil (Miller #565-38)
- L₂, L₃—Ferramic coil (Miller #565-30)
- L₄—Mutual coupling coil (Miller #565-12)
- L₅—Ferrite choke coil (Miller #565-36)
- CR₁—1N34 crystal diode

Schematic diagram of crystal AM tuner.

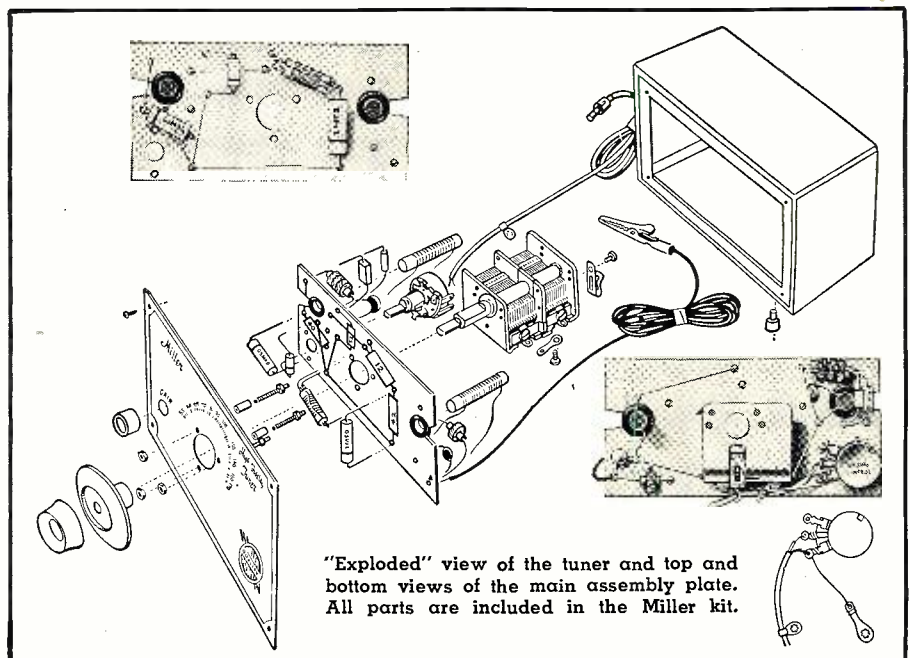

"Exploded" view of the tuner and top and bottom views of the main assembly plate. All parts are included in the Miller kit.

abacus



昨日之最好者

honorable ancestor of the UNIVAC

In theory many centuries have gone into the development of the Univac®. Only recently, at Remington Rand Univac, has it achieved product perfection. The tremendous strides forward in the past few years are due to the imagination and creative genius of the scientists and engineers of Univac. Recognized leaders in the field of electronic computer systems, they are the men *who set the standards for others to follow*. You can become a member of this team

... where ambition and professional skill find their reward in limitless opportunities in an expanding organization.

Immediate openings for:

FIELD LOCATION ENGINEERS with a college degree in a scientific or engineering field and experience in electronics. Extensive electronic background may substitute for some college. Many opportunities for rapid advancement.

FIELD LOCATION TECHNICIANS with technical school background and preferably some experience in electronics. These positions can lead to full engineering responsibility.

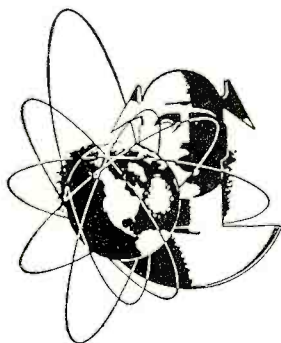

© Registered in U. S. Patent Office

Send complete resumé to

Remington Rand Univac

DIVISION OF SPERRY RAND CORPORATION

AT ANY ONE OF THESE THREE PLANT LOCATIONS

MR. D. A. BOWDOIN
Dept. MP-9
2300 W. Allegheny Ave.
Philadelphia, Pa.

MR. KURT PINKE
Dept. MS-9
1902 W. Minnehaha Ave.
St. Paul W4, Minn.

MR. FRANK KING
Dept. MN-9
Wilson Avenue
South Norwalk, Conn.

Pilot

designed
a
\$90 amplifier
and
produced it
to sell for

\$69⁵⁰

slightly higher West of Rockies.



with built-in phono preamp
and dual tone controls

illustrated with metal enclosure

\$4.95 additional

PILOT Radio Corp. Dept. TE-4
37-06 36th St., L.I.C. 1, N.Y.

Please send me complete information
about the Pilot AA-903 Amplifier.

Name

Address

City Zone State

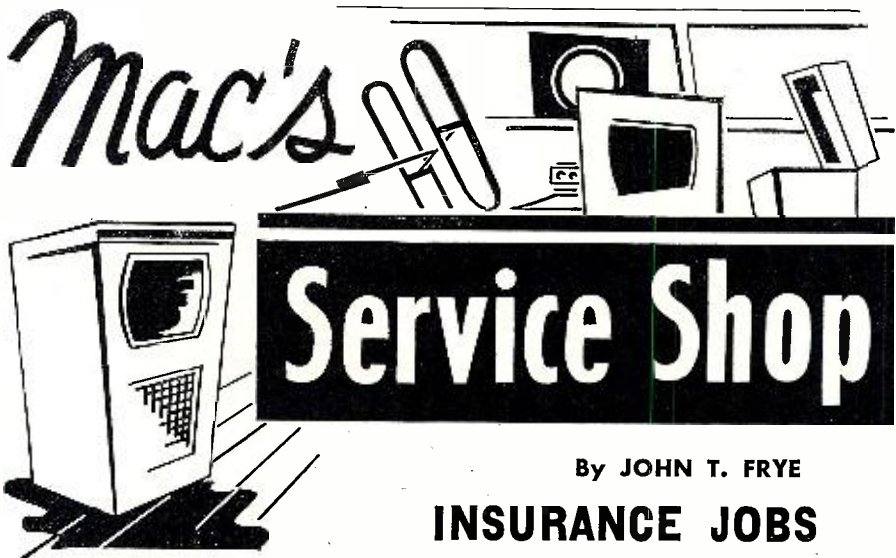

By JOHN T. FRYE

INSURANCE JOBS

BARNEY glanced down the workbench to where Mac, his boss, had the clock out of a clock radio and was apparently dismantling it.

"It's not enough that we radio-TV technicians must be electricians, roof-monkeys, salesmen, and furniture refinishers," Barney said with a sigh; "now we apparently must be jewelers, too. Do you really think you can repair a clock?"

"I know I can repair this one," Mac answered as he removed the motor field winding. "The only trouble with the clock is that lightning burned open this winding. I managed to get a new winding which I am now installing."

"How do you know lightning did it?"
"That's a good question and the same one asked by the customer's household fire insurance agent. In this case, fortunately, it was easy to answer."

As he said this Mac reached over and turned the small radio chassis upside down. The capacitor that went from the line switch to the opposite side of the line was blown apart, and a large scorched area on the chassis directly below showed clearly the effect of the flash of fire that must have accompanied the "blowing" of the capacitor.

"This visual evidence, backed up by the customer's story that a flash of fire and a puff of smoke came out the back of the set at the same instant lightning struck nearby might all be called circumstantial evidence; but, as Thoreau remarked, 'Some circumstantial evidence is very strong, as when you find a trout in the milk.'"

"Did the clock stop at the same instant?"

"That's right. Incidentally, a new clock listed at about seventeen dollars, and that is what the distributor wanted to sell me. He said he could not furnish individual clock parts. Most clock-radio manufacturers buy the clocks as units from a clock manufacturer, and the only way the radio distributor could furnish a new coil would be to take it out of a clock he had in stock. This would leave him

stuck with the rest of the clock. However, I wrote to the company that made the clock and asked them to send me a coil C.O.D., which they did for about one-tenth the price of a new clock. That's worth keeping in mind, for we are likely to get more of these burned-out-clock cases now that the thunderstorm season is starting."

"The insurance company will have to pay for this job without question, but what would you have done if the clock had been out but you did not have the other visual evidence of lightning? The coil *could* have opened by itself, you know. There must be many similar cases in which you are the one to decide whether the repair job is on the customer or on his insurance company. How do you handle such decisions?"

"To answer that and other questions that are bound to bubble out of you, let's just take a typical case right from the beginning. Suppose a customer brings in a set he says has not played since the last lightning storm. I make a note on the tag to check for possible lightning damage. If any is found, I call the customer and ask if he has insurance. If he has, I suggest that he call his insurance company and see if they want to inspect the set. Usually they do not. They simply call me on the phone and ask if I think lightning did the dirty work. If I say Yes, they take my word for it. Even when I candidly admit I cannot be sure, they often say to go ahead and repair the set and send the bill to them. Occasionally a company that does not know me will send a man around to look at the set. In this case I explain what I have found and point out any evidence of lightning's having been in the set. The decision is entirely up to him. In all of these cases, I feel that I have done my best to see that my customer receives all that is coming to him. It always surprises me to discover how many people do not realize that their insurance covers damage to their radio and TV sets from lightning."

"Yeah, but what do you do with the

RADIO & TELEVISION NEWS

wise guy who deliberately sets out to rook the insurance company? You know the kind I mean. They tell *you* that the set was damaged by lightning, slyly mention that you can pad your bill because an insurance company will pay it, etc., etc."

"Fortunately we do not run across many of those, but when one does rear his ugly head I simply reply that unless I find some evidence of lightning damage I cannot say it is an insurance loss. If the fellow wants to take his set elsewhere, he is perfectly free to do so.

"And about that business of padding the bill when an insurance company is paying it: that is strictly for the birds. You can't be 'almost honest.' It is just as crooked to pad a bill for an insurance company as it is to pad the bill for a poor widow, even though you may be able to build up a better sentimental defense of one than the other. Take the case of this clock radio. We could have increased our take by several dollars if we had sold the customer a whole new clock; but by treating the insurance companies just as fairly as we do our oldest customers, we have won their confidence. Very often when the insurance agent is called in first he sends the business to us because he knows his company will get a square shake here. So, if you just want to look at the thing purely from Ben Franklin's practical point of view, honesty is still the best policy."

"Is there any difference in billing and getting your money for these insurance jobs?"

"I usually make out the bills in triplicate on those *Dave Rice Order Book Forms*. One copy goes to the customer; one goes to the insurance company; and the third stays in our files. The charges are carefully itemized, and mention is made of the fact that 'Repair of lightning damage' was performed. The insurance company ordinarily sends the check to their insured; and it often takes two or three weeks for the check to come through. That means that you must exercise a little caution in securing your pay. The best idea is to have your customer pay you when he picks up the set and to give him both his own bill and that for his insurance company marked 'Paid.' From then on the matter is strictly between him and his company. However, when the bill is pretty good size and when the customer is an old and reliable one, I do not mind waiting until he gets his check."

"Anything else?"

"That's about all. The most important thing is to get an OK from the insurance company *before* you start any repairs. The insurance people may decide to replace the radio or TV set instead of having it repaired. In this case they will still be willing to pay you a fair amount for your appraisal of the damage."

"Not to change the subject, but Sunday right after I got home from
(Continued on page 154)

... another
MALLORY
service-engineered
product

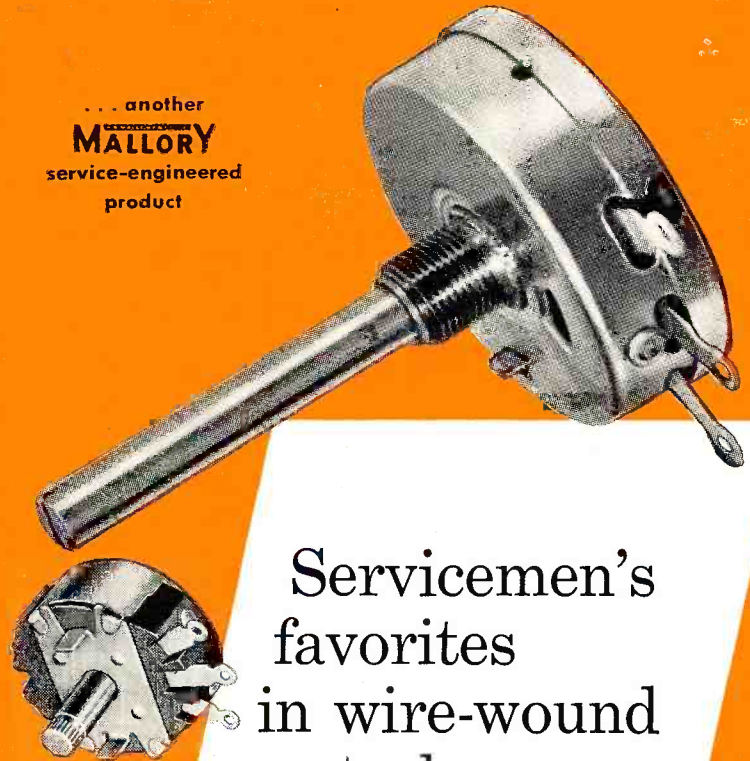

Servicemen's favorites in wire-wound controls

You're sure of giving your customers the best when you use Mallory wire-wound controls. The choice of servicemen and manufacturers everywhere, they have set the standards of the industry for value and performance.

They're conservatively rated—to assure you of cool operation without need for using over-sized units.

They're compact—fit readily into crowded chassis locations.

They're long lasting—give years of stable, dependable service.

They're uniform—made to strict specifications to meet or exceed original equipment requirements.

Mallory 2-watt and 4-watt controls are available in resistance values and tapers to match every replacement need. Your local Mallory distributor has a complete stock—see him today!

P. R. MALLORY & CO. Inc.
MALLORY

P. R. MALLORY & CO. Inc., INDIANAPOLIS 6, INDIANA

- Capacitors
- Controls
- Vibrators
- Switches
- Resistors
- Rectifiers
- Power Supplies
- Filters
- Mercury Batteries

1955 Edison Radio Amateur Award Winner

*Bob Gunderson, W2JIO,
blind amateur, wins
award for designing
more than thirty instru-
ments for the blind.*



Bob Gunderson uses a special continuity checker he designed to check a new circuit for blind.

MERIT, first in exact and universal replacement transformers, yokes, coils—the only manufacturer of transformers, yokes and coils who has complete production facilities for all parts sold under their brand name.

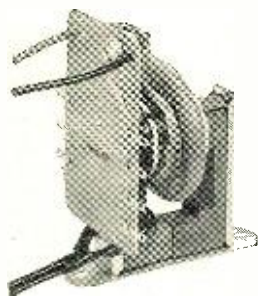

THE winner of the 1955 Edison Radio Amateur Award is a popular choice throughout "hamdom" since the honor goes to Robert W. Gunderson, W2JIO.

Bob, who has been blind since birth, was honored for his contributions in designing some 30 types of special radio test instruments for the blind. These instruments not only open the entire field of electronics to the blind as an occupation but they salvage manpower for this all-important field which plays such a vital role in everyday living. Bob also edits and publishes the only electronics magazine for the blind which is read by 5000 sightless persons. In addition he has translated many electronics reference books into Braille.

Bob teaches three nights a week at the New York Institute for the Education of the Blind and works three days a week as a radio consultant in the New York City store of Hudson Radio & Television Corp. He commutes to his various jobs from his apartment in the

Bronx. He moves about the city without the aid of a guide dog or cane.

Among the instruments that Bob has developed for the benefit of the sightless are a checker adapter, phase-meter, "Q" meter, inductance and capacitance bridges, field strength meter, grid dip oscillator, etc.

As "Ham of the Year," Mr. Gunderson received the trophy and a check for \$500.00 at the special Award Banquet held at the Mayflower Hotel in Washington in February.

The award and banquet, sponsored by the Tube Department of General Electric Company, are annual affairs. In addition to Mr. Gunderson, eight other amateurs were cited for their outstanding public services. Thirty-three amateurs were nominated for the 1955 award. A committee of four: Herbert Hoover, Jr.; FCC Commissioner E. M. Webster; E. Roland Harriman of the Red Cross, and G. L. Dosland, president of the ARRL, selected the winners.

—30—

HVO-42 FOR EXACT REPLACEMENT IN CBS-COLUMBIA.

Another in the complete MERIT line of exact and universal replacements—the only single source for all your transformer and coil requirements.

Merit

MERIT COIL & TRANSFORMER CORP.
4427 NORTH CLARK STREET
CHICAGO 40, ILLINOIS



Bob uses a tube checker with a special reference chart he translated into Braille. Special adapter gives audible indication.



A well-known voice and "fist" among hams is W2JIO. Bob Gunderson operates on several of the amateur radio frequencies.



IN RETURN FOR CHARACTER ... A CAREER

Because the finest single attribute anyone can offer is character, this, basically, is what IBM asks of its people, whatever their special aptitudes or abilities. IBM offers them in return—not just a job—but a career.

IBM electronic field technicians, for instance, receive more than training and early responsibility; they have a chance to work with the world's largest computer, use the latest testing equipment, employ

the finest computer testing techniques yet devised. Above all, they have the satisfaction of joining the electronics industry's most advanced program, destined for long-range national importance.

You could ask for no finer future.

If you are between 19 and 32 and have at least a 2-year technical school background, with emphasis on electronics, you can do important work on COMPUTER INPUT-OUTPUT functions. Write: Nelson O. Heyer, IBM, Room 4305 Neighborhood Rd., Kingston, N. Y.

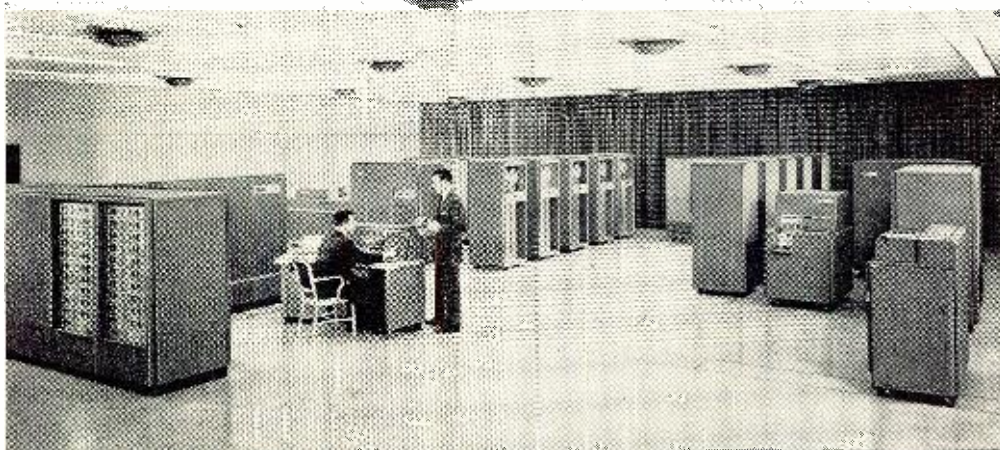

The 702 Electronic Data Processing Machine, typical of advances that have made engineering work at IBM one of the most provocative experiences in electronics.

INTERNATIONAL BUSINESS MACHINES CORPORATION

IBM
®

Producer of electronic data processing machines, electric typewriters, and electronic time equipment.

sions of *Philco Corporation* have named **JOHN E. KELLY** advertising manager. He has been with the firm for seven years . . . The appointment of **J. J. JENSEN** to the post of general manager has been announced by *Nebraska Electronics Manufacturing Company* . . . **WALTER W. SLOCUM** has been elected vice-president in charge of operations of *Daystrom, Inc.* He joined the firm early last year . . . *United Catalog Publishers, Inc.* has created two new positions within the company to help provide maximum service to manufacturers and distributors. **GEORGE M. KERNER** has been named as manufacturers' liaison man while **ROBERT J. MALES** has been appointed planning and research supervisor . . . **GEORGE T. STEWART** has been named distribution manager of *Sylvania's* radio and television division. In this newly-created post, he will maintain headquarters in Buffalo . . . **HOWARD R. PATTERSON**, formerly vice-president and general manager of *Chromatic Television Laboratories*, has joined *Varian Associates* as manager of its production engineering department in Palo Alto, California . . . **PHILIP R. GEFTE** is the new engineering director at *Hycor Company, Inc.*, North Hollywood manufacturer of wave filters, magnetic amplifiers, etc. He was formerly chief filter engineer at *Triad Transformer Corp.* . . . **CHARLES C. CAREY** has been named president of *General Radio Company*, Cambridge, Mass., to succeed **ERROL H. LOCKE** who recently retired. He has been with the company since 1927 . . . **HAROLD F. COOK** has been named director of advertising and market research for *Tung-Sol Electric Inc.* . . . **JAMES H. CARMINE**, president of *Philco Corporation*, has resigned his post but will continue as an active member of the company's board of directors and finance committee. **JAMES M. SKINNER, JR.** will succeed him in the post . . . **FRANK J. SKWAREK** has been elected vice-president of *Polarad Electronics Corporation* . . . **ROBERT L. ASHLEY** has been named sales manager for germanium and silicon products of *Radio Receptor Co., Inc.*

* * *
ROBERT E. KRUEGER has been named marketing manager of *Donner Scientific Company*, Berkeley, California manufacturer of instruments and electronic analogue computers.

Before assuming his new post as head of sales and advertising, Mr. Krueger was sales manager for *Unitek Corp.* of Pasadena and, previously, chief mechanical engineer at *Rutishauser Corp.* also of Pasadena. He was a staff member at Los Alamos Scientific Laboratory and earlier was associated

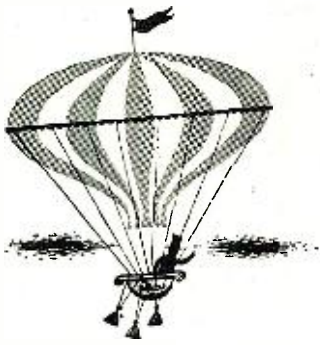

are you up in the air about

FOR DOWN TO EARTH VALUE
WHEATLAND
ELECTRIC-WELD
PRE-GALVANIZED
STRIP-TUBE

For quality at a price—here's masting fabricated of superior dip galvanized strip. The electric weld is removed—and the area is then sprayed with a galvanized coating so that the mast is weather protected.

Made by the Producers of WHETHA-TUBE it is your assurance of quality at a price.

TOPS IN LONG LASTING QUALITY
WHEATLAND
WHETHA-TUBE

HOT DIP GALVANIZED ELECTRIC WELD TUBING

For the man who is quality minded—there is no finer, longer lasting steel masting than WHETHA-TUBE. EACH LENGTH IS SEALED IN MOLTEN ZINC FOR COMPLETE RUST PROTECTION.

The Hot Dip Galvanizing process makes masts corrosion proof, chip and scratch proof—inside and outside. This treatment increases the weight of the mast—and insures longer lasting wear under all atmospheric conditions.

For the very best—specify WHETHA-TUBE!

WHEATLAND TUBE CO.

BANKERS SECURITIES BUILDING • PHILADELPHIA, PA.
MILLS, WHEATLAND, PENNSYLVANIA, DELAIRE, NEW JERSEY

COYNE
TRAINS YOU
IN SPARE TIME
AT HOME

COYNE
QUALITY
TRAINING
AT LOWEST
COST

TELEVISION
RADIO-COLOR TV

Only from famous COYNE do you get this modern up-to-the minute TV Home Training. Easy to follow instructions—fully illustrated with 2150 photos and diagrams. Not an old Radio Course with Television tacked on. Includes UHF and COLOR TV. Personal guidance by Coyne Staff. *Practical Job Guides* to help you EARN MONEY QUICKLY IN A TV-RADIO SALES AND SERVICE BUSINESS—part time or full time. COSTS MUCH LESS—pay only for training—no costly "put together kits."

SEND COUPON FOR FREE BOOK

SEND COUPON BELOW for Free Book and full details including EASY PAYMENT PLAN. NO COST OR OBLIGATION—NO SALESMAN WILL CALL.



B. W. COOKE, Pres.

COYNE
ELECTRICAL SCHOOL

FOUNDED 1899

A TECHNICAL TRADE INSTITUTE OPERATED NOT FOR PROFIT
500 S. Paulina Dept. 56-HT-5 Chicago 12, Illinois

COYNE ELECTRICAL SCHOOL
Television Home Training Div.
500 S. Paulina St., Chicago 12, Ill., Dept. 56-HT-5

Send FREE BOOK and details of your Television Home Training offer.

Name _____

Address _____

City _____ State _____

SELF SELECTING

ELSCO

NOISE REDUCING ANTENNAS

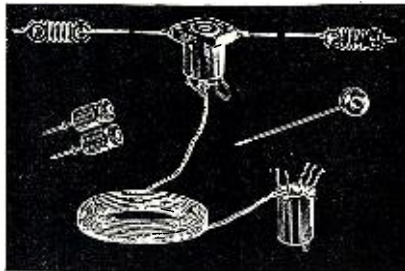

\$14.25 List

For years, the answer to noise-free reception for AM and FM Services—Engineered for peak performance in the Broadcast-Intermediate Short Wave and FM Bands. Recommended and used by government agencies, public institutions, schools, Shortwave listeners. Hams and many others who demand the best in reception, under the worst of conditions—Only ELSCO still manufactures such an antenna system that is automatically tuned to the signal you select for maximum performance.

Also available is the ELSCO Master Antenna Systems capable of handling from 15 to 25 or more outlets, (depending on strength of available signal) without amplifiers or power supplies. Ask for special bulletin. Antennas cut for any special service bands.

Write now or contact your favorite Distributor.

ELECTRONIC SPECIALTIES MFG. CORP.

76 Irving Street Worcester 10, Mass.

HERE IT IS...

BY **REPLICA**

A SERIES OF MODERN LONG PLAYING HIGH FIDELITY RECORDINGS
New Adventures in Sound

UNUSUAL RECORDINGS

for the Discriminating *Hi-Fi* Record Collector

AUDIO FIDELITY RECORDS presents
Studies in HIGH FIDELITY sound

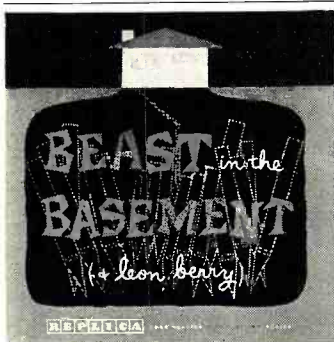

BEAST IN THE BASEMENT

Leon Berry removed a Mighty Wurlitzer Pipe Organ from a theatre and has it set up in the basement of his house, console, hundreds of pipes, glockenspiels, drums, klaxon and all. The sound is enormous; the dynamic range, utterly fantastic. Greatest yet!!

REPLICA 509 12-in. \$5.95

FABULOUS EDDIE OSBORN
 The "hit" of this season's Hi-Fi Shows. This album abounds in big sound and a sprightly mixture of polyphonic effects unique on a Mighty Wurlitzer Pipe Organ.
 REPLICA 511 12-in. \$5.95

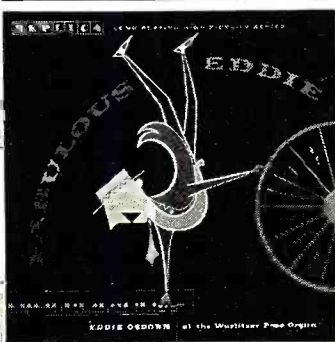

AL MELGARD AT THE CHICAGO STADIUM ORGAN

This is the world's largest unit pipe organ. A triple challenge for the modern audio system.

VOL. 1—REPLICA 504 12-in. \$5.95
 VOL. 2—REPLICA 510 12-in. \$5.95



THE BRAVE BULLS! — La Fiesta Brava
 Music of the Bullfight Ring

Featuring the "Banda Taurina" of the Plaza Mexico world's largest bullfight arena. A Hi-Fi presentation of an afternoon at the bullfights. Complete with book of 24 full color Bullfight Poster Reproductions. "brilliant engineering", High Fidelity.

AUDIO FIDELITY AFLP 1801 12-in. \$5.95

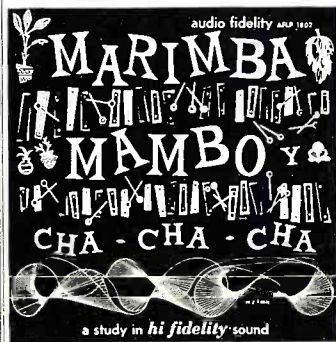

MARIMBA MAMBO y CHA-CHA-CHA
 The scintillating tropical rhythms of a 6 man Marimba plus orchestra. A Total Frequency Range Recording of the latest and greatest Latin dance tunes.
 AUDIO FIDELITY AFLP 1802 12-in. \$5.95

BAWDY SONGS and BACKROOM BALLADS

Oscar Brand, noted balladeer sings Folk-Americana often heard but never recorded. Rollicking songs for people with lusty appetites and strong musical tastes.

VOL. 1—AUDIO FIDELITY AFLP 906 10-in. \$4.00
 VOL. 2—AUDIO FIDELITY AFLP 1806 12-in. \$5.95



MATINEE
 Arsene Siegel at the Great Oriental Theatre Organ. Depth of feeling and limitless tonal resources.
 REPLICA 513 12-in. \$5.95

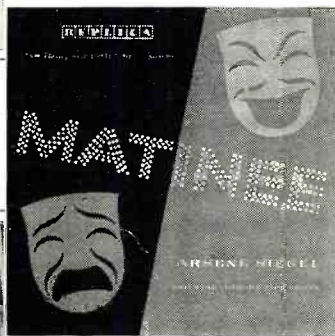

GLOCKENSPIELS, TRAPS and PLENTY OF PIPES

The greatest Hi-Fi demonstration records ever made. "Sounds never before committed to record" — High Fidelity Magazine.

VOL. 1—REPLICA 501 10-in. \$4.00
 VOL. 2—REPLICA 503 10-in. \$4.00
 VOL. 3—REPLICA 505 10-in. \$4.00
 VOL. 4—REPLICA 507 10-in. \$4.00

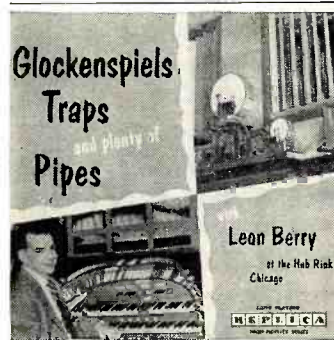

THE TALBOT BROTHERS of BERMUDA

The greatest tourist attraction that ever happened to any island, bar none. Calypso rhythms and pop favorites in an idyllic tropical setting.

VOL. 2—AUDIO FIDELITY AFLP 903 10-in. \$4.00
 VOL. 3—AUDIO FIDELITY AFLP 1807 12-in. \$5.95

STRINGS OF PEARL
 Pearl Chertok, harpist on the Arthur Godfrey Show plays a rare combination of the sophisticated and the primitive with the drum rhythms of Johnny Rodriguez. An absolutely captivating recording.
 AUDIO FIDELITY AFLP 1805 12-in. \$5.95



ENJOY THESE REPLICA HIGH FIDELITY RECORDINGS

JOHNNY HAMLIN JAZZ QUINTET	REPLICA 1000	10-in.	\$4.00
MEMORIES OF OLD VIENNA (Zither)	200	10-in.	4.00
BILL KNAUS PLAYS "SWELL" to "GREAT"	508	10-in.	4.00
HELEN'S HOLIDAY (Pipe Organ)	512	10-in.	4.00
ORGAN ECHOES with KAY McABEE	506	10-in.	4.00
HAL PEARL, ARAGON PIPE ORGAN	502	10-in.	4.00
THE LATIN SET, (Pipe Organ Tropicale)	500	10-in.	4.00

studies in HIGH FIDELITY sound

MERENGUES	AUDIO FIDELITY AFLP 905	10-in.	\$4.00
DRUMS OF THE CARIBBEAN	AFLP 902	10-in.	4.00
CIRCUS CALLOPE MUSIC	AFLP 904	10-in.	4.00
MERRY GO ROUND MUSIC	AFLP 901	10-in.	4.00
TRINIDAD STEEL BAND	AFLP 1809	12-in.	5.95
LORD INVADEE, CALYPSO	AFLP 1808	12-in.	5.95
KATHERINE DUNHAM, DRUMS OF CUBA-HAITI-BRAZIL	AFLP 1803	12-in.	5.95

These records are available at your favorite Audio or Record Shop

Nationally distributed by

DAUNTLESS INTERNATIONAL

DEPT. RT

750 TENTH AVE.
 NEW YORK 19, N. Y.

WRITE FOR
 FREE CATALOGS

Only

Natural Gems
qualify for
Fidelitone
diamond phonograph needles

Fidelitone Diamond Phonograph Needles are made from natural gem stones—not splints (cut-offs from larger diamonds). In our own plant, Fidelitone diamond tips are ground and finished to exacting shape specifications—then given a special micropolish.

Because of their precise shape and polish, Fidelitone Diamond Phonograph Needles give maximum performance, yet *prolong* record life (unlike imperfectly finished diamonds).

You can recommend Fidelitone Diamond Needles without reservation. They are *guaranteed*. See your Fidelitone distributor.

*Jewels Courtesy
C. D. Peacock, Jewelers, Chicago*

PERMO, INC. CHICAGO 26, ILLINOIS
26 YEARS OF LEADERSHIP IN SOUND REPRODUCTION

LEARN TV SERVICING
UHF—COLOR—VHF

Master the latest, up-to-the-minute TV and Color TV developments.

You can Earn to \$5,000-\$10,000 a year in TV servicing after a few short months. Education or age is no barrier. Find out how you can EARN WHILE YOU LEARN in our big Shops and Laboratories. You work with the latest equipment. Waste no time with Non-Essentials, Math or Design Theory. Complete information in our new FREE booklet. Address Dept. 4-56-R. Approved for veterans. Free Placement Service.

WESTERN TELEVISION INSTITUTE
341 W. 18th St. Los Angeles, Calif.

Dept. 5-56-R
Mail me information about training.
Name ..
Address ..

MUST HAVE FOR CURRENT ORDERS
PHONE COLLECT

BC-312	BC-314	BC-610
BC-342	BC-344	T-47/ART-13
R-5/ARN-7	ARC-3	ATC/ART-13

SEMLER INDUSTRIES INC. Stanley 7-1554
6853 Lankershim Blvd. North Hollywood, Calif.

SPECIAL "HI-FI" OFFER!

Amazing woven saran Hi-Fi fabrics now available direct to every Hi-Fi enthusiast. Special yarns and constructions mean least distortion. In Mahogany, Walnut, or Blond at the special **INTRODUCTORY PRICE** of \$3.19 Ppd., per Sq. Yd. Money back guarantee. Send check or M.O. to **HI-FI FABRICS INSTITUTE**
P. O. Box 15B, Huntington Station, New York

with Beckman Instruments and Douglas Aircraft in engineering capacities.

He is a member of IRE, AIEE, and ASM, and the author of four books and various technical papers. He will make his headquarters in Berkeley.

* * *

RETMA has scheduled an electronic components symposium at the Department of Interior Auditorium, Washington, D. C. for May 1 through 3. This will be the seventh in a series of annual technical meetings devoted to electronic components.

Sponsored by the AIEE, the IRE, RETMA, and WCEMA with the active participation of the Department of Defense and the National Bureau of Standards, the three-day program will be divided into seven sessions, including an evening session devoted to electron tubes and solid state devices.

Arrangements are under the direction of A. W. Rogers, U. S. Army Signal Corps, Fort Monmouth, N. J. and the technical program is being developed under the supervision of P. S. Darnell of Bell Telephone Laboratories.

* * *

MERLE W. KREMER has been appointed assistant general manager of *Sylvania Electric's* Parts Division with headquarters in Warren.



In addition to his new responsibilities, Mr. Kremer will continue his present duties as general manufacturing manager of the division. He joined the company last year. Prior to that he was assistant to the president of *Allied Products Corporation* of Detroit and from 1942 to 1952 he served in various executive and staff positions with *General Electric's* Lamp Department in Cleveland.

* * *

URSI and the IRE are co-sponsoring the annual Spring Meeting held at the National Bureau of Standards in Washington, April 30, May 1, 2, and 3.

A combined technical session of interest to all participants is scheduled for the morning of May 1 to be followed by one or more sessions in each of the following fields: radio measurements and standards, radio and troposphere, ionospheric radio, radio noise of terrestrial origin, radio astronomy, radio waves and circuits, and radio electronics.

Write John P. Hagen, secretary, USA National Committee URSL, National Research Council, 2101 Constitution Ave., N. W., Washington 25, D. C. for a complete schedule.

* * *

ARMOUR RESEARCH FOUNDATION of Illinois Institute of Technology has scheduled a conference on Industrial Nuclear Technology at the Museum of Science and Industry, May 15 and 16, in Chicago.

This meeting is one of several scheduled by the Foundation as part of its 20th anniversary celebration.

Excitingly new

"LIVING SOUND" IS YOURS TO ENJOY
WITH NORELCO *F.R.S.*

FULL RESONANCE TWIN-CONE SPEAKERS

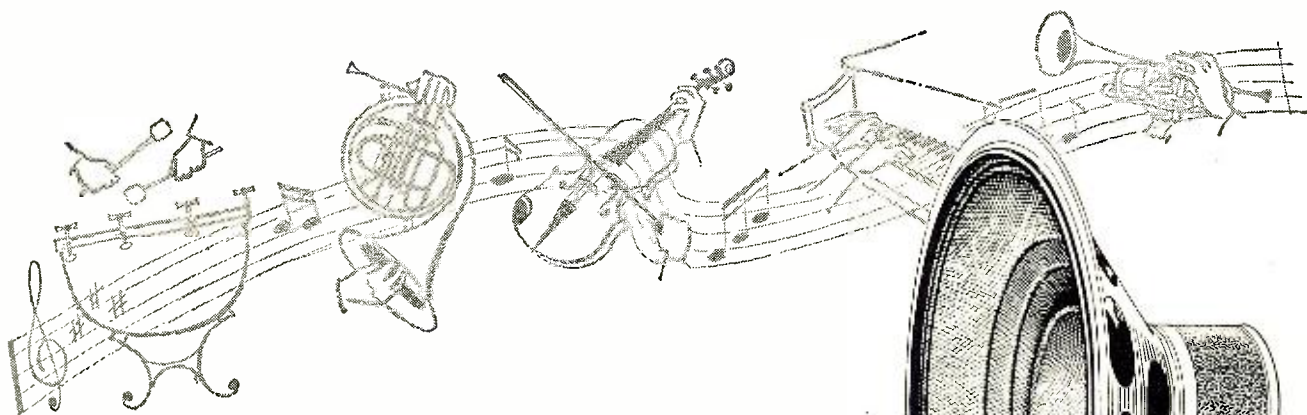

High fidelity and tonal qualities associated with expensive multi-unit speaker systems— are similarly produced with new Norelco FRS Twin-Cone Speakers.

Norelco's exclusive Twin Cones are made from specially selected and matched materials— operated from the same magnet and voice coil —some covering an extremely wide range up to 20,000 c/s. Norelco's twin-cones are always in phase and operate in harmony—providing the same degree of efficiency under all conditions.

Unequaled manufacturing precision and quality is inherent in all Norelco speakers. All component materials—including magnets, wire and even cone materials—are manufactured and assembled by Philips to suit a specific speaker design.

Many sizes in standard impedances are available from your dealer or send to Dept. G5 today for more details. Norelco FRS speakers are priced from \$59.98 to \$9.90 audiophile net.

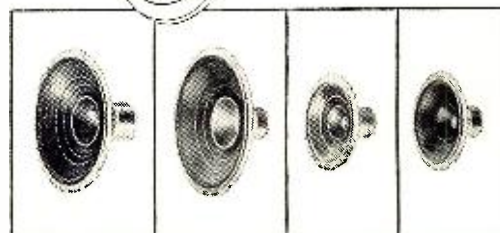

Add to...and improve any sound system
with *Norelco*

***FULL RESONANCE SPEAKERS**



NORTH AMERICAN PHILIPS CO., INC., 100 East 42nd Street, New York 17, N. Y.

symphony in sound

Sound by Stephens is always noteworthy when selecting the finest in superlative speaker systems. Designed, constructed, and tested by the pioneer sound engineers in high fidelity equipment, the name Stephens stands for true fidelity with music listeners the world over. Each pictured note represents quality speakers and components that will insure the listener a true symphony in sound. Consult your Stephens dealer as to a recommended Tru-Sonic speaker system for your particular needs.

 For name of dealer nearest you, write:
 STEPHENS MANUFACTURING CORP.
 8538 WARNER DRIVE/CULVER CITY, CALIFORNIA

CABLE ADDRESS: "MORHANEX" EXPORT ADDRESS 458 BROADWAY, NEW YORK 13, NEW YORK

General information about this and other conferences can be obtained by writing Joseph J. Kowal, Conference Secretary, Armour Research Foundation, 10 W. 35th Street, Chicago 16, Illinois.

* * *

IRE'S Dayton Section and the Professional Group on Aeronautical and Navigational Electronics are co-sponsoring the Eighth National Conference on Aeronautical Electronics which will be held at the Hotel Biltmore, Dayton, Ohio on May 14, 15, and 16.

The official mailing address for the conference is P. O. Box 621, Far Hills Branch, Dayton 9, Ohio.

* * *

AVERY FISHER, president of *Fisher Radio Corporation*, was unanimously elected chairman of the board of directors of the Institute of High Fidelity Manufacturers for the 1956 term.

A charter member of the Institute, Mr. Fisher has been active in all of the group's activities and most recently served as a member of the Philadelphia Show Committee.

The Institute maintains headquarters at 25 Broad Street, New York 4, New York.

* * *

RETMA'S symposium on reliable applications of electron tubes will be held May 21 and 22 at the Irvine Auditorium of the University of Pennsylvania, Philadelphia.

The session is intended primarily for design engineers. Both military and commercial applications will be covered.

Advanced registrations at \$3.00 are being accepted by the RETMA Engineering Department, 11 W. 42nd Street, New York 36, N. Y. Registration will be \$4.00 at the door.

* * *

SOUTHWEST RESEARCH INSTITUTE of San Antonio will sponsor a conference on the significance of atomic energy in cooperation with the Atomic Industrial Forum.

Sessions will be held May 10 and 11 at the Institute's headquarters at 6500 Culebra Road in San Antonio. Complete details on the conference are available from C. W. Smith of the Institute.

* * *

OHIO STATE'S College of Engineering is sponsoring its Third Annual Conference for Engineers on May 4th in Columbus, Ohio.

The keynote address on "The Creative Age—A Challenge to Engineers" will be delivered by John R. Hoover, president of the *B. F. Goodrich Chemical Co.* of Cleveland, Ohio.

At the luncheon session some thousand or more engineers will hear Dr. Dean E. Wooldridge, president of *Ramo-Wooldridge Corporation* of Los Angeles, present an address on "Systems Engineering."

Write Harold A. Bolz, Assoc. Dean, College of Engineering, Ohio State University, Columbus 10, for further information or reservations.

-50-

wanted career men

Train for a career instead of a job. Demand for our graduates exceeds supply. Effective placement. Modest costs. Small classes. Well-equipped labs. Beautiful campus. Approved for Vets. Enter June, Sept., Jan., March.

Bach. Sci. degree in 27 months
 Complete Radio Eng. courses . . . TV, UHF, FM, Electronics. Also Mech., Civil, Elec., Chem., Aero. Eng. 36-month B.S. in Bus. Adm. (Gen. Bus., Acctg., Motor Transport Mgt.) . . . capable students faster. Prep courses. Write Jean McCarthy, Dir. Adm., for catalog and "Your Career in Engineering & Commerce."

TRI-STATE COLLEGE
 1656 College Avenue, Angola, Indiana

TAPE RECORDERS

Tapes—Accessories
 Nationally Advertised Brands
UNUSUAL VALUES
 Send for Free Catalog
DRESSNER
 69-02 R-174 St.
 Flushing 65, N. Y.

MERITAPE
 Low Cost, High
 Quality Re-
 cording Tape—
 in boxes or
 cans.

**SCHEMATICS—CONVERSIONS
 FOR SURPLUS GEAR**

NEW LIST! MANY ADDITIONS!
 Send stamped, self addressed envelope for List D. Add 25c for chart explaining AN nomenclature. DO IT TODAY!

**R. E. BOX 1220
 GOODHEART BEVERLY HILLS, CAL.**

Heathkits

FOR THE ENTIRE ELECTRONICS INDUSTRY

more than 65 top-quality models to choose from, including such outstanding kit designs as . . .

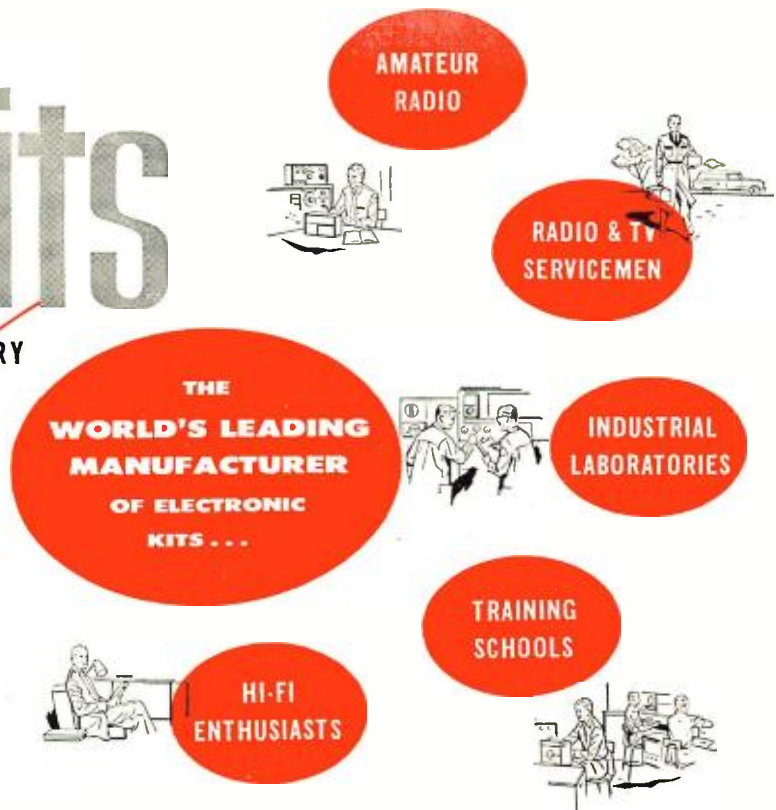

V-7A VACUUM TUBE VOLTMETER: Easily the world's largest selling VTVM. Features peak-to-peak scales—etched metal circuit board—1% precision resistors—full wave rectifier and AC input circuit—reads rms and peak-to-peak AC, DC, and ohms.

O-10 LABORATORY TYPE OSCILLOSCOPE: The world's largest selling oscilloscope kit, and the most successful oscilloscope in history. Designed especially for color and black-and-white TV service work. Its 5 megacycle bandwidth and new 500 Kc sweep generator readily qualify it for laboratory applications. Features easy-to-assemble etched metal circuit board construction.

WA-P2 HIGH FIDELITY PREAMPLIFIER: This is the world's largest selling hi fi preamplifier kit. Features complete equalization, 5 separate switch-selected inputs with individual pre-set level controls, beautiful modern appearance, high-quality components.

HIGH FIDELITY AMPLIFIERS: Five Heathkit Models to choose from at prices ranging from \$16.95 to \$59.75. Power output range from 7 to 25 watts.

DX-100 TRANSMITTER: A 100 watt phone and CW ham transmitter, offering the greatest dollar value available in the ham radio field today.

Greatest Dollar Value Through Factory-To-You Selling!

ONLY **Heathkits** **CAN GIVE YOU ALL**
OF THESE DISTINCTIVE ADVANTAGES!

- ▶ *The Most Complete Construction Manuals for Easy Assembly.*
- ▶ *Originality of Design—Developed Through Pioneering in the Kit Instrument Field.*
- ▶ *Greatest Dollar Value—Finest Quality with Real Economy.*
- ▶ *Direct Contact with Manufacturer—Lower Price, Guaranteed Performance.*
- ▶ *Etched Metal, Prewired Circuit Boards—Save Construction Time, Improve Performance.*
- ▶ *High Quality Standard Components for Long-Life Service.*

HEATH COMPANY

*A Subsidiary
of Daystrom, Inc.*

BENTON HARBOR 15, MICHIGAN

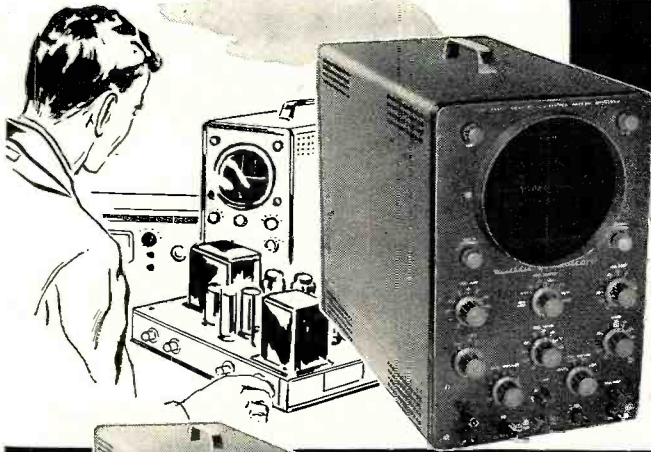

there is no substitute for
HEATHKIT QUALITY

YOU GET MORE: All first-run, top quality parts—the latest in electronic design—complete and comprehensive step-by-step assembly instructions with large pictorial diagrams and assembly drawings. Proven performance through the production of thousands of kits.

MODEL O-10
1

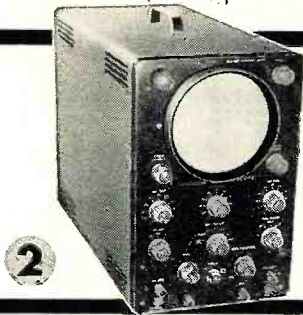

2



3

4

5

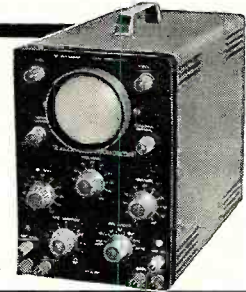

1 *Heathkit* ETCHED CIRCUIT
COLOR-TV
5" OSCILLOSCOPE KIT

This deluxe quality oscilloscope has proven itself through thousands of operating hours in service shops and laboratories. Features the best in components—and the best in circuit design.

Features amplifier response to 5 Mc for color TV work, and employs the radically new sweep circuit to provide stable operation up to 500,000 cps. In addition, etched metal, pre-wired circuit boards cut assembly time almost in half, and permit a level of circuit stability never before achieved in an oscilloscope of this type.

Vertical amplifiers flat within +2 db -5 db from 2 cps to 5 Mc, down only 1½ db at 3.58 Mc. Vertical sensitivity is 0.025 volts, (rms) per inch at 1 Kc. 11 tube circuit employs a 5UP1 CRT.

Plastic molded capacitors used for coupling and bypass—preformed and cabled wiring harness provided.

Features built-in peak-to-peak calibrating source—retrace blanking amplifier—push-pull amplifiers and step-attenuated input.

MODEL O-10
\$6950
Shpg. Wt. 21 Lbs.

2 *Heathkit* ETCHED CIRCUIT
5" OSCILLOSCOPE KIT

This is a general purpose oscilloscope for the more usual applications in the service shop or lab, yet is comparable to scopes costing many dollars more.

Features full size 5" CRT (5BP1), built-in peak-to-peak voltage calibration—3 step input attenuator—phasing control—push-pull deflection amplifiers—and etched metal pre-wired circuit boards.

Vertical channel flat within ±3 db from 2 cps to 200 Kc, with 0.09 V. rms/inch, peak-to-peak sensitivity at 1 Kc. Sweep circuit from 20 cps to 100,000 cps. A scope you will be proud to own and use.

MODEL OM-1
\$4950
Shpg. Wt. 21 Lbs.

3 *Heathkit* LOW CAPACITY
PROBE KIT

Scope investigation of circuits encountered in TV requires the use of special low capacity probe to prevent loss of gain, circuit loading, or distortion. This probe features a variable capacitor to provide correct instrument impedance matching. Also the ratio of attenuation can be controlled.

NO. 342
\$350
Shpg. Wt. 1 Lb.

4 *Heathkit* ETCHED CIRCUIT
SCOPE DEMODULATOR PROBE KIT

Extend the usefulness of your Oscilloscope by observing modulation envelope of R.F. or I.F. carriers found in TV and radio receivers. Functions like AM detector to pass only modulation of signal and not signal itself. Applied voltage limits are 30 V. RMS and 500 V. DC.

NO. 337-C
\$350
Shpg. Wt. 1 Lb.

5 *Heathkit* ETCHED CIRCUIT
3" OSCILLOSCOPE KIT

This compact little oscilloscope measures only 9½" H. x 6½" W. x 11¾" D., and weighs only 11 lbs! Easily employed for home service calls, for work in the field or is just the ticket for use in the ham shack or home workshop. Incorporates many of the features of the Model OM-1, but yet is smaller in physical size for portability.

Employing etched circuit boards, the Model OL-1 features vertical response within ± 3 db from 2 cps to 200 Kc. Vertical sensitivity is 0.25 V. RMS/inch peak-to-peak, and sweep generator operates from 20 cps to 100,000 cps. Provision for r.f. connection to deflection plates for modulation monitoring, and incorporates many features not expected at this price level. 8-tube circuit features a type 3GP1 Cathode Ray Tube.

MODEL OL-1
\$2950
Shpg. Wt. 14 Lbs.

HEATH COMPANY A Subsidiary of Daystrom, Inc. **BENTON HARBOR 15, MICHIGAN**

fill your test requirements WITH HEATHKITS

DESIGNED FOR YOU: *Heath Company test equipment is designed for the maximum in convenience. Besides being functional, Heathkits represent the very latest in modern physical appearance, and incorporate all the latest circuit design features for comprehensive test coverage.*

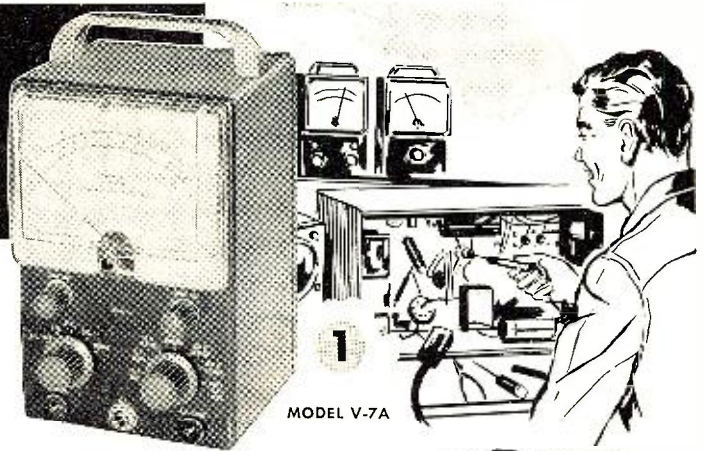

MODEL V-7A



2



3

4

5

6

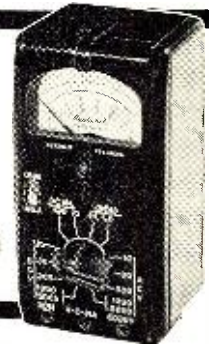

1 Heathkit ETCHED CIRCUIT VACUUM TUBE VOLTMETER KIT

Besides measuring AC (rms), DC and resistance, the modern-design V-7A incorporates peak-to-peak measurement for FM and television servicing.

AC (rms) and DC voltage ranges are 1.5, 5, 15, 50, 150, 500, and 1500. Peak-to-peak AC voltage ranges are 4, 14, 40, 140, 400, 1400, and 4000. Ohmmeter ranges are X1, X10, X100, X1000, X10K, X100K, and X1 megohm. Also a db scale is provided. A polarity reversing switch provided for DC measurements, and zero center operation within range of front panel controls. Employs a 200 μ a meter for indication. Input impedance is 11 megohms.

Etched metal, pre-wired circuit board for fast, easy assembly and reliable operation is 50% thicker for more rugged physical construction. 1% precision resistors for utmost accuracy.

MODEL V-7A
\$2450
Shpg. Wt. 7 Lbs.

3 Heathkit ETCHED CIRCUIT RF PROBE KIT

The Heathkit RF Probe used in conjunction with any 11 megohm VTVM will permit RF measurements up to 250 Mc with $\pm 10\%$ accuracy. Uses etched circuits for increased circuit stability and ease of assembly.

NO. 309-C
\$350
Shpg. Wt. 1 Lb.

4 Heathkit ETCHED CIRCUIT PEAK-TO-PEAK PROBE KIT

Now read peak-to-peak voltages on the DC scale of any 11 megohm VTVM with this new probe, employing etched circuit for stability and low loss. Readings made directly from VTVM scales, from 5 Kc to 5 Mc. Not required for Heathkit Model V-7A VTVM.

NO. 336
\$550
Shpg. Wt. 2 Lbs.

5 Heathkit 30,000 VOLT D.C. HIGH VOLTAGE PROBE KIT

For TV service work or similar application for measurement of high DC voltage. Precision multiplier resistor mounted inside plastic probe. Multiplication factor of 100 on the ranges of Heathkit 11 megohm VTVM.

NO. 336
\$450
Shpg. Wt. 2 Lbs.

2 Heathkit 20,000 OHMS/VOLT MULTIMETER KIT

The MM-1 is a portable instrument for outside servicing, for field testing, or for quick portability in the service shop. Combines attractive physical appearance with functional design. 20,000 ohms/v. DC, and 5000 ohms/v. AC. AC and DC voltage ranges are 0-1.5, 5, 50, 150, 500, 1500 and 5000 volts. Direct current ranges are 0-150 μ a., 15 ma., 150 ma., 500 ma., and 15 amperes. Resistance ranges are X1, X100, X10,000 providing center scale readings of 15, 1500 and 150,000 ohms. DB ranges cover -10 db to +65 db.

Features a $4\frac{1}{2}$ " 50 μ a. meter. Provides polarity reversal on DC measurements. 1% precision resistors used in multiplier circuits. Not affected by RF fields.

MODEL MM-1
\$2950
Shpg. Wt. 6 Lbs.

6 Heathkit HANDITESTER KIT

The Model M-1 measures AC or DC voltage at 0-10, 30, 300, 1000, and 5000 volts. Measures direct current at 0-10 ma. and 0-100 ma. Provides ohmmeter ranges of 0-3000 (30 ohm center scale) and 0-300,000 ohms (3000 ohms center scale). Features a 400 μ a. meter for sensitivity of 1000 ohms/volt. Because of its size, the M-1 is a very handy portable instrument that will fit in your coat pocket, tool box, glove compartment, or desk drawer. Makes a fine standby unit in the service shop when the main instruments are in use, or is ideal for the hobbyist or beginner. An unusual dollar value.

MODEL M-1
\$1450
Shpg. Wt. 3 Lbs.

HEATH COMPANY

A Subsidiary
of *Duysstrom, Inc.*

BENTON HARBOR 15, MICHIGAN

Heathkit TV ALIGNMENT GENERATOR KIT



1

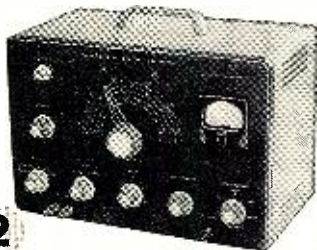

2



3



4

HEATH COMPANY

A SUBSIDIARY OF DAYSTROM INC.

The Model TS-4 features a controllable inductor for all-electronic sweep, improved oscillator and automatic gain circuitry, high RF output, center sweep operation, and improved linearity. It sets a new high standard for sweep generator operation, and is absolutely essential for the up-to-date service shop doing FM, black-and-white TV, and color TV work.

Voltage regulation and effective AGC action insure flat output over a wide frequency range. Electronic sweep insures complete absence of mechanical vibration. Sweep deviation controllable from 0 up to 40 Mc, depending upon base frequency. Effective two-way blanking.

Fundamental output from 3.6 Mc to 220 Mc in 4 bands. Crystal marker provides markers at 4.5 Mc and multiples thereof. Crystal included with kit. Variable marker covers from 19 Mc to 60 Mc on fundamentals, and up to 180 Mc on harmonics. Provision for external marker.



MODEL TS-4
\$4950

Shpg. Wt. 16 Lbs.

1

Heathkit LINEARITY PATTERN GENERATOR KIT

The new-design Model LP-1 produces vertical or horizontal bar patterns, a cross-hatch pattern, or white dots on the screen of the TV set under test. No internal connections required. Special clip is attached to the TV antenna terminals. Instant selection of the pattern desired for adjustment of vertical and horizontal linearity, picture size, aspect ratio, and focus. Dot pattern presentation is a *must* for color convergence adjustments on color TV sets.

Extended operating range covers all television channels from 2 to 13. Produces 6 to 12 vertical bars or 4 to 7 horizontal bars.

MODEL LP-1
\$2250

Shpg. Wt. 7 Lbs.

2

Heathkit LABORATORY GENERATOR KIT

The Heathkit Model LG-1 Laboratory Generator is a high-accuracy signal source for applications where metered performance is essential. It covers from 100 Kc to 30 Mc on fundamentals in 5 bands. Modulation is at 400 cycles, and modulation is variable from 0-50%. RF output from 100,000 μ v. to 1 μ v. 200 μ a. meter reads the RF output in microvolts, or percentage of modulation. Fixed step and variable output attenuation provided.

Features voltage regulation, and double copper plated shielding for stability. Provision for external modulation. Coaxial output cable (50 ohms).

MODEL LG-1
\$3950

Shpg. Wt. 16 Lbs.

3

Heathkit CATHODE RAY TUBE CHECKER KIT

This new-design instrument holds the key to rapid and complete picture tube testing, either in the set, on the work-bench, or in the carton. Tests for shorts, leakage, and emission. Features Shadowgraph test (a spot of light on the screen) to indicate whether the tube is capable of functioning.

The Model CC-1 tests all electromagnetic deflection picture tubes normally encountered in television servicing. Supplies all operating voltages to the tube under test, and indicates the condition of the tube on a large "GOOD-BAD" scale. Features spring loaded test switches for operator protection.

The CC-1 is housed in an attractive portable case and is light in weight — ideal for outside service calls.

MODEL CC-1
\$2250

Shpg. Wt. 10 Lbs.

4

Heathkit DIRECT READING CAPACITY METER KIT

Not only is this instrument popular in the service shop, but it has found extensive application in industrial situations. Ideal for quality control work, production line checking, or for matching pairs.

Features direct reading linear scales from 100 mmf to .1 mfd full scale. Necessary only to connect a capacitor of unknown value to the insulated binding posts, select the correct range, and read the meter. The CM-1 is not susceptible to hand capacity, and has a residual capacity of less than 1 mmf.

MODEL CM-1
\$2950

Shpg. Wt. 7 Lbs.

BENTON HARBOR 15, MICHIGAN
RADIO & TELEVISION NEWS



MODEL SG-8 \$1950
Shpg. Wt. 8 Lbs.

This is one of the biggest signal generator bargains available today. The tried and proven Model SG-8 offers all of the outstanding features required for a basic service instrument. High quality components and outstanding performance.

The SG-8 covers 160 Kc to 110 Mc on fundamentals in 5 bands, and calibrated harmonics extend its usefulness up to 220 Mc. The output signal is modulated at 400 cps, and the RF output is in excess of 100,000 uv. Output controlled by both a continuously variable and a fixed step attenuator. Also, audio output may be obtained for amplifier testing. Don't let the

low price deceive you. This is a professional type service instrument to fulfill the signal source requirements in the service lab.

Heathkit SIGNAL GENERATOR KIT

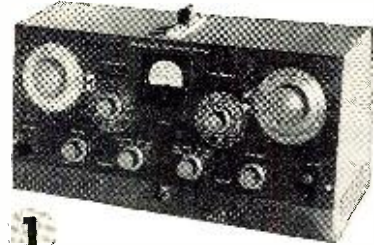

1

1 Heathkit ... IMPEDANCE BRIDGE KIT

The IB-2 features built-in adjustable phase shift oscillator and amplifier, and has panel provisions for external generator. Measures resistance, capacitance, inductance, dissipation factors of condensers, and storage factor of inductance.

D, Q, and DQ functions combined in one control. 1/2% resistors and 1/2% silver-mica capacitors especially selected for this instrument. A 100-0-100 microammeter provides null indications. Two-section CRL dial provides 10 separate "units" with an accuracy of .5%. Fractions of units read on variable control.

MODEL IB-2
\$5950
Shpg. Wt. 12 Lbs.

2 Heathkit "Q" METER KIT

The Heathkit Model QM-1 will measure the Q of inductances and the RF resistance and distributed capacity of coils. Employs a 4 1/2" 50 microampere meter for direct indication. Will test at frequencies of 150 Kc to 18 Mc in 4 ranges. Measures capacity from 40 mmf to 450 mmf within ± 3 mmf. Indispensable for coil winding and determining unknown condenser values. A worthwhile addition to your laboratory at an outstandingly low price. Useful for checking wave traps, chokes, peaking coils, etc. Laboratory facilities are now available to the service shop and home lab.

MODEL QM-1
\$4450
Shpg. Wt. 14 Lbs.

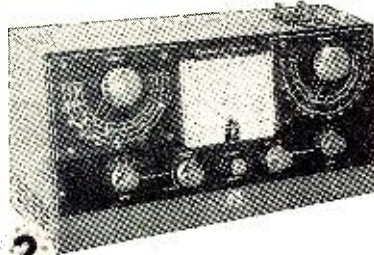

2

3 Heathkit 6-12 VOLT BATTERY ELIMINATOR KIT

This modern battery eliminator will supply 6 or 12 volt output for ordinary automobile radios as well as 12 volts for the new models in the latest model cars. Output voltage is variable from 0-8 volts DC, or 0-16 volts DC. Will deliver up to 15 amperes at 6 volts, or up to 7 amperes at 12 volts. Two 10,000 microfarad filter capacitors insure smooth DC output. Two panel meters monitor output voltage and current. Will double as a battery charger. Definitely required for automobile radio service work.

MODEL BE-4
\$3150
Shpg. Wt. 17 Lbs.

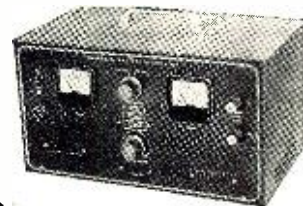

3

4 Heathkit DECADE RESISTANCE KIT

Twenty 1% precision resistors provide resistance from 1 to 99,999 ohms in 1 ohm steps. Indispensable around service shop laboratory, ham shack, or home workshop. Well worth the extremely low Heathkit price.

MODEL DR-1
\$1950
Shpg. Wt. 4 Lbs.



4

5 Heathkit VIBRATOR TESTER KIT

Tests vibrators for proper starting and indicates the quality of the output on a large "GOOD-BAD" scale. Checks both interrupter and self-rectifier types in 5 different sockets. Operates from any battery eliminator delivering variable voltage from 4 to 6 volts DC at 4 amps. Ideal companion to the Model BE-4.

MODEL VT-1
\$1450
Shpg. Wt. 6 Lbs.

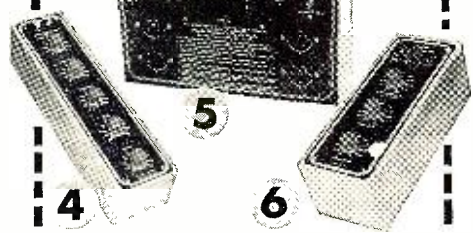

5

6 Heathkit DECADE CONDENSER KIT

Provides capacity values from 100 mmf to 0.111 mfd in steps of 100 mmf. ± 1% precision silver-mica condensers used. High quality ceramic switches for reduced leakage. Polished birch cabinet. Extremely valuable in all electronic activity.

MODEL DC-1
\$1650
Shpg. Wt. 3 Lbs.

6

HEATH COMPANY

A SUBSIDIARY OF DAYSTROM INC.

BENTON HARBOR 15, MICHIGAN

Heathkit TUBE CHECKER KIT

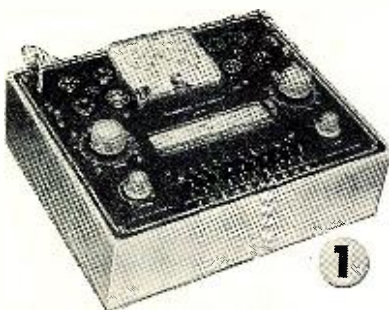

1

1 The Heathkit Model TC-2 is an emission type tube tester that represents a tremendous saving over the price of a comparable unit from any other source. At only \$29.50, you can have a tube tester of your own, even if you are an experimenter, or only do part time service work. Extremely popular with radio servicemen, it uses a 4½" meter with 3-color meter face for simple "GOOD-BAD" indications that the customer can understand. Will test all tubes commonly encountered in radio and TV service work.

Ten 3-position lever switches for "open" or "short" tests on each tube element. Neon bulb indicates filament continuity or short between tube elements. Line adjust control provided. The roll chart is illuminated.

Sockets provided for 4, 5, 6, and 7-pin, octal, and loctal tubes, 7 and 9 pin miniature tubes, and the 5 pin Hytron tubes. Blank space provided for future socket addition. Tests tubes for opens, and shorts, and for quality on the basis of total emission. 14 different filament voltage values provided.

MODEL TC-2

\$29.50

Shpg. Wt. 12 Lbs.

2 Heathkit PORTABLE TUBE CHECKER KIT

The Model TC-2P is identical to the Model TC-2 except that it is housed in a rugged carrying case. This strikingly attractive and practical two-tone case is finished in proxylin impregnated fabric. The cover is detachable, and the hardware is brass plated. This case imparts a real professional appearance to the instrument. Ideal for home service calls, or any portable application.

MODEL TC-2P

\$34.50

Shpg. Wt. 15 Lbs.



3

2

3 Heathkit TV PICTURE TUBE TEST ADAPTER

The Heathkit TV picture tube test adapter is designed for use with the Model TC-2 Tube Checker. Test picture tubes for emission, shorts, and thereby determine tube quality. Consists of 12-pin TV tube socket, 4 ft. cable, octal connector, and necessary technical data. (Not a kit.)

MODEL 355

\$4.50

Shpg. Wt. 1 Lb.

4 Heathkit... CONDENSER CHECKER KIT

Use this Condenser Checker to quickly and accurately measure those unknown condenser and resistor values. All readings taken directly from the calibrated panel scales without any involved calculation. Capacity measurements in four ranges from .00001 to 1000 mfd. Checks paper, mica, ceramic and electrolytic condensers. A power factor control is available for accurate indication of electrolytic condenser efficiency. Leakage test switch—selection of five polarizing voltages, 25 volts to 450 volts DC to indicate condenser operating quality under actual load conditions. Spring-return test switch automatically discharges condenser under test and eliminates shock hazard to the operator.

Resistance measurements can be made in the range from 100 ohms to 5 meg-ohms. Here again, all values are read directly on the calibrated scales. Increased sensitivity coupled with an electron beam null indicator increases overall instrument usefulness.

For safety of operation, the circuit is entirely transformer operated. An outstanding low kit price for this surprisingly accurate instrument.

MODEL C-3

\$19.50

Shpg. Wt. 7 Lbs.



4

5 Heathkit VISUAL-AURAL SIGNAL TRACER KIT

This signal tracer is extremely valuable in servicing AM, FM, and TV receivers, especially when it comes to isolating trouble to a particular stage of the circuit under test.

This visual-aural tracer features a high gain RF input channel to permit signal tracing from the receiver antenna input clear through all RF, IF, detector, and audio stages to the speaker. Separate low-gain channel provided for audio circuit exploration. Both visual and aural indication by means of a speaker or headphone, and electron beam "eye" tube as a level indicator. Also incorporates a noise locator circuit for DC noise checks, and a built-in calibrated wattmeter (30-500 watts). Panel terminals provided for "patching" output transformer or speaker into external circuit for test purposes. Designed especially for the radio and TV serviceman. Cabinet size: 9½" wide x 6½" high x 5" deep. A real test equipment bargain.

MODEL T-3

\$23.50

Shpg. Wt. 9 Lbs.



5

HEATH COMPANY

A SUBSIDIARY OF DAYSTRON INC

BENTON HARBOR 15, MICHIGAN

RADIO & TELEVISION NEWS

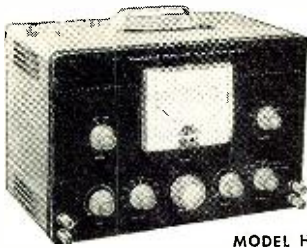

MODEL HD-1

Shpg. Wt. 13 Lbs. **\$4950**

Used with a sine wave generator, the Model HD-1 will check the harmonic distortion output of audio amplifiers under a variety of conditions. Reads distortion directly on the meter as a percentage of the input signal. Operates between 20 and 20,000 cps. High impedance VTVM circuit for initial reference settings and final distortion readings. Ranges are 0-1, 3, 10, and 30 volts full scale. 1% precision resistors. Distortion scales are 0-1, 3, 10, 30 and 100% full scale. Requires only .3 volt input for distortion test.

Heathkit HARMONIC DISTORTION METER KIT

1 Heathkit AUDIO ANALYZER KIT

This instrument consists of an audio wattmeter, an AC VTVM, and a complete IM analyzer, all in one compact unit.

Use the VTVM to measure noise, frequency response, output gain, power supply ripple, etc. Use the wattmeter for measurement of power output. Internal loads provided for 4, 8, 16, or 600 ohms; VTVM also calibrated for DBM units. High or low impedance IM measurements made with built-in 6KC and 60 cps generators. VTVM ranges are .01, to 300 volts in 10 steps. Wattmeter ranges are .15 mw. to 150 w. in 7 steps. IM scales are 1% to 100% in 5 steps. Shpg. Wt. 13 Lbs.

MODEL AA-1
\$5950

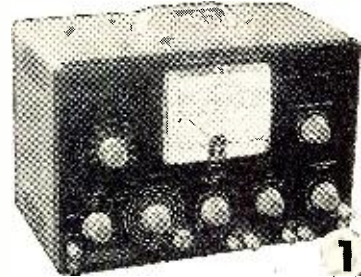

2 Heathkit AUDIO GENERATOR KIT

This new Heathkit Model features step-tuning from 10 cps to 100 Kc with three rotary switches that provide two significant figures and multiplier. Less than .1% distortion. Frequency accurate to within $\pm 5\%$.

Output monitored on a large 4½" meter that reads voltage or db. Both variable and step-type attenuation provided. Meter reads zero-to-maximum at each attenuator position. Output ranges (and therefore meter ranges) are 0-.003, .01, .03, .1, .3, 1, 3, 10 volts. Step-tuning provides rapid positive selection of the desired frequency, and allows accurate return to any given frequency. Shpg. Wt. 8 Lbs.

MODEL AG-9
\$3450



3 Heathkit AUDIO OSCILLATOR KIT

(SINE WAVE — SQUARE WAVE)

The Model AO-1 features sine wave or square wave coverage from 20-20,000 cps in 3 ranges. It is an instrument specifically designed to completely fulfill the needs of the serviceman and high fidelity enthusiast. Offers high level output across the entire frequency range, low distortion and low impedance output. Features a thermistor in the second amplifier stage to maintain essentially flat output through the entire frequency range. Produces an excellent sine wave for audio testing, or will produce good, clean, square waves with a rise time of only 2 microseconds. Shpg. Wt. 10 Lbs.

MODEL AO-1
\$2450

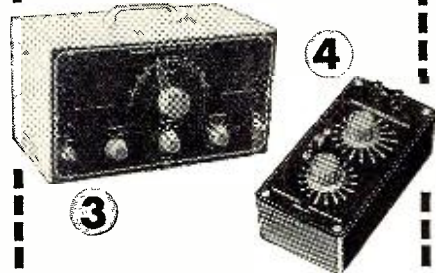

4 Heathkit RESISTANCE SUBSTITUTION BOX KIT...

Provides switch selection of 36 RTMA 1 watt standard 1% resistors ranging from 15 ohms to 10 megohms. Numerous applications in radio and TV work, and essential in the developmental laboratory. Shpg. Wt. 2 Lbs.

MODEL RS-1
\$550

5 Heathkit AC VACUUM TUBE VOLTMETER KIT...

The Heathkit AC VTVM features high impedance, wide frequency range, very high sensitivity, and extremely wide voltage range. Will accurately measure a voltage as small as 1 mv. at high impedance. Excellent for sensitive AC measurements required by laboratories, audio enthusiasts and experimenters. Frequency response is substantially flat from 10 cps to 50 Kc. Ranges are .01, .03, .1, 3, 1, 3, 10, 30, 100, and 300 v. RMS. Total db range -52 to + 52 db. Input impedance 1 megohm at 1 Kc. Shpg. Wt. 5 Lbs.

MODEL AV-2
\$2950

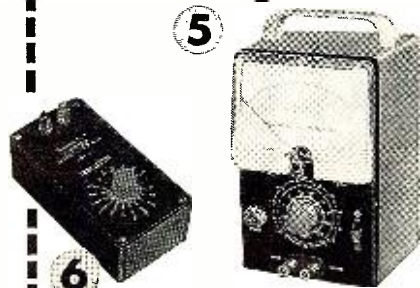

6 Heathkit CONDENSER SUBSTITUTION BOX KIT...

Very popular companion to Heathkit RS-1. Individual selection of 18 RTMA standard condenser values from .0001 mfd to .22 mfd. Includes 18" flexible leads with alligator clips. Shpg. Wt. 2 Lbs.

MODEL CS-1
\$550

BENTON HARBOR 15, MICHIGAN

**HEATH
COMPANY**

A SUBSIDIARY OF DAYSTROM INC.



HEATHKIT HAM GEAR

for high quality at moderate cost

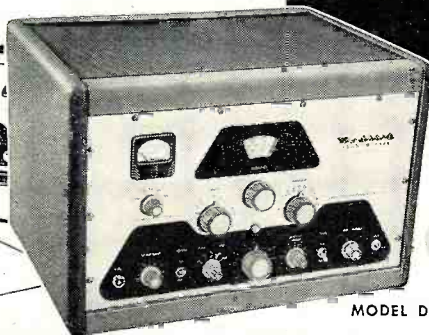

MODEL DX-100

DOLLAR VALUE: You get more for your Heathkit dollar because your labor is used to build the kit instead of paying for someone else's. Also, the middleman's margin of profit is eliminated when you deal directly with the manufacturer.

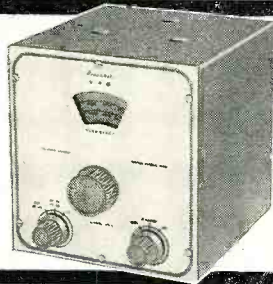

2



3

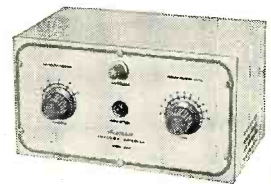

4

1 Heathkit DX-100 PHONE & CW TRANSMITTER KIT

The reception given this amateur transmitter has been tremendous. Reports from radio amateurs using the DX-100 are enthusiastic in praising its performance and the high quality of the components used in its assembly. Actual "on the air" results reflect the careful design that went into its development.

The DX-100 features a built-in VFO, modulator, and power supplies, and is completely bandswitching for phone or CW operation on 160, 80, 40, 20, 15, 11, and 10 meters. All parts necessary for construction are supplied in the kit, including tubes, cabinet, and detailed step-by-step instructions. Easy to build, and a genuine pleasure to operate.

Employs push-pull 1625's modulating parallel 6146's for RF output in excess of 100 watts on phone and 120 watts on CW. May be excited from the built-in VFO or from crystals (crystals not included with kit). Features five-point TVI suppression: (1) pi network interstage coupling to reduce harmonic transfer to the final stage; (2) pi network output coupling; (3) extensive shielding; (4) all incoming and outgoing circuits filtered; (5) inter-locking cabinet seams to eliminate radiation except through the coaxial output connector. Pi network output coupling will match 50 to 600 ohm non-reactive load. Illuminated VFO dial and meter face. Remote control socket provided.

The chassis is made of extra-strong #16 gauge copper-plated steel. It employs potted transformers, ceramic switch and variable capacitor insulation, solid silver loading switch terminals, and high-grade well-rated components throughout. Features a pre-formed wiring harness, and all coils are pre-wound.

High-gain speech amplifier for dynamic or crystal microphones, and restricted speech range for increased intelligence. Plenty of audio power reserve. Measures 20 $\frac{7}{8}$ " W. x 13 $\frac{3}{4}$ " H. x 16" D. Schematic diagram and complete technical specifications on request.

MODEL DX-100
\$189.50

Shpg. Wt. 120 Lbs.

Shipped Motor Freight Unless Otherwise Specified
\$50.00 Deposit Required on C.O.D. Orders

2 Heathkit VFO KIT

The Model VF-1 covers 160-80-40-20-15-11 and 10 meters with three basic oscillator frequencies. Better than 10-volt average RF output on fundamentals. Features illuminated and pre-calibrated dial scale. Cable and plug provided to fit crystal socket of any modern transmitter.

Enjoy the convenience and flexibility of VFO operation at no more than the price of crystals. May be powered from plug on the Heathkit Model AT-1 transmitter, or supplied with power from most transmitters. Measures: 7" H. x 6 $\frac{1}{2}$ " W. x 7" D.

MODEL VF-1

\$19.50

Shpg. Wt. 7 Lbs.

3 Heathkit CW AMATEUR TRANSMITTER KIT

The Model AT-1 is an ideal novice transmitter, and may be used to excite a higher power rig later on.

This CW transmitter is complete with its own power supply, and covers 80, 40, 20, 15, 11, and 10 meters. Features single-knob bandswitching, and panel meter indicates grid or plate current for the final amplifier. Designed for crystal operation or external VFO. Crystal not included in kit. Incorporates such features as key click filter, line filter, copper-plated chassis, pre-wound coils, 52 ohm coaxial output, and high quality components throughout. Instruction book simplifies assembly. Employs a 6AG7 oscillator, 6L6 final amplifier. Operates up to 35 watts plate power input.

MODEL AT-1

\$29.50

Shpg. Wt. 15 Lbs.

4 Heathkit ... ANTENNA COUPLER KIT

The Model AC-1 will properly match your low power transmitter to an end-fed long wire antenna. Also attenuates signals above 36 Mc, reducing TVI. 52 ohm coax. input—power up to 75 watts—10 through 80 meters—tapped inductor and variable condenser—neon RF indicator—copper plated chassis and high quality components. Ideal for use with Heathkit AT-1 Transmitter.

MODEL AC-1

\$14.50

Shpg. Wt. 4 Lbs.

HEATH COMPANY

A Subsidiary
of Daystrom, Inc.

BENTON HARBOR 15, MICHIGAN

"AMATEUR-ENGINEERED"

Equipment For The Ham

MODERN DESIGN; You can be sure of getting all the latest and most desirable design features when you buy Heathkits. Advanced-design is a minimum standard for new Heathkit models.

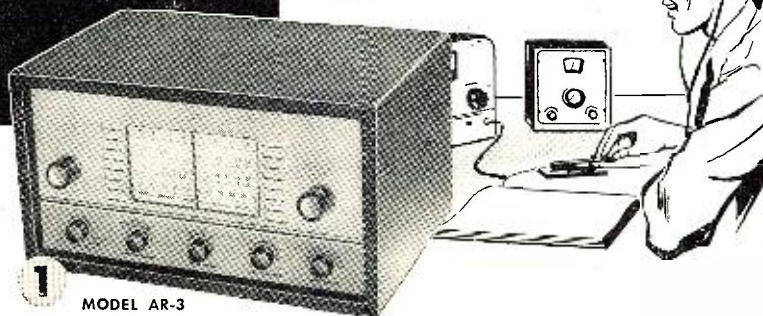

1 MODEL AR-3



2

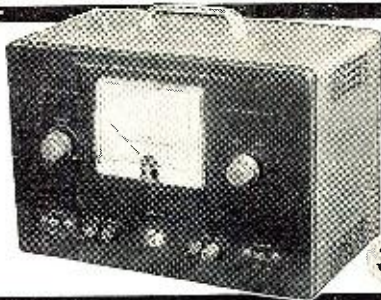

3



4



5

1 Heathkit COMMUNICATIONS-TYPE ALL BAND RECEIVER KIT

The new Model AR-3 features improved IF and RF performance, along with better image rejection on all bands. Completely new chassis layout for easier assembly, even for the beginner.

Covers 550 Kc to 30 Mc in four bands. Provides sharp tuning and good sensitivity over the entire range. Features a transformer-type power supply—electrical bandspread—separate RF and AF gain controls—antenna trimmer—noise limiter—AGC—BFO—headphone jacks—5½" PM speaker and illuminated tuning dial.

CABINET: Fabric covered cabinet with aluminum panel as shown. Part No. 91—shipping weight 5 lbs. \$4.50.

MODEL AR-3
\$27⁹⁵

Shpg. Wt. 12 Lbs.
(Less Cabinet)

2 Heathkit "Q" MULTIPLIER KIT

Here is the Heathkit Q Multiplier you hams have been asking for. A tremendous help on the phone and CW bands when the QRM is heavy. Provides an effective Q of approximately 4,000 for extremely sharp "peak" or "null." Use it to "peak" the desired signal or to "null" an undesired signal, or heterodyne. Tunes to any signal within the IF band-pass of your receiver. Also provides "broad peak" for conditions where extreme selectivity is not required.

Operates with any receiver having an IF frequency between 450 and 460 Kc. Will not function with AC-DC type receivers. Requires 6.3 volts AC at 300 ma. and 150 to 250 VDC at 2 ma. Derives operating power from your receiver. Uses a 12AX7 tube, and special High-Q shielded coils. Simple to connect with the cable and plugs supplied. Measures only 4-11/16"H.x7¾"W.x4½"D. A really valuable addition to the receiving equipment in your ham shack.

MODEL QF-1
\$9⁹⁵

Shpg. Wt. 3 Lbs.

3 Heathkit VARIABLE VOLTAGE REGULATED POWER SUPPLY KIT

Provides well filtered DC output, variable from zero to 500 volts at no load and regulated for stability. Will supply up to 10 ma. at 450 VDC, and up to 130 ma. at 200 VDC. Voltage or current monitored on front panel meter. Also provides 6.3 VAC at 4A. for filament. Filament voltage isolated from B+, and both isolated from ground. Invaluable around the ham shack for supplying operating potentials to experimental circuits. Use in all types of research and development laboratories as a temporary power supply, and to determine design requirements for ultimate power supply.

MODEL PS-3
\$35⁵⁰

Shpg. Wt. 17 lbs.

4 Heathkit ANTENNA IMPEDANCE METER KIT

Use in conjunction with a signal source for measuring antenna impedance, line matching, adjustment of beam and mobile antennas, etc. Will double as a phone monitor or relative field strength indicator. 100 µa. meter employed. Covers the range from 0-600 ohms. An instrument of many uses for the amateur.

MODEL AM-1
\$14⁵⁰

Shpg. Wt. 2 lb.

5 Heathkit GRID DIP METER KIT

This is an extremely valuable tool for accomplishing literally hundreds of jobs on all types of equipment. Covering from 2 Mc to 250 Mc, the GD-1B is compact and can be operated with one hand. Uses a 500 µa. meter for indication, with a sensitivity control and headphone jack. Includes prewound coils and rack. Indispensable instrument for hams, engineers, or servicemen.

MODEL GD-1B
\$19⁵⁰

Shpg. Wt. 4 lbs.

HEATH COMPANY

A Subsidiary
of Daystrom, Inc.

BENTON HARBOR 15, MICHIGAN

Heathkits
 PROVIDE THE
 "CONSTRUCTIVE"
 APPROACH TO
HIGH-FIDELITY



EASY TO BUILD: *The assembly instructions supplied with Heathkits are so complete and detailed that anyone can assemble the kits without difficulty. Plenty of pictorial diagrams and step-by-step instructions. Information on resistor color codes, soldering, use of tools, etc. Build-it-yourself with confidence!*

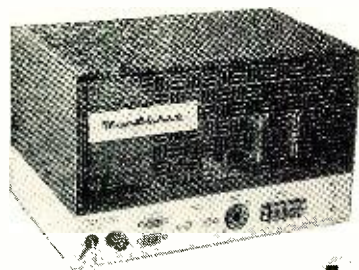

1 *Heathkit* **ADVANCED-DESIGN
 HIGH FIDELITY AMPLIFIER KIT**

The 25 Watt Model W-5 is one of the most outstanding high fidelity amplifiers available today—at any price. Incorporates the very latest design features to achieve true "presence" for the super-critical listener.

Features a new-design Peerless output transformer, and KT66 output tubes handle power peaks up to 42 watts. The unique "tweeter-saver" suppresses high frequency oscillation. A new type balancing circuit results in closer "dynamic" balance between output tubes. Features improved phase shift characteristics and frequency response, with reduced IM and harmonic distortion. Color styling harmonizes with the Heathkit WA-P2 Preamplifier and the FM-3 Tuner.

Frequency response—within ± 1 db from 5 cps to 160 Kc at 1 watt. Harmonic distortion only 1% at 25 watts, 20-20,000 cps. IM distortion only 1% at 20 watts, using 60 and 3,000 cps. Output impedance 4, 8, or 16 ohms. Hum and noise—99 db below rated output. Uses two 12AU7's, two KT66's and a 5R4GY.

KIT COMBINATIONS:

W-5M Amplifier Kit: Consists of main amplifier and power supply, all on one chassis. Complete with all necessary parts, tubes, and comprehensive manual. Shpg. Wt. 31 lbs. Express only.

\$59⁷⁵

W-5 Combination Amplifier Kit: Consists of W-5M Amplifier Kit listed above *plus* Heathkit Model WA-P2 Preamplifier Kit. Complete with all necessary parts, tubes, and construction manuals. Shpg. Wt. 38 lbs. Express only.

\$79⁵⁰



2 *Heathkit* **DUAL-CHASSIS WILLIAMSON TYPE
 HIGH FIDELITY AMPLIFIER KIT**

This is a very popular high fidelity amplifier kit that features dual-chassis type construction. The resulting physical dimensions offer an additional margin of flexibility in installation. It features the famous Acrosound TO-300 "ultra-linear" output transformer, and has a frequency response within ± 1 db from 6 cps to 150 Kc at 1 watt. Harmonic distortion only 1% at 21 watts. IM distortion at 20 watts only 1.3% at 60 and 3,000 cps. Rated power output is 20 watts. Output impedance 4, 8, or 16 ohms. Hum and noise—88 db below 20 watts. Uses two 6SN7's, two 5881's, and a 5V4G.

KIT COMBINATIONS:

W-3M: Consists of main amplifier and power supply for separate chassis construction. Includes all tubes and components necessary for assembly. Shpg. Wt. 29 lbs., Express only.

\$49⁷⁵

W-3: Consists of W-3M Kit listed above *plus* Heathkit Model WA-P2 Preamplifier described on opposite page. Shpg. Wt. 37 lbs., Express only.

\$69⁵⁰

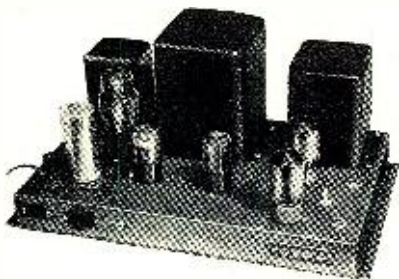

3 *Heathkit* **SINGLE-CHASSIS WILLIAMSON TYPE
 HIGH FIDELITY AMPLIFIER KIT**

This is the lowest priced Williamson type amplifier ever offered in kit form, and yet it retains all the usual features of the Williamson type circuit. Main amplifier and power supply combined on one chassis, and uses a new-design Chicago output transformer. Frequency response—within ± 1 db from 10 cps to 100 Kc at 1 watt. Harmonic distortion only 1.5% at 20 watts. IM distortion at rated output, 2.7% at 60 and 3,000 cps. Rated power output is 20 watts. Output impedance 4, 8, or 16 ohms. Hum and noise—95 db below 20 watts. Uses two 6SN7's, two 5881's, and one 5V4G.

Instructions are so complete that the kit may be assembled successfully even by a beginner in electronics.

KIT COMBINATIONS:

W-4AM: Consists of main amplifier and power supply for single chassis construction. Includes all tubes and components necessary for assembly. Shpg. Wt. 28 lbs. Express only.

\$39⁷⁵

W-4A: Consists of W-4AM Kit listed above *plus* Heathkit Model WA-P2 Preamplifier described on opposite page. Shpg. Wt. 35 lbs. Express only.

\$59⁵⁰

**HEATH
 COMPANY**

A SUBSIDIARY OF DAYSTROM INC.

BENTON HARBOR 15, MICHIGAN
 RADIO & TELEVISION NEWS

ATTRACTIVELY STYLED: *Heathkit high fidelity instruments are not only functional, but are most attractive in physical design. Such units as the preamplifier and the W-5 main amplifier are designed for beauty as well as performance. They blend with any room decor and are the kind of instruments you will be proud to own.*



enjoy....
**THE VERY BEST
 IN AUDIO WITH
 "BUILD-IT-YOURSELF"
 HEATHKITS**

1 *Heathkit* HIGH FIDELITY
PREAMPLIFIER KIT

This outstanding preamplifier is designed specifically for use with the Heathkit Williamson type amplifiers. It completely fulfills the requirements for remote control, compensation and preamplification, and exceeds even the most rigorous specifications for high fidelity performance.

Features five separate switch-selected input channels (2 low level and 3 high level), each with its own input control. Full record equalization with four-position turnover control and four-position rolloff control.

Output jack for tape recorder — separate bass control with 18 db boost and 12 db cut at 50 cps. — treble control offering 15 db boost and 20 db cut at 15,000 cps — special hum control to insure minimum hum level — and many other desirable features. Overall frequency response (with controls set to "flat" position) is within 1 db from 25 cps to 30,000 cps. Will do justice to the finest available program sources. Beautiful satin-gold finish.

Power requirements from the Heathkit Williamson type high fidelity amplifier — 6.3 VAC at 1 amp., and 300 VDC at 10 Ma. Uses two 12AX7's and one 12AU7.

MODEL WA-P2
\$1975
 Shpg. Wt. 7 lbs.

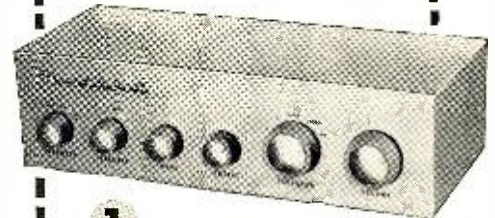

1

2 *Heathkit* 20-WATT HIGH FIDELITY
AMPLIFIER KIT

This Heathkit Model offers you the least expensive route to high fidelity performance. Frequency response is ± 1 db from 20-20,000 cps. Features full 20 watt output using push-pull 6L6's, and incorporates separate bass and treble tone controls. Preamplifier and main amplifier are built on the same chassis. Four switch-selected compensated inputs and separate bass and treble tone controls provide all necessary functions at minimum investment. Features miniature tube types for low hum and noise.

Uses 12AX7, two 12AU7's, two 6L6G's and a 5V4G. A most interesting "build-it-yourself" project, and an excellent hi-fi amplifier for home use. Well suited, also, for public address applications because of its high power output and high quality audio reproduction. Another Heathkit "best-buy" for you!

MODEL A-9B
\$3550
 Shpg. Wt. 23 lbs.



2

3 *Heathkit* 7-WATT
AMPLIFIER KIT

The redesigned Model A-7D features a new type output transformer for tapped screen operation, and provides improved sensitivity, reduced distortion, and increased power output.

The full 7-watt output of the Model A-7D is more than adequate for normal home installations. Frequency characteristics are $\pm 1\frac{1}{2}$ db from 20 to 20,000 cps. Potted output and power transformers employed. Push-pull output — detailed construction manual — top quality parts — high quality audio without great expense. Output transformer tapped at 4, 8, and 16 ohms. Bass and treble tone controls provided on the front chassis apron.

MODEL A-7D
\$1695
 Shpg. Wt. 10 lbs.

Model A-7E: Provides a preamplifier stage with two switch-selected inputs and RIAA compensation for variable reluctance or low level cartridges. Preamplifier built on same chassis as main amplifier. Model A-7E. Shipping weight 10 lbs. \$18.50.



3

**HEATH
 COMPANY**
 A SUBSIDIARY OF DAYSTROM INC.

BENTON HARBOR 15, MICHIGAN

May, 1956

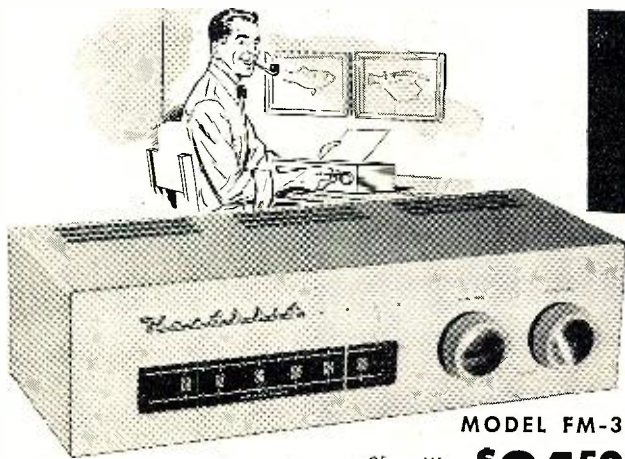

Brand New HEATHKIT HIGH-FIDELITY FM TUNER KIT

Features

- ▶ Brand New, Modern FM Circuit Using Latest Type Miniature Tubes.
- ▶ Low-Noise Cascode RF Stage—Two IF's—Ratio Detector—Stage of Audio.
- ▶ Extremely Good Sensitivity and Band-Pass for Outstanding Performance.
- ▶ Strikingly Attractive Satin-Gold Finish to Match Heathkit Model WA-P2 Preamplifier.
- ▶ Compact Physical Dimensions for Most Pleasing Appearance and Increased Circuit Efficiency.

MODEL FM-3

Shpg. Wt. **\$24.50**
7 lbs.
(with cabinet)

The new Heathkit Model FM-3 features tremendous circuit improvements and brand new physical design. Sensitivity is better than 10 μ v. for 20 db of quieting, and it employs a completely modern tube line-up for high gain and stable operation. Incorporates its own power supply, and has provision for low-level or high-level output at low impedance.

The attractive Model FM-3 matches the WA-P2 Preamplifier in color, styling, and physical size.

Incorporates automatic gain control, a highly stabilized oscillator, and illuminated tuning dial. Educational treatment of construction manual simplifies assembly for the newcomer to electronics. IF and ratio transformers are pre-aligned, and the front-end tuning unit is pre-assembled and aligned. Uses 6BQ7A as a cascode type RF stage, 6U8 oscillator-mixer, two 6CB6's as IF amplifiers, a 6AL5 ratio detector, a 6C4 audio amplifier, and 6X4 rectifier.

HEATHKIT BROADCAST-BAND RECEIVER KIT

Build your own radio receiver with confidence, even if you are a beginner. Complete instructions supplied.

Features transformer-type power supply, high-gain miniature tubes, built-in antenna, 5½" speaker, and planetary tuning from 550 Kc to 1500 Kc. Adaptable for use as AM Tuner and phono amplifier. Educational treatment of the construction manual helps the beginner learn about radio circuits and parts as he builds.

CABINET: Fabric covered plywood cabinet with aluminum panel as shown. Part 91-9, Shpg. Wt. 5 lbs., \$4.50.



MODEL BR-2
\$17.50 Less Cabinet
Shpg. Wt. 10 lbs.

Are you on our mailing list? If not—how about sending us your name?

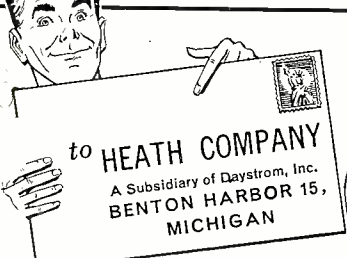

Phone
WALNUT
5-1175

to **HEATH COMPANY**
A Subsidiary of Daystrom, Inc.
BENTON HARBOR 15,
MICHIGAN

ORDER BLANK

from _____

SHIP VIA

Parcel Post

Express

Freight

Best Way

QUANTITY	ITEM (PLEASE PRINT)	MODEL NO.	PRICE

NOTE: ALL PRICES SUBJECT TO CHANGE WITHOUT NOTICE.

Enclosed find () check () money order for _____ Please ship C.O.D. () postage enclosed for _____ pounds.

On Express orders do not include transportation charges—they will be collected by the express agency at time of delivery.

ON PARCEL POST ORDERS include postage for weight shown. ORDERS FROM CANADA and APO's must include full remittance.

HEATH COMPANY A Subsidiary of Daystrom, Inc. **BENTON HARBOR 15, MICHIGAN**

Intercom Amplifier

(Continued from page 58)

frequency response is dependent upon the size of this capacitor. The last component, the output transformer, steps the high collector impedance back down to 4 ohms.

A complete circuit, Fig. 1B, shows the amplifier as it was built into a *Bogen* R-60 remote station. The extra contact on the push-to-talk button energizes the emitter when the button is depressed. Too little collector current (about 5 μ a.) flows, without emitter bias, to make it worthwhile installing a switch in the collector.

Because of the 50 μ fd. coupling capacitor's long time constant, there is no loud switching transient when the button is pressed-to-talk.

The three-wire output from the booster intercom follows the nomenclature developed in Fig. 2. Output from the booster amplifier connects into the master "listen" line, and the remote speaker is normally connected, by the push-to-talk button, to the master "talk" line.

Fig. 2 illustrates a multiple-remote intercommunication system. Only two remotes are shown. The transistorized remote is connected in the same way as a normal remote. However, remotes with built-in amplifiers must have their signals attenuated at the master, otherwise they will blast through at a much higher level than the other remotes. Do this by inserting a resistor at the points marked "X" in Fig. 2. The correct value can be found by experiment. However, we suggest that a value of about 20 ohms would probably be correct for most installations. One of these resistors must be used for each transistor-amplified remote. For example, if station #1 is replaced with a transistor remote, the resistor is placed at point X₁.

Fig. 3 gives the power gain vs frequency response of the amplifier. The power gain figures are based on the power delivered into a 4-ohm load by the transistor amplifier compared with

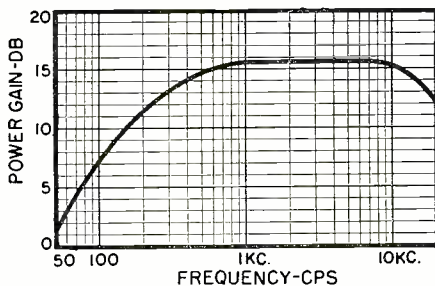

Fig. 3. Gain vs frequency response of the amplifier. Gain based on power delivered to 4-ohm load by the transistor amplifier compared with power delivered by the speaker-microphone into a 4-ohm load.

the power delivered by the speaker-microphone into a 4-ohm load.

The roll-off of bass response makes conversation more crisp and articulate. It is possible, we have noticed, to understand conversations quite distant from the remote that are inaudible under acoustical rumble and noise on the other remotes.

When the amplifier was first designed, there was some worry about transistor-generated noise. This trouble has failed to materialize. So far none of the transistors tested in the amplifier has produced any really noticeable noise.

Construction

The output transformer is a standard replacement unit available from almost any jobber. It has a 25,000-ohm center-tapped primary and a 4-ohm secondary impedance. The center tap is unused. Mercury cells, however, may have to be purchased from one of the mail order houses.

The polarity of these mercury cells is clearly marked, but we will once again point out that their construction is diametrically opposed to standard dry cells. The *outside case is positive*. Although it is not visible in the photograph the two mercury cells are insulated from each other and the metal holding strap by a strip of plastic tape wrapped around each cell.

None of the wires need to be shielded and their locations are not critical.

-30-

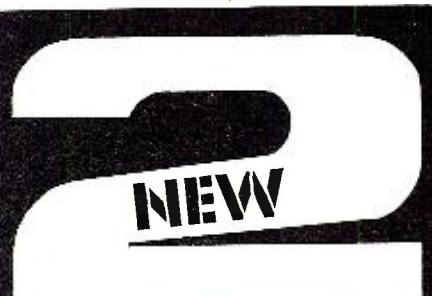
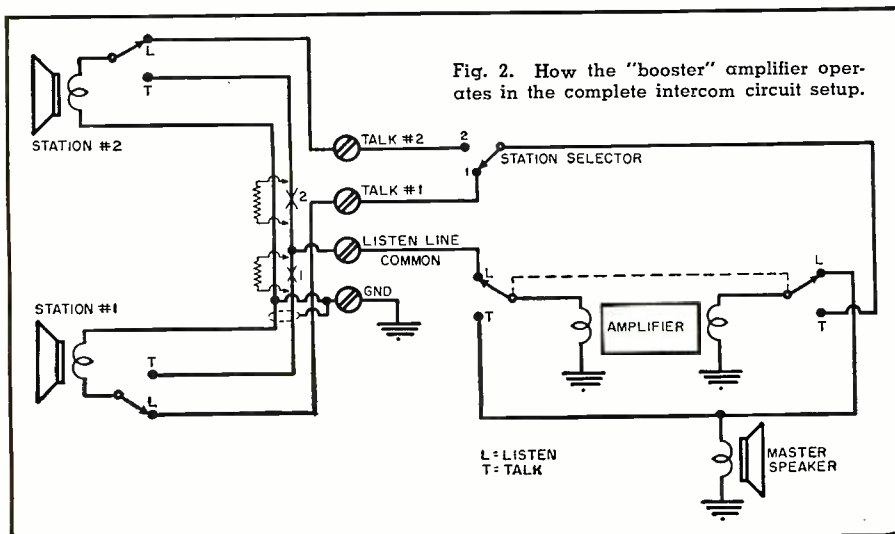

SILICONE SPRAYS

PERMANENT
Lubrication and
Protection with

SIL-LUBE

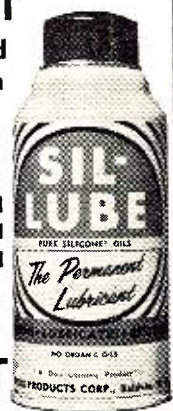

The Cleansing
and Restoring
LUBRICANT
Made from Pure
Silicone* Oils

- Moisture repellant, dielectric lubricant.
- Can be used on all surfaces and materials.
- Highly resistant to mineral acids and oxidation—not affected by extreme heat.
- Will not volatilize—will not affect capacity, inductance or resistance.



PERMANENT PROTECTION with SILIKONE

The Silicone*
Resin Spray

- Moisture resistant.
- Protects all electronic parts and equipment—metal, ceramic and plastic surfaces.
- Resists all extremes of atmosphere and climate.
- Eliminates hi-voltage corona discharge.

SOLD AT ALL LEADING DISTRIBUTORS.

*A Dow-Corning Product

EBCOR ELECTRONICS CO., INC.
87 MERRICK ROAD BALDWIN, N. Y.

Quick Check for Tubes in Series

By
MATTHEW MANDL

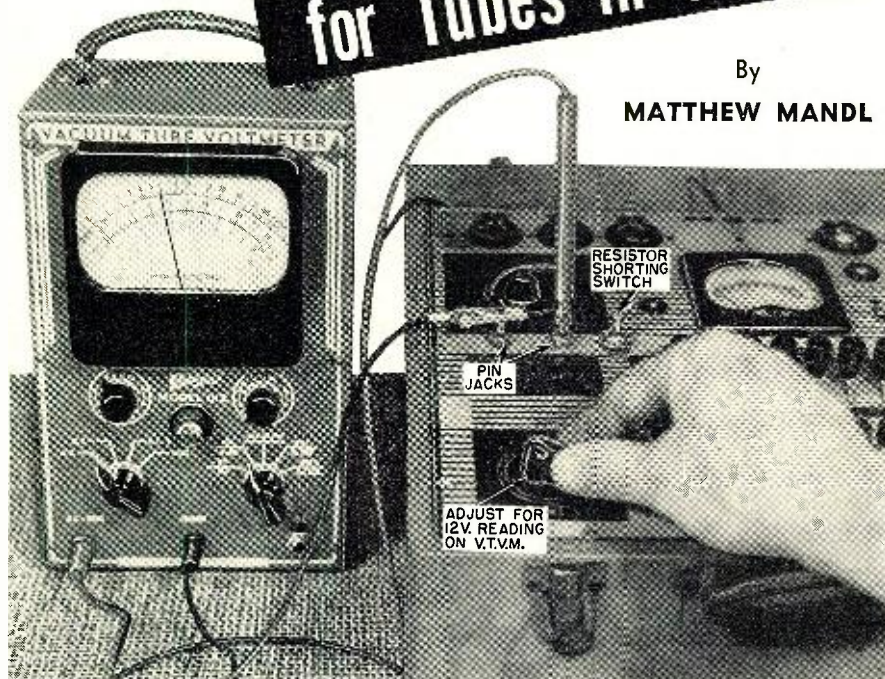

Fig. 1. Checking 600-milliamper tubes on a tester with the modifications of Fig. 4.

Practical suggestions for finding defective tubes in series strings and for testing 600-milliamper tubes.

AN increasing number of television receivers are using series heater strings made up of the newer 600-milliamper tubes. Since the new series-heater tubes differ in many respects from their older prototypes, servicing techniques of a different nature must be employed in order to expedite troubleshooting and to make sure that circuit performance is restored to what it was when the television receiver was new. The technician can do a better servicing job if he understands the essential differences between the newer and older series strings. Hence, a brief comparison between the two types will help illustrate the necessity for different servicing procedures when troubles occur in the newer series-heater circuits.

In the older series strings most of the tubes had a 6.3-volt heater rating, although occasionally 12-volt or 25-volt tubes were used in conjunction with the 6.3-volt types. Current requirements were often different for the various tubes, and in order to prevent excessive current from flowing through some tubes, it was necessary to use shunting resistors across them. Often, too, two tubes were placed in parallel in the series string to divide the current when such tubes did not draw as much current as flowed in the series circuit. Since there was no uniformity in warm-up time, some tubes received two or three times the normal voltage across their heaters when the receiver

was first turned on. Repeated applications of excessive voltage to such tubes during warm-up often resulted in short tube life. To minimize this, manufacturers placed a "Global" resistor in series with each string. Such a negative-temperature-coefficient resistor has a higher resistance when cold than after warm-up, measuring approximately 250 ohms when cold and only about 20 ohms after warm-up. These thermistor-type resistors limit the voltage surge which occurs when the set is first turned on and thus help to increase the life of the tubes as well as reduce the danger of heater burn-outs when the set is first turned on. The use of the special resistor, however, increased the warm-up time of the receiver and such a resistor was often a source of trouble because of poor contacts and intermittent operation as it aged. On occasion, arcing also occurred in the unit.

With the new type 600-milliamper tubes, however, the costly thermistor is eliminated and when a series resistor is necessary to make up the required line voltage drop across the string, an ordinary resistor is used. The "Global" resistor is not necessary because the 600-milliamper tubes have controlled heater warm-up time which minimizes the increase in voltage across a tube during warm-up and keeps such an increase well within the tolerable limits for long life. The newer tubes have also been especially designed for uni-

formity of current consumption. Thus, by having all the tubes draw the same current, shunting resistors across the heaters are no longer necessary.

The 600-milliamper tubes, however, are not uniform with respect to the voltage across the heaters. Hence, the voltage across one tube may be 3 volts, while 12 volts may appear across another. The approximate voltage for the tube is indicated by the first digits in the type number. Thus, a 3CB6 tube will have 3.15 volts across the heater when 600 milliamperes flow through it. A 6SN7GTB has a 6.3-volt rating, while a 12L6GT has a 12.6-volt rating.

Localizing Defective Tubes

When the heater of one tube of a series string opens, there is no current flow in the tubes leading to and away from the defective one. Hence, no voltage drop exists across any tube in the series string *except the one with the open heater*. This fact helps to localize a defective tube without the necessity for removing all the tubes and checking them in the tube tester.

Several methods can be employed for finding the open-circuit tube. If the underside of the chassis is readily accessible without chassis removal, an a.c. voltmeter set to read 120 volts can be utilized. The probes from the a.c. voltmeter are placed across the heater terminals of each socket and when the full line voltage is read, the open-heater tube will have been found. In receivers where the bottom of tube sockets are not accessible except after chassis removal, one tube can be removed at a time and the test probes of the a.c. voltmeter inserted into the respective heater socket holes.

Heater-to-cathode voltage ratings have generally been increased in the new 600-milliamper series-string tubes. Occasionally, however, the technician will encounter a heater-to-cathode short in one of the newer tubes and hence a tube checker may have to be used to isolate the shorted tube, since the voltmeter check will not indicate the short.

When a heater-to-cathode short occurs in a tube with a normally-grounded cathode, it is possible for some of the tubes in the series string to remain on while others will have their heaters out. This can be understood by referring to Fig. 2, which shows a portion of the series heater string of the *Hallcrafters* 1900D chassis. Tube V_{104} is a 6AW8, one-half of which is used as the video amplifier, and the other half as the sync clipper with a grounded cathode. If this tube develops a cathode-to-heater short, it will place the ground return of the a.c. line at the heater of this tube and, in consequence, will short out the remainder of the tubes in this string (V_{105} , V_{106} , V_{110} , V_{107} , and V_{113}). The shorted tubes cause the line voltage across the remaining tubes to go up approximately 33 volts with a consequent increase in the current through them. If the receiver is left on under

this condition, some of the tubes which are still lit may be damaged, or their life shortened considerably.

In this instance, the application of the probes of an a.c. voltmeter to the various tubes will indicate a slightly higher-than-normal voltage on the tubes which are lit, and zero voltage on the tubes which are out. While it may seem that only those tubes which are out need to be checked, the tube having a cathode-to-heater short may still be lit, and hence it may be necessary to check all the tubes before the defective one is found.

Much time can usually be saved by using the test resistors illustrated in Fig. 3. This method does not require chassis removal and localizes the defective tube by employing the two resistors shown. The pigtail leads of each resistor are extended by soldering a two-inch or three-inch length of wire to each one. The extra-length leads will permit bending them so that they can fit into the heater terminals of the tube sockets.

The procedure is also shown in Fig. 3. Here, assume that the sixth tube from the ground end has a cathode-to-heater short. Localization consists of removing *any one* of the lighted tubes and inserting the 50-ohm resistor into the heater socket holes of the tube which was removed. The 50-ohm resistor will have a 30-volt drop across it when 600 milliamperes flows through it. This reduces the excessive voltage and current on the lighted tubes.

Now, remove one of the tubes which is out and note whether the tubes which were lit have gone out. If they have, the tube with the cathode-to-heater short will have been found. If the remainder of the series string remains lit after the removal of each of the dead tubes, then the tube which has a cathode-to-heater short must be a lighted tube.

Now, remove one of the lighted tubes and insert the 20-ohm resistor in its heater socket terminals. If the removed tube is the defective one, the cathode-to-heater short will be absent and the tubes which were out will now light. If the latter tubes do not light, remove the 20-ohm resistor, replace the tube, and repeat the procedure for one of the other lighted tubes until the faulty tube is found.

Tube Testing

In most instances, the new 600-milliamper tubes can be tested on the tube checker without major changes except for the reduction of heater voltage where necessary. Thus, a series-string 12L6GT can be tested in a tube checker with the same settings as for a 6L6GT, except for an increase in the heater voltage from 6.3 to 12.6 volts. Also, a 3AU6 can be tested in a tube checker by making all the settings similar to those for a 6AU6, with the exception of reducing the heater voltage from 6.3 to 3.15.

One factor which is often overlooked is the change of resistance which may

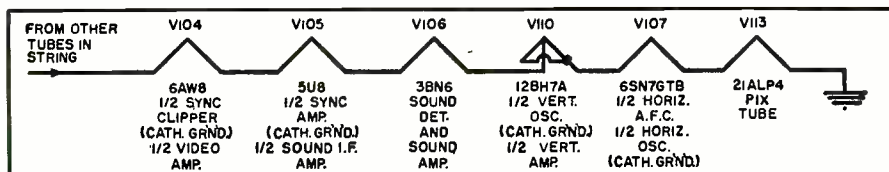

Fig. 2. A section of the series-heater string of the Hallicrafters 1900D chassis. This string is typical of those in use in many modern sets using multiple tubes.

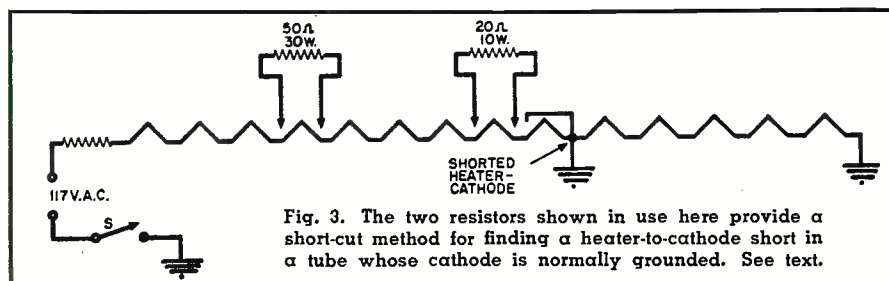

Fig. 3. The two resistors shown in use here provide a short-cut method for finding a heater-to-cathode short in a tube whose cathode is normally grounded. See text.

occur for a particular tube as it ages. If a 600-milliamper tube is tested in a tube tester, the latter will subject the tube to the same constant voltage conditions that would prevail if this tube were used in a parallel-heater, transformer-type receiver. In other words, a constant voltage would be applied across the tube, irrespective of the change in the resistance of the heater element. However, such a tube has incorrect power consumption in the heater and thus the cathode temperature may be abnormal. This would contribute to poor receiver performance.

These factors are an important consideration when checking the series-string tubes. Hence, it is highly desirable that some means be incorporated into the tube checker to make sure that 600 milliamperes of current flow through the heater while the tube is under test, irrespective of the voltage drop across the tube terminals.

Since a.c. milliammeters are rather costly, and usually not available in most shops, the simple modification of a tube tester outlined in Fig. 4 can be employed to insure constant current. Here, the heater winding of the tube tester's power transformer is opened beyond the heater-voltage adjusting potentiometer (or heater-voltage push-button selectors) of the tube tester. A 20-ohm, 10-watt resistor is then inserted as shown. Pin jacks are installed on the top panel of the tester, as shown in Fig. 1, and wired across the 20-ohm resistor. A toggle switch is also wired across the 20-ohm resistor so that the latter can be shorted out during testing of other than 600-milliamper tubes.

Before inserting a 600-milliamper tube to be tested, reduce the heater voltage supplied to the tester tube socket to the lowest value. Set the other tester controls and insert the tube to be checked. An a.c. voltmeter is then inserted into the pin jacks and the heater voltage to the 600-milliamper tube gradually increased until a reading of 12 volts is obtained across the pin jacks. This indicates that 600 milliamperes are flowing through the

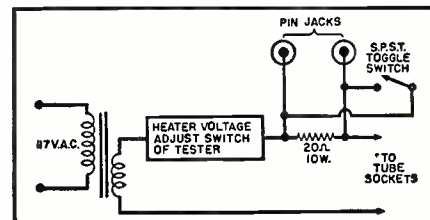

Fig. 4. Circuit addition to a tube tester to enable it to check 600-milliamper tubes accurately. Pin jacks are for v. t. v. m.

heater of the 600-milliamper tube, since the heater of the latter is in series with the 20-ohm resistor and current flow through a series circuit is the same throughout. The actual voltage which now drops across the 600-milliamper tube is of no consequence, since the current flow through the tube is of the proper amount, permitting a test of the tube under the conditions which would prevail when the tube is operated in its series string in the television receiver.

Some of the newer tube testers have provisions for regulating the current flow to the tube under test so that 600 milliamperes (.6 ampere) can be established for the new series-string tubes.

In some instances, 600-milliamper-type tubes can be used to replace older types. Thus, a 6SN7GTB can be used to replace a 6SN7GTA, since both have similar characteristics with respect to emission and conductance, as well as heater voltage and current ratings. The older type 6SN7GTA should not, however, be used to replace the newer type 6SN7GTB used in the 600-milliamper series strings. Even though both draw 600 milliamperes at 6.3 volts, the older type 6SN7GTA does not have controlled heater warm-up and will be short-lived. This precaution of not replacing controlled 600-milliamper tubes with older types also applies to other 600-milliamper tube types. For all 600-milliamper series strings, tube replacements should be made with exact duplicates to prevent a disturbance of the circuit function, warm-up time, and voltage surges.

recommended
reading for
buyers of...



TV COMPONENTS



and
TRANSFORMERS

2 NEW TRIAD CATALOGS

TV GUIDE TV-56, giving latest recommendations on Triad correct television replacements.

GENERAL CATALOG TR-56, listing the complete line of Triad transformers including 76 new items.

Ask your local TRIAD distributor or write ...



4055 Redwood Ave., Venice, California



A TRANSISTORIZED SCOPE CALIBRATOR

By JOSEPH CHERNOF

Improve performance of your inexpensive scope by adding this miniature calibrator.

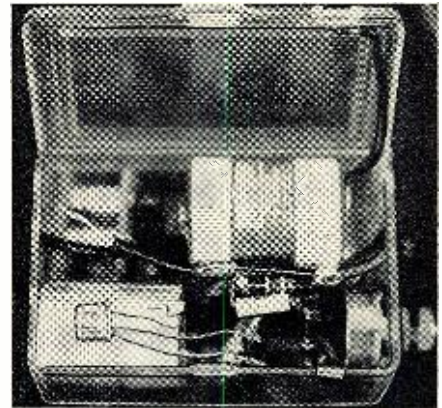

Over-all view of scope calibrator.

ONE of the most useful additions to the commercial laboratory or experimenter's workbench is the oscilloscope calibrator. In fact, the presence or lack of built-in calibration circuitry is one of the major differences between the inexpensive oscilloscope and its high-priced laboratory brother. An external scope calibration unit is not difficult to construct; however, conventional designs are not particularly compact and do require the use of an impressive number of components including power transformer, rectifier tube, two voltage regulator tubes and electrolytic filter capacitors. Yet, using the ordinary VR tube as a voltage reference source, accuracies of 3% to 5% are about the best that can be expected from conventional calibrator units.

This seemed to the writer to be a ripe field for the introduction of transistor circuits so, accordingly, a miniaturized calibration unit was built up in a small plastic box. This unit, using a minimum of components, will perform the following functions: Oscilloscope calibrator, source of standard a.c. and d.c. voltages for reference use in calibrating meters, etc., square wave audio oscillator for portable audio test unit or square wave test use in the lab. The unit is powered by a miniature 15 volt "B" battery and two tiny mercury "A" cells provide precise reference voltages.

The schematic diagram for the transistorized scope calibrator is shown in Fig. 1. A Radio Receptor type RR20 junction transistor is used as the audio oscillator, the output of which is clipped to provide the calibration signal. A UTC O-7 "Ouncer" transformer is used as the feedback element. C_1 and R_1 both control the oscillator frequency; the particular value shown for C_1 was chosen to give the most symmetrical output waveform from the oscillator circuit.

The circuit is not a critical one and performed satisfactorily when a number of RR20's were tried. A variety of other types of junction transistors were also substituted with good results. The "Ouncer" transformer was used mainly for its compact size; any audio transformer with a 3:1 turns ratio should be satisfactory. If another transformer is used, it should be connected so that the low impedance winding goes to the transistor base circuitry and the high impedance winding to the plus side of the "B" battery. Should the circuit fail to oscillate, phasing conditions are probably wrong and either the primary or secondary connections should be reversed to remedy this.

The oscillator output consists of a fairly symmetrical square wave at a frequency of 60 cycles using the components specified. This signal is coupled to the two diode clippers through

Fig. 1. Complete schematic of the transistorized oscilloscope calibrator.

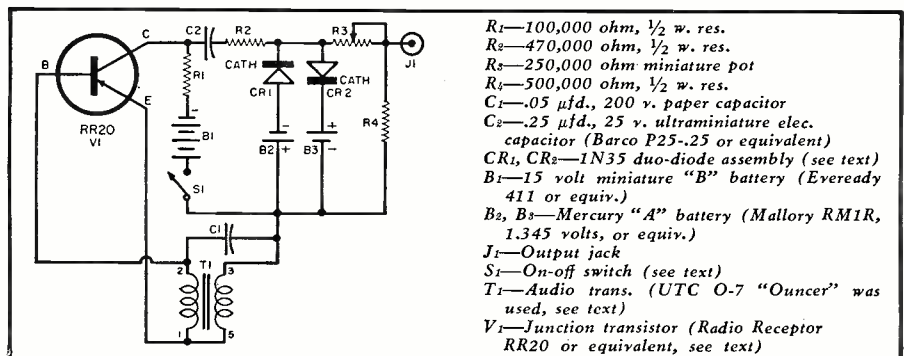



"Albert wouldn't miss his 9 o'clock schedule for anything."

SUMMERTIME IS MOBILE TIME

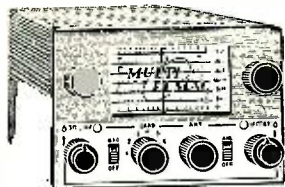

NEW ELMAC PMR-7 RECEIVER. Less power supply. Net \$159.00
PSR-612 Power Supply. 6-12 VDC. Net.....\$ 34.00



DYNAMOTOR

Brand new, government surplus. 12 VDC input. 440 VDC, 400 ma output. Can be filtered with 2 mfd paper condenser. Starting relay not included. Has snap-on mounting plate with Jones S-412-AB socket for input and output leads. Size 5 3/4"x4 1/2"x9" W, and weighs 13 1/2 lbs. Net.....\$ 14.95

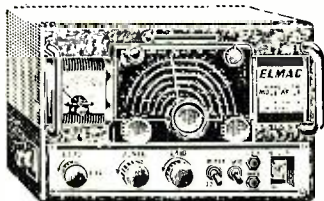

ELMAC AF-67 TRANS-CITER. Net.....\$ 177.00

Is your mobile gear ready for that summer driving? Whether it's your vacation, a trip to the mountains or the seashore, or just a short hop across town, there's nothing like the thrill of operating from your own car with a good, reliable mobile installation. Walter Ashe has a full line of the finest mobile equipment designed expressly for the roving ham. Go mobile the easy and inexpensive way - Walter Ashe is offering bigger-than-ever "Surprise" trade-in allowances on your used (factory-built) test and communications equipment. Use the handy coupon and get your trade-in deal working today.

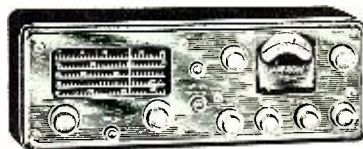

MORROW MATCHING RECEIVER AND TRANSMITTER

- MODEL MBR-5 RECEIVER.** 80 thru 10 meters. Dual conversion. 13 tubes. Less power supply and speaker. Net.....\$ 224.50
- MODEL MB-560 TRANSMITTER.** Same appearance and size as MBR-5 receiver. 80 thru 10 meters. 6146 final. Built-in VFO. 65 watts input. Net.....\$ 214.50
- MODEL RVP-250 Vibrator Power Supply.** For MBR-5 receiver. Also supplies low voltage for MB-560. Net.....\$ 39.95

USED EQUIPMENT

Special

ELMAC PMR-6A RECEIVER. Covers 160 thru 10 meters plus BC band. 10 tubes. Dual conversion. Checked and reconditioned. While they last.....\$ 74.50
PSR-6. 6 VDC power supply for above receiver. Reconditioned. Only.....\$ 12.50



GONSET G-66 RECEIVER. Less power supply and speaker. Net.....\$ 169.50
 Power Supply. 6-12VDC-115VAC. Built-in speaker. Net.....\$ 39.95

WRITE FOR FULL INFORMATION ABOUT OUR TIME PAYMENT PLAN

All prices f. o. b. St. Louis • Phone CHestnut 1-1125



RN-5-56

WALTER ASHE RADIO COMPANY
 1125 Pine Street, St. Louis, Mo.

Rush "Surprise" Trade-In Offer on my.....
 for.....
 (show make and model of new equipment desired)

Rush new free 1956 Walter Ashe catalog.

Name.....
 Address.....
 City..... Zone..... State.....

Every Serviceman's Profit-Maker Team...



Service Aids and
Your G-C Distributor!

G-C—MAKERS OF
SPRA-KLEEN
STOPS TELEVISION
AND RADIO CONTROL NOISES

ELIMINATES NOISE due to dirt, dust and corrosion
on electrical contacts.

JUST SPRAY ON... convenient power spray can
does the job in a wink. No need to dismantle
chassis.

CLEANS AND LUBRICATES contacts, controls, re-
lays, switches and other sliding electrical contact
devices in one operation.

SAVES TIME AND MONEY—gets the job done fast
—long lasting—full 6 ounces. No. 8666



POOF!

THERE GOES
NOISE

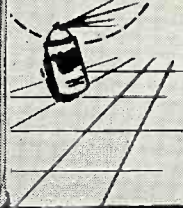

GENERAL CEMENT MFG. CO.

919 Taylor Avenue • Rockford, Illinois

FREE COPY... G-C Catalog. Send postcard today!



G-C
Chemicals



G-C
Alignment
Tools



G-C
Hardware



G-C
Service
Aids



TV-radio service work is faster, easier, more profitable... when you use
G-C Service Aids. You'll find thousands of them at your G-C parts distributor.

SEE US... BOOTH 590—ROOM 612—PARTS SHOW

**M
O
N
A
R
C
H**

BIGGEST
DOLLAR'S
WORTH IN
RECORD
CHANGERS!



**AUTOMATIC
RECORD
CHANGER**

★
AVAILABLE AT
ALL LEADING DISTRIBUTORS

the finest

PRECISION ENGINEERED BY



FOR BETTER RECEPTION

TELEVISION & FM ACCESSORIES
Tested and specifications certified by
New York Testing Laboratories, Inc.

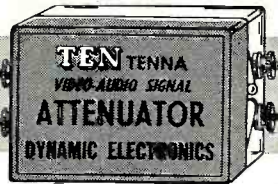

Assures removal of overload in strong signal areas... will improve and remedy faulty AGC circuits in TV and FM Receivers... regardless of cause.
• Eliminates ghosts and image tearing.
• Reduces audio and video distortion.
Model No. T121 List \$6.00

Introductory Price \$4.95

**SATISFACTION GUARANTEED OR
YOUR MONEY BACK**

FREE An 8-page booklet packed with every "Dynamic" accessory. "How to recognize and remedy your TV and FM problems"... Also improvement suggestions by eminent electronic engineers... Edited by Dr. H. S. Bennett, D.S.C. in E.E.

AVAILABLE AT LEADING PARTS DISTRIBUTORS.

Manufactured by
DYNAMIC ELECTRONICS-NEW YORK, INC.
FOREST HILLS, LONG ISLAND, N. Y.

a .25 μ fd., 12-volt electrolytic capacitor. This large value of capacity was necessary to avoid differentiating and thereby distorting the square wave output. Severe differentiation could reduce the amplitude of the trailing edge of the input square wave to below the diode clipping levels. For compactness, a Sangamo miniature tantalum foil capacitor was used for C_2 . This unit is approximately the same size as an ordinary 1/2-watt resistor.

The clipper circuits use two biased 1N35 crystal diodes. The 1N35's are actually a pair of electrically matched 1N34's assembled in a handy plastic mounting bracket. There would be no objection to using ordinary 1N34's in this application with some saving of space. The combination of the two crystal diodes and the series limiting resistor R_2 acts to limit an applied signal of approximately 10 volts peak-to-peak to a 2.69-volt peak-to-peak value. This is accomplished as follows. The plate of diode CR_1 is biased at 1.345 volts negative by being returned to the negative terminal of a Mallory type RM1R mercury "A" cell so that CR_1 will conduct when signals more negative than -1.345 volts are applied to its cathode. Thus peak negative input voltages exceeding the mercury cell reference voltage are effectively clipped. Similarly, the cathode of CR_2 is returned to the positive terminal of a second mercury cell so that all applied voltages at its plate exceeding +1.345 volts are also clipped. The output of these clipper circuits is a square wave with a constant 2.69-volt peak-to-peak amplitude. Use of the mercury cells for clipper reference voltages controls the output voltage of the unit to a high degree of accuracy since these batteries maintain their rated output voltages throughout their entire life and their service life should be a very long one in this type of low current drain circuit. Since an amplitude of 2.69 volts is a little unhandy as a calibration voltage, an adjustable divider network consisting of pot R_3 and fixed resistor R_4 is incorporated. R_3 is then adjusted to give a 2-volt peak-to-peak output voltage at output jack J_1 . No output attenuator switch was provided since it was found that the fixed 2-volt output proved an effective yardstick in measuring signals anywhere in a range of from .5 to 10 volts which was ample for the writer's purposes. An attenuator could be added if more flexibility is desired. By using a 22 1/2-volt "B" battery and higher clipping levels, output voltages as high as 10 volts peak-to-peak can be obtained from the unit.

Turning the unit "on" and "off" is accomplished by breaking the plus lead of the "B" battery (B_1). Switching is handled mechanically by soldering one lead to a small metal clip fastened around the lip of the cover of the plastic box and the other lead soldered to a second metal clip fastened to the mating edge of the box so that the two clips make contact when the box is closed. Thus the unit is turned

"on" when the box is closed and turned "off" when the cover is lifted. The metal clips were made by cutting down ordinary small *Fahnestock* clips. This arrangement is shown in the photograph.

The entire scope calibrator is housed in a 1x2x3 inch plastic box of the type available at most dime stores. A hinged cover is provided for access to the working parts, as shown in the accompanying photo. In addition to providing a high accuracy a.c. standard for scope calibration, it was found that the mercury "A" cells in the unit alone made excellent d.c. voltage standards for checking the calibration of multimeters. An extra output terminal could be added to the unit to bring out the voltage from one of the mercury cells for this purpose. The calibrator unit also makes an excellent source of low frequency square waves for hi-fi test work as well as a very compact portable oscillator for use in troubleshooting audio equipment on outside jobs. In this connection, the writer would like to venture the prediction that sometime in the not too distant future most of the bulky test equipment on the present-day workbench will have disappeared in favor of similar ultra-compact transistorized units performing the same functions. —30—

TESTING PORTABLES

By JAMES A. McROBERTS

A BATTERY tester, intended for checking portable radio batteries under load conditions, is also useful for those cases in which it is desired to test the output of a selenium or tube rectifier in 3-way portables when the remainder of the set is questionable.

At least 90 volts should be obtained with such a tester acting as a load on the selenium or tube supply. The tester should, of course, be set to 90 volts. Note that the tester loads the "B+" supply only so that with the filament drain taken off, the no-filament load "B+" voltage will run around 90 volts instead of about 67 which is the actual voltage used for "B" supply. Connections can be simplified by use of alligator clips slipped onto the test prods of the battery tester. —30—

REVERE RECORDER HINT

By JAMES A. McROBERTS

A HIGH-PITCHED rather shrill sound during "Record" on the Revere Model T-100 tape recorder may be due to the mechanical vibration of the pressure pad on its holder for either or both the "Record" and "Erase" heads. The friction with the moving tape causes the vibration.

To cure this annoying noise, dope whichever one is causing the trouble with airplane dope, insulating lacquer, or even Scotch pressure tape applied to the back of the pad only. A small amount of the dope can be placed on a pipe cleaner and touched to the back. Exercise care to see that the front is not doped in the process.

If you wish, press with a pencil or other light object against each pad in turn, with the tape running, so as to localize the trouble. The noise will stop or change its pitch if the pad being touched is its source. —30—

May, 1956



NEW! And Only! \$99⁵⁰

THE FISHER

FM TUNER

MODEL FM-40

HERE IT IS, a FISHER FM Tuner — with all that the name implies — for only \$99.50. Through the years it has been our policy to bring equipment of FISHER calibre within the reach of the widest possible audience. Rarely has that objective been more spectacularly attained. For the FM-40 represents one of our greatest values in almost two decades. It is a superb combination of engineering excellence and dazzling performance at moderate cost. Its specifications, conservatively outlined below, are your best index to the quality of this instrument.

Important Features of THE FISHER FM-40

- Meter for micro-accurate, center-of-channel tuning. ■ Sensitivity: 3 microvolts for 20 db of quieting. ■ Uniform response, ± 1 db, 20 to 20,000 cycles.
- Three-gang variable capacitor. ■ Three IF stages and a cascade RF stage.
- Two outputs: Detector/Multiplex (on switch) plus cathode-follower-type Main Audio, permitting leads up to 200 feet. ■ Two Controls: AC Power/Volume, and Station Selector. ■ Chassis completely shielded and shock-mounted; includes bottom plate. ■ 8 tubes: 1—6BQ7A, 1—6U8, 3—6BH6, 1—6AL5, 1—12AU7A, 1—6X4. ■ Folded dipole antenna supplied. ■ Heavy flywheel tuning mechanism. ■ Beautiful brown-and-gold brushed-brass, front control panel. ■ Highly legible, edge-lighted glass dial scale (accurately calibrated slide-rule type) with logging scale. ■ Self-powered. ■ SIZE: 12 $\frac{3}{4}$ " wide, 4" high, 8 $\frac{3}{8}$ " deep, including knobs. ■ SHIPPING WEIGHT: 15 pounds.

Professional FM Tuner • Only \$99.50

MAHOGANY OR BLONDE CABINET: \$14.95

Prices Slightly Higher West of the Rockies

WRITE TODAY FOR COMPLETE SPECIFICATIONS

FISHER RADIO CORP., 21-23 44th DRIVE • L. I. CITY 1 • N. Y.



AN EXCEPTIONAL, NEW THIRTY-WATT AMPLIFIER • HANDLES SIXTY-WATT PEAKS!

An Outstanding Buy!

THE 
FISHER

30-Watt Amplifier

MODEL 80-AZ

ANOTHER FISHER FIRST — our great new 30-watt amplifier with *PowerScope*, a Peak Power Indicator calibrated in watts to show instantly the peak load on your speaker system. The new FISHER 80-AZ Amplifier is the first with a positive indicator to prevent voice coil damage. The Model 80-AZ is magnificent in appearance and quality.

Incomparable Features of THE FISHER Model 80-AZ

- High output — less than 0.5% distortion at 30 watts; less than 0.05% at 10 watts. Handles 60-watt peaks. ■ Intermodulation distortion less than 0.5% at 25 watts and 0.2% at 10 watts. ■ Uniform response 10 to 50,000 cycles; within 0.1 db from 20 to 20,000 cycles. ■ Power output is constant within 1 db at 30 watts, from 15 to 35,000 cycles. ■ Hum and noise level better than 96 db below full output! ■ Three separate feedback loops for lowest distortion and superior transient response. ■ Unique cathode feedback circuit for triode performance with the efficiency of tetrodes. ■ Output transformer has interleaved windings and a grain-oriented steel core. ■ Three Controls: *PowerScope*, *Z-Matic* and Input Level. ■ Handsome, brushed-brass control panel (with sufficient cable for built-in installations.) ■ Tube Complement: 1—12AT7, 1—12AU7A, 2—EL-37 1—5V4-G, 1—*PowerScope* Indicator, 1—Regulator. ■ 8- and 16-ohm outputs. ■ Size: 15½ x 4¼ x 6¾" high. WEIGHT: 22 lbs.

Price Only \$99.50

Price Slightly Higher West of the Rockies

WRITE TODAY FOR COMPLETE SPECIFICATIONS

FISHER RADIO CORP., 21-23 44th DRIVE • L. I. CITY 1 • N. Y.



New Hi-Fi-Audio



Equipment

E-V CRYSTAL MICROPHONE

Electro-Voice, Inc., Buchanan, Michigan has announced the availability of a new crystal microphone that has been designed especially for p.a., call and paging systems, dictating machines, home recorders, amateur radio, and other general-purpose applications.

The Model 927 combines advanced functional styling, improved performance, and convenient operation in a smart, lightweight, easy-to-handle microphone. It slips into or out of an integrated base for tabletop or hand use. It is available with or without an "on-off" switch.

Frequency response is 60 to 6000 cps. Output level is -50 db while the RETMA sensitivity rating is -150 db. The polar pattern is essentially omnidirectional, becoming directional in the high-frequency range.

For complete information, send for Specification Sheet No. 53280, which is available without charge from the manufacturer.

SPHERICAL ENCLOSURE

Plastilex Products, Inc., 6515 North 10th Street, Philadelphia 26, Pa. is now offering a unique low-cost speaker system which uses a sphere of molded plastic as the enclosure.

Molded of lightweight foam plastic only 18" in diameter, the "Sonosphere" is a non-resonant infinite baffle capable of reproducing the entire audio spectrum. The spherical shape eliminates baffle reflections which often interfere with proper cone movement.

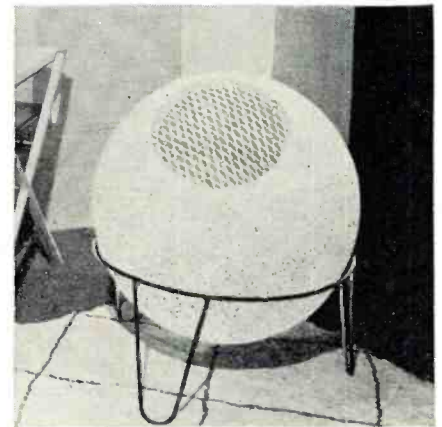

Sound "quality" can be tailored to individual tastes by turning the sphere so that the speaker opening faces toward the ceiling, floor, or any intermediate position.

The system is currently available either with or without the speaker. The enclosure is supplied with an 8-inch coaxial unit with a built-in

crossover network but can be used with other 8-inch speakers if desired.

Complete specifications on the "Bonn Sonosphere" are available from the manufacturer on request.

PORTABLE TAPE RECORDER

The Electronic Division of *Ercona Corporation*, 551 Fifth Avenue, New York 17, New York is handling the U.S. distribution of the Series 3A magnetic tape recorders manufactured by *British Ferroglyph Recorder Co., Ltd.* of London.

Designed and developed primarily for professional use, the new recorders

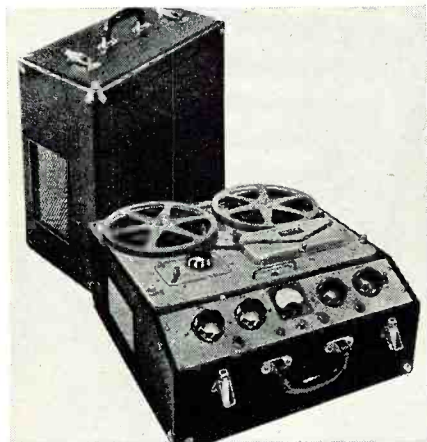

have three individual motors, one of which is a specially-designed "Octaquad" synchronous hysteresis capstan motor, which provides long-term speed stability, thus eliminating pitch errors on playback.

Two portable models are available with speeds of $3\frac{3}{4}$ and $7\frac{1}{2}$ ips and $7\frac{1}{2}$ ips and 15 ips. Both models accommodate 1750-foot reels of standard tape, have one-knob selector control, automatic stop switch, 60-second rewind, separate bass and treble controls, and output for a 15-ohm extension speaker.

The distributor will supply complete specifications and prices on request.

LANSING CABINET

James B. Lansing Sound, Inc., Los Angeles, California has started production on a new bass-reflex corner cabinet, the "Jordan," C-39.

The new enclosure, which is designed to complement the finest living room decor, can be used with an 8", 12", or 15" speaker or with a network system.

For full details on this new enclosure, write the manufacturer direct.

"SOUND-CENTER" KIT

The *Cabmart Division of G & H Wood Products Co., Inc.*, 99 N. 11th Street, Brooklyn 11, New York is now offering a series of "build-it-yourself" kits which can provide housing for a complete home entertainment center.

Ten units, nine cabinets and one base, comprise the ST series. The cabinets are modular and may be purchased singly allowing the hi-fi enthusiast to compose and select the most suitable wall-storage combina-

ALL-TRANSISTOR!

America's
FIRST!

MODEL
TR-1

BOTTOM VIEW WITH COVER REMOVED • PRECISION WORKMANSHIP THROUGHOUT

THE 
FISHER

ALL-TRANSISTOR Preamplifier-Equalizer

WE ARE PROUD to announce the new FISHER All-Transistor Preamplifier-Equalizer, Model TR-1. This little giant is the result of four years of research and development and represents one of the greatest achievements in the long line of FISHER FIRSTS. We believe the TR-1 is the first all-transistor product of any kind in the high fidelity field. Its development was no accident, but rather the fruit of twenty years of leadership in audio technology. The TR-1 has NO hum. We repeat: ABSOLUTELY NO HUM. Second, it has NO microphonism. Other unique features of the TR-1 are listed below. The initial demand for this revolutionary device may exceed the available supply. To avoid disappointment, may we suggest that you place your order now.

Outstanding Features of THE FISHER Model TR-1

- Can be used with any existing amplifier, audio control, or sound system. ■ Battery powered. Power consumption only 0.033 watts. Battery will last as long as it would when lying idle on a shelf! ■ Can be used as a phonograph or microphone preamplifier.
- Uniform response, within 2 db, 20 to 20,000 cycles. ■ Built-in switch selects cartridge impedance. ■ Handles all popular magnetic cartridges including very low-level type. Does not require transformer with the latter. ■ Hum level: *absolute zero!*
- Noise level, 65 db below 10 mv input for high impedance cartridges. Better than 60 db below 2 mv for low impedance cartridges. ■ Incorporates RIAA equalization, now standard on all records. ■ Permits output leads up to 200 ft. ■ Three Controls: Power/Volume, Cartridge Impedance Selector, Phono-Microphone Selector Switch.
- Uses three transistors. Printed wiring throughout. ■ Fully shielded chassis with bottom cover. ■ Attractive control plate. ■ SIZE: 2" x 4" x 4½" deep. ■ WGT.: 12 oz.

Price, \$27.50 • Battery, \$1.95 • 110V AC Power Supply, \$4.95

WRITE TODAY FOR COMPLETE SPECIFICATIONS

FISHER RADIO CORP. • 21-23 44th DRIVE • L. I. CITY 1, N. Y.



"Breathtaking!" — EDWARD TATNALL CANBY

THE FISHER

Master Audio Control

SERIES 80-C

"**S**TARTLINGLY DIFFERENT," says Edward Tatnall Canby, *Audio Magazine*. "Has everything, at a very reasonable price for top-quality hi-fi equipment. The easiest to read and operate I've ever seen. The specs on performance are breathtaking and the over-all quality of its electrical operation is pretty closely comparable to that of a professional broadcast console control board. This is the current standard for really hi-fi operation of controls in the home. Hum, distortion, *et al* are so low as to be inaudible and mostly unmeasurable in the lab. And all this, mind you, in the middle price range."

Chassis Only, **\$99.50** • Mahogany or Blonde Cabinet, **\$9.95**

Remarkable Features of THE FISHER 80-C

- Professional, lever-type equalization for all current recording characteristics.
 - Seven inputs, including two Phono, Mic and Tape.
 - Two cathode-follower outputs.
 - Complete mixing and fading on two, three, four or five channels.
 - Bass and Treble Tone Controls of the variable-crossover feedback type.
 - Accurately calibrated Loudness Balance Control.
 - Self-powered.
 - Magnetically shielded and potted transformer.
 - DC on all filaments; achieves hum level that is inaudible under any conditions.
 - Inherent hum: non-measurable. (On Phono, 72 db below output on 10 mv input signal; better than 85 db below 2v output on high-level channels.)
 - IM and harmonic distortion: non-measurable.
 - Frequency response: uniform, 10 to 100,000 cycles.
 - Separate equalization and amplification directly from tape playback head.
 - Four dual-purpose tubes, all shielded and shock-mounted.
 - Separate, high-gain microphone preamplifier.
 - Push-Button Channel-Selectors with individual indicator lights and simultaneous AC On-Off switching on two channels (for tuner, TV, etc.).
 - Master Volume Control plus 5 independent Level Controls on front panel.
 - 11 Controls plus 5 push-buttons.
 - Three auxiliary AC receptacles.
- SIZE: Chassis, 12 $\frac{3}{4}$ " x 7 $\frac{1}{4}$ " x 4 $\frac{1}{4}$ " high. In cabinet, 13-11/16" x 8" x 5 $\frac{1}{4}$ " high. Shipping weight, 10 pounds.

Prices Slightly Higher West of the Rockies

WRITE TODAY FOR COMPLETE SPECIFICATIONS

FISHER RADIO CORP. • 21-23 44th DRIVE • L. I. CITY 1, N. Y.

tion. The cabinets are identical in width. Sixteen, twenty-four, and thirty-two inch heights are available while the sixteen-inch depth permits all-purpose storage.

The entire line comes ready to assemble (with a screwdriver) or factory-assembled, ready to finish or paint. Write the company for complete details.

TRANSISTOR PREAMP-EQUALIZER

Fisher Radio Corporation, 21-21 44th Drive, Long Island City 1, New York has developed an all-transistor pre-amplifier-equalizer, believed to be the first all-transistor product in the high-fidelity field.

The Model TR-1 is free from hum and microphonics. It can be used as

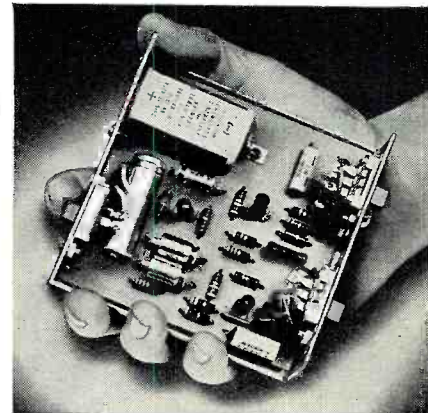

a phonograph or microphone preamplifier. Weighing only twelve ounces and using only .33 watt drawn from a self-contained battery, the TR-1 uses three transistors and printed wiring throughout. It can be used with any existing amplifier, audio control, or sound system.

The unit incorporates RIAA equalization. Three controls, operated from a control designation panel, permit complete flexibility of function. A cartridge impedance selector permits the preamp to be used with all popular magnetic cartridges, including the very-low-level type, and does not require a transformer.

"DUODYNE" HEADSET

Telex, Inc., Telex Park, St. Paul 1, Minnesota has developed a new head-

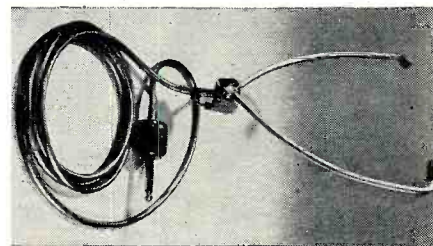

set whose design is based on data supplied by a U. S. Army research project recently conducted at the University of Cincinnati.

The "Duodyne" headset produces a "live" effect by inducing a 5 millisecond time delay in transmitting sound to one earpiece. One dynamic driver is located in a "Tenite" housing with the PL-55 plug and is separated

from the second driver in the tone arm junction by 5 feet of plastic tubing. Each driver feeds a separate ear, one driver emphasizing the highs and the other the lows.

Weighing only 2 ounces, this under-the-chin style headset has a frequency response of from 100 to 8000 cps and an impedance of 15 ohms.

CUSTOM-BUILT SYSTEMS

Gray Research & Development Company, Inc., Manchester, Conn. has announced its entry into the custom-built field to supply high-fidelity sound systems for hotels, restaurants, schools, concert halls, private homes, commercial buildings, etc.

Although the system is very flexible in size and layout and can be adapted to meet almost any requirement, basically it will consist of the company's "Viscous Damped" tone arm, turntable, amplifier and preamp, and speaker.

The system can be installed in most existing buildings or plans made for its installation in new construction.

E-V "CENTURION"

A new corner folded-horn enclosure and four-way loudspeaker system have

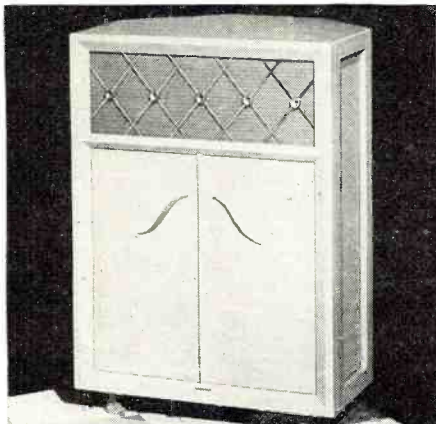

been introduced by *Electro-Voice, Inc.* of Buchanan, Michigan as the "Centurion."

The new unit provides design features of the company's "Georgian" but on a smaller scale at more modest cost. The acoustically-designed enclosure with the company's "W" single path indirect radiator folded-horn, fully utilizes the walls at the corner of the room to extend bass reproduction down below 35 cps.

When integrated with a matched E-V separate speaker system, the "Centurion" provides an efficient four-way reproducer.

The design is currently available as a factory-assembled enclosure, as a complete system, and as a "do-it-yourself" kit. Write the manufacturer for full specifications on any or all of these available models.

UNIVERSITY ENCLOSURE KITS

University Loudspeakers, Inc., 80 S. Kensico Ave., White Plains, New York has released a new series of "do-it-yourself" speaker enclosure kits.

Incorporating the company's "De-

May, 1956

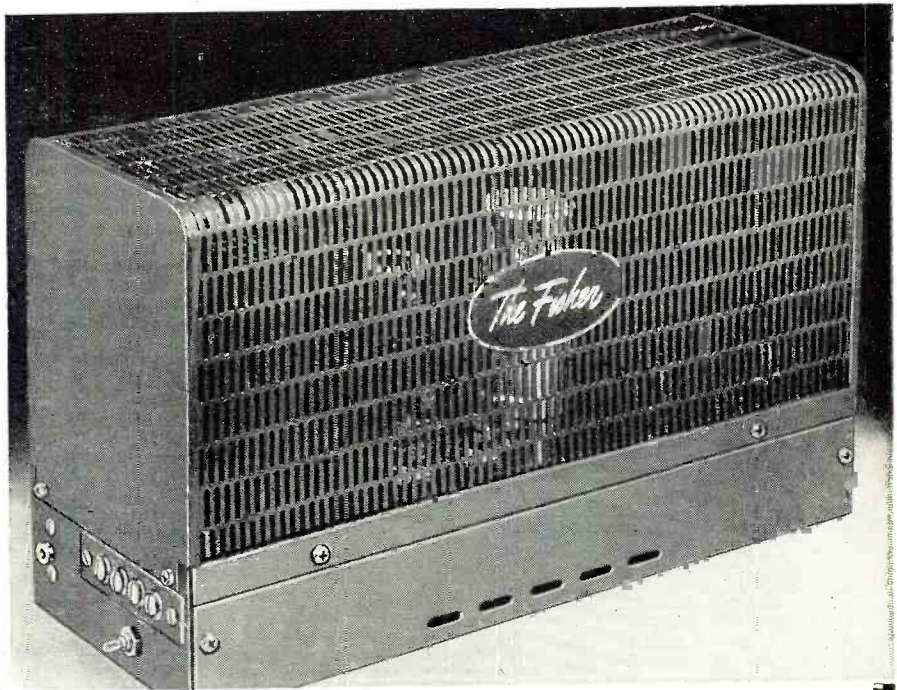

The Best In Its Class!

THE
NEW

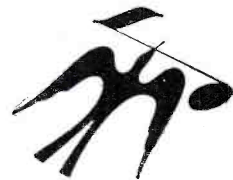

FISHER

Standard Amplifier

MODEL 20-A

HERE is the amplifier you have asked for — a *low-cost* unit of conspicuous *quality*. The new FISHER Standard Amplifier meets the most exacting requirements in its field. As you would expect, traditional FISHER quality, handsome appearance, excellent workmanship and advanced design are evident throughout this exceptional unit.

Incomparable Features of THE FISHER Model 20-A

- Power Output constant within 1 db at 15 watts from 15 to 30,000 cycles.
- Less than 0.7% distortion at 15 watts; less than 0.4% at 10 watts.
- Intermodulation distortion less than 1.5% at 10 watts and less than .75% at 5 watts.
- Uniform response, ± 0.1 db from 20 to 20,000 cycles; within 1 db from 10 to 100,000 cycles.
- Hum and noise better than 90 db below full output.
- Internal impedance is 1 ohm for 16-ohm operation, giving a damping factor of 16. This assures low distortion and superior transient response.
- TUBE COMPLEMENT: 1—12AX7, 2—EL84, 1—EZ80.
- OUTPUT IMPEDANCES: 4, 8 and 16 ohms.
- SIZE: 4 $\frac{1}{4}$ " x 13" x 6 $\frac{3}{4}$ " high. WEIGHT: 13 lbs.

Price Slightly Higher In the West

Price Only \$59.50

WRITE TODAY FOR COMPLETE SPECIFICATIONS

FISHER RADIO CORP. • 21-23 44th DRIVE • L. I. CITY 1, N. Y.

Your
HIGH FIDELITY
 System
 IS OFF TO A
 Perfect Start
 with a
REK-O-KUT
Rondine
TURNTABLE
 and
TURNTABLE ARM

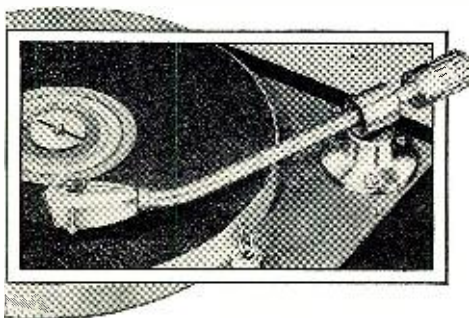

REK-O-KUT TURNTABLES:

3-Speed

Rondine Deluxe (hysteresis motor) . **\$129.95**
 Rondine (4-pole induction motor) . **79.95**

2-Speed (4-pole induction motors)

Rondine Jr.
 Model L-34 (33 $\frac{1}{3}$ and 45 rpm) . . . **\$49.95**
 Model L-37 (33 $\frac{1}{3}$ and 78 rpm) . . . **49.95**

REK-O-KUT ARMS:

Model 120 (12") **\$26.95**
 Model 160 (16") **29.95**



See them at your high fidelity dealer or write to Dept. RE-12



REK-O-KUT COMPANY

38-01 Queens Blvd., Long Isl. City 1, N.Y.

Makers of fine recording and playback equipment
 Engineered for the Studio • Designed for the Home

cor-Coustic" design, the EN-CB is a utility model of the firm's "Classic Deluxe" 3-way speaker system enclosure. It comes in $\frac{3}{4}$ " unfinished fir plywood. Measuring 40" wide, 30" high, and 24" deep, the enclosure can be used horizontally or vertically as part of a room divider.

The company is also offering the KEN series of "Kwikits" which are designed to be assembled from scratch. These kits employ $\frac{3}{4}$ " birch hardwood cabinet plywood which is machined, pre-shaped, and pre-drilled to allow assembly with a household screwdriver. Units to house 12" and 15" speakers are available in the kit series.

TAPE REEL CLIPS

Niblack Thorne Co., Box 86, Scottsdale, Arizona has developed a unique and inexpensive clip which keeps recording tape from unreeling during storage and handling.

Tradenamed the "Magi-Clip," this non-magnetic brass clip holds tape se-

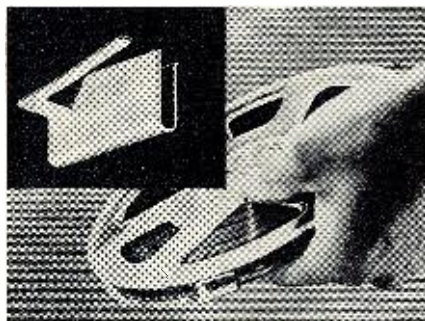

curely and reduces tape wear. The clip will fit any size reel and snaps on and off easily and quickly. The device is said to eliminate the need for masking tape or rubber bands.

Write Dept. P-38 for additional information and prices on these clips.

MAGNETIC CARTRIDGE

Audiogersh Corporation, 23 Park Place, New York 7, New York is currently offering a new variable-reluctance magnetic cartridge, the "Miratwin" Type MST-2.

Frequency response is flat within ± 2 db from 20 to 18,500 cps on vinylite on the microgroove unit and within ± 4 db on the standard-groove unit.

The unit is available with either two sapphire styli or with one 3-mil sapphire and one 1-mil diamond styli.

STROBOSCOPE UNIT

Berkshire Laboratories, 566 Bank Village, Greenville, New Hampshire is now offering a small, light, inexpensive stroboscope unit, the "Labstrobe Model 18-A."

The unit gives 60 brief flashes of light per second when connected to an ordinary 60-cycle power line. The Model 18-A incorporates a precision socket which provides accurate setting of the lamp and facilitates lamp replacement.

For checking turntable accuracy, the strobe is used in conjunction with the company's "Phonostrobe Disk."

The disc is designed so that it may be used with all three of the usual record speeds.

Write the company for full details on the strobe and the disc.

NEW CATALOGUES

"MAGNEMITE" RECORDERS

Amplifier Corp. of America, 398 Broadway, New York 13, New York is currently offering a four-page folder which describes its "VU Magnemite" series of portable, battery-operated, spring-motor magnetic tape recorders.

The brochure describes in detail features of fourteen models, all of which were especially designed for field applications. The various mechanical and electrical components are fully described and individually illustrated. The recorders' operations are concisely explained and complete technical specifications, recommended accessories, as well as direct factory prices, are included. The brochure is available free.

TAPE COATINGS

Minnesota Mining and Manufacturing Co., 900 Fauquier Street, St. Paul 6, Minn. is offering a free copy of its bulletin No. 31 which incorporates a technical discussion of the effect of coating thickness on frequency response of magnetic tape.

The three-page bulletin, illustrated by four charts, is intended for broadcast engineers, electronics specialists, and laymen interested in magnetic recording. It covers "optimum" recording conditions, bias and audio recording currents and their effects on high and low frequency response of tapes with various oxide coating depths.

In addition, these effects on specific "Scotch" brand magnetic tapes are summarized. Write Dept. A6-30 for a copy of this bulletin.

E-V AMPLIFIER DATA

A comprehensive bulletin covering its line of high-fidelity power amplifiers, amplifiers with controls, and music control centers with preamps has been issued by *Electro-Voice, Inc.*, of Buchanan, Michigan.

Complete data, specifications, and prices on the company's 15, 20, 30, and 50 watt hi-fi units and 15 and 20 watt amplifiers with controls are given in Bulletin 222.

For a free copy write the company direct.

"DYNAKIT" AMPLIFIER

Dyna Company, 5142 Master Street, Philadelphia 31, Pa. has available a four-page specification sheet covering its 50-watt power amplifier which is offered in kit form.

The booklet completely describes and illustrates the "Mark II" and explains some of the philosophy behind the design. The amplifier itself provides 50-watts continuous and 100-watts peak output. Frequency response is from 6 cps to over 60 kc. ± 5 db.

For a copy of this publication, write the company direct.

Wide-Range Spike Generator

By RUFUS P. TURNER

Add this non-critical circuit to your square-wave generator to increase its versatility.

A PATTERN of accurately-spaced spikes is convenient for marking-off time intervals on a scope screen. The horizontal axis can thus be calibrated in milliseconds or microseconds if the repetition rate of the spikes is known. The sharper the spikes the more accurately they may be used. Spikes are also useful for shock-exciting tuned circuits in certain experiments.

Fig. 1 shows a wide-range spike generator using only two resistors, one IN91 junction germanium power rectifier, and one IN34 germanium diode. This device is connected to the output of any square-wave generator and requires no tuning or adjustments. While square-wave input is best, fair results are obtained with sine waves.

Spike generation in this circuit results from the recovery-time characteristic of the IN91 rectifier. The square wave (A) is rectified by the IN91. However, the IN91 conducts heavily during the first part of the negative half-cycle because hole storage in the germanium junction prevents this rectifier from establishing its high back resistance immediately after the square wave switches negative. The result is the sharp negative spikes seen in pattern (B).

The voltage across the 1000-ohm load resistor has this waveform. This voltage, in turn, is applied to the reverse-connected IN34 diode which removes the positive half-cycles from waveform (B) leaving only the desired negative spikes (C) to reach the output terminals. The IN34 is a point-contact type of diode and so does not exhibit the spiking characteristics of the IN91. Spike amplitude is adjusted by means of the output control on the generator.

The spike amplitude increases at high frequencies (50 kc. and up), since hole storage effects become more evident at these frequencies.

If the output circuit of the square-wave generator employed has no return path for the IN91, a 100-ohm resistor must be connected across the input terminals of the spike generator, as shown dotted in Fig. 1.

-30-

Fig. 1. Schematic of spike generator.

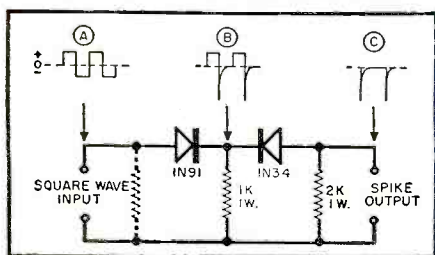

PLUS profits!

with this AMPHENOL PROFIT PROMOTER



CREATES IMPULSE SALES

check with your **AMPHENOL** distributor

or mail this coupon for details—TODAY!

AMERICAN PHENOLIC CORPORATION
Distributor Division
1830 S. 54th Avenue, Chicago 50, Illinois

Yes, send me full details on how I may obtain a free AMPHENOL Profit Promoter

NAME _____

COMPANY _____

ADDRESS _____

CITY _____ ZONE _____ STATE _____

When signal conditions demand a TOWER... choose one built by AERMOTOR

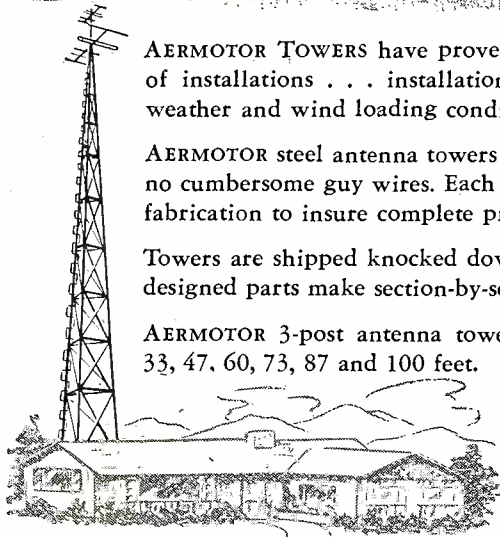

AERMOTOR TOWERS have proven their excellence in thousands of installations . . . installations exposed to the most severe weather and wind loading conditions.

AERMOTOR steel antenna towers are self supporting . . . require no cumbersome guy wires. Each part is heavily galvanized after fabrication to insure complete protection from exposure.

Towers are shipped knocked down in convenient bundles; well designed parts make section-by-section assembly easy.

AERMOTOR 3-post antenna towers are available in heights of 33, 47, 60, 73, 87 and 100 feet.

WRITE FOR ADDITIONAL INFORMATION ABOUT THE AERMOTOR TOWERS AND A DEALER FRANCHISE IN YOUR TERRITORY.

SINCE 1888, MANUFACTURERS OF QUALITY BUILT TOWERS

• AERMOTOR COMPANY •

2500 W. ROOSEVELT RD.—CHICAGO 8, ILLINOIS U.S.A. DEPT. 12U5

LEARN TV

'At the most practical school in the west'

Work on late model sets—using modern equipment and service techniques: under qualified technician instructors. Short resident and correspondence courses—no unnecessary math or theory—also UHF and Color TV. APPROVED FOR VETERANS . . . day and nite classes.

Write for free literature, Dept. IA for residence—Dept. IAC for correspondence.

V.S.I. TELEVISION SCHOOL

4570 Firestone Blvd., Box 359
South Gate, California

MARINE RADIO-TELEPHONES

FCC APPROVED

List Prices—Complete with ship to ship and distress channels only. Specify ship to shore crystals for your locality at \$15.00 per set. All Models equipped with Broadcast Band.



PORTABLE—Provides the maximum of safety when emergencies exist. Operation does not depend on ship power or ship antenna installation. All Portables equipped with 40 A. H. rechargeable 6 volt batteries. Antenna is telescopic for easy storage.

35 WATT—4 trans-rec channels and broadcast band. Complete with handset. **LIST PRICE \$375.00**

15 WATT—3 trans-rec channels and broadcast band. Complete with microphone. **LIST PRICE \$285.00**

FIXED—Uses ship power. Requires standard antenna installation. Furnished for either 6 or 12 volt operation. (Specify voltage required.)

35 WATT—4 trans-rec channels and broadcast band. Complete with handset. **LIST PRICE \$345.00**

15 WATT—3 trans-rec channels and broadcast band. Complete with microphone. **LIST PRICE \$260.00**

Discount to qualified Electronic Dealers. Demonstrator sold on 10 day guarantee or money refunded. Territory in certain areas open to Dealers and Manufacturers Representative.

MARINE DIVISION GENERAL DEVELOPMENT CORPORATION
ELKTON, MARYLAND

of equipment is necessary to generate a single-sideband signal irrespective of power output. Any increase in power is merely a function of the output stage and its associated power supply equipment. However, in the conventional AM transmitter in order to increase power not only the output amplifier stages and power supply must be increased in size, but the high level modulating equipment must also be increased in power capabilities which requires a larger power supply as well.

Many commercial users are going to be concerned with conversion of their present AM equipment to single-sideband operation. In many cases this will be possible and economically feasible. The actual conversion techniques will be covered later in this series. If a few minimum circuit requirements are met by the existing AM equipment it is possible to convert such transmitters to single-sideband transmission. This would allow the user to recoup up to 75% of his capital investment in AM equipment. In the case of low-powered AM transmitters (100 watts or less) it is believed that many such transmitters could not be converted to SSB economically.

In such cases it would be more economical to scrap the present AM equipment and install completely new single-sideband equipment. With transmitters having power outputs of a few hundred watts to several kilowatts, the possibilities of conversion to single-sideband should be carefully investigated. There are a number of different ways of converting existing AM equipment to SSB operation. The simplest method of conversion would be to eliminate the high-level modulation equipment of the AM transmitter but retain the present frequency control and frequency multiplication equipment plus the r.f. power amplifiers and power supply equipment. For many classes of commercial service this conversion would be very successful and would undoubtedly meet minimum FCC specifications. Let it be said, at this point, that the majority of AM transmitters in use can be successfully converted to single-sideband operation. More on the requirements and actual conversion later.

Single-Sideband Signal

There are two systems for generating a single-sideband signal; the older and "classical" technique is the filter method. In this system, often referred to as the "brute-force" system, the undesired sideband is actually filtered out of a generated double-sideband signal.

The other system for generating a single-sideband signal is commonly referred to as the "phasing" or "phase-shift" method of generation. This method of generation is possible be-

ALLIED knight-kits

**FINEST ELECTRONIC EQUIPMENT
IN LOWEST-COST KIT FORM**

- ★ Latest Advanced Design
- ★ Quality Components
- ★ Easiest to Assemble
- ★ Save Up To 50%

BUY DIRECT...YOU SAVE MORE

free **1956 CATALOG**

Send for it! Describes the famous KNIGHT-KITS in detail—shows you how you can easily assemble your own instruments and get performance and appearance equal to equipment selling for several times the KNIGHT-KIT price. The 324-page ALLIED Catalog is the leading buying guide to *everything* in Electronics—write for your copy.



SAVE ON THESE QUALITY knight-kit TEST INSTRUMENTS

 5" Wide-Band Oscilloscope Kit F-144 69.00	 Printed Circuit VTVM Kit F-125 24.95	 Tube Tester Kit F-143 counter type 29.75 F-142 portable type 34.75	 VOM Kit 1000 Ohms/Volt F-128 15.95	 VOM Kit 20,000 Ohms/Volt F-140 28.50	 In-Circuit Capacitor Checker Kit F-119 11.65
 Audio Generator Kit F-137 31.50	 Resistor-Capacitor Checker Kit F-124 18.75	 High-Gain Signal Tracer Kit F-135 23.75	 RF Signal Generator Kit F-145 19.75	 Resistance Substitution Box Kit F-139 5.95	 Capacitance Substitution Box Kit F-138 5.50

FAMOUS knight-kits FOR THE HOBBYIST

 "Space Spanner" 2-Band Receiver Kit S-243 13.95 S-247 cabinet, 2.85	 "10-in-1" Lab Kit S-265 12.45	 "Ranger" Superhet Receiver Kit S-735 14.85
 "Ocean Hopper" Receiver Kit S-740 10.75	 Transistor Radio Kit S-765 3.95	 Geiger Counter Kit S-242 15.95
 3-Way Portable Radio Kit S-730 19.95	 Photoflash Kit S-244 28.50 S-246 AC supply, 3.40	 Wireless Broadcaster Kit S-705 8.75

TOP QUALITY HIGH FIDELITY knight-kits

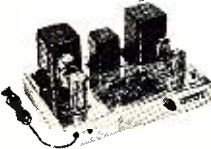
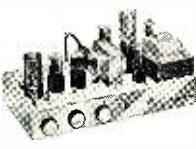
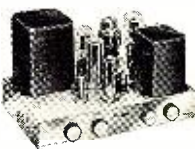
 Basic 25-Watt Deluxe Amplifier Kit S-755 41.50	 10-Watt Hi-Fi Amplifier Kit S-234 22.95	 20-Watt Hi-Fi Amplifier Kit S-750 35.75
--	--	--

LOW-COST knight-kits FOR THE AMATEUR

 50-Watt CW Transmitter Kit S-255 42.50	 Self-Powered VFO Kit S-725 27.50	 Code Practice Oscillator Kit S-239 3.95
--	---	--

All Prices Net F.O.B. Chicago
ORDER FROM

ALLIED RADIO

100 N. Western Ave., Chicago 80, Ill.

May, 1956

FREE



Send for the 324-page ALLIED Catalog describing all KNIGHT-KITS—and your buying guide to everything in Electronics.

ALLIED RADIO CORP., Dept. 1-E-6
100 N. Western Ave., Chicago 80, Ill.

Send FREE 1956 ALLIED Catalog.

Ship the following KNIGHT-KITS: _____

Name _____

Address _____

City _____ Zone _____ State _____

Two important steps
toward achieving
better sound...

**marantz
power amplifier**



Selective 40 Watt Ultralinear or
20 Watt Triode operation.
Built in metered tests and adjustments.
Highest type construction.

net \$189. West and
Deep South \$198.45

**marantz
audio consolette**

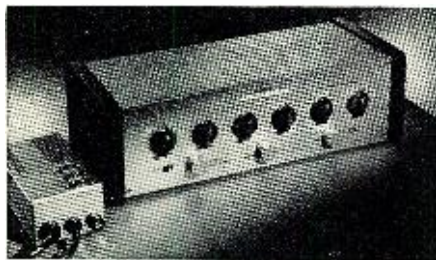

New tape monitoring switch.
High gain with extremely low distortion.
Hum free operation.
Superior performance
and construction.

with cabinet net \$162. West
and Deep South \$170.10

See your audio dealer or
write for specifications

marantz company

44-15 VERNON BLVD. • LONG ISLAND CITY, N.Y.

cause of the recent development of wide-band audio phase-shift networks.

For a detailed explanation of the theory behind both the filter and phasing methods of SSB generation, it is suggested that the reader refer to this author's booklet.³

Which System Is Cheaper?

Experience has shown that for signals having the same degree of side-band attenuation the phasing and filter systems cost approximately the same in the final analysis. As strange as it may seem, it turns out that the money that would be spent for filters in the filter generation system is almost equaled by the money spent on the precision components necessary in the wide-band phase-shift networks for the phasing systems. The yet-to-be-considered linear amplifiers for the two transmitters are in every respect identical and therefore no price differential exists. Experience has also shown that, in many cases, there is little choice between the two systems. By this is meant that a well adjusted and constructed phasing type transmitter will yield the same sideband suppression as a well-constructed and adjusted filter single-sideband transmitter.

REFERENCES

1. Schlaak, N. F.: "Single-Sideband System for Overseas Telephony," *Electronics*, November 1952.
2. Wrathall, E. T., & Beanland, C. P.: "The Single-Sideband System of High Frequency Radio Transmission," *Marconi Review*, First Quarter, 1951.
3. Brown, J. N.: "Single-Sideband Techniques," *Cowan Publishing Corp.*, New York. (To be continued)

INSTRUCTORS NEEDED

THE Samuel Gompers Vocational and Technical High School of New York City has sent out an urgent appeal for radio and television instructors.

Minimum educational qualifications include high school graduation (technical, vocational, or academic) plus from 5 to 7 years of appropriate trade experience. Maximum age limit is 60 years. Salaries range from \$3900 to \$7600 in periodic increases.

Instructors will be required to work from 180 to 200 days a year, daily for 6 hours and 20 minutes (including lunch).

Contact Monroe M. Freedman, administrative assistant, in care of the school at 145 Street and Southern Boulevard, Bronx 55, New York, MOtt Haven 5-0950, if you can help out. -30-

OREGON CONVENTION

THE Valley Radio Club of Eugene, Oregon, will play host to the Oregon Amateur Radio Association's 19th Annual Convention May 5th and 6th in Eugene.

About five hundred amateurs and their families are expected to attend from all over the northwest. There will be featured speakers, demonstrations, contests, prizes, mobile hunts, special group breakfasts, swapfests, banquet, and other entertainment.

Registration for amateurs is \$8.00 with non-hams being tapped for \$4.50. The price includes the banquet.

Write OARA Convention Headquarters, 828 Olive St., Eugene, Oregon, for full details or to register. -30-

**BUILD YOUR OWN
AMATEUR TRANSMITTERS**

from these easy-to-assemble kits!



VIKING "ADVENTURER" TRANSMITTER

Complete to the last detail, the Viking "Adventurer" is the ideal CW transmitter for the beginning amateur... the perfect standby transmitter for the experienced amateur. Effectively TVI suppressed—professional in appearance and design—easy to assemble and operate! 50 watts input—single knob bandswitching on 80, 40, 20, 15 and 11-10 meters. Packs enough power for world-wide radio contacts with just a simple antenna. Wide range pin-network output tuning—no antenna tuner needed. Kit is furnished complete with built-in power supply, tubes, cabinet, wiring instructions and antenna suggestions.

Cat. No. 240-181-1—Viking "Adventurer" Kit, less crystal and key. \$54.95

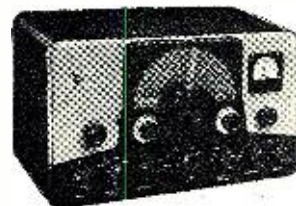

VIKING "RANGER" TRANSMITTER

Tops for operating convenience—enough power for world-wide contacts. Built-in VFO or may be crystal controlled. Band-switching 10 through 160 meters. 75 watts CW input, 65 watts phone. Drives most kilowatt amplifiers including the Viking Kilowatt. TVI suppressed—easy to build—professional in appearance. With timed sequence (break-in) keying system. Kit or wired and tested.

Cat. No. 240-161-1—Viking "Ranger" Kit with tubes, less crystals and key \$214.50
Cat. No. 240-161-2—Wired... \$293.00

For detailed information see your distributor or write to:



E. F. JOHNSON COMPANY

3110 Second Ave. S. W., Waseca, Minn.

**CABINETS
HI-FI—TELEVISION
CUSTOM-BUILT and STOCK**

write for descriptive literature

JACK CANTOR

171A Washington St.—New York 7, N. Y.

CODE SENDING SPEED
RECEIVING SPEED

Be a "key" man. Learn how to send and receive messages in code by telegraph and radio. Commerce needs thousands of men for jobs. Good pay, adventure, interesting work. Learn at home quickly through famous Gandler System. Qualify for Amateur or Commercial License. Write for FREE BOOK. **CANDLER SYSTEM CO.** Dept. 2-F, Box 928, Denver 1, Colo., U.S.A.

how long would it take you to solve this service problem?

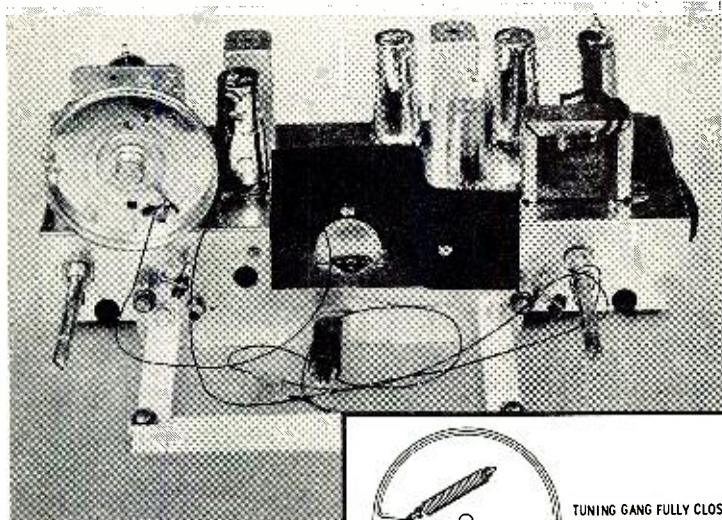

SYMPTOM:

Note the photo: The dial cord obviously needs repairing

It might be possible to replace or re-string the dial cord without a diagram, but why waste valuable time trying to figure out the correct way? With a PHOTOFACt Folder by your side, you save time. Here's why:

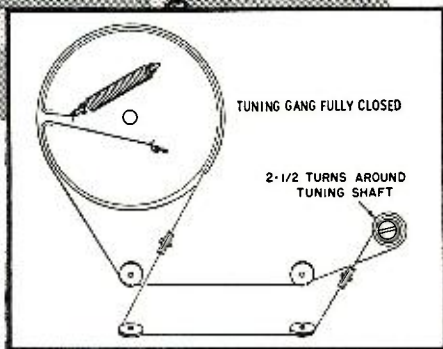

In just seconds, you refer to the Dial Cord Stringing Diagram in your PHOTOFACt Folder. It shows the one right way to re-string the cord. You don't waste time puzzling over why the dial pointer moves the wrong way, why the gang doesn't turn, why there's jamming or skipping. You solve this nuisance service problem in a few minutes with PHOTOFACt's help. It's just one of the important time-saving features found in PHOTOFACt—the world's finest service data.

**what's your
service problem?**

**THESE EXCLUSIVE PHOTOFACt FEATURES* HELP YOU SOLVE
ANY PROBLEM FASTER, EASIER, BETTER—HELP YOU EARN MORE**

PHOTOFACt gives you complete coverage on over 20,000 TV, Radio, Amplifier, Tuner and Changer models. And PHOTOFACt is a *current* service—keeps you right up with late model production—brings you these exclusive features:

FULL SCHEMATIC COVERAGE

1. Famous "Standard Notation" uniform symbols are used in every schematic. Diagrams are clear, large, easy to read and handle.
2. Wave forms and voltages are shown right on the schematic for fast analysis.
3. Transformer lead color-coding and winding resistances appear right on the schematic.
4. Schematics are keyed to parts lists and to parts on chassis photos.

FULL PHOTOGRAPHIC COVERAGE

5. Exclusive photo coverage of all chassis views is provided for each model; all parts are numbered and keyed to the schematic and parts lists for quicker parts identification and location.

ALIGNMENT INSTRUCTIONS

6. Complete, detailed alignment data is standard and uniformly presented in all Folders. Alignment frequencies are shown on radio photos adjacent to adjustment number—adjustments are keyed to schematic and photos.

TUBE PLACEMENT CHARTS

7. Top and bottom views are shown. Top view is positioned as seen from back of cabinet. Blank pin or locating key on each tube is shown. Charts include fuse location for quick service reference.

TUBE FAILURE CHECK CHARTS

8. Shows common trouble symptoms and tubes generally responsible for such troubles. Series filament strings are schematically presented for quick reference.

COMPLETE PARTS LISTS

9. Detailed parts list is given for each model. Proper replacement parts are listed (with installation notes where required). All parts are keyed to chassis photos and schematics for quick reference.

FIELD SERVICE NOTES

10. Each Folder includes time-saving tips for servicing in the customer's home. Gives valuable hints for quick access to pertinent adjustments, safety glass removal, special advice covering the specific chassis, etc.

**With PHOTOFACt by your side, you solve your service problems
in just minutes... you service more sets and earn more daily**



**MONEY BACK
GUARANTEE!**

Got a tough repair? Try this—at Howard W. Sams' own risk: see your Parts Distributor and buy the proper PHOTOFACt Folder Set covering the receiver. Then use it on the actual repair. If PHOTOFACt doesn't save you time, doesn't make the job easier and more profitable for you, Howard W. Sams wants you to return the complete Folder Set direct to him and he'll refund your purchase price promptly. **GET THE PROOF FOR YOURSELF—TRY PHOTOFACt NOW!**

free



Send for Sams' INDEX TO PHOTOFACt FOLDERS—your guide to virtually any receiver model ever to come into your shop; helps you locate the proper PHOTOFACt Folder you need to solve any service problem on any model. You'll want this valuable reference guide. Send coupon now.

*These are only a few of the 32 features found exclusively in PHOTOFACt—the world's finest service data

HOWARD W. SAMs & CO., INC.

Howard W. Sams & Co., Inc.
2203 E. 46th St., Indianapolis 5, Ind.

- Send FREE Index to PHOTOFACt Folders
 I am a Service Technician

Name _____
Address _____
City _____ Zone _____ State _____

only **LAFAYETTE**

can do it!

SAVE 33 1/3-50%

New Professional TRANSCRIPTION TURNTABLE

THE FINEST TRANSCRIPTION TURNTABLE FOR BOTH THE PROFESSIONAL USER AND THE AUDIOPHILE



- 12" CAST ALUMINUM RIM DRIVEN TURNTABLE • HEAVY DUTY 4-POLE CONSTANT SPEED MOTOR • VARIABLE SPEED CONTROL, PERMITS CONTINUOUSLY VARIABLE ADJUSTMENT OF EACH SPEED WITHIN $\pm 7\%$ • SPEED SELECTOR SAFETY SWITCH • FREELY FLOATING MOTOR MOUNT • RC FILTER NETWORK

New 3-speed instrument to delight the connoisseur. The 3 lb. 12" non-magnetic die-cast lathe turned aluminum turntable is precision engineered to provide dynamic balance and "wow-free" operation having an extra-heavy rim for smooth effective flywheel action. The turntable, mounted within a special deep flanged well, is rim-driven and actuated by perfectly true pulleys and a rubber wheel which are ball-bearing mounted. Ball-bearing balance like-wise assures noiseless rumble-free rotation of the precision ground main spindle. The extra-sized lubricant housing in which it is seated insures proper lubrication of the spindle at all times. A heavy rubber record cushion eliminates record slippage and makes for greater record protection.

A very high torque, heavy-duty, constant speed 4-pole shaded-pole motor rotates the turntable at 33-1/3, 45 or 78 rpm. A balanced armature insures minimum wow and flutter content and accurate speed regulation. A variable speed control permits instant adjustment of the individual speeds within $\pm 7\%$, through an exclusive adjustable 3-point brake action. A speed selector safety switch protects idlers and other mechanism by making it obligatory to pass through an OFF position when switching from one speed to another. The motor is freely suspended and isolated by means of three unique shock mountings which eliminate vibration transference. An R-C network does away with unwanted shut-off noise when the unit is turned off. For 100-130V 60 cycle AC, with each unit also equipped with a 50 cycle pulley. Wow is less than 0.2%, flutter less than 0.05% and there is practically no rumble. Size 13 1/2" deep, 14" wide, and requires clearances of 2 3/4" above motorboard (excluding pick-up arm) and 3/4" below motorboard. Supplied with removable 3-speed stroboscopic disc and removable 45 rpm adapter. Handsome hammertone gray finish. Shpg. wt. 20 lbs.

PK-100 Net **49.50**

Reg. Value **74.50**
Net **49.50**

COMBINATION DEAL
PK-100 TURNTABLE AND PK-90 TONE ARM **59.50**
The above with G.E. RPX-052A DIAMOND and SAPPHIRE Cartridge **72.50**
LATEST MODEL
The above with FAIRCHILD DIAMOND L.P. Cartridge **87.50**

VISCOUS-DAMPED TRANSCRIPTION TONE ARM

PROFESSIONAL QUALITY TRANSCRIPTION PICKUP ARM FOR THE MOST EXACTING HIGH FIDELITY INSTALLATIONS



"FLOATING ACTION"

- JEWEL BEARING SUPPORT • PERFECT RECORD TRACKING • AUTOMATIC FLUID CONTROL OF TONE ARM MOVEMENT • ACCEPTS RECORDS UP TO 16 INCH DIAMETER • INSTANT PLUG-IN SOLDERLESS CARTRIDGE CHANGE • ACCOMMODATES VIRTUALLY ALL STANDARD AMERICAN CARTRIDGES • PREVENTS TONE ARM DAMAGE TO RECORDS

This new Viscous-Damped tone arm represents the ultimate in advance transcription arm design and engineering, utilizing the principle of "viscous-damping" or fluid control to regulate both the horizontal and vertical movement of the tone arm. Perfect compliance is achieved at all three speeds for both old and new records at lowest stylus pressure, consequently eliminating tone arm resonance. The balance provided by this suspension principle virtually eliminates groove jumping and skipping.

The slide-in cartridge holder allows instantaneous mounting of all standard types, including the turnover G.E. cartridge, with correct stylus pressure automatically obtained. Spring clips maintain positive electrical contact without necessity of soldering. The amount of damping and pressure is controlled by a manual viscosity adjustment mounted on top of the arm. A finger rest positions the tone arm. Records are protected against damage even when the tone arm is accidentally dropped.

The arm is 12 inches long with its height fully adjustable by means of a telescoping shaft. Self-leveling screw adjustments are built into the tone arm base. A pick-up rest whose height is adjustable, accompanies the tone arm.

This tone arm is a professional quality companion to the PK100, with matching finish. Shpg. wt. 2 1/2 lbs.

PK-90 Net **19.50**

Reg. Value **39.95**
Net **19.50**

SPECIAL!

ARM WITH G.E. RPX-052A DIAMOND AND SAPPHIRE CARTRIDGE **34.50**

WITH FAIRCHILD DIAMOND LP CARTRIDGE **49.50**

New! IMPORTED 12" HI-FI COAX. SPEAKER

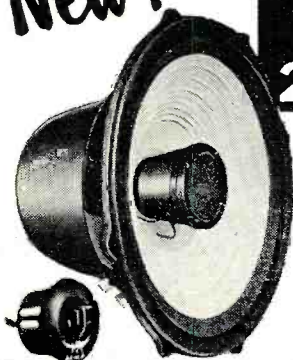

Reg. Price **44.50**
Net **29.50**

- FREQUENCY RANGE 30-15000 CPS
- HANDLES 20 WATTS OF POWER
- COMPLETE WITH LEVEL CONTROL
- POWERFUL TSK-5 MAGNETS
- SPECIAL SHEEPSKIN-EDGED CONE

A Lafayette exclusive import. This exceptional value in a high fidelity speaker consists of a 12" woofer and a built-in 2 1/2" tweeter coaxially mounted with its own metal case and protective grill. Cross-over network to provide proper separation of high and low frequencies is also built-in. The low resonant cone of specially processed fibre has a free edge of sheepskin, thus suppressing unwanted circular and radial nodal vibrations and insuring clear, beautiful tone quality. Highly efficient TSK-5 magnets give brilliant reproduction. Level control provides variation of up to 6db cut. Maximum input 20 watts. Voice coil impedance 8 ohms. Rugged all metal frame. If made in this country, this speaker would sell for at least 49.50. Shpg. wt. 11 lbs. **SK-58** Net **29.50**

New! TRIPLE PURPOSE SLIM CRYSTAL MICROPHONE

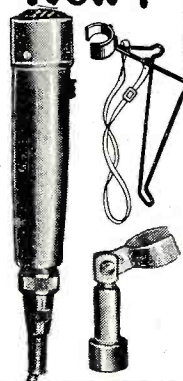

- May be hand-held, stand mounted or suspended by lavalier cord!
- Frequency 60-10,000 CPS
- On-Off Switch

A tremendous value! Unique design, only 4 3/8" L x 1 1/8" diam. Comes complete with swivel adapter to fit all standard mike stands, and lavalier cord and bracket which leaves both hands free. Smooth wide range response. Locking type on-off slide switch. Detachable 7 ft. cable and connector. Shpg. wt. 2 lbs.

PA-31
Each in lots of 3 **5.65**
Singly, Each **5.95**

Lafayette Radio DEPT R-E
100 6th Ave. NEW YORK 13, N.Y.

Boston, Mass.	110 Federal St.
Bronx, N. Y.	542 E. Fordham Rd.
Newark, N. J.	24 Central Ave.
Plainfield, N. J.	139 West 2nd St.

Write for FREE Bargain Packed Catalog! Remit by Check or Money Order. Include sufficient money for Postage. We Refund unused amounts.

Have you had the
Chassis Touching
JITTERS
Lately?



Adjust-A-Volt

LR-5 VARIABLE TRANSFORMER

with isolated primary winding lets you service any TV or radio set made without a chance of a "bite" no more chassis touching jitters.



\$29.50

Delivery from stock of your favorite jobber.

This husky 1/2 KVA electro-statically shielded unit is "Must" test equipment for thousands of service men. Intermittent operating TV or radio sets are checked by dropping line voltage to 105 V or lower to detect a faulty oscillator. Also used to cook a set at 130-140 V to break down intermittent part. On any application where either isolation or a variable transformer is needed Adjust-A-Volt will do the job. Black wrinkle finish, jeweled pilot light and convenient fuse. Write for new 18-page catalog listing all types and sizes.

**STANDARD
ELECTRICAL PRODUCTS CO.**

2238 E. THIRD ST. • DAYTON, OHIO



PEAKED TV ANTENNA

Winegard Company, 3000 Scotten Blvd., Burlington, Iowa, announces production of a new antenna, the "Combo," factory pre-tuned to 16 different channels.

This antenna is designed to meet 99% of all fringe area requirements. It is constructed entirely of aluminum and stainless steel, and features a new

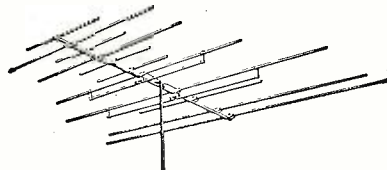

T-type driven element, twin-lock hardware, and extra heavy reflector elements.

Complete technical specifications and price information is available from the company.

MASTER CONVERTER

Blonder-Tongue Laboratories, Inc., 526-536 North Ave., Westfield, N. J., is now offering a custom-built, crystal-controlled, high-to-low channel v.h.f. converter. It is the model MVC. This unit may be used by community TV installers to convert high channels to lower frequency channels at the antenna site in order to reduce signal loss over long transmission lines.

In addition to extremely stable conversion, the unit supplies over 33 db gain (according to the manufacturer) through a low-noise, grounded-grid amplifier. Up to 1 volt r.m.s. maximum output is available at either of



two 75-ohm outlets. A third 75-ohm fitting handles the input from the high channel antenna. A v.h.f. mixing network is included to handle other converters or channel amplifiers.

The model MVC features a fused power supply and an a.c. receptacle for the power plug of the next unit.

REJECTS CO-CHANNEL TVI

JFD Manufacturing Co., Inc., 6101 16th Ave., Brooklyn 4, N. Y., has developed a new TV antenna, the "Shut-Out Helix," designed to reject co-channel interference on any channel specified by the installer. This antenna has an extremely high front-to-back ratio.

The forward section of this antenna employs the microwave helical design

for high gain. A "polyphase" dipole extends the bandwidth. A similar dipole to the rear of the antenna picks up the interfering signal in phase op-

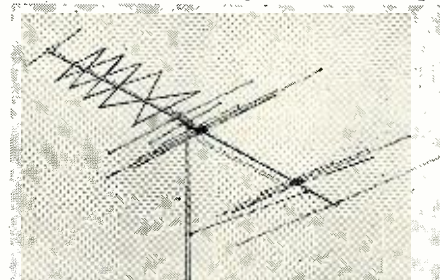

position to the forward section. The signals are combined in the harness and the interference is cancelled.

This antenna is boom braced, and constructed of high-grade aluminum.

20-STRAND TRANSMISSION LINE

Channel Master Corp., Ellenville, N. Y., now has two series of TV twin-lead transmission line available. Both series feature 20 strands of No. 33 pure copper wire in each conductor. This transmission line is said to be



extremely flexible and easy to work.

Low-loss virgin polyethylene is used as the insulation. The wire is marked with a deep impression every 10 feet for efficient use. The "Twin Twenty" line is available in silver or brown, while the "Challenger" line is available in brown only. Both series offer a complete range of web thicknesses.

NEW CONICAL

Clear Beam Antenna Corp., Canoga Park, Calif., is now marketing a new 100% snap-open conical antenna, the model C64. No tools are needed by the installer in the assembly of this antenna.

The front insulator provides a wide air-plastic spacing to prevent signal loss. Other features are a device for locking the transmission line to the antenna insulator to prevent strain on the line and terminals, all-aluminum

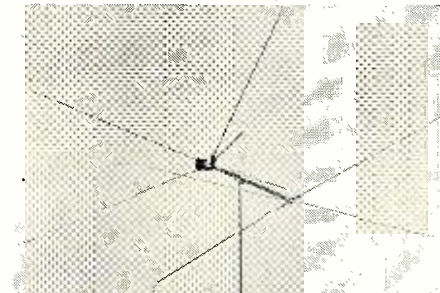

construction, and end caps in the elements to prevent wind howl.

This antenna is made up in six different combinations of dipoles and reflectors. It is also available in a two-bay model.

-30-

NEW!



THE NEW ALTEC LANSING "Acoustic Gate" * MICROPHONE

SPECIFICATIONS

- Type: Dynamic
- Frequency Response: 30-15,000 cps
- Output Impedance: Low, 30/50 ohms
Medium, 150/250 ohms
High, 20,000 ohms
- Output Level: -58 dbm/10 dynes/cm²
- Dimensions: Diameter, 1" body, 1-1/2" max.
Length, 7" (without connector)
- Weight: 8 oz. (without connector)
- Finish: Black and green anodized
- Mounting: "Slidein" holder with 5/8"-27
Swivel head.
- Price: \$96.00 net

6A Stand Switch is an accessory and must be ordered separately

RUGGED! DEPENDABLE! Years in development, the new Altec "Acoustic Gate" principle is available for the first time in the sensational Altec 680A microphone. This feature eliminates the high frequency peaks inherent in conventional dynamic microphones; and provides outstanding performance throughout an extended high frequency range. Here at last is a broadcast dynamic that can be used under any conditions. It is unaffected by wind, water, dirt or weather. The amazing Altec "Acoustic Gate" 680A is first for quality, ruggedness and serviceability.

* "Acoustic Gate" is a peripheral sound entrance channel of 2 mil width which provides an acoustical resistance loading to the front of the diaphragm thereby eliminating high frequency peaks and extending the frequency response over an exceptionally wide range. (Patent Pending)



SOUND REPUTATION SECOND TO NONE

Write Dept. 5-T
9356 Santa Monica Blvd., Beverly Hills, Calif.
161 Sixth Ave., New York 13, N.Y.

Here's The ANTENNA YOU CAN MAKE MONEY Installing

designed for 1 man... 7 minute installation

NEEDS ONLY A
HAMMER TO INSTALL

GENUINE *Color Beam*

\$1495 COMPLETE LIST

 Exclusive with
WINEGARD

ANY ANTENNA THREE YEARS
OLD SPOILS THE TV PICTURE

*designed for **BLACK and WHITE** and **COLOR**

Available at Leading Parts
Distributors Everywhere or Write

Winegard Company
Burlington, Iowa

For Pamphlet "How to Make Money
on One Man Antenna Installation."



Antenna boxed—completely assembled—attached lead-in

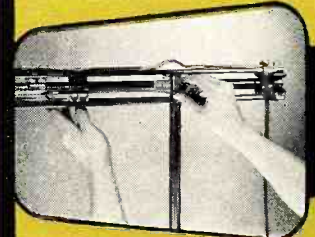

Raise main crossarm.

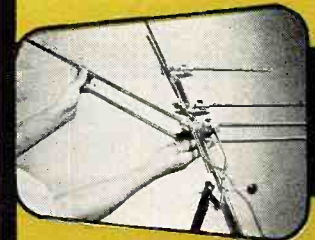

Snap secondary crossarms in place.

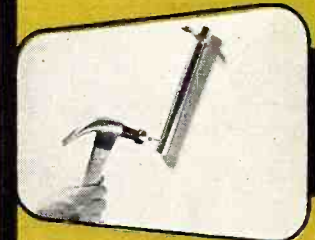

Nail up mounting bracket.

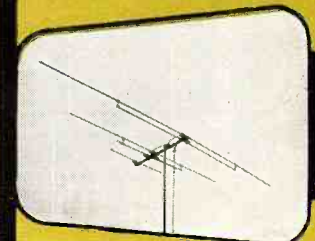

Drop lead-in wire.



Attach lead-in to TV set—special clip snaps on.

BURTON BROWNE ADVERTISING

Star Performers on Your Service Team...



Television Hardware and
your TELCO Distributor

BRINGING YOU THE ALL NEW

RATCHET CHIMNEY MOUNT

FAST INSTALLATION...
simply thread strap
thru ratchet bolt and
tighten.

REALLY HOLDS... ratchet
bolt design never lets go.
FITS MAST UP TO 1 1/4"
DIAMETER.

LONG LASTING zinc
plated and dicromate
dipped for double
weather proofing.

No. 9218 Ratchet mount with 24'
galvanized straps.
No. 9219 Ratchet mount with 24'
stainless steel straps.

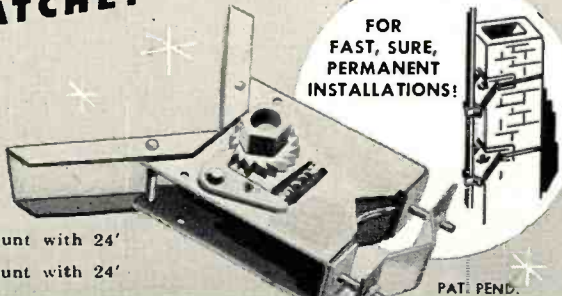

FOR
FAST, SURE,
PERMANENT
INSTALLATIONS!

PAT. PEND.

TELEVISION HARDWARE MFG. CO.

Division of General Cement Mfg. Co

919 Taylor Avenue, Rockford, Illinois

FREE COPY...TELCO Catalog. Write for yours now!

**TELCO
HARDWARE**



Everything for fast profitable TV installations—stand-offs, mounts, towers, arrestors,
all accessories. The complete line is at your nearby TELCO distributor.

SEE US . . . BOOTH 590—ROOM 612—PARTS SHOW

Quality,
Style and
Beauty



COMMUNICATIONS RECEIVER

- Six bands; .54 to 31 mc., AM, CW, MCW (FS with convert.)
- Accurate main tuning with full elect. bandspread
- Ferrite transformer, 75 ohm unbal. to bal. input
- One microvolt sensitivity on hf bands
- Image ratio; better than 60 db
- New Audio Selectivity design with variable bandwidth.
- 110 VAC 50/60 cy. appr. 90 Watts

Complete Receiver \$395 net

Matching spkr \$16.00

WRITE FOR BULLETIN R-179



**The TECHNICAL
MATERIEL
CORPORATION**

IN CANADA:
TMC Canada, LTD.
OTTAWA, ONTARIO

MAMARONECK,
NEW YORK

VIDEO PROBE METER

a professional instrument
designed for testing a T.V.
ABOVE and BELOW
chassis!

**THE VIDEO
PROBE METER!**

Saves **TWO HOURS PER
DAY** when used in shop for
under chassis work.



With the attachable pick-up loop, (where sufficient signal is available) the Probe Meter can detect and indicate radiation of signal thru I.F. and video amp tubes. (Simply slide loop over tube being tested.) Where internally shielded tubes are encountered, remove tube and insert probe tip into grid pin of socket. Indicates gain per stage.



**Dealer Net
\$31.50**

Can accurately trace and indicate the following T.V. circuits,—(from tuner to pix tube) R.F., I.F., Det., Video, Sync, local osc., Hz. osc., Hz. Drive, audio output, sound I.F. (Signal tracing radios.)

**EXCELLENT FOR TRACING AND COMPARING
COLOR T.V. CIRCUITS.**

ADDITIONAL FEATURES

Voltmeter, 0-500V. D.C., 20,000 Ohms/volt.

Fully Guaranteed

If your dealer cannot supply you, order direct full purchase price refunded if not satisfied.
DEALERS & REPS. INQUIRIES WILL RECEIVE IMMEDIATE ATTENTION.

Export Representative: **COMTRAD CORP.**
673 Broadway, New York, N.Y.

Research Inventions & Manufacturing Co.
617 F St., N. W., Washington 1, D. C.



**Manufacturers'
Literature**

SILICON RECTIFIERS

The Rectifier Division of *Sarkes Tarzian, Inc.*, 415 N. College Ave., Bloomington, Indiana is currently offering copies of its new silicon power rectifier catalogue to interested persons.

The new line covers a range of ratings from 500 ma. at 50 volts to 3 amps at 1000 volts with proper cooling and circuitry. The catalogue describes some of the units currently available in the line and invites inquiries regarding custom units for military or commercial applications.

Copies of the catalogue are available without charge upon written request to the division.

TV PICTURE TUBE DATA

Sylvania Electric Products Inc., 1740 Broadway, New York 19, New York has recently issued two charts of interest to the industry.

The first is a TV color tube chart which illustrates the workings of the most popularly used tubes to date. The chart, in color, identifies the most important parts of the 22" glass rectangular color tube and the 21" round metal and glass model.

The second publication is a TV picture tube comparison chart which provides type, face, body, focus, deflection, anode voltage, basing, ion trap magnet, and nominal length data on a wide range of picture tubes. This chart is designed to be mounted on the wall of the service shop for quick and easy reference.

SERVICE FOR TECHNICIANS

International Rectifier Corporation, El Segundo, California is now publishing a handy little four-page booklet for radio and television technicians.

Entitled "Tips," the new publication contains articles on subjects of interest to technicians, in addition to service hints and cartoons. A subscription to this publication is available without charge upon request. The booklet will be published occasionally on no fixed schedule.

ELECTRONIC GLASSWARE

A four-page, two-color brochure featuring the use of precision glassware for electronic applications is now available from *Wilmod Glass Company*, Landisville, New Jersey.

The brochure describes in detail the company's precision bore tubing which can be supplied with i.d. tolerance down to $\pm .0002$ ". In certain sizes the wall thickness can be made between .015" and .3125". Precision bore capillary tubing is also described. It is available in a range which runs from .004"

RADIO & TELEVISION NEWS

i.d. to .1255" i.d. with tolerance limits set at $\pm .0002$ ".

Electronic manufacturers who use glassware are invited to write for full details.

HEATH FLYER

Heath Company, Benton Harbor, Michigan has issued a new 16-page flyer which introduces five new kits to its extensive line of build-it-yourself equipment.

The new units include an AM tuner, a range-extending speaker system, a crystal receiver, an electronic crossover, and a c.w.-phone transmitter—all in kit form.

The flyer describes these and other units in the line in some detail and provides complete instructions for ordering. The flyer may be obtained without charge by writing the company direct.

RCA TECHNICAL BOOKLET

An up-to-date, revised edition of the technical booklet, "RCA Receiving Tubes for AM, FM, and Television Broadcast," has been announced by the Tube Division of Radio Corporation of America, Harrison, New Jersey.

The 28-page booklet gives the characteristics of more than 600 of the company's receiving tubes including picture tubes. Picture tube information is presented in a chart which lists and describes 75 types. Base and envelope connection diagrams are supplied for all tube types.

This new booklet is available from the company's tube distributors or from the Tube Division for 20 cents.

SUN BATTERY APPLICATIONS

International Rectifier Corporation, 1521 E. Grand Ave., El Segundo, California has recently published a new technical booklet entitled "The Use of Selenium Photocells and Sun Batteries" which it is offering to interested persons at \$1.50 a copy.

Designed to be of primary interest to engineers and amateur experimenters, the handbook contains 58 pages of technical information and over 35 illustrations, charts, and diagrams which describe in detail applications and devices in which sun batteries and other photocell products are successfully employed.

Copies of the booklet are available at parts distributors throughout the country or can be ordered direct from the Product Information Department of the company.

AUDIO CATALOGUE

Terminal Radio Corp., 85 Cortlandt St., New York 7, New York has announced the availability of its "1956 High Fidelity Audio Guide," a 132-page catalogue of audio equipment for the music lover, hobbyist, and professional.

The booklet illustrates and describes the firm's complete selection of high-fidelity phono equipment, tuners, amplifiers, speakers, cabinets, and tape

HIGH EFFICIENCY at Lower Cost

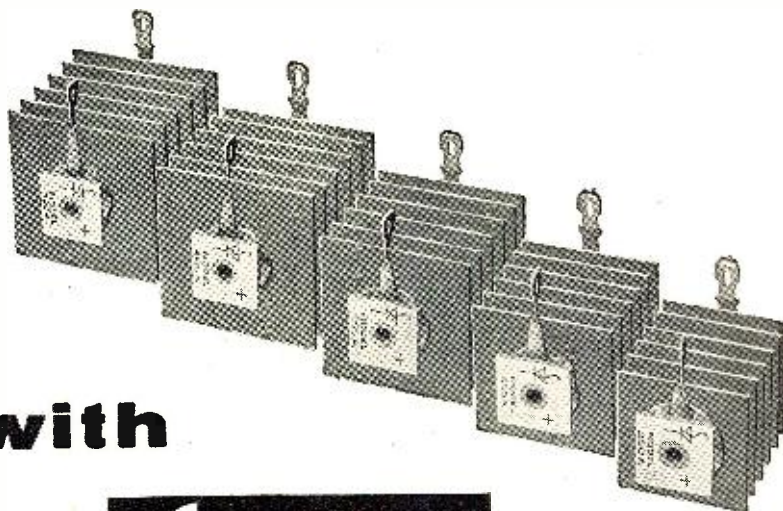

with



HIGH DENSITY RECTIFIERS

NEW

Sarkes Tarzian High Density Rectifiers provide safe field replacements at lower cost. Better for you and better for your customers. Get the new High Density Rectifiers at your distributors. The same high performance and long warranty as all Sarkes Tarzian Selenium Rectifiers.

SPECIFICATIONS

Model No.	Max. A.C. Input Volts	Max. D.C. Load Current	Plate Size	Overall Length	Replaces Model
250A	130	250	1.25" sq.	1 7/8"	200-250
300A	130	300	1.4" sq.	1 7/8"	300
350A	130	350	1.6" sq.	2 5/32"	350
400A	130	400	1.8" sq.	1 5/8"	400
500A	130	500	1.8" sq.	1 15/16"	500

Write for your copy of the latest Replacement Guide. Address Dept. N-1.

Sarkes Tarzian, Inc., Rectifier Division
415 N. COLLEGE AVENUE, BLOOMINGTON, INDIANA

In Canada: 700 Weston Rd., Toronto 9, Tel. Murray 7535 • Export: Ad Auriema, Inc., New York City

Especially

where

space

is

limited



the
GOODMANS

Axiette
8 inch

**HIGH FIDELITY
LOUDSPEAKER**

MADE IN ENGLAND

ROCKBAR CORPORATION, Dept. LE-5
215 East 37th St., New York 16, N. Y.

In Canada: A. C. Simmonds & Sons, Ltd.,
Toronto, Canada

Please send complete description of the
Goodmans Axiette.

Name.....

Address.....

City.....Zone.....State.....

My Dealer is.....

recorders in addition to microphones and p.a. equipment made by over seventy-five of the leading audio manufacturers.

Consumer net prices are given for all items. Thoroughly indexed and with items listed alphabetically by manufacturer within each major grouping, the catalogue has been designed for quick and easy reference and maximum utility.

SELENIUM RECTIFIERS

A new brochure describing selenium rectifiers designed for use in printed circuitry is now available from *Federal Telephone and Radio Company*, 100 Kingsland Road, Clifton, New Jersey.

The rectifiers, designed for radio, television, phonograph, recorder and industrial equipment applications, have three different types of terminals—square tipped, tapered, and snap-in. They are designed for rapid mechanical or manual insertion into printed circuit boards and cover an output rating range from 65 to 150 milliamperes.

The brochure, Information Bulletin M1, includes complete physical and electrical characteristic charts together with diagrams giving the exact dimensions of each type of rectifier described.

SERVICE SHOP EQUIPMENT

Precision Equipment Co., 3736 N. Milwaukee Ave., Chicago 41, Illinois has just issued a new catalogue which covers its standard line of lockers, storage cabinets, steel shelving, work benches, and office furniture for radio and TV service shops.

The booklet is illustrated not only with photographs of the equipment but by clever cartoons which help to liven the text material. Service technicians will find a wide assortment of storage equipment to meet various shop needs. The catalogue is free on request.

HOFFMAN SERVICE DATA

Electronic technicians and service dealers who subscribe to *Hoffman Electronics Corporation's* service data will now receive a year-end "bonus" in the form of a bound indexed book containing schematics, parts lists, tuner data, and general service notes on all sets released throughout the year.

Under the new plan, those who subscribe to the firm's technical data (mailed direct to the subscriber when each new set is released) are entitled to this extra set of service information for permanent shop reference.

Write the company at 3761 S. Hills St., Los Angeles 7, California for complete information on this new plan.

ICA GENERAL CATALOGUE

Insuline Corp. of America, 186 Granite St., Manchester, N. H. has just issued a new general catalogue which covers its 1956 line of metal fabrications, plugs, jacks, leads, tools, and associated equipment.

All of the products are graphically illustrated with schematics, specifications, and descriptions throughout the 80 pages of the new three-color catalogue. It is ideally suited for engineers, technicians, government agents, and labs.

-30-

"FLYING CRANE" LIFTS RAYTHEON RADAR TO TOWER TOP

AN ARMY helicopter was pressed into service recently when the problem of hoisting a 1250 pound pedestal for a Raytheon "Storm Detector" radar to the top of a 125-foot tower was encountered with no crane handy that could handle the job.

The "Whirly-bird" hovered over the machinery while technicians attached

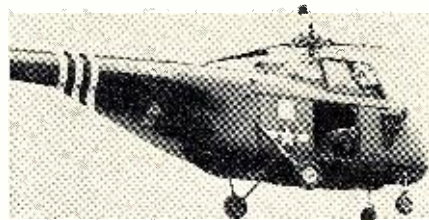

cable slings to it. When the "hitch" had been made, the equipment was lifted high enough off the ground to permit the wooden base to be removed, and then the lift was completed at a point just above the tower. With the assistance of the observer in the 'copter and a waiting crew on the tower top, the equipment was lowered into place.

The pedestal is part of an AN/CPS-9 weather radar made by Raytheon. It can locate storms as far as 300 miles away and give detailed information on size, intensity, type of precipitation, direction of movement, height, and other data on storms which are important to military operations.

-30-

RADIO & TELEVISION NEWS

HI FREQ. BOYS, COLOR TV'ERS, LABS!
Here's a new, truly terrific buy in a great, brand new **FREQUENCY METER AND TEST OSCILLATOR!** 115 V., 50-800 cy. power supply. In freq. meter section, crystal oscillator beats VFO. Osc. section puts out sine or pulse modulated RF. With tubes, headset, cords, adapters, radiators, etc. and INSTRUCTION BOOK. **\$19.95**
LU-3, 465-498.5 MC.

LU-1, 470-493.5 MC. **\$17.95**

MULTI-CHANNEL RADIO CONTROL
For model planes, cars, boats, lawn mowers, garage doors, gates, etc.
A COMPLETE SET OF 5 SHARP TONE FILTERS—at 300, 650, 935, 1390, and 3,000 cps. with circuit of the sharpest and best hook-up in any radio controlled receiver. Circuit taken from modern Air Force drone control. **\$3.95**
All for only
Schematic available only with purchase.
B MINIATURE 3-TUBE RADIO RECEIVER: Very sharp, ultra-sensitive. Range 70 to 80 MC AM. Originally used as a radio triggered MC AM. Originally used as a radio triggered circuit marker receiver. Output flips built in 5,000 ohm relay. With schematic, less **\$3.95**
the 3 standard tubes. Only
C TELEPHONE DIAL: For use in selecting a desired radio-controlled action. **\$2.95**
Each
D SENSITIVE RELAYS: KB-7 for adding circuits. Adjustable 1/2 MA to 2 MA. **\$1.95**
SPDT. Each

SPRING AUTOMATION SPECIAL!
Stop-Start Electro-Mechanical Devices!



24-HOUR TIMER
Start coffee, control lights, heater or humidifier, cook dinner, defrost refrigerator, wake up to radio or sprinkle your lawn—**ALL AUTOMATICALLY!** A handsome 24-hour clock, 115 V., 60 cycle, U.L. approved, with receptacle for appliance to be controlled. Any "on" as short as 15 minutes or as long as 23 3/4 hours, starting any moment during the 24 hour cycle. Repeats automatically every 24 hours or you can switch appliance on or off manually, switch lever at front without changing in automatic setting. Switch rated 7 amperes, 875 W. "Intermatic" Time-All. No. A224. Brand new. Only **\$9.95**

HERE'S SOMETHING TO TIME!
ELECTRICALLY-OPERATED SOLENOID VALVE: Water your lawn while you sleep! 1" standard pipe size. No opening in it is less than 1/2" diam. area. Normally closed; opens when 18-24 VDC at approx. 1/2 amp. is applied. Corrosion resistant. A \$75.00 value. NEW at only **\$2.95**; 4 for \$10.00

SELENIUM RECTIFIER & TRANSFORMER
For above valve OR ANY OTHER 24 VDC APPLICATION. Each rated at 1.2 amps. enough to handle 4 valves. RECTIFIER **\$1.98**
TRANSFORMER **\$1.98**

Combo Special Deal Timer, 4 valves, rectifier, transformer, all for only **\$21.95**

TBY PORTABLE MOBILE 10 & 6
The Marine Corps' proud record at Iwo was due to the bravery of the Marines and the TBY's. Transmitter-receiver, 28-80 MC., AM. With tubes, antenna, mike and headset in carrying bag. With modification instruction to xtal control, original, modified schematic, circuit explanation and power supply required. NEW, less power **\$24.95**
supply, but with accessories.....
TRANSCIVER UNIT only: Used, excellent condition, with tubes **\$14.95**
All shipts. FOB whse. Send 25% dep. with all COD orders. Item sub. to prior sale & change of price without notice. Min. order \$2.50.

ARROW SALES, INC.

Western Mailing Address:
Box 3007-R, NORTH HOLLYWOOD, CALIF.
Central Mailing Address & Sales Showroom
2441 S. MICH. AV. Dept. B, CHICAGO 16, ILL.
California Distributors' Stores
G. L. Electronics, Inc., 1632 Venice, Los Angeles
P.A.R.T.S., Inc., 2005 Empire Ave., Burbank

CONALERT MONITORS CONELRAD



- Fail-Safe
- Meets FCC Requirements
- 5 Channels
- FCDA Approved
- Low Cost
- Effective as of Jan. 2nd, 1957—

MANDATORY FOR OPERATORS OF ALL RADIO TRANSMITTERS!



For complete information write:
ENGINEERING CORP.
2981 Middlefield Road
Palo Alto, California

Stereophonic Operation

(Continued from page 57)

a head arrangement is considered advantageous in that for the man who already owns a library of staggered recorded tapes, it provides a means for utilizing these along with those of the new tapes which are being released only in the staggered configuration. Similarly, it permits the user to choose program material on the basis of its merit alone, without regard to the mode used in recording.

Even though it is probably a safe assumption that the stacked or in-line head will eventually become an industry standard, staggered head assemblies presently enjoy one distinct advantage. They are generally cheaper and easier to acquire. Stacked heads are more expensive to manufacture because of the very precise three-dimensional alignment of the cores which must be accomplished within the head itself prior to encapsulation. In staggered head assemblies this spacing and azimuth alignment of the individual heads is accomplished by adjusting, individually, the position of the heads on the mounting bracket.

Installation of Heads

In previous articles of this series it was shown how the basic *Viking* FF75 deck could be changed over to an erase-record deck merely by installation of the proper head assembly components. It is possible to purchase stereophonic models of the *Viking* deck, factory assembled and tested, as well as decks with any desired head combinations. However, it is possible to convert the basic deck to any of the other modes of operation merely by adding the required head assemblies. Fig. 2A shows the simplest monaural playback head assembly available from the company. Fig. 2B shows the unit with a staggered mounting bracket and two identical half-track heads, suited for playback of staggered tapes or, using the lower head only, for playback of monaural tapes. The owner of the single-head deck can convert to this head assembly by purchasing an additional 75-1 record-playback head at a cost of \$8.80 and a D340 bracket at \$1.40.

Note that this head arrangement does not permit space for an erase head to the right of the offset erase-record head. In this case, the tapes must be bulk erased prior to recording.

Fig. 2C shows the "universal" stereophonic head assembly which provides for playback of stacked tapes using the stacked heads, and playback of staggered tapes utilizing the upper of the stacked heads in combination with the single offset head. Crosstalk from the unused head section in this case cannot be detected under normal conditions and can be considered as having negligible effect. The offset head scans the lower track and is therefore available for monaural recording and playback.

The owner of the basic deck can

*Complete Compatibility...
Breathtaking Fidelity!*

one deck...

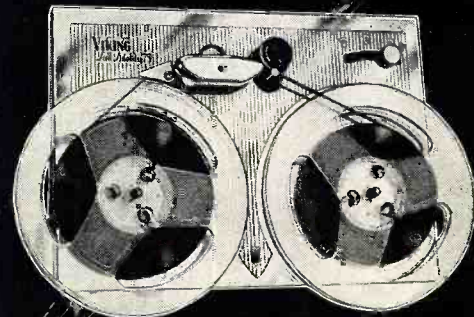

VIKING Full Fidelity 75

For faultless playback of pre-recorded tape or true professional quality recording, the FF75 series decks offer the ultimate in compatibility. Frequency response of 40 to 14,000 cycles ± 2 db at 7.5 inches tape speed. Full-floated motor mount and compliant belt drive minimize noise and vibration... filter out flutter and wow.

MONAURAL AND STEREOPHONIC PLAYBACK AND RECORDING
Popularly priced from \$59.95 Audiophile Net

...six head assemblies

Unique in design, the FF75 series decks permit a single basic mechanism to be used with a wide variety of head assemblies. Head assemblies available for: • Playback only • Erase-Record and Playback • Erase-Record-Monitor • Stacked or Staggered Stereophonic operation... in short any recording and playback need.

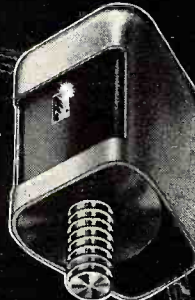

...two preamplifiers



The NEW RP61 Record/Playback Amplifier for professional quality playback, recording and duplicating.



The PB60, Preamplifier, for faultless playback of recorded tape.

Complete brochure available... write for yours today!
See and hear faultless Viking performance... at your dealers.



VIKING OF MINNEAPOLIS

2207 Lyndale Ave. So. • Minneapolis, Minnesota

EXPORT DIVISION: 26 Warren Street, New York City 7, New York
Cable: SIMONTRICE, NEW YORK (All Codes)

You'll find it faster

with **IRC**

Kits and Cabinets

There's no time-wasting search for the right resistor or choke when you buy them in IRC Kits and Cabinets. The part you want is always there—in a clearly identified compartment. Best of all, these sturdy, attractive kits and cabinets are free of extra cost. Ask your IRC Distributor about them.

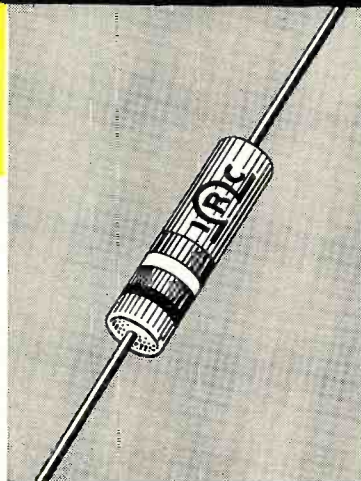

IRC Resist-O-Cabinets

Blue, yellow, and silver metal cabinets having 4 "non-spill" drawers with 28 identified compartments. Can be neatly stacked. Available with 1/2 watt, 1 watt, 2 watt, and combination assortments that handle most requirements.



IRC Resist-O-Kits

All metal pocket-size kit is ideal for service calls. Has 10 compartments. Lid snaps securely shut. Range marked on each resistor. Available with forty-five 1/2 watt or thirty 1 watt resistor assortments.



IRC Choke Cabinets

Handy metal cabinet contains 140 IRC insulated chokes in balanced assortments of popular values and 2 sizes. Four "non-spill" drawers with separate compartments for each value of choke. Conveniently stack with Resist-O-Cabinets.

Send for complete information today

convert to this head configuration by purchasing the same D340 bracket and a 75-S2 stacked head assembly at \$33.00. The original head is moved to the offset position on the bracket. A D368XA tapelifter and pressure pad assembly should be added at a cost of \$4.50.

Fig. 2D shows a head configuration which has grown out of demands for a head arrangement which would permit stereophonic playback (or recording) using stacked heads and which would also permit monaural erase-record operation. To convert the basic deck to this configuration it would be necessary to add a D340E bracket (\$1.60), the 75S-2 head assembly (\$33.00), and a 75-5 erase head (\$7.50). The original head serves in the center position. The tapelifter and pressure pad assembly is essential.

Using the head configuration of Fig. 2D, the record-playback preamplifier (described last month) is merely connected to the erase and record-playback heads in the normal manner for monaural erase-record operation. For stereophonic playback, it is preferable that two properly compensated preamplifiers be connected to the output jacks provided for the stacked heads. The record-playback preamplifier could, of course, be used in either of the stereophonic channels, if desired, eliminating the cost of one playback preamp. This, however, would involve the risk of accidentally erasing a valuable stereo tape.

As part of the installation procedure, of course, each of the heads must be carefully rotated on the axis of its mounting screw to provide maximum volume and then must be azimuth aligned, adjusting the two azimuth adjustment screws provided for each head until maximum volume is obtained. This alignment should normally be made using a high-frequency alignment tape or a music tape which has fairly consistent high-frequency output.

It should be noted that in-line heads are recommended only when used with pressure pads. This is due to the fact that a slight deformity of the tape can result in momentary loss of contact with one or the other of the head pole pieces resulting in momentarily reduced output. A tapelifter and pressure pad mechanism is available as an accessory. The pad assembly and tapelifter lifts automatically as the control is moved into the "stop," "fast forward," or "rewind" positions and holds the tape in contact with the heads when the control is in the "forward" position.

The tapelifter mechanism is desirable in any case in recording applications. Since it lifts the tape from the head in fast forward and rewind, it prevents accidental erasure of a tape in the event the operator forgets to switch the record-playback amplifier out of the "record" position upon completion of a recording.

Amplifier-Speaker Requirements

For stereophonic playback of recorded tapes, the basic preamplifier, power amplifier, and speaker system required for a monaural system can be exactly duplicated. The preamplifier function is adequately served by the *Viking* PB60, described in the March issue. Power amplifiers with only a few watts of power will provide acceptable performance, but high-fidelity amplifiers capable of handling from 30 to 60 watts of power will sound immeasurably better.

It is a common misconception that a stereophonic system eliminates the need for high-quality amplifiers and reproducers. Actually, the same fundamental requirements still apply. It is true that stereo reproduction has such brilliance and such a pleasing "new" sound that even an ordinary table radio or phono reproducer can be utilized as a means to an end. However, the same program material sounds infinitely better when reproduced with solid, well-damped amplifiers and true high-fidelity speakers.

It should be remembered that well-recorded tape provides a dynamic range of over 100 to 1. It takes adequate amplifier power, a low signal-to-noise ratio, and good speakers to fully utilize this range.

Speaker arrangement is a matter of personal taste and is affected by the individual room requirements. Both speakers should be arranged along one wall or, if preferred, in corners at one end of the listening area. The distance between the speakers should be less in a small room than in a large listening area. Normally, however, a spacing of from 6 to 15 feet will prove most desirable. To be completely technical,

INTERNATIONAL RESISTANCE CO.

Dept. 481, 401 N. Broad St., Phila. 8, Pa.

In Canada: International Resistance Co., Ltd., Toronto, Licensee

124

RADIO & TELEVISION NEWS



Wherever
Circuit Says

You're sure it's right

the ideal spacing would depend upon the microphone placement during recording, the size of the musical group being recorded, and on the acoustical properties of the room in which the recording was made. Manufacturers often state the microphone placement used for a given recording, but not with the expectation that it will be cause for rearrangement of furniture.

Incidentally, there is no real necessity for using matched amplifiers and speakers for stereo reproduction. If the system is to be used for monaural as well as stereo operation, however, it is logical that the best amplifier and the most adequate speaker be placed in the left-hand position. This is for two reasons. Properly set up, the left-hand channel (lower track on tape) feeds the left-hand speaker system. Thus in using the equipment for monaural recording and playback you automatically utilize the best amplifier and speaker system.

Stereophonic Recording

The same stacked or staggered head assemblies which serve for playback may be used for stereophonic recording. This fact will be of particular interest in those fortunate areas where stereophonic FM-AM broadcasts are available. It should be noted, however, that using present *Viking* equipment or, for that matter, any recorder which does not provide full-track or dual-track erase heads, bulk erasure is essential. This has the advantage, however, of insuring minimum noise level. Bulk erasers range in price from \$15.00 to \$50.00 or more. In its simplest form, the bulk eraser is a heavy a.c.-powered electromagnet to which a full reel of tape is thoroughly exposed. With the current still applied, the reel is slowly removed from the field. Careful and thorough bulk erasure will reduce tape noise to the lowest possible degree and is completely acceptable for most applications.

In stereophonic recording it is advisable that both heads be biased from the same bias source. This refers to the ultrasonic bias voltage discussed in connection with the record-playback preamplifier described in the April issue. If entirely independent bias oscillators are employed, as would be the case if two independent record-playback preamplifiers were used, the difference frequency of the two bias oscillators would appear on the recorded tracks as an audible beat frequency. This, of course, is the result of the crosstalk characteristic of the heads and, to some extent, would be a problem even with the isolation provided by a staggered head arrangement.

To overcome this it is necessary to supply bias to the two recording heads from only one of the record-playback preamplifiers. Circuit alterations are indicated in Fig. 3, which shows the essential portion of the *Viking* RP61 record-playback preamplifier circuit. In the right-hand channel amplifier, the bias oscillator is merely disabled by removing the 12AV7 oscillator tube, and the series resistor, R_0 , is disconnected at switch S_1 . That terminal on the switch is then bridged, using shielded cable, to the same switch terminal on the left-hand channel record-playback preamplifier. In thus doubling the load on the left-hand channel oscillator, it will be necessary to readjust the bias adjustment potentiometer, R_{13} . It will also be necessary to substitute a 27,000 ohm resistor for the 56,000 ohm resistor, R_0 . Note, also, that since bulk erasure is used, both erase head leads should be removed. The left-hand channel lead is replaced with a 30 mhy. choke in order to provide a suitable load for the oscillator. As in monaural recording a bias current of .8 ma. should be applied to each of the record-playback heads during recording. The method for determining this critical current is described in the April issue.

The RP61 record-playback preamplifier described here and in the preceding issue is, of course, adaptable to either monaural or stereophonic recording from microphones as well as from radio or phono inputs. The over-all recording amplifier gain of 60 db plus is adequate to justify use of better-than-average microphones having a frequency response characteristic of 60 to 12,000 cps or better. Dynamic microphones of this type are generally available in the \$40.00 to \$60.00 price range and are well worth the investment.

-50-

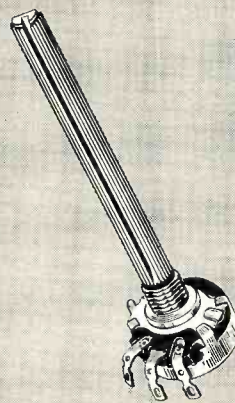

with IRC Controls and Resistor

Type Q Replacement Controls are the basic replacements for all modern set servicing. Servicemen favor their easy installation features. Customers like their quality appearance and "cushioned turn". Available from your IRC Distributor in a full line of standard single controls, exact duplicates for TV and auto sets, Concentrikits and other specials.

IRC BT and BW Resistors

Leading choice of Servicemen, BT Insulated Composition Resistors offer excellent stability and power dissipation and very low operating temperature; 1/4, 1/2, 1 and 2 watt sizes. BW Insulated Wire Wounds provide exceptional stability for low ranges.



IRC Type DC Precistors

1% accuracy, Deposited Carbon Resistors for TV and similar circuits. In 1/2, 1 and 2 watt sizes with a unique combination of close tolerance, high stability, low voltage coefficient and low cost.

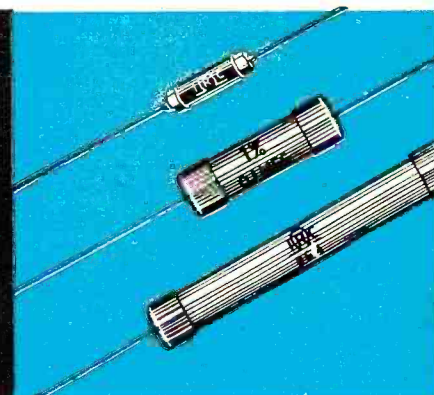

IRC Insulated Chokes

Molded housing gives full protection against humidity, guards winding from physical damage and prevents possible shorting to chassis. Available in 4 sizes permitting accurate replacement by size and electrical characteristics.

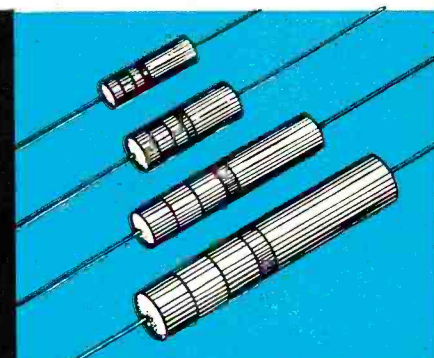

Send for complete information today

INTERNATIONAL RESISTANCE CO.

Dept. 481, 401 N. Broad St., Phila. 8, Pa.

In Canada: International Resistance Co. Ltd., Toronto, Licensee

Whenever
the Circuit Says



KESTER

Absolutely non-corrosive and non-conductive, KESTER "RESIN-FIVE" CORE SOLDER contains an activated type of resin that gives you that fast, positive action on all your jobs . . . including the most difficult.

KESTER SOLDER COMPANY
4235 Wrightwood Avenue • Chicago 39, Illinois
Newark 5, New Jersey • Brantford, Canada

SOLDER

RADIO and TELEVISION ELECTRONICS

in all Technical Phases
New Classes (Day and Evening) Start 1st of Dec., Mar., June, Sept.
Free Placement Service for Graduates
For Free Catalog write Dept. RN56
RCA INSTITUTES, INC.
A Service of Radio Corporation of America
350 WEST 4TH ST., NEW YORK 14, N. Y.

TV TUNER REPAIRS
48-HOUR SERVICE
Defective tuners rebuilt to factory standards.
New tuner guarantee. Ship prepaid.
RADIO PRODUCTS CO.
15-20 122nd Street • College Pt. 56, N. Y.
We carry a full line of Replacement Tuners for all makes of T. V.

TELEVISION

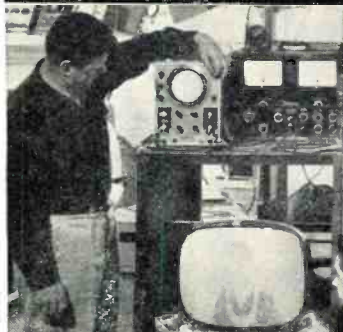

Industry needs Electronic Trained Men Now! **QUALIFY FOR BIG PAY JOB, 9 short months.** No other type of training can compare with actual shop practice you get at Healds under expert instructors.

Bachelor of Science Degree, 27 Months

- Electronics Engineering (B.S. Degree)
- Electrical Engineering (B.S. Degree)
- Television Technician (9 Months)
- Electronics Technician (12 Months)

Heald College ranks **FIRST** West of the Mississippi in "Who's Who in America"

Approved for Veterans

DAY AND EVENING CLASSES

Register Now. Write for Catalog. (No Obligation.)

Your Name

Address

City

State

AT HEALDS YOU LEARN
BY DOING IN MODERN
ELECTRONICS LABORATORIES

HEALD
ENGINEERING COLLEGE
Van Ness at Post
San Francisco, Calif.

Battery-Operated Cathode Follower

By RUFUS P. TURNER

ALTHOUGH little has been published about battery-tube cathode followers, such circuits are attractive for use as high-to-low impedance converters in portable installations. There are many such applications in field instrumentation.

Fig. 1 is the circuit of a cathode follower employing a triode-connected 1U4 tube. The low current drains ($\frac{1}{2}$ ma. @ 90 v. and 50 ma. @ $1\frac{1}{2}$ v.) permit the use of miniature self-contained batteries.

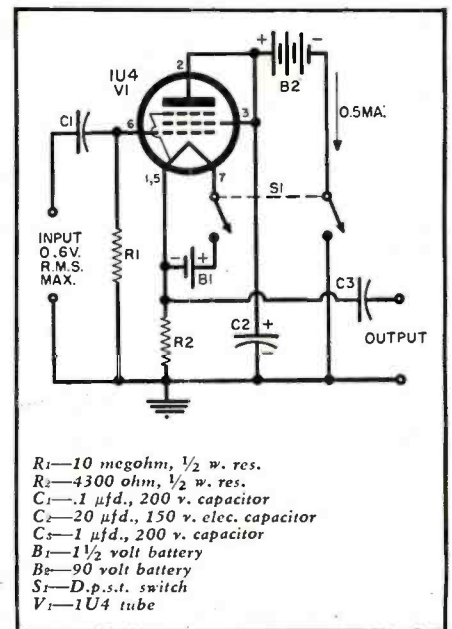

Optimum results are obtained with an external resistive load of 1800 ohms when power transfer is required. Fully loaded in this manner, the stage has a voltage gain of .33. With infinite external load (as when operated ahead of a v.t.v.m., scope, or amplifier with high input impedance) voltage gain is .66. Maximum signal input for low-distortion output is .6 volt r.m.s. The cathode follower has very high input impedance, corresponding to .1 μ f. in series with 10 megohms.

Fig. 2 is frequency response of stage in terms of response at 1000 cps. Response is flat from 20 cps to 20 kc., down less than 2 db at 100 kc.

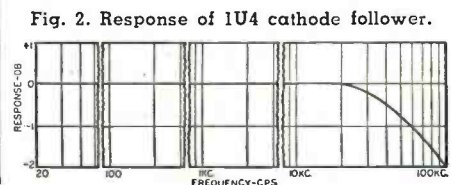

The new Model TC-55



New! SICO Streamlined TUBE TESTERS

FOR The Experimenter or Part-time Serviceman, who has delayed purchasing a higher priced Tube Tester. The Professional Serviceman, who needs an extra Tube Tester for outside calls. The busy TV Service Organization, which needs extra Tube Testers for its field men.

- You can't insert a tube in wrong socket. Separate sockets are used, one for each type of tube base.
- "Free-point" element switching system Any pin may be used as a filament pin and the voltage applied between that pin and any other pin, or even the "top-cap".
- Checks for shorts and leakages between all elements. Provides a super sensitive method of checking for shorts and leakages up to 5 Megohms between any and all of the terminals. Continuity between various sections is individually indicated.
- Elemental switches are numbered in strict accordance with R.M.A. specification. The 4 position fast-action snap switches are all numbered in exact accordance with the standard R.M.A. numbering system.

Speedy, yet efficient operation is accomplished by: Elimination of old style sockets used for testing obsolete tubes (26, 27, 57, 59, etc.) and providing sockets and circuits for efficiently testing the new Noval and Sub-Minar types.

Model TC-55 comes complete with operating instructions and charts and streamlined carrying case.

\$26⁹⁵ NET

New Model TV-50

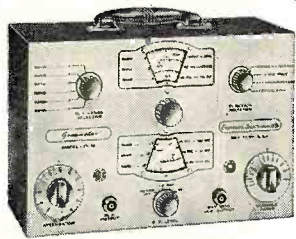

GENOMETER

A versatile all-inclusive GENERATOR which provides ALL the outputs for servicing:

A.M. Radio • F.M. Radio • Amplifiers • Black and White TV • Color TV

R. F. SIGNAL GENERATOR: Provides complete coverage for A.M. and F.M. alignment. Generates Radio Frequencies from 100 Kilocycles to 60 Megacycles on fundamentals and from 60 Megacycles to 180 Megacycles on powerful harmonics. • VARIABLE AUDIO FREQUENCY GENERATOR: In addition to a fixed 400 cycle sine-wave audio, the Genometer provides a variable 300 cycle to 20,000 cycle peaked wave audio signal. • BAR GENERATOR: Projects an actual Bar Pattern on any TV Receiver Screen. Pattern will consist of 4 to 16 horizontal bars or 7 to 20 vertical bars. • CROSS HATCH GENERATOR: Genometer will project a cross-hatch pattern on any TV picture tube. The pattern will consist of non-shifting horizontal and vertical lines interlaced to provide a stable cross-hatch effect. • DOT PATTERN GENERATOR (FOR COLOR TV): The Dot Pattern projected on any color TV Receiver tube by the Model TV-50 will enable you to adjust for proper color convergence. • MARKER GENERATOR: The following markers are provided: 189 Kc., 262.5 Kc., 456 Kc., 600 Kc., 1000 Kc., 1400 Kc., 1600 Kc., 2000 Kc., 2500 Kc., 3579 Kc., 4.5 Mc., 5 Mc., 10.7 Mc., (3579 Kc. is the color burst frequency).

MODEL TV-50 comes absolutely complete with shielded leads and operating instructions. Only

\$47⁵⁰ NET



The new Model TV-11

TUBE TESTER



- ★ Uses the new self-cleaning Lever Action Switches for individual element testing. Because all elements are numbered according to pin-number in the RMA base numbering system, the user can instantly identify which element is under test. Tubes having tapped filaments and tubes with filaments terminating in more than one pin are truly tested with the Model TV-11 as any of the pins may be placed in the neutral position when necessary.
- ★ The Model TV-11 does not use any combination type sockets. Instead individual sockets are used for each type of tube. Thus it is impossible to damage a tube by inserting it in the wrong socket.
- ★ Free-moving built-in roll chart provides complete data for all tubes.
- ★ NOISE TEST: Phono-jack on front panel for plugging in either phones or external amplifier will detect microphonic tubes or noise due to faulty elements and loose internal connections.

EXTRA SERVICE — The Model TV-11 may be used as an extremely sensitive Condenser Leakage Checker. A relaxation type oscillator incorporated in this model will detect leakages even when the frequency is one per minute.

The model TV-11 operates on 105-130 Volt 60 Cycles A.C. Comes housed in a beautiful hand-rubbed oak cabinet complete with portable cover.

\$47⁵⁰ NET



TRANS-CONDUCTANCE TUBE TESTER

The new Model TV-12

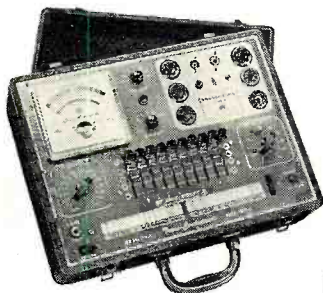

ALSO TESTS TRANSISTORS!

TESTING TUBES

- ★ Employs improved TRANS-CONDUCTANCE circuit. An in-phase signal is impressed on the input section of a tube and the resultant plate current change is measured. This provides the most suitable method of simulating the manner in which tubes actually operate in Radio & TV receivers, amplifiers and other circuits. Amplification factor, plate resistance and cathode emission are all correlated in one meter reading.
- ★ NEW LINE VOLTAGE ADJUSTING SYSTEM. A tapped transformer makes it possible to compensate for line voltage variations to a tolerance of better than 2%.
- ★ SAFETY BUTTON—protects both the tube under test and the instrument meter against damage due to overload or other form of improper switching.

- ★ NEWLY DESIGNED FIVE POSITION LEVER SWITCH ASSEMBLY. Permits application of separate voltages as required for both plate and grid of tube under test, resulting in improved Trans-Conductance circuit.

TESTING TRANSISTORS

A transistor can be safely and adequately tested only under dynamic conditions. The Model TV-12 will test all transistors in that approved manner, and quality is read directly on a special "transistor only" meter scale.

Model TV-12 housed in handsome rugged portable cabinet sells for only

\$72⁵⁰ NET

**EXAMINE BEFORE YOU BUY!
USE APPROVAL FORM ON NEXT PAGE**

New!



20,000 OHMS PER VOLT

ALLMETER

New Model TV-60

Includes services never before provided by an instrument of this type. Read and compare features and specifications below!



FEATURES

- ★ Giant recessed 6½ inch 40 Microampere meter with mirrored scale.
- ★ Built-in Isolation Transformer.
- ★ Use of the latest type printed circuit and 1% multipliers assure unchanging accurate readings.

- SPECIFICATIONS**
- 8 D.C. VOLTAGE RANGES (At a sensitivity of 20,000 Ohms per Volt) 0 to 15/75/150/300/750/1500/7500/30,000 Volts.
 - 7 A.C. VOLTAGE RANGES: (At a sensitivity of 5,000 Ohms per Volt) 0 to 15/75/150/300/750/1500/7500 Volts.
 - 3 RESISTANCE RANGES: 0 to 2,000/200,000 Ohms, 0-20 Megohms.
 - 2 CAPACITY RANGES: .0025 Mfd. to 30 Mfd.
 - 5 D.C. CURRENT RANGES: 0-75 Microamperes, 0 to 7.5/75/750 Milliampers, 0 to 15 Amperes.
 - 3 DECIBEL RANGES:—6 db to + 58 db.

R.F. SIGNAL TRACER SERVICE: Enables following the R.F. signal from the antenna to speaker of any radio or TV receiver and using that signal as a basis of measurement to first isolate the faulty stage and finally the component or circuit condition causing the trouble.

AUDIO SIGNAL TRACER SERVICE: Functions in the same manner as the R.F. Signal Tracing service specified above except that it is used for the location of cause of trouble in all audio and amplifier systems.

Model TV-60 comes complete with book of instructions; pair of standard test leads; high-voltage probe; detachable line cord; R.F. Signal Tracer Probe and Audio Signal Tracer Probe. Pilofilm bag for all above accessories is also included. Price complete. Nothing else to buy. **ONLY**

\$52.50 NET

SHIPPED ON APPROVAL NO MONEY WITH ORDER NO C.O.D.

TRY ANY of the instruments on this or on the facing page, for 10 days before you buy. If completely satisfied then send down payment and pay balance as indicated on coupon. No Interest or Finance Charges Added! If not completely satisfied return unit to us, no explanation necessary.
© M. Steir

New Model 670-A
SUPER-METER

Combination VOLT-OHM MILLIMETER PLUS CAPACITY REACTANCE INDUCTANCE & DECIBEL MEASUREMENTS

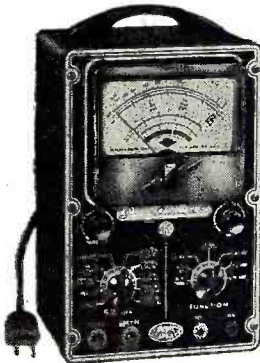

- SPECIFICATIONS**
- D.C. VOLTS: 0 to 7.5/15/75/150/750/1,500/7,500 Volts
 - A.C. VOLTS: 0 to 15/30/150/300/1,500/3,000 Volts
 - OUTPUT VOLTS: 0 to 15/30/150/300/1,500/3,000 Volts
 - D.C. CURRENT: 0 to 1.5/15/150 Ma. 0 to 1.5/15 Amperes
 - RESISTANCE: 0 to 1,000/100,000 Ohms 0 to 10 Megohms
 - CAPACITY: .001 to 1 Mfd. 1 to 50 Mfd. (Good-Bad scale for checking quality of electrolytic condensers.)
 - REACTANCE: 50 to 2,500 Ohms 2,500 Ohms to 2.5 Megohms
 - INDUCTANCE: .15 to 7 Henries 7 to 7,000 Henries
 - DECIBELS: —6 to +18 +14 to +38 +34 to +58

ADDED FEATURE:

Built-in ISOLATION TRANSFORMER reduces possibility of burning out meter through misuse.

The Model 670-A comes housed, in a rugged crackle-finished steel cabinet complete with test leads and operating instructions.

\$28.40 NET

MOSS ELECTRONIC DISTRIBUTING CO., INC.
Dept. D-231, 3849 Tenth Ave.
New York 34, N. Y.

Please send me the units checked. I agree to pay down payment within 10 days and to pay the monthly balance as shown. It is understood there will be no finance, interest or any other charges, provided I send my monthly payments when due. It is further understood that should I fail to make payment when due, the full unpaid balance shall become immediately due and payable.

- Model TC-55..... Total Price \$26.95 \$6.95 within 10 days. Balance \$5.00 monthly for 4 months.
- Model TV-12..... Total Price \$72.50 \$22.50 within 10 days. Balance \$10.00 monthly for 5 months.
- Model TV-60..... Total Price \$52.50 \$12.50 within 10 days. Balance \$8.00 monthly for 5 months.
- Model TV-11..... Total Price \$47.50 \$11.50 within 10 days. Balance \$6.00 monthly for 6 months.
- Model 670-A..... Total Price \$28.40 \$7.40 within 10 days. Balance \$3.50 monthly for 6 months.
- Model TV-50..... Total Price \$47.50 \$11.50 within 10 days. Balance \$6.00 monthly for 6 months.

Name _____
Address _____
City _____ Zone _____ State _____

**EXPAND YOUR TAPE
RECORDER SALES!!**



with

INVERTERS

for changing your storage battery current to

A.C. *Household*
ELECTRICITY
Anywhere

... in your
own car!

Make your car,
boat or plane
a "ROLLING
OFFICE"

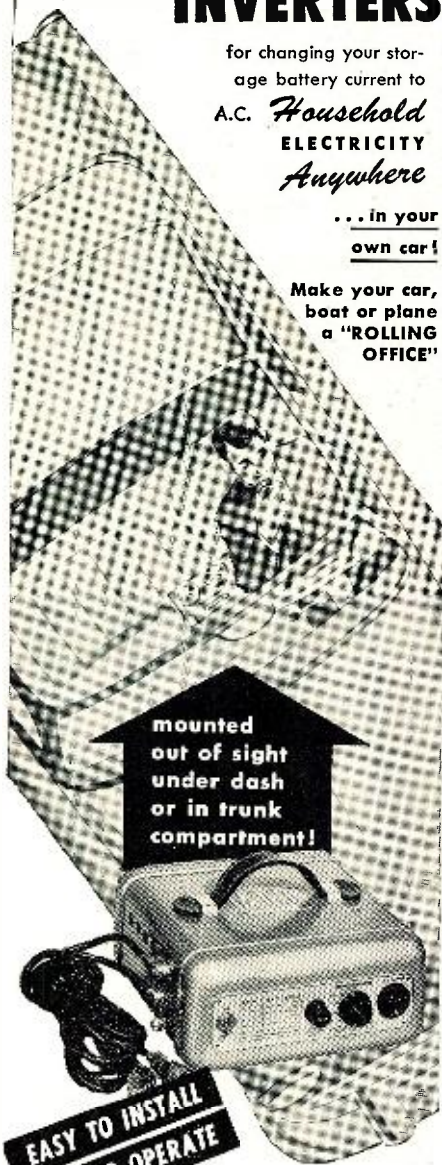

mounted
out of sight
under dash
or in trunk
compartment!

**EASY TO INSTALL
EASY TO OPERATE**

ATR INVERTERS

especially designed for operating
standard 110 volt A. C. . . .

- TAPE RECORDERS
- WIRE RECORDERS
- DICTATING MACHINES
- ELECTRIC RAZORS

for

- EXECUTIVES
- SALESMEN
- PUBLIC OFFICIALS
- POLICEMEN
- FIREMEN
- OUTDOOR MEN
- REPORTERS
- FIELD INSPECTORS
- DOCTORS
- LAWYERS, ETC.

See your jobber or write factory

✓ NEW MODELS ✓ NEW DESIGNS ✓ NEW LITERATURE
"A" Battery Eliminators, DC-AC Inverters, Auto Radio Vibrators



AMERICAN TELEVISION & RADIO CO.

Quality Products Since 1931

SAINT PAUL 1, MINNESOTA, U. S. A.

Using Your Test Equipment

By MEL BYRON

Vice-President for Engineering
Precise Development Corporation

*The difference between peak-to-peak and r.m.s. reading
v.t.v.m.'s Also, when and how to use r.f. v.t.v.m. probes.*

THE measurement of voltages in a circuit is probably one of the simplest types of measurements to make. Yet, even here, there are a few confusing aspects which need to be clarified. Some of these problems are: when should a peak-to-peak type meter be used, when an r.m.s. meter, what is the upper frequency limit of the voltages that can be measured with an a.c. vacuum-tube voltmeter without a special probe, when is a probe necessary? Other factors such as scale accuracy and the use of high and low impedance inputs also often need explanation. These factors will be discussed here.

If a peak-to-peak meter were used to measure the voltage shown in Fig. 1, the spike of voltage on the sine wave would produce a reading of 22 volts. If an r.m.s. meter were used, the spike would have very little effect and the reading would be about 7.07 volts. To ascertain which reading is appropriate, it is first necessary to find where the waveform is to be used. If this waveform is the input to the grid of an amplifier tube, the spike would certainly be important and must be measured and accounted for in the circuit. As an example, if the tube bias were only 10 volts, the two-volt peak would override the bias and drive the grid positively, perhaps causing distortion. Peak-to-peak measurements are, therefore, important when signal tracing and checking the drive to a tube.

In power line or "B+" measurements, where the primary consideration is power, the spike of voltage may not be too important. In a radio or TV set such a spike would soon be filtered out of the "B+" supply and would add little if anything to the d.c. voltage. It would likewise be of little importance in a tube heater circuit. In other words, an r.m.s. meter should be used since it will largely discount the spike and read approximately 70.7% of the normal sine wave peak.

Generally speaking, an r.m.s.-reading voltmeter when used without an r.f. probe will measure 60- to 120-cycle voltages accurately on its a.c. ranges, while a peak-to-peak reading voltmeter can be used for signal measurements. An r.m.s. type meter can be used for signal voltage measurements if use is made of an r.f. probe, but this will be discussed later.

Most peak-to-peak v.t.v.m.'s do not measure very high frequency signals with any reasonable accuracy unless

they are equipped with special frequency-compensated a.c. probes. In most cases, the length of the test leads and general distributed capacity of the input circuit of the meter limits its upper range to frequencies well below 100 kc. Consequently, such a v.t.v.m. may be used for peak-to-peak signal tracing of the horizontal and vertical sections of a TV receiver, but not for accurately measuring video signals. This does not mean that a peak-to-peak v.t.v.m. should not be used for measurements in the i.f. circuits of a TV set, for example, but rather, that a certain amount of discretion should be exercised when making such measurements. It must be remembered that all test equipment has its limitations.

For measuring signals whose frequency is above 100 kc., an r.f. probe should be used. The voltage is read on the d.c. scale of the instrument since the r.f. probe rectifies the radio frequencies. The primary use for an r.f. probe is for signal tracing and comparing. Unless specially calibrated and adjusted for a particular instrument, the probe should not be expected to have a high accuracy. It is also important that the probe match the input impedance of the meter. If a 10-megohm probe is used on an instrument with a 25-megohm input, it will develop readings which are higher than they should be. The converse is also true.

Most probes use germanium diodes and care must be taken not to exceed the voltage input limit of the diode. It is usually best to stay within about 10 volts. Special higher-voltage diodes are available, but these have frequency limitations.

On many a.c. meters the lower voltage scale is nonlinear. It is crowded on the left side and gradually expands toward the right. This is because the rectifier diode (vacuum tube or germanium) operates nonlinearly as the voltage to it approaches zero (square

Fig. 1. Sine wave with a 2-volt spike. Peak-to-peak and r.m.s. type meters give different readings for this waveform.

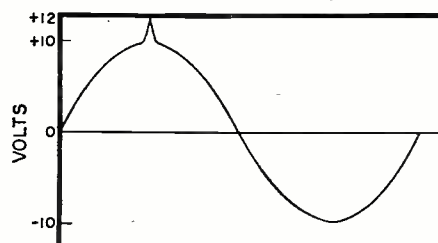

law region). The lower the voltage the more the tube operates in this region and the more nonlinear the meter scale must be to offset this.

The accuracy of a moving-needle type meter is usually taken with respect to full-scale readings and not with respect to the applied voltage. This means that readings lower than full scale may not be as accurate as the specified accuracy for that scale. As an example, a three-volt reading on a five-volt scale with an accuracy of 2% might be accurate within $\pm .1$ volt. The .1 volt is derived by multiplying the full-scale reading of 5 volts by .02. Although .1 volt is 2% of full scale, it is 3 1/3% of the input voltage being measured. An awareness of this fact is important when interpreting measurements.

The vacuum-tube voltmeter has long been acclaimed one of the most important pieces of equipment in the service and electronics laboratory. When used within its capabilities it earns its reputation.

-30-

Transistor Radios
(Continued from page 69)

B output stage has a current drain which is close to zero with no signal. When the earphone is in use, the signal path to the output stage is automatically opened. This prevents signals from reaching the output amplifiers and, in consequence, only a negligible amount of power is drawn by the stage. When speaker operation is desired, the earphone jack is removed, permitting the phone jack contact points to feed the signal into the final stage and, from here, to the speaker.

There is very little to add concerning the operation of the final stage. The 120-ohm resistor, common to the bases of both 2N35 output transistors, is designed to reduce crossover distortion by introducing a small amount of forward bias. The nearby 10-ohm resistor is employed as an aid in matching transistors when replacement becomes necessary. In effect, this serves as a floating balancing resistor, attempting by the voltage it develops to offset any difference in current flow between each transistor.

The 6 volts powering the receiver is supplied by four carbon-type penlite cells. These should last a minimum of 50 hours. Operating the receiver at reduced volume will usually double battery life. For much longer battery usage, mercury cells are suggested.

Note the preoccupation in all these transistor circuits with arrangements designed to reduce needless battery drain. When a receiver is a.c. operated, the urge to save a little power is seldom given much consideration because the savings gained in terms of money are not significant. When batteries are employed, however, it becomes a matter of importance and is accorded more attention.

-30-



A. A. Ghirardi

J. R. Johnson

**...here's how to LEARN
SERVICING R-I-G-H-T!**

Complete training in modern professional methods . . . only \$12 . . . 3 months to pay!

**FIX ANY RADIO OR TV SET EVER
MADE...easier...better...faster**

**Radio & TV
Receiver
TROUBLESHOOTING
AND REPAIR**

by Ghirardi & Johnson

822 pages, 417 illustrations
Price \$6.75

(See special offer in coupon)

This big, 822-page book brings you the kind of PROFESSIONAL training that helps you handle the toughest radio-television-electronic service jobs as slick and as accurately as you now do the easy ones!

For service beginners, Radio & Television Receiver TROUBLE-SHOOTING AND REPAIR is a complete, easily understood professional training course. For experienced servicemen, it is the ideal way to "brush up" on specific jobs; to develop better troubleshooting methods and shortcuts; and to find quick answers to puzzling service problems.

Step by step, it takes you through each service procedure . . . from locating troubles quicker and with less testing to repairing them faster and better.

You learn to deal with any kind of trouble in any kind of receiver. No guesswork. No aimless testing.

Here are just a few of the subjects covered: Components and Their Troubles; Basic Troubleshooting Methods; "Static" and "Dynamic" Testing; Practical Troubleshooting Tips and Ideas; AC/DC, 3-way Portable and Battery-set Problems; Servicing Communications Receivers; A Complete Guide to Television Service; AM, FM and TV Realignment Made Easy; Resistor, Capacitor, Inductor and Transformer Problems; Servicing Tuning, Selector and Switching Mechanisms; Loudspeakers; Servicing Recorders and Recording Equipment . . . and dozens more. Use coupon. Read it for 10 days at our risk.

**LEARN BASIC CIRCUITS...and watch
service "headaches" disappear!**

**Radio & TV
Receiver
CIRCUITRY
AND OPERATION**

by Ghirardi & Johnson

669 pages,
417 illustrations
Price \$6.50

(see special offer!)

It's amazing how much easier you can repair radio and television sets and even industrial electronic equipment when you know all about their circuits. You locate troubles in a jiffy because you know what to look for and where to look. You handle jobs lots faster, better . . . and more profitably.

Radio & Television Receiver CIRCUITRY AND OPERATION gives you a complete understanding of basic circuits as well as their variations. It teaches you to recognize them . . . to understand their peculiarities . . . to

know their likely "troublespots" . . . and how to eliminate guesswork and useless testing.

Throughout, this new book brings you the kind of above-average professional training that fits you for the bigger, better-pay jobs. Covers all circuits used in modern television and radio receivers, amplifiers, phono pick-ups, record players, etc.

Price only \$6.50 . . . or see money-saving combination offer in coupon. 10-day FREE examination.

FREE EXAMINATION . . . easy terms!

Dept. RN-56, RINEHART & CO., INC.,
232 Madison Ave., New York 16, N. Y.

Send books indicated for FREE EXAMINATION. In 10 days, I will either remit price indicated plus a few cents postage or return books postpaid and owe you nothing.

Radio & TV CIRCUITRY AND OPERATION (Price \$6.50) Radio & TV TROUBLE-SHOOTING AND REPAIR (Price \$6.75)

COMBINATION OFFER...Both books only \$12.00 (Regular price separately \$13.25 . . . you save \$1.25)
(Combination offer is payable at rate of \$3. plus postage, after 10 days if you decide to keep books, and \$3 a month thereafter until \$12 has been paid.)

Name

Address

City, Zone, State.....

OUTSIDE U.S.A. . . . \$7.25 for TROUBLESHOOTING AND REPAIR; \$7.00 for CIRCUITRY AND OPERATION; \$13.00 for both books; Cash with order, but money refunded if you return books in 10 days.



Make your training library complete. Have ALL the latest data at your fingertips. Get both these books at only \$12.00 for the two . . . YOU SAVE \$1.25.

RINEHART BOOKS ARE SOLD BY LEADING BOOK STORES

SO RY for the delay . . . We were swamped with orders & reorders . . .
New increased facilities and staff now ready to handle your orders quickly!

LOWEST PRICES

Take your pick!
Any Assortment!

TUBES

41c

ea.

Quantity Buyers!
100 Tubes — \$38.00

All Tubes Unconditionally Guaranteed For 1 Year

PRETESTED TUBES			INDIVIDUALLY BOXED		
0Z4	6AC7	6BK5	6SK7GT	12AL5	12SQ7
1B3GT	6AG5	6BK7	6SL7GT	12AT7	12SR7
1H5GT	6AG7	6BL7GT	6SN7GT	12A7G	19BG6G
11CS	6AF4	6BQ6GT	6SQ7	12AU7	25BQ6GT
11NS	6AK5	6BQ7	6SR7	12AV6	25L6GT
1N5GT	6ALS	6BY5G	6T8	12AV7	25W4GT
1Q5GT	6AQ5	6BZ7	6U8	12AX4GT	25Z5
1R5	6ASS	6C4	6V3	12AX7	25Z6GT
1S4	6AT6	6CB6	6V6GT	12BA6	35B5
1S5	6AU6	6CD6G	6W4GT	12BE6	35C5
1T4	6AU5GT	6F6	6W6GT	12AZ7	35L6GT
1T5GT	6AV5	6H6GT	6X4	12BH7	35W4
1U4	6AV6	6J5GT	6XSGT	12BY7	35Y4
1U5	6AX4GT	6J6	6Y6G	12SA7	35Z5GT
1X2	6AT6	6K6GT	6L6	7C5	50A5
3Q4	6AH4GT	6L6	6BA6	6S4	50B5
3S4	6BC5	6S8GT	7E7	7F7	50C5
3V4	6BE6	6SA7	7F7	7F8	50L6GT
5U4G	6BGGG	6SH7	7N7	12SN7GT	11Z73
5V4G	6BJ6	6SJ7GT			

BRAND NEW TV PICTURE TUBES

RCA and DUMONT Licensed		NO DUD REQUIRED!	
10BP4 \$10.95	15DP4 \$16.95	16RP4 \$17.00	19AP4 \$23.00
12LP4 12.95	16DP4 18.50	17BP4 19.00	20CP4 24.00
12QP4 13.95	16GP4 19.25	17GP4 21.00	21ALP4A 24.00
14CP4 15.25	16KP4 17.00	17LP4 18.00	21EP4 24.00

Picture Tubes Shipped F.O.B. Passaic, N. J.
PRescott 3-0330

TUBE MART

DISCOUNT HOUSE

The Lokpet Bldg. Passaic, N. J.

FREE POSTAGE on all prepaid U. S. A. orders. 25c handling charge on all orders under \$5.00. 25% Deposit on all C.O.D.'s. Subject to prior sale. Write for FREE TUBE LIST!

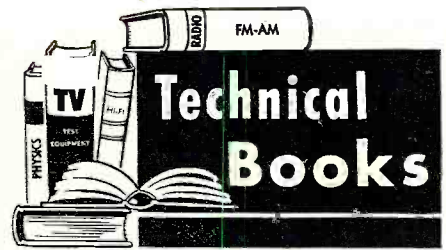

"TELEVISION, HOW IT WORKS" by J. Richard Johnson. Published by John F. Rider Publisher, Inc., New York. 344 pages. Price \$4.60. Limp binding. Second edition.

This is an expanded and up-to-date edition of the book which originally appeared in 1948. It has been written for the student, beginning technician, and the intelligent layman with a well-developed bump of curiosity.

In simple terms the author explains what goes on behind the front panel of a TV cabinet. The text covers the general aspects of a TV system; TV propagation, antennas, and transmission lines; TV front ends; the video i.f., detector, and a.g.c. sections; video amplifiers and d.c. restorers; the FM sound channel, the synchronizing section; the picture tube; power supplies; and color television.

Photographs, diagrams, patterns, and graphs are lavishly used to amplify the text material. A minimum of mathematics has been used in the text and the reader with only the sketchiest technical knowledge should have no difficulty grasping the author's lucid presentation.

"TV REPAIR QUESTIONS AND ANSWERS" by Sidney Platt. Published by John F. Rider Publisher, Inc., New York. 119 pages. Price \$2.10. Paper bound. Volume 4.

This is the fourth book in the current Rider series on the various circuits encountered in television receivers. This book covers deflection and high-voltage circuits and discusses the horizontal output circuits, high-voltage systems, damper-boost circuits, vertical output circuits, and deflection yokes.

As was the case with the earlier volumes, the text material is presented in "question and answer" form with an amplifying discussion following each answer. Partial schematics, scope patterns, and CRT picture tube traces are used to amplify the discussion.

Service technicians will find this work as enlightening and helpful as the earlier volumes in the series.

"ELECTRONS, WAVES AND MESSAGES" by John R. Pierce. Published by Hanover House, Garden City, New York. 309 pages. Price \$5.00.

This informally-written text is addressed to the general reader and the scientist in a field other than electronics who wishes a basic treatise on the subject.

The author, who is director of research (electrical communications) at the Bell Telephone Laboratories, has

RADIO & TELEVISION NEWS

FAIRCHILD

The BEST-DESIGNED
Arm You
Can Buy!



FAIRCHILD
Model 280
PLUG-IN
TRANSCRIPTION
ARM

No matter how good your pickup, it will *not* sound right unless mounted in a *proper* arm! The 280 SERIES ARMS (newly improved in ruggedness and appearance) make even the best cartridge sound better because they feature:

1. Fundamental resonance below audibility with any high quality cartridge.
2. Accurately calibrated offset and overhang for perfect tracking of all records.
3. Laterally balanced—No delicate leveling required—no skidding across records.
4. Quick Cartridge Change (Audio League says "Less than 5 second dead interval").
5. Accepts all standard cartridges (even GE turnaround) as PLUG-IN.
6. NO HUM when removing cartridge slide—leave volume on full, if desired. and many other *exclusive high-performance* features. Net Prices: 280A (12") \$33.95; 281A (16") \$35.95.

See your nearest Quality Hi-Fi dealer or write:

FAIRCHILD RECORDING EQUIPMENT CO. 9th Ave. & 154 St., Whitehouse 57, N. Y.

The most modern
CONTROL CENTER
and **PREAMPLIFIER**
you can buy!



FAIRCHILD
Model 240
PREAMPLIFIER -
EQUALIZER

where **PERFORMANCE . . . not PRICE is PRIMARY!**

Modern One-knob equalizer (type used in professional studios) — gives *correct* equalization *quickly, automatically* and the same everytime—both turnover and roll off.

Modern Cascade input circuit, gives highest gain with least noise (another Fairchild "first").

Modern Exclusive "Red-Knob" Listening Level Control—Obsoletes conventional loudness controls—gives low-level compensation that *sounds right*.

Modern Exclusive "Balanced-Bar" Tone Control—Easiest of all to see—Easiest to use.

Modern Styling by Raymond Loewy Associates.

And many other features... Net \$98.50

an impressive grasp of his subject and a contagious enthusiasm for sharing this knowledge. Mr. Pierce, however, makes no concessions to the non-scientific mind and a good bit of mathematical "know-how" is expected of the reader.

His first chapter is more or less of a survey of the field and he then covers the laws of motion, electric fields and electrons, magnetic fields, waves, Maxwell's equations, vacuum-tube amplifiers, signals, bandwidth, traveling wave tubes and millimeter waves, noise, radiation, microwave systems, television signals, communication theory, relativity and quantum mechanics, and a look at the future.

Those interested in the "art and science" of modern electronics will find this book their meat, but like this dietary staple, this book requires some careful chewing and digesting to get the "nourishment" that the author has to offer.

* * *

"PROCEEDINGS OF THE RETMA SYMPOSIUM ON AUTOMATION."

Published by *Engineering Publishers*, GPO Box 1151, New York 1, New York. 114 pages. Price \$5.00. Paper bound.

This book provides a permanent record of the papers presented at the RETMA-sponsored symposium on "Electronics for Automation and Automation of Electronics."

The papers are grouped under the headings: mechanization for high-volume assembly, data sensing, processing and utilization, the future of automation, automation for low-volume production, and redesign for automation of components and products.

Both practical and theoretical considerations of techniques and systems are treated and economic problems are discussed. Design principles and application details are also presented.

The current trend toward automation in the electronic industry makes this book of timely importance.

* * *

"TAPE RECORDERS — HOW THEY WORK" by Charles G. Westcott. Published by *Howard W. Sams & Co., Inc.*, Indianapolis, Ind. 169 pages. Price \$2.75. Paper bound.

This handy little book is designed for both recording enthusiasts and the men who service recording equipment. It covers all phases of tape recording from the theory behind the medium to a discussion of the best procedures for testing commercial and home type recorders.

The text is divided into eleven chapters covering the history of the industry, magnetic recording theory, the motorboard and tape transport mechanism, drive motors for tape recorders, volume indicators, bias oscillators, equalization circuits, the record and playback amplifier, magnetic recording heads, magnetic recording tape, and test procedures.

The book is lavishly illustrated with diagrams and photographs which should prove helpful to the reader,

May, 1956

PAYS ITS WAY every day

TESTS and REPAIRS TV PICTURE TUBES

Makes Customers Happy — Creates New Profits

Servicemen now earn new servicing dollars in minutes and build satisfied customers—with B&K Deluxe Portable CRT 400.

Spots and corrects picture tube troubles in a few minutes, right in the home, without removing tube from set! Restores emission, stops leakage, repairs inter-element shorts and open circuits. Grid cut-off reading indicates picture quality customer can expect. Life-test checks gas content and predicts remaining useful tube life. Cuts operating costs, eliminates tube transportation. Also saves money on TV set trade-in reconditioning. Profits start the very first day.

Send for Bulletin 104-N



DELUXE CRT 400 with 4 1/2" Plastic Meter

Weights only 5 lbs. mounted in rugged, luggage style, carrying case covered with handsome, durable leatherette. Size: 11 x 7 1/2 x 5". Net \$54.95

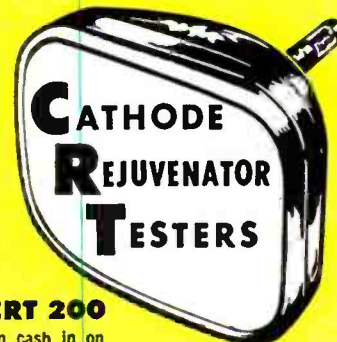

CATHODE REJUVENATOR TESTERS

PROVEN IN THE FIELD EVERY DAY BY OVER 20,000 SERVICEMEN



ECONOMY CRT 200

Every serviceman can cash in on picture tube repairs with this low priced quick profit maker. Performs most of the functions of the CRT 400. Has 3" meter. In leatherette carrying case. Size: 11 x 7 1/2 x 5". Weighs 5 lbs. Net \$39.95

Made by the Makers of the DYNA-QUIK Tube Tester

B & K MANUFACTURING CO.
3726 N. Southport Ave. · Chicago 13, Illinois



Say you "SAW IT IN RADIO & TELEVISION NEWS"

SOLA CONSTANT-VOLTAGE TRANSFORMER

Ends fluctuating line voltage!

OVER 60% OFF...



the factory price at a 1-input, 2,000 VA unit! And here's another bonus! This Air Force 2,000 VA overstock, Sola Cat. No. 30768, has 4 inputs! 90-125 V., 190-250 V., 60 cy. or 50 cy. Isolated secondary is constant 115.0 V., ±1% from no-load to full-load of 17.4 amp. So, if you choose, use it as a 220:115 V. step-down. And slash \$147.50 off the factory 1-input price! Brand new in original wood box. 4 cu. ft. Ship. wt. 254 lbs. **\$97.50** Pasco, Wash. Only

(EXPORTERS: Note choice of 50 cycles.)
THE M. R. COMPANY
P. O. Box 1220-A Beverly Hills, Calif.

EASY TO LEARN CODE

It is easy to learn or increase speed with an Instructograph Code Teacher. Affords the quickest and most practical method yet developed. For beginners or advanced students. Available tapes from beginner's alphabet to typical messages on all subjects. Speed range 5 to 40 WPM. Always ready—no QRM.



ENDORSED BY THOUSANDS!

The Instructograph Code Teacher literally takes the place of an operator-instructor and enables anyone to learn and master code without further assistance. Thousands of successful operators have "acquired the code" with the Instructograph System. Write today for convenient rental and purchase plans.

INSTRUCTOGRAPH COMPANY

4711 SHERIDAN ROAD, CHICAGO 40, ILLINOIS

Improves
phono
quality...

Ronette

new replacement cartridges

A new Ronette Fonofluid cartridge to enhance the sound of your present record player—regardless of make or model.

The Ronette high compliance, low intermodulation distortion and full frequency response assures peak performance from your equipment. Yet the cost is unbelievably low.

Acclaimed by critics and used by leading original equipment manufacturers, Ronette new replacement cartridges are available in high or low output, turnover or single needle models, and in a new universal mounting bracket that will fit your tone arm.

AT YOUR PARTS DISTRIBUTOR

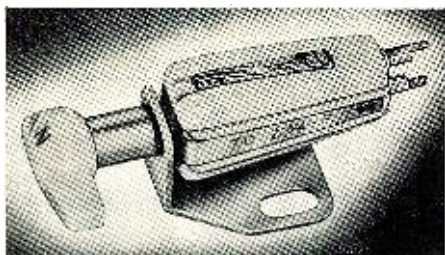

Model T0-284P (Illustrated): with 2 non-interacting sapphire needles \$7.50 net
Other models from 4.35 net

Diamond needles available at extra cost.

ELECTRONIC PARTS DISTRIBUTORS SHOW

CONRAD HILTON HOTEL
CHICAGO

room 609-A

Hear all the music you are paying for... use a Ronette.

Ronette
ACOUSTICAL CORP.
135 Front St., New York 5, N. Y.
BOWling Green 9-0380

whether a recorder owner or a technician.

Written by a man closely allied with the recording industry (*Minnesota Mining & Mfg. Co.*), this book will be welcomed by thousands of recording enthusiasts who have been seeking an authoritative and practical manual covering their hobby.

* * *

"THE RADIO HANDBOOK" edited by William I. Orr, W6SAI. Published by *Editors and Engineers Limited*, Summerland, California. 745 pages. Price \$7.50. 14th Edition.

The electronic industry has made vast strides since the 13th Edition of this basic reference work appeared in 1951.

The new volume mirrors this progress by the increased emphasis that has been placed on semiconductor devices and circuitry and new circuit techniques such as the newly popular single-sideband, etc.

In addition to presenting fundamentals which are basic to an understanding of radio and ham techniques, the book offers schematics and construction details on a number of tested and proven ham station designs. The chapters on shop practices and test equipment are especially useful to amateurs and hobbyists alike.

Hams will find they are meeting an old and cherished friend with the appearance of this new edition.

* * *

"THE RADIO AMATEUR'S HANDBOOK" compiled by the ARRL Staff. Published by *American Radio Relay League*, West Hartford, Conn. 569 pages plus tube tables and 144-page

catalogue section. Price \$3.00. Paper bound.

The appearance of the 33rd edition of the amateur's "bible" will undoubtedly set-off another round of huzzas from the ham fraternity who look forward to the new edition each year as they anticipate Spring hamfests.

They will not be disappointed in this newest volume since it contains much new and revised material of interest. Novice license holders and would-be Novices will find more circuits covering equipment for their class than ever before.

The tube data charts have been expanded to include new types and pertinent data on the popular semiconductors. Over 1350 illustrations and 122 basic formulas are also included in this edition.

* * *

"AUTO RADIO SERVICE DATA MANUAL" compiled by Sams Staff. Published by *Howard W. Sams & Co., Inc.*, Indianapolis 5, Indiana. 288 pages. Price \$3.50. Paper bound. Vol. 5.

This is another in the current specialized series of manuals for the technician. This particular volume carries complete service data on 87 models of auto radio receivers produced during the years 1954 and 1955.

Complete schematic diagrams, parts lists, and chassis photos are included for all of the receivers covered. A cumulative index covering this and the four previous volumes facilitates locating the required service data.

As with all of the company's "Photofact" publications, the material is presented so that it offers maximum utility to the technician.

-30-

TRANSISTORIZED REGENERATIVE RECEIVER

GOOD performance with a fairly short antenna is a feature of this two-tube regenerative receiver circuit. Although body-capacity effects are somewhat in evidence when open-type construction is employed, a metal panel or enclosed metal cabinet would undoubtedly eliminate such effects entirely.

Regeneration takes place in coil L_2 , which consists of 3 to 7 turns of #30 enamel wire wound on the standard "Ferry-Loopstick" coil, L_1 . The exact number of turns should be determined by performance—more turns will give greater volume and less sensitivity. Regeneration is controlled by C_3 . If oscillation cannot be obtained at the first trial, try reversing the leads to L_2 .

Detection of the signal takes place in the base-emitter circuit of V_1 . The re-

sulting audio signal is amplified in the collector-emitter circuit and is coupled to V_2 by means of the impedance-matching transformer T_1 , an Argonne No. AR-102 transistor interstage audio transformer. Resistor R_1 provides base bias for V_2 .

This receiver may be used with magnetic headphones (about 2000 ohms) in which case R_3 is omitted. For crystal headphones, R_3 must be included to provide a load for V_2 and a d.c. path to the collector of V_2 .

Standard parts are used throughout this circuit. A complete kit, including operating instructions, may be obtained from Lafayette Radio, 100 Sixth Ave., New York 13, N. Y. for \$10.95. Specify kit KT-70 when writing for this particular receiver.

-30-

Complete schematic of a transistorized regenerative broadcast-band receiver.

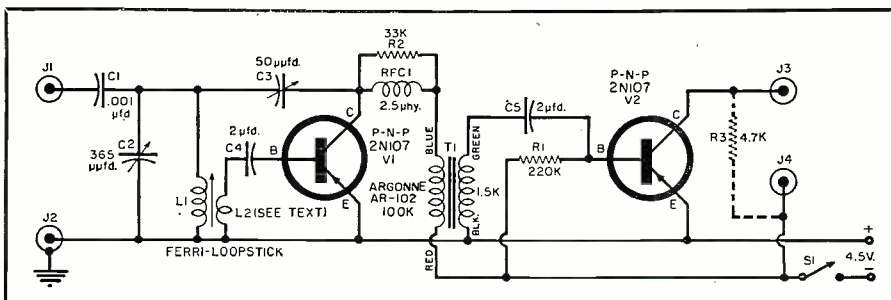

LIFETIME GUARANTEED TUBES

BRAND NEW PICTURE TUBES

- RCA Licensed
- One Year Unconditional Guarantee

Type	Price	Type	Price
10BP4	\$11.90	17BP4	\$20.63
12LP4	\$14.38	19AP4	\$24.81
14BP4	\$16.86	21AP4	\$28.79
16RP4	\$19.38	21EP4	\$28.79
16LP4	\$19.38	24AP4	\$42.50

Picture Tubes shipped F.O.B. Harrison, N. J. Above types are most popular. However, you may order any equivalent size at the same price.

NEW INDOOR ANTENNA

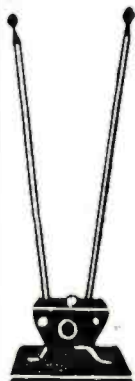

Both UHF and VHF. Brings better reception than most outdoor antennas. Use on top of TV.

List Price \$9.95

Your Price

Lots of 3 **\$3²⁹**

\$3.99 each

USED TV SETS



Picture Tube Guaranteed To Work!

- | | |
|-----------|------------|
| • Emerson | • Motorola |
| • RCA | • Zenith |
| • Philco | • Capehart |
| • GE | • Others |

10" SET	14" SET
Table Model... \$16.95	Table Model... \$27.95
Console... \$19.95	Console... \$31.00
12" SET	16" SET
Table Model... \$22.95	Table Model... \$32.00
Console... \$24.95	Console... \$34.95
17" SET	
Table Model... \$37.00	
Console... \$39.00	

All prices F.O.B. Harrison, N. J. Prices on request for 19", 20", 21" and 24" sets.

LOOK WHAT YOU GET FREE!

FREE BONUS BOX With Every \$25 Order

- 1 RCA Cheater Cord
- 10 Assorted resistors
- 10 Assorted 2 color "blank" tube cartons
- 1 6BQ6GT tube
- 1 6AU6 tube
- 1 6CB6 tube

FREE CLOCK RADIO

With Every \$125 Purchase Within 30 Days



Wakemaster clock radio with famous Sessions clock movement wakes you to music or alarm. May be purchased outright from MAJOR BRAND for \$17.95. In ivory or rust.

FREE GIFT CERTIFICATE* worth \$5 toward the purchase of any of our merchandise on future orders will be sent with any order of \$50 or more.

*Free Gift Certificate cannot be used to obtain another certificate unless order is \$55 or more.

HERE'S HOW LIFETIME GUARANTEED TUBES

SAVE YOU MONEY!

- We Guarantee to Replace Tubes Labeled MAJOR BRAND Forever
- Each Tube Individually Boxed and Guaranteed
- Over A Half Million Tubes Always In Stock
- Immediate Shipment
- Free Postage On All Orders With Full Remittance
- There are fewer "call backs"
- There are no "out of date" tubes
- "Peak Performance" testing in our fully equipped Testing Department before shipment guarantees quality

0Z443	6A757	6K6GT37	12AV635
1A7GT43	6AB45	6K739	12AV767
1A7G743	6AB443	6K865	12AX4GT65
1B3GT65	6AC767	6L668	12AX758
1C5GT41	6AF479	6L742	12AZ763
1D5GP43	6AG550	6N760	12B468
1E7GT41	6AG769	6Q740	12BA646
1GGT41	6AH669	6S440	12BD648
1HG43	6AJ570	6SA745	12BE646
1HS747	6AK554	6SC748	12BH760
1J6GT47	6AL539	6SG741	12BY765
1L445	6AQ546	6SH743	12BZ761
1L655	6AR546	6SJ748	12CUG95
1LA457	6AS548	6SK745	12SA745
1LA647	6AW770	6SL7GT55	12SJ745
1LB457	6A57G2.19	6SN7GT55	12SK745
1LC549	6AT639	6SQ739	12SN7GT56
1LC647	6AU4GT65	6SR742	12SQ737
1LD557	6AU5GT59	6S5741	12SR745
1LE357	6AU642	6T435	12V6GT47
1LG557	6AV5GT65	6T868	12X437
1LN464	6AV639	6U875	14A742
1LN547	6AX4GT60	6V380	14B638
1NSGT50	6AX5GT57	6V6GT46	14Q750
1R550	6B4G52	6W4GT46	19B6G1.15
1S542	6B869	6W6GT53	19T865
1T450	6BA47	6X434	24A39
1U547	6B758	6X578	25AV5GT78
1U842	6BC547	6X873	25BQ6GT78
1V265	6BC780	6Y6G55	25L6GT47
1X261	6BE645	7A445	25W4GT43
2A355	6BF540	7A553	25Z537
2A557	6BF650	7A645	25Z646
2A755	6BH650	7A743	2727
3A451	6BJ647	7A845	35A525
3A545	6BK568	7B539	35B550
3AL545	6BK776	7B642	35C550
3AU646	6BL7GT75	7B741	35L6GT47
3BC554	6BN658	7B845	35W434
3BN670	6BQ6GT78	7C439	35Z434
3CB652	6BQ778	7C542	35Z339
3C449	6BY5G58	7C643	35Z5GT34
3Q5GT57	6BZ788	7C745	3729
3S447	6C437	7E545	50A546
3V447	6CS35	7E655	50B550
4BQ789	6C649	7F770	50C550
4BZ795	6CD6G1.15	7F759	50L6GT43
5AW475	6D648	7F870	7542
5BG6G1.15	6E544	7G775	7642
5J663	6F537	7H750	7738
5T469	6G640	7J775	8034
5U4G43	6G838	7L775	84/6Z444
5U874	6I41.79	7N750	117L7GT1.09
5V4G59	6J539	12AT637	117N7GT1.09
5Y331	6J647	12AT766	117P7GT1.09
5Y4G36	6J743	12AU641	117Z335
5Z341	6J8G85	12AU753	117Z6GT63

ALL PARTS SHIPPED F. O. B. FROM HARRISON, N. J.

WE PAY ALL POSTAGE on orders shipped in USA, Territories and APO's. Send only purchase price of merchandise. Please include approximate postage on foreign shipments. All orders subject to prior sale. Add 25c handling on orders under \$5.00. Quantity users write for special discount.

Write for FREE Tube List—Order Blank—and FREE Sample Tube Carton. We want Y-O-U on Our Mailing List!

THIS AD IS WORTH M-O-N-E-Y

Clip out this ad and attach it to your order. Three 6SN7GT's will be shipped FREE with any order of \$10 or more.

Write Dept. RN-5

MAJOR BRAND TUBE CO.

Romano Bldg. ESsex 4-1106 Harrison, N. J.

McGEE OFFERS YOU A GENERAL ELECTRIC RPX-052A PHONO-CART. FOR \$15.95

GENERAL ELECTRIC RPX-052A \$15.95
VARIABLE RELUCTANCE PHONO CARTRIDGE

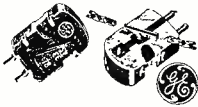

Genuine General Electric variable reluctance, high fidelity phono cartridge, model RPX-052A. Yes, the latest model with turnabout baton stylus and separate plug-in stylus. Diamond 1 mil and sapphire 3 mil. Regular cost is over \$23.00. McGee offers them to you for only \$15.95 each. We made a terrific purchase and pass the saving on to you. Only a few hundred to sell. Order now.

HI-FI FM-AM TUNER AND 10 WATT P.P. 6V6 AMPLIFIER BOTH FOR \$44.95



9 TUBES-PLUS 2 RECTIFIERS PHONO INPUT 10 W. AMP.

New Hi-Fi self-powered FM-AM tuner with 10 watt amplifier (push-pull 6V6's) on separate chassis. All you need is a record changer and speaker to have a complete home music system. 3 ft. cable connects tuner to amp. Tuner has input for crystal phono. (If changer with v.r. cartridge is purchased, we will include the necessary pre-amp, no charge.) Tuner has 6 tubes: 12AT7, 6BE6, 2-6AG5, 6AL5 and 6X4 rectifier. Amp has 2-6V6's, 6SN7 and rectifier. Full superhet circuit with AVC, 3 position tone control, 9" illuminated slide rule dial, escutcheon and knobs. Stick loop antenna for AM. Radio-FM-AM phono selector switch; tone control, volume control on tuner. Response 50 to 17,500 cps. Receives broadcast 540 to 1600 kc and FM 88 to 108 mc. Output matches any of the speakers shown above. No. FA9-2CR tuner and amplifier complete. Ship. wt. 22 lbs. Sale price, \$44.95. CU-14Y 12" coax speaker, \$10.00 extra; 15" coax speaker, \$20.00 extra.

9-TUBE HI-FIDELITY 12 Watts Audio Dual Tone Controls \$39.95



RECEIVES BROADCAST 550 TO 1650 K.G. LESS SPEAKER

Jackson AM9A, 12 watt hi-fi audio amplifier and broadcast tuner combined. Less than you would pay for the amp alone. Push-pull 6V6's. Response 50 to 15,000 cps. Inputs for crystal or v.r. phono and crystal or dynamic mike. Separate bass boost and treble tone controls, radio-phono selector, shielded output matches 3.2 or 8 ohm speaker. Heavy duty 150 mill power trans. 9 1/2" illuminated slide rule dial. 3 gang condenser with tuned R.F. and loop ant. Receives 550 to 1650 kc. Size 13" x 9 1/2" x 6" high. With tubes: 2-6BA6, 6AU6, 6BE6, 6SN7, 6AT6, 2-6V6 and 5Y3. Knobs, escutcheon, diagram and instructions included. Model AM9A. Ship. wt. 19 lbs. Sale price, \$39.95. CU-14Y 12" coax speaker, \$10.00 extra; 15" coax speaker, \$20.00 extra.

14 TUBE ESPEY HI-FI CUSTOM FM-AM CHASSIS



RESPONSE FROM 10-22,000 CPS—PUSH-PULL 6V6'S—TWIN TONE CONTROLS—WILLIAMSON TYPE CIRCUIT—INPUTS FOR V.R., CRYSTAL, TAPE, RADIO OR TV

SALE PRICE \$84.95 LESS SPEAKER

ESPEY MODEL HF-250C WITH MONARCH UAGU CHANGER \$112.95

New 1956 model, 14 tube FM-AM chassis. A true Hi-fidelity receiver built by a nationally famous maker of fine custom chassis. Espey Model HF-250C, 14 tube FM-AM chassis with push-pull 6V6, 10 watt audio. You could spend \$250 to \$280 for a separate tuner and amplifier and not have the quality of this receiver. Ultra-linear output used in Williamson type circuit gives frequency response of 10 to 22,000 cps. Output taps of 4, 8 and 16 ohms. Separate RF stages for FM and AM assure high sensitivity. Temperature compensated FM front end for minimum drift. Separate bass and treble tone controls. Pre-amp for all types of magnetic cartridges. 2nd input for crystal phono, tape recorder or TV. 3 position equalizer for accurate reproduction of all records. Built-in antennas for both FM and AM. Response plus or minus 1 db from 10 to 22,000 cps. Harmonic distortion less than 1%. Sensitivity: FM, 8 mv for 10 db quieting; AM, 75 mv for 6 db signal to noise ratio. Off-on-volume and equalizer are combined on a concentric control. Has 2 AC outlets on rear of chassis. Beautiful edge lighted flywheel inertia slide rule dial. Size: 7 3/4" x 13 3/4" x 10" deep. Ship. wt. 24 lbs. (not mailable) Model HF-250C. Sale price, \$84.95. With heavy duty Utah 15" coaxial PM speaker, both for only \$99.95. Buy either of these new Duotone "Norelica" speakers with your Espey chassis. Made by Philips of Holland. Features Ticonal magnet, improved cone design, built-in mechanical cross-over and copper ring fitted into air gap keeps voice coil impedance independent of frequency. Model 9760M, \$54.95 list 12" Philips speaker, response 30 to 20,000 cps, rated at 20 watts with Model HF-250C Espey chassis, both for only \$99.95. Model 9762M, \$59.95 list 12" Philips speaker, response 22 to 20,000 cps, rated at 20 watts with Model HF-250C Espey chassis, both for only \$119.95.

NEW IMPORTED MONARCH HIGH FIDELITY AUTOMATIC CHANGER WITH GOLDRING #500 VAR. REL. CARTRIDGE \$29.95



Monarch Model UAGU—new, imported high fidelity 3 speed automatic record changer. Plays 10" and 12" records automatically. Intermixes records of the same speed in any order. Features a 4 pole high fidelity motor eliminating rumble and wow. Pickup automatically returns to rest and motor turns off after last record has played. Full size 10" turntable has molded rubber pallet for better record cushioning. Base size, 10 1/2" x 12 3/4". Tone arm is counter balanced to assure minimum record wear. The changer features, at no added cost the regular \$9.90 not value Goldring #500 variable reluctance cartridge for the finest high fidelity record reproduction. Output 10 millivolts. Response, 20 to 16,500 cps. It requires the same input gain as popular American made variable reluctance cartridges. Model UAGU, Monarch automatic changer with Goldring cartridge, ship. wt. 15 lbs. Sale price, \$29.95; Large spindle for 45 RPM records, \$1.88 extra.

NEW 1957 MODEL 25 WATT 12" COAXIAL SPEAKER

- ★ 14 1/2 oz. G.E. 12" WOOFER—
- ★ 3 1/2" COAXIALLY SUSPENDED TWEETER—
- ★ BUILT-IN CROSSOVER—
- ★ ALUMINUM VOICE COIL WOOFER—

McGee's new 1957 model, GE-1201XT, 12" 25 watt high fidelity coaxial PM speaker. No frills or dummy pot cover, it's all speaker value. Features a General Electric 12", 14 1/2 oz. Alnico V woofer with aluminum voice coil and exponential molded scumless cone. The tweeter is a special made 1.47 oz. Alnico V, 3 1/2" speaker which extends the high frequency response to 17,500 cps. It is electrically connected to accept only the upper register of audio. Only two wires connect this complete high fidelity speaker to any 8 ohm amplifier. Ship. wt. 8 lbs. Stock No. GE-1201XT, McGee Sale Price, \$18.95.



McGee's Famous 12 AND 15 INCH COAXIAL P.M. HIGH FIDELITY SPEAKERS

\$12.95 \$23.95

12-inch Model CU-14Y 15-inch Model P15-CR

Model CU-14Y, 12" high fidelity coaxial PM speaker. Response from 30 to 17,500 cps. Full 6.8 oz. Alnico V magnet in the 12" woofer. Coaxially suspended tweeter. Built-in crossover network. Only two wires to connect to high frequency tweeter. Matches 3.2 to 8 ohm output. Don't confuse this speaker with your radio or amplifier. This is a fine quality speaker. Stock No. CU-14Y. Sale price \$12.95 each, two for \$25.00. Model P15-CR, 15" high fidelity coaxial PM speaker. Response down to 20 cps and up to 17,500 cps. Full 2 1/2 oz. Alnico V magnet in the 15" woofer. Built-in crossover network. Only two coaxially suspended 5" high frequency tweeter. Matches 3.2 to 8 ohm output transformer. A regular \$62.50 list speaker. Model P15-CR. McGee's Sale Price, \$23.95.

McGee's new 15" Junior coaxial PM speaker. 15" woofer has 6.8 oz. Alnico V magnet. Built-in crossover tweeter with crossover. Only two wires to connect to any 8 ohm radio or amplifier. Frequency response from 40 to 15,000 cps. Model No. M15-CR, 15" Junior coax PM speaker, Sale price, \$16.95.

NEW—SMALL VOLT-OHM METER \$9.95

2000 OHMS PER VOLT AC-DC WITH TEST LEADS 2 FOR \$19.50—4 FOR \$37.00



New, small Volt-Ohm meter 5 1/4" tall, 3 5/8" wide and 1 1/2" thick. 3 1/4" meter. Sensitivity 2000 ohms per volt. DC volts 0 to 1000 in 5 ranges; AC volts 0 to 1000 in 2 ranges; DC current 0 to 500 ma. in 3 ranges. Resistance 0 to 1.5 megohms in 2 ranges; Decibels minus 20 to plus 16 (Odb -77.4 volts). A thin, compact instrument small enough to fit in your service kit. A fine imported meter specially priced at \$9.95 like this. Model TP-5, complete with test leads. Never before have we offered \$9.95. Ship. value like this. Model TP-5, complete with test leads. Sale price, only \$9.95. Ship. wt. 2 lbs. Special quantity price, 2 for \$19.50, or buy 4 for only \$37.00. New, larger size Volt-ohm meter Model MT-1A, 6 3/4" tall, 4 1/4" wide and 2 1/2" thick. 2000 ohms per volt. Similar in appearance to Model TP-5, except that it is larger, has 3 1/2" meter and 4 resistance ranges instead of 2. Model MT-1A. Ship. wt. 2 lbs. Sale price, \$12.95 each, 2 for \$25.00.

MINIATURE BROADCASTING STATION FOR MICROPHONE AND PHONO WITH CRYSTAL MICROPHONE \$9.95



Sensational new model MCL-E3 miniature broadcasting station for microphone and phonograph. Can be received on any broadcast radio in the home. No wires to connect, tunes in just like a radio station. Has input jacks for crystal mike or record player. Comes with 12K8 and 70L7 tubes and instructions. Operates on 110 volts AC. Simple to operate; one control fades from microphone to record. Frequency can be adjusted so as not to interfere with local radio stations. Miniature broadcasting station complete with crystal hand mike and instructions. Ship. wt. 4 lbs. Net price \$9.95.

NEW 6-TUBE, 12-VOLT UNIVERSAL MOUNTING AUTO RADIO WITH 5" x 7" OR 6" x 9" SPEAKER \$29.99



SALE PRICE \$29.99

6-TUBE, 6-VOLT WITH \$19.99 SPEAKER

McGee makes another tremendous purchase and passes the saving on to you. This universal mounting, 6 tube, 6 volt auto radio is a full superhet with fully tuned R.F. stage. Made to order and America's best known manufacturers. Its very thin and compact construction lends it to a neat underdash installation in most any car or truck. Or, you can arrange a place in the dash for custom installation. (Dial requires a cut-out 3 1/2" long x 2 1/2" high; two control holes on 7" centers. A minimum depth behind dash.) When mounted underdash it extends only 2 1/2" below. Overall size: 9" wide, 4 1/4" high and 7 1/4" deep. Requires no more room under your dash than an ordinary auto radio remote control head. Not intended for an exact custom panel fit, but it lends itself very well for your custom installation ideas. Can be custom fit in most late model cars and trucks. Has no built-in speaker, but is furnished with a heavy duty 6x9" speaker. This is the most popular size auto radio speaker. Tubes: 6BE6, 2-6BD6, 6AV6, 6AQ5 and 6X4. Ship. wt. 12 lbs. Stock No. AH-759. McGee's Sale Price, \$19.99 for the radio complete with 6x9" speaker. 3 section top cowl antenna, \$2.29 extra.

NEW 12-VOLT MODEL WITH SPEAKER \$29.99

Model AH-1259, 12 volt universal mounting auto radio. This is the same set as pictured above (AH-759), except made for 12 volt model 1955 and 1956 cars. Stock No. AH-1259 with 6x9" 6x7" speaker, \$29.99. Stock No. RP-232X, 6x9" rear seat speaker kit for 12 volt cars, \$4.99 extra.

McGEE RADIO COMPANY PRICES F.O.B. KANSAS CITY SEND 25¢ OR FULL REMITTANCE WITH ORDER. BAL. SENT C.O.D. TELEPHONE VICTOR 2-5092 1903 McGEE ST., KANSAS CITY, MISSOURI



A compact wide range VTVM-Ohmmeter for modern electronic circuit checking in the laboratory, on the production line and for general service-maintenance. Features include Peak-to-Peak voltage ranges which afford a new high in P-P reading accuracy of pulsed wave-forms in color or monochrome TV and similar applications.

**7 DISTINCTLY SEPARATE FUNCTIONS
40 SELECTED, WIDE-SPREAD RANGES**

- ▶ **6 TRUE-ZERO-CENTER DC VOLT RANGES:**
Constant 26 $\frac{2}{3}$ Megs input resistance.
0 \pm 1.2 \pm 6 \pm 12 \pm 60 \pm 300 \pm 1200 volts.
- ▶ **5 ELECTRONIC OHMMETER RANGES:**
0-1000-10,000 ohms. 0-1-100-1000 Megs.
- ▶ **6 PLUS and 6 MINUS DC VOLT RANGES:**
(Left-Hand-Zero) constant 13 $\frac{1}{3}$ Megohms input.
0-1.2-6-12-60-300-1200V.
- ▶ **6 HIGH IMPEDANCE RMS AC VOLT RANGES:**
0-1.2-6-12-60-300-1200 volts
Input Characteristics: Up to 60V Range - 3 Megs., 90 mmfd; 300 V Range - 1 Meg., 70 mmfd; 1200V Range - 4 Megs., 67 mmfd.
- ▶ **6 HIGH IMPEDANCE P-P AC VOLT RANGES:**
0-3.2-16-32-160-800-3200 volts
Input Characteristics: Up to 160V Range - 6 Megs., 90 mmfd; 300V Range - 1 Meg., 70 mmfd; 3200V Range - 4 Megs., 67 mmfd.
- ▶ **5 SPECIAL HIGH FREQUENCY PROBE RANGES:**
0-1.2-6-12-60-300 volts RMS.
(Requires optional PRECISION RF-10AHF Probe).
Probe input capacity: -approximately 5 mmfd.
- **ONE UNIVERSAL COAX. AC-DC VTVM PROBE** serves all functions other than HF ranges.
- **PEAK-TO-PEAK "RE-SET" PUSH-BUTTON** for rapid "zero" return of special electronically damped test circuit.
- **EXTRA-LARGE 5 $\frac{1}{4}$ " RUGGED PACE METER.**
200 μ A sensitivity \pm 2% accuracy.
- **1% MULTIPLIERS and SHUNTS.**

MODEL 88: complete with detachable AC line cord, internal ohmmeter battery, coaxial VTVM Probe and operating manual.
Size: 5 $\frac{1}{2}$ x 7 x 3 $\frac{1}{2}$ "\$74.50 net

ACCESSORIES FOR THE MODEL 88
RF-10A HF vacuum tube probe.....\$14.40 net
TV-8 60 Kilovolt safety probe..... 14.75 net
ST-1 "Snap-on" foldaway tilt-stand..... 1.00 net

PRECISION Apparatus Company, Inc.
70-31 84th Street, Glendale 27, L. I., N. Y.
Export: 458 Broadway, New York 13, U. S. A.
Canada: Atlas Radio Corp., Ltd., 50 Wingham Ave., Toronto, 10

New

TUBE TESTER

Data

Keep your Eico and Jackson tube testers up-to-date for the new radio and TV tubes.

IN recent months many new receiving tubes for radio and television have been introduced by the various tube manufacturers. The information presented here will allow owners of the Eico model 625 and Jackson model 715/115 tube testers to test these new tubes.

The Electronic Instrument Co., Inc., 84 Withers St., Brooklyn 11, N. Y., and the Jackson Electrical Instrument Co., 18 South Patterson Blvd., Dayton 2, Ohio, regularly make new roll charts available for their tube testers. To obtain copies of these roll charts, write to the company mentioning the model number of the tester you have. For Jackson tube testers, also note the serial number.

Jackson charges \$1.50 for charts for testers over one year old. For testers less than one year old, charts are furnished free if the registration card is returned. The latest roll chart for the model 715/115 tester is form 715/115-9.

-30-

JACKSON MODEL 715/115

Tube	Filament	X	Plate	YZ
3B2	3.0	24567	48	8Q
3CE5	3.0	5	35	2JMS
3DT6	3.0	32	2JMNQ
4BS8	4.2	18	2LR
			18	4NR
5BR8	5.0	42	4JNS
			20	3KR
5BT8	5.0	35	4KNS
			33	2Q
			33	3Q
5V3	5.0	8	3S
			8	6S
Shows Short on 7				
6BE8	6.3	20	4JNPS
			18	3KR
6BH8	6.3	32	7JQQ
			20	9LR
6BJ8	6.3	25	5OR
			33	2Q
			33	4Q
6BL4	6.3F	1356	8	4S
6BR8	6.3	42	4JNS
			20	3KR
6BS8	6.3	18	2LR
			18	4NR
6BT8	6.3	35	4KNS
			33	2Q
			33	3Q
6BW4	6.3	9	2S
			9	5S
6CE5	6.3	5	35	2JMS
6CH7	6.3	7	17	2LR
			17	4NR
6CL5	6.3	247	9	8JNS
6CU5	6.3	6	18	5KMR
6DQ6	6.3	256	8	8JLS
6DT6	6.3	32	2JMNQ
12BW4	12.6	9	2S
			9	5S
12CU5	12.6	6	18	5KMR
12DQ6	12.6	256	8	8JLS
19AQ5	19	5	10	2LMS
25DQ6	25	256	8	8JLS
X-155	6.3	17	2LR
			17	4NR

EICO MODEL 625

Tube	Shunt	Filament	Selector	Up	Down
3BZ6	22	3.3	2	1, 5, 6	2, 3, 7
5BE8	23	5.0	2	1, 2	3, 4
	23	5.0	2	6, 7, 9	4, 8
6AZ8	21	6.3	2	1, 6	2, 3, 5
	16	6.3	1	8, 9	5, 7
6BA8	26	6.3	2	2, 3	1, 4
	24	6.3	2	7, 8	4, 6
6BC8	20	6.3	2	1, 2	3, 4
	20	6.3	2	6, 7	4, 8
6BE8	23	6.3	2	1, 2	3, 4
	23	6.3	2	6, 7, 9	4, 8
6BH8	24	6.3	2	2, 3	1, 4
	24	6.3	2	7, 8, 9	4, 6
6BZ6	22	6.3	2	1, 5, 6	2, 3, 7
6CB5	20	6.3	3	1, 4, 5, 8, 10	2, 3, 6
6CG7	16	6.3	1	1, 2	3, 4
	16	6.3	1	6, 7	4, 8
6CM7	100	6.3	1	1, 2	3, 4
	22	6.3	1	6, 7	4, 8
6CN7*	29	3.3	3	7, 8	4, 5, 6
	14	3.3	1	2	3, 4, 5
	14	3.3	1	1	3, 4, 5
6CS7	25	6.3	2	1, 3	4, 9
	28	6.3	2	6, 7	4, 8
6DE6	20	6.3	2	1, 5, 6	2, 3, 7
12BV7*	35	6.3	3	7, 8	1, 3, 4, 5, 9
12C5	19	12.6	3	2, 5, 6, 7	1, 3
19AU4	25	12.6	2	5	3, 7
EF86/Z-729	26	6.3	2	1, 6, 9	3, 4, 8

*Revised data

**Ham Special! Famous BC-645
XMITTER-RECEIVER**

With **DIAGRAM** for Easy Conversion to **CITIZEN'S BAND!** Makes wonderful mobile rig for 420-500 Mc. Easy to convert for phone or CW 2-way communication. **CONVERSION DIAGRAM INCLUDED.** This swell rig originally cost over \$1000—yours for practically a song! You get it all, in original factory carton, **BRAND NEW**, complete with 17 tubes, less power supply. **Conversion Instructions Included. \$29.50** Shpg. wt. 25 lbs.

PE-101C DYNAMOTOR for BC-645, has 12-24V input (easy to convert for 6V Battery operation) only **\$7.95**
UHF ANTENNA ASSEMBLY, for BC-645, Complete set of 10 Plugs **\$5.50** for BC-645
CONTROL BOX for above, **\$2.25**
SHOCK MOUNT for above, **\$1.25**
CONVERSION BOOKLET, Instructions for most useful surplus rigs. **\$2.50**

HEADPHONES Excellent BRAND Model Description Used NEW
HS-23 High Impedance, **\$2.25** **\$4.35**
HS-33 Low Impedance, **1.99** **4.65**
HS-30 Low Imp. (leatherwt.), **1.49** **2.25**
HS-1U High Imp. (2 units), **2.75** **7.95**
CD-307A Cords, with PL55 plug and JK26 Jack, **.99**

MOBILE TRANSCEIVER DYNAMOTOR
Special Buy! Output 625 Volts DC @ 225 Ma. Input 12 1/2 V @ 1.87 Amps, DC. Size 8 1/2 x 4 1/4 x 4 1/4"
BRAND NEW, \$10.95
Excellent Used **\$8.95**

OTHER DYNAMOTOR VALUES: Excellent BRAND Type Input Output Used NEW
DM-64A 12V 5.1A 275V .150A **\$7.95**
DM-32A 28V 1.1A 250V .05A **2.95** **5.95**
DM-34D 12V 2.8A 220V .080A **4.25** **5.50**
DM-28 28V 224V .07A **1.95** **4.95**
DM-33A 28V 5A 575V .16A **1.95** **3.95**
28V 7A 540V .25A
PE-103 6V 500V .160A **19.50** **34.50**
12V 500V .160A

D.P.D.T. RELAY
Made by Leach. Works on 12 1/2 Volts DC. Coil resistance 24 ohms. 10-amp contact. Regular value \$4.95.
BRAND NEW. \$1.19
OUR PRICE EACH.....

TS-100/AP OSCILLOSCOPE
BRAND NEW (worth \$750)
OUR LOW PRICE **\$34.50**

Can be used with linear sweep or general purpose test scope. Cables included. Also used with circular sweep as precision range calibrator. Self-contained in metal case 8 1/2 x 11 1/2 x 10" deep. For 110V 50 to 1200 cycles AC. Demilitarized, New, with all tubes including crystals and C. R. Tube.

BENDIX DIRECTION FINDER
MN-26-C. 12-tube remote control Navigation Direction Finder and communications receiver. 150 to 1500 Kc in 3 bands. 28 V. DC input. Ideal for commercial navigation on boats and planes. Complete installation comprises:
MN-26-C Receiver, used, with 12 tubes, **\$16.50**
MN-26-C With 12 Tubes, BRAND NEW **\$22.50**
MN-20-E Rotatable Loop, **4.25**
MN-22 Azimuth Control Box, **2.95**

MN26Y BENDIX DIRECTION FINDER
150 to 7 Mc. Complete with tubes, motor.
BRAND NEW **\$26.95**

MICROPHONES Excellent BRAND Model Description Used NEW
T-17 Carbon Hand Mike, **\$5.45** **\$7.95**
T-30 Carbon Throat Mike, **.33** **.69**
T-45 Navy Lip Mike, **.99**
RS-38 Navy Type, **2.45** **4.95**
T-24 Carbon Mike, **3.95**

TG-34A CODE KEYS
Self-contained automatic unit, reproduces code practice signals recorded on paper tape. By use of built-in speaker, provides code-practice signals to one or more persons at speeds from 5 to 25 WPM.
BRAND NEW, in original carton. **\$16.88**

**Spectacular Bargain!
AIRBORNE RECEIVER
APA/T3-10013A**

I.F. Pulse Signal 158 to 186 Megacycles. 5 Watt output. 24 Volts DC. 5 Amps 120 Watts Includes built-in dynamotor. ONLY A FEW LEFT at this terrific low price!
Complete with all tubes. **\$10.95**
BRAND NEW.....

AIRCRAFT RADIO TRANSMITTER-RECEIVER
RADIO SET SCR-AR-283. Consists of: RECEIVER, 201 to 398 Kc and 2500 to 7850 Kc. TRANSMITTER, 2500 to 7700 Kc. for unmodulated, tone-modulated, or voice. Here's what you get, at this fantastically low price: Receiver complete with 6 tubes; transmitter complete with 4 tubes, Dynamotor for 24 V DC operation, 5 coil sets, 2 control boxes, antenna switching relay, operating manual. ALL BRAND NEW—and All Yours, for only... **\$15.95**

TS-161APN TEST SET
Very Special at this low price. **\$12.95**
BRAND NEW.....

Type 2J1F1 SELSYNS
Operates from 57 1/2 volts, 400 cycles. New, tested. Conversion diagram for 110 volts AC included.
BRAND NEW, each..... **\$2.95**
CAPS FOR ABOVE, each..... **50c**

TYPE APN/1 ALTIMETER
Complete with all tubes. Limited quantity at this special low price! **\$8.95**

NAVY RECEIVER TYPE ARB
Four Band. 105 to 9050 kc. Low Freq. Ship Broadcast—40 to 80 meters. Includes tubes and dynamotor, for 24 volt operation. Easily converted for 110 V., 12 V, or 6 V. Schematic Included. Excellent Condition. Overall: 8 1/4" x 7 1/4" x 15 1/4". Wt. 30 lbs.
COMPLETE WITH ALL TUBES, **\$21.50**
Special.....

BUBBLE SEXTANT
Made for U. S. Armed Forces, by AGFA ANSCO. Actually worth \$150 or more! Has illuminated averaging disc for nighttime use. Complete with carrying case. **\$9.95**
Only.....

EE-8 FIELD PHONES
Talk as far as 17 miles! Dependable 2-way communication at low cost! Ideal for home, farm, field. Up to six phones can be used on one line. Each phone complete with rings. Originally cost govt. \$65.00 each. Excellent condition, OUR PRICE, **\$16.66**
EACH.....

2-VOLT BATTERY "PACKAGE!"
1—2V. 20 Amp. Hr. Willard Storage Battery, **\$2.45**
1—2V. 7 prong Synchronous Plug-in Vibrator, **1.49**
1—Quart Bottle Electrolyte (for 2 cells), **1.49**
ALL BRAND NEW! **\$4.95**
Combination Price.....

Willard 6-Volt Midget Storage Battery
3 Amp. Hour. BRAND NEW. 3 3/8" x 1-13/16" x 2 3/8"
Uses Standard Electrolyte..... Only **\$2.22**

WRITE FOR FREE CATALOG!
Please include 25¢ Deposit with order—Balance C.O.D. Minimum ORDER \$3.00. All Shipments F.O.B. Our Warehouse N.Y.C.

G & G Radio Supply Co.
Dept. N-5
51 Vesey St., New York 7, N. Y., CO 7-4605
Branch: 544 So. Broadway St., Dayton, Ohio

BC-458 TRANSMITTER
5.3 to 7 Mc.
Complete with all tubes and crystal.
BRAND NEW, OUR PRICE... **\$7.95**

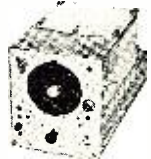

BC-457 TRANSMITTER—4.5-3 Mc. complete with all tubes and crystal. BRAND NEW... **\$8.95**
BC-459 TRANSMITTER—7.9-1 Mc. complete with all tubes and crystal. BRAND NEW... **\$11.95**

SCR-274 COMMAND EQUIPMENT
ALL COMPLETE WITH TUBES
Type Description Used Excellent BRAND
BC-453 Receiver, 190-550 Kc. **\$9.95** **\$11.95** **\$14.95**
BC-946-B Broadcast Rcvr 520 to 1500 Kc..... **19.95**
BC-454 Receiver 3-6 Mc..... **7.19** **8.29** **11.95**
BC-455 Receiver 6-9 Mc..... **5.25** **7.95** **9.95**
BC-456 Modulator..... **2.24** **2.75** **4.24**
BC-450 3-Receiver Control Box... **1.49** **1.95**
BC-451 Transmitter Control Box... **1.25** **1.49**

ARC-5/R-28 RECEIVER
2 Meter superhet, 100 to 156 Mc in 4 xtal channels. Loured alum. cabinet 7 3/8 x 4 7/8 x 1 1/4". Complete with 10 tubes and 4 xtals.
Excel. Cond. **\$14.95**

ARC-5/T-23 TRANSMITTER
Companion for above, incl. 2-832A, 2-1625 tubes and 4 xtals. **\$22.50**

ARC-5 MARINE RECEIVER-TRANSMITTER
Navy Type Comm. Receiver 1.5 to 3 Mc. BRAND NEW with 6 tubes. **\$16.95**
Navy Type Comm. Transmitter 2.1-3 Mc. BRAND NEW with 4 tubes and Xtal. **\$12.45**

SCR-522 FINEST 2-METER RIG!
Terrific buy! VHF Transmitter-Receiver, complete with all components. 100-156 Mc. 4 channels. Xtal. controlled, Amplitude modulated voice. They're going fast! Excellent condition.
SCR-522 Transmitter-Receiver, complete with all 18 tubes. **\$33.33**
COMBINATION. Special Receiver Only, with all tubes. **\$19.50**
Transmitter Only, with all tubes. **\$22.25**

LORAN APN-4 FINE QUALITY NAVIGATIONAL EQUIPMENT
Determine exact geographic position of your boat or plane! Complete. BRAND NEW installation consists of: ID-6B/APN-4 Indicator; R-9B/APN-4 Receiver; PE-20B Inverter; Set of Plugs; Visor for Indicator; Operation manual; Brand New, Export packed. **COMPLETE \$129.50**
APN-4 Terrific SPECIAL OFFER! BRAND NEW, less tubes and Crystal... **\$18.95**
R65/APN-9 LORAN Receiver-Indicator, complete with tubes and operating manual, BRAND NEW, export packed... **\$295.00**

SPECIAL APN-9 LORAN Receiver Indicator.
less tubes, NEW (demilitarized) **\$39.50**
BC1206-C BEACON RECEIVER
195 to 420 Kc. made by Setchel-Carlson. Works on 24-28 volts DC. 135 Kc IF. Complete with 5 tubes. Size 4" x 4" x 6". Wt. 4 lbs. BRAND NEW... **\$8.88**
Brand New, less tubes... **\$5.95**
BRAND NEW, less tubes... **\$5.95**
USED, with tubes... **5.95**
USED, less tubes... **2.95**

BC-221 FREQ. METER CASE
Aluminum case for BC-221 or TS-164 Freq. Meters. With volt. req. supply using VR105. 2 ballast tubes, relay, cable, etc. Inside front: 9 3/4 x 7 1/2 x 7 7/8". Inside rear, 2" deep. Shock-mounted.
BRAND NEW, (Add 50c for packing) **\$3.99**

Original Crystal for BC-221 1000 Kc. BRAND NEW. \$8.45
CARDWELL TUNING CONDENSER for BC-221 Freq. Meter. Massive precision construction, overall 4 x 3 x 3 1/4" 31 plates. Worm gear drive. **\$4.88**
BRAND NEW, special **\$4.88**
COMPLETE OPERATING MANUAL for BC-221 Freq. Meter **\$1.95**

BC-442 ANTENNA RELAY UNIT
Wonderful Value! Consists of 3/4 amp 2" RF Ammeter (antenna current indicator) 0-10 scale, Transmitter Receiver Switching relay, in aluminum case with associated components. BRAND NEW... **\$2.24**

don't be vague...

insist
on
SPRAGUE

ATOMS[®]



SPRAGUE

NORTH ADAMS, MASS.

always buy
RAD-TEL
for HIGHEST QUALITY
TUBES
at lowest prices



SAME DAY SERVICE—FULL YR. GUARANTEE. ALL TUBES INDIVIDUALLY BOXED FOR QUALITY, PERFORMANCE, DEPENDABILITY.

20,000 Ohms Per Volt
1 3/4" ROUND PANEL METER

0 to 50 Micro Amps
Model 321
Mfd. by Burlington Inst. Co.

25/8" diameter, 1 1/2" deep. Three mounting holes, sealed for protection against dust, moisture, etc. Scale calibrated 0 to .5. Use for VTVM, Field Strength Meters, S-Meter, etc.

\$425 each
Lots of 3, **\$395** ea.

ATTENTION! SCHOOLS
HOBBYISTS! RADIO TECHNICIANS
CATHODE RAY SCOPE TUBES

Made by SYLVANIA

3AP1 JAN1 Electrostatic focus and deflection medium 7 pin base. Individually cartoned! Packed for export. Regular net \$15.75. Individually packed 4 to a carton. Single 99¢ ea.

79¢ ea.
For lots of 4 (7 lbs. to cart. of 4)

FREE Tube & Parts Catalog Listing Over 400 High Quality Tube Types. Write Dept. RN-5
EXPORT INQUIRIES INVITED



Not Affil. With Any Other Tube Mail Order Co.

TUBE CO.

115 COIT ST., IRVINGTON II, N. J.



What's New
in Radio

PHAOSTRON V.O.M.

Phaotron Instrument and Electronic Company, 151 Pasadena Ave., South Pasadena, California is now in production on a new volt-ohm-milliammeter, the Model 555A.

The new test instrument offers meter movement protection up to 500 times overload. Designed for easier servicing and reliable performance, the 555A features only two jacks for all measurements, separate range and function switches, and an insulated zero adjustment. Forty-three unduplicated ranges provide a lower ratio of ranges for rapid measurements. The scales are large and are color-coded for clarity.

The unit weighs 2 pounds, 13 ounces and measures 4 3/8" x 6 1/8" x 2 1/8". It is housed in a non-magnetic steel case.

TRANSISTOR RADIO KIT

Superelex Electronics Corporation, 4-6 Radford Place, Yonkers, New York has added a "Trans-Atomic" transistor radio kit to its line of germanium diode, crystal, and one-tube receiver kits.

The kit features a matched transistor and diode, a calibrated slide-rule



dial, the company's "Loopstick," and an unbreakable palm-size plastic case. The set will operate for months on the power from the self-contained 10-cent flashlight batteries.

The kit is designed to be assembled in an evening with only a screwdriver required for the construction.

LIGHTWEIGHT SOLDER GUN

Hexacon Electric Company, 119 W. Clay Avenue, Roselle Park, New Jersey is currently introducing a new "instant solder gun" which features a 1/8" tip for the most critical soldering operations.

The smallest tip available on an instant solder gun, the new tool opens up a new field in this type of soldering. The gun is soldering-hot in a few seconds without the use of heavy transformers or fragile thermostats. The entire unit weighs 8 ounces. The special alloy "lifetime tip" cannot wear,

ASK FOR SPRAGUE BY
CATALOG NUMBER

Know what you're getting... get exactly what you want. Don't be vague... insist on Sprague. Use complete radio-TV service catalog C-610. Write Sprague Products Company, 51 Marshall Street, North Adams, Massachusetts.

DON'T JUST SAY
CAPACITORS
SAY

SPRAGUE[®]

WORLD'S LARGEST CAPACITOR MANUFACTURER



Willing to pay cash for Early
Phonographs with outside
horns

WANT Coronet (illustrated), Double Bell Wonder, Victor Types A, D, E, and O, Monarch Special and Improved Monarch. Also Edison Tin-foil (replica) machine, his Idelia, Excelsior, and Treadle Phonographs. Want early Bell-Tainter, American Gramophones, and Graphophones. Also catalogues or old literature on phonos made prior to 1906. Want unusual machines and coin-in-slot cylinder phonographs. Need a few early reproducers (sound boxes) for Victor, Columbia, and Edison.

A few duplicate Edisons
and graphophones are now
available for sale or trade.

Send clear snapshot and full information to
Box 50
RADIO & TELEVISION NEWS
366 Madison Ave., New York 17, N. Y.

corrode, or bend, thus eliminating tip maintenance.

Trigger control gives any degree of heat required without danger of overheating. The gun is especially recommended for printed circuits, subminiature assemblies, telephone, radio, and TV work. It is rated at 150 watts and is available for 120 volts. It will operate equally well on either d.c. or any cycle a.c. It is catalogued as the No. G148. Write the company for full details.

TRANSISTOR RECEIVERS

The *Regency Division of I.D.E.A., Inc.*, Indianapolis, Indiana has released two of its new transistor receivers in time to catch the beginning of the summer portable demand.

The new units are the TR-5 which measures 3½" x 5⅝" x 1⅝" and the TR-6, the company's deluxe model. The TR-5 uses the firm's new "Trans-

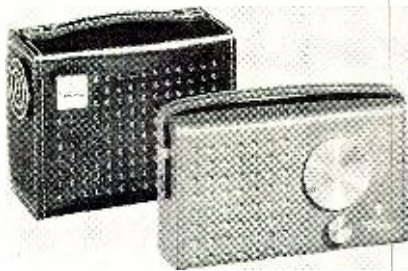

flex" circuit which permits up to ten times the audio output of other five-transistor radios. It comes in leather with copper trim. The TR-6 features a quality loudspeaker and uses flashlight cells for long battery life. It comes in a handsome black leather case.

Both of these units will be available in May. Write the company at 7900 Pendleton Pike for full details.

SUBMINIATURE SPEAKER

Lafayette Radio, 100 Sixth Avenue, New York 13, N.Y. is currently offering a new subminiature PM speaker which has been specifically designed for transistorized circuitry applications.

Measuring 1½" in diameter and only 15/16" deep, it is said to be the smallest PM speaker produced to date. Frequency range and audio output are in excess of requirements for miniature personal portable radios. The magnet is *Alnico V*. The voice coil impedance is 10 ohms. The total weight of the speaker is 1⅞ ounces. Mounting centers are 1-9/32" x 1-9/32".

A matching transformer, 2000 ohms to 10 ohms, measuring ⅝" x ⅞" x 11/16" is also available.

LOW-COST TV STATION

The Government and Industrial Division of *Philco Corporation*, 4700 Wissahickon Ave., Philadelphia 44, Pa. has announced the development of new low-power TV broadcasting "packages" which have been specifically designed to meet the needs of an estimated 800 small communities where TV has been unavailable because of

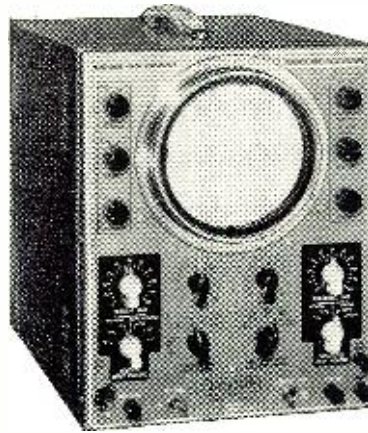

IT'S IDEAL FOR...

Color

JACKSON CRO-2 FIVE-INCH OSCILLOSCOPE

And, this Jackson scope has been good for color even before color standards were approved. For Jackson "Service-Engineering" wisely provided four years ago this wide-band, high sensitivity oscilloscope to answer the need for a good television instrument that would not become obsolete. Now provided with new probes (easily attached to older models) the Jackson CRO-2 is the ideal service oscilloscope, used by servicemen and manufacturers. If you're thinking of buying a 'scope, check these features.

Wide Band Amplifier—Flat within 1 db from 20 cycles thru 4.5 MC. This feature is absolutely essential for evaluating color burst signal and Chrominance signal.

Vertical Deflection Sensitivity—Two ranges with three positions for each range. Has fully compensated attenuators. Excellent transient response. Each unit completely tested for "hilt" and "overshoot."

Sensitivity Ranges—With a band width of 20 cycles thru 100 KC, the sensitivity ranges are .018, .18, 1.8 RMS volts per inch. The wide band position 20 cycles thru 4.5 MC has sensitivity ranges of .25, 2.5, 25 RMS volts per inch.

Internal Horizontal Sync.—Positive or negative signal is available to provide excellent stability due to using the best available component of the waveform, such as the leading edge of the horizontal sync. pulse of the standard TV signal. Reversing pattern vertically will not interfere with sync.

Horizontal Sweep Expansion—Four times screen width—up to 20 inches of equivalent width. This feature is excellent for enlarging any small portion of the total waveform. For example, the color TV sync. pulse can be spread to easily observe the 3.58 MC color burst signal so that the individual cycles can be clearly viewed.

Horizontal Deflection Sensitivity—Push-

pull horizontal amplifiers have a sensitivity for all applications of 0.40 RMS volts per inch.

Vertical Input Impedance—1.5 megohms, shunted by 20 mmf. Direct to plates balanced 6 megohms, shunted by 11 mmf.

Horizontal Input Impedance—1.1 meg.

Linear Sweep Oscillator—Saw tooth wave 20 cycles thru 50 KC per second in 5 steps. Sine wave sweep of 60 cycles also available. Provision for external sync.

Input Calibration—A standard voltage is provided to determine unknown voltages. Permits peak-to-peak measurements.

Vertical Polarity Reversal—By merely flipping a switch you can reverse the polarity of voltage to the vertical plates.

Return Trace Blanking—A new amplifier-timer combination for blanking return traces, providing a clearer, sharper image at all times. Prevents confusion in analysis.

Synchronizing Input Control—Four input control positions, Internal Positive—Internal Negative—External—60 cycle.

Deflection Plate Connections—Direct connections thru capacitors for AC only to deflection plates of CR tube by means of terminal block at back of instrument.

Intensity Modulation—Either 60 cycle internal intensity modulation or external intensity modulation through binding posts.

Accessories—Demodulation Probe, Model DEM-P available for using scope as signal tracing instrument. Low Capacity Cathode Follower Probe, Model LC2-1P with 2 to 1 attenuation ratio and not more than 8 mmf effective input capacitance. High Voltage Low Capacity Probe Model LC10-1P with 10 to 1 attenuation ratio for use up to 1,000 volts.

Model CRO-2 Oscilloscope...\$225.00, net
Model DEM-P Probe.....\$ 9.95, net
Model LC2-1P Probe.....\$ 19.95, net
Model LC10-1P Probe.....\$ 7.95, net

"Service Engineered"
Test Equipment



16-18 S. Patterson Boulevard, Dayton 2, Ohio • In Canada: The Canadian Marconi Company

100 TUBES \$49⁵⁰

TUBES PREMIER Unconditionally Guarantees All Tubes For One Full Year Very Best Brands Available For Immediate Delivery, Individually Boxed.

1A5GT	6A05	6U7GT	12SA7GT
1A6	6AT6	6UB	12SC7
1A7GT	6AU6	6V6GT	12SG7
1B3GT	6AU5GT	6V7	12SL7GT
1D8GT	6AU6	6W4GT	12SN7GT
1F5C	6AU8	6W6GT	12SQ7GT
1H5GT	6AV5	6X5GT	12Z3
1H6G	6AV6	6X8	14B6
1L4	6AX4GT	6Y6	14B8
1LA4	6AX5GT	7A5	14Q7
1LA6	6B4G	7A6	24A
1LC5	6BA6	7A7	25A6
1LC6	6BD6	7A8	25AC5GT
1LD5	6BE6	7AD7	25BQ6GT
1LH4	6BG6G	7B6	25CG6
1LN5	6BG6GT	7B7	25W4GT
1N5GT	6BQ6GT	7B8	25Z5
1P5GT	6BQ7	7C4	27
1Q5GT	6BY5G	7C5	32L7GT
1R5	6BZ7	7C6	35/51
1S5	6C4	7C7	35A5
1T4	6C5GT	7E5	35B5
1U4	6C6	7E6	35C5
1V	6C8G	7E7	35L6GT
1X2A	6C8B	7I7	35Y4
3A4	6CD8G	7L7	39/44
3B7	6DB	7N7	41
3C6	6DDG	7Q7	42
3Q4	6FDGT	7V7	43
3Q5	6GG	7W7	45
5U4G	6J6	7X7	46
5V4	6K6	12AT7	47
5Y3GT	6L6G	12AU6	50AX6
5Z3	6P5GT	12AU7	50L6GT
6A7	6Q7GT	12AV7	56
6A8GT	6S4	12AX4GT	57
6AB4	6SA7GT	12AX7	58
6AC5GT	6SD7GT	12AY7	58
6AC7	6SF5	12BA7	58
6AF4	6S17GT	12BD6	58
6AG5	6SH7GT	12BE6	58
6AH4	6SK7GT	12BH7	58
6AH6	6SL7GT	12F5GT	77
6AK5	6SN7GT	12J7GT	78
6AK6	6SQ7GT	12K7GT	117L7GT
6AL5	6S7	1307GT	117Z3
		158GT	117Z6GT

ANY ASSORTMENT — TAKE WHAT YOU WANT
5c Per tube extra for orders less than 100 tubes

NEW PICTURE TUBES

SIZE	PRICE	SIZE	PRICE
10BP4B	\$11.95	17LP4	\$21.95
12LP4A	\$13.95	17TP4	\$21.95
12UP4A		19AP4B	\$27.95
14BP4	\$18.95	19DP4B	\$27.95
14CP4		20CP4	\$26.95
16AEP4	\$17.95	20DP4	\$28.95
16AP4A		20HP4	\$28.95
16BP4A		21AP4	\$27.95
16EP4A		21EP4	\$28.95
16GP4A	\$19.95	21FP4	\$28.95
16JP4A		21MP4	\$29.95
16KP4	\$17.95	21WP4	\$27.95
16LP4A	\$19.95	21YP4	\$28.95
16RP4	\$17.95	21ZP4	\$27.95
16TP4		24CP4	\$49.95
16WP4A	\$19.95	27EP4	
17BP4A	\$17.95	27GP4	
17CP4	\$21.95	24AP4	\$59.50
17GP4		27NP4	
17HP4		27RP4	

ALL TUBES THROUGH 21" GUARANTEED 1 YEAR
24" AND 27" GUARANTEED 6 MONTHS
Aluminized tubes \$4.00 additional

RESISTORS \$1.49 PER HUNDRED 200 for \$2.50

All good values, sizes and types $\frac{1}{2}$ —1—2 watts
—20%—5%—10%—20% Precision—Insulated Carbon
—Carbon—Deposited Carbon.

SURPRISE KIT
10 lbs. Net of Reliable Radio and T.V. Parts—Each Kit includes a new Radio Cabinet—Good for 5 to 8 Tube Chassis. **\$1.98**

CAPACITORS

.001	600V	25 for \$1.25
1	400V	
40-40	150V	10 for \$2.39
120-50	150V	
10-10	450V	
60	150V	assorted

TUBE BRITENERS

89c each 10 for \$7.50

TERMS: 25% DEPOSIT with order, balance C.O.D. ALL shipments F.O.B. Chicago. ORDERS LESS THAN \$5.00—\$1.00 SERVICE CHARGE. These prices supersede all previously advertised prices, subject to change.

PREMIER TV Radio Supply
3239 W. North Ave.
Chicago 47 • ARmitage 6-3550

Write for **FREE** Bargain Catalog

the high cost of conventional equipment.

The "package" includes a transmitter, monitoring equipment, high-gain antenna, and transmission line, in addition to local program-originating facilities for the transmission of slides,



films, and local live shows. Even studio buildings and towers can be obtained in package form if desired.

The final power amplifier provides 150 watt peak visual power and 75 watt aural power output to the transmission line. The program-originating equipment consists of film and live camera chains, video monitoring and switching facilities, and audio facilities.

Those interested in obtaining full details on these station "packages" are invited to write the company direct.

COLOR SERVICE TOOL

Walsco Electronics Corporation, 3602 Crenshaw Blvd., Los Angeles 16, California has developed a new tool which speeds the servicing of all color TV receivers by enabling technicians to



make repairs, as well as use a high-voltage probe, with complete safety when the back of the set is removed.

Known as the "Color TV Interlock Cheater," the tool blocks the grounding of the set's high voltage supply to protect against costly tube damage while work is in progress. Made of high-dielectric polystyrene, the unit is now available at parts distributors.

RIGHT-ANGLE TUBE SOCKETS

Mounting tubes parallel to printed-wiring boards by means of right-angle tube sockets is the latest space-saving contribution of the Pacific Coast Division of Aerovox Corporation, 2724 S. Peck Street, Monrovia, California. The new tube sockets permit a worth-

while reduction in the height and depth of printed-wiring assemblies. The sockets are equally adaptable to hand- or machine-insertion methods. Terminals are of adequate length to slip into printed-wiring holes and be dip soldered. Silver-plated contacts provide non-fatiguing contact pressure with suitable insertion and withdrawal pressures.

These components are available in 7- and 9-pin sockets and in four different versions. Write the company for full specifications.

ULTRAMINIATURE ELECTROLYTIC

Barco, Inc., Box 1222, Milwaukee 1, Wisconsin has developed a new line of ultraminiature electrolytics which are especially designed for transistor equipment applications.

Now available in forty-two types, the capacity range is from .15 μ fd. to 160 μ fd. with voltage ratings from 1.5 to 70 volts. The units range in size from $\frac{1}{8}$ " to $2\frac{3}{4}$ " in diameter. These tiny units are hermetically sealed and are inherently low in leakage current. An operating temperature range of -30 degrees C to +60 degrees C is standard.

For complete data on the line, write Department RW of the company.

PORTABLE TRANSISTOR TESTER

The Semiconductor Product Division of General Electric Company, Elec-



tronics Park, Syracuse, N. Y. has developed a new, inexpensive portable transistor tester which will be of particular interest to radio and TV service technicians and hobbyists.

The new instrument is about the size of a pocket radio. It may be used to check all junction transistors for shorts, opens, leakage, and current gain. To simplify operation the meter has two scales, the lower scale for determining leakage which is divided into three large sections by different colors, and the upper scale which is used for checking current gain. This is accomplished by pushing a button on the tester deck and noting the amount of "needle jump."

Separate plug-in sockets are provided for n-p-n and p-n-p types. For full details and price, contact your nearest G-E tube distributor or write the company direct.

NEW HAM RECEIVER

Radio Mfg. Engineers, Inc., a Division of Electro-Voice, Inc., Buchanan, Michigan is now offering a new amateur communications receiver, the RME 4300.

One unique circuit feature of this

RADIO & TELEVISION NEWS

new receiver is the provision for injection control of the beat frequency oscillator. This is particularly useful for c.w. and SSB reception. The large,



evenly graduated, illuminated dial covers all six amateur bands from 1.76 mc. to 29.8 mc. Plates in the tuning capacitor are triple-spaced to reduce drift and microphonics.

The receiver is housed in an instrument-gray metal cabinet which measures 10" high, 16½" wide, and 10" deep. A detailed description of this receiver is contained in Bulletin No. 240 which is available without charge from the manufacturer.

TRANSISTOR PACKAGE

Sylvania Electric Products Inc., 1740 Broadway, New York 19, New York has packaged two of its type 2N35 transistors and one of its 1N34A general purpose crystal diodes which are being marketed at a special price of \$4.95.

Accompanying the kit is a copy of the firm's booklet covering 28 uses for such junction transistors so that the electronics experimenter or hobbyist may build up transistor circuits to gain the requisite experience with this type of component.

The box in which this material is housed carries the ratings and characteristics of the firm's transistors. Purchased in this form, the buyer saves \$4.65 over the list price of the individual items.

ENLARGER-TIMER KIT

Heath Company of Benton Harbor, Michigan has just released a kit which

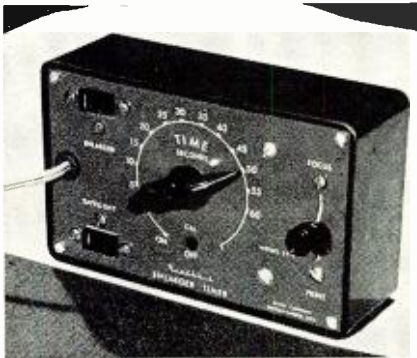

both camera fans and electronic hobbyists will find of interest.

The Model ET-1 is an all-electronic timer that automatically controls a photo enlarger exposure time. The

dial is calibrated from 5 to 60 seconds and the timing cycle is initiated by merely moving the spring-return lever switch to "print". As it turns the enlarger "on", it also turns a safelight off. The enlarger and safelight plug into receptacles on the front panel of the timer. An internal relay handles up to 350 watts.

Further information on this new kit is available from the company.

PHOTOCONDUCTIVE CELL

Clairex Corporation, 50 West 26th Street, New York 10, New York has recently announced the availability of a new and improved cadmium sulphide photoconductive cell, the Type CL-2.

The new unit, a successor to the firm's Type CL-1, has the same physical size and shape of its predecessor but features metallic electrodes soldered directly into the crystal, a special ceramic piece having the same temperature coefficient of expansion as the crystal as a base for mounting the crystal, and the elimination of all plastic that might come in contact with the crystal.

Current through the CL-2 is substantially linear with voltage over the entire range and down to zero volts. It is also substantially free from noise and is considerably more stable with respect to time and temperature than its predecessor.

Write the company for a copy of its

Just Out

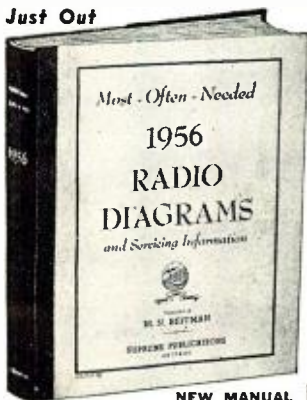

NEW MANUAL

Be prepared to repair quickly all new 1956 radio sets. In this big volume you have easy-to-use, large schematics, needed alignment data, replacement parts lists, voltage values, and information on stage gain, location of trimmers, and dial stringing, for almost every 1956 radio. Includes auto radios, portables, changers, and all types and makes of home sets. Giant size, 8½ x 11"; manual style, sturdy binding. Price, only \$2.50

New SUPREME 1956 Radio Manual

Now you can benefit and save money with Supreme amazing scoop of 1956. This one giant volume has all the service data you need on all recent radio sets. A full year of models of all popular makes, home and auto sets, portable radios, combinations, changers, all included. The full price for this mammoth 1956 manual is only \$2.50, nothing else to buy for a whole year. Other Supreme radio service volumes for previous years (mostly at \$2) are described below. Separate TV manuals are listed at right.

SUPREME RADIO MANUALS FOR PREVIOUS YEARS

Use Supreme manuals to repair all radios faster, easier; save time and make more money. Here is your lowest-priced service data. Covers all years, from 1926-38 to 1956 models, in 16 volumes. Used by 174,000 shrewd servicemen. Most volumes only \$2 each, see coupon. Average volume 190 large pages, 8½ x 11 inches. Quality printing, easy to use, manual-style binding. Amazing values. Be wise, use these manuals to get all needed diagrams, parts lists, alignment facts, and service hints, at the smallest cost. Send no-risk trial coupon today. →

SUPREME TELEVISION SERIES

Here is your complete source of TV service data at lowest prices. Supreme manuals at only \$3 each are amazing bargains and defy competition. Each annual manual covers a whole year of models, using original factory material. Include giant double-spread circuits and blueprints, alignment procedure, voltage charts, wave forms, factory revisions, and helpful service hints. Select volumes from list below and send no-risk coupon.



1956 TV Manual. New, giant volume of TV factory data. Complete, only \$3
 1955 Early TV, \$3
 1955 Late TV, \$3
 1954 TV Manual, \$3
 1953 TV Manual, \$3
 1952 TV Manual, \$3
 1951 TV Manual, \$3
 1950 TV Manual, \$3
 1949 TV Manual, \$3
 1948 TV Manual, \$3

NO-RISK TRIAL ORDER COUPON

SUPREME PUBLICATIONS, 1760 Balsam, Highland Park, ILL.

Radio Diagram Manuals

- 1956 Radio Manual, \$2.50
- 1955 Radio Manual, only \$2
- 1954
- 1953
- 1952
- 1951
- 1950
- 1949

THIS GROUP ONLY

- 1948
- 1947
- 1946
- 1942
- 1941
- 1940
- 1939
- 1926-1938 Manual, \$2.50
- Radio and TV Master Index, 25c

\$2 EACH

Rush today Radio manuals checked at left and TV manuals below. Satisfaction guaranteed.

- New 1956 Television Service Manual, only . . . \$3.
- Additional 1955 TV, \$3. Early 1955 TV, \$3.
- 1954 TV Manual, \$3. 1953 TV Manual, \$3.
- 1952 Television Manual, \$3. 1951 TV, \$3.
- 1950 Television Manual, \$3. 1949 TV, \$3.
- 1948 TV, \$3. 1947 TV & FM, only \$2.
- New Television Servicing Course, complete . . . \$3.

- I am enclosing \$ Send postpaid.
- Send C.O.D. I am enclosing \$ deposit.

Name:
 Address:

TELEVISION SERVICING COURSE

Let this new course help you in TV servicing. Amazing bargain, complete only \$3, full price for all lessons. Giant in size, mammoth in scope, topics just like a \$200.00 correspondence course. Lessons on picture faults, circuits, adjustments, short-cuts, UHF, hints, alignment facts, antenna problems, troubleshooting, how to use test equipment, fault-finding picture analysis. Special, only \$3



Supreme Publications
 Sold by All Leading Parts Jobbers

HARVEY has it... FOR IMMEDIATE DELIVERY



W3DZZ ANTENNA

- 5 Bands
- Single Antenna
- Single Feed Line

Model FT-200

SET OF TRAPS For 5-Band Wire Antenna

10, 15, 20, 40 and 75/80 Meters • 75 Ohm Twin-Lead or Coax Feed Line • Concentric Coil and Condenser Completely Potted in Polyester Resin • High-Voltage Polystyrene Insulation on Concentric Capacitor

Pair.....\$1295

Model FT-100 BEAM ANTENNA

Parasitic Array for 10, 15 and 20 Meters • 55 lbs. • 28 ft. Elements • RGSU Feed Line

Complete.....\$19500

4 mfd. 600 V \$195
OIL CAPACITORS

each just the thing for audio crossovers or filter use.

VOCALINE

**RADIO
TRANSCEIVER**
Model
JRC-400

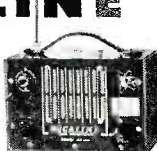

First really low-priced 2-way radio available. Provides satisfactory communication at a distance of 10 miles or more — depending on location and terrain. Amplitude modulated radio telephone operates on fixed frequency of 465 megacycles (Citizens Radio Band). RF power input is 2 watts; power output is 1/3 watt. Power supply operates on any 115 volt AC outlet or a 6 volt DC power source. Tubes: 6AV6, 6AF4, 6AS5. Weight: 4 lbs. Dimensions: 9"x6"x5". FCC approved.

Single unit, complete with mike.....\$6975
Pair.....\$139.50

FLORAC Pocket FM Receiver



Smaller than a Pack of Cigarettes • 2 Models • 114-144 Mc. or 144-162 Mc. • Two Tubes plus New Crystal Crystonic Power Multiplier Circuit

Complete with self-contained hearing-aid-type batteries and earpiece.....\$3450

**RADIO
SPECIALTIES '3 BANDER'**
20-15-10 METERS
1 TRANSMISSION LINE

Switches 3 Bands in Seconds • Uses Most TV Rotators • Exclusive Swing-A-Boom Permits Rotation of Boom and Elements in Vertical or Horizontal Planes • Tuning Adjustments Possible from Tower • 16 ft. Boom • 28 ft. Elements • Weighs 38 lbs. • 52 Ohm Match • 61 ST 6 Aluminum Elements

Complete.....\$13995

HARVEY ships everywhere in the world.
All orders shipped same day received.

Prices Net, F.O.B., N.Y.C.
Subject to change without notice



ESTABLISHED 1927
**HARVEY RADIO
CO., INC.**

103 W. 43rd St., N. Y. 36, N. Y. • JU 2-1500

new booklet giving complete electrical and mechanical specifications on the cell.

CRYSTAL CALIBRATOR

The availability of a compact, low-cost crystal calibrator with a usable range to approximately 55 mc. with check points every 100 kc. has been announced by *Hammarlund Manufacturing Company, Inc.*, 460 West 34th Street, New York, New York.

The new XC-100 crystal calibrator is designed as a frequency standard



for use in communications receivers. Special kits are provided for the company's HQ-140-X and SP-600 receivers. The new calibrator employs a hermetically-sealed military type 100 kc. quartz crystal oscillator and a 6BZ6 pentode, operating in an efficient circuit which results in effective output every 100 kc. A trimmer provides adjustment for zero beat against a primary frequency standard such as WWV.

Write the manufacturer for full details on this unit.

MOBILE RADIO CHECKER

The *Hickok Electrical Instrument Co.*, 10534 Dupont Ave., Cleveland 8, Ohio has recently released a new universal, all-band microvolt and crystal-controlled generator which has been specifically designed for complete cov-

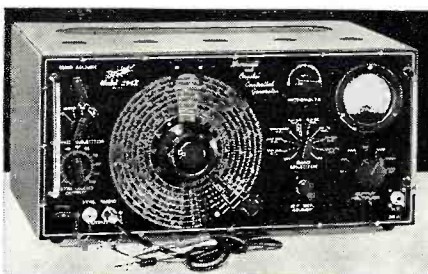

erage of mobile and aircraft frequencies on fundamentals.

The Model 295X permits the sensitivity, selectivity, and frequency of the receiver to be determined accurately without the use of correction factors or reference tables. The instrument features an unusually wide range of frequencies both variable and crystal controlled, a wide range of output voltages accurately metered, and stability of frequency and amplitude adjustment as well as calibrated r.f. output level as low as .1 microvolt.

TUNERS CONVERTERS

CRYSTAL CONTROLLED
POLICE • FIRE • CIVIL DEFENSE



- ✓ Precision—Stability
- ✓ Sensitivity
- ✓ Easy installation

only \$29.50 net

• A compact converter supplied with commercial tolerance crystals, made to your exact frequency requirements. Furnished with tubes and crystal.

A practical low cost converter suitable for 30-50 or 6 meter band. Net \$18.50.

VARIABLE TUNERS

Improved AM-FM
now available for
26 through 170MC
in 3 types
from \$22.50



12 WATT
MOBILE PA
AMPLIFIER

CIVIL DEFENSE, POLICE, FIRE

An extremely compact and durable 12 watt amplifier for 6 and/or 12 volts. 2 inputs, one mike, one phono. 2 output connections. 6 volt model list \$97.50.

WRITE FOR LITERATURE

KAHN ELECTRONICS

20 GLENWOOD CINCINNATI 17, OHIO

SURPLUS SCOOP

BRAND NEW 80 METER COMMAND
TRANSMITTER PLUS
TREMENDOUS BONUS

YOUR OPPORTUNITY TO OWN THE MOST VERSATILE SURPLUS TRANSMITTER AT AN ALL-TIME LOW PRICE AND GET THIS FREE BONUS.

You Get:

- 1 BRAND NEW 3-4 MC COMMAND XMTR COMPLETE W/ALL TUBES AND CRYSTAL.
- 1 24 VOLT 1.5 AMP FILAMENT XFORMER. COMPLETE SET OF SPARE TUBES 2-1625; 1-1626; 1-1629. ALL NEW AND BOXED.
- Transmitter Plus Bonus Only \$9.50 Complete Or Take 3 Plus 3 Bonuses For \$25.00

- ARC-5 Transmitters-New—4-5.3 MC Complete.....\$6.95
- 5.3-7 MC (Single Side Band Conversion).....\$6.95
- UHF ARC-5 Receiver—R-28 (100-156 MC) Good Cond. w/all tubes.....\$9.95
- Modulation Transformer—(Made for Collins Radio by Chicago) 20 watts PRI. Z, 6000; SEC. Z, 6000—8KV test. Cased, Potted, 8 1/2 x 2 1/2 x 2.....\$1.95; 3/\$5.00
- Stancore Voltage Regulator P6248—Input 65-145 V. Output 115 V.—50-60 Cy. 500 watts. Enclosed-Metered, Cable and Receptacle self contained. 5 3/4 x 4 3/4 x 4. New—At a fraction of regular cost.....\$14.95
- ARR-1 UHF Recvr w/all tubes. Conversion data—New.....\$1.95
- Sensitive Micro-Ammeter 0-50 Micro AMP. D.C. 2 1/2 Hermite Seal. JAN type—Brand New \$5.95
- National Transmuting Variable Condenser. Brand New—Boxed #TMC—250—250 MMFD—3KV—Worth \$14.00.....\$2.95
- Panel Typed Frequency Meter—Dual Range—48-52 and 58-62 Cycles 100-130 V.—Mfg. Biddle.....\$14.95
- Tube Type 1625—New—Boxed—Dozen.....\$2.25
- Tube Type 6C4—New—Boxed.....\$0.39; 3/\$1.00
- Filament Xformers—115 Volt—60 Cy—PRI T-1 5.0 VCT—13.0 AMP—Thordarson—T19F85—New.....\$2.95
- T-2 24.0 V. 1.5 AMP Philco—Open Frame—Complete.....\$1.95
- T-3 5.0 V. 4. AMP Thordar. Cased. Small.....\$1.79; 3/\$5.00
- T-4 2.5 VCT 2.5 AMP Thordar. Cased. Small.....\$1.79; 3/\$5.00
- B/TUB Condenser—1 MFD.—1500 VDC—Side Term.—CB—New.....\$0.12 quantity

REX RADIO SUPPLY

88 Cortland Street New York 7, N. Y.

For complete specifications on this test instrument, write the company for literature.

NEW MOBILE MIKE

Motorola Communications & Electronics, Inc., 4501 West Augusta Blvd., Chicago 51, Illinois has developed a transistorized dynamic microphone for mobile radio applications.

The microphone features a rugged,



specially-designed dynamic element employed in conjunction with a built-in transistor preamplifier. The transistor preamplifier, an integral part of the microphone, boosts the dynamic output to conventional transmitter input level, eliminating the need for preamplification at the transmitter. This technique is said to overcome the noise pickup problem inherent in mobile installations.

Full information on this new component is available from the manufacturer direct.

SNAP-IN CONTROL

A self-supporting, snap-in variable resistor for printed wiring applications has been announced by the Electronic Component Division of Stackpole Carbon Co., St. Marys, Pa.

This control, known as the Type LR-70, measures only 57/64" diameter

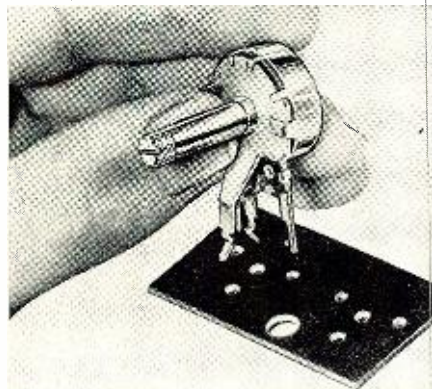

and stands 7/8" off the mounting board. It is supported by four legs, the three regular voltage taps and a larger case ground leg. No mounting hardware is required since the legs merely snap into the printed wiring board to form a strong support. Terminals are heavily tin-lead coated for fastest soldering with dip solder techniques.

Specifications and dimensions on this new component are available on letterhead request to the manufacturer.

-30-

May, 1956

Always insist on

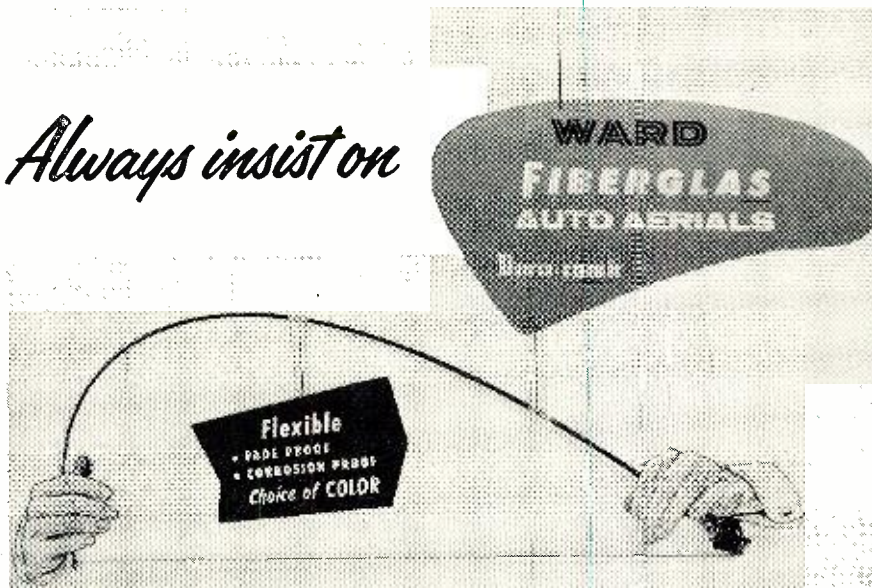

WARD AUTO AERIALS...

FOR ★ Top quality

**★ Customer acceptance
for over 20 years**

★ Reliable performance

★ Easiest installation

For every radio installation you make, a WARD AERIAL tops it off with the most dependable, acceptable and popular antenna you can buy... yet it costs no more than an ordinary aerial.

Here's the *complete* top-quality line for every requirement:

- EIGHT BALL—ever-popular favorite
- MAJORETTE—the economy model
- PHANTOM—disappearing antenna
- TWIN REAR MOUNT—midget 8-ball twins
- MIDGET PHANTOM—twin rear mounts
- SKY QUEEN—smartly styled side mount
- LONG RANGER—longer, for extra signal
- CONTINENTAL—flex-angle side mount for all foreign cars
- DURA-RAMIC®—the original Fiberglas aerial in full colors to complement the car.
Can't fade, rust, warp, break or corrode.

Order your WARD AERIALS now. Keep a few on hand all the time. Keep your customers satisfied with the... **World's Finest!**

WARD

PRODUCTS CORPORATION
DIVISION OF THE GABRIEL CO.

1148 EUCLID AVE.

• CLEVELAND 15, OHIO

CRYSTAL MICROPHONE ELEMENT

Crystal element mfd. by Brush Develop. Co. Excellent fidelity. Each element indiv. tested. Suitable for Ham use, PA systems, home recorders or any sound recording or transmission.
Size: 1 1/8" Sq. Make your own microphone.
98c

SMALL PIONEER GENEMOTORS

Ideal for Amateur or Commercial Service 5.5 to 6 volt DC input—output 400 volts at 1 1/2 MA. cont. or 275 MA intermittent duty. Comes complete with A & B filters, RF hash filter & internal cooling fan.....each \$19.95
Same as above—with 11.5 to 12 volt DC input.....each \$12.95

1" MINIATURE METER

High quality meter made by International Instrument Co. Mounts in a 1" hole like a pilot light. Basic movement 0-10 milli. Can be shunted to any milliamp range.
0-10 Mill. Special.....\$2.95

DYNAMOTOR STARTING RELAY

12V DC coil. Solenoid type fully enclosed. Will easily handle 50 amps. Contacts and winding isolated from ground.....ea. \$1.75
2 for \$3.00

WESTON 1 1/2" MINIATURE METER

MODEL 1011—A fine meter suitable for compact grid dipper, field strength, or other applications. 0-500 Microamps.....ea. \$4.50

ALLIED 110 VAC 60 cy RELAY, 4 Pole D.T. Contact pure silver.....\$1.75
NATIONAL EMC 250 VARIABLE COND. Steatite insulation 250 MMF.....1.25 ea.

G. E. RELAY CONTROL

(Ideal for Model Controls, Etc.) Contains a sigma nidget 8,000 ohm relay (rips at less than 2 MA), high impedance choke, bi-metal strip, neon pilot and many useful parts. The sensitive relay alone is worth much more than the total
low price of... \$1.25 ea. 10 for \$9.90

SENSITIVE RELAY

5000 ohm coil operates on 1 ma. adjustable contacts, adjustable contact tension. ADJUST base. Ideal for model work. Can also be used on AC. Draws.....ea. \$1.75
4 mill AC @ 110 V. Ideal for burglar alarm.....5 for \$7.50

UNIVERSITY MM2 SPEAKER

Weatherproof and waterproof reflex type speaker. Many industrial and commercial applications. Capacity 15 Watts, Impedance 16 ohms.
List \$40.00. OUR PRICE.....\$15.95

OIL CONDENSER SPECIALS BRAND NEW

25 MFD 350 VDC \$1.25	10 MFD 1400 VDC 2.50
2 MFD 600 VDC .50	1 MFD 2000 VDC .95
4 MFD 600 VDC .75	1 MFD 2000 VDC 4.50
6 MFD 600 VDC .85	2 MFD 2000 VDC 3.50
8 MFD 600 VDC .95	1 MFD 3000 VDC 1.85
10 MFD 600 VDC 1.10	1 MFD 3000 VDC 2.25
12 MFD 600 VDC 1.50	5 MFD 330 AC .95
2 MFD 1000 VDC .85	5 MFD (1000 DC) .95
8 MFD 1000 VDC 1.50	20 MFD 330 AC 2.50
1 MFD 1200 VDC .45	8 MFD 660 AC 2.50
2 MFD 1500 VDC 1.10	(2000 DC) 2.35
6 MFD 1500 VDC 1.95	

NEW PANEL METERS

G.E., WESTINGHOUSE, W.E., SIMPSON, etc.	
1" METERS	0-150 MA RF
0-1 Mill 3.95	Int. Thermo. 3.49
1 1/2" 0-5 Amps R.F. with ext. Thermocouple 3.95	0-4 Amps R.F. 3.49
	0-9 Amps R.F. 2.95
3" METERS	
0-100 Microamp \$3.95	0-1 1/2 Milli. 3.95
0-5 Amps DC 2.95	15-0.15 Milli. amps 3.95
0-10 Amps AC 2.95	0-50 Milliamps 3.95
0-35 Mill AC 2.95	0-1 Milli (Basic) 3.95
0-200 Mill AC 2.95	0-300 Milliamps 3.95
10-0.10 Amps DC 2.95	0-500 Milliamps 3.95
0-15 Volts AC 2.95	0-15 Amps DC 2.95
0-300 Volt AC 3.95	0-10 Mill AC 3.95
- 10 to + 60B 3.95	0-5 Amps AC 3.95

SHIELDED CHOKES

12 Henry 150 Ma.....\$1.65
Thorndarson 15 Henry 200 Ma.....2.25
6 Henry 300 Ma.....2.95

TURNER DYNAMIC MICROPHONE

Model 22D—200 ohm imp. Freq. response 10-9000 cy. Complete with desk stand and shielded cord. BRAND NEW.....\$14.95

METER SPECIAL

3 1/2" Sq. Bakelite cased meter. Scale 0-150 MA. Basic 0-1.5 MA. We supply shunt wire.....ea. \$3.45

Read 'n' Save Bargains

500 MMF CERAMIC CONDENSERS.....10 for \$5.50
150 MMF Var. Cond. micalex insul. db. SANGAMO PZL .001 5000 VOLTS WORKING—FRANKSMITH MILCA CONDENSES......75
25 WIRE WOUND RESISTORS in KIT.....1.95
.01 MMF 1000 VDC MICAS......5 for .95
.0004 2500 VDC MICAS......5 for .95
.025 600 V. MICAS......5 for .95
100,000 OHM, 100 WATT RESIST......75 ea.
RELAY 8 VOLT DC DPDT.....\$1.25 ea.
RELAY 12 VOLT DC DPDT.....\$1.25 ea.
1 MFD Oil Condenser 400 VDC.....25c ea. 10 for 2.00

All merchandise sold on a 10 day money back guarantee basis

Min. Order \$3.00—25% with Order—F.O.B. New York

PEAK

ELECTRONICS COMPANY

66 W. Broadway, New York 7, N.Y., WO-2-5439



CBS SALES DISC

CBS-Columbia, 3400 47th Ave., Long Island City 1, New York is now furnishing an unbreakable seven-inch disc to its distributor salesmen to help promote the sale of television and radio receivers.

The disc contains sample broadcast commercials by Arthur Godfrey, Amos and Andy, Bing Crosby, Tennessee Ernie, and Edgar Bergen and Charlie McCarthy.

When the salesman calls on a dealer, he can whip out the record, put it on a player, and let these popular entertainers go into their commercials prior to making his own sales pitch.

BATTERY PROMOTION

General Dry Batteries, Inc., 13000 Athens Avenue, Cleveland 7, Ohio is now offering a consumer-tested display-dispenser which takes up less than one foot of counter space yet merchandises four different batteries for the photographic market. This display handles "AA," "C," "D" and "B-C" battery units.

The company is also offering a four-page brochure which covers its line of



merchandiser, a flashing window-display unit that utilizes light and color to attract buyers, a new battery "Select-o-Meter" that permits portable set owners to determine automatically the replacement batteries required for their receivers, a spiral-bound ready reference guide for battery data, a pair of attractive window posters, assorted advertising mats for newspapers, and spot scripts for radio and television.

G-E "CIRCUS" PROMOTION

General Electric Company's Tube Department, Schenectady 5, New York has developed a unique and colorful distributor and dealer promotion pro-



gram which is known as a five-ring "Circus of Values."

The "Circus" includes a series of display cards, point-of-sale promotion cards, mailers, and other sales-getting materials.

Write the company or contact local G-E tube distributors for details on this promotion.

NEEDLE MERCHANDISERS

Recoton Corporation, 52-35 Barnett Avenue, Long Island City 4, N. Y. is currently offering a four-page brochure that lists a complete line of sales aids for merchandising its line of needles.

Form #5602 lists counter displays, storage and merchandising cards and cabinets, window streamers, inventory and order forms, service manuals, display cards, and envelope stuffers of various types.

Copies of this catalogue will be forwarded without charge upon request.

SNYDER SEAL

A newly-designed, oval-shaped 25th anniversary seal has been adopted by

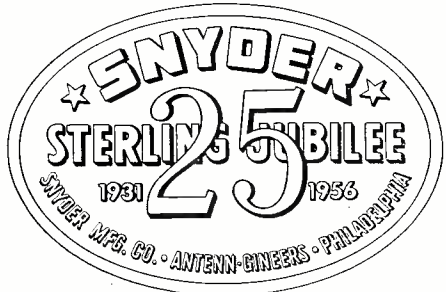

Snyder Mfg. Co. of Philadelphia which will be used on all of its communications throughout 1956.

The seal, embossed on silver foil, sets the theme for the company's an-

RCA BATTERY PROGRAM
A comprehensive sales-promotion program for its line of batteries has been developed by the Tube Division of Radio Corporation of America, Harrison, N. J. to aid distributors and dealers in merchandising these components.

The plan includes an extended payment program, attractive buying benefits, and technical selling tools, all backed up by the most extensive advertising and merchandising programs in the industry.

To support the program, the company has prepared a sturdy counter

niversary celebration year. The company's line of auto radio and television antennas, "Bumper-Jax", and other auto accessories will receive the "anniversary" treatment.

* * *

POINT-OF-SALE DISPLAY

All Wire Metal Products Co., 1627-45 North American Street, Philadelphia 22, Pa. has added a new display rack to its line of point-of-sale merchandisers.

The new unit is available in either chromette plated finish or black paint finish. It comes knocked down for shipping and storing but is easily assembled.

For details on this and other racks in the company's line write to Fred Podolsky at the company and refer to File #110.

* * *

CLEAR BEAM SALES AIDS

In line with its expanding consumer merchandising program, Clear Beam TV Antenna Co., P. O. Box 471, Canoga Park, California has prepared a five-page brochure cataloging a wide variety of newspaper mats and other promotional aids which the company has prepared for jobbers and dealers. The brochure is prepared in such a way that new pages may be added as new promotional material is available.

One of the visual sales aid presentations available from the company is a booklet "How to Pay Your Rent with a One Minute Sales Promotion!" included in this presentation is a merchandising program covering the company's "do-it-yourself antenna kits." This material is available as a separate booklet.

-30-

V.O.A. PROGRAM FOR HAMS

THE U. S. Information Agency has announced a new special weekly program for the world's radio amateurs. Each Saturday at 1:45 p.m. (EST), the "Voice of America" will carry a 15 minute program of information and entertainment.

Bill Leonard, CBS radio and television personality and operator of his own station (W2SKE), will narrate the program and supply facts on new equipment and operating techniques, announce forthcoming events of interest to hams, forecast atmospheric conditions, and interview experts in the communications field.

The program will be carried by the V.O.A. on 17,830, 15,280, 15,200, 11,870, and 11,790 kc. It will be carried by the "Voice's" Munich relay station on 7235 kc. and will be transmitted on 11,890 and 950 kc. by the "Voice's" Tangiers relay station.

J. R. Poppele, who heads the "Voice of America" and who first received his own amateur call letters 45 years ago, described the new program series as "of, by, and for the radio hams of the world."

Hams are invited to listen for this new program. Comments, suggestions, and reception reports can be forwarded to the U. S. Information Agency, Washington 25, D. C. All pertinent data should be included, ala a QSL card, to provide maximum service to the V.O.A. in planning future programs and keeping transmission standards high.

-30-

Costs only \$29.95 Slightly higher in West

QUICKLY PAYS FOR ITSELF MANY TIMES OVER!

"Hard to Find"

TUBE FAULTS LOCATED FAST!

Truly Portable!
6½" x 6½" x 2½" — 4 lbs.
Carry in Tube Caddy.



MODEL GCT-5

SECO

GRID CIRCUIT TUBE TESTER

NOW WITH EXPANDED TUBE LIST FOR UP-TO-DATE TV & INDUSTRIAL TUBE TESTING

The SECO GCT-5 TESTER is a specialized TV and industrial instrument that checks the critical "Control Grid" condition of vacuum tubes faster and more accurately than any other tester. Thousands of technicians have stopped guess-

ing and substitution checking . . . depending upon the SECO-EYE to indicate control grid emission, grid-to-cathode shorts, gaseous conditions, cathode-to-heater shorts AT A GLANCE!

IN TV SERVICING . . . the SECO GCT-5 TESTER quickly tracks down troubles like these:

- Poor picture contrast
- Grainy picture
- Twisting, bending or pulling of the picture
- AGC, RF, IF and Sync. group tube faults
- Vertical jitter or bounce
- Sync. buzz in the sound
- Sweep frequency drift
- Any or all symptoms caused by sync. plus compression.

You'll save service time, sell more tubes, improve customer relations! Join the thousands now using this indispensable SECO TESTER to do a better service job and to make bigger tube profits.

SECO serves the serviceman RIGHT with tested, indispensable instruments



SECO

Model FB-4
FLYBACK CIRCUIT
AND INDUCTANCE
ANALYZER

\$38.95
Slightly higher West

Requires no disconnecting, no charting; gives a fast, simple 'yes' or 'no' answer at a glance.



SECO

Model SL-10
MONITRON
SIGNAL TRACER
AND INTERMITTENT
LOCALIZER

\$119.50

The solution to your troublesome INTERMITTENT problems . . . monitors circuits without attention!

SOLD THROUGH JOBBERS



The Original is spelled "S-E-C-O"
SECO MFG. CO.

Phone: WAInut 6-4545
5015 PENN AVENUE S.
MINNEAPOLIS, MINN

Your Partner for Profitable Installations . . .

TELCO VHF-UHF ANTENNAS and your TELCO Distributor!



BRING YOU THE MASTERLINE CONICAL ANTENNA ALL ALUMINUM!

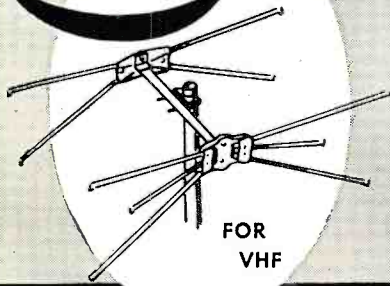

FOR
VHF

ALUMINUM CROSS ARM—high Tensile Alloy.
UNBREAKABLE INSULATOR—made of Styron.
DOWELED ELEMENTS—doweled with 6" dowels, 3/8" diameter, closed end aluminum elements.
DOUBLE LIFE AGAINST RUST . . . zinc plated and dicromate dipped insures long-lasting protection.
CROSS BAR ASSEMBLED . . . insures fast installation.
ALL CHANNEL COVERAGE engineered for peak reception.

No. A-8700-8S	8-Element 1-Bay
No. A-8700	10-Element 1-Bay
No. A-8702-8S	8-Element 2-Bay
No. A-8702	10-Element 2-Bay

TELCO ELECTRONICS MFG. CO.

Division of General Cement Mfg. Co.

919 Taylor Avenue, Rockford, Illinois

FREE COPY . . . Telco "Supermarket" Catalog. Send postcard today!



Telco
Roto-Indoor
Antenna
No. A-9263

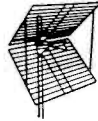

Telco
Deluxe Corner
Reflector
No. A-8984



Telco UHF
10-Element
Golden
Yagi No.
A-320



With such a wide variety of TELCO Antennas to choose from, you can be sure of profitable installations regardless of distance or location. Your nearby TELCO distributor will be glad to show you the complete TELCO line.

SEE US . . . BOOTH 590—ROOM 612—PARTS SHOW

Realistic High-Fidelity

(Continued from page 47)

verberation. Acoustical tiles will help in both ways, although sound insulation between rooms and from external noise should have been incorporated when the building was erected. Subsequent treatment for reducing reverberation can be calculated for tiles by using this formula:

$$t = \frac{.049V}{(-2.3 \log_{10} (1 - a))S}$$

where t is the reverberation time in seconds, V is the volume of the room in cubic feet, a is the absorption coefficient of the tiles, S is the surface area of the walls and ceiling (and the floor if not completely carpeted). V being fixed, since the room exists, the formula gives the area of tiles required to reduce the reverberation time to any desired figure.

As the absorption varies with frequency and as the reverberation period varies with room volume, the determination of absorbing area must be a matter for your personal taste. As I mentioned before, a completely dead room lacks the life needed for pleasant musical reproduction, so if you have overdamped, then the sound from the speaker must be diffused by suitable reflectors. This is regularly done in recording and broadcasting studios, for with the varying types of sound to be recorded or broadcast, conditions must be varied to suit the requirements of the control engineers. Suitable reflectors can be either flat or convex but not concave, since these focus sound, just like the concave reflector of an automobile headlamp focuses the light from the bulb. In studios the flat or convex reflectors are frequently mounted on pivots so that reflection can be controlled as desired. This elaboration is not needed for home listening; all you should consider is the avoidance of concave surfaces. If your listening room is L-shaped much better diffusion will be secured if the outer corner of the "L" is faced off with a diagonal panel set across it. If your room is long and narrow, a similar panel set across the angle between the ceiling and the wall farthest from the speaker will help to ensure a better mean sound distribution. All corners filled with convex moldings will help; the normal concave plaster coves on ceilings detract.

Naturally the position and direction of the speaker will determine to a great extent how the sound is ultimately distributed. Most speakers focus the highs, and speakers which focus severely may sound best by having the front covered with a slotted board, as mentioned in Part 1. This particularly applies to speakers which have an unduly large output at 2000 to 3000 cps (a common fault), for frequencies of this order don't seem to fit the absorption curves of tiles.

(To be continued)

E-Z WAY TOWERS

Looking for a tower that is easy to erect yet strong enough to withstand severe winds? This is it! E-Z Way Towers will stand a wind load of 40-60 lbs. per sq. ft. And with the new E-Z Way portable gin pole it's easy to erect a 120 ft. tower in one piece **without leaving the ground**. Unbelievable, isn't it? But E-Z Way Towers have been tested and proven. Thousands of E-Z Way Towers are giving outstanding service in all parts of the country and abroad. That's why E-Z Way is the Industry's New Leader. Find out about E-Z Way now!

SEND TODAY FOR
FREE CATALOG

Dept. CN
E-Z WAY TOWERS
P. O. Box 5491, Tampa, Florida

Send me your FREE catalogue on the following towers:

AM Radio Television
 Ham Radio Two-Way Communication

I am interested in a towerft. high.
I will use a antenna.
(State type and model)

Type of Rotor
Name
Address
City State

E-Z WAY TOWERS Inc.
P. O. Box 5491 • Tampa, Fla.
Telephone 4-2171

THE NEWEST!

Rebel
K-3

**CORNER
SPEAKER
CABINET KIT**

kitform of the original
corner speaker horn
. . . one of 39 new units!

slightly higher west and south **\$54**

Write for Complete Catalog
36 pages of radio furniture kits and speakers
for the high fidelity home music system.



**cabinart
'56**

Cabinart

99 North 11th Street, Brooklyn 11, N. Y.
largest manufacturer of cabinets and kits for hi fi
a division of G & H Wood Products Co., Inc.



CATHODE RAY TUBE SPECIALS ONE YEAR GUARANTEE

G.E.	Type	STAN-BURN	G.E.	Type	STAN-BURN	
\$13.25	10BP4	\$10.20	\$28.15	17CP4	\$19.50	
18.00	10FP4	14.00	31.25	17GP4	20.75	
16.25	12LP4A	13.95	32.25	19AP4A	22.50	
	12OP4	10.50	27.40	20CP4	18.95	
28.95	12UP4	14.50	33.00	21AP4	22.25	
18.15	14CP4	13.40	33.25	21MP4	23.50	
	15DP4	14.50	27.40	21EP4	20.15	
31.25	16AP4A	18.50	90.75	24AP4	49.00	
25.25	16KP4	15.75	DUMONT TUBES			
31.25	16GP4	18.50	120P4A	23.75	16P4	26.00
29.00	16LP4	15.25	150P4	26.55	17KP4	25.00
29.00	16WP4	15.25	160P4A	31.00	19AP4	32.25
22.50	17BP4	15.75			21KP4	38.50

PRICES SUBJECT TO CHANGE WITHOUT NOTICE

\$20 WORTH OF ELECTRONIC PARTS IN GRAB-BAG consisting of: Porcelain sockets, coils, speaker, transformers, resistors, condensers, etc. ONLY \$1.98 (plus 50c postage).

HI-FI ENTHUSIASTS!

AM-FM-SW AUTO RADIO

Drift Free FM—World's Finest Auto Radio—BECKER LeMANS—

For PUSH BUTTON For SIGNAL SEEKER
\$179.95
\$239.95

Price includes Hi-Fi GE Model 950 SPEAKER with GRILLE. (40-12,500 cps) and ELECTRIC ANTENNA which goes up automatically when set is ON, retracting when set is OFF. Simple installation for all makes of cars. Specify 6 or 12 Volt system.

VM 3 SPEED HI-FI CHANGER—Model 950 with Ronette Sonotone or Astatic flip-over cartridge—BRAND NEW. ORIGINAL CARTONS\$21.49

VM 4 SPEED HI-FI CHANGER—Model 1210 with Ronette, Sonotone or Astatic flip-over cartridge..\$22.95

3 SPEED PORTABLE RECORD PLAYER with MONARCH CHANGER—Ronette cartridge—Portable Two Tone Carrying Case\$32.95

WEBSTER Model 140-3 SPEED Automatic with Ronette Sonotone or Astatic flip-over cartridge..\$22.49

MONARCH 3 SPEED AUTO. INTERMIX CHANGER with crystal cartridge.....\$21.95 Same with British variable reluctance..... 24.95 45 RPM SPINDLE 1.88 TU-8 MONARCH 3 Speed MOTOR & TURN-TABLE UNIT (less arm)..... 4.95

PEERLESS PORTABLE BATTERY OPERATED RADIO—Colors: Green, White, Red or Black. TUBE IMPORT. \$14.95 less batteries BATTERY KIT for above.....\$2.00

JEWEL—Model 5200-5 TUBE AC-DC RADIO..\$12.50

RECORDING TAPE—Top quality—1200 Feet—Famous brand—BOXED—1 to 5—\$1.69 ea. 6 to 11—\$1.59 ea. 12 or more.....\$1.49 ea.

HALLICRAFTERS TV

Model 177S700M—Table Model... Dealer net \$ 91.95 Model 21TS60M—Table Model... Dealer net 129.46

SPECIAL!

HI-FI PACKAGE DEAL

This choice package includes:

COAXIAL 12" SPEAKER • MONARCH AUTOMATIC CHANGER with Variable reluctance. Beautifully styled 12" SPEAKER ENCLOSURE in Mahogany or Blond Wood • Matching base for changer —10 WATT AMPLIFIER (Choice of amplifier: BELL 2122C—BOGEN DB110—GROMMES LJ4—HARMON KARDON PC200).

COMPLETE—READY TO PLAYonly **99.50** net

or your choice of similar units at relative package price. Write for prices.

DEALERS: Write for low cost prices and foreign orders at minimum commissions. We are authorized distributors for United Motors, All Delco and Gen. Motors Auto Radio parts in stock. We also carry a complete line of popular makes of Radio Tubes at 50/10 discount. Also many other special purpose and transmitting tubes, and all electronic parts and equipment at lowest prices. Send us a list of your requirements for terms, quotations. Terms: 20% with order. Balance C.O.D. All prices F.O.B. NEW YORK Warehouse. Minimum order \$5.00. Write for our latest price list and Hi-Fi Catalog RN-5.

COMPLETE HIGH FIDELITY DEPARTMENT. SEND US YOUR LIST FOR LOWEST QUOTATIONS ON ANY ITEM.

We invite export inquiries and offers. Our export department will give special attention to expediting foreign orders at minimum commissions. We are authorized distributors for United Motors, All Delco and Gen. Motors Auto Radio parts in stock. We also carry a complete line of popular makes of Radio Tubes at 50/10 discount. Also many other special purpose and transmitting tubes, and all electronic parts and equipment at lowest prices. Send us a list of your requirements for terms, quotations. Terms: 20% with order. Balance C.O.D. All prices F.O.B. NEW YORK Warehouse. Minimum order \$5.00. Write for our latest price list and Hi-Fi Catalog RN-5.

STAN-BURN RADIO and ELECTRONICS CO.
558 CONEY ISLAND AVE. • B'KLYN T8, N. Y.

Clearing TV Interference

(Continued from page 49)

and caused serious overload or a direct short across the high voltage only when the receiver is on. A high-resistance check of the strip will not show up the leakage.) See that all connections are clean and that wiring is sufficiently spaced from the chassis, ground leads, etc., to prevent arcing.

Type: "Ticking" and metallic noises inside the set

Effect: Arcing, "singing," or static discharges in sweep or deflection circuits.

Source: In some cases, a "ticking" noise may result from leakage from the picture tube coating to a nearby metal tag. Similar noises may be caused by a loose core in the vertical output transformer. Other common sources are deflection or sweep leads passing through a metal rivet and wires running too close to low-potential or ground wires.

Remedy: Check these and similar points visually or by ear. If the trouble cannot be corrected by shimming the transformer, tightening core laminations, etc., replace the unit.

Type: 60-cycle hum in the picture (sound normal)

Effect: Top half of picture black, bottom half white, or vice versa as shown in Fig. 4. May be accompanied by pulling or tearing in the picture. (See Fig. 5.)

Source: Cathode-to-heater short in video i.f., r.f., video amplifier, video detector, or d.c. restorer tube, or picture tube. An open or defective filter capacitor will usually produce two sets of black and white bars (120 cycles).

Remedy: Check the preceding tubes (and capacitors) by substitution. (The video i.f. chain usually is the source.) If the effect remains, check waveforms in the video and sync circuits with a scope.

Type: Sound bars in the picture

Effect: Horizontal black lines which move or vary with changes in sound volume.

Source 1: Microphonic tube in the oscillator, video i.f., video amplifier, sync amplifier or sweep stages.

Remedy: Locate the microphonic tube by substitution or by tapping gently with the eraser end of a pencil.

Source 2: Misadjusted sound trap in the video i.f. stages.

Remedy: Align the trap. Also check for a defective trap or cold-soldered terminal connections.

Type: Barkhausen oscillation

Effect: Black vertical bars or lines on left side of screen. Under certain conditions, these lines may be white (see Fig. 6).

Sources: Defective horizontal output tube, incorrect horizontal drive adjustment, pickup of horizontal sweep signals by the video i.f. or video amplifier stages.

Remedies: Replace the horizontal output tube or install a small perma-

nent magnet (Barkhausen suppressor) on or near it. Reduce horizontal drive. In stubborn cases, try replacing the 300-ohm lead-in with shielded line.

Type: "Beat" interference

Effect: Grainy, meshed appearance in picture (on one channel only). Note the effect in Fig. 7.

Source 1: Change in i.f. frequency (caused by aging coils or change in composition of coil dope, capacitor values, trap adjustments, etc., so that an odd or even harmonic (5th, 7th, 8th, etc.) falls within one of the TV channels.

Remedy: Check the i.f. frequency and trap adjustments. Align the oscillator or check components if the frequency shift is unusually large.

Source 2: Beat interference from an FM receiver.

Remedy: Install ½-wavelength shorted stub or high-pass filter across antenna terminals.

Source 3: Deficiency in original circuit.

Remedy: Check with the manufacturer or distributor for specific information on circuit modifications, parts changes, etc. (A number of models have required modifications along this line.)

VERMONT QSO PARTY

THE Tri-County Amateur Radio Club of Brattleboro, Vt. has scheduled the 5th Vermont QSO Party for May 5 and 6 (6 p.m. Saturday to 6 p.m. Sunday).

All amateurs are invited to participate. Vermonters are urged to work as many out-of-state stations as possible so that interested amateurs can earn credit toward WAS, WANE, and W-VT awards.

Novices as well as old timers are invited to join in as all have an equal chance to win.

For complete contest rules, write to Raymond N. Flood, W1FPS, 2 Marlboro Ave., Brattleboro, Vt.

COLOR TV COURSE IN TEXAS

THE Adleta Company of 1914 Cedar Springs, Dallas, Texas, wholesale distributor of RCA Victor products, has initiated a training program on color TV that is open to all television service technicians whether they are affiliated with Adleta or not. This course is offered free.

In announcing the course, E. P. Miles, general manager of Adleta, stated that color television is coming faster than most people believed possible and it is urgent that service technicians prepare themselves immediately.

The entire program offered to the service technicians consists of the RCA Institutes' color course, and special purchase plans for color TV receivers and test equipment. The course itself is a nine lesson correspondence type, augmented by "in-person" review periods. At least 40% of the review period time will be devoted to shop techniques on actual color receivers.

The special purchase plan offers each participant in the course a color TV receiver at considerably less than key dealer price. This set can be financed over a 24-month period. A similar plan applies to color test equipment.

U.H.F. Oscillator

(Continued from page 55)

Lecher wire system is coupled to the oscillator by a small inductive loop . . . attach a one turn "hairpin" loop of #14 ga. copper bus bar to one end of a short length of r.f. coaxial cable and a standard coaxial connector (to match J_1) at the other end. Mount the hairpin loop so that it is inductively coupled to the shorted end of the Lecher wires. Connect the other end of the cable to the oscillator output jack. Now, with the oscillator turned "on" and set to the first calibration point, adjust the "eye sensitivity" control (R_2) until the eye just closes. Next, move the shorting bar along the Lecher wires, starting from the shorted end, until a "dip" occurs in the oscillator's output, as indicated by the tuning eye opening and closing. Carefully note the point at which the "dip" occurs and continue adjusting the shorting bar until a second dip occurs. Measure the distance between the two dips. The operating frequency, in megacycles, is equal to 5905 divided by the measured distance in inches. This technique is repeated for each calibration point.

Space limitations have prohibited giving a more detailed description of frequency measuring techniques than those just outlined. For a more detailed discussion of u.h.f. frequency measuring and calibration techniques, refer to any standard textbook or to "The Radio Amateur's Handbook."

Application Notes

The completed u.h.f. oscillator may be used as an auxiliary signal generator, as a general-purpose signal source for laboratory tests, or even as a small self-contained low-power transmitter for driving antenna and transmission line systems for experimental measurements. The tuning eye, connected in the grid circuit, permits the instrument's use as a u.h.f. grid dip meter. However, when using the instrument, the worker should always remember that the unit has been designed as a low cost, simple, easy-to-use, but reliable u.h.f. signal source, and, as such, that it is not a direct substitute for an expensive laboratory-type standard signal generator. When used as a signal generator, an external attenuator must be provided to control output. Since no "buffer" stage is provided, excessive loading may cause a shift in operating frequency. Although the output level may not be constant over the entire frequency range, it is generally possible to obtain at least a quarter of a volt, or more, across a fifty ohm non-inductive load, and the relative output, at any time, is indicated by the tuning eye's closure. At lower frequencies, it may be possible to obtain several volts output. Whenever using the instrument, it is a good idea to terminate the output cable in a non-inductive (composition) resistor equal to the cable's characteristic impedance.

-50-

May, 1956

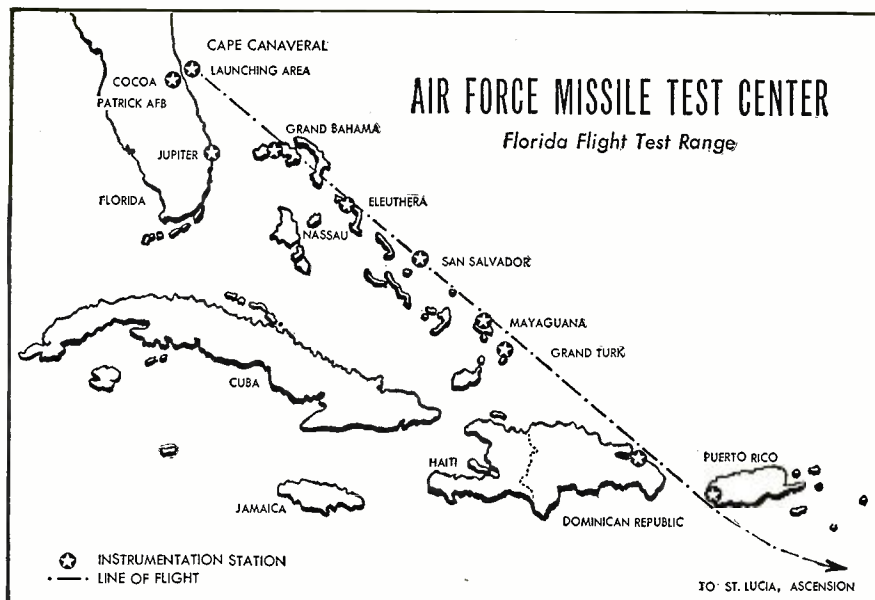

RCA

ANNOUNCES OPPORTUNITIES

In Guided Missile Test Instrumentation For Electronic Technicians

At the following locations

PATRICK AIR FORCE BASE, FLORIDA

Engineering development technicians
Radar
Communications
Test Equipment

CAPE CANAVERAL

Radar
Radio
Telemetry
Timing
Telephone
Optics

Enjoy pleasant Florida living and working at these locations.
Liberal company benefits. Relocation assistance.

INTERESTING DOWN-RANGE ASSIGNMENTS

Radar
Radio
Telemetry
Timing
Telephone
Optics

These positions are located on the Islands shown on the map above. Salary, 30% incentive, meals and lodging furnished. Return to U.S. every 3 months.



For information and arrangements for personal interview, send complete resume to:

Mr. H. C. Laur
Technical Employment, Dept. N-16E
Missile Test Project
RCA Service Co., Inc.
P.O. Box 1226, Melbourne, Florida



RADIO CORPORATION of AMERICA

EVERYBODY'S SHOOTING COLOR!

NEW—the world's first Annual devoted exclusively to color photography—including the largest collection of color photographs ever published in a single issue! Features work by such masters as: Basch, Eisenstaedt, Elisofon, Feingersh, Halsman, Karsh, Penn, Peskin, Rawlings, Weegee...



WATCH FOR THIS
172-PAGE COLOR
PHOTOGRAPHY ANNUAL

**ON SALE
MAY 17!**

At All Newsstands
and Camera Stores

PLUS—

- Tips on Using Color Creatively
- Cameras for Color
- Color Films
- Color Exposure Outdoors
- Color Exposure Indoors
- Color Filters
- Home Movies in Color
- 25 Ways to Improve Your Slide Shows

AND—

"The Future of Color"
—a symposium by experts

electronic technicians

- Had Electronic Training in military service?
- or Graduated from 2-year Technical School Course?

IF ANSWER IS "YES," there's an outstanding opportunity open to you today in **TEST WORK** at General Electric's Light Military Electronic Equipment Department in Utica, N. Y.

Assignments include complete aligning, testing and troubleshooting of ordinary electronic units. Also substitution testing on complex electronic equipment.

Ability and initiative determine your responsibility and compensation—not a "set" scale. Ample opportunities open to you to advance and increase your technical skills. And General Electric offers the utmost in employee benefits: insurance, stock bonus, pension, etc.

Please write, including details of experience, to:

MR. W. M. O'HARA
Personnel Office

Light Military Electronic Equip't. Dept.

GENERAL ELECTRIC

French Road, Utica, N. Y.

Every ELECTRONIC TUBE IN 3 MANUALS

WORLD'S RADIO TUBES

Radio Tubes Vade Mecum
Characteristics of all radio tubes made in all countries. World's most authoritative tube book. Classified numerically and alphabetically. Find any tube in seconds. Base connection section. **\$5.00**

WORLD'S EQUIVALENT TUBES

Equivalent Tubes Vade Mecum
All replacement tubes for a given type, both exact and near-equivalents (with points of difference detailed). Normal and advanced comparisons. Military tubes of 7 nations, with commercial equivalents. Over 43,900 comparisons! **\$5.00**

WORLD'S TELEVISION TUBES

Television Tubes Vade Mecum
Characteristics of all TV picture, C.R. and special purpose tubes. A "must" for all specialists. **\$5.00**



BUY FROM YOUR DISTRIBUTOR
Add 10% on direct mail orders to
EDITORS and ENGINEERS, Ltd.
Summerland 2, California

Using the 5AXP4

By LLOYD B. HUST

*Build this voltage divider
to prevent damage to tube.*

THE Sylvania 5AXP4 TV test picture tube is a real time and money saver when servicing receivers which have the picture tube mounted on the cabinet. This tube is especially useful for 24- and 27-inch sets as the size and weight of the picture tubes in these receivers makes their removal a real problem.

Since many of these sets use a second anode voltage of close to 20 kv., and since voltages of this magnitude can damage the small 5AXP4, some method must be devised to reduce the voltage. It is also necessary to provide for a sufficient load on the horizontal output system of the set being serviced.

The answer to the problem is a voltage divider of about 150 megohms. Use fifteen 10 megohm, 1 w. resistors in series to make the divider. An alligator clip is attached to each end of the series and a piece of high-voltage wire attached to the junction of the fifth and sixth resistors. A connector of the type to fit the second anode connection of the 5AXP4 is attached to the other end of the wire.

The whole string is then taped with high voltage plastic tape and the divider is ready for use.

To use, one of the alligator clips is attached to the high-voltage lead of the set under test and the other is attached to the chassis. The lead from the tap is connected to the anode of the 5AXP4. Use that side of the voltage divider with the tap five resistors away from the high-voltage lead for sets of moderately high voltage—usually 24-inch sets. This will give about $\frac{2}{3}$ of the available voltage for use at the anode of the 5AXP4. On sets with higher voltage—usually 27-inch sets, the alligator clips can be reversed; that is, the clip closest to the tap can be connected to the chassis, and the other to the high-voltage source. This will place about $\frac{1}{3}$ the normal voltage at the anode of the 5AXP4. Since this tube will operate over quite a wide range of 2nd anode voltages, this will give good results without the danger of damaging the tube. In some instances blooming may result, but this will in no way hamper the troubleshooting of the set under test.

It is not necessary that 10-megohm resistors be used in making up the total of 150 megohms in this voltage divider. However, it is best that a fairly large number of resistors be used in series rather than only a few of larger value, otherwise the power rating of the voltage divider will not be high enough. Also, it is not advisable to mount the resistors side by side on a terminal strip in an effort to make the unit more compact as this increases the danger of arcing from one resistor to another.

It will be found that this little device will make the already useful 5AXP4 even more versatile.

—30—

Capacitance Meter

(Continued from page 67)

ding across L_1 . Oscillator frequency is not critical. It merely has to stay put within a couple of per-cent.

Transistors

The relatively inexpensive *General Electric* 2N107 transistor specified in the parts list accompanying Fig. 2, has a rated *alpha* cut-off frequency of 1 megacycle, which should insure that an undamaged specimen of this particular type of transistor will oscillate readily at 500 kc., the operating frequency of this instrument.

Most type CK722's (*Raytheon*) will oscillate at this frequency too, so if you happen to have one in your collection of parts, by all means try it out first before investing in another transistor. If it works OK, you are money ahead.

The *General Electric* booklet covering transistor circuits designed to utilize the 2N107 transistor, carries the statement "Not for commercial use." In the absence of more detailed explanatory material, we can only assume that this means that there is a comparatively wide variation from unit to unit as far as cut-off frequency or some other characteristic is concerned and it does leave open the possibility that some individual 2N107 transistors might not perform adequately in this particular circuit. The author does not feel that this is likely since the 2N107 worked very well indeed in the prototype instrument. To be on the safe side, however, the builder might want to consider the more expensive *G-E* type 2N135 transistor if the instrument is to be used for critical applications.

Other precautions: leave the transistor leads at least an inch long and solder them quickly with a clean hot iron. The leads are of tinned steel wire, a poor heat conductor, but overheating is too damaging to allow taking a chance. Let the transistor be the last component to be soldered in, after all the other connections have been made to the terminal strip.

Finally, keep capacitive current surges from the 117-volt power line from going through the transistor. In keeping with *Philco's* recommendations, use an electric soldering iron on transistor connections only when the transistor equipment is not grounded and not connected to any other line-powered equipment. This, however, is not necessary if the soldering iron gets its power through an isolation transformer. Easiest thing to do is to disconnect the transistorized gear from everything else before soldering on it.

REFERENCE

1. Byers, W. F.: "A Compact Radio Frequency Capacitance Measuring Instrument," *General Radio Experimenter*, Nov. 1948.

-50-

May, 1956



CROWN

Professional Tape Recorder

SPECIFICATIONS

- "Micro-Linear" Heads
- Three Speeds
- Three Motors
- Meets NARTB Standards
- "Micro-Sync" Timing
- Straight Line Threading
- 4" Dual Lighted Meter
- Magnetism Braking
- Perfect Erasure

★ ★ ★ ★

GUARANTEED

Record & Playback Performance

IPS	15	7 1/2	3 3/4
% WOW	.12	.18	.25
DB	±2	±2	±3
CPS	29 to 23,000	30 to 16,000	30 to 10,000
NOISE RATIO	55	52	44

for Full Track Heads



CROWN IMPERIAL

Breaks Sound Barrier! Breaks Price Barrier!
Breaks Service Barrier!

A COMPLETE HI-FI PACKAGE!

- 3-Speed Recorder
- 20-Watt Micro-Linear Amplifier
- 2 Channel Mixer
- Exponential Curve Equalizer
- 10" Reel Facility
- Monitor Speaker

Dual or Full Track, S425, complete with case.

Write for literature. Address Dept. RNS

INTERNATIONAL RADIO & ELECTRONICS CORP.

Elkhart Indiana

ELECTRONICS TECHNICIANS

SR. LAB TECHNICIANS

Excellent opportunities and employee benefits at

SPERRY

a company with an enviable record of 44 years' growth and expansion.

ELECTRONICS TECHNICIANS Minimum 5 years' experience on construction of complex electronic equipment. Knowledge of pulse, radio, electronic and audio frequency circuits; ability to use common electronic test equipment required. Minimum 2 years' engineering school or equivalent training.

SR LAB TECHNICIAN 10 to 15 years exp. in the design, construction and maintenance of complicated electronic equipment.

LIBERAL COMPANY BENEFITS

Over 1,500 employees have been with Sperry more than 15 years ... ample evidence of opportunity, excellent benefits and fine working conditions.

PLEASE SUBMIT RESUME
to
Mr. E. Williams
Interviews may be arranged locally or at plant at company expense.



GYROSCOPE COMPANY

DIVISION OF SPERRY RAND CORP.
Marcus Ave. & Lakeville Rd.
Great Neck, L. I., N. Y.

BE AN AUDIO HI-FI EXPERT

Cash in on this Money-Making Field!

Know everything about all the different kinds and makes of turntables, pickups, speakers, amplifiers, enclosures, etc. Know how audio circuits work, how to use them properly—how to tell which parts work best in which systems. Let the FIRST and ONLY COMPLETE library of practical, detailed Audio and Hi-Fi know-how make money for you!

The Gernsback Audio and High-Fidelity Library—Written by the World's Foremost Audio Experts



A whole library loaded with diagrams and expert know-how... written in down-to-earth language... each book beautifully bound and stamped in gold leaf!

The Second Book Is Ready Now

MAINTAINING HI-FI EQUIPMENT, by Joseph Marshall—the first book that pinpoints all audio troubles. It covers: Preliminary diagnosis; Distortion; Common audio troubles; Phono pickups and styli; Turntables, equalizers, etc. This is a must book for all technicians and Hi-Fi fans! Then... the additional library books will include: Basic Audio Course; The Golden Ear; Audio Hints; Constructing Audio Amplifiers; The Audio Designers Guide Book; Loudspeakers and Speaker Systems; Loudspeaker Enclosures; Tape Recorders.

And You Can Save 25%

If you buy each of these books individually they cost \$5.00 each, but members of the GERNSBACK AUDIO AND HIGH-FIDELITY LIBRARY PLAN SAVE 25%. And

- You will receive the very latest book by mail every three months as it comes off the press. Examine it IN YOUR OWN HOME FOR 10 FULL DAYS AT YOUR RISK! If you don't like it, return it.
- You only have to take four of the Hi-Fi books to get each one at the special low member's price of only \$3.75 per copy.

Fill Out This No-Risk Coupon Today!

Just fill out the coupon and mail it today! (Check the box that suits you best.) Get your copy of MAINTAINING HI-FI EQUIPMENT for a FREE home examination now!

NO-RISK COUPON

GERNSBACK LIBRARY, INC.
Dept. 102, 154 West 14th St., New York 11, N. Y.

- Catch me up to other Library members. Send me both books so far published: **BASIC AUDIO COURSE** by Donald Carl Hoefler—and **MAINTAINING HI-FI EQUIPMENT** by Joseph Marshall (retail value \$10.00) for only \$7.50 postpaid!
- Start my membership with just the book checked below at \$3.75, postpaid:
 - Basic Audio Course
 - Maintaining Hi-Fi Equipment

I have 10 days in which to return any book if I am not satisfied. Otherwise, I will pay promptly when I get your bill.

- Send me more information on the GERNSBACK AUDIO AND HI-FI LIBRARY.

NAME please print

STREET

CITY STATE

Mac's Service Shop

(Continued from page 79)

church I tried to get you on the phone two or three times, but the line was busy all the time. Was your wife on the line?"

"No, I'm afraid I was the guilty one this time. A friend of mine who is in the tape-duplicating business over East called me, and we had a lengthy and most illuminating chat about some of the things he had discovered about tape recording in general while working with his particular line."

"Such as?"

"For one thing, he said that the fidelity of tape recordings made and played at comparatively slow speeds, such as 3 3/4 and 7 1/2 inches-per-second, depended chiefly on three important factors: (1) the quality of the tape, (2) the gap-size of the heads, especially the reproducing head, and (3) head alignment. He paid the tape manufacturers quite a compliment when he said he felt they had achieved about all the major improvement we could reasonably expect in that direction. Modern tape is good enough to 'take' all the fidelity required if we can just devise means of putting the signal on the tape and picking it off. He went on to say that he doubted that the gap size could be mechanically reduced much below that found in modern high-quality heads."

"Hold it!" Barney interrupted. "How else could you reduce the gap size except mechanically?"

"I asked about that, too, and he seems to think that possibly something could be done along the line of producing an 'electronic gap.' Candidly, I am not too clear on what he has in mind. Perhaps he means to produce the gap by some electronic lens shaping action. At any rate, substantial improvement in that direction would seem to be very much in the 'iffy' category."

"That leaves only head alignment."

"And that is where he thinks a lot can still be done. He tells me head alignment rapidly increases in importance as the tape speed is reduced. When he speaks of head alignment, he is not talking about just making sure the slit in the reproducing head is exactly parallel to that of the recording head. He says this is not enough. Experiments in his laboratories with first-class recorders reveal that when the heads are perfectly aligned in this respect, you can record a seven-inch reel of tape with a high-frequency tone and play it back immediately and lose several db of this signal between one end of the tape and the other. At any point, though, the loss can be recovered by changing the azimuth of the pickup head."

"Why?"

Instead of answering, Mac marched out into the office and stripped a couple of yards of paper from the roll on the adding machine. He fed this

IN DETROIT IT'S AARON

DYNAMIC MUTUAL CONDUCTANCE

1-177 tube testers. Guaranteed—in the best of condition—like new. Portable. Made by Hickok or to their specification. With chart and diagram. Sh. Wt. 19 lbs. \$24.95



TRIPLET METER

AC volt and output meter model 650 S.C. 4000 ~ res. 0-150 volts. In 5 ranges 0-60, 0-15, 0-6, 0-1.5. Just the meter for amateurs, electricians, experimenters, schools, and radio men. \$4.95
Size 6"x3"x2 1/2". At a Giveaway Price.

SCR-274 COMMAND EQUIPMENT

TRANSMITTERS COMPLETE WITH TUBES
1.3-2.1 MC-ARC/5-BRAND NEW.....\$19.95
2.1-3 MC-ARC/5-BRAND NEW..... 7.95
3-4 MC-ARC/5-EXCELLENT..... 7.95
3.3-7 MC-RC478-BRAND NEW..... 7.95
7.9-1 MC-ARC/5-BRAND NEW..... 7.95

FIRST TIME ON SURPLUS MARKET

ARC/5 (160 Meter Mobile) Transmitter
1.3-2.1 MC-BRAND NEW.....\$19.95
Comparison for 1.5-3MC Receiver

ARC/5 TRANSMITTER

3-4 MC. (80 Meters) Same as BC696 with tube and xtal. Ex. cond. Like new..... \$7.95
Receiver-BC-455, 6-9-1 MC..... \$3.95
Fair with tubes.....
Spined Tuning Knob. For Above Rcvr..... .89

701-A TETRODE. SIMILAR TO 4-125 A

Diagram and Info. For Amateur Use With Order
A dandy K.W. SSB final-41: 8 V @ 7.5 amps. plate: 300V @ 200 MA. screen 25 V @ 60 MA. Just 10 W. to drive pair 1 K.W. A.M. phone. Max. input 600 W. per tube, class C. ampl. \$2.95 ea. 2 for \$5.00.
Shipped and G'd via Railway Express Only



THERMOSTATS

General purpose, adjustable type. Ideal for fire alarm systems, heating, detecting, and warning devices.
3 for \$1.20 10 for \$3.50
Special Price for Quantity Buyer

DYNAMOTOR

For Mobile Receiver or low power Xmtr. 6-12 VDC input. 265-450 VDC output. @ 55-90 MA..... \$2.95

DRIVER XFMR.

1-1.6 Ratio. Pri. 5140 C.T. Sec. 2000 ~ watt 1.5 W. Ideal 150 Rtg..... \$2.95

TG-10 CODE KEYS SAME FUNCTION AS TG-634A IN STANDARD 1 1/2" x 2 1/4" x 8 1/2" metal cabinet. Used, no tubes or cell. With tubes, photo cell, tested. Excl. cond. .. \$14.95

MISCELLANEOUS

Attenuator, 500-500 ~, 1.5 watt, 60 DB range, 32 steps, adjustable..... \$3.95
Ceramic Split Stator, Tuning 70-160 MC. Ideal 2 meter oscillator section, or antenna matching section in place of Balun as described in Hints & Kinks, volume 3, page 75, with 95 tube..... \$1.25
15 MMF Split Stator with Coil, Freq. approx. 2 meter. Can be used with P.P. input circuits..... \$3.25
40 watt. Modulation transformer 2-1 ratio, matches 6L6's to 807's, etc. 600 VDC 4 prong, Plug-in type..... \$7.6
PYRL. cap. 1.1 MUF @ 3000 VDC..... \$1.95
ANTENNA RELAY UNIT RE-2/ARC-5. SAME AS BC-442. SWITCHING RELAY. 0-15 RF. TUBES AND 50 MMF VACUUM CONDENSER..... \$3.75
NEW
50 MMF VACUUM CONDENSER..... \$1.50
RELAY (RBM #23023) 700 ~..... \$1.50
110 VDC DPDT..... 97c

NOTE—Terms: 25% Deposit, Bal. C.O.D. Add 50c for orders under \$3.00

AARON ELECTRONICS

Dept. S. 3830 Chene St., Detroit 7, Michigan

CITIZENS RADIO TRANSCEIVER

Any U. S. citizen 18 years old or more may obtain a station license. No operators license is required. Operates on 465 MC. 117 volts AC or DC or 6 volts DC. Only \$59.75 per unit, \$119.50 per pair.

SPERA ELECTRONICS SUPPLY

37-10 33 St., Long Island City, N. Y.
Please Include Sufficient Postage.

WANT A BETTER JOB? BECOME AN ELECTRONIC ENGINEER

ONLY 32 MONTHS TO EARN A BACHELOR OF SCIENCE DEGREE IN ELECTRONIC ENGINEERING
Class enrollment limited to allow for individual instructions. Chartered by state of California. Nonprofit-organization, coeducational—established 26 years.

APPROVED FOR VETS—ENROLL NOW!

SEND FOR FREE CATALOG

PACIFIC STATES UNIVERSITY

1516 S. Western Ave., Dept. O, LOS ANGELES, CALIF.

into the typewriter and lined up the edges so the strip of paper was being fed straight through the rollers. As he continued to turn the feed roll, however, the narrow ribbon of paper began to skew, and as it finally left the typewriter it was describing an acute angle with the paper bail.

"That," Mac explained, "is what happens in the tape transport system of a recorder. It is virtually impossible to insure perfectly even tension clear across the width of the tape; yet the slightest difference results in skewing as happened to the adding machine paper. Remember one edge of the tape has to lead the other by only a small fraction of an inch to seriously impair the high-frequency response."

"Are better tape guides the answer?"

"No. We might be able to improve this condition by using enough rollers, special tape guides, etc., but then we should end up with a complicated tape-threading mechanism that would be a great nuisance."

"What is the answer then?"

"My friend thinks it's a self-aligning reproducing head. He argues the thing to do is to make the head align itself to the tape. That way the tape can skew if it likes without impairing the high-frequency response in the least. In fact, he has actually patented a head that works in this fashion."

"How does it work?"

"I am not sure how his works, but I have been thinking about possible ways of doing this. One would be to use a special recording head that put three tracks on the tape. Very narrow tracks along each edge would be recorded simultaneously with the same high-frequency note. The center track would be left for the music or other information that you wished to record. The pickup head, too, would be a three-part affair in which separate heads would pick up the edge-tracks and feed them to a special phase-comparing circuit. As long as the pickup head was perfectly aligned with the signal on the tape, the signals from the two edge-track heads would be exactly in step; but if the tape skewed, the signal from one head would lead that from the other by a definite amount, and this could produce a correcting voltage that could be used to exert a mechanical correcting influence on the head. The mechanical device might be a servomechanism when a slow-acting correction would be adequate, while for a more nearly instantaneous correction the electrostrictive characteristics of a crystal might be used. Since the three gaps in the recording head would be in a perfectly straight line and so would the three gaps in the reproducing head, keeping the reproducing head perfectly aligned with the edge recordings would automatically insure that the center head would be aligned with the information on the center track."

"Sounds a little fantastic, but I can't

Half the fun is building it... with a **TECH-MASTER** Kit!



Yes, you'll enjoy building a Tech-Master Kit almost as much as you'll enjoy using the finished product. Simple, step-by-step pictorial diagrams guide your every move right down to the last detail. Your feeling of pride and accomplishment will be well justified when you plug in the last tube and put your unit to its initial test. Then you will definitely agree, as do thousands of others, that when you build with Tech-Master, you build the best.

New

HI-FI FM TUNER



Self-contained power supply • Tuning range 87-109 Mc • 200Kc IF bandwidth • Grounded-grid RF stage • AFC with front-control cutoff • Micro-vernier tuning • No-drift ratio detector • 4 uv sensitivity for 20 db quieting • Standard de-emphasis network • .8 volt RMS cathode-follower output • 3.2 volt RMS high-impedance output • 300 ohm input impedance • Switch-controlled AC receptacle for auxiliary equipment.

Model FM-18, complete with punched chassis, tubes, and hardware (less wire and solder).....\$29.50

New

WILLIAMSON TYPE 20-WATT AMPLIFIER



Frequency response flat and smooth thru entire audible range • Less than .0025 distortion at normal listening levels • Excellent transient characteristics.

Model TM-15A, complete with tubes — sockets, terminal strips, and connectors mounted.....\$49.95

Deluxe

Self-Powered PREAMPLIFIER EQUALIZER



Cathode-follower output • Loudness-compensating control • Input selector • 4 input channels • Independent bass and treble boost and attenuation • 5-position equalization control • AC receptacle for auxiliary equipment • Self-contained power supply.

Model TM-16SP, complete with matching gold escutcheon.....\$24.50

Economy

PREAMPLIFIER with Cathode Follower Output



4 input channels • Separate bass and treble controls • 3-position equalizer • AC outlet for auxiliary equipment • Powered by main amplifier.

Model TM-17P, complete.....\$19.95

America's Finest

630-TYPE TV KIT



Advanced Cascade turret • AFC horizontal sync. • 3-stage sync. amplifier, clipper and separator • 4-stage stagger-tuned video IF • Adjacent-channel trap • 2-stage video amplifier • Direct-coupled keyed AGC circuit • 5 microvolt sensitivity • For 21" to 27" (90°) picture tube.

Model 630-9, complete with all components, brackets, speaker, and tubes (less kine, wire and solder).....\$159.50

New T-V CRAFT KIT



Super-selective 12-channel turret tuner • IF section completely wired and aligned • 9 microvolt sensitivity • 3-stage stagger-tuned IF • AGC • Syncro-guide AFC with horizontal hold • Ceramic core horizontal output xmfr with beam power amplifier. For L.V. electrostatic kines 17"—21".

Model 5516W, complete with tubes, hardware, and brackets (less kine, wire, and solder).....\$94.50

Note: The quality and performance of Tech-Master kits reflect the combination of long experience, skilled engineering, and painstaking craftsmanship, which has made Tech-Master the foremost name in Custom Tele-Vision. This is your assurance of the uniform excellence of every Tech-Master product.



Deluxe

SUPERHET AC-DC RADIO

Broadcast Band — 550-1720 KC • Super-sensitive circuit with built-in loop antenna • AVC • 5 tubes.

Model 3B5K, complete with tubes and handsome bakelite cabinet (less wire and solder).....\$19.95

Television • Radio • Audio



Write for latest catalog of complete Tech-Master line

TECH-MASTER CORPORATION

75 Front Street, Brooklyn 1, N. Y.

U.S. CRYSTALS GIGANTIC MOVING SALE

NOTE NEW ADDRESS,
NEW LOW PRICES!

Get **FREE CATALOG**
for solid savings on
SURPLUS CRYSTALS!

EACH | **10 OR MORE EACH**
49¢ | **44¢**

FT-243 SEND FOR
FREQUENCY
LIST

DC-34/35 FROM 1690
TO
4745 KC.

FT-171 FROM 2030
TO
3995 KC.

FT-241 FROM 370 TO
540 KC. &
FROM 729 TO
1040 KC.

Special frequencies, such as ship
band, novice, etc., not included
above, are listed and priced in our
latest catalog.

**4,000,000
GOVERNMENT
SURPLUS
CRYSTALS**

**DO
THIS
NOW!**

**SAVE
UP TO
90%
ON SURPLUS
CRYSTALS**

**SEND FOR
FREE
CATALOG**

MINIMUM ORDER \$2.50!

(Sorry, no exceptions!)

**SAME DAY SERVICE!
SATISFACTION GUARANTEED!**

Importers, exporters, manufacturers:
write for special quantity discounts.

"The House of Crystals"

U. S. CRYSTALS, Inc.
1342 S. La Brea Ave. Los Angeles 19, Cal.

see anything wrong with it," Barney said slowly. "I'd imagine something like that would be pretty expensive, though."

"Quite likely it would, but in certain industrial applications where good high-frequency response is essential, this would not be too important. Well, we had better pull our heads down out of the clouds and get to work."

"I should have known better than to mention 'expense,'" Barney said with a grin as he picked up his soldering gun.

-30-

Antenna Roundup (Continued from page 64)

(the lower one in Fig. 14) and one is rotated. The driven elements of both antennas are connected together for out-of-phase operation. Now consider Fig. 15. The fixed antenna points directly at the station to be received while the other antenna is rotated until its beam is so oriented that a complete cancellation of the first beam occurs in the direction from which there is interference. If a more or less permanent interference arises from one direction, it is not necessary to use a rotator; both antennas may be set up at the time of installation to reject this interference.

The bandwidth and gain requirements of a particular fringe area will determine the basic antenna type required. When several stations in the low and high band are received from approximately the same direction, a broadband antenna should be considered. If signals are received from different locations, such an antenna can also be used, but then a rotator is required. Where only two or three stations are received from different directions, separate single-channel antennas may be preferable, with their outputs switched as channels are changed.

It is hardly necessary to add that antennas made by a reliable manufacturer using quality materials and of sturdy mechanical design are the only types which will make for profitable installations. Fragile construction and shoddy workmanship in an antenna are not conducive to good customer relations and can directly damage the customer or his property.

-30-

Fig. 15. Individual response lobes of two antennas are combined to eliminate interference in the "Expo-I.R.I.S." system.

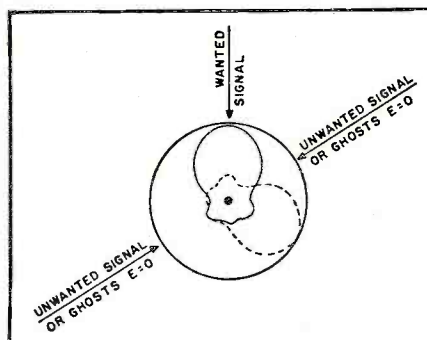

AUDIO UNLIMITED FOR ALL YOUR HI-FI NEEDS



**DYNAKIT TRUE HI-FI
50 WATT POWER
AMPLIFIER KIT**

**\$69.75
NET**

Pre-wired Printed Circuit Board

The finest amplifier kit on the market with the Dynaco A-430 output transformer—Highly stable circuit, 50 watts at less than 1% THD, 100 watts. Peak for clean bass response at all volume levels. Response ± 1 db 8 cps to 60KC. Full power available 20 cps to 20KC within 1 db of 50 watts without exceeding 1% harmonic distortion over this range. Complete with all top quality components. Pre-punched chassis, protective cover and detailed assembly instructions.

CBS COLUMBIA'S

Famous 1956

306 Series Model 420

- Push Pull Amp.
- Ronette Cartr.
- Diamond LP Stylus



Available in Blond or Mahogany

\$140.00 Value **\$98.50** Prepaid
NOW ONLY

AUTHORIZED DISTRIBUTORS

Fisher—Pilot—Fairchild—Harmon—Kardon—Interelec—tronics—H. H. Scott—Pentron—Crestwood—Perrygraph—VM—Columbia—Brenell—Wharfedale—Bozak—Stephens—A. R. Labs—E. V. Pickering—OrthoSonic—Reeves—Cabinart—Karlson—Miracord—Garrard—etc.

TELEFUNKEN

The Greatest Name in Radio
For the Home-Amateur Enthusiast



Operette

Plus
Royal Monarch
Record Changer



BOTH ONLY \$174.95 With Diamond Stylus
Ronette Cartr. You Save \$65

Console Quality—3 Matched Hi-Fi Speakers. Frequency Ranges—AM—145KC—340KC—20KC—1600KC. S.W. 16MC—49MC. FM—88MC—108MC. Superb walnut veneer cabinetry, polished to high gloss. Dual built-in antennas—Push button control. Size 21 3/4 x 8 1/2 x 14 1/4".
Royal Monarch Changer with Ronette Cartridge LP Dia. Stylus. Complete with 3-speed 4 pole motor.



TOP QUALITY RECORDING TAPE

"Plus 50"—1800' 7 1/2" Reel—Plastic Base—Low Noise. Fully Guaranteed. Stock Up at this Low Price. Each \$2.75. Lots of 10, Each \$24.50. TAPE RECORDERS—TAPES—ACCESSORIES—TOP QUALITY BRANDS.

Write us today for all your Hi-Fi Requirements—Prompt Reply.

Time payments arranged. Shipments prepaid. Sorry, No C.O.D.'s.

AUDIO UNLIMITED

Mail Orders Only
63-03 39th Avenue, Woodside 77, New York

Across Counter Purchases
N. Y. C. Store—169 West 57 Street
Opposite Carnegie Hall

TELEVISION

PREPARE FOR A GOOD JOB!
BROADCAST ENGINEER
ELECTRONICS RADIO SERVICING

Television Servicing

(Approved for Veterans)
SEND FOR FREE LITERATURE
BALTIMORE TECHNICAL INSTITUTE
1425 EUTAW PLACE, BALT. 17, MD.

Spot Radio News

(Continued from page 26)

Derivation of the electrical units from the three primary standards was illustrated with the Bureau's current balance. This apparatus measures a current in absolute amperes by determining the mechanical force between two parts of the circuit in which it flows. The force between coils carrying the current is measured with a sensitive balance. From the value of this force and the coils' mechanical dimensions, the absolute value of the ampere is computed in terms of the fundamental standards of length, mass, and time. The absolute ohm is defined in terms of the primary standards by another experiment involving mechanical measurement; and from these two derived units, the Bureau has set up standards for all other electrical quantities, such as voltage, power, and energy, in use today.

The guests were then shown how the current measured by the current balance can be used to deflect a stream of electrons. Since the amount of the deflection depends on the charge to mass ratio (e/m) of the electron and on the current in the deflecting coil, this experiment provides a means for relating the mass of the electron, through the current balance, to the standard kilogram.

In a report on forward scatter, the honored guests were told that the current interest in this new technique of transmission is due, in part, to the economic advantages of long-distance radio relays, which can eliminate a great many expensive relay stations.

The systematic study of scatter by the Bureau includes not only conventional methods, but also advanced concepts designed to explain and define observed scatter phenomena. The Bureau's activities in the field include investigations of such quantities as transmission loss, fading rate, fading range, phase variations, angular distance, obstacle gain due to diffraction, and path antenna gain.

In a commentary on instrumentation for forward scatter, it was revealed that instruments have been developed to measure variations in the phase difference of waves traveling in a single path and of waves traveling in multiple paths. For a single path, variations are measured at the two ends of the path, while for a multiple path the variations in the phase difference between the waves arriving over the first path and those arriving over an adjacent path are measured simultaneously. In addition, instrumentation has been designed to measure the very small changes in the amplitude of the received field which occur within the radio horizon. Use of these two types of instrumentation is expected to permit evaluation of the parameters which are important in the interpretation of scatter mechanisms, particularly where the instrumenta-

May, 1956



HELPS YOU EARN MORE
ON TV SET REPAIRS

Only \$2.00

SAMS BOOKS
keep you ahead in
ELECTRONICS

"KEY CHECK POINTS IN TV RECEIVERS"

Prepared by the Howard W. Sams engineering staff. Shows voltages and actual photos of waveforms (with amplitude for each) present at key points in a normally operating receiver. Based on analysis of TV models produced in late 1951 and in 1952. Covers many applications for general TV service work, including time-saving information showing the technician (1) how to make quick tests at key points to determine the section in which the trouble lies and (2) after making the particular repair, how to check the overall operation of the receiver to insure against callbacks. Complete with handy quick-reference index. An invaluable book—helps you save time and earn more. 182 pages; 5½ x 8½"; illustrated. Postpaid, only **\$2.00**

USE HANDY ORDER FORM BELOW

Sams books cover every phase of Electronics for the service technician, engineer, student or experimenter. Listed below are a few of the many valuable Sams books available at electronic parts distributors and leading book stores.

USE THIS ORDER FORM

KEY CHECK POINTS IN TV RECEIVERS \$2.00

- Transistors—Their Application in Television-Radio-Electronics.** The first practical, complete book on transistors; explains circuitry, installation, testing techniques, theory and servicing. 100 pages; 5½ x 8½" illustrated. **\$1.50**
- Fundamentals of Color Television.** An up-to-date explanation of Color TV, its theory, operation, installation and servicing, with photos, block diagrams and schematics. 224 pages; 5½ x 8½"; illustrated. **\$2.00**
- Servicing TV Sweep Systems.** Describes the operation, circuit function and circuit variation of vertical and horizontal sweep systems common to most TV receivers. Tells how to analyze circuits; trouble-shoots for you. 212 pages; 5½ x 8½", illustrated. **\$2.75**
- Technical Dictionary.** Over 4,000 definitions of radio, television, electronic, electrical and radar terms. Includes valuable charts, graphs, diagrams and symbols. Flexible binding for "on-the-job" use. 160 pages; 5½ x 8½" **\$2.00**
- TV Test Instruments.** Tells how each instrument operates, how to use it in actual servicing. Covers Vacuum Tube VM's, AM Signal Generators, Sweep Signal Generators, Scopes, Video Signal Generators, Field Intensity Meters and Voltage Calibrators. 180 pages; 8½ x 11" **\$3.00**
- The Recording and Reproduction of Sound.** Oliver Read's best-seller on audio and Hi-Fi. Covers theory of sound, basic recording methods, phono reproducers, amplifiers, speakers and enclosures, attenuators and mixers, tuners, home music and P.A. systems. 810 pages; 6 x 9" **\$7.95**
- Tape Recorders—How They Work.** Explains recording theory, tape characteristics, motorboard mechanisms, drive motors, amplifiers, magnetic heads, volume indicators, equalization circuits—covers everything you want to know about recorders. 176 pages; 5½ x 8½". **\$2.75**

NOW AVAILABLE RECORD CHANGER SERVICE MANUAL, VOL. 7

Includes diagrams, photos, "exploded" views, parts lists and service data for 7 record changers and 12 tape recorders produced during 1954 and 1955. 288 pages; 8½ x 11" **\$3.00**

- Vol. 6. 20 models; 1953-54; 288 pages **\$3.00**
- Vol. 5. 32 models; 1952-53; 288 pages **\$3.00**
- Vol. 4. 38 models; 1950-51; 288 pages **\$3.00**
- Vol. 3. 44 models; 1949-50; 288 pages **\$3.00**
- Vol. 2. 45 models; 1948-49; 432 pages **\$4.95**

Auto Radio Service Manuals

- Vol. 5. Presents complete, accurate service data, schematics, parts lists and photos based on actual laboratory analysis of 87 auto radio models produced during 1954-55. 288 pages; 8½ x 11" **\$3.50**
- Vol. 4. 48 models; 1953; 288 pages. **\$3.00**
- Vol. 3. 80 models; 1950-52; 288 pages. **\$3.00**
- Vol. 2. 90 models; 1948-50; 288 pages. **\$3.00**
- Vol. 1. 100 models; 1946-49; 396 p. **\$4.95**
- So You Want to Be a Ham.** Tells you what you need to know about getting your license and acquiring equipment. Covers such subjects as: Conquering the Code; Getting Your Ticket; Going on the Air; Electronics as a Career, etc. 196 pages; 5½ x 8½"; illustrated. **\$2.50**

There is an authoritative Sams book on virtually any Electronic subject in which you're interested. Check below for FREE Book List describing all Sams books.

Send Book List



Look for
SAMS BOOKS
on the
"Book Tree"
at your Parts
Distributor

HOWARD W. SAMS & CO., INC.

Order from your Parts Jobber today, or mail to Howard W. Sams & Co., Inc., Dept. 1-E6 2201 East 46th St., Indianapolis 5, Indiana.

Send books checked above. My (check) (money order) for \$ is enclosed.

Name

Address

City Zone State

(outside U.S.A. priced slightly higher)

Easy as pie!



HIGH FIDELITY ARKAY KITS

LABORATORY TESTED



Arkay FM-AM Tuner Kit

7 tube circuit plus selenium rectifier includes separate mixer and oscillator stages, 1 double tuned IF stages with Foster-Seelye discrimination and grounded grid amplifier for excellent response characteristics.

Sensitivity: FM, 200 kc bandwidth 0 db down; AM, 200V.

Selectivity: FM, 200 kc bandwidth 0 db down; AM, 4 to 10 db down 5 db down.

Frequency Range: FM, 88 to 108 MC; AM, 535 to 1600 kc; Distortion: less than 1%; Hum Level: -70 db.

Arkay FL-10 High Fidelity Amplifier Pre-Amp Kit; Williamson Type

pushpull 12 watt output; frequency response ± 2 db 20-20,000 cps with extremely low IM and Harmonic distortion; 5 position input selector with record equalizer; loudness, bass, and treble controls; tapped output; extremely low noise level; completely enclosed—no cabinet problem; for clean, flexible, brilliant audio.

AFC control and defeat \$29.95
Available in Florida only. Model FM6

\$29.95
Write for technical information of this model.



Arkay A-12 High Fidelity Amplifier Kit

Featuring

12 watt output; push pull 6V6's; frequency response ± 1 db 20-20,000 cps with low distortion; 5 inputs, master controlled at front panel; tapped output transformer; separate bass and treble control, each with maximum db boost and cut; built-in Pre-Amplifier; ideal for home installations.

\$22.95

Amazing Miniature Radio

Featuring a superheterodyne circuit and hearing aid type ear piece, this radio kit, which has set the industry talking, receives the full AM band. 3 tube circuit brings in all stations clear as a bell and its plastic case measures only 5 1/4" x 3 1/4" x 1" as small as a pocket book.

\$12.95

OTHER KITS IN THE ARKAY LINE

- Television Kits
- Testing Equipment • Phonographs
- Audio Amplifiers • Geiger Counters
- Experimenters Equipment • Radios

Visit your local distributor for these wonderful kits and write today for the special FREE Radio Kits Catalogue and list of dealers. Your copy will be sent by return mail with no obligation. Write to

Radio Kits Inc., Dept. R-12
120 Cedar Street New York

NEW TV GRANTS SINCE FREEZE LIFT

Continuing the listing of construction permits granted by FCC since lifting of freeze. Additional stations will be carried next month.

STATE	CITY	CALL	CHANNEL	FREQUENCY	POWER*
Arkansas	Hot Springs	—	9	186-192	151 (watts)
Colorado	Montrose	—	10 (Satellite)	192-198	204 (watts)
New Mexico	Clovis	—	12	204-210	29.74
New York	Hagaman	WAST	29	560-566	251
Tennessee	Chattanooga	WRGP-TV	3	60-66	100

NEW CALL LETTER ASSIGNMENTS

STATE	CITY	CALL	CHANNEL	FREQUENCY
California	Fresno	KFRE-TV	12	204-210
Florida	Miami	WCKT	7	174-180
New Mexico	Santa Fe	KVIT	2	54-60
Tennessee	Knoxville	WBIR-TV	10	192-198

CALL LETTER CHANGES

STATE	CITY	CALL	CHANNEL	FREQUENCY
Georgia	Atlanta	WATL-TV (Formerly WOXI-TV)	36	602-608
Ohio	Cleveland	KYW-TV (Formerly WNBK)	3	60-66

*ERP=(effective radiated power, kw.)

tion is used in connection with microwave refractometers and other meteorological equipment under a variety of atmospheric turbulence conditions.

MAJOR IMPROVEMENTS in broadcast services provided by the Bureau of Standard's stations WWV, near Washington, and WWVH in Hawaii, were made recently.

The broadcasts have been increased in accuracy from one part in 50 million to one part in 100 million; also the broadcast frequencies at WWV are now normally held within plus or minus one part in a billion of the Bureau's primary standard of frequency. The standard, which is constant to one part in a billion, is derived immediately from standard quartz crystal clocks, which are evaluated over long intervals with reference to standard time from the U. S. Naval Observatory.

Time signals from WWV are maintained in close agreement with a new uniform time, called U.T.2, determined by the observatory of the navy. This is done by occasional step adjustments in time, when necessary, of precisely plus or minus 20 milliseconds. When required, they are made on Wednesdays at 1900 UT simultaneously at WWV and WWVH.

The broadcast frequency from WWVH is now normally held within 5 parts in a billion of the primary standard. Adjustments are made if necessary at the station each day during an interval of 1900 to 1935 UT. During this same interval, the time signals from WWVH are adjusted, if necessary, so as to commence simultaneously with those from WWV, within plus or minus 500 microseconds.

Six technical radio services are given continuously by the Bureau's stations: standard radio frequencies, standard audio frequencies, standard time intervals, standard musical pitch, time signals, and radio propagation fore-

casts. The radio carrier frequencies (2.5, 5, 10, 15, 20 and 25 mc.) are unchanged.

Some of the additional modifications in the broadcast program are: At WWV and WWVH, the time interval for the tones 440 or 600 cps has been shortened from 4 to 3 minutes. This gives longer intervals free from modulation, which are useful in the assessment of precision frequency standards. At WWV, the 440 and 600-cycle tones are interrupted precisely 40 milliseconds each second, except at the beginning and end of each three-minute tone interval. The time pulse commences precisely 10 milliseconds after commencement of the 40-millisecond interruption. An additional pulse, .1 second later, is transmitted to identify the beginning of each minute. As before, no pulse is transmitted at the beginning of the last second of each minute. WWV is off the air approximately four minutes each hour; the silent period commences at 45 minutes, plus or minus 15 seconds, after each hour.

At WWV the tone frequency (440 or 600 cycles) except on 25 mc., is experimentally operated as a single upper sideband with full carrier. Power output from the sideband transmitter is about one-third of the carrier power. Single sideband tone on 25 mc. may be added later. Other signals, such as announcements and seconds pulses, remain at 100 per-cent amplitude modulation, double sideband.

At WWVH the waveform of the seconds pulse now consists of 6 cycles of a 1200-cycle tone. And also from this station the radio propagation forecasts at 9 and 39 minutes past each hour are for the North Pacific area. Those from WWV at 19 1/2 and 49 1/2 minutes past each hour are unchanged; they are for the North Atlantic area.

All inquiries concerning these services should be addressed to the Bureau's

at the Boulder Laboratories, Boulder, Colorado.

NOTWITHSTANDING the Congressional investigation and the bogging effect it has had on all TV activity, a number of TV grants are being made, as indicated on page 158.

ONE OF THE EARTH'S few remaining active volcanoes, Mount Erebus, Antarctica, has been selected as the site for one of the most spectacular broadcasts ever attempted.

The main communication station at McMurdo Sound, approximately 600 miles west of Little America and an important station in the Operation Deepfreeze expedition, will attempt to transmit over the 13,200-foot volcano to Washington, D. C. a distance of 12,000 miles. If transmission is unsuccessful over the volcano, the antenna, a rhombic, at McMurdo Sound, will be reversed and transmission accomplished in the opposite direction. We'll report on these tests as soon as they are tabulated. L. W.

TUBE TESTER REACTIVATES

By LESLIE HORTON

YOUR present tube checker may be modified so as to rejuvenate TV picture tubes. The tube checker used by the author was a Heathkit Model TC-2.

Most tube checkers have a blank socket. In this space, mount an octal socket; mount the selenium rectifier, see Fig. 1, on a 1" stud fastened to the panel. The 40- μ fd. capacitor can be mounted directly to the rectifier and pin 8 on the octal socket; the 500-ohm, 10-watt resistor directly between pins 7 and 8. Any push-button switch will work here.

The operation is simplicity itself. With all the regular switches in the neutral position, insert the octal plug of the picture-tube adapter into the new socket; the duodecal socket goes onto the picture tube. One note of warning, the heater voltage on the new socket will be whatever the heater switch is set for—do not use more than 12.6 volts for rejuvenating purposes.

With the heater switch set for 12.6 volts, press the push-button for from 5 to 15 seconds.

Fig. 1. Circuit modifications made to a Heathkit TC-2 tube tester to rejuvenate.

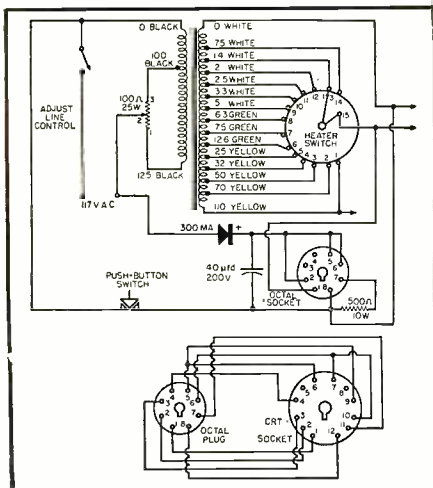

May, 1956

COMMAND

ARC-5 TRANSMITTER BC-458

Brand New.... \$495

7 to 9.1 mc. \$5.95

3 to 4 mc. like new..... \$5.95

Command Equipment (274N-ARC5, ATA)

Model	Less Tubes As Is	Excellent Used	Brand New
RECEIVERS			
520-1500 KC		\$14.95	\$19.95
1.5-3.0 MC		7.95	9.95
3-6 MC	\$2.95		
6-9 MC	2.95		
TRANSMITTERS			
2.1-3 MC		9.95	
4-5.3 MC		3.95	5.95
5.3-7 MC		3.95	4.95
100-156 MC		13.95	
BC 456 Modulator		2.95	4.95

LORAN EQUIPMENT

Marine or Airborne Long Range Navigational equipment! Determine the exact geographic position of your boat or airplane!

AN/APN4 Loran set. Frequency range 1700-2000 KC. complete with IDBG/APN4 indicator. R9B/APN4 receiver, crystal and plugs.**Brand New \$129.50**

Complete AN/APN-9 Brand New.....**\$295.00**
(Quantity prices available—write)

R-24/ARCS—Broadcast Receiver—520 to 1500 KC. broadcast band. 6 tubes: 3-12SK7, 12SH7, 12AB, 12K6, for dynamotor operation. Easily converted to 110 volt, 32 volt or 12 volt use. Two IF stages, 3 gang tuning cond. Brand new in sealed carton with tubes. Ea.**\$14.95**
New**\$19.95**

MN-26-C Remote Controlled Navigational Director. Manual DF in any one of three frequency bands, 150 to 1500 KC. 24V. Self contained dynamotor supply. Complete installation, including receiver, control box, loop, azimuth control. Left-Right Indicator, plugs, loop transmission line and flex. shafts, oper. & main manual. Ideal for use in boats, etc.
BRAND NEW \$39.50

MN-20-E Loop. Brand New **4.95**

MN-52 Crank Drive. New **2.50**

MN-26-C as is for parts **6.95**

MN-26-C Revr., New **12.95**

MN-28-C Control Box for above. New. ea. **6.95**

MN-40-B Azimuth Indicator 0-360° **9.95**
Brand New

\$4500 HI-FI Headset for only \$4.95

Uses annular grooved plastic fiber cones with voice coils as in speakers and padded chamois earmuffs to obtain spacing for correct acoustical load.
Gives finest music reproduction. 600 ohms. Checked out.

Exc. with earpads..... each \$4.95

BRAND NEW with earpads..... \$7.95

RT-24/APX-2 IFF EQUIPMENT. 44 tube transmitter, 11-6AG5, 19-6C4, 7-636, 2-9006, 1-VR150, 1-5Y3, 1-2021, 2-2C26 with usable parts, tube sockets, relays, coax fittings, condensers, resistors, etc. 24 volt Blower motor, 24V gear train motor. Power transformer 400 to 2400 cycles.**\$14.95**
Original govt. cost \$750.00.
Complete with tubes.....ea.**\$4.95**
Less tubes

A Sweet Oscilloscope Deal

INDICATOR UNIT. For conversion to test scope, panadapter, analyzer, etc. Double deck chassis. 5CP1 mounted in tube shield. Less small tubes and crystal, but complete with 5CP1.**\$9.95**
Brand new.....each

Freq. Meter—Cavity tuned—absorption type—110 VAC 60 cycle 150 to 240 Mc.**\$24.50**
Like New**\$24.50**
100 to 127 Mc.—Like New.....

REMOTE CONTROLS for your xmtr rig. Complete with mike, headset amplifier—selector unit, 400 ft. of 2 cond. cable—spare parts and trunk.**\$39.50**
New

PE-109 Inverter 12VDC input, 115V, 1.5 amps., single phase, 400 cycle output,**\$39.50 ea.**
HS-33 600 Ohm—New.....ea.**\$5.45**

HS-23 Hi-Imp. headphones—Brand New.....**\$5.45**

TS-9 Handset—Complete with cord & Butterfly switch. Brand New Original Cartons.....**\$6.95**

10 for**\$60.00**

T-26 Mobile Chest Mike. Brand new.....**\$1.29**

TU26—Excellent.....**\$1.95**

BC-375 XMITTERS

200 to 500 KC., 1500 to 12500 KC., using plug-in units, 100 Watts, Voice and C.W. Complete with tubes. Less tuning unit. Used,**\$14.95**
exc. cond.

WRITE FOR NEW BULLETIN AND PRICES.

12 V. DC DYNAMOTOR For Ham-mobile. Mobile Xmitters. Etc. Output 625 V. DC at 235 ma. These Dynamotors are NEW-UNUSED, Sig. Corp. Type DM-35, and ruggedly designed for long service. Ideally suited for application in portable or mobile transmitters, sound systems, etc. Incorporates mfg. plate and Jones connectors. Dim.: 8" long x 4 1/2" deep x 4" high. Shpg. wt. 17 lbs. **PRICED REAL LOW** for New Material**Used \$12.45**
.....**Used \$12.45**
.....**Used \$8.45**
SAME DYNO AS ABOVE EXCEPT 28V DC Input.
.....**Used 4.95**

BC 906 Cavity type freq. meter. 144 Mc to 235 Mc. Complete with antenna and operating manual. Brand new—Orig. factory pack.....**\$12.95 ea.**

SURPRISE PACKAGE

20 lbs. of MISCELLANEOUS ELECTRONIC EQUIPMENT—WORTH MUCH MORE **\$1.95** than this low price of ONLY.....

RG-8/U—COAXIAL CABLE—52 ohms, 50 ft. lengths with connectors, each end.....**\$2.95**

OIL FILLED CAPACITORS

All from 600 to 1000 volts. 2 mfd at 1000 VDC. 4 mfd at 600 VDC. 4—4 mfd at 600 VDC. 8 mfd at 600 VDC. 12 mfd at 600 VDC. 20 mfd at 600 VDC, plus others.**\$5.95**

LEEDS NORTHROP

Variable self inductance coil, 55 to 460 MH P/M 10MH. Brand New.....**\$24.95**

DYNAMOTORS

Type	Input	Output	Used	New
BD-77	12 VDC	1000 VDC	350 MA. \$14.95	
BD-83	12 VDC	375-150 MA.	1.95	\$4.95
DM-35	12VDC	625 VDC	225 MA.	8.45 12.45
DM-37	24 VDC	625 VDC	225 MA.	6.95 9.95
DM-64	12 VDC	275 VDC	150 MA.	3.95 5.95
DM-34	12 VDC	220 V	80 MA.	2.95 4.95

MOBILE HEAVY DUTY DYNAMOTOR: 14 V. INPUT-output: 1030 VDC 260 MA. Tapped 515 V. 215 MA. use or 6 V DC INPUT-500 V, 175 MA. While they last—DM-42-Excl. Condition.**\$4.95**
Brand New

METER—3"-0.5 Ma. 270° Indication—By Pass Shunt and add scale. Excellent Condition.....**\$5.00**
6 for

BRAND NEW

10 tubes for \$2.50

Includes, 316A, 211, 801, 6C4, 6SK7GT, 2X2, 1E1, EF50, 1G4, 1G6, 58, 56, 1H4, 954, 955, 957, 9006, 6SH7, 1623, 1625, 1626.

5CP1 3BP1 730A } **\$2.95 ea.**
5BP1 3CP1 31P1 }
5AP1 47A 3EP1 } **4 for \$10.00**
2J26 MAGNETRON—New.....\$1.95

LARGE CHAMOIS EAR CUSHIONS

For your headphones—brand new.....**\$1.49**

APG 5 or 15 CAVITY

10 Cm. 2C43 osc Xmmitter, 2C40 Loc. Ose. Rec. 1B27 TR; tunes 2400 to 3000 MCS, less tubes. Price

BEACON RECEIVER BC-1206-C

Complete with 5 tubes. Tunes 195 KC to 420 KC. IF Frequency—135 KC Receiver Sensitivity—3 Microvolts for 10 Milliwatts output. Output Impedance—300 Ohms and 4,000 Ohms. Volume Control—RF Gain Control. Power Supply—24-28 Volts Aeroplane Battery. Current—75 Amperes.**\$9.95**
BRAND NEW, with Tubes.....

FM WOBULATOR CAPACITOR

Frequency modulation unit with permanent magnetic field and a moving coil mechanism driving a metal diaphragm supported at its rim. This diaphragm acts as a moving plate of the frequency modulator capacitor. W/instructions, build TV sweep sig. gen. **BRAND NEW \$2.75**
2 for only.....**4.95**

AN/APR5A—Airborne superhet radar search rec. Freq. range 1000 to 6100 MC. Rec. has a 10 MC IF band width operating from 80/115V AC, single phase 60 to 2600 cps. and one amp. at 26V DC—complete with**\$250.00**
tubes

Lavoie VHF 2-Tube battery operated portable frequency meter, designed to measure frequencies from 325-725 MC. This unit is used for variety of measurements on VHF circuits. Unit has a 0-200 microamp meter. All in carrying case, with modulation.**\$14.95**
Excellent

RA-10DA Compass and Communication Receiver—Frequency range: 150-1100 KC; 2.0-10.0 MC. Complete with tubes, dynamotor **\$49.50**
and control box, New.....

CRYSTAL—100 KC. \$2.95

MG-149F—110V AC, 400 cycle-750 VA Inverter. Used.....**\$9.95**
each

ALL ITEMS F.O.B. CHICAGO
25% Deposit required with orders

R W ELECTRONICS

Dept. N, 2430 S. Michigan Ave., Chicago 16, Ill.
PHONE: CAIumet 5-1281-2-3

BUILD 16 ADIO CIRCUITS AT HOME \$19.95

With the New Deluxe 1956
PROGRESSIVE RADIO "EDU KIT" only

A PRACTICAL HOME RADIO COURSE

Now Includes
SOLDERING IRON,
TESTER, HIGH FI-
DELITY, SIGNAL
TRACER, CODE OS-
CILLATOR, PRINT-
ED CIRCUITRY

Reg. U.S.
Pat. Off.



FREE TOOLS

- No Knowledge of Radio Necessary
- No Additional Parts Needed
- Excellent Back-ground for TV
- 30 Day Money-Back Guarantee

Hi-Fi, Radio & TV Servicing Manuals on Request. (See Coupon Below).

WHAT THE "EDU-KIT" OFFERS YOU

The "Edu-Kit" offers you an outstanding PRACTICAL HOME RADIO COURSE at a rock-bottom price. You will learn radio theory, construction and servicing. You will learn how to build radios, using regular schematics; how to solder and wire in a professional manner; how to service and trouble-shoot radios. You will learn how to work with punched metal chassis as well as the new Printed Circuit chassis. You will learn the principles of RF and AF amplifiers and oscillators, detectors, rectifiers, test equipment. You will learn and practice code, using the Progressive Code Oscillator. You will build a Receiver, Transmitter, Code Oscillator, Signal Tracer and Signal Injector circuits, and learn how to operate them. You will receive an excellent background for TV. In brief, you will receive a basic education in Electronics and Radio, worth many times the small price you pay.

PROGRESSIVE TEACHING METHOD

The Progressive Radio "Edu-Kit" is the foremost educational radio kit in the world, and is universally accepted as the standard in the field of electronics training. The "Edu-Kit" uses the modern educational principle of "Learn by Doing." You begin by building a simple radio. Gradually, in a progressive manner, and at your own rate, you construct more advanced multi-tube radio circuits. Learn modern advanced theory and techniques, and do work like a professional radio technician.

THE KIT FOR EVERYONE

You do not need the slightest background in radio or science. The "Edu-Kit" is used by young and old, schools and clubs, by Armed Forces Personnel and Veterans for training and rehabilitation. The "Edu-Kit" is used in 79 countries throughout the world. Designed for universal use, the "Edu-Kit" operates on any voltage from 105 to 125 volts, AC and DC. For use in countries employing higher line voltages, a 210-250 Volt AC/DC model is available.

THE "EDU-KIT" IS COMPLETE

You will receive all parts and instructions necessary to build 16 different radio and electronics circuits, each guaranteed to operate. Our kits contain tubes, tube sockets, variable, electrolytic and paper dielectric condensers, resistors, tie strips, coils, hardware, tubing, punched metal chassis, Instruction Manuals, etc.
In addition, you receive Printed Circuit materials, including Printed Circuit chassis, special tube sockets, hardware and instructions. You also receive a useful set of tools, a professional electric soldering iron, and a self-powered, dynamic Radio and Electronics Tester. The "Edu-Kit" also includes Code Instructions and the Progressive Code Oscillator. You will also receive lessons for servicing with the Progressive Signal Tracer and the Progressive Signal Injector, a High Fidelity Guide and a Quiz Book.
All parts, components, etc. of the "Edu-Kit" are 100% unconditionally guaranteed, brand new, carefully selected, tested and matched. Everything is yours to keep. The complete price of this practical home Radio and Electronics course is only \$19.95.

TROUBLE-SHOOTING LESSONS

You will learn to trouble-shoot and service radios, using the professional Signal Tracer, the unique Signal Injector, and the dynamic Radio and Electronics Tester. Our Consultation Service will help you with any technical problems.

J. Stasatis, of 25 Poplar Pl., Waterbury, Conn., writes: "I have repaired several sets for my friends, and made money. The 'Edu-Kit' paid for itself. I was ready to spend \$240 for a course, but I found your ad and sent for your kit."

FREE EXTRAS

- Radio and Electronics Tester • Electric Soldering Iron • Set of Tools • Tester Instruction Book • Hi-Fi Book • TV Book • Quiz Book • Membership in Radio-TV Club: Consultation Service

ORDER FROM AD—RECEIVE FREE BONUS RESISTOR KIT WORTH \$5

UNCONDITIONAL 30-DAY MONEY-BACK GUARANTEE
 "Edu-Kit" Postpaid. Enclose full payment of \$19.95.
 "Edu-Kit" C.O.D. I will pay \$19.95 plus postage.
 Send me FREE additional information describing "Edu-Kit." Include FREE valuable Hi-Fi, Radio & TV Servicing Manuals. No obligation.
 (Outside U.S.A.—No C.O.D.'s. Send check on U.S. bank or Intern'l M.O. "Edu-Kit" for 105-125 V. AC/DC \$20.95; 210-250 V. AC/DC \$23.45.)
 Name
 Address

PROGRESSIVE "EDU-KITS" INC.
 497 Union Ave., Room 53E, Brooklyn 11, N. Y.

Certified Record Revue (Continued from page 74)

Spain" on an earlier *Capitol* disc, won much critical acclaim. In a highly varied program of works by Villa-Lobos, Barroso, Barrios, Ponce, and several of his own compositions, Almeida once again exhibits his dazzling technical skill and his richly expressive feeling for this type of repertoire. It would not be unkind to compare him with Segovia, who surpasses Almeida only in maturity of approach and his broader appreciation of the classical repertoire. Soundwise, Almeida is better treated than any of his contemporaries. This is a beautiful clean-cut recording, somewhat "close-up" so that finger action is very distinct, yet with just enough reverberation to keep the guitar from sounding too dry. Excellent transient and frequency response throughout the disc and the over-all realism was greatly aided by the superlatively quiet *Capitol* surfaces.

WAGNER PROGRAM Detroit Symphony Orchestra conducted by Paul Paray. Mercury MG5044. RIAA curve. Price \$3.98.

It is something of a paradox that Frenchman Paul Paray should be such a successful conductor of the music of Richard Wagner. There is more profundity and hewing to accepted lines in the conducting of Wagner by Furtwangler, Mengelberg, Reiner, and several others one could name, but it does not lessen the exciting experience that Paray can make of Wagnerian music. I have heard critics carp at his departure from classicism and other shortcomings and to this learned drivel, I say "Foosh!" Let's face it, Wagner has been darn near done to death. A fresh approach, even if inconsistent with accepted mores is at least refreshing.

Paray revels in the polyphonic textures of Wagner and does his utmost to bring this element to the fore. This is a newer, more vital Wagner, the spirited colt rather than the tired warhorse. Which is not to say that Paray is not properly reverential in his approach to the "Good Friday Spell" from "Parsifal" as heard on this disc. His perusal of this is not as "heaven reaching" nor profound as the old Toscanini reading, but the essential emotion is there, the respect of subject is not wanting and the whole is quite satisfactory. Nor is Paray unaware of the throbbing unbridled emotionalism of the "Prelude" and "Love Death" from "Tristan and Isolde." Except for the super-sensuous, heart-wrenching despair of the tremendous climax in the "Love Death," which Stokowski manages to evoke in his reading, Paray realizes the basic beauty of the score without wallowing in over-sentimentality, a common shortcoming of many of his contemporaries.

Paray comes into his own in the overture to the "Flying Dutchman" which in his capable hands, really flies! This is a tumultuous, explosive orchestral *tour-de-force* and Paray extracts great sonorities from his orchestra which are quite unbelievable. The tempi are on the fast side, dynamics are almost brutally expressive, and the whole is a taut, supercharged reading of a work which often suffers heavy-handed treatment from other conductors. In the final work, the "Siegfried Forest Murmurs," Paray is again challenged by Toscanini but does not especially defer to him. Where Toscanini's reading is ethereal, an almost other-world-like picture of nature, Paray's is more earthy, richly expressive with the typical Frenchman's love of nature an easily discernible facet.

The sound on this disc is sheer magnificence. The strings are rich and luxuriant, and an edgeless delight. The brass, especially French

horn and trombone, has that bright sheen one notices in the concert hall, the flutes, clarinets, oboe, and other woodwinds are reproduced with exceptional clarity, and the percussion is quite overwhelming. Listen to the opening bars of the "Flying Dutchman." Gadzooks, what a sound! You can hear the sharp brazen voice of the trumpets, trombones and French horn, including the peculiar intermodulation of the trombones and horns, the coruscating clash of cymbal and the heavy punctuation of the tympani and resoundingly huge thud of the bass drum. With the very wide dynamics involved and the tremendous transients, this is a sound to severely test even the best and biggest of hi-fi systems! Throughout the other works on the disc, the sound is equally exemplary. Frequency and dynamics are very wide, transient and groove distortion is minimal and while the elaborate polyphonic detail of the colorful Wagner orchestration is completely distinct, the whole has been clothed in spacious acoustics which affords a fabulous "liveness" to the reproduced sound. Truly, this is one of the finest Wagner recordings in the LP catalogue and well worth anyone's attention.

BRAHMS HUNGARIAN DANCES (COMPLETE) Vienna State Opera Orchestra conducted by Mario Rossi. Vanguard VRS473. RIAA curve. Price \$3.98.

The "Hungarian Dances" are not lacking in recorded performances as attested by the 16-odd discs in the LP catalogue, but for the most part these are only fragmentary, the most popular of the dances being mercifully "warhosed." Here we have the complete set of the "Hungarian Dances," with many lovely sections which will be totally unfamiliar to most people. An Italian conductor would seem a poor choice for this repertoire, but Rossi has surprised and earned the respect of many for his versatility and excellence in other works, supposedly equally unsuited to his talents. His reading here is fairly straightforward, he stays pretty close to the line, except in matter of tempi, where, happily, he has diverged and assayed a faster pace, which gives his performance a warmth and sparkle not found in many other recordings. He does not attempt a "gemutlichkeit" approach to the score, letting the essential folk elements of the work speak for themselves and this he manages most eloquently.

Sound is in the best *Vanguard* tradition, which is to say good clean string tone, bright crisp brass, fluent smooth woodwinds, and sharp accurate percussion. Frequency range and dynamics are outstanding in their breadth, good transient response was a feature, there was no discernible groove distortion. Slight pre- and post-echo the only blemish in an otherwise beautiful recording. If you like the familiar sections of the "Hungarian Dances" you'll enjoy this further exploration into this charming music.

HANDEL SIX CONCERTI GROSSI (Op. 3) Boyd Neel Orchestra conducted by Boyd Neel. London LL1130. RIAA curve. Price \$3.98.

Boyd Neel has long been admired as an interpreter of Handel and his recording of the twelve "Concerti Grossi Opus 6" is one of the finest things in the LP catalogue. Here he turns his talents to an earlier set of Handel concerti, which in addition to the usual complement of strings is scored as well for oboes, flutes, and bassoons, and in several of the concerti, harpsichord and organ is added. This is the work of a younger Handel and this is reflected in the very light and charming, altogether spirited scoring of these concerti. Of the six, I like the 4th, 5th, and

To insure only top quality merchandise Solar Electronics "set tests" each electron tube in powerfully loaded chassis.

Here Is Our New Guarantee Policy: Money back within 5 days of receipt of merchandise PLUS 5 year free factory replacement. ALL TUBES ARE CODED BY MONTH AND YEAR!

FREE BONUS OFFER!



A terrific Eico Tube Tester or TV FM Sweep Generator FREE when you buy \$200 worth of receiving tubes or more within 60 days at Solar. Tester or generator may be bought outright from Solar for \$33.50.

ANTENNA SPECIALS

List \$15! **\$845**

Complete Outdoor ALL CHANNEL CONICAL

Includes: 8 element antenna with crossbar, 5 ft. seamless aluminum mast chimney mount or 7" wall bracket, 8 stand offs, 50 ft. of 300 ohm wire. State your need!

New Indoor Antenna

\$375

Brings in UHF and VHF. Use on Top of TV. List \$9.95. Your Price

USED TV SETS

PICTURE TUBE GUARANTEED TO WORK!

10" Set Table Model ... \$17.50 Console ... \$20.00	16" Set Table Model ... \$32.50 Console ... \$35.00
12" Set Table Model ... \$22.50 Console ... \$25.00	17" Set Table Model ... \$36.00 Console ... \$38.50
14" Set Table Model ... \$27.50 Console ... \$30.00	19", 20", 21" and 24" Sets—prices on request.

FAMOUS MAKE TEST EQUIPMENT!

TUBE TESTER KIT

\$33²⁵

In carrying case
Factory wired, \$44.95

VACUUM TUBE VOLTMETER KIT

\$24⁹⁵

Factory wired, \$37.50

FLYBACK TRANSFORMER and YOKE TESTER KIT

\$21⁷⁵

Factory wired, \$31.75

Test Equipment Factory Guaranteed For One Year! ALL PARTS SHIPPED F.O.B. HARRISON, N. J.

EASY TERMS!

We pay all postage or freight in USA, Territories and APO's. 25c handling on orders less than \$5. Please send 25% deposit with C.O.D.'s. Remember! Your money cheerfully refunded within 5 days if you are not completely satisfied.

Electron Tubes With Energy Like The Sun
SOLAR ELECTRONICS

PICTURE TUBE SPECIALS!

Brand New—RCA Licensed
—One Year Guarantee

Type	Price
10BP4 or A	\$11.25
10FP4	\$14.95
12QP4 or A	\$13.95
12CP4	\$13.95
12JP4	\$13.25
12UP4	\$14.95
14BP4 or A	\$15.95
14CP4	\$15.95
15DP4 (for Du- mont)	\$17.95
16AP4 or A	\$18.95
16CP4 or A	\$18.95
16DP4 or A	\$18.75
16EP4	\$19.45
16GP4	\$19.25
16HP4 or A	\$18.75
16JP4 or A	\$18.75
16LP4 or A	\$18.75
16KP4	\$18.50
16RP4	\$18.50
16ZP4 or A	\$19.25
17BP4	\$19.85
17CP4	\$20.85
17GP4	\$21.25
19AP4	\$23.95
19DP4 or A	\$23.50
19FP4	\$24.25
20CP4 or A	\$24.50
20DP4 or A	\$24.50
21AP4	\$27.95
21EP4A	\$27.50
21FP4	\$28.25
21YP4	\$28.25
24AP4	\$44.95

All Picture Tubes Shipped FOB Harrison, N. J.

BIGGEST VALUES! BIGGEST SELECTIONS!
Partial List Only!

Type	Price	Type	Price	Type	Price	Type	Price
0A2	.67	6A7	.55	6SH7	.43	12K7	.49
0D3/VR150	.90	6AB4	.45	6SJ7	.43	12Q7	.44
0Z4	.44	6AC7	.65	6SK7	.44	12SA7	.43
1A4P	.30	6AF4	.85	6SL7GT	.53	12SG7	.59
1A7GT	.45	6AG5	.50	6SN7GT	.53	12SH7	.59
1A2	.65	6AG7	.75	6SQ7	.37	12SJ7	.44
1B3GT	.63	6AH4GT	.65	6S57	.43	12SK7	.43
1B4P	.88	6AH6	.64	6T4	.89	12SL7GT	.59
1C5GT	.45	6AK5	.57	6T8	.65	12SN7GT	.53
1D5GP	.40	6AL5	.38	6U8	.73	12SQ7	.35
1E7GT	.40	6AN4	1.25	6V3	.77	12V6GT	.44
1E7GT	.40	6AN8	.99	6V6GT	.44	12X4	.35
1H4G	.35	6AQ5	.45	6W4GT	.38	14A5	.90
1H5GT	.45	6AS6	1.50	6W6GT	.55	14A7	.44
1L4	.47	6AT6	.36	6X4	.35	14B6	.39
1L6	.53	6AU4GT	.70	6X5GT	.35	14E6	.59
1LA4	.55	6AU5GT	.60	6X8	.75	14E7	.59
1LA6	.55	6AU6	.40	6Y6G	.49	14F7	.59
1L84	.55	6AU7	.85	7A4	.44	14F8	.69
1LC6	.51	6AV5GT	.65	7A5	.53	14N7	.69
1LH4	.55	6AV6	.36	7A6	.44	19B6G	1.10
1LN5	.51	6AX4GT	.65	7A7	.44	19T8	.64
1N5GT	.53	6AX5GT	.59	7B4	.43	24A	.35
1R5	.58	6B8	.75	7B5	.40	25BQ6GT	.75
1S5	.41	6BA6	.45	7B6	.44	25CU6	1.10
1T4	.49	6BA7	.55	7B7	.44	25L6GT	.45
1T5GT	.57	6BC5	.50	7B8	.44	25W4GT	.42
1U4	.55	6BE6	.46	7C4	.44	25Z5	.39
1U5	.41	6BF5	.42	7C5	.44	25Z6GT	.35
1V2	.63	6BG6G	1.10	7C6	.44	26	.48
1X2	.65	6BH6	.52	7E5	.59	27	.29
2A7	.50	6BJ6	.49	7F7	.59	32L7GT	.53
2X2A	.55	6BK5	.65	7F8	.69	35	.32
3A4	.55	6BK7	.75	7H7	.69	35/51	.33
3A5	.55	6BL7GT	.69	7J7	.69	35A5	.44
3AL5	.48	6BN6	.60	7K7	.69	35B5	.48
3AU6	.48	6BO6GT	.75	7N7	.54	35C5	.48
3BC5	.56	6BQ7	.80	7X7	.69	35L6GT	.45
3BN6	.65	6BY5G	.60	7Y4	.39	35W4	.35
3CB6	.56	6BZ7	.80	7Z4	.39	35Y4	.35
3Q4	.45	6C4	.35	12A7	.38	35Z5GT	.35
3Q5GT	.55	6CB6	.50	12A7	.65	37	.30
354	.52	6CD6G	1.10	12AU6	.42	39/44	.35
3V4	.52	6CU6	.90	12AU7	.52	50A5	.44
4BQ7	.92	6D6	.45	12AV6	.38	50B5	.48
4BZ7	.97	6F6	.40	12AV7	.73	50C5	.48
5A0Q5	.52	6H6	.42	12AX4GT	.67	50L6GT	.45
5J6	.60	6J4	1.50	12AX7	.69	75	.40
5U4G	.45	6J5	.38	12AZ7	.65	76	.40
5U8	.68	6J6	.50	12BA6	.65	77	.40
5V4G	.56	6K6GT	.36	12BA6	.45	78	.40
5V6GT	.52	6L6	.65	12BA7	.59	80	.35
5X8	.78	68GT	.74	12BE6	.45	84/624	.41
5Y3	.29	6SA7	.44	12BH7	.59	117L7GT	1.39
5Y4G	.35	6SC7	.50	12BY7	.64	117N7GT	1.29
5Z3	.40	6SF5	.60	12CU6	1.09	117P7GT	1.29

SEND FOR FREE TUBE LISTING

SOLAR ELECTRONICS Post Office Square ESsex 4-5300
Harrison, N. J.

NEW BE QUALITY WISE .. BUY QUAL-KITS!

Hi-Fi AM-FM Tuner

Advanced 7 tube circuit provides full sensitivity and selectivity giving this AM-FM tuner exceptional hi-fi reception. Armstrong FM circuit with limiter, Foster-Seely Discriminator, 20-20,000 cps response, Full AFC control—no drift.



Hi-Fi Amp. Complete 6 tube-10 watt amplifier. Push-pull beam power output, built-in pre-amp. 5 position selector switch, 3 position record equalization, LP, RIAA, Eur. Response 1/2 db. 20-20,000 cps. Output 10 watts at less than 2% IM. Low noise level and harmonic distortion.

\$28.95

\$28.50

Cover and legs optional.

Every kit complete with 28 page fully illustrated, instruction and assembly manual. Write today for FREE catalogue and name of nearest dealer carrying these remarkable units.

Quality-Electronics Dept. T-4

319 Church Street New York 13, N. Y.

Latest HICKOK

Tube Tester Roll-Chart

To keep your HICKOK Tube Tester up to date, HICKOK reprints new roll-charts every 6 months. Easy to install. Send \$1 ... Be sure to specify model number of your HICKOK Tube Tester.

THE HICKOK ELECTRICAL INSTRUMENT COMPANY
10524 Dupont Ave. • Cleveland 8, Ohio

LMB BOX CHASSIS OFFERS FREE inside LMB boxes

10 tested kit diagram projects for the builder. Each one of these kit diagrams built by a recognized expert. Kit projects are complete in every detail. Circuit diagram, photo of project both front and rear photo. Rear photo shows wiring and parts. Detailed instructions for building, complete parts list and approximate cost. Complete to build except parts and your distributor can supply the parts. Ask your distributor for the list of LMB kit Diagram Projects. If he does not have them, write to

LMB 1011 Venice Blvd.
Los Angeles, 15, Calif.

do you want to learn TV servicing?

Just master the first few chapters of

ELEMENTS OF TV SERVICING

by ABRAHAM MARCUS (co-author of famous best seller, "Elements of Radio"), and SAMUEL GENDLER

And you are ready for business! Written in the same clear, easy-to-understand style that sold over a million copies of MARCUS' famous ELEMENTS OF RADIO.

Chapters 3 to 5 cover servicing in the field—servicing that takes care of over 80% of all service calls.

Chapters 6 to 14 cover bench servicing which accounts for the remainder of the service calls.

Chapters 15 to 17 cover the theory and servicing procedures for color television.

THE ONLY BOOK THAT GIVES FULL DETAILS OF THE NEW RCA 28-TUBE COLOR TV CIRCUIT

587 pages fully illustrated in black-and-white and in color

Published by Prentice-Hall, \$6.95
Get your copy today!

STANLEY ELECTRONICS

Write for new
Tube & Parts
catalog.

TUBES & Parts

PAY LESS HERE!

Special Introductory Offer!

DEDUCT 10%

from the total, if your order is \$20 or more!

Outstanding value!

300 Ohm. TWIN LEAD TV WIRE 100 feet \$1

TOP QUALITY TUBES

• Individually boxed • One year RTMA guarantee
• Best Brands Available • Partial listing

Type	Price	Type	Price	Type	Price	Type	Price
OZ4	.45	6AL7GT	.70	6S7G	.47	12BY7	.46
1B3GT	.79	6AS5	.50	6SA7GT	.50	12SA7	.52
1L4	.51	6AS6	2.00	6SC7	.50	12SH7	.47
1L6	.51	6AS7G	2.25	6SG7	.43	12SK7GT	.50
1L4A	.57	6AT6	.40	6SH7	.45	12SL7GT	.60
1L84	.66	6AU6GT	.70	6S17GT	.45	12SN7GT	.57
1L6C	.66	6AU6	.43	6SK7	.50	12SQ7GT	.40
1LD5	.57	6AV5GT	.75	6SL7GT	.70	14A5	.59
1LE3	.57	6AX5GT	.59	6SN7GT	.57	14A7	.45
1L65	.57	6B4G	.90	6SQ7GT	.44	14B8	.40
1LH4	.66	6B4E	.49	6V6GT	.48	14Q7	.52
1LN5	.47	6B5	.50	6W4GT	.40	18BSSG	1.18
1NSGT	.55	6BE6	.46	6W6	.60	19J6	.56
1R4	.66	6BG6G	1.18	6WG6T	.53	19T8	.70
1R5	.51	6BH6	.53	6X4	.35	25A7GT	1.50
1S4	.59	6BJ6	.49	6X5	.39	25AV5GT	.80
1S5	.51	6BK5	.70	6X5GT	.38	25B8G	.98
1T4	.51	6BK7A	.78	6X8	.75	25BQG	1.18
1U5	.50	6BN6	.59	6Y6G	.80	25V5	.45
1V	.57	6BL7GT	.77	7A4	.47	25Z5	.42
1X2A	.62	6BQ6GT	.80	7A5	.55	25Z6GT	.42
2D21	1.00	6BQ7A	.80	7A6	.47	35A5	.48
2V3G	.80	6BZ7	.90	7A7	.45	35B5	.48
2X2A	.90	6BY5G	.60	7A8	.46	35C5	.48
3D6	.45	6C4	.99	7B5	.49	35L6GT	.48
3FL4	.69	6C5	.36	7B7	.43	35W4	.39
3Q4	.55	6C6	.50	7B8	.47	35Y4	.40
3Q5GT	.63	6C6B	.51	7C4	.40	35Z3	.41
3V4	.58	6CD6G	1.18	7C5	.44	35Z6GT	.39
5T4	.70	6D5	.50	7C6	.45	50B5	.48
5U4G	.49	6E5	.46	7F8	.70	50C5	.43
5V4G	.71	6F6	.40	7Y4	.35	50L6GT	.48
5Y3GT	.89	6HG6T	.40	12AT6	.41	75	.44
5Y4G	.43	6J4	2.00	12AT7	.68	77	.39
5Z3	.45	6J5GT	.40	12AU6	.46	78	.39
5Z4	.54	6J7	.49	12AU7	.58	80	.35
6A7	.59	6J7	.45	12AV6	.42	33V	.60
6A8	.59	6K6GT	.39	12AX7	.63	11L7GT	2.00
6AB4	.45	6K7	.40	12AY7	.90	11N7GT	2.00
6AF4	.80	6L7	.44	12BA6	.46	11P7GT	2.00
6AG5	.52	6N7	.61	12B4	.70	11T73	.37
6AH6	.80	6Q7	.45	12BE6	.46	11T26GT	.65
6AK5	.89	6S4	.48	12BH7	.50		
6AL5	.42						

Dumont and RCA licensed PICTURE TUBES

• All brand new • One year guarantee • Discounts for the Quantity Purchaser • Partial listing • Picture tubes F.O.B. Passaic, N. J.

Type	Price	Type	Price	Type	Price
10BP4	10.95	16DP4	18.50	17GP4	21.00
12LP4	12.95	16P4	19.25	17LP4	18.00
14CP4	13.95	16KP4	17.00	19AP4	23.00
14CP4	15.25	16RP4	17.00	20CP4	24.00
15DP4	16.95	17BP4	19.00	21ALP4A	24.00

Write for Stanley's Tube & Parts Catalog!

FREE ELECTRIC TESTER equipped with genuine neon glow lamp. Test loads from 30 to 500 volts, AC or DC. With every \$3 or more ordered.

COUPONS Reg. \$4.95 5 pc. **SYLVANIA REPAIR KIT** Inc. flashlight head, Phillips and flat head screwdrivers, alignment tool and case, with every order of \$25 or more.

Terms: free postage on all Cont. U.S.A. orders. 50c handling charge on all orders under \$75.00. 25% deposit required on all C.O.D.'s. Subject to prior sale.

Stanley ELECTRONICS
935 MAIN AVENUE - PASSAIC, N. J.

DEPT. RN-456 GRegory 1-2498

6th the best. Neel knows his way around the intricacies of the Handelian scoring and nowhere is his mastery more evident than in his handling of the tricky 1st, 3rd, and 4th movements in the "4th Concerto." His tempi are always firm, his dynamic phrasing quite deft and one notices immediately the superbly disciplined playing of his orchestra.

These are marvelous little works and even though the title may seem formidable to those whose classical exposure has been limited to Tchaikovsky and other romantics, if you'll take five minutes to listen to this disc I think there will be many who will be surprised to find they like this charming work.

This present recording is superior both in performance and sound to the earlier disc by Prohaska and the Vienna State Opera Orchestra on the *Bach Guild* label. Good as the sound was in the older recording, it is here where this disc really shines. The famous Boyd Neel strings are heard with superb clarity and definition. They are precise, soft and sweet when called for, with a good aggressive bite in the allegros and vivaces. The flutes, oboes and bassoons are almost tangibly "live," their timbres being reproduced with convincing accuracy. The organ is a small chamber type and is baroque-like in its voicing. No big pedals here for the hi-fanatic... this is the nasal, reedy sound typical of that organ and quite appropriate for the score. This is sound of exceptionally wide range with a close-up perspective of detail, but with sufficiently spacious acoustics to maintain the feeling of concert-hall depth. Fortunately the engineers realized that this is, after all, just a smallish chamber orchestra, so the reverb is reasonable for a group this size. A little pre- and post-echo, the only fault in an otherwise splendid recording.

BETHOVEN
SONATA #14 IN C SHARP MINOR ("MOONLIGHT")
SONATA #3 IN C MINOR ("PATHETIQUE")

Rudolph Firkusny, pianist. Capitol P8322. RIAA curve. Price \$3.98.

This marks the recording debut of Firkusny on the *Capitol* label. And it is every bit as auspicious as was Nathan Milstein's of some time back. It looks very much like *Capitol* is going to do the same thing for Firkusny as it did for Milstein, make an already established artist, a still bigger name. How? By affording the artist superb recording, far better than was his lot with his previous record association. I still insist that, performances aside for a moment, if you can hear a given artist in sound of superior quality, that you can have a better appreciation of his talent. And somehow, the artist himself, feels impelled by this better sound quality (probably because his mistakes are all the more glaring and obvious) to perfect and polish his performance. Out of the eighteen recordings of the "Pathetique" and the nineteen recordings of the "Moonlight," I can't really say that Firkusny's is the top performance. He is shaded quite a bit by Backhaus and Gieseking in the "Pathetique" and by Kempff, Backhaus, and Gieseking in the "Moonlight." On the other hand, he does far better than many of the rest. His is the rather broad approach, with inner detail somewhat subservient to his sustaining of the classic line. All in all, more than acceptable performances, with sound quality that surpasses all previous efforts. The piano is very clean-lined, richly sonorous in the crisp delineation of its tone. This is a very expansive sound, recorded close-up, with a relatively short reverb period. There was no audible wow or flutter, transient ringing was minimal, the whole a believable mirror of a good-sounding piano. The very quiet surfaces

110 VOLT POWER SUPPLY

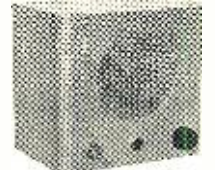

For ARMY or NAVY COMM. RECEIVERS
JUST PLUG IN And TURN ON ... That's ALL!

- 4 Inch SPEAKER
 - VOLUME CONTROL with On-Off Switch • C W Switch
 - NO CONVERSION of Set
 - For BC-453-454-455-946 or Any Other Sets Requiring 24 V @ 1 A and 250 V @ 50 MA
- Completely assembled. Has Cord and Plug to fit rear of receiver. Gray hammer tone finish. Shipping weight: 8 lbs. 25% Deposit on C.O.D. Orders!
- \$18.95** Postpaid U.S.A. ORDER NOW!

TAYLOR MFG. CO.
302 S. Union St. Lima, Ohio

Let me prove you can **FIX TV and F-M** 1/3 FASTER



I'll send you my new guide "TELEVISION and F-M RECEIVER SERVICING" for 10 DAYS' FREE USE if you mail coupon now!

By return mail I'll send you the biggest, most complete book on TV and F-M servicing ever published! Use it 10 DAYS FREE. Profit from its shortcuts, use its step-by-step methods and ideas on the sets in your shop and on your calls. Then if these practical techniques don't help you FIX SETS at least 33% FASTER, return the book and you don't owe me a cent!

Sample Contents from this Giant 320-page Book:

572 clear, easy-to-follow photos, drawings, layouts, schematics, diagrams, tables • 29 pages on antenna installation with details on 10 types • 80 pages on operation and servicing of: R.F., Video I.F., Video Detector Stages, Video amplifiers, D-C Restorers, A.G.C. Systems, picture tubes, test equipment • Complete chapter on Inter-carrier Receivers • 64 pages on Deflection Systems • Full chapter on aligning TV receivers • 40 pages on F-M fundamentals, receiver circuits, alignment, tips on servicing • Extra! Thorough Guide to U.H.F. television!

Yes, here's the first book that gathers everything about TV and F-M Receiver Servicing and puts it into one great, easy-to-use manual, illustrated with almost 600 clear pictures to help you fix more sets faster, save time and make more money! Fill in and mail coupon now. Let Milton Kiver send you his book by return mail to prove you will profit. Use book 10 DAYS FREE!



SEND NO MONEY

Milton S. Kiver, c/o D. Van Nostrand Co., Inc. Dept. RTN-556, Princeton, New Jersey

Send me a copy of TV and F-M RECEIVER SERVICING to use 10 DAYS FREE. At the end of that time I'll either remit \$4.20 (plus few cents postage) or will return book and owe nothing.

Name

Address

City Zone State

aided the illusion that the piano was "in the room" with you. I should imagine with Firkusny on their roster we will be getting some fine piano concertos from *Capitol*.

DVORAK
SLAVONIC DANCES (COMPLETE)
TCHAIKOVSKY
ROMEO AND JULIET OVERTURE
Vienna Philharmonic Orchestra conducted by Rafael Kubelik. London LL1283/4. RIAA curve. Price \$7.96. Two discs.

When Kubelik signed with *London Records* after a distinguished tenure with *Mercury*, it was expected that his considerable talents would be used for major repertoire. The first fruit was his magnificent performance of the Mahler "1st Symphony" and now in his latest recording we have what must be described as the definitive reading of the Dvorak "Slavonic Dances." Of the fifteen other recordings in the catalogue, only fellow countryman Talich can compete with Kubelik in this highly idiomatic music. And Talich fades from consideration since the sound of his recording (even the post-war version . . . he has five recordings in the LP catalogue) is but a pale shadow beside the gorgeous quality of this present *London* disc.

The only word for Kubelik's work in this recording is fabulous. How else to describe his vigor and power, the careful modeling, and dynamic shadings, the light hand on the orchestral rein which imbues the various sections with graceful warmth, with wonderful rhythmic spontaneity? And with Dvorak's colorful score, the *London* engineers have a field day! This is a richly satisfying sound, a tribute to the fine work Kubelik has done with the Vienna Philharmonic. The strings are exceptionally clean and almost luminous in the warmth of their projection, the famous Vienna woodwinds are most pervasively "live," brass is very bright and punchy, and the percussion is quite weighty and completely articulate. There is a marvelous acoustic balance here which lends an almost "3D" effect if heard through two speakers. Frequency and dynamic range are very wide; transient, or groove distortions were not audible, surfaces were quiet.

These "Slavonic Dances" are indeed an outstanding recorded experience, but why, oh why, did they have to couple them with Tchaikovsky's "Romeo and Juliet"? Surely, most people who are at all interested in hi-fi and recorded music, have long since acquired a copy of this poor tired warhorse. The fact that Kubelik gives a perfectly good performance with excellent sound, does not justify this coupling, when so many other far more appropriate works could have been recorded. Oh well, I guess I shouldn't gripe . . . the Dvorak is so splendid that it is well worth the price of the records!

LISZT
A FAUST SYMPHONY
L'Orchestre de las Societe Des Concerts de Paris and L'Orchestre de la Suisse Romande conducted by Ataulfo Argenta. London LL1303/4. RIAA curve. Price \$7.96. Two discs.

The prize here is the first really modern recording of the "Faust Symphony." This new version with the young Spanish conductor Argenta at the helm is miles ahead of the poor-sounding uneven performance by Sebastian on the *Urania* label. This theatrical score is not played too often these days, and I'm reasonably certain that the vast majority of hi-fi fans don't know the work at all. As a whole the score is a bit too contrived for the more sophisticated musical palates, but the hi-fi fan has never been known to turn a deaf ear to an exciting, even if somewhat bombastic work!

BARGAINS IN OUTSTANDING SURPLUS ELECTRONICS!

MOBILE FM RADIOTELEPHONE 152-174 MC.

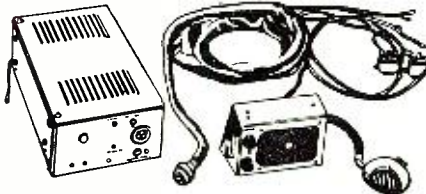

Mfd. by RCA, Model CMV-1A, type approved by FCC for Taxicabs, Common Carrier Mobile Radiocommunications, Industrial, etc. Single channel, crystal controlled transmitter and receiver. Power output is 5 to 10.0 watts at the higher frequencies, and 10 to 12 watts below 162 mc. Double conversion superheterodyne circuit, with 2 stages of RF amplification provides adequate selectivity. Also, 2 limiter stages and speech circuit. Transmitter-Receiver includes 6-Volt (DC) Power Supply in single case measuring 16" L. x 9" W. x 3 3/4" H. Remote Control includes Loudspeaker and all necessary controls (Volume, Squelch, On-Off, etc.), and microphone as illustrated. Supplied complete with all necessary relays, cable for trunk installation, instruction sheets and diagram. Everything but antenna! Condition USED-EXCELLENT. Shpg. wt. 70 lbs.
PRICE, PER COMPLETE SET, as above but \$119.50 not tested \$139.50

PRICE, COMPLETE, thoroughly checked out and tested. \$139.50

15-600 KC RECEIVER

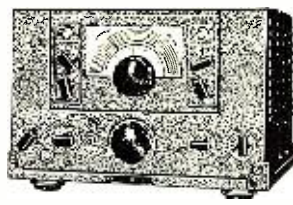

Navy Model RBL, mfd. by National and Wells Gardner (both types available) for ship and shore application. Designed for 110V. AC, 50-60 cycle operation. Receives CW, ICW and Phone signals, throughout the entire range of 15 to 600 KC (16 Bands).

Employs 7 modern metal tubes in TRF circuit with regeneration, plus two audio filters to allow choice of two band widths, 600 or 3000 cycles at 20 db down with peak response occurring at 750 and 1000 cps respectively. Also incorporated audio limiter stage which reduces noise and interference. This is an excellent receiver for wireless operators, hams, and all others interested in the long and intermediate wave bands. Dim: 17 3/4" x 15 1/2" D. x 10 1/2" H. (less shock mounts). Supplied complete with tubes, instruction sheets and diagram. Shpg. wt. 135 lbs.
PRICE, EACH, Excellent-Like New Condition \$79.50
PRICE, EACH, Used-Good Condition. \$64.50

DM-35 DYNAMOTOR

Ideal for Marine, Ham-Mobile, and Mobile PA eqpts., rated at 625 volts DC output at 225 ma., 12 V. DC INPUT. THESE UNITS ARE NEW, ORIGINAL EXPORT PACKING, with Spare Brushes, etc. Don't be misled or confused by reconditioned or slightly-used lower priced dynamotors quoted as new. We guarantee this dynamotor to be as represented! Shpg. wt. 17 lbs.
THESE ARE A REAL BUY
EACH \$12.95
AT

V.H.F. TEST EQPT.

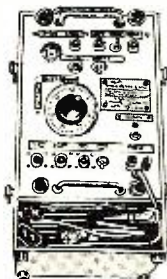

A Complete Test Instrument covering 150 to 250 mc. operating from 110 V. AC, 50/70 cycles. AC mfd. for Navy Model OAP. Permits following functions: (1) Tune a transmitter to given frequency. (2) Tune a receiver to a given frequency. (3) Adjust antenna system for best performance. (4) Measure power output of a transmitter. (5) Check wave shape of transmitter output with auxiliary oscilloscope. (6) Monitor a transmitter during operation. Incorporates Calibrated Tuned Absorption-Type Wave-meter. Signal Generator, a detector-amplifier circuit with electric-eye indicator which shows exact resonance with applied signal, plus an unbalanced VM Input connection so that this circuit will serve as a tube voltmeter. All housed in a metal cabinet, with cover, 15 1/2" L. x 8 1/2" W. x 10 1/2" H. Includes calibration chart, service manual and instruction line cord. LIKE-NEW condition. Shpg. wt. 50 lbs. **EACH \$49.50**

3-RANGE SIGNAL GENERATOR

Well-built and highly engineered, this test signal generator is a rare bargain for laboratories, service shops, and for production testing in factories. Known as the OAV-1 Test Generator, it provides any one or all of 3 outputs: (1) a V.H.F. output variable from 150 to 250 mc.; (2) a 15 mc. output (which can be changed to another nearby frequency for TV-IF alignment); and (3) Multivibrator output of .1, 1.0, 10.0 and 100 KC by means of a selector switch. Frequency stability is excellent and calibration at least as good as any excellent service signal generator. Includes following tubes: 1-25GCT, 1-6SL7, 1-6AG7, and 1-6X4. Operation is from 110 V. AC, 60 cycles. 1-phase AC. Dimensions are 14-19 1/2" L. x 11 1/2" D. Shpg. wt. 85 lbs. NEW units, with operating instructions and Schematics. **ONLY \$24.95**

SELECTIVE RINGER FOR MOBILE or MARINE RADIOTELEPHONES

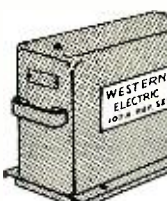

Western Electric Model 107A, for use with Bell telephone system for selective calling of marine or mobile radiotelephones. Operates at 600 and 1500 cycle tones, at a rate of 8 to 11 frequency shifts, actuates a selector mechanism to close a ringing or light circuit (not supplied). Dimensions of unit are: 14-1/16" long, 8 3/4" high, and 6-27/32" wide. AC operating voltage of from 90 to 250 V. is obtained from receiver. NEW-UNUSED units with Instruction Book, Reg. **PRICE, EACH, \$85.00**

FM TRANSCEIVER 28-39 MC.

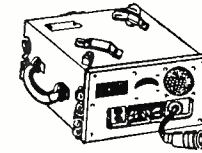

Signal Corps BC-659, part of popular SCR-609/610 Vehicle radio-cpt. Combination Transmitter-Receiver for Communications, 2 channels both crystal-controlled. Transmits and receives in one of many military or special applications, but receiver is identical to monitor 28 to 39 mc (can be extended by removing a few coil turns). Incorporates built-in loudspeaker, and construction is such to permit easy under dash mounting to permit complete access to front panel controls, simply required to provide 90 to 150 volts "B" supply, and 1.5 volts "A" supply. The PE-117 or 120, available separately, supplies these voltages from a 6, 12 or 24 volt DC source, batteries or other supply can be easily adapted. Dim. of Transceiver: 16" L. x 13" W. x 7 1/2" H. Supplied complete with all tubes and Instruction Sheets with Schematic Diagram. Shpg. wt. 50 lbs.

PRICE PER SET, Excellent Condition \$49.50
Price, PE-120 Power Supply, above \$25.00
Used-Good \$25.00

LIMITED QUANTITY BARGAINS

GENERAL RADIO TYPE 8048 SIGNAL GENERATOR. mfd. by Federal Mfg. covers 8 to 330 MC in 5 bands, with precision calibration. Incorporates: microvolt calibrated attenuator, internal (amp) modulation with precision modulator, internal 110 V. AC power supply. Used-Very Good Condition. Shpg. wt. 70 lbs. **\$79.50**

CONDENSER MICROPHONE, WITH 2-STAGE PRE-AMP. Real, Precision quality construction, double Helmholtz Resonator type, with combination microphone and amplifier. Cylindrical, rotor case 1 1/2 x 6 in. Uses types 30 and 32 tubes in amplifier. Employs acoustical low-pass filter plugs (removable) for resonance response: removing plugs (threaded) in venting cylinder case will result in high-quality, wide-range studio-type microphone. As is excellent for vibration response, for noise, shock sounds. Original use—Sound (Artillery) Ranging Eqpt. Model TR-3B-3-C. NEW UNITS. Shpg. wt. 25 lbs. **EACH \$11.95**

SCR-522 TRANS-RECEIVER, in case CS-80. AM transmission-reception from 100 to 156 mc. 4 crystal-controlled channels; operates from 12, 24 V. DC or 110 V. AC Power Supplies. Excellent Condition, with tubes, no accessories. Will quote on accessories upon request. Shpg. wt. 75 lbs. **EACH \$69.50**

48 V. DC, 110 V. AC, 3-Phase ROTARY INVERTER, like-New units. Ideal for marine, train, or farm installations to obtain AC power for operating AC devices. Compact. Shpg. wt. 275 lbs. **EACH \$95.00**

LINK 9UAR AM 30-40 MC RECEIVERS. Can be set up for any one frequency in 30-40 mc range, crystal-control. Designed for rack integr., with built-in 110 V. AC power supply. NEW-UNUSED. **EACH \$49.50**

PE-218 INVERTERS. 24-27.5 V. DC Input, 110 V., 400 cycles/1 phase, 1500 VA. Output. NEW UNITS. **EACH \$4.95**

RECTIFIER RA-20. 110 V. AC to 250 V., 100 MA DC. Compact Transformer-type all-shielded Power Supply for all receivers or test eqpt. Completely filtered output, with fuse and on-off switch. Excellent for converting dynamotor operated receivers to AC operation. Supplies 12.6 V. AC for heaters. Used-Excellent Condition. Dim: 6 1/2" x 3 1/2" x 5 3/4". Shpg. wt. 20 lbs. **EACH \$15.95**

RCA 1P25 INFRA-RED IMAGE CONVERTER TUBE, used in American Sniperscopes and Sniperscopes. All NEW. UNUSED Condition. Shpg. wt. 8 lbs. **EACH \$49.50**

60 W. WESTERN ELECTRIC SPEAKER UNITS, for straight baffleboard or baffle-type horn mtd. Employs shock and blastproof diaphragm, response to 7,000 cps, favoring high freq. Impedance 13 ohms. Dim: 6" x 6" x 4 1/2" deep. Throat opening 1 3/8" dia. Alnico 5 slug wt. approx. 6 lbs. Shpg. wt. 20 lbs. **EACH \$11.95**

BRITISH-TYPE INFRA-RED IMAGE (SNOOPERSCOPE) TUBES. Used in British "Tabby" for seeing in the dark for "snooper" or "sniperscopes." Will detect objects at night illuminated by "dark" infra-red rays. Requires power supply of 3000 to 4000 volts at a few microamperes. Screen size is 1 3/8" dia. All tubes checked before shipment. price \$3 for \$10.00

FRONT END LENS ASSEMBLY. For above. Smed P1.0, P1.1, 91.44 mm. Outside dia. at one end 60 mm. Length of mount, 64 mm. Each **\$7.00**

STEP-UP OR DOWN 120/240/460. 3KVA. TRANSFORMER. Heavy-duty transformer, single phase, 50/60 cycles mounted in oil immersion tank. Resolts to 22" high x 14" dia. can be removed from can, operated air-cooled with negligible drop in KVA rating, due to rugged overdesign. NEW-UNUSED units. In oil. Shpg. wt. 30 lbs. **EACH \$44.50**

O-1-S AMPS RF AMMETER. WESTON Model 107, 254" Metal flange dia. Built-in thermocouple. Black scale silver numerals. Removed from Two (2) FOR \$50.00

All Above Material Subject to Prior Sale. 25% Minimum Deposit with All C.O.D.'s. Min. Order —\$5.00 All Prices F.O.B. Our Address.

TELEMARINE COMMUNICATIONS CO.
3030 W. 21st Street, Brooklyn 24, N. Y.
Cable Address: Telemarine N. Y.
Phone: ES 2-4300

SPECIAL! 2" WESTINGHOUSE \$5.95
0-50 Microamp Panel Meter....

OIL CONDENSER
10 MFD 1400 VDC... \$1.95

WESTERN ELECTRIC
Stepping relay 44 steps, 6-12 Volt coil..... \$5.95

FILAMENT TRANSFORMER
25 Volt @ 5 amps Pfl 110 V... \$5.95

6 VOLT DYNAMOTOR
600V @ 150 ma... \$11.95

2 Mfd 4000 VDC
Oil Condenser Ceramic Ins. \$2.95 ea. 2 for \$5.90

1/2 INCH SQUARE METER
0-500 microamps, high accuracy.... \$3.95

VACUUM CONDENSER
50MMF 10,000 VDC Jennings type JCS... \$4.95

VACUUM CONDENSER
150MMF 10,000 VDC Jennings type JCS... \$6.95

SENSITIVE RELAY
DPDT, 6500 ohm, 5 MA. ea. \$1.39
10 for \$11.50

FILAMENT TRANS.
6.3 Volts @ 8 Amp & 6.3 volts @ 1 amp, 110 V, 60 cycle Pfl. \$1.39

1" Milliammeter
Mounts into 1" hole, 10 mill basic, easily shunted to other ranges. Free shunt wire. Your choice 0-10 ma. \$2.95

1" Microammeter
0-200 microamps. Same type as 1" milliammeter. Mounted in rubber casing which may be removed if desired. \$5.95

H. D. 12 VOLT DYNAMOTOR
500 volts output at 400 ma. Mounted on filter base with fuses, starting relay, etc. Has switch for 24 volt operation also. DM49AX. Brand New..... \$17.95

G. E. RELAY CONTROL
(Ideal for Model Controls, Etc.)
Contains a sigma midjet 8,000 ohm, relay (trips at less than 20 high impedance choke, bimetal strip, neon pilot and many useful parts. The sensitive relay alone is worth much more than the total low price of..... \$1.25 Each 10 for \$9.90
FREE Model Control Book with Purchase of 10.

COAX ANTENNA SWITCH
RF relay with low loss ins. Switches to either of 2 type 831R coax receptacles. Latching device removes voltage after actuated, permitting operation from 12 volts DC to 315 AC. Mounted in aluminum case. Terrific Value. \$1.95
2 for \$3.50

12-14 VOLT DYNAMOTOR
375 Volt at 150 Ma. with Filter... \$4.95

5-6 VOLT DYNAMOTOR
400 Volts @ 175 Mils out. Small size.... \$9.95

MOBILE DYNAMOTORS
5.5 to 6 VOLT DC INPUT

OUTPUT	INT. DUTY	CONTR. FILTER	PRICE
400 VDC	275 Mills	175 Mills with	\$19.95
300 VDC	300 Mills	200 Mills less	14.95
425 VDC	375 Mills	275 Mills less	24.50

11.5 to 12 VOLT DC INPUT

400 VDC	275 Mills	175 Mills with	12.95
625 VDC	225 Mills	175 Mills less	11.75

PANEL METERS
WESTON, G.E., SIMPSON, etc.

2" METERS

- 0-100 Microamp... \$4.95
- 100-0-100 Microamp... 4.95
- 0-150 Microamp... 6.50
- 0-1 Milliamp... 3.95
- 0-1.5 Milliamp... 2.95
- 0-5 Milliamp... 2.95
- 10-0-10 Amp DC... 2.95
- 15 0 to +15 METER MULTIPER... 2.95
- 0-300 Volt AC... 3.95

3" METERS

- 0-1.5 Milliamp... \$2.95
- 0-10 Milliamp... 2.95
- 0-150 Milliamp... 3.95
- 0-200 Milliamp... 3.95
- 0-300 Milliamp... 3.95
- 0-500 Milliamp... 3.95
- 0-150 Volts AC... 4.95
- 0-15 Amps DC... 2.95

OIL CONDENSER BARGAINS

1 mfd 600 VDC	.25	8 mfd 1000 vdc.	\$1.35
2 mfd 600 vdc.	.75	6 mfd 1500 vdc.	1.95
4 mfd 600 vdc.	.75	2 mfd 2000 vdc.	1.50
8 mfd 600 vdc.	.95	3 mfd 2000 vdc.	2.25
10 mfd 600 vdc.	.99	4 mfd 2000 vdc.	2.95
1 mfd 1000 vdc.	.60	1 mfd 3000 vdc.	1.85
2 mfd 1000 vdc.	.75	1 mfd 600 vac.	1.35
4 mfd 1000 vdc.	1.25		

BIG BARGAINS IN LITTLE TYPE
Kit of 25 WIRE WOUND RES. 5 to 50 watt. \$1.95
Kit of 10 TRANSMITTING MICAS. 1.00
9 Ohm 100 watt Non-inductive resistors. 6 for... 1.45
100,000 ohm, 100 watt bleeder res... 2 for... .89
.0004 2500 V DC MICAS 10... .99
500 MMF CERAMIC CONDENSERS... 10 for... .50
6-12 VOLT DC RELAY DPDT... .79
JENNINGS Vacuum Cond. 12 MMF 20 KVDC... 5.95
MN26 Direction Finder, LIKE NEW with tubes. 12.95
15 MEG 1% METER MULTIPER... 1.49
ADVANCE HER. SEAL OCTAL PLUG-IN RELAY, 10,000 OHM COIL, 3MA..... 1.95
1 MFD 400VDC OIL COND..... 10 for... .35

Min. Order \$3.00—25% with order F.O.B. New York
10 DAY GUAR. PRICE OF MDSE. ONLY

POST ELECTRONICS COMPANY
73 BARCLAY STREET, NEW YORK 7, N. Y.
Phone WOrth 4-2526

Argenta would at first glance seem a strange choice for this kind of repertoire, but actually he works out all right since he has had considerable experience with many highly atmospheric Spanish scores. He keeps things moving along at a good pace, his dynamic expression may run to a little excess at times, but it adds interest and color, and it is audibly evident that he knows how to elicit some good, well balanced playing from his orchestra.

The sound here is one of London's "big-hall" efforts, hugely proportioned, darkly sonorous, a sound of power that just escapes being a mite too ponderous. The strings are clean and beautifully defined, the delineation between first and second violins very easy to perceive. Add bright but heavy brass, typically good French woodwinds and sharply accurate percussion and the spacious acoustics, and this is a recording to satisfy the critical hi-fi ear.

"Les Preludes" gets a rousing performance at the hands of Argenta and the sonic values are excellent, but the reading is still out-gunned by the outstanding Paray/Mercury effort.

Tape Review

BACH, J. S. ORGAN MUSIC

Carl Weinrich, organist, playing the organ of the Varfrukyrka at Skannings, Sweden. Sonatpe SW5002. 7" reel, 7 1/2 ips, double-track. NARTB curve. Price \$11.95.

This is the second release in *Sonatpe's* projected survey of the entire Bach organ literature, and every bit as good, if not better than the first release. Included on this reel are such standards as the "St. Anne Prelude and Fugue," "The Dorian Toccata" and "Fugue in D Minor," the great "C Major Toccata," "Adagio and Fugue," the "D Minor Canzona" and the "D Major Alla Breve." As explained in the first review, these tapes derive from the *Westminster* label and as with the disc recordings of that company, the sound is very high quality indeed. Carl Weinrich continues to exhibit his mastery of the organ and his particular affinity for the works of Bach. You will find no mannerisms or flamboyance in his playing, neither will you find the stiff-necked pedantic. His performances are authentic and they are honest and, above all, highly musical. As previously related, the organ is perfectly suited to recording, and the fabulous acoustics of the church add to the superb realism of this tape. I can't recommend this too highly, as the best in organ recording now available.

—30—

MICROWAVE FOR G.O.P. MEET

WESTERN Electric Company has purchased television microwave equipment, which will operate in the 12,000-13,000 mc. band, for use in relaying the 1956 Republican National Convention proceedings in August.

The ten Raytheon relay systems will be used by Pacific Telephone and Telegraph Company to feed televised convention activities from points in and around San Francisco to convention headquarters at the Cow Palace. From there video and audio signals will be fed to the networks via the Long Lines Department of A. T. & T.

The new equipment was developed for operation in the higher (12,000-to 13,000 mc.) band because of the current overcrowding of the 6000 mc. common carrier band. The convention relay will be the first commercial application of the new equipment.

GEIGER COUNTER TUBES

This is "the heart" of the Geiger counter! Famous 1B5's. Brand new and boxed. Terrific buy for you do-it-yourselfers. \$4.95 Only.....

STROBOSCOPE TUBE

SN-4. Brand new. \$2.95
2 for \$5.25..... Each
5R4WG: Ruggedized 5R4 Commercial Type. Brand new. 2 for \$2.95..... Each

Oscillograph!!! Hickok Model RFO-5

This precision instrument originally cost \$400.00! Contains 0-3 MC. vertical amplifier 10-30 and 100-900 Kc. frequency modulated sweep, 0.40 Kc. sawtooth sweep. Demodulator input. Voltage calibrated vertical control. New in original Package. Get this high quality lab and service test instrument at fraction of former price!
Quantity limited..... \$59.50
SET OF SPARE TUBES, including scope tube, \$5.95 extra.

MINIATURE HAND CRANK GENERATOR

FREE! On request with every purchase of \$3.00 or more, one -51 Hand Code Key! AND, with a \$5.00 or more purchase, a free aircraft-type slide rule, on request.

Latest type, light weight. From recent model field phone. Many uses. Brand new. Terrific buy!
\$1.49

COMMAND TRANSMITTERS

- 2-3 MC. Good condition..... \$ 4.95
- 3-4 MC. Good condition..... 6.95
- 4-5 MC. Good condition..... 3.95
- ARB RECVR. 190 Kc-9.5 MC. Good cond... 14.95

HIFI PERMA-FLUX HEADS: Annular grooved plastic fibre cones with voice coil as in speakers. Chamois ear pads. Gives finest music reproduction. Brand new in original carton. \$7.95

CATALOGUE No. 105 is OFF THE PRESS!
Get your free copy today!
All items F.O.B. L.A. Prices subj. to change without notice. Calif. buyers add tax. Send 25¢ deposit with C.O.D. orders.
J. J. GLASS ELECTRONICS CO.
1615 S. Main St. Los Angeles 15, Calif.

EXAMINE FREE! Profit NOW with the latest on successful transistor design, application, operation —in ONE COMPLETE VOLUME!

TRANSISTOR ELECTRONICS

by Arthur W. Lo, Richard O. Endres, Jakob Zawels, Fred D. Waldhauer, Chung-Chih Cheng; all RCA engineers.

At last, here's an authoritative, practical book which rounds up all available information, ideas and techniques on transistors and presents this useful data to you in 520 illustrated, easy-to-follow pages! These RCA experts cover the whole field, from design and operation of transistors to their application. Much material is just released, printed here for the first time. Whether you're a beginner or seasoned vet... working in radar, TV, radio, computing, or allied fields... this complete, new book will give you mastery of transistors and show you how to use this knowledge profitably and successfully!



Gives Complete Coverage. Including:

Physical concepts (36 pages) . . . characteristics, parameters, equiv. circuits (44 pages) . . . basic amplifier configurations (50 pages) . . . low freq. amplifiers (42 pages) . . . hi-freq. amplifiers (39 pages) . . . power amplifiers (28 pages) . . . hi-freq. operation (47 pages) . . . physical interpretation of transistor parameters (38 pages) . . . oscillators (38 pages) . . . modulation & demod. (48 pages) . . . pulse circuits (76 pages) . . . tabular-analyses of fundamental transistor networks & circuits . . . shows parallels, contrasts between transistor and vac. tube circuits . . . features practical circuits . . . plus much more valuable material and workable, useful techniques.

MAIL NOW—FREE TRIAL OFFER

Prentice-Hall, Inc., Dept. 5741-G1
Englewood Cliffs, New Jersey

Please send me a copy of TRANSISTOR ELECTRONICS for 10 days FREE use. Within 10 days I'll either return book and owe nothing, or will keep it and remit \$4 down (plus small postage charge) and then \$4 a month for two months in full payment.

Name

Address

City Zone State

Save! Send \$12.00 with this coupon and we pay postage. Same return and refund guarantee.

Ceramic Cartridges

(Continued from page 45)

radio, TV, etc., bass is attenuated more than 11 db at 50 cps. Even if the load resistor is 1 megohm, attenuation at 50 cps exceeds 6 db. On the other hand, a 5-megohm resistor would result in 4 to 5 db boost over most of the bass range.

Curve 5 in Fig. 6, shown for reference purposes, is the bass portion of the RIAA amplitude recording curve. A sufficiently high load resistor would provide bass response closely following this curve all the way inasmuch as at low frequencies the ceramic pickup represented in Fig. 6 is quite flat in its response to a constant amplitude recording if the load resistor is large enough.

Occasionally, considerable effort may be involved in getting at and changing the existing load resistor, typically .5 megohm, in a sound reproducing system. To the user, the cost of having this change made by a technician can approach or exceed the cost of the pickup itself. In order to obtain good bass response without changing the input load resistor, one may instead follow the expedient of increasing C_2 , shown in Fig. 5. C_2 can be increased by wiring a miniature capacitor directly across the cartridge. Provided that the time constant $R_1(C_1 + C_2)$ remains the same (1300 microseconds for the pickup in question), frequency response as shown by Curve 4 in Fig. 4 remains unaffected.

However, in following this course one gets lower output. For example, in matching the ceramic cartridge of Fig. 5 to a .5-megohm load, it would be necessary to use a shunt capacitance (including cable) of approximately .002 μ fd., resulting in nearly 13 db attenuation. A 1-megohm load would require a shunt of about .0008 μ fd., resulting in about 7 db loss. Some reproducing systems with a good deal of gain can easily endure, or may require, such sacrifices, while other systems cannot tolerate these losses. In the latter cases, if good bass response is desired, the load resistor must be changed to the correct value.

Returning to Curve 4 in Fig. 4, it may be observed that over-all response is quite creditable, staying within ± 3 db between 30 and 11,000 cps. Useful response is maintained to 15,000 cps. The chief criticism concerns the gradual hump that occurs between about 100 and 1000 cps. However, this is easy to remove by means of a simple compensating circuit, suited to the particular pickup in question, which appears in the inset of Fig. 7. Curve 2 in Fig. 7 is the resulting response, and may be compared with Curve 1, which is the response obtained when the load consists of a 2.2 megohm resistor. Curve 2 is very little short of excellent, remaining within ± 2 db over the range of 30 to 11,000 cps, with useful response extending to 15,000 cps.



NOW...there's a
GARRARD
Auto-Manual
Record Changer
for every
hi-fi system



World's Finest
RECORD PLAYING EQUIPMENT
from Manual Players to
Professional Transcription
Turntables

New
RC 88
Deluxe Changer
\$54.50
net

Full manual and automatic positions. True-turret drive...uses no belts. 4-pole "Induction Surge" motor. Fool-proof Garrard Pusher Platform.



New
RC 121
Mini Changer
\$42.50
net

Garrard's most compact, economical changer - fits any cabinet. Simpli-Mix Operation permits stacking all record sizes together. 4-pole motor. Manual position.



New
RC 98
Super Changer
\$67.50
net

All RC 88 features, including full manual position and true-turret drive, PLUS continuous + or - variable speed control on all 3 speeds.



301
Turntable
\$89.00
net

Supreme in its class. Individual card gives performance measurements for each unit. Dynamically balanced cast aluminum turntable. Heavy-duty 4-pole shaded motor.



Model T
Manual Player
\$32.50
net

This is the answer for a quality budget system. Incorporates all record playing features of the famed RC 80 record changer. 4-pole motor; automatic stop.

MAIL THIS COUPON TODAY

All Garrard and other B.I.C. components are illustrated and described fully in the B.I.C. High Fidelity Plan Book, a useful guide in planning any hi-fi system.

A quality-endorsed product of the B.I.C. Group



To: British Industries Corporation Dept. GE-46
Port Washington, N. Y.

Please send B.I.C. High Fidelity Plan Book.

Name _____

Address _____

City _____ Zone _____ State _____

THE
NEW

No-Noise
TUNER TONIC

Volume
Control
and
Contact
Restorer
with
Perma-
Film



2 oz. bottle. Net to servicemen \$1.00

Cleans, lubricates, protects not a carbon-tet solution. Still available in the new 6 oz. spray can. Net to servicemen—\$2.25

"NO NOISE"

Also available in 8 oz. bottles and quart cans. At your nearest distributor.

with
PERMA-FILM

Cleans, lubricates, restores all tuners including water type. Won't change or affect capacities, inductance or resistance. Won't harm insulations or precious metals, nor attack plastics. For television, radio and FM. Eliminates all noise, oxidation and dirt indefinitely. Non-toxic. Net to servicemen. In-service-able, in-free performance. \$3.25 Extra economical because a small amount does the job!



ELECTRONIC CHEMICAL CORP.

813 Communipaw Avenue

Jersey City 4, N. J.

**NEW
THIS
YEAR!**

special
feature
on
color...
in the



NOW ON SALE

Everybody's shooting color! And this year, the PHOTOGRAPHY DIRECTORY & Buying Guide includes a new special feature on color materials, products and their uses. Color fans can't afford to be without it!

And see what else you get in the
1956 Photography Directory

Over 1,000 Illustrations—of the latest cameras, lenses, filters, films and papers, processing materials, movie, lighting, stereo and projection equipment and other accessories:

Complete Product Information—descriptions, prices, data, manufacturers' names.

Informative Articles—specially prepared by the editors of POPULAR PHOTOGRAPHY. They'll help you choose the right equipment and accessories to take better pictures.

Be Sure to Get Your Copy of This Biggest and Best Photography Directory & Buying Guide

AT ALL NEWSSTANDS and CAMERA STORES—ONLY 50c



1956 PHOTOGRAPHY DIRECTORY & Buying Guide

366 MADISON AVE. NEW YORK 17, N. Y.

The discussion thus far has been based on the premise that the piezoelectric cartridge is used as an amplitude-responsive device to play recordings made with the RIAA characteristic. Naturally the question arises as to how the pickup can be used to play recordings having one of the other equalization characteristics that were in widespread use until about two years ago and are encountered today to a limited extent.

The writer inclines to the view that generally satisfactory adjustment for the difference between the RIAA curve and other curves can be effected by means of bass and treble controls. (See the article by Burt Hines, "Do You Need a Preamp-Control Unit?" RADIO & TELEVISION NEWS, January 1956.) However, the fact remains that many listeners prefer to obtain nominally precise equalization by turning one or two switches on a preamplifier to a setting which is marked as providing LP, Old AES, 78, European, or other equalization.

To enable the user to take advantage of the multiplicity of equalization characteristics afforded by many preamplifiers, it is generally necessary to convert the amplitude-responsive piezoelectric pickup into a velocity-responsive device. The reason is that the phono-input of such preamplifiers is usually designed to accommodate magnetic cartridges, which respond to velocity.

Converting the piezoelectric pickup into a velocity device is simple. It is merely necessary to load the cartridge with a suitably small resistor, so that the time constant of the resistor, cartridge capacitance, and cable capacitance (see Fig. 5) results in rising response with frequency over all or most of the audio range. This is illustrated in Fig. 8.

Curve 1 represents a 6 db-per-octave rising velocity characteristic, as well as the response of an ideal velocity device, magnetic or otherwise, to this characteristic. Curve 2 is the response of a specific ceramic pickup to Curve 1 when an infinite load resistor is used. The hump in the treble range is due to physical resonances, as previously discussed.

Assume that we have a hypothetical ceramic pickup with the same capacitance as in Fig. 5 but without resonance in the audio range. Its response to Curve 1 would be flat. Next, assume that this hypothetical pickup is loaded by a 47,000-ohm resistor. The resulting response would be that of Curve 3, which is a 6 db-per-octave rising velocity characteristic except at the upper end. Now, by adding Curves 2 and 3, one can determine the response of the ceramic pickup in question to Curve 1 when it is loaded by a 47,000-ohm resistor. Curve 4 shows the resulting response. When the ceramic pickup is fed into a preamplifier input intended for a magnetic cartridge, and equalized accordingly, its deviation from flat response is as delineated by Curve 5. Curve 5 is the difference be-



"Amazing Binaural Sound!"
NEW HI-FI HEADSETS!
Uses annular grooved plastic fibre cones with voice coils as in speakers, and brand new (not lauded!) chamois ear pads to obtain spacing for correct acoustical load. GIVES FINEST MUSIC REPRODUCTION! Each capsule wired separately, with plug for binaural sound. Imp.: 300 Ohms per unit or 600 Ohms when wire in series. Brand new in original Perma-Flux carton. **\$9.95**

RG-8/U 52 OHM COAX CABLE FOR MOBILE: Cut just right for mobile use. 13 1/2 ft. rolls with connectors each end. Brand new. Per roll. **\$1.00**

6 V. SHIELDED VIBRATOR TRANSFORMERS: Brand new packaged output 310 V @ 150 M.A. Each. 75c; 3 for \$2.00

COMMAND TRANSMITTERS!
ALL EXCEL. COND. WITH TUBES
4-2 MC. 5-3.7 MC. Each \$2.95
SPECIAL! A best buy! 7-9.1 MC. Only \$3.95

R-4/ARR-2 SUPERHET RECEIVER: For conversion to 220 MC. 234-256 MC. Tunable, good cond. Complete but less tubes and dynamotor. Each. **\$1.49**

C.A.P. - - - - NOVICE - - - - C.D.
TWO METER VHF TRANSCEIVER
RT-19/ARC-4 Transceiver complete with new tubes in excellent like new condition. Each **\$19.50**

PACKAGE DEAL!
Above ARC-4 complete with all tubes PLUS the 110v 60 cycle Power Supply Kit. YOU SAVE \$2.50.
BUY BOTH UNITS FOR ONLY.. **\$27.50**

6 & 12 VDC VIBRATOR POWER SUPPLY
Originally used for plate and filament supply for 15-tube FM transmitter-receiver. Fairly small. brand new condition. With cables. A mobile special. **\$4.95**

DUAL VOLTAGE GENERATOR
Output 1,000 VDC @ 350 M.A. plus 12 VDC @ 25 amp. Brand new. Boxed **\$9.95**

COMPLETE 50 FT. ANTENNA MAST
4" O.D. Hollow center to provide for coax lead of rotor shaft. Dis-assembled, it collapses to five 11 ft. sections. Comp. with all hardware, base, top, corkscrew guy anchors, ground stake. New in overseas crate. 4 of these make terrific rhombic antenna. Package deal: 4 units for \$69.95. Truck shipment only. **\$19.95**
Each.

ASK FOR NEW ANNIVERSARY CATALOGUE!
All orders. FOB Los Angeles. 25% deposit required. All items subject to prior sale. MINIMUM ORDER \$3.00.
OPEN FRIDAY NITE TILL 10 P.M.

Columbia ELECTRONICS
2251 W. WASHINGTON BLVD.
LOS ANGELES 18, CALIFORNIA

HOW TO BE THE HAPPIEST CREATIVE ENGINEER IN CALIFORNIA



Beckman Instruments, Inc.* offers E.E.'s, M.E.'s, Manufacturing, and Sales Engineers the kinds of jobs that creative men dream about. Top salary, all employment "extras" including our Educational Assistance Plan, modern facilities and personal recognition that comes naturally with our decentralized operation. Small town living... but near metropolitan areas in either Fullerton, So. Pasadena, Newport Beach, Richmond or Palo Alto.

*We're pacing the commercial electronics field (\$3,000,000 sales in 1949 to \$21,000,000 sales in 1955) and we'll be disappointed if you don't grow with us.

Write Beckman Instruments, Inc., 2999 W. 6th St., Los Angeles 5, Calif. Ask for Career File 45.

NEW!—WHEN IT RAINS—
Heavy duty plastic TV chassis covers to protect your customers' sets when picking-up or delivering them in bad weather.
SET OF TWO COVERS..... \$4.95
WILL GIVE YEARS OF SERVICE
SHAWMUT TV SUPPLY CO.
P. O. BOX #776 LAWRENCE, MASS.

tween the response of a perfect velocity device (Curve 1) and the response of the ceramic cartridge in question when loaded by a 47,000-ohm resistor (Curve 4).

If the load resistor were appreciably lower than 47,000 ohms, say 10,000 ohms, the ceramic pickup in question would have a response proportional to velocity throughout the audio range plus treble emphasis due to resonance. Its resulting response, when equalized by a preamplifier as a velocity device, would be that of Curve 2. The reason for selection of a 47,000-ohm load resistor instead of a much higher or lower value is to provide a rising characteristic, such as Curve 3, that tapers off at the high end and thereby compensates the resonance hump as much as possible without unduly impairing response in the vicinity of 10,000 cps.

Curve 5 in Fig. 8 provides quite good response. The treble hump gradually reaches a peak of only slightly more than 3 db and response is maintained out to 11,500 cps before it is 3 db down.

Somewhat smoother response, that is, a treble hump with about as great a peak as in Curve 5 but extending over a smaller portion of the spectrum, can be obtained by using the compensating circuit shown in Fig. 9 with the ceramic cartridge in question. Curves 1 and 2 respectively show response when a 47,000-ohm load resistor is used and when the compensating network is used. The network can be mounted at the magnetic phono input of the preamplifier.

It is quite possible that a 47,000-ohm load resistor for the ceramic pickup under discussion may give more pleasing results than the network of Fig. 9, because the broader treble hump may compensate more satisfactorily for treble deficiencies in speaker response, room acoustics, hearing acuity, etc. Only a listening test can decide which is the better method of loading a ceramic cartridge.

Figure 10 shows the circuit recommended by *Electro-Voice* for converting its ceramic cartridge into a velocity device.

A correctly chosen load resistor, on a network such as shown in Figs. 9 and 10, is the best way of converting a piezoelectric cartridge into a velocity device. Another method sometimes employed is that of Fig. 11, where the cartridge output is in series with a capacitance small enough to produce a rising response characteristic over the entire audio range. The reactance of *C* in Fig. 11 is large compared to that of *R* at all audio frequen-

Fig. 10. Recommended circuit for converting the Electro-Voice ceramic cartridge into a velocity device. Refer to article.

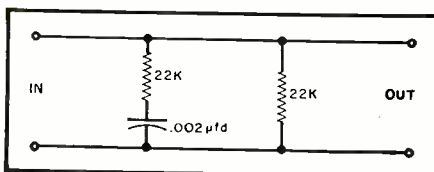

from the VOICE OF AUTHORITY IN SWEEPS...

SPOT and FIX TV FAULTS FAST!

FREE RAM BOOK SHOWS HOW!

Typical latest field-proven servicing data you'll find in your RAM book:

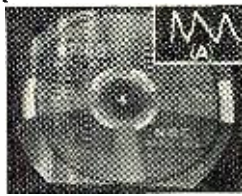

FAULT: "Ringing."
CAUSE: Incorrect value of balancing R-C network across one-half of H. Yoke winding.
(A): H. Yoke current wave-form. Obtained by connecting scope across 10-ohm resistor inserted in series.



FAULT: Picture compression and stretching.
CAUSE: Capacitance value of boost capacitor (connected to linearity coil) too low.
(B): H. Yoke current wave-form. Leaky boost capacitor could cause similar effect.



FAULT: Picture stretching at left and compression at right.
CAUSE: 0.02 mf boost capacitor (connected to linearity coil) used instead of 0.1 mf capacitor.
(D): H. Yoke current wave-form.

For over 10 years, RAM has specialized and pioneered in sweeps exclusively. RAM designs them, makes them, counsels TV set manufacturers on them, field-services them, educates Servicemen on them — leads the industry.

No one but RAM can bring you such proven data — as shown here and in the RAM Manual. In manufacturing know-how and field experience, you can depend on RAM for...

THE VOICE OF AUTHORITY IN SWEEPS

Send coupon today — get the BEST information from the FOREMOST manufacturer now!



RAM ELECTRONICS SALES CO. • Irvington, N. Y.
Canadian Sales Division: Telequipment Mfg. Co., Ltd., Ontario
Export Dept: Dage Corp., 219 E. 44 St., New York, N. Y.

Hi-Fi record reproduction requires a PRECISION turntable...

THE NEW PRESTO

Pirouette
T-18

MADE BY THE WORLD'S LARGEST MAKER OF PRECISION RECORDING EQUIPMENT

- Improves record performance tremendously...delivers professional broadcast quality!
- Simple operation—a sideways flick of the control lever selects 3 speeds—33½, 45, 78 rpm.
- Quiet Insured! Precision deep-well turntable bearing.
- Quality plus! Extra heavy weight, cast aluminum 12-inch turntable covered with non-slip cork.
- Beautiful design—smart telephone black and brushed chrome finish.
- Easy to install...only rectangular cut-out needed. Easy to buy at only \$66.00.



Revolutionary 3-Speed Mechanism
The Pirouette embodies the exclusive PRESTO "flick shift" speed mechanism, with 3 idler wheels mounted on a single movable plate. Insures professional speed accuracy and trouble-free performance.

The New PRESTO K-11 Disc Recorder

...A professional version of PRESTO's all-time favorite K-10—incorporating the revolutionary T-18 turntable—for only \$396.00*



For use as an on-location recorder. It's featherweight with a completely new pick-up arm, fully encased hi-fi speaker system, new panel design, push button controls and famous PRESTO cutting head. Three-speed operation.

Turntable mechanism including recording head and playback assembly available, separately, to fit into your sound system.

*with hysteresis motor \$445.00

Write for latest technical data
PRESTO RECORDING CORPORATION • PARAMUS, NEW JERSEY
Export Division: 25 Warren Street, New York 7, N.Y.
Canadian Div.: Instantaneous Recording Service, 47 Lombard St., Toronto

AMATEUR CRYSTAL HEADQUARTERS

FOR THE MAN WHO WANTS A Rugged Crystal

We have the DC-34 holder you can use with a 1/2" adapter—man! what output—a big 1/2" piece of quartz that really oscillates—ground by skilled craftsmen and counted to your exact frequency by our electronic counter.

NOVICE BANDS 79c
IN 1 KC STEPS
DC-34 OR FT-243 EACH

**6-10-20-40-80 METER
HAM BANDS IN DC-34
OR FT-243 79c**

STOCK XTALS
FT-241
FT-243
DC-34
FT-171
50c
EACH

Send postcard for free list of frequencies.

DC-34 HOLDERS

1690	2175	2360	2685	3000	3412	3790	4030	4275
1705	2195	2375	2710	3010	3422.5	3792	4035	4305
1720	2202	2390	2711	3023	3462	3825	4055	4310
1770	2215	2395	2732	3027	3480	3830	4065	4325
1790	2220	2415	2745	3055	3520	3855	4085	4345
1810	2235	2422	2775	3095	3540	3870	4095	4350
1830	2240	2435	2807	3117	3575	3885	4115	4370
1850	2255	2466	2816	3149	3580	3895	4130	4380
1870	2258	2467	2831	3161	3610	3905	4150	4397
2050	2260	2491	2851	3190	3630	3925	4150	4405
2065	2275	2514	2863	3279	3655	3935	4155	4415
2082	2280	2527	2894	3280	3665	3945	4175	4435
2090	2282	2540	2899	3311	3695	3950	4177	4440
2105	2295	2559	2925	3317	3702	3965	4192	
2106	2300	2587	2926	3345	3705	3988	4210	
2142	2326	2605	2960	3365	3745	3995	4215	
2155	2335	2623	2971	3385	3763	4012	4235	
2174	2355	2643	2980	3395	3775	4015	4255	

FT-243 HOLDERS 50c
5675KC-8650KC IN 25KC STEPS

FT-241 LATTICE XTALS 50c
ALL FREQ. FROM 370-540KC
500KC CRYSTALS \$1.00

TEXAS CRYSTALS

The biggest buy in the U. S."

8538 W. Grand Avenue
River Grove, Illinois

TERMS: All items subject to prior sale and change of price without notice. All crystal orders MUST be accompanied by check, cash or M. O. WITH PAYMENT IN FULL. NO C.O.D. Postpaid shipments made in U. S. and possessions only. Add 5c per crystal for postage and handling charge.

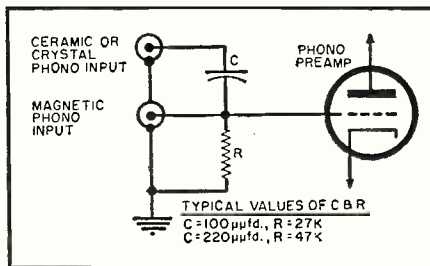

Fig. 11. Method used in some amplifiers to convert a piezoelectric cartridge into a velocity device. This is discussed in text.

cies. This method is used in several amplifiers on the market that have an input marked "ceramic or crystal phono input." Unfortunately, this method produces a departure from fiat response to the full extent of the cartridge's resonant characteristic in the treble range. Thus in the case of the cartridge used for illustrative purposes in this article, response would be that of Curve 2 in Fig. 8.

When R_s is omitted from the compensating circuit in Fig. 9, output available from the cartridge is on the order of 36 millivolts, referred to the standard reference level, which will overload many preamplifiers unless they have an input designed to accommodate high output magnetic cartridges. Preamplifiers often cannot accommodate more than 10-15 millivolts. To prevent overloading, a suitably low value of R_s should be used; the value selected does not appreciably affect response of the compensating network. For example, a 6800 ohm resistor produces an output of about 7 millivolts from the pickup depicted in Fig. 8. This is about right for many preamplifiers.

If a simple load resistor is used instead of a more complex compensating network, it is still necessary to guard against overloading. To reduce output, the single load resistor may be replaced by a voltage divider consisting of a potentiometer or two resistors.

The author wishes to thank *Astatic Corp.*, *Electro-Voice, Inc.*, *Ronette Acoustical Corp.*, and *Sonotone* for their courtesy in supplying data on their high-fidelity piezoelectric cartridges. —30—

The Southern California DX Club's annual award went to John Knight, W6YY for his contribution to the advancement of DX by good operating, clean signal, participation in club activities, and helping other amateurs. Willard Guimont, W6YMD (left) club president, presents the DX plaque.



Phonograph Evolution (Continued from page 73)

adjusts itself to the track or groove made by the stylus. With the Standard Speaker (a combination reproducer equipped with both recording and reproducing sapphires), it sometimes occurs that clear reproduction is not at first obtained. To obviate this, unscrew the adjusting screw (16) until its point disappears in the lug (17), and while listening, press the speaker lever (18) upward with the thumb of the right hand, and with the first and second fingers of the same hand turn the adjusting screw (16) slowly down until you can hear the record distinctly. Adjustment will bring the reproducer ball (stylus) into the groove of the record.

Regulation of Speed

"The speed of the machine in revolutions of the main shaft per-minute is regulated by the speed adjusting screw (23). To increase speed, screw the nut down, and to decrease it, unscrew this nut. Observe this carefully when reproducing music, as a different speed from that at which the music was recorded will produce an entirely different pitch. The standard pitch at which musical records are taken is about 125 revolutions a minute; talking records, about 80 per minute.

"A very good way for the beginner to determine the number of revolutions per minute is to hold his finger lightly against the mainshaft pulley set screw (37), and count the revolutions by his watch, for ten or more seconds.

To Record

"The machine is at rest. Open speaker clamps (19) and insert recorder with its speaker lever (18) pressed up against lug (17). Press up lift lever (15). Throw down lock bolt (14), and open swing arm (13) wide.

"Slip the wax cylinder (28), beveled end foremost, upon the tapering brass mandrel (1), and press it firmly, but not too forcibly, into place. Close the swing arm, and re-lock it.

"Raise the speaker arm from the straight edge upon which it rests in front, and slide to the left until directly over the beveled end of the cylinder, or the point at which you wish the record to commence. Again lower it to straight edge. Everything is now ready to record.

"Start the machine by pushing the switch (24) to the left. The machine is now in motion. Place speaking tube or horn upon the tube plate (21) of the speaker, lower lift lever (15) as far as possible and commence recording. In speaking into the instrument use a clear voice, and articulate well. Do not force the voice or speak too loud, if best results are sought.

"A fine white shaving will appear on the surface of the cylinder where it has been passed over by the stylus.

Remove the horn or speaking tube; raise the speaker arm, and throwing it back as far as possible, dust off the shavings, by holding the camel's-hair chip brush against the revolving cylinder, and passing it slowly from left to right.

Handling the Cylinder

"The wax cylinder, which is somewhat brittle, should be handled gently at first until the operator becomes practiced.

"Thrust the first and second fingers of the right hand into the thick end of the cylinder, and hold it fast by spreading the fingers apart. Touching the outside surface of a prepared cylinder, or record as it is called, destroys the attractiveness and generally the value of such record.

"Cylinders should be kept in boxes or cabinets made for the purpose, which have perpendicular pegs at fixed distances to prevent cylinders from coming in contact with each other. Over these pegs they are placed beveled end down. Use the camel's-hair chip brush to remove chips and dust from the wax. Do not attempt to blow it off.

"Do not leave the cylinder upon the brass mandrel (1) of the Phonograph for any length of time when the machine is not in use.

Shaving Cylinders

"Every Edison Home Phonograph is equipped with a simple device for shaving off or smoothing blank cylinders, which preparation is necessary before a blank can be used for recording. Here are the instructions for operating the turning rest. Machine is at rest. Wax cylinder firmly set upon mandrel. Hearing tube or horn removed. Speaker lever (18) set as for reproducing, that is, up against lug (17). Fasten back the speaker weight by passing rubber band around lower end of the weight and over the speaker arm.

"Lower the speaker arm about over the center of the cylinder, by dropping lift lever (15). Hold the end of the arm down firmly with the thumb and forefinger of the left hand, while the same fingers of the right screw down the button (22) which controls the knife bar. This will bring the sapphire shaving knife to the surface of the wax. As the depth of the cut to be taken is very slight indeed, the knife must be set very gently into the wax, as shallowly as possible. The machine is still at rest, with lift lever (15) down. Now raise speaker arm, slide it back to the extreme left, and start the Phonograph.

"The knife should always be allowed to pass over the entire length of the surface of the cylinder, otherwise there will remain a portion of the wax which is thicker than the rest, and if a new adjustment of the knife be made to the right of the end of former cut, it will not touch the surface to the left of it. If adjusted to the left, on reaching that part which was before un-

May, 1956

GRAND OPENING SALE

TO introduce you to our large new home
4 floors of QUALITY MERCHANDISE
at ROCK BOTTOM PRICES . . .

AIREX
THE ELECTRONICS
SUPERMARKET

SPECIAL OPENING BARGAIN COMPLETE TV SET—DESIGNED, ENGINEERED & MANUFACTURED BY TECH-MASTER WITH SYLVANIA ALUMINIZED PICTURE TUBE . . .

DESIGNED FOR
FRINGE AREA
OPERATION.

- 6 microvolt sensitivity
- Automatic gain control
- Auto-transformer high voltage system
- Synchronized sound and video
- 3 stage stagger-tuned IF
- Heavy duty power transformer
- 2 stage video amplifier sweep circuit
- High gain Standard Coil tuner
- 17 KV high voltage output
- Automatic brightness control
- Complete with mounting brackets, Alnico V speaker and knobs.
- Chassis with Sylvania Aluminized Tube.

21"-\$136.95 • 24"-\$147.95 • 27"-\$177.95

PICTURE TUBE GUARANTEED 1 YEAR

MASKS 1 Piece Lucite for above tubes;
outside mount
21"-\$7.95-24"-\$14.95-27"-\$17.95

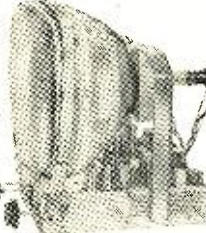

RECORD CHANGER BASES & BOARDS

for the changers listed
BASES . . . \$3.89 MOUNTING BOARDS . . . \$1.95
12" Alumin. Ball Bearing Photo Slides . . . pr. \$1.95

TRIPLE PLAY CART TYPE GE RPX 052 A	TRIPLE PLAY CART TYPE GE RPX 050A
Reluct. triple play .003 mill sapphire & .001 mill diam. Silver case. Reg. \$23.37.	Reluctance, Triple Play, Dual sapphire Needles
Ltd. Quantity . . . \$14.95	\$5.49

RONETTE HI-FI CAR- TRIDGE: with dual sap- phire styl. For use with any of changers listed	45 RPM SPINDLES GARRARD \$3.49 WESTER \$3.89 MARCH \$2.95 COLLARO \$3.79
Ltd. Quantity \$3.49	

MULLARD HI-FIDELITY TUBES

Type	Replaces	Description	Price
EL34	KT66; 6CA7	For amplifiers up to 100 watts	\$3.95
EL37	6L6; 5881; KT66	Increases power output 10-27% while reducing distortion level	\$3.50
EL84	6BQ5	2 in push-pull delivers up to 20 w.	\$2.40
ECC81	12AT7	Eliminates microphonics & reduces noise levels	\$2.50
ECC82	12AU7	Eliminates microphonics & reduces noise levels	\$2.15
ECC83	12AX7	Eliminates microphonics & reduces noise levels	\$2.30
EF86	Z729; 6267	Reduces hum, noises & microphonics	\$2.75
GZ32	5V4; 5U4	Delivers currents up to 300 MA. Sep cathode construction	\$2.95

Airex Hi-Fi Speaker Enclosures

8" Shelf Mdl. unfin. 23 1/2 x 11 x 10 1/2	\$16.95
8" Shelf Mdl, mahog or blond, 23 1/2 x 11 x 10 1/2	19.95
12" Shelf Mdl, unfin. 24 x 21 x 10 1/2	20.95
12" Shelf Mdl, mahog or blond, 24 x 21 x 10 1/2	23.95
15" Floor Mdl, unfin. 20 x 20 x 15 1/2	29.95
15" Floor Mdl, Mahog or blond, 20 x 20 x 15 1/2	34.95

All cabinets completely assembled with grill cloth and acoustical material. 15" floor models come with 6" legs and 12" adapter board.

Grommes Hi-Fi Amplifier Kit

10 Watts, 18 watts peak. Resp. 20-20,000 cps 1 db. Preamp., 4 inputs. Hum—80 db, 2% Harm. Dist at 10 watts, detailed step by step instruction manual, all resistors, condensers, tubes, wire & solder. Easy to make, 2-12AX7, 2-6V6, & 5Y3. Bass & Treble boost. Limited quantity.

3 TUBE AUDIO AMPLIFIER

Complete with tubes—12AU6; 35Z5; 50L6 & output transformer & extra AC receptacle. Phono jack input. 7 1/2" x 3" with mounting brackets.

Standard Coil Cascade TV Tuner

Replacement for any type TV set. 41 MC. IF. Shaft length 3 1/4".

Knobs to match—69c. **\$9.95**

WESTERN ELECTRIC POWER AMPLIFIER

Complete with ruggedized tubes 6S7, 6SC7, 6L6—condensers, chokes, resistors. Many uses. Original cartons. From radio equip. Gov't cost \$55. Tubes worth \$7.75. Complete

Send for our complete HI-FI Audio Catalog. Also complete HI-FI Kit Catalog. When in N. Y. visit our camera department and complete HI-FI showroom with a full line of amplifiers, speakers, tuners and enclosures. Send card to be put on mailing list.

RECORD CHANGER BARGAINS



COLLARO RC54: 3 speed intermix, automatic shut-off, weighted turntable, plug-in head. Shure ceramic cart. Reg. \$48.75. **\$34.95**

WEBSTER MDL 140: 3 speed intermix, automatic shut off, dual styl, cart, 2 pole motor. Reg. \$37.50. **\$21.95**

WEBSTER MDL 140 GE: 3 speed intermix, with GE reluctance RPX 050 cart., dual sapphire styli, automatic shut off. Reg. \$40. **\$25.95**

MONARCH MDL UAG: British made, 3 speed, weighted turntable, intermix, automatic stop and shut off, heavy duty 4 pole motor, rubber turntable mat. Reg. \$49.95. **\$22.95**

GARRARD RC 121: New, 3 speed, auto-manual changer; heavy duty turntable, 4 pole motor, plug-in head. **\$42.50**

GARRARD RC 88: Latest model, 3 speed, deluxe; weighted turntable mat, automatic shut off, line cord and plug. **\$54.50**

GARRARD RC 98: 3 speed (variable) super auto-manual changer with 45 RPM adapter spindle. **\$67.50**

All merchandise is brand new, factory fresh & guaranteed. Mail & phone orders filled on receipt of certified check or 50% of 20% of items as a deposit. Balance C.O.D., F.O.B. factory N. Y. Prices & specifications subject to change without notice.

AIREX RADIO CORP. 64 Cortlandt St., N.Y. 7, N.Y.
Phone CO 7-2137

MUST MOVE OUR WAREHOUSE

Set Builders—Experimenters

GIANT SURPRISE KIT \$4.95

25-30 lbs. of brand new RADIO PARTS . . . no junk . . . Transformers, Filter and Bypass Condensers, Resistors; Wirewound, Carbon, Volume Controls, Sockets, Wire, Variables, Chassis and Gang Switches. Parts that every Service Man, Experimenter or Ham needs. Express or Freight Shipments Only. No C.O.D.

NEWARK SURPLUS MATERIALS CO.
324 PLANE ST., Newark, N. J.

ELECTRONICS



Prepare for **ENGINEERING DEGREE** unlimited opportunities in **27 MONTHS**

the Electron-ic Age! Earn your B.S. degree in 27 months at Indiana Technical College. Intensive, specialized course. Comprehensive training in math and electrical engineering, advanced radio theory and design, television, electronics, Modern laboratories. Low rate. Also B.S. DEGREE IN 27 MONTHS in Aeronautical, Chemical, Civil, Electrical and Mechanical Engineering, G.I. approved. Enter June, September, December, March. Earn part of your expenses in Fort Wayne while studying. Write for catalog.

INDIANA TECHNICAL COLLEGE

956 E. Washington Blvd., Fort Wayne 2, Indiana. Please send me free information on B.S. ENGINEERING DEGREE IN 27 MONTHS as checked.

Electronics Chemical Aeronautical
 Civil Mechanical Electrical

Name
Address

SAVE dough! **HARJO!** 90



JUST IMPORTED FROM ENGLAND!
THE JUNERO

This miniature machine shop bends, cuts, drills, threads rod and strip stock to make those hard-to-get metal parts. MAKE YOUR OWN brackets for condensers—terminal boards—resistors—transformers—hundreds of other fittings. Complete Junero, including miniature thread cutting die and supply of metal stock. . . . \$5.95
Money back if not 100% satisfied!

★ **POSTPAID SPECIALS!** ★
★ **Yup!** We pay all postage charges for items in this box! Buy now and save! ★

★ **VEEDER-ROOT COUNTER** ★
With re-set, precision right-angle drive and pulley! Three-digit scale (to 999) measures wire, fishline, tape, film, etc. Brand new. . . . \$1.95
Postpaid only

★ **BE-51 TELEPHONE TEST SET** ★
Contains three-inch 5 mil DC meter. Enclosed in heavy duty leather case with neat shoulder strap and test lead. This beauty is easily adapted to use as mobile test meter. Brand new. . . . \$4.49
Postpaid

★ **VHF ANTENNA** ★
Small—but a powerhouse! Only 1 3/4" high. Complete with mount and coax fitting. New, boxed, postpaid \$1.49

★ **BUTTERFLY CONDENSER** ★
For TMBB Tuning Unit. Tuned to approximately 300-1,000 MC. New, boxed, postpaid. . . . \$2.95
Special at only

★ **HOUSE THERMOSTAT** ★
Here's a saving of at least 60%! This unit, a product of a national manufacturer, can be manually set to maintain any temperature from 40 to 100 degrees F. It's new, boxed, precision built, worth a lot more, sent postpaid for \$2.95
Only

★ **PHOTOFLASH CONDENSER** ★
★ **Hv. Shutterbugs!** This is for you! 30 mfd @ 2,000 VDC. Regular \$14.95. Brand new. . . . \$4.95 ★
★ Postpaid. Only

★ **ARC-4 VHF TRANSMITTER-RECEIVER** ★
For 2-meter. CAP, novice, etc. Excellent condition. With tubes and crystal \$19.50

TELEVISION CAMERA | **R.C.A. New!**
Surplus!

for Labs!
Export!
Industrials!
Medicine!
Closed Circuit
TV!

COMPLETE WITH ICONOSCOPE & F4:5 LENS

Labs, hobbyists, industrials, TV technicians—set up your own telecast system! It's a "mechanical eye" for factories, prisons, swim pools, closed circuit TV—100's other uses! Iconoscope, 6-stage video amplifier and clipper. View pilots, movies on closed circuit! Write for complete data. Limited quantity.

701-A TETRODE
Just the tube for that 1 K.W. SSB final—Fil.: 8 V. @ 7.5 amps. Plate: 3,000 V. @ 500 ma. Screen: 250 V. @ 50. Just 10 W. to drive pair 1 K.W. A.M. Ea. \$2.95
Phone 2 for \$4.95

701-A FILAMENT TRANSFORMER: \$2.95
When purchased with above tube.

701-A SOCKET:
When purchased with above tube. . . . Each \$1.50.
FREE DOPE SHEET 2 for \$2.95

APS-13 BRAND NEW! SPECIAL!
Complete with tubes and dynamotor. Only. . . \$9.95

HEAVY DUTY MOBILE ANTENNA MOUNT
Rugged as a rock! Ideal for home, vertical, mobile, marine, B'cast or commercial installation. Unbreakable bakelite base. Single hole mounting. Spring height 6 3/4" diam. 2 1/2". Overall height 11". Ship. wt. 10 lbs. New in orig. box. A \$15.00 value. Only. \$2.95

\$2.95 ANY METER HERE! \$2.95!

WESTINGHOUSE: 3" Rd. New. 0-15 mills. DC \$2.95
WESTINGHOUSE: 2" Rd. New. 0-5 amps. RF \$2.95
WESTON: 4" Rd. Excel. 1-25 mil. DC 2.95
DE JUR: 3" Rd. Excel. 1 mil movement. DC 2.95
BURLINGTON: 3" Rd. New. 500-0-500 microamps 2.95

GN-39 DUAL OUTPUT D.C. GENERATOR
Puts out 1,000 V. @ 350 ma. 12 V. @ 25 amps. Generator may be driven from fan belt of car, an auxiliary pulley on rear wheel, or by a direct coupled gasoline engine. Great unit for Field Day! \$12.95
BRAND NEW! Ship. wt. 100 lbs.

STOP & SWAP! We buy items! What have you?
25% deposit on all C.O.D. Min. order \$3.00
All items F.O.B. Whse., subject to prior sales and change of price without notice.

Harjo Sales Co.
Office-Warehouse: Dept. R-S, 503 N. VICTORY BLVD., BURBANK, CALIF.

shaved, the knife will take too deep a chip, and tear instead of cutting the wax.

"If the chip chute becomes clogged, it will prevent shaving. Keep the chute clean by raising the speaker arm from the straight edge, moving the carriage to the extreme right, and striking it gently against the back lug of the casting. Under no circumstance jar out the chips by striking the front of the speaker arm on the straight edge.

"If the slot in the face of the chip chute, through which the sapphire knife projects and into which the chips or shavings feed, becomes clogged, apply the camel's-hair chip brush or a wooden toothpick. Never touch the cutting edge of the sapphire with metal or any tool.

"If desired, the chip chute can be removed entirely by unscrewing its set screw, and the knife will shave without obstruction.

"The thinnest possible shaving will leave the smoothest surface. Shave several times in preference to a single deep cut.

"New blank cylinders require truing, as they are likely to be eccentric, and do not have prepared surfaces. In truing these, set the knife on the highest part, if any, of the blank. When once trued, blanks always remain cylindrical.

"When the shaving of a cylinder is completed, see that the knife bar is screwed back away from the cylinder, or it will cut the next record that is put on the machine. This is managed by manipulating the button (22).

Oiling

"Apply oil sparingly but thoroughly to the following parts: Back-rod (6); Main-shaft feed screw (2); Main-shafts centers (8 and 10); Roller on the straight edge; all motor shafts at their bearings; all gear teeth of motor; arbor on which main spring turns; idler pulley, occasionally, where tension spring holds it; governor disc, occasionally; winding shaft, if necessary.

"No oil should be permitted to get on the belt, and oil must not be smeared on the machine, as it will catch dust and make trouble.

"When the oil on the gear tooth gets black and dirty, wash it off with benzine before putting on new oil, which apply sparingly. Use best Phonograph oil, to avoid gumming. Above all, keep the machine clean. No mechanism will work perfectly unless free from grit."

Some strange terminology appears in the preceding text. For example, "the speaker arm" is now commonly called the tone arm or pickup. The term "speaker" referred to the transducer, sound box, reproducer and finally the phono cartridge (using present lingo).

The "Standard Speaker" was Edison's type B reproducer. The stylus could not self-adjust to seat into a groove.

The "Automatic Speaker," known as model C, overcame this limitation and provided lateral seating automatically.



Fiddles, trumpets, drums . . . these are musical instruments. They produce sound. And resonances are deliberately created to give the sound timbre and identity.

The loudspeaker, however, is not a musical instrument. Its specific function is to reproduce sound. It must in no way add to the sound it reproduces. It must be free from resonance, and free from distortion.

The HARTLEY 215 has no resonance . . . and produces no distortion.

Laboratory measurements have confirmed this fact, time and time again.

You've never heard it so good. Substitute a HARTLEY 215 in any system. Instantly you will hear the difference . . . clean bass, smooth highs . . . and a sense of realism and presence that will amaze you.

only \$65



NOTE: Because the new Hartley 215 has no resonance, a non-resonant baffle should be used. The bass-reflex, and other conventional enclosures are tuned resonant systems. For best results the Hartley BOFFLE Enclosure is recommended . . . available in single, dual, and 4-speaker models. Priced from \$50.75.

THE NEW **HARTLEY 215**

At franchised dealers or write for details:

HARTLEY PRODUCTS CO.
521 EAST 162nd STREET
NEW YORK 51, N. Y.
LUdlow 5-4239

In Canada:
J. C. Swail Co.
18 Kilbarry Crescent, Ottawa 2, Canada

ADAPTER

Write for Bull. 354B

TYPE 7B \$2.25
TYPE 7B \$2.50
TYPE 8B \$2.75
TYPE 9B \$2.75
(ILLUSTRATED)
plus shipping chgs.

- Min. size for use in crowded spaces
- RETMA color coded terminals
- Uses (All above chassis)

1. Modify circuits for max. performance and testing without soldering or unsoldering.
2. Break into any circuit for trouble shooting.
3. Measure voltage, resistance and current in conjunction with standard instruments.

A. L. PRODUCTS CO., INC.
— 311 Hickory St., Kearny, N. J. —

Things were indeed difficult in the gay '90's. Making a record of Junior's first words was a day's labor.

Cylinder machines were being produced in quantity by Edison and Columbia in the late '90's. All cylinders up until 1906 were of the two-minute type and it was not until 1908 that Edison introduced the four-minute Amberol cylinder records. Owners of the older model Edisons ("Home," "Standard," etc.) were able to buy simple gear attachments, so that these new four-minute cylinders could be played on the older machines. A new reproducer by Edison, type "H," was introduced and this was designed especially for reproduction of the new cylinders. Like other Edison reproducers the stylus was of sapphire. The model "H" had a tip radius of .0045".

In 1909 the Edison "Fireside" model (Fig. 2) was introduced as a "combination type" and featured a brand new development of Edison's, which was his model "K" dual-stylus cylinder reproducer. This device (Fig. 3) was, in appearance, similar to the model "C" and the model "H" and would fit the same housing, but as seen in Fig. 4, employed two separate sapphires (.007" and .0045") mounted to two cantilevers and coupled to a common diaphragm. The assembly could be rotated to bring either the two-minute sapphire (for Standard cylinders), or by twisting through an arc of 180 degrees, would bring in the proper stylus to reproduce the new Amberol four-minute cylinders. As far as we know, this was the original dual-stylus phono cartridge or reproducer (Figs. 4 and 5).

The Edison "Fireside" Phonograph (Fig. 2) was provided with a sectional type horn finished in japanned maroon with gilt decorations. It was 19 inches long and the bell had 8 petals and measured 11 inches in width. This was supported by a nickel-plated crane. The machine would play the Edison Amberol, Standard, and Grand Opera records. It featured a newly designed single-spring motor that could be wound while running. It also used an improved stop-and-start regulating device.

The Edison "Triumph" Phonograph (Fig. 6) known as model "E, F, and G" was an improved model which was produced in 1910. This was the last of the series bearing the name "Triumph." It featured a gooseneck type horn having a bell of steamed oak. This was supported by a crane mounted to the rear of the cabinet. Note that the carriage supporting the reproducer is designed to lie flat above the rotating mandrel. By means of adapters this housing would contain the Edison models "C," "H," "K," or "O" reproducers and, in addition, permitted Edison's new diamond point reproducer to be used when playing the Blue Amberol four-minute records which were introduced two years later, in 1912.

The series of "Standard" Phonographs of Edison also underwent improvement and change. The one shown

HENRY... 1^{st.} CHOICE for NEW Equipment!

HENRY
has ALL the new equipment First

hallicrafters



NEW

For top performance with extra pull power and ability to tune in stations.

SX100

\$29.50 Down

20 monthly payments of \$14.65

\$295.00 Cash Price

A few items in stock for immediate shipment are:

Model	Cash Down	20 Monthly Payments	CASH PRICE
S38 D	5.00	2.47	\$ 49.95
S53 A	9.00	4.45	89.95
S85	12.00	5.94	119.95
S X99	15.00	7.42	149.95
S X95	25.00	12.37	249.95
SX82 A	35.00	17.32	349.95
R46 B speaker			17.95
HT30	49.50	24.50	495.00
HT31	39.50	19.55	395.00
S94-S95	6.00	2.97	59.95
S102-S106	6.00	2.97	59.95

We have large stocks of ALL reconditioned amateur receivers and transmitters and equipment . . . all fully guaranteed and shipped on approval . . . and at BIG savings. We can supply nearly any equipment shown in any advertisement at lowest prices. WRITE FOR FREE PRICE LIST AND CATALOG.

Write, wire, phone or visit either store today.



Butler 1, Missouri
Phone 395

Henry Radio Stores

Granite 7-6701
11240 West Olympic Blvd. Los Angeles 64



Bob Henry,
W0ARA
Butler, Mo.



Ted Henry,
W0UOU
Los Angeles



"World's Largest Distributors of Short Wave Receivers."

CONVERT TO COLOR TV

COLORDAPTOR converts any BW TV to compatible COLOR



Typical COLORDAPTOR installation of Mod 855 as described in Jan. '56 RADIO ELECTRONICS. New Mod C415A incorporates many new features to give utmost in color quality, dependability and simplicity of construction.

COLORDAPTOR . . . a simple 10 tube circuit and rotating color wheel, converts any size black and white TV, direct view or projection, to receive compatible color TV. Attachment of the COLORDAPTOR to the standard TV set is simple and in no way affects its normal operation. The new Model C415A COLORDAPTOR is a simple, inexpensive means of having good color TV in the home. It can be built at low cost from parts most experimenters have on hand. You too can be one of the many experimenters and servicemen who have built and are enjoying this inexpensive color TV.

Complete specifications including theory of operation, simplified construction plans, schematic and sample color filters. . . . \$2.95

The following special parts are available for the COLORDAPTOR:

- K-5 Universal delay line. . . \$5.75, K-9 3.579545 mc crystal. . . \$3.25
- K-10A Tricolor filter material (sets to 17") \$2.35, (larger) . . \$4.15
- K-11A Small parts kit. . . includes K5, 9, 10A and all coils. . . \$19.75
- K-1 Complete parts kit (less color wheel & drive) . . . \$79.95

All other COLORDAPTOR parts and wired chassis, motors, etc., available. Write for information and prices.

COLORDAPTOR 3471 Ramona St. Palo Alto, Calif.

SPECIAL TV PUBLICATIONS

- Brooks **LIFE-SIZE TV INSTRUCTIONS** for building any #630 TV Receiver from the original 10" to the latest 27"..... **\$1.25** postpaid
- 90° **TV CONVERSION MANUAL**, how to convert any TV SET to 24", 27", etc. **50¢** postpaid
- 70° **TV CONVERSION MANUAL**, how to convert any TV SET to 17", 21", etc. **50¢** postpaid
- HINTS FOR BETTER PERFORMANCE** on your #630 TV receiver..... **50¢** postpaid
- Brooks **CASCADE MANUAL**, how to install Cascade Tuner in any make TV set..... **25¢** postpaid
- A.G.C. **STEP-BY-STEP INSTRUCTIONS**, how to add A.G.C. to any make TV Receiver... **25¢** postpaid

FREE CATALOG mailed on request

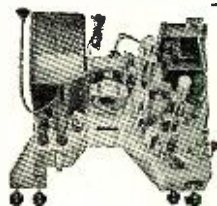

Build your own

**SUPER DE LUXE
31-TUBE
#630 TV
CHASSIS**

#630 SUPER DELUXE 31-TUBE TV KIT

OPERATES 16" to 21" PICTURE TUBES. • Engineered in strict adherence to the genuine RCA #630 plus added features. • FULL 4MC BANDWIDTH. • CAS-CODE TUNER. • COSINE DEFLECTION YOKE. • LARG-ER POWER TRANSFORMER. • KEYS AGC. • 12" SPEAKER. • CONDENSERS and RESISTORS at rated capacities and tolerance. You receive a COMPLETE SET OF PARTS and TUBES, everything needed is included (less CRT & wire). All I.F. Coils and Trans-formers are factory pre-aligned and tuned. You will enjoy building it with "LIFE-SIZE" easy to follow step-by-step ASSEMBLING INSTRUCTIONS" included with each KIT.

Slashed to **\$99.99**

Similar KIT for 24" or 27" CRT slashed to **\$110.39**

#630 SUPER TV CHASSIS

LICENSED UNDER RCA PATENTS
COMPLETE READY TO PLUG IN AND PLAY
Similar in features to the 16" to 21" TV KIT above.

Slashed to **\$142.27**
(less CRT)

#630 B TECHMASTER

COMPLETE LINE AT SPECIAL PRICES
Catalog mailed on request

STANDARD CASCADE TUNER

For better all around performance
Complete with tubes and Brooks CASCADE MANUAL with step-by-step instructions and all extra parts needed. **\$15.97**

21" TV CONVERSION KIT

Convert ANY MAKE TV RECEIVER including #630 to operate the 21" or ANY 70" PICTURE TUBE. COMPLETE SET OF ESSENTIAL PARTS includes matched set of Todd 70" COSINE DEFLECTION YOKE and TODD HV FLYBACK TRANSFORMER.

List Price **\$33.50**

Your price... **\$13.97** Incl. CONVERSION MANUAL with Step-by-Step Instructions & Diagrams.

Similar Kit for 24", 27" or any 90° CRT **\$15.98**

UNIVERSAL PICTURE TUBE MOUNTING BRACKETS

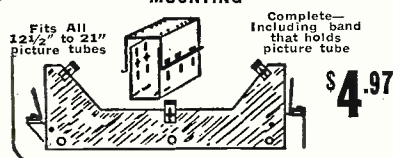

PULSE KEYED AGC KIT

Finest, most accurate and the easiest Kit to install in any make TV RECEIVER including the No. 630. Improves performance and insures a steady picture on all channels.

COMPLETE SET OF PARTS **\$2.99**
Including 6AU6 tube & instructions

CAPITAL ELECTRONICS
222 FULTON ST., N. Y., N. Y.

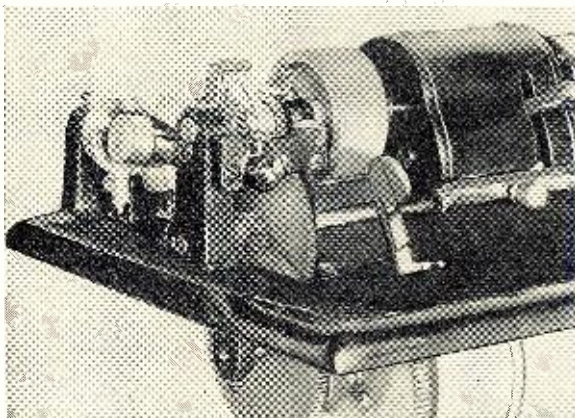

Fig. 12. The mechanical parts used in phonograph were precision made, many of them being tooled from solid brass.

in Fig. 7 was his model "E, F, and G" which also had the flat type carriage to contain the reproducer. This model was supplied with a black japanned metal horn which was supported by a nickel-plated crane and was coupled to the reproducer by means of a short section of rubber hose. This was a dual-speed phonograph and would play either the two-minute or four-minute cylinders simply by changing the gearing. The reproducer housing would also accommodate the diamond reproducer (Fig. 8) that was introduced along with the Blue Amberol cylinders.

The Edison "Home" Phonograph also underwent considerable change. This model was redesigned so that it would play either two- or four-minute cylinders. The model "E, F, and G" shown in Fig. 9 was supplied with both two- and four-minute reproducers and, like the machines previously described, would also accommodate Edison's new diamond stylus reproducer. The accessories for this model of the "Home" are similar to the previous types. Note that the swinging gate used on the earlier model Edisons has been eliminated in the new designs. This was a much needed improvement and saved considerable time when placing or removing cylinders from the machine.

The last in the series of Edison "Gem" Phonographs (Fig. 10) was known as models "D and E." This was supplied with Edison's "combination type" reproducer (type K) and was finished in maroon and gilt enamel. It was mounted to a polished oak base and was provided with an antique oak dust cover. The motor was a newly designed single-spring type that could be wound while running and it also featured a new start and stop regulating device and speed control. The gears were enclosed in a cast iron housing to protect them from dust. To the side of this housing may be seen the knob which was used to alter the gearing when changing from two- to four-minute cylinders. The Phonograph came complete with the "Fire-side" type horn which was also of japanned maroon and decorated with gilt. This particular model was first produced in 1908.

The Edison "Opera" Phonograph (Fig. 11) was first produced in 1911. It



Fig. 13. A large metal horn was supplied with this model phonograph for school use.

was later called the "Concert." This deluxe phonograph was designed especially to take full advantage of Edison's Blue Amberol cylinders. It featured a moving mandrel assembly and a series of cams which performed the function of engaging the feedscrew while at the same time lowering the reproducer onto the revolving cylinder. This model also had an automatic stopping device which could be set to the last groove on a cylinder and the machine upon operating to that point would automatically apply the brake to the governor of the spring motor. A deluxe gooseneck type horn, having a large bell of steamed oak, was supplied with this model. It was capable of producing enough volume to fill the average concert hall of its day.

The entire mechanism was skillfully assembled of heavy-duty parts throughout. Most of them were of solid brass (Fig. 12). This model employed a heavy-duty, springwound motor capable of playing up to a dozen cylinders per winding and its speed was regulated by a heavy-duty, three-ball governor in conjunction with a weighted flywheel. The entire gearing mechanism was protected from dust by a cast metal cover. The essential difference between this and other machines of Edison is that instead of the reproducer traveling above a fixed mandrel, in this model the reproducer assembly remained stationary and the mandrel assembly (including the cylinder) was propelled across and under the reproducer. This assembly rode on solid rails.

Due to the demand from various educational institutions and from music dealers Edison produced a special phonograph called the "Opera School" type (Fig. 13). This machine was produced in limited quantity during 1912. It consisted mainly of the various parts used in the regular "Opera" type.

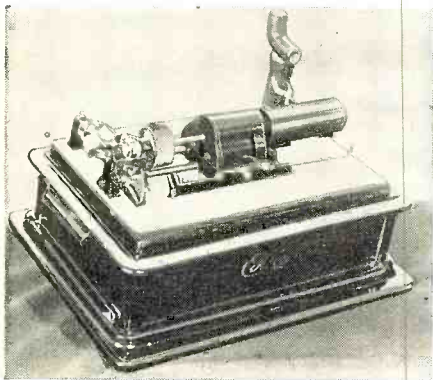

Fig. 14. Operating lever caused feed to engage to move the sliding mandrel of unit.

model, the essential difference being in the size of the horn which was of metal throughout and which was found capable of producing more volume than the machine designed for home purposes.

The top view of the mechanism of this model (Fig. 14) shows the moving mandrel and housing, the automatic stop and the mounting for the reproducer and for the horn.

The operating lever (Fig. 15) seen in the center of the mandrel housing is in the operating position which lowered the stylus to the cylinder and at

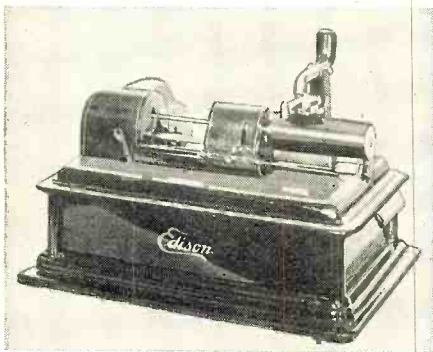

Fig. 15. Operating lever also dropped the reproducer onto the revolving cylinder.

the same time engaged the feedscrew which rotated beneath. This caused the mandrel assembly to move laterally beneath the reproducer.

A recording attachment (Fig. 16) was offered as an accessory to this and

Fig. 16. Recording attachment included a horn, recorder, and a special basket.



May, 1956

FOR HIGH PROFIT

...and Little Competition...

GET INTO MOBILE-RADIO MAINTENANCE

Wherever you see the tell-tale vertical antenna . . . on cars, trucks, or taxis . . . atop a building or mast . . . it's your tip-off . . . these outfits require first-rate, regular, radio maintenance . . . and they pay high profit!

LAMPKIN METERS ARE THE PREFERRED TEST EQUIPMENT!

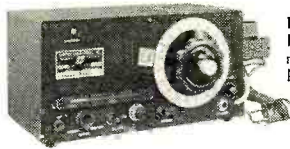

LAMPKIN 105-B MICROMETER FREQUENCY METER
Heterodyne type. Range 0.1 to 500 MC., all channels. Pinpoint VHF CW signal source. Weight 13 lbs. Width 13". Price \$220.00 net.

LAMPKIN 205-A FM MODULATION METER
Indicates peak voice deviation, ± 25 KC. Tunes 25-500 MC. in one band. Speaker. Oscilloscope output. Relative field-strength meter. Weight 13 lbs. Width 12". Price \$240.00 net.



Ask for our booklet "HOW TO MAKE MONEY IN MOBILE RADIO MAINTENANCE". Do it NOW! There's no charge.

LAMPKIN LABORATORIES, INC.
MFM Division, Bradenton, Florida

At no obligation to me, please send booklet "How to Make Money in Mobile-Radio Maintenance"

Name _____
Address _____
City _____ State _____

LAMPKIN LABORATORIES, INC.
MFM Division, Bradenton, Florida

SAVE HOURS OF WORK



quickly make round, square, key and "D" openings with Greenlee Radio Chassis Punches

In $1\frac{1}{2}$ minutes or less you can make a smooth, accurate hole in metal, bakelite or hard rubber with a GREENLEE Punch. Easy to operate . . . simply turn with an ordinary wrench. Wide range of sizes. Write for details. Greenlee Tool Co., 1885 Columbia Ave., Rockford, Ill.



AUDEL'S T.V. TELLS HOW TO ANSWER RADIO T.V. QUESTIONS

SERVICE LIBRARY

HERE IS LATE INFORMATION IN A HANDY FORM FOR TELEVISION AND RADIO REPAIRMEN, SERVICEMEN AND STUDENTS

AUDEL'S T.V. RADIO SERVICE LIBRARY—Highly Endorsed—Over 1500 Pages—1048 Illustrations & Diagrams. 1001 Important Facts & Figures on Modern Television, Radio, Electronic Devices at your finger ends.

INCLUDES TRANSISTORS & Transistor Circuits, Record Changers, Rectifiers, P.A. Systems, Tape Recorders, Phonograph Pick-ups, F.M., Auto Radio; Ultra High Frequency Wave, Radar, etc.

ASK TO SEE IT!
IT WILL PAY TO KNOW—
The Basic Principles—Construction—Installation—Operation—Repairs—TroubleShooting. Shows How to get Sharp, Clear T.V. Pictures. Install Aerials—How to Test. Explains Color Systems, Methods of Conversion, Terms, etc. Includes Ultra High Frequency—Valuable for Quick Ready Reference and Home Study.

6 COMPLETE 2 VOLUMES Get this Information for Yourself.

7 DAY TEST—PAY ONLY \$1 A Month

MAIL ORDER
AUDEL, Publishers, 49 W. 23 St., N.Y. 10, N.Y.
Mail AUDEL'S T.V. RADIO SERVICE LIBRARY (2 Volumes) \$6 on 7 days free trial. If O. K. I will remit \$1. in 7 days and \$1 monthly until \$6 is paid. Otherwise I will return them.

Name _____
Address _____
Occupation _____
Employed by _____ RN

173

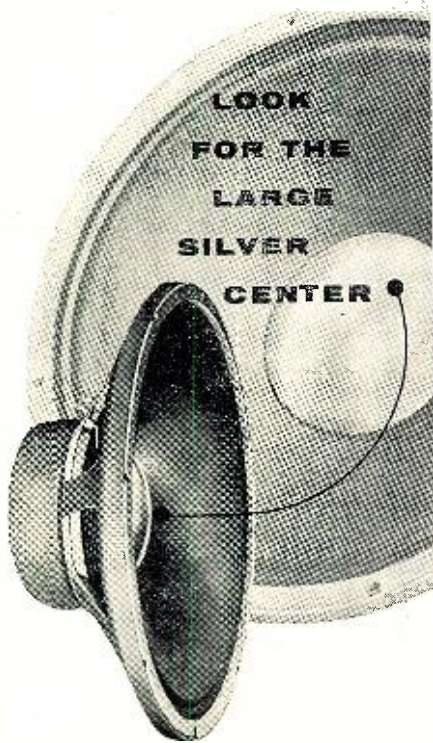

In your audio dealer's demonstration room where loudspeakers are lined up all in a military row . . . look for the speaker with the large, silvery dural dome in the center. Ear-test it with special care. This is the Jim Lansing Signature D130—the 15" Extended Range Speaker with 4" voice coil of edge-wound aluminum ribbon. The coil is attached directly to the 4" dural dome. Together they give the piston assembly exceptional rigidity. This is one reason why bass tones sound so crisp and clean . . . why the highs so smooth . . . the mid-range so well-defined. You will find the D130 to be as distinguished to your ear as it is to your eye.

THE SIGNATURE D130 (shown above) IS YOUR BASIC SPEAKER

Use it alone when you first begin your high fidelity system. Perfectly balanced with other Signature units, it later serves as a low frequency unit in your divided network system.

Additional Signature Precision Transducers with large domes and voice coils:



SIGNATURE D131 . . .
the finest 12" speaker made
O.D.—12½"
4" voice coil of edge-wound aluminum ribbon
Depth—5"
Power input—20 watts
Impedance—16 ohms

SIGNATURE D123 . . .
an innovation in speaker design
Depth—only 3½"
O.D.—12½"
3" voice coil of edge-wound aluminum ribbon
Power input—20 watts
Impedance—16 ohms

SIGNATURE D208 . . .
an 8" precision transducer
O.D.—8¼"
2" voice coil of edge-wound aluminum ribbon
Power input—12 watts
Impedance—D208—8 ohms
D216—16 ohms

See your audio dealer for complete catalog
FREE TECHNICAL BULLETINS DESCRIBING SIGNATURE EXTENDED RANGE SPEAKERS IN DETAIL WILL BE SENT TO YOU ON REQUEST. WRITE:
JAMES B. LANSING SOUND, INC.
2439 Fletcher Drive, Los Angeles 39, Calif.

other Edison phonographs. It included a metal horn and the Edison Recorder which were designed originally to record on the soft wax cylinders. We doubt if many of these attachments were sold since home recording on wax cylinders lost popularity after the turn of the century when records became abundant and when results were far superior to those obtained with the attachments. The last of the Edison phonographs using outside horns were produced in the year 1912.

(To be continued)

GEIGER COUNTER PROJECT

By **GEORGE E. BRADLEY**
Western Michigan College

THE appearance on the market of low-voltage Geiger counter tubes, such as the Victoreen 1B86, provides a simple project in the construction of a portable Geiger survey meter.

The instrument shown in the diagram employs this 300-volt Geiger tube, a CK722 transistor, six NE-2 neon bulbs, and a 6.3 volt, 1 amp. filament transformer. The instrument is powered by four penlite cells and may be constructed in a 3" x 4" x 5" chassis box.

Since the transistor is used to amplify the Geiger pulse, crystal phones are not needed but quite audible clicks may be heard with 2000-ohm headphones. The transistor used in this way comprises a conventional grounded-emitter amplifier. Battery drain ceases when the phones are removed from the circuit.

The 300 volts for the Geiger tube is supplied by interrupting, by means of a push-button switch, the current in the primary of the transformer. Actually, the filament transformer is connected into the circuit backwards with the 6.3 volt winding acting as the primary. Upon the breaking of the circuit, the six neon bulbs conduct, charging the capacitor. Overcharging is impossible since the neon bulbs act as regulators as well as rectifiers.

Preliminary polarity tests indicate proper connections of the transformer for charging the capacitor positively with respect to ground. Several interruptions will charge the capacitor for several minutes' operation.

Although simple in construction and made from standard parts available from any radio parts supply house, this unit can be built for less than \$12.00.

-30-

Schematic diagram of simple Geiger counter which uses low-voltage Geiger tube.

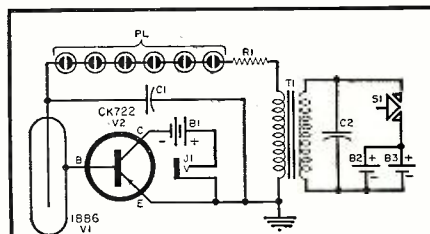

- R1—1 megohm, ½ w. res.
- C1—.05 µfd., 400 v. capacitor
- C2—.5 µfd., 200 v. capacitor
- J1—Open-circuit phone jack
- T1—Fil. trans., 6.3 v. @ 1 amp. (see text)
- S1—Push-button switch
- B1, B2, B3—1.5 volt penlite cell
- PL—Six NE-2 neon bulbs in series
- V1—1B86 Geiger counter tube (Victoreen)
- V2—CK722 junction transistor (Raytheon)

HERSHEL SPECIALS

All New MYSTERY PACKAGE
of ELECTRONIC PARTS

Worth \$40.00
Our Price **\$3.95**
Ship Wt. 20 lbs.

It's the surprise of your life! 20 pounds of BRAND NEW USA BUILT GOVT. surplus. The ideal gift for hams, etc.

BUTTERFLY CONDENSERS
YOUR CHOICE
\$4.95

TYPE A 4¼" Dia. TYPE A-100 330 MC—Antenna type
TYPE B 4¾" Dia. TYPE B-135 485 MC
TYPE C 2½" Dia. TYPE C-200 1000 MC
TYPE D 3" Dia. TYPE D-300 1000 MC—Close for Dial De

These units make the finest tuners for Ultra-high frequency transmitters, receivers, frequency meters, and oscillators.

RELAYS

3VDC 11-OHMS D.P.D.T. 3A. CONTACTS \$1.29
6VDC 24-OHMS D.P.S.T. 8A. CONTACTS \$1.95
110VAC 15A. CONTACTS S.P.S.T. \$1.75
TELEPHONE TYPE 7500-OHMS S.P.D.T. 2A. CONTACTS \$2.49

OIL CONDENSER
\$1.65

2 MFD. 3000 VDC. Pyranol Oil W/Mounting Brackets.
1-1 Mfd. 5000 VDC. New removed from equip. 4¾"x4¼"x 2½"

GE Pyranol Oil CONDENSER
95¢

12 MFD. 330 VAC. 60 Cy. Removed from equip. NEW.

RCA Output Transformer
P.P. coils 25 WATTS
Pri. 5000 ohms out put Sec. ±1 500 ohms, ±2 600 ohms, sidetone 15 to 15,000 cy. flat.

Hi Gain Dynamic Mike Kit
Uses UTC Transformer & Western Electric Mike. Ideal for Hams, PA, CAP, Recording Mobile Equip. 50 DB 80 to 7500 CPS. Diagram Furnished.

ALL-PURPOSE FIL TRANSFORMER
FRI. 117 v. 60 cyc. sec.
S. V. 12A
S. V. 10A
S. V. 8A
S. V. 6A
S. V. 5 V.
S. V. 2.5 V. \$1.75

SWING CHOKE **\$5.95**
2H-7H 550 MA. Thordarson T48003.

AUDIO CHOKE **95¢**
60H-1MA. 4,500 ohms. 15,000 turns of 44 wire. Size: 1½" x ¾" x ¾". Ideal for radio control, planes, boats, etc.

100 ASSORTED CRYSTALS
FT-243 FT-241A FT-171B Type Holders. FREQ. RANGE 2015 KC to 38.1 MC.
\$50.00 Value **\$7.95**
HOTTEST BUY IN THE U.S.A.

ALLIGATOR CLIP
Piercing type with 5 ft. cord and space lug. Ideal test clip. TL-137. **2 for 25¢**

TERMS: Cash with order or 25% DOWN—BALANCE C.O.D.
ALL PRICES NET F.O.B. DETROIT
MINIMUM ORDER \$2.00
TYler 8-9400

HERSHEL RADIO CO.
5249 GRAND RIVER Detroit 8, Michigan

USED TAPE

1200 ft. Plastic \$1.34 Lots of 10
\$1.49 single rolls
1800 ft. Mylar \$2.69 per roll
(Other sizes and recorder Bargains)
Send for price sheet
Please Include Sufficient Postage
COMMISSIONED ELECTRONICS, INC.
2503 Champlain St. N.W., Washington 9, D. C.

RADAR

Our school is now introducing a correspondence course in Radar, Microwaves, and Loran. Get your FCC endorsement, high paying job in industry as a radar technician. Special introductory offer.
Write
PROGRESSIVE ELECTRONICS INSTITUTE
P.O. Box 27764 Los Angeles 27, Calif.

RADIO-TV Service Industry News

AS REPORTED BY THE TELEVISION TECHNICIANS LECTURE BUREAU

HENRY FORD is said to have fathered the remark that "the only thing you can be sure of in American business is change."

For sheer speed in change and sudden developments, no other industry can match the record of the electronics industry since the end of World War II. New manufacturers blossomed, rode the crest of a wave of phenomenal prosperity, failed to gear themselves to the changes that were inevitable, and passed out of the picture.

While the tireless hand of change has moved manufacturers about like pawns in a giant chess game, distribution and service continued on their merry way to maintain and replace the products that uncontrolled production and unbridled promotions put into the hands of end users. But in the background, the hand of change has been subtly moving to bring about a new set of conditions which will greatly influence the business of distributors and service operators.

Many developments have been quietly shaping up which will affect the activity of electronic service as a business. The seemingly insatiable need of manufacturers for technicians in development, production, and maintenance work keeps draining the service industry of some of its best technicians. Low level averages of service charges have kept service technician pay scales too low to meet the competition of other elements of the industry for competent, technically-trained men.

The introduction of self-service tube checkers in traffic locations is eating into the basic part of the average TV service shop's business. Set owners who had noticed that three out of every four times they needed service only two or three tubes needed to be replaced, turned to the self-service checkers as the first resort when a set went out. In many areas, the average percentage of service jobs completed in the home by the replacement of a few receiving type tubes has dropped from better than 80% to 60% or less.

These normal changes in the industry through economic developments have served to lead independent service operators into thinking in terms of cooperative programs in the hope

of correcting some of the factors that affect their business.

Service Licensing

There is a strong trend among service associations to bring about some form of licensing both on local and state levels as one means of bringing about some measure of stability in the service industry.

The Radio and Television Guild of Long Island has developed an eight point plan for licensing its own members. These eight points provide:

1. The shop must adhere to the Guild Code of Ethics. The shop will use only ethical advertising as set forth previously under the Guild's public relations program.
2. The shop owner must show possession of adequate test equipment to cover the type of work performed by the shop (TV, phono, auto radio, etc.) and adequate service data.
3. The shop must be managed by a recognized technician (requirements to be decided by the Board of License Examiners) or employ a minimum of one full-time technician. Apprentices or trainees employed by the shop must be under the direct supervision of a recognized technician.
4. The shop must operate during established hours specified on the application.
5. The shop must issue a 90-day minimum guarantee on parts and service.
6. The shop must carry adequate liability insurance for the protection of property belonging to the consumer and the service technician.
7. If the shop is doing business under an assumed name, that name must also be registered.
8. The shop must be located in a business zone with full access by the public, with a business telephone listed by the telephone company in the shop's name.

This program is designed to license shops first and to institute a similar plan for technicians and apprentices at a later date. The license fee for the Guild plan is tentatively \$15.00 per shop plus \$5.00 per employee.

Similarly, the Associated Radio-Television Servicemen of New York plan to inaugurate a licensing program for

THE  SYMBOL
MEANS QUALITY



This "K" Symbol* identifies electronic equipment which meets standards prescribed by Keroes Enterprises. It is a certification that the equipment on which it appears is the finest the industry can produce.



The world famous "Ultra-Linear" circuit is protected by U. S. Patent No. 2,710,312, owned by Herbert I. Keroes. The phrase "Licensed Ultra-Linear" can be displayed only by amplifier manufacturers who are licensed under the patent. Technical services made available to licensees enable them to incorporate the latest refinements in "Ultra-Linear" design in their products.



The phrase "Licensed Ultra-Linear," when used with the "K" Symbol*, is your guarantee that the manufacturer of the amplifier to which it is affixed is using an amplifier circuit that makes the best use of its output tubes, produces maximum power over the greatest band-width for more articulate lows and sparkling highs, and reduces distortion to a minimum.



Your amplifier offers all the advantages of "Ultra-Linear" performance when it bears the black and gold "K" Symbol*. Inquiries concerning the benefits of "Ultra-Linear" operation are invited.

*Trademarks identifying electronic equipment meeting standards controlled and prescribed by Keroes Enterprises.

KEROES ENTERPRISES
369 SHURS LANE, PHILADELPHIA 28, PENNSYLVANIA

AMERICA'S GREATEST TUNER BUY!

The Sensational **Granco** FM TUNER



Amazing \$34⁹⁵*
Value... in walnut

Compare its performance with high priced tuners
**PROVIDES ENDLESS HOURS OF STATIC-FREE
AND DRIFT-FREE FM LISTENING PLEASURE**

The perfect addition to any HI-FI system,
TV set, phonograph or tape recorder!

- Model T-160
- Frequency Range: 88-108 Mc.
 - Selectivity: 200 Kc at 3 db points.
 - Audio Frequency Response: 20 cps to 20,000 cps.
 - Sensitivity: 4 microvolts for 20 db quieting.
 - Coaxial Tuner: Exclusive Granco feature assures drift-free reception.
 - Hum Level: 70 db below 1 volt.
 - Maximum Audio Output: 2 volts.
 - Antenna Input: 300 ohms or built-in line cord antenna.
 - Overall Dimensions: 7" w. x 5" h. x 4 3/4" d.

ASK YOUR DEALER FOR A DEMONSTRATION

See and hear Granco's FM and FM-AM table radios
and high fidelity radio-phonograph combinations

*Price slightly higher
in West and South

for name of your nearest dealer, write

GRANCO PRODUCTS, INC.

36-07 20th Ave., Long Island City 5, N. Y.

World's only manufacturer specializing in FM

CRASH...

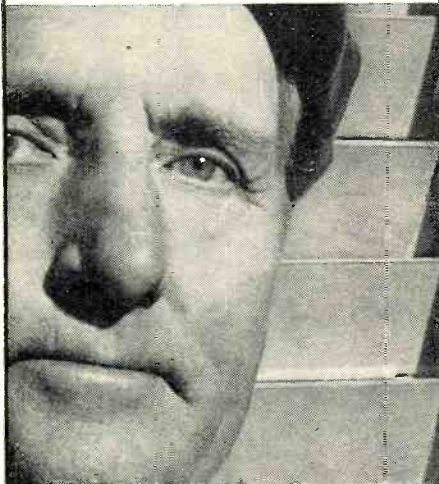

This man shatters the myth that every diamond needle protects records. Everybody's looking for his picture. Where? In the Duotone Diamond Needle Package. Why? Because he's the polisher who polishes the Duotone diamond tip 15,000 times. No chance of slight burr to feather-cut grooves. Result: More satisfaction—more sales with Duotone.

The Duotone Company Keyport, N. J.
Can. Rep., Chas. W. Pointon, Toronto;
Exp. Div., Ad Auriema, New York, N. Y.



Then Hear This:

At NORTHROP INSTITUTE over 50% of all ENGINEERING students work part-time, and usually within the Aviation or Avionics Industries.

Northrop Institute's two year engineering training program recognizes the tremendous part Electronics is playing in creative Aeronautics today. That is part of the reason why there is a waiting list for Northrop graduates.



COURSES APPROVED FOR VETERANS

MAIL COUPON BELOW FOR
COMPLETE INFORMATION.

NORTHROP AERONAUTICAL INSTITUTE
1185 W. Arbor Vitae Street, Inglewood 1, California

Please send me immediately the Northrop catalog, employment data, and schedule of class starting dates. I am interested in:

- Aeronautical Engineering Technology
- Aircraft Maintenance Engineering Technology
- Master Aircraft and Engine Mechanic
- Jet Engine Overhaul and Maintenance

Name..... Age.....

Address.....

City..... Zone..... State.....

Veterans: Check here for Special Veteran Training Information.

its own members. Under the association's present plans, members applying for technician license permits will have to pass a qualifying examination. Apprentices doing major repair work on television sets will have to be supervised by recognized and licensed service technicians.

This program will be backed by an association guarantee on all work performed by television service technicians licensed by the group. If a customer does not receive satisfactory work in servicing, the association will assign another service technician to do the job and reimburse him for his time. The association would then decide whether to take action against the offending technician. Violations will lead to loss of license and expulsion from the association.

Self-licensing programs are being studied by many state and local associations. In practically all of these licensing plans, there is provision for the minimum daytime hours a shop must be open to qualify for a license. It is apparently the hope of the originators of these programs that the requirements for a business location and the observance of specified business hours of operation will serve to eliminate the part-time technician who handles his service calls during the evening hours and on Saturdays and Sundays.

Changing Customers

Since it is the general public that will determine the type of service shop it will patronize, a study of the steady changes in the living and working habits of a large part of the populace might provide a yardstick to measure public acceptance of some provisions of these licensing plans.

Statistics show that the average wife is going back into industry as soon as the youngest child in the family reaches school age. Of course, many wives continue to work during their child-bearing years, particularly in those cases where arrangements can be made for the care of the children during the day. The result of this trend is that in thousands of homes, there is no adult member of a family at home during the normal weekday working hours. When a television set needs to be serviced these working families will look for a technician who will do the repairs at night or on Saturdays. If it is difficult to locate a competent technician to do the work during the hours the family is at home, the self-service tube checker in a nearby drug store becomes attractive as a means of getting the set back into operation.

The steady trend toward suburban living and shopping in community shopping centers is bringing about a decided change in the merchandise planning of the retail stores in these centers. The trend is toward staying open a greater number of evenings. Within a few years the standard business hours for stores in community centers will probably be from noon until nine at night every day. Retail

RADIO & TELEVISION NEWS

merchandisers know from experience that they cannot adjust the public's needs to suit their own convenience. Merchandising practices must be adjusted constantly to meet the needs of the times.

Harper Electronics of Toledo, Ohio, observed that they were getting an increasing volume of calls requesting service after four p.m. These came from families in which both the husband and wife were working. It threw a heavy burden on their technicians to stack calls for completion in a couple of hours in the late afternoon.

A complete readjustment of their working schedules provided the solution for giving satisfactory service after business hours. The field service staff was divided into two shifts. Each shift works a six-day week, twelve hours per day. The shifts have alternate weeks off. The men receive 40 hours-per-week pay for an average work week of 36 hours. Under the Harper plan, a shift reports on Thursday morning and the men work from nine in the morning until nine at night the last three days of the week and the first three days of the following week. Then that shift is off duty for an entire week while the second shift is doing its tour of duty.

Evening calls from four in the afternoon until nine p.m. account for about fifty per-cent of Harper's service volume. Most of the company's walk-in volume occurs after four p.m. They also provide a drive-in, "while you wait" service which enables the set owner to save the cost of the call at home by bringing his set to the shop. The bulk of this business comes in after four o'clock.

Major television service businesses must be constantly alert to set-owner needs and preferences to adjust their operating and advertising programs to conform with the needs of the times. Daily analyses of customer's requests for service, and field technicians' reports on calls will reveal, over a period of time, definite trends in the general pattern of home life in the city where the business is located.

Set-owner surveys like the recent poll made by the Elmo Roper Associates for RCA, provide vital information to the management of major service businesses. The Roper survey indicated that the most important factor to the average person when they call for service on a TV set is the promptness or speed in getting a technician to the home to fix the set. When the service is performed promptly, customers seldom complain about the charges. Seven out of ten people whose sets were repaired on the same day they called for service thought the service charges were "very good". Conversely, as the time lengthened between when service was requested and when it was performed, the cost of service loomed larger in the eyes of the customer. Service shops that run two to three days late in taking care of their customers run into a service cost problem and do not stand much

"GRIP" PRESENTING THE *New* SPINTITE® WRENCHES

PATENTS PENDING

FINEST QUALITY
STEEL SHANK
AND SLEEVE
•
BRIGHT PLATED
FINISH
•
STRONG
PLASTIC HANDLE

WITH THE EASY "FINGER-CONTROL"
GRIP AND RELEASE ACTION
FOR THOSE
HARD-TO-GET-AT PLACES

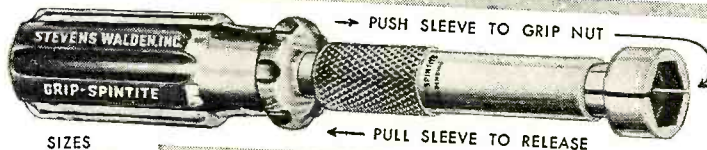

SIZES
3/16" TO 1 1/16"

BY THE MAKERS OF
THE ORIGINAL
SPINTITE
WRENCHES
OVER 150 STYLES
AND SIZES

ONE HAND OPERATION—

- GRIPS nuts or bolts of any material
- HOLDS firmly in any position
- TIGHTENS nut or bolt securely
- RELEASES at the pull of the fingers

Write for
catalogue

STEVENS WALDEN Inc.

450 SHREWSBURY STREET — WORCESTER, MASSACHUSETTS
MAKERS OF WORLD-FAMOUS HAND TOOLS FOR OVER 50 YEARS

Quickly locates "TOUGH DOGS" Senco Tube and Capacitor

Leakage Checker Model LC-2

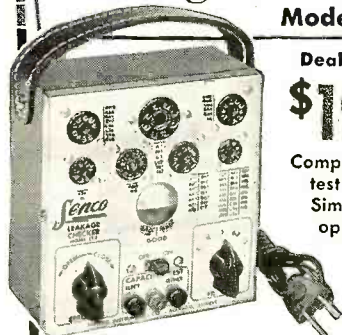

Dealer Net
\$19.95
Kit

Complete with
test leads.
Simple to
operate.
\$24.95
wired

"Two Testers In One"

Now—checks 70 critical tube types

- Quickly locates tubes with gas, grid to cathode or heater to cathode leakage, and grid emission in RF, IF and AGC Circuits.
- Only type tester that finds all tubes causing picture overload, low sensitivity, poor sync, etc.
- Checks all capacitors for leakage with voltage applied.

At Leading Distributors!

Mfg by
SERVICE INSTRUMENTS COMPANY
171 OFFICIAL ROAD • ADDISON, ILL

GET INTO ONE OF THESE TOP OPPORTUNITY FIELDS

ELECTRICITY — Electronics or TELEVISION — Radio-Color TV

TRAIN IN THE GREAT SHOPS OF

COYNE

OLDEST, BEST EQUIPPED
SCHOOL OF ITS KIND IN U.S.

Veterans and Non-Veterans—Prepare for a better job NOW that offers a real future, too! Get practical training in TELEVISION—RADIO—ELECTRICITY—ELECTRONICS—(Refrigeration & Electric Appliance Repair can be included). Learn on real equipment—no advanced education or previous experience needed. Lifetime employment service to graduates.

Finance Plan—enroll now, pay most of tuition later. Part time employment help to students.

FREE BOOK Clip coupon for Big Free Illustrated Book. No salesman will call. Act NOW.

B. W. COOKE President

COYNE ELECTRICAL SCHOOL

A TECHNICAL TRADE INSTITUTE OPERATED
NOT FOR PROFIT
500 S. PAULINA ST., CHICAGO, Dept. 56-85H
ELECTRICITY • TELEVISION • RADIO • REFRIGERATION • ELECTRONICS

B. W. COOKE, Pres., COYNE ELECTRICAL School

500 S. Paulina St., Chicago 12, Ill., Dept. 56-85H

Send FREE BOOK and details on:

- TELEVISION-RADIO
 ELECTRICITY-ELECTRONICS

NAME.....

ADDRESS.....

CITY.....STATE.....

Seal of Achievement

KARLSON ULTRA-FIDELITY ENCLOSURES

The Karlson Enclosure represents a major achievement in acoustic cabinetry. Fully engineered in every detail, its frequency response, radiation characteristics, transient fidelity, and tonal integration are without equal in the entire field of Audio. Even though this cabinet is small in size, and delicately styled to fit any decor, this amazing unit is capable of outperforming even a 30' horn. Its complete versatility and tonal balance make the Karlson Enclosure the final requisite for those who must have the finest in High Fidelity.

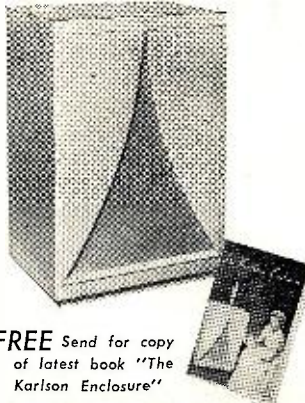

FREE Send for copy of latest book "The Karlson Enclosure"

There is a **KARLSON** for you

KARLSON ASSOCIATES, INC.

DEPT. U

1610 Neck Road

Brooklyn 29, New York

hi-fi ANNUAL & AUDIO HANDBOOK NOW ON SALE!

SAVE AT ESSE!

MICROMAX RECORDERS

LEEDS
&
NORTHROP
\$179.50

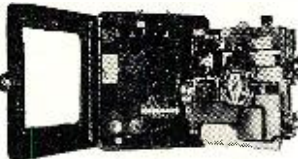

Strip type recorders for controlling and recording many processes. Originally for temp. range of 350-550 degrees C. May be changed for other uses. Operates on Wheatstone bridge principle. AC galvanometer movement. Original cost several times our price. Units removed from demilitarized equipment. Some units new, but all sold as used and guaranteed. Money back if not satisfied. **\$179.50**
Price each.....

110 V. 60 CYCLE



SELSYNS

\$4.95 ea.

Navy size 5 (approx. 6 1/2" L by 3 1/2" dia.). Order either motors, generators, differentials or control transformers at this price. Used but guaranteed good. Shp. wgt. approx. 6 lbs. ea. **\$4.95**
Choice, each.....

RL-42-B ANTENNA REEL/MOTOR



For remote control of automatic trailing wire antenna. Motor is 1/4 HP. 24 V. DC. Has gear train, breaking and disconnect mechanism, reversible and variable speed motor. Ideal for conversion to coil winders, etc. Wgt. approx. 5 lbs. **\$3.95**
Used.....\$2.50 New.....

Remit shipping charges with all orders, or order will be shipped express collect. All items guaranteed to your satisfaction or money refunded if returned within 10 days of receipt. Minimum order \$5.00.

ESSE RADIO CO.

Dept. R-5 • 42 W. South St. • Indianapolis 25, Ind.

RECORDS PRESSED

COMPLETE PACKAGE DEAL

- Tapes Duplicated
- Discs Converted to Tape
- Tapes Transferred to Discs

Top Quality Pressings in Small or Large Quantities

Send for Descriptive Brochure and Rate Schedules

Dept. F

CREST RECORDS, INC.

220 Broadway, Huntington Station, N. Y.

RADIO ELECTRONIC SURPLUS

APG 15 INDICATOR



Easily converted to a MODULATION INDICATOR Unit contains a 2AP1 tube with shield; also 9006 tube, miscellaneous potentiometers and resistors.

Brand new.....\$5.00 each

Conversion data to miniature modulation indicator with schematic.....\$1.50

DBM METER



0-200 microamp. Full scale. Hermetically sealed in 2" case. Manufactured by Marion. Brand new.

Each, postpaid.....\$3.50

NAVY TRANSMITTER



T-19/ARC-5

3-4 mc.....\$5.00 each

T-21/ARC-5

5-7 mc.....\$4.00 each

Slightly used; excellent condition.

NOTE: No C.O.D.'s. Enclose full amount of purchase with order. All merchandise F.O.B. Pasadena, California, unless otherwise specified.

C & H SALES CO.

2176 E. Colorado St., Pasadena 8, Calif.

of a chance of keeping the set owner as a regular customer.

The second most important factor in a customer's appraisal of a service technician is courtesy. When the technician is pleasant and courteous his company can count on repeat business from 85% of the customers he contacts. However, if he is "not at all courteous" his company will lose 8 out of every 10 customers they assign to him.

In many small service businesses, the boss himself works in the field every day making home service calls. Bench work is handled by employees. These service dealers feel that the continued success of their businesses is based on satisfied customers, so they devote all of their time to calling on their customers. When the volume of business requires help, the field service technician employee is given careful training in good customer relations.

These operators of small businesses have long used a plan lately adopted by most of the larger service companies. As each service job is completed the field service technician phones the office from the customer's home to learn if any calls for service have come in from that immediate neighborhood. In many instances they are able to call at a customer's home fifteen or twenty minutes after service was requested. This, naturally, makes quite an impression on the customer.

In the heyday of TV service when well-publicized service shops received more calls for service than their staff could handle, it was standard practice to provide each technician with a schedule of calls and a routing sheet for a full day's work. Many service companies have dropped this practice and now start each technician out with just one call—the first one he is to make. When he completes that job he calls the shop and is given the name and address of his next call. This plan provides the service company with better control over the activities of its field technicians. It also enables them to provide the fastest possible service and to give same day service to many set owners. The average number of completed calls per technician is greater under this system than the former plan.

Maintaining good customer relations should be accepted as a personal responsibility by every electronic service technician irrespective of whether he works alone or is an employee of a service company. Public confidence and respect is not gained through publicity but is earned through good and sincere dealings with every set owner.

No technician should ever lose sight of the fact that television is one of the greatest inventions of all times. It represents a phenomenal achievement of our time that is reshaping the course of our lives. A television receiver is the most complex instrument ever built by mass production for use in homes. Engineering ingenuity has made it simple to use and comparatively low in

price. It is the responsibility of the independent service industry to tell set owners over and over again about the complexity of these instruments that bring them so much entertainment and information.

Association Meetings

The annual convention of the National Alliance of Television and Electronic Service Associations will be held in Chicago, Illinois, on September 14, 15, and 16. The parts and equipment displays that were a featured part of previous NATESA conventions will be eliminated at this year's meeting. It was announced that the convention would feature lectures, seminars, business discussions, fun, and fellowship.

It was recently announced that the American Electronic Council for Service will hold a meeting at the Hotel Muehlbach in Kansas City on May 26 and 27. More than 300 service associations have been invited to attend the meeting to select a name and pass on the bylaws and plan of organization for a new national service association.

In assuming the presidency of the National Electronic Distributors' Association, Joseph A. DeMambro, head of the *DeMambro Radio Supply Co., Inc.*, of Boston, announced a ten-point program of aggressive action for the distributor organization.

Recently Morris Green, president of *Almo Radio Co.*, of Philadelphia, was named chairman of the association's committee on distributor-television service relations. The immediate purpose of the committee is to channel more service to independent service businesses. Its ultimate aim is to bring about the curtailment of manufacturer-controlled servicing. —50—

PHOTO CREDITS

Page	Credit
39, 40, 41, 122.....	Raytheon Manufacturing Co.
48, 49 (bottom), 68 (right), 69 (top), 80.....	General Electric Company
49 (top), 64 (bottom left).....	Radio Corporation of America
50, 51, 52.....	Sylvania Electric Products Inc.
56, 57.....	Viking of Minneapolis
59.....	Barker & Williamson
62 (left).....	Trio Mfg. Co.
62 (right).....	Finney Co.
63 (bottom left).....	Tescon TV Products Co.
63 (right).....	Channel Master Corp.
64 (right).....	Holloway Electronic Corp.
68 (left), 69 (bottom).....	Zenith Radio Corporation
72 (Figs. 2, 6, 7), 73 (Figs. 1, 9, 11), 172, 173.....	Thomas A. Edison Foundation
72 (Figs. 3, 4, 5).....	Tetrad
76.....	J. W. Miller Company
168.....	Southern California DX Club

ERRATUM

Inadvertently, the prices of three of the records reviewed on pages 148 and 149 of our April issue were quoted incorrectly. "Strings of Pearl," "Marimbo-Mambo-Cha-Cha-Cha," and "The Brave Bulls" are all listed at \$5.95 each instead of \$4.95 as indicated. Our apologies for any inconvenience caused by this error.

Trade High with Confidence

AT WRL . . . ON THE FAMOUS

hallicrafter line



SX-96
Only \$1362 per mo.
Cash price: \$249.95

HT-31
Only \$2153 per mo.
Cash price: \$395.00

SX-100
Only \$1608 per mo.
Cash price: \$295.00

HT-30
Only \$2698 per mo.
Cash price: \$495.00

SX-99
Only \$1192 per mo.
Cash price: \$149.95

S-38D
Only \$500 per mo.
Cash price: \$49.95

TOP TRADE-INS

Save up to 50% on Reconditioned Equipment

FREE 1956 CATALOG

Over 15,000 Top Value Items in Amateur Radio, Hi-Fi and Electronics . . . Send for Your Free Copy TODAY!

"the World's Largest Distributor of Amateur Radio Equipment"

PLEASE RUSH: FREE CATALOG QUOTE YOUR TOP TRADE OFFER ON MY PRESENT: _____ FOR YOUR: _____

(WRL Eqpt. Desired)

I Would Like Further Information on the Following Items:

1. _____ 2. _____

3. _____ 4. _____

Name: _____

Address: _____

City & State: _____

R-5

WHEN YOU ORDER BY MAIL . . .

please print your name and address clearly, be specific in your order, enclose proper amount, allow ample time for delivery.

GET INTO ELECTRONICS



You can enter this uncrowded, interesting field. Defense expansion, new developments demand trained specialists. Study all phases radio & electronics theory and practice; TV; FM; broadcasting; servicing; aviation, marine, police radio. 18-month course. Prepare for good pay. Graduates in demand by major companies. High School or equivalent required. Begin January, March, June, September. Campus life. Write for catalog.

VALPARAISO TECHNICAL INSTITUTE
Dept. RD Valparaiso, Indiana

WRITE FOR YOUR BARGAIN "TABOGRAM"
A Free Bonus with Every Order



"TAB" HI-FI SPEAKERS
Inbuilt network 2 wires needed for HF & LF Response Famous Hi-Fi mfgs.
Model P25CO 15" Coaxial PM & 5" Tweeter
25 Watt/20-17500 cycles... \$9.50
Model P12CO 12" Coaxial PM & 3 1/2" Tweeter
12W/145-15KC Cy... \$12.75
Model P8CO 8" Coaxial PM & 2 1/2" Tweeter
8 Watt/70-15KC... \$7.75

FINEST HI-FI RECORDING TAPE

7" Reel—1200 Ft. Per Reel
S S S Back Guarantee

Precision Coated & Silt Gtd. Splice Free. Quality Controlled. Plast. Base. Gtd. Constant Output. Freq. 7 1/2 TPS. 40-15KC. Oxide Wind In. "TAB" SPECIAL @ \$1.59 ea.; 3 FOR \$1.50 ea. ... 12 FOR \$1.45 ea.

COMPLETE HI-FI COMBO SPECIAL

BOGEN AMPLIFIER DB110
UNIVERSITY SPEAKER 6201
FAMOUS GARRARD INTERMIX
RECOTON CARTRIDGE 500-55
Complete Combination, Reg. Priced @ \$157.35
"TAB" Special ... \$124.95

\$124.95

NEW GE PHONO CARTRIDGES

*GE Original Boxed, S S S Back Gtd
RPX050A (SS) ... \$6.75
RPX052A* Golden Treasure (DS) ... \$19.25
RPX053A* Golden Treasure (DD) ... \$28.00

Replacement Needles "TETRAD" Diamond
RPJ013A Dual (DS) 001 & 003 "TETRAD" ... \$11.10
RPJ010 or RPJ010 Single (S) "TETRAD" ... \$9.55
RPJ015 or RPJ015 Single (S) "TETRAD" ... \$11.35
RPJ003 or RPJ004 Single (D) "TETRAD" ... \$9.85
MG or 75 Single (D) "TETRAD" ... \$9.85

NEW "SHAWLITE" ELECTRONIC Flash Kit 400II

Uses NEW to cost to voltage Super Circuit constant bright light output 60 Watt sec'd. Light duration 1/600 sec.; color Kelvin 6800% color #7+; B&W 225+. Cost per flash less than \$1.00 to 2000 flashes per set of (2) 240V batteries. Recycles 2 sec'ds. Parabolic reflector. Assembled gun. Less batteries.
Compact, Wgt. 2 3/4 lbs. MODEL 400 II @ \$24.95
"TABLITE" 600V AC 60W Sec'd @ \$36.95
SHAWLITE 600 II 120W Sec'd. Bat. Oper. @ \$36.95
"TABLITE" 600V AC & Bat. 120W Sec'd @ \$44.95
"TABLITE" 600V, 240W Sec'd. AC & Bat. @ \$59.95
KITS ASSEMBLED. Additional \$10
Two (2) 240 V BATTERIES @ \$10
Write For Complete Data & Specifications
Photoflash Cond. \$25WFD/460V/53W SEC. NEW LOW leakage, Famous mfg. ... @ \$8; 2/\$15

New, Unused • Individually Boxed TUBES FULL RETMA WARRANTY

No Electrical or Mechanical Rejects

024	.45	6AV5	.80	6K6	.45	12AX7	.55
1AX2	.95	6AV6	.45	6SA	.45	12BA6	.50
1B3	.65	6AX4	.95	6SA7	.50	12BE6	.65
1R5	.50	6AX5	.65	6S7	.65	12BH7	.65
1T4	.50	6BA6	.45	6SK7	.50	12BY7	.97
1U5	.45	6BC6	.60	6SL7	.55	12SA7	.64
1X2	.45	6BE6	.45	6S8	.55	12SK7	.65
3V4	.75	6BG6	1.24	6EQ7	.55	12SN7	.56
5U4	.45	6BK7A	1.11	6T4	1.15	12ST07	.50
5V4	1.28	6B7	1.78	6V6	.55	25L6	.42
5Y3	.65	6BN6	1.19	6V6	.55	25L6	.42
6AC7	.65	6BQ6	1.90	6W4	.35	25W4	1.03
6AG5	.45	6B7A	1.33	6X4	.45	25Z6	.70
6AK5	.60	6C4	.35	6X5	.45	35W4	.50
6AL5	.40	6CB6	.50	6XR	.85	35Z5	.48
6AQ5	.45	6D6	1.00	6Y6	.40	6X4	.45
6AT6	.40	6CF6	1.25	12AT7	.65	500C5	.52
6AU4	.95	6CL6	1.65	12AU6	.41	50L6	.55
6AU5	1.10	6J5	.40	12AU7	.50	75	.85
6AU5	.45	6L6	.45	12AX4	1.20	85V	1.22

"TAB" Bargains In Component Parts

100 CARBON RESISTORS, 1/2-1 & 2 Watts. All popular values—insulated & color code @ \$2.49
25 TUBE SOCKETS, all types—Octal, Loktal, 7 & 9 pin miniature @ \$1.85
20 OIL CONDENSERS, wide assortment of popular sizes & values @ \$1.85

VARIABLE 0 TO 6 & 12 VOLT/12 AMP DC Power Supply

Battery Eliminator, Charger, Model RR, Plator, Aircraft, Marine or any DC reg. Extra hvy duty Selenium Rectifier, 2 meters V & A. Designed for continuous service & up to 20 Amps intermittent overload.
MODEL T612V12AC... @ \$29.95

"TABTRON" HI CURRENT PWR SUPPLIES ONE YEAR GUARANTEE

Variable 0-28VDC. Completely Built. Incls: Full Wave Selenium Rectifier, Transformer, Variac, Volt & Amp Meters, Switch, Terminals & Fuse. In Hvy duty Steel Cabinet. Standard 115V/60cy Input or 220+ and 3 phase to order. SPECIFY.
Stk. No. Cont. Rating W-Meters
T28V5A 0-28 VDC at 5 Amp S 50
T28V12A 0-28 VDC at 12 Amp S 125
T28V24A† 0-28 VDC at 24 Amp S 155
T28V50A† 0-28 VDC at 50 Amp S 285
WRITE FOR COMPLETE LIST

NEW "TABTRON" SELENIUM BRIDGE Gtd. RECTIFIERS One Yr.

Variable 0-28VDC. Completely Built. Incls: Full Wave Selenium Rectifier, Transformer, Variac, Volt & Amp Meters, Switch, Terminals & Fuse. In Hvy duty Steel Cabinet. Standard 115V/60cy Input or 220+ and 3 phase to order. SPECIFY.
Stk. No. Cont. Rating W-Meters
T28V5A 0-28 VDC at 5 Amp S 50
T28V12A 0-28 VDC at 12 Amp S 125
T28V24A† 0-28 VDC at 24 Amp S 155
T28V50A† 0-28 VDC at 50 Amp S 285
WRITE FOR COMPLETE LIST

INFRARED SNOOPSCOPE See In Dark Tube

Selected Gtd. Image Converter Tube. High sensitivity, simplified design. 2" dia. Willamite screen. Hi Resolution. Tube & Data... Special @ \$3.90; 2/\$7.50
Snooperscope Power Supply Kit
4500VDC/35MA. Using Dual Doubler Crkt. Incls Transformer, Rectifiers, Sockets, Resistors, Capacitors and diagram 115V/60cy oper... \$13.50

"TAB" TERMS: Money Back Gtd (cost of mdsd only) 55 min order

F.O.B. N.Y.C. Add shipping charges or for C.O.D. 25% Dep. Tubes gtd. via R-Exp Only. Prices shown subject to change.
111 LIBERTY ST., N.Y. 6 N.Y. RECTORS 2-6245
DEPT. 5RNS-CABLE "TABPARTS"

INDEX OF Advertisers

While every precaution is taken to insure accuracy, we cannot guarantee against the possibility of an occasional change or omission in the preparation of this index.

ADVERTISER	PAGE	ADVERTISER	PAGE
A. L. Products Co., Inc.	170	Lansing Sound Inc., James B.	174
Aaron Electronics	154	Lektron Specialties	149
Aermotor Company	112	McGee Radio Company	136, 137
Airex Radio Corp.	169	M. R. Company, The	121
Allied Radio Corp.	9, 113	Major Brand Tube Co.	135
Altee Lansing Corporation	34, 119	Mallory & Co., Inc., P.R.	79, Fourth Cover
American Phenolic Corporation	111	Marantz Company	114
American Television & Radio Co.	130	Merit Coil & Transformer Company	80
Arrow Sales, Inc.	123	Millwaukee School of Engineering	76
Ashe Radio Company, Walter	103	Moss Electronic Distributing Co., Inc.	128, 129
Audel Publishers	173	Musical Masterpiece Society, Inc., The	11
Audio Unlimited	174	National Radio Institute	3, 7
B & K Manufacturing Co.	121	National Schools	27
Baltimore Technical Institute	156	Newark Surplus Materials Co.	169
Barry Electronics Corp.	181	North American Phillips Co., Inc.	85
Beckman Instruments, Inc.	166	Northrop Aeronautical Institute	176
Belden	28	Pacific States University	154
Bell Telephone Laboratories	36	Pearl Electronics Company	146
Blonder Tongue Laboratories	19, 20, 21, 22	Perno, Inc.	84
British Industries Corporation	165	Photography Directory and Buying Guide	166
CBS-Hytron	31	Pilot Radio Corp.	78
C & H Sales Co.	178	Post Electronics Company	164
Cabinart	148	Precise Development Corp.	18
Candler System Co.	114	Precision Apparatus Company, Inc.	138
Cantor, Jack	114	Premier TV Radio Supply	142
Capital Electronics	172	Prentice-Hall, Inc.	161, 164
Capitol Radio Engineering Institute	29	Presto-Recording Corporation	167
Centralab	14, 15	Progressive "Edu-Kits" Inc.	160
Channel Master Corp.	13	Progressive Electronics Institute	174
Cleveland Institute of Radio Electronics	17	Pyramid Electric Company	75
Colordaptor	171	Quality Electronics	161
Columbia Electronics	166	R.C.A. Institutes, Inc.	25, 126
Commissioned Electronics, Inc.	174	RW Electronics	59
Cornell-Dubilier	30	Radiart Corp., The	30
Coyne Electrical School	82, 177	Radio Corporation of America	151
Crest Records, Inc.	178	Radio Ham Shack, Inc.	182
Dauntless International	83	Radio Kits, Inc.	158
DeVry Technical Institute	5	Radio Products Co.	126
Discus Corp. (Monarch)	104	Radio-Television Training Association	23
Dressner	86	Rad-Tel Tube Co.	140
Dumont Laboratories, Inc., Allen B.	35	Ram Electronics Sales Co.	167
Duotone Company, The	176	Raytheon Manufacturing Company, 2nd Cover	6
Dynamic Electronics-New York, Inc.	104	Reeves Soundcraft Corp.	110
Ebor Electronics Co., Inc.	99	Rek-O-Kut Company	77
Editors and Engineers, Ltd.	152	Remington Rand Univac	77
Electronic Chemical Corp.	165	Research Inventions & Manufacturing Co.	120
Electronic Instrument Co., Inc. (EICO)	37, 38	Rex Radio Supply	144
Electronic Specialties Mfg. Corp.	82	Rinehart & Co., Inc.	131
Electro-Voice	8, 16	Rockbar Corporation	118
Esse Radio Co.	178	Ronette Acoustical Corp.	134
E-Z Way Towers, Inc.	148	Sams & Co., Inc., Howard W.	115, 157
Fair Radio Sales	127	Sarkes Tarzian, Inc.	133
Fairchild Recording Equipment Co.	132	Scott, Inc., H. H.	26
Federal Telephone and Radio Company	33	Seco Mfg. Company	147
Fisher Radio Corp.	105, 106, 107, 108, 109	Semler Industries, Inc.	84
G & G Radio Supply Co.	139	Service Instruments Company	177
General Cement Mfg. Co.	104	Shawmut TV Supply Co.	166
General Development Corporation	112	Solar Electronics	161
General Electric	152	Spera Electronics Supply	154
Gernsback Library, Inc.	154	Sperry Gyroscope Company	153
Goodheart, R. E.	86	Sprague Products Company	140
Granco Products, Inc.	176	Stan-Burn Radio & Electronics Co.	150
Greenlee Tool Co.	173	Standard Electrical Products Co.	122
Harjo Sales Co.	170	Stanley Electronics Co.	162
Hartley Products Co.	170	Stevens Manufacturing Corp.	86
Harvey Radio Co., Inc.	144	Stevens Walden, Inc.	177
Heald Engineering College	126	Supreme Publications	143
Heath Company	87, 88, 89, 90, 91, 92, 93, 94, 95, 96, 97, 98	Sylvania Electric Products, Inc.	12
Henry Radio Stores	171	"TAB"	180
Hershel Radio Co.	156	Taylor Mfg. Co.	162
Hickok Electrical Instrument Company	161	Tech-Master Corporation	155
Hi-Fi Fabrics Institute	84	Technical Materiel Corporation, The	120
Indiana Technical College	169	Telco Electronics Mfg. Co.	148
Instructograph Company	121	Telemarine Communications Co.	163
International Business Machines Corp.	81	Television Hardware Mfg. Co.	120
International Radio & Electronics Corp.	153	Teltron Electric Company	149
International Rectifier Corporation	24	Texas Crystals	168
International Resistance Company	124, 125	Triad Transformer Corp.	102
J. J. Glass Electronics Co.	164	Triplet Electrical Instrument Corp., 3rd Cover	86
Jackson Electrical Instrument Co.	141	Tube Mart	132
Jerrold Electronics Corp.	10	Tung-Sol Electric, Inc.	32
Johnson Company, E. F.	114	U. S. Crystals, Inc.	156
Kaer Engineering Corp.	123	V. S. I. Television School	112
Karlson Associates, Inc.	178	Valparaiso Technical Institute	179
Keroes Enterprises	175	D. Van Nostrand Co., Inc.	162
Kester Solder Company	126	Viking of Minneapolis	123
Kuhn Electronics	144	Ward Products Corporation	145
LMB Box Chassis	161	Western Television Institute	84
Lafayette Radio	116, 117	Wheatland Tube Co.	82
Lampkin Laboratories, Inc.	173	Winegard Company	119
		World Radio Laboratories	179

Classified

RATE: 50¢ per word. Minimum 10 words. July issue closes May 10th. Send order and remittance to: **RADIO & TELEVISION NEWS**, 366 Madison Ave., N. Y. C. 17.

RADIO ENGINEERING

COMPLETE radio, electronics theory & practice; television; broadcasting; servicing; aviation, marine, police radio. 13 or 21 months. Catalog. Valparaiso Technical Institute, Dept. N, Valparaiso, Ind.

FOR SALE

TRADE-IN Television Sets \$14. Jones Radio, 1115 Rambler, Pottstown, Pa.

DIAGRAMS—Radio \$1.00; record changers, recorders \$1.25. Television with service data \$2.00. Where model unknown, give part numbers. Kramer's Radio Service, Dept. JA5, 36 Columbus Ave., New York 23, N. Y.

ETCHED Circuit Kit 6"x6" XXXP copper clad sheet, etch, resist, complete instructions. \$2.25 postpaid. Transcircuits, 2105 West 42nd, Kansas City 3, Kansas.

DIAGRAMS for repairing radios \$1.00. Television \$2.00. Give make, model. Diagram Service, Box 672-RN, Hartford 1, Conn.

TV Trade-In sets. Philco, R.C.A., Emerson, others. List available. 10" —\$12. 12" to 17" —\$15. up. Washtek Service Co., Dept. R, 956 Southern Blvd., Bronx, N. Y.

TUBES—TV, Radio, Transmitting And Industrial Types At Sensibly Low Prices. New, Guaranteed, 1st Quality, Top Name Brands Only. Write For Free Catalog or Call Walker 5-7000, Barry Electronics Corp., 512 Broadway, New York 12N, N. Y.

EASY build radios, Hi-Fi phono-amplifiers. Plans, \$1.00 each. Wolins, Amazon Rd., Peekskill, N. Y.

COMPLETE electronic equipment for a community television system. (Used.) Write M. L. Houtz, 415 Spruce Street, Steelton, Penna.

COLLINS FM-A.M. (Back-Panel) Tuner. 3 M.V. Sensitivity; 1st-class condition. Only \$65.00. B. K. Balch, 611 Livingston Rd., Linden, N. J.

GEIGERS & Scintillators, Free Catalog. E.A.K. Research Labs, Tarrytown, N. Y.

HANDY Pocket Rubber Stamp. Self inking. Plastic case. 3 lines \$1.00 postpaid. Guaranteed. Veness, Mill City, Oregon.

Hi-Fidelity Specials. Limited Supply Order Today—Collaro RC-54-Mounting Board-Ronette Cartridge—Diamond Stylus on LP—only \$49.75 Prepaid—\$39.50 without Diamond. prepaid. 18007 Guaranteed tape—New—on 7" reel-plastic base 10 for \$24.00 Prepaid—Full line of Hi-Fi Equipment. Write today. Sound Mart Unlimited, Inc., 63-03 39th Ave., Woodside 77, New York.

TV-FM antennas. All types including UHF. Mounts, Accessories. Lowest prices. Wholesale Supply Co., Dept. H, Lunenburg, Mass.

FAMOUS brand supplies for home, office, shop, sports, clothing, jewelry, etc. Wholesale catalog \$1.00. Elvig's, Box 7123, Philadelphia 17.

DIAGRAMS—Repair Information! Radios, Amplifiers, Recorders \$1.00. Television \$1.50. Send Make, Model, Chassis. (Air-Mail? +20¢.) TV Mittie, Box 101, Hicksville, New York.

BUY Surplus radios, receivers, transmitters, radar equipment. Direct from Government. List \$1.00. Box 1842AE, Hartford 1, Connecticut.

PRE-RECORDED Tape for listening and dancing featuring Hammond Organ. 3" sample reel \$1.00. Tape Toons, Box 39, Smithtown, N. Y.

TV, Radio Parts, Tubes, Antennas, Wire, Speakers, Condensers, Selenium Rectifiers, Rotators, Towers, Benches, Shelving, Test Equipment, TV Tables. Make us your leading supplier. Catalog free. Radio Tube Merchandising Company, 508 Clifford Street, Flint 3, Michigan.

WANTED

HIGHEST prices paid for Surplus Radios—RT18/ARC1—ART 13—R5/ARN7—BC 788C—BC342 Etc. Write W2KUU, 308 Hickory, Arlington, N. J.

CYLINDER and old disc phonographs. Edison Concert, Balmoral, Conqueror, Opera, and Oratorio models. Berliner Gramophones and Zono-ophones, Columbia disc and cylinder Graphophones. Bettini micro-reproducer. Want old catalogues and literature on early phonos prior to 1919. Will pay cash or trade late hi-fi components. Box 50 % RADIO & TELEVISION NEWS.

AN/APR-4, AN/APR-9, other "APR-," "ARR-," "TS-," ARC-1, ARC-3, ART-13, everything surplus; Tubes, Manuals, Laboratory equipment. Describe, price in first letter. Engineering Associates, 434 Patterson Rd., Dayton 9, Ohio.

WANTED: ART-13 transmitters and parts—also ARC-1, ARC-3 and ARN-7. Have requirement for ARN-6 material, Iron Core Loops, need all types Collins and Bendix Aircraft Radio equipment. Florida Aircraft Radio & Marine, Inc. P. O. Box 205, International Airport Branch, Miami 48, Florida.

WANTED: Receiver R5/ARN-7, MN-62A Transceivers, RT18/ARC-1, AN/ARC-3, BC-788C, I-152C, Collins, Bendix equipment, Test Sets, Dynamotors, Inverters. We pay highest prices. Advise quantity, condition, price first letter. Aircraft Radio Industries, Inc., 15 East 40th St., New York City, telephone LEXington 2-6234.

TUBES and equipment bought, sold, and exchanged. For action and a fair deal write B. F. Gensler, W2LN1, 56 Crosby St., N. Y. 12N, N. Y.

NORELCO "Duo-Vue" Projection TV unit complete with cabinet for projecting TV picture onto regular home movie screen. This unit was designed to work with a standard small-screen TV receiver. Desire completely new unit in original carton with full instructions. Box 53, % RADIO & TELEVISION NEWS.

ART-13/T47A Transmitters, \$175.00; ART-13/T47 Transmitters, \$125.00; BC-788 C Altimeters, \$175.00; ARC-3 Transceiver Complete, \$325.00; R5/ARN-7 Radio Compass, \$175.00; BC-348 Rec'r Modified, \$25.00; BC-348 Rec'r Unmodified, \$50.00; ARC-1 Transceiver, \$300.00; BC-312 Rec'r, \$50.00; BC-312 Rec'r, \$40.00; I-152-C Indicator, \$50.00. Ship Via Express, C.O.D. Subject To Inspection To H. Finnegan, 49 Washington Ave., Little Ferry, N. J.

WANTED—All types of Electronic Tubes: broadcast, transmitting, receiving, Magnetrans, Klystrons. Need all types airborne equipment: ADF-70; ARC-1, -3, -4, -12, -15, -27, -33; ARN-6, -7, -12, -14, -18; BC-312, -342, -610E, -788C, -2121; I-152, ID-48, MN-24C, -31C, -36, -42, -53, -58, -61, -85, -97F, -100A; RA-18; TA-18; 17-L3; 51-R, -R3; 51-VI, Etc. Top Dollar Paid! Bob Sannet, W6REX, 1524 S. Edris Dr., Los Angeles 35, Calif.

REPAIRS AND SERVICING

HIGH Fidelity Speakers Repaired. Amprite Speaker Service, 70 Vesey St., N. Y. 7, N. Y. Ba. 7-2380.

TELEVISION Tuner Repairs. Dan's Television Laboratory, 9 West 183rd St., N.Y. 53, N.Y.

TAPE RECORDERS

TAPE Recorders, Tapes; Wholesale Prices. Klarston, 215 E. 88, New York City 28.

PRE-recorded tape music, recording tape, accessories. Excellent values. Catalogue, Eisco Sales, 270 E. Concord, West Hempstead, N. Y.

RECORDERS. Tapes. Sensational Discounts. Free Catalog. Towers, Box 155, Philadelphia 5.

TAPE Recorders, Tape. Unusual Values. Free catalog. Dressner 69-02 R, 174 St., Flushing 65, N. Y.

CORRESPONDENCE COURSES

USED Correspondence Courses and Books sold and rented. Money back guarantee. Catalog free. (Courses bought.) Leo Mountain, Pisgah, Ala.

MISCELLANEOUS

LETTERHEADS, envelopes, statements, cards, labels. Free price list. Prompt service. Harold Kroll, Seymour, Wisconsin.

Only the 5 TOP QUALITY brands of

STANDARD BRAND TUBES

AT SENSIBLE PRICES!

- Individually boxed • First quality only
- Brand New • Standard RTMA guarantee
- No private brands • No rejects
- No rebrands or rewashed bargains

Free! Newest handy air-mail order form for your ordering convenience. Lists over 400 popular replacement types.

WRITE FOR YOUR FREE COPY TODAY!

- Lists ALL popular TV & radio types,
- Makes mail-ordering a real pleasure.
- All tube orders over \$25.00 (with remittance) postpaid.

SPECIAL-PURPOSE TUBES

Write for our complete listing on Transmitting, Industrial Special-Purpose Tubes, and Crystal Diodes. We STOCK over 1000 types at excellent prices.

TRANSMITTING TUBE SPECIALS

(SURPLUS—NEW ORIG. BOXED)

4PR60A\$50.00	750TL\$40.00
304TH 8.75	807W 2.00
307A 47.50	807W/5933 2.85
450TH 47.50	872A 1.25

EQUIPMENT SPECIALS!

New & used at bargain prices. Subject to prior sale. All items guaranteed to be as advertised.

LM-15 NAVY FREQ. METER W/orig. book. \$49.50

KAY MEGA-MARKER SR., 13 channel xtal freq. TV marker, vy. gtd. \$49.50

SNOOPSCOPE TUBES, CR-143 or 147. New. 3.50

INFRA-RED FILTER for above. New. 1.50 (free data supplied with either above)

113 V. SELENIUM RECTIFIER, 1/2 amp. full wave bridge type. Sarks-Tarzan. New. 3.00

SELSYN MOTORS, 115 volt, 60 cycle, each. 5.95

2 COLOR TUBE CARTONS

Keeps your tube stock neat. New safety partition prevents tube breakage. Distinctively lithographed in glossy red and black. The most distinctive tube carton available today. Minimum quantity: 100 of any one size. Write for case lot prices.

SIZE	FOR TUBE	PER 100
Miniature	6AU6, etc.	\$1.00
GT	6SN7, etc.	1.25
Large GT	1B3, etc.	1.50
Large G	5U4, etc.	2.00

WHITE GLOSSY BOXES
Completely blank. No printing or color. Otherwise same as above. Same high quality, same low prices. Specify "white" when ordering.

TUBE STACKERS
White glossy only. Ministacker holds 10 Mini. tube cartons; "GT" stacker holds 10 "GT" cartons. 100 Ministacker \$1.50
GT 2.00

SMALL PARTS BOXES

Craft colored folding cardboard boxes ideal for kits of small parts, storage of seldom used material, light shipping, and a million and one other uses around the shop. Quantity is limited so order now! Available in two sizes.

3" x 4" x 5"	1¢	EITHER SIZE
6" x 6" x 5"	1¢	ea. (in case lots of 200 boxes)
		Single boxes 1/2¢ ea.

DIRECTRON SELENIUM RECTIFIERS

Full Wave Bridge Type

Max. Amps.	18 VAC	36 VAC	54 VAC	72 VAC	130 VAC
	14 VDC	28 VDC	42 VDC	56 VDC	100 VDC
1	\$1.35	\$2.30	\$3.70	\$4.50	\$7.40
2	2.00	4.10	5.90	5.90	9.15
2 1/2	2.90	6.40	7.90	14.85	12.70
3	3.50	8.40	11.25	14.35	21.70
4	3.95	7.70	12.75	17.30	29.65
6	5.85	11.35	19.40	24.80	41.25
12	14.25	22.00	37.25	39.85	83.85
20	13.05	25.05	37.25	48.75	78.50
24	14.25	28.75	44.50	57.65	81.00

We build other selenium rectifiers. Transformers and chokes to your specifications. Complete line of new rectifier transformers, chokes and filter capacitors in stock at all times. May be ordered at same time as selenium rectifiers above for immediate delivery. Write for complete price list.

FILAMENT TRANSFORMER SPECIALS

Super Electric #29600.12
Sec. 5 VCT @ 3 A; 5 VCT @ 3 A; 5 VCT @ 6 A.
Pri. 220 volts, 60 cycles.
SPECIAL EACH \$3.95

Kenyon #S-10694
Sec. 5 VCT @ 10 A.
Pri. 210-220-230-240 volts, 60 cy.
SPECIAL EACH \$4.95

Collins #672-1141-00 (mfg by Chi., herm. sealed)
Sec. 2.5 VCT @ 15 A.
Pri. 210-220-230-240-250 volts, 60 cy.
SPECIAL EACH \$4.95

WRITE FOR "BARRY'S GREEN SHEET" ISSUED MONTHLY. FREE!

TERMS: 25% deposit with order, balance C.O.D. All merchandise guaranteed, F.O.B. N.Y.C.

BARRY ELECTRONICS CORP.

512 Broadway, Dept. RN, N.Y. 12, N.Y.
Call Day or Night—24 Hour Phone Service
Phone: Walker 5-7000

When you order by mail . . .

please print your name and address clearly, be specific in your order, enclose proper amount, allow ample time for delivery.

SENSATIONNEL!

CASH for YOU!

We urgently need for government contracts, military electronic equipment, such as: BC312, BC342, BC348, ART13, APR4, ARG1, ARG3, ARNG, ARN7, BC221, BC788, BC610, and many others. State conditions, type and best price.

"Εχομεν πάντοτε παρακαταθήκη πλέον τῶν 2.000 διάφορα σωληνιαρια (tubes). "Όλα πρώτης τάξεως. Έγγυώμεθα ἐπιστροφήν τῶν χρημάτων σας ἐάν δὲν μείνετε εὐχαριστημένοι. "Όλα εἰς χωριστὸν κιβώτιον.

TRANSLATION: We have in stock at all times over 2,000 different types of tubes. All first quality, money-back guarantee, individually boxed

In any language your best buy is Radio Ham Shack for:

QUICK SERVICE • HIGH QUALITY • LOW PRICES

TEST EQUIPMENT

TS-3/AP	Power and freq. meter	S-band
TS-7/ASQ	Magnetic compensator	
TS-10 APN	Allimeter test set	Delay line
TS-12/AP	Standing wave ind.	X-band VSWR
TS-13/AP	Sig. gen. freq. mtr	X-band
TS-14 AP	Sig. gen. pwr mtr	S-band
TS-15/AP	Fluxmeter	1.2-4.5K GAUSS
TS-16/APN	Allimeter test set	340-7500 CYC
TS-18/AP	Voltage divider	100 : 1-15 : 1
TS-19/APQ-5	Calibrator	491.04 MC
TS-23/APN	Allimeter test set	
TS-24/ARR-2	Test oscillator	246 MC
TS-27/TSM	Line test set	0-50 MEG, 1-3 MFD
TS-28/UPN	Synchroscope	
TS-32/TRC-1	Test oscilloscope	1 KC FM, 70-1000
TS-33/AP	Frequency meter	
TS-34/AP	Portable oscilloscope	Fast sweep
TS-35/AP	Sig. gen. pwr and freq. mtr	X-band
TS-36/AP	Power meter	X-band
TS-45/APM-3	Power and freq. meter	S-band
TS-46/AP	Frequency meter	
TS-47/APR	Signal generator	40-500 MC
TS-51/APG-4	Goniometer	
TS-56/AP	Standing wave ind.	L-band
TS-59 APN	Delay line allimeter	High all.
TS-61/AP	Echo box	S-band
TS-62/AP	Echo box	X-band
TS-67/ARN-5	U/with RC103/ARN5	
TS-69/AP	Calibrator freq. meter	4-1KMC
TS-74/UPM	Attenuator and phantom ant.	S-band
TS-75/U	Test meter	U/with TS76
TS-76/APM-3	Wave guide kit	U/with TS45
TS-78/U	Phantom antenna	100-156 MC
TS-89/AP	Voltage divider	X-and S bands
TS-91 TPS-1	Echo box	1050-1110 MC
TS-92/AP	Broad band alignment	20-250 MC
TS-98/AP	Decade resistor	22.85 : 1
TS-100/AP	Oscilloscope circular sweep	
TS-102/AP	Range calibrator	Sine wave 327.8 KC
TS-108/AP	RF dummy load	X-band
TS-110/AP	Echo box	S-band
TS-111/CP	Wavemeter	S-band
TS-117/AP	Wavemeter, absorption	S-band
TS-118/AP	RF wattmeter	5-500 W
TS-120/UP	Sig. gen. pwr meter	X-band
TS-125/AP	Power meter	S-band
TS-126/AP	Radar range calibrator	400 YD, PIPS
TS-127/U	Frequency meter	375-725 MC
TS-131/AP	Field strength meter	20-3000 MC
TS-133/UPM-1	Wavemeter	115-235 MC
TS-134/UPM-1	Wavemeter	460-570 MC
TS-146/UP	FM Sig. gen. wave and pwr mtr	X-band
TS-147/UP	Sig. gen. pwr freq. meter	X-band
TS-148/UP	Spectrum analyzer	X-band
TS-155/UP	Pulse generator	S-band
TS-157/UP	Sig. gen. pwr freq. mtr	150-200 MC
TS-170/ARN-5	Test oscillator	332.6-335 MC
TS-173/UR	Frequency meter	90-450 MC
TS-174/U	Frequency calibrator	20-280 MC
TS-175/U	Frequency calibrator	85-1000 MC
TS-182/UP	Signal generator	157-187 MC
TS-184/AP	Echo box	400-430 MC
TS-192/CPM-4	Wavemeter	S-band
TS-204/AP	Reflectometer	
TS-218/UP	Tuned cavity	X-band
TS-226/AP	Wattmeter to K KW	400-425 MC
TS-247/APM-48	Wavemeter	215-275 MC
TS-250/APN	Allimeter calibrator	Delay line
TS-251/UP	Loran sig. generator	1700-2010 KC
TS-258/UP	Sig. gen. pwr and freq. mtr	X-band
TS-259/AP	FM signal generator	
TS-263/TPS-10	Sig. gen. wattmeter	X-band
TS-268/U	Xtal rect. test set	
TS-270/UP	Echo box	S-band
TS-278/AP	Test set	400-420 MC
TS-297/U	Multimeter	
TS-309/U	Sweep Generator	5-65 MC
TS-323/UR	Frequency meter	
TS-352/U	Multimeter	
TS-377/UP	Voltmeter	
TS-382/U	Audio oscillator	1000 KC
TS-505	Vac. tube voltmeter	
I-48	Megohmmeter	0-1000 MEG
I-56	Wheatstone bridge	0-10 MEG
I-72	Tube tester voltohmmeter	
I-83	Signal generator	100 KC-32 MC
I-86	Generator	470 MC
I-96A	Signal Generator	100-156 MC
I-100	Radio ADF test set	
I-130A	Signal generator	100-156 MC
I-203A	Balometer	S-band
I-208	Signal Generator	1.9-45 MC
I-222A	Signal Generator	8-230 MC
IE-17	Handy talky test set	
IE-19	SCR522 test set	100-156 MC
IE-36	SCR522 test set	
IE-46	IEF test set	156-166 MC
IE-56	IEF test set	160-186 MC
BC-221	Frequency meter	125-20000 KC
BC-376	Signal generator	75 MC
BC-1056	Test receiver	150-225 MC
BC-1077	Signal generator	S-band
BC-1203	Modulator unit	
BC-1277A	Sig. gen. pulsed	S-band
BC-1287	Oscilloscope	

TUBES! First Quality—Fully Guaranteed—Standard Brands—No Seconds TUBES!

RECEIVING TUBES

0Z4	.49	6B4G	.95	7B5	.65
1A3	.68	6B8	.67	7B6	.75
1A7GT	.52	6BA6	.63	7B7	.75
1AE4	.92	6BC5	.68	7C5	.75
1AX2	.95	6BE6	.65	7C6	.75
1B3GT	.79	6BF6	.68	7C7	.79
1C5GT	.55	6BG6G	1.75	7F7	.85
1G4GT	.65	6BH6	.79	7F8	1.10
1G6GT	.49	6BJ6	.69	7N7	.85
1H5GT	.58	6BK7	1.05	7R7	.95
1J6GT	.69	6BL7G	1.05	7V7	.95
1L4	.74	6BN6	1.10	7Y4	.65
1L6	.79	6BQ6GT	1.15	12A6	.57
1LA4	.79	6BQ7A	1.15	12A8GT	.79
1LA6	.85	6C4	.38	12AH7GT	1.00
1LB4	.85	6C5	.48	12AT6	.48
1LC5	.79	6C5GT	.46	12A77	.92
1LC6	.79	6C6	.49	12AU6	.62
1LD5	.85	6C8G	.85	12AU7	.75
1LE3	.79	6C8G	.68	12AV7	.95
1LH4	.85	6D6	.59	12AX7	.78
1LN5	.79	6E5	.75	12AY7	1.15
1N5GT	.59	6F5	.59	12BA6	.60
1R4	.65	6F6	.85	12BA7	.89
1R5	.65	6F6GT	.69	12BE6	.65
1RS	.65	6F7	.89	12BH7	.89
1S5	.65	6F8G	.72	12C8	.69
1T4	.65	6G6G	.72	12H6	.59
1T5GT	.67	6H6	.59	12J5GT	.65
1U4	.67	6H6GT	.49	12K7GT	.69
3U5	.59	6J5	.48	12K8	.69
1V	.65	6J5GT	.47	12SA7	.69
1V2	.59	6J6	.68	12SA7GT	.69
1V6	1.49	6J7	.82	12SC7	.75
1X2A	.85	6J7GT	.65	12SG7	.79
2A3	.95	6K6GT	.75	12SH7	.65
2A5	.65	6K7	.64	12SJ7	.65
2A6	.59	6K7GT	.59	12SK7	.69
2X2	.49	6K8	1.10	12SL7	.85
2X2A	1.35	6K8GT	.95	12SN7GT	.75
3A4	.60	6L6	1.69	12SQ7	.59
3A5	.64	6L6G	.98	12SR7	.73
3B7	.39	6L7	.95	12V6GT	.59
3D6	.39	6N7	.89	12W6GT	.87
3LF4	.85	6Q7	.85	14A7	.75
3Q4	.65	6Q7GT	.79	14B6	.69
3Q5GT	.75	6R7	.85	19BG6G	1.89
3S4	.65	6R7GT	.68	19T8	.95
3V4	.69	6S4	.57	25BQ6GT	1.25
5A W4	1.10	6SA7GT	.79	25L6GT	.65
5R4GY	1.45	6SA7GT	.79	25W4GT	.72
5T4	.90	6SB7Y	.87	25Z5	.75
5U4G	.58	6SC7	.72	25Z6	.62
5V4G	.88	6SF5	.72	30	.65
5W4GT	.65	6SF5GT	.69	32L7GT	.85
5X4G	.75	6SG7	.65	35A5	.68
5Y3GT	.49	6SH7	.74	35B5	.68
5Z3	.69	6SJ7	.69	35L6GT	.65
5Z4	.89	6SJ7GT	.59	35W4	.44
6A3	.95	6SK7	.64	35Y4	.65
6A6	.82	6SK7GT	.59	35Z3	.65
6A7	.89	6SL7GT	.75	35Z6GT	.44
6A8	1.05	6SN7GT	.75	41	.69
6A8GT	.95	6SQ7	.59	42	.65
6A8A	.95	6SQ7GT	.43	43	.79
6A87	.95	6SR7	.55	50A5	.68
6AC7	.85	6SS7	.75	50B5	.68
6AF6G	.45	6ST7	.95	50C5	.68
6AG5	.72	6T8	.95	50L6GT	.62
6AG7	.98	6U5/6G5	.85	50Y6GT	.78
6AH6	.85	6U8	.95	53	.92
6AJ5	1.49	6V6	1.10	70L7GT	1.15
6AK5	.69	6V6GT	.59	75	.65
6AK6	.75	6W4GT	.65	77	.47
6AL5	.58	6W6GT	.79	78	.57
6AL7	.95	6X4	.48	80	.59
6AQ5	.57	6X5GT	.49	83	.95
6AQ6	.57	6Y6G	.89	83V	.95
6AT6	.52	7A4	.79	84/6Z4	1.69
6AUSGT	1.10	7A5	.69	117L/M7GT	1.45
6AU6	.65	7A6	.78	117N/P7GT	1.45
6AV6	.53	7A7	.75	117Z3	.60
6AX4GT	.79	7A8	.95	117Z6GT	.60
6AX5GT	.69	7AG7	.75		

TRANSMITTING AND SPECIAL PURPOSE TUBES

0A3/VR90	.86	250TH	18.95	959	1.32
0B3/VR90	.73	250TL	14.75	991	.29
0C3/VR105	.68	274A	1.40	1603	2.95
0D3/VR150	.68	274B	.85	1616	.50
1B22	1.25	204TH	7.95	1619	.30
1B23	2.68	304TL	9.95	1622	1.45
1B24	4.85	307A	1.10	1624	.95
1B27	12.95	350A	2.65	1625	.29
1B35	3.45	350B	2.35	1626	.19
1B38	33.50	371B	.85	1633	.85
1N21	.39	393A	4.50	1635	1.48
1N21B	1.45	417A	2.95	1641	1.35
1N23	.68	434A	2.95	1654	1.75
1N23B	1.40	450TH	47.50	2050	.93
1N34	.42	450TL	35.00	2051	.65
1N34A	.48	575A	9.95	5516	6.90
2AP1	4.95	705A	.68	5517	1.65
2C39A	12.45	707B	4.25	5637	4.95
2C40	7.45	714Y4	35.00	5638	7.95
2C43	7.25	715C	10.95	5639	8.95
2V51	2.95	717A	.35	5642	.95
2D21	.65	721A	.65	5651	1.35
2E22	3.45	726A	6.95	5654	1.25
2E24	1.95	725A	2.95	5670	1.45
2E26	2.95	723A/B	8.45	5675	10.95
2E30	1.95	726C	32.50	5676	1.45
2J32	12.50	726C	32.50	5686	2.45
2J36	14.95	750TL	39.50	5687	2.65
2J51	97.50	801A	.38	5703	.95
2J65	39.50	802	2.45	5763	.95
2J61	12.95	803	1.40	5794	7.50
2J62	4.45	804	8.85	5814	.98
2K25	11.95	805	3.95	5819	34.50
2K28	27.50	806	4.85	5823	1.35
2K33A	56.50	807	1.18	5851	3.45
3AP1	2.90	808	1.25	5876	12.50
3B24	.95	809	2.20	5879	1.25

ACTUAL SIZE

complete with selector switch...

TRIPLETT

ELECTRICAL INSTRUMENT CO.
Bluffton, Ohio

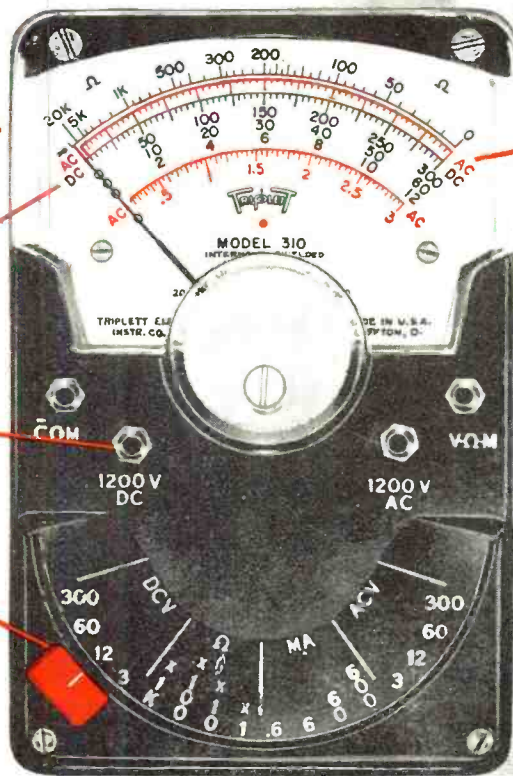

• 5,000 ohms per volt. A.C.

• 20,000 ohms per volt. D.C.

• BANANA-TYPE JACKS—positive connection and long life.

• EXCLUSIVE SELECTOR SWITCH speeds circuit and range settings. The first and only miniature VOM with this exclusive feature for quick, fool-proof selection of all ranges.



CARRYING CASE

Handsome leather carrying case with adequate space for Model 310 tester and accessories. Trousers belt slips through loop on back of the case for out-of-the-way carrying. MODEL 369 CASE—U.S.A. Dealer Net..... \$2.90

• SELF-SHIELDED FOR CHECKING IN STRONG MAGNETIC FIELDS. Self-shielded, rugged, higher-torque Bar-Ring instrument movement (exclusively Triplett).

Model **310** MIGHTY MITE

the only complete miniature V-O-M (AC-DC)

LOOK AT ALL THESE RANGES

DC VOLTS: 0-3-12-60-300-1200 at 20,000 Ohms/Volt.
AC VOLTS: 0-3-12-60-300-1200 at 5,000 Ohms/Volt.
DC MICROAMPERES: 0-600 at 250 Millivolts.
DC MILLIAMPERES: 0-6-60-600 at 250 Millivolts.
OHMS: 0-20,000-200,000 (200-2000 at center scale).
MEG OHMS: 0-2-20 (20,000-200,000 Ohms at center scale).
OUTPUT: Convenient chart in instruction book.

SEE IT AT YOUR JOBBER
AND IT'S ONLY ONE OF TRIPLETT'S MIGHTY NINE VOM LINE!

ONLY **\$29⁵⁰** Dealer Net

See us in Booth 320
at the May Parts Show

BURTON BROWNE ADVERTISING



- 631**
Combination
V-O-M—VTVM
- 630-NA**
For Best Testing
Around The Lab,
Production Line
or Bench
- 630**
The Popular
All-Purpose
V-O-M
- 630-A**
A Good Lab and
Production Line
V-O-M
- 310**
The Smallest
Complete V-O-M
With Switch
- 630-T**
For Telephone
Service
- 666-HH**
Medium Size
For
Field Testing
- 625-NA**
The First V-O-M
With 10,000
Ohms/Volt AC
- 666-R**
Medium Size
With
630 Features

...another
MALLORY
service-engineered
product

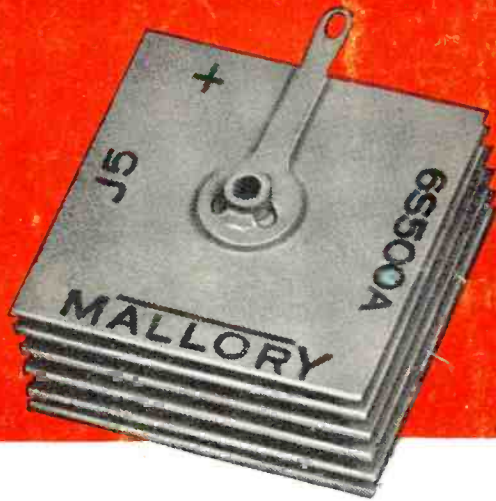

Every stack . . .
made better
to last longer!

There's good reason why you're sure of long life, high efficiency and top service from *every* Mallory selenium rectifier. Built into these stacks are many advanced techniques in rectifier manufacturing, developed by Mallory specialists.

Every step in processing and every material used is carefully controlled to produce stacks with unbeatable stability and freedom from sources of premature failure. 100% inspection, both of individual plates and of the completed stacks, assures absolute uniformity of quality.

Your Mallory distributor carries the new stacks in ratings for popular radio and TV sets . . . individually boxed and in the popular 10-Pack. See him today . . . get selenium rectifiers that equal or exceed original equipment specifications.

P. R. MALLORY & CO. Inc.
MALLORY

• Capacitors • Vibrators • Resistors • Controls • Switches
• Rectifiers • Power Supplies • Filters • Mercury Batteries