

RADIO & TELEVISION NEWS

AMC

OCTOBER
1953

35 CENTS
In Canada 40¢

IN THIS ISSUE

TV SWEEP GENERATORS

COLOR TV

THE "TRANSOIPPER"

THE KLIPSCH REBEL IV

LOUDNESS CONTROL

IMPROVED
KAPPLER AMPLIFIER

KNOW YOUR 1954
G-E TV RECEIVERS

A STUDENT
REGENERATIVE RECEIVER

THE OARAC
(See Page 83)

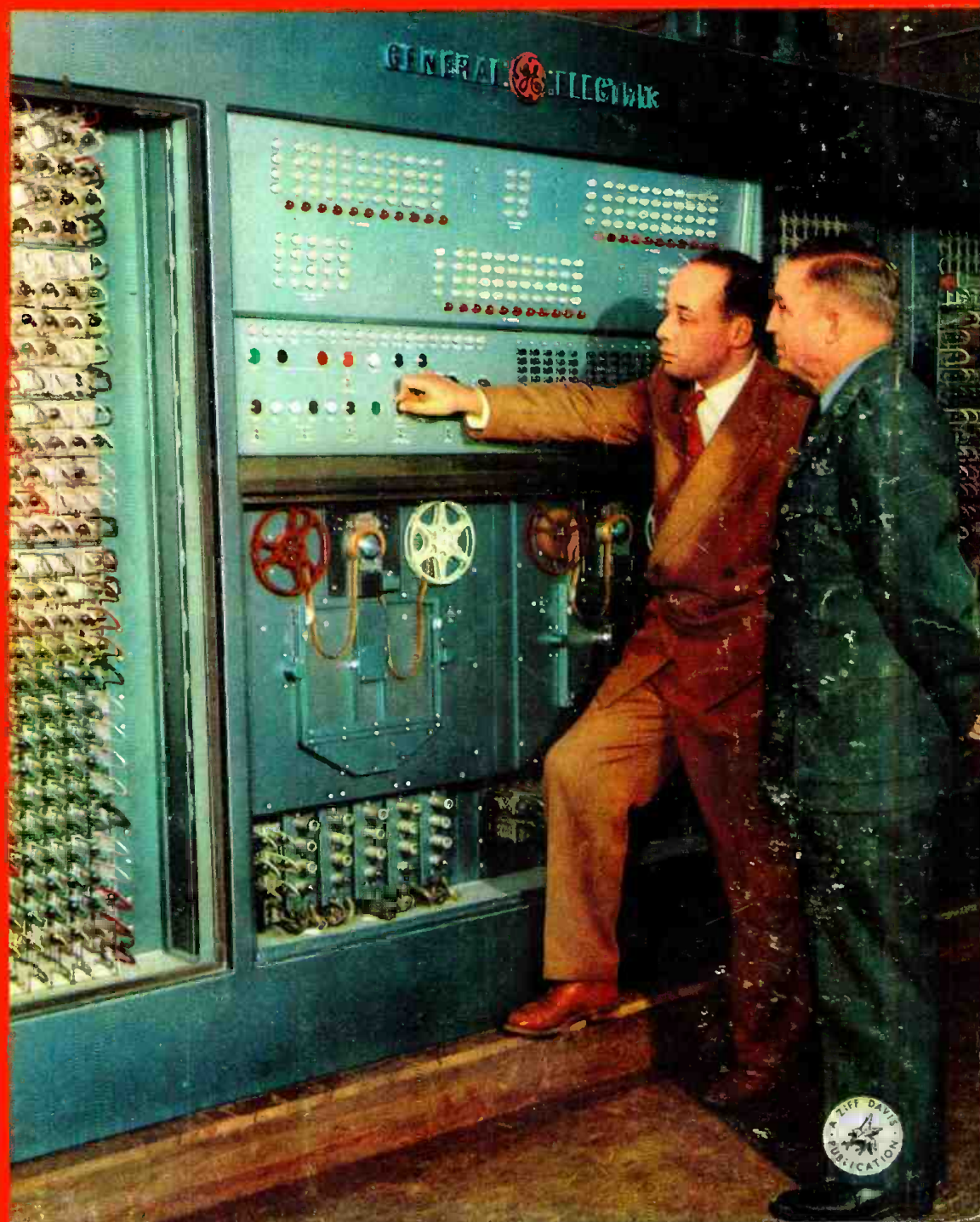

Have you hung up

your shingle?

IT PAYS TO KEEP GOOD COMPANY . . . and it's good business to advertise the good company you keep.

Thousands of dealers and servicemen are using the sales-magic in the RCA name to instill confidence in their customers. Identifying *your* name with RCA pays off in dollars and cents.

And it's so easy to do . . . because RCA's new Dealer Identification Program provides you with a handsome "shingle" with your name on it, that you'll be proud to display in your shop. When a customer sees this Dealer Identification Plaque he *knows* you are using the best tube products available.

So, we ask . . . "Have you hung up *your* shingle yet?" If not, be sure to see your **RCA Tube Distributor** today and learn how *you* can qualify for a Registered Dealer Plaque at no extra cost.

Unlock the door to bigger profits

Here's *your* key to better business . . . RCA's dynamic Dealer Identification Program. Ask your *RCA Tube Distributor* for your copy of the colorful, 16-page booklet "A Magic Pass-Key to Customer Confidence." It tells you how — for the first time—you can become a Registered Dealer . . . and get *extra* sales benefits.



RADIO CORPORATION of AMERICA
ELECTRON TUBES

HARRISON, N. J.

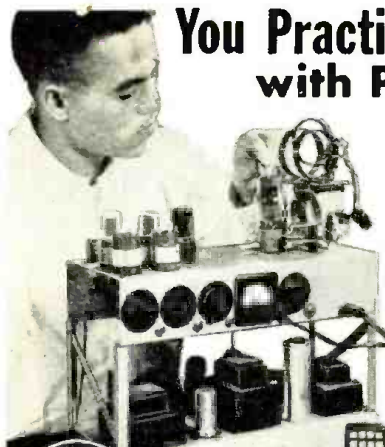

You Practice Broadcasting with Parts I Send

As part of my Communications Course I send you kits of parts to build the low-power Broadcasting Transmitter shown at left. You use it to get practical experience putting this station "on the air," performing procedures demanded of broadcasting station operators. Training plus opportunity is the PERFECT COMBINATION for job security, good pay, advancement. An FCC Commercial Operator's License can be your ticket to a better job and a bright future and my Communications Course gives you the training you need to get your license. Mail coupon below and see in my book other valuable equipment you build. All equipment I send is yours to keep.

J. E. Smith has trained more men for Radio-TV than any other man

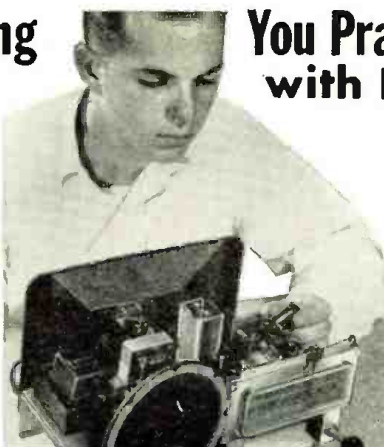

You Practice Servicing with Parts I Send

Nothing takes the place of PRACTICAL EXPERIENCE. That's why NRI training is based on LEARNING BY DOING. You use parts I furnish to build many circuits common to both Radio and Television. With my Servicing Course you build the modern Radio shown at left. You build an electronic Multitester which you use to help fix sets while training at home. Many students make \$10, \$15 a week extra fixing neighbors' sets in spare time, starting soon after enrolling. I send you special booklets that show you how. Mail coupon for my big 64-page book and actual Servicing Lesson, both FREE. See other equipment you build and keep.



I Will Train You at Home to be a RADIO-TELEVISION Technician

TELEVISION

Today's Good Job Maker

TV now reaches from coast-to-coast. Over 25 million TV sets are now in use; about 200 TV stations are on the air; hundreds more being built. This means more jobs, good pay jobs with bright futures. Now is the time to get ready for success in TV. Find out what Radio-Television offers you. Mail coupon now for my 2 Books FREE!



America's Fast Growing Industry Offers You Good Pay, Success

Do you want a good pay job, a bright future, security? Then get into the fast growing RADIO-TELEVISION industry. Hundreds I've trained are successful RADIO-TELEVISION TECHNICIANS. Most had no previous experience, many no more than grammar school education. Keep your job while training at home. Learn RADIO-TELEVISION principles from easy-to-understand lessons. Get practical experience on actual equipment you build with parts I send you.

Make Extra Money in Spare Time While Training

The day you enroll I start sending you SPECIAL BOOKLETS that show you how to service neighbors' Radios in spare time while training. Use MULTITESTER you build to help service sets, get practical experience working on circuits common to both Radio and Television. Find out how you can realize your ambition to be successful in the prosperous RADIO-TELEVISION industry. Even without Television, the industry is bigger than ever before. 115 million home and auto Radios, over 3000 Radio Stations, expanding Aviation and Police Radio. Micro-wave Relay, FM and Television are making opportunities for Servicing and Communications Technicians.

Mail Coupon — Find Out What Radio-TV Offers You

Send for my FREE DOUBLE OFFER. Cut out and mail coupon below. Send in envelope or paste on postal. You will get actual Servicing Lesson to prove it's practical to learn at home. You'll also receive my 64-page Book, "How to Be a Success in Radio-Television." Read what my graduates are doing, earning, see photos of equipment you practice with at home. J. E. Smith, President, Dept. 3KE National Radio Institute, Washington 9, D. C.

I TRAINED THESE MEN

Has Growing Business
"I am becoming an expert Teletrician as well as Radiotrician. Without your practical course I feel this would have been impossible. My business continues to grow."
—Philip G. Brogan, Louisville, Ky.

Good Job with Station
"I am Broadcast Engineer at WLPN. Another technician and I have opened a Radio-TV service shop in our spare time. Big TV sales here. As a result we have more work than we can handle."
—J. H. Bangle, Jr., Suffolk, Va.

Praises NRI as Best Course
"I was a high school student when I enrolled. My friends began to bring their Radios to me. I realized a profit of \$300 by the time I completed the course."
—John Hopper, Nitro, West Va.

NRI Training Leads to Good Jobs Like These

Broadcasting: Chief Technician, Chief Operator, Power Monitor, Recording Operator, Remote Control Operator. **Servicing:** Home and Auto Radios, P.A. Systems, Television Receivers, Electronic Controls, FM Radios. **In Radio Plants:** Design Assistant, Transmitter Design Technician, Tester, Serviceman, Service Manager. **Ship and Harbor Radio:** Chief Operator, Assistant Operator, Radiotelephone Operator. **Government Radio:** Operator in Army, Navy, Marine Corps, Coast Guard; Forestry Service Dispatcher, Airways Radio Operator. **Aviation Radio:** Transmitter Technician, Receiver Technician, Airport Transmitter Operator. **Television:** Pick-up Operator, Voice Transmitter Operator, Television Technician, Remote Control Operator, Service and Maintenance Technician.

Tested Way to Better Pay

AVAILABLE to all qualified **VETERANS** UNDER G. I. BILLS

Good for Both—FREE

MR. J. E. SMITH, President, Dept. 3KE
National Radio Institute, Washington 9, D. C.
Mail me Sample Lesson and 64-page Book, FREE. (No salesmen will call. Please write plainly.)
Name Age
Address
City Zone State

VETS write in date of discharge

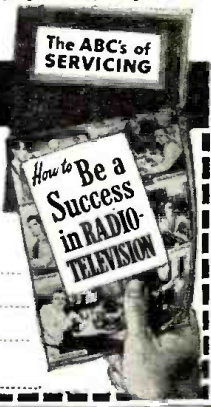

RADIO & TELEVISION NEWS is published monthly by the Ziff-Davis Publishing Company at 64 E. Lake St., Chicago 1, Ill. Entered as second-class matter, July 21, 1948, at the Post Office, Chicago, Ill., under the act of March 3, 1879. Authorized by Post Office Department, Ottawa, Canada, as second-class matter. SUBSCRIPTION RATES: Radio & Television News—one year, U. S. and Possessions, Pan-American countries, and Canada \$4.00; all other foreign countries \$5.00; Radio-Electronic Engineering Edition—one year, U. S. and Possessions, Pan-American countries, and Canada \$6.00; all other foreign countries \$7.00. Postmaster—Please return undelivered copies under form 3589 to 64 E. Lake St., Chicago 1, Ill.

Editor and Asst. Publisher
OLIVER READ, D.Sc., W1FTI

Managing Editor
WM. A. STOCKLIN, B.S.

Technical Editor
H. S. RENNE, M.S.

Service Editor
CHARLES TEPFER

Assistant Editors
P. B. HOEFER
M. C. MAGNA

Television Consultant
WALTER H. BUCHSBAUM

Short-Wave Editor
KENNETH R. BOORD

Art Editor
FRANK SAYLES

Draftsmen
A. A. GANS, W2TSP
J. A. GOLANEK

Advertising Manager
L. L. OSTEN

Midwest Adv. Manager
JOHN A. RONAN, JR.

Western Adv. Manager
JOHN E. PAYNE

RADIO & TELEVISION NEWS

Reg. U. S. Pat. Off.
Radio News Trademark Reg. U. S. Pat. Office • Television News Trademark Reg. U. S. Pat. Office.

First in
radio-television-electronics

Average Paid Circulation over 230,000

OCTOBER, 1953

CONTENTS

Television Sweep Generators.....	Milton S. Kiver	43
The Novice Station Receiver (Part 2).....	Larry Trombly, W0DCB & Robert A. Hathaway, W0GTK	47
The Klipsch Rebel IV—A Back-Loading Folded Corner Horn.....	Frederick I. Kantor	48
TV Tube Substitutions.....	Walter H. Buchsbaum	50
Color TV.....	William R. Feingold	51
Loudness Control.....	Michael H. Estkowski	54
New TV Intermittent Checker.....	Joseph Racker	56
Electronic Shipyard for Winter Cash.....	Elbert Robberson	57
Skiatron's "Subscriber-Vision".....	Rudolf F. Graf	58
The "Transdipper".....	C. A. West, W21YG	60
Know Your 1954 General Electric TV Receivers.....	Jack Najork	63
The "Fold-a-flex".....	Oliver Read	67
A Transistor Timer.....	Louis E. Garner, Jr.	68
Certified Record Revue.....	Bert Whyte	70
Improved Kappler Amplifier.....	Charles P. Boegli	71
The "LPRS" Preamp Control Unit.....	Joseph M. Diamond	74
A Student Regenerative Receiver.....	William C. Stoecker	76
Bring Your TV Set Up-to-Date.....	Richard C. Koch	78
Brightness Control in TV Receivers.....	John K. Frieborn	80
The Oarac.....	Bernard H. Geyer	83
The Con-VI.....	Richard Graham	84
Mac's Radio Service Shop.....	John T. Frye	86
High-Fidelity with Crystal Headphones.....	Charles E. Cohn	92
The Radio Craftsmen Model C-800 Tuner.....	W. Philbrook	107
Radio-TV Service Industry News.....		113
Make Your Electronic Flash More Versatile.....	E. Q. Proctor	126
New TV Stations on the Air.....		132
Selenium D.C. Voltage Regulators.....	Harry Braverman	158
New TV Grants Since Freeze Lift.....		166
An Adjustable Regulated Voltage Supply.....	J. J. Hoefler, W0IJJ	170
Simple Speedlamp Tester.....	Allan M. Ferres	174
Use Your Defective TV Transformers.....	Henry A. Setzke	178
An Electronic Metronome.....	Leon A. Wortman	182
Lincoln Tunnel Traffic Control.....		188
New Approach to TV Service.....	Carroll W. Hoshour	194
Service Hints on G-E TV Sets.....		210



COVER PHOTO: Brig. Gen. Leighton I. Davis, director of armament for the U.S. Air Force Air Research & Development Command, inspects the General Electric digital computer, OARAC, with C. R. Wayne, a G-E computer engineer. (Ektachrome by J. Frano)

ZIFF-DAVIS PUBLISHING COMPANY

Chairman of the Board and Publisher
WILLIAM B. ZIFF

President
B. G. DAVIS

Vice-Presidents
H. J. MORGANROTH

M. H. FROELICH

Secretary-Treasurer
G. E. CARNEY

BRANCH OFFICES

CHICAGO 111
64 E. Lake St., AN 3-3200
LOS ANGELES 1141
Stoller Center, 900 Wilshire Blvd., Mich. 9856

DEPARTMENTS

For The Record.....	The Editor	8	Technical Books.....	108
Spot Radio News.....		16	Manufacturers' Literature.....	110
Within the Industry.....		28	What's New in Radio.....	144
Short-Wave.....	K. R. Boord	82	New TV Products.....	204

COPYRIGHT 1953

(All Rights Reserved)

ZIFF-DAVIS PUBLISHING COMPANY

Editorial and Executive Offices

366 Madison Ave., New York 17, N. Y.

VOLUME 50 • NUMBER 4



Member
Audit Bureau of
Circulations

SUBSCRIPTION SERVICE: All communications concerning subscriptions should be addressed to Circulation Dept., 64 E. Lake St., Chicago 1, Ill. Subscribers should allow at least four weeks for change of address.
CONTRIBUTIONS: Contributors are advised to retain a copy of their manuscripts and illustrations. Contributions should be mailed to the New York Editorial Office and must be accompanied by return postage. Contributions will be handled with reasonable care, but this magazine assumes no responsibility for their safety. Any copy accepted is subject to whatever adaptations and revisions are necessary to meet the requirements of this publication. Payment covers all author's, contributor's, and contestant's rights, title, and interest in and to the material accepted and will be made at our current rates upon acceptance. All photos and drawings will be considered as part of the material purchased.

RADIO & TELEVISION NEWS

Now IN YOUR OWN HOME Learn

TELEVISION RADIO ELECTRONICS

the Amazingly Effective

D. T. I. WAY

—with the aid of BOTH
HOME EQUIPMENT
and HOME MOVIES

NO PREVIOUS EXPERIENCE NEEDED

NOW... get
**EVERYTHING
YOU NEED**

for real Laboratory-
type training
AT HOME

Above:
Work over
300
fascinating
experiments
with this
equipment

1. Build over 300 fascinating experiments from 16 BIG SHIPMENTS of Electronic-Radio parts which you KEEP.

2. Build valuable commercial-type test equipment—as shown to the left—which you KEEP. This includes a quality 5 INCH oscilloscope and jewel bearing Multi-Meter—both highly useful for Television work.

3. Build and keep a big 21 INCH TV Set. (D.T.I. offers another home training in Television-Radio-Electronics, but without the TV set.)

4. Use a 16 mm. movie projector and new series of highly instructive movies—a wonderful aid to help you grasp important fundamentals faster... easier... better.

5. Enjoy well-illustrated, easy-to-read lessons with handy FOLD-OUT diagrams.

6. Get an honest-to-goodness EMPLOYMENT SERVICE to help you get a good job after graduating—or assistance in starting your OWN SALES AND SERVICE BUSINESS. Mail coupon today for the complete details.

What will mailing the coupon below do for YOU? Just this! You'll find out about one of today's most remarkable... practical ways to prepare to get into America's amazing billion dollar opportunity field of TELEVISION-RADIO-ELECTRONICS. You'll see how to get into fascinating work that pays well... that offers one of America's most promising futures... that enables you to start your own business almost "on a shoe string," if you prefer this to a job opportunity.

And above all, you'll get some GOOD NEWS especially welcomed by men anxious to earn REAL MONEY in this thrilling field. For you'll see that NOW you can get the kind of practical, laboratory-type training so desirable for making real progress in Television-Radio-Electronics AND WITHOUT LEAVING HOME.

You'll see that DeForest's Training, Inc. sends everything needed to set up your own HOME LABORATORY.

You get and keep the same type of basic electronic equipment used in our modern Chicago Training Laboratories. You get home training that includes the knowledge and experience gained from training thousands of students first hand in Chicago.

And to top it all, you use DTI's amazingly effective and exclusive home training aid—INSTRUCTIVE MOVIES. But why not get the complete story? Mail coupon today for information-packed literature.

MODERN LABORATORIES

If you prefer, get all your preparation in our new Chicago Training Laboratories—one of the finest of its kind. Ample instructors, modern equipment. Write for details!

MILITARY SERVICE!

If you're subject to military service, the information we have for you should prove very helpful. Mail coupon today.

Get this

information-packed publication

FREE!

Mail Coupon Today



5 INCH
"SCOPE"

Oscilloscope

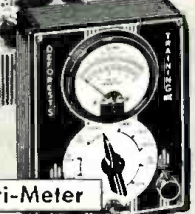

Multi-Meter



21 INCH

Build and keep this BIG DTI engineered TV set—easily converted to U.H.F.

"ONE OF AMERICA'S FOREMOST TELEVISION TRAINING CENTERS"
—Established 1931—



89 WAYS TO EARN MONEY
IN TELEVISION
RADIO-ELECTRONICS



DEFOREST'S TRAINING, INC.

AFFILIATED WITH

DEVRY Technical INSTITUTE

CHICAGO 14, ILLINOIS

DEFOREST'S TRAINING, INC.
2535 N. Ashland Avenue, Chicago 14, Ill.

RN-10J

I would like your valuable information-packed publication showing how I can get started toward a good job or my own business in Television-Radio-Electronics.

Name _____ Age _____
Street _____ Apt. _____
City _____ Zone _____ State _____

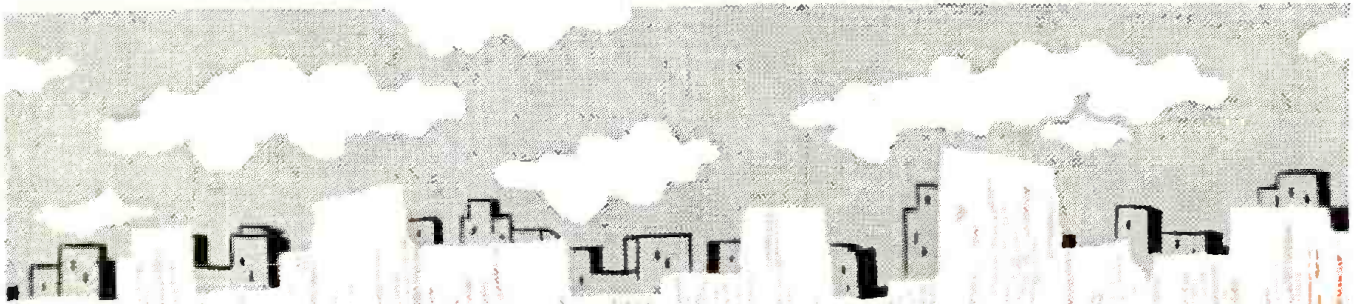

COMING SOON!



THE MOST STARTLING WARD DEVELOPMENT YET!

THE WARD

PRODUCTS CORP. DIVISION OF THE GABRIEL COMPANY
1148 EUCLID AVE. • CLEVELAND 15, OHIO
IN CANADA: ATLAS RADIO CO., LTD. • TORONTO, ONT.



RADIO & TELEVISION NEWS

Check the specs...

Check performance...

Then, They'll Choose Hallicrafters



Model S-76

Double conversion receiver. Broadcast Band 538-1580 kc plus three short-wave bands covering 1720 kc-34 Mc.

Calibrated electrical bandspread for easy tuning. Double superhet with 50 kc second i-f and giant 4-inch "S" meter. Five position selectivity, one r-f, two conversion, two i-f stages, temperature compensated. 3.2 or 500 ohm outputs.

Satin black steel cabinet. 18½" x 8⅞" x 9½" deep. Nine tubes, voltage regulator, and rectifier. For 105/125 V. 50/60 cycle AC. Use R-46 speaker. . . . **\$199⁹⁵**

SELECTIVITY CURVES, S-76

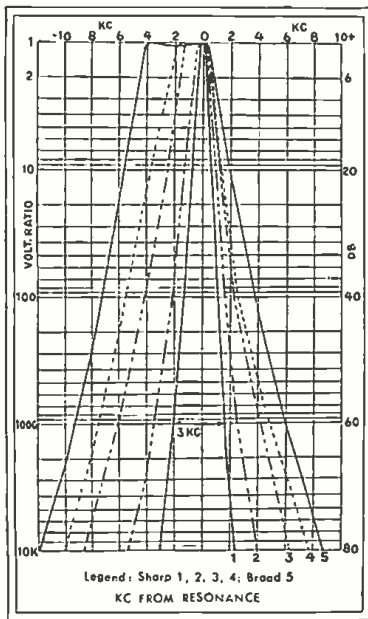

Do you know any better way, any other way, to judge SW equipment than to check the specifications and the performance? Frankly that's the only valid way we can think of to make sure you get your money's worth. Check these specs. Take a look at the selectivity curve for the S-76. It is typical of the outstanding value Hallicrafters offers in every price class.



Model HT-20. T.V.I. suppressed 100 watt AM-CW transmitter with all spurious outputs above 40 Mc at least 90 db. below full rated output.

All stages metered; single meter with eight position meter switch; output tuning indication. Frequency range of 1.7 Mc to 31 Mc continuous on front panel control. Seven tubes plus five rectifiers. For 105/125 V. 50/60 cycle **\$449⁵⁰**

Model SX-71. Covers Broadcast Band 535-1650 kc plus four short-wave bands covering 1650 kc-34 Mc. and 46-56 Mc.

Narrow Band FM one r-f, two conversion, and three i-f stages. Temperature compensated, voltage regulated. Three watt output (terminals for 500 and 3.2 ohms).

Satin black steel cabinet. 18½" x 8⅞" x 12" deep. 11 tubes plus regulator, rectifier. For 105/125 V. 50/60 cycle AC. Use R-46 speaker. **\$249⁹⁵**



Model R-46. Matching 10" PM speaker for use with Hallicrafters communications receivers SX-71, SX-76, SX-73 or SX-62. 80 to 5000 cycle range. Matching transformer with 500-ohm input. Speaker voice coil impedance, 3.2 ohms.

Satin black steel cabinet matches all Hallicrafters receivers. Cloth covered metal grille. 15" x 10⅞" x 10⅞" deep. Ship. wt. 17 lbs. **\$24⁹⁵**



hallicrafters

World's Leading Exclusive Manufacturer of Communications and High Fidelity Equipment, Radio and Television

4401 West Fifth Avenue, Chicago 24, Illinois
Hallicrafters Ltd., 51 Camden Street, Toronto, Canada

For the RECORD.

BY THE EDITOR

HOW MUCH CIRCULATION?

THERE is no business like the publishing business. This theatrical paraphrase is not without point, as you will see. A magazine is successful to the degree that it serves the interests of its readers by providing them with news and information that appeals to the audience for which the publication is edited. Just as it takes a top-flight theater cast to attract full houses for a long run, so does it require editorial excellence to attract and hold circulation.

Circulation is people and people are markets. Through its advertising columns, therefore, the magazine offers advertisers an opportunity to tell readers about goods and services. The value of this opportunity is in keeping with the stability, character, and size of the audience.

Thus it will be seen that the interests of subscribers, advertisers, and publishers are interrelated and interdependent, all centered around the heart of any publishing operation—CIRCULATION and RADIO & TELEVISION NEWS has the largest A.B.C. (by many thousands) paid circulation of any magazine in its field.

A key factor in the relations between publishers and advertisers is the manner in which the circulation is reported to advertisers. In order that advertising space may be purchased on the basis of a sound business investment, the circulation of a publication must be substantiated and described in accordance with uniform and accepted standards and terms to permit accurate evaluation (certain radio and TV service publications, please note) and comparison with other media. To accomplish this the Audit Bureau of Circulations was established in 1914. This Bureau, better known as A.B.C., is a voluntary, non-profit, and cooperative association of 3450 advertisers, advertising agencies, and publishers in the United States and Canada. Their first act was to establish a definition for paid circulation, then standards and rules for measuring, auditing, and reporting circulations.

At regular intervals the Bureau's experienced circulation auditors visit all publisher members to audit their circulation records. The information resulting from these audits is issued in A.B.C. reports which are distributed to advertisers and their agencies. These reports answer such questions as "How much circulation?" "Where does it go?" "How was it obtained?"—answers that make it possible for publishers to receive full credit for

their circulations and for advertisers to invest their advertising dollars as they buy raw materials and equipment, on the basis of facts and well-known standards. A.B.C., therefore, is a major factor in the integrity of relations between advertisers and publishers. Based on this mutual confidence, advertisers have appropriated the large amounts for investment in advertising which characterize our economy and which are recognized as essential in maintaining the mass communications and mass production that are so much a part of our general welfare.

This magazine is a member of A.B.C. Our circulation is *known*—not guessed at or claimed! Recognizing the direct benefits of the Bureau's work to publishers and advertisers, you will ask, "What does A.B.C. mean to me, as one of your readers?" The answer is that you are a customer of ours. You paid us good money for your subscription. In order to merit your continued patronage, we know that we must produce a publication of high editorial quality. Thus our obligation to you is also an obligation to ourselves, one that must be fulfilled if we are to stay in business. To maintain and build our circulation is a constant incentive for us to provide ever-improving service to you, our readers—the same incentive that manufacturers and merchants have in striving always to maintain leadership in their fields, to provide their customers with superior products and superior service.

Much more could be written about A.B.C.—how it aids in maintaining a free press through its contribution to the success of the advertising and publishing industry and as the world's outstanding successful example of self-regulation in business. This magazine is proud of its membership in the Audit Bureau of Circulations.

Our 6th annual Audio issue, coming next month, will include some of the very best articles on audio and hi-fi ever published. This November issue promises to break all previous records for circulation and amount of editorial features.

In addition to a wealth of audio material, service technicians and radio amateurs will find a fact-filled section devoted to their interests. No segment of our readership has been overlooked in planning the November issue for you.

Incidentally, this special issue will be 50 cents at the newsstands. Our regular subscribers receive this "bonus" at no extra charge. . . . O.R.

RADIO & TELEVISION NEWS

NEW HOME OF ALLIED RADIO

ultra-modern facilities TO SERVE YOU BEST

FREE!

get your
value-packed
**1954
ALLIED**
268-PAGE CATALOG

The World's Largest Stocks

- TV and Radio Parts
- Test Instruments
- High-Fidelity Equipment
- Custom TV Chassis
- AM, FM Tuners and Radios
- Recorders and Supplies
- P. A. Systems, Accessories
- Amateur Station Gear
- Builders' Kits, Supplies
- Equipment for Industry

**Fastest Service in
Electronic Supply**

the only
COMPLETE
catalog for
everything in
TV, Radio and
Industrial
Electronics



Send for it today!

You'll want the *one* complete Buying Guide to *Everything in Electronics*—268 pages packed with the world's largest selection of quality equipment at lowest, money-saving prices. See all the latest releases in custom TV chassis, TV antennas and accessories; AM and FM tuners and radios; *everything* in High-Fidelity custom components; latest P.A. Systems and accessories; recorders and supplies; Amateur receivers, transmitters and station gear; specialized industrial electronic equipment; test instruments; builders' kits; huge listings of parts, tubes, tools, books —your choice of the world's *most complete stocks* of quality equipment. ALLIED gives you *every* buying advantage: speedy shipment, expert personal help, lowest prices, liberal terms, assured satisfaction. Get the 1954 ALLIED Catalog. Keep it handy—and save time and money. Send for your **FREE** copy today.



**SAVE ON EVERYTHING
IN ELECTRONICS**

**SEND FOR THE LEADING
ELECTRONIC BUYING GUIDE**

free

ALLIED RADIO
World's Largest Electronic Supply House

EASY-PAY TERMS

Use ALLIED'S liberal Easy Payment Plan—only 10% down, 12 months to pay—no carrying charge if you pay in 60 days. Available on Hi-Fi and P. A. units, recorders, TV chassis, test instruments, Amateur gear, etc.

TV and HI-FI SPECIALISTS

To keep up with developments in High-Fidelity and TV, look to ALLIED. Count on us for *all* the latest releases and largest stocks of equipment in these important fields. If it's anything in High-Fidelity or Television—we have it *in stock!*

If you could advertise nationally, chances are you'd do just what CBS-Hytron is doing for you. You'd tell the world in **LIFE** and

Half-page advertisements will appear in LIFE Sept. 28, POST Oct. 3, LIFE Oct. 19, POST Oct. 31, LIFE Nov. 16, and POST Nov. 28. Reaching over 28,583,290 readers!

that you promise quality TV and Radio service, parts, and tubes

at fair charges. And that's just what CBS-Hytron is doing for you with

advertisements like these.

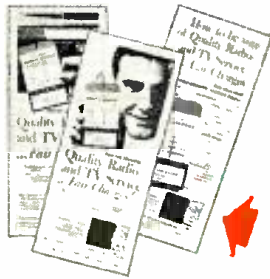

You'd identify your service repair

These are just some of our *Certified Quality Service* advertisements. They sell you . . . and without a lot of sell for CBS-Hytron, although CBS-Hytron gladly pays the bill. Why? Because as we build *public confidence* in *Certified Quality Service*, we build greater faith in you and more business for you . . . our customers.

shop as the *one* people are reading about in the magazines. You'd use this

Certified QUALITY SERVICE decalcomania on your door.

This *Certified Quality Service* decalcomania identifies you as a dealer with hard-earned technical knowledge and the latest in equipment. A dealer to whom the public can go for *Certified Quality Service*. It helps you cash in on your big *Certified Quality Service* plan.



You'd use

this *Certified* QUALITY SERVICE window streamer.



And

Let folks know you *Certify* the quality of your service, parts, and tubes . . . and at fair charges. Use all the *Certified Quality Service* sales material available to you. Be sure this window streamer is up during your consistent advertising campaign this Fall.

CBS-HYTRON, Danvers, Massachusetts

DIVISION OF COLUMBIA BROADCASTING SYSTEM, INC.

Member of the CBS family . . . CBS Radio • CBS Television • Columbia Records, Inc. • Laboratories • CBS-Columbia, Inc. • and CBS-Hytron

RADIO & TELEVISION NEWS

above all *you'd* use these *Certified* **QUALITY SERVICE** tags.



They tell *your*

This plan goes *all* the way to do the job. When *you* use these *Certified* Quality Service tags you're putting right into your customer's hands convincing *proof* . . . Proof that *Certified* Quality Service means *more* for your customer's money.

customer: he is getting more for his money when he calls *your* service repair

shop . . . because *you* *Certify* the quality of service, parts, and tubes . . . and

at fair charges. Yes, by using all this material, and more to come, *you*

cash in on *your* big *Certified* **QUALITY SERVICE** advertising campaign.



Get *your* kit.

It contains all the material

Make the most of *your* big *Certified* Quality Service advertising campaign. Be sure you have *all the facts* . . . and *all* the material you need. Get this sales promotion kit, today!

you need to identify *you* as a *Certified* **QUALITY SERVICE** dealer. Ask your

CBS-Hytron distributor for *special deal*. Or use coupon to order direct.

**SEE YOUR
CBS-HYTRON
DISTRIBUTOR
... OR MAIL
COUPON
TODAY!**

CBS-HYTRON, Danvers, Mass.

Please rush me the *Certified* Quality Service promotion kit, containing:

1. 18- by 28-inch LIFE and POST easel display . . .
2. New *Certified* Quality Service decal . . .
3. 8- by 23-inch window streamer . . .
4. AND 250 *Certified* Quality Service tags imprinted with MY name and address.

HERE IS MY 3-LINE IMPRINT:

Name _____ (please print)

Street _____

City _____ State _____

I enclose \$2.00 to cover the cost of imprinting.

Signed: _____

For accurate
flexible and
quick tube
testing at
low cost...
model 3413-A



Model 3413-A...\$79.50 at your distributor. (Price subject to change.) BV Adapter, \$7.90 Add'l.

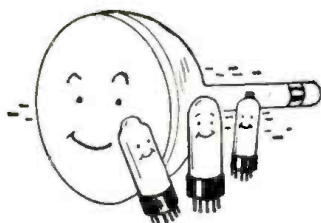

1. YOU CAN TEST MORE TYPES of tubes, also appliances for shorts and open circuits.

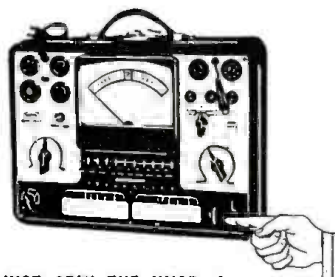

2. JUST SPIN THE KNOB—for correct, last-minute data, on the speed roll chart. Lists 700 tubes.

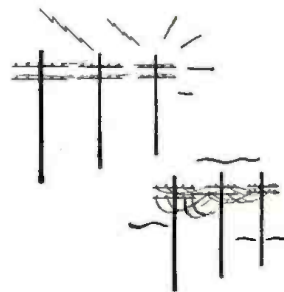

3. YOU CAN COMPENSATE for line voltage—just throw snap-action switch.

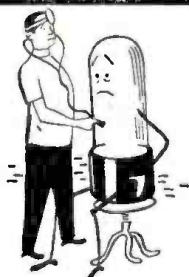

4. YOU CAN TEST EACH ELEMENT in each tube—by a simple flip of the switch.

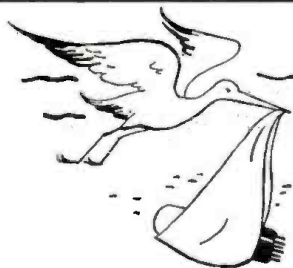

5. YOU CAN TEST THE NEW TUBES—including those with low cathode current.



6. YOU GET NEW TUBE DATA—immediately, while it is still news. No waiting.

Nearly Half a Century of Service to the Service Man

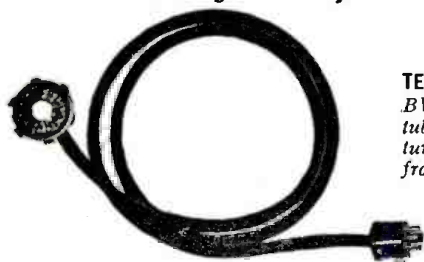

TESTS PICTURE TUBES, TOO! With this BV Adapter, Model 3413-A tests every tube in a TV receiver, including the Picture Tube—without even removing tube from receiver or carton! Saves time!

FOR THE MAN WHO TAKES PRIDE IN HIS WORK

Triplet

TRIPLIETT ELECTRICAL INSTRUMENT CO., BLUFFTON, OHIO, U. S. A.

Get in on the TV boom . . . starting today!

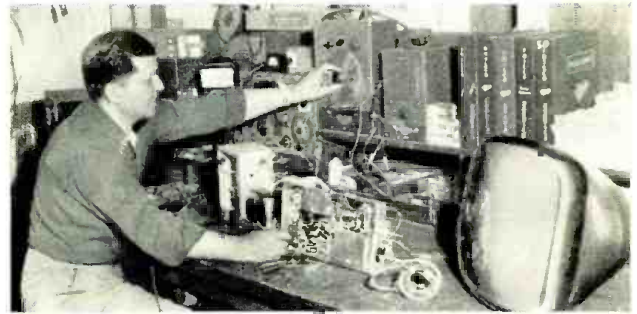
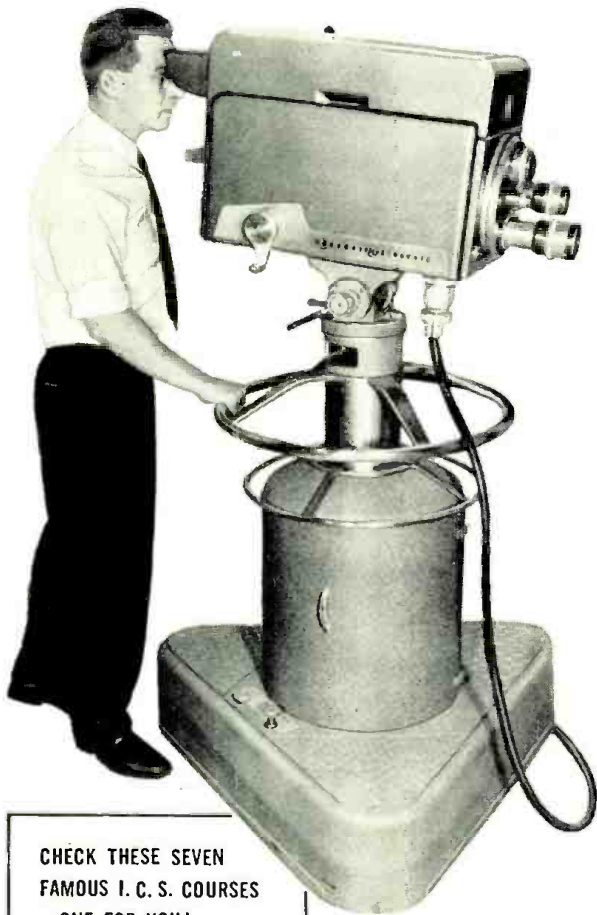

- Prepare now for the new Radio-TV-Electronics boom. Get in on VHF and UHF . . . aviation and mobile radio . . . color TV . . . binaural sound! The International Correspondence Schools can help you!

If you've ever thought about Radio or Television as a career . . . if you have the interest, but not the training . . . if you're waiting for a good time to start . . . NOW'S THE TIME!

No matter what your previous background, I.C.S. can help you. If Radio-TV servicing is your hobby, I.C.S. can make it your own profitable business. If you're interested in the new developments in Electronics, I.C.S. can give you the basic courses of training you need. If you have the job but want faster progress, I.C.S. can qualify you for promotions and pay raises.

I.C.S. training is *success-proved* training. Hundreds of I.C.S. graduates hold top jobs with top firms like R.C.A., G.E., DUMONT, I.T.&T. Hundreds of others have high ratings in military and civil service. Still others have successful businesses of their own.

With I.C.S., you get the rock-bottom basics and theory as well as the all-important bench practice and experimentation. You learn in your spare time—no interference with business or social life. You set your own pace—progress as rapidly as you wish.

Free career guidance: Send today for the two free success books, the 36-page "How to Succeed" and the informative catalog on the course you check below. No obligation. Just mark and mail the coupon. With so much at stake, you owe it to yourself to act—and act fast!

CHECK THESE SEVEN FAMOUS I. C. S. COURSES —ONE FOR YOU!

- PRACTICAL RADIO-TELEVISION ENGINEERING**—Foundation course for radio-television career. Basic principles plus advanced training. Radio, Sound, TV.
- TELEVISION TECHNICIAN**—To qualify you for high-level technical positions in television. Camera, studio, transmitter techniques. Manufacture, sale and installation of TV equipment.
- TELEVISION RECEIVER SERVICING**—Installation, servicing, conversion. Dealership. For the man who knows about radio and wants TV training.
- RADIO & TELEVISION SERVICING**—Designed to start you repairing, installing and servicing radio and television receivers soon after starting the course.
- RADIO & TELEVISION SERVICING WITH TRAINING EQUIPMENT**—Same as above but with addition of high-grade radio servicing equipment and tools.
- RADIO OPERATING COURSE**—Special course to help you pass the Government examination for operator's licenses. Code. TV, FM, Radio regulations.
- INDUSTRIAL ELECTRONICS**—Broad, solid background course devoted to the electron tube and to its many applications.

INTERNATIONAL CORRESPONDENCE SCHOOLS



BOX 2250-C, SCRANTON 9, PENNA.

Without cost or obligation, send me "HOW TO SUCCEED" and the booklet about the course BEFORE which I have marked X:

- | | | | | |
|---|---|--|---|---|
| <p>ART</p> <ul style="list-style-type: none"> <input type="checkbox"/> Commercial Art <input type="checkbox"/> Magazine and Book Illustrating <input type="checkbox"/> Cartooning <input type="checkbox"/> Show Card and Sign Lettering <input type="checkbox"/> Fashion Illustrating <p>AUTOMOTIVE</p> <ul style="list-style-type: none"> <input type="checkbox"/> Automobile, Mechanic <input type="checkbox"/> Auto-Elec. Technician <input type="checkbox"/> Auto Body Rebuilding and Refinishing <input type="checkbox"/> Diesel—Gas Engines <p>AVIATION</p> <ul style="list-style-type: none"> <input type="checkbox"/> Aeronautical Engineering, Jr. <input type="checkbox"/> Aircraft Engine Mechanic <input type="checkbox"/> Airplane Drafting <p>BUILDING</p> <ul style="list-style-type: none"> <input type="checkbox"/> Architecture <input type="checkbox"/> Arch. Drafting <input type="checkbox"/> Building Contractor <input type="checkbox"/> Estimating <input type="checkbox"/> Carpenter and Mill Work <input type="checkbox"/> Carpenter Foreman <input type="checkbox"/> Reading Blueprints <input type="checkbox"/> House Planning <input type="checkbox"/> Plumbing | <ul style="list-style-type: none"> <input type="checkbox"/> Heating <input type="checkbox"/> Steam Fitting <input type="checkbox"/> Air Conditioning <input type="checkbox"/> Electrician <p>BUSINESS</p> <ul style="list-style-type: none"> <input type="checkbox"/> Business Administration <input type="checkbox"/> Certified Public Accountant <input type="checkbox"/> Accounting <input type="checkbox"/> Bookkeeping <input type="checkbox"/> Stenography and Typing <input type="checkbox"/> Secretarial <input type="checkbox"/> Federal Tax <input type="checkbox"/> Business Correspondence <input type="checkbox"/> Personnel and Labor Relations <input type="checkbox"/> Advertising <input type="checkbox"/> Retail Business Management <input type="checkbox"/> Managing Small Business <input type="checkbox"/> Sales Management <input type="checkbox"/> Salesmanship <input type="checkbox"/> Traffic Management <p>CHEMISTRY</p> <ul style="list-style-type: none"> <input type="checkbox"/> Chemical Engineering <input type="checkbox"/> Chemistry <input type="checkbox"/> Analytical Chemistry <input type="checkbox"/> Petroleum—Nat'l Gas <input type="checkbox"/> Pulp and Paper Making <input type="checkbox"/> Plastics | <p>CIVIL, STRUCTURAL ENGINEERING</p> <ul style="list-style-type: none"> <input type="checkbox"/> Civil Engineering <input type="checkbox"/> Structural Engineering <input type="checkbox"/> Surveying and Mapping <input type="checkbox"/> Structural Drafting <input type="checkbox"/> Highway Engineering <input type="checkbox"/> Reading Blueprints <input type="checkbox"/> Concrete Construction <input type="checkbox"/> Sanitary Engineering <p>DRAFTING</p> <ul style="list-style-type: none"> <input type="checkbox"/> Aircraft Drafting <input type="checkbox"/> Architectural Drafting <input type="checkbox"/> Electrical Drafting <input type="checkbox"/> Mechanical Drafting <input type="checkbox"/> Structural Drafting <input type="checkbox"/> Sheet Metal Drafting <input type="checkbox"/> Mine Surveying and Drafting <p>ELECTRICAL</p> <ul style="list-style-type: none"> <input type="checkbox"/> Electrical Engineering <input type="checkbox"/> Electrician <input type="checkbox"/> Electrical Maintenance <input type="checkbox"/> Electrical Drafting <input type="checkbox"/> Electric Power and Light <input type="checkbox"/> Lineman <p>HIGH SCHOOL</p> <ul style="list-style-type: none"> <input type="checkbox"/> High School Subjects | <ul style="list-style-type: none"> <input type="checkbox"/> College Preparatory <input type="checkbox"/> Mathematics <input type="checkbox"/> Commercial <input type="checkbox"/> Good English <p>MECHANICAL AND SHOP</p> <ul style="list-style-type: none"> <input type="checkbox"/> Mechanical Engineering <input type="checkbox"/> Industrial Engineering <input type="checkbox"/> Industrial Supervision <input type="checkbox"/> Foremanship <input type="checkbox"/> Mechanical Drafting <input type="checkbox"/> Machine Design-Drafting <input type="checkbox"/> Machine Shop Practice <input type="checkbox"/> Machine Shop Practice <input type="checkbox"/> Tool Design <input type="checkbox"/> Heat Treatment—Metallurgy <input type="checkbox"/> Sheet Metal Work <input type="checkbox"/> Sheet Metal Pattern Drafting <input type="checkbox"/> Refrigeration <p>POWER</p> <ul style="list-style-type: none"> <input type="checkbox"/> Combustion Engineering <input type="checkbox"/> Diesel—Electric <input type="checkbox"/> Electric Light and Power | <ul style="list-style-type: none"> <input type="checkbox"/> Stationary Steam Engineering <input type="checkbox"/> Stationary Fireman <p>RADIO, TELEVISION, COMMUNICATIONS</p> <ul style="list-style-type: none"> <input type="checkbox"/> General Radio <input type="checkbox"/> Radio Operation <input type="checkbox"/> Radio Servicing—FM <input type="checkbox"/> Television <input type="checkbox"/> Electronics <input type="checkbox"/> Telephone Work <p>RAILROAD</p> <ul style="list-style-type: none"> <input type="checkbox"/> Locomotive Engineer <input type="checkbox"/> Diesel Locomotive <input type="checkbox"/> Air Brakes <input type="checkbox"/> Car Inspector <input type="checkbox"/> Railroad Administration <p>TEXTILE</p> <ul style="list-style-type: none"> <input type="checkbox"/> Textile Engineering <input type="checkbox"/> Cotton Manufacture <input type="checkbox"/> Rayon Manufacture <input type="checkbox"/> Woolen Manufacture <input type="checkbox"/> Loom Fixing <input type="checkbox"/> Finishing and Dyeing <input type="checkbox"/> Textile Designing |
|---|---|--|---|---|

Name _____ Age _____ Home Address _____
 City _____ Zone _____ State _____ Working Hours _____ A.M. to _____ P.M.
 Occupation _____

Special tuition rates to members of the U. S. Armed Forces. Canadian residents send coupon to International Correspondence Schools Canadian, Ltd., Montreal, Canada.

**YEAR OF THE SIX
MILLIONTH STUDENT**

ONLY TELCO UHF ANTENNAS HAVE THE "WISHBONE"

TELCO

UHF

"WISHBONE" HIGH DI-ELECTRIC INSULATOR

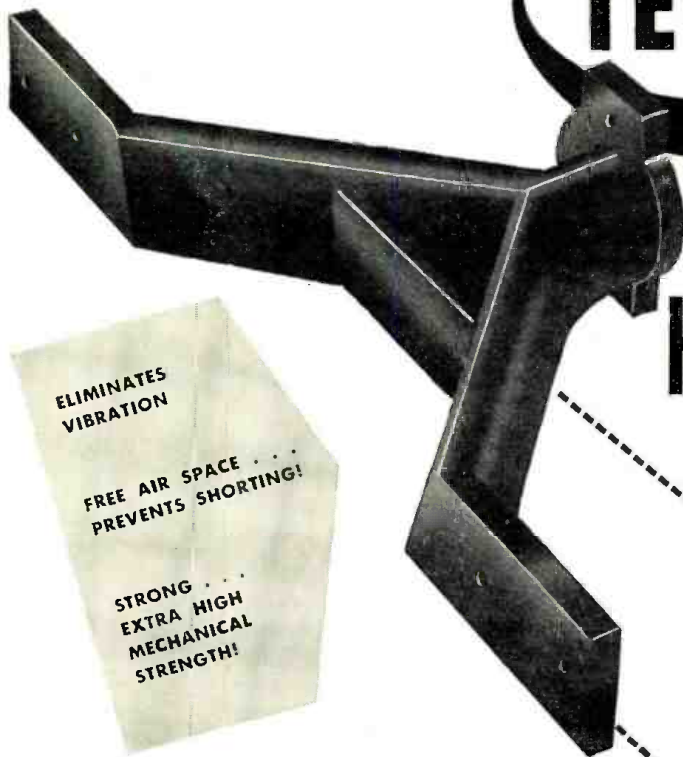

ELIMINATES
VIBRATION

FREE AIR SPACE . . .
PREVENTS SHORTING!

STRONG . . .
EXTRA HIGH
MECHANICAL
STRENGTH!

- EASY TO INSTALL
- ELIMINATES GHOSTS
- VERY HIGH GAIN

THAT'S RIGHT . . . Only TELCO'S got this remarkable new free air insulator . . . the "Wishbone" . . . that absolutely prevents shorting out under any conditions. Sturdy vibration-proof reflector and rugged aircraft aluminum elements are fastened to the "Wishbone" to prevent vibration and shaky pictures. Antenna performance is proved by actual UHF field testing . . . assures high gain on all channels. Better buy TELCO . . . your all-ways best UHF Antennas!

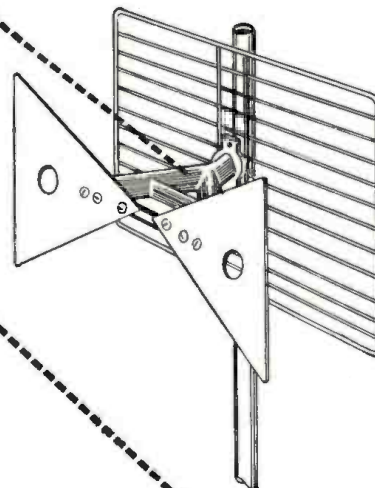

No. 8965-Butterfly
Wishbone Antenna,
complete with
stacking bar.
List \$7.50

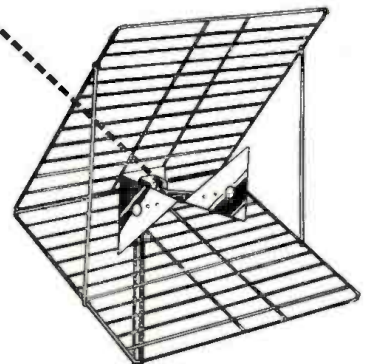

No. 8984 Wishbone
Corner Reflector.
List \$14.50



FREE! WRITE TODAY for all-new 32-page
TELCO Catalog. Send Postcard.

TELEVISION HARDWARE MFG. CO.
DIVISION OF GENERAL CEMENT MFG. CO.
904 TAYLOR AVENUE • ROCKFORD, ILLINOIS

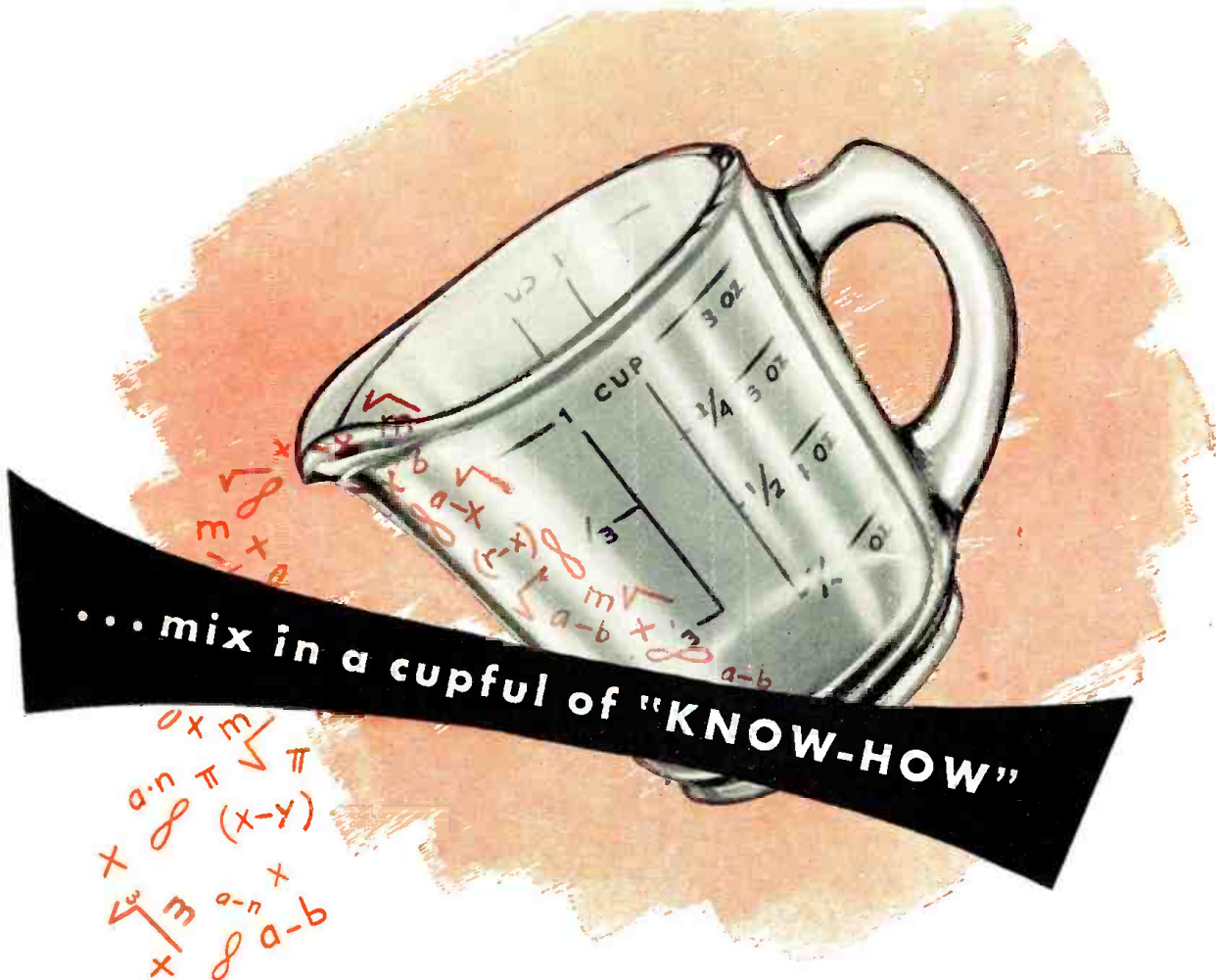

If knowledge came in containers, almost anyone could pioneer in the design and development of Electron Tubes — might even match RAYTHEON'S remarkable record of achievement in the industry.

But the kind of "know-how" that has helped RAYTHEON achieve so many industry-wide firsts, and established Raytheon Tubes as the quality standards of the industry, comes only through years of dedication to a single objective. For *thirty-years* that objective has been to *make the finest Electron Tubes in the world*. And the precious "know-how" accumulated during this period is now being used to maintain RAYTHEON TUBES' leadership in the years to come.

That's why you can use Raytheon Radio and Television Tubes — today and tomorrow — with complete confidence that you are using the finest. Ask your Raytheon Tube Distributor for them.

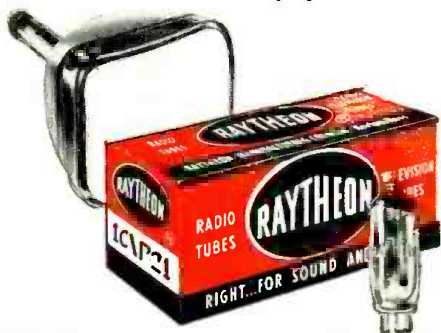

RIGHT... FOR SOUND AND SIGHT



RAYTHEON MANUFACTURING COMPANY

Receiving Tube Division
 Newton, Mass., Chicago, Ill., Atlanta, Ga., Los Angeles, Calif.

Excellence in Electronics

RAYTHEON MAKES ALL THESE: RECEIVING AND PICTURE TUBES • RELIABLE SUBMINIATURE AND MINIATURE TUBES • GERMANIUM DIODES AND TRANSISTORS • NUCLEONIC TUBES • MICROWAVE TUBES

Spot Radio News

★ Presenting latest information on the Radio Industry.

By RADIO & TELEVISION NEWS'
WASHINGTON EDITOR

COMPATIBLE COLOR TELEVISION, a vision, a promise, and a hope for nearly a decade, will at long last become an earthy official reality with the blessings of Washington, and within a matter of but a few months; thanks to an effective petition filed by the NTSC and supporting briefs submitted by members of industry. For the Commission has declared that unless major objections are entered, and at this writing none have been specifically registered, a new color order, replacing the sequential ruling, will be issued.

Even *Columbia*, whose disc system had been approved in '50, has agreed to go along with the new electronic method. There were a few rumbles of discontent with the compatible standards among some manufacturers. One set and tube maker in Chicago said that he would appeal for a hearing to halt approval, because the suggested system did not cover three-dimensional color transmission. Another indicated that since the first runs of color chassis will be costly and beyond the purchasing power of most of the public, the criterion set by the Commission, stipulating that receivers should be moderately priced, has not been met. Neither problem appears to have concerned the Commissioners. The high cost was not looked on as a bar, for in the early days of black and white TV, receivers were far from inexpensive; comparatively speaking they were more costly than the first color sets that will be offered for sale. For not only will there be many more tubes in the red-green-blue chassis, but the picture tube, that is actually three tubes in one, is extremely complex to build.

In Washington and industry, too, it is felt that even if a few dissents are made, satisfactory answers will be found and the green light will shine. According to one timetable, the OK should appear in about thirty to sixty days after comments are received, any hearings are held and approval is officially documented in the Federal Register.

An indication that all was well in the color case appeared a few weeks before NTSC and others transmitted their opinions to Washington. For, in a letter to Dr. Baker, color committee headman, the FCC's chairman had

inquired when the NTSC petition would be sent on. The memo from Washington was sparked by the *RCA* petition, which had noted that the . . . "color standards proposed . . . are technical signal specifications approved February 2, 1953, by outstanding engineers and scientists of the radio and television industry, including members of the petitioners' staffs, through the National Television System Committee."

The Commission's letter declared that . . . "since the NTSC has been engaged in a program of field testing of the NTSC color television specifications, and in light of the fact that the proposed signal specifications now urged . . . are those advanced by your organization, the Commission is desirous of determining when the results of your field testing program will be made available."

The boiling activity in compatible color disturbed some of the Commissioners who had to live through eighteen months of heated color controversy in '49-'50 when the sequential hearings were under way. According to ex-Chairman Paul A. Walker, the earlier sessions were a complete waste of time, because the authorization did not produce color, and black and white television could have had at least a year more behind it, through the earlier approval of the ultra-high channels.

The historic brief filed by the NTSC was an unusually compact document; it contained a report on the signal specs, an opinion on why the NTSC standards meet FCC criteria, and a review of the work that had been assigned to the 10 committees, which comprised the NTSC, and their membership. It also referred to the encyclopaedic appendices that had been filed earlier with the Commission, detailing the reports of each of the committees, the additional comments that were still on their way to Washington, and others that would be filed, as soon as additional data was compiled, for the record.

The proposed standards, said the petition, provide a signal which is capable of operating within a 6-mc. channel and can produce a color picture . . . "which has a high quality of color fidelity, adequate apparent definition, good picture texture (not

WANTED DISTRIBUTORS WHO WILL HELP

*the electronic
service technician*

Advertisements like the one shown here go a long way toward giving the serviceman the community standing he so rightfully deserves.

But obviously he cannot afford to go such a campaign alone. We, you and Sprague, can help. So let's all pitch in—

Order advertising mats and reprints of this advertisement for all your customers . . . who, in turn, can mail it or advertise it in newspapers to their customers.

Sprague's high volume printing makes reprints available at extremely low quantity rates. Write, wire, or phone for complete information.

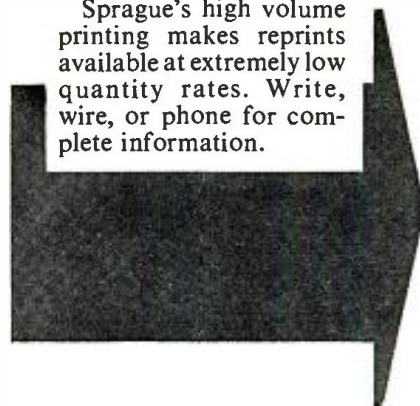

Get newspaper mats and reprints of this ad free from your distributor, or send 10c to Sprague to cover handling costs.



You'll never see your doctor advertise a special sale on appendectomies . . .
 You'll never see your lawyer announce cut-rates for divorce cases . . .
 You'll never see your dentist hold a "2-for-1" sale on extractions . . .
AND You'll never see the day when you can take your TV set in for a service "bargain" and be sure you're getting a square deal!

"Bargains" in home electronic service are as scarce as the proverbial hen's teeth! Here's why—

The expert service technician, just like other professional people, must undergo years of study and apprenticeship to learn the fundamentals of his skill. And a minimum investment of from \$3000 to \$6000 per shop technician is required for the necessary equipment to test today's highly complex sets. Finally, through manufacturer's training courses and his own technical journals, he must keep up with changes that are developing as fast as they ever did in medicine, law, or dentistry. Those best equipped to apply modern scientific methods are almost certain to be

most economical for you and definitely more satisfactory in the long run.

Unfortunately, as in any business, there will always be a few fly-by-night operators. But patients, clients, and TV set owners who recognize that you get only what you pay for, will never get gypped. "There just ARE no service bargains"...but there is GOOD SERVICE awaiting you at FAIR PRICES!

Harry Nathan
 PRESIDENT

SPRAGUE PRODUCTS COMPANY
 North Adams, Mass.

SPRAGUE

WORLD'S LARGEST MANUFACTURER OF ELECTRIC CONDENSERS

MEET *Telechief!*[®]

SANGAMO'S *NEW* PREMIUM TUBULAR CAPACITOR — designed to give

better TV performance!



EXTRA VALUE
at NO EXTRA COST!

Sangamo combines an amazing new molding compound with a new impregnant to bring you a completely new paper tubular capacitor—developed by request to meet rigid specifications so tough that no previously existing paper tubular could approach them.

Thousands of Telechiefs have been tested under actual service conditions... have proved their ability to outlast and outperform all other tubulars.

The new molding compound, Sangamo Humiditite, greatly

lengthens capacitor life. It has been proved, by severe tests, to give the best seal against moisture of any molding compound in the industry.

The new Sangamo impregnant holds rated capacity under all conditions and makes the Telechief really rugged.

Because we know that service men want only the *best* replacement parts—the new Telechief has been released to the service trade. Get in touch with your Jobber.

Those who know... choose Sangamo



SANGAMO ELECTRIC CO. MARION ILLINOIS

MOSLEY 3-WAY TV ANTENNA SWITCH *for Multiple*

UHF and VHF ANTENNA INSTALLATIONS



Cat. No. F-20 — MOSLEY
3-Way TV Antenna Switch
List Price\$3.75

- Install anywhere. Extension rod supplied for back of set mounting.
- Constant impedance—Low loss—Solderless.
- Sturdy rotary switch making silver-to-silver contact.
- In brown or ivory polystyrene case.
- Also available in Flush Wall Plate style.

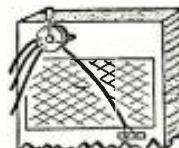

At Radio Parts Jobbers

MOSLEY Electronics, Inc.

8622 St. Charles Rock Road
St. Louis 14, Missouri

marked by such defects as misregistration, line crawl, jitter, or unduly prominent dot or other structure), of sufficient brightness so as to permit adequate contrast range, and capable of being viewed under normal home conditions without objectionable flicker."

The ten committees, the petition declared, were charged with the responsibility of studying and reporting on the subjective aspects of color; color transcriptions; color system analysis; color video standards; color synchronizing standards; receiver compatibility; field testing; broadcast systems; coordination; and definitions. The standards group had quite an assignment, for they had to provide recommended standards relating to the complete video signal, which included the determination of both colorimetric and electronic specifications. Problems they had to resolve included camera-taking and gamma characteristics; color-carrier frequency and its phase relation with respect to horizontal synchronizing signals; color sequence to be used and whether or not it should be of an oscillating type; bandwidths of the monochrome and color signals; relative amplitudes of the monochrome signal and the color carrier; maximum system amplitude demands at critical colors to enable the determination of picture-to-synchronizing ratios; and specifications of the radiated signal.

Describing the nature and extent of the work done by the field test panels, the petition pointed out that one group, who had to test the performance of receivers, required the attention of more than 100 engineers, who contributed more than 10,000 man-hours. Receivers tested were made by twelve manufacturers, and five transmitters were used in a total of seventeen field tests.

In a supporting petition, it was noted that the NTSC field tests... "establish that... with very few exceptions all existing black and white television receivers can get equal or better black and white pictures from the NTSC signal than from the present black and white signal." In addition, the brief added... "the interference problems and broadcasting service of existing broadcasting stations, with respect to black and white service, will be substantially unchanged, in the event that the NTSC signal is employed."

The brief also emphasized the fact that the... "NTSC signal will operate satisfactorily color receivers and will provide all the essential information necessary for the satisfactory operation of color receivers throughout substantially the same service area as black and white receivers."

Applauding the proposed standards, this petitioner said that the system as now evolved... "represents the soundest method, from a technical point of view, that is known at the present state of the art." It seems unlikely, they added, that... "there
(Continued on page 165)

ADVANCE! Raise your earning power—learn RADIO-TELEVISION-ELECTRONICS by SHOP-METHOD HOME TRAINING

GOOD JOBS AWAIT THE TRAINED RADIO-TV TECHNICIAN

There is a place for *you* in the great Radio-Television-Electronics industry when you are trained as National Schools will train you at home!

Trained technicians are in growing demand at good pay—in manufacturing, broadcasting, television, communications, radar, research laboratories, home Radio-TV service, and other branches of the field. National Schools Master Shop-Method Home Training, with newly added lessons and equipment, trains you in your spare time, right in your own home, for these fascinating opportunities. **OUR METHOD IS PROVED BY THE SUCCESS OF NATIONAL SCHOOLS TRAINED MEN, ALL OVER THE WORLD, SINCE 1905.**

EARN WHILE YOU LEARN

Many National students pay for all or part of their training with spare time earnings. We'll show you how you can do the same! Early in your training, you receive "Spare-time Work" Lessons which will enable you to earn extra money servicing neighbors' and friends' Radio and Television receivers, appliances, etc.



Signal Generator

Audio Oscillator

T. R. F. Receiver

National Schools Training is All-Embracing

National Schools prepares you for your choice of many job opportunities. Thousands of home, portable, and auto radios are being sold daily—more than ever before. Television is sweeping the country, too. Co-axial cables are now bringing Television to more cities, towns, and farms every day! National Schools' *complete* training program qualifies you in all fields. Read this partial list of opportunities for trained technicians:

Business of Your Own • Broadcasting
Radio Manufacturing, Sales, Service • Telecasting
Television Manufacturing, Sales, Service
Laboratories: Installation, Maintenance of Electronic Equipment
Electrolysis, Call Systems
Garages: Auto Radio Sales, Service
Sound Systems and Telephone Companies, Engineering Firms
Theatre Sound Systems, Police Radio
And scores of other good jobs in many related fields.

TELEVISION TRAINING

You get a complete series of up-to-the-minute lessons covering all phases of repairing, servicing and construction. The same lesson texts used by resident students in our modern and complete Television broadcast studios, laboratories and classrooms!



MASTER ALL PHASES!

Get Master Shop-Method Home Training from an Established Practical Resident School with its own Training Shops, Laboratories, Studios — almost 50 Years of Successful Experience in Training Ambitious Men.

We Bring National Schools To You!



You also receive this Multitester

Superheterodyne Receiver

LEARN BY DOING

You receive and keep all the modern equipment shown above, including tubes and valuable, professional quality Multitester. No extra charges.

FREE! RADIO-TV BOOK AND SAMPLE LESSON!

Send today for National Schools' new, illustrated Book of Opportunity in Radio-Television-

This course also offered in Spanish and Portuguese

Electronics, and an actual Sample Lesson. No cost—no obligation. Use the coupon now—we'll answer by return airmail.

APPROVED FOR VETERANS AND NON-VETERANS
Check coupon below

Both Resident and Home Study Courses Offered!

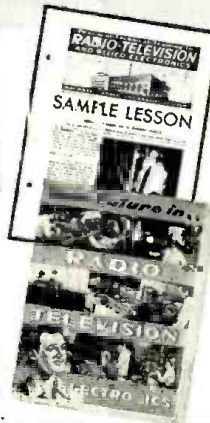

NATIONAL SCHOOLS

LOS ANGELES 37, CALIFORNIA • ESTABLISHED 1905
IN CANADA: 193 E. HASTINGS STREET, VANCOUVER, B.C.

FIND OUT NOW—MAIL COUPON TODAY!

NATIONAL SCHOOLS, Dept. RH-103
4000 South Figueroa Street
Los Angeles 37, California

Mail in envelope or paste on postal card.

Send FREE Radio-TV Electronics book and FREE sample lesson. I understand no salesman will call on me.

NAME _____ AGE _____
ADDRESS _____
CITY _____ ZONE _____ STATE _____
 Check here if released from service less than 4 years ago.
 Check here if interested in Resident Training at Los Angeles.

Guard your name with

*Assure Yourself a Share of
the New and Replacement Market*



the Nepco Line

Your name and reputation depends on your customers' satisfaction. That's why it pays you to take a tip from the growing list of dealer-installers who have turned to the NEPCO LINE to make sure of quality materials that won't let them down. They've learned this complete line of TV Antennas, Mountings and Accessories provides built-in ruggedness . . . meets the test of time and weather and assures them of a reputation for good work.

You Get EXTRA "Dividends" with the NEPCO Line!

Quality materials with the strength to stay on the job . . .

- All parts heavily zinc-coated plus baked enamel finish.
- Rigid heavy gauge $\frac{1}{8}$ " steel used in all mounts.
- Two 15' stainless steel chimney bands (ample even for the larger chimneys), $\frac{5}{16}$ " eye bolts, and four heavy gauge banding clips with patented imbedding screws available with each chimney mount.
- All hardware corrosion-protected in the same complete manner as the mounts.
- Every item in the NEPCO Line is engineered, tested and field proved to assure long service on the job.

Plus features for fast, easy installation and handling

- Unique adjustable mast clamp with one bolt mounting.
- Exclusive antenna mast clamp with positive alignment in all planes.
- Slotted hex-head bolts for screw driver or wrench installation.
- Versatile mounts that accommodate all types of installations.
- A line designed with your handling problems in mind . . . strong compact boxes easy to move and stack.
- Large easy-to-read illustrated package labels.

DEMAND THE **NEPCO** LINE

THE COMPLETE LINE FOR FAST, PERMANENT INSTALLATIONS

Write for the Name of Your Nearest Jobber Today
Catalog on request.

National Electric Products

RADIO & TELEVISION DEPARTMENT, PITTSBURGH, PA.

October, 1953

CHIMNEY MOUNTS

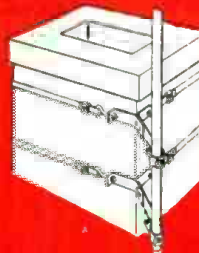

New "Y" Type Chimney Mount for extra rigidity using $\frac{3}{4}$ " eyebolts, extra heavy banding clips.



Complete with installation hardware and two 15' coils of stainless steel banding.

DORMER MOUNT

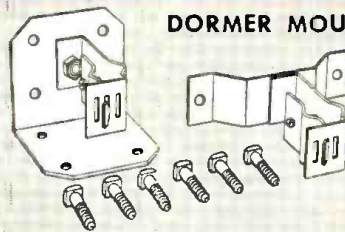

Used with 4" wall bracket for mounting masting to homes with dormer where other roof type installations would be hazardous. Furnished with 6 lag screws.

MAST ADAPTER BRACKET

For quick installation of UHF antennas on existing mast. Two to a unit.

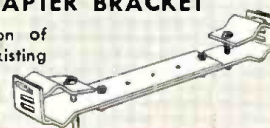

WALL BRACKETS



Allows 4" clearance.



Allows 6" clearance.



Adjustable clearance of 9" to 13 1/2".

Adjustment range 12" to 19 1/2".

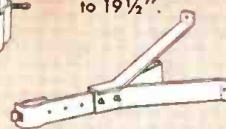

NEPCO STEEL PIPE—
With "Double" Weather Protection.

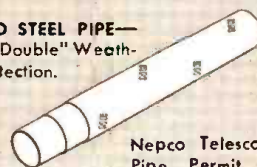

Nepco Telescoping Steel Pipe. Permit installations up to 40'.

Nepco Mailable Steel Pipe. Three 5' lengths to a carton, two with expanded ends.

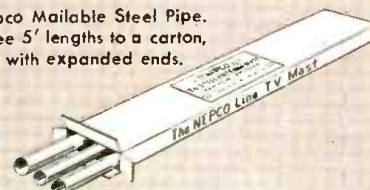

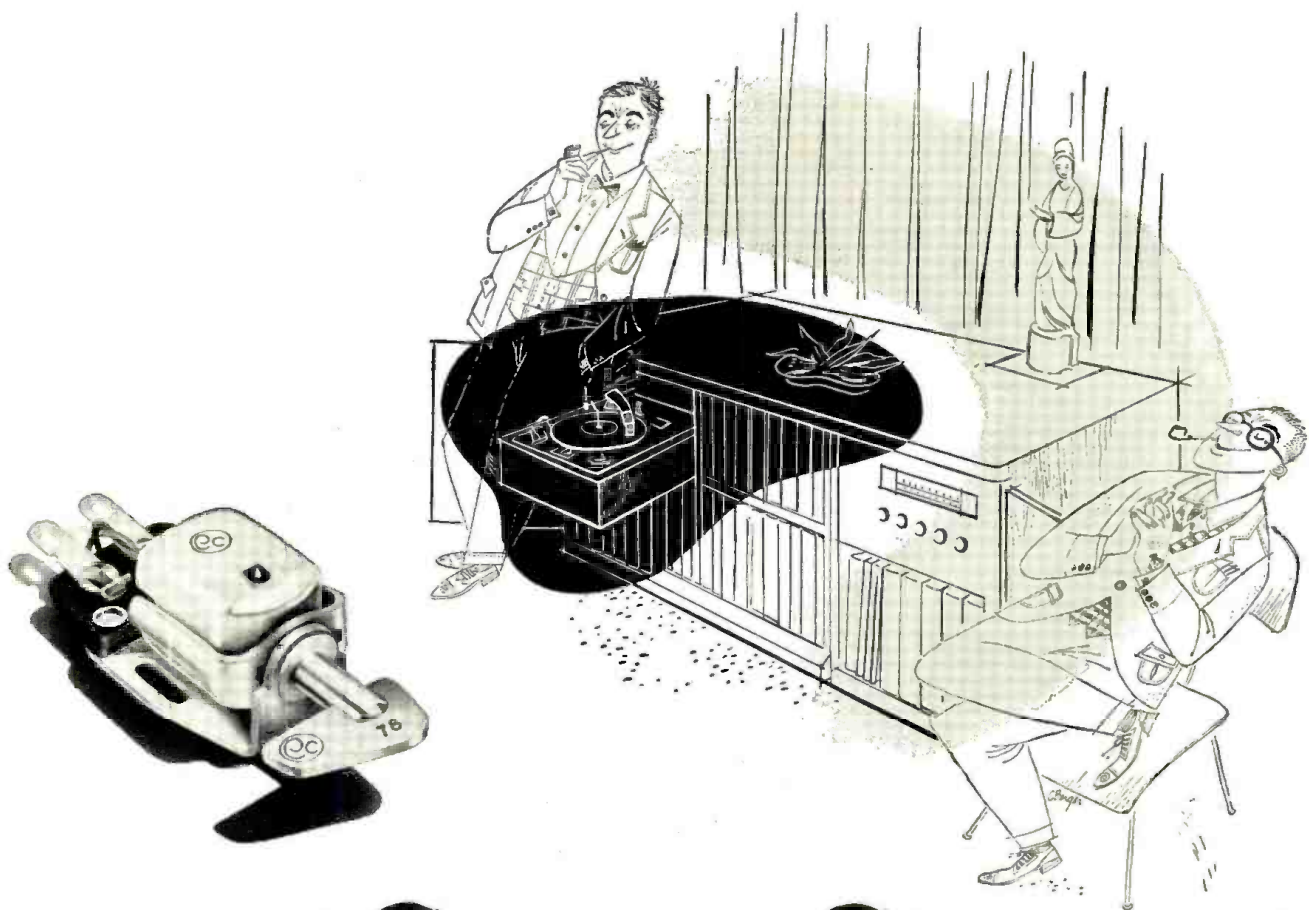

“I’m glad I waited...”

Here’s how I solved a problem that bothered me . . . and may be bothering you.

Many of my favorite recordings happen to be 78’s. They mean as much to me as any of my newer LP’s or 45’s. Changing pickups was often a real nuisance—and yet I wasn’t willing to give up the superior quality of my two Pickering cartridges.

Last fall my dealer offered a suggestion. “Wait a little longer,” he said. “You’ll be glad you did.”

He was right. I now have Pickering’s new turn-over cartridge. A simple flip of the handy lever and I’m ready to play any favorite that fits my mood—whether it’s standard or microgroove. *More than that, I’d swear my recordings sound better than ever.*

I’m glad I waited . . . but you won’t have to.

Ask your dealer to show you this convenient new turn-over cartridge. Have him demonstrate it. See if you, too, don’t hear the difference!

PICKERING and company incorporated • Oceanside, L. I., New York

PICKERING PROFESSIONAL AUDIO COMPONENTS

“For those who can hear the difference”

...Demonstrated and sold by Leading Radio Parts Distributors everywhere.
For the one nearest you and for detailed literature, write Dept. C-2





NO EXPERIENCE NECESSARY!
LEARN TELEVISION AT HOME
IN YOUR SPARE TIME!

L. C. Lane, B.S., M.A.
 President: Radio-Television Training Association
 Executive Director: Pierce School of Radio & Television

Super-Het Radio Receiver

Public Address System

C-W Telephone Transmitter

AC-DC Power Supply

Giant Screen TV Receiver

Combination Voltmeter-Ammeter-Ohm meter

RF Signal Generator



You build all this equipment and more! Everything yours to keep.

VETERANS! CIVILIANS!
PREPARE FOR A BRIGHTER FUTURE
AS A TRAINED TV TECHNICIAN!

Thousands of new jobs in TV are opening up in every state as new stations go on the air. You too can take your place in America's booming TELEVISION and Electronics industries... enjoy the success and happiness you always wanted. Keep your present job while I prepare you *at home* for a life-time career as a trained TV Technician. You "learn-by-doing" with the actual parts and equipment I send you... the same successful methods that have helped hundreds of men - *many with no more than grammar school training* - master television!

ENOUGH EQUIPMENT TO SET UP YOUR HOME LABORATORY!

As part of your training, I give you ALL the equipment you need to prepare for a BETTER PAY TV job. You build and keep a professional GIANT SCREEN TV RECEIVER complete with big picture tube (designed and engineered to take any size up to 21-inch)... also a Super-Het Radio Receiver, RF Signal Generator, Combination Voltmeter-Ammeter-Ohmmeter, C-W Telephone Transmitter, Public Address System, AC-DC Power Supply. Everything supplied including all tubes.

GOOD SPARE TIME EARNINGS!

Almost from the very start you can earn extra money *while learning*, repairing Radio-TV sets for friends and neighbors. Many of my students earn up to \$25 a week... pay their entire training from spare time earnings... start their own profitable service business. *Act now! Mail coupon and find out for yourself what a TV career can do for you!*

VETERANS!

MY SCHOOLS FULLY APPROVED TO TRAIN VETERANS UNDER NEW G.I. BILL! If discharged after June 27, 1950 - CHECK COUPON! Also approved for RESIDENT TRAINING in New York City... qualifies you for full subsistence allowance up to \$160 per month.

ADVANCED FM-TV TECHNICIAN TRAINING!

My FM-TV Technician Course can save you months of training if you have previous Armed Forces or civilian radio experience! Train at home with kits of parts, plus equipment to build BIG SCREEN TV RECEIVER, and FREE FCC Coaching Course! ALL FURNISHED AT NO EXTRA COST!

NEW! PRACTICAL TV CAMERAMAN & STUDIO COURSE!

(For men with previous radio & TV training)



I train you at home for an exciting high pay job as the man behind the TV camera. Work for TV stars in TV studios or "on location" at remote pick-ups! Course includes one week of actual work with TV CAMERAS and STUDIO EQUIPMENT at our associate resident school in New York City AT NO EXTRA COST!

FREE FCC COACHING COURSE!

QUALIFIES YOU FOR HIGHER PAY! Given to all my students AT NO EXTRA COST after TV Theory and Practice is completed. Helps you qualify for the TOP JOBS in Radio-TV that demand an FCC License! Full training and preparation at home for your FCC License.

At No Extra Cost! You Get A ROUND TRIP TO NEW YORK CITY
Only RTTA Makes This Amazing Offer!

Yes... FROM ANYWHERE IN THE U.S. OR CANADA - I pay your way to New York and return, PLUS 2 FREE WEEKS of advanced instruction and shop training at the PIERCE SCHOOL OF RADIO & TELEVISION! Available at NO EXTRA COST to all students enrolled for complete Radio-TV Technician Course after home study training is completed.

RADIO-TELEVISION TRAINING ASSOCIATION
 1629 Broadway, Radio City Station, New York City 19, N. Y.
 LICENSED BY THE STATE OF NEW YORK

MAIL COUPON TODAY!

MY 4 FREE AIDS SHOW YOU HOW AND WHERE TO GET A BETTER PAY JOB IN TELEVISION! See for yourself how my simple, practical methods make success easy.



NO SALESMAN WILL CALL!

Mr. Leonard C. Lane, President
 RADIO-TELEVISION TRAINING ASSOCIATION
 1629 Broadway, New York 19, N. Y. Dept. T-10A

Dear Mr. Lane: Mail me your NEW FREE BOOK, FREE SAMPLE LESSON, and FREE aids that will show me how I can make BIG MONEY IN TELEVISION. I understand I am under no obligation and no salesman will call.

(PLEASE PRINT PLAINLY)

NAME _____ AGE _____

ADDRESS _____

CITY _____ ZONE _____ STATE _____

I AM INTERESTED IN:

- Radio-TV Technician Course
 - FM-TV Course
 - TV Cameraman & Studio Course
- VETERANS! Check here for Training under NEW G.I. Bill**



the CDR Rotor

sells faster...sells easier

because.....

The best line of TV Rotors money can buy

It is the complete line of quality rotors, with a model and type to best serve 'most every type application.

TV Spot Campaign

To reach the buying public, an intensive campaign on Television in key markets pre-selling CDR ROTORS for you.

Newspaper Advertisements

Also directed at the consumer, a supporting campaign in key city newspapers exploiting the advantages of the CDR ROTOR.

Moving Displays

It's causing excitement everywhere, this display that is an eye and traffic stopper, a silent salesman for the CDR ROTOR.

Envelope Stuffers

Here's another selling tool that may be mailed directly to your customers, selling them the CDR ROTOR in their home.

Newspaper Mats

A full set of completely prepared advertisements for dealers and distributors to capture extra CDR ROTOR business.

Window Streamers

They let everybody going into and by your store know that you have the CDR ROTORS, a colorful and eye-catching streamer.

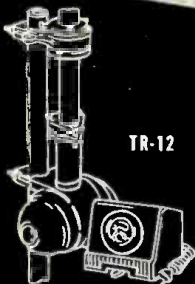

TR-12



TR-11

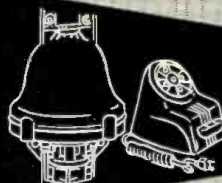

TR-2



THE RADIART CORPORATION
CLEVELAND 13, OHIO



CORNELL-DUBILIER ELEC. CORP.
SOUTH PLAINFIELD, NEW JERSEY

ANOTHER CBS-HYTRON CTS-RATED* FIRST

***CTS-RATED:** Rated for Continuous Television Service. In TV receivers, five tubes work . . . like transmitting tubes . . . *hard!* You know them: rectifiers, deflection amplifiers, damper diode. Larger-screen sets aggravate the problem. CBS-Hytron recognizes your need for huskier tubes for these sockets. Brand-new designs, not just improved tubes. CTS-Rated 5AW4 already answers your 5U4G low-voltage rectifier problem. Here is your new replacement for the 6BQ6GT: The new CTS-Rated 6CU6. Yes, more CBS-Hytron CTS-Rated tubes are coming. Watch for them.

FORGET: } RUN-AWAY PLATE CURRENT
 } HIGH-VOLTAGE ARC-OVERS
 } SHRINKING TV PICTURES

Replace 6BQ6GT with New Work-Horse

CBS-HYTRON 6CU6

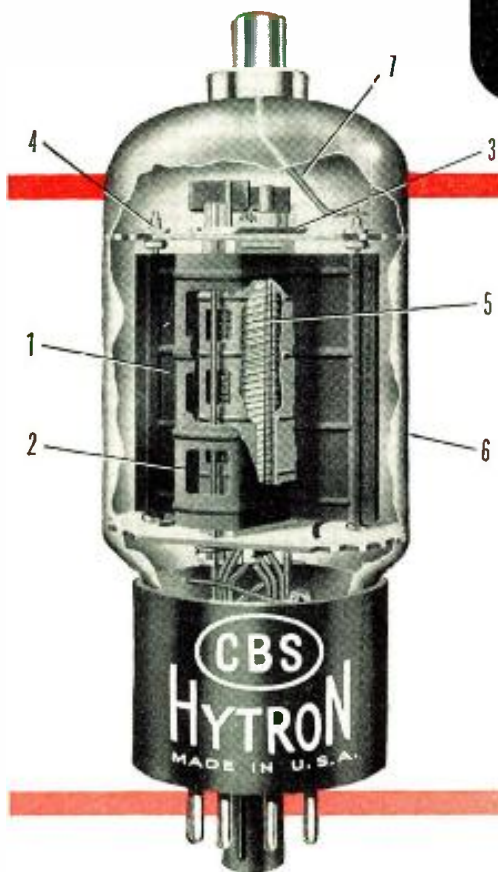

MECHANICAL FEATURES OF 6CU6

1. Heavier-gauge plate with large radiating fins.
2. Vents in beam plates and plate aligned for maximum radiation of heat from grids.
3. Anti-arc rings for uniform distribution of electrostatic field.
4. Anti-arc mica eyelets.
5. Gold-plated control grid to kill primary emission.
6. T-12 transmitting-type bulb.
7. Plate connection: "hard-soldered" and positioned to reduce heat conduction and arcing.

Cut your call-backs by up to 40 per cent with CBS-Hytron 6CU6. It's directly interchangeable with the 6BQ6GT. It's rated the same as the 6BQ6GT. *But* the new CTS-Rated 6CU6 will *live* under 6BQ6GT maximum ratings. How? The 6CU6 has generous *margins of safety* for: plate dissipation . . . plate current . . . high-voltage insulation . . . and high-line protection. The older 6BQ6GT is a good tube. But remember it was originally designed for 10- and 12-inch TV sets. Today it carries the load in 21-inch sets. Furthermore, it must combat the accumulated dissipation caused by: line-voltage variations . . . faulty receiver adjustment . . . and shifting values of components due to age and overload. Result: the 6BQ6GT may actually be operated well above its maximum ratings in many TV receivers.

In the new CBS-Hytron 6CU6, you have a tube that takes this rough treatment. And continues to ask for more. High voltage and heat meet their match. The weakest link in the TV tube line-up becomes the strongest. And your call-backs plunge downward. Bet you can't wait to try the CTS-Rated 6CU6. We couldn't. It's a honey! Watch for it soon at your CBS-Hytron distributor's.



Manufacturers of
Receiving Tubes Since 1921



CBS-HYTRON Main Office: Danvers, Massachusetts

A Division of Columbia Broadcasting System, Inc.

TRIO ZIG ZAG ANTENNAS

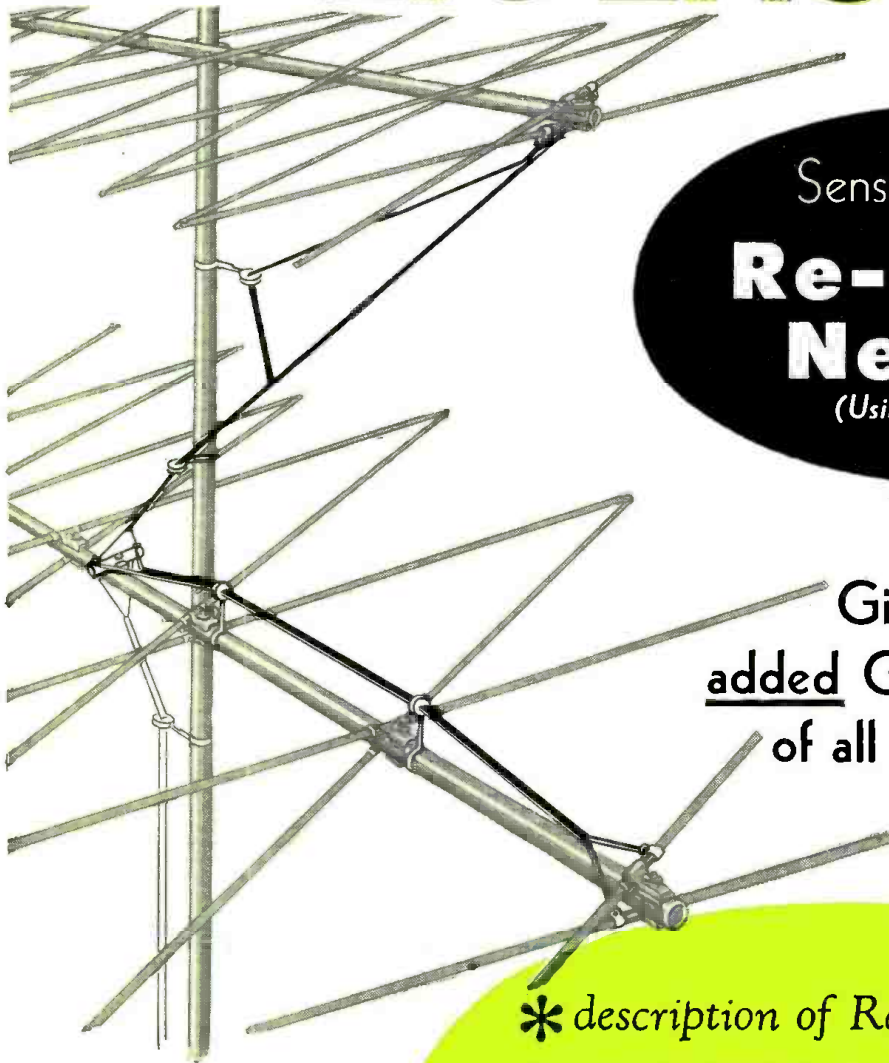

Sensational NEW
Re-entrant Network
(Using Single Lead-In)

Gives **ZIG ZAG**
added Gain over Best
of all other Antennas!

* description of Re-entrant Network

As developed by TRIO, the re-entrant network consists of two paralleled quarter wave transformer sections coupled to each antenna. One transformer provides an efficient impedance match throughout the upper channel coverage of the antenna, the other transformer covers the lower channels. The two transformer sections together offer a practically constant impedance termination to the feed-line, which is not affected by coupling a second antenna and its re-entrant network. Rain or shine, no antenna in America can match the performance of the ZIG-ZAG — on any channel!

ANOTHER NEW TRIO PLANT TO SERVE YOU!

A modern, new addition to TRIO's present facilities adds 24,000 sq. ft. of manufacturing space. A new laboratory, not illustrated, has also been added.

TRIO has on hand, or in the process of shipment from the mills, 60 carloads of aluminum to meet increased production schedules.

Despite these facts, we are not sure we will be able to fill all orders. We suggest you order now.

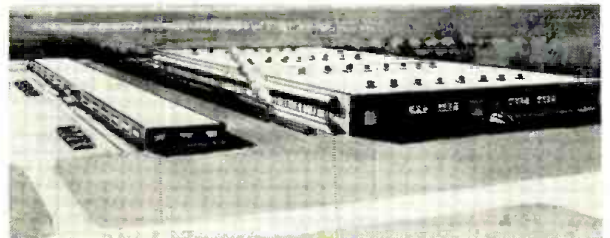

Outperform on ALL Channels!

Gain that is greater by far than that offered by the best of the collinears, conicals and multi-element Yagis, is now offered by famous TRIO ZIG-ZAG antennas!

A sensational new TRIO development — a new re-entrant type impedance matching network — makes possible this tremendous improvement by providing an almost perfect impedance match to the line on every channel! Unlike isolation filters, the ZIG-ZAG re-entrant network has NO insertion loss!

A single feed-line is used, even when stacking for all-channel operation!

Extensive tests were made in all sections of the country, in every conceivable type of terrain. Results prove that the ZZ12L, ZZ16H combination, with their associated re-entrant networks, provides the finest all VHF channel, single lead-in operation yet obtained.

Current shipments of TRIO ZIG-ZAG antennas include the complete network.

For channels 2 thru 6 or channels 7 thru 13 separately, or combined for channels 2 thru 13, TRIO ZIG-ZAG antennas are the hottest ever designed.

New descriptive literature available.

HIGH GAIN TRIO UHF ANTENNAS

UBT BOW-TIE SERIES

(4-stack, in actual tests, bests all other types)

The popular TRIO 4-stack bow-tie, in actual field tests, outperformed all other types because it takes advantage of the fact that UHF signals are composed of closely spaced layers of different signal strength. Because of its vertical height, the TRIO 4-stack taps one or more of these varying high density layers at all times — offers consistent high gain day in and day out.

TRIO bow-ties offer high forward gain without sacrificing excellent front-to-back ratio and good line

match. Adoption of reflectors using individual horizontal elements eliminates vertically polarized noise pick-up so often encountered with grid, mesh and solid type reflectors.

TRIO bow-ties are also available in 2-stack and single stack models. The 4-stack and two stack come assembled on 4 foot and 3 foot aluminum masts respectively, with phasing harness installed. The single bay model is furnished assembled on a 2 foot aluminum mast.

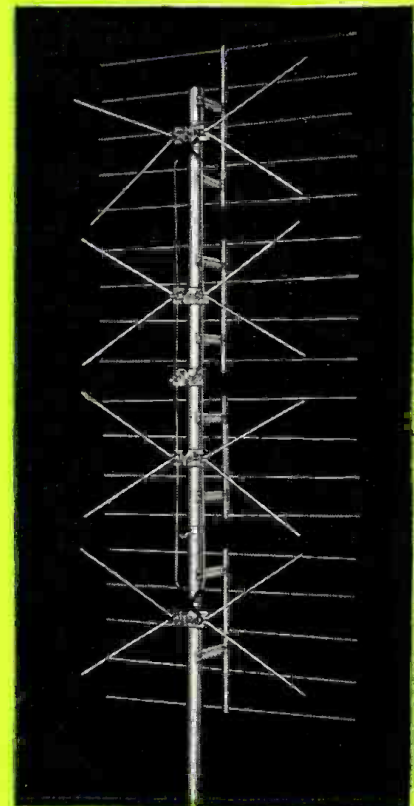

TRIO

Manufacturing Co.
GRIGGSVILLE, ILLINOIS

Do as TV manufacturers do ... use Hi-Vo-Kaps®

Centralab TV Hi-Vo-Kaps are the accepted standard of television manufacturers. That's why they're the recognized service leader too!

They will withstand continuous overload, up to TWICE rated working voltage — and come back for more! Capacitors are complete, ready to install.

Hi-Vo-Kaps are 100% tested at rated test voltage. You get a factory-guaranteed exact replacement every time.

Use Hi-Vo-Kaps for filter and by-pass in TV high-voltage power supply ... and pulse filter for cathode ray tubes. You'll find them the fastest ... safest for guaranteed servicing capacitors you've ever used. Ten different combinations available — individually packaged for instant use. See your Centralab distributor for stocks NOW.

Centralab®

CENTRALAB,
A Division of Globe-Union Inc.
910-J E. Keefe Ave., Milwaukee 1, Wis.
Please send me latest technical data on
Centralab's Ceramic TV Hi-Vo-Kaps.

Name.....
Firm.....
Address.....
City.....Zone.....State.....

Within the INDUSTRY

COMMANDER R. C. SERGEANT, USNR, is the new technical division officer of the Navy's Electronic Supply Office, Great Lakes, Illinois. His work will include technical and engineering research relating to procurement, inventory control, and distribution of electronic control. He will also serve as liaison officer between the Navy and the electronics industry.



The Electronic Supply Office is the control point of the entire electronic supply system of the U. S. Navy.

Before entering the Naval service in 1940 he was employed by the *Mackay Radio and Telegraph Company* as radio supervisor of the San Francisco office.

KARL W. JENSEN, vice-president of *Jensen Industries, Inc.*, Chicago, has been elected chairman of the Association of Electronic Parts & Equipment Manufacturers, trade association of 120 midwest firms.

Theodore Rossman, general manager of *Pentron Corporation* was elected vice-chairman, the position formerly held by Mr. Jensen. Mr. Jensen succeeds Francis F. Florsheim as chairman.

Helen Staniland Quam, distributor sales manager of *Quam-Nichols Co.*, was re-elected treasurer of the association for her sixteenth term. Kenneth C. Prince was renamed executive secretary.

THOMAS A. EDISON, INCORPORATED has purchased **MEASUREMENTS CORPORATION** of Boonton, N. J., and will operate the company as a wholly-owned subsidiary. No basic change in policies or personnel is anticipated. . . **LA POINTE ELECTRONICS INC.** of Rockville, Conn., has purchased **CIRCUITRON, INC.**, manufacturers of printed circuits.

RTMA has announced a change in the Association's name to the Radio-Electronics-Television Manufacturers Association (RETMA) and the approval of a reorganization plan which will expand the board of directors and provide larger representation for new segments of the industry, especially in the advanced electronics field.

Under provisions of the by-law amendments and in accordance with the action taken by the board of directors in Chicago, two committees of the board were established. They are the radio-television industry commit-

tee and the electronics industry committee. Each director will be asked to select one of the two committees as representing his major interest and will be permitted to designate an alternate to serve on the second committee providing his company is engaged in the manufacture and sale of products or services within the sphere of that committee.

The Association also announced the establishment of a West Coast office in Los Angeles. Joseph J. Peterson will head the new office.

WILLYS MOTORS, INC. has announced that its electronics division is entering the television transmitter field to help speed opening of the some-2000 authorized u.h.f. TV stations.

The company is planning to offer a "TV package" consisting of a 1000 watt transmitter (operating from 450 to 900 mc.), camera, projector, console, panel, etc. to licensees in areas of 50,000 population or less.

The company is also working with the National Association of Educational Broadcasters to develop a transmitter that meets the special requirements of educational TV systems.

BERNE FISHER has been named director of engineering for *Standard Coil Products Co. Inc.*

Mr. Fisher, who holds a number of mechanical and electrical patents relating largely to television equipment, has been associated with *General Instrument Corporation* for the past eighteen years, most recently as chief engineer and production manager.

The company makes television tuners and through its subsidiary, *Kollsman Instrument Corporation*, is a major producer of aviation instruments and systems.

WINCHARGER CORPORATION of Sioux City, Iowa, will build a new manufacturing plant on high ground away from the danger of flood waters that caused considerable damage to the plant last June. The new plant will have a floor space of 300,000 square feet, more than double the space occupied by the present factory. . . **RESEDL ENGINEERING CORPORATION** is building an additional plant of 21,000 square feet at 3636 San Fernando Road, Glendale, California. The firm is presently located at 2351 Riverside Drive, Los Angeles 39, California. . . **MOSLEY ELECTRONICS, INC.** of St. Louis has moved all execu-





**TRAIN *FASTER* — TRAIN *BETTER* — TRAIN *EASIER*
 IN 10 MONTHS — OR LESS — FOR
RADIO-TELEVISION**

Our 21st Year Training Men for Greater Incomes and Security in Radio-Television

**I SEND YOU
 18 BIG KITS**

of Radio-Television parts and equipment. Much of your training will be actual construction and experimentation... the kind of truly PRACTICAL instruction that prepares you for your Radio-Television career.



Frank L. Sprayberry
 President
 Sprayberry Academy
 of Radio

NEW! NO OBLIGATION PLAN

**You Have No Monthly Payment Contract to Sign
 Pay For Your Training as You Earn and Learn**

You can get into Radio-Television, today's fastest growing big money opportunity field, in *months* instead of years! My completely new "package unit" training plan prepares you in as little as 10 months or even less! *No monthly payment contract to sign—thus NO RISK to you!* This is America's finest, most complete, practical training—gets you ready to handle any practical job in the booming Radio-Television industry. Start your own profitable Radio-Television shop... or accept a good paying job. I have trained hundreds of successful Radio-Television technicians during the past 21 years—and stand ready to train you, even if you have no previous experience! Mail coupon and get all the facts—FREE!

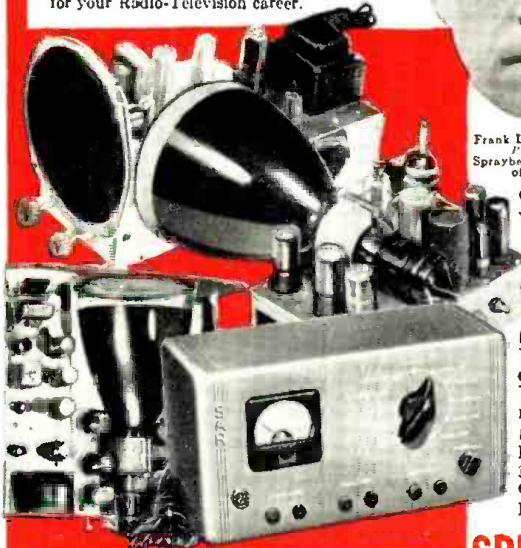

**Valuable Equipment Included
 With Training**

The new Sprayberry "package" plan includes many big kits of genuine, professional Radio-Television equipment. You perform over 300 demonstrations, experiments and construction projects. You build a powerful 6-tube 2-band radio set, multi-range test meter, signal generator, signal tracer, many other projects. All equipment and lessons are yours to keep... you have practically everything you need to set up your own profitable Radio-Television service shop.

Earn Extra Money While You Learn!

All your 10 months of training is IN YOUR HOME in spare hours. Keep on with your present job and income while learning. With each training "package" unit, you receive extra plans and "Business Builder" ideas for spare time Radio-Television jobs. New television stations everywhere, open vast new opportunities for trained Radio-Television Technicians—and those in training. If you expect to be in the armed forces later, there is no better preparation than practical Sprayberry Radio-Television training.

YOU BUILD the Television set and the powerful superhet radio receiver shown above. IN ADDITION to the other test units shown here (many are not shown because of lack of space). All equipment I send you is **YOURS TO KEEP.**

Approved for Veterans under the G. I. Bill

**SPRAYBERRY ACADEMY OF RADIO 111 NORTH CANAL ST.
 Dept. 25-B, Chicago 6, Ill.**

**MAIL COUPON
 TODAY!
 NO OBLIGATION**

I invite you to get all the facts—
**FREE TO YOU 3 BIG
 RADIO-TELEVISION BOOKS**

I want you to have ALL the facts about my new 10-MONTH Radio-Television Training—without cost! Rush coupon for my three big Radio-Television books: "How to Make Money in Radio-Television," PLUS my new Illustrated Television Bulletin PLUS an actual sample Sprayberry Lesson—ALL FREE. No obligation and no salesman will call. Mail coupon NOW!

**SPRAYBERRY ACADEMY OF RADIO, Dept. 25-B
 111 North Canal St., Chicago 6, Ill.**

Please rush to me all information on your 10-MONTH Radio-Television Training Plan. I understand this does not obligate me and that no salesman will call upon me. Be sure to include 3 books FREE.

Name..... Age.....
 Address.....
 City..... Zone..... State.....



THE FISHER HI-LO FILTER SYSTEM • MODEL 50-F

New!

PROFESSIONAL
AUDIO
EQUIPMENT AT
LOW
COST!

FISHER Hi-Lo Filter System

■ Here it is at last—America's first electronic *sharp cut-off* Filter System. Suppresses turn-table rumble, record scratch and distortion, etc., with the *absolute minimum* loss of frequency response. *Separate* low and high frequency cut-offs. Can be used with *any* tuner, preamplifier, amplifier, etc. No insertion loss. Uniform response 20-20,000 cycles, ± 0.5 db. Self-powered. All-triode. Beautiful plastic cabinet. Only \$29.95

FISHER Preamplifier-Equalizer

■ Now, professional record equalization facilities are within the reach of *every* record collector. THE FISHER Model 50-PR, like its big brother (Model 50-C) is beautifully designed and built. Only \$19.95

THE FISHER PREAMPLIFIER-EQUALIZER • MODEL 50-PR



OUTSTANDING FEATURES

- Independent switches for low-frequency turnover and high frequency roll-off.
- 16 combinations.
- Handles *any* low level magnetic pickup.
- Hum level 60 db below 10 mv input.
- Uniform response 20-20,000 cycles, ± 1 db.
- Two triode stages.
- Full low frequency equalization.
- Output lead any length up to 50 feet.
- Beautiful plastic cabinet, etched brass control panel.
- Completely shielded chassis.
- Built-in AC switch.
- Jewel indicator light.

Write for full details
FISHER RADIO CORP.
39 EAST 47th STREET • N. Y.

tive and general offices into new quarters at 8622 St. Charles Rock Road, St. Louis 14, Missouri . . . **CHICAGO TELEPHONE SUPPLY CORPORATION** has completed and equipped a new, modern building which adds 64,182 square feet to its manufacturing and office space in Elkhart, Indiana . . . **SKYLINE MFG. CO.** has increased its plant area at 1458 E. 17th St. in Cleveland, Ohio, by 25 per-cent. The new space will be used for the increased production of u.h.f.-v.h.f. antennas . . . **DESIGNERS FOR INDUSTRY, INC.** has expanded its engineering and research facilities in a newly-renovated building at 3107 Detroit Avenue, Cleveland. The new plant adds 8000 square feet to the company's development and manufacturing area . . . **AUDIO DEVICES, INC.** has expanded its plant and facilities in Glenbrook, Conn., to permit stepping up production of recording tape by at least 50 per-cent . . . **TELETRONICS LABORATORY, INC.** has recently completed the construction of a new engineering building located adjacent to its manufacturing plant on Kinkel Street, Westbury, L. I., New York . . . **THE HERLEC CORPORATION**, midwestern manufacturing subsidiary of **SPRAGUE ELECTRIC COMPANY** has moved all of its operations to its new plant at Grafton, Wisconsin. The new facility is located in a rural area about 25 miles from the company's former location in the heart of downtown Milwaukee . . . **THE HALLCRAFTERS COMPANY** has begun construction on a new \$400,000 plant in Toronto, Ontario. It is expected to be in operation by October.

* * *

ROSCOE A. AMMON, for twelve years general manager and chief engineer of the *Marion Electrical Instrument Company* of Manchester, N. H., has now become president and principal stockholder of the corporation.



He succeeds William F. McElroy who will retire from active management but continue to serve as a director and in an advisory capacity. Mr. Ammon assumes the duties of president and treasurer while Herbert Schachat will serve as vice-president in charge of operations.

The company makes a complete line of electrical indicating instruments.

* * *

EDWIN E. FREED has been named manager of operations of *General Instrument Corporation's* headquarters plant in Elizabeth, N. J. . . . **ROY E. NELSON**, veteran of *RCA* engineering and sales activities, has been promoted to the newly-created post of manager of semi-conductor equipment sales for the Tube Department of the *RCA Victor Division* . . . **DR. WILBUR A. LAZIER** has been named vice-president and technical director in charge of the *Sprague Electric Company's* research (Continued on page 213)

NEW!

4 P.E.C.* KITS

(NO EXTRA CHARGE FOR CABINETS)



PCK-18 18 P.E.C. units. Replace 42 old-style resistors and 52 old-style capacitors. Net - - - - \$9.00

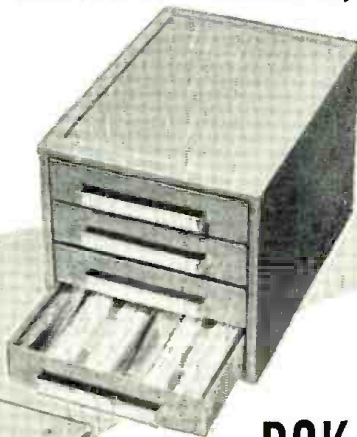

PCK-110 110 P.E.C. units. Replace 255 old-style resistors and 52 old-style capacitors. Net - \$55.80

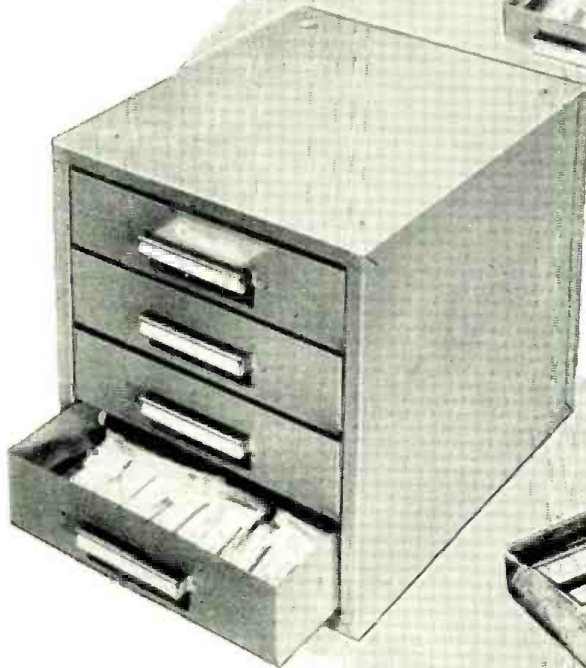

PCK-220 220 P.E.C. units. Replace 525 old-style resistors and 620 old-style capacitors. Net \$115.80



PCK-45 45 P.E.C. units. Replace 106 old-style resistors and 133 old-style capacitors. Net - \$24.00

Handy P.E.C. Guide No. 2 is included with each kit. Shows part listings, schematics, and test data.



Write for a list of the Centralab distributors in your area who have P.E.C. Kits.

Centralab

A Division of Globe-Union Inc.

910-J E. Keefe Avenue • Milwaukee 1, Wisconsin
In Canada, Box 208, Ajax, Ontario

*Trade Mark — Printed Electronic Circuit

FALCON

Introduces -

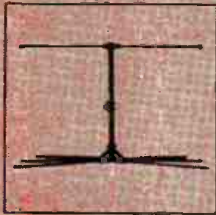

Channels 2-13, peaked for low channels (2 thru 6)

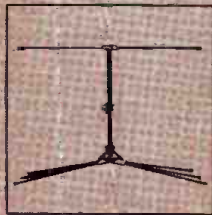

Channels 2-13, normal position, peaked for all VHF channels (2 thru 13)

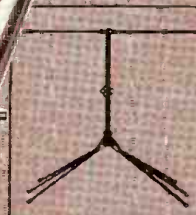

Channels 2-13, peaked for high channels (7 thru 13)

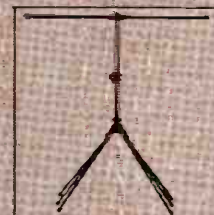

Channels 2-83, peaked for UHF channels



Falcon "VARI-CON" folded for packing

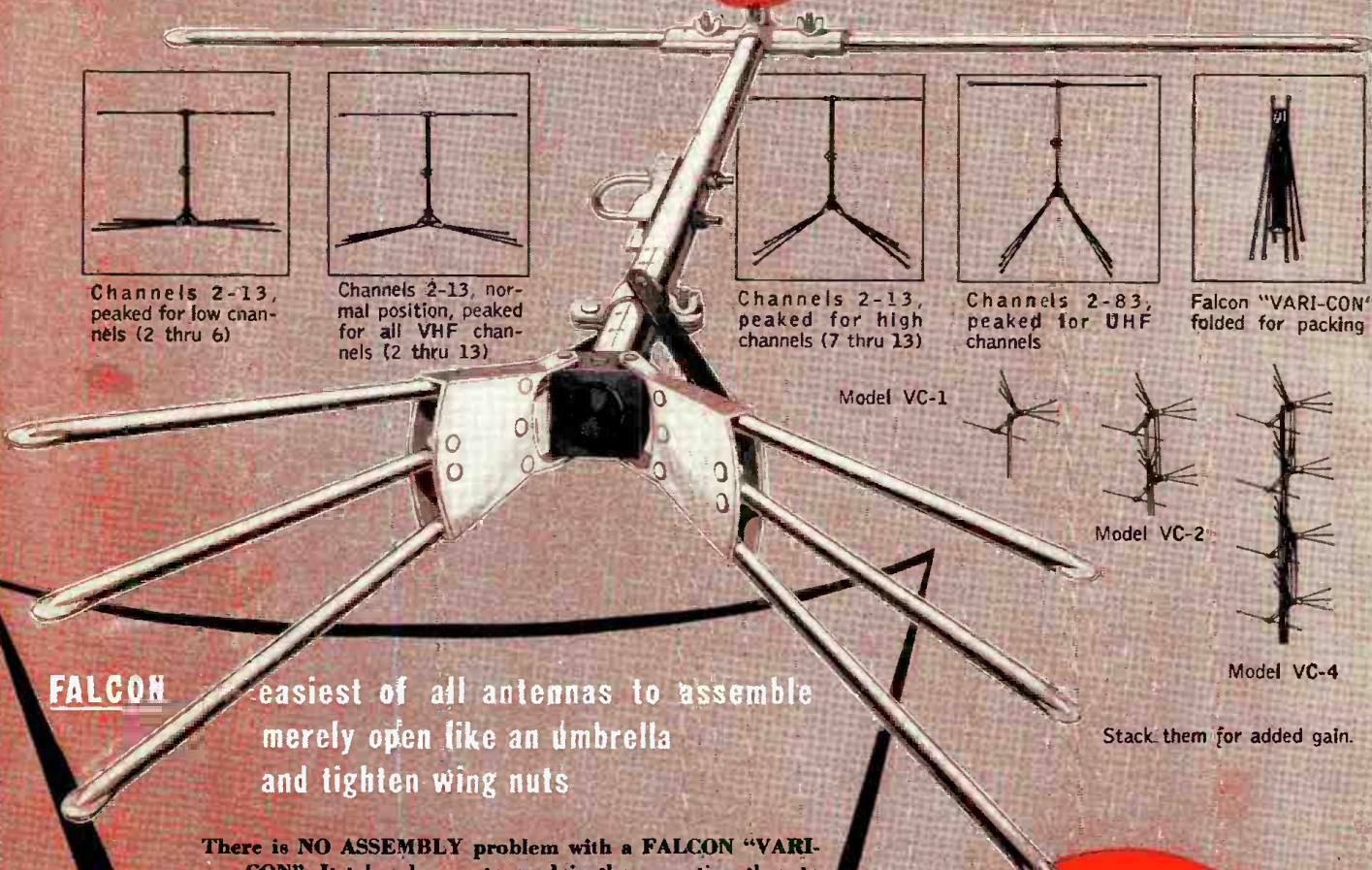

Model VC-1



Model VC-2



Model VC-4

Stack them for added gain.

FALCON

easiest of all antennas to assemble merely open like an umbrella and tighten wing nuts

There is NO ASSEMBLY problem with a FALCON "VARI-CON". It takes longer to explain the operation than to accomplish it! Your FALCON "VARI-CON" comes folded into one compact unit. You need only swing the reflector into position and tighten the wing nuts. Move the sliding sleeve to the calibrated channel setting you desire and tighten. The butterfly springs snap the elements into position and lock them securely. The FALCON "VARI-CON" is ready to install, ready to provide peak performance. *Changing the channel peaking of the "VARI-CON" is just as simple and easy as making the original setting. No tools are needed for either operation.*



Calibrated sleeve for quick peaking of antenna.

THE HEART OF THE "VARI-CON"

Above is a view of the new mechanism which enables anyone to adjust the peaking of the FALCON "VARI-CON" to any range of channels desired. The sliding sleeve, on the calibrated boom, automatically fans out the elements to their correct position.

A simple, trouble-proof, snap-action spring in the

butterfly keeps the elements solidly in place. The insulated hinge assembly is extremely strong, durable and weather-resistant and has an extra long leakage path. Weight has been kept to a minimum, strength at a maximum in order to assure long life and freedom from wind and weather damage. A heavily plated mast clamp is supplied.

the "VARI-CON"

(The conical that's variable)

Provides all Channel Performance...

Yet can be Peaked for Increased Gain on any Channel Range

The FALCON "VARI-CON" was designed for today, tomorrow and years to come. Its unusual construction permits setting the "VARI-CON" for all-channel performance peaked to provide the additional gain needed on special channels. In addition, the variable patterns obtainable are of great value in ghost elimination.

There is no guess work; no tedious assembly; no field strength equipment needed to peak the "VARI-CON" for high-gain, sharp pattern performance in your area. It's as simple and easy as opening an umbrella. Here's all you do: Unpack the "VARI-CON"—Slide the adjusting sleeve to the calibrated marking on the boom for the best reception of channels in your area—Fan out the reflector elements—Tighten the locking wing nuts. The "VARI-CON" is

automatically peaked WHERE YOU WANT IT and ready to install. It is the only conical that enables you to provide a custom-made installation resulting in higher gain and increased customer satisfaction.

The NEW FALCON "VARI-CON" is ruggedly constructed. Heavy-duty heads will not crack or break. The steel spring snap-action butterfly assemblies are unbreakable. Full length, 48 inch, elements are used. One of the most capable engineering staffs in the industry has worked out every last detail of this truly remarkable TV antenna. To the high gain all-channel performance and excellent line match of the conical, FALCON engineers have added the "plus" feature—adjustable, calibrated channel range peaking!

FALCON

The new "VARI-CON" is one of the most significant additions to antenna design. Watch for the other new FALCON antennas which will be announced in the near future! Each will represent the most advanced, most efficient antenna design of its type.

WRITE FOR ILLUSTRATED FOLDER AND PRICES



FALCON ELECTRONICS COMPANY • 2003 CEDAR ST. • QUINCY, ILLINOIS



NATIONAL ADVERTISING TO BACK NEW FALCON "VARI-CON"

To stimulate sales on all levels, FALCON is conducting one of the most aggressive advertising campaigns in the industry. Full two-page color spreads are appearing regularly in many of the nation's top trade and consumer publications.

Versatile!

NEW!

Exclusive!

PHILCO® Cross Dot TV Linearity Pattern Generator

More Stable Operation at
1/3 the Cost
of Comparable Generators

Again . . . Philco leads the field! For the finest possible linearity adjustments without station pattern, here is the all new *cross dot* linearity pattern generator. This unit not only lets you make TV linearity adjustments more quickly and accurately but also permits precise routine adjustments and trouble shooting with amazing economy of operation . . . Light, rugged, portable, heavy gauge steel case . . . finished in durable gray hammertone . . . See your Philco distributor now or write Philco, Accessory Division, "A" & Allegheny, Philadelphia, Pa.

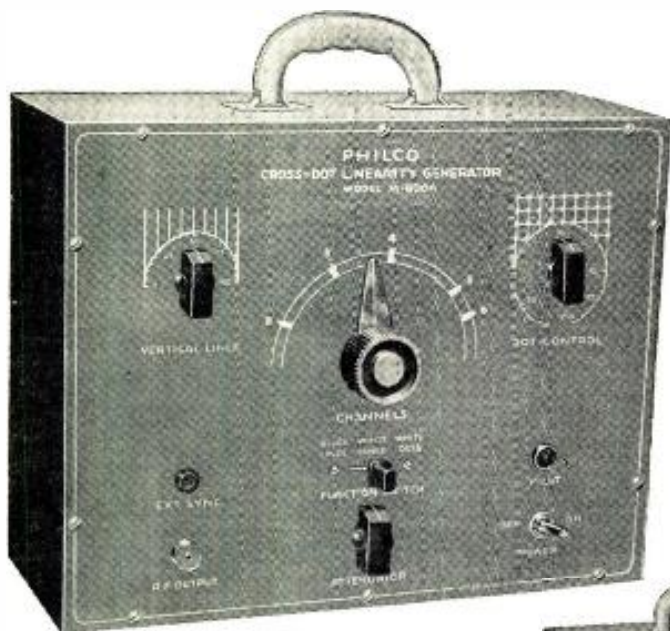

Model G-8004

Specifications: — Self stabilized oscillator • Variable output frequencies • Power consumption approximately 10 warts • Power supply—105-125 Volts, 60 cycles • large easy-to-tune dial • high level output controllable with variable attenuator.

*Now Yours on New
Special Payment Plan*



Model M-8104—TV Field Strength Meter • Offers more features than any unit at this popular price . . . Super Colorado Tuner for low noise and high gain . . . May be used to check TV boosters, antenna combinations, interfering signals and picture signal strength.



Model 7008—Visual Alignment Generator • Combines in one economical unit functions ordinarily found only in a cumbersome collection of costly devices . . . Includes extra sensitive built-in oscilloscope . . . AM, FM, and audio generators. Sweep output flat to within .2 DB/MC.

PHILCO
Test Equipment
Specifically Designed for the Serviceman

NEW

WALSCO *Imperial*

*

PROVEN THE MOST ADVANCED UHF CONVERTER IN AMERICA

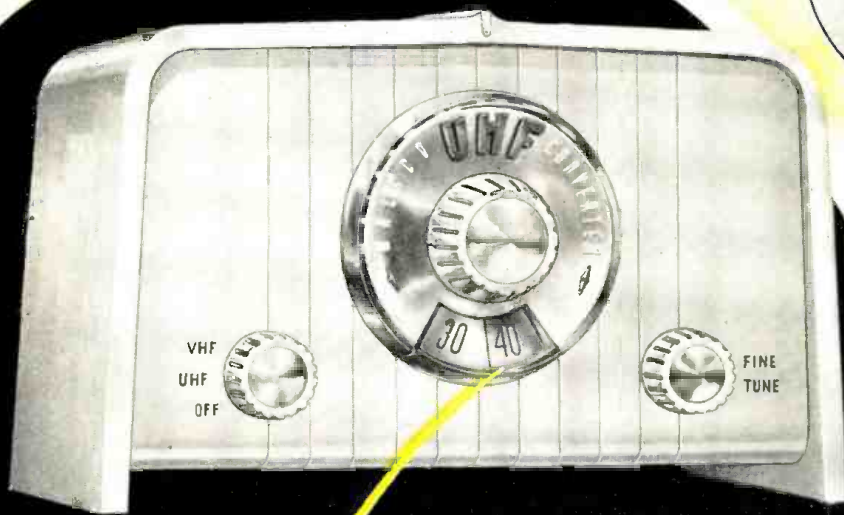

NEW distinctive cabinet design available in beautiful assortment of COLORS

WITH EXCLUSIVE
Surretune

UP TO

98%
GREATER POWER
GAIN

UP TO

88%

LESS NOISE
FACTOR

* **FACTS** from one of America's leading, independent research laboratories proved the WALSCO Imperial will out-perform all other UHF converters... anywhere!

	Average Power Gain DB			Average Noise Factor DB		
	500 mc	650 mc	800 mc	500 mc	650 mc	800 mc
WALSCO Imperial	10.0	9.5	9.5	15.0	15.5	16.0
Converter A	6.0	5.4	3.5	18.5	20.0	21.0
Converter B	7.0	6.5	5.0	18.0	18.5	20.0

WRITE FOR COMPLETE INFORMATION

WALSCO ELECTRONICS CORPORATION

3602 Crenshaw Blvd. • Los Angeles 16, California

3 New Electrical Advances!

CHANNEL MASTER'S

all-new UHF **BOW-FLECTOR**

model no. 408

The highest gain Bow and Screen antenna ever developed — single or stacked!

Enlarged Reflecting Screen. 53% more reflecting area — higher, flatter gain level.

Full-Wave Spacing of stacked antennas. Provides highest stacking gain ever obtained in an antenna of this type.

2-Stage Stacking Transformers for broad-band impedance match. Delivers high stacking gain over entire UHF band.

Only 20 seconds to install!

Just snap Bow into Screen, then fasten entire assembly to mast with Channel Master's exclusive "SPEED-NUTS." The antenna cannot move, twist, flutter, or vibrate! The light-weight Bow Flector is the most rugged, fastest-installing antenna of its type.



to 10 DB
single

to 12 1/2 DB
stacked

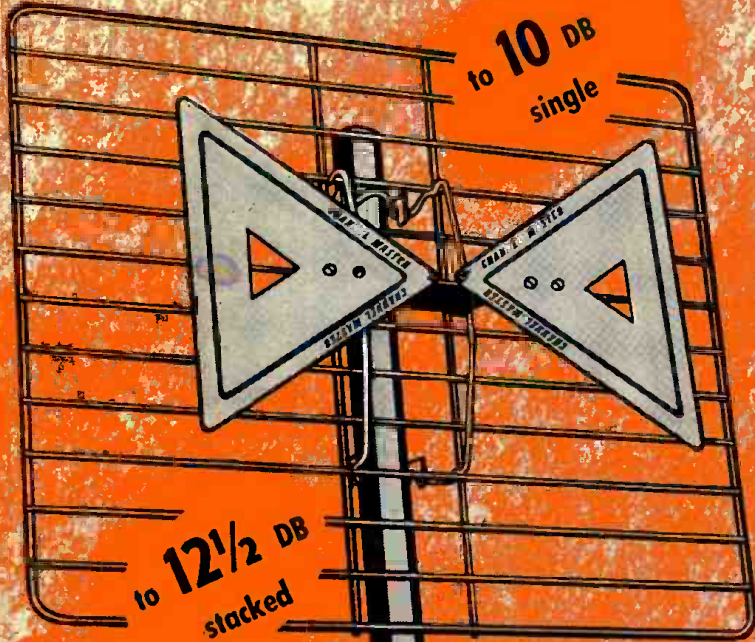

Terrific gain!

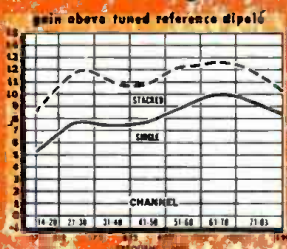

Horizontal Polar Patterns (Relative Voltage)

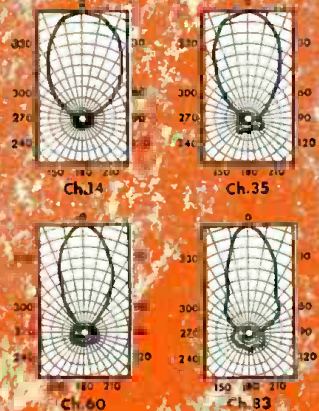

New Mechanical Features

- Deep-embossed "rigidized" aluminum dipoles.
- Snap-in assembly. No U-Bolts.
- High-impact molded insulator.

"Free-Space" terminals that prevent picture dim-out caused by the accumulation of dirt, ice or rainwater between antenna terminals.



One of 5
Great New
Channel Master
Products
For Fall

CHANNEL MASTER CORP.



Ask your Channel Master distributor for complete technical literature.

You've never seen a mast like it!

CHANNEL MASTER'S

all-new

STRATO-MATIC

TELESCOPING MAST

One of 5
Great New
Channel Master
Products
For Fall!

for antenna installations
that are

- easier • faster
- safer



Featuring the Amazing "Third Hand!"

— an automatic, removable locking device that actually acts as your "third hand," holds mast sections up when you let go! The Third Hand converts each guy ring, in turn, into a "safety lock." This permits you to raise sections freely, using only one hand. And . . . sections cannot slide down when you let go.

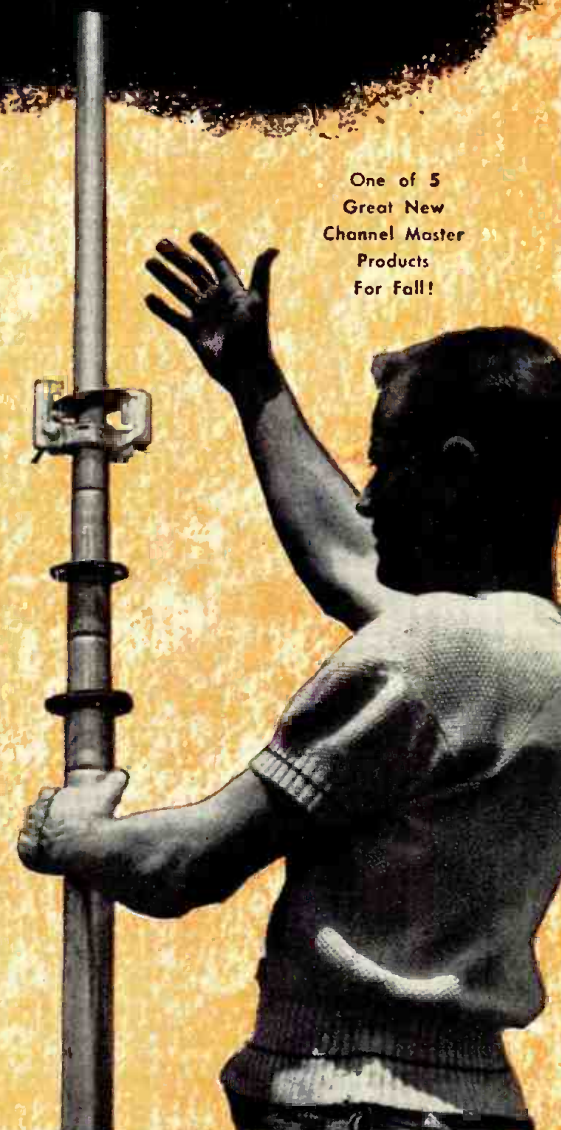

Automatic Mast Extension

The Step-Up Key, inserted through the bottom of the mast tubing, automatically extends each mast section 6 inches. Mast sections are kept partially extended even after mast is placed in vertical position — without using hardware or locking bolts!

World's Finest Mast Protection!

16-Gauge Mastings
**HOT-DIP
GALVANIZED**

Most permanent type of mast corrosion protection available today. Sections are immersed in cauldron of molten zinc, until a thick layer of pure zinc is fused to inner and outer surfaces — so thick it actually adds to the weight of the mast; gives long-term protection!

**ZINC IS
SELF-HEALING!**

When the protective zinc coating is scratched or broken, the surrounding zinc actually goes to work to "heal" the wound. Thus, the base metal is automatically protected against damage due to installation or handling. The only coating with this ability.

18-Gauge Mastings
**HEAVY ZINC
ELECTRO-PLATING**

Heavy layer of bright zinc, exceeding Army-Navy specifications, provides effective long-lasting protection against elements. A chromate dip adds brightness; increases corrosion resistance. The strongest, most durable protection jacket of its type.

Inter-Locked Sections

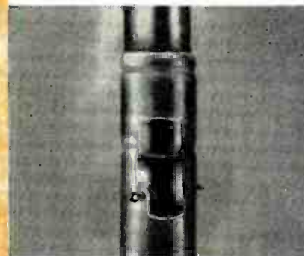

Safety Rings prevent sections from pulling out of each other. Notches in sections engage bolt — no twisting.

No Hidden Holes



Step-Up Key automatically extends mast sections high enough to provide easy access to bolt holes. You don't have to pull up next section to insert bolt!

Model No.		Sections	Lengths	Weights	
16-Gauge	18-Gauge			16-Gauge	18-Gauge
1620	1820	A, B	20'	20 lb.	15 lb.
1630	1830	A, B, C	30'	32 lb.	25 lb.
1640	1840	A, B, C, D	40'	46 lb.	35 lb.
1650	1850	A, B, C, D, E	50'	61 lb.	47 lb.



CHANNEL MASTER CORP. ELLENVILLE, N. Y.

Ask your Channel Master distributor for complete technical literature.

**THIS WESTINGHOUSE
UHF
SERVICE KIT**

**YOURS AT
NO COST**

with purchase of
**100 WESTINGHOUSE RELIATRON RECEIVING TUBES
OR
4 WESTINGHOUSE RELIATRON PICTURE TUBES**
from your Westinghouse Tube Distributor



1 32-PAGE UHF CONVERSION HANDBOOK
Tells How to Convert All Makes and Models

- Tells you all about:
Converters
Tuners
Strip Replacement
Antennas and Lead-In
- Written in easy-to-understand servicemen's language.
- More than 50 illustrations, diagrams.
- Makes UHF servicing easy and profitable.

**2 SENSATIONAL NEW 3-FOOT
HEAT-MOTOR
WINDOW
DISPLAY**

Reproduces
Actual Moving
TV Troubles in Lighted
Picture

Printed with
6 colors

Best display you
ever used



3 UHF WINDOW STREAMER
Makes You UHF Conversion
Headquarters

Attracts new
customers for
UHF conversion
business; turns
your UHF know-
how into quick
cash!



**4 EXCITING LUMINESCENT
"NEW LIFE" WINDOW STREAMER**



**5 FRAMED PRICE-
POLICY STATEMENT**

15½" x 13" simulated wooden
frame with protective acetate
window permanently displays
your standard labor charges
or shop policy. Interchange-
able inserts provided.

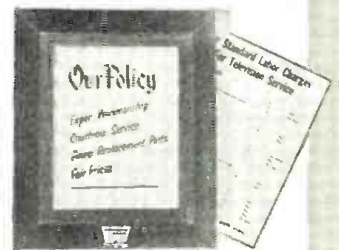

Get this UHF Service Kit from your Westinghouse Tube Distributor **THIS WEEK**. It will mean extra money in your pocket through new customers. Offer is limited, closes Nov. 30th. Remember, there's no charge for this Kit. Just buy tubes from your Westinghouse RELIATRON Tube Distributor. Write Dept. G-210 for complete information.

ET-95029

RELIATRON TUBES

WESTINGHOUSE ELECTRIC CORPORATION, ELECTRONIC TUBE DIVISION, ELMIRA, N. Y.

START ON THE ROAD TO SUCCESS

Study the RCA TV Servicing Course in your spare time

ARE YOU SATISFIED with the position you now hold? Do you feel you're worth more money? Are you pleased with yourself, your work, your associates . . . and your future? What does the next year hold for you . . . and the year after that?

Are you content merely to plod along through the best years of your life . . . or do you want to get into more pleasant work . . . hold a well-paid job . . . perhaps establish your own business?

If you are looking for a REAL opportunity . . . If you want to GROW with a GROWING INDUSTRY . . . If you want to grasp the success that should be yours, *then we say to you, study TV Servicing.*

Everyone knows that Television is the fastest growing industry today. Opportunities are going begging for men who have the training and ability to grasp them. Now *is the time to start on the road to success in TV Servicing.*

Study at Home in your spare time

The RCA Institutes Home Study Course in TV Servicing is easy to learn. You progress rapidly, step by step, as you learn the procedure of servicing and trouble-shooting TV receivers and installing TV antennas. Hundreds of pictures and diagrams help you understand the how-it-works information and the how-to-do-it techniques.

A Service of Radio Corporation of America

The RCA Institutes TV Servicing course was written and planned by instructors with years of specialized experience in training men. You get up-to-the-minute information, too, because you study right at the source of the latest developments in Television. Your lessons are carefully examined and accurately graded by competent teachers who are interested in helping YOU to succeed.

RCA Institutes is licensed by the University of the State of New York . . . an affiliate member of the American Society for Engineering Education . . . approved by leading Radio-Television Service Organizations.

It costs so little to gain so much

RCA Institutes makes it easy for you to take advantage of the big opportunities in TV Servicing. The cost of the TV Servicing Home Study Course has been cut to a minimum. You pay for the course on a pay-as-you-learn unit lesson basis. *No other home study course in TV Servicing offers so much for so little cost to you.*



RCA Institutes conducts a resident school in New York City offering day and evening courses in Radio and TV Servicing, Radio Code and Radio Operating, Radio Broadcasting, Advanced Technology. Write for free catalog on resident courses.

SEND FOR FREE BOOKLET—Mail the coupon—today. Get complete information on the RCA INSTITUTES Home Study Course in Television Servicing. Booklet gives you a general outline of the course by units. See how this practical home study course trains you quickly, easily. Mail coupon in envelope or paste on postal card.



MAIL COUPON NOW!

RCA INSTITUTES, INC., Home Study Dept. RN1053
350 West Fourth Street, New York 14, N. Y.

Without obligation on my part, please send me copy of booklet "RCA INSTITUTES Home Study Course in TELEVISION SERVICING." (No salesman will call.)

Name _____ (please print)

Address _____

City _____ Zone _____ State _____



RCA INSTITUTES, INC.
A SERVICE OF RADIO CORPORATION of AMERICA
350 WEST FOURTH STREET, NEW YORK 14, N. Y.

A

NEW

TWIST

IN

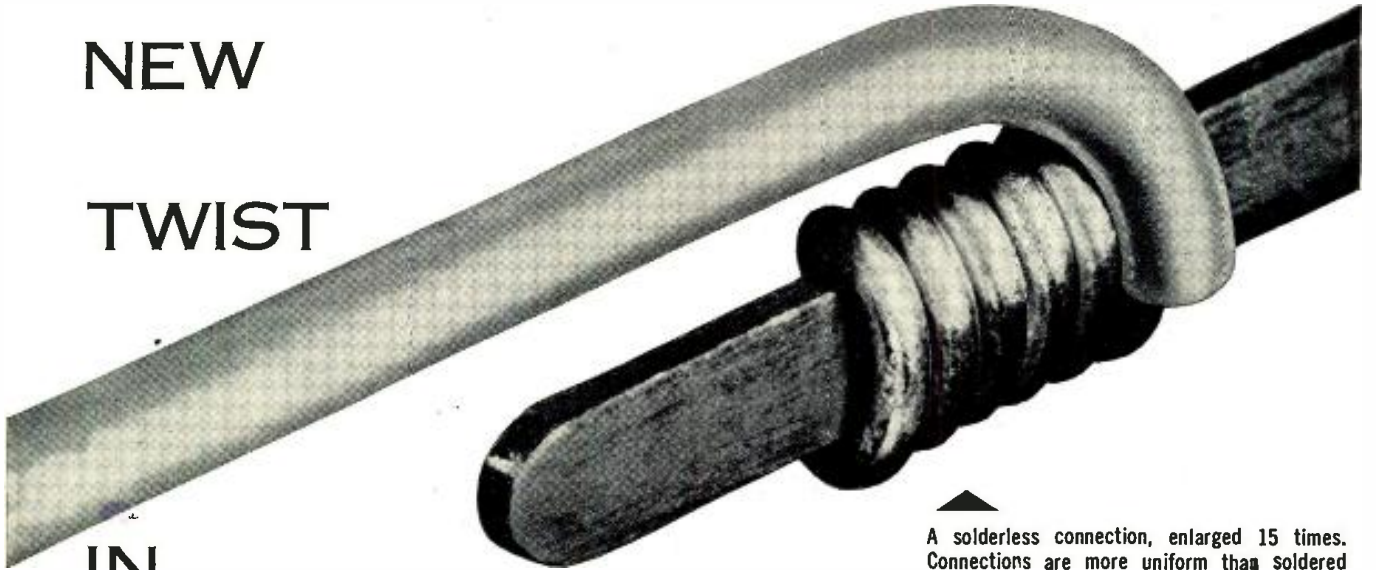

▲
A solderless connection, enlarged 15 times. Connections are more uniform than soldered ones and only half as bulky.

TELEPHONY

For years the accepted way to connect wires to telephone apparatus was with solder. Now, Bell Laboratories engineers have discovered how to make connections faster and better—without solder.

Solder, they reasoned, wouldn't be needed if wire and terminal could be kept tightly pressed together. But, for economy, this had to be done with the wire alone—without complicating screws and springs.

They found the answer in using a properly dimensioned terminal with sharp edges . . . whipping the wire around it under high tension. The terminal bites into the wire, locking it securely into position. Thereafter the squeezed edges maintain a contact pressure of at least 15,000 pounds per square inch—even under vibration that cracks soldered joints.

The new connections can be made in half the time—a big money-saver in the billion connections that Western Electric makes each year for the Bell System. It's another example of the way Bell Telephone Laboratories works continually to keep costs low.

BELL TELEPHONE LABORATORIES

IMPROVING TELEPHONE SERVICE FOR AMERICA PROVIDES CAREERS FOR CREATIVE MEN IN MECHANICAL ENGINEERING

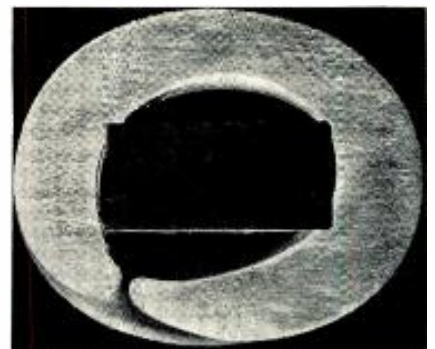

Cross section of solderless connection. Note terminal biting into wire. In a six-turn connection there are at least 20 clean contact areas impervious to moisture and corrosive gases, offering current a low resistance path.



Power tool whips wire on terminal in fraction of a second. There is no heat which could damage miniature components . . . no dropped solder or wire clippings to cause trouble later.

RADIO & TELEVISION NEWS

GET DEPENDABLE PERFORMANCE IN TV TEST EQUIPMENT!



All-Electronic Sweep TROUBLE-FREE LIFE— NO MOVING PARTS!

Sweep Generator ST-4A. The problems of moving parts that wear or break and inaccurate measurements from jarred components so common with mechanical systems have been banished completely in the G-E Variable Permeability Sweep Generator. You get the adjustable wide-band linear sweep needed for TV work *plus* a total absence of moving parts! Good attenuation, extremely low leakage, and continuously variable center frequency. Covers all broadcast TV channels. Take the guesswork out of your test measurements. Use this sweep and your technicians can handle more work...handle it more efficiently...add to your profits and your reputation!

Marker Generator ST-5A. Marks all the critical frequencies on a pass band as well as having continuous coverage. Gives fast manipulation with crystal controlled accuracy for outstanding performance. Features separate crystal on each TV channel with simultaneous picture, audio and trap markers on both channel and intermediate frequencies.

Oscilloscope ST-2A. Reports from thousands indicate this scope does the job they need in TV circuit work. Used in conjunction with the G-E Sweep and Marker you have an unbeatable combination. Special features include wide frequency response plus DC amplifier to adapt the equipment to other applications.

Balanced Output Adaptor ST-8A. Converts single-ended Sweep Generator output to balanced output for 300 ohm television receiver work.



Model ST-4A

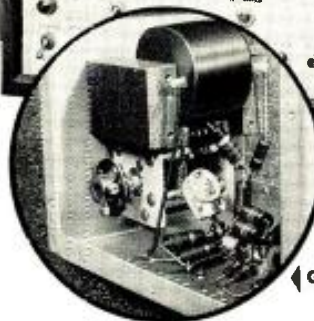

G-E VARIABLE PERMEABILITY
SWEEP ELEMENT



Model ST-5A



Model ST-2A

You can put your confidence in—

GENERAL  ELECTRIC



General Electric Company, Section 9103
Electronics Park, Syracuse, N. Y.
Please send me complete specifications on G-E
TV Test Equipment.

NAME.....
COMPANY.....
ADDRESS.....
CITY.....STATE.....

New! 7 INCH PUSH-PULL OSCILLOSCOPE

Only **EICO** Has All These Features:

- VERTICAL FREQ. RESPONSE: flat ± 2 db 30 cps - 1 mc
- VERTICAL SENS.: .01 volts rms/inch
- MOR. FREQ. RESP.: flat ± 0 db 10 cps - 200 kc, -4 db at 500 kc
- MOR. SENS.: .3 volts rms/inch
- SWEEP RANGE: 15 cps-100 kc
- 3-STEP FREQ.-COMPENSATED ATTENUATOR eliminates freq. distortion, overloading.
- CATHODE FOLLOWER inputs to both amplifiers
- PUSH-PULL outputs in both amplifiers
- RETURN TRACE BLANKING
- INT. VOLTAGE CALIBRATOR



MODEL 470K

- V & H TRACE EXPANSION & CENTERING: 1.5X full screen without distortion.
 - DIRECT CONNECTION to vert. CRT plates. KIT \$79.95. WIRED \$129.50.
 - PHASING CONTROL of internal 60 cps sine wave sweep.
 - AT FRONT PANEL: Intensity mod. input; 60 cps, sawtooth outputs.
- Famous EICO amazing feature-packed economy-priced 425K 5" PUSH-PULL SCOPE KIT \$44.95. WIRED \$19.95.

- AC & DC volts: 0-5, 10, 100, 500, 1000 V (30 KV with HVP-1 probe).
- 5 ohm ranges from .2 ohm to 1000 megs.
- DC input 2.26 megs.
- 4 1/2" meter movement in can't-burn-out circuit.
- 1% mult. resistors.

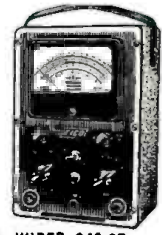

221K VTVM KIT \$25.95. WIRED \$49.95.

- HIGH VOLTAGE PROBE \$6.95
- Extends range of VTVMs & voltmeters to 30 KV.

- PIX TUBE ADAPTER for Tube Testers \$4.50. Checks TV picture tubes, while in set.



- Illum. gear-driven "Speed Rollchart."
- New lever-action switches for individual testing of every element.
- Tests all conventional & TV tubes.

625K TUBE TESTER KIT \$34.95. WIRED \$49.95.

COUNTER CABINET for above: add \$10.00 to Kit or Wired Prices.

- Continuous coverage of all TV & FM freqs. from 500 kc to 228 mc.
- Sweep width variable 0-30 mc.
- Crystal marker oscillator, variable amplitude.



360K SWEEP GEN. KIT \$34.95. WIRED \$49.95.

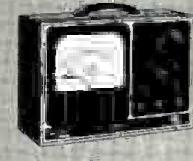

- Large 7 1/2" meter, can't-burn-out circuit.
- AC/DC volts: 0-5, 10, 100, 500, 1000 (30 KV with HV Probe).
- 5 ohms ranges from .2 ohm to 1000 megs.
- DC input 2.26 megs.
- 1% mult. resistors.

214K VTVM KIT \$34.95. WIRED \$54.95.



- Measures & tests all resistors; .5 ohm to 500 megohms.
- Every type condenser, 10 mmf to 5000 mfd.
- 0-500 DC voltage source for capacitor leakage testing.

950A-K R-C BRIDGE & R-C-L COMP. KIT \$19.95. WIRED \$29.95.

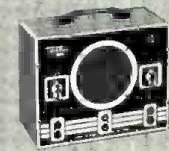

- Audibly signal traces all IF, RF, Video & Audio circuits from ANT to SPKR or CRT in all TV, FM, AM, etc. without switching.
- Germanium crystal diode probe responsive to over 200 mc.
- Integral test speaker.

145K SIG. TRACER KIT \$19.95. WIRED \$28.95.



- Fundamentals 150 kc to 34 mc, harmonics to 102 mc.
- 5-step band switching.
- Colpitts audio oscillator generates 400 cps pure sine wave voltage.
- Permits pure RF, modulated RF, or pure AF.

320K SIG. GEN. KIT \$19.95. WIRED \$29.95. 322K SIG. GEN. KIT \$23.95. WIRED \$34.95.



- Resistance values from 0 to 99,999 ohms with 0.5% precision.
- All resistors have 0.5% accuracy.

1171K RES. DECADE BOX KIT \$19.95. WIRED \$24.95.



- 1000 Ω/V ; 31 ranges
- DC/AC volts: Zero to 1, 5, 10, 50, 100, 500, 5000.
- DC/AC Current: 0-1, 10 ma; 0.1, 1 A.
- Ohms: 0-500, 100 K, 1 meg.

536K MULTIMETER KIT \$12.90. WIRED \$14.90. 526K MULTIMETER KIT \$13.90. WIRED \$16.90.



- Complete sine wave coverage, 20-200,000 cps in 4 direct-reading ranges.
- Complete square wave coverage, 60-50,000 cps.
- Cathode follower output circuit.

377K SINE & SQUARE WAVE AUDIO GEN. KIT \$31.95. WIRED \$49.95.



- 20,000 Ω/V ; 31 ranges
- DC/AC/Output volts 0-2.5, 10, 50, 250, 1000, 5000
- DC Current: 0-100 ua; 10, 100, 500 ma; 10 A.
- Ohms: 0-2K, 200K, 20 meg

565K MULTIMETER KIT \$24.95. WIRED \$29.95. 555K MULTIMETER KIT \$29.95. WIRED \$34.95.



- Covers range of 75 kc to 150 mc.
- 7 calibrated scales: accuracy better than 1%.
- Bandspread vernier tuning.
- 4-step RF shielded output multiplier: constant output Z.

315K DELUXE SIG. GEN. KIT \$39.95. WIRED \$59.95.

NOW! ONLY EICO

the largest manufacturer of its kind in the world - gives you **LIFETIME SERVICE & CALIBRATION GUARANTEE***
...the Industry's greatest protection for your test equipment investment!

* at less than our cost of handling (see the EICO Guarantee Card enclosed with each Kit and Instrument).



- NEW!**
SCOPE VOLTAGE CALIBRATOR KIT 495K KIT \$12.95. WIRED \$17.95.
- Sq. wave output at power-line freq. with full-scale readings of .1, 1, 10 or 100 V. peak-to-peak.
 - Accuracy $\pm 5\%$ of full-scale on each range.

- NEW!**
6V & 12V BATTERY ELIMINATOR KIT 1050K KIT \$29.95. WIRED \$38.95.
- DC output: 0-8 V or 0-16 V.
 - Continuous current ratings: 10 A at 6 V, 6 A at 12 V.
 - Intermittent current rating: 20 A at 6 V, 12 A at 12 V.
 - Separate Voltmeter & Ammeter.



- NEW!**
DECADE CAPACITOR BOX KIT 1180K KIT \$14.95. WIRED \$19.95.
- All capacitors precision silver mica, accuracy $\pm 1\%$.
 - Range from 100 mmf - 0.111 mfd in steps of 100 mmf.
 - Smooth-action positive detent ceramic switches.

Prices 5% higher on West Coast. Specifications and prices subject to change without notice.

EICO

Write NOW for FREE latest Catalog R-10

You build EICO Kits in one evening, but ... they last a lifetime!
And you **SAVE OVER 50%**! See the famous EICO line TODAY, in stock at your local jobber.

ELECTRONIC INSTRUMENT CO., Inc., 84 Withers Street, Brooklyn 11, N. Y.

TELEVISION

SWEEP

GENERATORS

The Triplett Model 3434-A.



Jackson's Model TVG-2 generator.



(Left) Philco's Model 7008 sweep generator for TV servicing.

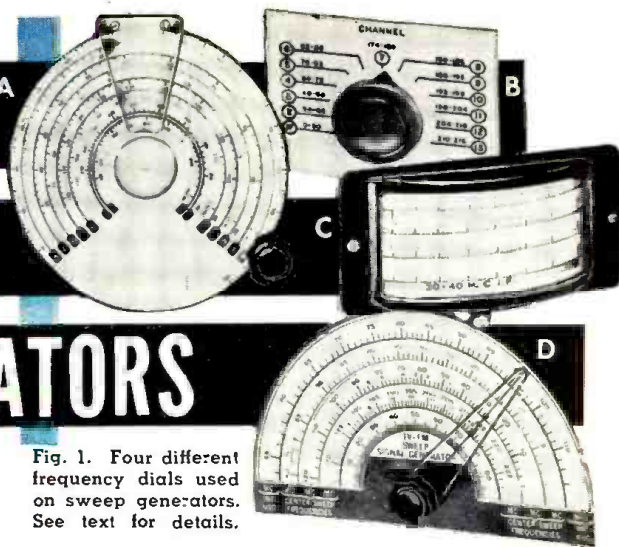

Fig. 1. Four different frequency dials used on sweep generators. See text for details.

By MILTON S. KIVER

Pres., Television Communications Institute

A survey of some commercially-available units, how they are used, and what they are able to do.

UNTIL the advent of television, comparatively few service shops boasted a sweep generator. Yet, today, the same instrument is considered one of the four basic instruments that every service shop must possess.

The reason for this change in status is not very hard to understand. An AM radio can be properly aligned using only an r.f. signal generator and a v.o.m. or v.t.v.m. A television receiver, on the other hand, has a bandpass of 3.2 to 4.0 megacycles in its i.f. stages and 6.0 mc. in its r.f. section. To attempt to align circuits covering this bandwidth with an r.f. generator would not only be time-consuming but, in most cases, almost impossible. Each time a change was made, a new alignment run would be required and, while this may be feasible for the hobbyist, it would be economic suicide for the service technician.

A sweep generator (also called FM generator and TV alignment generator) differs from the more familiar AM generator in that it produces a range of frequencies for each dial setting rather than a single frequency. All the frequencies within this range do not appear at the same time; rather, they appear in sequence. Thus, suppose we have a sweep generator that is set at a frequency of 24 mc. and the sweep width control is adjusted for a 4 mc.

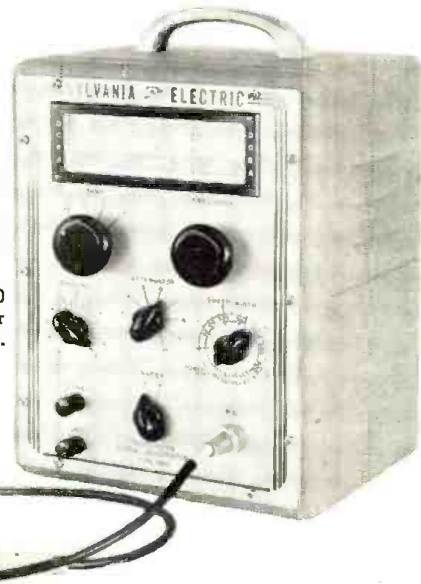

(Right) The Model 500 made by Sylvania for service applications.

sweep. This means that the output of the generator will sweep from 22 mc. to 26 mc. or over the specified range of 4 mc. This sweeping signal would then be applied to the input of, say, a video i.f. system. Here, each portion of the signal would be treated according to the characteristics of that system. It might be, for example, that the 22 mc. portion of the signal would receive more amplification than the 26 mc. portion, in which case the 22 mc. voltage would be stronger at the output of the system than the 26 mc.

signal. This variation in amplitude of the various signals will be detected at the video detector (which is an AM detector) and then presented on the screen of an oscilloscope.

Now, although the sweep generator is an important service tool, it seems to be one of the most difficult to operate. Part of the difficulty stems from the fact that it must be used in conjunction with an oscilloscope which is, in itself, somewhat complex; and

* Oscilloscopes—The Electronic Eye of the Service Technician" by M. S. Kiver, January, 1953.

part of the trouble is undoubtedly due to the bewildering array of response patterns that can be produced if the instrument is not properly set up.

Oscilloscopes and their operation have already been covered in a previous issue of this magazine*. Hence, here, we will turn our attention to the front panels of today's sweep generators in order to note what they contain and what each control does.

Sweep Generator Frequency Dial: The main control is the frequency dial. This tells you to what center

Table 1. Performance data on commercially-available TV sweep generators as received direct from the manufacturers.

Make and Model	Freq. Range	Blanking Control	Internal Marker Gen.	Sweep Phase Reversal Sw.	Price	Remarks
Eico Model 360	500 kc.-228 mc.	No	See Note 1	No	\$34.95 (kit form)	External binding post for connection of an external marker generator.
General Electric Model ST-4A	4-110 mc. 170-220 mc.	Yes	No	Yes	\$395.00	Strong, flat output, low leakage, and good attenuation. Wide range of phase control.
Hickok Model 610A	0-115 mc. 150-230 mc.	No	Variable from 19-48 mc.	No	\$219.00	Special FM scale for sweep width control. Crystal osc. and ext. crystal jack. Absorption-type marker plus regular pip-type marker.
Jackson Model TVG-2	2-108 mc. 174-216 mc.	Yes	Variable from 4-216 mc.	Yes	\$245.00	Separate crystal osc. and ext. crystal socket. Provision for video mod. of marker signal. Beat detector for signal calibration. 400-cycle AM modulation of marker signal. Two or three marker pips can be used simultaneously.
Philco Model 7008	4-120 mc. 145-260 mc.	Yes	Variable from 3.2-250 mc.	No	\$466.00	Contains separate scope with 3" screen. 400-cycle mod. of marker gen. Scope may be used externally. Internal crystal calibrator.
Precision Model E-400	2-480 mc.	Yes	See Note 1	Yes See Note 2	\$133.03	Special FM scale for sweep width control. Internal crystal osc. with provision for 4 ext. crystals. Ext. AM mod. of r.f. signal possible, if desired. Panel terminal for marker signal injection.
RCA Model WR-59C	0-50 mc. continuous. Channels 2-13 preset	Yes	No	No	\$274.50	Strong, flat output, low leakage, wide attenuation range, linear sweep, terminated output cables.
Simpson Model 479	2-120 mc. 140-260 mc.	Yes	Variable from 3.3-250 mc.	No	\$325.00	400-cycle AM modulation of marker gen. Internal crystal osc. for calibration, low signal leakage. Harmonics of AM, FM generators said to be useful in u.h.f. TV range.
Simpson Model 480	Same as Model 479 with addition of built-in 3" scope.				\$475.00	
Sylvania Model 500	2-230 mc.	No	No	No	\$139.50	Narrow- and wide-band sweep. Good attenuator control. Good output.
Triplet Model 3434-A	0-240 mc.	No	Variable from 3.5-4.9 mc. 19.5-48.6 mc. Harmonics to 241 mc.	No	\$199.50	Internal crystal osc. with ext. crystal socket. Bar generator for vert. linearity adjustment. Provides absorption and pip-type markers. 600-cycle modulation of marker generator.

Note 1: These generators have an internal crystal oscillator. By inserting the proper crystals via a front panel socket, various fixed marker frequencies can be obtained.

Note 2: The sweep width control has a center zero position that permits the operator to reverse the horizontal direction of the response curve.

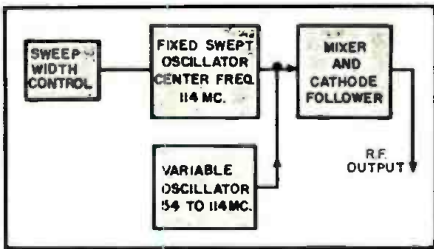

Fig. 2. Simplified block diagram of sweep generator shown in Fig. 1D. This arrangement provides output frequencies from 500 kc. to 228 mc. without using bandswitch.

frequency the instrument is set. Thus, if the dial is positioned at 26 mc., then the output sweep frequencies will vary an equal amount above and below this value. Just how much variation will occur depends upon the setting of another control, known as the sweep width control.

Several representative front dials are shown in Fig. 1. The dial shown in Fig. 1D has all of its ranges exposed and the desired frequency is obtained by setting the hairline over the proper figure. The frequency range available from this sweep generator extends roughly from 500 kc. to 228 mc. The bottom scale is a reference scale marked from 0 to 100 linearly. The next three scales, marked "center sweep frequencies," are calibrated from 0-60, 0-120, and 168-228 mc. The uppermost scale is an internal oscillator having a range of 54 to 114 mc.

Now, the rather surprising thing about this particular instrument is that all output ranges are available without bandswitching. This is achieved by the arrangement shown in Fig. 2. An oscillator with a fixed frequency of 114 mc. is frequency modulated to a maximum sweep width of 30 mc., sweeping this fixed oscillator back and forth from 99 to 129 mc. The amount of frequency modulation is controlled by the sweep width control setting.

The output of the fixed sweep oscillator is mixed with that of a variable oscillator. This second oscillator can be tuned to any frequency between 54 and 114 mc. by rotating the main tuning dial pointer. The resulting beats between these two oscillators (one fixed and frequency modulated and the other variable) provide the

Simpson's Model 479 sweep generator.



frequency ranges of the instrument.

For example, the "difference" frequencies between the 114 mc. fixed oscillator and the 54-114 mc. variable oscillator provide the frequency range of 60 to 0 mc. The "sum" frequencies of the two oscillators provide the range of 168 to 228 mc. The second harmonic of the "difference" frequencies gives the range 120 to 0 mc.

In the dial shown in Fig. 1A the hairline indicator is kept stationary and the dial is rotated. The various frequency ranges are selected here by means of a band selector switch and, in general, this is typical of most sweep generators using continuous tuning.

The illustration of a third dial, Fig. 1B, represents still another approach to this problem. Here, the main tuning dial is a thirteen-position selector switch. The first position is marked "0-50" (mc.) and in this position frequencies up to 50 mc. may be obtained from the instrument. Just precisely which frequencies is determined by another control which has markings on it of 5, 15, 25, 35, and 45. This second control thus enables the user to set the frequency at any point within the 0 to 50 mc. range. The five numbers are positioned at appropriate points around the rotational range of the second control in order to indicate approximately where the various frequencies may be obtained. In actual practice the service technician would rotate the second control until a response pattern appeared on the scope screen.

As the reader undoubtedly knows,

Hickok's Model 610A generator unit.



Precision Apparatus Co.'s Model E-400 television service sweep generator.

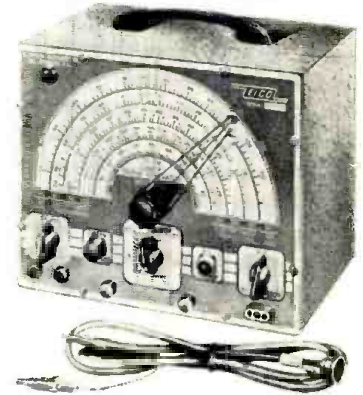

Electronic Instrument Company's (Eico) Model 360 unit available in kit form.

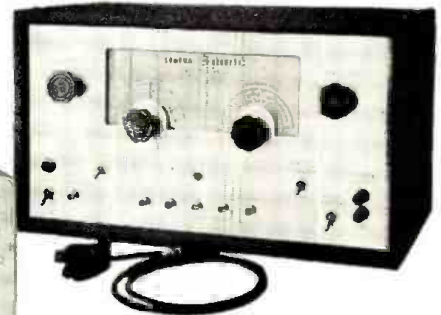

The Model ST-4A by General Electric.

Radio Corporation of America's WE-59C.

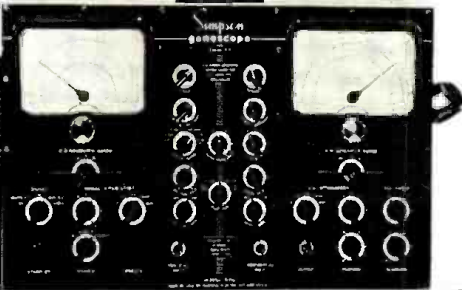
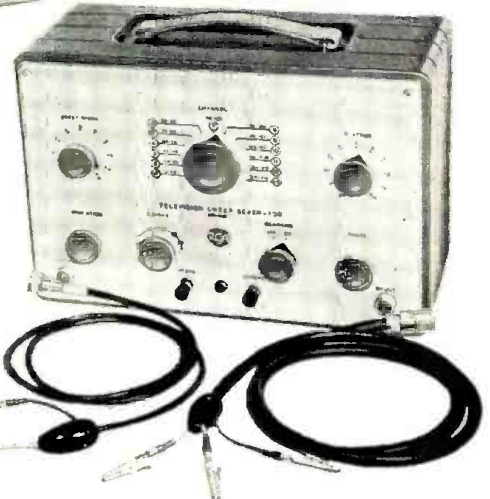

The Model 480 "Genescope" by Simpson.

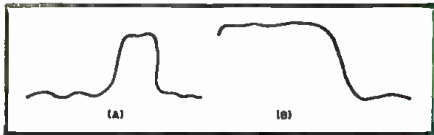

Fig. 3. When the sweep is too wide, the pattern will tend to crowd together (A). When too little sweep is used, the full pattern may not be obtained as shown in curve (B).

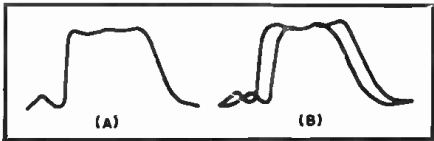

Fig. 4. (A) Desired single pattern response curve. (B) Double trace pattern obtained before phase control adjustment.

the 0-50 mc. range is employed for aligning the i.f. systems of television receivers. Then, for the r.f. frequencies of the twelve v.h.f. channels, the selector switch is set to the appropriate position. This particular arrangement possesses the very desirable advantage of simplicity. It can suffer if the circuit design is not sufficiently stable to maintain the various frequencies within the range specified at each position. Should this happen (and it may occasionally), then a series of internal adjustments are provided which the technician himself can perform.

The final dial illustration, Fig. 1C, employs a drum arrangement in which the frequency ranges are marked off around the outer surface of the drum. To choose the desired frequency, the drum is rotated until the appropriate figure is positioned directly underneath a fixed hairline indicator.

Sweep width control: Associated with the main tuning dial, and used in conjunction with it, is the sweep width control. The setting of this control determines the extent of the signal sweep about the frequency chosen by the main dial. On some instruments, the control has a scale marked off from 0 to 10, or 15, or 30 depending upon how great a sweep can be obtained with the instrument. On other generators, the scale is omitted. Actually, the markings on a scale, when used, are approximate anyway and most technicians seldom pay much at-

tention to them. They simply adjust the control until the full pattern is observed on the screen. Too much sweep will tend to narrow or crowd the pattern together (Fig. 3A); too little sweep will not bring the full pattern to the scope screen (Fig. 3B). The former, of course, is more desirable than the latter, but with a little practice it is not difficult to obtain the proper amount of sweep.

Incidentally, sweep values, when given, refer to the total width and not that which is swept out on either side of the center frequency. For example, setting the sweep width control to 10 mc. and using a center dial frequency of 24 mc. means that the output frequency will vary from 19 mc. ($24 - 5$) to 29 mc. ($24 + 5$).

Many television sweep generators are also capable of covering the FM r.f. range (88 to 108 mc.) and the FM i.f. range (10.7 mc.). Where this is true, a second scale is frequently inserted around the sweep width control knob, extending from 0 to 1 or 1.5 mc. A 1-megacycle sweep is adequate for the alignment of FM circuits and as a convenience to the user, this special range permits him to set the sweep control more easily. A special switch is usually available and when the generator is to be used on FM, the switch is flipped over and then the sweep width control deals with its FM scale (0 - 1 or 1.5 mc.) rather than the TV scale (0 - 10, 15, or 30 mc.).

It is, of course, perfectly possible to employ the same sweep width scale for both FM and TV receivers. The only precaution necessary is to see that the control is set to approximately 1 megacycle for FM. Providing a separate control variation for FM is a convenience; it is not, however, absolutely necessary.

It is interesting to note that when the sweep width control is set at zero, the signal output of the generator is simply a single r.f. frequency determined by the setting of the main dial. Thus, although the technician seldom uses his sweep generator as an r.f. generator, it does possess this facility. One manufacturer even goes so far as to provide input terminals to which an audio signal can be applied in order that the generator output may be amplitude modulated.

Possibly one reason why service technicians seldom use their sweep generators for single signal applications is because less emphasis is placed on dial marking accuracy in these units. Sweep generators are designed primarily to produce a response pattern on a scope screen and an accurate r.f. generator is then brought in for the purpose of supplying suitable identifying markers. As long as the sweep generator produces the desired response trace, its obligation is fulfilled and no one particularly cares whether or not the dial markings are accurate. However, when employed as an r.f. generator, frequency accuracy does become important and now close attention is paid to the dial setting. There is, of course, no reason why the dial markings of a sweep generator should not be correct and many are. But as a whole, they are less reliable than comparable AM generators.

The strength or amplitude of the output signal of the sweep generator is controlled by an r.f. output (or r.f. attenuator) potentiometer. Sometimes this is the only control; at other times it is accompanied by a coarse selector switch attenuator possessing steps of X1, X10, X100, X1000, and X10,000. Whatever the arrangement, the technician will find that the controls are usually kept much closer to their maximum positions than they are to their minimum positions.

Phase control: The phase control, which is found on the front panel of every sweep signal generator, has a function which is probably least understood and has, consequently, caused more trouble than any other control on the instrument.

First off, let it be stated that until a response pattern of the circuit under test is obtained on the scope screen, no attention is paid to the phase control. Once the pattern is developed, however, the phase control is rotated until a single trace, or as close as the technician can come to a single trace, is obtained. Thus, suppose the circuit receiving the sweep signal is the video i.f. system of a television receiver. Then its normal response pattern may be that shown in Fig. 4A. However, when the sweep generator and oscilloscope are first hooked up to the TV chassis, chances are the initial response pattern developed on the screen would be as shown in Fig. 4B. By rotating the phase control, the two patterns can be made to blend, giving the trace shown in Fig. 4A.

The phase control, then, is a corrective control, designed to bring the beam deflection of the scope in step with the frequency sweeping voltage obtained from the generator.

This leads us directly to another terminal on the front panel of the sweep generator. This terminal, known by such names as "Horiz. Sweep", "60-Cycles", "Phase 60 ~", "Horizontal CRO Input", "Scope", and "Sync", provides a sinusoidal 60-cycle voltage which is connected to the hor-

(Continued on page 200)

Fig. 5. Service bench setup showing how sweep generator is connected to receiver.

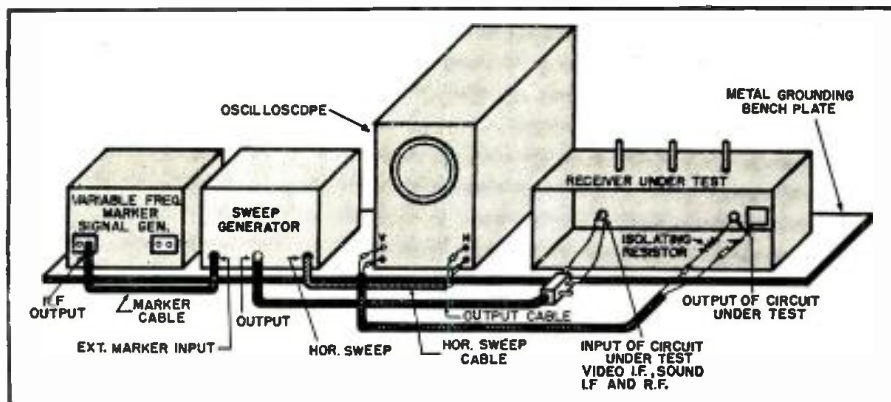

THE NOVICE STATION RECEIVER

By

LARRY TROMBLY, WØDCB

and

ROBERT A. HATHAWAY, WØGTK
Walter Ashe Radio Company

THE first article of this series described a transmitter and power supply. Including the receiver to be described here, these three units were built for less than \$50.00. This receiver, although quite simple and using circuits almost forgotten in today's amateur receivers, exceeds expectations and gives an excellent account of itself in the crowded Novice bands.

The receiver uses a 6SN7 tube, one section of which acts as a regenerative detector, and the second section as a transformer-coupled stage of audio amplification. One of the reasons for the good performance of this receiver is the use of regulated plate voltage, which is furnished by the VR tube in the power supply described in Part 1. Crystal-controlled signals sound the way they should, rather than the way they did in most regenerative receivers of twenty years ago when it was hard to tell whether you were listening to crystal control or to a self-excited oscillator.

All the parts of this unit are mounted on a 5"x7"x3" chassis. Their location can be seen from a study of the photographs and there is nothing critical about the placement of these parts. Since it was desired to keep the tuning condensers inside the chassis, it was not feasible to use a vernier dial. However, the use of a tapped coil and a low-capacity variable condenser for bandspread tuning

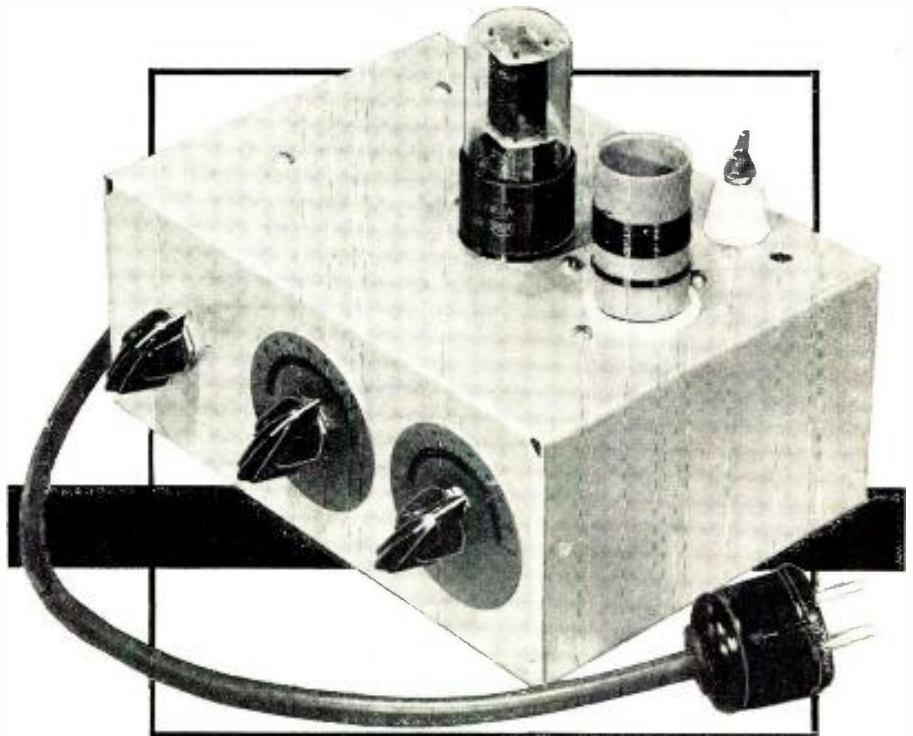

The Novice station receiver. Controls, left to right: regeneration, main tuning, bandspread. Hole near antenna insulator is for adjusting antenna trimmer. Cable plug fits socket on power supply described last month. 80-meter coil is in place.

Part 2: The receiver. The set uses one tube in a "two-tube" circuit. Performance is very high and construction simple. The transmitter and power supply were described last month.

permitted us to give almost 100 dial divisions of bandspread to the 50 kc. 80-meter Novice assignment and also to the 25 kc. 40-meter Novice band. This is more rotation of the tuning control per kilocycle covered than is

offered by many vernier dial arrangements.

To some builders a tapped coil may present something of a problem but there is a way of doing it which
(Continued on page 122)

Schematic of the Novice station receiver. Numbers at coil connections refer to pins on coil form, looking at bottom of form. C₂ is the bandspread condenser, C₁ is for main tuning. C₃ compensates for "dead spots" due to antenna resonances.

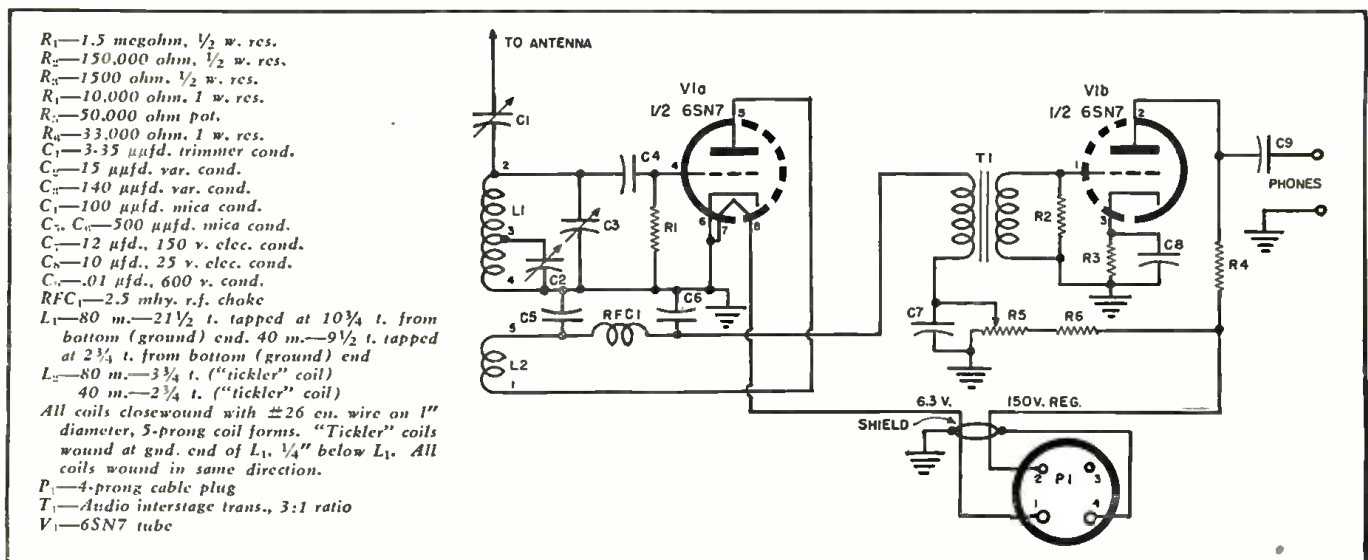

THE KLIPSCH REBEL IV A BACK-LOADING FOLDED CORNER HORN

By **FREDERICK I. KANTOR**
G & H Wood Products Co. (Cabinart)

THE speaker system to be described is a new version of the corner horn back-loading type. This general type has been developed independently by several workers, but this specific design stems from the *Klipsch* series of "Rebels," of which the IV is small enough for substantially any environment—even a monitoring studio—but with big enough performance for highly exacting requirements.

With the majority of loudspeakers suffering a loss of efficiency in the low-frequency region (from 100 cps down) a means of increasing radiation in this portion of the spectrum, without increasing distortion, is of significant interest.

At these low frequencies, the loudspeaker's cone action is essentially piston-like. That is, its function is to move a considerable amount of air. To do so, the cone is required to travel farther to generate the same acoustical power than it would be at a higher frequency. At its extreme limit of travel, nonlinearity must occur. At high levels the distortion caused at the bass end will simulate a square wave and give serious intermodulation effects to the middle and highs. Several means have been devised to eliminate this nonlinear effect and increase efficiency in the low-frequency ranges. Comparative evaluations of some of these types and an examination of the workings of the back-loaded folded horn will indicate why it is being demanded more and more for critical high-fidelity reproduction.

The present development entails a cavity and slot port, to form a resonant chamber, and a horn coupled to the slot. The slot is loaded by the horn; the proportioning of slot, cavity, and horn provide a base response below about 100 cps which corresponds in efficiency to the front-of-cone direct radiator response above 100 cycles. More complicated horn structures (except high-efficiency, full-range multiple horn systems) have been tried and discarded in favor of this simple and effective device. The function of this

Front view of Klipsch-licensed enclosure being manufactured by the G & H firm.

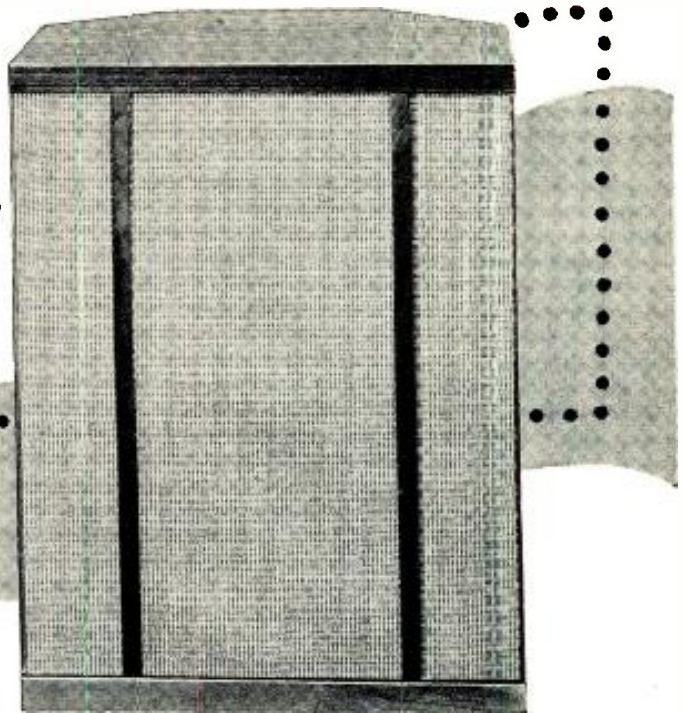

Details of an enclosure whose compact design makes it ideal for small apartments while providing big-cabinet response.

form of back-loading corner horn may be considered qualitatively in two different ways.

First, think of a bass reflex with a horn acting as a resistive load on the port. The resonances of the system are damped by useful radiation resistance, and the horn does not cost anything as it is formed by the already existing walls of the room at its corner.

Second, think of a horn which is essentially a high efficiency device—if a full horn were applied below 100 cycles, a boomy response would exist. But the cavity-port combination acts as an acoustic low-pass filter, the design of which can be such that the bass range response will correspond to the mid-range response.

In actual usage, the "Rebel IV's" performance is influenced by few restrictions. The cabinet must be placed flush with the walls of the corner, to maintain the horn flare. This is accomplished easily since the cabinet has no interfering sides and will clear any baseboard or molding. It is, of course, more desirable to mount the woofer in the lower position so that spatial distribution and high frequency absorption will not be influenced by walls, rugs, furniture, etc. The enclosure offers a means of mounting many and varied combinations, *i.e.*, one woofer or coaxial speaker, one woofer and tweeter, a three-way system, etc. This is accomplished by cutting two holes, and covering one with a backing board which is bolted over the additional hole. If you have a 12" speaker you want to mount in

addition to the woofer, just remove this board and install a speaker in its place. If it's a smaller speaker, tweeter, or what have you, remove this board, and cut out the opening to suit. There is space in the bottom for any crossover system and leads are brought to a barrier-type terminal board on the outside. The cabinet is constructed rigidly with $\frac{3}{4}$ " plywood with a unique system of inherent bracing to insure no cabinet resonances. This also provides quick installation of components and ready accessibility.

Tested in the home and sound studios throughout the country, the *Klipsch* "Rebel IV" has been well received by a gratifying number of discriminating audiophiles and music lovers. Its low frequency performance has enhanced systems with bass as it should be, clean, no boomy responses, no noticeable resonances. Intermodulation effects are reduced, and its small size and attractive appearance will fit and enhance any living room environment.

The complete mechanical details on this particular unit are included in the line drawings on the opposite page. All of the dimensions given are exact and should be adhered to for 12-inch speakers as well as the various combinations of speakers mentioned earlier in the article.

The commercial version of this cabinet is also available in a size to house a 15-inch loudspeaker as well as in kit form for both the 12-inch and 15-inch speakers.

—50—

RADIO & TELEVISION NEWS

Complete construction details on the G & H Wood Products Co.'s "Rebel IV," a Klipsch-licensed enclosure.

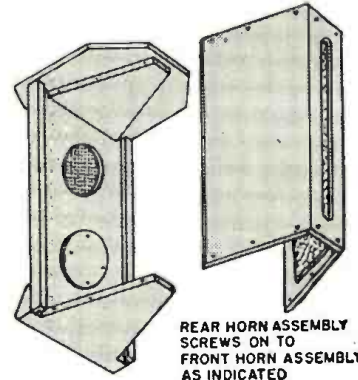
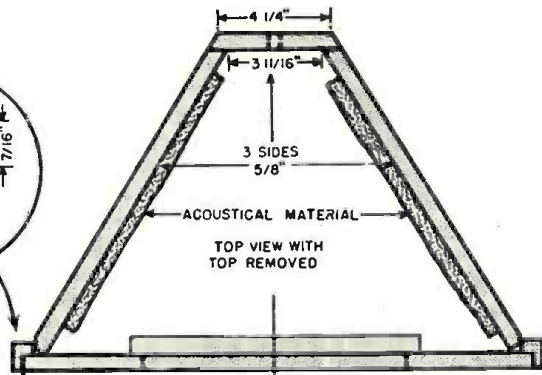
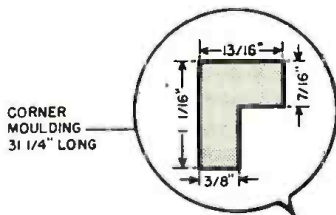

GRILLE CLOTH WRAPPED AROUND
SIDE EDGES OF SPEAKER MOUNTING
BOARD AND TACKED

MOULDING, TOP AND BOTTOM
(SIZE NOT IMPORTANT)

SLOT IN BACK PIECE 29" X 1/2"

SPEAKER MOUNTING BOARD
30 1/2" X 20" X 5/8"

WOODEN PLATE MAY BE REMOVED
FOR TWEETER INSTALLATION

STRIPS FOR DECORATION ONLY
(SIZE NOT IMPORTANT)

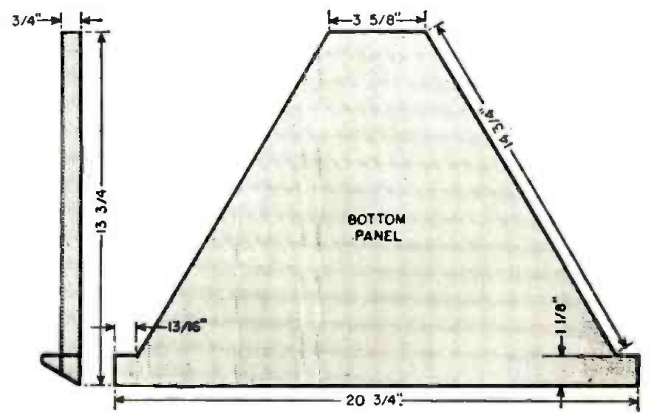
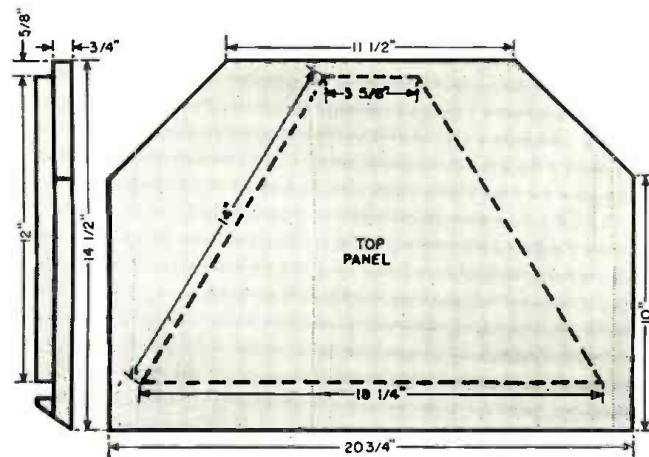
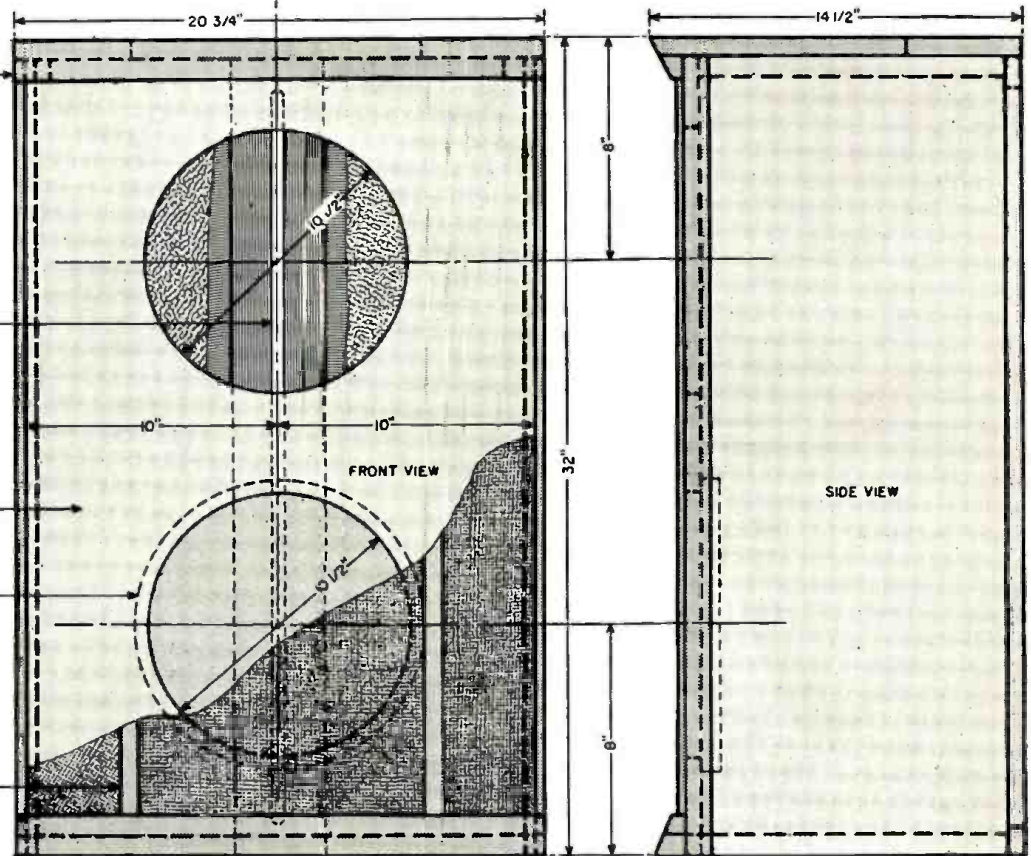

TV TUBE SUBSTITUTIONS

By
WALTER H. BUCHSBAUM
Television Consultant
RADIO & TELEVISION NEWS

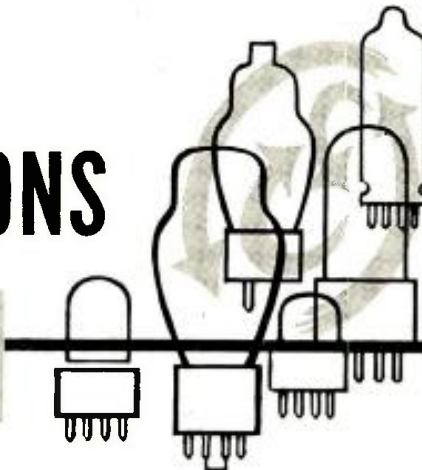

Save this handy guide which lists the tubes most often found in TV receivers and their substitutes.

WHEN a defective tube cannot be quickly replaced from the service technician's stock, the local distributor happens to be out of this number, and the customer is anxious to get his set back, a substitution is often possible. Sometimes another tube type can be plugged into the same socket, adjustment of the circuit might be required, or it may even be necessary to rewire the socket or use an adapter. Whatever means are taken to substitute a different tube

type, the customer should understand that the best performance will be obtained when the correct tube is used and that in most instances a substitute is just what the name implies—something to take the place of the correct tube.

Occasionally we hear of service technicians who make substitutions, even rewiring parts of the receiver, without informing the set owner. Usually the customer will find this out when he takes his set to another

technician and, whether the rewired portion is really an improvement or not, the customer will always feel distrustful and unhappy. Whenever any circuit changes or tube substitutions are made, be sure to explain them to the set owner.

Tube replacements in the r.f., i.f., and horizontal sync sections usually require realignment or some readjustment of secondary controls. When a slightly different tube type is used, this readjustment will also be necessary. In many instances the use of a different tube type is possible but would require a change in the circuit. The table of tube substitutions given below does not include any substitution where a different circuit component is also needed or where extensive rewiring is necessary. All the substitutions shown can be made either by direct plug-in, rewiring of socket pins only, or else by using a different socket.

Many of the tubes used in TV receivers are electrically identical but have different socket and bulb sizes. For example, the 12AU7 is a 9-pin miniature tube and is electrically interchangeable with the 6SN7, an octal base type. All that is needed to substitute one for the other is an adapter, or else removing the old socket and mounting a new one. This is often difficult because sockets are riveted to the chassis and in the process of

(Continued on page 183)

Table of TV tube substitutions. Some tubes have no practical substitute and are so listed.

TUBE	DIRECT SUBSTITUTE	CHANGE CONNECTION	CHANGE SOCKET	TUBE	DIRECT SUBSTITUTE	CHANGE CONNECTION	CHANGE SOCKET
1B3			1X2, 7-pin	6N7			6AH4, octal
1V2				6S4			6T8, 9-pin, 7X7 loctal
1X2			1B3, octal	6S8			6BE6 7-pin
5U4	5T4	5X4 (plates 3, 5; fil. 7, 8)	5Z3, 4-prong	6SA7	6SB7Y		6BE6 7-pin
5V4	5U4, 5T4	5X4 (plates 3, 5; fil. 7, 8)	5Z3, 4-prong	6SA7	6SA7		6AU6 7-pin
5W4	5V4, 5Y3	5Y4 (plates 3, 5; fil. 7, 8)		6SH7		6SJ7 (short 3, 5)	6AU6 7-pin
5Y3	5V4	5Y4 (plates 3, 5; fil. 7, 8)		6SJ7	6SH7		6AU6, 6CB6, 7-pin
6AB4				6SK7			6BD6 7-pin, 7A7 loctal
6AC7			6AH6, 7-pin	6SL7			12AX7* 9-pin
6AF4				6SN7			12AU7* 9-pin, 7N7 loctal
6AG5	6AK5, 6BC5	6CB6 (short 2 and 7)		6T4			
6AG7			6CL6, 9-pin	6T8			6S8 octal; 7X7 loctal
6AH4			6S4, 9-pin	6U4	6AX4		6V3 9-pin (top cap)
6AH6			6AC7, octal	6U8			
6AJ4				6V3			
6AK5	6BC5	6CB6 (short 2 and 7)	6H6, octal	6V6	6Y6, 6W6		7C5 loctal; 6AO5 7-pin
6AL5				6W4	6AX4, 6U4		6V3 9-pin (top cap)
6AM4			6V6, octal	6W6	6V6		
6AN4			6K6, octal	6X4			7Y4 loctal
6AQ3		6AR5 (short 1 and 7)		6X8			
6AQ6	6AV6			6Y6	6V6, 6L6		
6AR5	6AO5		7C6, 7B6, loctal	7A5			
6AS7				7A6			6H6 octal
6AT6	6AV6, 6AO6			7A7			6SK7 octal
6AU5	6AV5			7AD7			6AG7 octal; 6CL6 9-pin
6AU6		6CB6 (interchange 2, 7)		7B5			6K6 octal, 6AR5, 7-pin
6AV5	6AU5			7B6	7C6		6AT6, 6AV6, 7-pin
6AV6	6AT6, 6AO6			7C5			6V6 octal
6AX4	6U4		6V3, 9-pin (top cap)	7C6		7B6 (short 4, 7)	6AT6, 6AV6, 7-pin
6BA6	6BC5	6CB6 (interchange 2, 7)		7F8			12AT7* 9-pin
6BC5	6AG5, 6AK5		6SA7 octal; 7O7 loctal	7M7			6SN7 octal, 12AU7* 9-pin
6BE6			6SK7 octal	7O7			6BE6, 7-pin, 6SA7 octal
6BD6				7X7			6T8 9-pin, 6S8 octal
6BF5				7Y4			6X4 7-pin
6BG6	6CD6			12AT7	12AZ7		7F8* loctal
6BK7	6BQ7, 6BZ7			12AU7			6SN7* octal, 7N7* loctal
6BL7				12AV7	12AX7		6SL7* octal
6BN6				12AX7	12AV7		6SL7* octal
6BO6				12AY7			6SN7* octal, 7N7* loctal
6BQ7	6BK7, 6BZ7			12AZ7	12AT7		
6BY5				12BH7			6BL7*, 6SN7* octal
6BZ7	6BK7, 6BQ7			12BY7			
6C4			6J5 octal				
6CB6		6AU6 (interchange 2, 7)		12BZ7			
6CD6	6BG6			25L6			
6CL6		12BY7* (plate 7, screen 8, sup. 3, 9)	6AG7 octal	25Z5	25Z6		
			6AL5, 7-pin	25Z6	25Z5		
6HG			6C4, 7-pin	35L6			
6J5				35W4			35Y4 loctal
6J6				35Z3			35Z4, 35Z5 octal
6K6			7B5, loctal, 6AR5, 7-pin	35Z4	35Z5		35Z3 loctal
6L6				35Z5	35Z4		35Z3 loctal

*Note: Check whether 6.3 or 12.6 volt heater voltage is used.

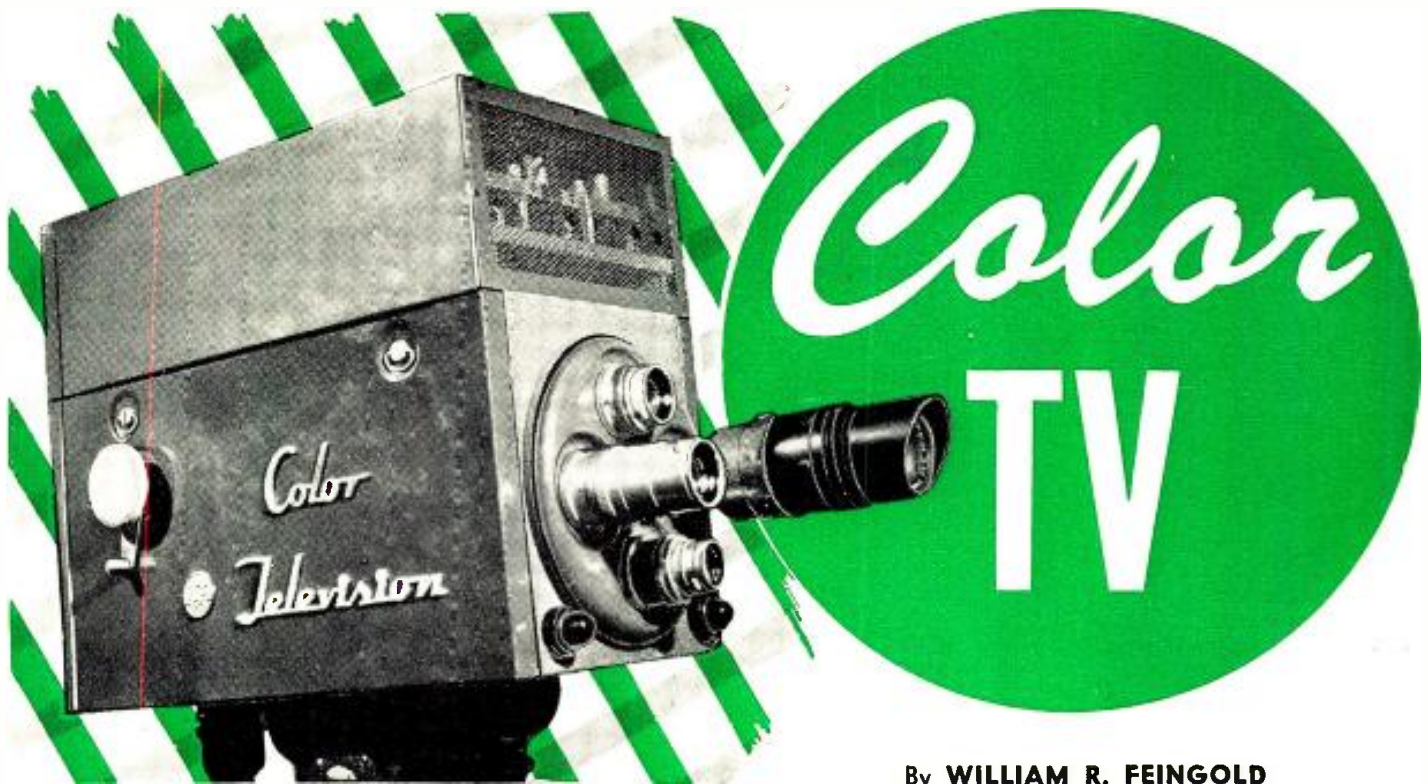

Fig. 1. An experimental single-tube color TV camera, not much larger than its black-and-white counterpart.

By **WILLIAM R. FEINGOLD**
Emerson Radio & Phonograph Corporation

ON October 11, 1950, the Federal Communications Commission approved the field sequential system (popularly known as the CBS system) as the official color TV standard for the United States. This system had been under development for approximately 10 years, and gave a fairly presentable performance in comparison with competitive methods which were more or less newly conceived. It was an unfortunate choice, however, because the field sequential color system required a vertical field rate of 144 per second (as opposed to the black and white of 60) and a line rate of 29,160 cycles-per-second (as against the black and white of 15,750) to eliminate flicker, thereby making this system incompatible with black and white transmission standards. Finally, when the NPA terminated all color TV activity on November 20, 1951 in the interest of national defense, the CBS system, as used in aerial TV transmissions, died a natural death. For strictly industrial television use, the CBS system is still being employed in closed circuit applications.

In the meantime, the Radio-Electronics-Television Manufacturers Association set up a committee to formulate an improved compatible color signal. The more than 200 engineers and physicists of this National Television System Committee (NTSC) from 91 leading companies in the television industry formulated and tested a color TV signal which could fit into the present 6 mc. channel, and was compatible with the black and white transmission standards.

The NTSC does not own any equipment, neither transmitters nor receivers,

Part 1: Clarifying the color TV situation with some predictions on what to expect in color receivers.

and is not interested in the detailed circuitry of either type of equipment. Its interest in equipment stops at the point where it has been established that the signal specifications *can* be met with readily available gear. The end goal is a set of signal specifications, proven and practical, that can be presented to the FCC for approval. That this goal has been met has been amply attested to by the fact that numerous organized field tests have been arranged by the NTSC and attended by some 15 different manufacturers with their color receivers. These receivers represent the varied outputs of the different engineers all working from the same signal specifications and all receivers are producing excellent pictures.

The NTSC Signal

Although a detailed treatment of this new color signal will be made in the second article of this series, a simplified treatment is in order.

From a welter of data pertaining to the physiological aspects of color vision and a mass of theoretical data regarding the character of the television signal itself, the following color signal has been formulated. To the present monochrome standards as they now exist an additional color signal specification has been added. The resultant effect is not unlike the conventional lithographic technique of printing in three colors plus black to add the de-

tail. In our case, the present monochrome information carries the shades of black and white including all the fine detail, and the color information is added on a color subcarrier to fill in the large areas of color (Fig. 2).

Tests have shown that the eye cannot perceive fine color detail, hence, there is no need to burden the color circuits with wide-band information. The shaded area on Fig. 2 indicates that this color information in the lower sideband is restricted to a bandwidth of 1.3 mc. Note, too, that the upper sideband cannot extend this far since the limits of the channel restrict this area to approximately 0.4 mc. Although this unsymmetrical distribution of sideband energy is not a desirable situation, it has been possible to design the details of the system in such a manner that it causes no extra trouble.

Because the lower sideband of the color information falls well within the monochrome video channel it was necessary, in the interest of compatibility, that this color data be made invisible on a standard black and white receiver. This was done (within the limitations of the linearity of the system) by setting the color subcarrier at a frequency which is an odd multiple of half the line repetition rate. The actual frequency selected by the NTSC is 3.58 mc. This unique feature of adding narrow-band color information on a special color subcarrier to a

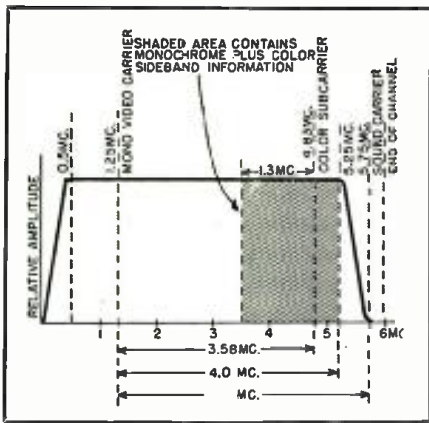

Fig. 2. Color signal characteristics.

standard monochrome transmission is the essential characteristic of the signal. When a color signal is transmitted, the conventional monochrome receiver will present the picture in shades of black, gray, and white with a negligible trace of the picture's color signal origin. An interesting point is that these black and white pictures usually have better resolution than that obtained from conventional monochrome reception. The reason for this improvement is simply that the transmitters have to be more carefully adjusted to handle the color data on the 3.58 mc. subcarrier and, as a result, the monochrome information is present in more detail.

The conversion of a good monochrome transmitter from black and

white to color is simplicity itself. (See Fig. 3.) If a color video signal is already available, either from a color camera or a network link, no changes are required. To get this video information from a network a minor investment in new terminal equipment will be required. Networks will probably be the main source of nationwide color transmissions until a sufficient number of color studios are constructed.

The color studio gear and the camera equipment are somewhat more complicated than their monochrome counterparts. Present color cameras consist of three pickup tubes mounted side by side with each one masked with a proper primary filter. By the use of properly positioned dichroic mirrors (mirrors which reflect light of one color and pass all other colors) the single viewed image of one lens is made to fall on each of the three photosensitive camera surfaces. Since these images must pass through green, red, and blue filters respectively before they strike these surfaces, the three resultant video outputs represent the green, red, and blue signals corresponding to these colors in the original scene.

Progress has already been made toward the development of a single camera pickup tube that will put out three primary signals (Fig. 1). There is no doubt that technical advances in studio equipment will be made towards simplification. In this connection it is interesting to note that the

compatible nature of the signal allows for testing transmitting and receiving equipment by radiating color signals (with FCC approval) without public announcements of the fact. One of the first such "sneak" transmissions took place late in June in New York City on WNBC during a "Howdy Doody" program.

The Color Receiver

The color receiver is basically a monochrome receiver with additional circuitry. This additional circuitry falls into two groups. The first group is that part required by the color information alone. In Fig. 4 this area is covered by the chroma, decoding, color sync, and matrix networks. This part produces as its end product the green, red, and blue video signals. The second group is that area of circuitry dictated by the requirements of the picture tube (or display device). Since Fig. 4 indicates an RCA tri-color tube, a dynamic convergence network is used, as required by this tube.

Although the interior of the color receiver is somewhat more complex than its monochrome brother, the user's controls are only complicated by the addition of one more knob. This control is marked "Chroma." It allows a customer who takes issue with the mathematically correct ratio of color to monochrome to vary this ratio. The picture color can thus be varied from a light pastel shading to an intense lush overly-colored display.

With regard to the fine tuning control, the public will have to be re-educated. It will be recalled that split-sound receivers of five years ago required a careful setting of the fine tuning control or there was no sound. This careful setting of the tuner oscillator made for optimum picture quality. However, the problem of oscillator drift gave way to the use of intercarrier systems with the net result that sound was always present and tuning the oscillator to obtain the best picture became a forgotten operation.

In order that the color receiver retain the benefits of intercarrier operation and yet force the customer to adjust the tuner oscillator to its proper place to insure good color quality, the designer is forced to use some sort of tuning indicator. In this case what could be better than the face of the picture tube? The sound traps in the receiver are made sharp and deep so that when the oscillator is properly tuned the picture is clean. When the oscillator is mistuned the picture will show annoying sound patterns.

The most publicized aspect of the color TV receiver has been the picture tube. All color tubes presently used or being developed have three color phosphors deposited on the front face of the picture tube in either a dot pattern array or a striped pattern, horizontal or vertical. The RCA tri-color tube¹, utilizing three gun structures is typical of the former type, while the Lawrence tube² as made by

Color TV signal generating equipment used by Emerson for the design and testing of color TV receivers. Included is a monoscope and flying-spot scanner.

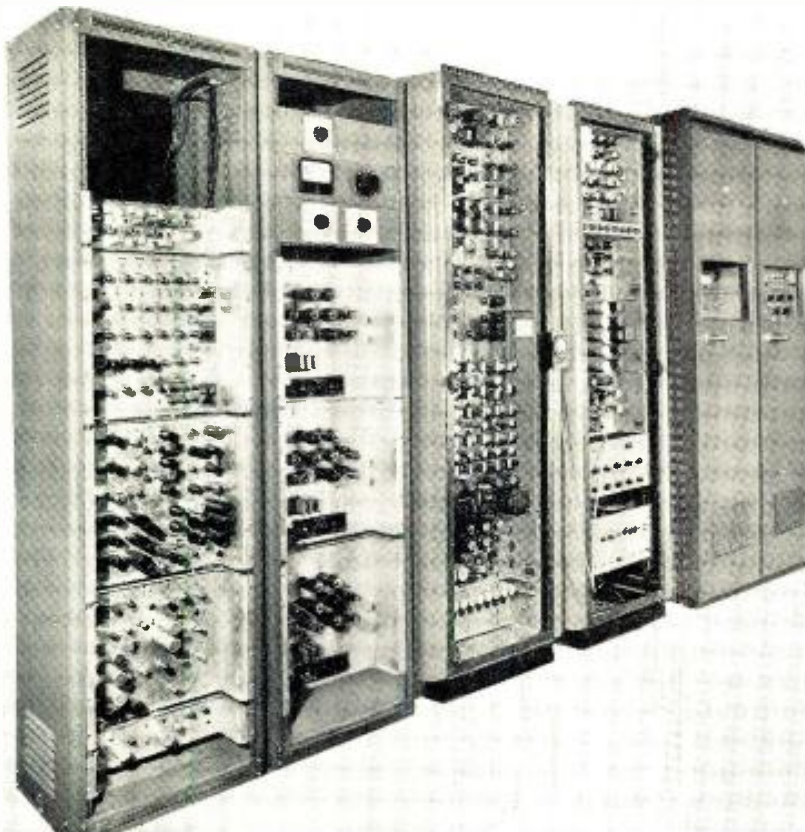

Chromatic Laboratories, containing a single gun, is typical of the latter.

The RCA picture tube contains a phosphor dot pattern consisting of 195,000 dots in each of three colors for a total of 585,000 dots. The three guns are so arranged that each gun will excite only its particular phosphor color. As a consequence it is possible and desirable to excite the three guns simultaneously with their respective color signals and thereby have a simultaneous light output in red, green, and blue. This design does not require any form of sequential color switching and provides a maximum light output roughly three times that which would be available on any sequential system using this tube. The use of three guns carries with it some severe mechanical and electronic circuit requirements. The first is the specification that each gun strike its respective phosphor without contamination from the other two. The second is the problem of registration of the three colored pictures. Improvements in the production control of the picture tube and in the electronic circuitry associated with the tube have reduced both problems to an acceptable level.

The Lawrence tube contains a series of red, green, and blue stripes approximately 0.015 inch wide with a built-in switching grid to allow the single electron beam to scan any one color depending on the switching potential present. Because of the single gun construction, a sequential display is essential. This means that this tube cannot suffer from any registration problems. However, it does suffer from a light output loss of two-thirds because only one phosphor is in use at one time. There is the additional requirement of substantial switching energy to the switching electrodes.

The test receivers used by the various manufacturers during NTSC field trials have utilized the RCA tri-color tube exclusively. Although limited numbers of the Lawrence tube have been released to the industry, a comparative appraisal is not possible at this time. It is probable that the first production color receivers will contain the RCA tube.

It should be quite obvious by now that the color receiver will be somewhat more complex and considerably more expensive than the present monochrome receiver. The picture tube alone is expected to cost from 150 to 200 dollars. The tube complement of the receiver will fall between 40 and 50 tubes. These two factors alone make a cost estimate of the first color receivers fall in the \$750 to \$1000 class. In addition, these receivers will produce a small picture, judged by present-day standards. The most successful RCA tri-color tube developed to date contains an exterior shell similar to the old 16AP4 and produces a 12½" pumpkin-type picture. Although intensive developmental work is now going on toward a 16" picture there is no indication

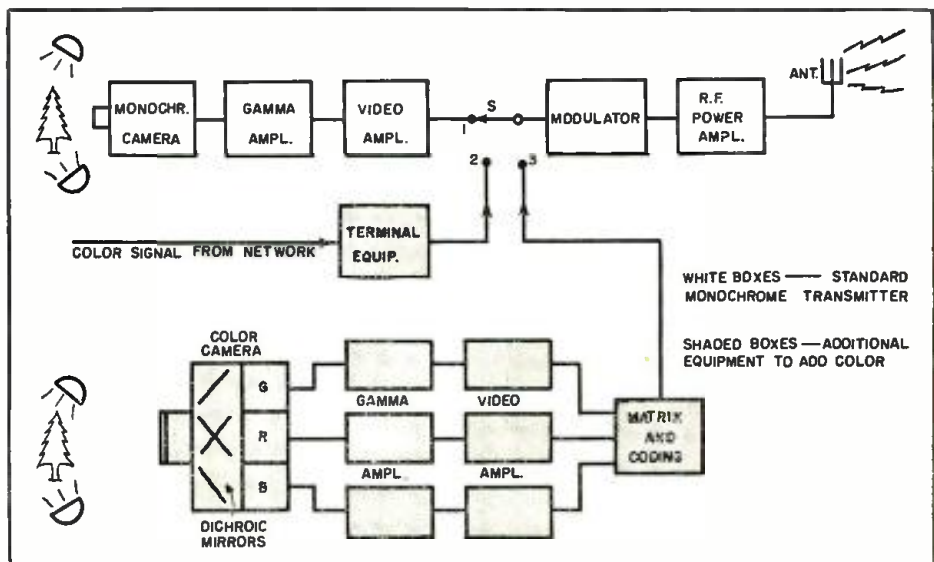

Fig. 3. Simplified block diagram of a typical color television transmitter.

when this larger tube will be available or how much it will cost.

Receiver Production

Obviously there will be no rush to buy the first color receivers. Very few prospective customers will buy a 12½" color picture at \$800 in preference to a 21" monochrome picture at \$300. However, the novelty is expected to appeal to some, and first production schedules will cater to this rather meager demand.

How soon manufacturers will put color receivers in the field, after FCC approval, is entirely up to the manufacturer himself. There will probably not be a repeat of the 630TS experience where RCA released complete data on this black and white receiver to their licensees, covering chassis layout, component specifications, alignment procedure, troubleshooting, etc. It will be necessary for each manufacturer to build up a nucleus of engineers familiar with the color TV problem. Fortunately, a number of

companies have already done this and have also accumulated a fair amount of specialized test and alignment equipment.

The next step, however, is actual production. The single bottleneck here is the test and alignment equipment for line use. Delivery of this material, from only a few sources, is quoted at from six months to a year. Realizing this, some manufacturers have already placed orders for production test equipment prior to FCC approval. Assuming FCC approval early in 1954, it is safe to say that the first color receiver will be released in the late spring of 1954 with a number of manufacturers in the field by the fall.

The Service Technician

The conscientious service technician who understands the workings of a black and white receiver will not fear the complexities of a color receiver. The transition is not as dramatic as

(Continued on page 173)

Fig. 4. Simplified block diagram of a typical color television receiver.

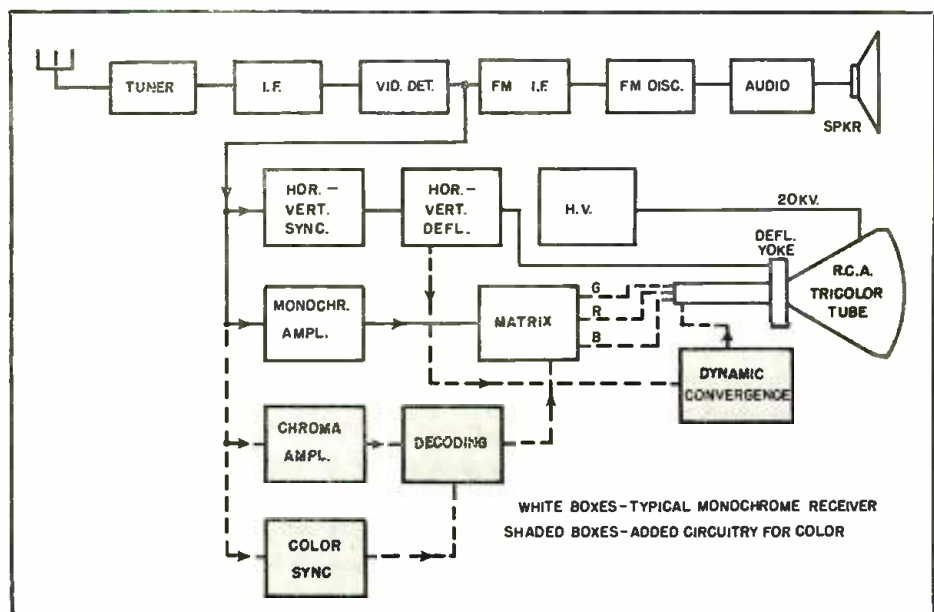

LOUDNESS CONTROL

By MICHAEL H. ESTKOWSKI

LLOUDNESS controls, as opposed to volume controls, have come to mean frequency-compensated, sound-power level controls. This article describes such a control. The various shortcomings of controls available on the market or through technical literature are circumvented in the author's version. Although loudness controls are a controversial topic, several publications have appeared which treat the problem in a rational and experimental manner (See References). For the reader's convenience, the salient factors affecting frequency compensation at various loudness levels are reviewed briefly.

The reference for all tonal compensation of volume controls is the Fletcher-Munson curves, shown in Fig. 1. These curves represent contours of equal hearing loudness at different frequencies over the audio spectrum at various sound-power levels. The upper and lower extremes of these contours are the sense of feel at and above 100 decibels, and the threshold of hearing at 0 decibels. For example, the 40 db curve represents the sound-power necessary at the different frequencies so the hearing loudness will be of equal intensity. Immediately we see that a flat frequency control will not do a satisfactory job at sound-power levels below the originally produced loudness. Unless our nerves are of non-resonant steel, we will not listen to music at its concert hall or dance hall loudness in our 15 foot by 20 foot living rooms.

At first glance we nurse the idea that we can use the bass boost tone control to handle the problem. However, if we want music at about a 50 db level (moderately loud), then from the Fletcher-Munson curves we notice that the volume setting for 25 cps is 35 db above the setting for 1000 cps (the reference frequency of these curves). So, if we look again, we realize that tone controls providing these characteristics are hard to get. If we go to a level of 40 db, the difference between the 25 and 1000 cps settings is about 42 db (40 db level is soft background music—the kind we like with our meals). What average tone control can do this!

A tone-compensated volume control which is relatively simple to build and follows the Fletcher-Munson curves very closely.

Besides these points, there is one more problem to contend with. It is the fact that in using amplifiers for reproducing purposes, the 100 db full-power reference level (threshold of feeling) may be excessively loud. So, it becomes necessary to lower the level of full-power to some appropriate value. As cited in Reference 1, this level is averaged at about the 80 db contour curve. In this case, the necessary compensation is about 14 or 15 db higher than the values given previously.

Nothing has been said about the high frequency end, i.e., frequencies above 1000 cps. The controversy on this point is complicated. However, the Fletcher-Munson curves do show some boost from 5000 cps on up above the 10,000 cps level. This boost exists at all levels of sound, though. The author contends that there is a need for some high-frequency boost above 5000 cps. It is especially true with amplifiers drooping at the high end and rooms where the noise level is above average. Furthermore, people with natural hearing impairments need extra compensation on the high-frequency end.

The author's control was designed to meet these requirements. Circuit-wise, the components are non-critical and the network is very simple, Fig. 2A. The volume level does not go all the way to zero, but this is not a fault since at a minimum setting the sound level is at or very close to the threshold of hearing (it can be made to fall in this range). In cases where the listener wants no sound he usually turns off the amplifier or takes the needle off the record.

Electronic operation of the control is based on two sections of RC low-frequency crossover circuits. There are three components in each branch, R_1 , R_2 , C_1 and R_3 , R_4 , C_2 . Values of R_2 - C_1 and R_4 - C_2 determine the crossover frequency and may therefore be

selected to produce the desired characteristic. The function of R_2 and R_4 is the flattening of frequency response beyond the crossover point. Calculations for achieving the desired results are very simple and an example illustrates the method of procedure.

Assume a value of R_1 to be 1 megohm (a volume control in this case) and further ascribe the condition that at a minimum setting of R_1 the bass frequency of 20 cps is to be attenuated 6 db—a voltage ratio of approximately 2. To attain this result it is necessary that $X_{C_1} + R_2$ at 20 cps equal 1 megohm. Furthermore, a crossover frequency of, say, 1500 cps is required. This is done by selecting the value of C_1 to have an impedance of 1 megohm at 20 cps and temporarily ignoring R_2 . Using a reactance chart or the Shure slide rule, C_1 is .008 μ fd. The next step is to find the reactance of C_1 at the crossover frequency, or 1500 cps. With the given value of C_1 , the reactance at the desired frequency is 13,300 ohms. At this stage the value of R_2 may be determined. If R_2 is 13,300 ohms it would seem that the crossover would fall at about 1500 cps and the attenuation remain flat from there on in. In practice, however, such is not the case. The crossover falls about an octave higher than the assumed frequency by using this method of calculation. So, if a resulting crossover frequency of 1500 cps is desired then the calculations should be based on about 800 cps. Revising the computations we find that X_{C_1} at 800 cps is 25,000 ohms in rough figures. R_2 is made 25,000 ohms. With these conditions the attenuation of 1500 cps at a minimum setting of R_1 is:

$$(25,000 + 13,300)/(1,000,000 + 25,000 + 13,300) = 1/36.9 \text{ or about } 31.4 \text{ db.}$$

This method does not produce a sharp crossover, but it nevertheless approaches the ideal asymptotes as

closely as simple RC networks can. The important part is the fact that the difference in attenuation between 20 cps and 1500 cps is 25.4 db. Furthermore, an RC network can only give a maximum attenuation curve of 6 db-per-octave, and the requirements need considerably more than that. Therefore, by cascading another similar section (in this case R_3 , C_2 , and R_4) the attenuation at a minimum setting of both R_1 and R_2 becomes 50.8 db (the potentiometers are ganged).

To boost the high frequency output at settings other than maximum a condenser shown as C_3 in Fig. 2B may be connected between the tops of R_3 and R_4 . The effectiveness of C_3 is counteracted by C_2 and therefore R_5 , Fig. 2B, of about 10,000 ohms may be inserted. It is to be noted that the degree of high-frequency boost may be controlled at will by appropriate values of C_3 and R_5 , providing R_5 does not become too large compared to R_3 . This latter fact will introduce an insertion loss since the total frequency spectrum is developed across R_3 and R_4 , while the output is taken across R_5 alone.

Response curves of the loudness control of Fig. 2A, are shown in Fig. 3. Comparing these with the Fletcher-Munson curves, Fig. 1, we note that although they do not coincide, the approach is close and considerably better than the curves published to date.

Listening tests proved that the control does a very good job. Some listeners bemoaned the lack of high-frequency notes. After inserting C_3 of 47 μ fd. and R_5 of 0 ohms even these critical individuals were satisfied.

Transference of the maximum reference level, mentioned previously, may be fulfilled by having a non-compensated volume control ahead of the control in question. As a matter of fact the compensated control acts as a very effective bass tone control when used with a straight attenuator ahead of it.

The home experimenter will be pleasantly surprised when the control is put through its paces. However, when building the control care must be taken to keep the component parts away from electrostatic fields. The circuit has fairly high impedances and resistances which are prone to pick up hum. To alleviate this situation R_1 and R_2 can be 500,000 ohms each. Then, to preserve the attenuation characteristics, C_1 , C_2 , R_3 , and R_4 have to be changed in accordance with the calculations given. The value of R_5 has to be high enough to prevent a shunting effect on R_3 , C_2 , and R_4 .

Besides operating as a non-linear attenuator of frequencies below the crossover point, the loudness control can operate as a low-frequency booster if it is the R_5 of a preceding vacuum tube stage. That is, if the loudness control has a shunting effect on the plate load of a vacuum tube amplification stage feeding into it, then the shunting effect decreases with lower frequencies and causes a higher

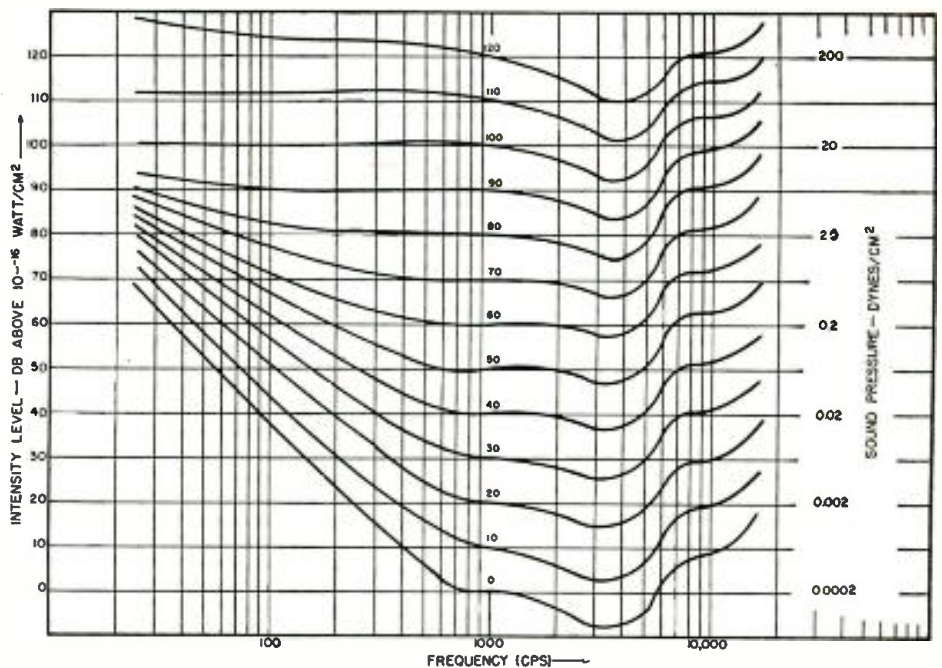

Fig. 1. Equal loudness contours for normal ears, known as the Fletcher-Munson curves.

output signal voltage—as compared to the output at frequencies above the crossover point. In this fashion the control has two simultaneous functions: (1) it acts as a bass boosting complex plate load for a vacuum tube (cancelling the effect of coupling condensers) and (2) it attenuates frequencies in a manner which results in the Fletcher-Munson hearing characteristic curves.

REFERENCES

1. Toth, Emerick: "The Design of Compensated Volume Controls," *Audio Engineering*, January and February 1952.
2. Schjelderup, John E.: "A Proposed Solution to the Loudness Control Problem," *Audio Engineering*, September 1952.
3. Johnson, E. E.: "A Continuously Variable Loudness Control," *Audio Engineering*, December 1950.

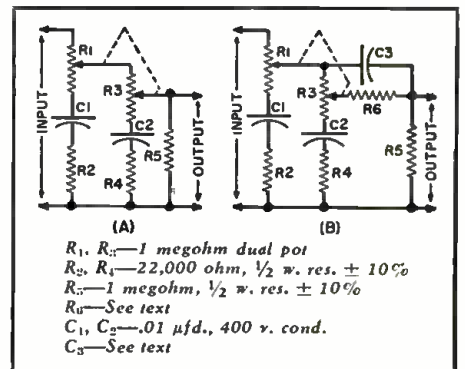
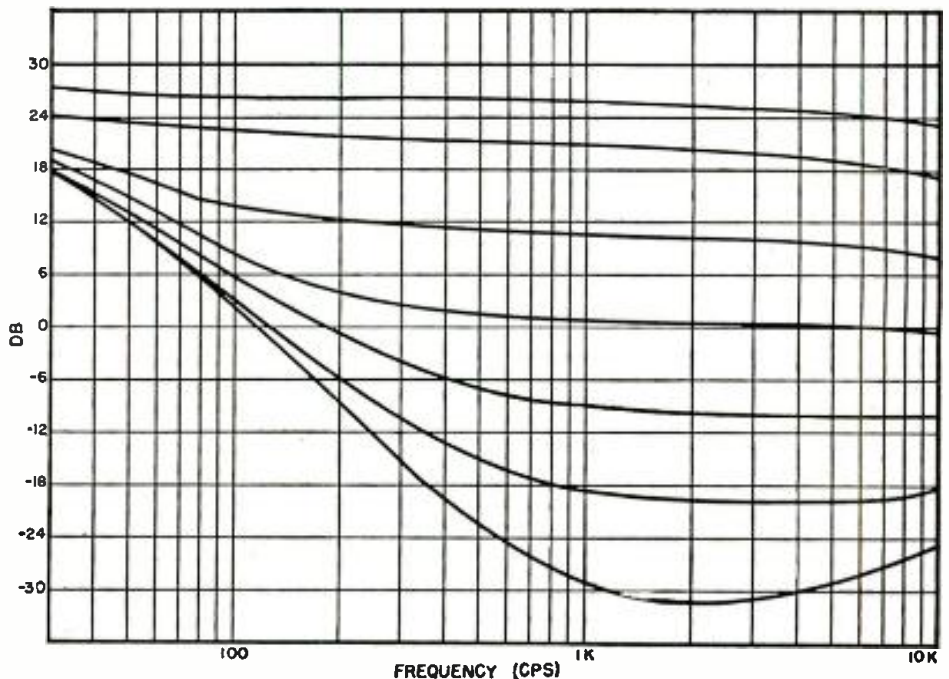

Fig. 2. (A) Basic circuit which produces the frequency response shown in Fig. 3. (B) Addition of C_3 and R_5 makes it possible to increase the output of the high frequencies.

Fig. 3. Response curves of the loudness control circuit shown in Fig. 2A. When pots R_1 and R_2 are set for maximum output, then the frequency response is flat at 30 db across the entire audio spectrum. See text for further discussion of this point.



NEW TV INTERMITTENT CHECKER

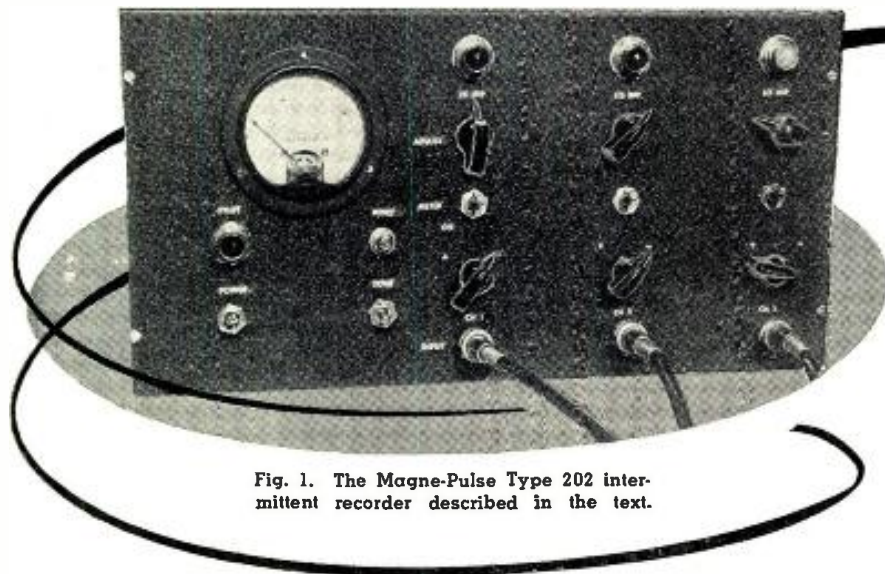

Fig. 1. The Magne-Pulse Type 202 intermittent recorder described in the text.

By
JOSEPH RACKER
Magne-Pulse Corporation

This new TV service instrument may help eliminate one of the most difficult TV service problems: intermittents.

ONE of the most troublesome and time-consuming service faults that the average technician encounters is an intermittent, that is, a trouble that occurs only for a short period of time and then disappears for a much longer time. Not only does such a trouble try the service technician's patience, but equally important, it is often the cause of customer dissatisfaction and many callbacks. Although only about 10% of the sets brought into the shop are intermittents, they often take from 30 to 40% of the technician's time.

A new instrument designed to detect intermittents and localize them to the specific circuits and components in which they occur is shown in Fig. 1. This intermittent recorder is connected to three key points in the intermittent radio or TV set, and the set is turned on. The service technician can then continue to service other sets. When the trouble occurs in the intermittent receiver, the recorder immediately detects it, a buzzer is sounded, and a lamp lights, indicating to the service technician exactly where the intermittent has occurred or is occurring. An important feature of this instrument is that this lamp remains on even if the trouble disappears. Thus, even if the service technician leaves the shop, he will know that an intermittent occurred, and in what circuit.

The intermittent recorder is extremely flexible in that it can monitor any three circuits in the set and can be used to localize the trouble to individual components. If the service

technician has no idea where the intermittent is occurring, the three lines can be used, for example, to check the video output, audio output, and high-voltage drive. Assume that the intermittent occurred in the video circuit. The video line lamp lights up. Now the three lines can be placed on three different stages in the video section. The next time the intermittent occurs, the trouble will be localized in a specific stage. Finally, the three lines can be placed at three points within the stage; for example, the grid, cathode, and plate circuit. This enables localization to several components.

The basic circuit of one channel of the intermittent recorder is shown in Fig. 2. V_1 rectifies the input signal from a stage in the TV set. V_2 is a dual-triode used in a balanced circuit. The grid of the first half is biased by

Fig. 2. Simplified basic circuit of one test channel of the intermittent recorder.

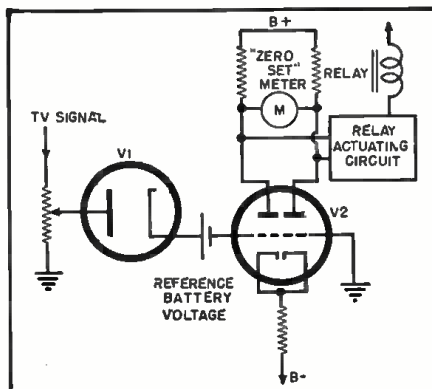

the TV signal and the bucking battery reference voltage. With the TV receiver operating normally, the potentiometer in the rectifier circuit is adjusted so that the rectified TV signal voltage exactly equals the battery voltage. This effectively places the grid of the first half of V_2 at zero potential and balances the circuit. In practice, this is simply done by adjusting the front panel potentiometer corresponding to the line used for a "zero" meter reading.

When an intermittent occurs, the TV voltage varies sufficiently to unbalance V_2 , which results in a voltage being applied to the relay actuating circuit. Actuation of the relay causes the buzzer to sound, turns on the lamp, and "locks out" all other monitor circuits. That is, only the test channel in which the intermittent occurred will become unbalanced. The other circuits which are affected by the intermittent milliseconds later do not cause their lamps to light up. For example, if three video stages are being monitored, an intermittent shorting condenser in the first stage will eventually affect voltages in the second and third stages. However, only the circuit monitoring the first stage will become unbalanced, since the intermittent is occurring in that stage. The instant that this circuit becomes unbalanced, it locks out the other stages. Thus, only the lamp of the test channel monitoring the first video stage will light up. The test channels in the intermittent recorder permit acceptance of positive or negative d.c. and a.c. voltages and cover various ranges of sensitivity.

Some typical servicing experiences with the intermittent recorder will give some indication of how it can be used. In one case, the customer complained that the picture on his TV set intermittently became narrow, and margins would be seen on both left and right. This happened after the set (a Motorola 16K2) was turned on for about one hour. Obviously the horizontal drive voltage was decreasing. The intermittent recorder was, therefore, connected directly to three circuits in the horizontal drive. The most sensitive test line was connected to the grid of the horizontal output tube, which checked all circuits up to

(Continued on page 196)

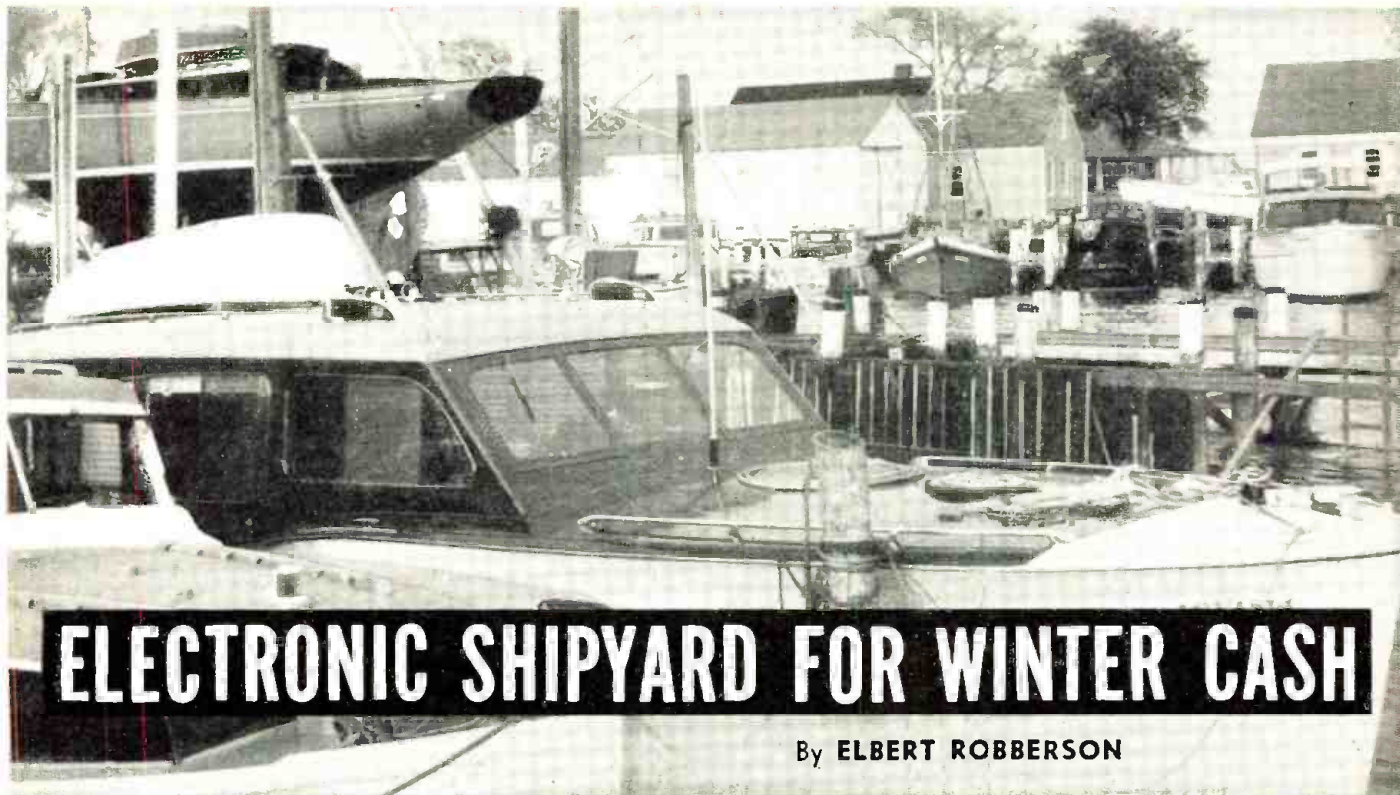

ELECTRONIC SHIPYARD FOR WINTER CASH

By ELBERT ROBBERSON

The time to start rehabilitation and repair of the electronic gear is when the boats come into the yard for winter storage.

MY FIRST winter in the marine-radio business was cold! But in the spring the way to pay the off-season rent became obvious: operate an "electronic shipyard!" When the shipyard hauls a boat, you haul the electronic gear in for a winter check-over, and safe warm storage.

I had been called to service a line-up of boats that had just been dunked, and the owners were breathing down my neck. In each case, after checking the external connections of the radio-telephone, and opening the cabinet to clip a voltmeter on the "B-plus," I had flipped the "on" switch—and got nothing! In a couple of cases there was "B"-voltage but also a wisp of smoke.

These boatmen had economized by leaving everything aboard through the winter. Anyone who has climbed aboard a boat early some wintery morning has seen condensed water glistening on all the metal in the cabin. It happens inside equipment as well as outside, so after a few months condenser plates grow a beard, contacts corrode, and insulators turn into low-grade resistors. I resolved that next winter, every piece of gear possible would come into the shop. After I worked out an assembly-line process this turned into a profitable procedure which can well be used by anyone in the game.

If the importance of proper winter care is in doubt, here are some statistics. Take three groups: (1) equipment left aboard all winter; (2) equipment removed by the owner or shipyard mechanics; and (3) equipment removed, stored, and reconditioned by a marine-radio technician.

Stagger your work load and stabilize your income by setting up a plan for handling your marine service work "off season".

In 90% of the vessels in case (1), when I was called to fire up the equipment in the spring, it had to be marked "Dead on Arrival." The 10% that worked were in boats that kept heat up, either by warm inside storage or other arrangements. The main causes of failure ranged from sticking vibrators to grass growing in the condensers, but a thorough shop check was indicated in every case, even though a little work on the spot might induce the set to show life. For instance, a stuck vibrator might be shock treated, by a stiff belt with the handle of a screwdriver, and the "B-plus" would come up—then it would drop and all that would be needed for smoke signaling would be an Indian blanket.

The boats in category (2) averaged about 50-50. The troubles were slightly different, but troubles there would be. After the vibrator was induced to buzz, the set might work, but not very well. Trouble ranged from the receiver being dead, because the owner had noticed a bunch of loose screws which he had of course tightened (the i.f. and front-end tuning adjustments, naturally); short-circuited transmitter-coil turns, dropping output to zero or just slightly more; to the bitter extreme of a reversed battery hookup causing electrolytic destruction of metal fittings and engine parts below the water line.

I went aboard one such boat on a

service call and found it sinking. A hurry-up call to the shipyard got the vessel hauled out just a little before the time when fish would have been swimming in and out of the portholes. Inspection showed the propeller shaft to be dissolved to the size of a pencil, the propeller a delicate bit of bronze lace, and some fittings were completely absent. To save money, the owner had connected up his own radiotelephone—backwards! Full battery voltage was put between the engine fittings and the ground plate, and the seagoing demon, electrolysis, sat down to the table for a full meal.

Failures on boats in group (3) were almost nil. Whenever trouble showed it was from causes external to the equipment, such as dead batteries, or short-circuited antenna insulators—all things easily corrected at the time of equipment re-installation.

There is just one big question mark, and that is: how can money be made on winter-storage service? Without an efficient system, time is wasted in travel and set-up for service, and the cost may be out of proportion to the job.

Preparation is required, both in the "administrative" department and in the shop. Toward fall, send a letter to every prospect offering the service. Customers like to know what they are getting into, so outline your rates. Labor may be charged for by the hour,

(Continued on page 189)

SKIATRON'S "SUBSCRIBER-VISION"

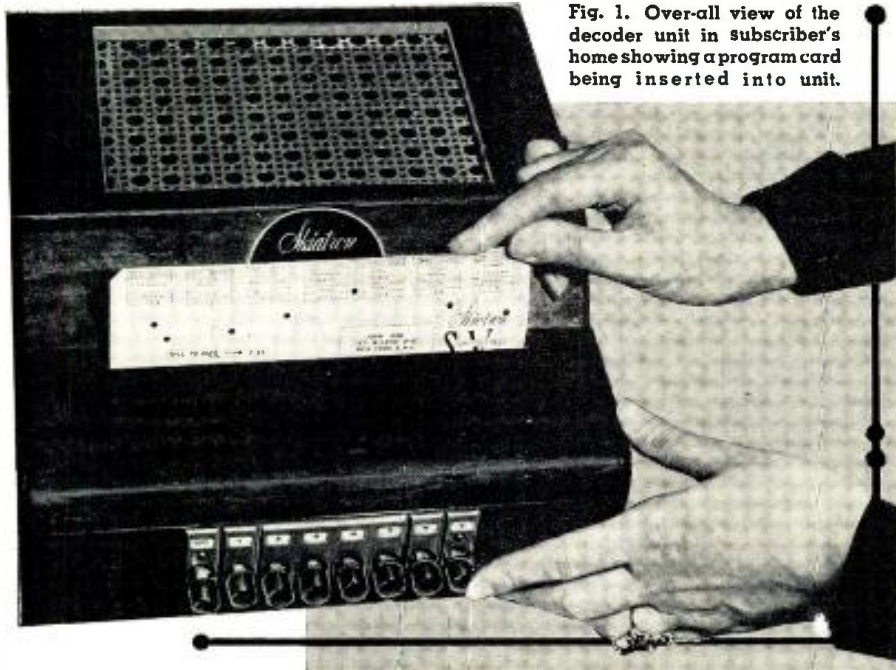

Fig. 1. Over-all view of the decoder unit in subscriber's home showing a program card being inserted into unit.

By
RUDOLF F. GRAF

Utilizing a program card which carries a printed circuit to complete connection, this system is now being demonstrated.

A NEW electronic system for the transmission of scrambled video and sound signals from a TV station and their unscrambling at the home of subscribers was demonstrated to a New York audience recently by Skiatron Electronics & Television Corp.

Basically, the "Subscriber-Vision" system of TV transmission and reception is not too complex. The picture as well as the sound signal is transmitted by a regular television station on its assigned channel. The station, however, must be equipped with an "S-V" coder unit. The coder scrambles the picture and sound signals in any desired random or regular manner. If this signal is picked up by any set not equipped with a decoder, the sound is completely unintelligible and the image on the screen is a multiple one.

At the receiving end, the set owner-subscriber has a small decoding unit which can be easily connected to any TV receiver. The decoder may be either a small box-like unit, as shown in Fig. 1, or the decoder circuit may be built into the receiver itself at the time of manufacture. The function of this decoder unit is exactly the opposite of that of the coder unit at the transmitter. It takes the scrambled picture and sound and unscrambles it.

The Decoder

The decoder operates in the follow-

ing manner. As can be seen from Fig. 1, a card is inserted into a slot in the decoder. This card looks very much like an IBM card and carries the codes that are used for the programs covered by the card. The programs for the week are listed on top of the card and the codes corresponding to these programs are contained in printed circuits on the lower part of the card. The card used at the demonstration listed seven programs, one for each day of the week. The subscriber selects his program on the card and when that program is about to start he depresses the corresponding push-button on the decoder unit. This push-button actuates a switch which connects the proper circuits in the decoder and the picture is unscrambled. As soon as any push-button is depressed, a small hole is punched into the subscription card so that there is proof that a certain program has been seen and should be billed.

Coding of the Signal

The transmitter and receiver block diagrams are shown in Figs. 2 and 5 with the additional equipment required for the "Subscriber-Vision" system shown within the dotted boxes.

In transmission, the picture is shifted several times in the horizontal direction. Thus, the video signal of several fields is shifted with respect to the horizontal sync pulses in such a manner that there is quite a notice-

able phase shift between fields. In this way a series of pictures is transmitted each of which is complete in itself but jiggles back and forth in a horizontal direction. This multiple transmission can consist of two or three or as many as five, six, or seven images. Furthermore, the fields do not necessarily have to appear in sequence. For example, let's assume the code deals with four pictures and see how this process is handled.

These four pictures could be sent out in the order: 1, 2, 3, 4, 1, 2, 3, 4, or they could be transmitted as 4, 3, 2, 1, 4, 3, 2, 1, or 4, 2, 3, 1, 4, 2, 3, 1, or 4, 1, 3, 2, 4, 1, 3, 2, or any of the other possible combinations. If we choose any of these or another similar code and repeat that sequence continuously, we have a code which varies at a regular rate. If the sequence varies in an unpredictable manner, we have a "random" code.

It can be seen that there is a tremendous number of possible combinations of horizontal displacements. The only problem left is to select a code which can be represented on the subscriber's card and yet be reasonably secret and tamper-proof. This can be accomplished quite easily as will be discussed.

The Transmitter

Three blocks in Fig. 2 make up the heart of the video coding unit. These are the "Field Selector," the "Switching and Coding Circuit," and "Sweep Generators #1, #2, #3." In order to simplify the explanation of this system, we have chosen a code which has a maximum variation of three, thus the picture will be in any of three positions at all times.

First let us consider the type of code used and then we will see how it is produced by these circuits. The present system works with a code that is basic with each card. That means that as soon as the card is inserted in the decoder, some of its twenty-nine contacts establish a basic code. The code is shown as the "Code for the Week" at the top of Fig. 4. Note that the code is incomplete by itself (every third space is blank) and must be filled in.

Even though the "Code for the Week" may be quite involved, the "filling in" may be accomplished by a very simple sequence such as 2, 1, 2, 1, 2, 1, or 3, 1, 3, 1, 3, 1 or 3, 2, 3, 2, 3, 2, etc. or any other sequence that may be set up. These numbers refer, of course, to the relative position of each field at any one particular time. If we study the sample codes for a minute, we see that the picture

will do quite a bit of moving along the screen of the tube. Although it will look like a jumbled mess, there is still a fixed sequence that is followed.

The input and output signals of the "Sweep Generators" are shown in Fig. 3. Into the circuit come horizontal sync pulses which hold the whole thing in phase. Coming out of these circuits are three horizontal sweep signals of exactly the same frequency, but each slightly displaced from the other. The three signals are designated as A, B, and C.

The "Field Selector" feeds rectangular pulses into the "Switching and Coding Circuit." These pulses take up the time of a complete field. Now, in order to put everything together, we have to refer back to Fig. 4 again. We will work with the code for program "Y" which has a sequence 1, 3, 3, 2, 3, 1, 3, 2, 3, 1, 1, 2, 3, etc.

The pulses shown at "A" are vertical sync pulses. They appear at a field rate. Thus the space between them is one field. In order to understand the system more easily, the spaces between each of these pulses have been filled in with the code numbers of program "Y." Therefore, the code sequence is actually the field sequence.

If we now realize that the output voltages from "Sweep Generators #1, #2, and #3, are used for fields 1, 2, and 3 respectively, we have the puzzle almost solved. All that remains now is to select these pulses at the right time for the duration of one field. This job is done by the "Switching Circuit." This circuit receives the square waves produced by the "Field Selector" at a rate corresponding to the particular code used. These square waves are shown in Fig. 4 as "B," "C," and "D." The separate sweep voltages they produce are shown as "E," "F," and "G" and their combined output as "H." Remember that we are here discussing fields and their individual lines. What is actually moved is the video signal. The horizontal sync pulses are not disturbed but the phase of the video signal between them is changed every field or so.

As far as the sound signal is concerned, the coding process is a little less involved. The audio signal is first amplitude modulated at a relatively low frequency in "Modulator #1." This modulated signal then goes to a frequency remodulator where it is scrambled at the same rate as the picture. This scrambled signal then goes through a bandpass filter into a conventional frequency modulator, designated as "Modulator #2." Then it is transmitted as a scrambled frequency-modulated signal.

No decoding pulses are transmitted. The decoding is done entirely at the viewer's home by using the proper card and depressing the correct button on the decoder.

The Receiver

The block diagram of the "Subscriber-Vision" adapted TV receiver is

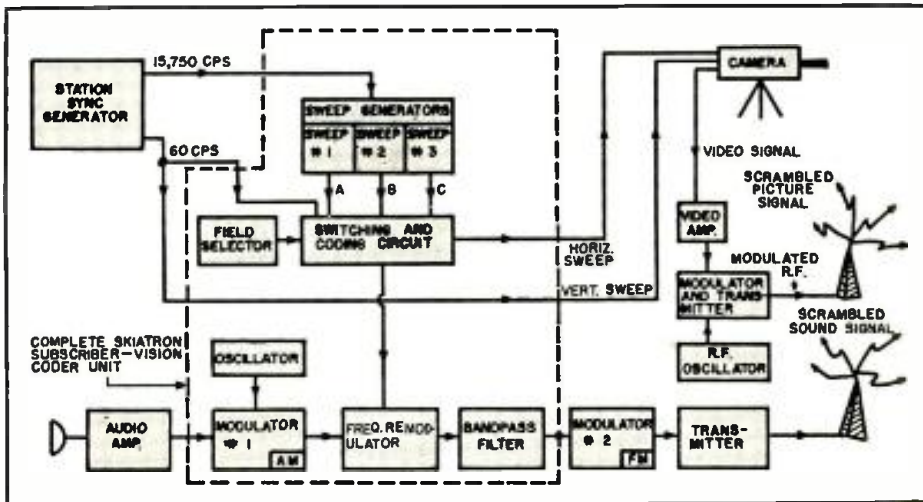

Fig. 2. Block diagram of transmitter adapted to handle S-V coded transmissions.

shown in Fig. 5. Since the problem here is to unscramble a scrambled picture, the circuits used must do essentially the opposite of what is done at the transmitter. Again the vertical and horizontal sync signals are utilized as at the transmitter. They are fed to a "Field Selector" and to "Sweep Generators #1, #2, and #3."

As before, the "Field Selector" feeds rectangular pulses to the "Decoder Unit." These pulses again cover one or more fields depending on the code. The output signals from the three "Sweep Generators" are out-of-phase with each other by exactly the same amount as those at the transmitter. The sequence in which these three signals A, B, and C are used, is determined by the push-button depressed. The bottom part of the program card contains twenty-nine electrically conductive areas which are interconnected in a manner determined by the code used during that

(Continued on page 191)

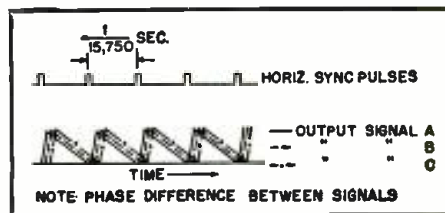

Fig. 3. Output signals of sweep generators #1, #2, #3 of S-V transmission system.

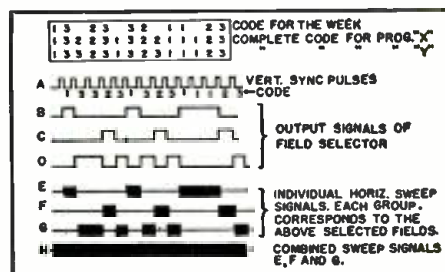
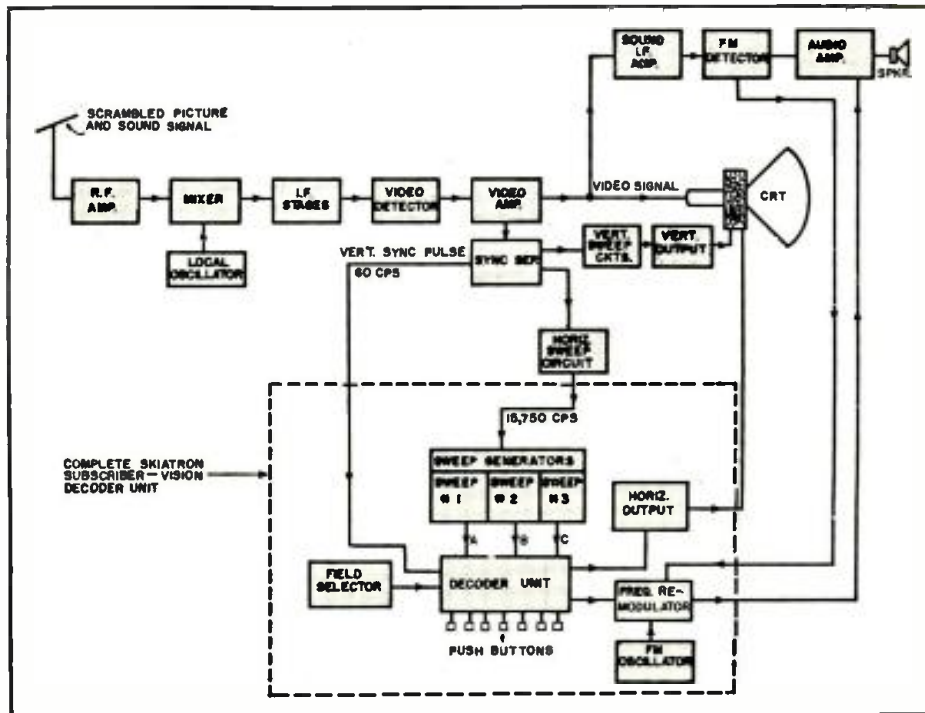
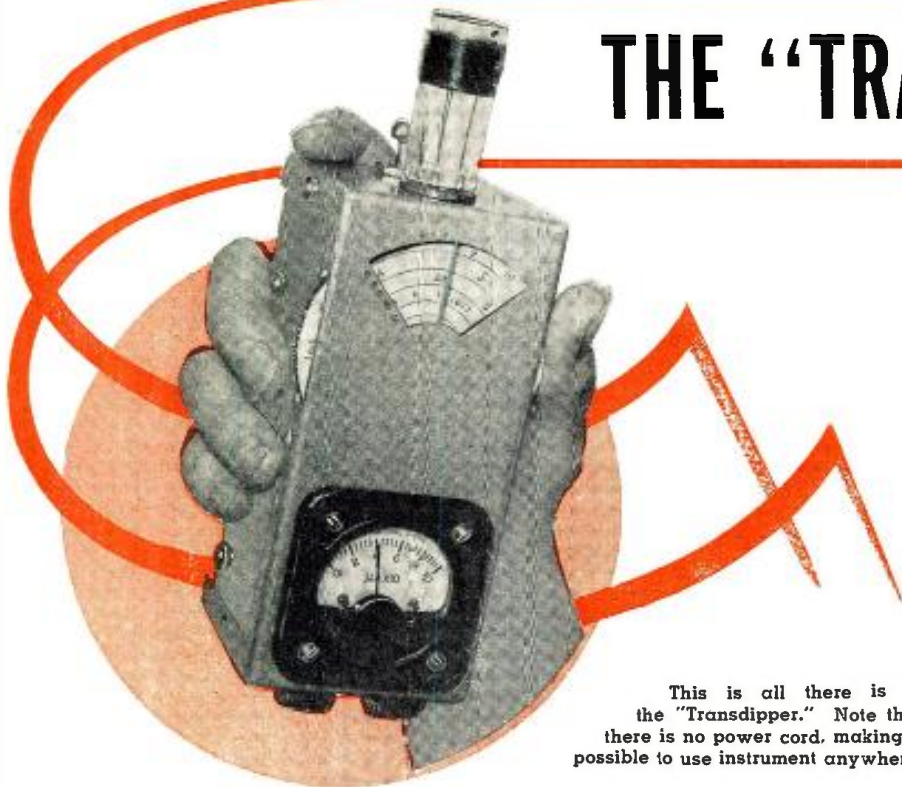

Fig. 4. Signals at field selector and coding and switching circuit of Figs. 2 and 5. See text for details on these patterns.

Fig. 5. Block diagram of the S-V decoder installed in a standard television set.



THE "TRANSDIPPER"



This is all there is to the "Transdipper." Note that there is no power cord, making it possible to use instrument anywhere.

A pioneering amateur development in the transistor field, the "Transdipper" is a "grid-dip" meter in its most modern form. Completely self-contained, its range is 1.7-33 mc.

THE difficulties connected with the use of a grid-dip oscillator in adjusting the elements of a parasitic array—dragging a long extension cord and the oscillator with its associated power supply up a steel tower, supporting yourself and the instruments at the top of the tower, and trying to take readings and adjust the elements at the same time—make it plain that a portable, self-powered GDO would be a very handy gadget to have. Such an instrument would find many uses, not only outdoors but in the "shack".

The necessary features for such a gadget include (1) portability, (2) self-contained power supply, (3) compactness, and (4) one-hand operation. In the "Transdipper", which is shown in the over-all photograph, all these features were made practicable through the use of the newest member of the electronic-devices family—the transistor.

The use of an RCA 2N33 transistor affords great opportunities for miniaturization and simplicity because this tiny device utilizes no "heater" power, requires no warm-up, and uses little power. The transistor also provides greater stability of operation during handling of the instrument because it is shock-resistant. The "Transdipper" is capable of being held and operated with one hand, and is powered with a small hearing-aid battery. Operating at about 25 milliwatts, it is in-

stant-starting, is extremely stable, and compares favorably for sensitivity with its bigger brothers employing electron tubes.

Design Considerations

The first problem in building a transistor GDO was finding a suitable oscillator circuit of the variable-frequency type. Information on high-frequency transistor oscillators was rather scarce at this stage, but, some basic oscillator circuits were located¹ and the first unit was built breadboard fashion. With the aid of a heterodyne frequency meter and a crystal probe, a variable-frequency oscillator was finally constructed which was reasonably stable.

The next problem, the toughest one of all, was to locate a point or points in the oscillator circuit at which a maximum change in current or voltage occurred when the tank circuit of the oscillator was loaded. Because the input to the oscillator was on the order of 25 milliwatts, it was necessary to use low-range instruments for this search. The idea of using a d.c. instrument as an indicating device was quickly abandoned because changes in direct current readings were never greater, at best, than about 10 per-cent. Because a search for changes in r.f. current or voltage might prove more successful, a crystal probe coupled to a 0-50 μ a. d.c. micro-

By
C. A. WEST, W2IYG
RCA Tube Department
Harrison, N. J.

ammeter was used to probe the circuit for r.f. voltage points which would give the desired indication. Although good readings were obtained at various points in the circuit, the changes in r.f. voltage, although much greater than the direct-current changes, were still not entirely satisfactory. At this point it appeared that further improvement in the oscillator circuit itself was in order.

After considerable experimentation it was discovered that the "Q" of the tank circuit played an important part as far as sensitivity and maximum r.f. voltage change were concerned. The "Q" of the circuit was improved by connecting the transistor base, originally connected at one end to the tank circuit and at the other end to "B+" through a bypassed resistor, to the center tap of the tank coil. An improvement in dip resulted from this change.

Further experimentation with the breadboard model involved circuit modifications which resulted in increasing the output from the oscillator, improving the "Q" of the experimental coils, locating a point in the circuit which gave the maximum dip, and eliminating serious false dips. The circuit shown in Fig. 1 was finally developed. In this circuit, which is basically simple, L_1 and C_1 determine the frequency of oscillation. The indicating circuit, a conventional crystal probe with a microammeter in the output, is connected across the tuned tank circuit and indicates r.f. voltage. When the tank circuit is loaded the r.f. voltage drops giving the desired dip in the meter reading.

Possible Layouts

Because further experimentation might prove interesting, it was decided at first to build the "Transdipper" as shown in the drawing of Fig. 1. This type of construction has proved quite popular for certain types of instruments. It is ideal for those who wish to experiment further with the circuit, because it allows use of the instrument during periods of experimentation and provides breadboard layout facilitating experimental work. After some thought, however, the plans for this type of construction were abandoned because they did not lend themselves to one-hand operation or pro-

vide ruggedness, shielding, and further miniaturization.

A search for miniature components showed that the indicating instrument would be the largest component. The battery, tuning condenser, switch, and variable resistors, in that order, are next in size. A number of full-scale drawings was made of the parts layout and parts were rearranged to provide compactness, ease of operation, and shortest wiring paths. A two-piece metal case was finally selected; upon completion of construction and adjustment, the two pieces are snapped or screwed together to provide the proper shielding and protection planned for initially. A 2 1/4" x 2 1/4" x 5" ICA "Flexi-Mount" case was found to be quite satisfactory. The final arrangement of parts, shown in Figs. 3 and 4, is easily recognized as the type used in some commercially available grid-dip oscillators employing an electron tube or tubes.

Construction

Because a suitable dial for the "Transdipper" was not commercially available, and because this part was the only one lacking before construction could get under way, a home-made dial was devised to fit the instrument. This dial, which was cut from a one-eighth inch sheet of *Lucite*, protrudes from the upper front sides of the case for easy manipulation. The dial is read through a cut-out hole in the case. A brass bushing about 3/4" in diameter and 1/4" thick having a 1/8" hole and set screw was fastened to the *Lucite* disc by means of two countersunk machine screws. A piece of white drawing paper was cemented to the upper surface to complete the dial.

Many of the parts used in the "Transdipper" fitted compactly, some clearances being as small as 1/32 inch. If a simpler tuning-condenser mounting is desired, it is quite practical to attach the condenser directly to the upper side of the case. The dial may now be located on the outside of the case, instead of on the inside as shown.

It is a good idea to solder lengths of wire to the terminals before mounting any of the components because it may prove difficult to reach the terminals with a soldering iron after the components are mounted. The components were mounted in the following order: coil socket, switch and tuning condenser, meter, and the two variable resistors. It is wiser to wire the circuit as the components are installed than to install the components completely and then attempt to complete the wiring, because space is limited. The use of a soldering gun for this type of construction is quite helpful.

Coil Design

In line with the compact design, *Amphenol* 24-5H forms were used for the coils. The completed coils are shown in Fig. 2. The use of small-size coils provides for more convenient access to tight places when measure-

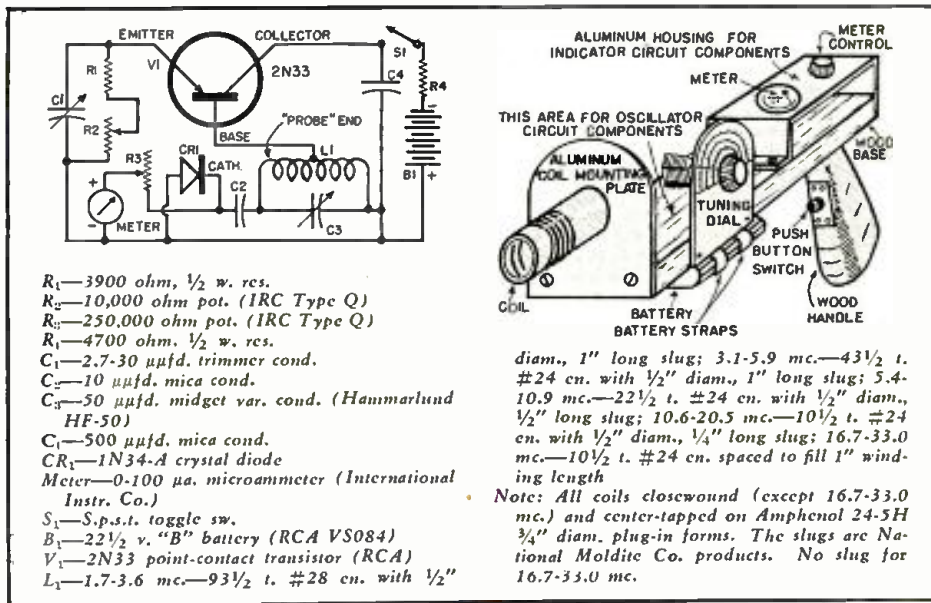

Fig. 1. Complete schematic of the "Transdipper" and an experimental "breadboard" layout which still affords operating convenience. The metering circuit measures changes of r.f. voltage, which is more effective than measuring d.c. current dips.

ments are being made. It is important that coils having a reasonably high "Q" be employed with the instrument to help obtain a good dip. Unfortunately, high-"Q" coils at first caused greater difficulty with false dips. It was observed during experimentation that the coils used for the low-frequency bands (160 and 80 meters) created the chief difficulty with "Q". Powdered-iron slugs were finally provided for four of the five coils to improve the "Q". Holes were drilled and tapped in the bottom of the coil form and each slug was screwed into position with the aid of a lock washer and nut. The top of the slug was lined up approximately with the probe end of the coil. The coil data in Fig. 1 gives the necessary specifications for making the five coils which cover the five low-frequency amateur bands.

The use of the "Transdipper" can be simplified if the coils are color-coded to match the colored frequency scales on the dial. Upon completion

they should be coated to hold the wire in place. A plastic spray is suitable.

Adjustment

Because some readers may wish to build a "Transdipper" for their own use, the remainder of this article is written in a "how-to-do-it" style. Because transistors are rather costly, it is a good idea to double-check the circuit wiring. It is especially important that the correct polarity be used for the battery connections. Transistors are extremely rugged mechanically, but may be easily damaged electrically.²

Before the case is assembled connect the instrument to a d.c. source which will supply the proper voltage. A low-range d.c. milliammeter may be used during this initial test to measure the total battery current which is approximately 3.5 ma. It is advisable to turn the switch off before inserting one of the coils. Adjust the meter control knob for maximum re-

Fig. 2. The plug-in coils for the "Transdipper." Left to right, coils for 1.7-3.6 mc., 5.4-10.9 mc., 3.1-5.9 mc., 10.6-20.5 mc., 16.7-33.0 mc. The four lowest-frequency coils have slugs to adjust the "Q" of the coils to obtain reliable "dipping" action.

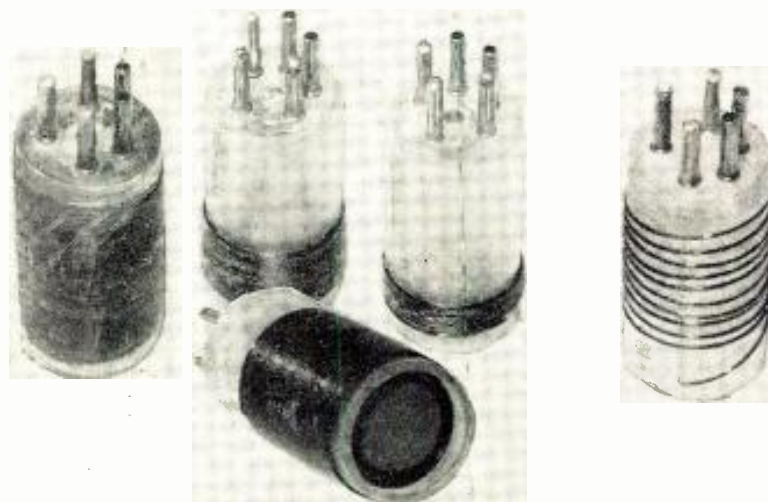

sistance and apply power. The "Transdipper" microammeter should show a reading indicating that the oscillator is functioning. Now, listen for the oscillator signal with a receiver. The beat-frequency oscillator of the receiver should be turned on. (Incidentally, the 2N33 transistor should not be inserted into or withdrawn from the socket with the power on because high transient currents may cause permanent damage to the transistor.) When the signal is located, it should be checked for frequency stability and tone. Tap the instrument. If the circuit has been wired correctly, satisfactory solder connections made, and components rigidly mounted, the frequency should not change more than a few cycles during this test.

The next step is adjustment of condenser C_1 . The emitter resistor R_2 should be set for maximum resistance when this adjustment is made. At the low frequencies a larger value of capacitance is required for C_1 to sustain oscillation than at the high frequencies. To eliminate continual adjustment of this screwdriver control, therefore, it is recommended that the minimum value of capacitance required to sustain oscillation at the lowest frequency be used. This minimum value of capacitance is also suitable for the high frequencies, although better output and dip are obtained when this condenser is adjusted for maximum output on any tuning range. The adjustment of C_1 may be eliminated by the installation of a small fixed condenser in the base of each coil connected to the two unused pins on the coil form. Wire the coil socket

accordingly. Select the optimum value of capacitance for each coil range.

Grasp the probe end of the coil and observe the meter reading. If the instrument is operating properly there should be a noticeable dip in current. The case may now be assembled and all coils checked for operation, proper frequency range, and overlap.

Calibration

Because the primary function of a grid-dip oscillator is to determine, conveniently and quickly, the approximate resonant frequency of a tuned circuit, the accuracy of the tuning dial is generally not considered too important. Therefore, the station receiver may be utilized satisfactorily for calibration of the dial.

Calibration of the dial is accomplished by providing a suitable reference line above the dial and, starting with the lowest frequency coil, simply placing a dot on the paper scale below the reference line with a pencil and marking in the frequency. To provide for easy reading of the dial, use the innermost arc for the lowest frequency coil and progress outward during the calibration of the other coils.

The dial may now be inked and, if desired, may be coated with a plastic spray for protection.

Operation

To determine the resonant frequency of an unknown circuit, insert a coil which you anticipate will be suitable. Turn the switch on, adjust the emitter resistor for maximum output, and then set the meter needle to about three quarters of full scale

with the meter control potentiometer. Couple the coil of the "Transdipper" *tightly* with the circuit under test and swing the tuning dial slowly over its range. A large dip will occur at resonance. The tight coupling, however, will throw the dial calibration off slightly; the instrument should be backed away, therefore, until only a small dip is observed.

If difficulty is experienced with false dips, readjustment of the emitter condenser or the emitter resistor will help. Locate the largest false dip and maximize output on that frequency. When reasonably high-"Q" circuits are checked, the real dip at resonance is unmistakable provided tight coupling is used.

Like conventional grid-dip oscillators, the "Transdipper" may be used as a wavemeter, signal generator, and field-strength meter, and for the determination of values of L or C when one set of values is known.

When the "Transdipper" is used as a wavemeter, leave the switch in the "on" position and gradually approach the source of r.f. The meter will peak sharply at resonance.

Finally, the author wishes to express his appreciation to R. M. Cohen, A. L. Cleland, and D. R. Baird of the RCA Tube Department for their valuable suggestions and helpful assistance.

REFERENCES

1. Endres, R. O., Moore, R. P., & Oser, E. A.: "Transistor Oscillators," *RCA Review*, September 1952.
2. Turner, Rufus P.: "Care of Transistors," *Radio & Television News*, February 1953.

-30-

Fig. 3. The "Transdipper" is built in half of an ICA "Flexi-Mount" case; other half holds batteries. The positive battery posts are grounded to case by phosphor-bronze springs. Another phosphor-bronze strip contacts the "B-Minus" connection post near the meter. C_1 is mounted on a bracket secured by S_1 .

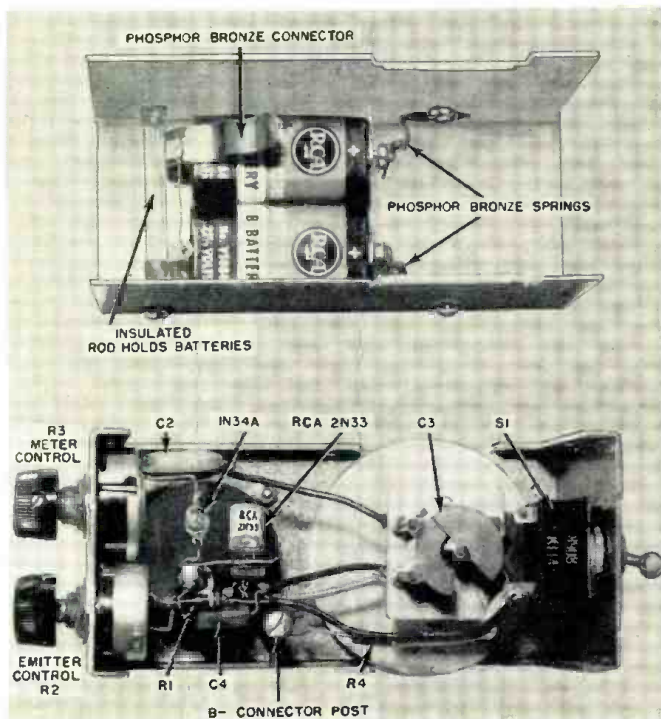
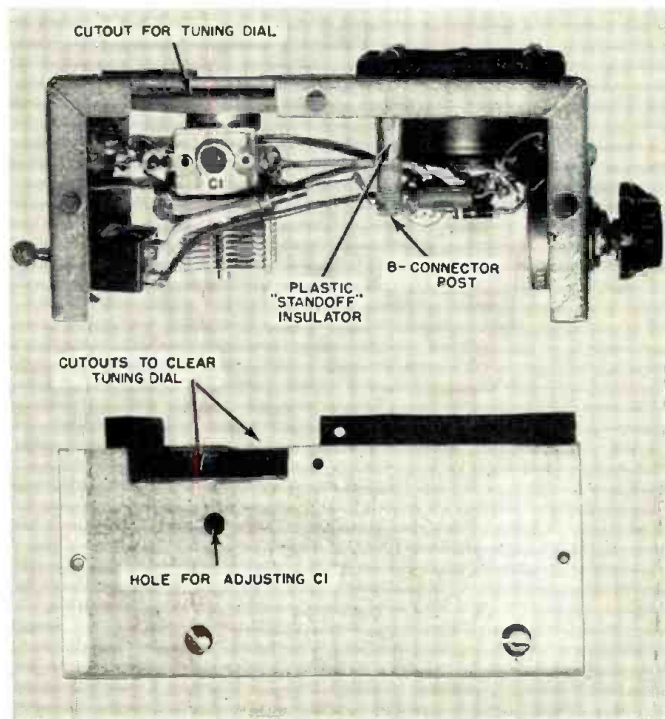

Fig. 4. Side views of the box sections, showing cuts necessary to clear the tuning dial. As the rotor of C_1 is grounded, C_1 may be mounted directly on the side of the box with the dial outside, eliminating cutting. C_1 , the emitter condenser, is visible in this view. Its adjusting hole is on other cover.



KNOW YOUR 1954 GENERAL ELECTRIC

TV RECEIVERS

By

JACK NAJORK

District Service Supervisor
Radio & TV Dept., General Electric Company

ALL 1954 *General Electric* television receiver models incorporating the feature "Ultravision," use the "EE" chassis described in this article and shown in Fig. 1. This chassis, as well as the standard "F" chassis, are manufactured by a relatively new, mechanized, dip-solder process. Since many service technicians are not familiar with this process and are, therefore, uncertain as to what repair techniques to use when removing or testing components, a brief description of this soldering system follows.

Referring to Fig. 2, four basic steps are involved. For simplicity, the cross-section of only one joint is shown. In actual production, approximately 400 of these joints are soldered simultaneously. The joint base consists of a hollow pin secured to a textolite board; the board, in turn, being riveted to the main chassis deck. These details can be seen from Fig. 1.

In the first assembly step, component leads and wiring are inserted into the pins while the chassis is in an inverted position. When all wiring and components are in place, the completed chassis, still inverted, is dipped into a pool of hot flux. Capillary action draws the flux up into the pin. In the third step, the chassis is dipped into a molten solder pool and capillary action again draws the solder up into the pin. Excess leads are trimmed after the solder has hardened, in the fourth step, and the joint is completed.

In replacing or removing components, the dip-joint can be softened and resoldered from the bottom of the chassis with a small-tipped soldering iron or soldering gun, and the lead pulled out from the hollow pin with long-nosed pliers. The small mass involved, plus the freedom from the usual twisting and crimping of leads, makes this an easy operation. On ground pins, more heat is required because the pin is directly secured to the metal chassis.

General Circuitry

The "EE" chassis and v.h.f. tuner, Figs. 3 and 6, employ an improved headend using two r.f. stages with low-noise, grounded-grid input; four video i.f. stages; automatic noise cancellation, horizontal and vertical retrace blanking, and delayed keyed a.g.c.

The built-in, continuous-tuning u.h.f. converter (designated "U.H.F.

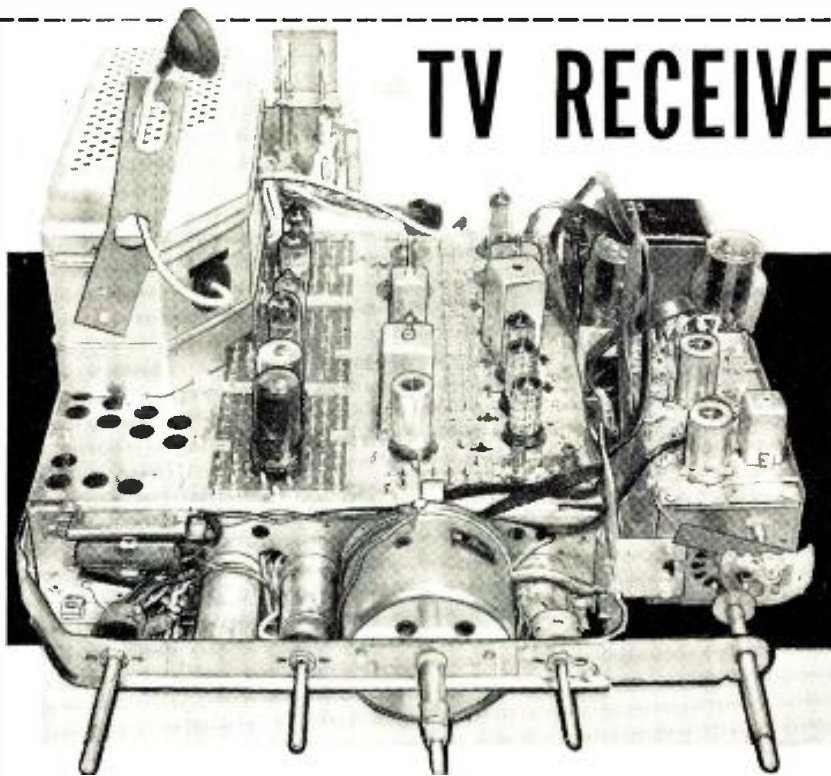

Fig. 1. The G-E dip-soldered "EE" chassis, used in its new TV line.

Complete service data on the new G-E TV sets, including circuit theory, schematic diagram, and service hints.

70") has, in addition to the continuous tuning range, two "click" positions which can be preset to any two u.h.f. stations.

Head end: The essential features of the "A/K" headend used in previous *General Electric* chassis have been retained in the unit employed with the "EE" chassis. This unit is a switch-type tuner, as can be seen from Fig. 1; its schematic diagram is shown in Fig. 6.

One section of a 6BK7A (early production models use a 6AB4) is

used as a low-noise, grounded-grid input stage. The second section of this tube is not used. To obtain the best possible signal-to-noise ratio, the input stage is run wide open at all times; that is, a.g.c. voltage is not applied. The second r.f. stage, a pentode-connected 6AK5, receives a.g.c. voltage from a delayed system. Hence, this stage operates at full gain in weak-signal areas, delivering sufficient signal to the mixer (V_{100n} , $\frac{1}{2}$ 12AT7) to override mixer tube noise and, on stronger signals, the a.g.c. delay is removed and the gain of the 6AK5 is reduced.

The output of the mixer is coupled to the first i.f. stage via a low impedance coaxial cable. This form of coupling, together with thorough shielding and lead filtering, reduces oscillator radiation to a minimum.

A 40 to 50 mc. trap, L_{100} , in the 6BK7A input stage suppresses signal pickup in the i.f. range and is factory adjusted to 43 mc. In localities where extremely strong signals in the i.f. range are present, added attenuation can be achieved with a shielded, plug-in type high-pass filter which plugs into the headend input terminals at rear of tuner. This filter is normally not supplied with the receiver but is available from *General Electric* distributors, should it be required.

Fig. 2. The four basic dip-solder steps.

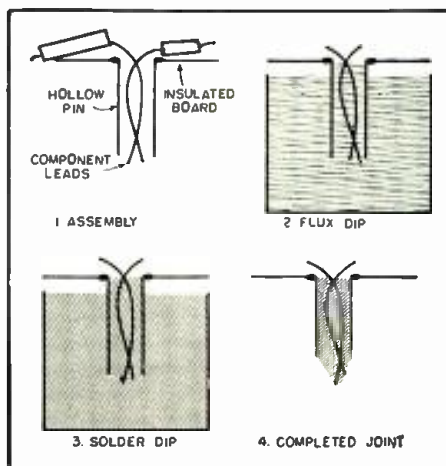
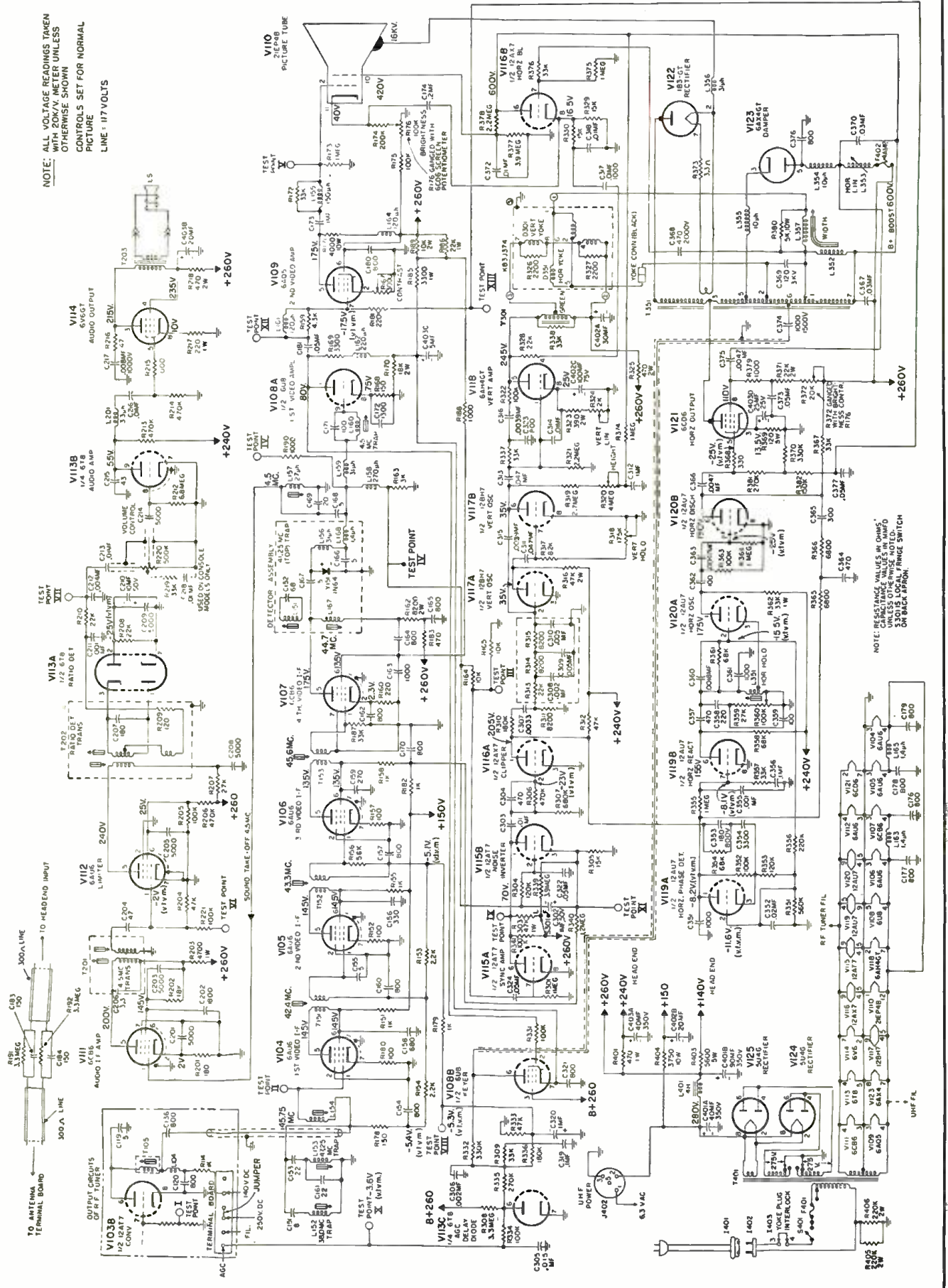

Fig. 3. Schematic diagram of the General Electric "EE" chassis. The tuner schematics are shown in Figs. 5 and 6.

NOTE: ALL VOLTAGE READINGS TAKEN WITH 20K Ω METER UNLESS OTHERWISE SHOWN
 CONTROLS SET FOR NORMAL PICTURE
 LINE: 117 VOLTS



NOTE: RESISTANCE VALUES IN OHMS UNLESS OTHERWISE SHOWN
 330 IS LOCAL FRINGE SWITCH ON BACK BOARD.

Servicing note: When replacing the "A/K" headend in the field, the technician should make certain to wire the jumper into the power terminals on the headend that supply 250 volts to the input stage. Omission of this jumper, shown on the headend schematic, will cause extremely "snowy" reception in all but very strong signal areas.

I.F. channel: With the exception of the low-impedance input circuit, bifilar-wound, single-tuned transformers are used throughout the stagger-tuned i.f. amplifier (see Fig. 3). Elimination of the RC time-constant in the grid circuits contributes materially to improved noise characteristics by removing the possibility of grid-blocking. An a.g.c. voltage is applied to the first three i.f. amplifier tubes.

Three traps, tuned to 47.25 mc. (adjacent sound), 41.25 mc. (own sound) and 38 mc. (adjacent picture) are incorporated in the i.f. amplifier.

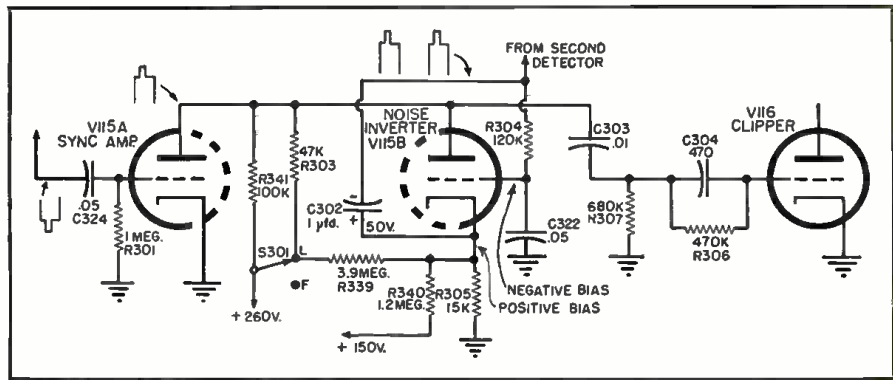

Fig. 4. Partial schematic diagram of the noise inverter circuit used in the G-E "EE" chassis. As shown here, sync pulses are fed to the inverter from two sources.

Since adjacent picture interference normally falls at 39.75 mc. the question arises, "Why trap 38 mc.?" Field experience has shown that, in nearly every case, adjacent-channel picture interference is encountered in

fringe areas where the desired signal is weak and the interfering signal is strong. Under such conditions, the receiver's fine tuning control is usually adjusted so that the desired picture carrier rides on the top of the i.f. re-

Table 1. Alignment procedure for the video i.f. and sound circuits of the G-E "EE" chassis.

VIDEO I. F. ALIGNMENT						
STEP	SIGNAL GENERATOR FREQUENCY	CONNECT TO	OUTPUT INDICATOR	CONNECT TO	ADJUST	REMARKS
1	41.25 mc. unmodulated	Junction of L ₁₅₄ & R ₁₇₈ & chassis	Oscilloscope	Test Point 5 (CRT grid)	L ₁₅₁ for minimum	Refer to the notes under alignment in the text
2	47.25 mc. unmodulated	Same as above	Same as above	Same as above	L ₁₅₃ for minimum	May require maximum oscilloscope vert. gain
3	38.0 mc. unmodulated	Same as above	Same as above	Same as above	L ₁₅₂ for minimum	Same as above. If insufficient "null" is obtained turn core of L ₁₅₄ two or three turns into coil
4	4.5 mc. unmodulated	Test point 4 (diode load)	Same as above	Same as above (see remarks)	L ₁₆₀ for minimum	Connect network shown in Fig. 8 between scope input and receiver test point 5. Remove V ₁₀₇
5	44.0 mc. center freq. 10 mc. sweep	Test point 2 and chassis through .001 μfd. condenser	Same as above. Calibrate vert. gain of scope to provide 2-in. deflection for 1½ volt peak-to-peak input signal	Test point 3 (junction of R ₁₆₄ & R ₁₆₅)	T ₁₅₁ , T ₁₅₂ , T ₁₅₃ , & L ₁₆₇ for waveform below— 	Picture contrast control should be set to minimum. Apply a negative 6-volt battery bias to test point 8; connect positive lead to chassis
6	44.0 mc. center freq. 10 mc. sweep	Test point 1 & chassis through .001 μfd. condenser	Same as above	Same as above	L ₁₅₄ and T ₁₀₅ (r.f. tuner) for waveform below— 	
SOUND I. F. ALIGNMENT						
7	Tune in a local TV station	V.T.V.M.	V.T.V.M.	Test point 6 & chassis	L ₁₅₇ & T ₂₀₁ (top & bottom) for maximum	Voltage to be read is negative with respect to chassis
8		Same as above	Same as above	Pin 2, V _{113A} & chassis	T ₂₀₂ primary (bottom) for maximum	
9		Same as above	Same as above	Test point 7 & center of two 100,000 ohm resistors, see Fig. 9	T ₂₀₂ secondary (top) for zero d.c. output	Remove 100,000 ohm resistors after alignment

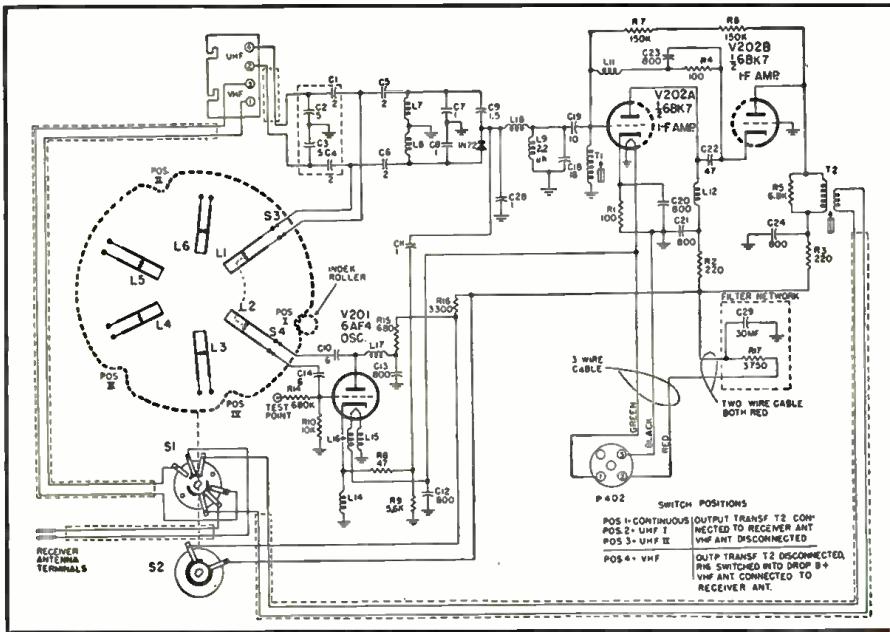
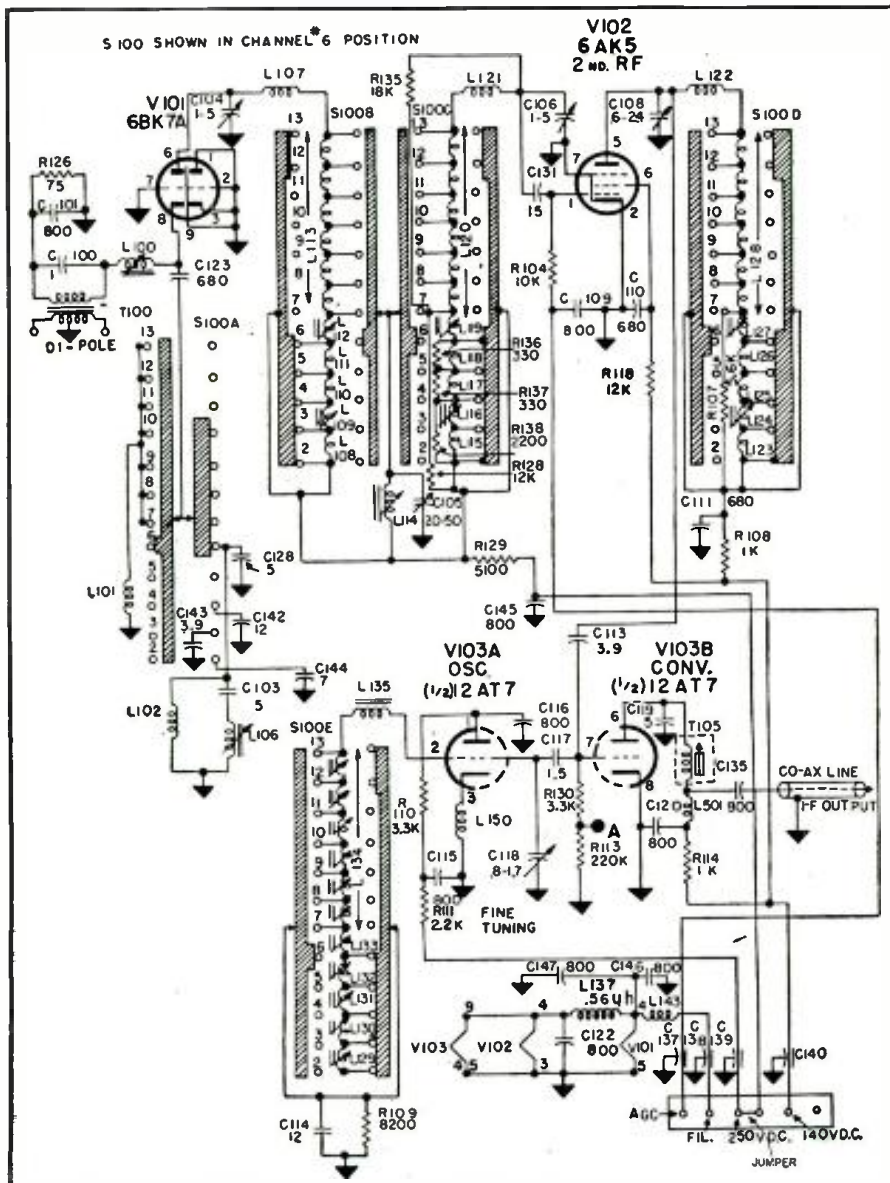

Fig. 5. Schematic of the G-E "U.H.F. 70" converter used with the "EE" chassis.

Fig. 6. Schematic diagram of the v.h.f. tuner of the General Electric "EE" chassis.



response curve to obtain more video output. This point on the i.f. curve generally falls around 44 mc., as shown in Fig. 7. This deliberate mistuning of the receiver also changes the i.f. frequency which corresponds to the interfering adjacent-channel picture carrier. Thus, if the normal picture i.f. is 45.75 mc., then adjacent-channel picture equals 39.75 mc. If, however, the picture carrier is set to 44 mc., the adjacent-picture frequency becomes 38 mc. Hence, fringe tuning will drop the adjacent-channel signal into the 38 mc. trap, whereas a 39.75 mc. trap would be ineffectual.

The approximate alignment frequency for each i.f. transformer is shown on the schematic, Fig. 3, to facilitate visual alignment adjustments only. The use of an AM generator and single-frequency peaking is not recommended for over-all i.f. alignment. The AM generator can be used, however, to adjust the traps.

Second detector and video amplifier: Both 4.5 mc. sound and composite sync are taken off at the second detector, a 1N64 germanium diode. The sound signal is taken off through the 4.5 mc. tuned circuit $L_{187}-C_{169}$, and then fed into the 4.5 mc. i.f. amplifier, limiter, and ratio detector.

An a. c. coupling is used in the two-stage video amplifier which consists of the triode section of a 6U8 and a 6AQ5 (later production models use a 6CL6).

Noise inverter: Composite sync and video are amplified in V_{115A} , $\frac{1}{2}$ a 12AT7, and fed across the noise inverter to the clipper stage, V_{118A} .

The noise inverter, as the name implies, actually inverts and cancels completely all noise pulses which exceed the tips of the sync pulse. This circuit should, therefore, not be confused with other sync-stabilizing arrangements which simply clip or limit noise pulses to the sync level.

Referring to Fig. 4, the noise inverter tube receives bias from two sources. A fixed, positive voltage is applied to the cathode through two networks made up of $R_{310}-R_{305}$ and $R_{303}-R_{239}$. Negative voltage which varies with the average signal level is fed from the second detector to the grid of the noise inverter through R_{301} . These bias voltages combine to virtually cut off the noise inverter tube in the presence of strong, noise-free signals.

In addition to supplying bias to the noise inverter grid, the second detector also feeds, from the same source point, a negative-sync signal through C_{302} to the cathode of the noise inverter. A strong noise pulse exceeding sync-tip level at the detector will, therefore, drive the cathode of the noise inverter less positive, causing the tube to conduct heavily. At the instant of conduction, the plate-cathode circuit of the noise inverter looks like a low impedance. Since this low impedance path shunts the output of the sync amplifier, the

(Continued on page 152)

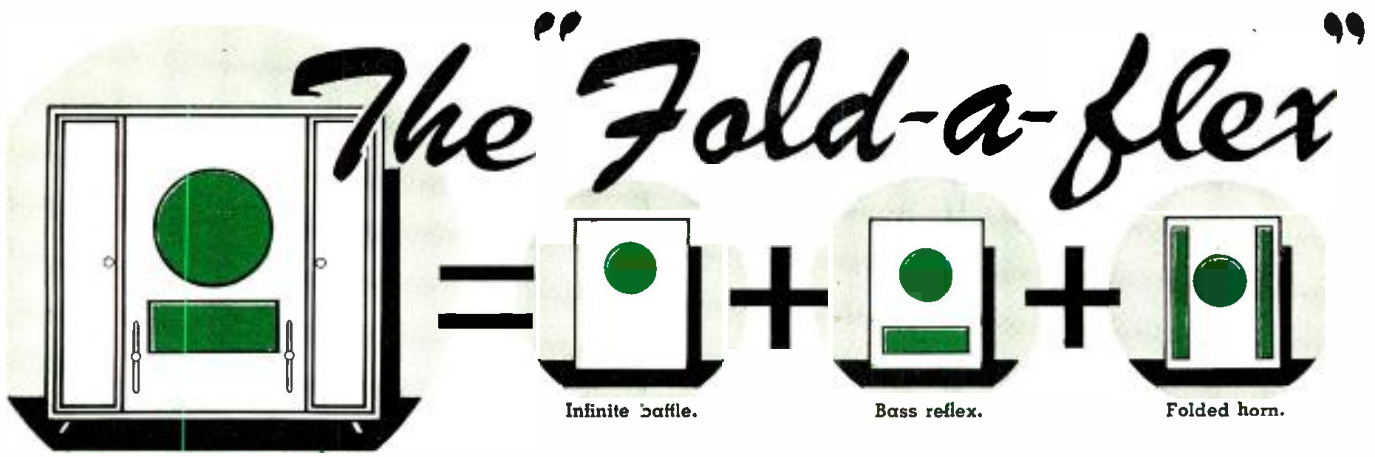

By
OLIVER READ*

An original design of an all-purpose loudspeaker enclosure † capable of providing the characteristics of: infinite baffle, bass reflex, or folded horn. Optimum performance of 12-inch or 15-inch speaker systems may be achieved by adjusting the variable port openings.

DEALERS in high-fidelity components and systems are daily confronted with the problem of choosing the proper enclosure for a quality speaker installation. Consumers, too, are very much in the dark when it comes to making the proper choice of an enclosure which will be best suited to their own room acoustics and to their particular listening criteria. The "Fold-a-flex," designed by the author, is the result of experiments begun early this year on an enclosure that could have its characteristics altered by some simple mechanical means. The READ "FOLD-A-FLEX," Fig. 1, and data accompanying this article shows how a choice of any one of the three most popular speaker enclosure types may be made.

Infinite Baffle

The design of a loudspeaker enclosure and the choice of amplifier impedance must be based on subjective judgments by the users as to what constitutes "quality" or perhaps simply listening "satisfaction." An important factor determining the transient response of a speaker and cabinet is the amount of damping. The damping may be changed by choice of amplifier impedance and by adjustment of the resistive component of the impedance. The first design criterion which we should attempt to meet is to expand the low-frequency response to as low a frequency as possible. This means that the value of the compliance for the loudspeaker housing should be made as large as possible so that the compliance of the loudspeaker suspension sets a resonant frequency. The tables for a completely enclosed box recommend a volume of 10 cubic feet or more for a 15-inch loudspeaker. The "Fold-a-flex" provides this type

(Continued on page 176)

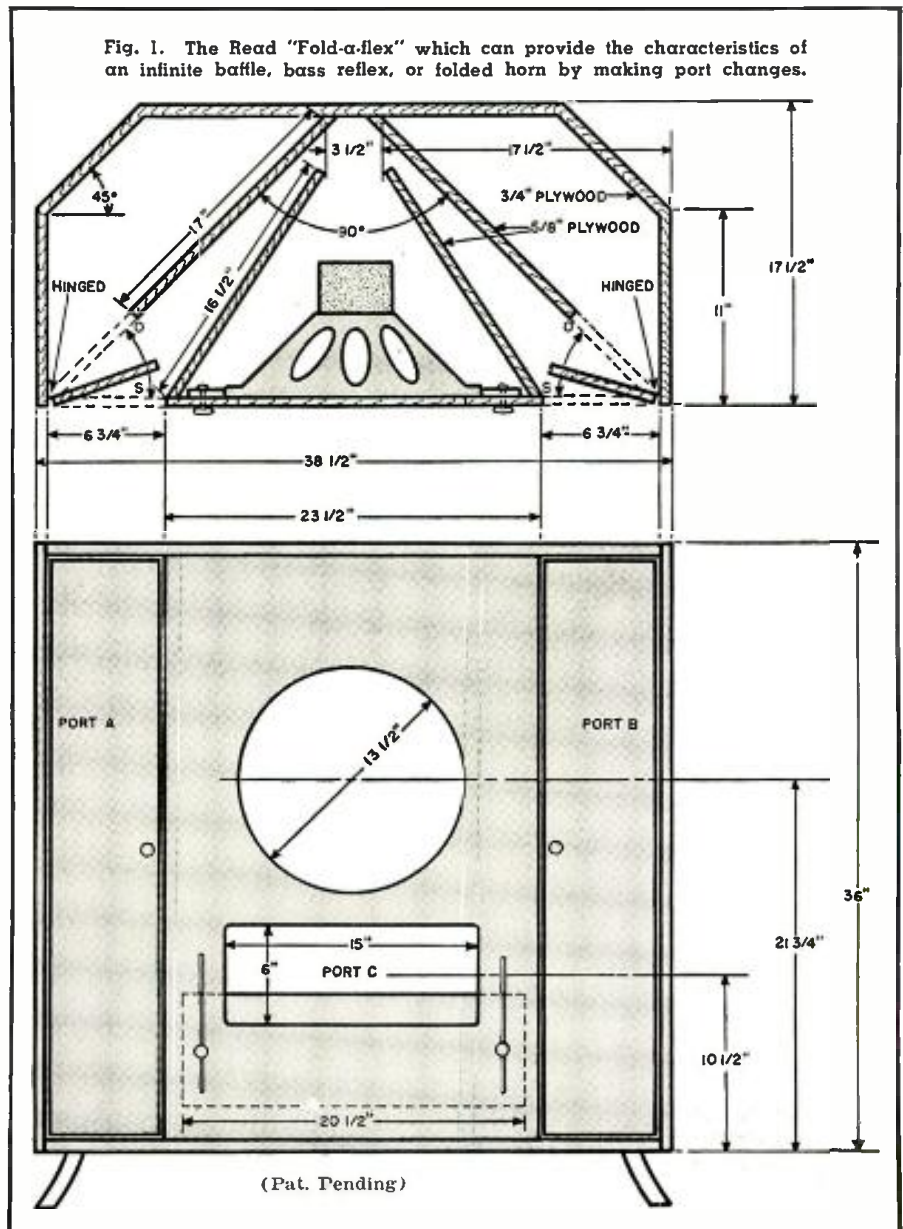

* Editor and Assistant Publisher, RADIO & TELEVISION NEWS, RADIO-ELECTRONIC ENGINEERING. † Patent Pending

A TRANSISTOR TIMER

By LOUIS E. GARNER, JR.

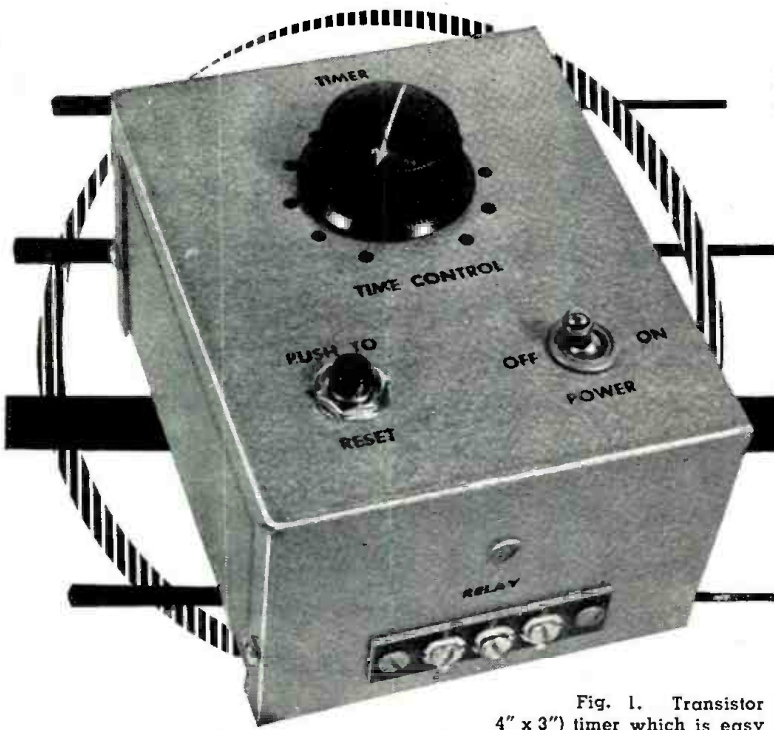

Fig. 1. Transistor (5" x 4" x 3") timer which is easy to operate, easy to build, rugged, and compact.

A "natural" for the photo lab, this timer requires no external power source and offers a wide selection of timing intervals.

MOST electronic timers suffer from two disadvantages—they require a source of line voltage and they become extremely warm when left on for any length of time. Both disadvantages result from the necessity of using vacuum tubes and comparatively high voltages.

Although the necessity of having line voltage available seems like a small problem, occasions do arise when it is desired to control (turn "off" or "on") battery-operated or portable equipment over pre-determined time intervals.

The second disadvantage mentioned is of real importance in some applications. Anyone who has worked in a darkroom in summer soon realizes that *any* heat is too much! Yet it is in the photographic darkroom that a large percentage of electronic timers are employed.

With these problems in mind, an effort was made to design a timer that would meet the following specifications: (a) Simple in construction and wiring; (b) Easy to operate; (c) Completely self-contained, using no line power; (d) Generating as little heat as possible; (e) Rugged, yet compact. The result is shown in Fig. 1.

The timer shown in Fig. 1 is reasonably small (over-all dimensions of the case are 5" x 4" x 3") and lightweight, requires no line voltage, is easy to operate (only three controls—"Power" switch, "Reset" button, and "Time Control"), produces virtually no heat in its operation, and

yet is fairly simple to wire (refer to the schematic diagram of Fig. 2).

All of these features have been made possible by employing a *Raytheon* Type CK722 junction transistor as a control element in place of the usual vacuum tube and providing for battery operation. Battery life is unusually long, since the maximum current drain is only slightly over a milliampere, and this only for short periods. In fact, the battery life should equal the normal "shelf life" of the units.

Circuit Description

The operation of the circuit is not at all complex, as can be readily observed by reference to the schematic diagram of Fig. 2.

In operation, when the "Power" switch, S_2 , is closed, current can flow through R_2 and R_1 , charging condenser C_1 , and permitting a momentary surge of base current. The base current flow, in turn, permits collector current to flow, closing the relay.

As soon as condenser C_1 is charged, the current flow over the R_2 , R_1 , C_1 and the base-emitter path ceases. The drop in base current flow to virtually zero results in a corresponding drop in collector current flow, permitting the relay to open or "drop out."

The time period in which the relay "holds in" depends on the period of collector current flow, which, in turn, depends on the period of base current flow, and hence on the time it takes condenser C_1 to charge. This,

in turn, depends on the time constant of C_1 , R_1 , R_2 and the base-emitter impedance.

If any of the parameters in the RC charging circuit thus formed are changed, then the time interval may be changed. In practice, an adjustable time interval is obtained by using a rheostat for R_2 , keeping R_1 at a small value simply to limit base current flow and hence to protect the transistor. However, if fixed time intervals are desired instead of a continuously adjustable control, a single fixed resistor may be used in place of R_1 and R_2 , and different values of C_1 chosen by using a conventional selector switch.

Once the unit is "set-up" for operation as described, the desired "timing interval" is selected by adjusting R_2 . The "Reset" switch, S_1 , is then depressed, shorting out and discharging C_1 . When the "Reset" switch is released, C_1 starts to charge again and the relay closes, opening again after C_1 is charged. The timing interval may be repeated as often as desired simply by depressing and releasing the "Reset" button.

The layout and parts arrangement used by the author are readily seen by referring to the interior and exterior photographs of the model, given in Figs. 3 and 1, respectively. As is easily seen, no attempt was made to "miniaturize" the model and hence there is no crowding of parts. Because of this, wiring the unit should be simple, even if the builder is not highly skilled.

Leads can be any length desired, and the builder may use either "point-to-point" or "right-angle cabled" wiring, or a combination of both, as he prefers.

Although the author wired the transistor directly into the circuit, soldering the leads, the builder might prefer to use a socket—an ordinary 5-pin flat subminiature tube socket is employed. Should the builder follow the author's practice, however, take care to keep the transistor leads at least an inch long and do the soldering as quickly as possible to avoid overheating and damaging the transistor. Use the same "safety rules"

that are followed when working with germanium diodes.

The author's model was assembled in a standard *Bud* "Minibox" (5" x 4" x 3"), but the unit may be built in any way preferred by the reader. A plastic, or even a wooden, box might well be employed.

Should the reader wish to incorporate the timer circuit in some other piece of equipment, the entire assembly may be easily wired on a flat metal panel or on a small sub-chassis.

Inexpensive "rubber feet" were provided in the model shown by using thick rubber grommets, mounted in holes drilled in the back of the "Minibox."

The batteries were mounted by using a flat metal strap and two long 6-32 machine screws.

Parts Substitutions

Although the relay used by the author is moderately expensive, it is positive-acting, quite rugged, and can handle currents up to 5 amperes at 117 volts a.c. (ample for almost all uses). A less expensive or a more expensive relay may be substituted by the builder if desired; however, the following considerations should be kept in mind.

The relay should be positive acting. Another relay tried by the author had such a weak spring that the armature moved slowly from the "front" to the "back" position as the collector current dropped. Where a reasonable load is connected to the contacts, such slow movement would cause excessive arcing and pitting of the contacts.

The relay should be reasonably sensitive. A "very sensitive" relay is not required in this application. However, the relay should be capable of closing on five milliamperes or less, since 5 ma. is the maximum rated collector current for the CK722 transistor.

Battery voltage should be adjusted for the relay coil resistance and sensitivity. The relay used by the author has a 5500 ohm coil, requiring 5.3 volts d.c. to operate, hence the six volts provided by the battery is ample (there is little drop in the transistor when conducting). However, if a different relay is used, it may be necessary to use either greater or less battery voltage.

Resistor R_1 is used primarily to limit base current and hence its size is not too critical. As little as 500 ohms may be used here, although the larger resistor is preferred.

With the components specified in the parts list, the timing range is from slightly less than three to slightly less than ten seconds (ample for most photographic enlarger timing, where average paper is used). Shorter time intervals may be obtained by using a small condenser in place of C_1 , while longer intervals may be obtained by increasing the value of C_1 .

The timing range of another model, even using the parts values as given, may be found to vary somewhat from the values given due to tolerances in

components. Such variation should be considered normal and not as an indication that any part is defective or that wiring mistakes have been made.

Black decals were used to label the model. A "factory-built" appearance was obtained by spraying three coats of plastic on the front panel after applying the decal labels.

Operation and Adjustment

No attempt was made to calibrate the main "Timing Control" in the model. However, the average builder will undoubtedly wish to calibrate the control settings. This may be done accurately by using a stop watch to time the relay clicks and marking the dial settings accordingly.

If a stop watch is not available, reasonably accurate calibration may be obtained by using a "one-second" count — one-pause-two-pause-three-pause-four-pause-five, etc.

To use the unit, the following procedure may be employed:

(1) Connect the switch lead of the equipment to be turned "on" or "off" to the proper relay contacts.

(2) Turn on the "Timer" and wait until the relay drops out.

(3) Set the "Time Control" (R_2) to the desired time interval and press the "Reset" button. If another time interval is desired, press the "Reset" button a second time after the relay has dropped out. The interval may be repeated as often as desired simply by pressing the "Reset" button each time operation is desired.

(4) If a different time interval is desired, wait until the relay "drops out" (that is, until the unit is ready for recycling) and set the "Time Control" to the new time, pressing the "Reset" button to initiate operation. If the setting is from a longer to a shorter time interval, the "Time Control" should be moved *slowly* back, to prevent a current surge that may cause the relay to close.

If the relay specified in the parts list is employed, it should not be necessary to change the manufacturer's adjustment. If another relay is employed, however, some change either in spring tension or in armature position might prove necessary.

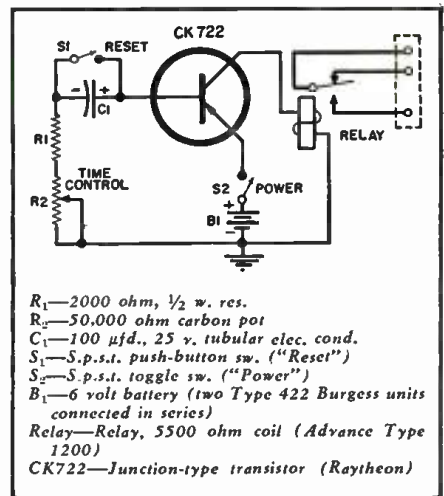

Fig. 2. Circuit diagram of transistor timer.

In general, the armature spring tension should be adjusted so that really positive action is obtained. If it is necessary to increase the spring tension to accomplish this, it may also be found necessary to change the armature spacing with respect to the pole piece in order to regain sensitivity.

The relay's sensitivity may be increased by adjusting the "front" and "back" contacts until the armature is moved *closer* to the pole piece. Sensitivity is reduced by moving the armature *away* from the pole piece (or increasing spring tension, or both).

Applications

One major application of a timer is in photographic work. In this field, the timer is especially valuable when making a series of identical prints. Once the proper time interval has been determined (using test prints or an enlarging meter), the timer may be set to this interval, and any number of additional prints made, almost "automatically."

The relay contacts are simply used as a switch to turn the enlarger or printing box "on" and "off."

Still another application of the timer is in scientific work and in chemistry, where it is desired to turn a heater

(Continued on page 187)

Fig. 3. Internal view of timer. Layout can be changed to suit the individual builder.

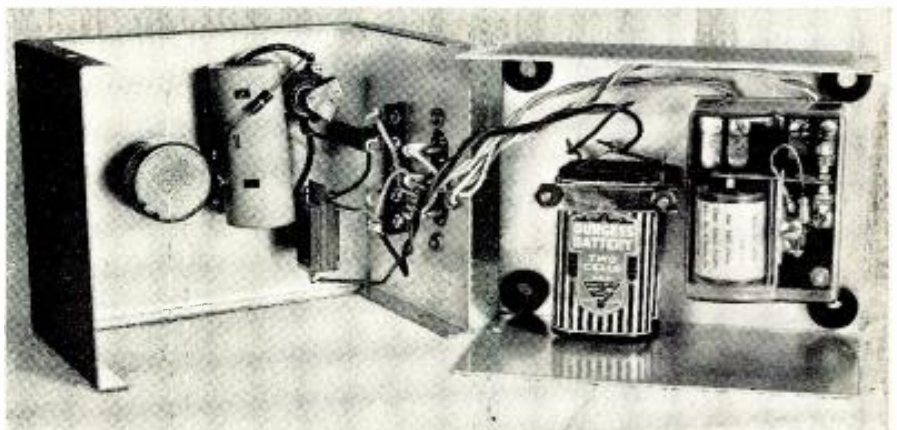

Certified
RECORD REVUE

By **BERT WHYTE**

HIGH FIDELITY OR HIGH FUTILITY?

THE National Association of Music Merchants held their annual convention not long ago, in Chicago. In many respects, this year's convention was more like the Audio Fair we are used to attending. Primarily, the NAMM is composed of the merchants who sell you your records and do a heavy business in the commercial phonograph field. You know the kind of stuff they sell—table model, 3-speed outfits from 25 dollars upward, mahogany monstrosities with a little single-ended amplifier hidden in its vast innards, and countless other gimmicks purporting to reproduce music from records. Well, the boys are hep now. They've got the word and the word is "High Fidelity."

According to reports, minutes after opening, the Palmer House staggered from the full-throated roar, the cacophonous melange of sound usually associated with the annual hoe-down at the Hotel New Yorker. Yep, "high fidelity" for the masses is here. At least that is what our music merchandiser friends would have you believe. "Billboard" reported on the show thusly, "the boom is on," and this was quite literally true. Now don't get me wrong. I'm all for Joe Doakes getting more music for his moola. But if the irresponsible advertising blurbs continue, irreparable harm will be done the cause of better music reproduction. Boy, they hung the "high-fidelity" handle on anything that revolved and had a stylus. In all fairness there were many units offered that, considering their modest price, did a remarkably good job. But by and large, the boys just went overboard on the "high-fidelity specifications" of their music boxes. One of the most flagrant and blatant blurbs went something like this: "... most commercial (get that!) high-fidelity phonographs only reproduce between the ranges 50 to 15,000 cycles. Our unit has full-frequency response from 20 to 20,000 cycles. Get this added plus when you buy! . . ." This claim for a *table model* job with pint-sized amplifier and two miniscule speakers *a la Columbia 360*, is patently ridicu-

lous. Sure, it's very heartening and encouraging that high-fidelity sound reproduction is no longer an anathema to these record dealers, and that the public is increasingly aware of its blessings. But the only purpose to be served by these reckless and misleading claims is the alienation of the public and their general distrust of *all* high-fidelity equipment. It is probably useless to ask these manufacturers to police themselves and be less flamboyant in their claims and advertising. They should remember that eventually the public will wise up to almost anything and when they do—Look out! Unfortunately for the cause of high fidelity and better reproduction, the damage will have been done and we'll have to pick up the pieces and start all over again. It is too bad the avariciousness of a few must taint the many who are sincere and ethical in their business practices.

Equipment used in reviewing this month's records includes: *Weathers* pickup, *Fisher* master control, *Fairchild* turnable, *Cinema Engineering* equalizer, *McIntosh* 50-watt amplifier, and *Altec* 800 series loudspeaker system.

Note to those concerned: *Victor* and *Columbia* as two of the major companies certainly deserve representation on these pages. But I wish their respective review departments would get on the ball. To make this month's deadline I had to *borrow* their recordings herein reviewed.

SMETANA

MY FATHERLAND

Chicago Symphony Orchestra conducted by Rafael Kubelik. Mercury OL-2100, 33 1/3 rpm, AES curve. Price \$5.95.

"Monumental" is a word so often used by critics, that it becomes almost a cliché. Be that as it may, monumental is the most fitting description for this great music and great recording. There have been several other complete editions of this work, none of which were anything near definitive, from the standpoint of either recording or performance. This present edition should stand unchallenged. Most people are familiar with

the famous sections of the work notably "Der Moldau," and "Bohemia's Meadow and Forest." To overlook the other sections of the work is to deprive yourself of a very rewarding musical experience. Rafael Kubelik's conducting is obviously a labor of love. Himself a Czech, he has projected taste and deep feeling into the score without wallowing in nationalistic fervor as many conductors are prone to do when performing works from their countries of origin. The sound on this disc is magnificent. Smetana's score is such as to evoke tremendous sonorities from the orchestra. In this recording not only can you hear them, you can feel them. Very deceptive music, too. In the movement entitled, "Tabor," the music starts very quietly, almost dirge-like, begins to expand dynamically, and then gradually builds up to one of the most ear shattering tympani rolls yet recorded. Throughout the disc the recording is beautifully clean, with brass and percussion finely delineated and with some exceptional woodwind playing, especially that of Julius Baker on the flute. With equalization set at AES, no touch up was needed on the bass or treble controls. Record surfaces were quiet. A note of warning: The writing in this work is rather thick textured at times, and for this reason should be played as close to full room volume as possible to preserve proper dynamic balance. *Mercury* urges this practice on the back of their record jackets, and it is especially true in this particular recording.

CHARPENTIER (MARC-ANTOINE)

TE DEUM, MARCHÉ DE TRIOMPHE, and OTHER SELECTIONS
Orchestra of the Concerts Pasdeloup with Choral Group conducted by Louis-Martini. Haydn Society HSL 2065, 33 1/3 rpm, NARTB curve. Price \$5.95.

We are concerned here mainly with the "Te Deum," although the other pieces are well played and quite interesting. Many people have preconceived notions about sacred music and avoid such things as Masses and Te Deums like the plague. If you've been like that, give this disc a try. It would be hard to understand why anyone who loves music could turn a deaf ear to this fabulous work. Charpentier's music has been mouldering in oblivion for nearly 300 years. This "Te Deum" is more than worthwhile evidence of the wisdom of those who resurrected the score. For this is music in the "grand manner." It is music that generates a tremendous excitement, with its rousing high-register trumpets and tympani flourishes. For good measure you have a full-throated organ and some magnificent choral work. Those of you who have outfits with big speaker systems will find this quite an experience. The recorded sound generally is good, especially the brilliant trumpet work. If I must quibble about the somewhat

(Continued on page 197)



Fig. 1. Over-all view of an improved version of the well-known Kappler amplifier.

IMPROVED KAPPLER AMPLIFIER

By
CHARLES P. BOEGLI

A self-contained, low-cost amplifier for crystal or magnetic pickups, tuners, etc. It can be housed on a single chassis.

THE November 1950 issue of this magazine carried a description of an excellent single-chassis, 10-watt amplifier employing 18 db negative feedback around three stages and the output transformer ("A Flexible General Purpose Amplifier" by J. N. A. Hawkins). The design was the product not of one person but of many, each of whom contributed at various times over a period of some twelve years. Most important among such additions was an excellent direct-coupled phase inverter designed by M. O. Kappler, by virtue of which the circuit was called the "Kappler" amplifier. The unit, constructed at a very reasonable cost, provides sound of excellent quality. One of them, for instance, has been installed in the Films and Recordings Center of the Cincinnati Public Library and, even when played through a very mediocre speaker, listeners have agreed that the reproduction is good.

The fact that a single chassis supports the power supply, amplifier, and preamplifier makes for a simplicity that appeals to many music lovers, particularly since the layout of the unit makes this economy possible without undesirably high hum or noise levels. Actually, the greatest advantage of putting the preamplifier and power amplifier on a single chassis is that it can result in a substantial reduction in the noise level at a given output level by permitting the most favorable circuit location of the volume and tone controls, which is not economically possible in a separate preamplifier feeding a power amplifier capable of handling only about one volt. The degenerative type of tone control, for example, which as will be seen is capable of furnishing far more desirable boost characteristics than any other type, has a noise level sufficiently high to preclude its use in conventional separate preamplifiers¹ but in a single-unit am-

plifier it can be located so that its noise level is of no consequence and full advantage can still be taken of its distortionless control characteristics.

The unit previously described has nevertheless suffered from a few shortcomings; namely, a completely inadequate preamplifier (which was, however, equivalent to that included in most other single-chassis amplifiers), a rather unsatisfactory tone-control stage, a paucity of input jacks, and certain undesirable layout features. By retaining the excellent power-amplifier section of the original amplifier and completely redesigning the front end, the writer has developed the first unit to his knowledge that combines, on a single chassis, not only a power amplifier of surpassing quality but also a preamplifier and tone-control circuit filling the most exacting requirements for high-quality reproduction. The improved amplifier is shown photographically in Fig. 1, and schematically in Fig. 4.

Circuit Features

In order to handle discs with the (unfortunately) wide diversity of current recording characteristics, the preamplifier of the previous unit has been replaced by a simple dual-triode circuit utilizing straight-through equalizers, of the type described in previous articles.^{2, 3, 4, 5, 6} With only five condensers and ten resistors, the equalizing switch (Fig. 4 inset) compensates exactly for nine different recording characteristics. The features of this switch have been described in a previous article⁴ which also indicates the discs for which each position is to be used, and the precau-

tions to be followed in constructing the switch. The position of the switch on the chassis is critical in several respects: it must be placed well away from strong hum fields, that is, from the power transformer, and it requires enough room under the chassis to necessitate the careful location of adjacent components like tube sockets. The preamplifier tube itself, a 12AY7, must be situated quite close to the switch in order to avoid hum pickup in long interconnecting leads. Low-noise plate-load resistors should be used in the preamplifier stage if records are to be played with low-output cartridges like the *General Electric*.

Four input jacks are provided, two for tuners and one each for magnetic and crystal pickups. The latter two are properly loaded so that the entire preamplifier is used not only with magnetic cartridges but also with crystal pickups. With this arrangement, playback with a high-quality crystal pickup is often difficult to distinguish from that with a magnetic cartridge. The exact reason why such complicated equalizing systems are used in most preamplifiers for magnetic cartridges while the output of a crystal cartridge is subjected to no equalization whatsoever has never been very clear. The present circuit permits, for example, the use of a magnetic cartridge for 33.3-rpm discs and a crystal for 45-rpm records (the usual 45-rpm changer has a crystal pickup) with realization of excellent reproduction and full compensation of recording characteristics in each case.

The input switch is arranged so that when the tuner inputs are used the pre-

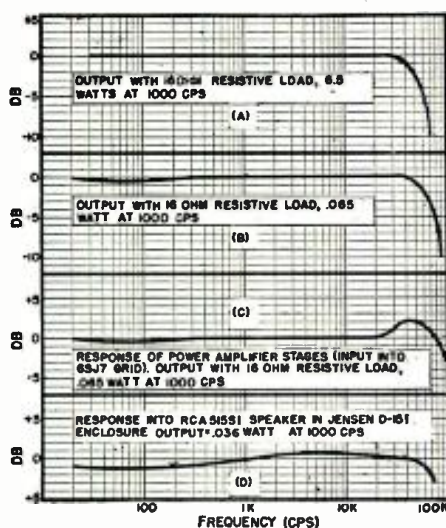

Fig. 2. (A, B & C) Response curves for amplifier with resistive load. (D) Response with RCA speaker housed in Jensen cabinet.

amplifier inputs are grounded. By means of simple resistive networks, average tuner input voltages are brought to a level comparable to the output from the preamplifier when a low-voltage magnetic pickup is used, so that large alterations in the volume control settings are not required when changing from phonograph to radio. At the same time, the tuner signal-source impedance at the 6SL7-GT grid has been made approximately equal to the output impedance of the last 12AY7 section, so that the high-frequency response attained with tuner input is substantially the same as that with phonograph input.

The size of the volume-control potentiometer has been carefully chosen so that, irrespective of its position, the high-frequency response is never down more than 3 db at 55 kc., even though the 6SL7GT stage suffers from the common complaint of all high- μ triodes, large input capacitance. The gain of the 6SL7GT is quite adequate without cathode bypassing but the bypass condenser is nevertheless required if a suitably low hum level is to be realized.

Tone control is accomplished by means of a degenerative circuit utilizing the second section of the 6SL7GT. The performance of this tone control is superior to that of a previously-described circuit¹ utilizing a low- μ triode because the bass and treble boosts continue to the very limits of audibility instead of leveling off at moderately low or high frequencies. The importance of this type of characteristic, particularly in the bass region, cannot be overestimated. The difference between this and other tone control circuits is most marked when playing organ recordings, which generally make heavy demands upon the low-frequency performance of the reproducing equipment. Other than the use of a high- μ triode this circuit is substantially the same as that described in the previous reference, and it has the same desirable simplicity of control. Use of low-noise load resistors is also desirable in this stage, particu-

larly in the cathode of the 6SL7GT. Direct current is blocked from the bass-control reactor by means of a large electrolytic condenser which, in a single-ended stage, cannot be eliminated; its presence sometimes causes a thump to be heard in the output when the bass control is twisted rapidly. Once the bass control is set, however, it has absolutely no adverse effects. It is important that the 6SL7GT tube be located very near the reactor and the tone controls to reduce noise pickup in the high-impedance circuits.

Tone controls of this type have generally been subjected to several criticisms, among which are hum pickup by the choke and "transient distortion" from the resonant circuit. The *Triad* A-75J choke used in the circuit has 45 db of shielding and a hum-bucking winding which virtually eliminates it from consideration as a source of hum. The presence of excessive transient distortion has never been demonstrated and it can furthermore be proven that the transient response of a circuit containing a resonant combination is exactly the same as that of a circuit utilizing only resistors and condensers, if the frequency responses of the two circuits are identical. With a degenerative tone control of the type described here, the "flat" position is always at the center of each control. This is not the case with the familiar RC tone control utilizing audio-taper potentiometers, with which flat response must generally be set with the aid of response-measuring equipment.

The output of the tone control stage is fed directly into the first tube of the power amplifier, the 6SJ7. Except for minor changes, the remainder of the circuit is the same as that of the previously-described unit. Specifically, the availability of an improved output transformer (*Triad* HSM-81) permits the elimination of the phase-correcting network that appeared across the transformer primary in the previous design. Other output transformers may of course be used but a phase-correcting network may again be necessary to avoid oscillation. The filter-condenser arrangement has been slightly altered.

By means of careful layout, the new amplifier can be accommodated on a chassis of the same size as the previous one. The input jacks are located on the side of the chassis away from the output tubes, which prevents troublesome high-frequency oscillation at high volume settings and the need for shielded cable for connections.

Fig. 3. The responses of the amplifier with tone controls in their extreme positions.

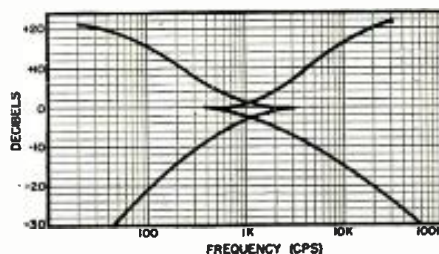

In order to make the underchassis wiring as compact as possible, vector turret-sockets are used for the 6SJ7, 6SL7GT, and 12AY7 tubes in the experimental amplifier. The remaining stages are simple enough to permit the employment of *Cinch* 8AB sockets, which mount in holes of the same size. Following the writer's preference, all stage grounds were made to the tube socket saddles, power transformer grounds were made at the power transformer, filter condenser cases were grounded to their mountings, and all other grounds were generally made to the nearest point.

The 117-volt leads going to the a.c. switch on the volume control have always been a troublesome source of hum. In an effort to reduce the hum radiation, a d.p.s.t. switch was installed on the volume control. Both sides of the 117-volt line were switched, and the leads going to the switch were paired and twisted. None of the buzzing type of hum usually introduced by 117-volt leads was present in the amplifier output; the improvement may possibly be attributable to this arrangement of the leads.

It is often quite desirable to replace slotted-head knob set screws with socket-head screws on the switch knobs. The latter can be screwed much more tightly and the twisting of the knob on the shaft, most troublesome with heavy-detent switches, is thus prevented.

Performance

The response of the amplifier connected for 16-ohm output and loaded with a 16-ohm resistor is shown in Fig. 2 for several output levels. Also illustrated in the same figure is a typical response curve for the power amplifier only; that is, with the input into the 6SJ7 grid. This latter response is to be compared to curves for such amplifiers as the Williamson, which include no controls of their own.

The response of the amplifier into a typical speaker load is shown in Fig. 2D. The speaker in this case was an RCA 515S1 housed in a *Jensen* D-151 enclosure. The absence of humps or peaks in the curve is particularly to be noted; it is an indication that the output impedance of the amplifier is sufficiently low for quality performance.

Responses with the tone controls in extreme positions are shown in Fig. 3. That the boost actions are quite uniform to the limits of audibility is obvious and particularly important for reasons previously given. The crossover at about 1000 cps has been chosen on the basis of Fletcher-Munson equal-loudness curves. Because of the powerful boosting action of the bass control in the lowest bass region, less use of the control will generally be required with this particular amplifier than with other amplifiers utilizing different types of controls.

The noise level of the completed unit will of course depend to a large extent upon the care taken in construction. For the experimental unit described

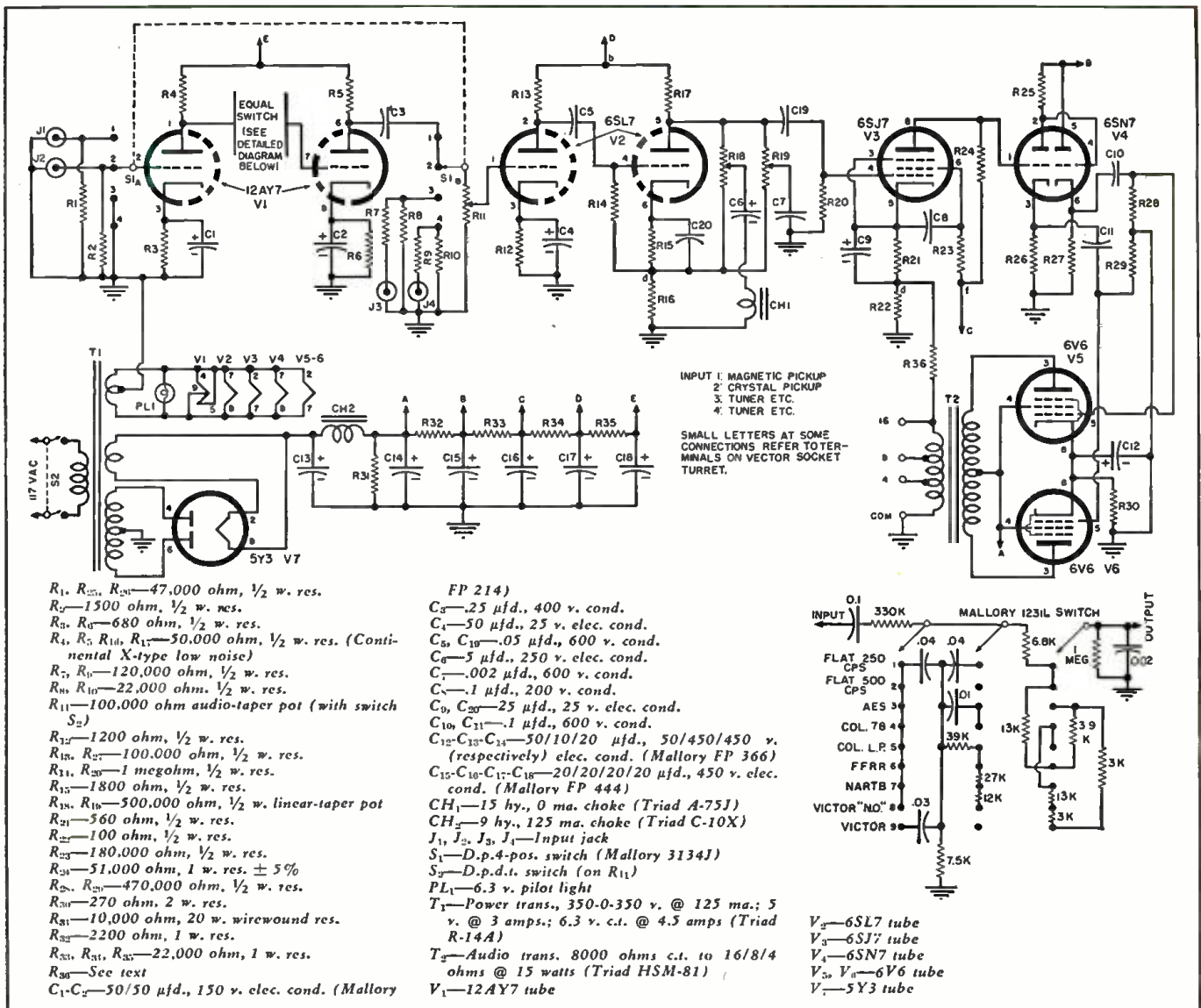

Fig. 4. Complete schematic of improved Kappler amplifier. Equalizer circuit is shown in the inset diagram above.

here, the noise level was 56 db below maximum output (10 watts) with tuner input and tone-controls in flat position. The noise level with preamplifier input corresponded to a noise input approximately 38 db below 10 mv. at the magnetic cartridge input jack. Thus, even with a *General Electric* pickup the noise is quite inaudible. Because of the large boost available at very low frequencies, turntables of low quality are apt to cause an objectionable amount of rumble in the output, and if this cannot be alleviated by procurement of a better turntable it may be advisable to reduce the size of the coupling condensers in the preamplifier stages. Some loudspeakers are easily overloaded by large low-frequency signals; this difficulty may be remedied by the same expedient used for excessive rumble. In both cases, the employment of high-quality components is the preferable alternative.

The minimum input to the magnetic-cartridge jack for full 10-watt output is .01 volt at 1000 cps. The tuner inputs require approximately 1 volt minimum. At the full output of 10

watts, the distortion remains very low (less than 0.5% from 40-40,000 cycles).

Feedback Circuit

Just a word or two on the feedback network. Except for the specified values for the feedback resistor, R₃₆, the circuit is conventional.

The loop itself includes V₄, V₅, V₆, and the output transformer, T₂. As shown in the diagram, Fig. 4, the feedback resistor is connected to the 16-ohm tap. If a 16-ohm speaker is used, the resistance of R₃₆ should be 1000 ohms. If an 8-ohm speaker is connected to the 8-ohm tap, R₃₆ should be 750 ohms, connected to the 8-ohm tap. The same holds true with a 4-ohm unit in which case R₃₆, 500 ohms, is connected to the 4-ohm tap.

Conclusions

The improved "Kappler" amplifier is tailored to the needs of individuals who want reproduction of superlative quality without investing heavily in multiple-chassis amplifiers and control systems. Wide frequency response and low distortion, coupled with the large

number of recording-characteristic equalizers available, place this amplifier ahead of current developments in other audio components like pickups and loudspeakers and insure it against early obsolescence.

Once the parts have been properly located on the chassis, the wiring of the unit is quite free from complications and the lead placements are not critical. Construction of the amplifier can thus be recommended to the audiophile interested in building his own equipment with a minimum of difficulty.

REFERENCES

1. Boegli, Charles P.: "The Degenerative Tone Control," *Radio & Television News*, June 1951.
2. _____: "A Preamp for Magnetic and Crystal Pickups" *Radio & Television News*, July 1950.
3. _____: "An Improved Equalizer-Preamp," *Radio & Television News*, April 1951.
4. _____: "Phono-Equalizer Chart," *Radio & Television News*, April 1952.
5. "The Radio & Television News Pre-amp," *Radio & Television News*, November 1952.
6. Boegli, Charles P.: "New Developments in Phono Equalizers," *Radio & Television News*, April 1953.

THE "LPRS" PREAMP CONTROL UNIT

By
JOSEPH M. DIAMOND

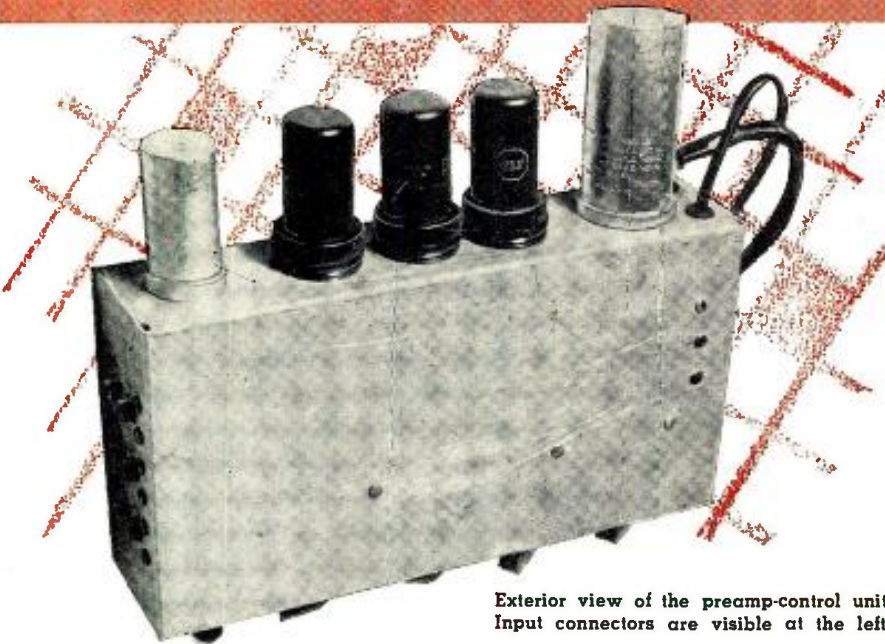

Exterior view of the preamp-control unit. Input connectors are visible at the left.

Developed for the Long Playing Record Society of New York, this unit incorporates many features of commercial units, including a loudness control. Three tubes are used with heaters connected in series. A d. c. voltage of about 38 volts is thus required.

THE unit to be described here was developed by the author for the Long Playing Record Society of New York and has proved to be reliable, easy to operate, and easy to build.

The essential requirements in a pre-amplifier-control unit include such features as:

1. Enough gain to drive a power amplifier such as the Williamson (2 volts r.m.s.) from the well-known low output magnetic cartridges (10 mv. r.m.s.), that is, at least 46 db.
2. Negligible hum, noise, and distortion
3. Adequate record compensation and tone control

In addition, features such as:

4. Stable operation without a separate power supply
5. A loudness control
6. Use of ordinary tubes and simple, inexpensive circuitry, and,
7. Reasonable freedom from microphonics

are also desirable for such a unit.

The fact that the preamplifier to be described can combine these features is due to the new tone control-record compensation circuit shown in Fig. 1. It is a single tube feedback circuit whose gain is determined by (and is roughly equal to) the ratio of the plate-grid impedance to the grid-input impedance. At mid-frequencies the $R_1 + R_2$ path is of very high impedance compared to the condensers, while $R_3 + R_4$ is considerably lower; therefore, the mid-frequency gain is determined by the ratio of the condensers as shown in Fig. 1B, and in the present case is approximately unity. The value of unity is not essential and only occurs here because it happens to permit the proper degree of bass boost with the 12SJ7 tube used. At the extreme low end (see Fig. 1C) the capacitive path disappears so that the gain is determined by the setting of the low frequency control (gain equals approximately R_2/R_1). At the extreme high end only R_3 and R_4 are still effectively in the circuit (Fig. 1D) so that the gain is determined by the setting of the high-frequency control (gain equals approximately R_4/R_3). Between the low-, mid-, and high-frequencies, the gain varies at a maximum rate of 6 db-per-octave. The circuit, therefore, has fixed mid-frequency gain and continuously variable low- and high-frequency gains, both cut and boost. It offers the following advantages in a preamplifier design:

Fig. 1. Tone control-record compensation circuits. (A) Continuous tone control. (B) Mid-frequency equivalent. (C) Low-frequency and (D) high-frequency equivalent circuits.

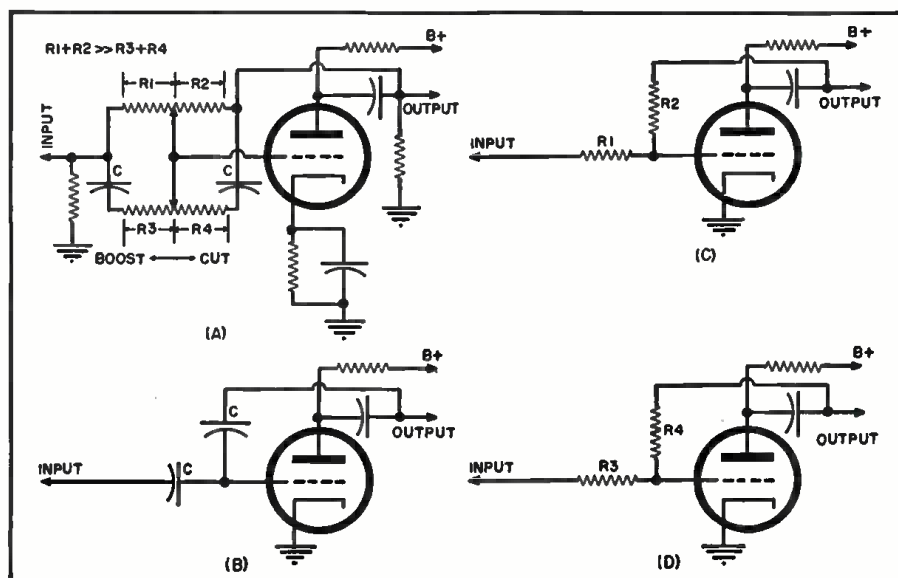

1. Because it is a feedback circuit it can provide a great deal of boost without distortion and without a very high input or low output levels.

2. Because control is continuous and the range is sufficient, the same circuit can be used for tone control and record compensation. In addition to eliminating a stage and front panel, the result is a simplification of the motorboating problem.

3. Both cut and boost are available. The component values used in the tone circuit are given in the parts list accompanying the schematic diagram of Fig. 2. The over-all preamplifier

frequency response curves are shown in Fig. 3. The very moderate degree of treble boost available (8 db) is due to the output impedance of the middle stage (100,000 ohms) which is effectively in series with R_4 at the high end. However, with magnetic cartridges the treble control is normally operated cutting so that the effective treble boost available is very large and quite adequate even for tuners. The treble cut curves vary from 6 db-per-octave starting at 1300 cps to more gentle roll-offs at higher frequencies—a desirable feature considering the indefinite state of high-frequency equalization.

Low-frequency turnover can be varied from 200 to 1000 cps with good response curves, except that the Columbia leveling off below 100 cps is not obtained (at least not until the speaker is reached). The 330,000 and 820,000 ohm resistors seen at either end of the low frequency control are inserted to limit the range of control which would otherwise be quite violent.

The Front End

Since the tone control stage has no gain, it is still necessary to supply at least 46 db, plus 6 db (to make up for the loss of the IRC loudness control, LC_1) for a total of 52 db. Two 12SJ7 stages are used to supply about 55 db, as shown in Fig. 2. The 12SJ7's, the first connected as a triode and the second as a pentode, are used instead of a high-gain double triode for the following reasons:

1. The 12SJ7 is capable of producing considerable gain in a low-impedance circuit; for example, when driving the tone control stage whose input impedance is fairly low when the controls are set for boost.
2. 12SJ7's are quiet, self-shielding, and uniform.
3. The input stage is triode-connected for lower thermal noise, the gain being adequate.
4. The use of three identical tubes in the preamplifier is a convenience in itself and permits the quietest tube to be placed in front, although little variation in tube noise has been found to date.
5. Stray pickup between the first two stages is low.

When driving a Williamson amplifier under typical high-gain operating conditions (bass boosted, treble flat or cut, gain full) the residual noise is a barely audible low-frequency whirring sound, probably due to cathode flicker. High-frequency hiss is perceptible but weaker and there is no hum whatsoever, since there is no a.c. on the chassis—even the power switch is placed elsewhere. The noise output is so low, in fact, that high-level inputs (tuners, crystal pickups, etc.) are fed into the input stage through voltage dividers to avoid the more complicated switching involved in cutting out the first stage (a voltage division of 10- or 20-to-1 is convenient to avoid overloading the first stage).

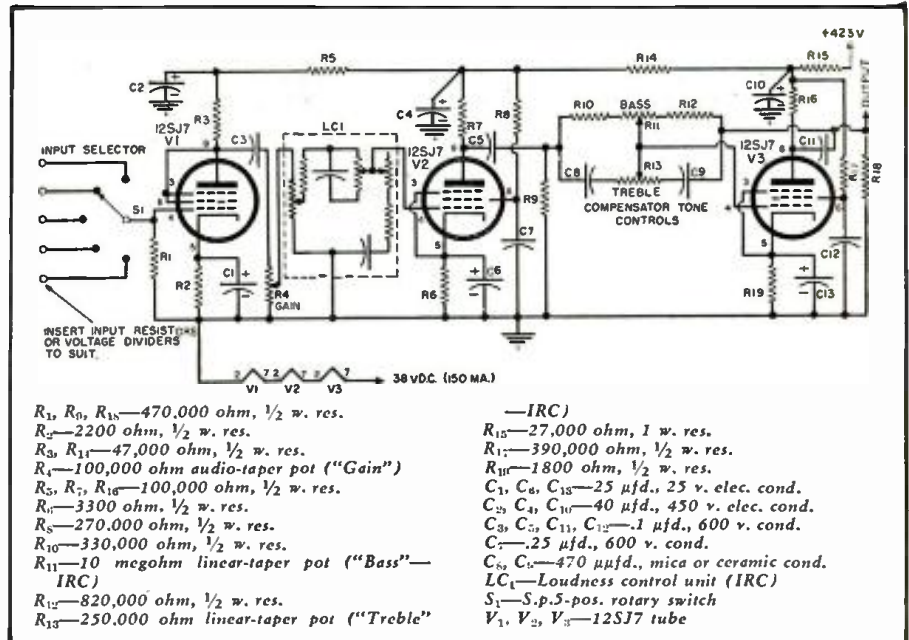

Fig. 2. Complete schematic diagram and parts list for preamplifier-control unit.

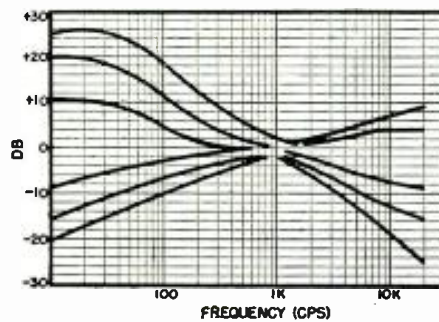

Fig. 3. Over-all preamp response curves.

As a result, the input switching is very flexible, and as many as eleven inputs can easily be provided with a
(Continued on page 106)

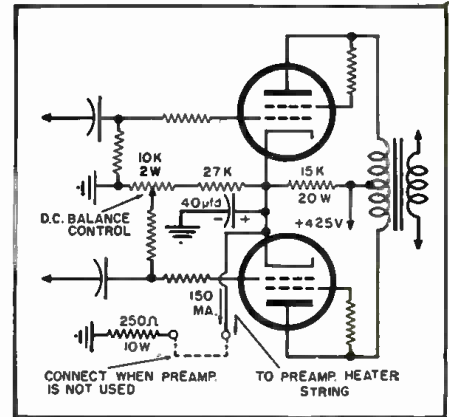
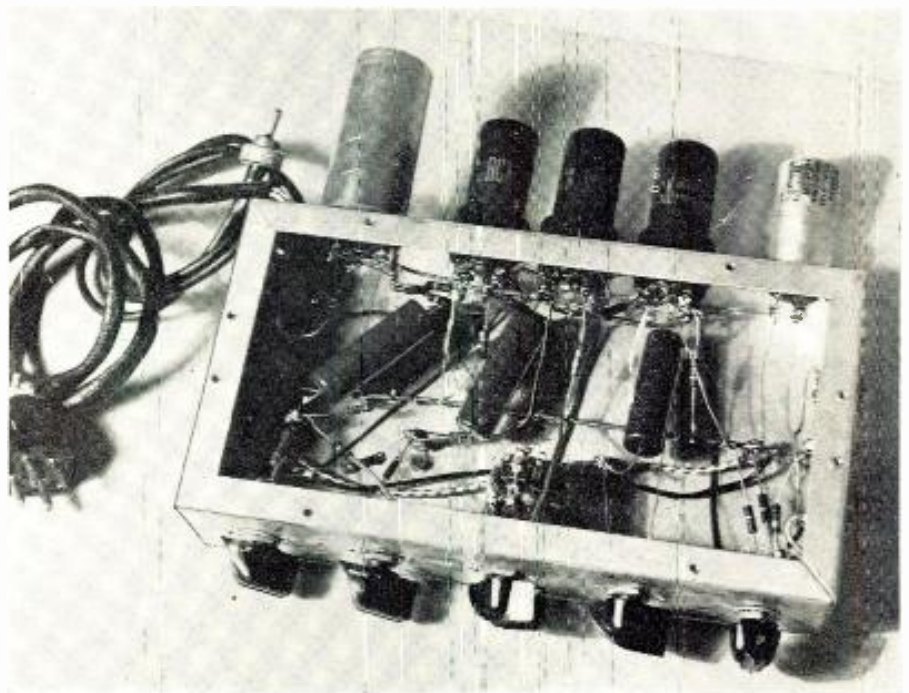

Fig. 4. Modification of the Williamson circuit to obtain 150 ma. d.c. heater current.

Internal view of the preamp-control unit showing point-to-point wiring of parts.



A STUDENT REGENERATIVE RECEIVER

By
WILLIAM C. STOECKER



The regeneration control (knob at left) is a 140- μ fd. variable condenser, providing smoother regeneration than other methods. Receiver is housed in an 8"x8"x7" cabinet.

A rugged, useful receiver—this beginner's set has good operating characteristics and smooth regeneration control.

THE regenerative receiver, a favorite of many years ago, still has a remarkable popularity with experimenters and home set builders. The reason is that the regenerative detector circuit is highly sensitive and functions very efficiently on weak signals. While it has several well-known disadvantages, this detector enables the builder to get very good results with a comparatively small investment in parts. A receiver using it can be built quite easily by an inexperienced constructor and may, in some cases, appeal to the experimenter of longer standing.

The set described here was designed chiefly for broadcast reception. With three plug-in coils the standard broadcast band and two short-wave ranges are covered including most of the frequencies used in world-wide, short-wave broadcasting. It uses two battery-operated tubes, a triode regenerative detector and a pentode power amplifier. The batteries required are a 1.5 volt "A" battery, a 45 volt "B" battery, and a 4.5 volt "C" battery. An ordinary pair of magnetic headphones, having a d.c. resistance of 2000 ohms, is used.

With this simple set, and a 30-foot indoor antenna, we have obtained good reception from many stations in Europe and other parts of the world. Reception from Radio Australia and Radio Moscow has been particularly good at times. A good many out-of-town stations have been logged on the broadcast band.

The detector is a medium-mu triode (1LE3) using grid circuit rectification by means of the familiar grid-leak and condenser arrangement. The r.f. energy is fed from the plate circuit into the tuned grid circuit as a result of magnetic coupling between the grid and tickler coils. This causes "regeneration," helping the detector amplify weak signals. The amount of r.f. current which can flow in the plate circuit depends on the reactance of the path from the plate through the tickler coil to ground. A 140 μ fd. variable condenser provides a means of varying the reactance of this path and thereby controlling regeneration.

A 7.5 mhy. r.f. choke blocks the passage of r.f. current into the next stage so that it cannot flow to ground except through the 140 μ fd. condenser.

This method of controlling regeneration is one of several which have been used extensively in the past. We found it efficient in operation, and well suited for use in a multi-range receiver where interchange of coils is required. The set can be put into or out of oscillation quietly over the entire tuning range. The setting of the regeneration control has an almost negligible effect on the frequency of the tuned circuit provided that the coupling between grid and tickler coils is not too tight. As in all regeneration detectors, however, the setting of the regeneration control for given regeneration varies as the tuning condenser is varied.

A two-section midget superhetero-

dyne condenser is used for tuning. The detector and oscillator sections have maximum capacitances of 365 and 133 μ fd. respectively. The 365 μ fd. section is used for tuning the broadcast coil and the 133 μ fd. section for the two short-wave coils. Switching is accomplished by the arrangement of wiring to the pins on the plug-in coils.

The audio amplifier is a power amplifier pentode (1LB4) particularly designed for use on a 45-volt plate supply. Much of the sensitivity of the receiver is a result of the high amplification it provides for the audio signals coupled from the detector plate circuit. The proper load impedance for this tube is 20,000 ohms and this condition is fairly well met by the usual magnetic headset with a d.c. resistance of 2000 ohms.

An interstage audio transformer having a primary impedance of 10,000 ohms is used to couple the detector plate to the audio grid. We used resistance coupling at first, with a plate load resistor of 47,000 ohms. With this arrangement the voltage on the detector plate was about 35 volts for a new battery. The detector has a somewhat greater sensitivity with 40 to 45 volts on the plate, however. Since the audio transformer primary has a relatively low d.c. resistance, practically the entire "B"-battery voltage is placed on the detector plate. A higher voltage "B" battery could have been used, but it was considered essential to hold "B" battery requirements to a minimum.

The "A" and "B" battery drains are 100 and 3.1 milliamperes respectively. No current is drawn from the "C" battery. At these rates the batteries last a long time.

Mechanical layout of the chassis. A home-made chassis is easily bent up from sheet metal. Holes for jack and switch are $\frac{3}{16}$ ". Binding-post strip is on rear, not shown.

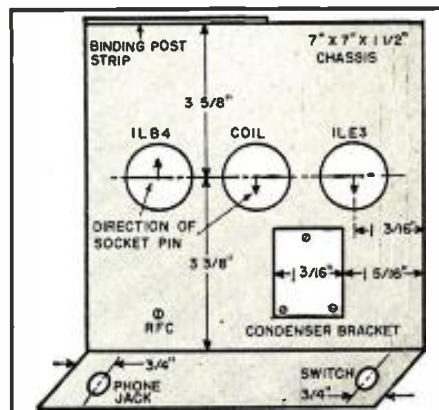

The receiver was constructed in a steel cabinet 8" wide, 8" deep, and 7" high, and having a hinged lid on top. An open-ended chassis 7" x 7" x 1½" was attached to the panel by means of the switch and phone-jack mountings so that the panel and chassis could be removed as a unit. Because of a flange around the front edge of the cabinet, it was necessary to mount wood strips ½" thick and 1½" wide on the floor of the cabinet running from front to back to form a support for the chassis. Access to a binding-post strip on the back end of the chassis was made by sawing a window 1¼" x 6¼" in the back of the cabinet one inch from the bottom. Antenna and battery terminals were mounted on a strip of *Micarta*, and soldering lugs were used on the under side. Binding posts were made from 6-32 brass screws and knurled brass nuts taken from an old battery. Large holes were drilled in the chassis under the binding-post strip to permit the strip to be mounted flush. Two grounded binding posts were attached directly to the chassis beside the strip. Although this makes a neat arrangement, battery connections could be made by using flexible leads running through a rubber grommet in the chassis directly to points where they connect. A battery tray 3" x 7" was made by bending up a sheet of aluminum at the long sides. This serves to keep batteries from sliding into the other parts when the receiver is moved.

The layout drawing and the photographs show the mounting of essential parts. The arrangement used seems to be most satisfactory, and permits short coil and detector circuit leads. Small variations may have to be made, however, to accommodate parts of different sizes. The tuning condenser was mounted on an angle bracket attached to the floor of the chassis. This bracket was drilled and positioned with care in

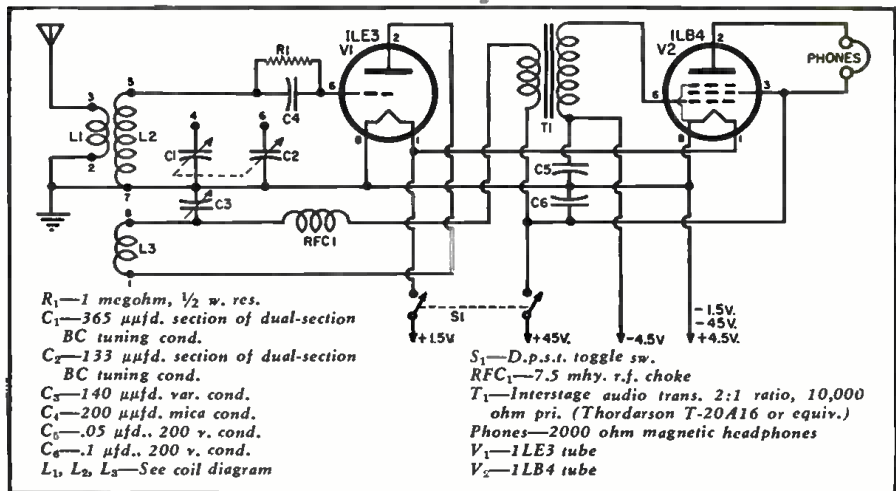

Schematic and parts list for regenerative receiver. The numbers in the tuning circuit refer to pins on the octal socket used for the coils. The proper tuning condenser for each band (C₁ or C₂) is connected through the coil form wiring (diagram below). C₁ is regeneration control. If set does not regenerate, reverse the connections of L₁. Set should be connected to external ground by fairly short lead.

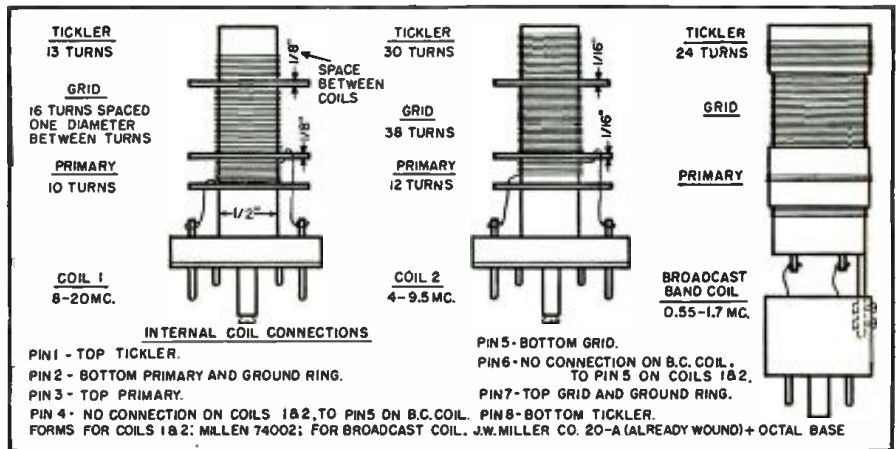

Coil diagram of the student receiver. The Millen forms have octal bases. Looking at the bottom of a form, with the octal key pointing down, pin 1 is to the lower left of key; other pins are counted clockwise from pin 1. The broadcast coil is ready-made (J. W. Miller Co. No. 20-A) and is attached to an old octal tube base.

order to align it properly with the flexible metal coupling between the vernier dial mounted on the panel. A (Continued on page 185)

Bottom view of chassis, showing neat and roomy layout of parts. The round object at left is the 7.5 mhy. plate-circuit choke.

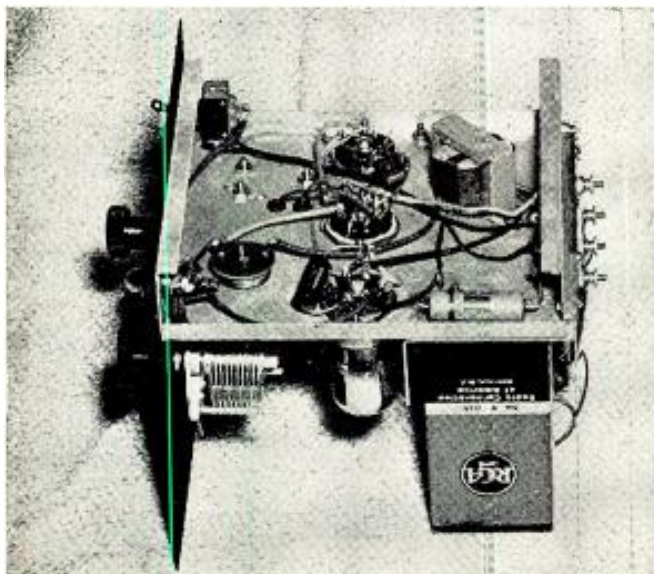

Top view. Short-wave coil is in place, covered by a Millen shield which is part of coil form. Broadcast coil is in front.

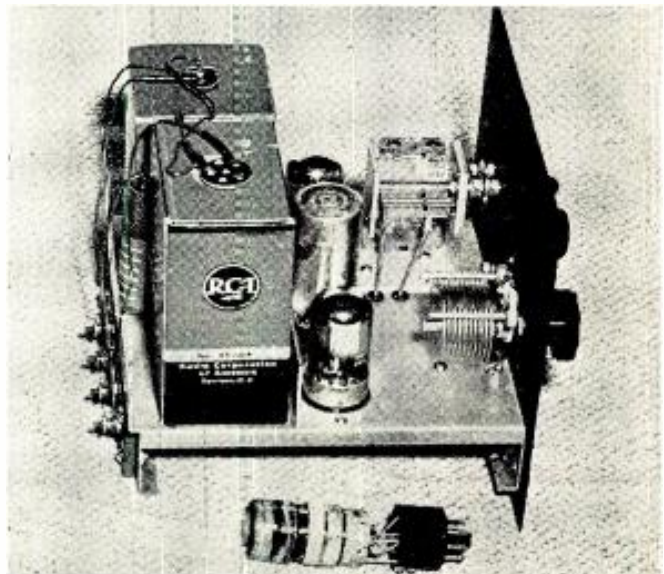



Fig. 1. A "Regency" booster used in conjunction with a television set.

BRING YOUR TV SET UP-TO-DATE

By **RICHARD C. KOCH**
Senior Project Engineer
Regency Div., I.D.E.A., Inc.

Increase the sensitivity of older model receivers and sets in the fringe areas by adding a modern television booster.

"NEW LAMPS FOR OLD." the cry of the disguised magician in that delightful fantasy, *Aladdin's Lamp*, can today be echoed with a similar cry—"New TV sets for Old." But unlike the story, today's magic change need not be wrought with trickery; all it needs is a good, honest booster based on some firm, solid facts.

Each year, in every progressive industry, some changes are made which tend to improve last year's product. Undeniably, the average 1953 television receiver is a more sensitive device than the sets of 1949, 1950, 1951, or 1952. The 1953 receiver also generates less internal noise than its predecessors and the combination of both these factors brings to the viewer a cleaner, more pleasing picture than he has had heretofore.

Now, you and I, and millions of other people, have television receivers which we bought in prior years and from which we still obtain a considerable amount of viewing pleasure. Perhaps our picture does not possess as much contrast as it could and perhaps it is spottier (with noise spots) than we care to have it. Still, this television set represents a substantial investment in many cases and few of us care to pay out more money for a new set when there is apparently so much "life" remaining in our present one.

So there's the dilemma. We would like to enjoy the benefits of the newest sets without being forced to spend a wad of money doing it. But can this be done?

The answer is *yes*. It can be done

and at much less cost than most people would imagine.

Before we see how this can be done, let us determine what accounts for the somewhat poorer performance of the older television set. Assuming that your television set is operating normally and is not in need of repair, there are three factors which govern the quality of the picture you see. First, there is the amount of signal which your set is receiving from its antenna and obviously it cannot give you a full-blown picture from a half-baked signal. In other words, if you are not getting enough signal at the input, you cannot obtain a clear, rich looking picture on the screen.

Second, there is the sensitivity of your set. If your set is sensitive, it will require *less* signal to produce the picture you want than if it is not very sensitive. Sensitivity is something most of us are familiar with because it applies to radio sets in the same way it does to television receivers. A highly sensitive radio set will work almost anywhere in a house; a less sensitive unit will bring in the weaker stations only in certain parts of the house.

The third important factor that determines the quality of the picture you see is the amount of noise the set itself generates. This may be news to some readers, but every electronic network develops a certain amount of noise voltage. In a television system this noise can be particularly bothersome because it will travel along with the incoming video signal and appear in the picture. Now, if the received

signal is strong, the noise spots (frequently called "snow") are "over-powered" and are not visible to the viewer. But if the signal is weak, then in a noisy set the noise will predominate and completely ruin your picture. A noisy, spotty picture is a common sight in fringe or weak signal areas. But these are not the only places you see such pictures! Noisy, spotty pictures are *not* uncommon even in relatively strong signal areas. Sometimes it is the fault of the location; more often it is the set.

In a receiver, the noise that is developed by the first stage (the r.f. amplifier) is actually the most important because at this point in the system the level of the incoming signal is more nearly on a par with the receiver noise level than it is at any other point in the receiver. Whatever noise voltage is present at the input to the r.f. amplifier is amplified along with the signal and so, to obtain the best noise-free picture, we want to have as much signal and *as little noise* as possible at the front end of the set.

Now, of the three factors named, the amount of signal your set receives will not be considered further because we will assume that a competent technician installed your antenna and that you are picking up as much of the available signal as you can. This leaves set sensitivity and set noise, and any improvement in these quantities will definitely improve the quality of your present picture.

Now, how can this be done? By installing a well-designed, well-constructed booster between the antenna and your set. But why a booster, you ask? Because a booster will, as its name suggests, boost the amplification of your set. Boosters are basically nothing more than r.f. amplifiers and when you attach one of them to your set, you are, in effect, adding one or more r.f. amplifiers to the one already present in your television set. Thus, a booster will raise the sensitivity of your present receiver, bringing it more in line with the newer sets and enabling you to obtain more contrast in your picture than you did before.

Sheer amplification, we have seen, is only half the story. Also to be considered is the existing noise factor of

your set. Here again a well-designed, well-constructed booster can be of immeasurable assistance. For if the noise level of the booster is lower than that of your set, it will add less noise to the weak incoming signal. Then, by the time the signal reaches your set, it will have been amplified by the booster and be in a much better position to override the receiver noise.

In short, by increasing the signal level before it reaches your set, whatever noise is present in your receiver will be *less* effective than it is when no booster is present.

Of course, it is most important that the booster itself have little noise, otherwise you will gain nothing except a stronger signal with stronger noise. But if the booster noise is low—and it will be in a well designed unit—then the improvement in picture quality will amaze you.

That booster manufacturers recognize this situation is amply revealed by the following excerpt from the literature of one such manufacturer. He states, in part, that, "The noise of the initial amplifier stages in the TV receiver fixes the quality of reception. If the noise factor is high, reception is poor. A good booster not only supplies the signal with sufficient r.f. gain to overcome the noisy television tuner, but possesses a low noise factor to furnish the best in reception."

Thus, boosters are designed with two aims in mind: To improve the signal-to-noise ratio and to amplify the weak incoming signal. Both features are important and both are needed. A booster capable of high gain but incapable of providing a good signal-to-noise ratio will give a picture filled with disturbing noise spots. A booster possessing a minimum of internal noise but capable of little gain will not amplify the signal sufficiently to permit it to override the set noise. So again the picture will be covered with noise spots. Your booster must have both attributes or it might as well have none.

To show what improvement can be

achieved with a good booster, consider the figures shown at the top of the chart of Table 1. Here we have the sensitivities of an average television receiver produced in each of three years, 1950, 1951, and 1952. For each year the table lists the minimum required amount of input signal for three low-band and three high-band channels. These facts provide us with a fairly complete picture not only on how the average receiver performed on various channels, but also how its performance varied from year to year. Thus, here is what we know:

1. In any given year, the set required less signal to produce a certain output on Channel 2 than on any other channel. In 1950, for example, an input of 566 microvolts was required to produce standard output at the picture tube. On Channel 4 we needed 636 microvolts to do the same thing; on Channel 6, 672 microvolts; and so on up until, at Channel 13, 1250 microvolts were required. Obviously, the set was less sensitive as the frequency increased.

2. In each succeeding year, sets became more sensitive; that is, they required less input signal to obtain the same output. Even so, it still took over 300 microvolts of signal on a 1952 receiver to give you what we might term a good picture on the high band (all other things being equal).

The data given in the lower part of Table 1 shows the improvement wrought by the addition of a booster to the receiver. Compare first the 1950 receiver performance with and without the booster. Without the booster your 1950 receiver is relatively insensitive compared to a 1952 model.

But look what happens when you add a booster! Not only does the combination sensitivity increase, but you actually require less signal than a 1952 receiver needs to produce the same picture. Here you have, by the relatively simple addition of a fairly inexpensive booster, improved the sensitivity of a 1950 set so that it exceeds that of the much newer 1952

WITHOUT BOOSTER			
CHANNEL	1950	1951	1952
2	566 μ v.	425 μ v.	150 μ v.
4	636 μ v.	496 μ v.	175 μ v.
6	672 μ v.	530 μ v.	200 μ v.
7	1110 μ v.	850 μ v.	320 μ v.
10	1170 μ v.	955 μ v.	320 μ v.
13	1250 μ v.	990 μ v.	320 μ v.
WITH BOOSTER			
CHANNEL	1950	1951	
2	113 μ v.	85 μ v.	
4	127 μ v.	99 μ v.	
6	134 μ v.	106 μ v.	
7	278 μ v.	213 μ v.	
10	293 μ v.	241 μ v.	
13	313 μ v.	250 μ v.	

Table 1. Comparison of receiver sensitivity with and without booster. Improvement in sensitivity of 1952 when booster was added is not shown as the improvement was slight.

WITHOUT BOOSTER			
CHANNEL	1950	1951	1952
2	11.5 db	9.5 db	6.5 db
4	12 db	10.5 db	7 db
6	13 db	10 db	7.5 db
7	15 db	14 db	10 db
10	15.5 db	14.5 db	10 db
13	15.5 db	15.5 db	10.5 db
WITH BOOSTER			
CHANNEL	1950	1951	1952
2	6.5 db	6.3 db	6.1 db
4	6.5 db	6.4 db	6.2 db
6	6.6 db	6.3 db	6.2 db
7	8.8 db	8.5 db	7.9 db
10	8.9 db	8.7 db	7.9 db
13	9.2 db	8.9 db	8.0 db

Table 2. Comparison of over-all noise figure with and without a booster in circuit.

set and this improvement is reflected on every channel. In many respects you get the benefits of 1952 set performance without expending the money needed to purchase a 1952 receiver.

What can be achieved with a 1950 set can, of course, be done with a 1951 set. Similar computations will show that the set of any year can have its sensitivity materially improved and this means that you can go as far back as the first postwar television receiver. As a matter of fact, the poorer the set sensitivity, the more marked the improvement when a booster is added as can be seen from Figs. 2 and 3.

Now let us consider the noise in
(Continued on page 212)

Fig. 2. Television picture with heavy noise interference.

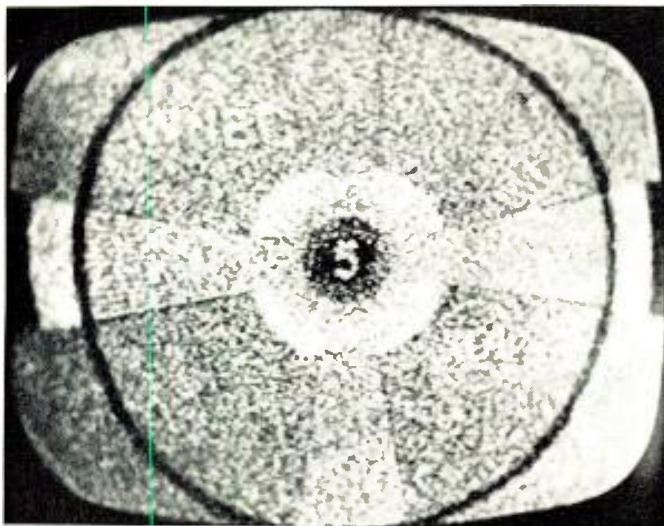

Fig. 3. Picture obtained after a booster was installed.



BRIGHTNESS CONTROL

IN TV RECEIVERS

By JOHN K. FRIEBORN

Explains the operation of the various automatic brightness control circuits used in TV receivers.

STYLES in automatic brightness control have changed. The circuits used in most receivers today are different from those used in most receivers a few years ago. The methods now popular are not new; they were used in early postwar production, but by only a few manufacturers. On the other hand, the methods which used to be standard still are being used in some receivers.

The new styles are not merely different in detail from those which used to be popular; they use a basically different approach to the problem. Automatic brightness control in a television receiver is needed to keep the average picture brightness not constant, but natural. When the brightness of the scene being transmitted increases, the brightness of the picture at the receiver should increase. However, the transmitted video signal does not allow us to reproduce the average brightness directly, except by using direct coupling in the video amplifier. Even that solution presents special problems of its own and does not, by itself, completely solve the problem of automatic brightness control.

Fig. 1 shows a typical video signal waveform for two picture lines. The dashed lines represent average brightness of the respective lines. This average brightness varies irregularly from line to line, according to the scene being transmitted. The minimum brightness or black level occurs at definite times (during the parts of the blanking pulses before and after the sync pulses). The maximum brightness has an identifiable amplitude (at the video detector output it is the minimum signal amplitude). If we keep the minimum and maximum brightness correct, the average will be

correct, provided that transmission and reception are linear.

There are several ways of keeping either the black level or the white level (maximum brightness) approximately constant. Most of them are based upon the idea of clamping some part of the signal. Clamping is, in effect, adding a slowly varying voltage, positive or negative, to the signal, so that the total voltage during the selected part of the signal always is approximately the same. The variations of the rest of the signal with respect to the clamped portion are preserved approximately as they were originally.

All of the old-style circuits are based on the idea of keeping the black level constant and practically all of them use sync pulse clamping. A simplified schematic of a typical circuit, the familiar diode d.c. re-inserter, is shown in Fig. 2. In this circuit, irrespective of the values of the a.c. and d.c. components of the signal at the plate of the video amplifier, the d.c. component produced by the varying charge on condenser *C* is just enough to place the picture tube grid at ground potential during the sync pulses. The blanking pulses make the grid somewhat positive. The picture tube cathode potential is adjusted by the brightness control so the blanking pulses bring the grid just up to cut-off, but not beyond. The peak value of the signal is adjusted by the contrast control to give the desired white level.

This method does not do everything required to keep the average brightness of the received picture natural under all conditions. It keeps the black level nearly constant, but the white level and average brightness vary with signal strength. To complete the job,

we must have a.g.c. in the receiver to keep the peak video signal output from the video detector constant.

Another minor defect of this circuit, even with a.g.c., is that it does not compensate for variations in blanking to sync pulse ratio. Fixing the sync pulse and white levels will not fix the black level unless the blanking pulse is a constant fraction of the sync pulse amplitude. If the blanking pulse amplitude decreases after the brightness control is adjusted, the retrace lines may become visible. If it increases, some parts of the picture which are supposed to be gray will be black and indistinguishable from the parts which are rightly black.

According to FCC standards, the blanking pulse amplitude is $75\% \pm 2.5\%$ of the sync pulse amplitude. If the station maintains this tolerance, sync pulse clamping keeps the blanking level at the grid of the picture tube constant within a volt or two and the variation is unnoticeable. The actual ratio in signals transmitted by certain stations in the past has varied from about 65% to 85%. This means a variation of ± 5 volts or more at the picture tube grid, which produces a noticeable effect. (See Fig. 3.)

The black level can be kept constant by blanking pulse clamping, used in a few *Sparton* and *Stromberg-Carlson* models. The basic circuit, in Fig. 4, is similar to the one in Fig. 2, except for the amplified negative sync pulse applied to the plate of the diode. Because of this pulse, the cathode of the diode is not negative with respect to the plate during sync pulses, so diode current cannot flow then. It does flow during the blanking pulses, the part of the video signal which makes the cathode most negative with respect to the plate. In the same way as the circuit in Fig. 2 clamps the sync pulses, this circuit clamps the blanking pulses to ground potential at the grid of the picture tube.

A different method of sync pulse clamping is shown in Fig. 5. In this method, the cathode and grid of a video amplifier tube are used the same way as the cathode and plate of the diode in Fig. 2. The positive sync pulses are clamped to ground potential at the video amplifier tube grid. A certain potential at the plate of the video amplifier tube corresponds to zero bias on the grid, depending upon the tube characteristics and other circuit components. Sync pulses are clamped to this potential at the video amplifier plate and the picture tube grid. The blanking pulses make the grid of the picture tube more positive, the exact potential depending upon the video signal. The brightness control places the picture tube cathode at a potential positive enough with respect to the grid during the blanking pulses to cut off the beam current. The remarks made in connection with Fig. 2, about the effects of variations in peak signal amplitude and in blanking pulse to sync pulse ratio, also apply here.

Several other methods of sync pulse clamping, including ones using separate triode or pentode tubes, can be found in various receivers, both old and new.

The old-style circuits we have been discussing up to this point use either blanking pulse clamping, which is only another name for black level clamping, or sync pulse clamping, which is approximately the same. Most current receivers use what might be called white clamping for automatic brightness control.

The circuit of Fig. 6, used by *Stewart-Warner*, has grid-leak bias as does the one in Fig. 5, but the phase of the signal at the grid of the video amplifier is opposite to that in Fig. 5. Grid current flows not during the sync pulses, but during the parts of the picture signal corresponding to the brightest parts of the picture (the "white" parts). The white level is clamped to ground potential at the video amplifier grid and to corresponding potentials at the amplifier plate and the picture tube cathode.

The blanking pulses make the picture tube cathode more positive by an amount depending upon the signal. The grid potential can be adjusted by the brightness control so the blanking pulses just blank out the screen. A decrease in signal amplitude will cause dark portions of the picture to become less dark and make the retrace lines visible.

Automatic gain control is even more necessary in receivers having white clamping than in those using sync pulse clamping. Reference to Fig. 7 establishes that for a given change in the peak value of the signal, the black level changes almost three times as much when the white level is held constant as when the sync pulses are clamped.

White clamping using grid leak bias on the picture tube is incorporated in receivers made by *Emerson*, *General Electric*, *Hallicrafters*, *Magnavox*, *Meck*, *Motorola*, *Philco*, *Stromberg-Carlson*, and *Zenith*, among others. Fig. 8 shows a partial schematic of a circuit used by *Magnavox*. When the video signal corresponding to a light part of the picture makes the picture tube cathode more negative than the grid, electron flow from cathode to grid very rapidly makes terminal A of condenser C (and the picture tube cathode) less negative. During the rest of the video signal, electron flow through R to terminal A very slowly makes terminal A more negative with respect to terminal B. The white level therefore is clamped at the picture tube cathode to a potential very slightly negative with respect to the grid and the rest of the signal makes the cathode more positive.

If the brightness control is adjusted to reduce the positive cathode bias and increase the picture brightness, the increased negative cathode potential during the bright parts of the picture causes more grid current flow and more grid-leak bias, returning the pic-

ture to its former brightness. This automatic increase of the grid-leak bias keeps too high a brightness control setting from pushing the light or medium gray portions of the picture up to the maximum brightness level. Too low a brightness control setting or too small a signal amplitude may keep the picture tube cathode from ever being driven negative with respect to the grid, so no grid-leak bias is produced and there is no automatic brightness control.

The term, "d.c. restoration," which often is used in discussions of automatic brightness control, suggests that

an answer to the problem would be to use direct coupling in the video amplifier, so the d.c. component of the video signal would not be lost. Actually, direct coupling in the video amplifier has somewhat the same effect as white clamping. (See Fig. 9, the video amplifier circuit of *Arvin* chassis TE315-2.) In this circuit, the output of the video detector is most negative during the sync pulses, approximately 75% as negative during the blanking pulses, and approximately 10% as negative during the brightest parts of the picture. These voltages at the video am-

(Continued on page 193)

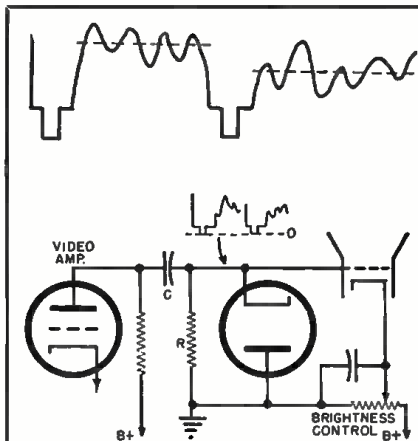

Fig. 2. Diode sync pulse clamping circuit.

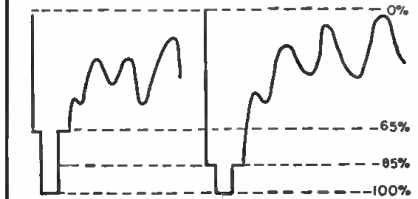

Fig. 3. Effect on black level of a change in blanking pulse amplitude percentage.

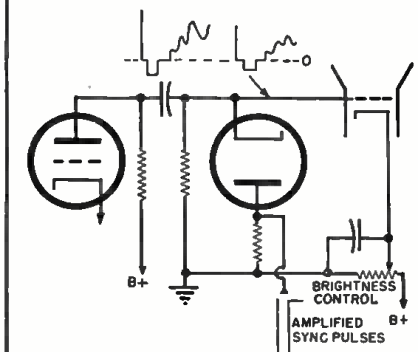

Fig. 4. Diode blanking pulse clamping.

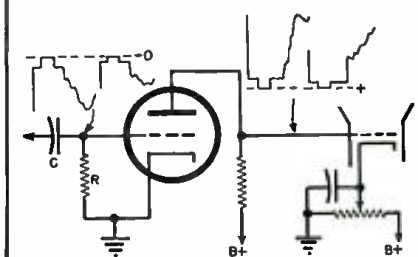

Fig. 5. Grid leak bias sync pulse clamping automatic brightness control circuit.

Fig. 1. Video signal for two picture lines showing the change in average brightness.

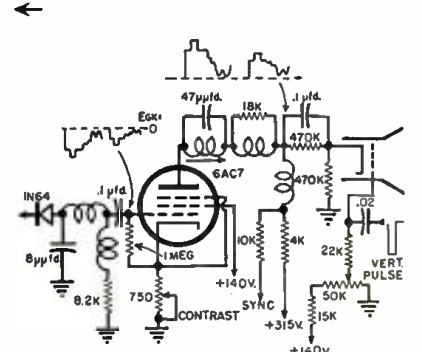

Fig. 6. White clamping type of automatic brightness control circuit used by Stewart Warner in their model 9202-C TV receiver.

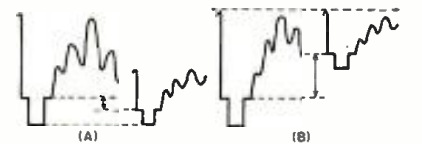

Fig. 7. Effect of a change in signal level on the black level for circuit using (A) sync pulse clamping; (B) white clamping.

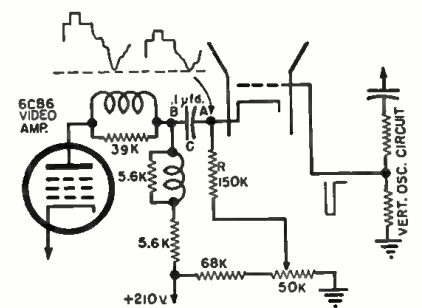

Fig. 8. Automatic brightness control circuit of the Magnavox 104 series sets.

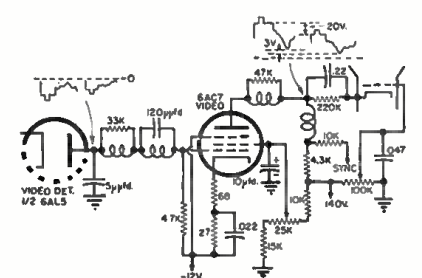

Fig. 9. Arvin's white clamping circuit.



International SHORT-WAVE



Compiled by **KENNETH R. BOORD**

ARNE SKOOG, DX Editor, *Radio Sweden*, tells me that the "Short Wave Game" (contest) sponsored by Teknikens Varld, Stockholm, last March was a great success with 1451 contestants. Participating stations numbered 24 from all parts of the globe. "The aim of promoting interest in short-wave listening was obviously reached, and our radio club has enrolled 2000 new members during the past few months, making a total of more than 15,000 members as of July," Skoog explains. It is planned to make this "Radio Game" an annual affair—with the 1954 competition set for the Easter weekend.

* * *

DX Program

Tentative plans have been made for your *ISW DEPARTMENT* editor to play a program of Christmas organ melodies, by tape transcription, in a special DX broadcast from HCJB, Quito, Ecuador, on Thursday, December 17 at 0330 (0830 GMT) with beam to Europe on 15.115, 11.915, 9.745; reputedly 1600 (2100 GMT) with beam to the South Pacific on 17.890, 15.115, 11.915.

By that time, the move of transmitters to Pifo should have been completed, and reception reports will be

especially welcomed. HCJB verifies correct reports 100 per-cent; an IRC is appreciated but is not required. More details next month.

* * *

This Month's Schedules

(Note: Some stations may have reverted to winter schedules and/or frequencies between the time this was compiled and now; in such cases, you may find some schedules one hour later than listed herein.—K.R.B.)

Afghanistan—Kabul Radio, 9.975A, is heard in Sweden 1140-1205 in English; starts with Eastern music, has news 1150, and Western music 1155; CWQRM. (Arvidsson)

Alaska—ALF, 5.260, Juneau, heard testing 0100; will QSL from Box 380. (Cain, Nevada) Better include return postage with report.

Algeria—Radio Algerie, 6.165, was noted 1830 with Eastern music; closed 1930 with "La Marsellaise." (Ferguson, N. C.)

(Note: Unless otherwise indicated, all time is expressed in American EST; add 5 hours for GCT. "News" refers to newscasts in the English language. In order to avoid confusion, the 24 hour clock has been used in designating the times of broadcasts. The hours from midnight until noon are shown as 0000 to 1200 while from 1 p.m. to midnight are shown as 1300 to 2400.) The symbol "v" following a listed frequency indicates "varying." The station may operate either above or below the frequency given. "A" means frequency is approximate.

Fourteen-year-old Bill Crowell, Harrisburg, Pa., now a monitor for RADIO & TELEVISION NEWS, became interested in short-wave listening as a result of the first "Boys' Life" Radio Listening Contest ("Boys' Life" is the official publication of the Boy Scouts of America). While he didn't do so well in the competition, Bill says he has found many hours of fun and excitement in pulling in distant stations and in receiving QSL cards and letters from the stations logged. He has logged 56 foreign countries. Bill types out his log sheets and puts them on the wall over his receiver for ready reference.



Anglo-Egyptian Sudan—Radio Omdurman now uses 6.438 and 7.664; has English on Fri. 1230-1300, Sun., Wed. at 1115. (Radio Sweden, others) Heard near 7.655 in Arabic at 1240 tune-in. (Pearce, England)

Angola—Luanda, 11.862, is good strength in Sweden 1400-1430; before and after that time has QRM from BBC. (Arvidsson)

Argentina—Radio Splendid has good level 1630 on 9.320A; Radio Belgrano, 9.76, is fair signal 1700, and Radio El Mundo, LRX1, 6.120, is heard with news in Spanish by woman 1700. (Lorentzson, Sweden)

Australia—VLC9, 9.615, is now used to Eastern North America 0700-0845; to Western North America 1015-1115; DX session Sun. 0830. (Bellington, N. Y., others) VLA15, 15.200, is excellent around 2155-2315 to West Coast. (Bates, Calif.; Dannenfelzer, Md.) VLC9, 9.615, is a satisfactory signal in Minn. around 0830. (Peterson) And in West Coast session 1015-1115. (Smits, Minn.) VLB9, 9.58, noted with music 0725. (Frazier, Texas)

Austria—Blue Danube Network, Salzburg, now lists channels of 9.617, 5.080, 6.055. (Pearce, England, others)

Azores—CSA93, 4.865, Ponta Delgada, noted closing 1800 with "A Portuguesa," weak level in Denmark.

Belgian Congo—OTC, 9.655, Leopoldville, is excellent with English relay from ORU, Brussels, Belgium, 2000-2200 closedown. (Kirby, Mo.; Zerosh, Pa., others)

Belgium—ORU4, 9.767, is good level to USA-Canada 1930-2200; English from 2000. (Kubachi, Mass.; Dannenfelzer, Md., others)

Bolivia—CP38, La Paz, lists current frequency as 9.444 on the air Sun. 0755-0900, 0700-1600; weekdays 0655-0815, 1030-1330, 1855-2200. (Bellington, N. Y.) On a recent check, however, seemed to be still on 9.497A at 2000 where had bad QRM. (Stark, Texas)

Brazil—ZYC8, 9.610, Radio Tamoio, is heard as early as 1600 at good level but with some QRM from c.w. stations. (Gade-Joergensen, Denmark) PRK9, 15.190, noted with music from 1650. (Arvidsson, Sweden) PRL7, 9.72, Rio de Janeiro, noted with musical program 2200, with English and Portuguese announcements. (Corson, Iowa) Radio Record, Sao Paulo, has been noted dual on 9.505, 11.965A around 1830.

(Continued on page 128)

THE OARAC

THE OARAC (Office of Air Research Automatic Calculator) is an electronic calculating machine (illustrated on this month's cover) designed and built for the U.S. Air Force by the *General Electric Company*. It is capable of solving the most complex mathematical problems at speeds which seem fantastic to those not acquainted with the principles of electronics.

It may be said that OARAC has a 10,000 word memory with an average access time of 9 milliseconds, that it can multiply two ten-digit numbers in approximately 8 milliseconds, that it can add two such numbers in less than 100 microseconds, and that it can perform as many as 100 arithmetic operations per second. It might, however, be more informative to look into this 1400 tube electronic giant with the eyes of a layman who has never heard of a 10,000 word memory or a 9 millisecond access time.

One of the first things to come to the attention of our hypothetical layman would be the OARAC memory. This part of the computer (some call it the "brain" or "heart" of the machine though that is hardly justified) centers around an aluminum cylinder 22" in diameter and 30" long. This cylinder rotates at a speed of 3350 rpm and is coated with a magnetic oxide similar to that found on the tapes used in magnetic tape recorders. Approximately 200 magnetic record-playback heads are spaced along the axis of the cylinder approximately 0.002" from its surface. When a positive or negative electrical pulse is applied to one of these heads the magnetic surface of the cylinder immediately adjacent to the head is magnetized to form a positive or negative magnetic spot. Each of the 200 heads can write 2600 such spots around the circumference of the cylinder. That is a total of $200 \times 2600 = 520,000$ spots! The same head reads back a positive or negative electrical signal whenever one of the magnetic spots passes beneath it. Thus it may be seen that once a spot has been recorded on the cylinder it is available to be read back once each drum revolution thereafter.

In the language of electronic computers, each of these 520,000 magnetic spots represents one "bit" (binary digit) of information. In the OARAC, a group of 52 bits is called a word space, hence it may be seen that the OARAC memory contains 10,000 word spaces. Thus we say that OARAC has a 10,000 word memory.

Since each spot on the memory cy-

(Continued on page 180)

By

BERNARD H. GEYER

Electronics Laboratory, General Electric Co., Syracuse, New York

Capable of solving 1011 simultaneous equations, this ingenious calculating machine speeds operations for the U.S. Air Force.

HOW THE DIGITAL COMPUTER SOLVES A PROBLEM

OARAC is a large-scale digital computer with an extra-large memory. It can solve 1011 simultaneous equations. The simple illustration that follows will give you an idea of how the computer operates. Actually, the equation used might only be one thousandth part of a highly complicated problem.

In the equation—

$$y = 3x^2 + 5x + 2 = [3x + 5]x + 2$$

find y for all values of x between 1 and 1000 in steps of one.

The following information is stored at addresses in the computer's memory—a rotating magnetic drum:

Address	Number	Line	Address	Instruction Operation	Address
0000	$x = 1$	1	1201	21	0000
0001	999	2	1201	24	0003
0002	1	3	1203	22	0004
0003	3	4	1204	24	0000
0004	5	5	1205	22	0005
0005	2	6	1206	12	0006
0006	y	7	1207	31	0006
		8	1208	21	0001

Key to Instructions

21 = put into accumulator	9	1209	23	0000
22 = add	10	1210	30	1215
23 = subtract				
24 = multiply	11	1211	21	0000
30 = choice (see further)				
31 = read to tape	12	1212	22	0002
32 = go back to				
12 = write into memory	13	1213	12	0000
34 = stop and ring bell				
	14	1214	32	1201
	15	1215	34	0000

By turning a knob and pushing buttons on OARAC's front panel, the operator tells it to go to address 1201 and perform operation 1. It automatically proceeds from there to operation 2, 3, 4, and so on, performing the operations as follows—

Line Number	Operation
1	"Bring what is at address 0000 into the accumulator." At this address the number 1 is stored. ($x=1$)
2	"Multiply the number in the accumulator by 3." Result: $3x=3$
3	"Add to what is in the accumulator, the number at 0004." Result: $3x+5=8$
4	"Multiply result of operation three by value at 0000." Result: $(3x+5)x=8$
5	"Add what is in 0005." Result: $(3x+5)x+2=10=y$
6	"Put answer at address 0006 on the magnetic drum."
7	"Record answer on magnetic tape for future printing."
8	"Put into accumulator the number at address 0001."
9	"Subtract x from that number." Result: $(999-x)$
10	"Make a choice . . . if $(999-x)$ is positive or zero, continue with operations 11, 12, and so on; otherwise perform operation 15, ringing bell to indicate problem is finished."
11	"Put x into accumulator."
12	"Add 1, giving $(x+1)$, the new value of x ."
13	"Record this at address 0000, making the new value of x available for calculating y ."
14	"Go back to operation 1 at address 1201."

From here on, the computer repeats steps 1 through 14 until x reaches 1000. Then operation 10 stops the calculation and rings bell to signal operator his instructions have been carried out.

Fig. 1. The "Con-VI" shown being used with a Heathkit AV-2 a.c. vacuum-tube voltmeter.

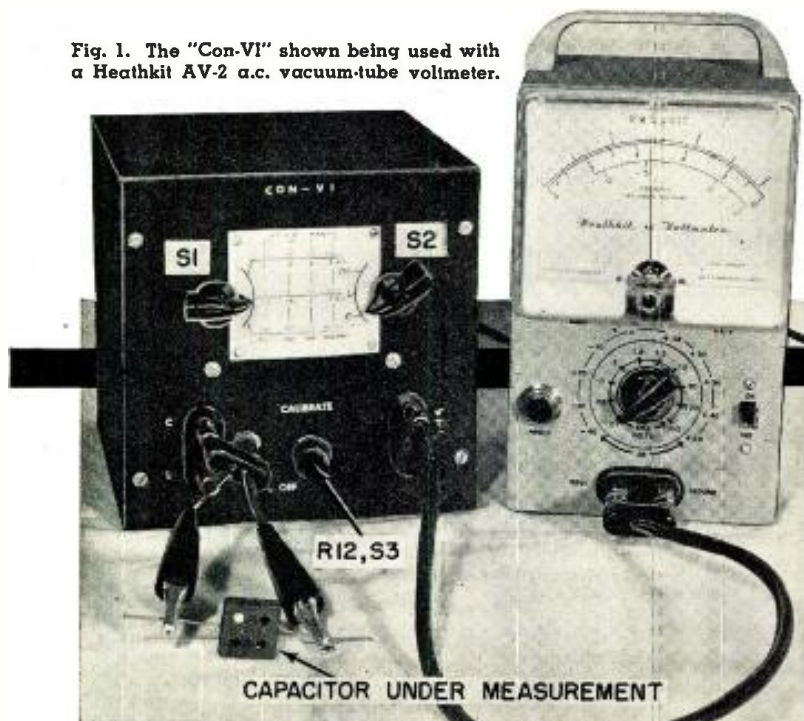

The CON-VI

By RICHARD GRAHAM

device to be described can be abbreviated somewhat. Let's refer to the unit as the "Con-VI" from here on in.

Principles of Operation

Whenever an unknown impedance, Z , is placed across a high impedance source, the voltage across the impedance Z is a function of the value of that impedance. The high impedance source can be devised simply by placing a high resistance in series with the output of an audio oscillator. This is illustrated in Fig. 2A.

If the value of the unknown impedance, Z , is small in comparison with the internal impedance of the generator (which in this case is substantially 1 megohm) then the generator can be considered to be a constant-current source. Thus as long as the value of the unknown impedance, Z , is substantially smaller than 1 megohm, the current, I , flowing is always substantially the same. If this is so, then the voltage read on the v.t.v.m. of Fig. 2A is directly proportional to the value of the impedance Z .

Now, if an inductance, L , is placed across the output terminals of a constant current source, we note that the voltage appearing across the inductance is:

$$X = E/I = 2\pi fL$$

$$E = 2\pi fIL$$

If the significant value of the voltage, as read on the v.t.v.m., is to be the same as the significant figure of the inductance, the $2\pi fI$ has to be made some power of 10. This can be easily accomplished by adjusting the output of the oscillator as shown in Fig. 2B to 10 volts. The current, I , flowing will then be 10 microamperes. Now by choosing an oscillator frequency of some multiple or sub-multiple of 1592, the $2\pi f$ in the equation also becomes a power of 10. The significant figure of Fig. 2A is now the same as the significant value of the inductance. The circuit shown in Fig. 2A, is basically the same as that used in the "Con-VI" when measuring inductance.

A condenser could be measured on the constant current setup just de-

Used in conjunction with an a.c. vacuum-tube voltmeter, this device permits direct reading of a wide range of L and C.

SOME device for measuring inductance and capacitance is, of course, a necessity in any well equipped lab or shop. In places where "time is money" the speed with which the answer is obtained means dollars—perhaps in servicing jobs completed or engineering hours gained. But we've become so accustomed to thinking that only bridge type instruments are used for LC measurement that we are prone to forget that there is more than one way to "skin a cat."

The method described in this article utilizes a constant current and voltage source and an a.c. vacuum-tube voltmeter. The conditions of test are such that the value of unknown capacitance or inductance can be read directly on the scales of the v.t.v.m. Thus, this method features speed and convenience with fairly good accu-

racy. The full scale readings range from 10 millihenrys to 300 henrys, and 100 micromicrofarads to 3 microfarads. Furthermore there is no adjusting and juggling of any null or balance controls. This method, while not new, is worthy of review by busy service shops and labs and is ideal for a host of other production and industrial applications.

Basically the instrument is quite simple. It consists of an audio oscillator which will operate on three specific frequencies (more about this later), a power amplifier, and a power supply. The output of the power amplifier is either in series with a low resistance or a very high resistance, thus converting the oscillator into either a constant voltage or constant current generator. This rather lengthy and awkward sounding title for the

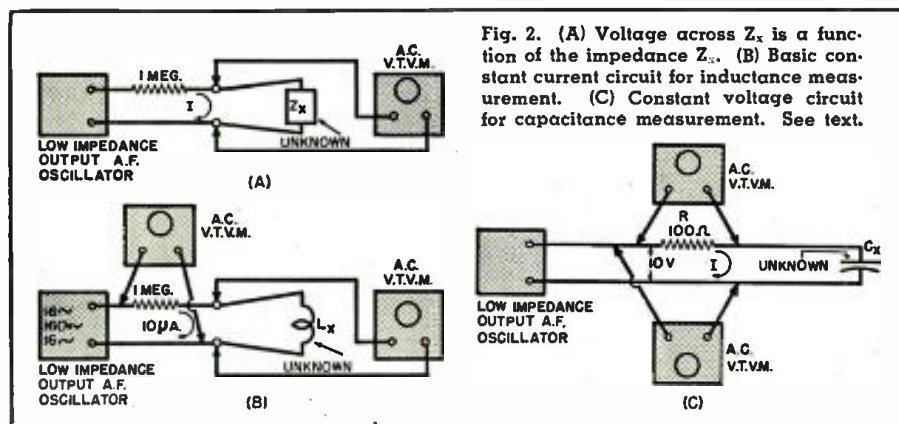

Fig. 2. (A) Voltage across Z_x is a function of the impedance Z_x . (B) Basic constant current circuit for inductance measurement. (C) Constant voltage circuit for capacitance measurement. See text.

scribed, however the condenser value could never be read directly off the scale of the v.t.v.m. A conversion chart would be necessary. This is because the reactance of a condenser is inversely proportional to the voltage across it. A large meter reading would indicate a small capacitance and *vice versa*. By using a constant voltage circuit, as shown in Fig. 2C, condensers can also be read directly on the meter scale.

In Fig. 2C, the current flowing is directly proportional to the value of condenser C . If there is no capacitance present, there will be no current flowing, and *vice versa*. This can be expressed more rigorously by the following:

$$X = E/I = 1/(2\pi fC)$$

therefore: $I = (E) (2\pi fC)$

This current can be determined by measuring the voltage drop across a low ohm precision resistor, R , in series with condenser C .

Once again by making the value of $2\pi fE$ in the above expression a power of 10, the v.t.v.m. can be made direct reading. This condition is satisfied by letting the generator output voltage E , equal 10 volts, and making f a multiple of 1592 as before.

For example to make the meter read 100 μfd . full scale, a voltage of 10 volts with a frequency of 16,000 cycles will cause a current of 100 microamperes to flow. This current flowing through a 100 ohm precision resistor means that the meter when placed on the .01 volt scale will read 100 μfd . full scale.

Circuit

All of the functions shown in Figs. 2B and 2C have been combined into

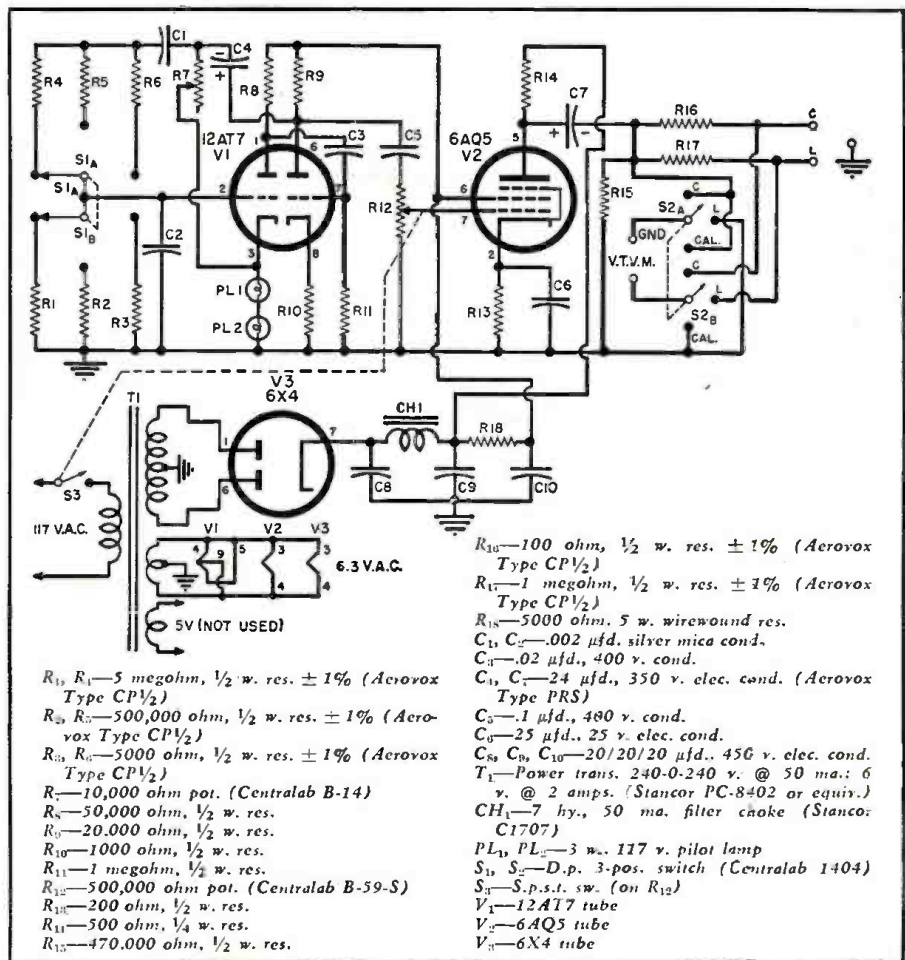

Fig. 3. Complete schematic diagram and parts list for the "Con-VI."

one unit to make up the "Con-VI." The schematic diagram of this unit is shown in Fig. 3.

A single 12AT7 serves as a Wien bridge oscillator which can be switched (Continued on page 162)

Fig. 4. Top chassis view of the "Con-VI" showing parts layout.

Fig. 5. Under chassis view of unit with major parts identified.

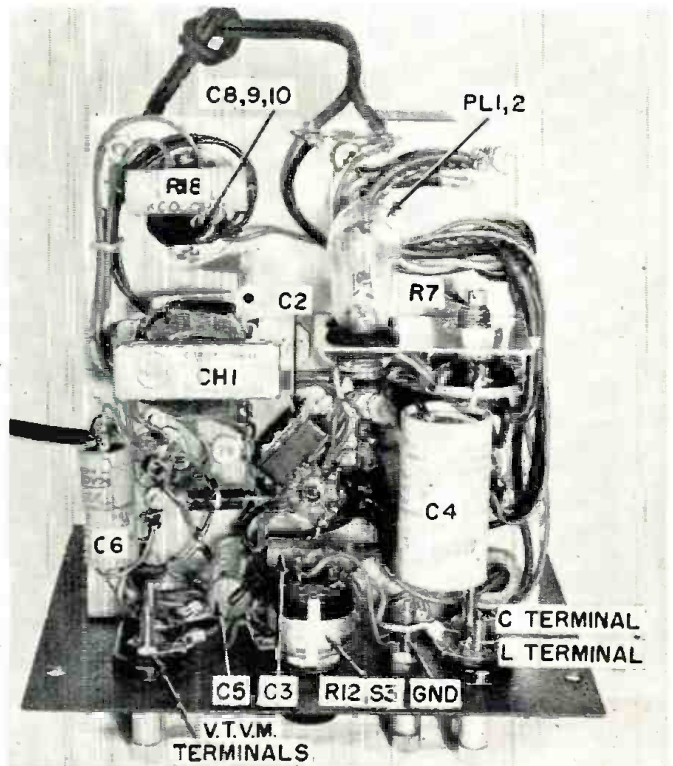
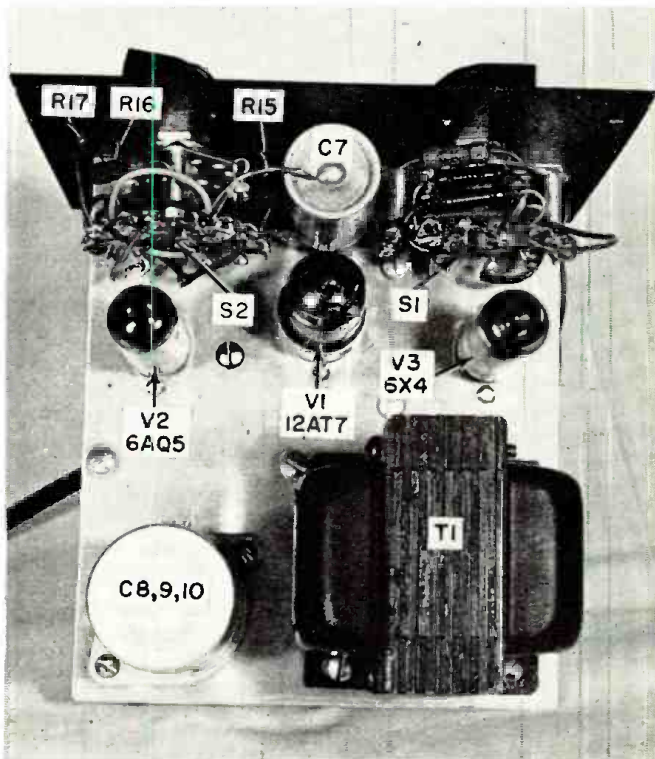

MAC'S RADIO SERVICE SHOP

By JOHN T. FRYE

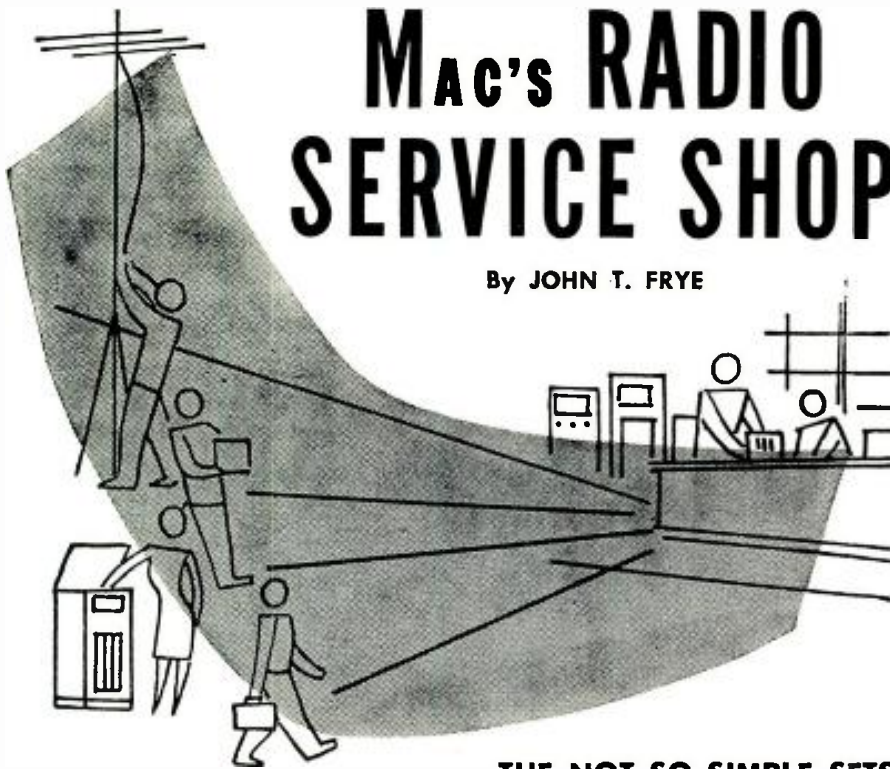

THE NOT-SO-SIMPLE SETS

MIDGET DAY" was what Barney termed it. He was referring to the fact that every set slated for repair that day was of the small a.c.-d.c. variety, and the youth was looking forward to a pleasant afternoon of "turning 'em out like hotcakes," as he put it.

However Mac, his boss, noticed that the boy seemed to be taking an unconscionably long time to cook the first hotcake. In fact, after probing and snipping and soldering on the small chassis for nearly an hour, he was looking more puzzled and exasperated every minute.

"Surely an electronic engineer of your caliber can't be having trouble with a simple midget set," Mac taunted him.

"Simple my eye" Barney exploded. "This thing is about as simple as Sanskrit. It don't make sense. When you first turn it on, you can barely hear the local station; but the longer it runs, the better it gets. After it has been on twenty minutes or so, the sensitivity and volume gradually improve to where you can pick up several out-of-town stations, although the receiver is still not as hot as it should be."

"And what kind of a message do you get from these symptoms?" Mac asked with a quizzical grin.

"First I decided it must be a tube with low emission that took a long time to get hot enough to put out; so I changed all the tubes—but that was the only thing that changed. Next I concluded that perhaps an i.f. transformer had a defect so it was out of line when cold and sort of drifted in as the set warmed up, but that was a bum steer, too. I got to thinking perhaps there was a plate or screen-drop-

ping resistor that had a real high resistance when cold but came down to somewhere near normal when warm, but a careful check with the ohmmeter proved that hunch was no good. The 'B-plus' voltage is around seventy-five or eighty volts, which is a little low but not low enough to account for the deadness of the set when you first turn it on. That brings you up-to-date on my thinking. No reasonable suggestion from those present will be ignored."

Mac pulled down the service manual that contained the diagram of the set and took a long look at it. Then he asked mildly, "Have you looked at this?"

"Who needs to look at diagrams of a.c.-d.c. receivers?" Barney scoffed. "I can draw every one of them with my eyes shut and recite 'The Shooting of Dan McGrew' backwards while I'm doing it."

Mac did not argue, but he took a small electrolytic condenser from a drawer and bridged it across one of the condensers in the little set. Immediately the volume increased at least four-fold, and the receiver acquired that between-stations hiss that goes along with good sensitivity.

"Let me have a gander at that diagram that tells you so much," Barney muttered as he reached for the service manual. After glancing at it for only a minute he looked up with a sheepish grin. "Now I get it," he said. "That dog uses a voltage-doubling rectifier, and where I was measuring 75 volts I should have been getting 190. One of the current-storing condensers is about gone. When cold, it has practically no capacity; but as it warms up it does achieve a microfarad or so, and then the voltage goes up and

gives the set more pep. And before you say it," he hurried on as Mac opened his mouth, "I know I should have turned to the circuit diagram when I first began to feel stumped, as you so often have told me to do."

"I might as well have saved my breath to cool solder joints," Mac complained. "Your trouble is that you are always letting what you think you know get in the way of a real chance to learn. Don't ever sell these little sets short when it comes to giving you headaches. Many of them use almost identical circuits, but that just lulls you into a condition where the occasional different circuit can waste a lot of time.

"That set I just finished was a good example. It would play fine for a few minutes, and then the volume would slowly fade away. I shucked it out of the cabinet so I could get a good look at it, and then I noticed that just before the volume started to fade some of the tubes lighted very brightly while a couple of them became very dim."

"Doesn't sound so tough," Barney broke in. "Probably one of the heaters was shorting through a cathode to ground and cutting heater current off the tubes that went dim. Since the voltage that used to be divided among all the heaters was now across only a part of them, these heaters naturally got brighter."

"That makes me wonder if I'm starting to slip," Mac replied, "for my first thoughts followed exactly along the same channel as yours. Ignoring the obvious fact that if a short of that nature was occurring the tubes without heater current would have gone clear out instead of just growing dim, I replaced all tubes that either grew brighter or dimmer. When this made no difference, I looked at the diagram and found out the two dimming tubes had 300 ma. heaters while the remaining 150 ma. tubes were arranged in two parallel strings in series with the 300 ma. jobs.

"Normally this arrangement gave each tube its proper heater current, but now one of the 150 ma. heaters was intermittently opening. When it did, it left only one 150 ma. string in series with the 300 ma. tubes. This meant that the current through the smaller heaters was greatly in excess of what it should be for them, but at the same time this current was inadequate to light the 300 ma. heaters to normal temperature. It so happened that the tubes in the string that was cutting on and off had very dark bulbs that hid this action from sight. This is the first time in a long, long time I have run across this deal in a radio, although it is pretty common in TV sets."

While Mac was talking Barney had replaced all the filter condensers in the set he had been working on and had located an output transformer with an open primary in an overgrown table model. He quickly re-

(Continued on page 192)

over **99%***

hit the bull's-eye
for quality!

that's why we call

Federal
PICTURE TUBES

"BEST-IN-SIGHT"

Thousands of famous-name picture tubes were quality-tested by a famous-name TV set manufacturer.* When the scoring was over, Federal led all the brands tested . . . with an "OK" on over 99% of its tubes!

Here's proof, Mr. Serviceman, that it pays to replace with *Federal* . . . here's assurance of top performance . . . of less time wasted on call-backs . . . of more profit per tube replaced!

Federal quality brings to servicemen a tremendous opportunity to create customer-goodwill . . . to build steady replacement business.

Federal quality *stands by* servicemen, because it *stands up* in service . . . backs up their years of experience and know-how . . . their *trained* judgment. That's one of many big reasons why more and more servicemen are specifying Federal "Best-in-Sight" picture tubes.

Join the trend today . . . ask your Federal Distributor about the popular-size line that takes care of over 90% of all TV replacements . . . ! For information, write to Dept. N-359.

"Federal always has made better tubes"

Federal
Telephone and Radio Company

100 KINGSLAND ROAD, CLIFTON, N. J.

In Canada: Federal Electric Manufacturing Company, Ltd., Montreal, P. Q.
Export Distributors: International Standard Electric Corp., 67 Broad St., N. Y.

October, 1953



Get Your Copy of
Federal's
TV Picture Tube
DATA BOOK

12-page booklet with information on interchangeability, basing diagrams, bulb outlines, dimensions, characteristics. Address your inquiry to Dept. listed above.



TRANSISTOR POWER SUPPLY

By LOUIS D. CARCANO

A VARIABLE-VOLTAGE power supply is highly desirable when experimenting with transistor circuits. Sometimes transistor circuits are critical as to voltage. Whether or not a given circuit is critical, is an important thing to find out. Moreover, the first step in finding out whether a particular circuit is operable is to try varying the supply voltage.

The circuit illustrated is simple and compact. Because the current drain is small and good regulation is not required, it is feasible to use a potentiometer R_2 to vary the a.c. voltage to the power transformer. The bulkiest and most expensive component, a "Variac" or similar variable transformer, is thus eliminated. The power transformer is a small unit having a 117-volt secondary rated at about 20 ma., as well as a 6.3-volt secondary. The latter winding is not used. These small transformers are available as replacement types for TV boosters, and also on the commercial surplus market. A small selenium rectifier and an RC filter complete the supply. Hum is less than 2 millivolts. Maximum output is 40 volts, 5 milliamperes.

Metering of both voltage and load current is very desirable. A single meter with a switch may be used, but separate meters are better.

When operating an unfamiliar transistor circuit, always make sure that there is enough resistance in series with the emitter circuit to limit the current to the rated maximum (usually 3 ma.) or less. Keep a current-limiting resistor in series with the collector supply too. Before removing the resistance, make sure that reducing the resistance does not make the current rise rapidly.

Always start out with the supply voltage turned down to zero, and after connecting the transistor circuit to the supply, raise the voltage cautiously, keeping an eagle eye on the current meter.

Never connect a doubtful transistor circuit to a power supply of this sort unless the voltmeter reads zero. If the current drawn by the circuit should have any tendency to "run away," the transistor could be burned out by the charge stored in the filter condensers.

Most of the newer circuits for junction transistors require only a single power supply or battery. Where a grounded-base circuit needs a separate emitter source, a single flashlight cell is usually all that is needed in addition to the power supply described here.

An inexpensive variable power supply for use with experimental transistor circuits.

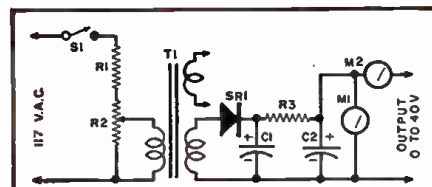

- R_1 —3300 ohm, 2 w. res.
- R_2 —2000 ohm, 2 w. vol. control
- R_3 —3300 ohm, 1/2 w. res.
- C_1, C_2 —50 μ d., 50 v. elec. cond.
- SR_1 —25 ma. selenium rectifier
- T_1 —TV booster-type power trans. with 117 v. sec.
- M_1 —0-50 volt meter
- M_2 —0-5 ma. meter
- S_1 —S.p.s.t. switch

You can **SEE** the difference...
HEAR the difference
 in the **NEW**

BRILLANTE



BRILLANTE—Genuine mahogany—Model HF 25 M—Complete—Enclosure and Speaker—\$144.50 Blondo Korina Model HF 100 B Complete—\$ 145.00

SEE

the difference **STYLING**—A cabinet designed by Maurice—with simple, modern-classical lines that will smartly blend in and grace any decor. The new Brillante will be admired by everyone.

HEAR

the difference **PERFORMANCE**—An enclosure and high fidelity speaker system designed as a unit that reproduces smooth, fundamental bass and bright, clean highs—every nuance of tone—from the softest pianissimo to thunderous fortissimo.

BEAUTY—Glowing with the splendor and lustre of fine woods—hand rubbed to a rich patina of fine furniture—the new Brillante—in either genuine honduras mahogany or blonde korina—is truly a masterpiece of woodworking art.

QUALITY—The new Brillante marks an epoch in design and engineering. Produced by Utah—a pioneer and leader for over 30 years in the field of sound engineering—the name Utah assures the finest quality in design, engineering, production and performance. Quality is built right in. It is right—because it is built right by Utah.

Write today for complete details

RADIO PRODUCTS CO., INC.
 1350 MONROE ST., HUNTINGTON, IND.

HIGH GAIN AT LOW COST HERE'S ANSWER TO LOW GAIN PROBLEM

- 10-20-40 METER GROUND PLANE ANTENNAS ARE PRACTICAL USING OUR LIGHTWEIGHT MOLYBDENUM STEEL WHIPS, COPPER PLATED with baked paint finish, threaded tapered sections, standard 3/8 unthreaded stud on bottom section. Five 16 ft. elements suitable for 20 meter ground plane. \$19.95
- 32-FOOT VERTICAL WHIP FOR FIXED SERVICES, uses 10 heavy duty copper plated steel threaded sections, swell for 20 meters, or use with ground planes, for 40 meters. 5.95
- 16-FOOT MOBILE WHIP ANTENNA. 3.75
- BRAND NEW DYNAMOTORS**
- 6 VOLT INPUT, 180V/200 ma. output. 8.95
- 6 VOLT INPUT, 300V/150 ma. output. 9.95
- 12/24 VOLT INPUT, 400V/150 ma. output, will deliver 350V/200 ma. 11.95
- 12/24 VOLT INPUT, 600V/175 ma. output. 12.95
- PE-101C DYNAMOTORS, brand new in original cartons, operates on 6, 12, 24 volt input, economical mobile power. 4.45
- DRY CHARGED PLASTIC CASE STORAGE BATTERIES**
- 2 VOLT 20 AMPERE, Willard BB-54. 2.95
- 4 VOLT 40 AMPERE, Willard. 4.95
- 6 VOLT 40 AMPERE, Willard ER-40. 5.95
- 6 VOLT 8 AMPERE MINIATURE Willard NT-6 COMBINATION A & B DRY BATTERY PACK, 41.5V, 90 & 150 volts output. Ideal for compact mobile equipment supply. 2.95
- LINK & BOSCH MOBILE POLICE RECEIVERS, 5 tubes (RF stage) fixed tunable 2-3 mc adj. squelch control. Ideal for HAM, C.D., MARS & MARINE MONITOR SERVICES. Connect to auto radio for B supply or use with simple AC pack. Used, operating condition, special. \$7.95
- CRYSTAL CONTROLLED OSCILLATOR UNITS. 8.95

BUY ESSCO FOR BEST R/C VALUES

- SIGMA 4F RELAY, 8,000 ohm, top value. 4.95
 - KURMAN BK-35, 10,000 ohm at 1/2 ma. SPDT. 4.95
 - PETERSEN Z9A, 27,255 /04 tolerance, W/socket. 4.95
 - LORENZ RECEIVER, COMPLETE ready for inst. 14.95
 - DITTO, WITH SIGMA 4F and ED MARK III Escapement, complete sets, not a kit. 24.95
 - PARTS KIT TO BUILD YOUR OWN, WITH TUBES MILLER RECEIVER PARTS KIT, WITH SIGMA 4F RELAY AND DRILLED BASE. 10.95
 - OSR TYPE QUENCH COILS for all hard tube sets 1.75
 - 2 VOLT VIBRATOR POWER SUPPLY PARTS KIT, complete with drilled chassis. 9.95
 - PRECISION WESTON 2" SQUARE PANEL METERS 0-5 ma., \$2.95; 0-50 ma., \$3.45; 0-1 ma., \$5.95; 0-500 us. 5.95
 - FLEAWEGHT HOOKUP WIRE, 25 feet of 5 colors LINEN BASE BAKELITE BOARDS FOR ALL RECEIVERS. \$0.25; DRILLED BOARDS. 1.00
 - ESSCO SUPER 5 WATT TRANSMITTER, a 2 tube full 5 watt job with built-in 2 volt battery & power supply. 34.95
 - COMBINATION FIELD STRENGTH & TEST METER SET**, checks transmitter output & for all-round checking, kit/parts incl. precision resistors. 11.95
 - 1/2 ft. Sectional whip antenna with top of cabinet mt. 2.95
 - SIGMA 4F RELAY REPLACEMENT COILS, 2000, 3000 & 10,000 ohm units available, for repairing defective relays. 1.25
 - MICRO-SWITCH KEYSWITCH. .65
- SEND FOR FREE CATALOG. MONEY BACK GUARANTEE ON ALL ITEMS. SAVE C.O.D. FEES, include postage, excess refunded.

ELECTRONIC SPECIALTY SUPPLY CO.
 58 Walker Street, New York 13, New York

CUSTOMERS EVERYWHERE KNOW
 SYLVANIA TUBES JUST
 CAN'T BE BEAT FOR **QUALITY!**



WHY SYLVANIA PRODUCTS MEAN BETTER BUSINESS!

YOU'RE really on board the *better-profit* special when you feature Sylvania Picture Tubes and Receiving Tubes.

Your customers know Sylvania as a pioneer in the development of fine radio and television products. From the very beginning, the name Sylvania has stood for the highest possible quality. And, as the industry has progressed and expanded, Sylvania has taken great care to maintain its recognized leadership.

Now, due to advanced manufacturing techniques and precision testing methods, Sylvania tubes can point to outstanding records, both in long life and fine performance. Today 7 of the 10 leading set manufacturers use Sylvania Picture Tubes and Receiving Tubes.

So, if you want *recognized quality* working on your side . . . sell *Sylvania!* Call your local Sylvania Distributor for the latest fall prices and money-making promotion offers, or write to: Sylvania Electric Products Inc., Dept. 3R-2110, 1740 Broadway, New York 19, N. Y.

SYLVANIA



LIGHTING • RADIO • ELECTRONICS • TELEVISION

**Television keeps telling
 about Sylvania quality**



Sylvania's popular nation-wide television show "Beat the Clock" continues to tell millions of your customers week after week, all through the year, about the unbeatable quality of Sylvania products.

In Canada: Sylvania Electric (Canada) Ltd.
 University Tower Bldg., St. Catherine Street, Montreal, P. Q.

no better choice...

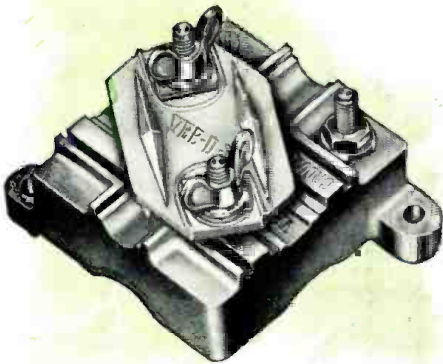

THE SENSATIONALLY NEW VEE-D-X UNIVERSAL LIGHTNING ARRESTER FOR UHF - VHF - AM - FM

With revolutionary new design, Model ULA takes all popular transmission lines — flat, tubular, oval, round, open wire. No need for separate lightning arresters for each type of transmission line. This single hermetically-sealed Lightning Arrester takes 'em all. Compact, simple, inexpensive. The first and only Lightning Arrester with printed circuit.

TAKES ALL POPULAR TRANSMISSION LINES

VEE-D-X ANTENNA ROTATOR the finest in design, construction and performance.

Precision-built to the highest quality standards in both material and craftsmanship. Modern streamlined case design. Unique, compact gearing assures dependable performance. Fast and easy-to-install.

MAGNIFICENT DECORATOR STYLED CONTROL CONSOLE

Beautiful, efficient Control Console operates easily, positively with convenient downward pressure. Instantaneous clockwise and counter-clockwise action. Compact and streamlined. Beautifully styled. Available in two eye-appealing colors: Heather Green and Cordovan Mahogany.



MM-40-A

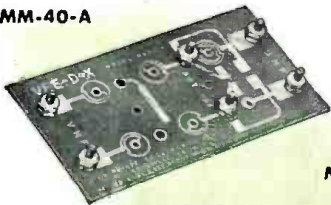

MM-40

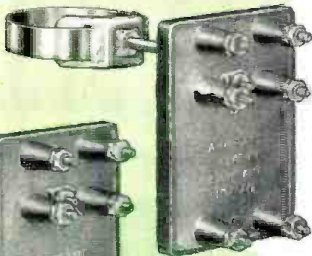

MM-25

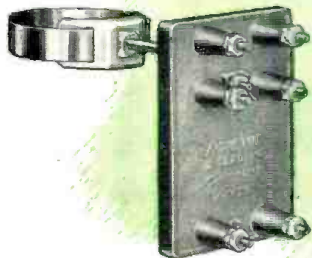

THE FAMOUS VEE-D-X MIGHTY MATCH

now 3 new improved models with the finest most efficient cross-over network filters ever perfected.

NEW MM-40 (yellow case) For combining UHF and VHF antennas to a single transmission line. New patented* printed circuit. Amazingly low insertion loss. New type terminals. Moisture-resistant case.

NEW MM-40-A Single line termination filter for use at set or converter. Separate terminals for UHF and VHF. Patented* printed circuit.

NEW MM-25 (green case) Permits use of single transmission line between separate high and low channel VHF antennas. New patented* printed circuit. Low insertion loss. New type terminals and moisture-resistant case.

*Lic. A,A.K. Pats. 2,422,458; 2,282,292; 2,611,086; others pending.

world's most powerful antenna systems

VHF ANTENNAS

MODEL DC Famous VEE-D-X low cost 5-element yagi with original VEE-D-X Delta Match construction.

MODEL DX The famous economy super power yagi. Has 30% higher gain on high channels than any other 10-element yagi. Delta Match and boom braced.

"V" SERIES BROAD BAND YAGIS Finest of all. 5-6 element "V" series in 2 cuttings. Cover entire VHF channel range.

"X" SERIES BROAD BAND YAGIS More popular than ever. Low cost 10-element "X" series in 3 cuttings. Cover entire VHF channel range.

MODEL JC For the most powerful single channel performance. A popular 5-element yagi. Easy-to-install.

MODEL QT The brilliant Q-Tee all-channel VHF antenna with patented* printed circuit channel separators. New improved construction and performance. Can be stacked for additional gain.

UHF ANTENNAS

MODEL BT-U The aristocrat of Bow-Tie antennas. Superior construction and performance. Can be stacked for extra gain.

MODEL COR-U Corner Reflector has 40% higher gain than a single Bow-Tie. Finest construction, rugged Fiberglas boom. Solid aluminum elements. Minimizes probing.

MODEL CA-U Famous Colinear with the highest gain of all broad band, fringe area UHF antennas. Available in Dual, Jr. models for specific area requirements.

MODEL LJ-U The UHF Long John. Single channel, 8-element yagi for primary and fringe areas. Compact. Efficient. Pre-assembled. Easy-to-install.

MODEL LLJ-U The most powerful of all single channel UHF antennas. Rugged Fiberglas boom and solid aluminum elements.

MODEL UQT Famous Ultra Q-Tee all-channel (2-83) UHF-VHF antenna. Has printed circuit filters. Ideal for primary area.

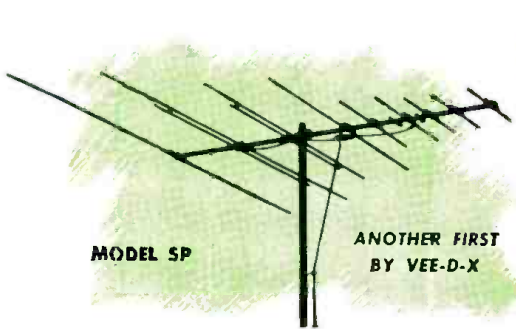
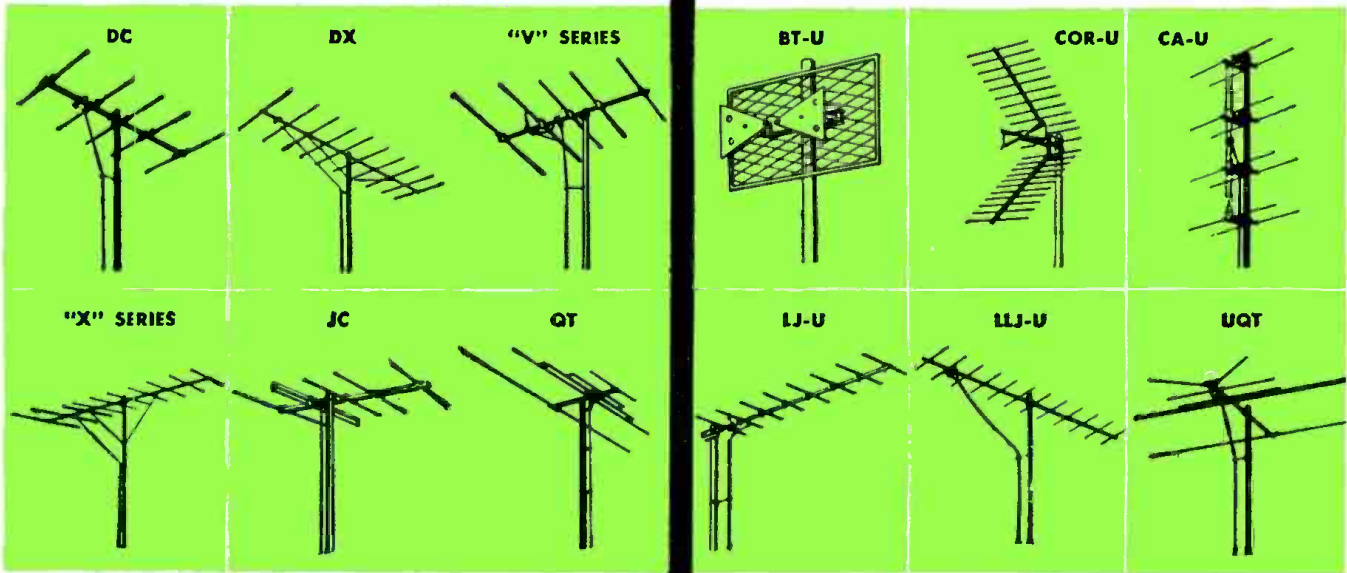

THE ONE AND ONLY ALL-CHANNEL YAGI VEE-D-X tra Special

Higher gain than a double-stacked conical. Yagi power and directivity plus all-channel performance — all in one exceptional antenna — Model SP. Nine-element hi-low yagi (5-element on high channel—4 on low) "T" matched. Hi-Low sections phased together with new isolation filter (MM-25).

FREE LITERATURE



Write for your copies of the complete VEE-D-X Specification Sheets and the new 36-page pocket guide to the world's finest antenna systems.

LaPointe ELECTRONICS INC.
Rockville, Connecticut

Send copies of the new complete antenna booklet and specification sheets for
(indicate by model number)

Name
Street
City Zone State

Engineering

WRITERS

ENGINEERS, E. E. or PHYSICS GRADUATES, for preparation of technical manuals...

HUGHES RESEARCH AND DEVELOPMENT LABORATORIES' expanding program for production of radar, electronic digital computers, guided missiles and other military advanced electronic systems and devices requires the following:

1 ELECTRICAL ENGINEERING AND PHYSICS GRADUATES to prepare operating, servicing and overhauling instructions for complex electronic equipment. Those with previous maintenance experience on military equipment preferred. Writers will participate in a three-month program in our technical training school to become familiar with the latest Hughes equipment prior to writing assignments.

2 ENGINEERS EXPERIENCED in the writing and preparation of maintenance manuals for electronic equipment or guided missiles. These specialists will work step-by-step with the people designing, developing and manufacturing the products involved. Experience in the writing of engineering reports is of value.

HOW TO APPLY

Write full details of your qualifications to

HUGHES

Research and Development Laboratories

SCIENTIFIC AND ENGINEERING STAFF

Culver City, Los Angeles County California

Assurance is required that relocation of the applicant will not cause disruption of an urgent military project.

HIGH-FIDELITY WITH CRYSTAL HEADPHONES

By CHARLES E. COHN

Use these relatively inexpensive phones to provide hi-fi listening, record monitoring, or for private hearing.

CRYSTAL headphones of the high-fidelity type are capable of giving quality comparable to that obtained from the best amplifier-speaker systems. For this reason, they are useful for low-cost, high-fidelity listening, for recording monitoring, or for listening without disturbing others. However, this quality is not obtainable without certain precautions which will be explained here.

The manufacturer's literature accompanying crystal headphones states that they may be connected into any tube circuit without affecting the frequency response. However, this is not quite true, as the impedance of these phones is capacitive and thus decreases with frequency. For example, the Brush BA-209 single phone (one unit of the BA-206 headset) has an impedance of 100,000 ohms at 1000 cycles and 10,000 ohms at 10,000 cycles. These specifications may be considered typical of all crystal phones. When these phones are bought as double headsets, they are connected in parallel, which means that the impedance of the headset will be 50,000 ohms at 1 kc. and 5000 ohms at 10 kc. Since these phones are flat across the greater part of the audio range with a constant voltage input, it is clear that these impedance characteristics will cause a considerable degradation of treble response if the phones are connected to a circuit having a high output impedance. For example, if this headset were driven by a pentode, its response would be 20 db down at 10 kc., with a high- μ triode it would be about 17 db down, while with a medium- μ triode it would be about 8 db down. This is clearly unacceptable performance, and shows that, despite the manufacturer's statements, these phones cannot be connected to just any circuit with acceptable results.

The ideal solution to this problem is to drive these phones with a cathode follower, but if the extra tube for this purpose is undesirable a compromise can be made. This can be done by replacing the original phone cord with a standard replacement cord, which would connect the phones in series instead of in parallel. Thus the impedances would be 200,000 ohms at 1 kc. and 20,000 ohms at 10 kc. This is still unacceptable for a pentode or high- μ triode, but with a medium- μ triode will cause a drop of only 3 db at 10 kc., which is not too bad, and can possibly be compensated for by tone control adjustment or altering the de-emphasis network if the phones

are used with an FM set. The 6 db loss in audio volume caused by the series connection is, of course, unimportant if the system has any reserve gain, as it should have.

The circuit which the manufacturer recommends for headphone connection is shown in the accompanying diagram. The value of the blocking condenser is not especially critical, but it should be of high quality in order to prevent damage to the phones through d.c. leakage. The 1 megohm resistor across the phones does not affect the response, but serves to prevent too large d.c. voltages from being built up across the phones in case of slight condenser leakage. The manufacturer states that this resistor can be replaced with a volume control, but from the above discussion it is clear that such is not advisable, as it would lead to a great loss of treble with the volume control turned down.

Audio levels required for normal listening are about 3 volts for the parallel connection and about 6 for the series connection. Plenty of output should be available, as high-fidelity listening requires lots of volume. These phones can handle any output which the ear can stand.

In this article the author has tried to show how crystal phones can be used to provide fidelity comparable to the best presently available. This information should be of particular interest to the high-fidelity fan with limited resources, as a pair of these phones and an FM tuner can give him much listening pleasure while he saves up to buy a good amplifier and speaker. Other cases where these phones would prove useful are if there is no room for a satisfactory speaker enclosure, or if the high volume which high-fidelity fans like would cause trouble with the family or the neighbors.

REFERENCE

"New High Quality Headphone Receiver," Brush Strokes, September 1952 (Brush Development Company)

-50-

Recommended phone connection circuit.

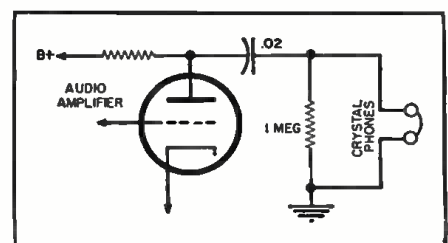



did you know . . .

that Rauland made the first rectangular tube in 1945?
everybody knows . . . that engineering leadership means
sales leadership . . . and that means RAULAND

THE RAULAND CORPORATION, 4245 N. KNOX AVENUE, CHICAGO 41, ILLINOIS • MULBERRY 5-5000

RAULAND

did you know . . .



that Rauland was the first company to produce the
electrostatic low focus voltage tube?
everybody knows . . . that engineering leadership means
sales leadership . . . and that means RAULAND



THE RAULAND CORPORATION, 4245 N. KNOX AVENUE, CHICAGO 41, ILLINOIS • MULBERRY 5-5000



DID YOU KNOW

that Rauland was the first company to manufacture
aluminized tubes on a production basis?
everybody knows . . . that engineering leadership
means sales leadership . . . and that means RAULAND

THE RAULAND CORPORATION, 4245 N. KNOX AVENUE, CHICAGO 41, ILLINOIS • MULBERRY 5-5000

Burton Brown Advertising

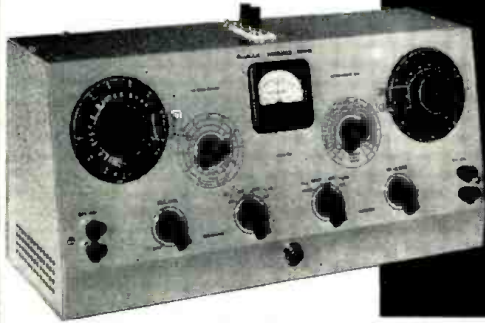

Heathkit IMPEDANCE BRIDGE KIT

MODEL IB-2

\$59⁵⁰

SHIPPING WT.
15 LBS.

Another new, outstanding instrument design so typically characteristic of Heathkit operation in producing high quality instrument kits at the lowest possible price. A new, improved model Impedance Bridge kit featuring modern cabinet styling, with slanted panel for convenience of operation and interpretation of scales at a \$10.00 price reduction over the preceding model. Built-in adjustable phase shift oscillator and amplifier with all rubes of the battery operated type completely eliminates warm-up time. The instrument is entirely AC line operated. No bothersome battery replacements.

The Heathkit IB-2 Impedance Bridge Kit actually represents four instruments in one compact unit. The Wheatstone Bridge for resistance measurements, the Capacity Comparison Bridge for capacity measurements, Maxwell Bridge for low Q, and Hay Bridge for high Q inductance measurements. Read Q, D, DQ all on one dial thereby eliminating possible confusion due to the incorrect dial, reference or adjustment. Only one set of instrument terminals nec-

essary for any measurement function. Panel provisions provided for external generator use.

A newly designed two section CRL dial provides ten separate "units" switch settings with an accuracy of .5%. Fractions of units are read on a continuously variable calibrated wire-wound control. A special minimum capacity, shielded, balanced impedance matching transformer between the generator and the bridge. The correct impedance match is automatically switch selected to provide constant load operation of the generator circuit. The instrument uses 1/2% precision resistors and condensers in all measurement circuits.

The new Heathkit IB-2 provides outstanding design features not found in any other kit instrument. The single low price includes the power supply, generator, and amplifier stages. No need to purchase separate instrument accessories in order to obtain the type of operation desired.

Features

- Simpson 100-0-100 microampere meter.
- Completely AC operated.
- Built-in phase shift generator and amplifier.
- Battery type tubes, no warm-up required.
- Newly designed two section CRL dial.
- Single knob D, Q, and DQ functions.
- Special impedance matching transformer.
- New modern cabinet styling.
- 1/2% precision resistors and silver mica condensers.

Heathkit AUDIO WATTMETER KIT

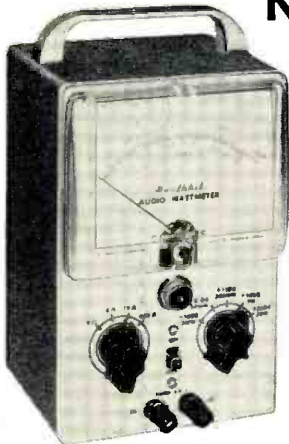

MODEL AW-1

\$29⁵⁰

SHIPPING WT.
6 LBS.

A new Heathkit design for the audio engineer, serious hi fi enthusiast, recording studio, or broadcast station; the Heathkit Audio Wattmeter Kit. This specialized instrument instantly indicates the output level of the equipment under test without requiring the use of external load resistors. All readings are taken directly from the calibrated scales of a 4 1/2" 200 microampere Simpson meter.

The Heathkit Audio Wattmeter features five full scale power measurement ranges from 5 milliwatts up to 50 watts with db ranges of -15 db to +48 db. The instrument has a power measurement rating of 25 watts continuous and 50 watts maximum for intermittent operation. Non-inductive resistance load impedances of 4, 8, 16, and 600 ohms are provided through a panel impedance selector switch. Frequency effect is negligible from 10 cycles to 250 kc. A conventional VTVM circuit utilizes a 12AU7 twin triode tube. The meter bridge circuit uses four germanium diodes for good linearity.

With the Heathkit AW-1 desired information can be obtained instantly and conveniently without bothering with the irksome setups and calculations usually required. Useful for power curve measurements, frequency response checks, monitoring indicator, etc. Convenient calibration directly from 110 volt AC line source. This new instrument will help to supply the answers to your audio operating or power output problems.

Heathkit LABORATORY GENERATOR KIT

MODEL LG-1

\$39⁵⁰

SHIP. WT.
16 LBS.



Another welcome new addition to the popular line of Heathkit instruments, the Heathkit Laboratory Generator. Specifically designed for flexibility of operation, accuracy and versatility beyond the performance level provided by the conventional service type generator. Frequency coverage of the Colpitts oscillator is 150kc to 30mc in five convenient ranges with provisions for internal or external modulation up to 50%, and .1 volt RF output throughout the frequency range. Panel mounted 200 microampere Simpson meter for RF "set reference level" to provide relative indication of RF output. Individually shielded oscillator and shielded variable and step attenuator provide flexible control of RF output.

The circuit features a 6AF4 high frequency oscillator, a 6AV5 amplifier with grid modulation, 12AU7 400 cycle oscillator and modulator, OB2 voltage regulator tube, and a selenium rectifier for the transformer operated power supply. The smart professional instrument appearance and over-all flexibility of operation will prove a decided asset to any industrial or educational laboratory. The Heathkit Laboratory Generator sets a new level of operation, far superior to any instrument in this price classification.

HEATH COMPANY • Benton Harbor 15, Mich.

CHECK THESE *Features*

- ✓ New 5U1 CR tube
- ✓ Re-trace blanking
- ✓ Voltage regulation
- ✓ Extended band width
- ✓ Peak-to-peak calibrating provisions
- ✓ Good square wave response
- ✓ Astigmatism control
- ✓ New heavy duty shielded power transformer

NEW 5" *Heathkit*
**OSCILLOSCOPE
KIT**

MODEL O-9

\$59⁵⁰

SHIPPING
WT. 28 LBS.



Announcing the latest addition to a brilliant series of Heathkit Oscilloscopes, the new Model O-9. This outstanding instrument incorporates all of the features developed and proven in the production of well over 50,000 kits, in addition to a host of many new design features for truly outstanding performance. This new scope features a brand new (no surplus) commercially available 5U1 cathode ray tube for fine focusing, high intensity, and freedom from halation. The 5" CR tube is the standard size for design and industrial laboratories, development engineers, and service men. The only size CR tube offering a wide range of types, colors, phosphors, and persistence. The answer to good oscilloscope performance lies in improved basic design and operating characteristics, and not in the use of larger CR tubes.

VERTICAL AMPLIFIER — New extended band width vertical amplifier with sensitivity of .025 volts per inch, down 3 db at 2 mc, down only 5 1/2 db at 3 mc. Three step vertical input attenuator, quality ceramic variable capacitors for proper input compensation, provisions for calibrated 1 volt peak-to-peak reference, with calibrated screen for direct reading of TV pulses.

HORIZONTAL AMPLIFIER —

New input selector switch provides choice of horizontal input, 60 cycle sweep input, line sync, internal sync, and external sync. Expanded horizontal sweep produces sweep width several times the cathode ray tube diameter. New blanking amplifier for complete retrace blanking and new phasing control.

POWER SUPPLY — New high voltage power supply and filtering circuit for really fine hairline focusing. New heavy duty power transformer with adequate operating reserve. Voltage regulated supply for both vertical and horizontal amplifiers for absolutely rock steady traces and complete freedom from bounce and jitter due to line variations.

The acid test of any oscilloscope operation is the ability to reproduce high frequency square waves and the new Heathkit O-9 will faithfully reproduce square waves up to 500 kc. This is the ideal all around, general purpose oscilloscope for educational and industrial use, radio and TV servicing, and any other type of work requiring the instantaneous reproduction and observation of actual wave forms and other electrical phenomena.

Heathkit **LOW CAPACITY
PROBE KIT**



NO. 342

\$3⁵⁰ SHIP. WT.
1 LB.

Oscilloscope investigation of high frequency, high impedance, or broad bandwidth circuits encountered in television work requires the use of a low capacity probe to prevent loss of gain, distortion, or false service information. The Heathkit Low Capacity Probe features a variable capacitor to provide the necessary degree of instrument impedance matching. New probe styling with bright polished aluminum housing and polystyrene probe ends.



NO. 337-B

\$3⁵⁰

SHIP. WT. 1 LB.

Heathkit
**SCOPE DEMODULATOR
PROBE KIT**

In applications such as trouble shooting or aligning TV, RF, IF, and video stages, the frequency ranges encountered require demodulation of signals before oscilloscope presentation. The newly-styled Heathkit Demodulator Probe in polished aluminum housing will fulfill this function and readily prove its value as an oscilloscope service accessory. Detailed assembly sheet provided, including instructions for probe operation.

Heathkit
VOLTAGE CALIBRATOR KIT

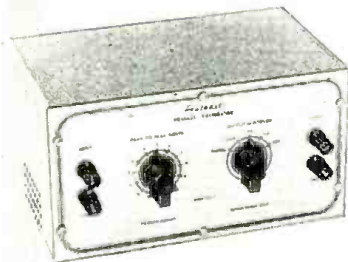

MODEL VC-2

\$11⁵⁰

SHIPPING WT.
4 LBS.

The Heathkit Voltage Calibrator provides a convenient method of making peak-to-peak voltage measurements with an oscilloscope by establishing a relationship on a comparison basis between the amplitude of an unknown wave shape and the known output of the voltage calibrator. Peak-to-peak voltage values are read directly on the calibrated panel scales. To offset line voltage supply irregularities, the instrument features a voltage regulator tube.

With the Heathkit Voltage Calibrator, it is possible to measure all types of complex wave forms within a voltage range of .01 to 100 volts peak-to-peak. A convenient "signal" position on the panel switch bypasses the calibrator completely and the signal is applied to the oscilloscope input thereby eliminating the necessity for transferring test leads.

Heathkit
**ELECTRONIC SWITCH
KIT**

The basic function of the Heathkit S-2 Electronic Switch Kit is to permit simultaneous oscilloscope observation of two separate traces which can be either separated or superimposed for individual study. A typical example would be observation of a signal as it appears at both the input and output stages of an amplifier. It will also serve as a square wave generator over the range of switching frequencies, often providing the necessary wave form response information without incurring the expense of an additional instrument.

Continuously variable switching rates in three ranges from less than 10 cps to over 2,000 cps. Individual controls for each input channel and a positioning control. The five tube transformer operated circuit utilizes two 6SJ7, two 6SN7, and one 6X5 tubes. Buy this kit and enjoy increased versatility of operation from your oscilloscope.



MODEL S-2

\$23⁵⁰

SHIP. WT. 11 LBS.

HEATH COMPANY • Benton Harbor 15, Mich.

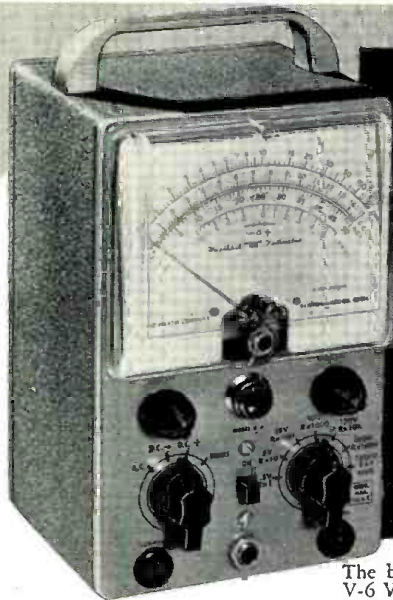

Heathkit VACUUM TUBE VOLTMETER KIT

MODEL V-6

\$24.50

SHIPPING WT. 6 LBS.

The beautiful Heathkit Model V-6 VTVM, the world's largest selling kit instrument, now offers many outstanding new features in addition to retaining all of the refinements developed and proven in the production of over 100,000 VTVM's. This is the basic measuring instrument for every branch of electronics. Easily meets all requirements for accuracy, stability, sensitivity, convenience of ranges, meter readability, and modern styling. It will accurately measure DC voltages, AC voltages, offers tremendous ohmmeter range coverage, and a complete db scale for a total of 35 meter ranges.

New 1½ volt full scale low range provides well over 2¼" of scale length per volt. Upper DC scale limit 1,500 volts. DC ranges 0-1.5, 5, 15, 50, 150, 500, 1,500 volts full scale. AC ranges 0-1.5, 5, 15, 50, 150, 500, 1,500 (1,000 volts maximum). Seven ohm-

meter ranges from .1 ohm to 1,000 megohms. For added convenience a DC polarity reversing switch and a center scale zero adjustment for FM alignment.

The smartly styled, compact, sturdy, formed aluminum cabinet is finished in an attractive gray crackle exterior. The beautiful two-color, durable, infra-red, baked enamel panel further adds to the over-all professional appearance.

Top quality components used throughout. 1% precision resistors — silver contact range and selector switches — selenium rectifier — transformer operated power supply. Individual calibration on both AC and DC for maximum accuracy. DB scale printed in red for easy identification, all other scales a sharp, crisp black for easy reading. A variety of accessory probes shown on this page still add further to over-all instrument usefulness.

Features

- ✓ New 1½ volt full scale low range
- ✓ 1,500 volt upper limit DC range
- ✓ Increased accuracy through 50% greater scale coverage
- ✓ High impedance 11 megohm input
- ✓ Center scale zero adjust
- ✓ Polarity reversal switch
- ✓ 1% precision resistors
- ✓ Clearly marked db scales

Heathkit 30,000 VOLT DC PROBE KIT

For TV service work or any similar application where the measurement of high DC voltage is required, the Heathkit Model 336 High Voltage Probe Kit will prove invaluable. A precision multiplier resistor mounted inside the two-color, sleek, plastic probe body provides a multiplication factor of 100 on the DC ranges of the Heathkit 11 megohm VTVM. The entire kit includes precision resistor, two-color plastic probe, tip connector spring, test lead, phone plug panel connector, and complete assembly instructions.



No. 336

\$4.50

SHIP. WT.
2 LBS.

No. 338-B

Heathkit PEAK-TO-PEAK PROBE KIT



\$5.50

SHIP. WT. 2 LBS.

Now read peak-to-peak voltages on the DC scales of the Heathkit 11 megohm VTVM. Readings can be directly made from the VTVM scale without involved calculations. Measurements over the frequency range of 5 kc to 5 mc. Use this probe to extend the usefulness of your VTVM in radio and TV service work. The Peak-to-Peak Probe Kit features the new polished aluminum housing with two-color polystyrene probe ends. Detailed assembly sheet including instructions for probe operation.

Heathkit RF PROBE KIT

The Heathkit RF Probe used in conjunction with any 11 megohm VTVM will permit RF measurements up to 250 mc, ± 10%. A useful, convenient accessory for those occasions when RF measurements are desired. The RF probe body is housed in the new, smartly-styled polished aluminum probe body featuring two-color polystyrene probe ends and a low capacity flexible shielded test lead. The kit is complete with all necessary material and a detailed assembly sheet as well as instructions for probe operation.



No. 309-B

\$3.50

SHIP. WT. 2 LBS.

Heathkit AC VACUUM TUBE VOLTMETER KIT

MODEL AV-2

\$29.50

SHIPPING WT.
5 LBS.

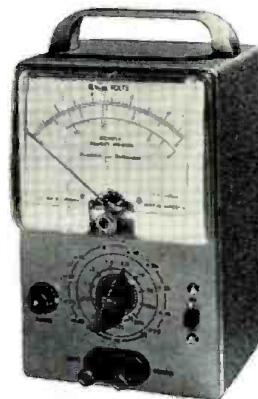

The new Heathkit AC VTVM that makes possible those sensitive AC measurements required by laboratories, audio enthusiasts, and experimenters. Especially useful for hum investigation, sensitive null detection, phono pick-up output measure-

ments, making frequency response runs, gain measurements, ripple voltage checks, etc. Low level measurements are easy to make because of the complete voltage coverage of the instrument and the one knob operation.

The large 200 microampere Simpson meter has clearly marked and easy to read meter scales. Ten voltage ranges covering from .01 rms full scale to 300 volts rms full scale, with frequency response ± 1 db from 20 cycles to 50,000 cycles. Instrument input impedance 1 megohm, ten db ranges from -52 db to +52 db. For stability and good linearity characteristics the meter bridge circuit features 4 germanium diodes. Attractive instrument styling, a companion piece for the popular Heathkit VTVM and the new AW-1 Audio Wattmeter.

HEATH COMPANY • Benton Harbor 15, Mich.

CHECK THESE *Features*

- ✓ 20,000 ohms per volt DC sensitivity, 5,000 ohms per volt on AC
- ✓ Polarity reversal switch
- ✓ 1% precision multiplier resistors
- ✓ 50 microampere 4½" Simpson meter
- ✓ Meter ranges for service convenience
- ✓ New resistor ring-switch assembly
- ✓ Total of 35 meter ranges
- ✓ New Modern cabinet styling

NEW *Heathkit*
**MULTIMETER
KIT**

MODEL MM-1

\$26.50

SHIPPING WT. 6 LBS.



The most important Heathkit announcement of the year, the new 20,000 ohms per volt Heathkit Multimeter, Model MM-1. The universal service measuring instrument, accurate, sensitive, portable, and completely independent of AC line supply. Particularly designed for service use incorporating many desirable features for the convenience of the service man. Full 20,000 ohms per volt sensitivity on DC ranges — 5,000 ohms per volt sensitivity on AC — polarity reversal switch, no bothersome transferring of test leads — 1% precision multiplier resistors — large 4½" recessed non-glare 50 microampere Simpson meter — conveniently slanted control panel — recessed safety type banana jacks — standard universally available batteries — rugged practical sized cabinet with plastic carrying handle, and a total of 35 calibrated meter ranges.

RANGES

Voltage ranges selected entirely for service convenience. For example 1½ volt full scale low range for measuring portable radio filament voltages, bias voltages, etc., 150 volt full scale range for AC-DC service work, 500 volt full scale range for conventional transformer operated power supply systems. Complete voltage ranges AC and DC, 0-1.5—5—50—150—500—1,500—5,000 volts. DC current ranges, 0-150 microamperes—15 milliamperes—150 milliamperes—500 milliamperes—15 amperes. Resistance measurements from .2 ohms to 20 meg-

ohms x 1 x 1,000 x 10,000.

DB coverage from -10 db to +65 db.

CONSTRUCTION

Entirely new design permits assembly, mounting and wiring of precision resistors on a ring-switch assembly unit. The major portion of instrument wiring is completed before mounting the ring-switch assembly to the panel. No calibration procedure is required, all precision resistors readily accessible in event of replacement.

CABINET

Strikingly modern cabinet styling featuring two piece construction, durable black Bakelite cabinet, with easy to read panel designations. Cabinet size 5½" wide x 4" deep x 7½" high. Good cabinet physical stability when operated in vertical position.

The Heathkit MM-1 represents a terrific instrument value for a high quality 20,000 ohms per volt unit using all 1% deposited carbon type precision resistors. Here is quality, performance, functional design, and attractive appearance, all combined in one low priced package.

Heathkit

BATTERY TESTER KIT



MODEL BT-1

\$8.50

SHIP. WT.
2 LBS.

The Heathkit Battery Tester measures all types of dry batteries between 1½ volts and 150 volts under actual load conditions. Readings are made directly on a three color Good-Weak-Replace scale. Operation is extremely simple and merely requires that the test leads be connected to the battery under test. Only one control to adjust in addition to a panel switch for "A" or "B" battery types. The Heathkit Battery Tester features compact assembly, accurate meter movement, and a three deck wire-wound control, all mounted in a portable rugged plastic cabinet. Checks portable radio batteries, hearing aid batteries, lantern batteries, etc.

Heathkit

HANDITESTER KIT



MODEL M-1

\$14.50

SHIPPING WT.
3 LBS.

The Heathkit Model M-1 Handitester readily fulfills major requirements for a compact, portable volt ohm milliammeter. Despite its compact size, the Handitester is packed with every desirable feature required in an instrument of this type. AC or DC voltage ranges full scale, 0-10—30—300—1,000—5,000 volts. Two ohmmeter ranges, 0-3,000 and 0-300,000. Two DC current measurement ranges, 0-10 milliamperes and 0-100 milliamperes. The instrument uses a Simpson 400 microampere meter movement, which is shunted with resistors to provide a uniform 1 milliampere load on both AC and DC ranges. Special type, easily accessible, battery mounting bracket — 1% deposited carbon type precision resistors — hearing aid type ohms adjust control. The Handitester is easily assembled from complete instructions and pictorial diagrams. Necessary test leads are included in the price of this popular kit.

HEATH COMPANY • Benton Harbor 15, Mich.

New *Heathkit* 12 Volt BATTERY ELIMINATOR KIT

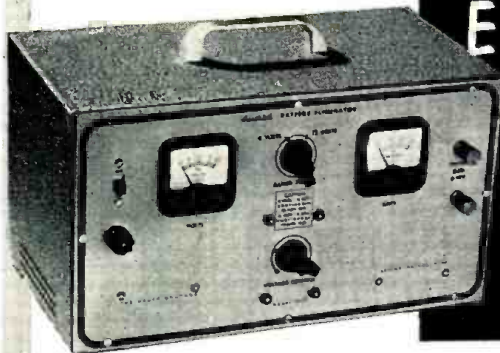

MODEL BE-4

\$31⁵⁰

SHIPPING WT.
18 LBS.

CHECK THESE *Features*

- ✓ Either 6 or 12 volt operation
- ✓ Continuously variable voltage output
- ✓ Constant ammeter and voltmeter monitoring
- ✓ Automatic overload relay — self-resetting
- ✓ Two 10,000 mf condensers
- ✓ New 18 disc split type heavy duty rectifier unit
- ✓ Fuse protection

Here is the new Heathkit Battery Eliminator necessary for modern, up-to-date operation of your service shop. The Heathkit Model BE-4 furnishes either 6 volts or 12 volts output which can be selected at the flick of a panel switch. Use the BE-4 to service the new 12 volt car radios in addition to the conventional 6 volt radios.

This new Battery Eliminator provides two continuously variable output ranges, 0-8 volts DC at 10 amperes continuously, or 15 amperes maximum intermittent; 0-16 volts DC at 5 amperes continuously or 7.5 amperes maximum intermittent. The output voltage is clean and well filtered as the circuit uses two 10,000 mf condensers. The continuously variable voltage output feature is a definite aid in determining the starting point of vibrators, the voltage operating range of oscillator circuits, etc. Panel mounted meters constantly monitor voltage and cur-

rent output and will quickly indicate the presence of a major circuit fault in the equipment under test. The power transformer primary winding is fuse protected and for additional safety an automatic relay of the self-resetting type is incorporated in the DC output circuit. The heavy duty rectifier is a split type 18 plate magnesium copper sulfide unit used either as a full wave rectifier or voltage doubler according to the position of the panel range switch.

Here is the ideal battery eliminator for all of your service problems and as an additional feature, it can also be used as a battery charger. Another new application for the Heathkit Battery Eliminator is a variable source of DC filament supply in audio development and research. More than adequate variable voltage and current range for normal applications.

Heathkit VIBRATOR TESTER KIT

Your repair time is valuable, and service use of the Heathkit Vibrator Tester will save you many hours of work. This tester will instantly tell you the condition of the vibrator being checked. Checks vibrators for proper starting and the easy to read meter indicates quality of output on a large Bad-?-Good scale. The Heathkit VT-1 checks both interrupter and self rectifier types of vibrators. Five different sockets for checking hundreds of vibrator types.

The Heathkit Vibrator Tester operates from any battery eliminator capable of delivering continuously variable voltage from 4 to 6 volts DC at 4 amperes. The new Heathkit Model BE-4 Battery Eliminator would be an ideal source of supply.

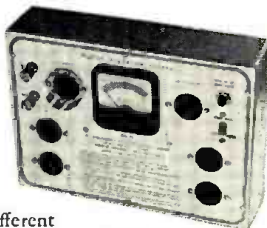

MODEL VT-1

\$14⁵⁰

SHIPPING WT.
6 LBS.

NEW *Heathkit* VARIABLE VOLTAGE ISOLATION TRANSFORMER KIT

The new Heathkit Isolation Transformer Kit provides line isolation for AC-DC radios (not an auto transformer), thereby eliminating shock hazard, hum problems, alignment difficulties, etc. The output voltage is variable from 90 to 130 volts AC and is constantly monitored by a panel mounted AC volt meter. Use it to increase AC supply voltage in order to induce breakdown of faulty components in circuits thereby saving service time. Use it also to simulate varying line voltage conditions and to determine the line voltage level at which oscillator circuits cease functioning, particularly in three-way portable radios. Rated at 100 watts continuous operation and up to 200 watts maximum intermittent operation. A useful radio and TV service tool.



MODEL IT-1

\$16⁵⁰

SHIP. WT. 9 LBS.

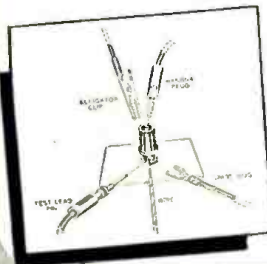

Heathkit BINDING POST

Binding post kit now available so that standardization of all instrument connectors is possible. This new, five-way binding post will accommodate an alligator clip, banana plug, test lead pin, spade lug, or hook-up wire. Sold in units of 20 binding post assemblies. Each assembly includes binding post, flat and shoulder fiber washers, solder lug, and nut. 120 pieces in all. Kit 362, \$4.00.



Heathkit TECHNICAL

APPLICATION BULLETINS

An exclusive Heathkit service. Technical application bulletins prepared by recognized instrument authorities outlining various combinations of instrument applications. Available now with 40 four-page illustrated bulletins and an attractive flexible loose-leaf binder. Only \$2.00. (No c.o.d. on this item, please.)

HEATH COMPANY • Benton Harbor 15, Mich.

CHECK THESE *Features*

- ✓ INCREDUCTOR controllable inductor sweep
- ✓ TV and IF sweep deviation 12-30 mc
- ✓ 4 mc- 220 mc continuous frequency coverage
- ✓ Oscillator operation entirely on fundamentals
- ✓ Output in excess of 100,000 microvolts
- ✓ Automatic amplitude circuit
- ✓ Voltage regulation
- ✓ Simplified operation

NEW *Heathkit*
**TV ALIGNMENT
GENERATOR
KIT**

MODEL TS-3

\$44.50

SHIPPING WEIGHT
18 POUNDS



Proudly announcing an entirely new, advanced model TV and FM Sweep Generator, the Heathkit Model TS-3. This new design provides features and combinations of functions not found in any other service type instrument. Every design consideration has been given to the requirements of the TV service man to provide a flexible, variable sweep source with more than adequate RF output and complete frequency coverage throughout the TV and FM spectrum.

The frequency range of the TS-3 is from 4 mc to 220 mc in four switch selected ranges. All frequency ranges are overlapping for complete coverage. A particularly important feature of the instrument is that the oscillator operates entirely on fundamentals, thereby providing complete freedom from spurious oscillation and parasitics normally encountered in beat frequency type oscillators. This circuitry assures a much higher total RF output level and simplifies attenuation problems.

The new TS-3 features an entirely new principle of sweep operation. Sweep action is entirely electronic with no moving parts or electro-mechanical devices so commonly used. The heart of the sweep system is a newly-developed INCREDUCTOR, controllable inductor. With this system, the value of inductance of each oscil-

lator coil is electrically varied with an AC control current, and the inductance variation is achieved by a change in the magnetic state of the core on which the oscillator coils are wound. This system provides a sweep deviation of not less than 12 mc on all TV frequencies, and up to a maximum of 30 mc on TV IF frequencies. The high RF output level throughout the instrument frequency range overcomes the most common complaint of the older type sweep generators. A new, automatic amplitude control circuit maintains the output level flat to ± 2 db throughout the instrument range. For convenience of operation a low impedance 50 ohm output is used.

Operation of the instrument has been simplified through the reduction of panel controls and separate panel terminals provide for external synchronization if desired. The circuit uses a voltage regulator tube to maintain stable instrument operation. A built-in variable oscillator marker further adds to flexibility of instrument operation. Provisions are also made for the use of an external marker, such as your service type signal generator, if desired. Use the Heathkit TS-3 for rapid, accurate TV alignment work, and let it help you solve those time consuming, irksome problems so frequently encountered.

NEW *Heathkit*
SIGNAL GENERATOR KIT

MODEL SG-8

\$19.50

SHIPPING WEIGHT
8 POUNDS



Announcing the new Heathkit Model SG-8 service type Signal Generator, incorporating many design features not usually found in an instrument in this price range. The RF

output is from 160 kc to 100 mc in five ranges, all on fundamentals, with useful harmonics up to 200 mc. The RF output level is in excess of 100,000 microvolts throughout the frequency range.

The oscillator circuit consists of a 12AT7 twin triode tube. One half is used as a Colpitts oscillator, and the other half as a cathode follower output which acts as a buffer between the oscillator and external load. This circuitry eliminates oscillator frequency shift usually caused by external circuit loading.

All coils are factory wound and adjusted, thereby completely eliminating the need for calibration and the use of additional calibrating equipment. The stable low impedance output features a step and variable attenuator for complete control of RF level. A 6C4 triode acts as a 400 cycle sine wave oscillator and a panel switching system permits a choice of either external or internal modulation.

The transformer operated circuit is easy to assemble, requires no calibration, and meets every service requirement for an adjustable level variable frequency signal source, either modulated or un-modulated.

NEW *Heathkit*
BAR GENERATOR KIT

MODEL BG-1

\$14.50

SHIPPING WEIGHT
6 POUNDS



The Heathkit BG-1 Bar Generator represents another welcome addition to the fast growing line of popular Heathkits. The

station transmitted test pattern is rapidly disappearing, and the bar generator is the logical answer to the TV service man's problem in obtaining quick, accurate adjustment information without waiting for test patterns.

The Heathkit BG-1 produces a series of horizontal or vertical bars on a TV screen. Since these bars are equally spaced, they will quickly indicate picture linearity of the receiver under test. Panel switch provides "stand-by position" — "horizontal position" — "vertical position." The oscillator unit utilizes a 12AT7 twin triode for the RF oscillator and video carrier frequencies. A neon relaxation oscillator provides low frequency for vertical linearity tests. The instrument will not only produce bar patterns but will also provide an indication of horizontal and vertical sync circuit stability, as well as overall picture size.

Instrument operation is extremely simple, and merely requires connection to the TV receiver antenna terminal. The unit is transformer operated for safety when used in conjunction with universal or transformerless type TV circuits.

HEATH COMPANY • Benton Harbor 15, Mich.



NEW *Heathkit* TUBE CHECKER KIT

MODEL TC-2

\$29⁵⁰

SHIP. WT. 12 LBS.

The new Model TC-2 Heathkit Tube Checker features many circuit improvements, simplified wiring, new roll chart drive and illumination of roll chart. The instrument is primarily designed for the convenience of the radio and TV service man and will check the operating quality of tubes commonly encountered in this type of work. Test set-up procedure is simplified, rapid, and flexible. Panel sockets accommodate 4, 5, 6, and 7 pin tubes, octal and loctal, 7 and 9 pin miniatures, 5 pin Hytron and a blank socket for new tubes. Built-in neon short indicator, individual three-position lever switch for each tube element, spring return test switch, 14 filament voltage ranges, and line set control to compensate for supply voltage variations, all represent important design features of the TC-2. Results of tube tests are read directly from a large 4½" Simpson three-color meter, calibrated in terms of Bad-?-Good. Information that your customer can readily understand. Checks emission, shorted elements, open elements, and continuity.

The use of closer tolerance resistors in critical circuits assures correct test information and eliminates the possibility of inaccurate test interpretation. Improvement has been made in the mechanical roll chart drive system, completely eliminating diagonal running, erratic operation, and backlash. The thumb wheel gear driven action is smooth, positive, and free running. As an additional feature, the roll chart is illuminated for easier reading, particularly when the tube checker is used on radio or TV home service calls.

Wiring procedure has been simplified through the extended use of multi-cable, color coded wires, providing a harness type installation between tube sockets and lever switches. This procedure insures standard assembly and imparts that "factory built" appearance to instrument construction. Completely detailed information is furnished in the new step-by-step construction manual, regarding the set-up procedure for testing of new or unlisted tube types. No delay necessary for release of factory data.

The new Heathkit Tube Checker will prove its value in building service prestige through usefulness — simplified operation — attractive professional appearance. Don't overlook the fact that the kit price represents a savings of \$40.00 to \$50.00 over the price of a comparable commercially built instrument. At this low price, no service man need be without the advantages offered by the Heathkit Tube Checker.

CHECK THESE NEW *Features*

- ✓ Simplified harness wiring
- ✓ Improved, smooth, anti-backlash roll chart action
- ✓ Optional roll chart illumination
- ✓ Individual element switches
- ✓ Portable or counter style cabinet
- ✓ Spare blank socket
- ✓ Contact type pilot light test socket
- ✓ Simplified test set-up procedure
- ✓ Line adjust control
- ✓ 4½" three-color meter

New

HEATHKIT PORTABLE TUBE CHECKER KIT

MODEL TC-2P

\$34⁵⁰

SHIP. WT. 14 LBS.

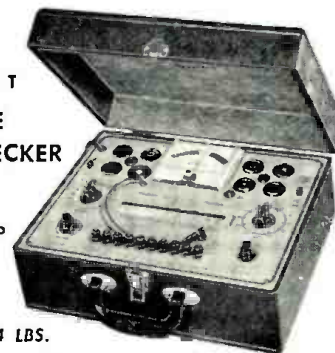

The portable model is supplied with a strikingly attractive two-tone cabinet finished in rich maroon, proxylin impregnated, fabric covering with a contrasting gray on the inside cover. Detachable cover, brass-plated hardware, sturdy plastic handle help to impart a truly professional appearance to the instrument.

PORTABLE TUBE CHECKER CABINET as described above will fit all earlier Heathkit TC-1 Tube Checkers. Shipping weight 7 lbs. Cabinet only, 91-8, \$7.50.



No. 355 **\$4⁵⁰**
Ship. Wt. 1 lb.

Heathkit TV PICTURE TUBE TEST ADAPTER

The Heathkit TV Picture Tube Test Adapter used with the Heathkit Tube Checker will quickly check for emission, shorts, etc., and determine picture tube quality. Consists of standard 12 pin TV tube socket, four feet of cable, octal socket connector, and data sheet.

Heathkit POWER SUPPLY KIT



MODEL PS-2

\$33⁵⁰

SHIPPING WT.
17 LBS.

The Heathkit Laboratory Power Supply features continuously variable, regulated, voltage output with good stability under wide load variations. A 4½" Simpson plastic enclosed panel mounted meter provides accurate meter output information of voltage or current. All panel terminals completely isolated from the cabinet. Separate 6.3 volt AC supply at 4 amperes for filament requirements. Ripple component exceptionally low, stand-by switch provided to eliminate warm-up time of the five tube circuit.



LABORATORY AND SERVICE SHOP BOOKLETS

"Planning Your Service Business" by John T. Frye, and "Establishing the Industrial Electronics Laboratory" by Louis B. Garner, Jr., are booklets available to Heathkit customers at no charge. These booklets, written by nationally recognized authorities, outline the various requirements and considerations for establishing your own service business or for setting up an industrial electronics laboratory. Full attention is given to various details that are frequently overlooked when projects of this nature are undertaken. Just write in to the Heath Company requesting your free copy, or attach a memo to your next order.

HEATH COMPANY • Benton Harbor 15, Mich.

CHECK THESE *Features*

- ✓ Visual and aural signal tracing
- ✓ Two channel input
- ✓ High RF sensitivity
- ✓ Unique noise locator circuit
- ✓ Calibrated wattmeter
- ✓ Substitution test speaker
- ✓ Utility amplifier
- ✓ RF, audio probes and test leads included

Heathkit VISUAL-AURAL SIGNAL TRACER KIT

MODEL T-3
\$23⁵⁰
SHIPPING WEIGHT
10 POUNDS



An entirely new type of signal tracer incorporating a combination of features not found in any other instrument. Designed expressly for the radio and TV service man, particularly for the servicing of AM, FM, and TV circuits. Here in a five tube, transformer operated instrument are all of the useful functions so necessary for speedy, accurate isolation of service difficulty.

This new signal tracer features a special high gain RF input channel, used in conjunction with a newly-designed wide frequency range demodulator probe. High RF sensitivity permits signal tracing at the receiver antenna input. A separate low gain channel and probe available for audio circuit exploration. Both input channels are constantly monitored by an electron ray beam indicator, so that visual as well as aural signal indications may be observed. The instrument can also be used for comparative estimation of gain per stage.

A decidedly unusual feature is a noise localizer circuit in conjunction with the audio probe. With this system, a DC potential is applied to a suspected circuit component and the action of the

voltage in the component can be seen as well as heard. Invaluable for ferreting out noisy or intermittent condensers, noisy resistors, controls, coils, IF and power transformers, etc. A built-in calibrated wattmeter circuit is very useful for a quick preliminary check of the total wattage consumption of the equipment under test. Separate panel terminals provide external use of the speaker or output transformer for substitution purposes. Saves valuable service time by eliminating the necessity for speaker removal on every service job. The terminals also permit the utilization of other shop equipment, such as your oscilloscope or VTVM. The T-3 Signal Tracer can be used as a high gain amplifier for checking tuners, record changers, microphones, phono crystals, etc.

Don't overlook the interesting service possibilities provided through the use of this new instrument and let it work for you by saving time and money. The kit is supplied complete with all tubes, circuit components, demodulator probe, audio probe, and additional test leads.



Heathkit DECADE RESISTANCE KIT

MODEL DR-1 The Decade Resistance Kit provides individual switch selection of resistance values using twenty 1% resistors providing a choice of 1 to 99,999 ohms in 1 ohm steps. Ceramic wafer switches, silver-plated contacts, smooth, positive detent action, baked enamel panel, and handsome, polished birch cabinet.

\$19⁵⁰
SHIP. WT.
4 LBS.

Heathkit DECADE CONDENSER KIT

The Heathkit Decade Condenser Kit features silver mica, precision condensers with a rated accuracy of $\pm 1\%$. Capacity values are arranged in three decades from 100 mmf to .111 mf in steps of 100 mmf. Ceramic wafer switches with silver-plated contacts and smooth detent action. Useful in laboratory work, for circuit development.

MODEL DC-1
\$16⁵⁰
SHIP WT
4 LBS.



Heathkit RESISTANCE SUBSTITUTION BOX KIT



MODEL RS-1 The Heathkit Resistance Substitution Box provides individual switch selection of any one of 36 RTMA 1 watt 10% standard value resistors, ranging from 15 ohms to 10 megohms. Many applications in circuit development work, and also in radio and TV service work. Ideal for experimentally determining resistance values and for quickly altering circuit operating characteristics. Entire unit housed in attractive Bakelite cabinet, featuring the new universal type Heathkit binding posts to simplify circuit connections.

\$5⁵⁰
SHIP. WT.
2 LBS.

Heathkit CONDENSER CHECKER KIT

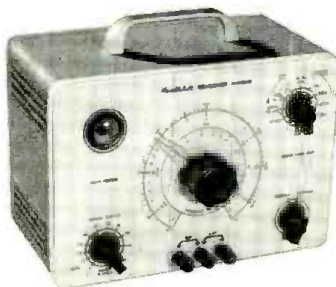

MODEL C-3
\$19⁵⁰
SHIPPING WT.
8 POUNDS

Use the Heathkit C-3 Condenser Checker to quickly and accurately measure those unknown condenser and resistor values. All readings are taken directly from the calibrated panel scales without requiring any involved calculation. Capacity measurements in four ranges from .00001 mf to 1,000 mf. Checks paper, mica, ceramic, and electrolytic condensers. A power factor control is available for accurate indication of electrolytic condenser measurements. A leakage test switch with switch selection of five polarizing voltages, 25 volts to 450 volts DC, will indicate condenser operating quality under actual load condition. The spring return leakage test switch automatically discharges the condenser under test and eliminates shock hazard to the operator.

Resistance measurements can be made in the range from 100 ohms to 5 megohms. Here again all values are read directly on the calibrated scale. Increased circuit sensitivity coupled with an electron beam null indicator increases overall instrument usefulness.

For safety of operation the circuit is entirely transformer operated and the instrument is housed in the attractive, newly-styled Heathkit cabinet, featuring rounded corners, and drawn aluminum panel. The outstanding low kit price for this surprisingly accurate instrument includes necessary test leads. Good service shop operation requires the use of this specialized instrument, designed for the express purpose of determining unknown condenser values and operating characteristics.

HEATH COMPANY • Benton Harbor 15, Mich.



Heathkit AMATEUR TRANSMITTER KIT

MODEL AT-1

\$29.50

SHIPPING WEIGHT
16 POUNDS

CHECK THESE NEW Features

- ✓ Single knob band switching
- ✓ Pre-wound coils
- ✓ Metered operation
- ✓ 52 ohm coaxial output
- ✓ Crystal or VFO excitation
- ✓ Built-in power supply
- ✓ Rugged, clean construction

Here is the latest Heathkit addition to the ham radio field, the AT-1 Transmitter Kit, incorporating many desirable design features at the lowest possible dollar-per-watts price. Panel mounted crystal socket, stand-by switch, key click filter, AC line filtering, good shielding, etc. VFO or crystal excitation—up to 35 watts input. Built-in power supply provides 425 volts at 100 ma. This kit features pre-wound coils, single knob band switching, 52 ohm coaxial output, plug in chassis provisions for VFO or modulator and rugged clean construction. Frequency range 80, 40, 20,

15, 11, and 10 meters. Tube line-up 6AG7 oscillator-multiplier, 6L6 amplifier-doubler, 5U4G rectifier. Physical dimensions 8 1/8" high x 13 1/8" wide x 7" deep. This amazingly low kit price includes all circuit components, tubes, cabinet, punched chassis, and detailed construction manual. The ideal kit for the novice just breaking into ham radio. It can be used later on as a stand-by rig or an all band exciter for higher powered transmitter.

NEW Heathkit ANTENNA COUPLER KIT

New Heathkit Antenna Coupler, specially designed for the Heathkit AT-1 Transmitter. The Antenna Coupler can be used with any 52 ohm coaxial input—up to 75 watts power. Low pass filter with cut-off frequency of approximately 36 mc — L section tuning network — neon tuning indicator — rugged, compact construction — transmitter type variable condenser, and high Q coil are all outstanding features. The AC-1 has both inductance and capacity tuning for maximum operating versatility. Dimensions 8 1/8" wide x 4 3/8" high x 1 7/8" deep.

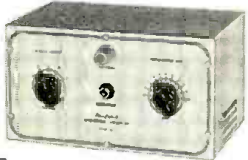

MODEL AC-1
\$14.50 SHIP. WT. 3 LBS.

Heathkit ANTENNA IMPEDANCE METER

Use the Heathkit Antenna Impedance Meter for measuring antenna impedance for line matching purposes—adjustment of beam antennas—phone monitor, etc. It will determine antenna resistance at resonance, match transmission line for minimum SWR, determine receiver input impedance, and provide a rough indication of SWR. Precision resistors, germanium diode, 100 micro-ampere Simpson meter. Dial calibrated from 0-500 ohms. Shielded aluminum cabinet. 7" long x 2 1/2" wide x 3 1/4" deep.



\$14.50 SHIP. WT. 3 LBS. MODEL AM-1

Heathkit COMMUNICATIONS RECEIVER KIT



MODEL AR-2
\$25.50 SHIP. WT. 12 LBS.

Here is the new receiver kit you have repeatedly asked for, the Heathkit Communications Receiver. The perfect companion piece for the AT-1 Transmitter kit. Many outstandingly desirable features have been incorporated in the design of the AR-2; such as, electrical bandspread — high gain miniature tubes — IF transformers for high sensitivity and good signal to noise ratio — separate RF gain control with optional automatic volume control or manual volume control, in addition to the conventional audio gain control. Noise limiter — stand-by switch — stable BFO oscillator circuit — headphone jack — transformer operation, etc., all contribute to a high performance standard. Frequency coverage is continuous from 535 kc to 35 mc in four ranges. For added convenience, various ham bands have been separately identified in respect to their relative placement on the slide rule tuning scale. A chassis mounted, 5 1/2" PM speaker is included with this kit. Tube line up 12BE6 mixer oscillator, 12BA6 IF amplifier, 12AV6 detector AVC audio, 12BA6 BFO oscillator, 12A6 beam power output, 5Y3GT rectifier. RECEIVER CABINET Proxilyn impregnated, fabric covered, plywood cabinet with aluminum panel designed expressly for the AR-2 Receiver. Part 91-10, shipping weight 5 lbs., \$4.50.



IMPROVED Heathkit
GRID DIP
METER KIT
\$19.50 SHIP. WT. 4 LBS. MODEL GD-1B

The invaluable instrument for service men, hams, and experimenters. Useful in TV service work for alignment of traps, filters, IF stages, peaking compensation networks, etc. Locates spurious oscillation, provides a relative indication of power in transmitter stages, use it for neutralization, locating parasites, correcting TVI, measuring C, L, and Q of components, and determining RF circuit resonant frequencies. With oscillator energized, useful for finding resonant frequency of tuned circuits. With the oscillator not energized, the instrument acts as an absorption wave meter. Variable meter sensitivity control, head phone jack, 500 microampere Simpson meter. Continuous frequency coverage from 2 mc. to 250 mc. Pre-wound coil kit and rack, new three prong coil mounting, 6AF4 high frequency triode. Two additional plug-in coils are available and provide continuous extension of low frequency coverage down to 355 kc. Dial correlation curves included. Shipping weight 1 lb., kit 341, \$3.00.



HEATH COMPANY • Benton Harbor 15, Mich.

CHECK THESE *Features*

- ✓ First popular priced Q Meter
- ✓ Reads Q directly on calibrated scale
- ✓ Oscillator supplies RF frequencies of 150 kc to 18 mc
- ✓ Calibrate capacitor with range of 40 mmf to 450 mmf with vernier of ± 3 mmf
- ✓ Measures Q of condensers, RF resistance, and distributed capacity of coils
- ✓ Many applications in design and development work
- ✓ Useful in TV service work for checking deflection yokes, coils, chokes, etc.

Heathkit "Q" METER KIT

MODEL QM-1

\$44.50

SHIPPING WT. 14 POUNDS

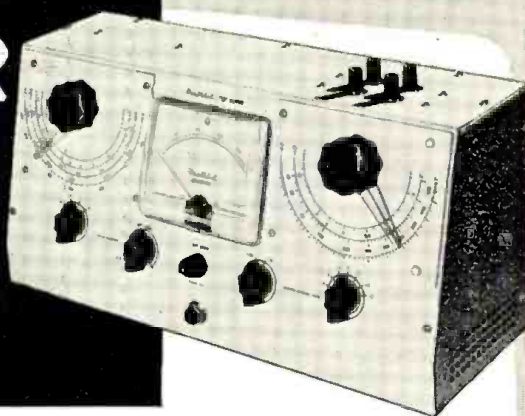

Another outstanding example of successful Heathkit engineering effort in producing a Q Meter Kit within the price range of TV service men, schools, laboratories, and experimenters. This Q Meter meets RF design requirements for rapid, accurate measurement of capacity, inductance, and Q at the operating frequency and all indications of value can be read directly on the meter calibrated scales. Oscillator section supplies RF fre-

quencies of 150 kc to 18 mc. Calibrate capacitor with range of 40 mmf to 450 mmf, with vernier of ± 3 mmf.

Particularly useful in TV service work for checking peaking coils, wave traps, chokes, deflection coils, width and linearity coils, etc. At this low kit price research laboratory facilities are within the range of service shops, schools, and experimenters.

Heathkit INTERMODULATION ANALYZER KIT



MODEL IM-1

\$39.50

SHIPPING WT. 17 POUNDS

The Heathkit IM-1 is an extremely versatile instrument specifically designed for measuring the degree of inter-action between two signals in any portion of an audio chain. It is primarily intended for making tests of audio amplifiers, but may be used in other applications, such as checking microphones, records, recording equipment, phonograph pick-ups, and loud-speakers. High and low test frequency source, intermodulation unit, power supply, and AC vacuum tube volt meter all in one complete instrument. Per cent intermodulation is directly read on the calibrated scales, 50%, 10%, and 3% full scale. Both 4:1 and 1:1 ratios of low to high frequency easily set up. With this instrument the performance level of present equipment, or newly developed equipment can be easily and accurately checked. At this low price, you can now enjoy the benefits of intermodulation analysis for accurate audio interpretation.

Heathkit AUDIO GENERATOR KIT

A Heathkit Audio Generator with frequency coverage from 20 cycles to 1 mc. Response flat ± 1 db from 20 cycles to 400 kc, down 3 db at 600 kc, and down only 8 db at 1 mc. Calibrated, continuously variable, and step attenuator output controls provide convenient reference output level. Distortion is less than .4% from 100 cps through the audible range. The ideal controllable extended frequency sine wave source for audio circuit investigation and development.



MODEL AG-8

\$29.50

SHIP. WT. 11 LBS.

Heathkit AUDIO OSCILLATOR KIT

Sine or square wave coverage from 20 to 20,000 cycles in three ranges at a controllable output level up to 10 volts. Low distortion, 1% precision resistors in multiplier circuits, high level output across entire frequency range, etc., readily qualify this instrument for audio experimentation and development work. Special circuit design consideration features thermistor operation for good control of linearity.



MODEL AO-1

\$24.50

SHIP. WT. 11 LBS.

Heathkit AUDIO FREQUENCY METER KIT



MODEL AF-1

\$34.50

SHIP. WT. 12 LBS.

The Heathkit Audio Frequency Meter provides a simple and convenient means of checking unknown audio frequencies from 10 cycles to 100 kc at any voltage level between 3 and 300 volts rms with any non-critical wave shape. Instrument operation is entirely

electronic. Just set the range switch, feed an unknown frequency into the instrument, and read the frequency directly on the calibrated scale of the Simpson 4 1/2" meter.

Heathkit SQUARE WAVE GENERATOR KIT

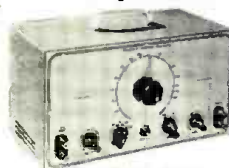

MODEL SQ-1

\$29.50

SHIP. WT. 12 LBS.

The Heathkit Square Wave Generator provides an excellent square wave frequency source with completely variable coverage from 10 cycles to 100 kc. This generator features low output impedance of 600 ohms and the output voltage is continuously variable between 0 and 20 volts, thereby providing the necessary degree of operating flexibility. An invaluable instrument for those specialized circuit investigations requiring a good, stable, variable square wave source.

HEATH COMPANY • Benton Harbor 15, Mich.

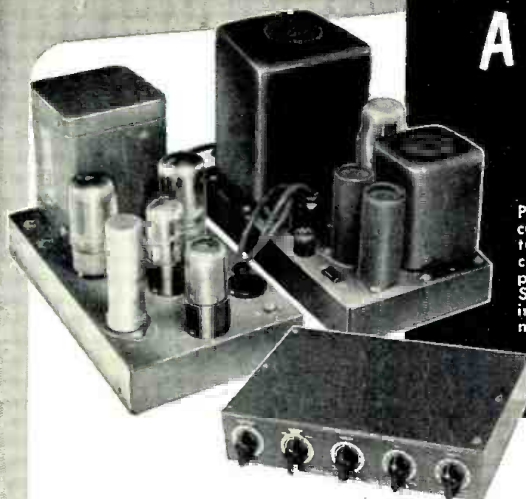

Heathkit
WILLIAMSON TYPE
AMPLIFIER KIT
MODEL W-2

Particularly designed for custom installations, featuring separate cable connected units for simplicity of installation. Sheet metal work finished in attractive gray hamertone for smart appearance. All control shafts of the adjustable length break-off type.

\$69⁵⁰

PRICES OF COMBINATIONS

- W-2 Amplifier Kit including main amplifier, power supply, and WA-P1 Preamplifier Kit. Shipping Weight 37 lbs. Shipped Express only. **\$69⁵⁰**
- W-2M Amplifier Kit includes main amplifier and power supply. Shipping Weight 29 lbs. Shipped Express only. **\$49⁷⁵**
- WA-P1 Preamplifier Kit only. Shipping Weight 6 lbs. Shipped Express or Parcel Post. **\$19⁷⁵**

When selecting an amplifier for the heart of your high fidelity audio system, investigate the outstanding advantages offered by the Heathkit Williamson Type Amplifier. Meets every high fidelity audio requirement and makes listening to recorded music a thrilling new experience. This outstanding amplifier is offered with optional output transformer

operation, providing either the conventional triode output circuit or the new extended power circuitry in which the screen supply voltage is obtained from separate transformer primary taps. Frequency response within ± 1 db from 10 cycles to 100 kc. Tube complement — 6SN7 cascade amplifier and phase splitter, 6SN7 push pull driver, two 5881 push pull power amplifiers, one 5V4G cathode type rectifier. Matching preamplifier available providing three switch selected inputs, correct compensation, and individual bass and treble tone controls. Uses 12AX7 (or 12AX7) preamplifier — 12AU7 tone control amplifier. Particularly designed for the novice kit builder and requires no specialized knowledge or equipment for successful assembly and operation.

NEW *Heathkit* 20 WATT
High Fidelity AMPLIFIER KIT



MODEL A-9A

\$35⁵⁰

SHIP. WT. 18 LBS.

A new 20 watt high fidelity amplifier, designed especially for custom audio installations demanding clean reproduction, adequate power, and flexibility to meet individual requirements. Separate treble and bass tone controls provide up to 15 db boost or cut. Four switch selected inputs, each with the necessary compensation for the service desired. Output transformer impedances of 4, 8, and 16 ohms. Preamplifier, tone control, and phase splitter circuits utilize 9 pin twin triode miniature tubes for low hum and noise level. Two 6L6 push pull power output tubes provide full 20 watts power. Frequency response ± 1 db, 20-20,000 cycles. Total harmonic distortion 1% (at 3 db below rated output). Tube line-up: 12AX7 preamplifier, 12AU7 voltage amplifier and tone control, 12AU7 voltage amplifier and phase splitter, two 6L6 push pull pentode power output, 5U4G rectifier. Truly outstanding amplifier performance coupled with low cost.

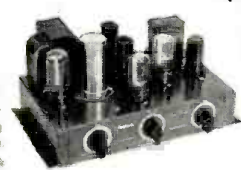

Heathkit ECONOMY 6 WATT
AMPLIFIER KIT

MODEL A-7B

\$15⁵⁰

SHIP. WT. 10 LBS.

The new Heathkit Model A-7B Amplifier offers many unusually fine features not normally expected in this low price range. Either of the two input circuits may be individually switch selected for phono or tuner operation. Separate bass and treble tone controls. Output impedances of 4, 8, and 15 ohms. Push pull beam power output stage for balanced reproduction. Excellent voltage gain characteristics, good frequency response, and full 6 watts power output. 12J5 amplifier, 12SL6 second amplifier and phase splitter, two 12A6 beam power output, one 5Y5 GT rectifier. A-7C incorporates preamplifier stage with special compensated network to provide necessary gain for operation with variable reluctance or low output level phono cartridge. Circuit is properly compensated for microphone operation. \$17.50.

NEW *Heathkit*
BROADCAST BAND
RECEIVER KIT

Another new Heathkit for the student, beginner, or hobbyist. If you have ever had the urge to build your own radio receiver, this kit warrants your attention. New high gain miniature tubes and IF transformers provide excellent sensitivity and good signal to noise ratio. A built-in ferrite core rod type antenna has been provided. A chassis mounted $5\frac{1}{2}$ " PM speaker provides excellent tone and volume. Convenient phono input. Can be operated either as a receiver or tuner. Simplified construction manual outlines circuit theory. Ideal for students. Tube line-up: 12BE6 mixer oscillator, 12BA6 IF amplifier, 12AV6 detector-AVC-first audio, 12A6 beam power output, 5Y3GT rectifier.



MODEL BR-2

\$17⁵⁰ SHIP. WT. 11 LBS.

CABINET — Proxilyn impregnated fabric covered plywood cabinet. Shipping weight 5 lbs. Part number 91-9, \$4.50.

Heathkit
FM TUNER KIT

The Heathkit FM-2 Tuner was specifically designed for simplified kit construction. Can be operated through the "phono" portion of your radio or with a separate amplifier. The kit features a pre-assembled and adjusted tuning unit, three double tuned IF transformers, and a discriminator transformer in an 8 tube AC operated circuit. Frequency coverage 88 to 108 mc. Experience the thrill of building your own FM tuner and at the same time enjoy all of the advantages of true FM reception.

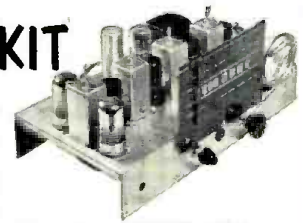

MODEL FM-2

\$22⁵⁰

SHIP. WT. 9 LBS.

Free CATALOG

Write for free catalog containing latest price information, schematics, specifications, and descriptions of all Heathkits.

Perma-Power
merchandise

sells!



Our Newest
Catalog is
Now Available

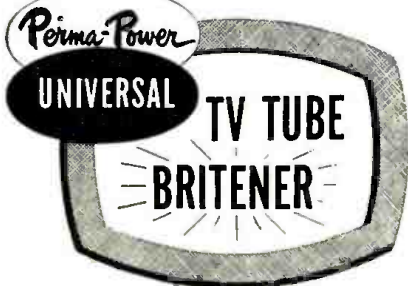

Here is Engineering
at its Peak!

IT'S PARALLEL!
IT'S SERIES!
IT'S ISOLATION!
IT'S ELECTROSTATIC!
IT'S UNIVERSAL!

List Price
\$445

Sold Through Better Jobbers

manufactured by
Perma-Power COMPANY
Chicago 25, Ill.
Manufacturers of Electronic Equipment Since 1928

"LPRS" Preamp Control
(Continued from page 75)

compact, inexpensive, single-circuit selector switch. Long input cables can be used with magnetic pickups because of their low terminating resistors and with high-level inputs if the voltage dividers (or at least the series elements of the voltage dividers) are placed at the signal sources, since the lines then operate at low impedance. Crystal pickups can either be fed into voltage divider inputs, the tone controls being set more or less flat, or they may be fed into 15,000 ohm loads as recommended by Charles Boegli ("A Preamp for Magnetic and Crystal Pickups," RADIO & TELEVISION NEWS, July 1950) the tone controls then being set as for a magnetic pickup. Superior pickup damping is claimed for this latter scheme. Tests on the present equipment show good but inconclusive results in this regard. A final point concerns the "Gain" control. Its low value of 100,000 ohms was selected as it must drive the IRC loudness control.

Both "B+" and d.c. heater power are obtained from the power amplifier. It is necessary to obtain 150 ma. at 37.8 volts (in practice a somewhat higher voltage is designed for to allow for output tube aging) for the three 12SJ7's in series. Fortunately, the Williamson output stage has about 125 ma. at 39 volts available at the cathodes. Thus it is only necessary to add 25 ma. from "B+" through a bleeder, as shown in Fig. 4. The extra drain on the power supply is usually of no consequence.

Other power amplifiers may require somewhat different modifications, depending on the current and voltage available at the cathodes. It should be noted that the balancing circuit used requires the output tubes to be plugged in the right way. A 250-ohm dummy resistor is provided on the power amplifier chassis to replace the 12SJ7 heater string when the preamplifier is not used. A jumper plug, replacing the preamplifier power connector, makes the connection. Thus, a power amplifier converted as shown is not harmed in any way and may still be used as before. —50—

TUBE TECHNIQUES

THE National Conference on Tube Techniques, sponsored by the Department of Defense, will convene at the Western Union Auditorium, 60 Hudson Street, New York 13, New York, October 13, 14, and 15.

The program of the meeting will cover all phases of electron tube making techniques, processing, and materials. Fifteen-minute papers on such subjects as cathodes, phosphors, vacuum techniques, glass-to-metal seals, insulators, etc., will also be given.

For further details on this conference, contact Harold J. Sullivan, Research and Development Board Committee on Electronics Panel on Electron tubes, 346 Broadway, New York. —50—

arrow electronics
audio center
offers
professional
turntable
performance
at low price!

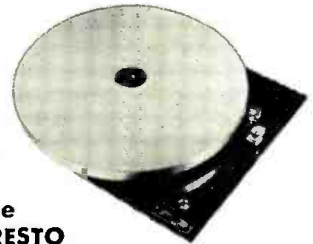

The
PRESTO
15-G TURNTABLE

A truly superior 12" turntable with 3-speed drive for 33 $\frac{1}{3}$, 45, and 78 r.p.m. Machined from a heavy aluminum casting and mounted on a steel shaft which turns on a bearing in the base panel. Speed regulation and rumble kept to a minimum. Changes speeds instantly with the turn of a knob.

PRESTO 15-G \$53.50



The
PRESTO
10-C RECORDER

The entire mechanical section of the famous PRESTO K-10! Has all the fine recording qualities including microgroove, 33 $\frac{1}{3}$ and 78 r.p.m.! Cutting head has 8 ohms impedance. This truly fine recording mechanism for those audiophiles who want to use it with their own amplifiers. Includes pickup with permanent sapphire stylus.

PRESTO 10-C \$250.00

Order this fine PRESTO equipment from Arrow's Audio Center, today.

Send 25% deposit to our N. Y. Audio Center on C.O.D.s — Deduct 2% on Prepaid orders. FOB New York.

Visit our exhibit at the
NEW YORK AUDIO FAIR
October 14th thru 17th
ROOM 541
HOTEL NEW YORKER

ARROW ELECTRONICS

Audio Center
65 Cortlandt St. — N. Y. 7
215 Front St. — Hempstead, N. Y.

RADIO & TELEVISION NEWS

THE RADIO CRAFTSMEN MODEL C-800 TUNER

By W. PHILBROOK

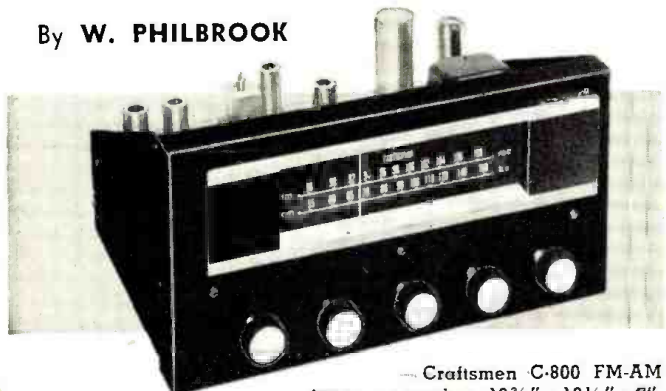

— Craftsman C-800 FM-AM tuner measuring 13 $\frac{3}{4}$ " x 10 $\frac{1}{2}$ " x 7".

Details on a high-quality tuner designed especially for custom fidelity systems.

OF INTEREST to devotees of high-fidelity reproduction is the recently developed C-800 FM-AM tuner, made by *The Radio Craftsmen, Incorporated*, Chicago manufacturer of custom high-fidelity equipment.

The tuner circuit itself offers wider bandwidth, providing greater AM fidelity and sharper i.f. bandpass "skirts" for greater selectivity than its predecessor model, the *Craftsmen RC-10* tuner.

The instrument features separate tuned r.f. stages and triode converters on both FM and AM bands to insure low noise level. A 10 kc. whistle filter is used to eliminate AM adjacent-channel heterodyne whistle.

A double-shadow tuning eye and no-drift a.f.c. on FM simplifies tuning. A front-panel control cuts out the a.f.c. when tuning weak stations. A completely shielded chassis design, including a bottom plate, minimizes oscillator radiation and helps to insure isolation. The tuner is highly sensitive—requiring only 5 microvolts to obtain a usable signal on either AM or FM.

The audio output is from a cathode follower enabling remote installation and provides 2 volts at less than 1/2 per-cent distortion. The detector output also provides a cathode follower for recording applications. The output matches high- or low-gain amplifiers with input impedances of 10,000 ohms or higher.

In addition to providing AM and FM coverage, this tuner also incorporates a phonograph preamplifier and record equalizer on the same chassis. The inverse feedback, compensated dual-triode phono preamplifier provides correct turnover and roll-off characteristics to cover three of the most often used equalization characteristics, the AES, LP, and European recordings. A front-panel switch permits the selection of any of these characteristics. Input jacks are also provided for television and "spare" (an additional input that can be used if desired).

The front panel controls are, from left to right; the selector switch, bass, volume, "on-off-treble," and tuning. The selector switch permits the choice of (in clockwise rotation) FM, FM-a.f.c., AM, TV, LP, AES, European, and the "spare." The dual tone controls are continuously variable from 15 db boost through 15 db attenuation with the flat position clearly marked.

The tuner uses fifteen tubes, a 6CB6, two 12AT7's, two 6BA6's, four 6AU6's, one 6AL5, two 12AX7's a 6AV6, a 6AL7GT, and the 5Y3GT rectifier.

The entire unit is housed in a chassis measuring 13 $\frac{3}{4}$ " x 10 $\frac{1}{2}$ " x 7". It is also available with a mahogany-finished wood cabinet which measures 16" x 11 $\frac{3}{4}$ " x 9 $\frac{1}{4}$ ". —30—

FOR ALL YOUR REPLACEMENT CONTROL REQUIREMENTS

IRC Volume Control Plant
Asheville, North Carolina



From IRC's new volume control manufacturing plant comes your answer to all of today's replacement control needs. No other single source offers you a combination of such complete coverage, easy installation and trouble-free performance.

Set servicing is simpler when you order IRC—most service technicians do.

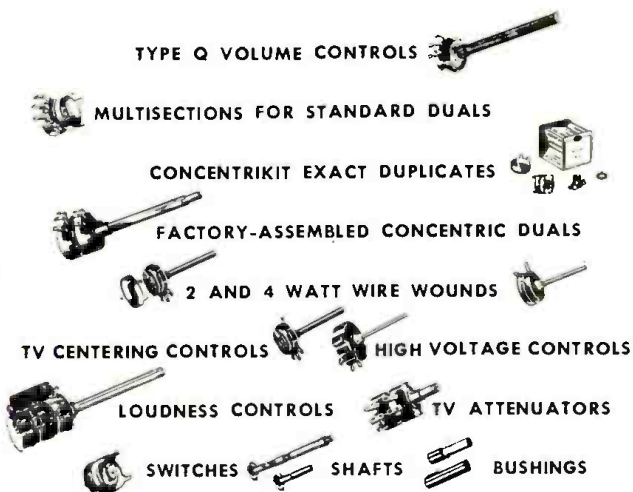

Send For New IRC Control Catalog DC1D

FOR ONE-SOURCE SERVICE ON
ALL YOUR CONTROL REQUIREMENTS
ORDER FROM YOUR IRC DISTRIBUTOR



FOR
MORE
IRC CONTROL NEWS TURN TO
NEXT
PAGE

INTERNATIONAL RESISTANCE CO.
415 North Broad Street, Philadelphia 8, Penna.

Wherever the Circuit Sings

NOW YOU'LL Really Know How to Use 'Scopes!



**DON'T LET THE
OSCILLOSCOPE
'STUMP' YOU!**

Learn to use it fully
on all sorts of jobs—
and watch your effi-
ciency soar!

MODERN OSCILLOSCOPES AND THEIR USES

BY JACOB H. RUITER, JR.
of Allen B. DuMont Laboratories, Inc.
326 pages, 370 illustrations, \$6.00

Here at last is a book that makes it easy for you to become expert in the many uses of the greatest, most versatile service instrument of all—the oscilloscope! It contains no involved mathematics. First, the author explains oscilloscopes fully—then gets right down to earth in telling exactly how to use them on AM, FM and TV service work . . . from locating receiver troubles to aligning and adjusting the most complicated circuits.

HOW THEY WORK

Expert knowledge of oscilloscopes helps you work faster, far more accurately and more profitably on all sorts of service and laboratory jobs. Basic subjects covered include: 1—Introduction to Oscilloscopes; 2—History of the Oscillograph; 3—Development of the Cathode Ray Tube; 4—Principles of Cathode Ray Tube Operation; 5—Details of the Modern Cathode Ray Tube; 6—The General-Purpose Oscilloscope; 7—Power-Supply Circuits; 8—Amplifiers, Attenuators and Positioning Circuits; 9—Time-Base Circuits.

HOW TO GET THE MOST OUT OF THEM ON ANY JOB

Each operation is carefully explained including the making of connections, adjustment of circuit components, setting the oscilloscope controls and analyzing patterns. About 400 illustrations including dozens of pattern photos make things doubly clear. Here are the specific how-to-do-it subjects covered: 10—Operation; 11—Interpretation of Basic Patterns; 12—Auxiliary Equipment; 13—Typical Applications in Electronics; 14—Servicing A-M Receivers; 15—Servicing F-M Receivers; 16—Television Receiver Servicing; 17—Use of the Radio Transmitter; 18—Using the Oscilloscope in Teaching; 19—Additional Industrial Uses; 20—Photographing Cathode Ray Tube Patterns; (a) Glossary.

READ IT 10 DAYS . . . at our risk!

Dept. RN-103, RINEHART BOOKS, Inc.,
Technical Division,
232 Madison Ave., New York 16, N. Y.

Send MODERN OSCILLOSCOPES AND THEIR USES for 10-DAY FREE EXAMINATION. If book is satisfactory, I will then send you \$6.00 promptly in full payment. If not, I will return book postpaid in good condition and owe you nothing.

Name

Address

City, Zone, State

Employers' Name and Address

Price outside U. S. A. \$6.50, cash only.
Money back if you return book within 10 days.

Technical BOOKS

"TELEVISION AND RADIO REPAIRING" by John Markus. Published by McGraw-Hill Book Company, Inc., New York. 544 pages. Price \$7.95.

This volume is a primer for would-be service technicians and is written as simply and clearly as possible so that the student will have no trouble handling the material presented.

The text material is progressive so that from the first chapters the student can begin repairing receivers, progressing to more complicated sets of all types.

The first two chapters comprise a down-to-earth survey of the servicing field, its opportunities, advantages, and disadvantages. They also cover tools required, service manuals, establishing credit, how to order replacement parts, etc.

The balance of the book is a step-by-step "guided tour" through radio and television circuitry expressed in the simplest, non-technical terms.

Since no previous knowledge of servicing or electrical theory is required of the reader, this book should be a natural for the beginner who wants to enter this interesting and profitable profession.

"NEW SCREEN TECHNIQUES" Edited by Martin Quigley, Jr. Published by Quigley Publishing Co., Inc., Rockefeller Center, New York 20. Price \$4.50.

This is a compilation of articles written by leading authorities on all phases of three-dimensional screen and sound techniques.

Included are papers on such subjects as "Polaroid" and 3D films, basic principles of 3D photography and projection, "Natural Vision," the stereo window, 3D in Europe, Cinerama, Cinemascope, sound for Cinemascope, etc.

The text is lavishly illustrated and carries a preface by Dr. Alfred N. Goldsmith.

Those concerned with all phases of movie film and sound will find this symposium of value.

"AUDIO AMPLIFIERS AND ASSOCIATED EQUIPMENT" compiled and published by Howard W. Sams & Co., Indianapolis. Vol. 4. Price \$3.95. Paper bound.

This is the Fourth Volume in the Sams library covering amplifiers and has been prepared for the audio engineer, service technician, and others interested in amplifiers and amplifier circuitry.

A cumulative index covering all four volumes is also included. Each amplifier is pictured with special controls identified, complete parts list, and circuit diagram.

This volume, used in conjunction with the other three books, will pro-

This Month's Special

• ARC-3 PARTS					
T-206 Output XFMR. #55320	\$2.75			
T-101 Mike XFMR. #55543	1.50			
T-102 Driver XFMR. #55545	1.75			
T-103 Audio XFMR. #55546	1.75			
T-104 Modulation XFMR. #55547	3.25			
T-105 Side Tone XFMR. #55544	1.85			
• Driver Transformer, for ART-13, T-202	1.29			
• Side-Tone Transformer, for ART-13, T-203	1.19			
• Modulation Transformer, ES-691025 for BC 456	1.19			
• AN-104A Antennas for SCR 52295			
• BC 929 Indicators, p/o APN-2	32.50			
• BC 451 Trans. Control Box, p/o SCR 274N	1.85			
• C-30/ARC-5 Control Box	1.65			
• RT-225-A Mounting Racks	1.65			
• FT-227-A Shock Mount Racks	1.65			
J-22/ARC-5 Junction Boxes	1.75			
J-17/ARC-5 Junction Boxes	2.75			
MD7/ARC-5 Modulators, all Tubes	5.95			
MC 211 Right Angle Drives21			
BC 433G Compass Revers., Used, Excellent	32.50			
ART-13 Barometric Limit Switches	8.75			
BC 306 Antenna Loading Unit for BC 375	3.00			
RL-7 Interphone Amplifiers, Used, Excellent, Less Tubes	3.75			
SA-4A/APA-1 Motor Driven (28 VDC) Yaoui-Antenna Switch	24.50			
MT-36-C Ant. Loading Unit for TA-21 XMTR	35.00			
A-62 Phantom Antennas, for use with Mobile XMTRS. 20-38.9 MC 40 Watts	3.95			
RT-19/ARC-4 Trans-Receiver, 24 VDC, covers Amateur 2-Meter Band. Complete with Tubes and Crystals	39.50			
Radar Trainer, Type IS-C. Consists of 4 separate XMTRS. Operating 380-500 MC. 1—Pulse Gen. 1—Power Supply, all Cables. 2 Inst. Books	215.00			
Rubber Inserts, M-300 for HS-30 Headsets. 3.25/M				
BC 496A Dual Control Boxes (Receiver) for SCR 274N	1.35			
T-30 Throat Microphones69			
National XS-3 Double-Down Insulators, fits 2 3/4" Hole. All Hardware included65			
IN-84 Double Cone Insulations	\$12 for 1.00			
ARC-5 PLUGS					
#584235c	#702745c
#557735c	#702535c
#PL 15470c	#PL 15285c
#PL 154A70c	#641835c
C-114 Loading Coils85			
Overload Breaker: 500 MA @ 1000VOC Manual Reset. Heinemann AM 1610—5	1.45			
Voice Coil & Diaphragm Assy. (Spares) for Coachmaster Speaker Assy. Will handle 50 W. Audio85			

PLATE TRANSFORMERS

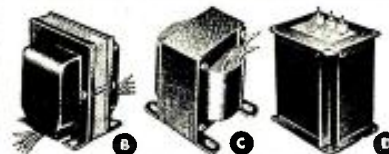

(All primaries are 110 v. 60 cps, single phase)
DC rating and approximate values obtained at output of a 2-section choke input filter using MV rect. tubes.

TYPE	VOLTS AC R.M.S.	D.C. VOLTS	D.C. MA.	FIG.	PRICE
PT 175	550-550	400	150	B	\$ 6.43
PT 157	660-660	500	250	B	8.42
	550-550	400			
PT 158	1180-1080	1000	125	B	10.00
	500-500	400	150		
PT 159	900-900	750	225	B	9.70
	800-800	600			
PT 167	1400-1400	1200	300	C	24.10
	1175-1175				
PT 168	2100-2100	1750	300	C	30.58
	1800-1800	1500			
PT 062	2900-2900	2500	300	D	47.04
	2385-2385	2000			

Simultaneous ratings

FILTER CHOKES

(Smoothing)

TYPE	IND. CUR. HYS.	CUR. MA.	DCR (OHMS)	TEST VOLTS	FIG.	PRICE
181	10	200	140	3000	B	\$4.70
182	10	250	125	3000	B	6.47
183	8	300	80	3000	B	6.76
Swinging input chokes						
187	4-16	150	210	3000	B	3.82
189	4-16	250	125	3000	B	6.47
190	3-14	300	80	3000	B	6.76

DYNAMOTORS

ALL BRAND NEW—ORIGINAL PACKING

TYPE	VOLTS INPUT	VOLTS OUTPUT	AMPS	AMPS	PRICE
PE 86	28	1.25	250	.960	\$4.25
DM 416	14	6.2	330	1.170	6.75
DM 33A	28	7	340	1.250	1.95
BD AR 93	28	3.25	375	1.150	7.50
23350	27	1.75	285	.075	1.95
B-19 Pack	12	3.4	275	1.110	3.95
			500	.850	
			300	.260	
DA-3A*	28	10	150	.010	6.95
			14.5		
			5.		
5053	28	14	250	.960	3.95
PE 73 CM**	28	19	1000	1.350	**
337	14	8	425	1.160	7.95

* Replacement for PE 94.
** Price sent on request.

ALL MERCHANDISE GUARANTEED. EVERY ITEM IS NEW UNLESS STATED OTHERWISE

Send M.O. or Check. Shipping Chgs. C.O.D.
COMMUNICATIONS EQUIPMENT CO.
131 Liberty St. Dept. N-10 New York City 7, N. Y.

vide a complete service library covering postwar amplifiers.

* * *

"RADIO AMATEURS' MOBILE HANDBOOK" by William I. Orr, W6SAI. Published by *Cowan Publishing Corp.*, New York. 186 pages. Price \$2.00. Paper bound.

This is a practical handbook for the mobileer and covers automotive electrical systems, mobile power supplies, mobile receivers, noise suppression, mobile transmitters and antennas, and test equipment for mobile equipment.

Since it is written by a ham for hams, the treatment is concise and fact-packed. The lavish use of circuit diagrams and photographs helps to advance the subject matter rapidly and provide the reader with practical working diagrams of tested circuits for mobile use.

Details on commercially-built mobile equipment are also provided along with data supplied by the manufacturers themselves in a special "catalogue" section of the text.

Both old timer mobileers and those about to join the "fraternity" will find this book of interest.

* * *

"AUTO RADIO SERVICE DATA MANUAL" compiled and published by *Howard W. Sams & Co.*, Indianapolis. Vols. 2 and 3. Price \$3.00 each volume. Paper bound.

Due to the immediate and enthusiastic acceptance of the first volume of this series, the publishers have brought out these two additional handbooks to cover most postwar auto receivers.

As was the case with the earlier volume, each set is pictured, identified as to manufacturer, tube line-up, and alignment data provided. A complete parts list with replacement part numbers is given for each receiver in addition to the complete schematic and top and under-chassis views.

By adding these two volumes to his service library the technician specializing in auto radio work ought to be fully equipped to handle any set that comes into the shop.

* * *

"TV MANUFACTURERS' RECEIVER TROUBLE CURES" edited by Milton S. Snitzer. Published by *John F. Eider Publisher, Inc.*, New York. Vol. 4. 115 pages. Price \$1.80. Paper bound.

This is the fourth in the current series of pocket-size handbooks for the service technician. As was the case with the previous releases, this book lists specific cures for service faults as devised by the manufacturer of the set in question.

This volume covers *Philharmonic, Pilot, Radio and Television, RCA Victor, Remington, Scott, Sears Roebuck, Sentinel, Setchell Carlson, and Shaw* receivers.

Subsequent volumes will cover other television receivers manufactured by other firms.

* * *

"MOST-OFTEN-NEEDED 1953 UHF CONVERTERS AND TUNERS" compiled by M. N. Beitman. Published by *Supreme Publications*, Chicago. 96 pages. Price \$1.50. Paper bound.

With new u.h.f. stations going on the air almost daily, the need for information on converters and tuners to be used with v.h.f. receivers to provide u.h.f. reception is rather urgent.

This volume covers the tuners and/or converters made by fourteen companies, including mechanical and electrical details on each unit.

In addition there is a section on u.h.f. transmission and reception, installing *Admiral* u.h.f. channel strips, antennas, and transmission lines.

-30-

PHILADELPHIA HI-FI CONFERENCE

PHILADELPHIA'S Third Annual High Fidelity Conference and Audio Show will be held November 3rd and 4th at the Benjamin Franklin Hotel in Philadelphia. The entire fourth floor has been reserved for manufacturers' use in presenting live demonstrations for visitors. The Crystal Room will be given over to displays by distributors and manufacturers as well as panel discussions and lectures by audio experts.

Complete details on this event are available from *Isadore Waber*, 105 Heatherwood Rd., Haverton, Pa.

-30-

October, 1953

109

FOR WIDEST

REPLACEMENT CONTROL

COVERAGE

Radio-TV Technicians
Volume Control Type Q

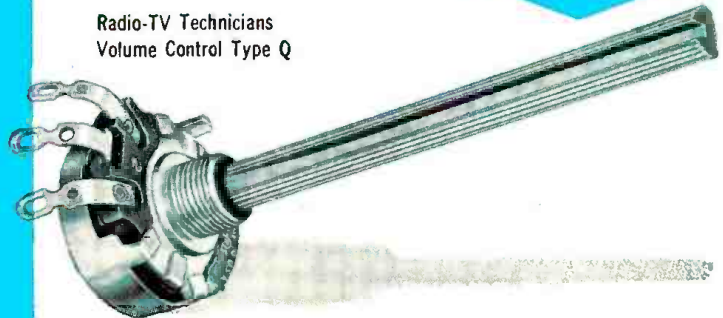

This handsome, modern control looks best, feels best and performs best. "Cushioned turn" rotation and quiet element provide quality performance to match its quality appearance.

The Type Q Control is engineered to modern set servicing, and preferred over all other brands.

**KNOBMASTER
FIXED SHAFT**



Standard shaft is knurled, flattened and slotted and fits most knobs without alteration.

**13 INTERCHANGEABLE
FIXED SHAFTS**



Quick and easy conversion to "specials" with FIXED shaft security

1/4" LONG BUSHING

Shorter bushing and compact 1 1/8" design suits Q Controls to all small sets, yet handles large set needs as well.

82 VALUES • 7 TAPERS

The greatest coverage with the least stock of any control brand. Plain and tapped for TV, FM and AM.

Send For New IRC Control Catalog DC1D

YOUR IRC DISTRIBUTOR IS
YOUR ONE-STOP-SOURCE OF SUPPLY
FOR ALL CONTROL REQUIREMENTS

FOR
MORE
IRC CONTROL NEWS TURN TO
NEXT
PAGE

INTERNATIONAL RESISTANCE CO.
415 North Broad Street, Philadelphia 8, Penna.

Wherever the Circuit Says

**BECOME AN
ELECTRICAL ENGINEER**



**Bachelor of Science Degree
in 36 months.**

Major in Electronics or Power.
Now, prepare for a career in
these rapidly expanding fields.

This school will prepare you to be-
come an engineer, technician or ser-
vice man. Previous military, academic
or practical training may be evaluated
for advanced credit.

Enter Both Radio and Television

In 12 months you can attain the Radio-
Technician's certificate. An added 6
months course qualifies you for the
Radio-TV Technician's certificate and
the Degree of "Associate in Applied
Science." The Technician's course is
the first third of the program leading to
a Bachelor of Science Degree in Elec-
trical Engineering with a major in
Electronics.

Also offered: 12-month Radio-TV ser-
vice course; 12-month Electronics or
Electro Technician Courses; 6-month
Electrical Service Course and 3-month
refresher and general preparatory
classes.

Terms Open Oct., Jan., April, July

Famous for its Concentric Curriculum.
Faculty of specialists. 50,000 former
students. Annual enrolment from 48
states and 23 overseas countries. Non-
profit. 50th year. Courses approved for
Veterans. Residence courses only.



**MILWAUKEE
SCHOOL OF ENGINEERING**

MILWAUKEE SCHOOL OF ENGINEERING
Dept. RN-1053, 1025 N. Milwaukee
Milwaukee 1, Wisconsin

Send: Free 45-page "Your Career" booklet
describing Electrical Engineering Courses:
 Booklet on Careers in Radio-TV.

I am interested in _____
name of course

Name _____ Age _____

Address _____

City _____ Zone _____ State _____

If veteran, indicate date of discharge _____

**Manufacturers'
Literature**

Readers are asked to write di-
rectly to the manufacturer for
the literature. By mentioning
RADIO & TELEVISION NEWS,
the issue and page, and enclosing
the proper amount, when indi-
cated, delay will be prevented.

TUBES FOR U.H.F.

Sylvania Electric Products Inc., 1740
Broadway, New York, New York has
recently issued a 16-page booklet en-
titled "Sylvania Tubes for U.H.F."

The publication provides informa-
tion on the company's 6AN4 and 6T4
tube types which have been designed
for v.h.f. and u.h.f. applications.

A copy of this booklet is available
on request to the company direct.

WIRE CATALOGUE

A unique identification chart for
electronic wire and cable is incor-
porated in the new catalogue No. 53
released by *Alpha Wire Corporation*,
430 Broadway, New York 13, New
York.

This new approach to wire iden-
tification and correlation is set up on
a two-page chart. It is designed to
allow even the inexperienced to posi-
tively and quickly correlate one of the
company's wires from a vague gen-
eral description.

A copy of this 28-page catalogue is
available from Dept. A of the com-
pany.

CATALOGUE SHEET

A four-page catalogue sheet which
lists the firm's complete line of elec-
tronic equipment is now available
from *Perma-Power Company*, 4727
North Damen Ave., Chicago 25, Illi-
nois.

Items listed in the catalogue include
a new TV voltage regulator, the
company's deluxe model TV tube "Bri-
tener," the "C-Brite" tube "Britener,"
a TV insulated high-voltage grid cap
assembly, etc.

Please make your request for a copy
on your company or store letter-
head.

**ELECTRONIC
COMPONENTS SYMPOSIUM**

The text of all papers presented
during the 1953 Electronic Compon-
ents Symposium is now available in
book form from the 1953 Electronic
Components Symposium, Suite 1011,
621 S. Hope Street, Los Angeles 17,
California. The price is \$4.50 per copy.

The Symposium was held earlier
this year in Pasadena under the joint
sponsorship of the Radio-Electronic-
Television Manufacturers Association,
A.I.E.E., IRE, and the West Coast
Manufacturers' Assn.

Thirty papers by recognized author-

to the

E. E. or

PHYSICS GRADUATE

with an interest
or experience in

RADAR or

ELECTRONICS

*Hughes Research and
Development Laboratories, one
of the nation's large electronic
organizations, are now creating a
number of new openings in an
important phase of operations.*

*Here is
what one of
these
positions offers
you*

OUR COMPANY

located in Southern California. is presently
engaged in the development of advanced
radar devices, electronic computers and
guided missiles.

THESE NEW POSITIONS

are for men who will serve as technical ad-
visors to the companies and government
agencies purchasing Hughes equipment.

YOU WILL BE TRAINED

(at full pay) in our Laboratories for several
months until you are thoroughly familiar
with the equipment that you will later help
the Services to understand and properly
employ.

AFTER TRAINING

you may (1) remain with the Laboratories
in Southern California in an instruction or
administrative capacity, (2) become the
Hughes representative at a company where
our equipment is being installed, or (3) be
the Hughes representative at a military base
in this country—or overseas (single men
only). Adequate traveling allowances are
given, and married men keep their families
with them at all times.

YOUR FUTURE

in the expanding electronics field will be
enhanced by the all-around experience
gained. As the employment of commercial
electronic systems increases, you will find
this training in the most advanced tech-
niques extremely valuable.

*How
to
apply*

*If you are under 35 years of age
and have an E.E. or Physics
degree and an interest or
experience in radar or electronics,*

write

to **HUGHES**

**RESEARCH AND DEVELOPMENT
LABORATORIES**

*Scientific and Engineering Staff
Culver City,
Los Angeles County, California*

Assurance is required that the relocation of the
applicant will not cause the disruption of an
urgent military project.

RADIO & TELEVISION NEWS

ities in the industry were presented at the meeting and are included in this new publication.

PUBLIC SERVICE BOOKLET

RCA Service Company is now distributing copies of a new consumer booklet to TV service associations and managers of Better Business Bureaus throughout the United States.

Entitled "How to Give Your Television Set the Service it Deserves," the 12-page booklet was prepared by the firm as a public service and a tribute to service technicians throughout the nation who have done such an outstanding job in maintaining and servicing receivers.

The text is in a light vein with cartoon illustrations. It points out that TV service technicians spend up to four years in studying electronics to learn their work, and that they must take constant refresher courses to keep up on changes in receiver construction and new service data. In addition, the booklet shows that the technician must invest up to \$10,000 in equipment and facilities before he can start business.

Other plans for the booklet include distribution to RCA television dealers, spot announcements describing it on RCA-sponsored radio and TV shows, and in the company's newspaper and magazine advertising.

ELECTRONIC COMPONENTS

Waldom Electronics, Inc., 911 No. Larrabee St., Chicago has issued a comprehensive catalogue listing ready-to-ship electronic components and "Croname" products.

Designated as Catalogue 5C3, the new publication lists more than two thousand items in stock. Included are tuner assemblies; mask, glass, and escutcheon kits; title plates, dial and switch plates; knobs; instrument drives and dials; terminal lugs, cases and dial locks; terminal strips, etc.

Write the company direct for a copy of this catalogue.

"WHEN U.H.F. COMES TO TOWN"

Philco Corporation has produced a new 15-minute educational film for release to distributors in areas throughout the country where new u.h.f. broadcasting stations are going on the air.

Entitled "When U.H.F. Comes to Town," the film depicts the actual activity and excitement created in a community when a u.h.f. station starts broadcasting. It is made up principally of scenes filmed on the spot in new u.h.f. television areas.

The film is available in 16 mm sound for showing to TV dealers and others interested in building up enthusiasm for the new u.h.f. television service. The Sales Training Department of the company, Philadelphia, will provide additional information on how prints of the film may be obtained for showings.

TRANSISTOR BULLETINS

Electronic Research Associates, Inc., Box 29, Caldwell, New Jersey is currently offering a new bulletin on available types of transistors, manufacturers, and other supplementary data.

Also available is a several-page bulletin on the Model TT-11 transistor tester. Data is also provided on the Model CC-60 constant current converter and the Model 110 transistor power supply.

These bulletins are available from Dept. RN of the company or by phoning Little Falls 4-1836, Caldwell, N. J.

TURNER CONVERTER

Turner Company, 900 17th Street, N.E., Cedar Rapids, Iowa has announced the availability of a complete technical bulletin on its new u.h.f. converter, the Model TV-3.

Copies of this bulletin may be obtained from electronic parts jobbers or by writing the manufacturer direct.

TRANSISTOR BULLETIN

Two new production types of hermetically-sealed, grown-junction transistors are covered in Bulletin DL-S 310, recently released by Texas Instruments Incorporated, 600 Lemmon Ave., Dallas 9, Texas.

The publication contains two pages on the theory and

FOR STANDARD DUAL OR TRIPLE CONTROLS

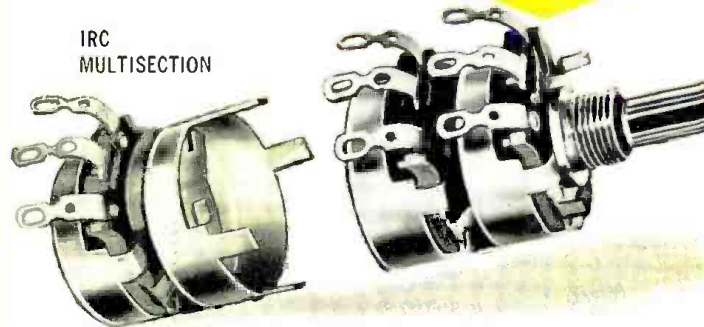

IRC
MULTISECTION

IRC MULTISECTIONS are your service-proved solution to ganged controls. Standard duals, triples and even quadruples are assembled in minutes with an IRC Multisection and a Q Control. Simply remove control cover and attach Multisection; then, add a switch if required. Another practical step to more profitable set servicing.

- Over 15,000,000 Combinations
- Assemble Like Switches
- Accommodate Switches
- 20 Resistance Values
- Provide Low-Cost L Pads and T Pads
- An Exclusive IRC Feature
- Designed With Service Technicians In Mind

Send For Your IRC Control Charts, DC70

YOUR IRC DISTRIBUTOR HAS
MULTISECTIONS PLUS ALL OF YOUR OTHER
REPLACEMENT CONTROL EQUIPMENTS



FOR
MORE
IRC CONTROL NEWS TURN TO
NEXT
PAGE

INTERNATIONAL RESISTANCE CO.
415 North Broad Street, Philadelphia 8, Penna.

It Removes the Circuit Sump - 1/2"

CANNON PLUGS



Send for Cannon Bulletin RJC-6 ... a special condensed catalog

Covers the Radio, Sound and Miniature Connectors that are available to you through Franchised Distributors, Electrical Wholesalers and Radio Parts Distributors.

TYPE **XL**



FITTINGS: For audio, instrument and related uses. 3 contacts, 15a max., 1-4 basic shapes. Latchlock coupling. Available at your Radio Parts Distributor.

TYPE **P**



FITTINGS: For audio, TV and instrument uses. 2 to 8 contacts, 30a max., 16 basic shapes. Universally used in sound and allied applications.

TYPE **O**



FITTINGS: 3-contact oval-shaped plugs and receptacles, equipped with latchlock device. For microphones and related uses. 6 basic shapes, 30a max.

TYPE **UA**



FITTINGS: Designed in cooperation with RMA Committee, combining all features of P, O and XL Series. Gold plated contacts. Rubber relief collar and bushings.

TYPE **45-E**



TEST POINT JACKS: High quality phone tip jacks to accommodate ATMA phone tip for laboratory uses. Rugged construction, nylon insulation precision-made for long life.

TV CONNECTORS:

Specialized "LK" and "LKT" plugs used on television cameras and related equipment.

TYPE **U**



SUB-MINIATURE SERIES: Hermetic sealed, vitreous insulated receptacles and Silcan insulated plugs for instruments, relays, transformers and other sealed components.

TYPE **D**



SUB-MINIATURE SERIES: Gold plated contacts. Rack-and-panel or cord mounted disconnect for portable radio and related equipment. Hermetic sealed if desired.

Additional related audio and power Cannon connectors include Types X, XK, M1, GB and BP, all available through selected Cannon Franchised Distributors. See your classified telephone directory.

CANNON ELECTRIC

Since 1915



CANNON ELECTRIC CO., LOS ANGELES 31, CALIF. Factories in Los Angeles, Toronto, New Haven. Representatives in principal cities. Address inquiries to Cannon Electric Company, Department J-145, Los Angeles 31, California.

application of junction transistors as well as detailed specifications and curves on the company's Types 200 and 201 *n-p-n* triodes with glass-to-metal hermetic sealing.

A copy is available without charge from the company.

* * *

SUBSTITUTION CHART

A time-saving substitution chart for television picture tubes has been compiled by CBS-Hytron engineers and is now available without charge from distributors, or direct from the company's main office in Danvers, Massachusetts.

The 8-page chart includes all electromagnetically deflected tubes, irrespective of make. An index leads to the proper substitution group listing all readily interchangeable types, and from this group the service technician can pick an available type with the least number of required service adjustments.

* * *

SHURE CATALOGUE

Shure Brothers, Inc. has just issued a new general catalogue, No. 44.

The publication covers microphones, microphone parts and accessories, phono cartridges and pickups, wire and tape recording heads and lists replacement information on phono cartridges, communications microphones, and magnetic recording heads of various manufacturers.

The catalogue is designed to be of maximum value to distributor counter-men and salesmen, service technicians, sound dealers, hams, hobbyists, and engineers.

Write the company at 225 W. Huron St., Chicago 10, Ill. for a copy.

* * *

STANCOR TRANSFORMERS

Chicago Standard Transformer Corp., Standard Division, Elston and Addison, Chicago 18, Ill. has issued a 24-page catalogue listing complete electrical and physical specifications on almost 500 Stancor transformers.

Included in the listing are transformers for radio, television, high fidelity, amateur, military, and other electronic applications.

A cross index chart between obsolete power transformers and the current "8400" series power transformers has been included in the catalogue.

It is available without charge from Stancor distributors or from the company direct.

* * *

TAPE ERASURE

Minnesota Mining and Manufacturing Co., 900 Fauquier St., St. Paul 6, Minn. is offering a copy of its "Sound Talk" bulletin No. 24 to interested persons.

This particular issue deals with the a.c. erasure of magnetic tape and describes the theory and practice of a.c. erasure. It covers such points as orientation, speed, and the number of passes required. In addition, procedure for obtaining best results both with 60-cycle bulk erasers and with machines is outlined.

-50-

BUILD 15 RADIOS

AT HOME ONLY

With the New Improved 1954 \$19⁹⁵

Progressive Radio "EDU-KIT"

NOW INCLUDES

SIGNAL TRACER
and
CODE OSCILLATOR

- FREE TOOLS WITH KIT
- ABSOLUTELY NO KNOWLEDGE OF RADIO NECESSARY
- NO ADDITIONAL PARTS NEEDED
- EXCELLENT BACKGROUND FOR TELEVISION
- 10-DAY MONEY-BACK GUARANTEE



WHAT THE PROGRESSIVE RADIO "EDU-KIT" OFFERS YOU

The "Edu-Kit" offers you a Home Radio Technician Course at a rock-bottom price. You will learn how to identify Radio Symbols and Diagrams; how to build radios, using regular radio schematics; how to wire and solder in a professional manner. You will learn how to operate Receivers, Transmitters, and Audio Amplifiers. You will learn how to service and trouble-shoot radios. You will learn code. You will receive training for F.C.C. license. In brief, you will receive a basic education in Radio exactly like the kind you would expect to receive in a Radio Course costing several hundred dollars.

THE KIT FOR EVERYONE

It is not necessary that you have even the slightest background in science or radio. The "Edu-Kit" is used by young and old; by radio schools and clubs; by the Veterans' Administration for Vocational Guidance and Training. No instructor is required. Instructions are complete, simple and clear. You cannot make a mistake.

PROGRESSIVE TEACHING METHOD

The "Edu-Kit" uses the principle of "Learn by Doing." Therefore you will build radios, perform jobs, and conduct experiments to illustrate the principles which you learn. You begin by learning the function and theory of each of the radio parts. Then you build a simple radio. Gradually in a progressive manner, you will find yourself constructing more advanced multi-tube radio sets, and doing work like a professional Radio Technician. The "Edu-Kit" Instruction Books are exceedingly clear in its explanations, photographs and diagrams. These sets operate on 105-125 V. AC-DC.

The Progressive Radio "EDU-KIT" Is Complete

You will receive every part necessary to build fifteen different radio sets. Our kits contain tubes, tube sockets, chassis, variable condensers, electrolytic condensers, mica condensers, paper condensers, resistors, line cords, selenium rectifiers, tie strips, coils, hardware, tubing, hook-up wire, solder, etc. Tools are included, as well as an Electrical and Radio Tester. Complete, easy-to-follow instructions are provided. In addition, the "Edu-Kit" now contains lessons for servicing with the Progressive Signal Tracer, F.C.C. instructions, quizzes. The "Edu-Kit" is a complete radio course, down to the smallest detail.

TROUBLE-SHOOTING LESSONS

Trouble-shooting and servicing are included. You will be taught to recognize and repair troubles. You will build and learn to operate a professional Signal Tracer. You receive an Electrical and Radio Tester, and learn to use it for radio repairs. While you are learning in this practical way, you will be able to do many a repair job for your neighbors and friends and charge fees which will far exceed the cost of the "Edu-Kit." Our Consultation Service will help you with any technical problems which you may have.

FREE EXTRAS

- Electrical and Radio Tester • Electric Soldering Iron • Book on Television • Radio Trouble-Shooting Guide • Membership in Radio-Television Club • Consultation Service • Quizzes • Training for F.C.C. License.

Send me the "Edu-Kit" with Money-back Guarantee—include All FREE extras.

- Check or M.O. enclosed—postage prepaid
- C.O.D. (U. S. Only)—I will pay postage
- Send further information

Outside U.S.A.—cash orders only; send intern'tl M.O. or check on U.S. bank. Postage Prepaid. "Edu-Kit" for 210-250 V. AC/DC \$22.45.

NAME _____

ADDRESS _____

PROGRESSIVE ELECTRONICS CO.

497 Union Ave., Dept. RN-23, Brooklyn 11, N. Y.

RADIO-TV Service Industry News

AS REPORTED BY THE TELEVISION TECHNICIANS LECTURE BUREAU

EVERYTIME we wade into a batch of statistics to try to interpret how contemplated or possible industry developments are likely to affect the business of independent service dealers, memory always brings to mind a discussion of mortality rates in combat that we sat in on during our stint in service during the recent world war.

It was a bull session in the barracks. The outfit was made up largely of airborne radio operators, potential tail and belly gunners, and various and sundry specialists in combat aircraft maintenance. The talk turned to ships lost in combat when one of the outfit's military masterminds came out knowingly with a lot of statistics about the comparatively low mortality rate among air force personnel.

Finally one of the boys who was ticketed for early shipment as a replacement in a combat outfit, said:

"Those statistics are a lot of bunk to me. If I get in the road of a slug and can't come back under my own power as far as I am concerned the mortality rate is 100%."

TV Future and Independent Service

Although television has steadily advanced since the freeze was lifted last year, the mortality rate among small service businesses has increased since the presidential election year "boom" in service started to taper off, after the turn of the year. Percentage-wise, the business mortality rate has been 100% for each of those aspiring technicians who launched out on his own as an independent operator and "fell by the wayside" as business steadily tightened up.

But all forecasts for Fall business are very optimistic. With more than twenty-two million sets in operation, there will probably be a big rush for service when the football season and World Series stimulate a new interest in TV and in picture quality restoration.

A recent forecast of sales of TV sets during the coming four years indicates a possibility that thirty million sets will be sold during that period, providing a "mild recession" doesn't occur with the easing of international tensions. Against this volume of sales, this forecast estimates that about 4,000,000 older sets will be junked and destroyed. On the basis of these estimates, about fifty million TV sets will be in use by the beginning of 1958.

It is, of course, impossible to measure at this time the effect color television developments will have on the sale of monochrome receivers. The National Television Systems Committee (NTSC) filed a petition with the FCC late in July for the establishment of standards based upon its system of compatible color television. RCA, who had filed their petition late in June, amended it slightly to conform exactly with the NTSC proposal. That the entire industry was backing the NTSC standards was clearly shown when Dr. Peter Goldmark, chief engineer of the CBS laboratories which developed the FCC approved CBS system for color TV, seconded the motion to accept the NTSC committees' recommendations for presentation to the FCC.

With the electronics industry solidly behind it there seems no doubt that the NTSC color TV system recommendations will get early consideration from the Federal

FOR EXACT DUPLICATE

CONCENTRIC DUALS

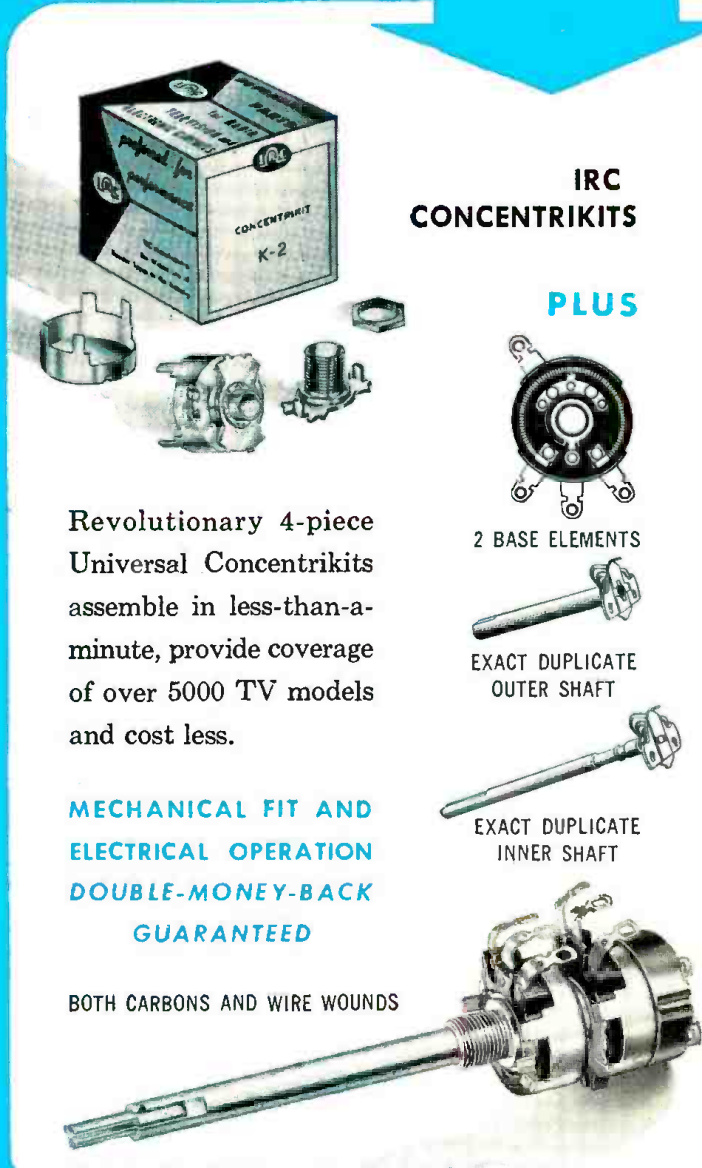

**IRC
CONCENTRIKITS**

PLUS

Revolutionary 4-piece Universal Concentrikits assemble in less-than-a-minute, provide coverage of over 5000 TV models and cost less.

MECHANICAL FIT AND ELECTRICAL OPERATION DOUBLE-MONEY-BACK GUARANTEED

BOTH CARBONS AND WIRE WOUNDS

2 BASE ELEMENTS

EXACT DUPLICATE OUTER SHAFT

EXACT DUPLICATE INNER SHAFT

Send For New IRC Control Catalog DC1D

FOR SERVICE ON

CONTROLS

CONTROL NEWS TURN TO

NEXT PAGE

INTERNATIONAL RESISTANCE CO.

415 North Broad Street, Philadelphia 8, Penna.

Wherever the Circuit Says - 

CONCORD PROUDLY PRESENTS

NEW! EICO 7 INCH PUSH-PULL SCOPE

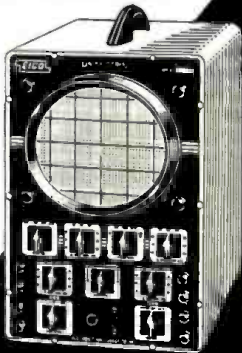

MODEL
470

KIT \$79.95 Factory Wired \$129.50

- VERTICAL FREQ. RESPONSE: flat ± 2 db 10 cps - 1 mc.
- VERTICAL SENS.: .01 volts rms/inch.
- HOR. FREQ. RESP.: flat ± 0 db 10 cps - 200 kc. -4 db at 500 kc.
- HOR. SENS.: 3 volts rms/inch.
- SWEEP RANGE: 15 cps - 100 kc.
- 3-STEP FREQ.-COMPENSATED ATTENUATOR eliminates freq. distortion, overloading.
- CATHODE FOLLOWER inputs to both amplifiers.
- PUSH-PULL outputs in both amplifiers.
- RETURN TRACE BLANKING
- INT. VOLTAGE CALIBRATOR
- V & H TRACE EXPANSION & CENTERING: 1.5X full screen without distortion.
- DIRECT CONNECTION to vert. CRT plates.
- PHASING CONTROL of internal 60 cps sine wave sweep.
- AT FRONT PANEL: intensity mod. input; 60 cps, sawtooth outputs.

Famous EICO amazing value-packed economy-priced 425K 5" Push-Pull Scope KIT \$44.95. Wired \$79.95.



NEW EICO 6V & 12V BATTERY ELIMINATOR & CHARGER

1050K KIT \$29.95. Factory Wired \$38.95.

- DC OUTPUT: 0.8 V or 0-16 V.
- CONTINUOUS CURRENT RATING: 10 A at 6 V, 6 A at 12 V.
- INTERMITTENT CURRENT RATING: 20 A at 6 V, 12 A at 12 V.
- SEPARATE VOLTMETER & AMMETER.

Send for our new 1954 CONCORD CATALOG!

FREE! A complete, comprehensive listing of all your electronic requirements. Bursting with those SPECIAL VALUES that only CONCORD can present.



Concord Radio

53 Vesey Street.
New York 7, N. Y.

Phone
Dlgy 9-1132

Communications Commission and all necessary steps leading to its acceptance will be completed at an early date. Then the big question will be—When the average prospective TV buyer sees a color receiver in operation will he put off buying a monochrome receiver and wait until he can get a color set?

However, no matter what happens, the market for service will continue to grow. TV sets that are kept in service for long periods of time will require more and more major service jobs to keep them operating. And as color television sets become available they will require a new level of technical competence and provide more volume for the capably managed shops.

Major Service Jobs

A TV service job that costs twenty-five dollars or more usually puts quite a strain on the budget of the average family. The American system of time payment purchases has developed a national habit of regularly splitting up the pay check to pay for many things on easy payments.

Automobile manufacturers realistically solved the problem of helping car owners finance major repair jobs by making car repair finance plans available through their regular financing agencies. This, of course, helped the car dealers retain their service customers but it was no help to the independent garages.

Here's how credit facilities were made available to independent garages according to Mr. Charles M. Cawley, vice-president of the Beneficial Management Corporation, in a speech before the National Sales Executives Convention:

"Not too long ago, the independent car repair business was losing ground to the large auto dealer franchises. A survey by a national magazine showed that the independent garage dealer's share of the auto repair business had dropped from 65% of the prewar market to a low after the war of 35%.

"One of our clients—a manufacturer of automotive parts—was disturbed about this trend, as well he ought be. He sells his product largely to independent garages, and they, in turn, install them in cars brought in for servicing and repairs. The less business they did, the fewer units he sold. And based on the trend, he was going to sell less in the future.

"An analysis of this situation convinced this manufacturer that the only way his independent garage dealers could compete with large automobile dealers was to have all of their advantages. This meant, among other things, a sound credit plan—which most of the independent garage dealers did not have.

"Therefore, between us we created a Car Credit Plan for garages. This is sold as a part of the merchandising package which the manufacturer makes available to his dealers. The manufacturer's salesmen back up the

CRYSTALS! LOWEST PRICES!

In FT 241-A Holders—1/2 in. Pin SPC. Designated 54th Harmonic MC freq. Listed by fundamental freq. with fractions omitted.

ACT NOW

370	392	414	437	494	477	505
374	396	418	440	459	481	509
375	398	420	442	461	483	511
376	400	422	444	463	485	512
379	401	424	446	464	487	514
381	403	425	448	466	488	516
383	405	427	450	468	490	518
385	407	429	451	470	492	520
387	409	431	453	472	494	522
388	411	433	455	474	496	524
390	412	435	457	475	497	525

5 CRYSTALS. Assorted ONLY \$2.75
60 for \$4.50, 20 for \$4.50
COMPLETE SETS—50 crystals covering above base freq. including a 500 Kc. crystal. Lowest Price in United States! This month ONLY \$12.50

SPECIAL 500 Kc. Crystal \$1.25
200 Kc. Crystal 2.25
All above crystals sent postpaid. Also available in complete sets for SCR-608, SCR-528, SCR-628, and TRC. Foreign, wholesale, and dealer inquiries invited. NOTE: All crystals guaranteed to oscillate. Frequencies not checked.

SUPREME MODEL 400 Illuminated TUBE & SET TESTER

Tests all latest tubes. Seven in. multi-tester tests DC 0-2,500 V. in 7 ranges. AC 0-2,500 V. in 8 ranges. DC current 7 ranges: 0-1,000 microamps, 0-1,000 ma., and 0-10 amps. Ohmmeter 5 ranges: 0-20 megohms. Output meter and battery tester which tests radio batteries under load. Comes with test leads and spray metal hammerhead case. 11.5x8.5x4 in. Factory guarantee includes 1 year of free tube setting service. BRAND NEW IN ORIGINAL BOXES. You know this set is designed to net for \$117.50. While they last, our \$69.95 price—the country's lowest, only. Shipping charges prepaid.

ARC-4 VHF 3-METER TRANSCEIVER. All tubes. Excellent cond. With conversion data. \$27.50
PE-104 VIBRATOR SUPPLY. Part of BC-634. Trans. Rec. 6. Input 12 V. Output positive: 6, 14 and 84 VDC; negative: 1.4, 6, 12, 51 VDC. New with spare parts \$12.95
BC-603 10-METER TANK RECEIVER. Freq. 20-28 Mc. Easily converted to 10-meter. Good used cond. with all tubes and schematic, less dynamotor \$49.50
MINIATURE 6 V. WET CELL BATTERY. With 6 V. rev. DC motor. F.B. for R/C boat. 3 1/2x2 1/2x1 3/4". Battery less motor. \$1.49 With motor. \$2.99

EXTRA HOT ASSORTMENTS!
SWITCH ASSORTMENT: Used, good cond. Micro, toggle etc. 10 for \$1.95
POTENTIOMETER ASSORTMENT: Long & short shafts. With & without switches. Used, good cond. 10 for \$1.95
RESISTOR ASSORTMENT: 1/4, 1/2, 1 W. Used, good cond. 100 for \$1.95

BD-77 DYNAMOTOR. 12 V. input. 1,000 V. output @ 350 mls. New. \$22.95

AIRCRAFT, HAMS & MARINE MEN!
SCR-183 12 V. RECEIVER & TRANSMITTER! Covers aircraft, marine and ham bands! Complete with 2 coils, control boxes, tuning knob, rack and shock mount! Plus 12 V. Dynamotor! Individual parts worth \$25.38. Approx. 25w. output. EXCEL. COND. COMPLETE! Never before sold at \$15.95 this seasonally low price. PLUS schematic \$15.95

ARC-5 OR 274-N TRANSMITTERS
2-1-3 mcs. Brand new. \$19.95
3-4 mcs. With tubes. 25.00
4-5-3 mcs. With tubes. 8.95
5-3-7 mcs. With tubes. 14.50
7-8-1 With tubes. 22.50
T-23 ARC-5 VHF TRANSMITTER. For C.A.P. with tubes. 100-150 MC. Crystal control. 29.95

ARC-5 OR 274-N RECEIVERS
Equipped with tuning knobs \$19.95
1.5-3 mcs. Like new. 24.50
3-6 mcs. Brand new. 22.50
3-6 mcs. With tubes. 10.95
6-9-1 mcs. With tubes. Used. 7.95
New. 22.50
6-9-1 mcs. Used. Less tubes. 6.95
BC-456 274-N Modulator. Less dynamotor. Excel. cond. 3.95
12 V. COMMAND RECEIVER DYNAMOTOR. New. 12.95
Plus All Accessories Needed for Above. Conversion dope available on request.

HI-FI!

That's short for Highest Figures! Yep! We out-match anyone in highest prices for new or used radio gear. What do you want for yours? Write today!

Write Today—and ask for FREE CATALOGUE!
All orders F.O.B. Los Angeles, 25% deposit required.
All items subject to prior sale.

COLUMBIA ELECTRONIC SALES
522 South San Pedro St. Los Angeles 13, Calif.

AUDIO (SOUND) ENGINEERING COURSE HOME STUDY TRAINING

Prepare yourself, in your spare time for a BIG PAY JOB as an AUDIO ENGINEER. Practical, easy-to-understand lessons, written by nationally recognized Audio Engineers and Educators. Prepare for a SUCCESSFUL CAREER in the TELEVISION, RADIO, DISC AND TAPE RECORDING, ELECTRONICS.

Training will not interfere with present employment.

EARN WHILE YOU LEARN
WRITE FOR COMPLETE DETAILS—TODAY
HOLLYWOOD TECHNICAL INSTITUTE
15228 Ventura Blvd. Sherman Oaks, Calif.

package by merchandising the credit plan to the local dealers—explaining its advantages, giving full details of its operation, and holding meetings to tell them how others have used it successfully.”

Many service dealers have plans of their own which enable the set owner to buy a new picture tube on a monthly payment plan. However, a service business would have to have substantial cash resources to handle this kind of financing themselves. Usually, arrangements are made with the dealer's bank to handle this “paper.” Banks and financing agencies have both the facilities and the proper psychological atmosphere for handling collections.

The important thing about any time payment plan is that it must be simple and the credit information assembled and passed on without embarrassment to the customer. Most people are annoyed when they are asked to furnish information about themselves for a credit report. Some dealers handle this smoothly by calling their credit statements “Let's Get Acquainted” Reports and the personnel who handle them are thoroughly indoctrinated in how to get the needed information by “getting acquainted” with the customer.

Cost of Doing Business

In the continuing surveys conducted by your editors to gather specific information on all phases of electronic service business operation one of the most important but elusive factors is the cost of making home service calls. It is appalling to find that only a very small percentage of service dealers know what it is actually costing them to do business.

The more successful businesses, of course, know their costs. The following breakdown recently furnished us by a major service business in a metropolitan city, details their cost of handling home service calls. These figures are based upon 1000 calls and the time factor involved includes time spent checking in and out, in handling exchanges of parts, etc. The time averages out at 1½ hours per call. Here is the detail and the total cost-per-call for this company:

1½ hrs @ \$2.00 (minimum scale).....	\$2.25
8 miles travel @ 7c per mile.....	.56
Dispatch & management of routes.....	.40
Clerical, bookkeeping, rent, heat, light, and miscellaneous expenses.....	.76
Advertising.....	.50
Depreciation & investment.....	.18

Total cost per call..... \$4.65

In all of the analyses that have been furnished us, the cost of making home service calls based upon actual costs of operation run from \$4.55 to \$5.37 per call, the variations being due largely to the individual characteristics of the area where the TV service business operates. These figures are from efficient business enterprises where management is continually studying costs of operation to increase efficiency and provide the highest grade of competent technical service.

If it actually costs more than \$4.50 to handle home service calls how, you may logically ask, can those technicians operate who advertise home service calls for \$2.50 or \$3.00?

In an effort to find some answers to this question your editors recently contacted nine TV technicians in a medium-sized city who were advertising home service calls for \$2.50. It is interesting to note that although every one of these men claimed he was making a good living handling service at \$2.50 per call, five of them had plans to discontinue their independent work as soon as they found jobs that would pay eighty dollars per week or more.

The illusion that leads technicians to feel they can make more money “on their own” by handling service calls at \$2.50 each is explained in this composite analysis of thinking composed of the information developed in all of these interviews:

While working for a regular TV service dealer the technician averages 8 calls per day for which his boss

FOR FACTORY-ASSEMBLED

EXACT DUPLICATES

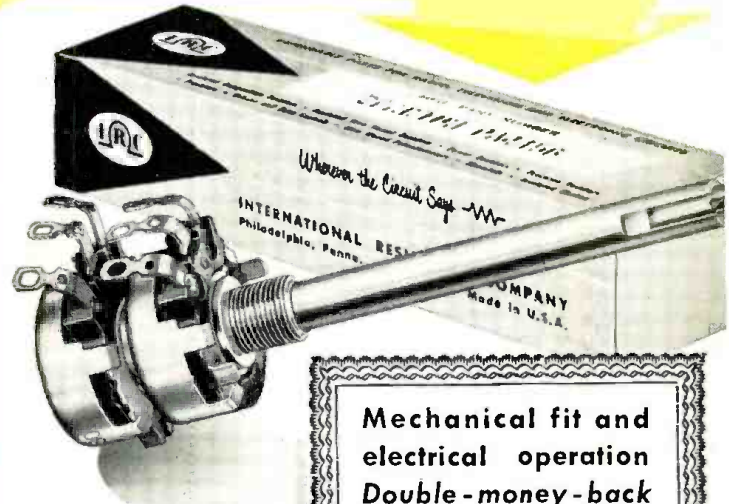

CONCENTRIC
DUAL CONTROL

**Mechanical fit and
electrical operation
Double-money-back
GUARANTEED!**

For Service Technicians who prefer factory-assembled controls, IRC's complete line includes 492 Factory-Assembled Exact Duplicate Concentric Duals.

Mechanical and electrical specifications are all based on set manufacturers' procurement prints. Resistance values are matched; tapers are closely followed; shaft lengths are never less than manufacturers' nominal, never more than 3/32" longer.

- Cover 882 Parts Numbers
- Meet Needs of Over 5,000 TV Sets
- Both Carbon and Wire Wound

Send For New IRC Control Catalog DC1D

YOUR IRC DISTRIBUTOR IS
YOUR ONE-STOP-SOURCE OF SUPPLY
FOR ALL CONTROL REQUIREMENTS

IRC

FOR
MORE
IRC CONTROL NEWS TURN TO
NEXT
PAGE

INTERNATIONAL RESISTANCE CO.

415 North Broad Street, Philadelphia 8, Penna.

Wherever the Circuit Says

NOW...TWO INCOMPARABLE TUBE-BOOKS!

BY P. H. BRANS



THE WORLD'S EQUIVALENT TUBES

The youngest of the great VADE MECUM family gives at a glance all replacement tubes of a given type, either completely equivalent, or near equivalent, in which case the differences are listed. A very practical book, it deals with thousands of tubes and gives no less than 43,900 comparisons. It lists characteristics of the tubes of all U.S.A. manufacturers in additions to those of every country in the world.

\$500 PER COPY
plus any tax

THE WORLD'S RADIO TUBES

Our standard work, acknowledged all over the world as the most authoritative tube-book, lists complete characteristics of all existing radio tubes. Data supplied by 348 manufacturers. The book is composed of one great table in which all types are classified numerically. To find a given type is a matter of seconds. Base connections have separate numbers, easy to find. Symbols and abbreviations have been restricted to a minimum and are explained on a book-marker, which can be laid next to the data.

\$500 PER COPY
plus any tax



BUY FROM YOUR DISTRIBUTOR
AT PRICES SHOWN, OR ADD 10% ON DIRECT MAIL ORDERS TO
EDITORS AND ENGINEERS, Ltd., P. O. BOX 689A SANTA BARBARA, CALIF.
Bookstores order from BAKER AND TAYLOR CO., Hillside, New Jersey

GARRARD RECORD CHANGER

LEAK AMPLIFIER

KT66 TUBES

WHARFEDALE LOUDSPEAKERS

GARRARD STYLUS PRESSURE GAUGE

RJ SPEAKER ENCLOSURES

A Cordial Invitation

to visit the British Industries suite at the New York Audio Fair, Oct. 14-17, Rooms 650, 652, 653, Hotel New Yorker. Meet and discuss your home music system with world-famed British Audio Engineers G. A. Briggs and Harold J. Leak... see new Garrard models and the transparent RJ Enclosure... hear high fidelity with Britain's finest audio equipment. Come to the Fair!

IF YOU CANNOT ATTEND THE AUDIO FAIR, PLEASE SEND FOR FREE LITERATURE AND ADDRESSES OF DEALERS
BRITISH INDUSTRIES CORPORATION, 164 DUANE STREET, NEW YORK 13, N. Y.

collects \$5.00 per call plus the profit on the tubes and parts used in servicing the sets. The technician reasons that where he is making eight calls a day working for someone else, he could work a little harder working for himself and average 10 calls per day.

At ten calls per day, he reasons, he will make \$25.00 a day for his labor plus the profit on the tubes and parts he sells. He concludes that by working six days a week he will get \$150.00 for his labor and the profit on tubes and parts will pay his operating expenses.

The delusion occurs after he has tried for ten months to make his income take care of his outgo working at \$2.50 per call.

The fundamental fault of this kind of reasoning is the assumption that day-in-and-day-out, Spring, Summer, Fall, and Winter—throughout the 52 weeks of the year—ten TV set owners will call him for service. It just doesn't work out that way.

If a technician is able to average ten sets serviced in the home per day to the satisfaction of the set owners, that is his *maximum* potential of business, operating alone. From the limited funds available to him from his maximum potential the advertising he can buy would not produce an average of one-third, 3 calls, consistently throughout the year. Sure, every once in a while when everyone seems to need TV service at the same time and all shops are swamped, he will be exposed to more business than he can handle. But those are rare instances. Averaged out over a year a business of six sets per day is difficult to maintain for the independent technician with limited promotional resources.

The final results are usually the same: At the end of a year the technician who started out on his own with inadequate resources has a worn out car, debts, and a yen for a job with a guaranteed salary.

We would like to point out, though, that there are some exceptionally able men who operate successfully as one-man TV service businesses. But most of these men handle service for a group of reliable set dealers and the subsequent COD service for their dealers' customers after the sets are out of warranty. By maintaining a mailing list of all of the set purchasers they have handled for dealers they are able to confine their sales promotion to users they have worked for and who are acquainted with them. And it is interesting to note that all of these people your editors have contacted get \$5.00 per call for home service.

TV Service Is Complex Business

The operation of a successful TV service business is a complex undertaking. In the first place, it requires substantial financing. The studies of successful service businesses made by your editors in all sections of the country show that a ten thousand

FOR SPECIAL-PURPOSE

CONTROLS

Special-Purpose Controls are no problem when you depend on your IRC Distributor for complete Control service. No other brand of replacement controls offers you such practical support. No wonder IRC is the choice of most Servicemen. No doubt, yours too!

2 WATT WIRE WOUNDS

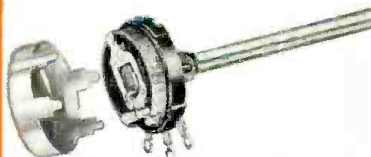

Two styles—full rounded shaft and Knobmaster shaft.

4 WATT WIRE WOUNDS



Two styles—short, knurled and slotted shaft and Knobmaster shaft.

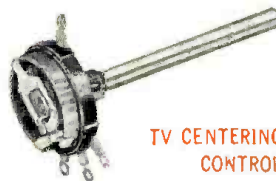

TV CENTERING CONTROL

Two watt wire wound control with center tap.



HIGH VOLTAGE CONTROL

Two watt carbon-element control with Knobmaster shaft.

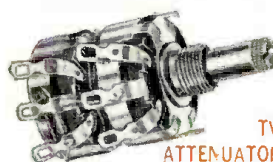

TV ATTENUATOR

Carbon-element control for adjustment of signal input.



LOUDNESS CONTROL

Continuously variable, brings higher fidelity to commercial audio.

Send For New IRC Control Catalog DC1D

YOUR IRC DISTRIBUTOR HAS THESE SPECIAL-PURPOSE CONTROLS PLUS ALL YOUR OTHER REPLACEMENT CONTROL REQUIREMENTS

FOR MORE IRC CONTROL NEWS TURN TO PRECEDING FIVE PAGES

IRC

INTERNATIONAL RESISTANCE CO.
415 North Broad Street, Philadelphia 8, Penna.

Wherever the Circuit Says 

ollar capital investment is nominal. Managers of service businesses employing only four technicians are usually proud of their ability to hold their replacement tube parts, and equipment investment down to only \$3000. Technicians working on their own with limited stocks lose a large part of their effective working time in trips to parts houses to pick up needed parts or tubes.

The biggest problem that faces any service business is that of maintaining an adequate volume of business. As someone quipped the other day, "It certainly pays to advertise. There are 26 mountains in Colorado higher than Pike's Peak." But advertising can be both expensive and ineffective. A service business needs a service selling program that is designed for its individual needs and section. Merely advertising doesn't pay off.

Service organizations capable of supporting four or more technicians have proven to be the most consistently successful television service businesses. This size organization, with an adequate business control system, permits each man to give his time to the phase of the work for which he is best qualified and allows the operating executive time to devote to the task of maintaining the volume of service work that the organization requires to pay its way.

Owner Education

The most important part of the job of public relations on behalf of independent service that needs to be done is to acquaint the public with what they should expect to pay for competent service. They have been given no yardstick with which to measure whether a service charge is low or high. In buying service on their cars, they have been educated by auto dealers to pay a flat rate or various types of service plus the cost of the parts and supplies needed.

The American public has acquired an interesting "price appraisal habit." If they have been educated to pay a certain price for a particular kind of service and have found that service to be satisfactory at that price, they will be skeptical or suspicious of anyone who offers to perform that same service for less money. Most everyone has been stung sometimes by an "I'll-do-it-for-less" character.

The education of the public about what to expect to pay for competent TV service must be done by the independent service operators themselves. Legal restrictions prevent the industry as a whole from promoting this type of campaign.

Sometime ago the Bureau made a national survey of the standard charges for TV service operations that organizations in different sections of the country are using. Averages of these charges were used in developing a schedule of average charges. This schedule was made up in a chart titled the "Standard Labor Charges for Television Service and Repairs."

Hundreds of service dealers bought these wall charts and asked about a mailing piece listing these charges that could be mailed or given to TV service customers. This part has been reproduced as an 8½ x 11 flyer which, folded three ways, can be mailed in a standard #10 envelope.

The chart is also available in the form of a printing mat. Some service businesses wanted to make up their own mailing pieces. They can do this by writing their own copy to go on one side of an 8½ x 11 flyer, and their printer can cast type from the mat to print the standard labor charges schedule on the other side of the flyer.

These mats are available from the Bureau at \$2.00 each. For information about it address your letter to: FLB Information Services, P.O. Box 1321, Indianapolis, Indiana. Please enclose a stamp or a stamped envelope in reply.

New Consumer Booklet

The RCA Service Company recently announced a new consumer booklet that lauds the independent TV service technician and tells an interesting story about what the TV technician does, to provide competent TV service. It gives a graphic presentation on Pages 10 and 11 of



**NEW! THE ONLY
COMPLETE BOOK ON
TELECASTING!**
covers every phase

**"Principles & Practices of
TELECASTING
OPERATIONS"**

by HAROLD E. ENNES



**600 PAGES
OF PRACTICAL
INFORMATION
for everyone
interested in
TELECASTING**

Indispensable to the
Engineer, Production Man,
Director, Technician, and
to all Students of
the Video-Audio Art

top reference
on Telecasting

CONTENTS:

A Partial List of Authoritative Chapters:
Basic Telecasting Equipment; The TV Camera;
The TV Control Room; Fundamentals of
TV Studio Lighting and Equipment; Network
Program Relay Systems; TV Operational and
Maintenance Practices; Technical Production
of TV Shows; Field Equipment and Micro-
Wave Relays; Analysis of Video and Audio
Transmitting Plants; Technical Definitions
— PLUS HUNDREDS OF OTHER SUBJECTS

Here, in one complete, easy-to-understand volume is the whole fascinating story of Telecasting operations. Whether you are a Chief Engineer, Production Director or Technical Director; if you are now working in or planning to work in TV, or if you are simply interested in Telecasting, this book is *meant* for you. Here is practical, useful information that makes you familiar with the equipment and techniques used in Telecasting, tells you *everything*—answers all your questions about TV production and transmission. If you work or are interested in Telecasting, you'll want this vast wealth of reliable information—you'll want this book in your library. Order your copy today!

600 Pages, 450 Illustrations
6" x 9"
Hard Covers **\$7.95**

**ORDER
TODAY!**

Order from your electronic parts distributor or bookstore, or write direct to Howard W. Sams & Co., Inc. 2203 E. 46th St., Indianapolis 5, Ind.

My (check) (money order) for \$..... enclosed. Send the following:..... copy(ies) of "Telecasting Operations" (\$7.95 per copy).

Name.....

Address.....

City..... State.....

"What goes into the bill for the services of a qualified television technician."

In sending copies of this consumer booklet to all dealer and service organizations, Mr. E. C. Cahill, president of the *RCA Service Company* said: "All far-sighted people in this industry are dedicated to the objective of keeping up the present high standards of the television service, so that we may be recognized not only for the part we play in bringing good service and enjoyment to the customers we serve but also as worth-

while members of the communities in which we live."

The *RCA Service Company* credit line is not only very modest but is in itself a very fine tribute to members of the independent TV service fraternity.

These booklets are available to service businesses at the *RCA Service Company's* cost of 3c per booklet. They are known as Form 2244 and may be obtained through *R. L. Polk & Co. Inc.*, 809 Chestnut Street, Philadelphia 7, Pa.

-30-

MEET "OLD TIMER" ANTHONY HAGEN

By C. HOWARD BOWERS

WE ARE interested in finding out what has become of all the old time wireless operators—those who started about 1912. We are attempting to develop this information through this column, and we hope it will prove interesting to radiomen of lesser years' experience. If you qualify as an "Old Timer," write us care of this column.

In this issue we scan the career of **ANTHONY HAGEN**, 1416 Stickney Avenue, South St. Paul, Minn. Mr. Hagen's first experience as a commercial wireless operator was in 1911 at Isle Royale, Michigan, for the old Marconi Wireless Company of The Great Lakes, and later as a night operator at Duluth, Minn. Taking to water, "Tony" subsequently shipped out as operator aboard the "SS American," then in succession the steamers "Lakeland," "Tionesta," and various ore vessels. Mr. Hagen says his equipment consisted of both 2 kw. and 5 kw. transmitters, with plain and rotary spark gaps, together with old type Leyden jar condensers. Receivers were the slider-type tuning coils with carborundum and silicon crystal detectors. This equipment was remarkable for its inefficiency and,

quoting Mr. Hagen, "The receivers were so insensitive that QRM from flocks of sea gulls was eliminated by wrapping a towel around one's head, over the ear-phones, thereby causing remarks from the passengers as to what we had drunk the night before!"

Shore duty about 1912-1913 paid our subject Wireless Man the munificent salary of \$75.00 per month, seven days per week, while shipboard duty paid \$48.00 per month, board and room included.

In 1917, Mr. Hagen enlisted for service in World War I and acted as code instructor. After that tour, he entered business for himself but later accepted employment with the Pullman Company as an electrician, where he is today.

"Tony" Hagen is now middle aged, "But I can still remember," he says, "when the 'Wireless Age' magazine offered \$5.00 for original crystal set hook-ups in 1913 and, yet today in **RADIO & TELEVISION NEWS** comes an offer of \$10,000.00 in prizes for crystal hook-ups, only they call them transistors!"

We doubt if Mr. Hagen still favors old style wireless.

-30-

"Tony" Hagen as he looks today (left) and as he looked at the beginning of his career forty years ago. (Below) The old Marconi Wireless station at Duluth, Minn.

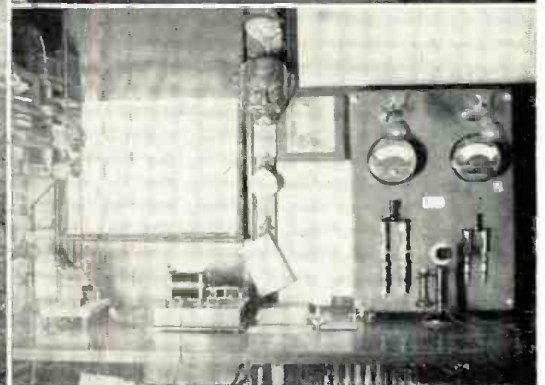

PRICES Slashed

SAVE UP TO
50%
during
GIGANTIC CLEARANCE SALE of
USED TEST and COMMUNICATION EQUIPMENT

Our entire stock of reconditioned, "good-as-new" equipment must go at a record-breaking sacrifice. Each and every instrument guaranteed to meet manufacturer's original tolerance when shipped to you. All bands and functions on receivers and all ranges on test equipment have been carefully checked. While this is only a partial list of our huge inventory (available at the time this publication goes to press) bargains like these simply can't last! So act now and avoid disappointment. Wire, write, phone or use the handy coupon today! When ordering indicate first, second and third choice. All merchandise subject to prior sale.

COMMUNICATIONS EQUIPMENT

Collins 32V1 Transmitter.....	\$395.00
Collins 32V2 Transmitter.....	449.50
Collins 75A1 Receiver with spkr.....	274.50
Collins 75A2 Receiver with spkr.....	349.50
Eldico TR75TV Wired but AS IS.....	27.50
Gonset 10 meter Converter.....	12.50
Hallicrafter HT9 Transmitter.....	184.50
Hallicrafter HT17 Transmitter.....	27.50
Hallicrafter HT18 VFO.....	79.50
Hallicrafter S20R Recvr.....	39.50
Hallicrafter SX25 Recvr. less spkr.....	79.50
Hallicrafter S38 Recvr.....	29.50
Hallicrafter S40 Recvr.....	49.50
Hallicrafter S40A Recvr.....	59.50
Hallicrafter S40B Recvr.....	69.50
Hallicrafter SX42 Recvr. less spkr.....	149.50
Hallicrafter SX43 Recvr. less spkr.....	99.50
Hallicrafter S47 FM-AM-Shortwave Recvr.....	47.50
Hallicrafter S53A Recvr.....	52.50
Hallicrafter SX62 Recvr. less spkr.....	179.50
Hallicrafter S72 Portable Recvr.....	59.50
Hallicrafter S72L Portable Recvr.....	52.50
Hallicrafter S77 Recvr.....	69.50
Hammarlund HQ129X Recvr. with spkr.....	159.00
Harvey Wells TBS50 Transmitter.....	59.50
Harvey Wells TBS50C Transmitter.....	69.50
Harvey Wells TBS50D Transmitter.....	84.50
Harvey Wells AP550 Power Supply.....	24.50
Johnson Viking I—Wired and tested ..	199.50
Lysco 600 Transmitter.....	99.50
Lysco 600S Transmitter.....	139.50
Meck T60 Transmitter.....	69.50
Meissner EX Signal Shifter—Wired.....	39.50
Meissner FMX.....	5.00
Meissner 9-1008 Signal Booster.....	19.50
Meissner 9-1090 Signal Shifter.....	49.50

Millen 90800 Exciter with tubes.....	14.95
Millen 92101 R'9er with tube & 1 coil ..	12.50
Mon-Key Automatic Key.....	19.95
National HFS Recvr. with P. S.....	110.00
National NC57 Recvr.....	59.50
National NC125 Recvr. with spkr.....	134.50
National NC183 Recvr. with spkr.....	199.50
RME HF10-20 Converter.....	49.50
RME DB22A Preselector.....	37.50
RME 50 Receiver with spkr.....	124.50
RME VHF 152 Converter.....	37.50
RME VHF 152A Converter.....	42.50
Simpson 380 Wavemeter.....	19.50
Sonar MR3 Mobile Recvr. less P. S....	49.50
Sonar MB611—NBFM Mobile Transmitter.....	14.50
Sonar VFX 680 NBFM Exciter.....	19.50
Surplus BC221 Freq. Meter with Xtal & Book.....	59.50
Sylvania X7018 Modulation Meter.....	19.50
Telvar T60-2 Transmitter.....	74.50

TEST EQUIPMENT

TUBE TESTERS	
Simpson 305.....	27.50
Superior 450.....	22.50
VOM'S	
RCP 447.....	14.95
Simpson 260.....	27.50
Superior 670.....	19.95
Supreme 542.....	12.50
Triplet 666H.....	14.95
Weston 772.....	36.50
CROSS HATCH GENERATOR	
Hickok 620.....	99.50

SIGNAL GENERATORS

EICO 360 Wired and tested.....	29.50
Heath TS2—Wired and tested.....	34.50
Hickok 191X.....	64.50
Hickok 288X.....	89.50
Hickok 610.....	99.50
Jackson 640.....	27.50
McMurdo Silver 906.....	39.95
RCA WR53A.....	37.50
Supreme 576.....	22.50
Vision TSW50 Telesweep.....	19.50

VTVM

Sylvania 134.....	39.50
-------------------	-------

ANALYZERS

Meissner Analyst.....	27.50
RCA Chanalyst.....	39.50

CONDENSER CHECKERS

Solar CC.....	17.50
Solar CE.....	17.50
Solar CF.....	32.50

OSCILLOSCOPES

Dumont 164E 3".....	42.50
Dumont 274 5".....	74.50
EICO 425 5"—Wired and tested	44.50
Hickok 305 3".....	59.50
Hickok 505 5".....	89.50
Precision ES500 5".....	99.50
RCA 155 3".....	24.50
Sylvania 132 7".....	74.50

RIDERS MANUALS

1-15 Complete.....	87.50
1-17 Complete.....	99.50

HUNDREDS OF ADDITIONAL GOOD BUYS IN USED TEST INSTRUMENTS. SEND FOR COMPLETE LIST.

Walter Ashe Radio Co. RN-53-10
1125 Pine St., St. Louis 1, Mo.

Rush my order for used equipment as follows:
(1st choice).....
(2nd Choice).....
(3rd choice).....

Remittance for \$..... is enclosed.

Send free list of additional used equipment bargains.

Name.....

Address.....

City..... Zone..... State.....

All prices
f. o. b.
St. Louis
•
Phone
Chestnut 1125

Walter Ashe
RADIO CO.
1125 PINE ST. • ST. LOUIS 1, MO.

REG. \$117.50 SUPREME TUBE TESTER—V.O.M. ON SALE AT MCGEE FOR \$64.95

WITH ROLL CHART—7 INCH METER—BUILT IN BATTERY TESTER

Supreme Model 616 tube tester and battery tester. This is the same instrument as the model 600 except it has no volt-ohm and milliamper scale. However, it is a top quality tube tester, with illuminated roll chart and a complete dry battery tester. Made to sell for \$87.45 dealers' net. Our price of \$49.95 is good only as long as the limited supply lasts. Shipping weight 24 lbs. Sale price, \$49.95.

MODEL 616
REG. \$87.45 **\$49.95**

SUPREME MODEL 600 \$64.95
Supreme Model 600 tube tester, dry battery tester, volt ohm meter. All in one gray metal portable carrying case, 16"x12"x7 3/4". Large 7" meter, easy to read. Calibrated food-bad scale for tube testing with easy to read volt-ohm and milliamper scale. Most people can operate this meter without glasses, the printing is so large, as you would expect with a 7" meter. Illuminated roll chart. Push button tube checker operation. Easy to learn how to operate. Battery tester will check all dry batteries under proper load. Has 5 resistance ranges from .1 to 20 megohms. 6 AC-DC volt ranges from 0 to 2500 volts. 6 milliamper ranges from 1 to 1000 and 0 to 10 amps. This meter had a regular net price of \$117.50. Our special purchase makes this \$64.95 price possible. Think of it, the battery and VOM part is worth one-half our sale price. Stock No. 600 Supreme tube-set tester on sale for only \$64.95 at McGee. Only a limited supply is available. SHIPPING weight 24 lbs.



SUPREME MODEL 600

INDIVIDUALLY CARTONED ELECTRONIC RADIO & TV TUBES

McGee offers you a wide selection of good quality TV and Radio tube types, individually cartoned. Our private brand. These are not set mfg's. culls, but a carefully inspected private line of tubes with a full 6 months' guarantee. Types listed are in stock in good quantity at this time. Thousands sold. Order 50 tubes and take 10% off the listed prices

D2450.59	6BA769	6T879	12K8GT59
1A7GT59	6B8C59	6U879	12Q7GT59
1B3GT79	6BD649	6V6GT59	12SF5GT69
1H5GT59	6BF559	6W4GT59	12S17M59
1L559	6BE659	6X459	12S17GT59
1R559	6BG6G1.29	6X5GT49	12S17GT69
1S559	6BM659	7A769	12S17GT79
1T459	6BJ659	7B669	1986GG1.79
1U459	6BK799	7H779	25B06GT99
1U559	6BQ6GT99	7Y469	25L6GT59
3Q459	6C439	12A1559	32L7GT79
3Q5GT69	6CB659	12A8GT69	35B559
3S459	6C06G1.49	12A7649	35C559
3V459	6M6GT59	12A7769	35W439
5U4G49	6K7GT59	12A8G59	35L6GT59
6AB469	6L6G1.09	12A8G69	4379
6AK589	65459	12A8G59	4789
6AL549	65A7GT59	12A8G59	50B559
6AQ549	65H7GT59	12A8G59	50C559
6AT649	65F5GT59	12A8G59	50L6GT59
6AU669	65K7GT39	12A8G59	70L7GT99
6AV649	65L7GT69	12B659	117Z339
6AX4GT69	65N7GT69	12B0659	
6BA649	65U7GT69	12B679	

ESPEY 12-TUBE FM-AM CHASSIS, \$59.95

- ★ BUILT-IN PRE-AMP FOR G. E. VARIABLE RELUCTANCE PICK-UP
- ★ WIDE RANGE AUDIO
- ★ WHY NOT ORDER WITH A COAXIAL SPEAKER AND A RECORD CHANGER? SEE OUR SPECIAL OFFERING

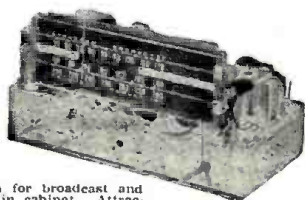

McGee's new 1953 model 12-tube FM-AM chassis. Latest design with phono inputs for all types of record players, crystal or G.E. variable reluctance. Receives standard broadcast 550 to 1700 kc and FM 88 to 108 mc. Wide range audio response (push-pull 6V6 output) and bass boost (one control). Loop antenna for broadcast and 300 ohm line type FM antenna may be stapled in cabinet. Attractive lighted slide rule dial. Chassis size, 13 1/2" x 9" high and 9" deep. Complete with tubes: 6BE6, 6BA6, 6BAG, 12AT7, 6SH7, 6AL5, 6SQ7, 6SQ7, 12AT7, 3-6V6GT and 2Y3GT rectifier. Shipping weight 20 lbs. Stock No. 7C-X Espey 12-tube FM-AM chassis. Sale price, \$59.95, less speaker. Output matches voice coil of our 12" or 15" coaxial speakers.

ESPEY DEAL (1), \$99.95
Espey 7-C chassis complete with 12" coaxial PM speaker CU-14Y and VM-950 G.E. 3-speed changer equipped with a G.E. turnabout variable reluctance cartridge. A better home music system than ordinarily available. Espey Deal #1. Sale price \$99.95. With 15" coaxial PM speaker P-15CS instead of CU-14Y. \$10.00 extra.

ESPEY DEAL (2), \$118.95
Espey 7-C chassis complete with 12" coaxial PM speaker CU-14Y and the Enrich Garrard 3-speed changer equipped with a G.E. variable reluctance turnabout cartridge. Our best home music system. Espey Deal #2. Sale price \$118.95. With 15" coaxial PM speaker P-15CS instead of CU-14Y. \$10.00 extra.

AMERICA'S FINEST 28 WATT—50 WATT AND 10 WATT P.A. VALUES

\$69.95 BUYS A 28 WATT \$150.00 LIST VALUE PORTABLE P.A. SYSTEM



50-WATT PORTABLE P.A. ON SALE \$99.95
3-SPEED PHONO TOP—TWO 12" SPEAKERS
(Illustration A)

10-tube portable 50-watt public address system. 4-6L6G (push-pull parallel) output tubes. Inputs for 2 microphones, either crystal or dynamic, with separate mixing volume controls. Twin bass and treble tone controls. High fidelity wide range output transformer with taps at 4, 8, 16, 125, 250 and 500 ohms. Complete with 2 super heavy duty 12" FM speakers and 25 ft. cables mounted in separate leatherette-covered carrying cases, 21"x21"x13 1/2". The amplifier fits in one of the cases for carrying. This amplifier will put out 40 watts all day long and 50 to 60 watts peak with ease. 3-speed turntable and pickup arm to play all records 33 1/3, 45 and 78 RPM is mounted in the top of the amplifier. Stock No. AP-60X. 50 watt portable P.A. system similar to the 28-watt model pictured above, less microphone. Sale price, \$99.95. Shipping weight, 100 lbs. Shipped via Express or Truck only. Regular \$145.00 list Electro-Voice 910 dynamic microphones with 20 ft. cable and desk stand, \$14.95 extra. For floor stand instead of desk stand, add \$4.95.

3-SPEED PHONO TOP—TWO 12-INCH SPEAKERS
7-TUBES PUSH PULL 6L6'S HEAVY LEATHERETTE COVERED PLYWOOD PORTABLE CASES
CRYSTAL MIKE \$8.95 EXTRA

Stock No. AP-28X. Portable 28 watt public address system. You get a 7-tube heavy duty push-pull 6L6 amplifier with inputs for 2 mikes either crystal or dynamic with separate mixing volume controls. One phono input. Fully variable tone control high fidelity, wide range frequency response. The heavy duty output transformer has taps for 4, 8, 16, 125, 250 and 500 ohm speaker connections. Two heavy duty 12 inch alnico V P.M. speakers, each with 25 feet of speaker cable. Each speaker is mounted in separate carrying cases. Each case has a snap on lock and is large enough to give good speaker baffling. Each case is 21 x 16 x 13 inches. One is used to carry the amplifier. A 3-speed phono motor and pickup is mounted in the top of the amplifier to play 33 1/3, 45 and 78 RPM records.

This portable PA system will put out 20 watts all day long and 28 to 30 watts peak audio. McGee offers you this \$150.00 list portable PA system at a terrific savings.
Stock No. AP-28X complete portable PA system with 3-speed phono and speakers as pictured (less mike) ship. wt. 71 lbs. \$69.95.
Electro Voice model 910 \$28.50 list crystal mike with 20 feet of cable and desk stand \$8.95 extra.
Floor type mike stand instead of desk stand \$4.95 extra.

10-WATT PORTABLE P.A. ON SALE \$42.95
3-SPEED PHONO TOP—10" ALNICO PM SPEAKER
(Illustration C)

5-tube portable 10-watt (14-watt peak) public address system. (Push-pull 7C5 U. L. approved amplifier with wide range response. Inputs for microphone and phono, with separate mixing volume controls. Tone control. 10" Alnico V PM speaker is housed in a leatherette case 21"x16"x13 1/2" which holds the amplifier for carrying. 3-speed turntable and pickup arm to play all records 33 1/3, 45 and 78 RPM is mounted in the top of the amplifier. List value, \$90.00. Stock No. AP-10X. 10-watt portable P.A. system has only one case and one 10" speaker, less microphone. Sale price, \$42.95. Shipping weight 41 lbs. Shipped via Express or Truck only.
Crystal microphone with non-removable desk stand, \$3.95 extra when ordered with the AP-10X portable P.A. system.

McGEE RADIO COMPANY

Prices F.O.B. K.C. Send 25% Deposit with Order, Balance Sent C.O.D. With Parcel Post Orders, Include Postage

TELEPHONE VICTOR 9045. WRITE FOR FLYER
1422 GRAND AVE., KANSAS CITY, MISSOURI

McGEE OFFERS YOU TERRIFIC VALUES

STANDARD COIL SUPER CASCODE TUNER \$19.95

Replace that old tuner with a new cascode—another McGee scoop



The Cascode Circuit of the Standard Tuner offers a new development in this famous TV front end assembly which affords a 2-to-1 improvement in gain and a 35% to 50% reduction of noise over the standard tuner. Other advances include: easy conversion to UHF operation by interchange of channel indicators; increased sensitivity for V sets in fringe areas; elimination of booster use; and a high profit margin for the serviceman as a replacement unit sale. Brand new factory TV-2000 TV tuner, compl. with tubes 6BK7 or 6BQ7 and a G10. Shaft length 3/4" or 4/8".

14-Inch Conversion Kit \$25.95 WITH G.E. TUBE

14-inch conversion kit: You get a 14-inch black face, 1 year guarantee G.E. 14CP4 picture tube, a 70° deflection yoke with matching 14,000 volt G.E. flyback and a 14" plexiglas gold trim safety mask, plus conversion instructions. Stock No. 14C-V. Sale price, \$25.95.

17-INCH CONVERSION KIT \$25.95

17-inch conversion kit with a 17BP4A, rectangular blackface electro-magnetic tube picture tube with 6 months' guarantee, plus a matched 70° cosine yoke, a G.E. 14,000 volt flyback and a 17" rectangular gold trimmed plexiglas mask and safety shield. Suggested diagram furnished. Shipping weight, 30 lbs. via Express or truck only. Stock No. 17-4XL. 17" conversion kit. Sale price, \$25.95. Kit Price thru GE or Raytheon 1 year guarantee picture tube, \$5.00 extra.

20-inch Conversion Kit \$29.95

Our 20" conversion kit includes a 6-month guaranteed 20HP4, 20" rectangular blackface picture tube, plus a 14,000 volt G.E. flyback, high voltage flyback transformer, plus a matched 70° cosine yoke, plus a 20" rectangular gold trimmed plexiglas mask and suggested diagram. The picture tube is the latest electro-static focus type that requires no focus coil. Shipping via express or truck only. Ship. weight, 40 lbs. Stock No. 20-TP, net price, \$29.95. Price with Raytheon or GE 1 year guarantee picture tube, \$10.00 extra.

SPEAKER AND BAFFLE SALE

8" SPEAKER AND BAFFLE \$4.95

Stock No. 818, Tan leatherette covered, plywood slant type wall baffle; plus an 8" Oxford, 2.15 ohm, Alnico V magnet PM speaker. A red hot McGee special for only \$4.95 each, or \$4.70 each in lots of 3 or more.

12" SPEAKER AND BAFFLE \$6.50

Stock No. CA-10, Tan leatherette covered plywood slant type wall baffle; plus 10" Alnico V PM speaker. Only a few hundred to sell at \$6.50 each, or \$6.25 each in lots of 3 or more.

12" SPEAKER AND BAFFLE \$7.95

Stock No. CA-12, Tan leatherette covered plywood slant type wall baffle; plus a 12" Alnico V magnet PM speaker. A terrific McGee value for only \$7.95 each, or \$7.50 each in lots of 3 or more.

3 STATION INTERCOM MASTER \$16.95 SUB STATION \$3.95

3-station intercom master housed in chrome plated metal cabinet 7 1/2" x 5" sloping front. Full 3-tube amplifier for 110 volt AC-DC operation. Presto-talk switch is on top of the cabinet and volume control with off-on switch and station selector switch are on either side. May be used with from one to 3 sub-stations. (See matching cabinet chrome plated sub-station No. PM-A5.) Master is quiet at all times except when presto-talk switch is pressed at the master or call-back switch is pressed at the sub. Uses 3-wire intercom cable. 3-station intercom master MPM-A3, shipping weight 10 lbs. Sale price, \$16.95 each, sub-stations extra. 3-wire plastic intercom cable, 100 ft. for \$1.95, 500 ft. for \$6.95.

1000 INTERCOM SUB-STATIONS TO SELL AT \$3.95 EACH

Chrome plated, with call back switch for a 3-wire intercom master. Size 7 1/2" x 5" sloping front. 5" Alnico V PM speaker. Intercom dealers buy at less than present production costs. Limited quantity. Stock No. PM-A5, ship. weight 8 lbs. Sale price, \$3.95 each or 3 for \$10.00. Special 3-wire plastic intercom cable, 100 ft. for \$1.95, 500 ft. for \$6.95. Brown leatherette covered intercom sub-station with call back switch for use with 3-wire intercom masters. 7" square and 2 1/2" deep. Has new plastic grill cloth. Alnico V PM speaker. A true McGee value. Stock No. NE-5, ship. weight, 1 1/2 lbs. Sale price, \$3.95 each or 3 for \$10.00. 3-wire plastic intercom cable, 100 ft. for \$1.95, 500 ft. for \$6.95.

IN T. V. BOOSTERS—AMP'S AND KITS

FRINGE AREA TV RECEPTION IS BETTER WITH OUR McMURDO SILVER TV BOOSTER

\$10.95—TWO FOR \$20.00



Read the article on pages 52 and 53 of the December "Radio & TV News." You will see how a booster like the McMURDO Silver Super Sonic was used for fringe area TV reception. We can't guarantee this unusual reception, but we will guarantee this booster to be a sensational value. Continuously variable inductance type tuner from channel 13 including the FM band through channel 13. Self-powered for 110 volts AC operation. Incorporates a 6J6 tube. Input for 300 ohm TV line and 300 ohm output to TV set. Single knob tuning. Attractive plastic case. Sale price, \$10.95 each or two for \$20.00.

3-TUBE SARKES-TARZIAN T.V. TUNER \$9.95

This popular Sarkes-Tarzian Type 3 tuner is widely used. 13 channel rotary tuner with individually tuned coils. Price is complete with diagram and three tubes: 6C4 osc., 6BH6 R.F. and 6AG5 mixer. Regular factory cost is twice our price. Each tuner is wired ready to hook up to a video and sound IF strip. May be used with either intercom or separate sound IF circuits. Has built-on converter coil, built in fine frequency control. Sarkes-Tarzian TV tuner, with 3 tubes. Net price, \$9.95 each. Shaft length, 2 1/2".

50-WATT BOOSTER AMPLIFIER

50-WATT BOOSTER AMP. \$39.95
2-Mike Pre-Amp \$12.95 Extra. Not a Kit, but a Manufactured Amp.
50-WATT BOOSTER A sensational value. 50 watt booster amplifier with push-pull parallel 6L6 output tubes. Connect to your present amplifier as a booster or use with the PM-2X pre-amp to add the use of 2 mikes and gives 50 watts of audio. Booster has a 6 lb. potted case high efficiency output transformer, matches speaker with 4-8-10 ohm voice coil, also 60 ohm and 250 ohm line. Booster has a 225 mill power supply with 50A rectifier. Price includes tubes (4) 6X4, 7N7 and 6J4. The two variable controls are for master volume control and bass boost tone control. Size 8 x 6 1/2 x 1 1/2. Stock No. PA-55N. Shipping weight 26 lbs. Sale price \$39.95 ea.

Pre-amplifier plugs in directly to the PA-55N booster amplifier. It enables use of 2 Crystal or Dynamic Mikes plus one low level input. Furnished with 4 foot cables and plugs for remote control of the 55 watt booster. Net price \$12.95 ea.

McGEE'S \$62.50 LIST 15" COAXIAL SPEAKER, \$23.95

New 1953 Model—21 Oz. Alnico V Magnet—5" Tweeter This is the finest 15" coaxial PM speaker value that we have ever offered. New 1953 production of a famous manufacturer of fine speakers. The 15" speaker has a 2 1/4" oz. Alnico V magnet; equal to 1 1/2" 6B speaker. The cone is free floating, of one piece construction. Will reproduce low frequencies down to 20 cps. The 5" tweeter is coaxially suspended and has a ridged cone to reproduce only the high frequencies. It will respond up to 17,500 cps. The high-pass filter is concealed under the pot cover, leaving only two wires to connect both the tweeter and woofer to any 8 ohm output transformer of a radio or high fidelity music lover's amplifier. Stock No. P-15CS, shipping weight 13 lbs. Net price \$23.95.

12" COAXIAL SPEAKER, \$12.95
McGee offers the new 1953 model 12" coaxial PM speaker. Quality you would put in your finest sets if you were a manufacturer. 12" woofer has 6.8 oz. Alnico V magnet. Tweeter is coaxially suspended and has a new diffuser. High pass filter is under the pot cover. Only two wires to connect with radio or audio amplifier, 8 ohm with 18 watt peak and 10 watt rms. Response from 30 to 17,500 cps. Stock No. CU-14V. Sale price \$12.95 each; 2 for \$25.00.

12" JENSEN PM, \$15.95

Another McGee Scoop! Jensen Concert 12", 1 1/2" oz. Alnico V magnet PM speaker, 8 ohm voice coil. Will take 2 1/2 watt input. You save dollars on this speaker. Just 100 to sell. Shipping weight 8 lbs. Stock No. P-12P. Sale price \$15.95; 2 for \$30.00.

G.I. 3-SPEED CHANGER WITH G.E. \$22.95

VARIABLE RELUCTANCE TURN-ABOUT CARTRIDGE
Another tremendous McGee Scoop! Brand new General Instrument 3-speed automatic record changers. Complete with RPX-050 G.E. variable reluctance cartridge with turn-about stylus. Plays all 3 speeds automatically. 7" 10" or 12" records. Has record button. Repeats last record. Base size, 12" x 12 1/2". Shipping weight 14 lbs. Stock No. 700-GE. Scoop price, \$22.95.

GI 3-speed changer same as above, but with Webster flip-over twin needle cartridge. Stock No. GI-700. Sale price, \$21.95 each.

COMPLETE RADIO, TELEVISION AND AMPLIFIER KITS AT McGEE

20" T.V. Kit \$59.95 Less Tubes

Complete kit of parts to build an 20" television set. Includes transformer, tuned circuits, television chassis for use with 17", 17" or 20" rectangular picture tube. The 12 channel Sarkes-Tarzian converter is ready to use in the 4" video IF strip, built in of the conventional design. Do not buy this unless you understand television. It is difficult to assemble. We furnish schematic. Kit model \$59.95. Cascade tuner \$10.00 extra. 10 tubes, less picture tube \$10.95. 17BP4A, \$17.95. 20HP4, \$25.00.

8-Tube Hi-Fi Amplifier Kit \$29.95

A complete kit, including tubes: 3-7E5, 2-12AX7, 2-6X4, 1-12BE6 rectifier diagram and photos. Inputs for radio tuner and any kind of phono pickup (cervical or G.E. variable reluctance) and either crystal or dynamic mike. Output matches 8 ohm voice coil. Twin electronic bass and treble tone controls with range selector switch for either high quality with heavy bass response or brilliant symphonic range. Response 18 to 20,000 cps. 8 tube all grade amplifier kit. Shipping weight 25 lbs. Model 7X5. Net \$29.95.

1954 Model 9-Tube Radio-Amp-Kit

BUILD IT FOR \$29.95
A new 1954 model high fidelity amplifier and broadcast radio rec. kit all one chassis. The radio circuit is a straight forward 3 gang condenser broadcast rec. with 456 I.F.'s A.V.C. Loop Ant. etc. The amplifier has gain for a crystal mike or crystal phonograph pick up as well as gain and compensation for G.E. or Pickering variable reluctance pick ups. Twin electronic tone controls one for bass boost one for treble boost. Push null 6V6 output tubes. Fully shielded output transformer for use with any high quality 12 or 15 inch pm speaker. Everything furnished including ready punched chassis 12 x 9 x 7. Full 150 mill power trans. all parts tubes and diagram. Tube complement 6AK5 RP, 6HE6 converter, 6AU6 I.F. 6AT6 det. 1st audio, 12AX7 mike V.R. stage, 5L7 phase inverter. Two 6V6 audio 5Y3 rect. Stock No. BK100. Ship. weight 20 lbs. Sale price \$29.95 (less speaker), 12 inch Coaxial PM Speaker \$12.95 extra, 15 inch Coaxial PM Speaker \$23.95 extra.
3-Speed G.I. Changer with variable reluctance cartridge \$22.95.
3-Speed Garrard Changer with RPX050 G.E. cartridge \$47.40 extra.
Crystal Mike and Desk Stand \$4.95 extra.

6-TUBE 2-BAND KIT \$14.95

Popular with schools and colleges for training. 6 tube AC-DC, 2 band radio kit with furnished cabinet. Receives a broadcast and 6 to 18 mc shortwave. Full 2 gang superhet with 5" slide rule dial. A complete kit with tubes: 12SK7, 12K8, 12SK7, 12SQ7, 50L6 and 3Z5Z, diagram and instructions. Factory quality. Cabinet size 13" x 6 3/4" x 6 3/4". Shipping weight 2 1/2 lbs. Model ME-2. Net \$14.95.

5-TUBE AC-DC KIT \$12.95

Model RS-5. A 5 tube AC-DC straight broadcast kit, housed in the same cabinet as ME-2 above. Complete with tubes. Shipping weight 10 lbs.. Net \$12.95.

AC POWERED BROADCAST TUNER KIT \$14.95

A self-powered, 3-gang superhet tuner kit with R.F. stage. This complete kit is furnished with a schematic, diagram, photo and tubes. 6BA6 R.F., 6HE6 oscillator R.F., 6BA6 I.F. detector, diode, AVC, plus rectifier. Connect to any audio amplifier. Ideal for use with our 8-2020 or 7x5 amplifier kits. Chassis size, 9 1/2" x 4 1/2" x 1 1/2". Shipping weight 7 lbs. Broadcast tuner kit Model BT-38X. Net price, \$14.95.

Id Your Own Phono-Mike \$7.95

Model DE-6R. With a simple kit, you can build a 3-tube phono amplifier that also has a 1/2" input. Will exceed over any radio within your home, (about 75 feet) from 10 to 1500 kc. Inputs for crystal mike or phono pickup. Fader control fades a mike to record. Ideal for a home P.A. system, baby listener and home entertainment. A complete kit of parts including exc. Kit Model DE-6R. Net price, \$7.95. 6BW7 wired and tested. \$14.95. 95. Crystal mike and desk stand, \$4.95 extra. Concealed microphone unit, only 1" diameter and 1/4" thick. Specially hidden when ordering. Stock No. 7-001. Net. 95 extra.

WRITE FOR McGEE'S 1954 CATALOGUE

FULL OF BARGAINS—EVERYTHING FOR THE TELEVISION AND RADIO SERVICE MAN. UP TO DATE UHF TELEVISION MATERIAL. WRITE FOR YOUR COPY TODAY.

McGEE RADIO COMPANY Prices F.O.B. K.C. Send 25% Deposit with Order. Balance Sent C.O.D. With Parcel Post Orders, Include Postage. TELEPHONE VICTOR 9045. WRITE FOR FLYER 1422 GRAND AVE. KANSAS CITY, MISSOURI

NOW!
GET ON THE AIR
FOR ONLY
\$44.95

**With These Amazing New
 NOVICE KITS**

(Available in Single Units If Desired)

You've read about them in the pages of Radio and TV News. Now get one or all of these superb units... with chassis already punched... ready for quick and easy assembly from simple directions furnished free with each kit.

**WAT-25 Novice
 Transmitter Kit.**
 Complete with
 tubes and key.
 crystal, less key.
 Only \$17.31



**WAR-25 Novice
 Receiver Kit.**
 Complete with
 tube.
 Only \$13.41

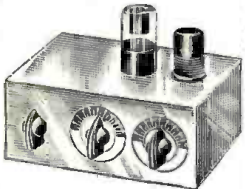

**WAP-25 Novice
 Station Power
 Supply Kit. Complete
 with tubes.**
 Only \$14.23

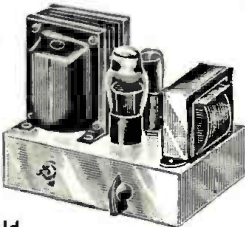

Novices and "old timers" too, will appreciate the high quality and performance characteristics of this swell rig. So don't delay. Mail the handy coupon today.

WALTER ASHE RADIO CO. RNK-10-53
 1125 Pine St., St. Louis 1, Mo.

Enclosed is remittance of \$_____ Send me:

_____ WAT-25 Transmitter Kit

(QUANTITY)

_____ WAR-25 Receiver Kit

(QUANTITY)

_____ WAP-25 Power Supply

(QUANTITY)

Rush free Novice Kit circular.

Name _____

Address _____

City _____ Zone _____ State _____

All prices F. O. B. St. Louis • Phone Chestnut 1125

Walter Ashe
RADIO CO.
 1125 PINE ST. • ST. LOUIS 1, MO.

Novice Receiver
 (Continued from page 47)

makes it almost as easy as a two-terminal coil. For example, taking the 80-meter coil with its 21½-turn, center-tapped coil, start with two pieces of wire about three feet long. Twist two inches or so of these wires together and put them through the proper hole in the coil form and solder them into the pin at the bottom of the form. Now wind one piece of wire towards the top end of the coil form, run it through its proper hole and solder it to its pin, then wind the other piece of wire in the opposite direction down on the coil form to its hole and solder it to its pin connection. The fractional turn counts given in the coil data are caused by the fact that the holes for the wires are drilled above the appropriate pins on the coil forms. These pin numbers are shown at the ends of the coils in the schematic diagram. The spacing between the primary and the tickler coils is about one-quarter inch in the case of both the 80- and 40-meter coils and the tickler is wound on the lower end of the coil form. Be sure to wind the primary and the tickler (the small coil) in the same direction.

Naturally the enamel insulation will have to be removed from the ends of the wires before they are soldered. It will help considerably in soldering the coil wires into their pins to "tin" them lightly before inserting them, by giving them a thin coat of solder. The builder will notice that the wire ends and terminals of the various parts, such as resistors, condensers, etc. have already been tinned

by the manufacturer. The coil ends need not be scraped or tinned for much more than half an inch.

The two tuning condensers and the regeneration control are mounted on the front edge of the chassis and the phone tip jacks and power cord are brought out through the rear edge. A plate load resistor and blocking condenser are used in the output stage to keep d.c. off the headphone wires.

When the wiring is completed and checked for correctness, you are ready to try the receiver. After a moment or so of warmup, turning the regeneration control clockwise should cause a "plopping" sound in the headphones. This plopping sound occurs at the point where the detector breaks into oscillation. On the clockwise side of this point, there should be a slight rushing sound in the headset while on the counter-clockwise side there is only silence. Voice reception is achieved with the regeneration control set just short of the regeneration point while code is received with the control turned over into the regenerative state.

Almost any length of wire makes a satisfactory receiving antenna, preferably one over 30 feet long. The same wire you use for transmitting makes an excellent antenna for the receiver if you provide a single-pole, double-throw switch to change the antenna from transmitter to receiver during standby periods.

With a simple receiver of this kind and a long receiving antenna, there is a possibility of cross-modulation if you live near a strong broadcast station or other powerful transmitter. Cross-modulation causes the broadcast program to be heard in the back-

Under-chassis view of the Novice station receiver. The audio transformer is seen at left, below the regeneration control. Phone tip jacks and power cable can be seen along rear edge of chassis. Coil socket is at extreme right. Note roomy layout.

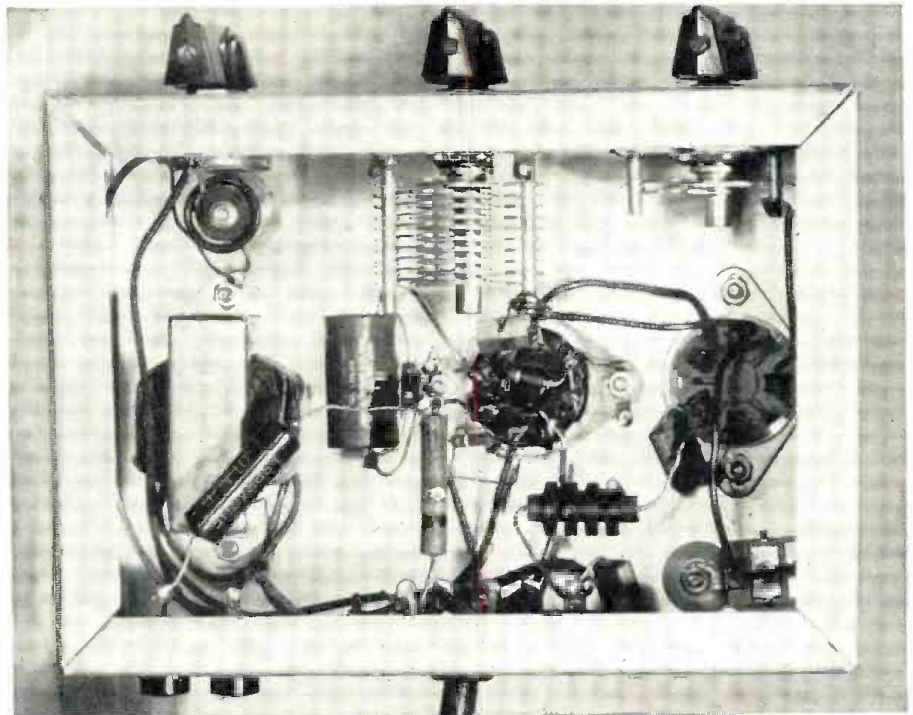

Pre-sold to Millions!



Custom Music Ensemble



G-E DUAL COAXIAL SPEAKER
Model A1-400

New approach to coaxial speaker design—high sensitivity at low cost. Exceptional balance between speakers with G-E Acoustic Balancer. Newly developed Pressure Equalizer . . . a wavefront shaping plug . . . provides smooth tweeter response.



G-E POWER AMPLIFIER
Model A1-300

A medium power, compact amplifier designed to provide needed speaker power. Essential element in the new General Electric "Custom Music" Ensemble. Delivers high-fidelity performance at very low cost.



G-E PREAMPLIFIER-CONTROL UNIT
Model A1-200

Combines functions of equalized pre-amplifier plus adjustable record compensation, program input selection, tone controls and volume control. Matching unit for the "Custom Music" amplifier. Self-powered for use with any installation.



G-E DELUXE TONE ARMS
A1-500 (12") A1-501 (16")

For home or broadcast station use. Compatible with the exceptional quality of G-E cartridges. Calibrated stylus pressure adjustment . . . 4 to 14 grams. They were developed to improve record reproduction in every installation.

G-E SPEAKER ENCLOSURE
Model A1-406 (6 cu. ft.)

Attractive corner or wall cabinet in hand-rubbed blond or mahogany veneers. "Distributed port" design provides full low frequency response. Tonal range with G-E Coaxial Speaker—40 to 15,000 cycles.



FOR SUPERIOR PERFORMANCE...
LOW COST...MINIMUM SERVICE...
INSTALLATION ECONOMY!

● Through the pages of nine top consumer magazines . . . in display rooms . . . on FM broadcasts . . . and at shows millions are discovering —indicating a preference for—the unique features of a G-E Custom Music Ensemble. Here is the single package of *matched high-fidelity equipment* you need to expand your audio business, assure satisfied customers. Get in tune today with the growing popularity of custom audio installations . . . add to your net profit . . . with complete General Electric equipment!

Individual components or the complete ensemble now available! Call a local G-E distributor or write for information.

SEND FOR COMPLETE INFORMATION

General Electric Company, Section 9103
Electronics Park, Syracuse, N. Y.

Please send me specifications and other data on the new G-E Custom Music Ensemble.

NAME.....

ADDRESS.....

CITY.....STATE.....

You can put your confidence in—

GENERAL  ELECTRIC

KESTER

FASTER ACTING

EASIER TO USE

LONGER LASTING

THE BEST

Since the most important single step in Radio-Television Servicing is soldering . . . it's just plain good sense to use the best — **KESTER SOLDER** . . . Key Name in Solder for More Than 50 Years.

KESTER SOLDER COMPANY
4235 Wrightwood Avenue • Chicago 39, Illinois
Newark 5, New Jersey • Brantford, Canada

SOLDER

ground along with the desired signal even though the receiver is tuned to a frequency far removed from the broadcast station's. To eliminate this effect, decrease the capacity in the antenna trimmer condenser. This condenser also helps take out any "dead spots" in the tuning range caused by antenna resonance effects. The receiver tunes through the range 3.5 to 18 megacycles with the two coils described in the parts list. Other coils could be suitably proportioned to extend the range if desired. The Novice can learn much by experimenting with other coils wound with the aid of the inductance-capacity charts and other data found in the various radio handbooks.

-50-

UNUSUAL SERVICE CALL

By JAMES B. TAYLOR

THE phone rang and the voice on the other end of the line asked, "Can you send a serviceman out to check my television set? The last commercial that the station ran over an hour ago is still on the screen."

"What?" I asked, "do you mean that the station is running one commercial for over an hour?"

"Oh no," replied the voice on the other end, "but when they ran a cottage-cheese ad about an hour ago, it must have been awfully strong for it stuck to my picture-tube screen and stayed there. I can still see the other programs through the ad, but they are not clear."

Muttering to myself that somebody is either drunk or crazy, I picked up my service kit and headed for the address given. What I saw can be seen in the accompanying photograph. There was the cottage-cheese ad as clear as you would want on the screen in black, with the set still working and getting a picture, except for the black portions being masked by the ad. The only clue the set owner could give was that he heard a dull thud when it happened.

EDITOR'S NOTE: Such an effect may be due to ion acceleration in the tube and the resultant bombardment of the screen by heavy ions. Where there is a large accumulation of electrons on the screen (light portions of the picture) there will be a great attraction for the ions, and this portion of the screen will receive heavy bombardment resulting in a burn on the screen. Darker portions of the picture will be burned in less than lighter portions. Hence, the picture reversal effect.

-30-

TV picture tube with commercial burned onto screen due to ion bombardment.



the 630

IS STILL THE FINEST TV CHASSIS EVER DESIGNED

...and there is no finer 630 chassis than the **GOLD MEDAL**

by TECH-MASTER

There is a Tech-Master Custom-Designed, custom-built TV Chassis for every requirement where quality and reliability are the predominant factors.

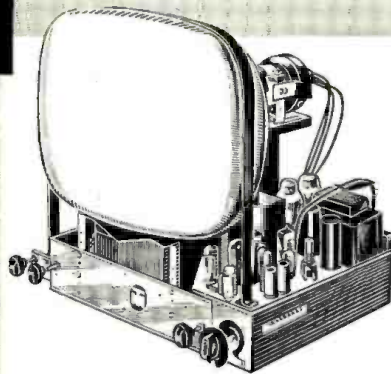

- MODEL 2430: For picture tubes up to 24". Audio connection for optional use of external amplifier.
Net Price.....(Less Kine).....\$189.50
- MODEL 2431P: Same as 2430, but with true fidelity Push-Pull audio amplifier.
Net Price.....(Less Kine).....\$199.50
- MODEL 2439: For new 90° kinescopes. (21" rectangular, 27" and 30")
Net Price.....(Less Kine).....\$262.50

Write for Detailed Data



TECH-MASTER PRODUCTS CO.

455 BROADWAY, NEW YORK 13, N. Y.

TECH-MASTER TV Chassis

TECH-MASTER TV Kits

TECH-MASTER Audio Equipment

CREI prepares you quickly for success in

The future is in your hands!

The signs are plain as to the future of the trained men in the electronics industry. It is a tremendous industry, and—at the *present time* there are more jobs than there are trained men to fill them. But—when there's a choice between a trained and untrained applicant, the trained man will get the job. Your biggest problem is to decide on—and begin the best possible training program.

CREI Home Study . . . The Quick Way to Get There.



Since 1927, CREI has given thousands of ambitious young men the technical knowledge that leads to more money and security. The time-tested CREI procedure can help *you*, too—if you really want to be helped. CREI lessons are prepared by experts in easy-to-understand form. There is a course of instruction geared to the field in which you want to specialize. You study at *your* convenience, at *your* rate of speed. Your CREI instructors guide you carefully through the material, and grade your written work personally (not by machine).

Industry Recognizes CREI Training.

CREI courses are prepared, and taught with an eye to the needs and demands of industry, so your CREI diploma can open many doors for you. Countless CREI graduates now enjoy important,

good-paying positions with America's most important companies. Many famous organizations have arranged CREI group training for their radio-electronics-television personnel. To name a few: All America Cables and Radio, Inc.; Canadian Aviation Electronics, Ltd.; Canadian Broadcasting Corporation; Columbia Broadcasting System; Canadian Marconi Company; Hoffman Radio Corporation; Machlett Laboratories; Glenn L. Martin Company; Magnavox Company; Pan American Airways, Atlantic Division; Radio Corporation of America, RCA Victor Division; Technical Appliance Corporation; Trans-Canada Air Lines; United Air Lines. Their choice for training of their own personnel is a good cue for *your* choice of a school.



Benefits Felt Right Away.

Almost immediately, you feel the benefits of CREI training. Your employer, when informed of your step toward advancement (only at your request), is certain to take new interest in you and in your future. What you learn in CREI Home Study can start helping you do a better job immediately.

- BROADCASTING
- TELEVISION
- MANUFACTURING
- COMMUNICATIONS
- SERVICING
- AERONAUTICAL ELECTRONICS



CREI also offers Resident Instruction

at the same high technical level—day or night, in Washington, D. C. New classes start once a month. If this instruction meets your requirements, check the coupon for Residence School catalog.

INFORMATION FOR VETERANS

If you were discharged after June 27, 1950—let the new G. I. Bill of Rights help you obtain resident instruction. Check the coupon for full information.

Get this fact-packed booklet today. It's free.

Called "Your Future in the New World of Electronics," this free illustrated booklet gives you the latest picture of the growth and future of the gigantic electronics world. It includes a complete outline of the courses CREI offers (except Television and FM Servicing) together with all the facts you need to judge and compare. Take 2 minutes to send for this booklet right now. We'll promptly send your copy. The rest—your future—is up to you.



CAPITOL RADIO ENGINEERING INSTITUTE

An Accredited Technical Institute • Founded in 1927

3224 16th Street, N.W.

Washington 10, D. C.

MAIL COUPON TODAY

CAPITOL RADIO ENGINEERING INSTITUTE

Dept. 120, 3224 16th St., N.W., Washington 10, D. C.

Send booklet "Your Future in the New World of Electronics" and course outline.

- CHECK FIELD OF GREATEST INTEREST
- TV, FM & Advanced AM Servicing
 - Practical Radio Engineering
 - Broadcast Radio Engineering (AM, FM, TV)
 - Practical Television Engineering
 - Aeronautical Radio Engineering

Name.....

Street.....

City.....Zone.....State.....

Check— Residence School Veteran

NEW...

POWER BOOSTER

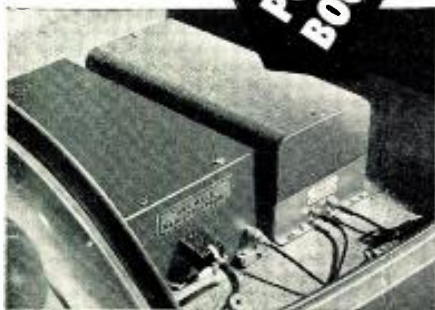

NEW POWER BOOSTER Boosts Power instantly!

Stronger signals and greater transmission range even in hilly country are now possible through use of the new Kaar Power Booster, which increases by six times the power output of any 8 to 10 watt mobile transmitter, without adding to standby battery needs—a recent, outstanding engineering achievement of the Kaar research laboratories.

**DEPENDABLE
MOBILE
COMMUNICATION**

RADIOPAK



Rugged construction... simplicity of design... lowest possible battery drain... exceptional voice quality—these are the features that make the Radiopak the most dependable single unit mobile radiotelephone available today. Furnished for both the 25 to 50 mc band and the 152 to 174 mc band, the Radiopak is ideally suited for use in police cars, taxis, fire department vehicles, trucks, and three-wheeled motorcycles.

DEALERS!

Kaar is the only major radiotelephone manufacturer selling through authorized dealers. Write for complete information.

- WRITE FOR SUMMARY CATALOG ON ALL KAAR MOBILE EQUIPMENT

KAAR

ENGINEERING CORP.
MIDDLEFIELD ROAD • PALO ALTO, CALIF.

MAKE YOUR ELECTRONIC FLASH MORE VERSATILE

By E. Q. PROCTOR

Simple circuit changes, incorporating a means of varying the light intensity, will make your flash equipment more useful.

“THE greatest light output per dollar” is the rule generally followed by the prospective purchaser or constructor of electronic flash equipment. Frankly, this rule is hard to beat if the unit is to be used for general purpose shooting; the slow speed of color films and those long shots in black and white make it mandatory. On the other hand, this high light intensity can be something of a disadvantage under certain circumstances.

A large percentage of the flash equipment that is bought or built by the average amateur has only one flash bulb which is usually mounted on the camera. Used in this manner, the photographer may find that he has *too much* light for shots under eight or ten feet. As an example, a typical 60 to 100 watt-second unit will have a light output sufficient to give an exposure guide number in the vicinity of 160 with a certain film. This means that at 10 feet, the camera lens aperture should be set at *f*16; at 7 feet, *f*22; at 5 feet, *f*32; and at 3½ feet, *f*45. Trouble arises at these distances if the camera lens aperture can not be reduced beyond *f*16 or *f*22 because there aren't any markings beyond that point.

Actually, very few miniature camera lenses have markings beyond *f*22, the markings on press-type camera lenses usually stop at *f*32, and *f*45 is generally found only on long focal length portrait and view camera lenses. As a result, the average amateur photographer, attempting to take a close-up of “little Peggy” to send to her dotting grandparents, may find that he has to resort to undesirable gadgets such as a filter over the lens, a handkerchief hung over the flash tube, or some other means to reduce the effect of that brilliant flash of light.

The obvious solution to this problem is to have a means whereby the light intensity may be varied to suit the needs of different lighting requirements. While a few manufacturers have this feature incorporated in one or two of their models, I do not recall having seen it presented in an article on constructing flash equipment. I constructed a single flash unit several years ago with variable light output included in the design, and the variability has been a very useful innovation.

The principle of the variable feature is quite simple, and so is its construction: With a given operating voltage, the light output of a flash unit is determined by the capacity of the storage condensers used; that is, the more capacity, the more light output up to the power limit imposed by the flash tube. Therefore, in units that employ more than one storage condenser, the light output can be varied by means of a switching arrangement which allows all or just part of the condensers to be switched into the circuit. The exact switching arrangement to be used will depend largely on the number of condensers employed and can best be determined by the needs of the user. Preferably, it should be included in a unit's design before construction; however, it may readily be incorporated in existing equipment that has more than one condenser and in which space for the switch is available.

In the case of a unit that has only two condensers, such as the one described in the March 1953 issue of *RADIO & TELEVISION NEWS*, all that is needed is a s.p.s.t. toggle switch connected in a lead of either of the storage condensers. With the switch on, both condensers will be in the circuit; with the switch off, one condenser will be removed from the circuit, and the power to the flash tube will be cut in half. Toggle switches can be used in this manner for any number of condensers if a suitable rotary type is not available. My unit uses four condensers, and I found, after considerable searching, that one of the older type electric range switches with four positions—high, medium, low, and off—filled the bill perfectly. In the “off” position, one condenser is connected permanently in the circuit, and each succeeding step adds one more.

My experience has shown that the guide number varies directly with the amount of capacity used. My unit has a 2000-volt power supply and uses four 8 μ fd. oil-filled condensers which give a maximum 64 watt-seconds output. Using film with an ASA rating of 50 and with all four condensers switched into the circuit, a guide number of 160 gives very good results with recommended film development. By using only three of the four condensers, the guide number is reduced to 120; with

RADIO & TELEVISION NEWS

RCA INTERMATCHED HIGH FIDELITY

... to assure you of HIGH FIDELITY EXACTLY AS YOU WANT IT



Now—from RCA—comes the ideal way to achieve *exactly what you want in high fidelity*. You can be confident of top quality—every component in your system bears *the name you know best in electronics*.

For extra assurance—RCA offers a broad selection of components—all designed for top performance in their class—all *intermatched* to work together, regardless of the combination you choose.

Listen to the full line of RCA *Intermatched* high-fidelity components, look at the distinctive cabinet styles, and make your choice. You'll have a completely matched

system that's right for your home and your taste in high fidelity. You'll have a complete system that you can assemble in minutes, with just a screwdriver. And you'll be prepared at any time to add more power or extra coverage—if you feel you need them—without mismatches at any stage.

Hear RCA *Intermatched High-Fidelity* at your local RCA Electronics Distributor's. You'll agree it's high fidelity at its finest. You'll agree it's the sensible approach to high fidelity. For information, for the address of your local distributor, mail coupon below.

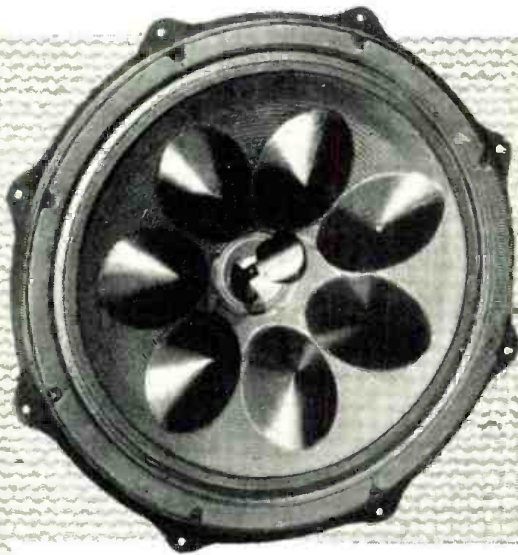

The superb LC-1A Speaker—the measure of high fidelity among professional users of sound—now more brilliant than ever with ACOUSTIC DOMES for wide-range reproduction and DEFLECTION VANES for wide-angle sound distribution. Intermatched for top performance with all other RCA components.



RCA INTERMATCHED CHANGER



RCA INTERMATCHED TUNERS



RCA INTERMATCHED AMPLIFIERS

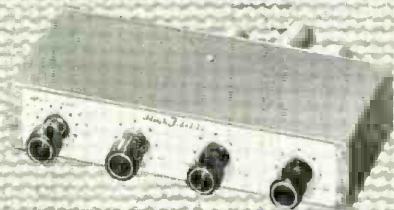

RCA INTERMATCHED PREAMPLIFIER



RADIO CORPORATION of AMERICA
ENGINEERING PRODUCTS DEPARTMENT. CAMDEN, N. J.

RCA Engineering Products
Dept. 222V, Building 15-1, Camden, N. J.

- Please send me your new, free booklet on RCA Intermatched high-fidelity equipment.
- Please send me information on the new RCA high-fidelity "Victrola"® phonographs.

Name _____
Address _____
City _____ Zone _____ State _____

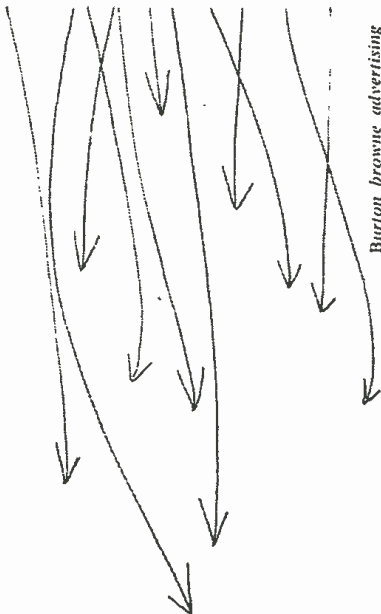

Bob Henry

to all radio hams and hobbyists—

Over!

Yes—you're at the controls when you do business with Bob Henry! As one radio fan to another, Bob knows what equipment and services you want—and he's made both his stores to-the-order of the radio ham or hobbyist. Dealing with Bob, you get 90 days FREE service—really liberal trade-ins—and a payment plan that just can't be matched! Write, wire, phone or visit either store today. Find out all the "extras" you get with Bob Henry—the world's largest distributor of short wave receivers.

Bob Henry has

a complete line of new Hallicrafter receivers and transmitters.



MODEL SX-71...Double superheterodyne circuit plus built-in Narrow Band FM reception. Temperature compensated, voltage regulated. 5 position band selector for 538-1650 Kc, 1600-4800 Kc, 4.6-13.5 Kc, 12.5-35 Mc, 46-56 Mc. 11 tubes plus voltage regulator and rectifier, \$224.50.

Also available—Hallicrafters Model HT-20, \$449.50 • Model S-76, \$179.50 • Model SX-62, \$299.50 • And all other models.

HENRY RADIO STORES

LARGEST DISTRIBUTORS OF SHORT WAVE RECEIVERS

LOS ANGELES OFFICE: 11240 Olympic Blvd., Los Angeles 64. BRadshaw 2-2917

BUTLER OFFICE: Butler 1, Missouri. Phone: 395

half the condensers in use, the guide number of 160 is halved; and with one condenser, the number is 40. This wide variation in available light has many possibilities including not having to stop the lens down when great depth of field is undesirable, not having the flash "swamp" the main light when using it as a fill-in light, etc.

Care should be used in selecting the switches to be certain that they will handle the high momentary current surges and that their insulation will not break down under the voltage employed. When my unit was under construction, I had on hand a 3-gang ceramic bandswitch; and with some misgivings, I connected it in the circuit. After a little use, my doubts were confirmed: the contacts on such a switch just couldn't take the heavy current surges and the arcing involved in switching uncharged condensers into the circuit. Spring-loaded switches that make contact quickly and positively are the best types to use. Otherwise, slow making and breaking will result in arcing between contacts and will shorten the life of the switch.

As a precaution against breakdown, switch contacts should be connected in the condenser lead that would normally be connected to the grounded side of the power supply. *The shafts and toggle handles of the switches should also be grounded to the chassis in such a way that, should a breakdown occur, the high voltage can not reach the operator.*

In any unit having switches included as described, all condensers should be connected into the circuit before the power is turned off to allow the condensers to be discharged in a normal manner through the unit's bleeder system.

International Short-Wave

(Continued from page 82)

Burma—Rangoon, 4.750A, becomes audible in Australia 1000 and closes 1020. (Williams)

Canada—Reports for the CBC should be addressed to Box 6,000, Montreal, Quebec, Canada. (WRH, others) VED, 7.32, Edmonton, Alta., noted recently 1830 with classical music, fair level but bad QRM. (Bellington, N.Y.) CHNX, 6.130, Halifax, N. S., has "Hobby Program" Thur. 1530-1545. (Grace, Conn.)

Ceylon—Radio Ceylon's Commercial Service sent letter-veri for 11.975 and listed India beam in English 2030-2330, 15.120, 9.520; 0730-1230, 11.975, 9.520; in Hindi 2030-2300, 0830-1130, 7.190. (Pearce, England) Heard on 6.006 at 0730 with music, commercials. (Sanderson, Australia)

Chile—CE1515, 15.15, Santiago, noted in Spanish 2100.

China—Radio Peking is seldom audible for English session 0830 on 15.06, 11.69A, but the Home Service is good then on 10.20, 10.26, 9.04, 7.50. 6.20. (Balbi, Calif.)

Colombia—The new Colombian on

PHILCO TV TURRET TUNER (Pt±76-3109, less contact strips). For '48 & '49 models. . . . \$1.49
 PHILCO TUNER with 3 socket wired RF strip. . . 1.98
 PHILCO 3 MIN. SOCKET RF STRIP containing over \$4.00 worth of resistors, cond., etc.59
 1/17 H.P. G.E. MOTOR (Type SD)—1725 RPM, 7 amp. Dble 3/4" shaft. 110 VDC. 4 3/4"x3 1/2". 3.95
 MAGNETIC CIRCUIT BREAKER (Heineman)—100VDC. 20 Amps. \$1.29; 5/5.00
 PORTABLE RADIO-AMPLIFIER 2.49
 —(14"x8"x8" deep). Exc. also for Test. Medical or Industrial Envt. Includes hinged front cover. panel & slide open mk in rear.
 EXPERIMENTAL TUBES—for Test, Research. Kit of 40 asstd. revg. types. Fil. Tested 1.98

"ALNICO MAGNETS"—Polished Bar, 9/16"x7/32"x3/32". Excel. for Meters. \$1.00
 Phones. \$2.00 CABINET 3/50
 Polished "U" type. 1/2"x3/8"x1/2". ea. 49c; 12/5.00
 Hvy. Duty "U" MAGNET.
 2"x1 1/2"x1 1/4". ea. 1.25; 5/5.00
 "HEELING" MAGNETS—set of 2 Alnico Round 5/4" O.D. Bars in wood case. 4 1/4" & 1 3/4" long. set \$1.98; 5/10.95
 ALNICO "CHIP" MAGNETS—sm. Irreg. shapes. Approx. 90 pcs./oz. oz. 15c; lb. \$1.50
 ALNICO MAGNET KIT—powerful Bar, Block, "U" Rod, etc. Kit of 10 assorted. 1.98
 (WRITE FOR LATEST "ALNICO" SUPPLEMENT)

10 FT. WHIP ANTENNAS—6 steel screw sects. \$ 3.49
 25W-250 Ohm POTENTIOMETER (Claro).49
 HS-33 HEADSET—3 ft. cord less Plug. 2.95
 SPONGE RUBBER PHONE CUSHIONS. \$1.50
 PL-34 JK26 CONNECTORS. set 39c; 10/3.50

!!! IT'S TERRIFIC. OVER 5000 SOLD !!!



and the NEW TUNING RADIO-ELECTRONICS PARTS KIT is now even BETTER & BETTER THAN EVER! HERE'S WHAT YOU GET: TV Parts, Photofacts and TV Diag., Condensers, Resistors, Coils, Sockets, Wire Switches, Controls AND MUCH, MUCH MORE! Shpg. wt. 20 lbs.

\$3.95

115V/230V. RECORDING MOTOR (G.I.) . . . \$0.60 cy. RM-4 type. Last reduce drive assembly. 3 1/2"x2 1/2"x2 1/4". S4 93
 STOCK UP ON TUBES !! LOW, LOW PRICES !!
 90 DAY GUARANTEED, unsealed cartons \$24.
 24, 26, 34, 41, 42, 55, 56, 59 or 6K7 each 29c
 1H4, 1H6, 1J6, 5U4, 5Y3, 5Y4, 6B7, 6C5, 6F5, 6E5, 6J3, 6K6, 6SD7, 6SQ7, 6R7, 7B, 7C or 80 each 39c
 1L4, 6A8, 6AC5, 6AU6, 6BE6, 6CB6, 6F6, 6HG, 6J6, 6SA7, 6SK7, 6W4, 7A4, 7C, 12SN7, 43 or 71, ea. 49c
 1A7, 1L7, 1LH4, 2A3, 2A6, 6A3, 6A6, 6B8, 6BQ6, 6C7, 6L7, 6SC7, 6SF5, 6SH7, 6T8, 6TJ7, 7AG7, 7A7, 7B6, 7C7, 7C7, 7Y4, 7Y5, 12AX7, 12AT7, 12AU7, 50, 58 or 81. ea. 69c
 "OCS, OD3, 6AG7, 6BG6, 6L6, 7B8 or 7Q7 ea. 98c

"DIRECT FACTORY SPEAKER REPAIRS SINCE 1927"
 Min. order \$3.00. 20% deposit req. on all C.O.D.'s.
 Please add sufficient postage—excess refunded.

LEOTONE RADIO CORP.
 67 Day Street
 New York 7, N. Y.

South River
NEWS
 ★ ★ ★

GUY WIRE CLAMP
 Model GC-3

Clamps on mast with a sure grip accommodates mast to 2" O.D. Features 3 eyebolts for guy wire attachment.

Model GC-1 6 holes for guy wire attachment. Accommodates masts to 1 1/2" O.D.

Model GC-2 similar to Model GC-1 with 2 eyebolts for guy wire attachment.

South River Antenna Mounting Accessories are carried by every leading TV Parts Jobber from coast to coast.

Write for your copy of our new 1953 catalog.

In Canada—
 A. T. R. Armstrong Co., Toronto

SOUTH RIVER METAL PRODUCTS CO., INC.
 SOUTH RIVER, N. J.

PIONEER AND OUTSTANDING PRODUCER OF FINEST LINE OF ANTENNA MOUNTS

5.070 identifies as "Radiofonica Colombia;" opens around 0600; strong in N. Z., Australia. (Cushen, N. Z.; Hutchins, Australia)

Costa Rica—Radio Crystal, TIHBC, 6.006. San Jose, sent letter-veri; listed schedule of 0745-2400. (Pearce, England)

Cuba—The Cuban which has been QRM-ing VLC9, 9.615, Australia, mornings (EST) may be COJK, moved from 8.663. (Stark, Texas)

Cyprus—Sharq-al-Adna, 6.790. Limassol, noted 1255-1335 in Arabic; has news in Arabic 1330. (Arvidsson, Sweden) Heard on 9.650 with call in Arabic 1115 followed by slow-speed news in that language. (Pearce, England)

Czechoslovakia—OLR3A, 9.55, Prague, noted in English to North America 1930-2000. (Zerosh, Pa.) And at 2300-2330, announcing "This is the Voice of Peace from Prague." (Morris, Pa). A letter from a station official says will be glad to answer requests and questions during the "Answers to Listeners" session 2300 Sat.; has musical half hour Sun, 2300-2330. (Lund, Iowa) Heard on 9.504 with English from 1400 sign-on. (Pearce, England) Uses this channel for English now 0715-0745. (ISWC, London)

Denmark—Copenhagen's OZF, 9.52, noted with DX session on Tue. around 2120. (Crowell, Pa.) And repeated 2245A. (Ferguson, N. C.) Tests for Greenland on this channel noted daily 1900-2000. (Boyce, N. J.)

Dominican Republic—HIIZ, 6.115A, Ciudad Trujillo, is showing up with strong signal around 1830; at times says "Emisora Nacional" as well as "La Voz de Muchachos." (Niblack, Ind.) HI2T, 9.727A, noted 2125 with Spanish, fine level in Michigan. (Hornstein)

Dutch New Guinea—Word from Radio Omroep Nieuw Guinea, Hollandia, indicates that the station will be moved at the end of this year to Biak, one of the Schouten Islands, where a new studio and a 5 kw. transmitter will be put into service. Present schedule on 7.126 was listed 0430-0700 daily; Thur. 0400-0700; Sat. 0430-0730; Fri. there is a special transmission 2200-2300, Sat. at 2100-2300; present power is 350 watts. (Scheiner, N. J.) Heard lately in Australia on 5.045 at 0500-0630 closedown. (Williams) Is parallel with 7.126 and usually has news in Dutch 0500. (Cushen, N. Z.)

Ecuador—By this time, transmitters of HCJB, Quito, "The Voice of the Andes," should have been moved to Pifo where it is expected signals will be much improved. *Wants reports.*

HC1BF, 4.750, Radio Commercial, Quito, noted with dance music, Spanish identification 2200 to 2300 sign-off; fair level. HC1FM, 6.830, Radio Equinoccial. Ibarra, heard with dance music 2200. weak, CWQRM. (Hardwick, N. Z.)

Egypt—Cairo has been testing one of its new, powerful transmitters (probably 100 kw.) on 9.615, heard
(Continued on page 134)

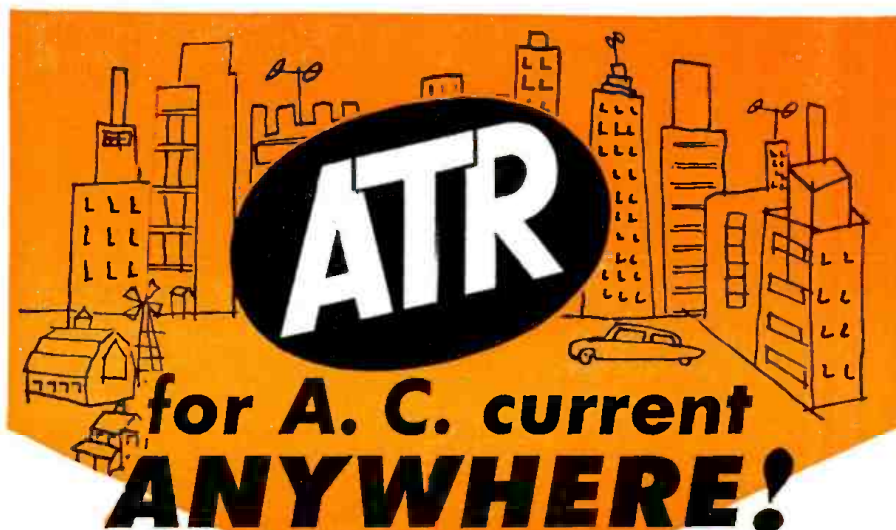

AT NEW
LOW COST

\$25⁵⁵
And Up
Retail Price

INVERTERS

For Inverting D.C. to A.C. . . . Specially Designed for operating A.C. Radios, Tape Recorders, Wire Recorders, Record Changers, Television Sets, Amplifiers, Address Systems, Radio Test Equipment and most small electrical and electronic devices from D. C. Voltages in Vehicles, Ships, Trains, Planes and in D. C. Districts.

Type	Input DC Volts	A.C. Output 60 Cycles	Output Int.	Wattage Cont.	Consumer Net Price
6-LIF	6	110 volts	40	35	\$25.55
12-LIF	12	110	50	35	25.55
* 6-RSD	6	110	85	75	39.25
*12-RSD	12	110	125	100	39.25
32-RSD	32	110	150	100	39.25
110-RSD	110	110	250	150	39.25
*12T-HSG	12	110	250	200	96.45
110AT-RHE	110	110	325	250	56.95



See your jobber
or write factory



There is an ATR model for most any application.
* Available with leather carrying handle at \$1.00 additional—optional.



"A" Battery Eliminators, DC-AC Inverters, Auto Radio Vibrators

AMERICAN TELEVISION & RADIO Co.
Quality Products Since 1931

SAINT PAUL 1, MINNESOTA—U. S. A.

OLSON'S PENNY-PROFIT POLICY MEANS GREATER BARGAINS

BRAND NEW 14-TUBE ESPEY AM-FM RADIO CHASSIS

- 13 WATTS PUSH-PULL OUTPUT
- 6-GANG TUNING CONDENSER
- PRE-AMP STAGE FOR VR PICKUP

Olson comes through again with quality-plus at an unbelievable bargain price—it's the Brand New World-Famous Espey Superheterodyne AM-FM Receiver that wholesales for \$118.50. With our low price you save \$48.55. How can we offer such an amazing bargain? We simply bought all the manufacturer had in stock—at our price.

Features New Improved FM Circuit—Drift Compensated. 14 Tubes—5 dual purpose—thus gives 10-Tube Performance. Treble and Full Range Bass Tone Controls. Automatic Volume Control. Built-in AM Loop and FM Folded Dipole Antennas and provision for external antennas. Pre-Wired for high and low impedance Pick-ups. AM and FM Circuits include Tuned RF Amplifier stages and interference-free Ratio Detector Circuits. Tuning Ranges: AM-535 to 1720 Kc, FM-88 to 108 Mc. Large easy-to-read "eye-rate" dial. Multi-tap (3.2, 8 and 500 ohm) output transformer will match any popular Hi-Fi speaker such as 12" Co-Axial below. High Fidelity assured by use of RCA and Hazline licensed circuits and highest quality parts throughout.

Features New Improved FM Circuit—Drift Compensated. 14 Tubes—5 dual purpose—thus gives 10-Tube Performance. Treble and Full Range Bass Tone Controls. Automatic Volume Control. Built-in AM Loop and FM Folded Dipole Antennas and provision for external antennas. Pre-Wired for high and low impedance Pick-ups. AM and FM Circuits include Tuned RF Amplifier stages and interference-free Ratio Detector Circuits. Tuning Ranges: AM-535 to 1720 Kc, FM-88 to 108 Mc. Large easy-to-read "eye-rate" dial. Multi-tap (3.2, 8 and 500 ohm) output transformer will match any popular Hi-Fi speaker such as 12" Co-Axial below. High Fidelity assured by use of RCA and Hazline licensed circuits and highest quality parts throughout.

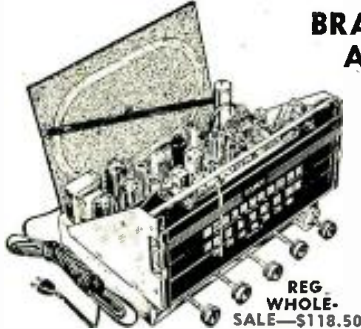

REG. WHOLE-
SALE—\$118.50
Custom Buy
of 1953
OLSON SPECIAL \$69.95
Stock No. RA-150

Tubes: 1 AM-RF Amplifier tube. 1 FM-RF Amplifier tube. 1 AM Oscillator tube. 1 FM Oscillator tube. 1 FM Detector Driver tube. 1 Mixer tube. 1 AM Detector, Audio Amplifier tube. 1 Audio Amplifier-Inverter tube. 2 Push-Pull Power Amplifier tubes. 1 Rectifier tube. 1 Pre-amp Pickup tube. 105/125 V., 50-60 cycles—Chassis size: 13 1/2" wide x 8 1/2" high x 10" deep. Factory-Sealed Cartons. Shpg. wt. 20 lbs.



12" CO-AXIAL
SPEAKER
\$12.95
Stock No. S-168

Our new 1953 Model. Guaranteed to outperform any speaker in its price class. Equipped with two "high concentration" Alnico 5 magnets and a high frequency diffuser. The 12" section delivers the bass while the inner 3" tweeter speaker section delivers the treble tones. Together they give you "living tone." This speaker is unconditionally guaranteed to satisfy even the most critical user or Olson promises to refund your money. Only two wires to connect to any radio or amplifier. Voice coil impedance 8 ohms. Frequency response 30 to 17,500 cps. Shpg. wt. 10 lbs.

10 WATT HI-FI PUSH-PULL AMPLIFIER \$32.95
• Built-In Pre-Amplifier • G-E Cartridge Input
• Treble and Bass Boost • All-Aluminum Chassis
• Push-Pull Output • Multiple Speaker Impedance TUBES
• Bombshell Value! It's unbelievable. A full 10 watt Hi-Fi Amplifier, completely assembled and ready to play. Has built-in PRE-AMP for G. E. and similar types of magnetic pickups. 4 inputs: 1 crystal phono, 1 magnetic phono, 1 radio, 1 FM Detector tube. 1 FM Oscillator tube. 1 Bass, 1 Treble, 1 Volume, 1 Phono-radio Switch. Output Impedance: 4, 8, 16 ohms. Peak Power output 17 watts. Order this amplifier today and see what brilliant realistic tone it will deliver. Supply is limited. Everyone in factory sealed carton. You couldn't buy the parts alone for this price. Remember this is a full size amplifier, transformer operated, not an AC-DC job. Frequency response 30 to 20,000 cps at less than 1% distortion. 5 Tubes: 1-6X4, 1-6SC7, 2-6V6, 1-12A6. Complete with tubes. Size 12" x 6 1/2" x 5 1/2". Shpg. wt. 15 lbs. Can be used with any phono or speaker but you should take advantage of the Combination Deal offered below.



Stock No. RA-102



COMBINATION
DEAL!
Both for only \$39.95 WITH TUBES
Completely wired. Not a kit.

10 WATT HI-FI PUSH-PULL AMPLIFIER COMPLETE WITH 12" CO-AXIAL SPEAKER
Stock No. AS-67
This is the best matched Amplifier-Speaker Deal in America Today. You get the 10 Watt Hi-Fi Amplifier as described above PLUS the 12" Co-Axial Speaker—also as described above. Can be built into any cabinet or bookcase. Giving you a complete amplifier system you will be proud to own and show to your friends. Look at our Amazing Low Price—and Order Today. Shpg. wt. 25 lbs.



FAMOUS V-M Tri-O-Matic RECORD CHANGER WITH SHURE TURN-OVER CRYSTAL CARTRIDGE
\$26.95
BRAND NEW—FULLY AUTOMATIC
3-SPEED—33 1/3, 45, 78 R.P.M.
PLAYS ALL 7, 10, 12" RECORDS

Olson offers for the first time one of the most popular changers on the market today—at a brand new super low price. Here's your chance to get that V-M changer you've been wanting at the price you've been waiting for. Makes ideal changer for above amplifier, speaker and radio. 100% Automatic. Motor shuts off after last record is played. Handles twelve 10" or ten 12" (33 1/3, 45, 78 or 78 or 78 1/2) (33 1/3 or 45). Same speed guaranteed. Ref. Price \$46.50. Mfg. Ctrs.—14 1/2" W, 12 1/2" D, 5 3/4" H above and 11 1/2" below plate. Full instructions. 105/125 V., 60 cycle AC. Factory Sealed Cartons. Shpg. wt. 12 lbs.

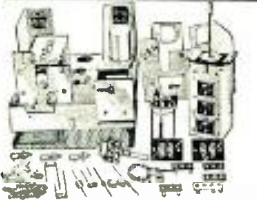

AMAZING DUMONT KIT OF PARTS
STOCK NO. AS-90
MALLORY INDUCTUNER Plus Over 24 VALUABLE BRAND NEW PARTS
\$3.99
Olson gives you the most colossal bargain ever offered servicemen and experimenters. It's the Big Basic Kit of Parts for the FAMOUS DUMONT RA-146 TV Booster. Because we couldn't get the diagrams and some of the parts—we are able to make this terrific offer. Included are the basic parts for building an FM or TV Booster, a pre-selector to remove unwanted signals or interference, a 2-meter Ham receiver, a signal generator, and a 2-meter transmitter. Includes punch-down, bottom plate, 3-gang Mallory Inductuner electrolytic filter condenser, combination AC and DPDT switch, 3 silver plated VIF coils, 3 low loss feed through air-trimmers, resistor, 1 silver mica and ceramic capacitors, 2 chokes, panel lamp socket, mounting panels, terminal binding, 1/8" strips and assembling hardware. All Brand New—Fully Guaranteed. All Standard parts for general servicing. Chassis size: 7" x 7 1/4" x 1 1/2". Shpg. wt. 6 lbs.



DUMONT TV BOOSTER CABINET
STOCK NO. K-62 \$1.99
Reg. \$15.00 Mallory Spiral Inductuner
STOCK NO. X-337 \$2.99

Handsome mahogany finish cabinet for the outfit described above. Bottom drilled to fit chassis. Front openings match switch and tuner shafts. Makes Deluxe cabinet for boosters, amplifiers, tuners or receivers. Size 10" x 9" x 6". Shpg. wt. 5 lbs.

The heart of the above Dumont TV Booster. A 3-gang variable inductance tuning device. Provide efficient front-end tuning in deluxe TV and FM receivers and boosters. Makes a perfect unit for building 2 meter receivers. Covers entire range 52 through 216 Mc. Shaft 2 1/8" long, 1/4" dia. 6 turns covers band. Size: 4-11/16" x 2" x 2 1/8". Shpg. wt. 3 lbs.

SAVE MONEY ON FAMOUS SPEED WAY POWER TOOLS



REG. \$19.50
\$14.95
STOCK NO. TL-24

1/2" ELECTRIC SPEED DRILL

Equipped with keyed Jacobs chuck; Power: 125 watts output at chuck; Capacity: 1/4" in steel, 1/2" in wood; Full load speed: 1500 R.P.M. Lightweight—yet packs terrific power and speed. Die-cast aluminum case and chassis with cast-in air cooling system. Self-aligning, oilless bearings with felt seals. Ball thrust bearing. Trigger switch and lock—releases instantly. Built-in spindle lock for easy chuck release. Specially wound high torque Speed-Way universal motor (115 V. AC-DC). The perfect drill for the repairman, hobbyist, mechanic, etc., at an Olson Bargain Price. Shpg. wt. 6 lbs.

1/2" SPEED WAY ELECTRIC SPEED DRILL

STOCK NO. TL-25
Keyed Jacobs chuck; 1/2 H.P. Universal Motor; 600 R.P.M. Free Running Speed: 110-120 V. AC-DC U.L. Approved. Today's greatest low drill value. Lightweight yet built for speed and power. Has all the features of the 1/2" drill and then some. Alloy steel cut gears. Heavy thrust bearing enclosed and sealed for life. Removable side handle formed to hand. In-line breast plate grip. Shpg. wt. 16 lbs.

SPEED WAY PORTABLE HAND SAW

Convert Your Electric Drill Into a Portable Power Saw, Only..... \$4.50
REG. \$5.95
STOCK NO. TL-30

Olson now helps you take the work out of hand sawing for little cost. Makes 2 tools out of your 1/2" electric drill. Hand Saw is light-weight—only 1 1/2 lbs. complete. Easy and safe to use on any trimming, rip or crosscut electric drill chuck or flexible shaft. Offset bronze bearing. Direct drive—no gears to get out of order. 1/4" dia. shank for fitting into beautiful crackle finish. Shpg. wt. 2 lbs.

REGULAR \$12.95 DRILL STAND

Easily Convert 1/4" Speed Drill Into Useful Drill Press
STOCK NO. TL-31 \$9.95 ONLY
Olson offers this drill stand at a give-away price. Your hand drill will be truly universal with this sturdily constructed, smooth coil spring-action drill stand. Now's your chance to have a professional type workshop at a tremendous saving. Simple to install and operate—you can't afford to pass up Olson's Bargain Price. Shpg. wt. 11 lbs.

SPEED WAY SPEED SAW

REG. \$29.95
\$24.95
STOCK NO. TL-28
1/4 H.P. AC-DC 3500 R.P.M. motor; adjusts at any angle from 0° to 45°; 5" blade cuts from 0" to 1 1/2" combination cross-cut and rip saw blade. Those difficult and tedious cutting jobs are all in the past with this new Speed Saw—Fully Guaranteed by Olson and Speed Way. Saws both straight and square. Ample cuts, can cut-off, rip, trim, groove or "blank-out" openings in walls or floors. Lightweight—cast aluminum housing and blade guards. Adjustable rip fence. Safety Thumb Switch on handle automatically stops blade the instant grip is released. Don't be misled by Olson's Low Price—this is an outstanding quality-built tool with all the versatility and features of much higher priced models. Order from Olson and Save. Shpg. wt. 13 lbs.

SPEED WAY GRINDER KIT

REG. \$14.50
\$11.95
STOCK NO. TL-26
Handiest tool kit ever made for the shop or home. Hundreds of uses, and it's priced right by Olson. Kit contains famous Speed Way Electric Hand Grinder with finger lip control. Super power air-cooled 20,000 R.P.M. motor, 3 1/2" orbital motion 110-120 V. 60 cycle AC. 4 mounted grinding stones, 4 steel cutting burrs, 3 mounted bristle brushes, 1 wire scratch brush, 1 abrasive rubber polishing tool, 2 mandrels, and 12 sanding discs. 1 instruction manual, all in dark blue leatherette covered wooden case. Shpg. wt. 4 lbs.

Speed Way Speed Sander

SANDS • SMOOTHS • POLISHES
STOCK NO. TL-27 \$27.95
REG. \$34.50
Professional model. Sands old finishes from wood or metal, or smooths and polishes to a "piano finish." Takes any grade of sandpaper or abrasive, 3 1/2" orbital motion 110-120 V. 60 cycle air cooled 4550 r.p.m. motor—direct driven. Cast aluminum body—all sealed ball bearing construction. Lightweight—only 5 lbs. complete.

SPEED WAY BENCH GRINDER

REG. \$16.50
\$12.95
STOCK NO. TL-29
110-120 Volt 60 Cycle AC (ONLY) 3400 R.P.M.; 4 1/4" x 3 1/2" x 3/4" fine and coarse wheels; self-aligning bronze bearings; U.L. Approved. Aero-balanced—smooth and silent running—no creepings. Lightweight—7 1/2 lbs. Rubber feet prevent scratches or may be bolted to bench. Strong 1-piece cast aluminum body—all sealed ball bearing construction. Handsome crackle finish—a must for every home or shop and a fabulous buy at Olson's low price. Shpg. wt. 8 lbs.

USE HANDY ORDER BLANK ON NEXT PAGE →

OLSON RADIO WAREHOUSE 275-F EAST MARKET ST., AKRON 8, OHIO

Here's the new SHURE SLIM-X

All-Purpose Crystal MICROPHONE



MODEL 777
List Price \$21.00

MODEL 777s
(with switch)
List Price \$23.00

(Price includes cradle for mounting on stand)

Its Versatility and "Hand-a-Bility" make it an ideal low-cost all-purpose microphone



LIGHT! The new "777" Slim-X Microphones are rugged little microphones weighing only 6 ounces! They are designed for good-quality voice and music reproduction. Their versatility and "hand-a-bility" make them ideal for use by lecturers, announcers, instructors, and Hams; for audience participation shows; carnivals; panel and quiz shows; and use with home-recorders. When mounted on either cradle or swivel, the "777" can be removed in a flash (no tools necessary)—simply by lifting it out of the holder. This makes it an ideal "walk-around" hand-held microphone.

TECHNICAL INFORMATION: Smooth frequency response—60 to 10,000 c.p.s.; special-scaled crystal element—for long operating life; high impedance; 7' single-conductor cable, disconnect type. Dimensions: (Microphone only) Length, 4½"; Diameter 1". *Finish:* Rich satin chrome overall.

NOTE: Lavalier cord for suspension of Microphone around neck is included.

ACCESSORIES FOR "777"

MODEL S38 STAND is a heavy die-cast base. Includes metal screw machine stud for connecting microphone adaptor to stand base.

List Price: \$3.30

MODEL A25 SWIVEL ADAPTOR features a long-life, high-quality swivel connector. Is lined with a long-life nylon sleeve—for noise-free and scratch-free insertion and removal of microphone.

List Price: \$5.50



SHURE BROTHERS, Inc.
MICROPHONES and ACOUSTIC DEVICES

225 W. Huron St., Chicago 10, Ill., Cable: SHUREMICRO

NEW TV STATIONS ON THE AIR

(As of September 25, 1953)

The following new stations bring the lists published in previous issues up to date.

STATE, CITY	STATION	CHANNEL	FREQUENCY RANGE (IN MC.)	VIDEO WAVELENGTH (IN FT.)	VIDEO POWER* (IN KW.)
Florida					
Panama City	WJDM-TV	7	174-180	5.61	10.5
Pensacola	WPFA-TV	15	476-482	2.06	21
West Palm Beach	WIRK-TV	21	512-518	1.92	24
Kentucky					
Louisville	WKLO-TV	21	512-518	1.92	230
Maine					
Portland	WPMT	53	704-710	1.4	22
Massachusetts					
Cambridge	WTAO-TV	56	722-728	1.36	21.5
Michigan					
Battle Creek	WBCK-TV	58	734-740	1.34	20.5
Lansing	WILS-TV	54	710-716	1.38	25.5
Missouri					
Kansas City	KMBC-TV ¹	9	186-192	5.25	30
Kansas City	WHB-TV ¹	9	186-192	5.25	30
Montana					
Butte	KOPR-TV	4	66-72	14.6	18
Butte	KXLF-TV	6	82-88	11.8	2
New York					
Buffalo	WBES-TV	59	740-746	1.33	21.4
Ohio					
Dayton	WIFE	22	518-524	1.9	254
Oklahoma					
Oklahoma City	KLPR-TV	19	500-506	1.96	260
Pennsylvania					
Wilkes-Barre	WILK-TV	34	590-596	1.67	250
South Carolina					
Columbia	WNOK-TV	67	788-794	1.25	93.5
Texas					
Houston	KNUZ-TV	39	620-626	1.58	89
Longview	KTVE	32	578-584	1.7	20
Waco	KANG-TV	34	590-596	1.67	5
Virginia					
Harrisonburg	WSVA-TV	3	60-66	16.06	100
West Virginia					
Charleston	WKNA-TV	49	680-686	1.44	221
Wisconsin					
Milwaukee	WOKY-TV	19	500-506	1.96	240

*From Station CP application. ¹Share time on air. The frequency of the video carrier = 1.25 + channel lower freq. limit. Total number of television stations now on the air: 261 (84 of which are u.h.f.)

A TRANSISTOR BRIDGE NULL DETECTOR

By LOUIS D. CARCANO

IMPEDANCE bridges and capacitance bridges which employ headphones for null detectors, offer good opportunity for transistorization. A visual null indicator is more convenient than a pair of "cans." Null detector circuits using vacuum tubes, however, are inconvenient because of long warm-up time, and require a separate power supply.

The transistor circuit shown requires no waiting after it is turned on and takes all its power from the 6-volt battery usually included in the impedance bridge.

The circuit consists of two grounded-emitter stages using junction transistors, and a rectifier and a microammeter. Sensitivity is not quite as great as with headphones, but was found to be adequate.

The input impedance is about 20,000 ohms. Ordinary midget output transformers make satisfactory interstage coupling units. Transformer T_2 is tuned to 1000 cycles with a condenser C_2 . The value of C_2 will vary with the particular model of transformer, but should be around .002 to .005 μ f.

The second stage should overload just before the meter goes off scale. Overload level depends on the emitter bias current, which is determined by resistor R_2 for any particular battery voltage. R_2 may require adjustment for the particular transistor used. A more sensitive microammeter can be used if R_2 is increased accordingly.

—30—

Circuit of a bridge null detector which uses two CK722 "p-n-p" junction transistors.

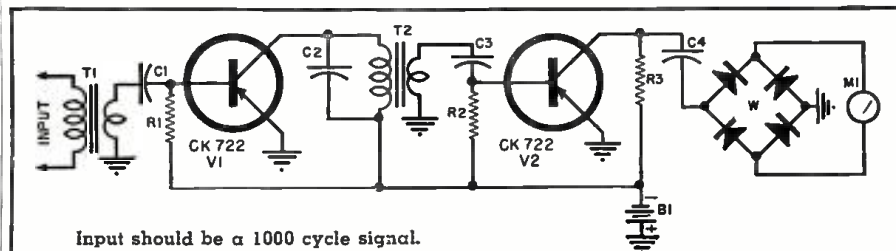

Input should be a 1000 cycle signal.

R_1, R_2 —47,000 ohm, ½ w. res. (see text)

R_3 —4700 ohm, ½ w. res.

C_1, C_3 —.5 μ f., 200 v. cond.

C_2 —See text

C_4 —25 μ f., 200 v. cond.

T_1, T_2 —Output trans., 1500 ohms to 3 ohms

W —Bridge instrument rectifier or four germanium diodes connected in bridge circuit

M_1 —0-500 microampere meter

B_1 —6 volt battery

V_1, V_2 —CK722 "p-n-p" junction transistor (Raytheon)

Sweeping the Country!

**BUY DIRECT
AND SAVE**

'PRE-FAB' COLLINS TUNERS and RECEIVERS

AUDIO PRODUCTS CO.

Collins Audio Products Co. is in no way affiliated with Collins Radio Co.

Two ALL NEW Complete Kits for
Every High-Fidelity Need

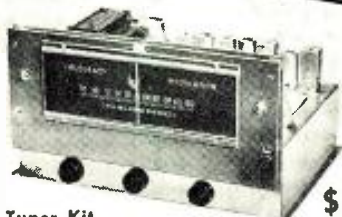

FM Tuner Kit

\$55

The FM-11 tuner is available in kit form with the IF Amplifier mounted in the chassis, wired and tested by us. You mount the completed RF Tuning Unit and power supply, then after some simple wiring, it's all set to operate. 11 tubes: 6J6 RF amp, 6AG5 converter, 6C4 oscillator, 6BA6 1st IF, (2) 6AU6 2nd and 3rd IF, (2) 6AU6 limiters, 6AL5 discriminator, 6AL7-GT double tuning eye, 5Y3-GT rectifier. Sensitivity 6 to 10 microvolts, less than 1/2 of 1% distortion, 20 to 20,000 cycle response with 20dB variation. Chassis dimensions: 12 1/2" wide, 8" deep, 7" high; illustrated manual supplied. Shipping weight 14 lbs.

Each Collins Tuner Kit is complete with punched chassis, tubes, power transformer, power supply components, hardware, dial assembly, tuning eye, knobs, wire, etc., as well as the completed sub-assemblies: FM tuning units, AM tuning units, IF amplifiers, etc., where applicable. Since all these sub-assemblies are wired, tested and aligned at the factory, Collins Pre-Fab Kits are easily assembled even without technical knowledge. The end result is a fine, high quality, high fidelity instrument at often less than half the cost — because you helped make it and bought it direct from the factory. Bring your present reproducing system up to date with a new Collins Tuner.



FM/AM Tuner Kit

\$77⁵⁰

The original 15 tube deluxe FM/AM pre-fab kit redesigned on a smaller chassis. The tuner now measures 14" wide by 12" deep by 7 1/2" high. This attractive new front and dial assembly opens up new applications where space is at a premium. Kit includes everything necessary to put it into operation—punched chassis, tubes, wired and aligned components, power supply, hardware, etc. Kit comprises: FMF-3 tuning unit, IF-6 amplifier, AM-4 AM tuning unit, magic eye assembly and complete instructions. All tubes included. Shipping weight 19 lbs.

Selected Basic Components For Special Applications

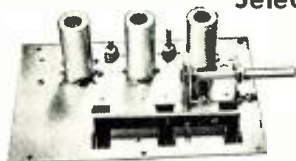

FMF-3 Tuning Unit

\$15²⁵

The best for FM. The most sensitive and most selective type of "front end" on the market. 6 to 10 microvolts sensitivity. Image ratio 500 to 1. 6J6 tuned RF stage, 6AG5 converter, 6C4 oscillator. Permeability tuned, stable and drift-free. Chassis plate measures 6 1/2" x 4 1/2". In combination with the IF-6 amplifier, the highest order of sensitivity on FM can be obtained. Tubes included as well as schematic and instructions. Draws 30 ma. Shipping weight FMF-3: 2 1/2 lbs. Dial available @ \$3.85



IF-6 Amplifier

\$19⁷⁵

A remarkable value! 6 tubes are used in the IF amplifier: 6BA6 1st IF, (2) 6AU6 2nd and 3rd IF's, (2) 6AU6 limiters and 6AL5 discriminator. High gain, wide-band response (200 KC) for highest fidelity. 20 to 20,000 cycles. Distortion less than 1/2 of 1%. Draws 40 ma @ 220 volts. Chassis plate dimensions: 11-5/16" x 2 1/2" Shipping weight: 3 lbs.

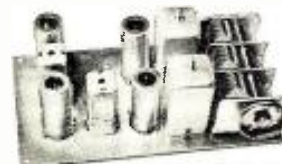

AM-4 Tuning Unit

\$24⁵⁰

Taps in AM superhet performance! A 3-gang tuning condenser gives 3 tuned stages with high sensitivity and selectivity. Assembly is completely wired, tested and aligned ready for immediate use. Frequency coverage 540 KC to 1650 KC at a sensitivity of 5 microvolts. Tubes 6BA6 RF amplifier; 6BE6 converter; 6BA6 IF amplifier and 6AT6 detector. Draws 30 ma @ 220 volts. Mounts on a chassis plate measuring 4" x 7 3/8". Shipping weight 2 1/2 lbs. Dial available at \$3.85.



RD-1C Tuner & Dial

\$28⁵⁰

The COLLINS RD-1C FM tuner chassis is unique in the field. A whole, compact FM tuner and dial that fits in the palm of your hand. Convert AM sets to FM/AM receivers for only a few dollars! Unlimited applications where space is at a premium. Use in conjunction with your phonograph amplifier. Full frequency response to 20,000 cycles. Sensitivity 20 microvolts, permeability tuned. Tuning unit and IF amplifier on the same chassis plate. Draws 40 ma @ 100 volts. Tubes: 6AG5 converter, 6C4 oscillator, (2) 6AU6 IF amplifiers, 6AL5 in new ratio detector circuit. Shipping weight tuner and dial 5 lbs

**MAIL
COUPON
TODAY**

To: Collins Audio Products Co. Inc.
P.O. Box 368, Westfield, N. J.
Tel. WEStfield 2-4390

- FM Tuner Kit FM/AM Tuner Kit Slide Rule Dial Assembly
 FMF-3 Tuning Unit IF-6 Amplifier RD-1C Tuner and Dial
 AM-4 Tuning Unit

NAME.....

ADDRESS.....

CITY..... STATE.....

Amount for Kit \$..... See weights, add shipping cost \$.....

Total amount enclosed \$..... Check Money Order

WHEN YOU THINK OF TUNERS, THINK OF COLLINS AUDIO PRODUCTS

Service Technicians!



NOW you can own
the invaluable
PHOTOFACT Library
this **EASY** way!

- ✓ Own the **COMPLETE** Library
- ✓ Fill in your present Library

Yes, now you can get through your PHOTOFACT Distributor, the complete PHOTOFACT Library (200 Sets of Folders) for only \$25.00 down and 18 full months to pay! Or you can fill in your present library and bring it up-to-date on the same amazing terms. Absolutely no interest and no carrying charge! You get immediate *prepaid* delivery of the world's finest service data. You use it *now*. It earns for you while it *pays for itself!* See your PHOTOFACT Distributor today!

YES ONLY \$25.00 DOWN!
UP TO 18 MONTHS TO PAY
No Interest • No Carrying Charge

PLUS the ultimate in
filing convenience. Your choice of:



BINDERS: Handsome, sturdy permanent binders that make up into handy volumes of 10 sets of Folders each. Order 20 for the 200 set Library or as many as you need to fill in. Shipped prepaid.



FILING CABINET: Sturdy 4-drawer file cabinet to hold your PHOTOFACT Library in ship-shape, easy-reference order. Shipped FOB factory.

Yes, you get either Binders or File Cabinet with your PHOTOFACT Library under the same Easy Terms — the entire deal for just \$25.00 down, up to 18 months to pay!

ORDER TODAY!

PAY AS YOU PROFIT with
The World's Finest Service Data

See your PHOTOFACT Distributor for Full details. If you don't know his name, write us for it. Address: HOWARD W. SAMS & CO., INC. 2203 E. 46th St., Indianapolis 5, Ind.

International Short-Wave (Continued from page 129)

1215-1630 to Europe with calls in English, French every quarter-hour, followed by a tone of 1000 cycles; reports requested. (Radio Sweden, WRH, others) The 11.815 outlet which carries mostly English, French seems to close daily now 1700, but the Arabic session on 11.965A, 6.085, in parallel, runs later. (Pearce, England, others)

El Salvador—YSS, 9.55A, Radio Nacional, San Salvador, noted with uninterrupted classical music 2235 to identification at 2300 closedown. (Pow-ers, Ohio)

England—To observe its 25th anniversary, the BBC is now conducting a contest among listeners, to determine what programs have been enjoyed most. (Bellington, N. Y.)

The Standard Frequency Station, MSF, Rugby, appears to be using 2.500, 5.000, 10.000 continuously 24 hours a day now. Callsign in slow Morse code and speech announcements are given at the 14th minute of each quarter-hour; reports are requested to the National Physical Laboratory, Teddington, Middlesex, England. (Patrick, Catch, Pearce, England; others)

Fiji Islands—ZJV, Suva, is noted daily around 0300 on announced 3.980; closes 0500; signal usually poor in Australia. (Williams) Lately noted back on 5.980A parallel 3.980. (Hardwick, N. Z.) Heard on this channel by Saylor, Va., 0100-0400 fade-out, with news 0215. Cain, Nevada, received ZVJ (m.w.) card verifying tests over 6.005 some time ago; had picture of native on card; asked for more reports.

France—Paris has English for Britain 0145-0200 on 7.240; 1500-1600 on 6.045A. (Catch, England) Mail Bag session on Wed.

French Morocco—Radio Maroc, 7.220, Rabat, noted at weak level opening 0700; good level when returned 0800, French news. (Pearce, England) This transmission closes 0900A; is listed with news in Spanish 0700.

Germany—Cologne, 11.795, noted with call and announcements in Spanish, German 1655 in transmission to Latin America; at 1703 news in German; good level. (*Mosquita e Sousa*, Portugal) Noted on this channel 2330 closing transmission to North America with English announcement; slight CWQRM, fair level. (Christie, Calif.) Although not announced, 5.98 parallels in this transmission 2030-2330A. (Bellington, N. Y.)

Greece—Central Forces Station, Athens, has returned to 7.420A and is heard 2325-0105; news in Greek 0027; CWQRM from 0005. (Arvidsson, Sweden) Is heard in Virginia sometimes around 2350-0200 fade-out. (Saylor) Larissa, 6.752, noted at good level around 1416 with music. (Lorentzson, Sweden)

Guadeloupe—FG8HA, 9.423AV, Basse-Terre, varies considerably; noted as

ATLAS PROJECTORS



9 models to
choose from for
EVERY application

The performance-proved ATLAS Double Re-entrant ('DR') design combines compactness with unequalled high efficiency and uniform response in a rugged, stormproof, demountable construction. The larger size horns are excellent for greatest efficiency and low-frequency response. Where space and cost limits exist, the smaller horns are recommended. For complete details on 'DR' Projectors and the famous ATLAS line of Public Address and Microphone Stand equipment...

WRITE NOW for FREE Catalog 553



ATLAS SOUND CORP.

1442 39th St., Brooklyn 18, N. Y.
In Canada: Atlas Radio Corp., Ltd., Toronto, Ont.

TUBES! ONE FULL YEAR TUBES! GUARANTEE

Type	Price	Type	Price	Type	Price
0B3 VR90...	.75	6BD6	.45	12AL5	.37
1A5GT	.46	6BE6	.39	12AT6	.37
1A9GT	.49	6BF5	.41	12AT7	.56
1A8S	.59	6BG6G	1.19	12AU7	.38
1B3	.65	6BH6	.48	12AV6	.39
1B5	.59	6BJ6	.39	12AX7	.48
1B7GT	.59	6BK7	.59	12AX4	.48
1C5GT	.43	6BL7	.59	12AX7	.48
1G5	.60	6BQ6GT	.69	12AZ7	.59
1L4	.48	6BY5	.65	12BA6	.38
1H5GT	.40	6BQ7	.90	12BD6	.45
1G6	.46	6BZ7	.90	12BE6	.39
1L4	.46	6CA	.37	12BF6	.39
1LC5	.51	6C5GT	.39	12BH7	.63
1M5	.48	6C6	.44	12B5GT	.42
1P5	.57	6CD6G	1.29	12C7G	.39
1Q5	.58	6D6	.45	12D6	.70
1R5	.45	6E5	.48	12E7GT	.44
1S5	.39	6F3GT	.39	12F7GT	.52
1T4	.45	6F6	.37	12J3T	.44
1U4	.45	6G6	.37	12KYGT	.48
1U4	.45	6GGGT	.41	12L7GT	.47
1U5	.39	6J5GT	.37	12SN7GT	.52
1X2	.60	6J6	.52	12SQ7	.42
2A3	.70	6K6GT	.37	12SR7	.49
2X2	1.50	6J7G	.43	14AF7	.50
3A4	.45	6J8	.45	14E6	.70
3E5	.46	6K5	.47	14N7	.60
3Q4	.48	6K7	.44	19B6G	.95
3Q5GT	.49	6L6	.63	19C6	.70
3S5	.46	6Q7	.45	19T8	.79
3V4	.47	6S4	.38	19V8	.89
5U4G	.73	6SA7GT	.43	25B6G	.62
5V5	.40	6SD7GT	.42	25L6	.39
5X4	.50	6SF5GT	.48	25Z5	.40
5Y3G	.32	6SH7	.73	25Z6GT	.37
5Y3GT	.32	6SHT	.41	25W4	.56
5Y4G	.35	6S7GT	.41	26	.45
5Z5	.46	6SK7GT	.41	27	.39
6A3	.59	6SL7GT	.48	35B5	.40
6A7	.59	6SN7GT	.49	35C5	.39
6A8	.59	6SQ7GT	.37	35L6GT	.41
6AR4	.44	6SR7GT	.60	35W4	.37
6AG5	.55	6S5	.44	50L6GT	.40
6AK5	.70	6T8	.86	35Z5GT	.37
6AL5	.72	6U4	.60	36	.60
6AS5	.65	6U5	.44	42	.42
6AS5	.39	6U6	.63	43	.55
6A05	.37	6U8	.61	45	.55
6AR5	.37	6V5	.39	50C5	.39
6AT5	.37	6V6GT	.39	50B5	.39
6AV5	.53	6W4GT	.44	50C6	.59
6AV5	.53	6W6GT	.44	50L6GT	.40
6AX4	.53	6X7	.37	50Y8	.46
6B4C	.54	6XS5GT	.37	50Y7	.80
6B5	.54	6Y6G	.47	70L7GT	1.09
6B7	.54	7A6	.47	75	.41
6BAC	.39	7AF7	.53	76	.44
6BA7	.57	7C6	.40	80	.35
6BA5	.57	7C5	.40	80	.35
6BC3	.44	7E6	.49	117Z3	.37
6BC7	.71	7X7	.59	117L7	.39
6BD5GT	.59	7X7	.59	127L7	1.20

25% deposit on all orders, balance C.O.D. Orders under \$10.00 add \$1.00 handling charge. Shipments F.O.B. Irvington, N.J., and tubes subject to prior sale.

HI-LITE ELECTRONIC SALES CO.
837 18th Avenue Irvington, N. J.

low as 9.415, later back on 9.423AV; checked around 1939; heavy QRM. (Niblack, Ind.)

Guatemala—TGOQ, 9.705A, is heard well 2315 without interference from Sofia, 9.700, Bulgaria. TG2, 6.618A, Quezaltenango, is good level as early as 1900 when identifies in Spanish as "Radio Morse." TGNA, 9.668, 11.85, heard *testing* in *English* with announcements only 1130, 1215 recently, excellent level. (Niblack, Ind.) Noted closing down on 9.668 in *English* 2345. (Powers, Ohio) TGWB, 6.182, good level when closing 2400. (Cain, Nevada)

Haiti—A strong signal is reported from "Radio Commerce," *testing* at various times on 9.485A in French, Spanish, *English* and perhaps other languages; has been heard around 1100-1230 sign-off; around 1700-2300 sign-off. By now is probably on regular schedule of 0600A-2300. QRA is Box 94, Port-au-Prince, Haiti; *wants reports*. (West, Va., Grenell, Ohio; Bellington, N. Y., others) Noted 1445 in French. (Niblack, Ind.) With French news 2100. (Balbi, Calif.)

At least on Thur., 4VRW, *Radio Haiti*, 10.065A, Port-au-Prince, has an *English* program ("Your Music Caravan") at 2130-2220; this one identifies in *English* as well as French quite often now. (West, Va., others)

4VEH, Cap Haitien, has received permission to go on the air in the 60-m. band with 1 kw., and in the 49-m. band with 5 kw., *daytime hours only*; is building directional antennas. Latest schedule is daily *except Thur.* 0600-0900, Sun. 1630-1900 on 9.690; Sun. also 1900-2140, 9.728. Plans a Mailbag Program soon for *English*-speaking listeners. (West, Va.)

Holland—*Radio Nederland*, 6.025, noted 1545 with announcement in Spanish. (*Mesquita e Sousa*, Portugal) Heard on this channel in *English* to North America around 2200. (Crowell, Pa.) Is good level in *English* 1645-1725 on 11.73. (Mullen, Mass.) Noted on 9.59 *after* 1800 in Dutch. (Zerosh, Pa.)

Honduras—Stark, Texas, notes *Radio Monserrat* down to 6.019 from 6.660 with continued distortion; opens around 0730 and signs off 2300A.

Hong-Kong—ZBW3, 9.525, noted 0500, good level with music. (Sanderson, Australia) Lists *current* schedule in Chinese-*English* as 2230-0000 Sun.-Fri., 0400-0930 daily, 1900-2300 Sat., 1800-2400 public holidays. (Scheiner, N. J.)

Hungary—*Radio Budapest*, 9.833, noted with *English* 1945-2000, then Hungarian. (Grace, Conn.) Has *English* for North America 1715-1745, 1930-2000, 2300-2330, 11.91, 9.833, 7.22; Radio Mailbag is Sun. (Smits, Minn.)

India—AIR, 15.380, noted signing on *English* for Southeast Asia 0830; said parallel on 11.78; had news 0835; off 0945. (Pearce, England)

Indo-China (Vietnam)—According to word direct from Saigon, there will be *new* s.w. transmitters and increases of power soon. (Scheiner, N. J.) In



PAMPER YOUR TV AND RADIO SETS WITH DEPENDABLE OHMITE® REPLACEMENTS

Little Devil® COMPOSITION RESISTORS



Tiny, yes . . . but what dependability, ruggedness, and stability! And they provide an *extra* margin of safety—being rated at 70C rather than 40C. Completely sealed and insulated by molded plastic, they meet all JAN-R-11 requirements . . . are available in ½, 1, and 2-watt sizes in all RTMA values.

TYPE AB NOISE-FREE POTENTIOMETERS



Because the resistance material in these units is solid-molded—not sprayed or painted on—continued use has practically no effect on the resistance. Often, the noise-level *decreases* with use . . . and they provide exceptionally long, trouble-free service. Rated at 2 watts, with a good safety factor.

BROWN DEVIL® AND DIVIDOHM® RESISTORS



BROWN DEVIL fixed resistors and DIVIDOHM adjustable resistors are favorite vitreous-enameled units! DIVIDOHM resistors are available in 10 to 200-watt sizes; BROWN DEVILS in 5, 10, and 20-watt sizes.



WRITE FOR
STOCK
CATALOG



OHMITE MFG. CO.
3634 W. Howard St.
Skokie, Ill.
(Suburb of Chicago)

Be Right With . . .

OHMITE

RHEOSTATS • RESISTORS • TAP SWITCHES



Top Quality for Top Performance
**SOUNDCRAFT MAGNETIC
 RECORDING TAPE**

QUALITY — that's the reason why popular recording stars insist on Soundcraft Magnetic Recording Tape. They *know* that Soundcraft always delivers the quality performance tape users demand . . . the true, note-for-note fidelity their work requires.

QUALITY, too, is why so many audio fans — in ever-increasing numbers — today use *only* Soundcraft tape for the utmost in listening pleasure. QUALITY is why so many servicemen and electronics dealers carry Soundcraft tape.

How about you? Have you tried Soundcraft yet? If not, do it now.

Write for FREE booklet on
 Soundcraft Magnetic Recording Tape

**REEVES
 SOUNDCRAFT
 CORP.**

Dept. X-10.
 10 East 52 St., N. Y. 22, N. Y.



verifying, *Radio France-Asie*, Saigon, listed *English* to Europe 1100 on 11.950; 2030 on 11.935 to India; 0900 on 11.935 to Southeast Asia. India; 1830 on 7.230 to Far East and Southeast Asia; 0400 on 15.430 to Pacific. (Arvidsson, Sweden) *Radio Hirondelle*, 7.410A, Hanoi noted around 0515; starts to fade 0600. (Williams, Australia, and others)

Ireland (Eire)—While vacationing in Ireland, Catch, England, visited *Radio Eireann* where he learned that it is *not known* when s.w. broadcasts will be resumed, although both a *new* 100 kw. transmitter and a 1.5 kw. one are available; the new 100 kw. transmitter is suitable for the 16-, 19-, 25-, or 31-m. band but has never been tested although it is "warmed up" once a week.

Israel—Officials of the Israel Broadcasting Service inform Scheiner, N. J., that the *new* 50 kw. s.w. transmitter should be on the air soon.

Japan—*Far East Network*, AFRS, Tokyo, sent QSL card for 11.825, 9.605; listed JKL, 4.860, 0345-1000; 9.605, 1815-0330; 4.860, 1600-1800, JKI, 11.825, 1815-0330, 6.080, 1600-1800. (Pearce, England) *Radio Japan*, 15.135, noted 0005 with news, fair level in Iowa. (Lund) And in Washington State. (Simmons) Noted in Japanese 0030-0100. (Glover, Texas)

Italy—Rome 9.750, noted with news 2145 to North America. (Corson, Iowa)

Libya—Forces Broadcasting Station, 4.965, Tripoli, noted 1531 with popular music; at 1600 closedown gave time as "11 p.m.," and said would return 2330 on 1486 kc. and "experimentally on 4.965." Said "Goodnight to listeners in Tripolitania and to short-wave listeners wherever they may be;" closed with "God Save the Queen." Formerly used *announced* 4.782. Sent QSL card from No. 1 Forces Broadcasting Station, Tripoli, M.E.L.F. 1; power listed 250 watts; transmitter is BC-610; antenna a dipole. Confirmed move from 4.782 to 4.965 and asked for further reports. (Pearce, England, others)

Mozambique—Current schedule received from Lourenco Marques lists Portuguese 0000-0100, 0430-0630, 1045-1515 on 11.815, 10 kw. 15.285, 10 kw., 4.829, 7.5 kw.; *English* 2300-1300, 11.761, 7.5 kw.; 2300-1600, 4.916, 7.5 kw.; 0130-1000, 7.262, 7.5 kw.; 1100-1600, 3.490, 7.5 kw. (Scheiner, N. J.) The 4.916A channel noted at good level around 2330-0100 fade-out. (Saylor, Va.; Scheiner, N. J.) Heard opening 0000 on 11.955. (Cushen, N. Z.) Heard well in Sweden on that channel 1200 with news in Portuguese, then music. (Lorentzson)

New Caledonia—*Radio Noumea*, F08AA, has been heard back on 6.035 with talk in French 0350; fair signal, in clear. (Balbi, Calif.) Noted opening there 0200. (Williams, Australia) Heard by Fox, N. Z., and Sanderson, Australia, over a second transmitter on 3.350 at fair level.

New Zealand—ZL9, 11.81, Wellington, noted around 0000 with music. (Harder, Washington State)

Norway—*Radio Norway*, 9.610, Oslo, noted opening to Western North America 2300 in Norwegian but also with *English* announcements. (Deskins, Calif.) Closes 2400. (Neyland, Calif.) Good on this channel to Eastern North America 2000-2100. (Zerosh, Pa., others)

Pakistan—*Radio Pakistan* noted with news 1015-1030 on 9.484; with slow-speed news 1310-1330 on 7.010, 11.650. (Pearce, England) Heard widely to Turkey 1445-1530, to Britain 1530-1615 closedown on 11.65 parallel 9.645. (Boice, Conn.; Bellington, N. Y., others) Heard on 9.645 at 0500 with Home Service of news, music. (Sanderson, Australia) Heard 2015-2100 over 11.885, some *English*. (West, Va.) And parallel on 15.335. (Cain, Nevada)

Paraguay—ZPA5, 11.95, has news in Spanish 1700; QRN from Lisbon. (Lorentzson, Sweden)

Peru—OAX4T, 9.562, Lima, *Radio Nacional del Peru*, noted 2305-2315 with Spanish music, announcements. (Morris, Pa.)

Philippines—Far East Broadcasting Co., Manila, is heard well from 2300 onwards on its 17.805 outlet. (Hutchins, Australia) DZ17, 6.080, Manila, noted in *English* 0500 relaying DZMB, (Williams, Australia) According to word from DYSR-DYH-4, a *new* 10 kw. transmitter is planned probably for use on 6.055; also plans to operate later on in the tropical band on a frequency of 3.277 mc.; at

Which Do You Want?



add technical training to your practical experience and

Get Your FCC Ticket
-Then Use Our
Amazingly Effective
Job-Finding Service
To Get a Better Job

**Get Your
FCC COMMERCIAL
RADIO OPERATOR
LICENSE
IN A MINIMUM OF TIME!**



I can train you to pass your FCC License Exams in a minimum of time if you've had any practical radio experience — amateur, Army, Navy, radio servicing or other. My time-proven plan can help put you, too, on the road to success.

Let me send you FREE the entire story. Just fill out the coupon and mail it. I will send you, free of charge a copy of "How to Pass FCC License Exams," plus a sample FCC-type Exam, and the amazing new booklet, "Money Making FCC License information."

Edw. H. Guilford
Vice President

Get This
Amazing Booklet
FREE...

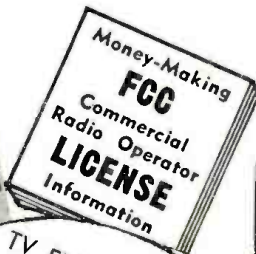

TV ENGINEERING
INCLUDED IN OUR
TRAINING AND
COACHING

TELLS HOW

HERE IS YOUR GUARANTEE
If you fail to pass your Commercial License exam after completing our course, we guarantee to continue your training without additional cost of any kind, until you successfully obtain your Commercial license, provided you first sit for this examination within 90 days after completing your course.

We Guarantee

TO TRAIN AND COACH YOU AT HOME IN SPARE TIME UNTIL YOU GET YOUR FCC LICENSE

TELLS HOW

Employers Make

JOB OFFERS Like These to Our Graduates Every Month

Letter from nationally-known Airlines. "We would also appreciate if you would place the following additional advertisement in your bulletin—Wanted—Superintendent of Communications..... Salary \$666.66 per month.

Letter from nationally-known Airlines. "We are contemplating placing..... an Airline Ground Radio Engineer." Starting salary \$385 per month.

These are just a few examples of the job offers that come to our office periodically. Some licensed radioman filled each of these jobs... it might have been you!

HERE'S PROOF FCC LICENSES ARE OFTEN SECURED IN A FEW HOURS OF STUDY WITH OUR Coaching AT HOME in Spare Time

Name and Address	License	Lessons
Lee Worthy 2210 1/2 Wilshire St., Bakersfield, Cal.	16
Clifford E. Vogt Box 1010, Dunsmuir, Fla.	20
Francis X. Forch 18 Beuter Pl., Bergenfield, N. J.	38

CLEVELAND INSTITUTE OF RADIO ELECTRONICS
Desk RN-57, 4900 Euclid Bldg., Cleveland 3, Ohio
CARL E. SMITH, E.E., Consulting Engineer, Pres.

TELLS HOW

Our Amazingly Effective JOB-FINDING SERVICE Helps CIRE Students Get Better Jobs

Here is just one recent example of Job-Finding Results Gets Five Job-Offer from Broadcast Stations

OURS IS THE ONLY HOME STUDY COURSE WHICH SUPPLIES FCC-TYPE EXAMINATIONS WITH ALL LESSENS AND FINAL TESTS.

"Your 'Chief Engineer's Bulletin' is a grand way of obtaining employment for your graduates who have obtained their 1st class license. Since my name has been on the list, I have received calls or letters from five stations in the southern states, and am now employed as Transmitter Engineer at WMMT." Elmer Powell, Box 274, Sparta, Tenn.

Your FCC Ticket is always recognized in all radio fields as proof of your technical ability.

Get All 3 Free
MAIL
COUPON
NOW



B

Cleveland Institute of Radio Electronics
Desk RN-57, 4900 Euclid Bldg., Cleveland 3, Ohio
(Address to Desk No. to avoid delay)

I want to know how I can get my FCC ticket in a minimum of time. Send me your FREE booklet, "How to Pass FCC License Examinations" (does not cover exams for Amateur License), as well as a sample FCC-type exam and the amazing new booklet, "Money-Making FCC License Information." Be sure to tell me about your Television Engineering Course.

Name.....
Address.....
City..... Zone..... State.....

Paste on 2-cent postcard or send air mail.

NATIONAL ELECTRONICS' BARGAIN OF THE YEAR DUE TO A SPECIAL BUY WE MADE—BUY EARLY—STOCKS LIMITED



Leave it to National Electronics to make a special buy like this. This is the kind of buy you would expect only during the off season, but not in October! Made by one of the leading makers of antennas who wouldn't allow us to use his name because of this low price, these Yagis are engineered to cover three adjacent channels with high average gain, and offer pin-point directivity and a superior signal-to-noise ratio. Single arrays give good pictures in the medium fringe and stacked arrays at 70 miles or better. Look at these prices:

MODEL	SINGLE BAY NET EACH	2-BAY ARRAYS EACH	SINGLE BAY LOTS OF 6 EACH
XY-11-13	\$3.50	\$ 7.50	\$2.95
XY-9-11	\$3.50	\$ 7.50	\$2.95
XY-7-9	\$3.50	\$ 7.50	\$2.95
XY-456	\$6.25	\$11.95	\$4.95
XY-345	\$6.25	\$11.95	\$4.95
XY-234	\$6.25	\$11.95	\$4.95

Model numbers indicate channels covered—be sure to specify.

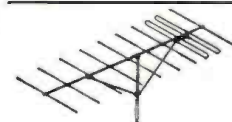

Super-Gain 10 Element

TWIN-DRIVEN YAGI

Designed for finest reception in ultra-fringe weak signal areas. TWIN-DRIVEN for Channels 2-6. Uni-Driven for Channels 7-13. Single array produces 11 db gain. Finest construction. Each array includes 10 airplane-type aluminum elements, mast boom, mast clamp and supporting brackets. Pre-assembled for easy installation.

Channel 2 \$21.90 Channel 3 or 4 . . . \$18.90
Channel 5 or 6 . . . \$16.90 Channel 7 to 13 . . \$ 7.95
(Give exact channel required)

SAVE WITH ROCKET 35 FOOT MAST KITS
Economy mast kit contains 3 self-coupling 10' seamless TRI-COATED 1 1/4" O.D. masts, one 5' mast, 300 feet of 6/20 galvanized steel guy wire, and everything else needed including guy rings, insulators, cable clamps, Euy hooks, and swivel mounting base.

35 ft. Mast Kit. \$15.95 25 ft. Mast Kit. \$11.95

ALL PRICES F.O.B. CLEVELAND, OHIO
Do not remit more than complete purchase price. Pay shipping charges on receipt of goods. 25% deposit on all C.O.D. orders. Please. Money-back Guarantee.
Prices Subject to Change Without Notice.

Sensational Powermaster ALL DIRECTIONAL TV ANTENNA

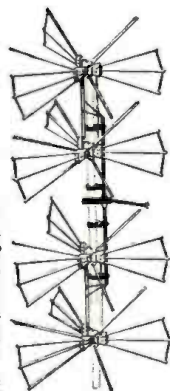

Electronically rotates in all directions **\$41.50**

Especially designed for ultra-fringe areas where signals arrive from several directions. Offers extra high gain over any broad-band antenna. Requires no motors—no electric power. 160° rotation by means of G-position switch located at set. 48 elements, with 6 matched tie rods. Complete with G-position Beam Switch, 100' Tubular Low-Loss Tri-X Universal Mast Clamps. Order Model AX-548-10. With 150' lead-in, order AX-548-15. \$44.95

Model AX-524—same Directronic operation as Model AX-548. Provides 2-bays, 24 elements. Complete with G-position switch, 75' tubular cable, 3 matched stacking bars. \$23.50
Model AX-524 with 100' cable. \$24.95

BARGAIN in All-Channel CONICALS

3 Hi-gain 2-Bay 16-element arrays including hi-band adapters and 3 pair Tie Rods. \$13.95
Same, less Tie Rods. \$12.50
Only 600 Left—Order Early.

Sensational Low Prices On Accessories

- Mast Steel (Dualcoated 5' crimped) 1 1/4" O.D. \$ 1.05
- Mast Steel (Dualcoated 10') 1 1/4" O.D. 1.95
- Mast Connectors for 1 1/4" Mast.59
- Chimney Mount complete with straps. 1.19
- Peak Roof Saddle (will take up to 1 1/2" Mast). . . 1.59
- Lighting Arrestor—TV.69
- Steel Guy Wire—6/20—100' coil.85
- Rocket Twin-lead—7/28 stranded. 2cft.
- UHF Tubular Twin-lead Low-loss 100' coil. 4.95
- Mast Stand-off Insulators—3'.10
- Screw Type stand-off Insulators—3'.03
- Sutco Combination UHF Converter and VHF Booster. Efficient and a real buy at. 34.95
- Reflexory VHF TV Booster. With plenty of gain; designed for new and old front ends. 19.50
- Alliance ATR Antenna Rotator. Efficient and dependable—economically priced. 20.53
- 4-conductor motor wire—cut to order. 4cft.

NEW FALL AND WINTER CATALOG AVAILABLE

National Electronics OF CLEVELAND

THE HOUSE OF TV VALUES

110 Delco Building Cleveland 3, Ohio

present uses 6.055 with 1 kw., 6.000 with a BC-610. (Williams) DZH3, 9.500, noted 0430 with English; DZH2, 9.640, heard with news, music around 0415. (Sanderson, Australia)

Poland—Warsaw, 7.145A, noted in English for USA around 2320-2330. (Morris, Pa.) Heard closing English to North America 1800 on 11.74; probably opens 1745. (Roberts, Conn.) Warsaw noted on 9.57 at 0930-1030 with special program called "Music, the Common Language of All Peoples," announces this for Wed., Sat. only, and says is parallel on 42.11 m. (Pearce, England)

Saudi Arabia—Djeddah was tuned recently near 7.095 at 1317 when had interval signal, signed on 1323 with march-anthem, call in native, then usual man chanting without accompaniment; news in Arabic 1357A and left air 1410. (Pearce, England) Noted on 11.95 at 2300 with Arabic program of news, music. (Sanderson, Australia)

Somali—Radio Somali lists frequency as 7.420 but is heard near 7.380 now; scheduled 0445-0530, 1200-1800 in Italian; 0915-1015, 1100-1200 in Somali. (Pearce, England, others)

Spain—Madrid's English session to North America 2200-2245 on 9.363 comes through well in Colo. (Kippel)

Sweden—Radio Sweden, 11.88, Stockholm, is good level in English 2300A. (Lund, Iowa) weak signal on 15.155 noted 1200-1215; some QSB. (Kirby, Mo.) Noted with English 0700-0715 on 15.155. (Kubachi, Mass.)

Syria—Radio Damascus, 11.913A, noted with French news 1600 to Europe. (Mesquita e Sousa, Portugal) Noted in English 1700-1730 closedown; news 1715. (Kroll, N. Y.) Appears parallel with 11.750A to Latin America closing around 2100. (Scheiner, N. J., others)

Tahiti—Radio Tahiti, 6.134, Papeete, can be heard from around 2330 fade-in to 0100 sign-off, using mostly French. Sign-on is listed 2245. (Caine, Nevada) Papeete is heard on 6.980 at good level to 0130 closedown; no English; native to 0015, then French. (Cushen, N. Z.)

Taiwan (Formosa)—BED4, 11.920, still noted with English to Europe 1320-1345; has French around 1350. "The Voice of Righteousness," Shih-Lin, Taipei, says in part, "Our station broadcasts in both Chinese and English on 7.300, formerly 7.400, at 1700-2000," asked for reports on English session. (Pearce, England) BEC36 opens 0630 or 0700 daily on 7.355, good level. (Williams, Australia) Lately, Taipei has been noted on new schedule to Western North America 0000-0100, news 0030; fair on 15.235, poor on 11.735. (Balbi, Calif.) BED26, 10.080, heard 0400 with Chinese news and Western music; BED32, 9.778V, heard 0415 with Western music, then Chinese news; BED24, 9.820A, heard 0430 with Western music and Chinese news, bad QRM. (Sanderson, Australia)

Thailand (Siam)—The Thai Army Signal Corps Radio Service, HSIJS, is

the new H. H. Scott "99"

\$99.95 net

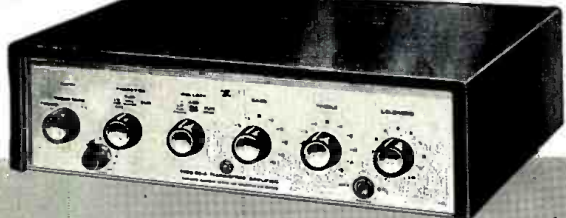

THE TYPE 99-A TRANSCRIPTION AMPLIFIER

"That amplifier of yours is fantastic". So said a leading expert, hearing the "99" perform against amplifiers costing several times as much. Even we are flabbergasted (but happy) at the response — "When can I have one?", "That I want.", "Save me one of the first". The "99" is unique — a complete amplifier in one compact case with 4-position input selector, separate turn-over and rolloff record equalizers, treble and bass controls, adjustable loudness compensation and pickup-level control. See and hear an H. H. Scott amplifier at only 99.95 — the phenomenal "99".

FREE BOOKLET R-53

99 **HERMON HOSMER SCOTT, INC.** **99**
"PACKAGED ENGINEERING"
385 PUTNAM AVE. • CAMBRIDGE 39, MASS.

"ON TOP
OF-THE-STATION
RECEPTION"
in the
FRINGE
AREAS

OUT PERFORMS

all other

VHF

Antennas!

BJ-2

These "BIG JACK" Antennas are performing with outstanding success in many areas. Near-station installations of the BJ-1 provide a higher gain and clearer picture on all VHF channels in range. The BJ-2, for fringe area installations, has provided excellent reception where other antennas have failed.

Kay-Townes superior constructions and engineering details plus fringe area "Know-How" make the BIG JACK series the greatest high-gain VHF antennas ever built.

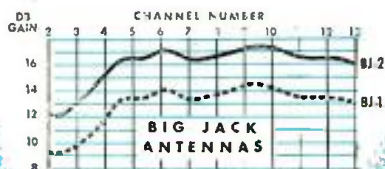

Kay-Townes Antennas and Accessories are sold only through selected wholesale outlets. . . . Contact your jobber or write for name of nearest distributor.

*Pat. Pending

THE BEST SET IS ONLY
AS GOOD AS ITS ANTENNA!

KAY-TOWNES
ANTENNA CO.
BOX 586, ROME, GA.

heard daily 0630-0700 on 4.875; poor signal in Australia. The Overseas Service on 11.700 is strong from 0600, although has some QRM from *Radio Japan*, 11.705. (Williams) Has news 0515-0530; service runs 0500-0700. The lower-powered transmitters now open 0630 and carry Thai Home Service. Call on 11.700 appears to be HSK9. (Radio Australia, others) Is heard on 6.000A parallel the 11.700 outlet. (Williams)

Trieste—The *British Forces Station*, 15.125, signs off 1800 with "God Save the Queen." (Ferguson, N. C., others) Station officials say "The Service is intended for comparatively local reception and you may find that future listening conditions will deteriorate as we make final adjustment to our aerial system." (Patrick, England) Should sign on at 1100.

Turkey—The Technical School of Istanbul station has been off the air this summer, but should return by the middle of October—presumably on old channel 6.690A. (WRH) The Technical University of Istanbul is heard on 7.030 from about 1315 to 1500 (*except Sat.*); is to increase power shortly to 1 kw.; has CWQRM. (Patrick, England and others)

USI (Indonesia)—Djakarta, 9.710, noted with music 1000 and announcement in very poor *English*, (Harder, Washington State) Plans to install two more 50 kw. transmitters; these are expected in Indonesia at the end of this year and might be in use soon after that "to enlarge and to improve our foreign broadcasts," officials have informed Scheiner, N. J. according to the *N. Z. DX Times*, YDD, 3.205, Djakarta, is good level in N. Z. 0730 with news in Indonesian, and Jogjakarta, 5.060, is strong level there at 0800.

USSR—Alma Ata, 9.340, has been heard in Sweden 0900. (Skoog) Grenell, Ohio, says Radio Moscow is coming through nicely all day (*EST*) on 11.78, 9.59.

Vatican—HVJ, 11.74, is sometimes readable 1315-1330 in English period. (Niblack, Ind.; Scheiner, N. J.)

Venezuela—YVOA, 4.830, signs on 0530; YVNB, 4.820, is heard 0630 atop Singapore, Malaya. (*N. Z. DX Times*)

Yugoslavia—Radio Yugoslavia has *English* 0115-0130 on 9.618, 6.100; at 1645-1700 on 6.100. (Pearce, England) Has native musical session 2200-2230 daily on 6.100, 9.618. (Bellington, N. Y.)

Press Time Flashes

Arthur T. Cushen, Invercargill, N. Z., for many years a regular contributor to the *ISW DEPARTMENT*, was recently awarded the Coronation Medal by Her Majesty Queen Elizabeth II, for the POW work he has done over the years. Arthur has received his 1000th BCB verification, and his s.w. verifies now total around 1600.

"Deutsche Welle", Cologne, "The Voice of Germany", has informed Scheiner, N. J., that reception reports "will be verified with a QSL card if, aside from technical data, details about 15 minutes of programming are included in order to allow for a clear comparison with our program lists". QRA is Deutsche Welle, Koln, NWDR, Wallrafplatz 5, Cologne, Germany.

Canada's service for the Northwest Territories is listed daily 2340-0020 over 9.585, 6.060; Mon.-Fri. only, 0725-0805 over 11.90, 9.63.

Radio Cotonou, Dahomey, operates in French, Dahomey dialects 0145-0200, 1225-1330 (to 1400 Sat.) over 1485 kc., 1 kw., and on 41 m. with 250 watts (to be increased to 1 kw. in 1954). (Scheiner, N. J.) *What is 41-m. frequency?*

A Colombian station on 6.196A has been heard around 2228 when identified as "La Voz de Cali." (Bellington, N. Y.; Niblack, Ind., others) *Radio Sweden* lists call as HJEZ, but Stark, Texas says is "La Voz del Valle," Cali, moved up from 6.135, with call of HJEV.

Berne, Switzerland, recently tested (with relay of its European program) on HER22, 3.961; HER33, 3.981; HER44, 3.989; heard well in Britain around 1700. (Pearce, Catch, Patrick)

Listeners in the South Pacific have been alerted to report reception as soon as the new station on Pitcairn Island takes to the air; watch for a report on this one over Radio Australia's DX session Saturday 2300, 15.200, repeated Sunday 0830, 9.615.

Do you have
Home-monic distortion?

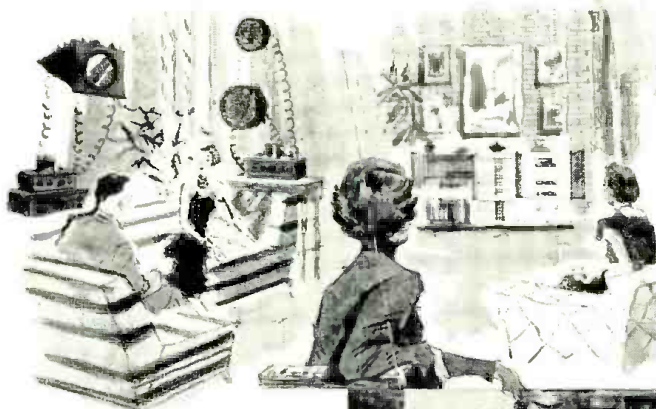

Engineered styling makes Angle Genesee Cabinets a perfect fit for any combination of equipment. Best of all... you can change equipment by just changing panels.

Angle Genesee cabinets can be ordered from your dealer in any of these ways:
Custom designed from your list of equipment.
Made to your specifications from our catalogue sheets.
In standard combinations for extra economy.

See your dealer or write for catalogue sheets.



Traditional and Modern Styling



Music has eye appeal, too. It's part of your home. Angle Genesee custom cabinets are styled for the most discriminating taste... whether traditional or modern.

* Home-monic distortion — Wife's-eye view of "hard-to-clean-around" wires, glowing tubes, bare speakers.
Cure: A-G cabinets.

ANGLE
GENESEEE
CORPORATION

106 Norris Drive • Rochester 10, New York

Dealers Note: Franchises now available for this quality cabinet line.
October, 1953

THE Greatest UHF-VHF ANTENNAS EVER BUILT!

FAR-REACHING and PHOTO-CLEAR RECEPTION!

HIGHER GAIN
on all Channels 2-83

Original, revolutionary design... **FIXED IMPEDANCE Point System** provides All-Channel, High-Gain reception with a single transmission line.

BJU-2

Kay-Townes' BJU Antennas are the recognized leaders in the field of clear picture, high-gain, trouble-free UHF-VHF antenna performance! Simplified, but more exacting and effective engineering has resulted in "bug-free" antennas that provide photo-clear reception. One lead-in wire only. No matching pads or isolation filters... no coils or condensers... which tend to cut down signals.

"THE BEST ALL CHANNEL UHF-VHF ANTENNA AVAILABLE!" says Leading Alabama Dealer Henry N. Bailey of Mobile says: "We have tested more than 25 different antennas in our search for a good performer on UHF channel 48 and our local VHF channel 10... and your BJU-1 all-channel UHF-VHF antenna did the job that others failed to do... and in addition performed superbly as a fringe antenna on channel 6, New Orleans... over 150 miles away!"

K-T Antennas are sold through selected distributors only... write for name of your nearest jobber.

BJU-1

THE BEST SET IS ONLY AS GOOD AS ITS ANTENNA! *Pat. Applied For

KAY-TOWNES ANTENNA CO.
BOX 586, ROME, GA.

NOW! The KLIPZON MINI-PROD CONNECTOR

IT'S A MINIATURE CLIP . . . it's a MINIATURE TEST PROD, too!

STREAMLINED FOR MODERN ELECTRONICS

FOR LABORATORY, SERVICE SHOP, PRODUCTION LINE TESTING

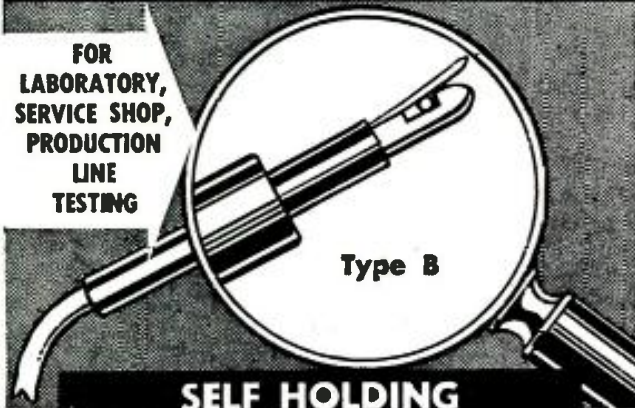

Type B

SELF HOLDING
For Every Test Application



**KLIPZON SELF-HOLDING POINTS
DESIGNED FOR MODERN ELECTRONICS**

★
Now three years old, and
over 750,000 in service!

★
Used by Leading TV, RADIO and
ELECTRONIC MANUFACTURERS

★
SOLD NATIONALLY BY MORE THAN
1000 RADIO PARTS DISTRIBUTORS!

★
Ask for KLIPZONS at YOUR Local Distributor
Write for FREE FOLDER #1 describing
MINI-PRODS and Other KLIPZON Products.

United Technical Laboratories

Engineers MORRISTOWN, N. J. Manufacturers

English broadcasts from *Radio Sweden* are 1930-2000, 2100-2145, 2200-2215, 9.535; 2300-2315, 15.155; 2300-2330, 11.880; 0000-0030, 15.155; 0600-0615, 0700-0715, 0800-0815, 0930-1030, 1200-1215, 1300-1315, 15.155; 1500-1530, 6.095; 1800-1815, 11.880. (ISWC, London)

Current Paris schedules include French 2230-2245, 7.105; 0030-0130, 9.550; 0145-0230, 11.920, 15.240; 0230-0300, 15.240, 17.850; 0530-0600, 15.240; 0758-1000, 15.400, 17.850; 1100-1215, 15.350, 17.850; 1215-1300, 9.675, 11.845; 1500-1559, 5.995, 7.105, 9.685; 1500-1630, 11.700, 15.240; 1730-1800, 9.675; 1830-2000, 9.685, 11.700. English 0145-0200, 7.240; 1500-1600, 6.045. German 1300-1400, 6.045. Spanish 1600-1645, 5.955, 7.240; 1800-1815, 9.685, 11.700. Portuguese 0200-0215, 1300-1315, 7.240; 1400-1430, 7.240, 9.765. Home service relays are Program National on Sun. 0400-0500, 7.200; Program Paris-Inter, weekdays 0100-1100, 6.200, 1100-1815, 6.200, 9.550; Sundays 0130-0400, 0500-1115, 6.200, 1115-1815, 6.200, 9.550. (WRH)

A French-speaking station heard on 6.11A at 0830 through heavy QRM may be *Radio France-Asie*, Saigon, Indo-China (Vietnam), no longer found on 9.75A at that time. (Balbi, Calif.) *Radio Renascença*, Portugal, operates on 6.154 at 1230-1800. (Radio Sweden)

Latest schedule of "Deutsche Welle." Cologne, Germany, is 2030-2330, 5.980, 7.290 (to North America); 0530-0830, 15.275; 0930-1230, and 1700-2000, 11.795.

Acknowledgement

Thanks for FB reports; keep them coming during the winter DX season to Ken Boord, 948 Stewartstown Road, Morgantown, West Virginia, USA. Good listening, fellows! K.R.B.

DISTRIBUTOR SEMINARS PLANNED

THE JOINT Electronic Parts Show—NEDA committee has appropriated \$30,000 to conduct a series of regional seminars and educational programs for distributors, replacing the educational sessions formerly held during the Parts Show.

Tentative plans include seminars to be held in centrally located cities in six trade areas.

NEW SUPER POST TOWERS FOR TELEVISION ANTENNAS IN FRINGE AREAS

**TOWERS OF STRENGTH
TO LAST A LIFETIME**

Self-supporting tower built up of galvanized steel sections. No guy wires necessary. Easy to erect. Safe and resistant to high wind. Available in heights 47 ft., 60 ft., 73 ft., 87 ft. and 100 ft., with bases in proportion.

**FRINGE AREA TV BUYERS MUST
HAVE SPECIALLY BUILT TOWERS
FOR CLEAR RECEPTION**

Tower and the TV set go hand in hand as a package sale to rural TV buyers. Provides an extra sale and profit to dealers. An excellent fast selling accessory for jobbers and dealers.

**TERRITORIES OPEN FOR
JOBBER DEALER FRANCHISE**

Write for complete structural details, packing, prices, discounts, and territorial assignment.

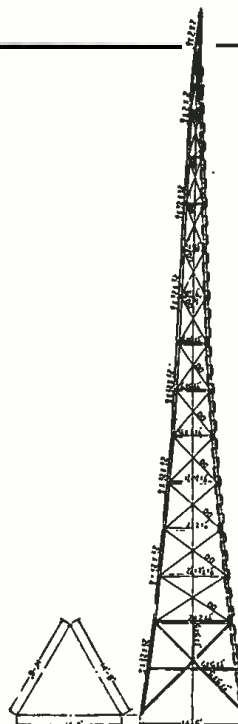

MANUFACTURED BY

AERMOTOR CO.

Dept. 6110, 2500 Roosevelt Road, Chicago 8, Illinois
BUILDERS OF STEEL TOWERS SINCE 1888

**NO
INTEREST!!**

Buy on our radically new
Time Payment Plan

**NO CARRYING
CHARGES!!**



Measures 6 1/4" x 9 1/2" x 4 1/2"

Superior's new
Model 670-A

SUPER METER

A COMBINATION VOLT-OHM MILLIAMMETER PLUS
CAPACITY REACTANCE INDUCTANCE AND DECIBEL MEASUREMENTS

SPECIFICATIONS:

D.C. VOLTS: 0 to 7.5/15/75/150/750/1,500/7,500 Volts
A.C. VOLTS: 0 to 15/30/150/300/1,500/3,000 Volts
OUTPUT VOLTS: 0 to 15/30/150/300/1,500/3,000 Volts
D.C. CURRENT: 0 to 1.5/15/150 Ma. 0 to 1.5/15 Amperes
RESISTANCE: 0 to 1,000/100,000 Ohms to 10 Megohms
CAPACITY: .001 to 1 Mfd. 1 to 50 Mfd. (Quality test for electrolytics)
REACTANCE: 50 to 2,500 Ohms, 2,500 Ohms to 2.5 Megohms
INDUCTANCE: .15 to 7 Henries 7 to 7,000 Henries
DECIBELS: -6 to +18 +14 to +38 +34 to +58

ADDED FEATURE:

The Model 670-A includes a special **GOOD-BAD** scale for checking the quality of electrolytic condensers at a test potential of 150 Volts.

The Model 670-A comes housed in a rugged, crackle-finished steel cabinet complete with test leads and operating instructions.

\$28⁴⁰
NET



Superior's new
Model TV-11

TUBE TESTER

SPECIFICATIONS:

- ★ Tests all tubes including 4, 5, 6, 7, Octal, Lock-in, Peanut, Bantam, Hearing Aid, Thyatron, Miniatures, Sub-Miniatures, Novals, Sub-minars, Proximity fuse types, etc.
- ★ Uses the new self-cleaning Lever Action Switches for individual element testing. Because all elements are numbered according to pin-number in the RMA base numbering system, the user can instantly identify which element is under test. Tubes having tapped filaments and tubes with filaments terminating in more than one pin are truly tested with the Model TV-11 as any of the pins may be placed in the neutral position when necessary.
- ★ The Model TV-11 does not use any combination type sockets. Instead individual sockets are used for each type of tube. Thus it is impossible

to damage a tube by inserting it in the wrong socket.

- ★ Free-moving built-in roll chart provides complete data for all tubes.
- ★ Newly designed Line Voltage Control compensates for variation of any Line Voltage between 105 Volts and 130 Volts.
- ★ **NOISE TEST:** Phono-jack on front panel for plugging in either phones or external amplifier will detect microphonic tubes or noise due to faulty elements and loose internal connections.

The model TV-11 operates on 105-130 Volt 60 Cycles A.C. Comes housed in a beautiful hand-rubbed oak cabinet complete with portable cover

EXTRA SERVICE—The Model TV-11 may be used as an extremely sensitive Condenser Leakage Checker. A relaxation type oscil-

lator incorporated in this model will detect leakages even when the frequency is one per minute.

\$47⁵⁰
NET



Superior's New Model 660-A AN AC OPERATED

SIGNAL GENERATOR

PROVIDES COMPLETE COVERAGE for AM-FM & TV Alignment

SPECIFICATIONS:

• Generates Radio Frequencies from 100 Kilocycles to 60 Megacycles on fundamentals and from 60 Megacycles to 220 Megacycles on powerful harmonics. • Accuracy and Stability are assured by the use of permeability trimmed Hi-Q coils. • R.F. available separately or modulated by the internal audio oscillator. — Built in 400 cycle sine wave audio oscillator used to modulate the R.F. signal also available separately for audio testing of receivers, amplifiers, hard of hearing aids, etc. • R.F. Oscillator Circuit: A

high transconductance heptode is used as an R.F. oscillator, mixer and amplifier. Modulation is effected by electron coupling in the mixer section thus isolating the oscillator from load changes and affording high stability. • A.F. Oscillator Circuit: A high transconductance heptode connected as a high- μ triode is used as an audio oscillator in a High-C Colpitts Circuit. The output (over 1 Volt) is nearly pure sine wave. • Attenuator: A 5 step ladder type of attenuator is used.

The Model 660-A comes complete with coaxial cable test lead and instructions.

Tubes used: 1—6BE6 as R.F. Oscillator, mixer and amplifier. 1—6BE6 as Audio Oscillator. 1—6H6 as Power Rectifier.

\$42⁹⁵
NET

MOSS ELECTRONIC DISTRIBUTING CO., INC.
Dept. B-77, 38 Murray St., New York 7, N. Y.

- MODEL 670-A Total Price \$28.40 \$7.40 down payment. Balance \$3.60 monthly for 6 months.
- MODEL TV-11 Total Price \$47.50 \$11.60 down payment. Balance \$6.00 monthly for 6 months.
- MODEL 660-A Total Price \$42.95 \$12.95 down payment. Balance \$6.00 monthly for 6 months.
- I enclose \$..... as down payment.
- Ship C. O. D. for the down payment.

Please send me the units checked. I am enclosing the down payment with order and agree to pay the monthly balance as shown. It is understood there will be no carrying interest or any other charges provided I send my monthly payments when due. It is further understood that should I fail to make payment when due, the full unpaid balance shall become immediately due and payable.

Name.....
Address.....
City..... Zone..... State.....

UHF

AMPHENOL

VHF

television antennas

WHAT'S

News in Radio

For additional information on any of the items described herein, readers are asked to write direct to the manufacturer. By mentioning RADIO & TELEVISION NEWS, the page and the issue number, delay will be avoided.

TAPE RECORDER

Crescent Industries, Inc., 5900 W. Touhy Avenue, Chicago 31, Illinois is marketing a low-cost tape recorder, the Model 907.

The new recorder is a dual-track, 7½ inch-per-second machine with fast forward and rewind, essentially flat frequency response from 70 to 8500 cps, less than ½ of 1 per-cent wow and flutter, a 3-watt amplifier, and only one control for record and play. It will handle up to 7 inch reels, gives two hours of recording time, has mike and radio-phono input, plus 3.2 ohm output for speaker and high impedance output for connection to an external amplifier.

A companion model, the 903, is available for those who want the 3.75 inch-per-second speed.

A data sheet on this new recorder is available from the company on request.

BATTERY ELIMINATOR-CHARGER

Electronic Instrument Co., Inc., 84 Withers Street, Brooklyn 11, New York has responded to the demand for a combined 6 volt and 12 volt battery eliminator and charger by bringing out the *Eico* Model 1050 in kit and wired form.

The unit is designed for use as a battery eliminator in the servicing and demonstrating of both 6- and 12-volt operated auto radios, marine and aircraft equipment, and for charging both 6-volt and the new 12-volt storage batteries.

Rated above normal needs in these applications and fully protected against overloads, the Model 1050 incorporates continuously variable output voltage, separate voltmeter and ammeter, and quality components throughout. In kit form, the instrument is designated as the Model 1050-K.

METAL DETECTOR

The Radiac Company, Inc., 489 Fifth Avenue, New York 17, New York is currently offering the "Private Eye," a portable ten-pound electronic detector for locating metals and minerals in all terrains, flat or mountainous.

A unique, simplified, high-efficiency circuit provides high sensitivity and penetration. The unit was designed for use by public utility companies and engineers as well as for treasure hunters, prospectors, etc.



The "Private Eye" is enclosed in a baked enamel, aluminum case of modern design. It uses low voltage radio batteries and consists of transmitter and receiver that may be folded in suitcase fashion when not in use.

GERMANIUM DIODES

Hermetically-sealed germanium diodes in production quantities are now available from *Hughes Aircraft Company's* Semiconductor Department, Florence Ave. at Teale St., Culver City, California.

The units are supplied in seventeen RETMA (RTMA) types, including three JAN-approved diodes, as well as other types laboratory-tested to customers' special requirements.

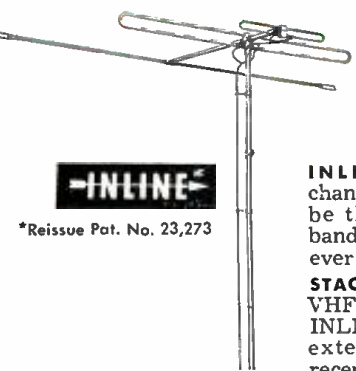
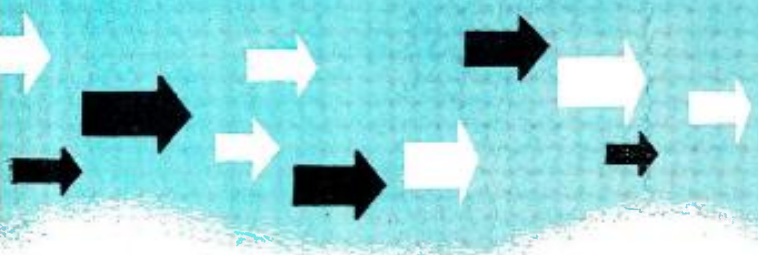

-IN-LINE-

*Reissue Pat. No. 23,273

IN-LINE* All VHF channels - proven to be the best broad-banded VHF antenna ever developed.

STACKED ARRAY All VHF channels - two IN-LINES, stacked for extended distances reception.

BO-TY All UHF channels - available as single or stacked, gives top reception.

CORNER REFLECTOR All UHF channels - high gain, extended distances reception.

YAGI Specified UHF channel groups-eight models cut to narrow channel widths give custom reception.

RHOMBIC All UHF channels - high gain and top performance.

STACKED-V All UHF or VHF channels-receives every station, best for major signal areas.

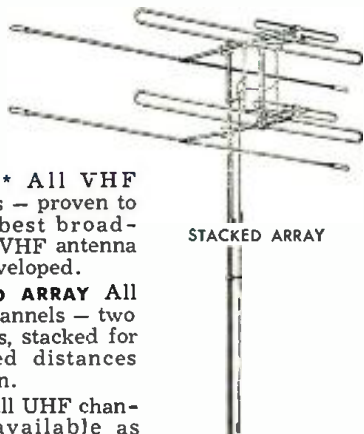

STACKED ARRAY



BO-TY



CORNER REFLECTOR



YAGI

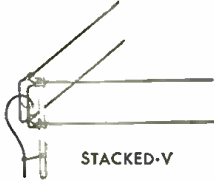

STACKED-V

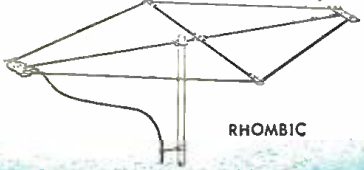

RHOMBIC

Mail the coupon on the opposite page for your copy of AMPHENOL's new "TVAntenna Folio." Done with Kodachrome illustrations from the AMPHENOL film "The UHF/VHF Television Antenna Story," it gives complete information on UHF and VHF television. The "TVAntenna Folio" contains, as well, AMPHENOL antenna and accessories catalog sheets.



The glass-to-metal seal is made by a special *Hughes*-developed process of fusion sealing at high temperatures. The result is a rigid, one-piece glass envelope which insures complete freedom from moisture penetration of the diode envelope.

Inquiries on these diodes should be sent to the firm's Semiconductor Sales Department.

WILCOX-GAY PHONOGRAPH

Wilcox-Gay Corporation, 79 Washington St., Brooklyn 1, N. Y. has entered the home high-quality phonograph instrument field with a new table model automatic player for all type records.

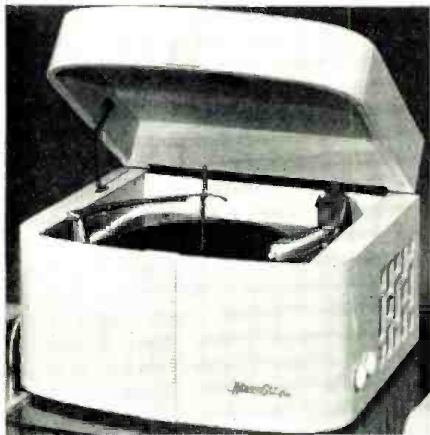

The especially-designed, three-speed changer utilizes a turn-over ceramic cartridge with sapphire needles which is used in conjunction with a custom-built amplifier with push-pull amplification. The set uses two side-mounted 6-inch

speakers featuring extra-heavy *Alnico* magnets. The cabinet, styled with a rounded front, has a built-in acoustic chamber which is constructed to match the electrical requirements of the speaker system and amplifier. The four-tube amplifier delivers 3 watts of audio output. Frequency response of the unit is 40 to 12,000 cycles.

VOLTAGE REGULATOR

Avion Instrument Corp., Division of *American Car and Foundry Company*, 291-26 State Highway #17, Paramus, New Jersey has developed a new a.c. regulator for 400-cycle supplies.

The rms output voltage is adjustable with regulation to .01 per-cent up to half the rated load (50 volt-amperes) and to .02 per-cent up to the full rated load (100 volt-amperes). This regulation is maintained with allowable input voltage fluctuations of ± 10 per-cent, about the adjusted output level and frequency fluctuation of ± 5 per-cent. Recovery time from transients is less than .01 second. Developed harmonics are less than 1 per-cent.

The regulator measures 17" x 9½" x 7" and is easily portable or suitable for bench mounting. Further information will be supplied by the manufacturer on request.

PRECISION RESISTORS

Erie Resistor Corp. of Erie, Pa. is now in production on ½ watt deposited carbon precision resistors in values from 100 ohms to ½ megohm. Standard tolerances are 1, 2, and 5 per-cent.

A distinctive feature of this stable pyrolytic resistor, designated as Style 155, is the one-piece molded case. The thermosetting molded insulation provides protection against humidity and also gives assurance against mechanical damage to the carbon film. Added insulating sleeving is not required on these units.

VIBRATOR TESTER

P. R. Mallory & Co. Inc. of 3029 E. Washington St., Indianapolis 6, Ind. has added a vibrator tester to its line of service equipment.

The 12VT1D is designed as a companion unit to other "Rectopower" bench power supplies and will test directly, without adapters, either 6 or 12 volt vibrators of the most popular types and all auto radio vibrators used since 1940.

In conjunction with a filtered d.c. power supply, such as the *Mallory* 12RS6D or 12RS14D, the vibrator test-

a complete line of dependable performers...

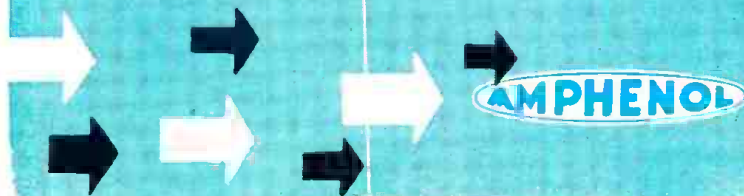

AMPHENOL's complete line of UHF and VHF television antennas offer viewing satisfaction to every set owner. Because of their superb electrical characteristics, qualities engineered by AMPHENOL, each antenna assures the finest picture quality that a set can deliver. Because of their sturdy construction, fine materials assembled into a rugged example of craftsmanship, each antenna gives long years of trouble-free performance.

In every television set installation, remember the importance of viewing satisfaction and specify an AMPHENOL antenna.



coupon:

Department 139

AMERICAN PHENOLIC CORPORATION

1830 South 54th Avenue

Chicago 50, Illinois

Send me the free "TV Antenna Folio."

Name _____

Company _____

Street _____

City _____ Zone _____ State _____

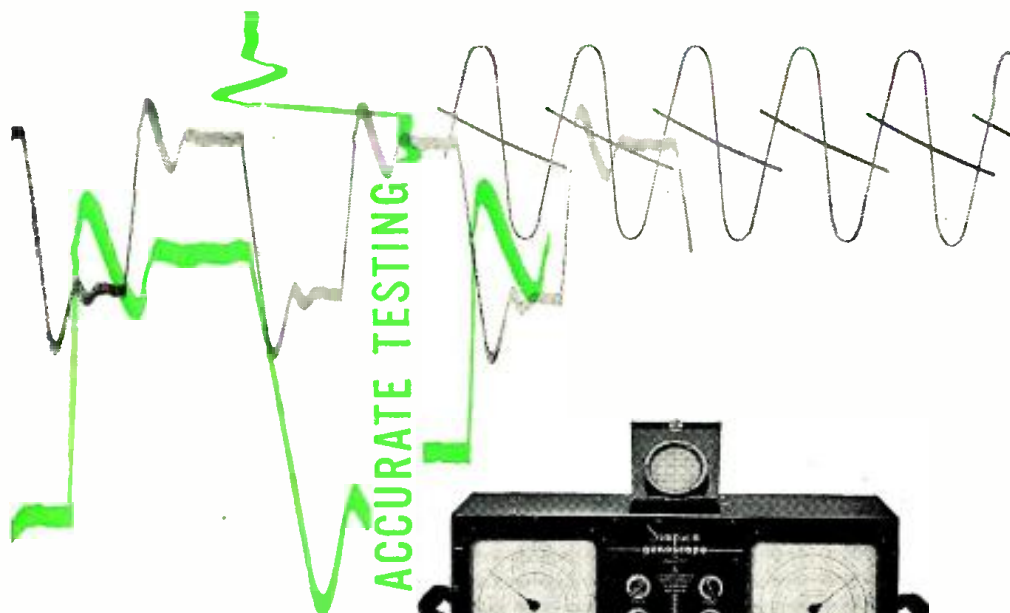

SIMPSON MODEL 480 GENESCOPE FOR ACCURATE TESTING

approved by
service managers of:

- admiral
- zenith
- motorola
- emerson
- hoffman
- hallicrafters



- All the necessary signal sources for alignment of FM and TV receivers • Includes the Simpson High Sensitivity Oscilloscope and high frequency crystal probe for signal tracing • Independent, continuously variable attenuators and step attenuators for both AM and FM units offer complete control of output at all times • 0.15 megacycle sweep is provided by a noiseless specially designed sweep motor based on D'Arsonval meter movement principles • The exclusive Simpson output cable (illustrated) includes a variable termination network, quickly adapted to provide open, 75 or 300 ohm terminations —the addition of a pad provides attenuation and isolation. Use of appropriate resistors across certain terminals will provide any other termination required. A .002 MFD blocking condenser can be added on any termination for use on circuits containing a DC component • The FM generator output voltage is constant within .2 DB per MC of sweep.

dealer's net \$475.00

SIMPSON ELECTRIC COMPANY

5200 W. Kinzie St., Chicago 44, Illinois • Phone ESTebrook 9-1121 • In Canada: Bach-Simpson, Ltd., London, Ont.

GET INTO ELECTRONICS

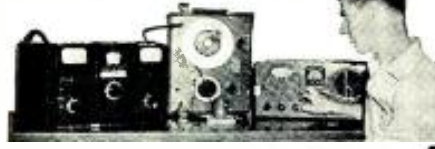

You can enter this uncrowded, interesting field. Defense expansion, new developments demand trained specialists. Study all phases radio & electronics theory and practice: TV; FM; broadcasting; servicing; aviation, marine, police radio. 18-month course. Graduates in demand by major companies. H.S. or equivalent required. Begin Jan., March, June, Sept. Campus life. Write for catalog.

VALPARAISO TECHNICAL INSTITUTE
Dept. RD Valparaiso, Indiana

SPEAKER RECONING

Complete line Cones, Spiders, Rings and Voice Coils. Custom Built Voice Coils. Low prices. Write for Parts List and Reconing information.

WESTERN ELECTRONICS CO.
3164 West Colfax Denver 4, Colo.

ANOTHER OUTSTANDING JOBBER PAYETTE RADIO, LTD.

730 St. James West Montreal, Canada

HAS THE SENSATIONAL NEW **EICO** 470-K 7" SCOPE KIT IN STOCK! \$79.95

er will test accurately either self-rectifying or tube-rectified vibrators of any frequency from 100 to 250 cycles.

Over-all dimensions are 6 3/4" high, 10 3/8" wide, and 5 1/2" deep. Shipping weight is approximately eight pounds.

TRANSISTOR TESTER

Dunn Engineering Associates, 11 Windsor Street, Cambridge, Mass. has introduced a new piece of test equipment, the DEA Model 2 transistor characteristic plotter.

The new unit automatically displays any one of four different families of static characteristic curves on the face of an auxiliary oscilloscope. The sets of curves presented are the transfer characteristic and the collector characteristic for both grounded-emitter and grounded-base connections. The rapid repetition rate of the displays obviates flicker and thermal ef-



fects. Both *n-p-n* and *p-n-p* junction transistors as well as point-contact units can be accommodated.

The unit is intended for both production line and laboratory use. A descriptive bulletin is available from the manufacturer.

POWER SUPPLY

Lee Electronic Labs, Inc., 233 Dudley St., Boston 19, Mass. has developed a new miniature electronic power supply, Model PS-1, for use with its Model E-C or E-A circuit analyzers.

The new unit provides both a.c. and d.c. test voltages, permitting an extremely wide range of resistance and continuity tests and increasing the sensitivity of the analyzers to over 200 megohms.

The Model PS-1 features a minia-

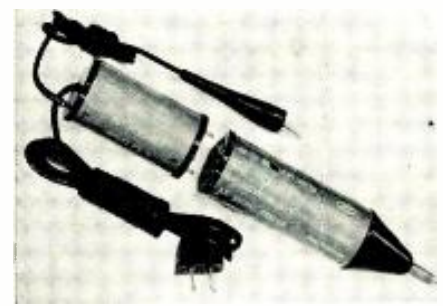

ture selenium rectifier and dual-condenser RC filter network in a special circuit. The plug-in design, to match the analyzer models, comes with a 6 foot power cord and rubber plug and operates on any 100-125 volt a.c. line.

18-INCH WOOFER

C.-S. Manufacturing Company, 4089 Lincoln Blvd., Venice, California is

MONEY BACK GUARANTEED

TO RECEIVE *All* UHF and *All* VHF STATIONS IN *All* DIRECTIONS FOR 60 MILES WITHOUT A ROTORMOTOR OF ANY KIND!!

WORLD'S MOST POWERFUL UHF - VHF TELEVISION ANTENNA

While antenna reception is guaranteed for 60 miles, perfect pictures have been consistently received as far as 160 miles from stations.

All NEW DESIGN FOR '54

- LOW-LOSS SWITCH
- LOW-LOSS PHENOLIC INSULATORS
- USES NEW 4-CONDUCTOR MATCHED IMPEDANCE LINE
- ONLY 10 INCH SPACING BETWEEN ANTENNA BAYS

ONE INSTALLATION ONE ANTENNA
ONE TRANSMISSION LINE

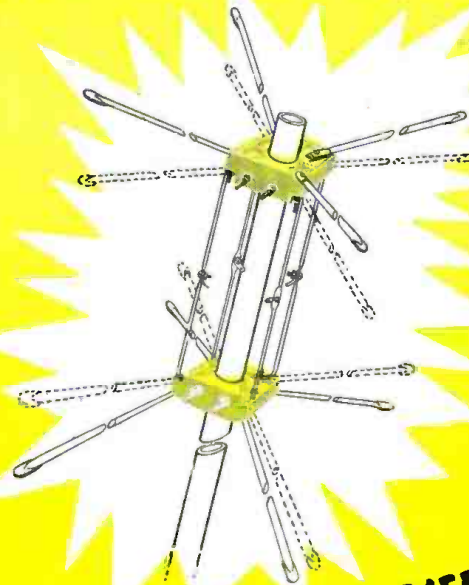

MODEL
**SUPER
60**

**SO NEW! SO DIFFERENT!
IT'S PATENTED!**

- # 2,585,670
- # 2,609,503
- # 2,625,655
- # 2,644,091

Money Back Guarantee
IN ALL LOCATIONS IN EVERY AREA
WITH STATIONS IN ALL DIRECTIONS

The new All Channel Model Super 60 is guaranteed to bring in, immediately on installation, every UHF and every VHF station within 60 miles in any direction, giving clearer and sharper pictures than any antenna or combination of antennas with or without rotor motors.

If, immediately on installation, it fails to do this, we agree to refund to the jobber to whom we sold and shipped it, his full purchase price.



The 9 position selector switch electronically rotates the antenna in a stationary position.

LIST PRICE
\$36⁷⁵
SEE YOUR LOCAL
JOBBER

PRICE INCLUDES
Complete stacked array • 4 stacking bars • 9 position switch • Switch-to-set coupler • 3 - 7 1/2" stand offs • Individually boxed in mailable carton

BE READY NOW — FOR THE FUTURE

ALL CHANNEL ANTENNA CORP., 70-07 QUEENS BLVD., WOODSIDE 77, NEW YORK



This new Adashaft control has 9 lives

Yes, patented design of Centralab's newer, smaller Adashaft Radiohms* lets you attach any of nine types of shafts to a basic control. Patented stub-shaft permits instant, positive locking for faster service. Result: a solid, well aligned unit every time.

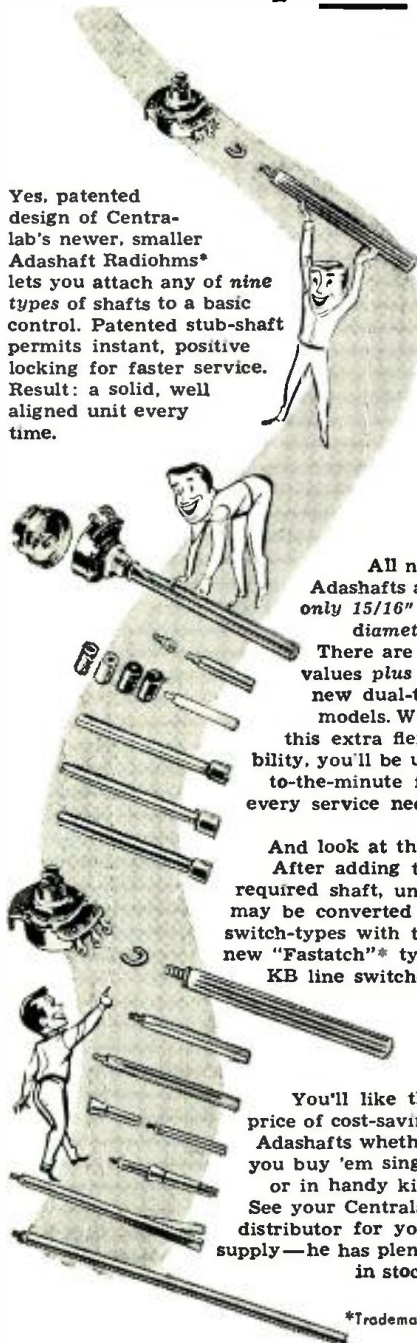

All new Adashafts are only 15/16" in diameter. There are 85 values plus 10 new dual-tap models. With this extra flexibility, you'll be up-to-the-minute for every service need.

And look at this: After adding the required shaft, units may be converted to switch-types with the new "Fastatch"* type KB line switches.

You'll like the price of cost-saving Adashafts whether you buy 'em single or in handy kits. See your Centralab distributor for your supply—he has plenty in stock.

*Trademark

Centralab

CENTRALAB,
A Division of Globe-Union Inc.
910-J.E. Keefe Ave., Milwaukee 1, Wis.
Please send me complete technical data on Centralab's newest Adashaft Radiohms.

Name.....
Firm.....
Address.....
City.....Zone.....State.....

now marketing an improved 18-inch woofer, the Model #CS-518.

Frequency response is from 30 to 4000 cps; maximum power input is 25 watts; impedance is 12 ohms. The cone resonance is 27 to 31 cps. The over-all diameter of the speaker is 18 inches, the baffle opening is 16 1/4 inches, and the depth behind the panel is 7 1/2 inches.

Information for bass-reflex, horn-loading, and air-coupler enclosures may be obtained from the manufacturer on request.

TRADEMARK DECALS

Tekni-Labels Company, 232 North Glenoaks Blvd., Burbank, California has added an "Alphabets" and "Trademarks" series to its line of decals.

The new series are available in four colors: white, black, red, and gold. With these new sets it is possible for individual technicians to make their own trademarks, name plates, decorative panel designs, etc. By combining portions of different colored decal sets, multi-color designs and trademarks can be made.

R.F. BRIDGE

Boonton Radio Corporation, Boonton, N. J. has recently introduced a new completely self-contained r.f. bridge, the Type 250-A RX meter.

The new instrument permits the direct measurement of equivalent paral-

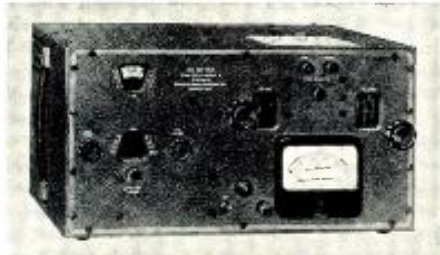

lel resistance and capacitance of two-terminal networks over an unusually wide frequency range. It has a frequency coverage of 500 kc. to 250 mc. in eight ranges; a resistance range of 15 to 100,000 ohms; and a capacitance range of + 20 μfd. to - 100 μfd. Resistances from 0 to 15 ohms may be determined by indirect means while the capacitance range can be increased to 0 to 120 μfd. by use of auxiliary resonating coils.

The company will provide complete details on request.

"MICRO-POLISHING" PROCESS

Reeves Soundcraft Corporation, 10 E. 52nd Street, New York 22, N. Y. has developed and patented the new "Micro-Polishing" process which is now being used in the manufacture of the company's complete line of magnetic recording tapes.

The new process develops high mechanical stresses on the oxide nodules and the surface of the tape, resulting in a mirror-smooth finish, thus practically eliminating drop-outs and increasing the accuracy of magnetic calculating systems.

All of the company's magnetic re-

SPECIAL OF THE MONTH

GENERAL ELECTRIC R.F. AMMETER
0-4 Amp R.F., 2 Inch Round, \$2.95
BRAND NEW
STANDARD BRAND OIL CONDENSER
6Mfd, 1500 V. DC. \$2.95
SPECIAL

NON-INDUCTIVE RESISTORS \$59¢
Ohmite, 250 Ohm, 100 Watt.
Special, 5 for \$2.50

SOLA CONSTANT VOLT. TRANSFORMER
Pri. 95-125 volts, 60 cy. Sec. Regulated
at 115 volts..... 30 VA. \$ 9.95

PLATE TRANSFORMER
1000-0-1000 Volts @ 400 mills. 115 v., 60 cy.
pri. Removed from equipment but guaranteed
perfect.....ea. \$8.95

BLOWER MOTOR
Squirrel cage, 140 CFM. 115 volt 60 cy.
motor. Extremely quiet. Made by Redmond.
BRAND NEW..... \$6.95

HIEHMANN CIRCUIT BREAKERS
5 Amperes, 115 V. 60 Cycle.
BRAND NEW..... 95¢ Ea.
10 for \$8.50

A.C. RELAY \$1.95
220 V. 60 cy. Model 506. Cutler-Hammer
SPST 15 amp. or 1/2 H.P. contacts. NEW

MOBILE DYNAMOTORS
MADE BY PIONEER AND EIGOR
6 Volts Input, 425 Volts at 375
MA Output, 6 3/4" Long, 4" Di-
ameter. Weight 10 lbs. List
Price Approx. \$70.00.
BRAND NEW, ONLY..... \$24.95

CARTER SUPER DYNAMOTOR
12 Volts Input, 400 V. Output @ 200 MA
Continuous or 375 MA Intermittent duty. Model B420.
Designed for Police, Aircraft and Marine
Use. Small, rugged and effi-
cient. \$24.95 Each
BRAND NEW, ONLY.....

CONTINENTAL MOBILE DYNAMOTORS
11.5 Volts Input, output 270 V. @
70 mills..... \$8.95 Each
11 Volts input, output 475 V. @
210 mills..... \$19.95 Each

12 VOLT D.C. ANTENNA RELAY \$1.75 Each
Micalac insulation DPDT

G. E. RELAY CONTROL
(Ideal for Model Controls, Etc.)
Contains a sigma midget 8,000 ohm, relay (trips
at less than 2 MA), high impedance choke, bi-
metal strip, neon pilot and many useful parts.
The sensitive relay alone is worth much more
than the total \$1.25 Each 10 for \$9.90
low price of.....

Panel Meters		OIL CONDENSER BARGAINS	
NEW GOVT. SURPL.	STANDARD BRANDS	4 MFD-600 VDC \$0.95	10 MFD-600 VDC 1.75
2" METERS	DB meter-10 to +20..... \$3.49	2 MFD-1000 VDC .95	4 MFD-1500 VDC 2.50
0-500 ma DC..... 3.49	0-150 UA..... 4.95	5 MFD-1500 VDC 2.95	8 MFD-1500 VDC 3.50
3" METERS	0-200 Microamps..... \$6.95	2 MFD-2000 VDC 2.50	4 MFD-2500 VDC 5.95
0-400 Microamps..... 5.95	0-500 Microamps..... 5.95	2 MFD-3000 VDC 5.95	2 MFD-4000 VDC 5.50
0-150 Milliamp..... 4.50	0-200 Milliamp..... 4.50	1 MFD-5000 VDC 3.95	2 MFD-5000 VDC 5.95
0-1000 Milliamp..... 4.50	0-150 V. DC (1 MA)..... 4.95	3.75 mfd 600 VAC..... 1.75	1 mfd 750VDC..... 2.45
0-1.5 Volts AC..... 4.95	0-3 Volts AC..... 4.95	1 12KV DC..... 2.95	.01x .01 12KV DC..... 2.95
4" METERS	0-200 Microamps..... \$8.95	5 mfd 650 VAC..... 2.95	

WIRE WOUND RESISTORS
Stock too long to list. We can supply most sizes, so order what you need.

10 Watts. From 1 Ohm to 70K Ohms..Ea. \$.15	25 Watts. From 1 Ohm to 100K Ohms..Ea. .30
50 Watts. From 5 Ohms to 100K Ohms..Ea. .40	100 Watts. From 50 Ohms to 100K Ohms..Ea. .50
ADJUSTABLE SLIDER, WIRE WOUND	10 Watts from 1 Ohm to 10K Ohms..... \$.25
25 Watts from 20 Ohms to 2.5K..... .35	

VACUUM CONDENSERS
50 mmf. 5 KV. General Electric..... \$ 5.95
100 mmf. 20 KV. Jennings..... 12.95

1 MEGOHM, 1% W.W. PRECISION RESISTORS,
SHALLCROSS.
ONLY..... 97¢ ea. 10 for \$8.95

BAKELITE CASED MICAS					
MFD	VDC	Price	MFD	VDC	Price
.001	600	\$.18	.01	1 KV	.45
.002	600	.24	.002	1200	.35
.01	600	.26	.024	1500	.65
.02	600	.28	.033	1500	.75
			.02	2500	.50

Min. Order \$3.00-25% with Order
PEAK ELECTRONICS CO.
66 West Broadway, New York 7, N. Y.
Phone WOrth 2-5439

ording tapes are now being subjected to this process at no increase in the existing price.

ATR INVERTERS

American Television & Radio Company, 300 East Fourth St., St. Paul, Minnesota has introduced a series of new models in its line of inverters.

The new units operate from 6- or



12-volt car storage batteries and provide 110 volt a.c. 60-cycle output in various wattage capacities for the operation of dictating machines, tape recorders, wire recorders, radio sets, test equipment, and other related small electrical or electronic apparatus.

Inverter models are also available for operating from other d.c. input voltages ranging from 6 volts d.c. to 220 volts d.c.

Complete literature is available from the factory.

RADIOPHONE

Communication Research & Development Co., Inc., 9530 Aurora Ave., Seattle 3, Washington is now in production on a new, self-contained radiophone which weighs only 14 pounds.

Known as the Model B-3, the set utilizes portable radio batteries and can be supplied for any frequency from 2 to 30 mc. with crystal control of both sending and receiving. The receiver uses two 1L4's, a 1R5, a 1U5,

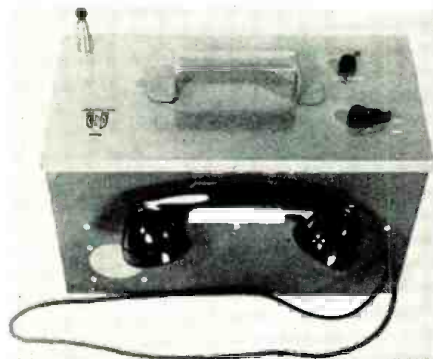

and output push-pull 3S4's. The transmitter section uses six 3S4's.

The company will supply full details on the Model B-3 on request.

METER CALIBRATOR

Kalbfell Laboratories, Inc., P. O. Box 1578, San Diego 10, California has added a meter calibrator to its "Kay-Lab" line of electronic instruments.

The Model 123 is a precision d.c. reference source which produces a cali-

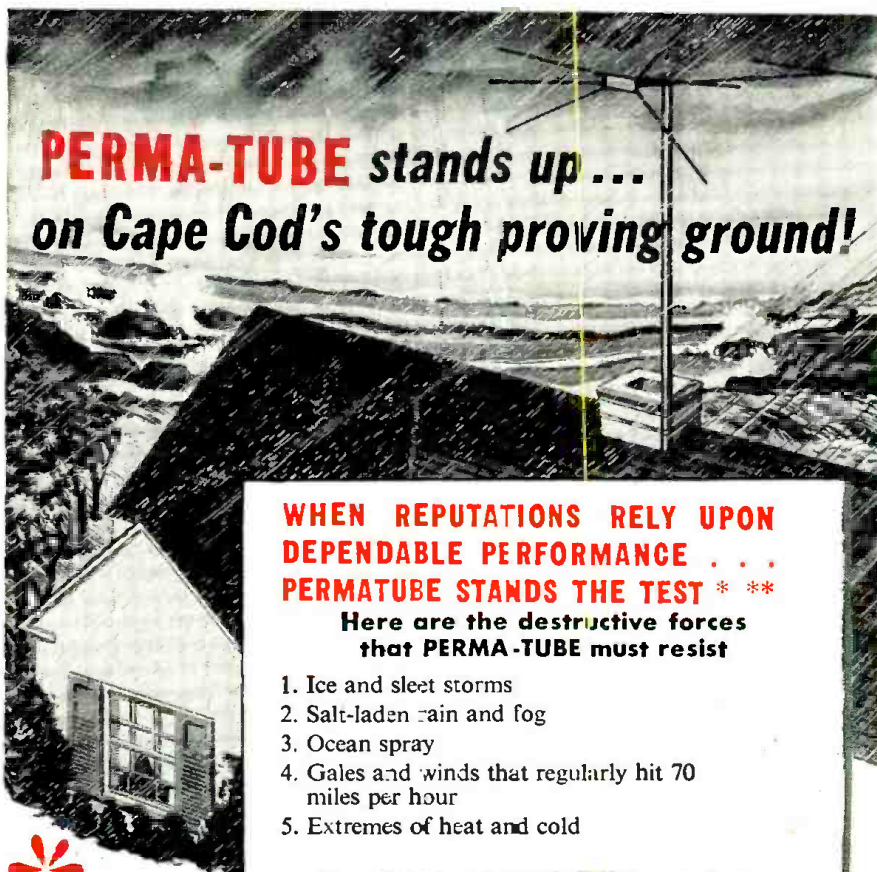

PERMA-TUBE stands up ...
on Cape Cod's tough proving ground!

**WHEN REPUTATIONS RELY UPON
DEPENDABLE PERFORMANCE . . .
PERMATUBE STANDS THE TEST * ****

**Here are the destructive forces
that PERMA-TUBE must resist**

1. Ice and sleet storms
2. Salt-laden rain and fog
3. Ocean spray
4. Gales and winds that regularly hit 70 miles per hour
5. Extremes of heat and cold

**Here's why PERMA-TUBE stands up
under the most severe conditions**

1. PERMA-TUBE is STURDY . . . it's made of special, high-strength, J&L steel.
2. PERMA-TUBE IS CORROSION-PROOF . . . it's treated with vinsynite—then coated inside and outside with a metallic vinyl resin base.
3. PERMA-TUBE IS MECHANICALLY SOUND . . . it's the only mast with both ends of the joint machine fitted.



*From the records of Ware Radio Supply Company of Brockton, Massachusetts . . . over 500,000 feet of PERMA-TUBE used on Cape Cod installations—and not a single complaint.

**From the records of Bill Perry—Cape Cod radio and television sales and service expert . . . over 1000 installations of PERMA-TUBE in three years—and not one single mast failure.

Here's proof of how Perma-Tube resists corrosion

Section of ordinary conduit tubing used for TV masts after 96 hours in a salt spray test (A.S.T.M. Designation B-117-49T) to accelerate corrosion. Extensive rust inside the mast has reduced strength—caused rusty water to drain onto the owner's home.

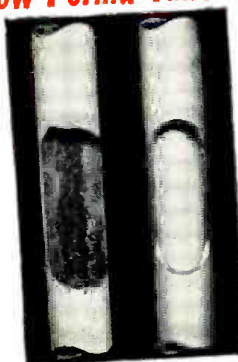

Section of PERMA-TUBE after 500 hours salt spray test shows no evidence of corrosion. Strength has been retained and the chance of rust streaks on owner's home is eliminated. Note sturdier wall thickness of PERMA-TUBE sample.

PERMA-TUBE IS AVAILABLE IN STANDARD LENGTHS . . . DIAMETERS . . . WALL THICKNESSES. FOR COMPLETE INFORMATION MAIL THIS COUPON.



Jones & Laughlin Steel Corporation
495 Gateway Center, Pittsburgh 30, Pa.

Without charge Name of nearest distributor
please send me Complete information on PERMA-TUBE

Name _____

Company _____

Address _____

The MANHATTAN

CUSTOM-BUILT TV CABINETS



2 LEADING STYLES in genuine Mahogany or Walnut (blond 10% extra). Drilled for a #630 or blank knob panel for any make TV SET. Complete as pictured for 16", 17", 20" or 21" C.R.T.

The VOGUE



H-41", W-25", D-23" H-25", W-26", D-22"

\$59³⁷ Incl. Mask, Safety Glass, Brackets, Decals, Etc. \$39⁸⁹

PARTS FOR #630 TV SETS

- TV WIRE & SOLDER KIT, for any Set..... \$ 1.49
- 630-KIT, screws, nuts, rivets, washers, etc. 1.69
- PUNCHED CHASSIS PAN, cadmium plated 4.87
- UNIVERSAL CRT MOUNTING BRACKETS. 6.97
- STANDARD CASCODE TUNER, incl. tubes. 22.49
- ESCUTCHEON PLATE, for tuner. .69
- COMPLETE SET OF KNOBS, incl. decals. 1.34
- POWER TRANSFORMER, 295ma. 20116. 9.97
- VERTICAL OUTPUT TRANS. 20412. 2.69
- VERTICAL BLOCKING TRANS. 20812. 1.32
- HORIZONTAL OUTPUT TRANS. 21115. 3.98
- FOCUS COIL, 470 ohms. 20202. 3.42
- DEFLECTION YOKE, Cosine 70° 3.98
- AGC KIT, complete with instructions. 4.59
- VIDEO AND I.F. KIT, 19 items. 7.84
- VARIABLE CONTROL KIT, 9 resistors. 7.84
- CARBON RESISTOR KIT, 107 controls. 5.83
- WIREWOUND RESISTOR KIT, 4 resistors. 6.98
- BRACKET AND SHIELD KIT, 18 items. 2.31
- ELECTROLYTIC CONDENSER KIT, 6 cond. 5.63
- TUBULAR CONDENSER KIT, 38 condensers. 7.37
- CERAMIC CONDENSER KIT, 28 condensers. 4.28
- MICA CONDENSER KIT, 11 condensers. 1.38

BROOKS RADIO & TV CORP., 84 Vesey St., Dept. B, New York 7, N. Y.



Build your own

SUPER DELUXE 31-TUBE #630 TV CHASSIS With U. H. F.

With a #630 SUPER DELUXE 31-TUBE TV KIT including your favorite U.H.F. Station. Engineered in strict adherence to the Genuine RCA #630 plus added features • OPERATES 16" to 24" PICTURE TUBES • CASCODE TUNER • COSINE YOKE • LARGER POWER TRANSFORMER • KEYED AGC • 12" SPEAKER • CONDENSERS and RESISTORS at rated capacities and tolerances. You receive a COMPLETE SET OF PARTS and TUBES, everything needed is included (loss wire & solder). All I.F. Coils and Transformers are factory pre-aligned and tuned. You will enjoy building it with "LIFE-SIZE" easy-to-follow, step-by-step ASSEMBLING INSTRUCTIONS" included with each KIT.

NOTHING BETTER AT ANY PRICE!

Only . . . \$119⁴⁴

#630 SUPER DELUXE TV CHASSIS \$157⁹⁷
Complete Ready to Play (less CRT)
..... Reduced to

#630 SPECIALS BY TECH-MASTER

No. C30. TV Chassis. A modified model retaining the outstanding characteristics of the RCA-630 circuitry plus new innovations (30 tubes). Complete (less CRT)..... \$149⁵⁰
No. 2430-9 TV Chassis. The last word in #630's. Operates the 24", 27" Rectron, and 30" Round CRT's..... \$262⁵⁰ (less CRT)

STANDARD PICTURE TUBES—1 Year Guarantee

17"—\$29.63 21"—\$44.68 24"—\$58.26

Brooks LIFE-SIZE TV Instructions, for building any #630 TV Receiver. Postpaid \$2.49

HINTS FOR BETTER PERFORMANCE on #630 TV Receiver..... Postpaid \$1.00

Brooks CASCODE MANUAL, how to install Cascode Tuner in any make TV Set. Postpaid 50¢

brated voltage essentially independent of input line voltage and output load variations.

Accurate and simple calibration of d.c. meters is afforded by this instrument. The circuit continually compares the output voltage against the internal standard cell and in this manner insures absolute calibration and stability.

The company will supply additional information on request.

TOOL CASE

Of interest to radio and television technicians is the newly-developed tool case now being offered by *General Cement Mfg. Co.*, 919 Taylor Ave., Rockford, Ill.

Designed to be worn on the belt, the new case is fitted to hold an unusually large number of hand tools. The case is molded of "Alathon," a tough and flexible material which will withstand the most rigorous service conditions.

ELECTRONIC RELAY

Servo-Tek Products Co., 1086 Goffle Road, Hawthorn, N. J. is in production on an "ultra-sensitive" electronic relay which is available for immediate delivery.

The relay action is initiated by external contact as high as one-half megohm with current as low as 1/10,000 ampere. The unit mounts on a standard 4-inch electrical connector box and will operate on 115 volts, 25-60 cycles, single phase. Other voltages and frequencies are available on special order.

POLARITY REVERSING SWITCH

Pomona Electronics Co., 524 W. 5th Avenue, Pomona, California is now



offering a meter reversing polarity switch, the Model MS-1.

The switch is designed to reverse polarity when making circuit tests without removing the test lead to the meter and can be instantly attached by plugging into test lead holes on the *Simpson* tester model 260 for which the switch was exclusively designed.

Of compact, durable phenolic construction and scientifically engineered for the technician's use, the switch is now available at local jobbers. —30—

ANOTHER OUTSTANDING JOBBER
CENTRAL RADIO SUPPLY
609 West 1st Street
Hastings, Nebraska

HAS THE SENSATIONAL NEW
EICO 1050-K 6V & 12V BATTERY ELIM. KIT
IN STOCK!

\$29.95

Att.: Schools, Labs, Hams!

Cash in on your surplus Radio Parts & Equipment!
We pay more—or trade for something you really need.
TV Sets, Mobile Equipment Available for Trade. Write Now!

HARJO SALES CO.
4109 Burbank Blvd.
Burbank, Calif. Cable HARJO

STANDARD BRANDS TUBES ALL RADIO & TV TYPES
Standard Warranty . . . Bulk Packed or Individually Boxed

1B3GT72	6AC795	6BH665	6SN7GT . . .65	19BG6G . . .1.59
1L467	6AH685	6BJ655	6T885	19T885
1R565	6AK585	6BL7GT . . .1.10	6V6GT55	25BQ6GT . . .1.10
1S473	6AL549	6BQ6GT . . .1.05	6W4GT55	25L6GT55
1S555	6AQ555	6BQ71.05	6W6GT65	35B565
1T465	6AG565	6BK795	6X5GT45	35C565
1U465	6AT645	6C445	12AT645	35L6GT60
1U555	6AU649	6C559	12AT780	35W445
1X2A73	6AV645	6CB660	12AU650	35Z542
3Q5GT78	6B4G1.10	6CD6G1.49	12AU765	50B565
3S465	6BA655	6H655	12BA655	50C565
3V465	6BC565	6J5GT50	12BE657	50L6GT60
5U4G50	6BE655	6J672	12BH775	
5Y3GT45	6BG6G1.59	6K6GT50	12SN7GT . . .65	

More than 400 types in stock, include all your needs when ordering

Orders less than \$10.00—add \$1.00 service charge. Terms: 25% with order, balance C.O.D. All prices subject to change without notice. F.O.B. New York City, mail order division.

TeleVision Materials Corp.
125 Cedar St., New York 6, N. Y. • COrtlandt 7-4307

Concord Radio presents the world's most powerful UHF-VHF-FM antenna!



MONEY BACK GUARANTEED

TO RECEIVE *All* UHF and *All* VHF STATIONS IN *All* DIRECTIONS FOR 60 MILES WITHOUT A ROTORMOTOR OF ANY KIND!!

While antenna reception is guaranteed for 60 miles, perfect pictures have been consistently received as far as 160 miles from stations.

All **NEW DESIGN FOR '54**

- LOW-LOSS SWITCH
- LOW-LOSS PHENOLIC INSULATORS
- USES NEW 4-CONDUCTOR MATCHED IMPEDANCE LINE
- ONLY 10 INCH SPACING BETWEEN ANTENNA BAYS

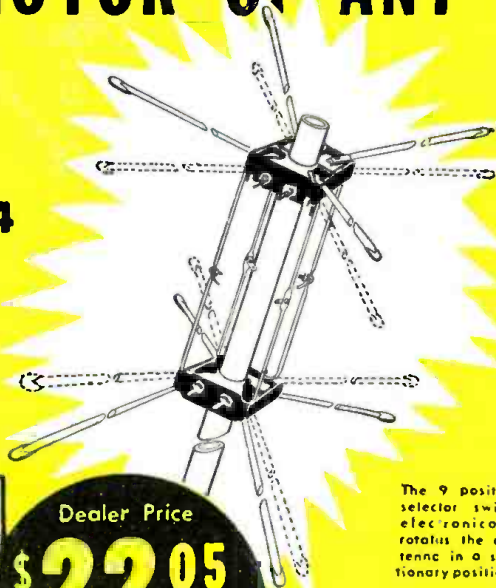

MODEL SUPER 60

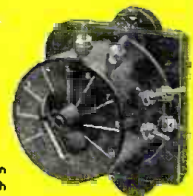

The 9 position selector switch electronically rotates the antenna in a stationary position.

PRICE INCLUDES
Complete stacked array • 4 stacking bars • 9 position switch • Switch-to-set coupler • 3 - 7 1/2" stand offs • Individually boxed in mailable carton

NEW! POLYMICALENE 4 CONDUCTOR Matched Impedance

TRANSMISSION LINE

Improves Both UHF and VHF Performance of any ALL-CHANNEL Antenna!

100 Ft. \$8.90
150 Ft. \$13.90
200 Ft. \$17.50

Minimum quantity 100 ft.

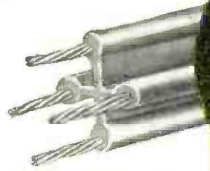

Dealer Price

\$22.05

LIST PRICE

\$36.75

Mfg. solely by

ALL CHANNEL ANTENNA CORP.

New York N. Y.

under license Pat. No's 2,585,670.

2,609,503. 2,625,655. others pending.

WRITE FOR FREE CATALOG

Concord Radio

53 Vesey Street, New York 7, N. Y. • Digby 9-1132

CONCORD RADIO 53 Vesey Street, New York 7, N. Y.

Please send me amount at \$36.95 list price.

Please send me amount at \$22.05 dealer net.

Dealers order on letterhead.

Please send mefeet of 4 conductor tubular at

Name _____

Address _____

City _____

State _____

Check Enclosed

Money Order Enclosed

C.O.D. enclosed please find 25% of total purchase price ... check ...

Money Order. Send Giant New FREE Concord Catalog at once

Please put my name on your "Special Bargain" mailing list.

() Enclosed find \$_____ in full. Send prepaid.

NEW!

NICHOLS NEVER-STAIN

Aluminum TV AND RADIO GROUND WIRE

RUST PROOF



- ★ High Electrical Conductivity
- ★ Inconspicuous — Low Reflectivity
- ★ Pliable — Specially Tempered
- ★ Etched finish — clean
- ★ STD. No. 8 B & S Ga. (.128" dia.)

Aluminum TV ANTENNA GUY CABLE

RUST PROOF



- ★ Seven — 18 Ga. Stranded Wires
- ★ Flexible — Specially Tempered
- ★ High Strength Aluminum Alloy for all Types of Antennas.
- ★ Approx. break strength — 500 lbs.



*Packed 2-500 ft. continuous coils per carton marked every 100 ft. with bright red tape.



PACKAGING DATA		
ITEM	PKG. NO.	DESCRIPTION
TV Grd. Wire	8	100 ft. coil per box, 10 boxes per ctn.
TV Grd. Wire	9°	2 - 500 ft. continuous coils.
TV Cable	50	100 ft. coil per box, 10 boxes per ctn.
TV Cable	60°	2 - 500 ft. continuous coils.

Order from your jobber or write us direct. Address Dept. TVN-3

NICHOLS WIRE & ALUMINUM CO.
DAVENPORT, IOWA
World's Largest Manufacturer of Aluminum Nails

1954 G-E TV Sets
(Continued from page 66)

noise pulse is bypassed to ground. Each noise pulse, therefore, short-circuits the sync amplifier output and the noise pulses are thus prevented from reaching the clipper grid.

Oscillographic examination of the sync amplifier output on noise-ridden signals will show actual "holes" in the composite sync and video signal. These "holes," which extend to the baseline, are the inverted noise pulses that have committed suicide.

The inherent flywheel effect of the horizontal and vertical oscillator circuits tends to maintain synchronism during periods when sync pulse output is lost at the clipper because of noise inverter action.

R_{201} and C_{222} in the grid circuit of the inverter form a filter that prevents signal voltages from appearing on this grid. This filter does not, however, impede the relatively slow changes in bias obtained from the second detector.

Switch S_{301} is a "local-fringe" switch located on the rear apron of the chas-

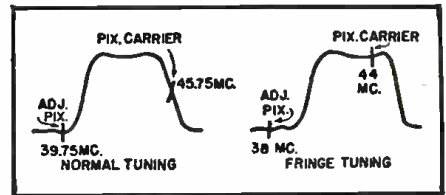

Fig. 7. Response curves for both normal and fringe areas to provide best tuning.

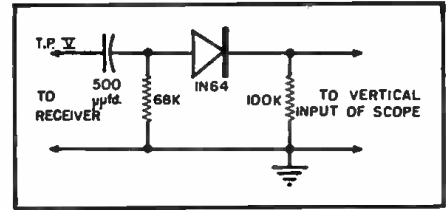

Fig. 8. Detector circuit for step 4. Table 1.

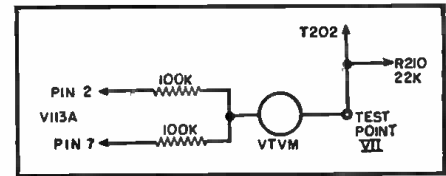
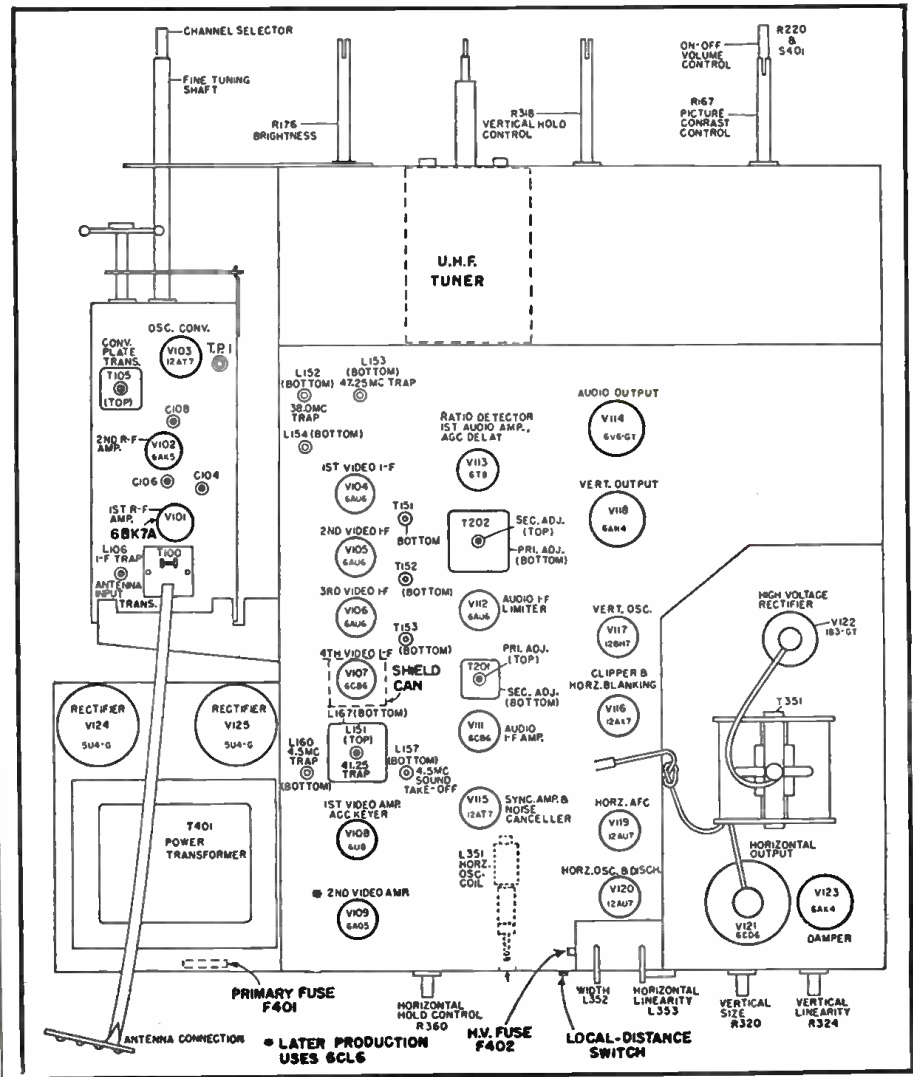

Fig. 9. Resistor network used in step 9. Table 1. The resistors are equal within 5%.

Fig. 10. Top view of the G-E "EE" chassis showing the tube and parts layout.



sis. In the "local" position, the output of the sync amplifier is reduced by decreasing the plate load; simultaneously, the cathode bias on the noise inverter is increased so that this tube will not conduct on the tips of sync pulses on strong signals.

Noise inverter test: To test the noise inverter, connect an oscilloscope to the output of the sync amplifier and obtain a relative, composite sync video level. On sets so equipped, set the "local-fringe" switch to the "fringe" position. Next, open the cathode circuit of the noise inverter or shunt R_{c10} with a 22,000 ohm resistor. Either of these operations should result in a slight increase in sync pulse level on the oscilloscope. In normal operation in strong signal areas, the noise inverter tends to "wipe-off" a small amount of sync pulse. Thus, disabling the inverter should increase sync level slightly. In noisy, fringe areas, the noise-inverting action of the circuit can be clearly observed by noting the "holes" in the video and sync signal at the sync amplifier output.

A.G.C. circuit: The pentode section of the 6U8 (V_{105B}) is employed as a keying tube whose plate supply consists of positive pulses taken from a tap on the high-voltage transformer. Since keyed a.g.c. has been covered in many previous articles, a detailed explanation of this circuit should not be necessary.

As pointed out earlier, it is highly desirable to operate the 6AK5 second r.f. stage without a.g.c. in fringe areas to obtain the best signal-to-noise ratio. This is accomplished by bucking out low a.g.c. voltage levels through a voltage divider network connected to a "B+" source. Diode V_{110C} ($\frac{1}{4}$ of a 6T8) acts as a clamp to prevent positive voltage from appearing on the 6AK5 grid. With strong signal reception, the a.g.c. voltage rises above the bucking voltage and the diode can be considered out of the circuit.

Vertical and horizontal blanking: Vertical retrace blanking is accomplished by feeding a highly positive "spike" to the cathode of the picture tube during the retrace period. This pulse is picked off the plate of the vertical output tube, sharpened up (differentiated) by R_{128} and C_{117} and applied to the picture tube cathode through R_{130} and C_{171} . V_{116B} , the horizontal blanking triode, performs no function in the vertical blanking operation.

Horizontal blanking is accomplished by again feeding a positive pulse to the cathode of the picture tube during the horizontal retrace period, thus driving the tube to cut-off. V_{116B} , the horizontal blanking tube, is connected as a cathode follower. Positive pulses, picked off the high-voltage transformer through C_{300} are applied to the grid of the blanking triode. These pulses appear in the same polarity but at a lower impedance at the cathode of the blanker and are then fed to the picture tube cathode.



"Of the very best!"

—HIGH FIDELITY MAGAZINE

FISHER

SERIES "50"

■ It is only natural that more than one manufacturer will claim *his* product is the best. For that reason it remains for *you* to be the judge. We say—*demand the specs.* Then check workmanship, performance and beauty of appearance. If you do all these things, the answer will inevitably be . . . THE FISHER SERIES "50." There is no finer made.

THE FISHER Master Audio Control MODEL 50-C

■ "One of the finest units yet offered to the enthusiast or audio engineer." —*Radio and TV News.* Can be used with *any* amplifier. IM distortion virtually unmeasurable. Complete, professional equalization settings and tone controls; genuine F-M loudness control; five inputs, five independent input level controls, two cathode follower outputs. Self-powered.

Chassis, \$89.50 • With blonde or dark cabinet, \$97.50

THE FISHER FM-AM Tuner MODEL 50-R

■ Features *extreme sensitivity* (1.5 mv for 20 db of quieting); *low distortion* (less than 0.04% for 1 volt output); *low hum* (more than 100 db below 2 volts output.) Armstrong system, *adjustable AFC* with switch, *adjustable* AM selectivity, separate FM and AM front ends (shock-mounted), cathode follower output, fully shielded, aluminum chassis, self-powered.

THE FISHER 50-Watt Amplifier MODEL 50-A

■ Truly the world's finest all-triode amplifier, yet moderately priced. A man's size unit! Less than 1% distortion at 50 watts; (.08% at 10 watts.) IM distortion below 2% at 50 watts. Uniform response within .1 db from 20 to 20,000 cycles; 1 db, 5 to 100,000 cycles. Hum and noise more than 96 db below full output. Quality components throughout. **\$159.50**

Prices slightly higher west of the Rockies

WRITE TODAY FOR COMPLETE SPECIFICATIONS

FISHER RADIO CORPORATION • 39 EAST 47th STREET • N. Y.

TACO BROAD-BAND YAGIS PROVIDE...

POWER plus BROAD-TUNING

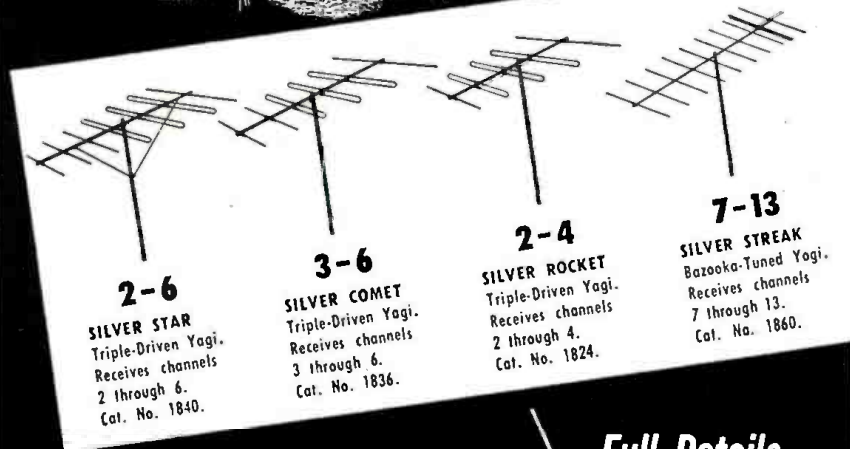

TACO

TECHNICAL APPLIANCE CORP.
Sherburne, New York

In Canada: Hackbusch Electronics, Ltd., Toronto 4, Ontario

Full Details
at your TACO
DISTRIBUTOR

Let MILTON S. KIVER Help You
Prepare For U.H.F.-TV
And...

TELEVISION SERVICING

Easy to TRAIN AT HOME This Practical Way!

Men with the right training in Television Servicing are in big demand... pull down big pay. T.C.I. TRAINS YOU RIGHT with easy-to-follow technical training designed by servicemen, for servicemen! You learn practical, professional type Television Servicing without leaving your present job. Included are money-making extras such as set conversion, master antenna installation, U.H.F.-TV and field servicing short cuts. You can start earning Television money after the first few lessons. You learn to test, trouble shoot and repair all types of TV sets the proven, practical way!

HERE'S HOW YOU GET EXPERIENCE!

You train on your own large screen modern television receiver, furnished as part of your course. This set is yours to keep! As an optional feature you can get two weeks of actual field experience out on service jobs and on the repair bench for Chicago's largest independent servicing organization. You learn Television Servicing by actually doing Television Servicing... you get the practical know-how you need to qualify for BIG MONEY in this fast-growing field! Age is no barrier, Many TCI students are over 40!

VETERANS!
T.C.I. is approved
for G.I. training
under Public Law
850. Check coupon.

ACT NOW! Mail coupon for
FREE Catalog and SAMPLE
LESSON. Write TODAY!

TELEVISION COMMUNICATIONS INSTITUTE

205 W. Wacker Dr., Dept. AS Chicago 6, Ill.

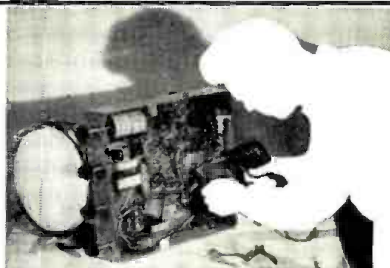

YOU GET and keep modern large screen Television receiver.

YOU DO actual testing, servicing, trouble shooting and repairing

**BEGINNERS! LEARN ABOUT
NEW BASIC TV COURSE!**
You don't need radio experience for practical, home-study training in Basic Television. Start earning money in TV after first few easy lessons. Check coupon for details.

MAIL NOW FOR FREE BOOKLET

MILTON S. KIVER, President
TELEVISION COMMUNICATIONS INSTITUTE
205 W. Wacker Dr., Dept. AS, Chicago 6, Ill.

Rush full facts on practical TV training. I am not obligated. Salesman will not call.

Name Veterans: check here
Address
City Zone State
 BEGINNERS check here for information on Basic Television Course.

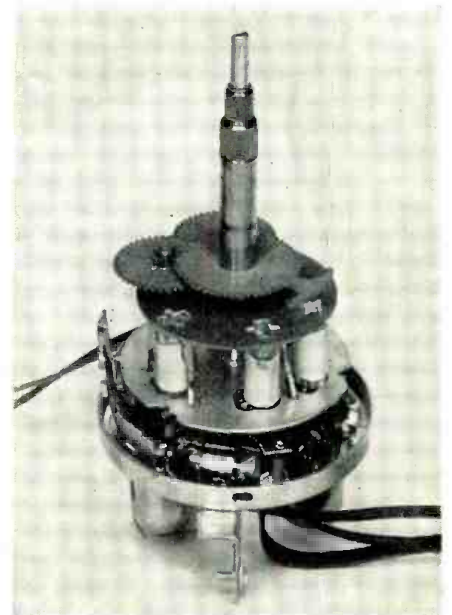

Fig. 11. The G-E "U.H.F. 70" converter shown with the shield can removed. Note that the crystal is held by spring clips.

It will be noted that the brightness control is ganged to a potentiometer in the screen circuit of the 6CD6 horizontal output stage. Increasing the brightness setting therefore automatically increases 6CD6 screen voltage. This arrangement tends to counteract picture "blooming" caused by increasing current drain from the high voltage supply.

The primary line fuse, F_{4012} is located behind a protective cover on the rear apron of the power-supply chassis. A low-voltage tap on the transformer primary is brought out to a second set of fuse contacts, hence, full output from the power supply can be maintained in low voltage (105 volt) areas by switching the fuse to the second set of contacts on the fuse block.

U.H.F. Converter

The "U.H.F.-70" converter can be identified in Fig. 1 as the round "coffee-can" occupying the front-center position on the chassis.

The circuitry consists of a 1N72 crystal mixer, 6AF4 local oscillator, and a 6BK7A cascade amplifier as shown in Fig. 5. Output of the converter is factory-set to Channel 5; but this can be shifted easily to Channel 6 in the field should interference problems arise. Tuning elements in the mixer and oscillator circuits are quarter-wave transmission lines in coiled form (as seen on the turret in Fig. 11). Tuning is accomplished by silver-plated slugs threaded into the coiled lines to act as shorting bars.

Three sets of tuning elements are used in a turret-switching arrangement. In the continuous tuning position, the slugs are driven through a gear and vernier arrangement from the dual front-panel u.h.f. control. The second knob on this control actuates the turret assembly permitting selection of the continuous tuning range or

AIREX'S FALL TV RIOT!

LOW PRICES... SENSATIONAL VALUES

ONLY **\$169⁹⁵** GETS YOU THE
TOPS IN
INTERMEDIATE
AREA TV
RECEPTION



\$169⁹⁵

FED. TAX INCL.
In Blond—\$10 Additional

SENSATIONAL FEATURES FOUND ONLY IN HIGH PRICE SETS

- Limiter ratio detector—FM Sound
- Separate high & low sync clippers
- Standard coil 4 circuit tuner
- Retrace Blanking Circuit
- 3 1/2 watts audio output
- Automatic Gain Control
- Built-in antenna
- 3 stage 6CB6 IF system
- Automatic frequency control
- Easily adaptable to UHF

• Beautiful Mahogany all wood cabinet

17 INCH TABLE MODEL—**\$139.95** FED. TAX INCL.

21 INCH TABLE MODEL—**\$159.95** FED. TAX INCL.

IN BLOND—\$10 ADDITIONAL

1 YEAR PICTURE TUBE WARRANTY. 3 MONTHS RMA GUAR. TUBES & PARTS

Airex complete 21 inch
Console Model...Just
plug in and play...

You'll enjoy the sensational
clarity of picture quality and
the lovely tone of this specially
designed set. It gives you the
ultimate in reception in Metro-
politan and Suburban areas.
The finest of parts are used to
assure you trouble free opera-
tion.

FREE DELIVERY* On 630 FA-2 Chassis
And Cabinets

3 MONTHS

RMA
GUAR.
ON ALL
PARTS

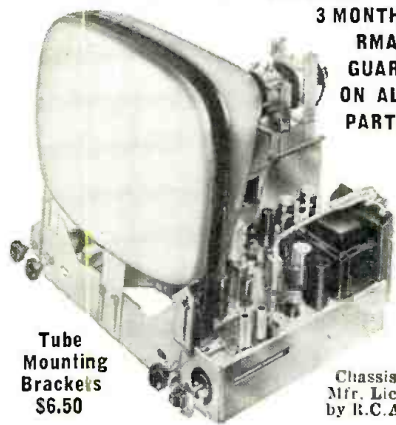

Tube
Mounting
Brackets
\$6.50

Chassis
Mfr. Lic.
by R.C.A.

New 1953 Co-Channel 630 FA-2... with genuine FM Armstrong sound system

Here is the most powerful fringe area
chassis on the market today... the one
TV engineers and servicemen are buying
for themselves. Clear, sharp, exceptional
reception up to 200 miles.

CHECK THESE EXCLUSIVE FEATURES

- 10 WATT push-pull audio output. Frequency range from 40 to 12,000 cycles • 3 position fringe area switch • Delayed graded AGC system • Standard Coil Cascade Tuner prevents radiation • Retrace Blanking Circuit allows you to raise the brightness without the annoying vertical retrace lines • Heavy duty front focus control • Automatic gain control potentiometer allows you to adjust the threshold sensitivity as low as 4 microvolts & still keep the full 4 MC band width • Improved sync amplifier • Improved automatic brightness control • Set aligned for 21.9 MC. New Ham band will not interfere • Improved fused high voltage power supply gives full 14.5 KV under load. Will handle all picture tubes up to 24 inch with full sweep • Improved video amplifier has a gain of 40 • All moulded plastic condensers give long life & trouble-free operation • Easily adapted to new UHF stations in 2 minutes by just changing a strip in the tuner • Extra heavy duty power transformer with lagre safety factor • 6CB6 tubes in Video IF to give full gain • Extra filtering in power supply for hum & ripple-free operation • Phono Connection & switch on chassis allows you to play your phonograph or tuner through the built-in 10 watt hi-fidelity amplifier • Extra heavy duty focus coil, which runs cool • Full focus cosine yoke.

THE ONLY CHASSIS WITH
PUSH-PULL AUDIO OUTPUT AT

\$169⁹⁵

Fed. Tax
Included

Less C.R. Tube
and Brackets

Complete with 12" ROLA Hi-Fi Speaker
Detailed Service Manual & Schematic—\$1

* Free Delivery in U. S. Only

OVER 100 BARGAIN-PRICED CABINETS FOR TV AND AUDIO INSTALLATIONS

... Send for FREE folder and price list. Full
line table models, consoles, consolettes and TV-
Radio Phono combinations. Many styles, Mahog-
any, blonde, etc.

TUBES AT WHOLESALE

PRICES SLASHED—UP TO 90% OFF!

BRAND NEW—BOXED—100% GUAR. 3 MOS.

1B3—70c	6AT6—45c	6X5—41c	7G7—83c
1R5—64c	6AU6—50c	6Y6—66c	12AT6—45c
1R5—64c	6AV6—45c	6RA6—52c	12AT7—77c
1T4—65c	6AX4—67c	6RC5—62c	12AV6—50c
1U4—64c	6P6M—52c	6RE6—54c	12AU7—62c
1U5—53c	6HF6—56c	6RF5—62c	12AV7—81c
1X2A—71c	6J5—47c	6BG6—1.47	12BA6—52c
3Q4—69c	6J6—69c	6BH6—65c	12BE6—54c
3S4—65c	6KE—48c	6BL6—56c	12BH7—72c
3V4—65c	6L6G—87c	6BK7—82c	12SA7—57c
5U4—45c	6S4—51c	6BL7—91c	12SK7—57c
5V4—82c	6SA7—57c	6RN6—81c	12SN7—62c
5Y3—37c	6SK7—57c	6BQ6—98c	12SQ7—49c
6AB4—53c	6SL7—69c	6BQ7—92c	25L6—54c
6AC7—89c	6SN7—62c	6BZ7—1.02	35W4—38c
6AG5—61c	6SQ7—49c	6C4—44c	35Y4—42c
6AH6—1.17	6T8—85c	6CB6—61c	3Z5—38c
6AK5—1.11	6U8—85c	6CD6—1.82	50A5—55c
6AL5—49c	6V6—53c	7A4—20c	50B5—55c
6AQ5—55c	6W4—53c	7A6—19c	50L6—54c
6AQ6—49c	6X4—41c	7F8—95c	117Z3—47c

DISCOUNTS: 50-100... 5%; 100-250... 10%;
OVER 250... 20%

Minimum order 10 tubes. Send 50% deposit with tube order.

SEND FOR FREE NEW TV PARTS & HI-FI CATALOG

TV PICTURE TUBE SALE

Standard Brands. Fact. New.
Guar. 1 full year.

- 16" Tube \$26.95
- 17" Tube \$27.95
- 20" Tube \$34.95
- 21" Tube \$39.95
- 24" Tube \$79.95
- (Guar. 6 Mos.) \$79.95
- Ring and Sleeve for 24" \$7.50

TV Gold Plastic Masks

- 16" and 17" \$ 4.95
- 20" and 21" \$ 7.95
- 24" \$14.95

Bargain Cabinet Buy!

Beautiful mahogany consolette
Cabinet cut for 630
FA-2 Chassis. Complete
with mask, glass & tube
mounting brackets
In Blond \$59.95

\$4995

SEND POSTCARD TO BE PUT
ON MAILING LIST

All merchandise is brand new, factory fresh & fully guaranteed. Mail & phone orders filled upon receipt of certified check or money order for \$25 as deposit on TV chassis. 20% on other items. Balance C.O.D.. P.O.B. N. Y. Prices & specifications subject to change without notice. NO FED. TAXES TO PAY.

AIREX RADIO CORP.

SHOWROOM: 171 Washington St., N. Y. 7, N.Y.

MAIL ORDER DEPT.: 400 Lafayette St., N. Y. 3

4 for 53 NEW Trav-Electric CONVERTERS

CHANGE 6 OR 12 VOLT D.C. TO 110 VOLT A.C. 60 CYCLE
Just plug into Cigar Lighter on Dash.



Trav-Electric Super
Model 6-71160
60 cycle
60-75 Watts
\$37.95 LIST

Size 4" x 5" x 6"

Operates

- Wire Recorders
- Dictating Machines
- Amplifiers
- Turntables
- Soldering Iron
- Small Electric Drill



Trav-Electric Master
Model 6-51160
60 cycle
40-50 Watts
\$24.95 LIST

Size 4" x 5" x 6"

Operates

- Curling Irons
- Small Dictating Machines
- Radios
- Test Equipment, etc.
- Turntables
- Portable Phonographs



Trav-Electric Senior
Model 6-11160
60 cycle
35-40 Watts
\$15.95 LIST

Size 2 1/2" x 2 1/2" x 4 1/2"

Operates

- Test Equipment
- Short, Long Wave Radios
- Turntables
- Portable Phonographs
- Lights
- Electric Shavers, etc.



Trav-Electric Midget
Model 6-11160
60 cycle
10-15 Watts
\$11.95 LIST

Size 2" x 2" x 3 1/2"

Operates Test Equipment, All Electric Shavers

Fully Guaranteed

See Your Jobber or Dealer

TERADO COMPANY

MFRS. OF PRECISION EQUIPMENT

1068 RAYMOND AVE. • ST. PAUL 14, MINN.

In Canada write: Atlas Radio Corp., Ltd.
560 King St. West, Toronto 28, Ont.

Export Sales Division: Scheel International, Inc.,
4237 N. Lincoln Ave., Chicago 18, Ill., U. S. A.
Cable Address—Harscheel

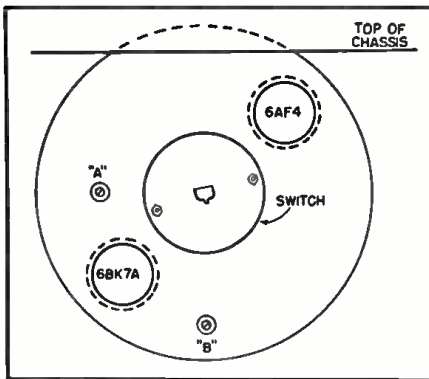

Fig. 12. Rear view of "U.H.F. 70" tuner showing location of i.f. adjustments.

the two "click" positions. A fourth position on this switch disables the u.h.f. converter and permits v.h.f. reception.

Reference to the main chassis photograph (Fig. 1) will show two openings in the front of the u.h.f. tuner which permit access to the mixer and oscillator tuning adjustments. Removal of the u.h.f. knobs on the receiver permits these adjustments to be reached without chassis removal and enables the service technician to tune the two "click" positions to local u.h.f. stations in the area. Viewed from the front, the left opening is for the mixer circuit and the right opening is for the local oscillator.

Tune-up on the click positions consists merely of first tuning the oscillator slug until the station is received and then peaking the mixer slug for maximum signal. The v.h.f. selector should be set on Channel 5 and the v.h.f. fine tuning control set to the center of its range. Two responses will be noted as the oscillator slug is turned clockwise (increasing frequency). The first response obtained as the slug is turned clockwise is the correct one. A second response will show up as the slug is turned further, this being the image response in which the oscillator is tuned above the incoming signal. It may be necessary to rotate the continuous tuning knob slightly to reach the slugs because the cam-gear arrangement cov-

ers up one of the adjustments in the course of its travel.

No adjustment is required if only the continuous tuning range is employed because mixer and oscillator slug tuning is ganged and tracked at the factory.

When adjusting the r.f. and oscillator tuning slugs be careful not to exert any pressure in the extreme clockwise direction as the coil can become distorted, making it difficult to turn the slug. Also, be careful not to scrape the coil loops when inserting the screwdriver. A fiber rod type of screwdriver should be used.

If i.f. output on Channel 6 is required because of a local station on Channel 5, refer to Fig. 12, showing the rear view of the u.h.f. tuner, and the i.f. adjusting screws. These adjustments are underneath the chassis and can be reached on most models through the trap door opening at the bottom of the cabinet. Turn core "A" (i.f. output transformer) three turns counterclockwise. Turn core "B" (i.f. input coil) two and one-half turns counterclockwise. Since the i.f. response of the 6BK7A is fairly broad, these adjustments are not overly critical.

Table 1 contains the procedure to be followed when aligning the video i.f., sound i.f., and trap circuits of the receiver. Before performing the alignment, however, do the following:

1. Remove the plate cap from V_{121} , the 6CD6 horizontal output tube. Temporarily connect a 2500 ohm, 25 watt resistor from the 260 volt "B+" point to chassis.

2. Remove V_{113} , the 12AT7 sync amplifier and noise inverter, from its socket.

3. Turn the volume control to minimum and the picture contrast control to maximum. Turn the brightness control fully counterclockwise.

4. Set the channel selector to the Channel 11 position. Set the fine tuning control to its maximum counterclockwise position.

5. Allow the receiver and test equipment to warm up for twenty minutes. Proceed to step 1 on Table 1.

-30-

Allied Radio Corporation's new two-million dollar home at 100 N. Western Avenue in Chicago. Reputed to be the world's largest plant for the distribution of electronic equipment, the two-story structure provides a total area of 147,000 square feet. Ultra-modern, air-conditioned salesrooms and warehousing, shipping and receiving sections occupy the first floor area. Offices, reception rooms, and the company's cafeteria are located on the second floor. The expansion was dictated by the fact that the company's 1954 catalogue lists 20,000 separate items as against 8,000 items carried shortly after the war. A system of pneumatic tubes and conveyor belts is used in the new building to speed order handling and movement of merchandise. The new location, ten minutes from Chicago's Loop, also offers ample parking facilities.



Send for Your
FREE
Copy of the **NEW 1954**
MIDWEST
TELEVISION and
RADIO Catalog

MIDWEST *Presents*

For 1954 a Completely **NEW LINE** of
21" and 27" TELEVISION

CONSOLES
TABLE MODELS

and
COMPLETE CHASSIS

at
LOW FACTORY PRICES



YOUR CHOICE OF EITHER 12 CHANNEL VHF or All-Channel VHF-UHF Models

Buy your Television or Radio Direct from the Midwest Factory . . . on **30 DAYS TRIAL** . . . Easy Terms . . . and at **LOW FACTORY PRICES**. For 34 years Midwest, the world's largest and oldest exclusive Factory-To-You radio and television manufacturer, has served hundreds of thousands of satisfied customers all over the world.



EASY TERMS
— • —
30 DAYS TRIAL



All models available in your choice of mahogany, walnut finish or blond lined oak.

FACTORY-TO-YOU

Also—Powerful New 1954 World-Ranging
MIDWEST Series 16 RADIOS
In Beautiful Consoles and Complete Chassis

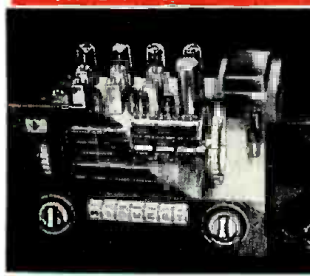

Once again Midwest offers its famous series 16 five band AM-FM radio chassis and the magnificent new Symphony Grand Radio-Phonograph with 3-Speed Automatic Intermix Record Player. Also, a complete line of clock radios, table radios, and portables.

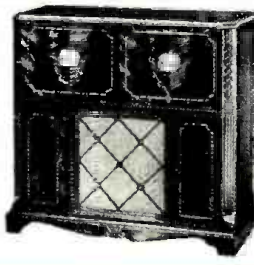

WRITE IN NAME AND ADDRESS (PLEASE PRINT) ON COUPON OR 2c POSTCARD

MIDWEST RADIO & TELEVISION CORP.
Dept. B-37, 909 BROADWAY • CINCINNATI 2, OHIO
Please send me your new FREE 1954 Catalog.

NAME _____
ADDRESS _____
CITY _____ ZONE _____ STATE _____

MIDWEST RADIO & TELEVISION CORP.
DEPT. B-37, 909 BROADWAY, CINCINNATI 2, OHIO

We Predict
the New

BROOK

MODEL 22A

Is Destined
To Create
A Sensation!



10-watt
single-chassis
power and pre-
amplifier combination

- ... so dramatically different, it's a new concept in amplifier design.
- ... so functionally compact, it simplifies any installation.
- ... so exceptionally attractive, it captivates at first glance.
- ... But, FOREMOST, so genuine in HIGH QUALITY AUDIO PERFORMANCE, despite it's unprecedented low cost.

SEE and HEAR the Model 22A BROOK "Junior" at the AUDIO FAIR—Room 511, Hotel New Yorker, October 14-17. Write for descriptive and technical data, also name of nearest local dealer.

Dept. RK-3

BROOK ELECTRONICS, INC.

Find us in the High-Quality Audio Field From 1974
34 DeHART PLACE, ELIZABETH, N. J.

SELENIUM D. C. VOLTAGE REGULATORS

By HARRY BRAVERMAN
Signal Corps Engineering Labs.

Take advantage of the non-linear characteristics of selenium rectifiers to provide useful regulation.

A DEVICE used in voltage regulating circuits to provide a relatively constant output voltage regardless of changes in load current or input voltage is called a voltage regulator. The non-linear characteristic of selenium regulators (rectifiers) makes it particularly useful for regulation purposes.

Heretofore, selenium regulators used in electronic equipment were made of rectifier plates which were not specifically designed for this purpose. This caused considerable difficulty for equipment design engineers, since regulator circuits are usually critical with regard to stability of operation. Selenium plates produced for regulators are manufactured by slightly different techniques than those used for commercial rectifier stacks. The manufacture of the former plates is an intricate process requiring high technical skill, engineering know-how, and the maintenance of rigidly controlled specifications for each step in the manufacturing process.

The curves shown in Figs. 2 and 3 are taken from tests made at the Signal Corp Engineering Laboratories on units of one manufacturer of these selenium regulators. The 2X2 type consists of two selenium plates, 1¼" x 1¼", connected in series on a mounting bracket. This unit is recommended for the regulation of d.c. voltages on the order of 2 volts and constitutes the basic design of a series of regulators for other voltages. For example, units consisting of three or four plates in series are designated as 2X3 and 2X4 respectively. As more plates are added to the basic design, the regulating voltage can be extended to any practical range in the low voltage field. For good regulation, this series of regulators is de-

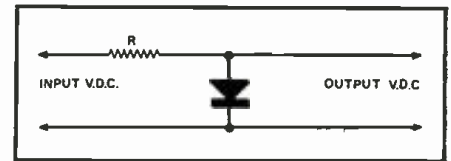

Fig. 1. A basic d.c. regulator circuit.

signed to operate in the range of 150 to 450 ma. In applications utilizing a regulated voltage, with load current in excess of the maximum rating of one regulator, two or more regulators may be placed in series and parallel respectively or else one regulator of another type, e.g., type 2X4, 2X6, etc. may be used.

For regulating d.c. voltages, the regulator is connected in shunt (See Fig. 1). Regulation is accomplished by utilizing the forward characteristic shown in Fig. 2. For example, when the voltage is as required, a normal current flows through the regulator. If, in the operation of the equipment, the load current decreases, the voltage across the load rises. With this increased voltage across the regulator, the regulator current will be higher. However, this higher current drain causes a larger voltage drop across *R* (Fig. 1) and the load voltage drops to its normal value. On the other hand, if the load current increases, the load voltage will drop. At this lower voltage, the regulator will draw less current causing a lower drop across *R* and thereby increasing the load voltage to its original value. Similarly, the regulator will keep the load voltage relatively constant regardless of changes in the input voltage.

It will be noted that in Fig. 3, the volt-ampere characteristic shifts to the right as the temperature is decreased. This shift, which is well

Fig. 2. Regulation characteristics for various regulators. See text for discussion.

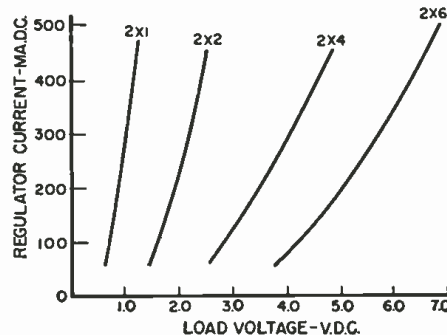
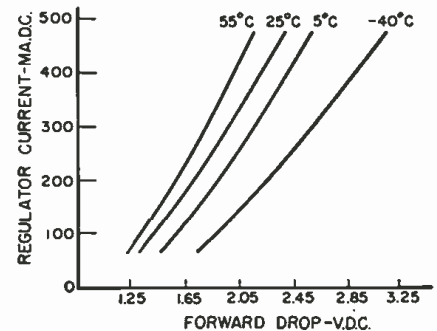

Fig. 3. Variation of regulation characteristics with temperature. Refer to text.



HERE'S THE **WORLD'S GREATEST SCOPE KIT . . .**
NEW, FULL 8½" **OSCILLOSCOPE** *by* **precise**

THE OSCILLOSCOPE YOU'VE BEEN SEEKING . . . NO OTHER OSCILLOSCOPE AT ANY PRICE HAS ALL THESE DESIRABLE FEATURES * AVAILABLE IN BOTH KIT AND WIRED FORM



**HERE ARE JUST A FEW
OF THE
BIG VALUES
IN THE NEW 156 PAGE
1954 B-A CATALOG**

**WRITE US, IF YOU HAVE NOT
RECEIVED IT**

**35 MA—130 VOLT
SELENIUM RECTIFIER**

EACH
35c



Very compact 3/4"x1/2" dia. in tubular fibre sleeve, sealed with high temp. wax—easy to mount anywhere with the self supporting 2" tinned wire leads.

An exact replacement for Standard B51 and many other TV boosters and ideal for countless other rectifier needs.

No. 15A1172 **35c** 10 Lots **29c**
Spec. Ea..... Each.....

6AK5 TUBES

6 FOR
\$4.79



INSULATED RESISTORS



100
ASSTD.
\$1.49

Do not confuse with non-insulated, foreign makes etc. offered by others. 50 Assorted top quality 1/2 watt insulated resistors in most popular capacities.

17A871. Per Ass't. of 50. **99c**

ASSORTMENT OF 100

Consists of 75-1/2 watt and 25-1 watt insulated top quality resistors
No. 19B796

Per Assortment of 100..... **\$1.49**

**36 MOLDED PLASTIC
TUBULAR
CONDENSERS**

\$11.70 List Value

\$3.88

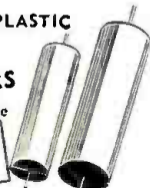

known for selenium rectifiers, must be taken into account when designing the selenium regulator into equipment. It is sometimes necessary to stabilize the cells over the entire temperature range to be encountered in the operation of the equipment. If this is not done, the regulator, after being subjected to a cycle or more of extreme temperature, will shift the characteristic and consequently the regulation voltage of the circuit.

These selenium regulators are produced to operate within a small tolerance band by carefully controlled production techniques and are readily available from normal production. When narrower tolerances are required due to rigid circuit requirements, the desired units are obtainable by more careful selection with, of course, a corresponding increase in cost to the user.

In conclusion, it is recommended that problems on individual applications may best be solved by working very closely with the manufacturer of these selenium regulators.

-50-

TV SERVICE HINT

By JACK DARR

A 1952 17-inch Philco TV table model receiver with the D-1 deflection chassis had a very weak and fuzzy picture, with the screen dark most of the time. Although adjustment of the brightness and contrast controls would bring the picture back momentarily, it would be badly out of focus and soon disappear.

Brightness and contrast controls were checked and found OK, as were all the tubes associated with the power supply, video amplifier, and video output. In the deflection chassis, there was a distinct "whispering" sound such as that associated with a large corona discharge. Although the high-voltage cage was shielded very well, no glow was visible; however, the odor of ozone was quite plain. Finally, the set was turned on—and left on for two or three minutes. A small, thin line of fire was seen crawling around the bottom of one of the 2.5-megohm special filter resistors (R₁₀₆) in the high-voltage circuit. Tested, this resistor was found to be open, and the other one (R₁₀₇) had increased to nearly 4 megohms. The resistor had failed internally, and this refused to show up until the fire broke through the paint.

Replacement of this bad resistor cured the trouble. These are special resistors, 2.5 megohms for the 17-inch tubes, and 2 megohms for the 20-inch tubes. They are located just inside the doghouse, from the 1B3CT socket to a terminal strip located near the top cap of the 1X2 doubler.

-50-

Portion of the Philco D-1 chassis circuit showing source of possible service fault.

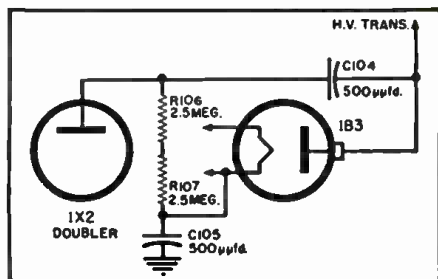

October, 1953

BARGAINS · BARGAINS · BARGAINS

Famous
STEVE-EL
BRANDED

TUBES

All Brand New
Individually Boxed
FAR BELOW WHOLESALE COST!

1A7	50.59	6AX4	52.65A	44 7K7	.62	6BL6	.48
1B3	.63	6BA6	52.65A7	52 12A6	.48	6C5	.42
1P5	.54	6BE6	45.65G7	49 12AT7	.48	6CS6	.47
1R5	.56	6BD5	58.65K7	49 12AT7	.68	6DL6	.48
155	.48	6BD7	56.65L7	52 12AV6	.52	6EW5	.48
1U4	.48	6BH6	48.65N7	54 12AU7	.56	6F5	.47
1U5	.48	6BH6	1.21 65Q7	42 12AX7	.68	6G5	.48
3V4	.48	6BH6	62.65R7	44 12AZ7	.94	6N6	.38
5W4	.48	6BJ6	53.67B	74 12BA6	.46	6P7	.36
6A8	.51	6BN6	.74 6U6	57 12BE6	.59	6R5	.48
6AG5	.62	6C4	.34 6U8	78 12BE6	.46	6X4	.48
6AK5	1.14	6CB6	.48 6V6GT	46 12SL7	.57	6Y4	.48
6AL5	.43	6CD5	1.21 6V8	63 12SF7	.54	6Z5	.48
6AU6	.43	6F6	.49 6W4	45 12AF7	.54	6Z5	.48
6AV6	.37	6J5	.37 6W6	52 12AN7	.64	6Z5	.48
6AS5	.49	6J6	.79 6X4	34 12AT7	.78	6Z5	.48
6AQ5	.39	6K6	.41 6X5	37 58Q6	.71	6Z5	.48
6AT6	.37	6L6G	.89 17N7	52 12SW4	.42	6Z5	.48

SPECIAL DISCOUNTS
50 Asst. } 5%
100 Asst. } 10%

INTERCOM SPECIAL



Now you can own an intercom that has a thousand uses at a price you would normally pay for a kit. This intercom comes housed in wooden cabinets completely wired and ready to operate. Outfit consists of one master, one sub station and fifty feet of two wire cable. Ideal for home as baby sitter. Perfect for office or factory. Order now as quantities are limited.

YOUR COST COMPLETE only.. \$1595

AC-DC SUPERHET 5 TUBE RADIO KIT

Easy to build. Complete with all parts, plastic cabinet and step by step schematic drawings. Standard broadcast 550 to 1600 K.C.—2. I.F. transformers 455 K.C. Alnico Speaker. Built in antenna. Slide rule dial. Walnut cabinet.

Only \$1.89

STEVE-EL now carries full line of Eico, E.M.C., Pilot, Tech-Master, Pentron, Wen Products, Burgess, Shure, etc. Write for free catalog.

STEVE-EL ELECTRONICS CORP.

Dept. N-10 61 Reade St., New York 7, N. Y. COrtland 7-0086

CUT HOLES 1/2 to 3 1/2 IN RADIO CHASSIS



WITH A GREENLEE RADIO CHASSIS PUNCH

● Save hours of work... no reaming or tedious filing. Punch cuts through chassis quickly... makes accurate, clean holes for sockets, plugs, and other receptacles. Just turn with an ordinary wrench. There's a GREENLEE Punch in each of these sizes: 1/2", 5/8", 3/4", 7/8", 1", 1 1/8", 1 1/4", 1 1/2", 1 3/4", 1 1/2", 1 3/4", 1 7/8", 2", 2 1/4". Write for facts. Also get information on Knockout Punches and Cutters for conduit and meter holes up to 3 1/2". Greenlee Tool Co., 1890 Columbia Avenue, Rockford, Illinois.



SPECIAL VALUES

- TV Alignment Signal Generator channels 1-13 Sound & Video crystal controlled. \$ 850.00
- Hazeltine Model 1314, 1317 Complete. EXC. 1200.00
- Lit-1 Frequency Meter 160KC.-30MC. EXC. 225.00
- TS-34/AP Frequency Meter 8700-9500MC. EXC. 99.50
- HC-121 & LM Freq. Meters. EXC. 350.00
- Signal Generator Ferris 14C 75-30,000KC. EXC. 900.00
- TS-12/AP X Band Test Sets Complete. EXC. 590.00
- TS-13/AP X Band Signal Generator. EXC. 400.00
- Model 80 Signal Generator—Measurements Co. NEW 590.00
- 804C Signal Generator 8-300MC. EXC. 600.00
- TS-146/UP X Band Signal Generator. EXC. 125.00
- ME1/U RF Wattmeter. NEW 225.00
- AN/SGC-1 Teletype Terminal Set. LIKE NEW 275.00
- Capacitance Bridge—General Radio 711B EXC. 275.00
- Impedance Bridge—General Radio 161A EXC. 225.00
- A LARGE STOCK OF ARC-1, ARC-3, ART-13, APN4A, APN4B, APR4, ARC, BC-312, BC-342, BC-348, BC-433G, BC-611, BC-1306, CMT-3, 196A, 1222, 1E-19A, 1E-35A, 1E-36A, SCR-284, SCR-322, SCR-578, SCR-625, TCS, T19/AP45, TS-34/AP, TS-100/AP, TS-184/AP, 14C, Plus and Selsyns. PUI*

WANTED

All types of radio and electronic surplus. We especially need: APA10, APN9, APR4, ARN4, ARC1, ARC3, ART13, ATC, BC221, BC342, BC348, BC611, HC721, DY12, DY17, 1100, LM10 to LM18, MG149F, MG-49H, PU14, R5/ARN7, R5A/ARN7, SCR18C, TCS, TS16, TN17, TN19, TN54, TN52, TS18/AP, TS33, TS51, TS45, TS75, TS76, TS102, TS147/UP, TS148/UP, TS173, T14, TS175, TS250, TS251, TS323, (ICT, IF, IG, 5CT, 6DG, 5F, 5G, 6DG, 6G 115V, 60 c.p.s. Selsyns), and all types of Hewlett Packard, General Radio Co., Measurements Corp., Boonton Radio, Ferris, Leeds & Northrup, and other test equipment.

Please state accurate description, condition, and your lowest price. Explain modification, if any. We pay freight charges.

NEW CATALOG NOW AVAILABLE
PHOTOCON SALES
417 N. Foothill Blvd. SYcamore 2-4131
Pasadena 8, California RYan 1-6751
CABLE: PHOTOCON, PASADENA

Windsor TUBES

RADIO & TV RECEIVING

**TESTED and
GUARANTEED
for PEAK
PERFORMANCE!**

TO MERIT YOUR CONFIDENCE—to insure your satisfaction—Every tube we ship has been tested in a radio or TV set for **PEAK PERFORMANCE**. Each tube is attractively packaged in individual carton—and, each WINDSOR Tube you buy carries the full RTMA GUARANTEE!

Type	Each	Type	Each	Type	Each	Type	Each	Type	Each	Type	Each	Type	Each
1A7GT	\$.67	5U4G	\$.44	6BN6	\$.98	6W4GT	\$.50	7L7	\$.85				
1B3GT	\$.69	5V4G	\$.83	6BQ6GT	\$.98	6W6GT	\$.63	7N7	\$.62				
1C6	1.06	5Y3GT	\$.32	6BQ7	\$.92	6X4	\$.37	7Q7	\$.62				
1E7GT	1.09	5Y4G	\$.43	6BZ7	1.09	6X5GT	\$.36	7R7	\$.70				
1H5GT	\$.51	6AB4	\$.51	6C4	\$.41	6Y6G	\$.64	7S7	\$.90				
1L4	\$.63	6AG5	\$.59	6CB6	\$.58	7A4/XXL	\$.57	7V7	\$.92	Type	Each		
1L6	\$.66	6AH4	\$.68	6CD6G	2.04	7A5	\$.70	7X6	\$.62	1466	\$.70		
1LA4	\$.82	6AK5	1.05	6E5	\$.72	7A6	\$.57	7Y4	\$.45	14E7	\$.85		
1LA6	\$.80	6AL5	\$.44	6F5GT	\$.54	7A7	\$.58	7Z4	\$.50	14F7	\$.69		
1LB4	\$.82	6AQ5	\$.51	6J5GT	\$.44	7A8	\$.56	12AT6	\$.53	14C7	\$.70		
1LC5	\$.80	6AQ6	\$.47	6J6	\$.68	7AD7	1.05	12AT7	\$.75	14F8	\$.99		
1LC6	\$.80	6AQ7	\$.75	6J7	\$.70	7AF7	\$.63	12AU6	\$.47	14J7	\$.85		
1LD5	\$.80	6AR5	\$.42	6K6GT	\$.45	7AG7	\$.65	12AU7	\$.58	14N7	\$.75		
1LE3	\$.80	6AS5	\$.55	6K7	\$.70	7AH7	\$.65	12AV6	\$.41	14Q7	\$.62		
1LG5	\$.80	6AT6	\$.42	6L6G	\$.88	7AJ7	\$.70	12AV7	\$.87	14R7	\$.85		
1LH4	\$.80	6AU6	\$.47	6L6GA	\$.88	7B4	\$.70	12AX4	\$.72	14S7	\$.80		
1LN5	\$.80	6AV6	\$.41	6Q7GT	\$.55	7B5	\$.51	12AX7	\$.67	19B6G	1.53		
1N5GT	\$.63	6AX4	\$.72	6S4	\$.51	7B6	\$.52	12AY7	2.15	19T8	\$.87		
1R5	\$.62	6BA6	\$.50	6S8GT	\$.75	7B7	\$.58	12BA6	\$.50	25BQ6GT	\$.98		
1S4	\$.67	6BA7	\$.66	6SA7GT	\$.57	7C4	1.05	12BA7	\$.66	25L6GT	\$.53		
1S5	\$.52	6BC5	\$.58	6SC7	\$.63	7C5	\$.56	12BD6	\$.51	25W4GT	\$.53		
1T4	\$.62	6BD5GT	\$.98	6SD7	\$.55	7C6	\$.50	12BE6	\$.52	25Z6GT	\$.46		
1T5GT	\$.78	6BD6	\$.54	6SF5GT	\$.66	7C7	\$.58	12BH7	\$.69	35A5	\$.55		
1U4	\$.61	6BE6	\$.51	6SH7GT	\$.52	7E5	\$.85	12SA7GT	\$.57	35B5	\$.53		
1U5	\$.51	6BF5	\$.66	6K6GT	\$.45	7E6	\$.65	12SK7GT	\$.55	35C5	\$.53		
1X2A	\$.74	6BF6	\$.43	6SL7GT	\$.68	7E7	\$.85	12SL7GT	\$.67	35L6GT	\$.52		
2X2	1.43	6BG6G	1.47	6SN7GT	\$.59	7F7	\$.69	12SN7GT	\$.59	35Z5GT	\$.33		
3Q4	\$.66	6BH6	\$.63	6SQ7GT	\$.46	7F8	\$.97	12SQ7GT	\$.46	50A5	\$.55		
3Q5GT	\$.72	6BJ6	\$.53	6T8	\$.85	7G7	\$.85	14A7	\$.58	50B5	\$.52		
3S4	\$.61	6BK5	\$.76	6U8	\$.86	7H7	\$.61	14AF7	\$.68	50C5	\$.52		
3V4	\$.62	6BK7	\$.97	6V3	1.09	7J7	\$.85	14B6	\$.50	50L6GT	\$.52		
5R4GY	1.00	6BL7GT	\$.94	6V6GT	\$.51	7K7	\$.85	14C5	\$.85	117Z3	\$.43		



WRITE FOR Additional Tube Types and Prices. We also stock Special Purpose and Transmitting Tubes at similar savings!

25% DEPOSIT with Order. All Merchandise F.O.B. New York City. For orders less than \$10, add \$1 handling cost. Deduct 2% if full remittance accompanies order. All merchandise subject to prior sale and price change without notice. Dept. N-10.

Windsor ELECTRONIC TUBE CO.
1515-N SHEEPSHEAD BAY ROAD, BROOKLYN 35, N. Y.

STOP

Volume Control Noise!

"NO NOISE"

Contains the amazing new

PERMA-FILM

- ★ **CLEANS!**
Gets rid of dirt and oxidation immediately on contact.
- ★ **LUBRICATES!**
One drop eliminates scratch, hum and noise.
- ★ **PROTECTS!**
NEW Perma-Film assures continued top performance.

The PERFECT Contact Restorer
Cleans and restores volume controls, hand switches, push button assemblies, electrical contacts.

- **NOT A CARBON TET SOLUTION**
NO NOISE is a scientific formula especially compounded for contacts!

Available in 8 oz. bottle, quart cans and 6 oz. spray can. 2 oz. Net to Servicemen

\$1.00

Nearest Distributor or order direct from
ELECTRONIC CHEMICAL CORP.
813 Communipaw Ave., Jersey City 4, N. J.

(Advertisement)

"Dancing's a lot more exciting when we use a JENSEN NEEDLE!"

The "Con-VI"

(Continued from page 85)

to operate on 16 cycles, 160 cycles, or 16,000 cycles. These frequency multiples were chosen to provide the widest range with a minimum of overlapping within the range of the instrument. The output of the oscillator is fed into a 6AQ5 power amplifier which produces a maximum of approximately 18 volts output. The calibrating control R_{12} is used to adjust the output in the calibrating position S_2 to 10 volts on the v.t.v.m.

The a.c. output of the 6AQ5 appears across R_{15} . Resistor R_{16} serves to keep the electrolytic coupling condenser charged up and prevents terminals C and L , and those of the v.t.v.m. from being "hot." The output voltage is then fed in series with either a 100-ohm resistor to measure capacitance, or a one-megohm resistor to measure inductance. The v.t.v.m. is then switched by S_2 to either read the output across R_{15} in the "CAL" position; the voltage across the 100-ohm resistor in the C position; or the voltage from the L terminal to ground in the L position.

A standard full-wave power supply furnishes 250 volts at the output of the filter and adequately takes care of the d.c. requirements of the unit.

The unit can be quite comfortably fitted in a 6"x6"x6" utility cabinet as shown in the photographs of the unit. The chassis is a 5"x5½" aluminum shelf fastened to the front panel. If the constructor desires to use another layout, the usual precautions applicable to amplifier-oscillator construction apply, i.e., keep a reasonable distance between grid leads of the 12AT7 and any a.c. carrying leads and components. More specifically, keep the power transformer away from the 12AT7 and switch S_1 entirely.

Another wiring precaution—and one which is peculiar to this instrument only—is to keep the internal stray wiring capacity associated with the C terminal and the 100-ohm resistor, R_{16} , to an absolute minimum. Any stray capacitance at this point will show up on the v.t.v.m. as a capacitance, thus upsetting the accuracy on the lower portion of the low (100 $\mu\mu\text{fd.}$) capacitance range.

With the meter in the .01 position, shielding of the meter leads becomes mandatory to reduce stray pick-up. Millen plug #37212 and terminals similar to those used on the v.t.v.m. provide a uniform, convenient, and fast method of hooking up the instrument to the v.t.v.m., particularly since the a.c. v.t.v.m. will probably be used for other applications as well. These same terminals were used to provide a quick changeover from capacitance to inductance measurement. In this case, an extra Millen #37222 post was spaced an equal ¼ inch from both the C and L terminals on the panel. Thus to change from capacitance to inductance

NOW ON SALE!

an exciting array of the world's greatest pictures as selected by the Editors of PHOTOGRAPHY magazine.

with a symposium on Photography Today by the distinguished judges of PHOTOGRAPHY magazine's \$25,000.00 Picture Contest for 1953; Norris Harkness—Wilson Hicks—Irving Penn—Arthur Rothstein—W. Eugene Smith—Frank Zachary.

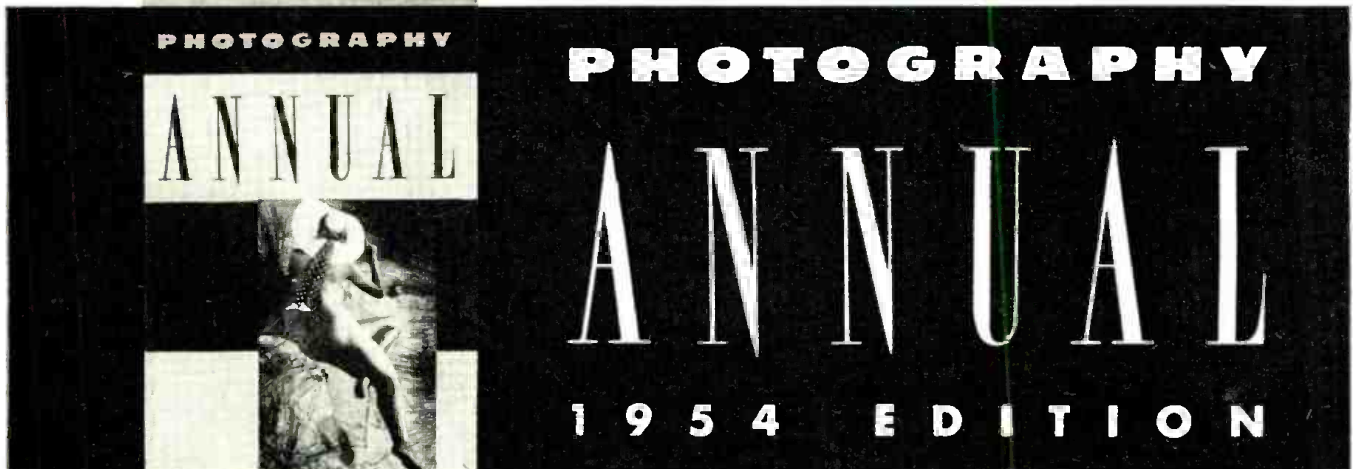

OVER 250 PICTURES! —

Complete technical data on every picture! Each basic technique thoroughly explained.

24 PAGES OF BRILLIANT COLOR!

PORTFOLIOS BY FAMOUS PHOTOGRAPHERS!

5 BIG SECTIONS LOADED WITH KNOW-HOW, INSPIRATION, NEW IDEAS!

- Camera Techniques...the shutter...the aperture... lenses, what they do... points of view... offbeat effects... technique of color...
- Light at Work... Daylight-down to dusk... after dark... flash, floods and spots... electronic flash... available light... filters... lighting for color...
- In the Darkroom... printing problems... darkroom magic...
- Top Amateur Color... slides... stereos...
- The Approach to Pictures.

PHOTOGRAPHY ANNUAL — THE PERFECT GIFT — THE IDEAL ADDITION TO EVERY PHOTOGRAPHIC LIBRARY.

Reserve your copies at your Newsdealer—Camera Store—Bookshop



ZIFF-DAVIS Publishing Company, Publishers of: PHOTOGRAPHY magazine—PHOTOGRAPHY Annual—MODERN BRIDE—FLYING—RADIO & TELEVISION NEWS—RADIO-ELECTRONIC ENGINEERING Edition of RADIO & TELEVISION NEWS—FICTION GROUP—G.I. JOE Comics.

PHOTOGRAPHY ANNUAL • 1954 EDITION

BIG TALK about small rotary switches

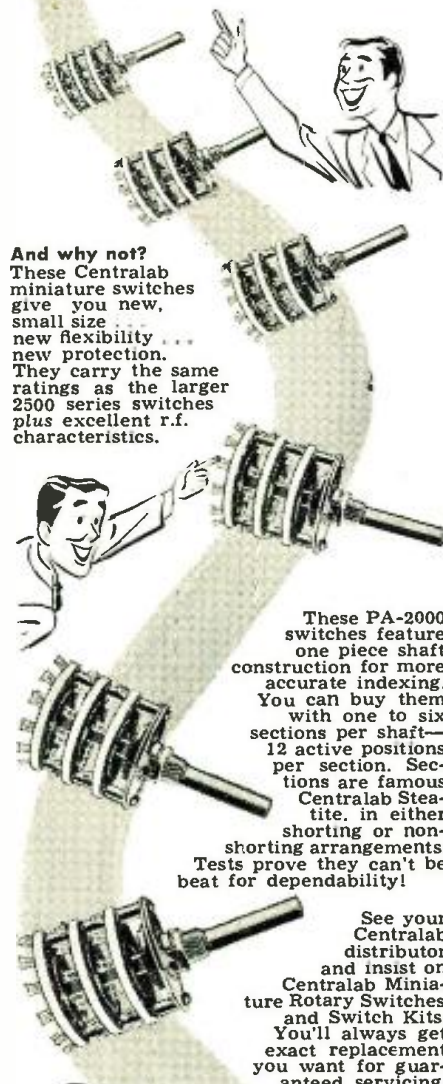

And why not? These Centralab miniature switches give you new, small size, new flexibility... new protection. They carry the same ratings as the larger 2500 series switches plus excellent r.f. characteristics.

These PA-2000 switches feature one piece shaft construction for more accurate indexing. You can buy them with one to six sections per shaft—12 active positions per section. Sections are famous Centralab Steatite, in either shorting or non-shorting arrangements. Tests prove they can't be beat for dependability!

See your Centralab distributor and insist on Centralab Miniature Rotary Switches and Switch Kits. You'll always get exact replacement you want for guaranteed servicing.

BUY 'EM AS COMPLETE SWITCHES OR SEPARATE ASSEMBLIES. STEATITE SECTIONS, INDEXES, HARDWARE AND ACCESSORIES ALWAYS AVAILABLE.

Centralab

CENTRALAB, A Division of Globe-Union Inc. 910-J.E. Keefe Ave., Milwaukee 1, Wis. Please send me technical data on Centralab Miniature Rotary Switches and Kits.

Name.....
Firm.....
Address.....
City.....Zone.....State.....

tance measurement, it is only necessary to remove the plug from the C terminal and ground and re-insert it in the L terminal and ground.

A replica of the scale used on this instrument is shown in Fig. 6. This chart-like scale eliminates the inevitable confusion which would result in trying to figure out which oscillator frequency setting goes with which meter setting, for what capacitance—if you see what I mean! In this case, the capacitance full scale markings are in red, the inductance in blue, and the other markings in black. This makes the scale easily readable. A piece of thin lucite is fastened over the scale with self-tapping screws.

There is only one adjustment necessary on the "Con-VI" after construction has been completed. Adjust potentiometer R_1 until the waveform of the output with the unit in the "CAL" position is a pure sine wave. This can be observed on an oscilloscope hooked up to the v.t.v.m. terminals.

To operate the "Con-VI," hook the unknown L or C to the proper terminals, i.e., between the L or C terminal and ground. Set switch S_1 to the "CAL" position. Adjust the calibrate control to produce a reading of 10 volts on the v.t.v.m. Set selector switch S_2 to the appropriate range. This also indicates the correct v.t.v.m. range. Set switch S_3 to either L or C, as the case may be. Read the v.t.v.m. meter scale, and that's it. Actually the procedure is a lot simpler to do than describe.

To compensate for small errors and variations in the oscillator frequency and the v.t.v.m., the output voltage in the "calibrate" position can be varied from the 10 volt setting previously described. Just how much the 10 volt setting should be varied can be determined by substituting a known condenser and adjusting the calibrate control to produce the exact value reading on the v.t.v.m. Switching back to the "CAL" position will show how much compensation is necessary. However errors of this sort should be very small.

The unit "in action" is shown in Fig. 1. The a.c. v.t.v.m. shown is the Heathkit AV-2. Other units, such as those made by Ballantine and Hewlett-Packard, will serve equally as well. The Hewlett-Packard model 400-C, which has full scale readings of .001 volt, can be used to extend the range of the "Con-VI" down to 1 millihenry and 10 micromicrofarads full scale.

Fig. 6. Detail of the scale used on "Con-VI."

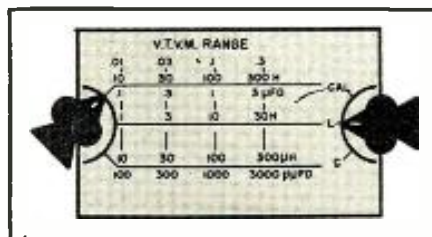

The Magnemite*

Battery-Operated Spring-Motor Portable Recorder

Field recordings can now be made with equivalent quality and with as little effort as studio console recordings. Smaller than a portable typewriter (11½ x 10 x 8 inches) and weighing 15 lbs. including the dry-cell batteries that last 100 operating hours, the Magnemite* is easily carried and operated anywhere.

Here are truly professional specifications:

- Model 610-SD (7½ ips, 50 to 7500 cycles meets NARTB standards.
- Model 610-E (15 ips, 50 to 15,000 cycles) meets primary NARTB standards.
- Dynamic range 50 db.
- Flutter ± 0.1%.
- Constant speed governor-controlled.
- Monitoring and playback facilities.

Write for complete technical literature and direct factory prices to Dept. RT:



AMPLIFIER CORP. of AMERICA

398 Broadway, N. Y. 13, N. Y.

*Trade Mark Reg. Pat. Pend.

L. A. HAM SHACK SELLS FOR LESS

METERS—WESTON · SANGAMO

ALL NEW · ALL O. C. · 2" SQUARE

0-5 Ma	} EACH or 3 for \$9.00
0-15 Ma	
0-50 Ma	
0-100 Ma	
0-200 Ma	
0-300 Ma	
0-2 Ma \$3.95	

Mfg'r's inquiries: lots over 100

Voltmeter, 2" sq.—0 to 20 Volts	\$3.29
DC Voltmeter, 2" sq.—0 to 300 Volts w/Ext. resistance, Complete	\$3.95
RF Ampmeter, 2" sq.—0 to .5 Amp.	\$3.95
Ampmeter, 2" rd.—0 to 50 Amps.	\$3.29
Ampmeter, 2" sq.—0 to 50 Amps.	\$3.29
3" Round Meters, DC, All New, 0-15, 0-30, 0-300 Mills.	\$4.95 Each
Milliammeters, 2½" rd.—0-30 Mills.	Each \$3.95
Milliammeters, 2" rd.—0-50 Ma, 0 to 5 Ma. movement.	Each \$3.29
Thermocouple, 2" rd. 350 Milliamp. HF.	\$3.29
"S" METER, Illuminated face. Full scale reading of 5 ma. A standard value for most "S" Meter Circuits. 2½". Black face. New.	\$2.49
Amp. Meter, No. 60-0-60. New.	\$1.29

COMMAND AND/OR ARC 5 TRANSMITTERS and RECEIVERS

3-6 MC Receiver	Used \$7.95—New \$17.95
6-9.1 Receiver	Used 7.95—New 14.95
Triple Receiver Rack	1.95
V.H.F. ARC 5 Transmitter or Receiver, Complete w/tubes	Used 24.95
ARC-4 w/tubes. Good	Used 22.95
4-5.3 MC Transmitter with tubes	\$ 8.95
5.3-7 MC Transmitter with tubes	8.95
7-9.1 MC Transmitter with tubes	10.95
3-4 MC Transmitter with tubes	18.95
Trans. & Choke Combination	\$5.95
PR1: 115V. 60 cy.	SEC: 5.0V 2.0A
SEC: 5.0V 3.0A	412/710 VCT
6.4V 1.2A	225 MA. 6.4V 10.4A

DYNAMOTORS—NEW:

BD-77	\$24.95	PE-73	\$9.95
-------	---------	-------	--------

HEAD SETS HS-33	New \$4.95
HS-30, single only	New .95
HS-23	Used \$2.95
Matching Transformer for HS-30	.69

Cash with order. Calif. orders include 3½% Sales Tax. Please include approximate postage

—excess refunded.
L.A. HAM SHACK
1306 Bond Street, at Pico, Los Angeles 15, Calif.

Spot Radio News
(Continued from page 18)

will be any revolutionary new developments insofar as systems are concerned, which would suggest any reason for changing these standards at any time in the foreseeable future."

One balky problem was cited in this supporting bid for color; the color tube. Thus far, this manufacturer declared, the tubes demonstrated and for which . . . "production plans have been asserted, give only a small picture and are complicated and costly to produce." The big job ahead, they feel, revolves about the development of a . . . "simplified, large-screen color tube that can be manufactured at reasonable cost." Such a project, they said, will involve a . . . "great deal of invention and engineering work." However, they added, it is felt that it should be possible to meet this goal within two or three years.

The compatible color set and particularly its variable design features, possible because of the flexibility of the proposed standards, were aptly described in the petition, too. Noting that there is . . . "considerable leeway in the design of receivers in use with the NTSC standards . . ." it was pointed that it is likely that . . . "manufacturers . . . will have different ideas as to the optimum design of color receivers."

The Commission has received one color set for test and is expected to have many more during the next few weeks for study. All will be probed for ease of operation, lack of critical color controls and registration, and the prospective cost to consumers.

One of the extremely bright items on the color front was announced a few days before NTSC filed. The telephone company labs declared that they have developed a wide-band coax carrier system; a 4.2 megacycle affair, called the L-3 design. The labs say that the system has been so designed that high quality results will obtain after 4000 miles of transmission. Featured in the new link are line repeaters spaced at approximately four-mile intervals, and connecting terminal or dropping repeaters. In addition, along the route, are equalization equipment, power generating, and power transmission plus maintenance equipment, at 100 to 200-mile intervals.

This new broadband transmission system will not only insure a striking quality to networked color signals, but to black and white transmission, for it represents nearly a 100% improvement over the present cables.

While color broadcasting does not involve too many changes in the actual transmitter, an array of complementary equipment is required for pickup and feed. According to one supplier, several assortments will be available, depending on the specific colorcasting schedules involved. For

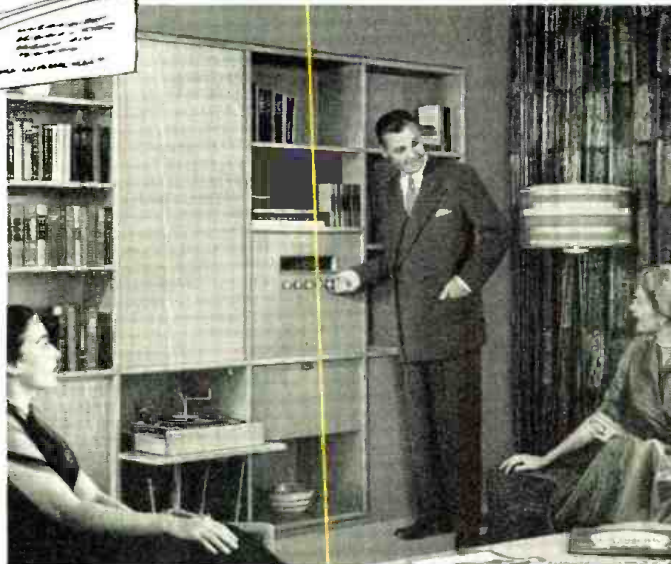
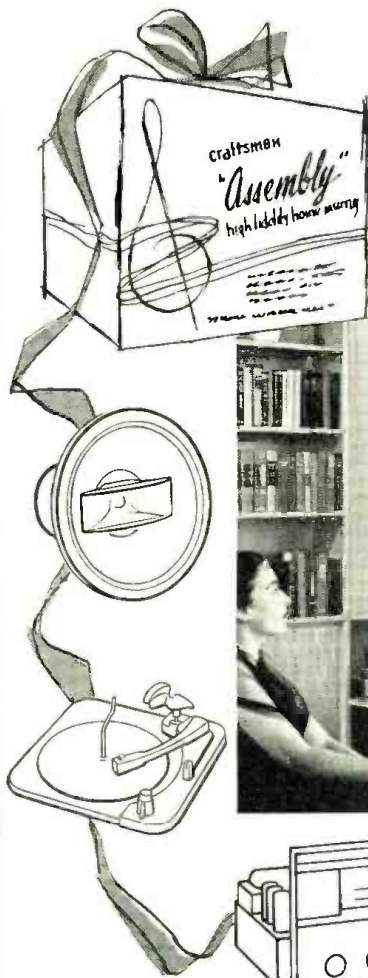

An *Altogether* new idea for music lovers!

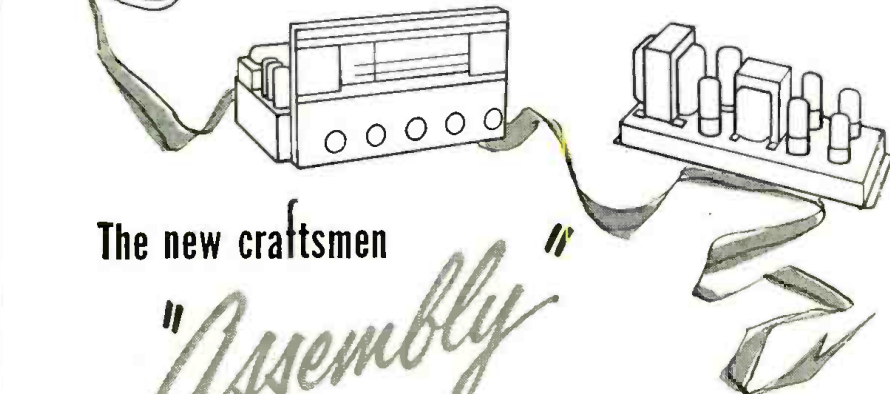

The new craftsmen
"Assembly"
high fidelity home music system

DID YOU KNOW that buried away in your own phonograph records there's a treasure of beautiful music you probably have never heard? It's true! Today's High Fidelity recording (and broadcasting) techniques bring you music with a clarity and tonal range never before possible outside the concert hall.

To enjoy this full measure of realism, you need an instrument capable of reproducing all the music without distortion—a High Fidelity home music system.

Now, in one package, the world's most respected name in High Fidelity brings you a complete system of perfectly matched units—the Craftsmen "ASSEMBLY."

You get the performance-proved Craftsmen FM-AM Tuner and Amplifier

. . . two new Craftsmen speakers coaxially mounted and 3-speed record player with dual sapphire magnetic pick-up . . . many accessories, too.

The Craftsmen "ASSEMBLY" is waiting for your critical ear in the sound rooms of a Radio Parts Supplier near you. Drop in today for a demonstration of *distinctly* better listening.

Send for this booklet on High Fidelity by DEEMS TAYLOR

Ask your Supplier for a copy of this 24-page booklet by Deems Taylor—or write to us, enclosing 10¢ to cover handling and mailing.



high fidelity by craftsmen® means distinctly better listening

The Radio Craftsmen, Inc., Dept. R-10, 4401 N. Ravenswood Ave., Chicago 40, Illinois

Train IN
Great COYNE shops
for big pay jobs

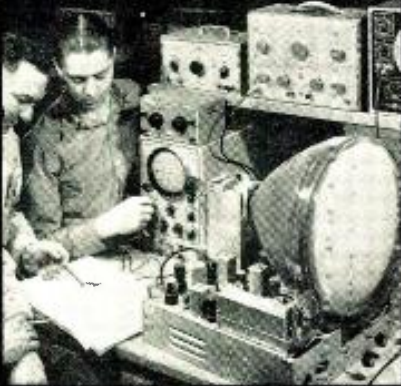

IN Television
-Radio



OR
Electricity
-ELECTRONICS

Learn on REAL EQUIPMENT!
in Best Equipped School of its
kind in U. S.

Prepare for your future NOW! Come to the Great Shops of Coyne. Get practical training in opportunity fields—TELEVISION-RADIO—ELECTRICITY—ELECTRONICS. Prepare for a better job in Industry or better service rating if drafted.

WE TRAIN YOU IN CHICAGO

At Coyne you learn on real, full-size equipment. Trained instructors show you how, then you do shop jobs yourself. No previous experience or advanced education needed.

Approved for Veterans

Finance Plan—Enroll now, pay most of tuition later. If you need part-time work to help out with living expenses while at Coyne, we'll help you get it. Special tuition plan for men of draft age.

FREE BOOK Clip coupon for Big Free Illustrated Book. No salesman will call. Act NOW.

COYNE
[SCHOOL]

510 S. Paulina St., Dept. 73-85H
Established 1899
APPROVED for VETERANS

E. W. COOKE, Pres.
COYNE School
510 S. Paulina St., Chicago 12, Ill., Dept. 73-85H
Send FREE BOOK and full details on:
 TELEVISION-RADIO ELECTRICITY

NAME
ADDRESS.....
CITY.....STATE.....

broadcasting of network programs only, necessary equipment will include two color-stabilizing amplifiers, and a tri-color monitor with picture tube. For locally-originated color programs, gear needed can include a color slide camera chain, a color film chain, color studio-camera chain, which can consist of a color camera without or with three matched image orthicons. In addition, stations will need test equipment featuring a color bar generator.

Many TV casters are so convinced that the big push in color will begin next summer that they have already entered their orders for local and network equipment. Set makers are equally optimistic, declaring that at least 50,000 tri-color receivers will be made in '54.

SUBSCRIPTION TV and theater TV, a couple of acute headaches plaguing the Commission, have dropped into the halls of Congress and attracted the attention of a Representative from California, Carl Hinshaw. Feeling that both of these forms of transmission are beyond the spheres of actual broadcasting, he has introduced a bill asking that they be placed in the public-utilities category, so that the FCC can set tariffs and rates for types of service rendered, with return entitled on investment as a consideration for such schedules.

The measure, under study by the House Interstate and Foreign Commerce Committee, could prevent the Commission from approving subscription TV as a division of broadcasting.

Presentation of the bill will also probably postpone any immediate consideration of "pay-as-you-see" TV by the Commission, since now FCC mem-

bers will probably be called on to testify before the House committee, and they will not meet again until next year when the second session of the 83rd Congress convenes.

The Congressman declared that he offered his bill to permit a clarification of the law involving charges for radio or TV programs. He also felt that pay-TV should be probed by Congress since it introduces a new type of public service, warranting strict control. Several members of the House committee concurred in this view, and undoubtedly next winter will see a full-scale review of the subject.

EDITOR'S NOTE: For details on one type of "pay-as-you-see" television system see "Skiatron's Subscriber-Vision," page 58 of this issue.

In the meantime, the FCC has been requested by four ultra-high-channel holders to approve the use of subscription TV on their stations. Such a plan, it was said, was urgently needed now, for it would enable these broadcasters to meet competition from network stations operating on the standard bands.

Those who made the plea include the Home News Publishing Co., New Brunswick, WDHN-TV, Channel 47; Pennsylvania Broadcasting Co., Philadelphia, WIP-TV, Channel 29; Stamford-Norwalk Television Corp., Stamford, Conn., Channel 27; and Connecticut Radio Foundation, New Haven, WELI-TV, Channel 59.

COMMUNITY TV, another problem child, has appeared on the FCC docket during the past few weeks. An application has been received from the Mountain States Telephone and Telegraph Company, in Denver, asking for permission to build six microwave

NEW TV GRANTS SINCE FREEZE LIFT

Continuing the listing of construction permits granted by FCC since lifting of freeze. Additional stations will be carried next month.

STATE	CITY	CALL**	CHANNEL	FREQUENCY (mc.)	POWER* (Video)
Illinois	Champaign-Urbana	21	512-518	16.2
Maine	Poland	8	180-186	105
"	Portland	WCSH†	6	82-88	100
"	Lewiston	WLAM†	17	488-494	15.8
Massachusetts	Brockton	62	758-764	195
Mississippi	Jackson	WSLI†	12	204-210	214
Nebraska	Kearney	13	210-216	56.2
New York	Utica	19	500-506	52.5
North Carolina	Wilmington	WMFD-TV†	6	82-88	53.7
"	Winston-Salem	12	204-210	316
Oklahoma	Oklahoma City	9	186-192	316
South Carolina	Greenville	4	66-72	100
"	Spartanburg	17	488-494	105
Tennessee	Nashville	WSIX†	8	180-186	316
Texas	Midland	2	54-60	10
"	Weslaco	KRGV-TV†	5	78-82	28.8
West Virginia	Fairmont	WVVW†	35	596-602	17.4
Virginia	Portsmouth	WLOW†	27	548-554	89.1
Alaska	Anchorage	2	54-60	13.8
"	Fairbanks	(Sharing air time with)	2	54-60	13.8
"	Anchorage	11	198-204	18.2

*ERP = (effective radiated power, kw.). .. = Call letters to be announced
† = Temporary call letters.

Newest

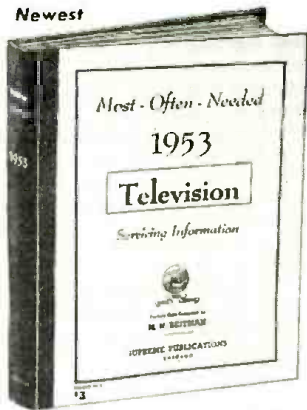

This newest giant volume of the Supreme TV manuals covers 1953 factory data on all popular television sets of all makes. There are explanations of new circuits, 192 pages of alignment procedure, test patterns, response curves, pages of waveforms, voltage charts, service hints, production changes, and dozens of double-circuit diagrams. Manual-style binding (opens flat). Special price, only... **\$3**

New SUPREME 1953 TV Manual

A FULL YEAR'S TV MATERIAL IN A GIANT BOOK — \$3

COVERS ALL POPULAR SETS | AMAZING BARGAIN OFFER

This new *Supreme* 1953 TV manual has all the required service material on every popular television set of every important manufacturer. Here is helpful, practical, factory-prepared data that will really make TV servicing and adjustment easy for you. Benefit and save with this amazing manual scoop. This new giant TV manual, as well as the previous volumes for other years, has complete circuits, alignment facts, test patterns, response curves, service hints, recommended changes, voltage charts, waveforms, and many double-page diagram blueprints. Here is your TV service material to help you do more expert work quicker; and priced at only \$3 and \$2 per manual covering a whole year of material. See coupon below for the complete list of all TV volumes, from 1947 to 1953, and the 1953 UHF Converters manual. Order for a 10-day trial.

The new 1953 TV manual is the most remarkable value offered by Supreme Publications in their 20 years of business. This mammoth television servicing manual at only \$3, or the TV manuals for previous years for only \$3 and \$2 each, are amazing bargains and defy competition. There is nothing else like them. Each manual is a virtual treatise on practical television repairs. By normal standards, each such large manual packed as it is with practical facts, hundreds of illustrations, diagrams, charts, photographs, and expensive extra-large blueprints, should sell for \$10 — but as SUPREME special values they are priced at \$3 and \$2 each. Only a publisher who sold over one million TV and radio manuals can offer such bargains based on tremendous volume-sales. Be ready to repair any TV set by having in your shop all seven Television Manuals listed in coupon. Or try the new 1953 TV manual to see what an amazing bargain you get for only \$3. Send no-risk trial coupon.

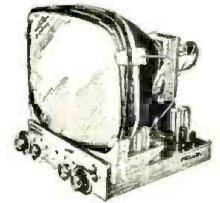

The repair of any television set is really simple with Supreme TV service manuals. Every set is covered in a practical manner that will simplify troubleshooting and repair. This is the help you need to find toughest faults in a jiffy. Each \$3 volume covers a whole year of material. Be wise, buy Supreme Manuals only once each year instead of spending dollars every week for not needed data.

Just Out



RADIO DIAGRAMS

Here is your complete source of all needed RADIO diagrams and service data. Covers everything from most recent radios to pre-war old-timers: home radios, auto sets, combinations, chargers, and portable sets. Sensational values. Still sold at pre-Korean prices. Only \$2 for most volumes. Every Radio manual contains large schematics, all needed alignment facts, parts lists, voltage values, trimmers, dial stringing, and helpful service hints. Volumes are large in size, 8 1/2 x 11 inches, about 192 pages. See coupon at right for a complete list of these low-priced manuals.

NO-RISK TRIAL ORDER COUPON

SUPREME PUBLICATIONS, 1760 Balsam, Highland Park, ILL.

Radio Diagram Manuals

- New 1953 Manual, \$2.50
- 1952 Radio
- 1951 Diagrams } EACH
- 1950 Manual } \$2.50
- 1949 Radio
- 1948
- 1947
- 1946
- 1942
- 1941
- 1940
- 1939
- 1926-1938 Manual, \$2.50

PRICED AT ONLY \$2 EACH

Send TV and Radio manuals checked below and at left. Satisfaction guaranteed or your money back.

- 1953 TV Manual, \$3.
- 1952 Television Manual, \$3.
- 1950 Television Manual, \$3.
- 1948 TV, \$3.
- 1953 UHF Units, \$1.50
- 1951 TV, \$3.
- 1949 TV, \$3.
- 1947 TV & FM, only \$2.

- I am enclosing \$..... Send postpaid.
- Send C.O.D. I am enclosing \$..... deposit.

Name:

Address:

Supreme Publications

Available from Leading Radio Jobbers

Presenting . . . at most moderate cost . . .

ESPEY

25th Anniversary "Trophy" Models

AM-FM CHASSIS • TUNERS • AMPLIFIERS



In commemoration of twenty-five years' experience in the manufacture and development of high-fidelity audio equipment, Espey is proud to present its distinguished "Trophy" models. Renowned for beauty of styling and excellence of performance, the new Espey models are so reasonably priced that for the first time magnificent listening pleasure is within the means of all lovers of fine audio reproduction.

Descriptive literature on the new Espey AM-FM chassis, tuners and amplifiers is now available . . . your inquiry is invited.

SYLVAN A. WOLIN & ASSOCIATES SALES CORP., 409 GRAND AVENUE, ENGLEWOOD, N. J.

NOW!
make any
tube tester
a picture tube tester
with this adapter

395

NO WIRING. Plug this adapter into your present tube tester (any make or model) and onto picture tube. Overall length 49 1/2". Checks any picture tube, electrostatic or magnetic 10" to 30", right inside the cabinet, for cathode emission, shorts, etc.

C.O.D. orders, plus postage. Send check or M.O., we pay postage. Money back guarantee.

Act Now! Order Today Direct from

SupereX CORP.
ELECTRONICS

DEPT. N
23 ATHONTON STREET, YONKERS, NEW YORK
JOBBER: a few choice territories still available!

WIRE WARNING!

WHY

pay more for questionable quality* tubular TV lead-in wire?
*subject to patent infringement.

LOOK



for highest quality license-labeled* Tubular TV Wire ...

*JSC Tubular Wire is manufactured under license of Amphenol Pat. 2543696.

DEMAND

the most for your wire dollar ... get BOTH Quality***! AND Low Price**!

**JSC—Highest in Quality ... Lowest in Price

JSC NEW Twin Tubular TV Lead-In Wire ...

The best low loss, low cost 300 ohm lead-in for UHF and VHF television.

Rain, snow, dirt or salt deposits do not materially affect impedance and electrical efficiency. JSC tubular construction contains and protects the concentrated field of energy and reduces to a minimum high ratio signal losses.



Always Look for Orange & Blue Disc of Quality

"SOMETHING FABULOUSLY BEAUTIFUL ...

... Amazed by new purity of sound ... clarity ... clean definition!"

says noted Record Reviewer

FAIRCHILD
SERIES 215
HIGH COMPLIANCE
Diamond Cartridge



First to achieve near-perfect lateral compliance—freedom of stylus to yield to rapid deflections of sensitive microgroove recordings—the amazing new Fairchild Series 215 provides all these exciting improvements:

★ New shades of tone color from fine recordings! ★ New clear timbre in high volume piano chords! ★ Rich low-frequency tones never previously heard! ★ Needle talk, record hiss, base concentration caused by arm resonance—reduced to a new low low! ★ Stylus wear vastly reduced, record quality preserved! ★ And above all—TRACKING DISTORTION ELIMINATED!

ORDER FROM YOUR
AUDIO DEALER
or
Mail Coupon for
FREE "HI-FI Facts"
folder

Fairchild Recording Equipment Corp.
8th Ave. & 154th St., Whitestone, L.I., N.Y.
Please mail folder "Hi-Fi Facts" to:
Name _____
Address _____
City _____ State _____

VISIT US AT THE AUDIO FAIR, HOTEL NEW YORKER, OCT. 14-17

stations which would furnish viewers in Casper, Wyoming, and surrounding towns with signals from Denver via Laramie. Distance between relay stations near Laramie and Casper is over 100 miles, over mountainous terrain.

The route described, which runs parallel to an existing toll line, would be equipped with alarm circuits to insure operation.

For over a year the Commission has had a similar proposal from a group in Poplar Bluff, Mo., who also were interested in erecting microwave relays to serve those in Kennett and Poplar Bluff.

Since common carrier services are involved, the Commission must determine rates, classify types of service, and consider too, if the relayed programs would create unfair competition for those who might install TV stations, as well as those who have already received permission to build.

The Hinshaw proposal to amend the Communications Act, placing all types of charge service under a public-utility format, has also concerned the Commission in this matter, and will probably delay consideration of the applications until Congressional action on the House measure is taken next year.

MOUNTAIN-TOP transmission, featured by scores of TV stations, was highlighted recently in the approval of Channel 8 to Mt. Washington, Inc. The official grant noted that the station, with studios at Poland, Maine, and transmitter atop towering Mt. Washington, New Hampshire, will serve a radius of 100 miles.

Maine found itself a headliner on the TV station approval list as the summer came to a close with three grants; two for low-band and one for the higher channels, or 6, 8, and 17, as noted in the station table on page 166.

MORE DOLLARS, to ease the FCC TV application load, appeared in the appropriations bill that was signed by the President.

Specifically, the Commission received \$900,000 more than it got for the fiscal year '53. The addition, according to Senator Johnson, will make it possible to hire 14 more examiner teams to process applications. This will give the Commission a total of 24 teams for the huge job of speeding up grants.

ONE OF TV's greats, youthful Philo T. Farnsworth, received the plaudits of broadcasters recently during a banquet in his home state, Utah.

Hailing the inventor, Harold E. Fellows, prexy of the National Association of Radio-Television Broadcasters called him ... "a giant among geniuses whose inventions have made modern-day television possible."

Farnsworth, who was born in Beaver, Utah, was described as owner of over a half-dozen basic TV patents used in practically every chassis, and

over 100 patents on electronic devices.

Huzzahs to this bold pioneer whose driving resourcefulness has helped to blaze new frontiers, bringing better viewing to all L.W.

TRANSISTOR CATHODE FOLLOWER

By A. H. HELLMERS

THE transistor equivalent of a cathode follower is the grounded-collector circuit, more recently known as the "emitter-follower". The accompanying circuit gives practical circuit constants for a general-purpose emitter-follower using a Raytheon CK722 "p-n-p" junction transistor.

The gain of this circuit was measured at over 0.98, comparing very favorably with tube circuits. The input impedance is, however, much lower. Input impedance values, ranging from 100,000 to 200,000 ohms, were measured with several transistors of the same type. In this type of circuit, the input impedance is nearly equal to the collector resistance, i.e., the dynamic resistance between collector and base. This dynamic resistance actually shunts the input circuit, as can be seen from the circuit diagram, and the degeneration in the emitter circuit can do nothing to reduce this shunting effect. The published value of collector resistance for junction transistors is usually around 10,000 ohms, but an operating point can usually be found at which the collector resistance is higher, as in the present case.

The input resistance can be measured by inserting a variable resistor in series with the input and finding by trial the value required to reduce the output signal by half. The emitter resistor R_1 will require some adjustment to get the highest input impedance for any particular transistor. The best plan is to try several resistors ranging from 1 megohm to 3.3 megohms.

Output impedance is around 10,000 ohms, and frequency response begins to droop around 50 kc.

The battery current drain is about 50 microamperes. Most of the current goes through emitter load resistor R_2 , thence through the emitter, base, collector, and through the battery. Only a small fraction of the current passes through the base-to-ground resistor R_1 .

-50-

Transistor equivalent of "cathode follower."

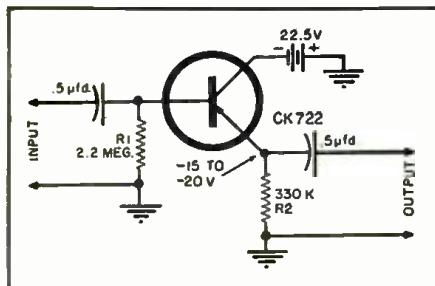

FOLLOW ARROW FOR BIGGEST STOCK AT LOWEST PRICES

- RADAR—TRANSMITTERS
- RECEIVERS — TUBES — PARTS

BEACON RECEIVER BC-1206



Frequency Range—195 KC to 420 KC. IF Frequency—135 KC Receiver Sensitivity—3 Microvolts for 10 Milliwatts output. Output Impedance—300 Ohms and 4000 Ohms to be selected internally. Volume Control—RF Gain Control. Power Supply—24-28 Volts Aeroplane Battery. Current—75 Amperes. **\$9.95**

RADAR TEST EQUIPMENT

TS-3, TS-12, TS-13, TS-15, TS-33, TS-34, TS-35, TS-36, TS-45A1M3.

FOLLOW ARROW TO GET HIGHEST PRICES FOR YOUR NEW AND USED RADIO GEAR! What have you to sell? WRITE TODAY!

Monthly Specials!

BC-604 30 W. FM TRANSMITTER. For 20-27 MC. band. Ideal for 10-11 meters. Complete with tubes, temperature controlled crystal oven and technical manual with all instructions for BC-603 and BC-604. Less dynamotor and crystals. Excel. cond. **\$12.95**

OK-2 V. VIBRATOR. New. Each. **39c**
10 for **\$3.50**
MT-77 for BC-442. New. **.95**
MT-68-E for RTA-1B. New. **P.U.R.**
MT-230A/ARC-1 for ARC-1. New. **P.U.R.**

COMMAND EQUIPMENT (SCR-274N)

	Used	New		Used	New
BC-442 ANTENNA RELAY. Less cond. with cond.	\$1.95	3.95	MC-211 90° ANGLE COUPLING UNIT.		\$0.95
BC-451 TRANSMITTER CONTROL BOX		1.50	FT-234 MOUNTING RACK for single transmitter	\$2.95	3.50
BC-450 3-RECEIVER REMOTE CONTROL BOX		2.95	FT-226 MOUNTING RACK for 2 Command Receivers		3.95
MC-215 MECHANICAL DRIVE SHAFT. Per length		2.95	FT-221 MOUNTING PLATE for FT-220		1.50
BC-496 2-POSITION RECEIVER CONTROL BOX		2.95	FT-220 MOUNTING RACK for 3 receivers	2.25	3.95
BC-455 6-9 MC RECEIVER. With tubes	9.95	14.95	FT-225 MOUNTING PLATE for BC-455		2.25
			BC-456 MODULATOR. For SCR-274	5.75	1.25
			Complete set of 4 tubes for transmitter		



C.A.P. SPECIAL BC-625 VHF TRANSMITTER
Freq. range 100-156 MC. With modulation section. Less tubes & crystals, with conversion dope. Used, good condition **\$9.95**



UHF 420 MC TRANSCEIVER
Complete transmitter-receiver unit with 5 stages of 30 MC. IF amplifier. This unit is the famous APS-13 Radar Set. Less tubes and dynamotor. With Schematic. Excel. cond. **\$12.95**

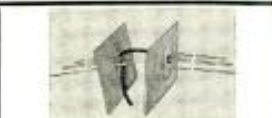

UHF MOBILE DIRECTIONAL ANTENNA
Complete with directors, reflectors, and mounting plate. Made for use with accompanying APS-13 transceiver. New **95c**

Miscellaneous Specials!

H-16U HEADSET. 8,000 ohms. **\$3.95**
HS-18 HEADSET. New. **2.45**
HS-23 HEADSET. High imp. New. **4.95**
HS-30 HEADSET. Featherweight type. Low imp. New. **\$2.49** USED. **1.49**
HS-33 HEADSET. Low imp. New. **6.95**
HS-38 HEADSET. USED. excel. cond. **1.49** NEW. **3.50**
T-32 DESK STAND MIKE. New. **5.95**
T-48 DESK STAND MIKE. New. **4.95**
LIP MIKE. Navy type. New. **.98**
MP-22 MOBILE ANTENNA. MOUNTING RACK. Comp. with hardware. Per Pair **\$4.95**. Ea. **2.95**
TU-17 TUNING UNIT. (2-3 MC.) For BC-223 Xmt. Used. **2.95**
TU-25 TUNING UNIT. (3.5-5.2 MC.) For BC-223 Xmt. Used. **2.95**
I-70 "5" TUNING METER. NEW. **2.50**
WOBLATOR. See p. 43 Dec. '51 RADIO NEWS **5.95**
BC-1023 75 MC. MARKER BEACON RECEIVER. Complete with tubes, mut. rack. NEW **10.95**

ID6/APN-4
Complete with tubes and crystal. Excel. cond. Only **\$47.50**

250 TL TUBES—Limited Quantity!
Only **\$9.95** each
Save **\$2.00!** Order 2 for only **\$17.00**

INDUSTRIAL CORPORATIONS
We carry one of the most complete stocks in U.S. of Military Electronic Equipment, Test Equipment, and Aircraft Electronics. Call or write for free catalogue.

\$5.00 MINIMUM ORDER ACCEPTED. All items subject to prior sale. All shipments F.O.B. warehouse. Calif. residents add tax with remittance. 20% deposit required. Please specify shipping instructions with order. **EQUIPMENT WANTED!** Highest prices paid for all types of Electronic Gear!

ARROW SALES, INC.
Cable Address: ARROWSALES PO Box 5-1810
Mailing Address: P. O. Box 3878-R, N. Hollywood, Calif.
Office-Warehouse: 7460 Varma Ave., N. Hollywood, Calif.

Here's how to SAVE MONEY ON INSTRUMENTS!

- ✓ . . . how to do faster, better testing with fewer instruments
- ✓ . . . how to increase the usefulness of your present instruments
- ✓ . . . how to choose the right instrument for each job



- ✓ . . . how to understand instrument operating principles
- ✓ . . . how to evaluate instrument readings and put them to practical use

The Instrument Book Written Especially for • SERVICEMEN • AMATEURS • EXPERIMENTERS

★ HERE'S a brand new book that can save you money on instruments and help you use your present instruments lots more efficiently! Over 60 instruments—from the most modern TV pattern generators to special-purpose bridges—are carefully described. Their uses are fully explained and valuable work-saving short cuts outlined. Included are complete details on simple meters for current and voltage; ohmmeters and V-O-M's; V-T voltmeters; power meters; impedance meters; capacitor checkers; inductance checkers; special-purpose bridges; oscilloscopes (this material alone is worth the entire price of the book to busy servicemen!); r-f test oscillators and signal generators; audio test oscillators; radio frequency and audio frequency measuring devices; audio-amplifier testing devices; r-f signal tracers and tube testers. Among other things, BASIC ELECTRIC TEST INSTRUMENTS is a complete training course in the latest instruments including grid-dip oscillators, TV sweep and marker generators; TV linearity pattern generators, square-wave generators, distortion meters and others.

SEE WHAT IT CAN DO!

You are shown new uses for VOM's, scopes, signal generators and other old standbys. You learn how easy it is to extend the range of many old instruments; how power drain measurements can be used for fast TV troubleshooting; how a useful and accurate bridge can be built from a combination of familiar general-purpose instruments; how to calculate shunts and multipliers; how to measure r-f impedance with a simple T-network; how to measure inductance and capacitance with a grid-dip oscillator and scores of other money-saving "tricks." Just off the press! Read BASIC ELECTRIC TEST INSTRUMENTS for 10 days at our risk!

10-DAY FREE EXAMINATION

Dept. RN-103, Rinehart Books, Inc.
Technical Division,
232 Madison Ave., New York 16, N. Y.

Send Turner's BASIC ELECTRIC TEST INSTRUMENTS for 10-day FREE EXAMINATION. If I decide to keep book, I will then remit \$4.00 plus postage. Otherwise I will return book postpaid promptly and owe you nothing.

Name

Address

City, Zone, State

Employer's Name and Address

OUTSIDE U.S.A.—Price \$4.50, cash only. Money back if book is returned postpaid in 10 days.

AN ADJUSTABLE REGULATED VOLTAGE SUPPLY

By J. J. HOEFER, WØIIJ

Increase the versatility of your 300-volt power supply by adding this circuit to give 30, 75, 105, 180, or 255 volts.

OCCASIONALLY, for the workshop, lab, or ham shack, a regulated power supply which has an adjustable output available is needed.

Using four voltage regulator tubes, a switch, and a few resistors, the gadget described may be attached to any 300-volt supply to obtain several regulated voltages.

Before proceeding with a description of such a unit, let us review some fundamentals.

Fig. 1A shows the basic voltage regulator circuit. The supply voltage must be approximately 20% in excess of the regulated voltage required, in order to cause the VR tube to fire.

The resistance R_1 is determined by the supply voltage, VR tube type, and current through the load R_L . Thus, for a supply voltage of 250 volts, a VR150, and load current of 25 ma., and since approximately 5 ma. must flow through the VR tube to keep it fired, R_1 must be 100/.030 or 33,000 ohms at more than 3 watts.

If the load is removed by opening S_1 , the load current must flow through the VR tube. This value of current must not exceed the tube's maximum value permitted, usually 40 ma.

Referring to Fig. 1B it is seen that the load current must now flow through VR_2 whenever S_1 is closed.

If this load current is within the capabilities of the VR tube, a constant voltage drop appears across VR_2 and the voltage appearing at the load is less than that across VR_1 by this amount.

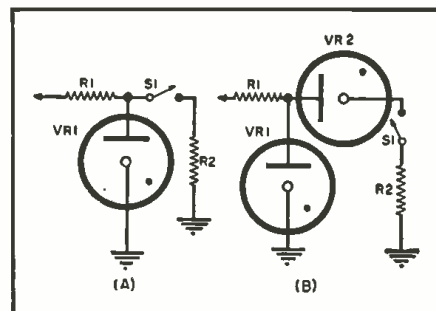

Fig. 1. (A) Basic voltage regulator circuit. (B) Another version of a voltage regulator.

For example, assuming the values as calculated before, and VR_2 is a VR105, the voltage appearing across the load is 45 volts.

Note that the 45 volts is a regulated voltage. If VR_2 is replaced by a resistor of sufficient rating to drop the load voltage to 45 volts, the load voltage will change with varying load current, and cease to be a regulated voltage.

More than one VR tube may be added in series with VR_2 , further decreasing the load voltage; more VR tubes may be added in series with VR_1 , increasing the load voltage.

Now refer to Fig. 2 for the schematic diagram of the unit. In switch position 1 only two tubes are in the circuit, the VR75 subtracting from the VR105, giving 30 volts output.

Other switch positions give voltages of 75, 105, 180, and 255. Maximum load current is 30 ma.

Fig. 2. Schematic of circuit which provides adjustable feature for power supply.

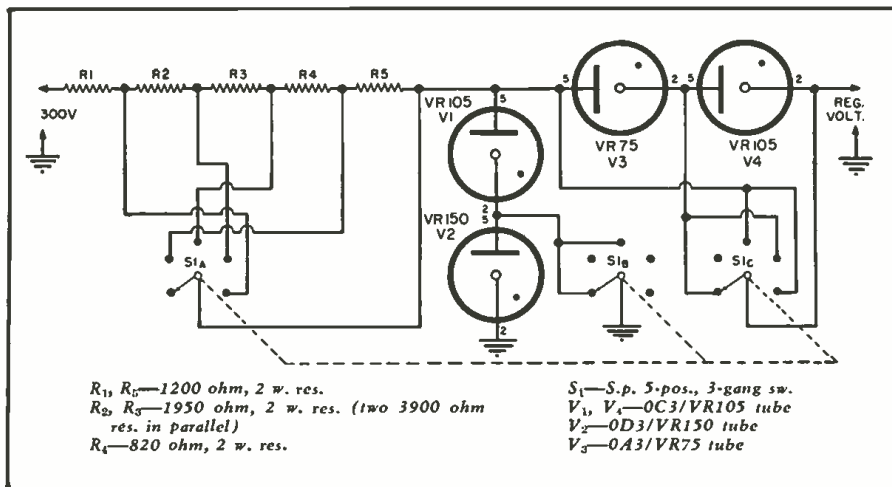

Key Components in Hundreds of Applications...



SELENIUM RECTIFIERS

- Arc Welders
- Brakes and Clutches
- Computer Power Supply
- Counters
- Electroplating
- Elevator Controls
- Facsimile Telegraph
- Fast Chargers
- Fence Chargers
- Generator and Motor Fields
- Guided Missiles and Planes
- Gun Fire Control
- Industrial Truck Battery Charging
- Jet Engine Starters
- Magnetic Amplifiers
- Magnetic Memory Devices
- Motor Operation
- Motion Picture Arc Projectors
- Oscilloscopes
- Portable Radios
- TV Sets and Boosters
- Therapeutic Machines
- Voltage Regulators
- X-Ray Machines

... AND MANY OTHERS!



Besides SELETRON Selenium Rectifiers, Radio Receptor Co. also manufactures Germanium Transistors and Diodes. Our engineering department will gladly aid in the solution of problems relating to these products. Submit your requirements and let us make recommendations... without obligation, of course! See our catalog in Sweet's Product Design file, or write us for Bulletin no. RT-2

SELETRON & GERMANIUM DIVISION

RADIO RECEPTOR COMPANY, INC.

Since 1922 in Radio and Electronics

SALES DEPT.: 251 West 19th Street, New York 11, N. Y.

FACTORY: 84 North 9th Street, Brooklyn 11, N. Y.

NEW!



**SNAPS-ON!
LOKS-ON!**



"Snap-on, Lok-on" action of new, improved IE LOK-ON STANDOFF prevents walking, twisting & rotating! Stays secure even in severest weather, thanks to IE's "gripping" clamp rib design with raised edges that "bite" into mast... and the standoff wire itself, which forms final enclosure around the mast and acts as positive locking device.

Available in three sizes:

- No. 1214.1" masts
 - No. 1215.1 1/4" masts
 - No. 1216.1 1/2" masts
- Details in new IE Catalog #10. Send for your free copy!

SPECIFY IE STANDOFF INSERTS FOR ALL YOUR LEAD-IN REQUIREMENTS



NEW! UNIVERSAL-UHF-VHF INSERT

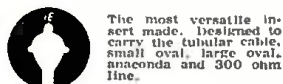

The most versatile insert made. Designed to carry the tubular cable, small oval, large oval, anaconda and 300 ohm line.



325 NORTH HOYNE AVE., CHICAGO 12, ILL.

ANTENNAS • MOUNTS • ACCESSORIES

"custom"
HIGH FIDELITY
is as easy as this



V-M Record Changer Attachment \$69.95**
"all the music is all you hear"

V-M triomatic®

936_{HF} High Fidelity RECORD CHANGER ATTACHMENT

Beautiful music and simplicity go hand in hand. Connecting your V-M 936HF to amplifier and speaker is like plugging in a lamp. Your reward... hearing your finest records faithfully played with rich, "live-performance" tonal beauty.

These V-M 936HF features give you more in performance, record protection and convenience than any other changer attachment.



Exclusive, resonance-free aluminum die cast tone arm.

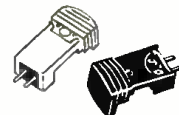

Two plug-in tone arm heads, will fit most cartridges.*



Exclusive laminated turntable and powerful 4-pole, 4-COIL motor for silent, steady, speed.



Gentle tri-o-matic spindle protects records, eliminates groove-gripping record holders.

Made by V-M Corporation, world's largest manufacturer of phonographs and record changers exclusively.

*Pre-amplification stage required with magnetic type pickups.
**Slightly higher in the west.

Look for the



V-M CORPORATION, Benton Harbor 4, Mich.

Please send illustrated folder, "Bring Concert Halls With a Your Walls."

Name _____

Address _____

City _____ State _____

HARVEY

for Civilian Defense
COMMUNICATION
EQUIPMENT



GONSET "COMMUNICATOR"

A complete two-way station for 2 meter band operation. Suitable for mobile or fixed location use. Receiver is a sensitive superheterodyne with built-in noise clipper circuit and 6BQ7 Cascade rf stage. Transmitter uses 2E26 in final 15 watts input. Employs 8 mc. crystals for stability, and has a range of over 100 miles. Operates on either 110 volts AC or 6 volts DC. Weight approx. 16 pounds.



Complete with Tubes (less crystal and microphone) **\$209.50**

Deluxe Model. All features as above, plus: earphone jack, built-in adjustable squelch, and new ventilated cabinet. **\$229.50**

Deluxe Transmitter Kit JOHNSON VIKING II

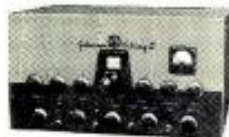

100 WATTS ON PHONE
130 WATTS ON CW

Every desirable feature has been included in this outstanding transmitter: BAND-SWITCHING to all amateur bands, from 160 through 10 meters... TVI suppression... 100% AM modulation... PARALLEL OUTPUT 6146 tubes... PUSH-PULL 807 MODULATORS. Supplied complete with pre-punched chassis, copper-plated steel cabinet, tubes, hardware, assembly instructions, and all necessary parts and components. **\$279.50**

- Viking II complete with tubes, wired and air tested **\$324.50**
- Viking VFO Kit **42.75**
- VFO Kit—wired and tested (with tubes)... **62.75**
- Viking Mobile Kit, up to 60 Watts input **99.50**
- Viking Low Pass Filter, 4 section, 75 DB Att., handles a KW **16.50**
- Viking TVI Kit, everything to TVI suppress the Viking I **24.75**

The NEW NATIONAL NC-88 Receiver



Covers 540 kcs to 40 mcs with illuminated calibrated band-spread scales for 80, 40, 20, and 10 meter bands. Has tuned RF stage, two IF stages, and two high fidelity audio stages, with phono input and tone control provided with built-in speaker, antenna trimmer, separate high frequency oscillator, gain control, noise limiter, AVC, headphone jack, and send-receiver switch.

Complete with tubes **\$1199.50**

Generous Trade-in Allowances
Made for All Equipment

Visit the Harvey AUDIOtorium
See, hear, and compare sound equipment from the largest selection available anywhere.

NOTE: Prices Net, F.O.B., N.Y.C.
Subject to change without notice.



Harvey
RADIO COMPANY, INC.

103 W. 43rd St., N. Y. 36, N. Y. • JU 2-1500

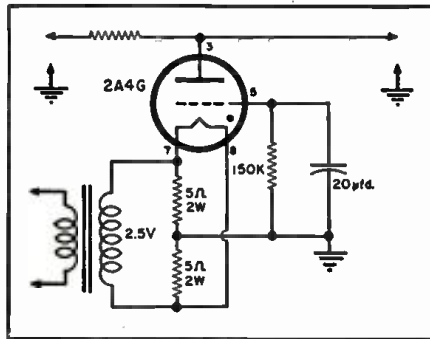

Fig. 3. Alternate circuit using a 2A4G.

Resistor values are shown for a 300 volt input, but by employing the relationships set forth earlier in this article their values may be calculated for any supply voltage.

Much more elaborate switching circuits may be employed with these and other tubes for a larger number of steps, but it was felt the steps shown represent a good compromise between complexity and versatility.

For those who wish to design their own circuits it should be pointed out that the 2A4G makes a good VR150.

A supply was built using three 2A4G tubes, a VR105, and a VR150, with the output variable in 15 volt steps from 15 to 300 volts.

Special connections for the 2A4G are shown in Fig. 3. Its major disadvantage is that separate filament windings are needed for each tube.

Another possibility for a VR tube is the common neon bulb. Current ratings are small, however. The NE-48 has a nominal current rating of 2 ma. and will maintain approximately 75 volts across it.

The useful life of these neon bulbs varies inversely as the cube of the current, consequently doubling the current reduces the life to one-eighth of the normal value.

As has been shown many times, a simple relaxation oscillator may be built using a VR tube circuit with suitable values of capacity across it.

Therefore a word of warning is in order. Do not exceed the value of capacitance across the VR tubes, as stated by the manufacturer, or unwanted oscillations may occur. For most VR tubes this is .1 μ fd.

For a simple to build, inexpensive unit, this circuit offers you a handy gadget for the work bench.

STATIONS JOIN NET

A. T. & T. has connected six more stations into its nation-wide network facilities. Stations WTVI, Belleville, Illinois; WGVL, Greenville, S. C.; KBES-TV, Medford, Oregon; WHB-TV and KMBC-TV, Kansas City; WBUF-TV, Buffalo; KEDD, Wichita, Kansas; and WETV, Macon, Georgia, are now tied into the network.

With the addition of these stations network programs are now available to 154 stations in 103 cities in the United States. This figure includes installations made by the Bell System up to and including August 24th.

V. E. C.

TUBES

AT
WHOLESALE

MINIMUM ORDER \$10.00
OR 25 TUBES

BRAND NEW • BOXED • BRANDED
• 100% GUARANTEED •

1A7GT	\$.55	6BE6	\$.48	12A7E	\$.39
1B3GT	\$.64	6BQ6G	1.20	12A77	\$.73
1NSGT	\$.53	6BW6	\$.53	12AU6	\$.60
1L4	\$.53	6BJ6	\$.80	12AV7	\$.75
1L6	\$.53	6BK7	\$.80	12AV7	\$.75
1NSGT	\$.53	6BL7GT	\$.80	12AV7	\$.75
1RS	\$.53	6BQ6GT	\$.68	12BK6	\$.63
1S5	\$.45	6BQ7	\$.87	12BA6	\$.48
1T4	\$.53	6BZ7	\$.88	12BA7	\$.55
1U4	\$.53	6C4	\$.83	12BB6	\$.48
1U5	\$.45	6CB7	\$.83	12BH7	\$.63
1X2	\$.67	6CD6G	1.05	12SA7GT	\$.47
3Q4	\$.55	6F6GT	\$.42	12S7GT	\$.47
3Q5GT	\$.63	6I6	\$.83	12S7GT	\$.63
3S4	\$.50	6K6GT	\$.40	12S7GT	\$.58
3V4	\$.50	6L6	\$.80	12S7GT	\$.40
5U4G	\$.45	6S4	\$.83	19A6	1.50
5Y3	\$.34	6S8GT	\$.67	19T5	\$.73
5Z3	\$.44	6SA7GT	\$.47	250B6GT	\$.84
6AB4	\$.45	6SD7GT	\$.73	25L5GT	\$.43
6AQ5	\$.54	6SK7GT	\$.47	25W4GT	\$.45
6AR5	\$.98	6SL7GT	\$.62	25Z4GT	\$.38
6AK5	\$.98	6SN7GT	\$.62	35B5	\$.50
6AL5	\$.45	6SU7GT	\$.40	35C5	\$.50
6AR5	\$.50	6T8	\$.73	35L6GT	\$.43
6AT5	\$.39	6U8	\$.78	35W4	\$.35
6AU6	\$.45	6V6GT	\$.50	35Z5GT	\$.35
6AV6	\$.39	6W4GT	\$.48	50B5	\$.50
6BA5	\$.58	6W6GT	\$.39	50C5	\$.50
6B7	\$.60	6X4	\$.83	50L6GT	\$.52
6BC5	\$.50	6XSQT	\$.39	117.7GT	1.09
6BD5GT	\$.60	12AL5	\$.45	117J3	\$.35

• UNBEATABLE TUBE KIT VALUES •

KIT	KIT CONTAINS	LIST PRICE	NET PRICE
1	3Q4, 1T4, 1RS, 1S5	\$8.00	
2	3S4, 1T4, 1S5, 1RS	7.80	1.85
3	1U4, 3S4, 1S5, 1RS	7.80	
4	3V4, 1RS, 1S5, 1T4	7.80	
5	117Z3, 1U5, 3V4, 1RS, 1T4	9.75	2.10
6	12A7E, 12BA6, 12BE6, 35W4, 50C5	8.70	
7	12SA7, 12SK7, 12SQ7, 35Z5, 50L6	8.40	

SAVE C.O.D. FEES. All orders accompanied by full remittance will be shipped POST PAID anywhere within continental U.S.A.

PRICES are guaranteed to remain as advertised until NOV. 1 or until stock is exhausted.

25% DEPOSIT on all C.O.D. orders. NO OPEN ACCOUNTS.

WRITE FOR FREE TUBE LISTING

VIDEO ELECTRIC CO.
P. O. BOX 911 NEWARK, N. J.

Read

RADIO & TELEVISION NEWS

every month

for the Latest

Authentic Information

CONSTANT VOLT. TRANSFORMERS

GE 90-130V 60 cy in. 115V 1% 30VA out. \$ 8.50
SOLA 90-130V 60 cy in. 115V 1% 250VA out 45.00
SOLA 90-130V 50 cy in. 115V 1% 250VA out 42.00
SOLA 90-130V 60 cy in. 115V 1% 1000VA out 95.00

110V POWER TRANSFORMERS 60 CY

THORDARSON, new, boxed, 870 VCT @ 250MA, 80V tap. 5V 3A. 2.5VCT 10A. 2.5V 3A. 6.3V 1.5A **\$6.95**
THORDARSON, new, boxed, 880 VCT @ 125MA, 75V tap. 5V 3A. 6.3VCT 3.3A **\$5.95**
7 HY. 125MA choke, cased. **\$1.75**, 2 for **\$3.00**
10 HY. 250MA choke, cased. **\$3.75**, 2 for **\$7.00**

HIGH VOLTAGE CERAMIC MICAS, G1 TYPE

.0002 MFD 6 KVDC. **\$6.95**, 2 for **\$12.00**

W. E. #724B AIRCRAFT RANGE FILTER, VOICE OR CW. 1020 CY., CAA APPROVED. NEW BOXED

\$2.95

Mine Detector HUMMERS, M-356-C, New... \$ 2.50
LM-10 FREQ. MTR. less callb. hook. **49.50**
H/23-U Handset for SCR-300, New Boxed... **10.00**
M/G in RELAY, 2K ohm, 1-2 ma. SPDT. New **4.50**

WHEN IN N. Y. VISIT OUR STORE

PUNIM SURPLUS CORP.

316 CANAL ST. NEW YORK 13, N. Y.
WORTH 2-1835

Color TV

(Continued from page 53)

his previous transition from a 5-tube radio to a 25-tube TV receiver. The additional 15 to 25 tubes required by a color receiver are, in some circuits, just more of the same. However, in other circuits there are new concepts, an understanding of which is essential to the proper diagnosis of trouble. At the present stage of color receiver development, color adjustments are extremely critical, requiring a broad knowledge of color circuitry. Service technicians will have to study such circuits conscientiously to be successful in this field.

At this point the writer would like to utter a small prayer on the service technician's behalf. Knowing that more service test and alignment equipment will be required in working with a color receiver let us hope that the designers of this test gear (it has not yet been designed) will keep down the size and weight. In the same breath let us pray that the designers of these new color receivers allow for troubleshooting in the home and in the cabinet. These larger chassis are considerably heavier than black and white chassis with half their tube complement. A combination of lighter test gear and a chassis which could be "troubleshooter" in the cabinet will make for fewer ruptured service technicians, fewer chassis dropped down the stairs, and what is not a negligible factor in service technician-customer relations, smaller service bills.

This article has attempted to dispel the fog that has shrouded the color TV picture. Considerable progress has been made in the formulation of an improved compatible color signal. Two applications for a "Change of Rule" have been filed with the FCC. The first was made on June 25, 1953 by RCA, and the second by the NTSC one month later on July 23, 1953. In each case a request was made to have the present monochrome standards amended to provide for color TV transmissions in accordance with the new NTSC signal. FCC approval is expected by the first of the year or shortly thereafter.

Receiver production should start slowly in the fall of 1954 with a price range of \$750 to \$1000. This price range is expected to fall as developmental work continues. One laboratory has already produced an experimental receiver which requires only 34 tubes.

Part 2 of this series will discuss the color signal in detail and examine a typical color receiver.

REFERENCES

1. Buchsbaum, Walter H.: "The RCA Tri-color Tube." RADIO & TELEVISION NEWS, November 1951.
2. Dressler, Robert: "The PDF Chromatron—A Single or Multi-Gun Tri-Color Cathode-Ray Tube," Proceedings of the IRE, July 1953.

(To be continued)

SAVE \$\$\$ WITH THESE TERRIFIC BARGAINS!!

SPECIAL! Platt will cheerfully refund your local carfare with a purchase at either of his value-packed stores (159 Greenwich St., N. Y. C.—just off Cortland St. or 489 Broome St., N. Y. C.). Many bargains not listed here are on display.

HEADSETS

- HS-23 High impedance, BRAND NEW with ear pads..... \$5.95
- HS-13 low impedance, BRAND NEW with ear pads, cord and PL54 plug..... 6.45
- CD-307A Cords, 6 ft. NEW..... \$1.49
- H-16/U high impedance. Includes two receiving units..... 3.95
- HS-16 high impedance—used..... .98

SPECIAL! HS-33 HEADSET, used... \$1.89

SPECIAL!

20 LBS. OF ASSORTED RADIO PARTS
A terrific buy at only
\$1.99



SPECIAL!

Merit M-345 VTVM

4 1/2" meter with adjustable pointer to zero center for TV & FM discriminator alignment. AC-DC Range: 0-5 / 10 / 100 / 500 / 1000 V. 5 Resistance Ranges: 2 ohms—1000 megohms. DB scale for audio and gain measurements. Completely wired & tested—ready for use—SPECIAL WHILE THEY LAST!..... **\$19.95**

MULTI-TESTER FOUNDATION BIAS METER I-97A

Complete, Brand New. Special! \$5.95



RECEIVERS	USED	USED	NEW
BC-453—190 to 550 KC.....	\$29.95	54.95	54.95
BC-454—3 to 6 MC.....	6.95 (as is)	24.95	24.95
BC-455—6 to 9 MC.....		13.95	19.95
1.5 to 3.....			34.95

TRANSMITTERS	USED	NEW
A-958—2 1/2 to 3 MC.....	14.95	29.95
BC-457—4 to 5.3 MC.....	9.95	29.95
BC-458—5.3 to 7 MC.....		29.95
BC-459—7 to 11 MC.....		29.95
T-15 ARC 5—500 to 800 KC.....		29.95

ADDITIONAL EQUIPMENT	USED	NEW
BC-456 Modulator.....	1.49	1.95
BC-450 Control Box (3 Receiver).....	1.29	1.79
BC-451 Control Box (Transmitter).....		5.69
BC-442 Relay Unit (ANT).....		5.69
Plugs: PL-147, 148, 151, 152, 153, 154, 155—EACH.....		1.25
Flexible Shafting with gear to fit receivers.....		2.69
3 Receiver Rack.....	1.79	2.29
2 Transmitter Rack.....	1.69	2.39
Single Transmitter Rack.....		3.97
DH-33 Dynamotor for Command Set. Mounts for Above Racks.....	2.95	3.95

Field Telephones
Army surplus, completely reconditioned and electrically tested, using 2 flashlight cells and a pair of interconnecting wires. GUARANTEED. New \$28.95. Like new

\$22.95

SPECIAL! NOW! Fill Your Battery Only Twice a Year with Automatic Battery Filter
Made by leading Detroit Auto Mfr. Doubles battery life over ordinary care, prevents battery break-downs, fits all cars, instantly installed.

ONLY 69c COMPLETE

NEW SUPPLY ARRIVED! LIMITED QUANTITY TRANSMITTER-RECEIVER Navy Model ABA-1 (CG-43AAG) Army Model SCR-515A, known as the BC-645 450 MC—15 Tubes

BRAND NEW—ORIGINAL CARTON
Can be easily converted for phone or CW 2-way communication. Covering for the following bands: 420-450 Mc ham band, 450-460 Mc for fixed or mobile, 460-470 Mc for citizens, 470-500 Mc television experimental. Size 10 1/2 x 13 1/2 x 4 3/4. Contains 15 tubes: 4—7F7, 4—717, 2—7E6, 2—6F6, 2—955, 1—WE-316A door knob. Price includes Dynamotor, Control Box, Mount, Tubes..... **\$34.95**

MINIMUM ORDER \$2.00
Immediate Delivery—Send 25% deposit on C.O.D. orders. All shipments F.O.B., N.Y.C. (N.Y.C. residents add sales tax to your remittance.)

BEACON RECEIVER BC-1206

Frequency Range—195 KC to 420 KC. IF Frequency—135 KC. Receiver Sensitivity—3 Microvolts for 10 Milliwatts output. Output Impedance—300 Ohms and 4000 Ohms to be selected internally. Power Output—300 Milliwatts. Volume Control—RF Gain Control. Power Supply—24-28 Volts Acroplane Battery. Current—.75 Amperes
BRAND NEW—ONLY \$16.95

PRE-AMPLIFIER MODEL K-1
The K-1 is used to amplify output level for microphones and phonographs. Operates on 24-28 VDC, can be converted to 110 AC. Comes complete with PL 55 plug and 2-foot 119-B cord. 2 terminal blocks and instruction book.
BRAND NEW.....SPECIAL! \$3.95

ARMY TEST UNIT I-236
Meter is contained in a metal box 5 1/2" long x 3 3/4" wide x 3 3/4" deep. Comes complete with test leads and instruction book. Can be used for testing between AC and DC measuring resistance of circuits, checking fuses and testing capacitors.
SPECIAL \$4.19

LIMITED QUANTITY SPECIAL! TU-10 TRANSMITTER TUNING UNIT for BC-375 or BC-101—Frequency 10,000 to 120,000 Kc, 75% complete, excellent for spare parts..... \$2.95

TUNING UNITS (TU-18 3000-4500 Kc; TU-25 3500-5250 Kc; Brand New in Original Carton..... \$6.95 Metal Case to Hold Above Tuning Units..... \$1.00

BC-221 Frequency Meter
Real value! QUANTITY IS LIMITED—30 first come, first served. They are just like new, with original calibration charts. Range 125-20,000 KC with crystal check points in all ranges. Complete with crystal and tubes..... **\$139.50**
MODULATED TYPE..... \$169.50
MODULATED TYPE with AC Power Supply..... 189.50
These Frequency Meters are factory treated, checked for frequency alignment and GUARANTEED.

TUBES BRAND NEW! JAN! BOXED! TUBES

SPECIAL! Add only 10% to the price of any tube you buy and receive two at a sensational saving!

1B22.....69c	114B.....29c	841.....29c
1B23.....\$3.75	215A.....09c	843.....17c
2B22.....49c	221A.....28c	866.....28c
3C26.....09c	316A.....29c	162B.....19c
3C26A.....09c	388A.....59c	71B3.....19c
1B22.....\$1.19	471A.....\$1.19	9002.....69c
3D6.....39c	532A.....\$1.19	E1148.....49c
7C.....39c	722A.....99c	RK34.....99c
12KB7.....39c	801A.....19c	VR2.....14c
15R.....39c	826.....39c	VT127.....15c
39/44.....29c		

ARC-5/R-28 2 MTR RCVR \$25.95
Here is the 2-meter superhet you have been looking for! Absolutely one of the BEST available today! Tunes from 100 to 155 Mcs. In four crystal channels. (Easily converted to continuous tuning.) Tube lineup is as follows:
717A—R.F., 717A—Mixer, 2-12SH7—1st and 2nd I.F. 16.0 MC.
12SL7—Det. AVC Spuetch, 12SL7—1st audio-spuetch amplifier.
12A6—2nd audio, 12SH7—R.F. Osc.—4th Harmonic Gen.
717A—Trip, 12th Harmonic Gen. 717A—Dblr.—12th Harmonic, used..... **\$25.95**

ELECTRIC MEGAPHONE SYSTEM
For Rural Areas, Hotels, Commercial Steamers, Ball Parks, Etc.

U. S. NAVY type PAE-1 Electric Megaphone equipment is designed for voice reinforcement in much the same manner as, but to a greater degree than, the familiar acoustic megaphone. Consists of Megaphone Unit (which combines a microphone and reproducer in a single assembly), Portable Amplifier which electrically amplifies the output signal of the microphone section of the megaphone and feeds this amplified signal to the reproducer section. Charging Rack for recharging the self-contained storage battery of the portable amplifier. BRAND NEW—A TREMENDOUS VALUE! DEMONSTRATION GIVEN AT EITHER OF **\$149.50** PLATT'S STORES

PLATT ELECTRONICS CORP.
DEPT. A, 489 BROOME ST., NEW YORK 13, N. Y.
PHONES: WO 4-0827 and WO 4-0828

Sky's the limit for these Centralab "Buffer" Capacitors

Originally designed for use in electric shavers, these Centralab disc Hi-Kaps are now widely used for buffers in auto radios. No telling how many more high-voltage, HF and by-pass coupling problems they'll solve! The sky's the limit.

Hi-Kap discs are totally unaffected by heat, humidity and vibration. Their exceptional thinness gives you very high capacity in minimum space. Plenty of values in the 1600 V. range. What's more, they cost less than ordinary paper or mica capacitors of similar rating.

Have plenty of these newer Hi-Kaps on hand — use them to replace old-fashioned or dangerously old capacitors. Your Centralab distributor has complete stocks — see him soon.



Centralab

CENTRALAB,
A Division of Globe-Union Inc.
910-J E. Keefe Ave., Milwaukee 1, Wis.
Please send me complete technical data
on new Centralab disc Hi-Kaps.

Name.....
Firm.....
Address.....
City.....Zone.....State.....

SIMPLE SPEEDLAMP TESTER

By ALLAN M. FERRES

This easily-built unit can mean more dollars for the shop owner. Servicing speedlamps is easy and quite profitable.

SURE-FIRE operation of electronic speedlamps is imperative for both the amateur and professional photographer. This requires careful testing of the flash unit, especially after a repair or adjustment has been made or a new tube installed. One successful repair service operates the speedlamps two hundred times at their rated recharging time. If the light continues to operate during this test it can be assumed that it will function properly on the job. This service shop has the agency for a professional speedlamp which has a recharging time of 15 seconds. This simple tester was designed to perform this test automatically to relieve the technician of a monotonous and time-consuming task. Reliability and low cost were two definite requirements of the test unit, together with a reasonable interval accuracy. This device fulfills all three requirements adequately and is easy to build and operate.

The speedlamp itself consists of a wet-cell battery operating a vibrator in the primary circuit of a high-voltage transformer. The high voltage is rectified and used to charge two high-capacity condensers in parallel. The switch on the camera shutter operates a relay which connects the condensers in series across the flashtube. When the flash unit is operating properly, the condensers can be fully charged in 15 seconds and are capable of firing the tube. If the tube cannot be fired in 15 seconds, trouble is indicated. What is needed is a set of contacts to take the place of the switch on the camera.

The test unit is built around a double-pole, single-throw plate circuit relay and a dual triode. The first triode section of the tube, V_{1A} , has its cathode connected to one side of the 117-volt a.c. line; the plate, in series with the relay coil, connects to the other side of the line. The grid return is through R_1 and R_2 in series to the cathode. Across the two grid resistors is connected 6 μ f. of capacity, made up of a 4 μ f. and a 2 μ f. in parallel which were picked up on a "surplus" bargain counter. The other section of the tube, V_{1B} , is connected as a half-wave rectifier with the plate and grid tied together and connected to the arm of the "A" set of relay contacts. The cathode is connected to the line side of the relay coil. A 50 μ f., 50-volt electrolytic condenser is connected across the relay coil to prevent the relay from chattering on the pulsating

d.c. R_3 , which is between the normally-open contacts of the relay and the grid of V_{1A} , reduces the surge current through the rectifier section and holds the relay closed long enough to insure positive action of the speedlamp relay. A 12BH7 was selected as the tube due to its ability to stand a high negative pulse on its control grid.

The operation of the circuit is extremely simple. When the test unit is first turned on, no bias is applied to V_{1A} , and when the tube has reached operating temperature, sufficient plate current is drawn to operate the relay and close the contacts. When the "A" contacts close, about 150 volts negative from V_{1B} are placed on the grid of V_{1A} , cutting off the plate current and charging C_1 . Cutting off the plate current causes the relay to open. The relay remains open until C_1 has discharged through R_1 and R_2 to about 6 volts, the bias which will permit enough plate current to flow to close the relay again. The cycle is then repeated. The arm of the normally open "B" contacts of the relay are connected to a jack suitable for the lead which would normally connect to the camera shutter.

The interval between the momentary closings of the relay contacts depends upon C_1 and the sum of R_1 plus

Complete schematic of compact tester unit.

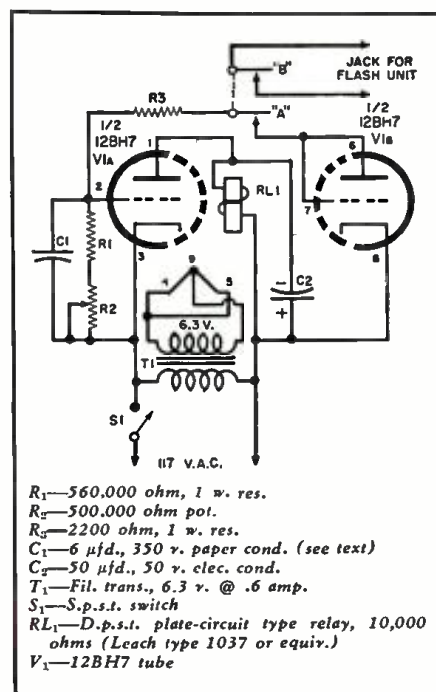

R_2 ; the maximum charging voltage on C_1 , and the maximum bias which permits enough plate current to flow to operate the relay. After the tester is built, slip a piece of paper between the "A" contacts so that they won't touch, and then plug it in to an a.c. outlet. When the tube warms up, the relay should close. If it doesn't, reduce the spring tension and, if necessary, bend the stop so that the armature is closer to the pole piece. The relay should close with a definite snap. Set R_2 to minimum resistance and pull the paper from between the contacts. The relay will spring open and after about 10 seconds close and open immediately. With a stop watch or the second hand of an electric clock, check the length of time between the relay operations. Increasing the resistance of R_2 will lengthen the interval. If the maximum interval is too short, increase the value of R_1 , and if the minimum interval is too long, reduce R_1 . With the original tester, a variation between 12 and 20 seconds was obtained with the value of R_1 560,000 ohms. R_2 , then, serves as a vernier so that the exact timing can be easily set to the operating interval required, in this case, 15 seconds. If a much longer interval is required, such as 30 seconds or more, C_1 can be changed to 12 μ fd.

The parts are mounted in a 6" x 6" x 6" steel utility box in any convenient arrangement, as lead length is not critical. Do not connect any part of the circuit, except the jack, to the steel case, as a severe shock hazard will result due to the direct connection of the circuit to the 117-volt line.

-30-

THAT WORD "HAM"

FROM the "Short Wave Magazine" of England, we reprint one of the recent "Random Jottings by the Old Timer," which will be of interest to American amateurs:

"Readers cannot have failed to notice that the word 'ham' appears extremely seldom in this publication. One of the reasons, no doubt, is that there is certainly a lack of dignity about that slang appellation, and its traditional meaning is completely lost on the uninitiated, who regard a 'ham' in radio as being rather like a 'ham' in the acting profession. I am very strongly of the opinion that we should make more use of the term, but only in very privileged cases. 'Ham spirit' used to be proverbial, embodying all that was best and friendliest in amateur radio. Much of the traditional 'ham spirit,' alas, has now been lost. As a start towards reviving it, I feel that only the very best of amateurs should be honored by the term 'ham,' which should imply that a person so designated is one of the real 'good types.' Most of us are only 'amateurs' in amateur radio, but a ham has progressed beyond this stage; he gives his help in every way he can, his behavior at all times is faultless, he never radiates a bad signal, and he never makes a nuisance of himself in any way. There are very few of him about—are YOU one?"

-30-

OVER 50% OFF! NEW 12-TUBE HIGH-FIDELITY FM-AM TUNER BUILT TO SELL FOR \$85.00

Approved Electronics 1954 Model "V-12"



Reg. Net Price
\$85

TRUE DISCRIMINATOR DOUBLE-LIMITER HIGH-FIDELITY FM!

\$41.95

ORDER 36-206RN

AN EXCLUSIVE RADIO SHACK 'SCOOP'!

When Approved's chief engineer showed us the prototype of this fine company's 1954 Model V-12, we contracted to buy the ENTIRE year's supply — the biggest special purchase of tuners EVER made by a single company. First, because V-12 is vastly superior to the previous Model A-710. Secondly, to eliminate middleman profits and save our many friends some REAL money. If you ordered an Approved A-710 from us and found, to your sorrow, we are sold out: NOW is the time to act. If you are considering buying a hi-fi tuner: NOW is the time to buy a *reputable* product from the East's best-known mail order company at savings NOBODY IN THE WORLD can duplicate!

SPECIFICATIONS: 12 miniature tubes plus 1N34 germanium diode 2nd det. AM. Two limiters, FM detector. Tuned RF stage on both AM and FM. Separate RF and IF stages on AM and FM. Rugged 6-gang variable, F71 section copper plates. Improved sensitivity and AVC on AM. *Guaranteed 15 uv.* for 20 db quieting on FM. Dual AM-FM band-indicating lamps. Controls: power, tuning, bandswitch; no volume control to upset output impedance or frequency response. *Cathode follower output*, 30-15,000 cps. All top quality components. Standard RMA guarantee. *Ultra compact:* 8 1/4" W x 5 1/4" H x 8" D., ship. wt. 7 lbs. Notice: requires 6.3V AC @ 4 amps, 190V DC @ 55 ma power supply.

TUNER POWER SUPPLY ONLY \$12.05



110-115V 50-60 cycles; delivers 6.3V AC @ 4 amps, 190V DC @ 55 ma. Size 3 1/2" W x 4 5/8" H x 8" D. Ship. wt. 7 lbs. Built by Approved to match V-12 tuner! Order No. 36-207RN.



VERY SPECIAL SALE!

Limited quantity of \$82.50-list RCA 15" duo-cone coaxial speakers 'way off price. 2 voice coils. 40-12,000 cps, 25 watts, 2 lb. magnet. Design by Dr. Olson! Ship. wt. 16 lbs. **\$29.50** LIST \$82.50 ORD. NO. RN-5108

ORDER BY MAIL! INCLUDE POSTAGE! SEND 25% WITH COD'S!

JUST PUBLISHED! FREE! OUR 1954 CATALOG



All new, 224-pages, including 32-page hi-fi section in rotogravure! Write TODAY for your copy of radio's favorite book!

RADIO SHACK

CORPORATION

167 Washington St., Boston 8, Mass.

the New McIntosh

30 WATT AMPLIFIER

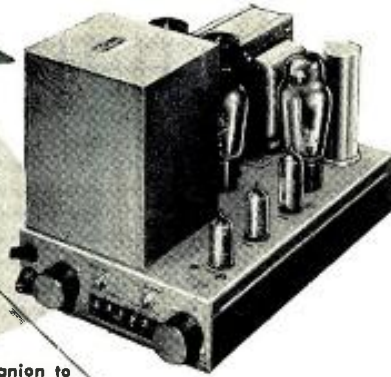

Companion to the McIntosh 50

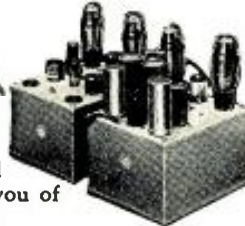

For you who expect the finest. Designed to satisfy a demand for professional performance in home sound systems at reasonable price. The new McIntosh 30 watt amplifier features the same patented output transformer circuit used in its widely acclaimed companion, the 50 watt model. Guaranteed less than 0.5% harmonic distortion at full 30 watts assures you of complete listening pleasure. Any tuner zero VU line will drive to full output. Hear it perform at your high fidelity dealer's showroom soon!

Write today for LOST INSTRUMENTS a free 32 page booklet explaining the fundamentals of high fidelity sound enjoyment.



322 WATER ST., BINGHAMTON, N. Y. • PHONE 3-3566
EXPORT DIVISION: 25 WARREN ST., NEW YORK 7, N. Y.

The "Fold-a-Flex" (Continued from page 67)

of enclosure by closing Ports A and B to position S-S. The reflex Port C is also completely closed. Approximately 11 cubic feet are provided for operation as an infinite baffle.

Bass Reflex

Well designed bass reflex cabinets are capable of excellent results. Many manufacturers provide such cabinets to accommodate their loudspeakers. However, they sometimes compromise between optimum performance and space requirements because not all customers will tolerate a cabinet as large as is necessary for best possible results. The "Fold-a-flex" provides an alternate choice of two cabinet volumes.

Bass reflex performance is obtained in the "Fold-a-flex" by closing Ports A and B in positions S-S and by tuning the port for correct reflex action. Details on this tuning will be discussed in a subsequent article. The port is placed close to the loudspeaker opening so as to take advantage of the radiation impedance (in-phase simultaneous compression of the air between the two openings tends to reinforce the transfer of energy to the air).

Folded Horn

Various types of corner cabinets have achieved great popularity in recent months. The "Fold-a-flex" embraces a true folded horn when Ports A and B are placed at position O-O and when reflex Port C is closed or tuned in conjunction with the horn characteristics. By placing the enclosure in a corner, two walls of the room will extend the effect of the folded horn. When placed against a flat wall, there is sufficient horn loading to provide very clean response well below 50 cycles. It is entirely possible to combine the bass reflex principle with the folded horn design.

Construction

The dimensions shown for the "Fold-a-flex" are typical for 15-inch speakers. Kimsul blocks are placed at random throughout the inside of the cabinet walls to prevent standing waves within the cabinet. Two inch Kimsul is placed at the apex of the horn within the cabinet directly back of the speaker. Braces of 1X2's may be added at random angles within the cabinet to offset cabinet resonance tendencies.

The partitions extend the full inside height of the enclosure and these may be 1/2 inch plywood. The main cabinet structure and the removable front baffle are constructed from 3/4 inch plywood. Gaskets are used around Ports A and B to insure an airtight seal.

Two vertical slots are located adjacent to the front mounting baffle C so

RADIO & TELEVISION NEWS

New		Standard	
Guaranteed	TUBES	Brands	
0A2	\$1.00	4X150A	22.50
0A3/VR75	1.10	4X500A	75.00
0A4G	1.00	8P1	4.50
0B2	1.40	5C22	42.00
0C3/VR105	1.00	5D21	15.00
0D3/VR130	1.50	5E9	1.95
1A3	1.00	5R4GY	1.25
1022	2.00	5T4	1.50
1523	2.50	6AL5W	1.75
1824	2.50	6AN5	2.90
1826	2.30		
1N27	12.50	6X4	8.50
1N28	1.25	6X5	8.50
1N29	1.25	6X6	8.50
1N30	1.25	6X7	8.50
1N31	1.25	6X8	8.50
1N32	1.25	6X9	8.50
1N33	1.25	6X10	8.50
1N34	1.25	6X11	8.50
1N35	1.25	6X12	8.50
1N36	1.25	6X13	8.50
1N37	1.25	6X14	8.50
1N38	1.25	6X15	8.50
1N39	1.25	6X16	8.50
1N40	1.25	6X17	8.50
1N41	1.25	6X18	8.50
1N42	1.25	6X19	8.50
1N43	1.25	6X20	8.50
1N44	1.25	6X21	8.50
1N45	1.25	6X22	8.50
1N46	1.25	6X23	8.50
1N47	1.25	6X24	8.50
1N48	1.25	6X25	8.50
1N49	1.25	6X26	8.50
1N50	1.25	6X27	8.50
1N51	1.25	6X28	8.50
1N52	1.25	6X29	8.50
1N53	1.25	6X30	8.50
1N54	1.25	6X31	8.50
1N55	1.25	6X32	8.50
1N56	1.25	6X33	8.50
1N57	1.25	6X34	8.50
1N58	1.25	6X35	8.50
1N59	1.25	6X36	8.50
1N60	1.25	6X37	8.50
1N61	1.25	6X38	8.50
1N62	1.25	6X39	8.50
1N63	1.25	6X40	8.50
1N64	1.25	6X41	8.50
1N65	1.25	6X42	8.50
1N66	1.25	6X43	8.50
1N67	1.25	6X44	8.50
1N68	1.25	6X45	8.50
1N69	1.25	6X46	8.50
1N70	1.25	6X47	8.50
1N71	1.25	6X48	8.50
1N72	1.25	6X49	8.50
1N73	1.25	6X50	8.50
1N74	1.25	6X51	8.50
1N75	1.25	6X52	8.50
1N76	1.25	6X53	8.50
1N77	1.25	6X54	8.50
1N78	1.25	6X55	8.50
1N79	1.25	6X56	8.50
1N80	1.25	6X57	8.50
1N81	1.25	6X58	8.50
1N82	1.25	6X59	8.50
1N83	1.25	6X60	8.50
1N84	1.25	6X61	8.50
1N85	1.25	6X62	8.50
1N86	1.25	6X63	8.50
1N87	1.25	6X64	8.50
1N88	1.25	6X65	8.50
1N89	1.25	6X66	8.50
1N90	1.25	6X67	8.50
1N91	1.25	6X68	8.50
1N92	1.25	6X69	8.50
1N93	1.25	6X70	8.50
1N94	1.25	6X71	8.50
1N95	1.25	6X72	8.50
1N96	1.25	6X73	8.50
1N97	1.25	6X74	8.50
1N98	1.25	6X75	8.50
1N99	1.25	6X76	8.50
1N00	1.25	6X77	8.50
1N01	1.25	6X78	8.50
1N02	1.25	6X79	8.50
1N03	1.25	6X80	8.50
1N04	1.25	6X81	8.50
1N05	1.25	6X82	8.50
1N06	1.25	6X83	8.50
1N07	1.25	6X84	8.50
1N08	1.25	6X85	8.50
1N09	1.25	6X86	8.50
1N10	1.25	6X87	8.50
1N11	1.25	6X88	8.50
1N12	1.25	6X89	8.50
1N13	1.25	6X90	8.50
1N14	1.25	6X91	8.50
1N15	1.25	6X92	8.50
1N16	1.25	6X93	8.50
1N17	1.25	6X94	8.50
1N18	1.25	6X95	8.50
1N19	1.25	6X96	8.50
1N20	1.25	6X97	8.50
1N21	1.25	6X98	8.50
1N22	1.25	6X99	8.50
1N23	1.25	6X00	8.50
1N24	1.25	6X01	8.50
1N25	1.25	6X02	8.50
1N26	1.25	6X03	8.50
1N27	1.25	6X04	8.50
1N28	1.25	6X05	8.50
1N29	1.25	6X06	8.50
1N30	1.25	6X07	8.50
1N31	1.25	6X08	8.50
1N32	1.25	6X09	8.50
1N33	1.25	6X10	8.50
1N34	1.25	6X11	8.50
1N35	1.25	6X12	8.50
1N36	1.25	6X13	8.50
1N37	1.25	6X14	8.50
1N38	1.25	6X15	8.50
1N39	1.25	6X16	8.50
1N40	1.25	6X17	8.50
1N41	1.25	6X18	8.50
1N42	1.25	6X19	8.50
1N43	1.25	6X20	8.50
1N44	1.25	6X21	8.50
1N45	1.25	6X22	8.50
1N46	1.25	6X23	8.50
1N47	1.25	6X24	8.50
1N48	1.25	6X25	8.50
1N49	1.25	6X26	8.50
1N50	1.25	6X27	8.50
1N51	1.25	6X28	8.50
1N52	1.25	6X29	8.50
1N53	1.25	6X30	8.50
1N54	1.25	6X31	8.50
1N55	1.25	6X32	8.50
1N56	1.25	6X33	8.50
1N57	1.25	6X34	8.50
1N58	1.25	6X35	8.50
1N59	1.25	6X36	8.50
1N60	1.25	6X37	8.50
1N61	1.25	6X38	8.50
1N62	1.25	6X39	8.50
1N63	1.25	6X40	8.50
1N64	1.25	6X41	8.50
1N65	1.25	6X42	8.50
1N66	1.25	6X43	8.50
1N67	1.25	6X44	8.50
1N68	1.25	6X45	8.50
1N69	1.25	6X46	8.50
1N70	1.25	6X47	8.50
1N71	1.25	6X48	8.50
1N72	1.25	6X49	8.50
1N73	1.25	6X50	8.50
1N74	1.25	6X51	8.50
1N75	1.25	6X52	8.50
1N76	1.25	6X53	8.50
1N77	1.25	6X54	8.50
1N78	1.25	6X55	8.50
1N79	1.25	6X56	8.50
1N80	1.25	6X57	8.50
1N81	1.25	6X58	8.50
1N82	1.25	6X59	8.50
1N83	1.25	6X60	8.50
1N84	1.25	6X61	8.50
1N85	1.25	6X62	8.50
1N86	1.25	6X63	8.50
1N87	1.25	6X64	8.50
1N88	1.25	6X65	8.50
1N89	1.25	6X66	8.50
1N90	1.25	6X67	8.50
1N91	1.25	6X68	8.50
1N92	1.25	6X69	8.50
1N93	1.25	6X70	8.50
1N94	1.25	6X71	8.50
1N95	1.25	6X72	8.50
1N96	1.25	6X73	8.50
1N97	1.25	6X74	8.50
1N98	1.25	6X75	8.50
1N99	1.25	6X76	8.50
1N00	1.25	6X77	8.50
1N01	1.25	6X78	8.50
1N02	1.25	6X79	8.50
1N03	1.25	6X80	8.50
1N04	1.25	6X81	8.50
1N05	1.25	6X82	8.50
1N06	1.25	6X83	8.50
1N07	1.25	6X84	8.50
1N08	1.25	6X85	8.50
1N09	1.25	6X86	8.50
1N10	1.25	6X87	8.50
1N11	1.25	6X88	8.50
1N12	1.25	6X89	8.50
1N13	1.25	6X90	8.50
1N14	1.25	6X91	8.50
1N15	1.25	6X92	8.50
1N16	1.25	6X93	8.50
1N17	1.25	6X94	8.50
1N18	1.25	6X95	8.50
1N19	1.25	6X96	8.50
1N20	1.25	6X97	8.50
1N21	1.25	6X98	8.50
1N22	1.25	6X99	8.50
1N23	1.25	6X00	8.50
1N24	1.25	6X01	8.50
1N25	1.25	6X02	8.50
1N26	1.25	6X03	8.50
1N27	1.25	6X04	8.50
1N28	1.25	6X05	8.50
1N29	1.25	6X06	8.50
1N30	1.25	6X07	8.50
1N31	1.25	6X08	8.50
1N32	1.25	6X09	8.50
1N33	1.25	6X10	8.50
1N34	1.25	6X11	8.50
1N35	1.25	6X12	8.50
1N36	1.25	6X13	8.50
1N37	1.25	6X14	8.50
1N38	1.25	6X15	8.50
1N39	1.25	6X16	8.50
1N40	1.25	6X17	8.50
1N41	1.25	6X18	8.50
1N42	1.25	6X19	8.50
1N43	1.25	6X20	8.50
1N44	1.25	6X21	8.50
1N45	1.25	6X22	8.50
1N46	1.25	6X23	8.50
1N47	1.25	6X24	8.50
1N48	1.25	6X25	8.50
1N49	1.25	6X26	8.50
1N50	1.25	6X27	8.50
1N51	1.25	6X28	8.50
1N52	1.25	6X29	8.50
1N53	1.25	6X30	8.50
1N54	1.25	6X31	8.50
1N55	1.25	6X32	8.50
1N56	1.25	6X33	8.50
1N57	1.25	6X34	8.50
1N58	1.25	6X35	8.50
1N59	1.25	6X36	8.50
1N60	1.25	6X37	8.50
1N61	1.25	6X38	8.50
1N62	1.25	6X39	8.50
1N63	1.25	6X40	8.50
1N64	1.25	6X41	8.50
1N65	1.25	6X42	8.50
1N66	1.25	6X43	8.50
1N67	1.25	6X44	8.50
1N68	1.25	6X45	8.50
1N69	1.25	6X46	8.50
1N70	1.25	6X47	8.50
1N71	1.25	6X48	8.50
1N72	1.25	6X49	8.50
1N73	1.25	6X50	8.50
1N74	1.25	6X51	8.50
1N75	1.25	6X52	8.50
1N76	1.2		

that the piece of plywood shown in the drawings may be moved up and down directly back of the reflex Port C simply by loosening the two knobs, tuning the port, and then tightening the knobs which permit the slide to be securely held in any chosen position. It is imperative that any reflex enclosure be tuned to the speaker for optimum results.

An improved model of the Read "Fold-a-flex" utilizes a modification of Ports A and B as shown in Fig. 2. Note that the hinged edge of the ports are rounded and that a 1/8 inch felt strip is glued to the inside of the cabinet serving as an air seal regardless of the position of the ports. This technique also provides a braking action to retain the ports in any chosen position. Modified Ports A and B are constructed like a "V" and the following action results: when set in Position 1, the characteristics of the enclosure will be that of a folded horn. When in Position 2, the air volume of the cabinet is decreased to provide reduced loading for the cabinet when used as a bass reflex and also to provide better characteristics for 12-inch speakers. When Ports A and B are placed at Position 3, the total air volume of the enclosure is available to provide an infinite baffle characteristic or as a reflex using large air volume.

While the modified construction of the ports does present a greater construction problem, it will be well worth the effort for the experimenter and custom installer as it will provide the widest possible choice of baffle characteristics for the demonstration of high-fidelity equipment. With these adjustable ports at your fingertips the speaker characteristics can be modified to create the most pleasing effect.

Subsequent data will appear giving full details for construction of this enclosure design for both 12-inch and 15-inch speakers including the coaxial as well as two- and three-way speaker systems. Measurements are now being made on several representative speakers and performance curves will appear in later issues.

Fig. 2. An experimental model of the "Fold-a-flex" with a modification of Ports A, B.

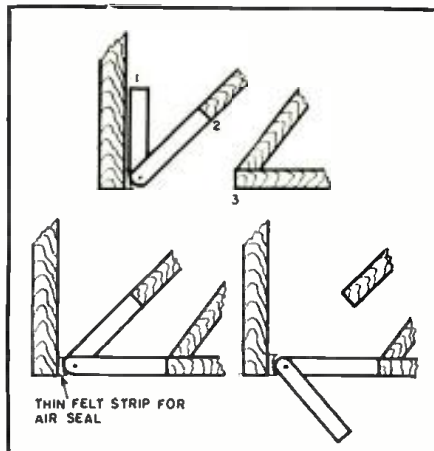

SPECIAL ... Communications Receivers



Contains \$ **69.50**
All Components
Complete Kit ... **69.50** KIT PRICE EACH

COMPLETE KIT—This kit is complete with everything necessary to assemble into a finished receiver, including tubes and cabinet. Chassis is punched and marked. Mount the parts, wire it, align it and you have a fine receiver of commercial appearance, that can't be beat for 3 or 4 times the price. Parts layout, schematic diagram and alignment instructions are supplied.

FEATURES:

- 2 Watt P.P. Audio Amplified AVC
- Voltage Regulated Oscillator Supply
- Noise Limiter
- Beat Oscillator
- Air Tuned R.F. Trimmers
- 2 Stage Permeability Tuned 455 KC I.F. Plus Crystal Filter
- Phone Jack — Built-in Stand-by Relay
- Operates on 105 to 125 Volts AC or DC Power Source
- Frequency Range 200 KC to 400 KC and 450 KC to 19 MC in Six Bands
- 40:1 Geared Ratio Dial Drive
- 11 Tubes Plus Selenium Rectifier
- 6SQ7 RF AMP.
- 6SB7 Mixer
- 2-6SQ7 I.F.
- 6H6 2nd Det & N. L.
- 6SF7 AVC AMP.
- 6SL7 BFO & 1st Audio Inverter
- P.P. 25L6GT Audio
- VR-75 Voltage Regulator
- Full Vision Calibrated Dial
- Cabinet 19 1/2" long x 10 1/2" high x 12 1/2" deep
- Finished in fine grain black wrinkle
- Front panel silk screened to identify each control
- Shpg. weight 45 lbs.
- Shipped Express Only.

FRONT PANEL CONTROLS

- Tuning
- R.F. Gain
- Audio Gain
- BFO-AVC Switch
- BFO Pitch
- Power On-Off
- Stand-by
- Noise Limiter On-Off and Control
- Antenna Trimmer
- Crystal Filter On-Off
- Crystal Phasing
- Selectivity
- Band Change Switch
- Calibrated Dial Face

Order Today!

CO AX CONNECTOR

Amphenol type 83-IR chassis connector, mica filled insert signal corps type S0239 **59¢** ea.

304TL's

Elmac, Jan. 304T L's, individually boxed **\$10.95** each

TYPE J POTS

500 ohm 2 watt type J Pot 3/4" long shaft 1/4" long bushing.

100 ohm type J with 3/4" bushing and locking nut screwdriver slot. Price each **79¢**

HAND MICROPHONE

Replacement for T-17 Mike—English make, single button, removable element—press to talk switch, 3 wire unshielded cable, price each **\$2.50**

FREE GIFT If you visit our store and bring this ad with you.

ORDER TODAY!
TERMS: 25% Deposit with order. Balance C.O.D. Include postage with parcel post orders. All prices F.O.B. Chicago and subject to change without notice. All merchandise subject to prior sale.

Boulevard Electronics, Inc.

808 W. Jackson Blvd.
CHICAGO 7, ILLINOIS
Phone: DE 2-4458

FILAMENT TRANSFORMER

24 volts at 1 amp. 2 1/2 volts at 1 amp—secondaries. Primary 113 volts—60 cycle horizontal 1/4 shell with 1 1/4 by 2 1/4 mounting. Price each **\$1.25**

AMPHENOL Double Stacked TV ANTENNAS

Amphenol 114-322 double stacked T.V. antenna with 100 ft. of twin lead and 5 ft. mast. Regular \$22.75 value for only **\$18.95**

ALL AMERICAN TUBE KITS

12AT6, 12BA6, 12BE6, 35W4, 50B5, 5 Tubes for **\$2.59**
50L6GT, 35Z5GT, 12SQ7GT, 12SK7GT, 12SA7GT, 5 Tbs for **\$3.22**

MAIL COUPON FOR HI-FI BROCHURE FREE BOOKLET

BOULEVARD ELECTRONICS, INC.
808 W. Jackson Blvd., Chicago 7, Illinois

Send FREE New High Fidelity Brochure.

NAME: _____

ADDRESS: _____

CITY: _____ ZONE: _____ STATE: _____

PHONO MOTOR

Brand new 78 r.p.m. PHONO MOTOR without reduction, 1,000 r.p.m. **49¢**

SCOPE TRANSFORMER

SECONDARY 2500 Volts at 1.6 Ma, 7500 Volts insulation. Open frame mounting. Mounting centers 3 3/4". Each **\$1.49**

FILTERS Thordarson Band Pass

600 Ohms to 600 Ohms, 1700 cycles to 3300 cycles. Attenuation 25 DB. at 1450 cycles or 50 DB. at 4880. Cases size 6" x 6 1/2" x 5". Prices each **\$5.00**

LAB POTENTIOMETER

DeJur type model 260, 6 watts 20,000 ohms resistance tolerance plus or minus 5%, 5 finger bronze wiper. Bakelite shaft 3/4" diameter x 1 1/4" long...ca. **\$1.95**

THE
Original
WRENCH
WITH THE
SCREWDRIVER ACTION!

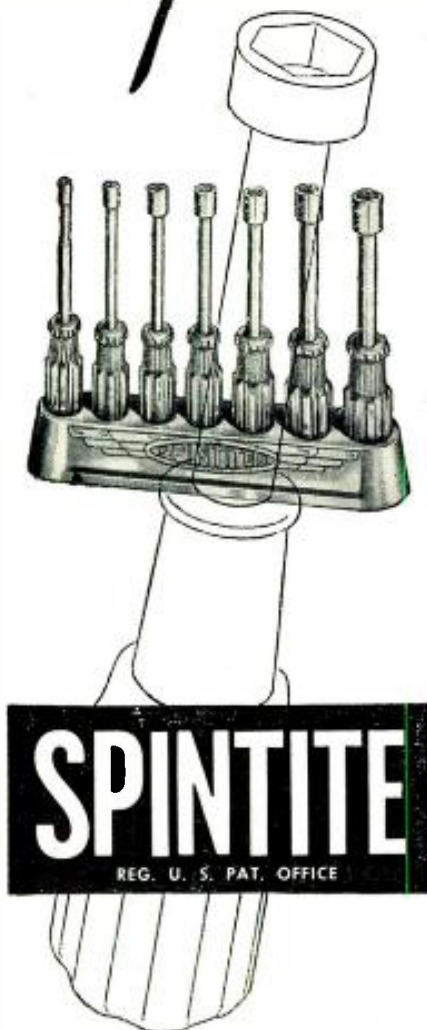

120 STYLES and SIZES

for

- ASSEMBLY WORK
- REPAIR WORK
- RADIO
- TELEVISION
- INDUSTRIAL
- AIRCRAFT



STEVENS WALDEN, Inc.
WORCESTER 4, MASS.

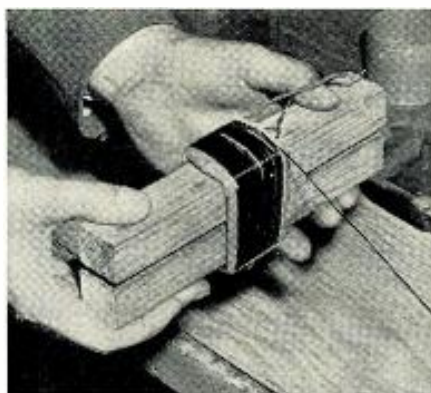

Fig. 1. Winding the new secondary. The block of wood prevents damage to wire.

USE YOUR DEFECTIVE TV TRANSFORMERS

By

HENRY A. SETZKE

Discarded components can be utilized to build this handy variable voltage transformer for service shop test work.

THE piece of equipment to be described should be standard equipment for every service technician. It is as necessary when testing television receivers as when servicing a.c.-d.c. radios and the like. The variable line voltage transformer can be used to test for voltage-surge intermittents, excessive bleeder resistance drops, and many other defects. It is also useful for isolation purposes. The particular unit described here can be constructed from any ordinary defective TV power transformer.

The power transformer from a TV set is desirable because it is designed to supply 250 to 300 watts and therefore is capable of delivering this much power after it is rewound. Most defects in TV power transformers occur as a shorted or open high voltage winding. The transformer selected must have this type of defect because all the windings except the high voltage one will be used again.

The first step is to disassemble the core. While removing the core laminations carefully observe the way the core was constructed; later it must be replaced the same way, see Fig. 2. Care should be taken when removing the laminations so that they are not bent or damaged in any way.

The second step is to remove the defective high voltage winding *without disturbing the other windings*. The high voltage winding will be the winding with the smallest diameter wire. All insulating paper should be saved for later use.

If the high voltage winding is the outermost winding it should be removed up to and without disturbing the insulation which separates the high voltage coil from the next coil. The new secondary can then be wound directly upon this insulation using the inner coils as a coil form. A block of wood one foot long through the center of the coil will make winding easier and also prevent damage to wires from the other coils during the winding process. See Fig. 1.

If the high voltage winding is the

innermost coil a slightly different procedure must be followed. The coils are always wound upon a heavy cardboard form; since the cardboard form will be used with the new coil, care should be taken when removing it. A single cut with a razor blade or sharp knife should be made, and the cardboard form carefully removed. Then the high voltage winding is removed up to the insulation that separates the high voltage coil from the next coil. A block of wood about one foot long, and the same dimensions as the inside of the cardboard form, will make winding the coil easier. Two or three pieces of wood may be used to get the desired size, see Fig. 1.

The third step is to determine the number of turns needed for the new secondary. After the high voltage winding is removed the "volts-per-secondary-turn" can be determined by temporarily winding 10 full turns of #18 enamel covered magnet wire around the windings that are left and temporarily replacing the core material. Connect the primary to the line and accurately measure the voltage of the 10-turn winding. The "volts-per-turn" is this voltage divided by 10.

The number of turns for the new secondary coil can be determined by dividing 120 by the "volts-per-turn." About 125 feet of wire will be required. The coil can be wound in either direction, but when once started the direction of winding should not

Fig. 2. How transformer core is disassembled.



be changed. A thin layer of insulating paper should be placed between

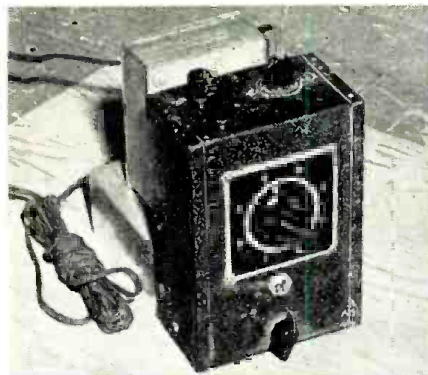

Fig. 3. Over-all view of unit showing compact size. A meter can be added if desired.

layers. The coil should be tapped at 10 volts from the end. The number of turns from the end where the tap should be placed can be determined by dividing 10 by the "volts-per-turn." The tap is twisted together, insulated, and the remaining wire wound over it as shown in Fig. 1. After the new coil is wound on the cardboard form, insulating paper should be used to build up the size so that it fits firmly inside of the old coils.

The fifth step is to connect the secondary windings in series aiding and to bring the connecting points out to a switch. (See Fig. 4.) If there are more secondaries than the customary 6.3 volt and 5 volt windings more taps can be added. With the minimum number of secondaries the circuit should be wired as shown in the circuit diagram, Fig. 4.

To help connect the secondaries properly, an a.c. voltmeter should be used. If it reads 113.7 volts when the 120 volt and 6.3 volt windings are placed in series opposing, it means the windings are in series opposing. To correct this interchange the 6.3 volt wires. The voltage should then read 126.3 volts. The same procedure is followed with the 5 volt winding. A 0-150 volt a.c. meter may be connected across the secondary of the transformer as shown in Fig. 4 to give a continuous indication of the secondary voltage.

Taking into account the small outlay of cash and time required to build this unit, this is a worthwhile project from every standpoint.

Fig. 4. Circuit diagram of junk-box supply.

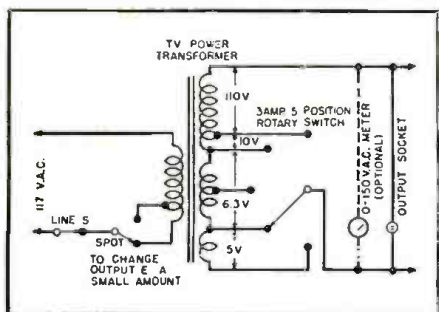

SURPLUS

6 VOLT DYNAMOTORS
A real surplus value for mobile use. 250 V. @ 65 M.A. output. 6 volt DC. input. In enclosed case. Used. excellent cond. Ea. **\$12.50**

MOBILE RECEIVERS
6 volt operated. Frequency coverage slug tuned from 1600 KC to 2500 KC. Use for Police, Boats or 160 and 80 meter Ham Bands. Power supply and Receiver in separate cases. All checked out. For Set **\$24.95**

SPECIAL PURPOSE TUBES ALL NEW REPACKS
723 A/B \$12.95
2K25 18.95
2K45 85.00

12 VOLT GENERATOR
Famous "Joen Generator." 12 Volt. D.C. at 55 Amp. Complete with charging ammeter and 55 Amp. Voltage Regulator. All in enclosed housing. Use for Trucks, Tractors or Mobile Radio. In excellent condition. **\$49.95**

REVERSIBLE MOTOR
1/40 H.P. Ball-bearing 3450 R.P.M. in Blast-proof case. Needs only a capacitor for starting. All Brand New. 110 V. 60 **\$4.95**
Cy. Special Low Price. Starting Capacitor. \$0.69 Ea.

DRY BATTERIES
New shipment of recent Expiration Date Surplus Batteries. All Checked.
TYPE NO. VOLTAGE EACH TEN \$
BA-51 67 1/2 V. Portable Batt. 75 7.50
BA-51 11 1/2 V. Handy Talkie Batt. 25 2.00
BA-38 102 1/2 V. Handy Talkie Batt. 75 7.00
BA-38 4 1/2 V. Portable Batt. 60 5.00

PROP PITCH MOTORS
For your Beam Antenna. 20 Volt to 32 Volt. 1/2 H.P. or D.C. Motor. 1 1/2 RPM Gear Reduction. 9000 to 1. **\$16.95**
ALL BRAND NEW. Each

HYDRAULIC TRANSMISSION
Variable speed for use in Lathes, Pumps, Drills, Milling Machines, etc. Speed can be varied from 0 R.P.M. to 650 R.P.M. forward or reverse. At 1/2 H.P. to 1 1/2 H.P. Input. Unit must be converted to bring external switch and speed control outside case. Has 5 1/2 H.P. 115 V. Motor mounted on unit. Complete. **\$47.50**
In excellent condition.

SOUND POWER PHONES
These are the old style telephone magnetic earpiece which now can be used as sound power phones. Will work up to a few hundred feet without external voltage source. Sound power phones never before at this low price. **\$1.00 PER PAIR**

12 or 24 VOLT VIBRATOR INVERTER
Use for Mobile Radio, Trucks, Boats, etc., where 110 Volt, 60 Cycle is desired. Can be used on 12 Volt or 24 Volt D.C. input. 110 V. 60 cycle, 210 watt maximum output. Uses separate vibrator for each input voltage. In enclosed case. **\$27.50**
excellent condition.

NEW 12 VOLT BATTERIES
For Mobile or Light Airplanes. In Original factory boxes. Weight: 37 Lbs. Size: 5 1/2" wide x 10" long x 10" high. Signal Corps Type BB-33. 12 Volt, 34 AH. **\$9.95**
A real terrific surplus value while they last, all new. Ea.

MICA CAPACITORS
FIG. A UPRIGHT MOUNTINGS

MFD.	Ea.	MFD.	Ea.	MFD.	Ea.
1.	\$1.00	.025	2.25	.00005	.95
.07	.95	.00075	1.50	5000 V.	
.062	.90	.0006	1.50	.004	3.50
.05	.85	.00025	1.25	.002	3.25
1500 V.					
.075	1.25	.006	1.50	.001	3.25
.05	1.10	.005	1.50	.00075	3.25
.029	1.10	.003	1.50	.0005	2.75
.03	1.00	.002	1.50	.00045	2.75
2000 V.					
.03	2.25	.001	3000 V. 1.35	.0002	1.75
.01	2.00	.000625	1.35	.00009	1.50
.006	1.50	.0005	1.25	7500 V.	
.005	1.50	.0004	1.25	.0005	3.95
.002	1.25	.00025	1.25	8000 V.	
.00275	1.25	.0001	1.15	.01	5.95
.0025	1.25	.00009	1.10	.0006	4.50
.00125	1.00	.00008	1.00	.0005	4.50
.00003	1.00	.000075	1.00	.00025	3.95

FIG. B SCREW TERMINAL

500 V.	1200 V.	2500 V.
.05 1.00	.022 .85	.015 1.50
.04 .85	.02 .85	.01 1.60
.02 .75	.01 .75	.005 1.25
600 V.		
.01 .65	.005 .50	.003 1.25
.007 .65		.002 1.00
.0047 .65		.0015 1.00
.00375 .75		.00063 .90
.00275 .75		.0005 .90
.002 .75		.0005 .90
.0015 .45		.0004 .85
.0015 .35		.0004 .85
.00005 .75		.00015 .85
1000 V.		
.01 .75	.0004 .75	.00005 .75
.00005 .75	.00007 .75	.005 1.50

FIG. C. SOLDER LUG TYPE

500 V.	600 V.	1250 V.
.02 .75	.005 .65	.02 1.50
.01 .75	.00004 .50	.002 1.50
.005 .65	.03 .60	.00005 .50

All Mail Orders Promptly Filled. F.O.B., San Francisco. Do not send postage stamps. Write for new 1953 free booklet listing our stock and prices on Radio, Electronics, Tools, Hardware, Motors, Wire, Motors, Batteries, Aluminum Sheets, etc. 20% D.P. on C.O.D. orders. All items subject to prior sale and prices subject to change without notice. On purchases under \$5.00, send full amount.

ARC 5 EQUIPMENT:

TRANSMITTERS
4 to 5.3 MCS. 8.95
5.3 to 7 MCS. 7.95
With all tubes and crystal. In excellent condition.
R-4/ARR-2 RECEIVER-234-258 MCS
Complete with all tubes and dynamotor. Excellent condition. **\$19.95**

RECEIVERS
150 to 550 KC \$16.95
6 to 9 MCS. 9.95
With all tubes and dynamotor. In excellent condition.

COMPONENTS
MOUNTING RACKS
Single Trans. \$1.00 Ea.
Double Trans. 1.75 Ea.
Triple Trans. 2.25 Ea.
RE-2ARC-5 ANTENNA RELAY UNIT
Comp. with Meter and **\$11.50**

SPECIAL A.C. MOTORS
1/40 Horse Power. Bodine Sync. Motor. 1800 R.P.M. Operates on 110 V. 60 Cy. Has 2 shafts and fan type flange mount. Uses 5 Mfd. Capacitor for starting. Use for fan, or small Grinder, Buffer or Hobby work. All in excellent condition. Price. **\$7.95**
Capacitor. Ea. \$1.00

MIDGE SELBY
AY6 type operates from 6-12 volts 60 Cycle. Use as both transmitter and receiver. These compact little units draw almost no current and work fine for all remote position indicating applications. OD 2 1/2 x 3 1/2". Has spring return shaft. All New (Appr. wt. 1 lb.) **\$1.95**
AY-6 type same as above but has a continuous 1/2" rotating shaft. These compact units are all new. **\$4.95**

ARMY AMMUNITION CANS
Type M-3 50 Cal. Cans 12" Long x 9" Wide x 7 1/2" Deep.
Type M-1 Cans 12 1/2" Long x 3 1/2" Wide x 6 1/2" Deep.
All aluminum with Leather Handle and Hinged Top with latch. Use for all your small parts or tools. O.D. Color. Clean them and buff or paint. **\$1.50**

BK-22 RELAY UNIT
Part of Ratlo Compress Equipment. Contains 1-12 V. D.F.-T. Leach Relay and 1-Solenoid operated 10 pole double throw switch. Terminal markings on back of unit. All enclosed aluminum housing. Brand New. Each **\$4.95**

Thousands! CRYSTALS Thousands!

FT-211	54th Harmonic Type.	Fundamental Frequencies listed below in KC.
370	390	410 430 449 469 488 508
372	392	412 432 451 470 488 510
374	394	414 434 453 471 490 512
376	396	416 436 455 473 492 514
378	398	418 438 456 475 494 516
380	400	420 440 458 477 496 518
382	402	422 442 460 479 498 520
384	404	424 444 462 480 502
386	406	426 446 464 482 504
388	408	428 448 466 484 506

Each Frequency—35c Ea.; 3 for \$1.00; 10 for \$3.00

12 VOLT BLOWER MOTOR
The famous Trate Wind Blower for use on Trucks, Boats, Etc. Ideal for Engine Room use as motor is completely enclosed and Sparkproof. 4" outlet. All Brand New. Each **\$9.95**

ARC-4 TRANSCEIVER
140-144 MC. Ideal for 2 meters. Complete with 20 tubes and control box. BRAND NEW **\$29.95**

WILLARD 2 VOLT RADIO BATTERY
NEW. Uncharged (Appr. wt. 4 lbs.) TYPE 20-2. Ea. **\$2.50**
Complete set of three with box and Connections to make a 6 volt. 20 Amp. Hrs. Battery Uncharged **\$8.95**
(Appr. wt. 15 lbs.) Set

2 VOLT VIBRATORS. VBBA Synchronous Type. Used in all portable radios having 2 volt wet cell supply. All new. **\$1.00**

AIRCRAFT HEATERS
Stewart-Warner Gasoline Heater with 24 Volt Blower Motor attached 8.5M B.T.U. Per Hour. All in Excellent Condition. Each **\$3.95**

12 VOLT GENERATOR
Same generator as used in Trucks and Tractor Units. 12 Volt 25 Amp. with V-Pulley for connection to motor or engine. Used. **\$6.95**

SOUND POWERED HEAD AND CHEST SET
Use same way as Hand Set except you have freedom of hands. No Batteries or power source required for operation. Excellent Condition. Per Pair **\$11.95**

HOBBY MOTORS
Operates from 110 Volts. 60 Cy. A.C. Geared Motors: 3 Speeds: 4,000 RPM., 200 RPM., 5 RPM. These motors can be used for Bar-Que, 2000 V. Home Work shops or any low speed application. Each speed on a separate shaft. Can be used separately or at the same time. All New. Each **\$12.95**

CAPACITORS — FIXED — OIL FILLED
Solar, Pyranol, C.O. Etc.

ALL D.C. VOLTAGE RATINGS	
2 MFD. 400 V. \$0.79	1 MFD. 1000 V. \$1.00
3M3 MFD. 400 V. 1.95	2 MFD. 1000 V. 1.25
10 MFD. 400 V. 2.95	5 MFD. 1000 V. 3.75
1 MFD. 600 V. .75	10 MFD. 1000 V. 4.50
4 MFD. 600 V. 1.95	1 MFD. 1500 V. 1.50
5 MFD. 600 V. 1.95	4 MFD. 1500 V. 2.25
6 MFD. 600 V. 1.95	6 MFD. 1500 V. 2.25
7 MFD. 600 V. 1.95	1 MFD. 2000 V. 1.65
8 MFD. 600 V. 1.95	2 MFD. 2000 V. 1.65
8x8 MFD. 600 V. 2.25	3 MFD. 2000 V. 3.50
10 MFD. 600 V. 2.25	1 MFD. 3000 V. 3.50
15 MFD. 600 V. 2.95	1 MFD. 5000 V. 5.50
20 MFD. 600 V. 2.95	

STANDARD SURPLUS
1230 Market St., San Francisco 3, Cal.
Telephone HEMlock 1-3106

now!

0.09%

INTERMODULATION DISTORTION

AT AVERAGE LISTENING LEVELS

FOR ONLY \$109.95

The **NEW Shields**
Model SPA-25
AMPLIFIER

- Outstanding sound quality at a record low price.
- A power output of 25 watts with less than 0.7% intermodulation distortion. Power response from 18 cps. to 40 kcs. plus or minus one db.
- Internal output impedance of less than one ohm.
- A compact, sturdy unit adaptable to almost any high fidelity system.

GET THE FACTS — MAIL THIS COUPON TODAY!

Shields Laboratories, Inc.
Please send me your bulletin on the new SPA-25 Power Amplifier.

SEE YOU AT THE FAIRS!

NAME

ADDRESS

CITY

STATE

RTVN-1053

Shields LABORATORIES, INC.
810 N. LINCOLN AVENUE
PITTSBURGH 12, PA.

The OARAC
(Continued from page 83)

linder passes under a magnetic head only once for each revolution of the cylinder, it is not possible to read any arbitrary spot at any arbitrary time. It may be necessary to wait up to a full revolution before the desired spot passes beneath a magnetic head. Since the cylinder rotates at 3350 rpm or approximately 56 revolutions per second, one revolution takes 1/56 second or approximately 18/1000 second which is 18 milliseconds. This is the maximum access time for the memory. The waiting time for the desired spot (or more properly "word" since a full word is always read at one time) to be read may vary from zero up to the maximum access time of 18 milliseconds, hence it is useful to speak of the average waiting time. This is just 1/2 the maximum access time, thus we say that the average access time is 9 milliseconds.

Turning away from the OARAC memory our layman encounters a large cabinet filled with vacuum tubes, germanium diodes, and associated electronic components not to mention an almost undecipherable maze of wires. The contents of this cabinet are primarily the arithmetic and control circuits of the computer. In spite of their electronic complexity, the basic functions of these circuits are quite simple. Let's consider the arithmetic unit first.

The arithmetic unit is that part of the computer which does the arith-

metic calculation. It may be compared to a very high-speed desk calculator which is capable of adding two ten-decimal-digit numbers in about 90/1,000,000 of a second, or in computer language, 90 microseconds. The multiplication of two such numbers takes approximately 8/1000 second or 8 milliseconds.

The main components of the arithmetic unit are three storage registers, an adder, and a counter. The storage registers are electronic circuits (each contains 44 tubes plus 352 germanium diodes and associated components) each of which is capable of storing one ten-decimal-digit number, or word as it is sometimes called. These registers are used to store numbers temporarily while the arithmetic operations are being carried out. The adder may be compared to an electronic addition table. When electrical signals representing two numbers are fed to its input an output signal representing the sum of the two numbers appears at its output terminals. When the adder is properly connected to two of the three storage registers, the numbers stored in the registers are added and the sum is stored in one of the registers. Subtraction is accomplished by first making one of the numbers negative and then adding them.

Multiplication is accomplished by means of repeated additions. For example, $7 \times 3 = 21$ may be written $7 + 7 + 7 = 21$. Using this method, multiplication makes use of the adder and the counter is used to keep track of the number of additions that are made. This is a somewhat simplified



Close-up view of plug-in turret used in the OARAC electronic calculator.



Mathematician and typist with the input unit set up problem to be solved.

version of how the computer actually multiplies, but it serves to illustrate the basic principle involved.

The control circuits of OARAC may be divided into two parts—the arithmetic controls and the sequencing circuits. The arithmetic control circuits send the necessary signals to the arithmetic unit to cause it to add, subtract, divide, etc. as required. The sequencing circuits are the real heart of the computer. It is this part of the machine which governs the automatic operation and so to speak "bosses" the rest of the computer.

Before a problem is turned over to OARAC for solution, a mathematician must break it down into a series of simple steps such as additions, multiplications, etc., which the computer can execute. The computer is told to carry out each of these steps (and a typical problem might have several thousand steps many of which the computer repeats hundreds or even thousands of times) by means of an instruction for each step. An instruction is essentially a code number which tells the computer what to do. For example, 220005 is an instruction telling the computer to add (code 22) the number stored in the memory at word space 0005 to the number already in the arithmetic unit. When the problem is put on the computer, the list of instructions together with the necessary numbers is stored in the memory. Each instruction or number is stored at a specified address in the memory. (The word spaces in the memory are all numbered and these numbers are called addresses.)

After the problem is stored in the memory the computer is placed in operation from the control panel by specifying the address of the first instruction to be executed.

The sequencing circuits send out the necessary signals to cause the first instruction to be read from the memory. When it has been read back from the memory, the sequencing circuits interpret it and send out the necessary signals to the arithmetic control circuits to cause them to execute the instruction. After the instruction has been carried out, the arithmetic control circuits send a signal back to the sequencing circuits. When the sequencing circuits receive this signal they automatically cause the next instruction to be read back from the memory, interpret it, and signal the proper section of the arithmetic control to carry it out. This cycle continues at a rate up to 100 instructions per second until an instruction to stop is reached, or until an error which causes the computer to stop is made. The computer is so built that it automatically detects most of the errors which it occasionally makes and automatically corrects many of them. If the computer cannot correct its error by repeating the computation it stops and signals the operator by means of an alarm bell. The operator then corrects the trouble and restarts the computer.

FAMOUS B-29 BOMB SIGHT

ASSEMBLED BY SPERRY GYROSCOPE CO.



- Experimenters
- Physicists
- Schools
- Research Men
- Mechanics
- Opticians
- Laboratories
- Tech Institutes
- Engineers
- Repairmen
- Manufacturers
- Electricians

Recently declared a war surplus item, this bomb-sight is now selling at a ridiculously low price! As parts or as precision units, this P-4 Computer can be used to make instrument and machinery repairs, in manufacturing and assembling, in home and industrial workshops. It can be used in teaching, aeromatics, engineering, navigation, physics, optics, mechanics, etc.

Comes in three units—the main body and two attachable periscopes. 22 and 68 inches high, alternate parts of an intricate optical system made by Eastman-Kodak Co. Main body is 35x25x14 inches. Contains at least 8 27 VDC motors, electric heater and temp. control, precision sextant, dozens of switches and controls, hundreds of fine gears and driving rods all types. Shipping wt. 250 lbs.

Cost to U. S. Govt. \$21,000. **Your Cost BRAND NEW... \$295.00**

Terrific Transmitter-Receiver Buy! FAMOUS BC-645 450 Mc.—15 Tubes



BRAND NEW, in original carton! Easy to convert for phone or CW 2-way communication, covering these bands: 420-450 Mc Ham Band, 450-460 Mc fixed or Mobile, 460-470 Citizens Band, 470-500 Mc TV experimental. Contains 15 tubes: 4-7F7, 4-7H7, 2-7E6, 2-6F6, 2-955, 1-WE-316A. Size 10 1/2 x 13 1/2 x 4 3/4". Wt. 25 lbs.

BRAND NEW
\$49.50
each

CONVERSION DIAGRAM INCLUDED!

PE-101C DYNAMOTOR for above BC-645... **\$4.85**

UHF ANTENNA ASSY, for above BC-645... **\$2.45**

TRANSMITTER BC-223-AX

Ideal for 80-meter band! 801 osc., 801 P.A., 2 4S modulators, 1—4E speech amp., 4 xtal freq. and master osc., on selector switch. 10 to 30-watt output, tone, voice case, complete with freq. chart, 3 tuning units and tubes in original cases, less xtals. Specially low price, shpg. wt. 80 lbs. **\$99.50**

BRAND NEW, Used, excellent condition... \$44.50

SCR-274N COMMAND & ARC-5 EQUIPMENT

Type	Excellent USED	BRAND NEW
BC-453 Rcvr. 190-550 Kc.	\$28.50	\$44.50
BC-454 Rcvr. 3-6 Mc.	12.50	19.95
BC-455 Rcvr. 6-9 Mc.	12.95	17.95
BC-456 Modulator	9.75	5.75
BC-457 Xmtr. 4-5.3 Mc.	18.50	29.50
BC-458 Xmtr. 5.3-7 Mc.	7.75	37.50
BC-459 Xmtr. 7-9.1 Mc.	19.95	24.50
BC-450 3 Rcvr. control box	1.49	2.45
BC-451 Xmtr. control box	1.25	1.95
3 Receiver rack	1.79	2.95
2 Transmitter rack	1.59	3.25
Single Transmitter rack	1.59	3.25

ARC-5/T-23 Transmitter

With tubes. Brand New... **\$59.50**



SETCHELL-CARLSON BEACON RECEIVER BC-1206-C

Receives A-N beam signals. Tunes 195 to 420 Mc. Size 4 1/2" x 6 1/2" x 4 1/2". Wt. 4 lbs. Complete with 5 tubes.

BRAND NEW... **\$13.50**
Used, less tubes... **\$8.95**

McElroy Automatic KEYSER BRAND NEW

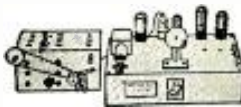

Suitable for keying transmitter, or for code practice. Has photoelectric cell and sensitive relay. Variable speed motor operates on 110 volts 60 cycles AC, or DC, complete with 2-11726 and 1-11717 tubes, your cost **\$27.95**

Sensational Buy! MODULATED BC-221-AK FREQUENCY METER

BRAND NEW! Limited quantity, first come, first served! Range 125 to 20,000 Kc, with crystal check points in all ranges. Complete with tubes, crystal, calibration charts. **\$210.00**
Your cost, BRAND NEW... \$129.50
Used, Excel. Cond. with tubes & crystal... \$129.50



HEADSETS

	Excellent USED	BRAND NEW
HS-23 high impedance	\$2.95	\$4.75
HS-33 low impedance	2.45	5.75
HS-30 low imp (feather)	1.49	2.45
H-16/U high imp (2 units)	.09	4.95
CD-307A cords, with PL55 plug and JK26 jack, 8' long		1.19



CARBON HANDMIKE

Genuine Sig. Corps Mike, 200 ohm, single button, has press-to-talk switch, 4-ft. rubber cable, amphenol plug. Beautiful satin chrome finish. **BRAND NEW... \$5.95**

MICROPHONES

	Excellent USED	BRAND NEW
T-45 Lip Mike, navy type	\$.49	\$1.45
T-30 Throat Mike	.49	.85

ARMY FIELD PHONES

Type EEB—Talk as far as 17 miles. Dependable 2-way communication at low cost. Ideal for home, farm, field. Up to six phones can be used on one line. Each phone complete with ringer. Originally cost gov't. \$65.00 each. Excellent Condition. **Your cost... \$22.25**



DYNAMOTORS

TYPE	INPUT Volts	OUTPUT V	A	Excellent USED	BRAND NEW
PE-86	28	250 @ .06	\$ 2.95	\$ 5.50	
DM-28	28	224 @ .07	4.95	10.50	
PE-101C	12-24	400 @ .13	2.75	4.25	
PE-94	28	300 @ .2	4.95	7.95	
DM-32	28	250 @ .06	4.90	8.95	
DM-21	14	235 @ .09	6.85	16.50	
SB-7	1.4	1000 @ .35		29.50	

PE-103 DYNAMOTOR 6.12 V input, 600 V @ 160 MA output. BRAND NEW, export packed... \$39.50
PE-206A 80-VOLT AC INVERTER. 28V DC input, 80V 800 cycle AC output. Complete with filter... \$12.50

SENSATIONAL Smash Value!

NEW COMPLETE I.F.F. Equipment RC-188-A

Bargain opportunity of a lifetime! This I.F.F. equipment originally cost about \$20,000

... now buy it for a tiny fraction of cost! Easily converted for Television. Complete assembly consists of Control unit with 5" C.R. Tube, transmitter and receiver assembly (157 to 185 Mc). Indicator unit, and Power Supply (450 watts), operating on 110 volts, 60 cycles AC. All assembled, ready to operate. 62 Tubes included: 8—6V6GT, 8—6SL7GT, 14—6SN7GT, 1—6CP1, 2—9006, 1—6Y6G, 2—6E5, 1—100TH, 2—6J5, 2—2C26, 1—3E29, 1—6H6, 7—6AG5, 3—6AK5, 1—6C4, 3—2X2, 1—6X5GT, 3—5U6GT. Overall size 55" high, 28" wide, 20 1/2" deep. Shpg. weight 85 lbs. Your cost complete, **\$350.00**
BRAND NEW, in original packing...

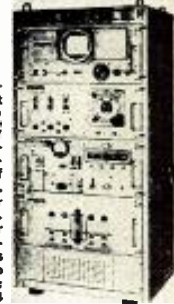

WILLARD 6-VOLT MIDGET STORAGE BATTERY

3-amp hr. BRAND NEW. 3 5/8" x 1-13/16" x 2 3/4". Uses standard electrolyte... **\$2.65**

WILLARD 2-VOLT STORAGE BATTERY

20 AMP. HR. BRAND NEW... **\$2.69**
1-QUART ELECTROLYTE FOR ABOVE. ENOUGH FOR TWO CELLS... BOTTLE **\$1.45**
7-PRONG 2-VOLT VIBRATOR, FOR PORTABLE AND FARM SETS (GE LB530)... **\$1.49**

Please include 25% Deposit with order—Balance C.O.D. MINIMUM ORDER \$3.00. All Shipments F.O.B. Our Warehouse N.Y.C.

G & G RADIO SUPPLY COMPANY

Phone COrtlandt 7-4605

51 VESEY STREET • NEW YORK 7, N. Y.

Branch: 7123 Bryn Mawr Ave., Chicago, Ill.

ATTENUATOR SWITCH eliminates "cut and try" methods for better TV reception

A twist of the dial on this Centralab TV Attenuator Switch instantly shows proper amount of attenuation for best reception. You know how important this is in multi-station areas!

Four different H-pads are mounted in the attractive metal case. You simply hook up the 300-ohm antenna twin-lead and dial finds correct setting. Then, unhook leads and install proper H-pad. Simple as that. And it's accomplished in a few minutes.

If customers want permanent selective attenuation installation, a handy mounting bracket does the trick. And it's another sale for you!

Yes, time saved by Centralab TV Attenuator on one job is profit time for another job. That's why you'll want to contact your distributor for full details.

AN ELECTRONIC METRONOME

By LEON A. WORTMAN

A simple instrument with an adjustable rate. The noise of relay closing marks beats.

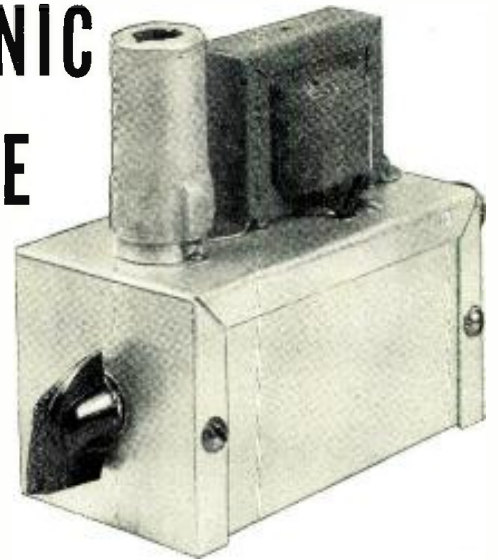

IF YOU haven't raided the "junk box" yet for the fun of building an electronic metronome, here's a circuit that's quick, foolproof, and easy. If your daughter, son, niece, or nephew is at the piano-lesson stage, here's a metronic device (electronic metronome) that the teacher will approve. If you're a storekeeper with space for animated displays, this same device will provide automatic "stop-go" control for lights, motors, and solenoids.

The circuit uses a 2D21 thyratron tube as the gating control for the heavy duty relay. Action time for the gating control is determined by the values of R_1 , R_2 , and C_1 . Variation in the timing is afforded by making R_1 or R_2 or C_1 variable. Of course, it's not practical to make a .25 μ fd. condenser variable. It is very simple, however, to make R_1 or R_2 the variable element. A wider range of time control is available by making R_2 , the larger of the two values, the variable. A standard carbon-type potentiometer is ideal for the purpose. The acoustic sound made by the mechanical and instantaneous action of the relay creates the sound of the meter of the tempo. R_3 serves as a grid current limiting resistor. It can be eliminated but would shorten the life of the 2D21. C_2 eliminates relay chatter and contributes to smooth positive relay action. The simplest method of calibration is to beat the acoustic sound against a mechanical metronome.

For use as an animated display "stop-go" control, the spare set of s.p.d.t. contacts on the relay can be wired in series with the electric motor, light, or solenoid of the display.

The size of the box in which the unit is constructed has no bearing on the performance. However, the small number of components and their small sizes enables compact construction and a more attractive appearance. The author's unit is built in a 2 1/4 x 2 1/4 x 4 inch aluminum box. —30—

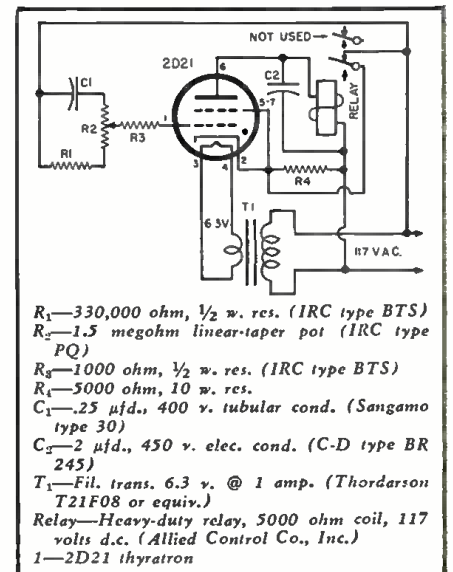

Centralab

CENTRALAB,
 A Division of Globe-Union Inc.
 910-J.E. Keefe Ave., Milwaukee 1, Wis.

Please send additional technical data on Centralab's TV Attenuator and H-pads.

Name.....

Firm.....

Address.....

City.....Zone.....State.....

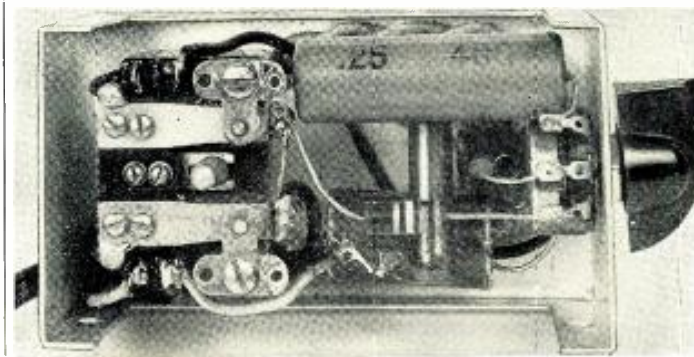

Circuit diagram of the home-made metronome. A 2D21 thyratron is used as a gating control for relay.



Under chassis view of unit. It is housed in a 2 1/4" x 2 1/4" x 4" aluminum cabinet.

TV Tube Substitutions (Continued from page 50)

drilling out the rivets other parts might be damaged, the rivets may be inaccessible, etc. In those instances it is possible to wire the new socket right into the old one by filling the pin holes of the old socket with solder and connecting the new socket with short lengths of bus bar. To avoid shorts, cover the bus bar with insulated sleeving.

One of the things to watch when substituting tubes is the heater power required. In most TV sets using 6.3 volt heater tubes, the extra power needed by a substitute can usually be supplied by the transformer without substantially lowering the heater voltage. Where a series heater string is used, a substitute tube requiring more heater current or higher voltage cannot be connected.

If the substitute takes less current, a shunting resistor must be added.

Many of the 6.3 volt tubes used in TV receivers have 12 volt equivalents such as the 6AU6, 6AT6, etc. and their 12AU6, 12AT6, etc. brothers. Since these tubes are identical in all but the heater voltage and current, the 12-volt types are not listed here. There is little chance of substituting, for example, a 12SN7 for a 6SN7. On the other hand, a 6AT6 can be substituted for a 6AV6, similarly a 12AT6 can be used in place of a 12AV6. The series heater equivalents for other TV tubes, such as the 19BG6 for the 6BG6 etc., are also omitted for the same reasons. The 6-volt equivalents may be used for 12-volt tubes which have center-tapped heaters (12AU7, 12AX7) paralleled across 6.3-volts.

Keep this tube substitution list on hand to use as a quick reference when a particular tube type is out of stock and also to show to the customer what substitutions can be made. —50—

Let me show you how EASY it is to LEARN TV

the practical way... **ASSEMBLE A TRANSVISION TV KIT**

Pay as You Wire \$ **39**
Down Payment

I WILL HELP YOU to start learning TV the practical way — by assembling a TRANSVISION TV KIT in EASY STAGES. For only \$39 you get PACKAGE #1 (standard first pkg. for all of our kits). This package gives you the BASIC CHASSIS and over 450 TV COMPONENTS with complete Instructions, Drawings, Photos, Service Booklet, and a year's subscription to my "TV and Electronics Notes". When ready, you order the next stage (pkg. #2), etc. Low prices make your complete kit a terrific buy!

FREE CATALOG Shows 6 Great TV Kits:
EXCLUSIVE: Only Transvision TV Kits are adaptable to UHF. Ideal for FRINGE AREAS. No Previous Technical Knowledge required. Write now!
TRANSVISION, INC., Dept. RN10
NEW ROCHELLE, N. Y.

— MAIL THIS COUPON TODAY —
Mr. D. Gnessin, Educational Director
TRANSVISION, INC., NEW ROCHELLE, N. Y., Dept. RN10
 I'm enclosing \$_____ deposit. Send standard kit PACKAGE #1, with all instruction material. Enclose C.O.D.
 Send FREE copy of your new TV Kit Catalog.
Name _____
Address _____
City _____ State _____



Servicemen, Technicians, secure your future —
I WILL START YOU in a WELL-PAYING TV SET BUSINESS

Be a TRANSVISION Factory Agent — and make good money full time or part time.

Would you like to increase your income with at least \$5000 a year, or more? Then get on the Transvision Factory Agent band wagon. Here's a golden opportunity to get that extra income you've been dreaming of—without investing in merchandise or overhead.

That's right — I don't tie you up with inventory. ALL YOU NEED is my SALES KIT costing only \$9.95. This kit gives you our 3-Dimensional Illuminated Viewer, Natural-color Slides displaying our complete line of gorgeous TV Sets; also our spiral-bound Salesman's Catalog and price list.

YOU CARRY NO STOCK: With my Sales Kit you sell from our million-dollar inventory. We ship either to you, or direct to your customer, as you wish. YOU MAKE 2 INCOMES FROM EACH SALE — profit on the set, and a fee for the installation (we expect all of our Factory Agents to be competent installation-and-service men).

YOU CAN BEAT COMPETITION: Our prices on giant screen TV sets will enable you to meet and best competition at a good profit.

YOU SELL THE FINEST SETS: You sell sets with the incomparable RCA-licensed 630 Chassis — the finest on the market — or the famous fine-quality Transvision A6 Chassis. You have a wider sales range — a greater choice of Table Models, Consoles, Combinations, in screen sizes from 17" to 21". You have a set and a price for every prospect.

SECURE YOUR FUTURE: Don't lose time. Get started making more money now. Fill out and mail the coupon to me — TODAY!

FOR THE AMAZINGLY SMALL INVESTMENT OF ONLY \$ **9.95**



CLINCH SALES in prospect's home with my 3-Dimensional Illuminated Viewer, Natural Color Slides, and Salesman's Catalog.

We offer the LATEST, 31-tube **630 DE LUXE TYPE TV CHASSIS** with High-Fidelity Sound
Mfr. licensed under RCA patents
Has Super-Fringe Area Circuit... Redesigned for peak UHF performance... High fidelity push-pull audio (40-13,000 cycles)... 12" Hi-Fidelity Speaker... 31 tubes (28 tubes, cycles)... plus CRT makes 32 tubes... handles all picture tubes up to 24"... made with only the finest parts... carries standard RMA Guarantee.
JOBBER INQUIRIES INVITED



BEAUTIFUL, IRRESISTIBLE CABINETRY: This illustration is only suggestive of our vast line of gorgeous TV Sets. Get the SALES KIT. See the Natural-Color Slides. You'll agree that Transvision offers the hottest TV deal in the entire industry!

TRANSVISION, INC.
NEW ROCHELLE, N. Y.
NE 6-6000
RUSH THIS COUPON NOW

Mr. H. D. Sueshultz, Gen. Mgr.
TRANSVISION, INC., NEW ROCHELLE, N. Y., Dept. RN10
 I enclose \$9.95 for your complete FACTORY AGENT'S SALES KIT
 I like the idea but would appreciate more details.
Name _____
Address _____
City _____ State _____

Tremendous Opportunities in COIN TV and COMMERCIAL TV

TRANSVISION offers the only specially designed line of Coin-Operated and Commercial TV with the **FREEVIEWER* ATTACHMENT** (Pat. Pend.)

This field offers rich rewards to enterprising servicemen or dealers — on part time or full time basis. *The Electronic Freeviewer is a patented device which makes coin operation really pay off in a big way. Boosts revenue by "sampling" — by giving a short freeview of TV programs to prospective customers. Works like magic in enticing sales.

Get details now. TRANSVISION, INC. NEW ROCHELLE, N. Y.

— MAIL THIS COUPON TODAY —
TRANSVISION, INC., NEW ROCHELLE, N. Y., Dept. RN10
 Rush full details on COIN OPERATED TV.
Name _____
Address _____
City _____ State _____

ADCO JOE SAYS:



Here are just a few of our 10,000 Bargains
SAVE MONEY—
ORDER BY MAIL!

SPECIAL OFFER!

1 CBS-HYTRON 5AW4

GIVEN FREE WITH THE PURCHASE OF

5-6SN7GT
5-12AU7
5-1B3GT
5-6CB6 } for only **\$23.45**

the 5AW4 is the new heavy-duty work horse. Cuts 5U4G call-backs.

<p>SELENIUM RECTIFIERS</p> <p>350 ma.—\$1.75 500 ma.—\$2.02</p> <p><i>Additional 10% discount on lots of 12 assorted.</i></p>	<p>TV TUBE SOCKETS with leads 45c</p>	<p>TV LINE CORDS 29c</p>	<p>SPRAY KLEEN Contact Cleaners 99c</p>
<p>PHILCO FLYBACK NO. 32 - 8509 Reg. price \$11.10. OUR SPECIAL PRICE \$3.75</p>	<p>6"x9" or 7" PM auto type replacement speaker \$2.50</p>	<p>TV PICTURE TUBE BRITENER \$1.30 ea.</p>	
<p>PHONO-XTAL</p> <p><i>Most popular of all crystal cartridge replacements. 3V. output.</i></p> <p>\$1.95 each in lots of 3</p>	<p>Vertical output transformer—3 wire, universal type ...\$1.49</p>	<p>10" & 12" FLYBACK TRANSFORMER Special—\$1.75</p>	

20% deposit on all orders—Balance C.O.D. All Shipments F.O.B. Baltimore.

AMERICAN DISTRIBUTING COMPANY

1200 N. FULTON AVE. — BALTIMORE 17, MD.

TVI COMMITTEE

AN OUTSTANDING example of a public service being rendered by an amateur radio group is the Washington Television Interference Committee (WTVIC) operating in and around Washington, D. C.

The committee was formed in April 1952 to combat television interference. Representatives from each of seven active amateur radio clubs in metropolitan Washington, D. C. were organized into one coordinated committee of technical and public relations experts.

In order for the program to operate most effectively and on a mutual assistance, cooperative basis with other organizations interested in communications problems, the committee maintains close liaison with associate agencies such as RETMA, NAB, Electric Institute of Washington, Telecasting Services, FCC, MARS, and the power companies.

The prime purpose and function of this public-spirited committee is to provide diagnostic and technical assistance for amateurs involved in television interference problems and, at the same time, to develop and maintain good neighborhood relations between amateurs and television set owners.

The ultimate success of the committee plan will depend, to a great extent, upon the degree of support and cooperation extended by manufacturers of television receivers and their service technicians, in applying corrective measures to receivers which respond to signals outside of the television band.

WTVIC has striven to create first an atmosphere of continuing mutual understanding and interest between the amateur and service technician and second, to promote an acceptable "educational" program for TV technicians for developing the most effective and efficient approach to the solution of the TVI problem in general.

In line with this thinking the committee has issued a poster and a pamphlet for distribution among service shops and their personnel in the Greater Washington area.

The pamphlet, prepared in cooperation with RETMA, outlines the problem, explains the amateur's role in TVI complaints, the use of filters, and solicits the cooperation of manufacturers in handling the problem.

The poster, entitled "Television Interference Aids," has been prepared by WTVIC, RETMA, and the FCC. It is being published and distributed as a public service by the Electric Institute of Washington. The poster lists TVI causes, effects and solutions and gives a circuit diagram for a high-pass filter for a 300-ohm receiver input, a chart of r.f. oscillator settings for 20-30 mc. and 40-50 mc., as well as other service tips of value to the technician.

Widespread distribution of these posters plus the many favorable reports on the committee's work have done much to alleviate TVI problems and their consequences in the Greater Washington area.

Chairman of the WTVIC is Mike Loria, W3IZL, 5131 70th Place, Landover Hills, Maryland. Other amateur groups interested in setting up a similar committee should contact Mr. Loria for further details.

REVOLUTIONARY NEW Magne-Pulse

intermittent recorder

GREATEST TIME SAVER Ever Developed for Television Servicemen!
IN STOCK at TERMINAL



Automatically Locates Intermittents

The most troublesome and time-consuming job in TV servicing . . . locating intermittents NOW made easy and practically automatic with the sensational Magne-Pulse Recorder. Performs the work of 3 VTVM's. Reduces intermittent servicing time to virtually zero. Easy to operate, simply connect three Recorder leads to three points in TV set, and zero set meter. You set it and forget it.

WHEN TROUBLE OCCURS, BUZZER SOUNDS, LIGHT INDICATES EXACTLY WHERE INTERMITTENT OCCURRED. Most important, light remains lit indicating defective circuit . . . other circuits immediately locked out to avoid indicating side effects. It's foolproof . . . simplifies repairs . . . saves time and money. Fully described in this issue (see article). Complete with all test leads — ready to use. 115 Volt—60 Cycle.—Dealer Net **\$19950**

Write for Literature

Radio • Audio • Video • Electronic Equipment
Phone: WOrth 4-3311

Terminal
RADIO CORP.
85 Cortlandt St. • New York 7, N. Y.

COMPARISON PROVES

EICO OFFERS GREATEST V-O-M values!



GET the MOST for your money — Before you buy, see chart below!

World-renowned **EICO** VOLT-OHM-MILLIAMMETERS

*#536 KIT \$12.90. Wired \$14.90
#526 KIT (with 1% multipliers) only \$13.90. Wired \$16.90

VERIFY AT YOUR DEALER'S	EICO \$12.90 up (KIT)	Co. A	Co. B	Co. C	Co. D EICO price range
31 ranges?	YES	No	No	No	No
Full-size 3-inch meter?	YES	Yes	Yes	Yes	No
400 μ sensitivity?	YES	Yes	Yes	Yes	No
Zero to 1 v. range on both AC and DC?	YES	No	No	No	No
5000 v. range on both AC and DC?	YES	Yes	No	Yes	No
AC/DC sens: 1000 μ v.?	YES	Yes	Yes	Yes	No
DC and AC Current Ranges?	YES	No	No	No	No
In KIT and Wired Form?	YES	Wired Only	Wired Only	Wired Only	Wired Only
Lowest cost in the industry?	YES *See Above	No	No	No	No; EICO price range

Write for FREE Catalog MR-10 & name of local dealer. Prices 5% higher on West Coast.

ELECTRONIC INSTRUMENT CO., Inc.
84 WITHERS STREET, BROOKLYN 11, N. Y.

Regenerative Receiver
(Continued from page 77)

condenser shaft and the dial serves two important purposes: to compensate for any small mechanical misalignment, and to prevent stresses applied to the dial or panel from being transmitted directly to the condenser and detuning it. Insulating washers are required in mounting the phone jack since neither side is grounded.

The coil diagram shows the details of coil construction. The broadcast-band coil is made from a broadcast antenna coil (J. W. Miller Co. No. 20-A) by adding the tickler coil (wound on a small cardboard tube). The assembly was attached to an old octal tube base, having all eight pins, using small machine screws and the mounting bracket that was on the coil. The manufacturer's markings were reversed for both the primary and the grid coils; that is, the terminal for the grid connection was grounded and the ground connection fed to the grid, etc. The builder will find that the primary is wound on its own short form which slides over the grid coil. This is intended to be cemented in any position desired by the user. For this receiver, it should be cemented in place with its center $\frac{3}{8}$ " from the bottom (terminal or lug end) of the grid coil. The tickler is wound with 24 turns of No. 28 enameled wire on a form made of a piece of cardboard tubing of large enough inside diameter to fit tightly over the very end of the broadcast coil form ($1\frac{1}{16}$ "). Some time and trouble in finding the right-sized form can be saved by purchasing a Meissner No. 14-6852 "slip-over primary," which costs twenty-five cents, stripping the original winding from it, and using this as the tickler form. Wind the tickler and cement the forms together so that the tickler and grid windings are about $\frac{1}{8}$ " apart. When plugging in or removing the completed assembly, the fingers should grip the base.

The short-wave coils were wound on Miller No. 74002 coil forms with No. 28 enameled magnet wire. The direction of winding was the same for each of the three coil elements, primary, grid, and tickler. Small holes were drilled in the spacers to provide anchors for the coil ends during winding. It is best to coat each coil element with polystyrene coil dope after winding it and before winding the next element of the coil. If any adjustment of the coil is required, it will probably be on the tickler, which is wound last. This part can be doped later.

After the wiring is checked and the batteries connected, it is a good plan to measure the voltage between pins 1 and 8 of each tube, or to test with a small flashlight bulb before inserting the tubes. If any voltage other than 1.5 volts were placed on the filaments as a result of incorrect wir-

proved engineering

From our latest achievement, the Clipper All-Channel antenna to our Yagis and UHF Fans, performance statistics reported by enthusiastic owners have been extremely gratifying. In fringe areas, near fringe and primary TV areas, WW antennas have proven their worth by bringing brilliant performance everywhere.



CLIPPER V H F ALL CHANNEL Antenna
Another WW First In High Gain VHF Fringe Area Reception



COMBINATION HAIRPIN YAGI
K series. For Two or more VHF Channels

WW your sign of proved performance in UHF-VHF antennas

Exhaustive field tests, constant experimentation and sound engineering principle: go into every WW antenna. Engineered to PERFORM as specified, our complete line of antennas have been fulfilling their function with extremely fine results.

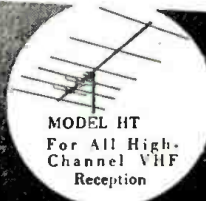

MODEL HT
For All High-Channel VHF Reception



UHF FANS Complete Line For Performance in All UHF Channels — also without reflector screen



MODEL UH
6 Element UHF Yagi Cut to Channel

proved construction

Constructed of finest quality material for long, satisfactory service, WW antennas have withstood the ravages of weather and the test of time. Designed for extreme rigidity and constructed by skilled workmen, these antennas bring clear, steady reception month in and month out under all weather conditions — lasting use that stretch your customers' dollars!

See your WW Authorized Distributor or Write wire or Phone for Prompt and Immediate Attention!

Wells and Winegard

television accessory mfgs.
DEPT. R.T.N. BURLINGTON, IOWA



Bag these capacitors...without hunting

These new Centralab Ceramic tubular and disc BC Capacitor Kits end parts hunting. With parts at your finger-tips, you save unnecessary trips... you stay in the shop and build more profit time.



Each assortment has been completely revised to keep pace with the rapidly changing electronics field.

Kit DK-200, for example, contains 200 tubulars and discs in 31 fast-moving types. All parts are sealed in envelopes. You pay nothing extra for handy metal cabinet.



Pocket-sized KIT DK-100 contains 100 tubulars and discs in 5 most popular values. Box is free.



Other Kits of 12 and 25 Hi-Kaps are values you use every day for TV and radio.



See your Centralab distributor NOW for complete facts on BC Capacitor Kits. You'll be time and money ahead if you do.

Centralab

CENTRALAB,
A Division of Globe-Union Inc.
910-J E. Keefe Ave., Milwaukee 1, Wis.

Please rush complete technical data on Centralab's Ceramic Capacitor Kits.

Name.....

Firm.....

Address.....

City.....Zone.....State.....



ing, the tubes would, of course, burn out instantly.

The standard parts lists that go with circuit diagrams in the usual construction article show only electrical parts, so to save the beginning student some trouble in selecting mechanical accessories they will be mentioned here. The front-view photograph shows a vernier dial; either of the *National* types B or BM would be suitable. A standard phone plug should be purchased for the headphones, as they will come with phone tips, now seldom used. The front-panel jack for them should be of the open-circuit type. Three tube sockets will be needed, two octal and one octal. The open-ended chassis is a *Bud* CB-41. The flexible coupling for the condenser shaft is a *National* TX-22. Similar units of other makes may be used. The purchase of a spool of #28 enameled wire and of a bottle of polystyrene coil cement or "dope" was implied earlier. Use rosin-core "radio" solder; do not use acid-core solder or soldering flux in this application. Even slight corrosion in a radio joint can ruin the performance of the equipment.

Operation

The detector is put into oscillation by turning the regeneration control in the direction of increasing capacitance. The appearance of oscillation is marked by a soft hiss if the control is turned slowly, or a click if it is turned more rapidly. Tune for weak signals with the set just oscillating until a signal is heard, and then "back off" the regeneration control. Greatest regenerative amplification is obtained at the point just before the detector starts to oscillate. Strong signals, particularly on the broadcast band, are best tuned in with the set not oscillating. The c.w. signals are received with the set oscillating, and the point of greatest sensitivity is just beyond the point where it starts to oscillate.

If the set does not oscillate properly, the wiring should be checked again, and particularly the tickler connections. A common cause of failure of a set to oscillate is reversed tickler connections. If the set does not oscillate at the low frequency end of a tuning range (condenser plates closed), the maximum available feedback is insufficient. This condition may be corrected by winding additional turns on the tickler coil. On the other hand, if oscillation cannot be stopped at the high frequency end, turns should be removed from the tickler. Sometimes oscillations may fail over a short interval in the tuning range. Such "dead spots" are due to resonance effects in the antenna and may usually be cured by inserting a small condenser, 100 μ fd. or less, in the antenna lead.

"Body capacity" is a common ailment of short-wave regenerative receivers when the antenna is coupled directly to the detector. This is a

ARE YOU GETTING A GOOD PICTURE HERE?
AND LOSING IT BEFORE IT GETS HERE?
WRITE FOR FREE CIRCULAR
R. J. BUCHAN CO.
BRICELYN 7, MINN.

GET CLEAR SHARP RECEPTION WITH THE NEW LL300 OPEN WIRE LINE



300 OHMS IMPEDANCE
This results in maximum signal transfer from antenna to set.

EXTREMELY LOW LOSS

Air dielectric plus clear polystyrene spacers results in the lowest possible loss of signal.

LESS NOISE PICKUP

Close spacing plus perfect impedance match results in lowest possible noise pickup.

EASILY INSTALLED

Conventional hardware for 300 ohm ribbon lines are perfect for LL300 open wire line.

LONG LIFE

Copperweld conductors, polystyrene spacers, plus light weight and low wind resistance result in virtually indefinite life.

EASY TO USE SPOOLS

Packaged on 100, 150, 200, 250' convenient, easy to use spools.

If not available through your regular Jobber, order direct, immediate shipment via parcel post. Dealer cost \$4.95 per 100 feet.

PERFECT FOR VHF - UHF INSTALLATIONS

WE ARE QUICK AND CASH BUYERS
We're looking for surplus inventories of all types of electronic parts—receiving, transmitting and special-purpose Tubes. Anything in the Radio, TV and electronic field.
SMALL OR LARGE QUANTITIES—SEND US YOUR LIST
Submit samples where possible. Amount of each item and prices.
NAT ADELMAN
168 Washington St. New York 6, N. Y.

YOUR OWN ELECTRONIC MUSIC
How to build and play my latest model electronic organ without a knowledge of music. Or get blueprints for a miniature electronic brain and other projects for electronic constructors. Send 3c stamp for air mail reply.
JIM KIRK, W6DEG.
1552 Church St., San Francisco 14, Cal.

condition in which the operator may cause a slight change in frequency or regeneration by touching the receiver or phone leads. It is caused by the fact that the operator becomes part of the antenna circuit and alters its electrical characteristics. We had some trouble from this source above 14 mc., but were able to eliminate nearly all of it by moving the receiver to a location where a short connection to a radiator ground could be used. Other methods which may be effective in individual cases are: inserting a small fixed or variable condenser in the antenna lead, loosening the antenna coupling, bypassing the phone leads with a condenser (about .001 or .002 μ f.), or grounding to two separate points.

If the receiver is located too near a strong station on the standard broadcast band, difficulty will probably be encountered in tuning it out completely. Although the receiver has a high selectivity when the regeneration control is advanced, a very strong signal tends to "tail off" over a considerable portion of the dial. The only real remedy for this difficulty would be to use more tuned circuits, but then we would be dealing with a different type of receiver altogether. By careful tuning to the exact frequency of the desired signal, the ratio of the strength of the two signals may often be made such as to practically eliminate the interference. For local reception, all but three or four feet of antenna may be disconnected and still leave enough sensitivity for good results. Various wave-trap circuits may also be used.

A little skill is required to tune a regenerative set properly, but an evening or so of patient effort will reward the constructor with many hours of enjoyable listening.

Transistor Timer (Continued from page 69)

on for a specific short interval (as when warming solutions). Where a heating element or other piece of equipment requiring large current is used, care must be taken that the maximum current rating of the relay contacts is not exceeded.

Still another application is in controlling a tape machine or record player so that a specific commercial message may be delivered when the "Reset" button is pressed. A typical example would be in the display room of a convention or show. When a passerby presses the button, a tape playback machine operates for a specific period of time, giving any desired message or "sales talk."

A similar application is in the operation of mechanical displays.

The reader can undoubtedly list many other possible applications of the timer. Then, too, once the builder has had a chance to experiment with the completed unit, other possibilities will occur to him.

DRUGSTORE COIL FORMS

By WM. BRUCE CAMERON, W8IVJ

AN EXCELLENT coil form for many purposes may be found at most drugstores in the form of a small plastic vial, used for pills, capsules, etc. These come in a variety of diameters and lengths, are hard transparent plastic, fitted with flexible plastic caps.

They appear to be good r. f. material, judging from the ones I use in my grid dipper and v. h. f. gear. For receiver and transmitter use, the caps may be fastened to the chassis with a machine screw, and the pre-wound coils slipped in and out easily. These are excellent for grid-dippers, since the flexible caps can be fitted with banana plugs and will take rough handling without breaking.

Since the forms are transparent, data on the coils, such as frequency range, can be typed on a slip of paper and inserted in the forms before sealing, giving them a truly professional appearance. Caps and vials may be permanently joined with "Duco" or similar cements. Prices will vary with size and with the druggist, but will run around fifteen cents—less than many commercial forms.

ENGINEERS WANTED

THE Rome Air Development Center has challenging jobs at salaries from \$5040 to \$9600 a year in all phases of electronic research and development.

Write the Professional and Scientific Recruiter, Rome Air Development Center, Griffiss Air Force Base, Rome, New York for full details.



Hudson
RADIO & TELEVISION CORP.

Authorized Distributors of
Electronic Equipment and Components,
on the Opening of Their New Salesrooms in
NEWARK, N. J.
at 35 WILLIAM STREET

Everybody in Electronics welcomes the great new HUDSON Salesrooms just opened in the heart of the mighty New Jersey market—to provide the same Huge Stocks, Low Prices, and Superlative Service that have made our two New York Stores the Leading Electronic Supply Centers of the East!

Radio and TV Dealers and Servicemen, Industrial Users of Electronic Equipment and Components, Radio Amateurs, High-Fidelity Enthusiasts... all have come to learn that "HUDSON has EVERYTHING IN ELECTRONICS—at the LOWEST Published Price of Them All!" Visit our Newark Store, you Jersey Area Patrons—see our Huge Stocks and Facilities, meet our Friendly, Helpful People—you'll enjoy the experience!

- SAME DAY SERVICE
- FREE TRUCK DELIVERY IN 25-MILE AREA
- FREE PARKING
- HI-FI STUDIOS

These Nationally Famous Manufacturers of Standard Brand Top Quality Electronic Products and High Fidelity Components, whose Complete Lines are found in ALL THREE Great HUDSON Salesrooms, join in congratulating us on the Opening of the Newark Store:

- | | | | |
|------------------------------|------------------------------|-----------------------------|-------------------------------|
| Acro Products - | Clarostat Mfg. Co., Inc. | Jackson Industries, Inc. | Quam-Nichols Co. |
| Advance Elec. & Relay Co. | Consolidated Wire | Jersey Tech Labs | Radio Apparatus Corp. |
| Aerovox Corp. | Continental Carbon, Inc | Jennings Radio Mfg. Co. | Radio Corp. of America |
| Alpha Wire Corp. | Cornell-Dubilier | Jensen Industries, Inc. | Radio Craftsmen, Inc. |
| Altec-Lansing Corp. | Dow-Key, Inc. | Jensen Mfg. Co. | Raytheon Mfg. Co. |
| American Elec. Heater Co. | Drake Electric Works | E. F. Johnson Co. | Sangamo Electric Co. |
| Amperex Electronic Corp. | Allen B. Dumont Labs, Inc. | Mathias Klein & Sons | Shure Bros., Inc. |
| Arrow-Hart Hegeman Elec. Co. | Electronic Instr. Corp. | Krauter & Co. | Simpson Electric Co. |
| Arco Electronics | Electro-Voice, Inc. | Littelfuse, Inc. | Herman H. Smith, Inc. |
| Audio Devics, Inc. | Multi Products, Inc. | Livingston Electronic Corp. | Snap-On Drawer Co. |
| Barker & Williamson, Inc. | Erie Resistor Corp. | P. R. Mallory & Co., Inc. | Sonar Radio Corp. |
| Bell Sound Systems, Inc. | Espey Mfg. Co. | Mark Simpson Mfg. Co. | Sprague Products Co. |
| Beriant Associates | Eveready Batteries | Meissner Mfg. | Stanwyk Winding Co. |
| Bliley Electric Co. | Freed Transformer Co., Inc. | Morrow Radio Mfg. Co. | Stephens Mfg. Corp. |
| David Bogen Co., Inc. | General Electric Co. | Mosley Electronics | Switchcraft, Inc. |
| British Industries Corp. | General Industries Co. | Mueller Electric Co. | Sylvania Electric Products |
| Brook Electronics, Inc. | Ganset Co. | National Co. | Taylor Tubes, Inc. |
| Brush Development Co. | Gordon Specialties Co. | Ohmite Mfg. Co. | Tech-Master Products Co. |
| Burgess Battery Co. | Gray Research & Develop. | Par Metal Products Corp. | Triplet Elec. Instruments |
| Cambridge Co. | Guardian Electric Mfg. Co. | Pentron Corp. | Turner Co. |
| Camburn, Inc. | Hallcrafters Co. | Perma-Pow Co. | Ungar Electric Tools, Inc. |
| Cannon Electric Co. | Hammarlund Mfg. Co. | Pilot Radio Corp. | United Transformer Corp. |
| Carter Motor Co. | Harvey-Wells Electronics | Potter-Brumfield Co., Inc. | University Loudspeakers, Inc. |
| Centralab | Hickok Electrical Inst. Co. | Precision Apparatus Co. | Vector Electronic Co. |
| Chicago Stand. Transformer | Harvey Hubbell Co. | Precision Electronics, Inc. | Walter L. Schott Co. |
| Cinch-Jones Sales | Insuline Corp of America | Premier Metal Products | Webster-Chicago Corp. |
| Clarkstan Corp. | International Resistance Co. | Pyramid Electric Co. | Weston Elec. Instrument Co. |

One Call
for All...



write for complete,
new 1954 Giant
Hudson Catalog!
Dept. A-10

Adjoining Radio City
48 West 48th St., N. Y. 36
Phone: Circle 6-4060

Downtown New York
212 Fulton St., N. Y. 7

NEWARK, N. J.
35 William Street
Phone: Market 4-5151

You can do **MORE**
with an RCP "DO-ALL"
for **UHF**
and VHF

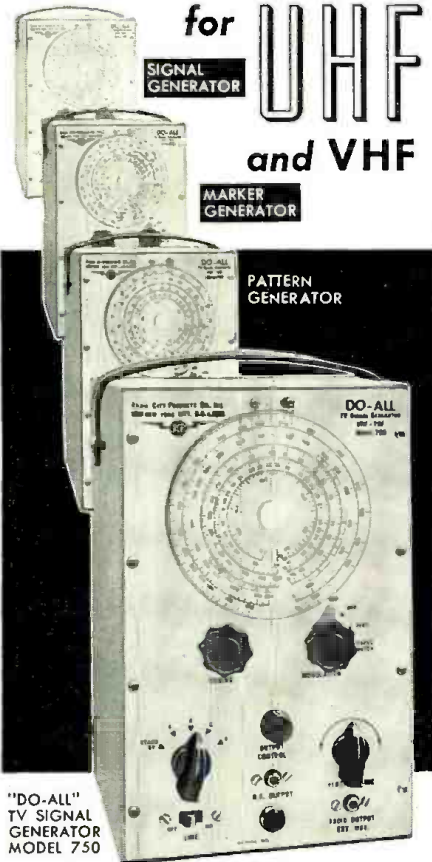

"DO-ALL"
TV SIGNAL
GENERATOR
MODEL 750

ONE

RCP "DO-ALL"

SIGNAL GENERATOR

for all

THREE

- SIGNAL GENERATOR
- MARKER GENERATOR
- PATTERN GENERATOR

Designed for portable or bench use, the 750 reflects the finest in construction and appearance. It is handsomely finished in an attractive brushed aluminum panel with a steel carrying case.

- Inductuner insures accuracy of within 1/2 of 1% over the entire range of 9 Mc to 900 Mc.
- All VHF frequencies are on fundamentals.
- RF's and IF's are clearly calibrated on a large etched aluminum dial.
- Steady horizontal bars, vertical bars and cross-hatch pattern individually produced on all channels.

PRICE \$79.50

MODEL 740A—Same as Model 750 described above, less Calibrated UHF scale. Perfect for VHF areas.

\$69.50

See Model 750 and Model 740A At Your Local Parts Distributor

Write For Complete Catalog RN-10

RADIO CITY PRODUCTS CO., INC.

152 WEST 25th STREET  NEW YORK 1, N. Y.

LINCOLN TUNNEL TRAFFIC CONTROL

Traffic snarls are rare and relatively painless thanks to "Message-Repeater" units.

A TINY cartridge, smaller than a man's hand, is playing an important role in meeting emergencies in the Lincoln Tunnel, linking Manhattan and New Jersey.

Since January 1952, the south tube of the tunnel has been equipped with a radio transmitter. As motorists enter the tube from Weehawken, N. J., they pass under a large sign which reads, "Lincoln Tunnel Radio—500 on Your Dial." By tuning in that frequency they receive music and messages to make the under-river trip faster and more pleasant.

Between musical selections, the tunnel radio advises drivers to relax in their cars if they should have a breakdown or a flat because the Port Authority will move the car safely and quickly without charge.

In cases of emergency, a special cartridge is inserted in the "Message-Repeater" alongside the transmitter and the appropriate warning is transmitted to the drivers. Each cartridge bears a pre-recorded message prepared by a professional announcer to meet varying situations. Utilizing the canned message frees one tunnel officer from the task of making vocal an-

nouncements when anything goes wrong. If anything occurs which isn't covered by a prepared tape, the tunnel officer in charge can speak into the "Message-Repeater" through a hand microphone and instantly record a message to meet the new conditions.

Officers at the control tower in the tunnel are enthusiastic over the success of the operation. They are hoping that funds will soon be available to provide a similar setup for the third tube which is now under construction and they would like to see the system extended to the highways which feed the tunnel. As one officer explained, "When the cars get here there isn't much we can do except explain the reasons for the tie-up, but if the radio were extended to the highways we would and could channel traffic to other of the cross-river routes when we're tied up."

The tunnel radio system was developed and installed by *Touradio Inc.* of 25 Vanderbilt Ave., New York, N. Y. and the "Message-Repeater" unit is a product of the *Mohawk Business Machines Corp.* of 47 West Street, New York, N. Y.

—30—

The master control unit of the Lincoln Tunnel radio system with the "Message-Repeater" unit at right. Pre-recorded messages can be transmitted at will.

Sgt. J. Knight of the N. Y. Bridge and Tunnel Authority inserts a cartridge containing a pre-recorded message in repeater. Message is on endless tape.



Electronic Shipyard (Continued from page 57)

and storage according to the space occupied by equipment.

Then arrange to work on boats in groups, rather than as single "strays" here and there, so travel costs can be spread. In removing equipment, mark and tape cables to prevent accidental short-circuit.

Power-boat antennas should be taken down, any joints greased, and any holes left in the deck or bulkheads plugged. Leaving an antenna up invites damage. Yard workmen have been known to break the antenna off trying to squeeze a boat through a low doorway, or to tear it out by the roots to clear an obstruction.

The moment any equipment is taken to the shop increase your insurance to cover because, although most boats have marine insurance covering all equipage, you need protection in case of suit for contingent liability by the marine underwriter. The cost can be pro-rated among the boats so served.

A stout tag, with a number, and a space for a description of the work to be done, and a parts and time record should be put on the panel of each instrument, and the same number marked on every piece, such as the handset, cabinet, and remote control.

Each set should be put on the bench and checked for operation, a preliminary test to find out early if the set has some serious fault which might need parts from the factory to correct. Early in the winter is the time to take care of these troubles—not when boats start slipping down the ways in the spring. Do not bother with any alignment or other adjustments of the "final" type. Too much can happen between now and commissioning time.

After this check the chassis can be blown out, brushed and vacuumed, a touch of silicone put on switch contacts, and any corrosion removed. Kerosene, applied with a toothbrush, has been found to be about as effective as anything for this job.

Cabinets that are not too badly corroded can be spotted, after bad spots are smoothed and the old paint "feathered" with sandpaper. A dull touch-up lacquer is best, or it may be possible to get an air-drying mix from the set manufacturer that will blend. Chromed parts can be sent out for re-chroming. Worn handset cords should be replaced, and operation tested, as they receive rough treatment.

Now is also the time to take care of refinements, such as having engraved plates many owners want put on their telephone panels giving the boat name and call letters, or modifying the equipment for external speakers, the driving of "bull horns" on deck, or providing for remote controls. The chances are that some of these things will be thought of by the owner the next time he takes the boat out—it is

COMMAND CLOSEOUT!!

Here goes our entire stock of 274N and ARC-5 Command Equipment AT 1946 PRICES!

FIRST COME—FIRST SERVED

All with free dope sheets and schematics.

TRANSMITTERS

T-20/ARC-5, 4-5.3 mc. EXCELLENT, with tubes \$5.95
AS IS, less tubes..... 3.95
BC-458, 5.3-7 mc. EXCELLENT, with tubes \$4.95
AS IS, less tubes..... 2.95
*Free novice conversion instructions included.
T-22/ARC-5 or..... EXCELLENT, with tubes \$6.95
BC-459, 7-9.1 mc. AS IS, less tubes..... 4.95
T-23/ARC-5 VHF, less tubes and covers..... 7.95
ATA 2.1-3 mc MARINE frequencies! New..... 12.95

RECEIVERS

3-6 mc, NEW.....\$9.95 6-9.1 mc, NEW.....\$7.95
1.5-3 mc. Use with 12 or 24 volt dynamotor as marine receiver. Covers all marine two-way frequencies..... EXCELLENT \$24.50
MISCELLANEOUS CHASSIS, for parts..... \$1.75

ACCESSORIES

BC-456 Modulators, for 274N, NEW.....\$2.95
Three-receiver control boxes, NEW..... 1.95
One-receiver control boxes, EXCELLENT..... 1.95
One-transmitter racks, 274N, NEW..... 2.45
Two-transmitter racks, 274N, NEW; \$2.45, USED 1.50
Two-receiver racks, NEW..... 2.50
Three-receiver racks, NEW \$2.50, USED..... 1.39
SHOCK MOUNTS FOR ANY RACK..... 37c
Mechanical drive shaft, per length (av. 15")..... 1.95
Transmitter Dynamotors, 24 V, EXCELLENT..... 2.45
Receiver dynamotors, EXC. \$5.95; 24 V, EXC..... 2.95
Transmitter remote control box, EXC..... 1.45
LOCAL CONTROL PARTS for all command receivers, Exact pot. switch, etched plate, instructions..... 1.29
SPLINE tuning knob for command receivers..... 49c
274N plug, fits back of all receivers, also fits 274N and ATA Command Xmitters, 21c; 5 for 1.00

WESTON SENSITOL 10 MICROAMP RELAY
Built like meter, needle moves into PM magnet which grips it to close contact rated 1 amp. Highly damped, vibration proof. Works directly from photocells, thermocouples, etc., without amplification. A momentary application of 12 to 30 v. AC or DC, resets it. A 500.00 device for only..... \$12.95

POLARIZED RELAY REPLACES SELSYNS
This is the micro-positioning device the Selsyns used instead of selsyns and torque amplifiers. SP/DT, both contacts normally open. The POLARITY of an applied 1/2 v. (3 ma) determines which contact closes. Use for beam rotators, remote control, etc. Our free data sheet shows this and other bridge circuits for control or alarm devices. In a neat metal box with additional heavier duty relays. NEW, slightly dirty..... \$6.95
(Shipping wt. 4 lbs.)

SUPER-SENSITIVE ADJUSTABLE RELAY BK-7-B
SP/DT. With adjustment arm at "5" on calibrated scale sensitivity is 1/4 ma (1 mw, 2 v) and decreases linearly to 1.5 na as arm is moved to "40". 1 1/2" x 3/8" x 1 1/2". Wt. 6 oz. NEW. Ship. wt. 1 lb.
Only \$1.95, or 10 for \$17.50

2-IN-1 SENSITIVE RELAY BARGAIN
For any sensitive relay application or for voltage-controlled sequence switching. First set of contacts close at 4 ma, second set at 6 1/2 ma. 6000 ohms. 1 1/2" x 2 1/4" x 1 1/4". Removed from clean equipment.
Only 98c each, 3 for \$2.75

PRECISION 200 KC CRYSTAL
June Radio & TV News describes tubelens crystal calibrator. Here is the Depot Spares Kit from Collins xmtrs. gives close-together check points all the way up the spectrum, in transistor or standard oscillator circuits. 1/2" in diameter, FT-243-A holders. NEW, tested \$2.95

12-CHANNEL TV FRONT END
Famous "Silver Circle" tuner, with original factory instructions. Use for 2-meter converters, receivers, etc. The TV bargain of the year! Factory rejected for minor damage. Less tubes..... \$1.95 each, 3 for \$5.00 (Shipping wt. each 3 lbs.) Tully shields and knobs for above..... \$1.25 set, 3 for \$3.00

NEW 600 VOLT OIL-FILLED FILTER CONDENSERS
10 Mfd. 3" x 1 1/4" x 5 1/4" OA ht..... \$1.95
6-4 total 12" mfd. 2 1/4" x 2 1/4" x 4 1/4" OA ht..... 2.25
8-8 (total 16) mfd. 2 1/4" x 2 1/4" x 4" OA ht..... 2.95

G. L. ELECTRONICS 905 S. VERMONT AVE. LOS ANGELES 6, CALIF.

ALL PRICES F. O. B. LOS ANGELES, CALIF. BUYERS ADD SALES TAX

AUDIO SUPER-SPECIALS

SUPER HI-Q high cut choke. 0.65 H. 55 ohms DC. Tune with .001-.0004 MF. ONLY.....98c
LOW CUT. 5 ll. 284 ohms. Tune with 1 MF. Or use 88 50 ma filter choke. ONLY.....98c
DUNCAN Transformers, one for mike to push-pull grids, flat 30 to 15,000 CPS; other for push-pull output, tapped sec., turns 14:1. In unit with resistors, condensers, etc. BOTH FOR ONLY.....98c
PHASE SPLITTER, or low-level mixer, or hybrid, or push-pull unit. Has 3 windings, each exactly 1:1 to any other; essentially flat 100-15,000 CPS. BRAND NEW, ONLY.....69c
"DAGO" FLUORTESTER—Originally for testing auto fluorescent lamps and fixtures. Contains ballast lamp sockets, lots of switches, 250 MA AC meter, nice usable coils and Jones plugs, and a beautiful, rugged, leatherette-covered 11" x 15" x 6" carrying case perfect for portable equipment. New, clean, orig. packing.....\$4.95
13V TO 9V in one volt steps: Tapped transformer, 3 amps out. Input 115 V, 60 Cy. Use for Model Railroad or heaters of surplus receiver.....\$1.89

BROADCAST BAND & AERO

MN-26-C Remote Controlled navigational direction finder and communications receiver. Manual DF in any one of three freq. bands, 150 to 1500 KC. 24 V. Self-contained dynamic motor supply. Complete installation, including receiver, control box, loop, azimuth control, Left-Right Indicator, plugs, loop transmission line, and flex. shafts. BRAND NEW, ORIG. PACK..... \$69.50
(Shipping Wt. 75 lbs. Express Collect.)

SPECIAL ON MN-20-E LOOP

Here is a dandy! Use as a remote-controlled loop with any MC-124 flexshat shaft, or mount a lightweight beam antenna on the loop and use the slip-plugs. Inbuilt gears are 60:1 ratio. Originally used with MN-20 or H-10. DR. BRAN) NEW and CLEAN. Special ONLY.....\$4.95
MC-124 flexshat, will ship length in your specs.....30c ft.
MN 52 crank drive with azimuth scale, for above loop.....\$2.50

HI-FI HEADSET

Uses annular grooved plastic fibre cones with voice coils as in speakers, and padded chamfer ear muffs to obtain speed for correct acoustical load. Gives realistic reproduction, flat far beyond upper and lower limits of auditory perception. 600 ohms obtained with built-in high quality transformers. Checked out with freshly laundered ear muffs.....\$7.95
(Shipping weight, 3 lbs.)

6 V VIBRATOR KIT. Vibrator plus non-synic transformer. two outputs: 700 VCT, 1.45 ma for plates; 13 V for bias. Can deliver 320 V at 130 ma. (Shipping wt. 6 lbs.).....NEW \$2.89

PE-101-C DYNAMOTOR. Brand new..... \$4.95
(Shipping weight 13 lbs.)

OUTPUT TRANSFORMER. 5000 ohms input to TWO outputs, 300 ohms of 3.5 ohms. Use as output for 12AF, 6V6, etc. or to match speaker or headset. NEW. Potted, shielded.....79c

ANTENNA MAST SECTIONS, MS-49, 50, 51, 52, 39c
New, original packing.

CRYSTAL MICROPHONE GIVEAWAY!
Sensitive hearing aid capsule sealed in compact, flat container with pinned terminals. Crisp, clear, high-level output. Ideal for lapels, ties, tuck-away, and more. Virtually tested, guaranteed..... ONLY 98c

MINIATURE 6 VOLT WET BATTERIES

Just arrived! The famous NT-6 2.4 AH 6 Volt battery. A standard for model control, etc. Plastic case, only 3/4" long, 1-13/16" wide, 2 1/4" high. Uses standard electrolyte..... \$2.49, or 4 for \$8.50
(Shipping wt. 2 lbs.)

NEW CR TUBE GIVEAWAYS

5BP4.....\$3.25 5BP1.....\$3.95
(Shipped express collect)

TUBE GRAB BAG. At least 10 tubes of special interest: 6X4, 6X5, old types, list ones. Little ones; some new. Some used but good. A big value at.....\$1.29

EASY MONEY!
We're still buying surplus gear. Tell us what you've got, its condition, and your price. If we like it you'll get our check quick.

SCHEMATICS—CONVERSIONS FOR SURPLUS GEAR

NEW LIST! MANY ADDITIONS!
Send stamped, self addressed envelope for List C. Add 25c for chart explaining AN nomenclature.
R. E. BOX 1220
GOODHEART BEVERLY HILLS, CAL.

MEASURE:
INDUCTANCE, CAPACITY, DISTRIBUTED CAPACITY & MUTUAL INDUCTANCE.
Use this CALIBRATED CAPACITOR with a grid dip meter or VTVM and signal generator, for an engineering approach to service and experimental work. Price \$5.00. Write for information.
P. E. HAWKINS CO.
3208 E. 56th St. N.
KANSAS CITY 16, MO.



GET out of a RUT! INTO TV!

Yes, get away from the humdrum daily grind of being in a "rut"—a job with little interest, small future! Instead get into the "groove" where pay is TOPS—\$100-200 a week—where everyday is exciting, exhilarating, inspiring! Be a TV Technician, No experience needed. Age makes no difference. Learn TV from A to Z by building your own big 17 inch screen TV Set. Also learn Installing, Repairing, Servicing! We supply big, interesting 100-lesson TV Home-Training Course, and also TWENTY FINE KITS of Parts, Professional Equipment and Tools. DEMAND for Trained Men is TREMENDOUS—start a profitable part-time or full-time TV business of your own. Why be satisfied with less than the best in Business Opportunity and Business Training, when the Proved C.T.I. TV Home-Training Plan can put you right in the "groove" of Big Pay, Success and an unlimited future? Get FULL FACTS FREE. Write: COMMERCIAL TRADES INSTITUTE, Dept. T19-10, 1400 Greenleaf Ave., Chicago 26, Ill.

RESCO

**ULTRA-LINEAR
Williamson
AMPLIFIER KIT
Featuring the
ACRO TO-300**



Build the finest amplifier ever developed. Complete with all components, punched chassis, and easy-to-follow instructions. Get the full benefits of Acrosound TO-300 performance as shown by specifications listed below.

ONLY AT **\$74⁵⁰**
RESCO . . .

**ULTRA-LINEAR WILLIAMSON
ACRO TO-300**



**THE WORLD'S
FINEST
AUDIO OUTPUT
TRANSFORMER**

Only a few resistors and condensers are involved in converting to ultra-linear operation — layout remains the same. Get more out of your Williamson by giving it the specifications listed below.

SPECIFICATIONS

- Response — 1 db. 2 cps. to 200 kc.
- 30 watts of clean power within 1 db. 20 cps. to 30 kc.
- Less than 1% IM at 20 watts.
- Square wave transmission to 50 kc.

ACRO TO-300 net \$24.75

ACRO TO-310 net \$18.75
(TO-310 used to change over 6V6 amplifier to ultra-linear operation)

ACRO TO-330. net \$39.75

(Push-pull parallel ultra-linear operation using 4 KT 66's, 5881's, or 807's to deliver a power output of 60 watts.)

TO-300 TO-310 (Shipping wt.—7 lbs.)
 TO-330 (Shipping wt.—15 lbs.)
 Amplifier Kit (Shipping wt.—25 lbs.)
 Check or M.O. enclosed. Include postage.
 Name

Address

City..... Zone... State.....

Radio Electric
SERVICE CO. OF PENNA., INC.
7th & Arch Streets, Phila. 6, Pa.

better to think of them now when the work can conveniently and unhurriedly be done.

Well in advance of spring drag out all of the sets. Group them according to kind and use a check list for the operations. Check all tubes. Very few will be found low, but remember that marine radio is an emergency service, and the best place to catch incipient failures is on the shop bench. Another thing this will do is scrape corrosion off the tube pins and socket terminals. For this reason, also wiggle the crystals and the vibrator, even though it has a nice steady hum.

Align the receiver and check sensitivity with a signal generator. For sets not having crystal-controlled receiver oscillators use a "live" signal or an accurate frequency meter to line up the front end.

Measure the transmitter frequency on each channel. The FCC regulations call for the official measurement to be made with the equipment on board the boat—but a preliminary check is justified because if a critical condenser has spilled its microfarads it can more easily be replaced in the shop than out in the bay.

Transmitter power-amplifier tuning should be checked with no load. A milliammeter or voltmeter jack is provided, and, if necessary, the final tank should be readjusted for minimum plate current. The transmitter coils should be carefully inspected for short-circuited turns, and any clips close enough to touch should be wrapped with plastic insulating tape. Clips should be tightened, as required.

Last, a dummy antenna should be connected, and the power output and modulation tested. Power is measured using a variable condenser and non-inductive 34-ohm load, and an r.f. ammeter in series from the transmitter antenna post to ground.

Modulation may be measured with instruments built specifically for the purpose, or an oscilloscope. If these are not on hand observe antenna-current rise under full modulation. If there is no carrier shift a 22% increase is indicative of 100% modulation, while a 10% increase indicates about 65% modulation. The signal should also be monitored on a receiver to detect any hum, distortion, or other objectionable characteristics. During modulation measurements, amplifier-plate current should be watched to make sure it does not fluctuate more than a few per-cent, which would be indicative of excitation shortage, parasitics, or overcoupling.

In the spring, re-installation will simply amount to putting the gear aboard, connecting up, and final check.

Work to be done should be strictly understood with the owner, and bills should be itemized in full. This became apparent to me after one nearly-painful experience.

The owner had said, very off-handedly, that when his radiotelephone was stored all of the garish (to him) brass on the panel should be removed,

CRYSTALS

LARGEST STOCK IN THE WORLD

In FT 241-A Holders—1/2 In. Pin SPC. These are designated 54th or 72nd Harmonic MC freq. Listed by fundamental freq. with fractions omitted.

370	398	419	443	466	491	517
372	397	420	444	468	492	514
374	398	422	446	469	493	515
376	400	423	447	470	494	516
377	401	424	448	471	495	518
377	402	425	448	473	496	519
379	403	426	450	474	497	520
380	404	428	452	475	498	522
381	405	427	451	477	499	523
383	406	430	453	477	501	525
384	407	431	454	479	502	526
385	408	433	454	480	503	527
387	409	434	456	481	504	528
388	411	435	457	483	506	530
389	412	436	458	484	506	531
390	413	437	461	485	507	534
392	414	438	462	486	508	536
393	415	440	463	487	509	537
394	416	441	464	488	511	538
395	418	442	465	490	512	540

All above crystals sent postpaid. Foreign, wholesale, and dealer inquiries invited. Write for QUANTITY DISCOUNTS.
 2 ASSORTED CRYSTALS ONLY \$2.75
 10 for 4.50

COMPLETE SET—80 CRYSTALS

In above graduations from 370-516 Kc., 54th Harmonic, INCLUDING 500 Kc. & 455 Kc. crystals. Only Per set **\$9.95**

COMPLETE SET—120 CRYSTALS

In above graduations from 370-540 Kc., 72nd Harmonic, PLUS 500 Kc. & 455 Kc. crystals. Only Per set **\$14.95**

200 KC. CRYSTAL Ea. \$2.25
500 KC. CRYSTAL Ea. 1.25
1,000 KC. CRYSTAL Ea. 3.25

All crystals sold as is.

MISCELLANEOUS BEST BUYS

- ARC-4 TRANSCEIVER: Excellent 2-meter rig. Less tubes and dynamotor. Only . . . **\$10.95**
- 12/24 V. DYNAMOTOR: For ARC-4 . . . **\$7.50**
- APS-13 TRANSCEIVER: Complete with tubes and dynamotor. Easily converted to 420 MC. Excellent cond. **\$19.95**
- RL-42 REVERSIBLE MOTOR & CLUTCH: Used good condition. A HOT buy at only . . . **\$2.95**
- WILLARD 6 V. MIDGET STORAGE BATTERY. 3-amphr. 1 1/2" 16" x 2 3/4". Uses standard electrolyte. New **\$2.49**
- 6 V. WET CELL BATTERY: In heavy, polystyrene plastic case. 6 x 4 x 4 inches. New **\$4.95**
- PE-73 DYNAMOTOR. Used **\$3.49**
- BARBEQUE MOTOR. AC. New **\$4.45**
- T-24 MIKE. New **\$3.49**
- TELEPHONE DIAL **1.25**
- 4" METER. 0-1 mil. Just add scale. **3.49**
- COMPLETE 2-WAY SOUND POWERED COMMUNICATION SET: Consists of single unit on each end PLUS 50 ft. of wire. The set COMPLETE only **\$3.35**

All prices are net F.O.B. Los Angeles. All items subject to prior sale.

J. J. GLASS ELECTRONICS CO.
 1615 S. MAIN STREET
 LOS ANGELES 15, CALIF.

HI-GAIN TUNER-BOOSTER

LESS TUBES WITH DIAL

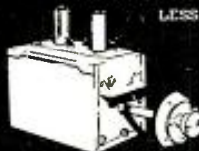

\$4.75

COMPLETE WITH TUBES

\$6.00

Solve poor TV reception with a Hi-Gain Booster. Banish weak fringe areas, reduce snow. This unit comes to you as a highly serviceable High-Gain Tuner. Uses 616 Tubes in very efficient Hi-Q Circuit. Has 8 tuned circuits using pure silver inductances and individual compensation providing high gain on all channels. Built in 5.1 Vernier Drive.

All necessary parts and instr. included makes highest gain booster on the market reg. of price.

\$10 VALUE FOR \$1.00

100 Assorted 1/2, 1, 2W RESISTORS

Shipments sent postpaid when full payment is enclosed. 25% deposit on C.O.D. Send for our new bulletin.

FRANK W. DECRAE & ASSOC.
 11842 W. Jefferson Blvd. Culver City, Calif.

buffed, and chrome-plated, so the telephone would better match the decor of his cabin. This sort of request is common so the girl in my office jotted down the order without comment.

This telephone happened to have the whole works fastened to the panel and getting the brass separated required turning the set into a frightening octopus of sockets, cables, and dangling parts—strictly a basket case. When the thing was finally put back together, resplendent in its new chrome front, the boatman was presented the bill: \$93. He sailed off on a cruise and didn't show up the rest of the summer.

When he returned we had the bill broken down so it was apparent that it had taken so many hours to pull the set apart, so much was charged by the plater, and then it took so many more hours to put the parts back together. Although the total still came to \$93 he could now understand why, and he paid without a whimper.

Start now to get some of this winter work lined up. Hardly a boatman should need reminding that if they help keep you alive during the off-season you'll be around, better than ever, when they need you next spring.

EDITOR'S NOTE: All transmitter adjustments as described in this article must be made by the holder of a commercial radiotelephone second-class (or higher) operator's license. Any service shop contemplating entering the marine servicing field should see that someone in the organization has or takes out this license. The examination contains no code elements and is within the technical capabilities of a competent service technician. —50—

"Subscriber-Vision"
(Continued from page 59)

particular week. The proper button selects the correct combination to be added for the particular program. The correct sweep signals are then fed to the horizontal output stage and applied to the horizontal deflection coil.

The sound signal goes through the sound i.f. stages and is then detected in the normal manner. However, the output of the detector will be a scrambled amplitude-modulated signal. In order to clear it up, the process at the transmitter is reversed. The signal is fed into a frequency remodulator which might actually be considered as a second detector. Also going into this frequency remodulator is a signal from the "Decoder" unit. With the correct decoding signal, the unscrambled sound is then fed to the audio amplifier and then to the speaker.

It should be emphasized that this system, like other subscription plans currently being introduced, is still to be approved by the Federal Communications Commission before anything other than test transmissions are permitted. When such action will be taken is anyone's guess. —50—



"Boy... Have I Got the Lines!"

You, too, can have the lines—that meet your exact leadline conditions — whether you are a TV Set Dealer or Service Organization making the finest television reception installations, or a TV fan that demands sharp, "SNOW-FREE" pictures.

We specialize in the manufacture of television transmission lines — built with only one idea in mind: "THE FINEST TELEVISION RECEPTION!"

For UHF and VHF

"SHEATH-LEED" — the all-weather leadline for the toughest conditions: Salt spray in coastal areas; hot, humid weather, or for frosty, icy, wintry wind-whipping conditions which impose a severe tax... Pure Polyethylene Tubing encasing Standard GOODLINE AIRLEAD.



"GOODLINE" AIRLEAD—standard of leadline excellence —with 80% of the loss producing web removed. Correct impedance for sharp, "snow-free" pictures. Of pure polyethylene with flexible stranded copper-clad conductors. MANY IMPORTANT FEATURES.

NEW FULL-WEB "SHEATH-LEED" — the pure polyethylene of "SHEATH-LEED" and full characteristics of GOODLINE AIRLEAD — but NO PERFORATED WEB. No 20 (7 strand 28) copperweld wire in pure electronic golden clear polyethylene — with a pure silver-gray polyethylene sheath overall — for Maximum Weather Protection.

Don Good, INC.

SOLD BY LEADING JOBBERS & DEALERS

Send coupon NOW!
Get samples "in your hands"
—you'll realize why
Don Good Products make
the finest television
reception possible.

DON GOOD, INC. 1-9
1014 Fair Oaks Ave., So. Pasadena, Calif.
Please rush Samples and Complete Information covering Don Good Products.

Name _____
Street _____
City _____ State _____

ANOTHER OUTSTANDING JOBBER

NIDISCO 713 Newark Ave. Jersey City, N. J.
55 State St. Hackensack, N. J.
658 Anderson Ave. Cliffside, N. J.
294 Passaic St. Passaic, N. J.
126 So. Warren St. Trenton, N. J.

\$29.95

HAS THE SENSATIONAL NEW
TECO 1050-K 6V & 12V BATTERY ELIM. KIT
IN STOCK!

STANDARD BRAND TUBES—Most Types Are Jans and Fully Guaranteed—All Are Bored

1A7GT	\$.50	6AF6	\$.50	6SL7GT	\$.60
1B3GT	\$.80	6AG5	\$.60	6SN7GT	\$.65
1C5GT	\$.45	6AG7	\$.95	6S77	\$.75
1L4	\$.50	6AH6	1.10	6V6GT	\$.50
1LC6	\$.40	6AJ5	1.10	6W4GT	\$.55
1LH4	\$.50	6AK5	\$.85	6X5GT	\$.45
1LH5	\$.40	6AL5	\$.45	6Y6	\$.60
1R4	\$.40	6AQ5	\$.60	7A7	\$.50
1R5	\$.50	6AS5	\$.65	7E5	\$.80
1S5	\$.50	6AT6	\$.42	7N7	\$.70
1T3	\$.45	6AU5	\$.60	7V7	\$.80
1U4	\$.50	6AV6	\$.45	7W7	\$.80
2A3	\$.65	6B4C	\$.75	7Y4	\$.50
2A4	\$.95	6RC6	1.70	12AT7	\$.85
2X2	\$.45	6BZ7	1.25	12AU7	\$.55
3A4	\$.60	6C4	\$.50	12SL7GT	\$.75
3A5	\$.75	6CB6	\$.60	32	\$.75
3B7	\$.40	6F6	\$.60	24A	\$.65
3D6	\$.40	6H6	\$.45	30	\$.65
3Q4	\$.50	6J5	\$.40	33	\$.75
3S4	\$.50	6J6	\$.75	34	\$.85
5Y4	1.25	6K6GT	\$.50	39/44	\$.50
5U4G	\$.50	6L6G, GA	\$.95	43	\$.45
5Z3G	\$.40	6R7	\$.80	46	\$.65
6A7	\$.65	6S77	\$.50	50	1.75
6AB7	\$.75	6SH7	\$.65	50B5	\$.60
6AC7	\$.65		\$.59	59	\$.75

CRYSTAL DIODES: IN23A—\$2.50; IN23B—\$2.75; IN26—\$7.50; IN34—65c.
Minimum Order \$5.00—F.O.B. N. Y. C.—25% Deposit with Order. Balance C.O.D.
ALLIED ELECTRONIC SALES, Dept. G
74 Cortlandt St., New York 7, N. Y., BRkley 7-5839, 40

Build Your Own Interior - Styled Cabinets

BASS REFLEX AND EQUIPMENT CABINETS

Ideal housing for hi-fi components. Removable panels make future changes easier. Loudspeaker cabinet acoustically designed for either 12" or 15" speaker.

Overall dimensions: #80 27.00*
 33 1/2" H, 23" W, 16" D (equipment kit)
 Tuner Compartment: #8112 18.00*
 20" H, 21 3/4" W (in. side dimensions) (12" speaker)
 15 1/4" D
 Baffle volume: #8115 16.00*
 6 cubic feet (15" speaker)

Corner Folded Horn Enclosures

Reproduces a quality of bass heretofore only possible through the use of far more expensive designs.

#61 (12" speaker) 19.95*
 #63 (15" speaker) 23.95*

Write for free catalog and nearest distributor



All kits include 5/8" white pine plywood cut to size, baffle pre-cut for 12" or 15" speaker, Saran Plastic AcoustiCloth, Kimsul Acoustic Insulation, Assembly and finishing instructions, hardware, plastic wood, sandpaper and glue.

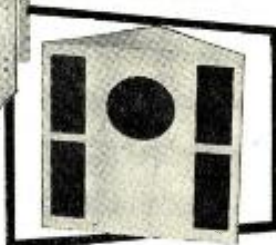

*Net prices, slightly higher West and South. Sold only through parts distributors.

G & H WOOD PRODUCTS COMPANY - 75 NORTH 11th STREET - BROOKLYN 11, N. Y.
 Pioneers in radio furniture for high fidelity equipment.

EASY TO LEARN CODE

It is easy to learn or increase speed with an Instructograph Code Teacher. Affords the quickest and most practical method yet developed. For beginners or advanced students. Available tapes from beginner's alphabet to typical messages on all subjects. Speed range 5 to 40 WPM. Always ready—no QRM.



ENDORSED BY THOUSANDS!

The Instructograph Code Teacher literally takes the place of an operator-instructor and enables anyone to learn and master code without further assistance. Thousands of successful operators have "acquired the code" with the Instructograph System. Write today for convenient rental and purchase plans.

INSTRUCTOGRAPH COMPANY

4711 SHERIDAN ROAD, CHICAGO 40, ILLINOIS

KITS by Cabinart

now available in select white pine wood—takes a beautiful blond or mahogany finish

Mac's Service Shop (Continued from page 86)

moved the defective unit and replaced it with a new transformer, but when he turned on the receiver it gave out with very poor quality and produced an audio howl at certain settings of the volume control. No checking of filter or audio bypass condensers turned up anything wrong, nor could any of the normal causes of audio amplifier instability be discovered.

"I should have stood in bed," Barney said with a sigh. "And this was the day I thought was going to be an easy one! I can't pick a set that has one nice simple little thing wrong with it like an open transformer. Oh no! I've got to draw one with complications."

"Maybe it didn't have complications until you replaced the transformer," Mac suggested.

"What do you mean by that crack?" Barney demanded truculently. "Are you insinuating I can't even replace an output transformer without making a mistake?"

"Could be," Mac said with a shrug as he picked up the speaker with the new transformer mounted on its frame. "What's this wire going from one side of the voice coil to the speaker plug?"

"I didn't trace it out, but I guessed it went to a terminal on the chassis for connecting an output meter across the voice coil," Barney replied. "Lots of sets use that, you know."

"But does this one?" Mac insisted as he pointed at the service manual shelf.

Reluctantly Barney hauled down a service manual and studied the diagram. "It doesn't go to a terminal," he said slowly. "Instead it seems to go back to the input of the first audio tube."

While the boy had been looking at the diagram, Mac had picked up the solder gun and had reversed the leads coming from the output transformer secondary, leaving all the rest of the connections intact.

Then he turned on the set, and the tone quality was excellent. No sign of amplifier instability could be found at any setting of the volume control. "Since when has a guy got to observe polarity in output transformer secondary leads?" Barney demanded. "If that's necessary, why don't they color-code them?"

"Ninety-nine times out of a hundred it's not necessary," Mac explained; but this is the hundredth time. This set uses negative feedback, and the feedback tap is taken from one side of the voice coil. There is, of course, a 180 degree phase shift from one end of the voice coil to the other. When you replaced the transformer, you happened to solder the tap to the wrong side of the voice coil and so started feeding back voltage that was "positive" rather than "negative."

TELEPHONE EQUIPMENT & PARTS

New TS9 handsets for EES.....Each 57.00
 Reconditioned TS9 handsets with switch...Each 4.95
 Weco 4H dials, less esc. plate.....Each 2.00
 Conn. Tel. dials.....Each 1.75
 Upright desk telephones (For extensions inter-coms, etc.).....Each 1.40
 Batteries BA40-BA70-BA30-BA208U.
 EES army field telephones, reconditioned and tested.....Each 19.50
 New ATR Inverter-Input 115V. D.C. Output 115V. A.C.....Each 40.00
 New WECCO Relays U-468, 110, 679, 629, 105, 125, 157, 6015, 612, 144, 89, 891, 90.
 New WECCO tools.

Terms: Check with order F.O.B. Brooklyn, N. Y.

EASTERN TELEPHONE CO.
 323 Vanderbilt Ave. Brooklyn 5, N. Y.

PAY LESS FOR TUBES

INDIVIDUALLY BOXED - FULLY TESTED - EACH TUBE GUARANTEED FOR SIX MONTHS

Type	Price	Type	Price	Type	Price	Type	Price
1B3GT	\$.69	6A55	\$.50	6K6GT	\$.41	12A27	\$.70
1H5GT	.46	6AT6	.38	6L6G	.80	12B6E	.45
1L4	.57	6AU6	.43	6L6GA	.80	12B6G	.47
1NSGT	.57	6AV6	.38	6S4	.46	12BH7	.63
1R5	.56	6B4G	.96	6SA7GT	.52	12BZ7	.75
1S5	.47	6BA6	.45	6S17GT	.47	12SA7GT	.52
1T4	.56	6BC5	.53	6SK7GT	.60	12SL7GT	.50
1T5GT	.71	6BD5GT	.89	6SL7GT	.62	12SL7GT	.61
1X2	.67	6BE6	.47	6SN7GT	.54	12SN7GT	.54
3Q5GT	.65	6BF5	.60	6SQ7GT	.42	12SQ7GT	.44
354	.55	6BG6	1.34	6T8	.78	19B6G	1.39
3V4	.56	6BH6	.57	6U8	.85	19C8	.94
5U4G	.43	6BJ6	.48	6V6GT	.46	19T8	.79
5V4G	.73	6BK7	1.10	6W4GT	.45	25B06	.89
5Y3G	.34	6BL7	.83	6W6GT	.57	25L6GT	.48
5Y3GT	.30	6BQ6	.89	6X4	.34	25Z6GT	.42
6AB4	.46	6BQ7	1.10	6X5GT	.33	35A5	.48
6AF4	1.40	6BZ7	1.10	6Y6G	.59	35B5	.47
6AG5	.54	6C4	.34	7N7	.52	35C5	.47
6AK5	.95	6CB6	.53	12A7E	.38	35L6GT	.47
6AK6	.63	6CD6	1.65	12A77	.68	39W6	.31
6AL5	.40	6FGGT	.45	12A16	.43	32S5GT	.30
6AN4	1.30	6HG6GT	.49	12A17	.55	50B5	.47
6AQ5	.46	6H5GT	.40	12AV6	.38	50C5	.47
6AQ6	.42	6J5GT	.40	12AV7	.80	50L6	.47
6AR5	.38	6J6	.62	12AX7	.61	11Z23	.39
						11Z26	.68

Motorola Ballast Tube #17A485459 30
 Each tube is performance-proven. 25% deposit must accompany all orders. Balance C.O.D. All prices F.O.B., N.Y.C. If remittance is made with order, you can deduct 2%, \$1.00 handling charge for orders under \$10.00. Subject to Prior Sale. Importer inquiries invited.

PHILLIPS TUBE COMPANY

2281 Nostrand Ave.
 BROOKLYN 10, N. Y.
 CLoverdale 3-8010-1-2

This, of course, accounted for the poor quality and the tendency to oscillate. When the leads from the transformer were reversed, all was well. If you had just looked at the diagram in the beginning to make sure of the purpose of that lead from the voice coil, you could have figured all this out for yourself."

"I'm sure a prize dope," Barney admitted. "As many times as you have told me, it looks like I would learn to use the manuals. I've always been like that, though. When I'm looking for something in a catalogue, I only use the index as a last resort, even though I know I can find what I want much quicker by using it. I kind of feel like I've been licked if I have to use the index.

"It's the same way with the manuals. I guess I'm trying to prove how smart I am by showing that I can get along without them. What I end up proving, as I've just shown, is how dumb I am."

"Don't be too hard on yourself," Mac consoled. "A mistake that's recognized is half corrected, and I'll make a manual-thumber out of you yet—I hope!"

Brightness Control (Continued from page 81)

plifier grid produce corresponding voltages, amplified and shifted in phase, at the plate and on the picture tube cathode. The brightness control is adjusted so that, during the blanking pulses, the picture tube cathode is sufficiently positive with respect to the grid and the first anode to blank out the screen. If the signal amplitude decreases by half, the picture tube cathode might become 20 volts less positive during the blanking pulses, but only about 3 volts less positive during the brightest parts of the picture. The retrace lines would not be changed much. Video amplifier direct coupling is not, by itself, the whole answer to the problem of automatic brightness control. It does only half the job, keeping the white level approximately constant; the other half, keeping the black level constant, requires a.g.c. in the receiver.

Video amplifier direct coupling does have two advantages over the other methods mentioned. Its white level regulation is instantaneous, since it does not depend upon condenser charging or discharging, while its black level regulation is as rapid as the receiver's a.g.c. system. If the maximum brightness changes from scene to scene, the change is reproduced, whereas, with direct white clamping, every scene has the same maximum brightness. Many manufacturers, such as Admiral, Arvin, Bendix, Fada, General Electric, Hoffman, RCA Victor, Sparton, Sylvania, and Westinghouse, have used or are using direct-coupled video amplifiers.

INEXPENSIVE ENCLOSURE

By J. WESLEY SWAUGER

WHEN I saw the specifications for the E-W speaker enclosure in the July, 1953 issue of RADIO & TELEVISION NEWS, I became enthusiastic about building one. Since the budget wouldn't stand the cost of the prescribed materials, I decided to attempt to construct it with ordinary corrugated pasteboard.

I first made a box of the right size and then proceeded to build it up by gluing on layer after layer of pasteboard. I staggered the overlaps for added strength and applied new layers until it was five layers thick. Then I glued in the baffle plates and the partition.

My enclosure actually consists of two boxes: the one which contains the baffles

and has no front slides inside the one on which the speaker is mounted and which has no back. This was necessary to provide a means of speaker installation.

The results are most gratifying. Although a plywood model would undoubtedly be superior, my eight-inch speaker gives better low-frequency response in this enclosure than it has ever given in any other baffle. It took a long time to complete the project because I had to let the glue on each piece dry for twelve hours, but the total cash outlay (for glue) was only seventy-five cents!

If you want an inexpensive enclosure that is fun to build and easy on the pocketbook, this is it.

-30-

ORDER BY MAIL FROM "WHOLESALE RADIO"

Equal to \$100
TV Aerial Systems

360° SUPER
DIRECTRONIC

Electronically Rotates
in All Directions

Exclusive Snyder Engineering and Design \$44.95
cuts cost to.....

Especially for ultra-fringe areas where signals arrive from more than one direction. Extra high gain over any other broadband aerial. No motors or electric power. 48 elements. COMPLETE WITH 6-POSITION DIRECTRONIC BEAM SELECTOR, 150' TUBULAR TRIN-CABLE, UNIVERSAL U CLAMPS. Order Snyder Model AX 518.

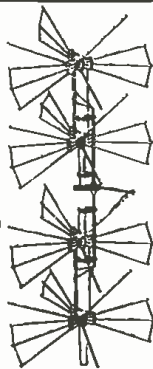

Equal to \$50
TV Aerial Systems

DUAL BAY
DIRECTRONIC

For Fringe Area

Same directronic operation as AX-518 above. Two bays for fringe area. Complete with three 3 1/2 ft. masts, 75 ft. flat three cond. cable. Beam selector sw., guy ring and mtg. base.

AX-599 same as TX-599 less masts, guy ring and mtg. base..... \$16.95

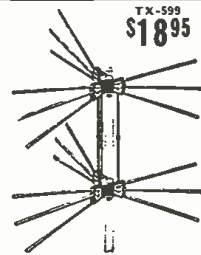

Stop Fiddlin' With Your Indoor Antenna!!!

UHF/VHF DIRECTRONIC
PORTABLE TV ANTENNA



Flick of beam selector switch electronically rotates antenna for clearest picture on any channel instantly. Equal to outdoor antenna in metropolitan areas. Channels 2 to 83. Model 3D..... \$6.95

Write for Quantity Price

Why Waste Time Waiting for Test Pattern

RMS TV BAR
GENERATOR

Makes Actual Bars on Any TV Screen

Make accurate, on-the-spot linearity adjustments. No chassis removal necessary. Operates directly into antenna terminals. Adjust number of horiz. & vert. bars. Complete unit. Order RMS BAR-1. \$14.95

CLETRON 60 OHM AND 100 OHM
ELECTRO DYNAMIC TV SPEAKERS

Size	Model	Field Res.	Mtg. Ctrs.	Price
5"	ED-570	60 ohms	3 5/16" x 3 5/16"	\$2.85
5"	ED-5710	100 ohms	3 5/16" x 3 5/16"	2.85
4x8"	ED-4676	60 ohms	3 5/16" x 4 5/8"	3.15
4x8"	ED-46710	100 ohms	3 5/16" x 4 5/8"	3.15
6"	ED-6710	100 ohms	4 3/4" x 4 3/4"	3.30

PRECISE 300 K
7" SCOPE KIT

Sensitivity—Less than 10 mv.

Has true electronic sweep magnifier. Astigmatism control. Push-pull vertical from input thru output; push-pull horizontal. Internal blanking and Z modulation with blanking amplifier. Driven and non-driven sweep. Over 5 MC flat response (3 db.) IC amplifiers. Cathode follower input on vert. and horiz. Internal calibrator. Horiz. and vert. stepping generator. NEW 7" tube. Highest sensitivity. COMPLETE WITH ALL TUBES, HARDWARE AND STEP-BY-STEP CONSTRUCTION BOOK.



MODEL 300 K
\$94.95

More Famous PRECISE Kits!

- 630K RF-AF-TV & MARKER GENERATOR KIT...\$33.95 (630KA pre-assembled head \$38.95) (630W wired \$53.95)
- 635K UNIVERSAL AF SINE SQUARE & PULSE GENERATOR KIT.....\$33.50 (635 wired \$52.50)
- 610K RF SIGNAL GENERATOR KIT.....\$23.95 (610KA pre-assembled head \$28.95) (610 wired \$39.95)
- 907K VFM KIT WITH 7 1/2" METER.....\$38.98 (907 wired \$57.98)

NEW EICO KITS

6V & 12V BATTERY ELIMINATOR AND CHARGER



DC output: 0-8V or 0-16V; 6V-12V toggle switch. Current rating at 0-8V: 10A continuous, 30A intermittent. Current rating at 0-16V: 6A continuous, 12A intermittent. Model 1050 Kit...\$29.95 | Wired \$38.95

New! MODEL 495K OSCILLOSCOPE VOLTAGE CALIBRATOR.....\$12.95 (factory wired—\$17.95)

New! MODEL 1180K DECADE CONDENSER BOX \$14.95 (factory wired—\$19.95)

New! MODEL 470K-7 INCH SCOPE.....\$79.95 (factory wired—\$129.50)

Exact Replacement

STANCOR FLYBACK TRANSFORMERS

- A-8132 For MUNTZ Part No. T0-004.....\$6.30
- A-8135 For ADMIRAL Part Nos. 79D41-1 and 79D41-2.....\$6.45
- A-8136 For PHILHARMONIC Part Nos. 80-263, 80-265 and 80-265-2. Also covers AMC, PATHE, SILVERTONE and other "private label" sets.....\$6.00

GENERAL ELECTRIC AND WESTINGHOUSE TUBES

0Z4.....83	68E6.....95	12AT7.....1.43
1A7GT.....1.15	68G6C.....2.40	12AU7.....1.20
1B3GT.....1.28	68K7A.....1.60	12AX7.....1.23
1R5.....1.05	68L7GT.....1.60	12BE6......95
1X2A.....1.25	68O6GT.....1.68	12BH7.....1.25
3Q5GT.....1.25	6C4......85	12BY7.....1.33
5U4G.....1.85	6C06G.....2.40	12CA7......90
5V4G.....1.33	6F5GT......93	12SK7......88
5Y3GT......68	6J6.....1.25	12SN7GT.....1.13
6A4......95	6K6GT......83	12SQ7......80
6A6S.....1.10	6L6G.....1.60	25W4GT......98
6AK5.....2.18	65N7C7A.....1.10	25T6GT......83
6AL5......88	6V6GT.....1.00	35W4......80
6AUSGT.....1.35	6W4GT......90	3Z5GT......65
6AU6......90	6W6GT.....1.10	50B5......98
6AV5GT.....1.05	6Y5GT......70	50E6GT......85
6BC5.....1.00	6N7.....1.10	11Z23......80

FREE! Write for new value-packed "FYI" bulletin #120. Write for our big audio guide, "Hi-fidelity Magic."

WHOLESALE RADIO PARTS CO., Inc.

311 W. BALTIMORE ST., BALTIMORE 1, MD.



Special Offer On This Complete **RADIO ENGINEERING LIBRARY**

New, Up-To-Date Edition of Famous Library Covers Whole Field of Radio Engineering. Places Latest Facts, Standards, Data, Practice, and Theory At Your Fingertips.

The five big volumes of the new edition of the Radio Engineering Library now include the very latest facts, standards, data, and practice. This Library will help solve hundreds of problems for designers, researchers, engineers, and students in any field based on radio.

Written by leading radio engineers, these books cover circuit phenomena, networks, tube theory, vacuum tubes, amplification, measurements, etc.—give specialized treatment of all fields of practical design and application. They provide you with a complete and dependable encyclopedia of facts.

- 5 Volumes. 3872 Pages, 2770 Illustrations.
- Eastman's **FUNDAMENTALS OF VACUUM TUBES**, 3rd Edition.
- Terman's **RADIO ENGINEERING**, 3rd Edition.
- Everitt's **COMMUNICATION ENGINEERING**, 2nd Edition.
- Hund's **HIGH FREQUENCY MEASUREMENTS**, 2nd Edition.
- Henney's **RADIO ENGINEERING HANDBOOK**, 4th Edition.

SEND NO MONEY

Special Low Prices—Easy Terms

On this special offer you get this Library for \$37.50, instead of \$43.50. You save \$6.00 and may pay on easy terms. Mail coupon below to examine the Library FREE for 10 days. No obligation. These books are recognized as standard works; you are bound to need them. So take advantage of this special money-saving offer. Mail coupon at once!

McGraw-Hill Book Co., Dept. RTN-10,
327 West 41st St., New York 36, N. Y.

Send for 10 days' FREE trial, the RADIO ENGINEERING LIBRARY. If not satisfied I will return books. Otherwise I will send \$7.50, plus delivery charges, then; and \$6 a month for 5 months. (Reg. price \$43.50; you save \$6).

Name.....

Home Address..... RTN-10

City & State.....

Employed by.....

We'll Pay Delivery Charges if you enclose \$7.50 first payment WITH coupon. Same return privilege for full refund. (Offer applies to U. S. Only.)

NEW APPROACH TO TV SERVICE

By **CARROLL W. HOSHOUR**

Director of Sales Engineering
TV & Radio Div., Raytheon Manufacturing Company

A consumer guide and factory manual allow the service technician to do half the job before leaving the shop.

THE American TV-owning public has come to realize that no matter how well designed, engineered, and manufactured a TV set may be, sometime during the first year or two it will require service. This service may involve anything from component parts or tube replacement to something as relatively minor as a back apron control adjustment.

Any plan that makes such servicing faster and better is of benefit not only to the TV set owner, but to the service technician and the TV manufacturer as well. Among TV manufacturers there are those who believe that to admit that their sets will require service is "negative selling" and will cut down on their sales. The Raytheon Manufacturing Company, on the other hand, believing that a planned program or device that would assist both the consumer and the service technician toward a fast, efficient, and economical solution to their service problems would be of benefit to all concerned, has introduced the "Service Saver" to the TV industry.

The term "Service Saver" is used for the program since its prime function is to save time, save nuisance service calls, and, in turn, save money.

Primarily, the "Service Saver" makes possible the transfer of factual information from the customer to the service technician. Today, when Mrs. Jones calls for TV service and complains of black wavy lines in her picture, the service technician has to take a wild guess as to whether it is r.f. interference, sound bars, poor horizontal hold, or a.f.c. trouble. It is quite obvious that if he could see the condition that Mrs. Jones is attempting to explain, he could, in the great majority of cases, come completely equipped with proper tubes or components that would effect a speedy remedy.

Raytheon has shown in their "How to Interpret What You See" lectures to service technicians across the nation (see RADIO & TELEVISION NEWS, April, May, and June, 1952) that approximately 90 to 95 per-cent of the troubles which occur in TV receivers appear as visible defects on the face of the picture tube. The service technician who has learned to interpret

from the face of the picture tube what the various circuits of a TV receiver contribute in the average picture can, in turn, recognize what circuit failure is responsible when a bad picture is produced.

Some service dealers use apprentices or trainees on preliminary calls, saving the more skilled technicians for bench work or special calls. With an accurate description of the trouble from the customer, the skilled technician can explain to the apprentice exactly what tubes, adjustments, or circuits should be checked.

The "Service Saver" consists of two units. One, a TV owner's guide, accompanies each new Raytheon TV receiver. This booklet contains 40 pictures of different defects shown on the face of a TV picture tube and covers approximately 95 per-cent of the troubles that can be caused by misadjustment, tube, or component failure. Each picture is numbered and corresponds to a specific defect. Arrows and a word of explanation are used to indicate movement of the picture or interference effect. These pictures were produced by a flying spot scanner, using a black shaded map of the United States feeding into a TV chassis. In addition to the pictures, letters are used to denote five different sound conditions that further assist the technician. Thus, for example, "A" denotes normal sound, "B" no sound, and "E" hum or buzz in sound.

The second unit is the factory service manual which is available to all service technicians. This manual contains a section in which the numbered pictures in the owner's guide are reproduced. However, here, each numbered condition is described in detail, with a sectional schematic covering the particular circuit responsible, a parts list, a layout drawing of the chassis showing the position of the parts in question, and a suggested procedure for remedying the condition.

Upon original installation of the receiver, the customer is told that if trouble should occur, she (or he) should compare the picture on the face of the CRT with the 40 pictures in the guide. She then reports the number corresponding to her picture and the letter corresponding to the

sound to the service technician (or girl taking the call at the service dealer). The service technician then merely uses his service manual to correlate the picture with the defect.

In a test of a group of average housewives who were asked to identify 12 different conditions on a TV receiver, using the "Service Saver," over 92 per-cent of the answers were correct.

Both the "Service Saver" consumer guide and the service manual are available to all TV service technicians from the Raytheon Receiving Tube Division.

-30-

R.F. SUPPLY FOR SCOPES

By HOWARD ZIMMERMAN

WE CONVERTED one of our scopes to r.f. power supply some time ago, and ran into considerable difficulty adapting TV-type transformers to this application. We tried several different makes and styles of coils before finding one which would give us the desired results without the use of extensive modifications or trick circuitry.

The circuit shown here is the one we finally settled on. Standard parts are used throughout, and the bleeder circuit in the scope does not have to be changed to higher value resistors due to the reserve power developed by the oscillator. The two terminals of the transformer, coded "#2," were tied together on the original unit and must be separated to obtain a negative voltage supply.

The voltage output of the circuit can be varied over a considerable range by selection of different oscillator tubes. Three tubes with the voltages we obtained from them are given in the parts list. The amount of output, therefore, is dependent upon the tube selected, e.g., with a 6F6 the output is 1750 volts, with a 6V6 it is 2100, and with a 6W6 the output voltage becomes 2700 volts. -30-

Simple power supply circuit for a scope.

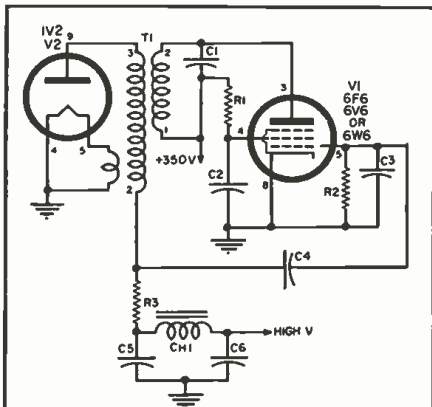

- R₁—20,000 ohm, 1 w. res.
- R₂—100,000 ohm, 1/2 w. res.
- R₃—500,000 ohm, 1 w. res.
- C₁—0.03 μfd. mica cond.
- C₂—0.05 μfd., 600 v. cond.
- C₃, C₄—50 μfd., 1000 v. cond.
- C₅, C₆—0.02 μfd., 2500 v. cond. (use 5000 v. with 6W6)
- T₁—5.5 kv. r.f. high voltage trans. (Stanwyck Type 960)
- CH₁—10 mhy. choke
- V₁—6F6, 6V6, or 6W6 tube (High-voltage output 1750, 2100, and 2700 volts respectively)
- V₂—1V2 tube

LOOKING for the RIGHT TV REPLACEMENT TRANSFORMER?



you'll find it in

STANCOR'S NEW TV REPLACEMENT GUIDE



Easier to use . . . lists replacements by manufacturer's model and chassis number and also by original part number.

Up-to-date . . . over 5600 models and chassis are covered, including virtually all sets built prior to 1953 as well as most 1953 models.

You'll save time and trouble when you use this valuable Stancor reference. Get it now from your Stancor distributor, or write us directly for your free copy.

FIVE NEW STANCOR EXACT REPLACEMENT FLYBACKS

Many of these units are the result of recommendations of the Stancor Servicemen Advisory board, composed of the top TV servicemen throughout the country.

PLUS A-8126 Universal vertical blocking-oscillator transformer for all Philco sets, including 1953 models.

Stancor Part No.	Exact Replacement For	No. of Models Using Flyback
A-8137	Hoffman #5035	29
A-8220	Philco #32-8555	24
A-8221	Philco #32-8565	18
A-8222	Philco #32-8533 & #32-8534	38
A-8223	Philco #32-8572	15



CHICAGO STANDARD TRANSFORMER CORPORATION

3584 ELSTON AVENUE • CHICAGO 18, ILLINOIS

EXPORT SALES—Roburn Agencies, Inc., 39 Warren St., New York 7, N. Y.

USED RECORDING TAPE (PLASTIC BASE)



\$1.99 for 7"—1200 foot
1.09 for 5"—600 foot
.59 for 4"—300 foot
.29 for 3"—150 foot
Plastic reels included with all above sizes.

Money cheerfully refunded if you do not find this tape cleanly erased and as good as new. (If you are skeptical and from Missouri send us 12c in stamps and we'll roll you a sample.)

New empty plastic reels in boxes for easy labeling, 3"—10c; 4"—22c; 5"—24c; 7"—30c ea. EMPTY BOXES: 3"—3c; 4"—5c; 5"—5c; 7"—10c ea.

We carry new recorders, recording blanks, tape, tape recorders, etc., at large savings. PLEASE INCLUDE SUFFICIENT POSTAGE.

COMMISSIONED ELECTRONICS CO.
2503 Champlain St. N. W., Washington 9, D. C.

RADIO ENGINEERING DEGREE IN 27 MONTHS

Radio engineering is a big field. There's room for you in it—if you're good. Get first-class training at Indiana Tech. Intensive, specialized course, including strong basis in mathematics and electrical engineering, advanced radio theory and design, television, electronics, Modern Laboratories. Low rate. Also B.S. DEGREE IN 27 MONTHS in Aeronautical, Chemical, Civil, Electrical and Mechanical Engineering. G.I. Government approved. Enter December, March, June, September. You can earn part of your expenses right here in Fort Wayne while you are studying.

INDIANA TECHNICAL COLLEGE

9102 E. Washington Blvd., Fort Wayne 2, Indiana

Please send me free information on B.S. Engineering Degree in 27 months as checked.

- Radio-Television Aeronautical
 Civil Mechanical Electrical

Name

Address

**Eliminate
major mechanical
changes**



**with TRIAD
TRANSFORMERS**

Triad doesn't expect a serviceman to reconstruct or re-engineer a television chassis to accommodate a replacement part.

For that reason every Triad television component is circuit tested.



As an example, Triad's R-BS Series Power Transformers, listed below, are tube socket types for use where rectifier tube is mounted directly on the transformer.

They are made for under-chassis or top-chassis mounting and are exact replacements for many popular chassis.

Type No.	Plate Supply		Filaments—Volts and Amperes		
	AC Volts	DC Ma.			
R-47BS*	725 V.C.T.	225	5v.—3A.	6.3v.—10A.	6.3v.—2.7A.
Tube socket type, wired for 5U4G and designed to deliver 360 v. into 80 m.f.d. condenser, low capacity damper tube winding.					
R-48BS*	750 V.C.T.	180	5v.—3A.	6.3v.—9A.	6.3v.—2.7A.
Tube socket type, wired for 5U4G and designed to deliver 375 v. into 80 m.f.d. condenser, low capacity damper tube winding.					
R-49BS*	650 V.C.T.	240	5v.—3A.	6.3v.—9A.	6.3v.—1.2A.
Tube socket type, wired for 5U4G and designed to deliver 325 v. into 80 m.f.d. condenser, low capacity damper tube winding.					

*B means Horizontal Mount; S, Socket Type

Triad Television Components will simplify and speed your service work. See your jobber for Triad Television Components, catalogs and replacements guides, or

Write for Catalogs TR-53A and TV-53A



4055 Redwood Ave., Venice, Calif.

Intermittent Checker
(Continued from page 56)

the output stage. The other lines were placed at the screen of the output stage and at the cathode of the damper. After a period of about 50 minutes, the buzzer sounded and lamp #2 (monitoring the screen circuit) lighted. This indicated that the trouble was in the screen of the horizontal output stage. The trouble could not be in any of the previous stages, otherwise the grid lamp would have gone on. Checking the components in the screen circuit, it was noted that a 6800-ohm resistor had a resistance of 10,000 ohms. This resistor was checked about five minutes after the set was allowed to cool and, consequently, it may be assumed that it had an even higher resistance when the transient occurred. Replacing the resistor, which apparently was increasing in value as the temperature increased, remedied the trouble.

In another set, the video and audio disappeared and re-appeared intermittently but the raster remained. The trouble was therefore in common

circuits; i.e., r.f., i.f., or video. The set used a Capehart CX-37 chassis. The three lines were connected as follows: #1 at the output of the video detector; #2 on the "B+" to the tuner, since previous experience with this set indicated that the bleeder resistor frequently opened; and #3 to the output of the video amplifier. After about 15 minutes, the buzzer sounded and lamp #1 lighted. This indicated that the trouble was either in the video i.f. amplifiers or video detector. With #1 left at the same point, #2 was placed at the 3rd video i.f. plate, and #3 at the 2nd video i.f. amplifier. After about 20 minutes, the buzzer sounded and lamp #3 lighted, indicating trouble in either the 2nd or 1st i.f. Examining the plate circuit of the 2nd i.f., however, showed that a connection to the i.f. transformer was corroded. The connection was removed and resoldered, and the trouble was remedied.

These two examples should serve to illustrate the wide field of applications in TV service work of the intermittent recorder. No longer need intermittents be the bugaboo of the service shop. This instrument should help to reduce callbacks appreciably. —30—

TRANSISTOR "WIRELESS MIKE"

By A. H. HELLMERS

AN ENTERTAINING gadget of durable popularity is the "wireless mike," a voice-modulated r.f. oscillator which can be picked up in a standard broadcast receiver at distances up to 20 or 30 feet. In common with "wireless" phonograph oscillators and the radio remote-tuning devices sold some years back, these units are not transmitters in the FCC sense of the term as long as their range is small compared to the wavelength at the operating frequency.

The transistor circuit shown operates in the low-frequency half of the broadcast band, where the wavelength is upwards of 900 feet. V_1 is the r.f. oscillator. The Colpitts-type circuit is tuned by means of a powdered-iron slug to an empty spot in the broadcast band, somewhere in the vicinity of 700 kc. This oscillator is "plate" modulated in the regular Heising style by a second transistor V_2 . The microphone was a balanced-armature magnetic unit having a d.c. resistance of 200 ohms, obtained from a surplus collection. Since the input impedance of V_2 is on the order of 1000 ohms, a low-impedance mike is required. Crystal microphones will not work.

It was found that the tank capacitances in the r.f. oscillator circuit shown must be small, or the circuit will not oscillate at frequencies as high as the lower edge of the broadcast band. Hence an inductance somewhat larger than the usual broadcast coil (0.3 millihenry) is needed. The one used here is a commercial surplus item. However, it should be effective to rewind a broadcast-band coil to about twice the original number of turns. Experimentation is easy because no tap is required, and the "Q" need not be particularly high. In the present state of the transistor art there is, of course, no assurance that all individual transistors of any particular type will have the same upper frequency limit of oscillation. Broadcast band frequencies are definitely at the high limit, for

junction transistors, apparently, and all that can be said is that two transistors worked in this circuit.

The battery drain for the oscillator should be between 0.4 milliamperes and 1 milliamperes. Before operating the circuit, this must be checked. Proper bias will vary with different transistors. Bias is adjusted by selecting the value of resistor R_1 . The lower it is, the higher the collector current. Bias for the modulator transistor V_2 is determined by resistor R_2 , which should be selected to give a collector current of 0.8 to 1.5 milliamperes. —30—

"Wireless mike" using CK722 transistors.

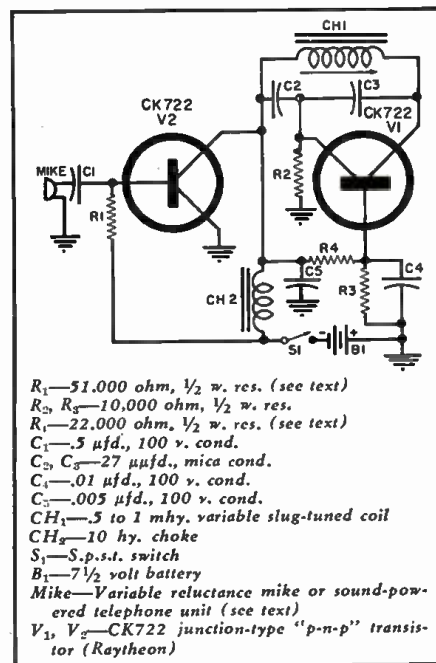

- R_1 —51,000 ohm, 1/2 w. res. (see text)
- R_2 , R_3 —10,000 ohm, 1/2 w. res.
- R_4 —22,000 ohm, 1/2 w. res. (see text)
- C_1 —.5 μ f.d., 100 v. cond.
- C_2 , C_3 —27 μ f.d., mica cond.
- C_4 —.01 μ f.d., 100 v. cond.
- C_5 —.005 μ f.d., 100 v. cond.
- CH_1 —.5 to 1 mhy. variable slug-tuned coil
- CH_2 —10 hy. choke
- S_1 —S.p.s.t. switch
- B_1 —7 1/2 volt battery
- Mike—Variable reluctance mike or sound-powered telephone unit (see text)
- V_1 , V_2 —CK722 junction-type "p-n-p" transistor (Raytheon)

Certified Record Revue

(Continued from page 70)

"tubby" bass, it is more than offset by the sheer beauty of this great work. With NARTB equalization, a slight boost in bass and treble was necessary. Surfaces were quiet. Certainly not a hi-fi demonstration record, but a very thrilling piece of music, well worth your time.

GRANADOS

TWELVE SPANISH DANCES

Jose Echaniz, pianist. Westminster WL5181, 33 1/3 rpm, NARTB curve. Price \$5.95.

Granados was a master of his chosen instrument, the piano. In his writing that fact is very clearly revealed. These twelve pieces are not simple Spanish folk tunes embroidered and embellished by a master craftsman. These are the very essence of Spanish musical idiom, a penetrating and very personal utterance of a man who knew and loved his country. Mr. Echaniz has a big, solid tone and the technical proficiency to cope with the complexities of the score. Rhythm is the essential basis of this music and the artist is right at home with the colorful figurations which give this music its typically Spanish character. The piano recording is sharp, close to, generally good. There is occasional thinness of tone and some noticeable flutter, but these are minor faults. Reproduction was satisfactory with NARTB equalization and bass and treble controls set flat. Surfaces were a little noisy in my copy. Really enjoyable little pieces, but I would advise against a dose of all twelve of them at one time. They can get a little repetitious. An interesting note is the way in which Granados died. Most composers certainly don't meet their end in this fashion: he went down with the English steamship "Essex," when it was torpedoed by a German sub in 1916!

SCHOENBERG

A SURVIVOR FROM WARSAW, SECOND CHAMBER SYMPHONY, and KOL NIDRE

Vienna Symphony Orchestra and Academic Chamber Chorus conducted by Hans Swarowsky and Herbert Haffner. Columbia ML 4664, 33 1/3 rpm, Columbia curve. Price \$5.45.

Three interesting works by Schoenberg, "high priest" of the twelve-tone system of music. "Survivor from Warsaw," for speaker, male chorus, and orchestra, is a cantata about a death march of some victims of the Nazis. Narrated by one who escaped the march, the work is somewhat obvious in its propagandizing, but nevertheless is a powerfully written and grim little tale of horror. The "Second Chamber Symphony" is for Schoenberg, a very lyrical piece and not characterized by much of his atonal devices and effects. Recording is good if un-

even in the three works and surfaces were quiet. The LP curve reproduces it quite nicely without any touch up. An off-beat item you might like.

BRITTEN

VARIATIONS ON A THEME BY BRIDGES

WARLOCK

CAPRIOL SUITE

Boyd Neel String Orchestra conducted by Boyd Neel. London LFR 11801, 33 1/3 rpm, NARTB curve. Price \$5.95.

Here is some more of the special Coronation releases of music by British composers. The Britten piece is by far the better of the two. The "Capriol Suite" is well recorded, but the per-

formance leaves something to be desired. The "Frank Bridges Variations" is a vigorous work, though somewhat rough-hewn. The string tone has none of the "steeliness" some people complain about from London. Rather, the strings are rich and clean, with just enough edge to give them presence. Oddly enough, instead of the usual roll-off necessary in the bass end of London records, with equalization set at NARTB this one needed a little boost. This kind of music is Boyd Neel's particular dish and he makes the most of it. Except for occasional raggedness, the string playing is outstanding and Mr. Neel elicits some wonderful sound from his well disciplined group.

THIS NEWEST WELLER GUN INVITES COMPARISON

NOW 275 WATTS

COMPARE It To The Soldering Tool You Now Use

COMPARE It To Any Soldering Tool On The Market

Here's the professional tool with all the features you've wanted for fast, dependable soldering.

- **COMPARE the soldering capacity.** This newest Weller Gun handles up to 275 watts. Four new models from 100 to 275 watts give full coverage of heavy or light soldering.
- **COMPARE the performance.** 5 second heat saves time and current. Dual heat gives extra soldering capacity. Thermostatic control instantly and automatically regulates tip temperature.
- **COMPARE the comfort.** This newest Weller Gun floats in your hand. Perfect wrist-action balance and streamlined design, with pistol grip centered under housing, provide easier operation.
- **COMPARE the versatility.** There are 4 new Weller models—heavy duty, light duty, single heat and dual heat. And 2 new accessory tips are available for all models. A hot knife-blade cutting tip and a trowel-shape smoothing tip add to the practical uses of a Weller Gun.
- **COMPARE the reputation.** This newest Weller gun is backed by the first name in the soldering gun field. Over a half-million Weller Guns are used by professional servicemen and craftsmen. See this newest Weller Gun at your Distributor or write for Bulletin direct.

Weller

Better from Grip to Tip!

810 Packer Street
Easton, Pa.

SOLDERING GUNS

You can build a reputation on Tung-Sol Quality

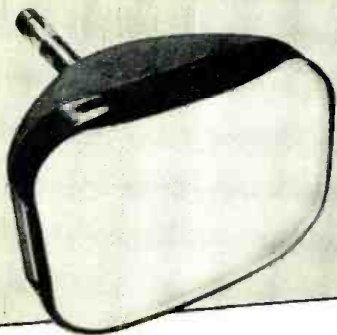

TUNG-SOL makes
All-Glass Sealed Beam Lamps,
Miniature Lamps,
Signal Flashers,
Picture Tubes, Radio, TV,
Special Purpose Electron Tubes,
Semiconductor Products.

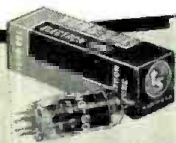

TUNG-SOL ELECTRIC INC.
Newark 4, New Jersey

Sales Offices: Atlanta, Chicago, Columbus, Culver City (Los Angeles), Dallas, Denver, Detroit, Newark, Seattle

BARTOK
SONATA FOR TWO PIANOS AND PERCUSSION
GOEB
SYMPHONY NO. 3
Leopold Stokowski and his orchestra. Gerson Yessin and Raymond Viola, pianists; Elaine Jones and Alfred Howard, percussion. RCA Victor LMI727, 33 1/3 rpm. RCA Orthophonic curve. Price \$5.72.

Well, I wish I could report to you that we have a real bang-up new version of the Bartok, but such is not the case. Oh, all the elements needed to make this a success are there all right. Mr. Stokowski is an absolute genius when it comes to conducting the moderns, the pianists are highly proficient with a keen insight of the complex score, the percussionists precise and alert. What's wrong? The sound dear friends, the sound. This should have been a hi-fi *tour de force*. Goodness knows there is enough material in the Bartok! What with snares and pedaled tympani and side drum, tam tam, cymbals, the gran cassa, bells, triangle, etc. you ought to be able to tear the house down. Unfortunately, whatever Victor did with the top end of this disc, it just doesn't come off. This is doubly unfortunate, because actually this is one of Victor's better efforts. The pianos are properly percussive in tone, the percussion bright and clean. It is just that very top end, that little extra that adds the punch and the presence to a recording that you miss so much. I dunno, maybe I'm hearing too much of this stuff lately, and I am splitting hairs and being hypercritical. Maybe you'll think it's great. It is just lacking that little something that sends me. The Roger Goeb work has some marvelous writing in it, although its not the kind of thing you fall in love with on the first hearing. Again Mr. Stokowski is at home with the music and favors it with a powerful reading. The Orthophonic curve needed correction for bass deficiency. As with most of Victor's records the surfaces were very quiet. In fact I think this quietness has something to do with the top end trouble. I'm going to investigate and I'll let you know what I find out.

BACH
VARIATIONS ON SEI GEGRUSSET, JESU GUTIG, and FIVE CHORAL PRELUDES
Finn Videro, organist. Haydn Society HSL3063, 33 1/3 rpm, AES curve. Price \$5.95.

Finn Videro is one of the world's great organ virtuosos. His playing of these beautiful Bach pieces is a model of good taste and his registration admirably chosen. It is too bad this is such a poor recording. The work played on a magnificent old baroque organ, suffers from tape flutter, and in the inner diameters the intermodulation distortion gets pretty fierce. This is not the kind of organ recording to test out the low frequency response of your speaker system. Its a

AUTUMN SALE

PRICES SLASHED

T.V. TUBES—ROCK BOTTOM PRICES

In lots of 6 each No. only
68G6 . . . 89c 6C8G . . . 39c 6AQ5 . . . 39c 6Y8 . . . 59c
198G . . . 89c 6AK5 . . . 89c 6CD6 . . . 51.00 1L4 . . . 45c
12AX7 . . . 47c 68Q6 . . . 57c 654 . . . 49c 1T4 . . . 45c

Tube Special—Broken Keys—Electrically Perfect
12AG . . . 29c; 4 for \$1.00 12K8 . . . 49c; 7 for \$3.00
Tube Sale—2A7-55-27-85-31-5G, No Mixed Ass^{ts} 6 of Any Type \$2.25

Heavy Duty Shielded P.P. Input Trans. \$1.00
H.D. Silver Contact Trans. Keys 1.00
Isolantite Octal Panel Clamp Sockets 3c ea.
100 Assorted Resistors \$1.95
1 Mfd., 1,000V Oil Filled Cond. 75c
2 Gang Var. Cond. 456 K.C. with Osc. Section.
2 3/4 in. Pulley on 3/8" Shaft. 49c
Westinghouse Kuprox Rectifier 0.64 Amp. 28
Volts. Reg. \$11.00 ea. Special. \$1.95

BRAND NEW 10" PHONO RECORDS—Ass't.
Jazz—Popular—Rhythm—Blues. Please specify.
12 for \$1.79 or 24 for \$3.00 or 50 for \$5.75

Single Pole—10 Pos. 2 Gang Switch 29c
Grind your own Crystals. Pure Brazilian Quartz. Various sizes and thicknesses. 1/4 lb. pkg. \$1.00
4 Tube Drilled Chassis. 4 1/2" x 6 1/2" x 1 1/2". 29c each
Signal Corps Phones—2 M. Ohms (8 M. Ohms Imp.) \$1.25
2 Ft. Ext. Cord and Plug 40c
2 1/4" x 4" Bake. Panel Mounting—5 Res.; 6 Mica Cond.; 2 Choke Coils 49c
2 1/2 M.M. R.F. Choke Coil 27c ea.; 4 for \$1.00
7 ft. Und. App. AC Line Cord 20c
Miniature 7 & 9 pr. Sockets 7c Ea. 60c Doz.
RCA 4" x 6" Oval P. M. Speakers \$1.25

TUBULAR ELECTROLYTICS
20-20 MFD. 150 V. 49c 30-30 MFD. 150 V. 57c
40-40 MFD. 150 V. 59c 80-50 MFD. 150 V. 75c

Low-Loss Short Wave
Lock Type Air Trimmer
Variable Condensers
5 Pl.—20 Mmfd. 16c
7 Pl.—25-30 Mmfd. 18c
8 Pl.—30-35 Mmfd. 20c
14 Pl.—56 Mmfd. 28c

3 GANG T.R.F.
VARIABLE CONDENSERS
D.E.N.S.E.R.S.
0.00385 Con. 65c
D.P.D.T. SLIDE
TOGGLE
SWITCH 15c

1,000 OHM WIRE WOUND POTENTIOMETER 15c
30 WY.FILTER CHOKES SHIELD 3 for \$1.25

FIXED CRYSTAL HOLDERS. 12 for \$1.00—\$6.00 per C
RCA Band Switches—
3 gang, 3 pos. 3 band. 30c 6 gang, 4 pos. 4-5 band. 40c
Trimmer-Padder Ass't.—all isolantite—singles, dual; triples—100 ass't. \$2.25

ATTENTION! Prospectors, Explorers for Hidden Treasures!
Construct a U.S. Army Type of Metallic Mine Detector Amplifier. Amplifier unit only (less tubes and batteries) with cables, headphone cord, and jack. Army wiring diagram. Type AN/PRS-1. \$1.95
Philco push button Rotary Switch Double Pole 35c
8 or 9 Gang Push Button Switch 49c

DRILLED CHASSIS FOR 5-0 tubes 5" x 10" x 1 1/2". 25c
PHONE JACKS—OPEN & CLOSED AUTO 48c
156-1 RATIO VERNIER DIALS—4 in. 3/4 in. Hub. 35c
SALE—PHONO RECORD ALBUMS—12"—3 comp.—15c;
10"—3 comp.—15c; 4 comp.—20c; 12 comp.—59c

VULCAN HEAVY DUTY 100 WATT SOLDERING IRON.
Built for U.S.N.—Brand New—Equip. sells for \$8.50. **DUR PRICE \$3.25**

MINIMUM ORDER \$3.00—NO C.O.D.
SHIPMENTS—PLEASE INCLUDE POSTAGE
NEWARK SURPLUS MATERIALS CO.
324 Plane Street, Dept. OC, NEWARK 1, N. J.



17" Table
\$122⁶⁸
Pl. \$12.27 Fed. Excise Tax

20" Table
\$134⁵⁰
Pl. \$13.45 Fed. Excise Tax

20" Console
\$149⁹⁵
Pl. \$15.00 Fed. Excise Tax

21" Console
\$164⁹⁵
Pl. \$16.50 Fed. Excise Tax

Check these luxury features:
Ultra sensitivity, dynamic range control, UHF adaptability, Duo power supply, Acousticlear Sound system . . . all in a beautiful Mahogany finish cabinet.

ALSO AVAILABLE TV CHASSIS

All sets have full 1-yr. factory picture tube warranty, and standard 90-day RTMA parts warranty. Mail and Phone Orders Filled. \$25 deposit, balance C.O.D., Shipping Charges Additional.

STEPHEN SALES CORP.

45 Crosby St., N.Y. 12, N.Y. Phone: WO 4-8233

Dealer Inquiries Invited

RADIO & TELEVISION NEWS

shame, because the playing is well done.

BEETHOVEN

SONATA NO. 29
Royal Philharmonic Orchestra conducted by Felix Weingartner. Columbia M14675, 33 1/3 rpm, NARTB curve. Price \$5.45.

This is the famous orchestral transcription Weingartner made from the original piano many years ago. Columbia has done an admirable transfer job from the 78's and the recording itself has benefited. Certainly not up to today's standards, it is nonetheless an exciting work and a good sounding disc. Good orchestral balance with excellent string tone and comparatively quiet in spite of its 78 origin. As to whether this great work is more effective in the original piano version or this transcription is a moot point. I like them both, and since it is extremely difficult to come by a really good performance in the piano original, this is a welcome, if somewhat novel change. In transfer, the equalization has become the standard NARTB and reproduces well from that curve with a few db of boost in both bass and treble.

RAVEL

BOLERO
RIMSKY-KORSAKOV
CAPPRICIO ESPAGNOL

Detroit Symphony Orchestra conducted by Paul Paray. Mercury MG50020, 33 1/3 rpm, AES curve. Price \$5.95.

This is the initial effort of the Detroit Symphony for the Mercury "Olympian Series." To say that they put their best foot forward is to put it mildly. The "Bolero" has finally come of age in this recording. You may ask, why another "Bolero" when there are already umpteen in the LP catalogue? The question is valid until you analyze the existing recordings. First, there is no really modern recording, and the others of fairly recent vintage were not wholly satisfactory. Secondly, there has not been a really good performance of this work since the old Koussevitsky reading on Victor. Here in this disc, the "Bolero" becomes a new and thrilling experience instead of the same tired old warhorse. Paray is an engaging fellow who knows his way around, especially with French repertoire. His pace in the work is neither too slow, nor does it become frenetic. With poise and restraint he builds, tower upon tower of sound until the final, shattering climax. The snare is finally the way it should always sound, crisp, clean and compellingly insistent. The brass has good bite and is well played, the woodwinds ragged at times, but good solo work throughout. The dynamic range on this disc is incredible. Try this: play the work through to the climax and then quickly put your pickup to the beginning. You won't believe it! The "Cappricio Espagnol" is a knock out! This will be the hi-fi crowd's delight. Terrific brass, thundering

tympani, and bass drum. Sharp, incisive strings. Clashing cymbals and gongs! All the things that are dear to the hearts of audiophiles. Paray gives the colorful work a spirited performance. His dynamic shadings are marvelously detailed and his beat sure and strong. If you want a big kick, wait till you hear the snare roll at the start of the second section. Wow!

DELIUS

BRIGG FAIR, ON HEARING THE FIRST CUCKOO IN SPRING, and OTHER SELECTIONS

London Symphony Orchestra conducted by Anthony Collins. London ffr, 33 1/3 rpm, London ffr curve. Price \$5.95.

Still another of those special Coro-

nation releases. This is soft lovely music, typical of Delius' dreamy half-world stuff. Innocuous pieces, yet they have a certain strength and character. Collins leads his orchestra in a competent well-paced reading. Beecham is supposed to have the inside track with Delius, but I don't see how he could excel this Collins reading very much. Altogether admirable. The sound is good and clean, if unsensational. This is not for the blood and thunder boys, but rather is the quiet dreamy sort of thing that goes well in the summertime, with a glass of cold beer on the front porch. Try it for yourself. This stuff can grow on you in no time.

SPECIAL BUYS!



Radar Indicator unit for conversion to test scope or for use as a modulation monitor. Complete with tubes. But, less 5BP1. Parts alone are worth much more. **\$9.95**

New



CRYSTALS

Low Freq.—FT 241 A for 558, lattice filter, 1/2" spc. 54th harm channels listed by fund. Fractions omitted.

370	398	407	425	444	462	481	501
372	390	409	427	446	464	483	503
374	392	411	429	448	466	485	505
375	394	412	431	450	468	487	507
377	396	414	433	451	470	488	509
379	398	416	435	453	472	490	511
381	400	418	437	455	474	492	512
383	401	420	438	457	475	494	514
385	403	422	440	459	477	496	516
387	405	424	442	461	479	498	

49c each

10 for \$4.00

WHILE THEY LAST!

350 ft. of 50 ohm coaxial cable. \$ 9.95

Attenuator—one cavity type. 7.95

TS11 Hand Sets, excellent condition. 5.95

TS Type, exc., less cord. 2.95

E8B Portable Telephone exc. cond. ea. 18.95

10 assorted electrolytics.95

100 ass'd. 1/2 and 1 watt carbon resistors 1.49

2.2-2 mfd @ 4000 Volts. 2.95

R-1/ARR-1—220 mc converted with minor alterations becomes a high gain converter with two stages of R. F. amplification—(see "Radio & TV News," Jan. 1949) new \$4.95

TS-1—Test Set for above. 4.95

304TL, 5BPI, 5CPI \$5.95 ea.

954, 955, CK1005, 1625, 1626, 1619, 33, 34, 9002, 9004, 9006, 927G, 12SQ7, G156, 12A6, 12SL7G7, 12SQ7G7-10 assorted for \$3.00.

SURPRISE PACKAGE. 15 lbs. of assorted good radio parts.

A real value at. **\$1.95**

DYNAMOTORS: The best dynamotor for conversion to 6v. Multiline which offers conversion you choose of 100 or 350 v. at 50 MA or 250 v. at 100 MA. Complete dope sheet furnished. **\$4.65**

BRAND NEW (see "CQ" Aug. Issue)

MG-149F excellent condition \$89.50

MG-149H excellent condition 129.50

PE-206 Inverter, like new \$ 12.95

PE-218 Inverter, excellent condition 29.95

BC-640 \$795.00

BC-639 with RA 42 rectifier 295.00

RT 34 APS 13 Transceiver used as a tall warning radar on -117 MC. Containing a 30MC IF Strip and various other parts, these units have been stripped of RF sections and all tubes, but are an excellent buy if only for parts and IF Strip. used \$ 4.95

MIKES and HEADSETS: H5-33 Low Impedance Headset exc. \$2.95 new \$5.95

H5-23 Headset used 2.95 new 4.95

CQ-307 Ext. cord for H5-23-33 like new .79

Throat Mike—T-30 new .98

Lip Mike—Navy Type. new .98

CW-49505 High Impedance headset complete with headband Used **98c**

H5-33. New \$5.45

H5-23. New 4.45

T-45 Lip Mike. New 1.75

H5-30 miniature headset. Used \$1.49. new 2.49

MISCELLANEOUS EQUIPMENT

FL-8 used, exc. \$1.19 | BC-347 each. used 95c

BC-906 each 9.95

WANTED: All TS, APR, APS, ARC, ARN, SCR, R89 and BC equipment write today!

Quote lowest prices in your first letter

Hundreds of items in stock. WRITE FOR PRICES.

Shipments F.O.B. warehouse. 20% Deposit on orders. Sales tax to remittance.

MONTHLY SPECIAL!

RT7/APN-1 TRANSCIVER UNIT—Used as an altimeter. It may be converted for signaling circuits, etc. **\$4.95**

Used, less tubes, as is.

TRANSCIVER—140-144 mc, 2 meter, used, excellent condition, less dynamotor, less tubes. only \$17.95

BC-624 receiver (SCR 522), less tubes. used \$14.95

100-150MC

MN-20LB Receiver exc. 59.50

	AS 15	EXC.	
	LES	USED	NEW
BC-454	Receiver, 6 to 9 mc.	\$4.95	\$11.95
BC-456	Receiver.	2.95	9.95
BC-457	Modulator.	2.95	4.95
BC-457	Transmitter.		
BC-458	Transmitter.	4.95	
BC-459	Transmitter.	4.95	
BC-459	Transmitter.	7.95	14.95

Control Boxes, racks, receivers for above in stock—write.

BC-357—Exc. L/T \$5.95

BC-709—Inter. Amp. New. 3.95

SCR-625—Famous Army Mine-Detector. For Prospectors, Miners, Oil Companies, Plumbers, etc. This unit sold now at a considerable reduction in price. Recently advertised at \$79.50 it is now available in the same brand new wrappings in suitcase style carrying case (less batteries) **\$59.50**

WOBULATOR

BUILD TV-FM-AM SWEEP GENERATOR

You can build "Versatile Sweep Frequency Generator" with APN-1 magnetic units. \$ 8.95

BC-120B Beacon Receiver 200-400KC 9.95

TS-184/AP Test Set 39.50

APR-2 Radar Search Receiver. 85-1000MC 35.00

APR-4 Radar Search Receiver. 38-4000MC 399.00

TUNING Units—TN16, TN17, TN18 each 200.00

IF 19A-SCR222 Test Unit. Used 295.00

MG-153 Inverter Used, exc. 125.00

I-222-Signal Generator Like new 189.50

AN/APT5 Transmitter Like new 189.50

SELBYN TRANSMITTER: Autodyn Transmitter Assembly for matching to I-82 Indicator. Used, excellent condition

ONLY \$7.95, Complete with Indicator. \$14.95

RL-42 Reversible Motor with antenna reel and clutch. used \$ 2.95

BC-433 RADIO COMPASS RECEIVER, 200 to 1700 KC. used, excellent condition, with tubes 39.95

used, exc. less tubes. 14.95

used, as is, less tubes and cover, exc. for parts 8.95

BROADCAST BAND & AERO

Ideal for Use in Boats, etc.

MN-26-C Remote Controlled Navigational Direction finder and communications receiver. Manual DF in any one of three freq. bands, 150 to 1500 KC. 24 V. Self contained dynamotor supply. Complete installation, including receiver, control box, loop, azimuth control, left-right indicator, plugs, loop transmission line and flex shafts.

BRAND NEW \$89.50

LIKE NEW 69.50

MN-26-V 150 to 325 KC. 325 to 695 KC. 3.4 to 7 mcrcycles, comp. installation. 69.50

Receiver alone 39.95

MN-26-C alone, like new. 39.50

MN-26-C or MN-26-V as is less tubes. 13.95

With tubes. Used good. 24.95

MN-20-E Loop, Brand New. 6.95

MN-52 Crank drive, New. 2.50

AMERTRAN 0 to 130 V. Maximum amperage 100. Like New **\$135.00**

Minimum order \$5.00. Illinois residents, add regular sales tax to remittance. Prices subject to change without notice.

R W ELECTRONICS Dept. N, 1712-14 S. Michigan Ave., Chicago 16, Ill.
PHONE: HARRISON 7-5377

October, 1953

199

www.americanradiohistory.com

TV Sweep Generators
(Continued from page 46)

horizontal input terminal of the oscilloscope. The saw-tooth deflection voltage which is normally used in the scope is turned off and the 60-cycle sine-wave voltage from the generator is used instead to sweep the beam across the screen.

Now, why is this done? This is done because the frequencies being obtained from the sweep generator are varying back and forth across the band in a sinusoidal manner. Only by combining a sinusoidally deflected scanning beam with a sinusoidal sweep frequency variation can we obtain a response pattern in which the frequency is evenly spaced. This may sound somewhat complicated but it boils down to this: If we vary the sweep generator output one way, then to obtain a properly shaped pattern, the beam deflection in the scope should be similarly varied.

Suppose we don't do this. Suppose we forget to bring the extra 60-cycle voltage from the sweep generator to the scope. Then what? Then, instead of the single pattern shown in Fig. 4A, we obtain the double pattern shown in Fig. 6 with a 60-cycle sweep. It is possible to work with these two patterns if you appreciate how they were produced. But, unless you have a complete mastery of alignment techniques, it is best to stick to the more normal approach.

Now, it is possible to deflect the beam in the scope sinusoidally without making the above-mentioned connection between the sweep generator and the scope. However, in such instances, the scope must have two things: (1) a means of supplying its own 60-cycle sine voltage to its horizontal deflection system and (2) its own phase control. Under these conditions, we adjust the scope's phase control to obtain a single pattern. We disregard the sweep generator's phase control because its 60-cycle voltage is not being used. More and more oscilloscopes are incorporating their own 60-cycle sine wave deflection voltages and the corresponding phase control.

Blanking voltages and controls: A feature that is finding increasing use in sweep generators is the blanking circuit. This circuit, when turned on, injects a negative pulse into the sweep oscillator circuit in such a manner that oscillation is stopped for half the cycle. This has the effect of removing one of the two traces that is normally produced on the screen. Thus, the electron beam in the oscilloscope traces out the response curve of the

Fig. 6. Curves obtained when scope uses its own saw-tooth sweep instead of 60-cycle sine-wave deflection voltage of generator.

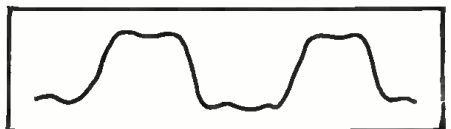

opportunities
AT
BELL TELEPHONE LABORATORIES

A career for you with one of the nation's leaders in research and development in communications and military electronics.

ELECTRIC TECHNICIANS DRAFTSMEN
ELECTROMECHANICAL TECHNICIANS

Openings require previous training at high school, armed service school, or technical institute level and in general 2 or more years of applicable industrial or military experience.

Applications particularly invited from those who reside within about 1000 miles of the Laboratories.

Send your name and address for application, telephone collect within 100 miles for information, or visit us Monday through Saturday. Evening interviews arranged.

BELL TELEPHONE LABORATORIES
WHIPPANY, N.J. (Near Morristown) WHIPPANY 8-1000, Ext. 326
MURRAY HILL, N.J. (Near Summit) SUMMIT 6-6000, Ext. 3381
NEW YORK, N.Y., 463 West Street, CHELSEA 3-1000, Ext. 1114

Unlimited Opportunities in
RADIO ENGINEERING

DEGREE IN 27 MONTHS

Complete Radio Engineering course, including Telev., U.H.F. and F.M. Bachelor of Science Degree also in Mech., Civil, Elect., Chem., and Aero. Eng.; Bus. Adm., Aect. Extensive campus, modern buildings, well equipped labs. Low cost. Prep courses. Personalized, practical instruction. Founded 1884. Placement service. Growing shortage of engineers. Prepare now for unlimited opportunities ahead. Approved for Korean vets. Enter September, January, March, June. Write for catalog.



TRI-STATE COLLEGE

16103 College Avenue, ANGOLA, INDIANA

Look, Old Radio Vibrators
Repaired
\$1.25 each

30 Day Guarantee

RADIO PRODUCTS SERVICE
P. O. Box 591 SPRINGFIELD, OHIO

ARKAY
world's finest radio kits
Write for free Brochure
RADIO KITS, INC., 120 Cedar St., N. Y. 6

Brand New
Set Mfr's
SURPLUS

TUBES

**STANDARD
BRAND
WARRANTY**

Bulk Packed in Original Mfr's Nested Cartons or Individually Boxed
Every tube meter and chassis tested for top quality... **BRANDED**

1B3GT54	6AC771	6BH649	6SN7GT .. .49	198G6G .. 1.19
1L450	6AH664	6BJ649	6T864	19T864
1R549	6AK564	6BL7GT .. .82	6V6GT41	25BQ6GT .. .82
15455	6AL537	6BQ6GT .. .79	6W4GT41	25L6GT41
15541	6AQ541	6BQ779	6W6GT31	35B549
1T449	6AG549	6BK771	6X5GT34	35C549
1U449	6AT634	6C434	12AT634	35L6GT45
1U541	6AU637	6C544	12AT760	35W432
1X2A55	6AV634	6C8B45	12AU637	35Z531
3Q5GT58	6B4G82	6CD6G ... 1.11	12AU749	50B549
35449	6BA641	6H641	12BA641	50C549
3V449	6BC549	6J5GT37	12BE641	50L6GT .. .45
5U4G37	6BE641	6J654	12BH756	
5Y3GT34	6BQ6G ... 1.19	6K6GT37	12SN7GT .. .49	

More than 400 types in stock, include all your needs when ordering.

Orders less than \$10.00—add \$1.00 service charge. Terms: 25% with order, balance C.O.D. All prices subject to change without notice. F.O.B. New York City, mail order division.

TRANSAMERICA ELECTRONICS CORP.

120 LIBERTY ST., NEW YORK 6, N. Y. | COrtlandt 7-4307

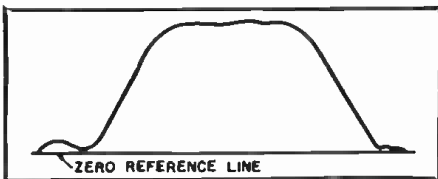

Fig. 7. A blanking circuit in a sweep generator produces a zero reference line on the screen of the service oscilloscope.

circuit under test on its first trip across the screen. On the return trip, the beam would normally trace back over the same curve. Actually this second tracing is not necessary since it provides the same information as the previous trace. Furthermore, there is generally sufficient unbalance existing in the circuit so that the second trace does not coincide at all points with the first trace, resulting in two curves at one or more points. Through the use of the blanking circuit in the sweep generator, the sweep voltage producing the second trace is eliminated.

Within the scope, however, the beam is not similarly blanked out and so it produces a zero voltage or reference line because during this period it is receiving nothing from the circuit under test. See Fig. 7. (The circuit, by the same token, is not putting out any voltage because it is receiving nothing from the sweep generator.) The presence of the base line aids the technician in evaluating the various values of the response curve and thereby tends to simplify and hasten the servicing and alignment process. The zero base line proves to be especially valuable for FM discriminator alignment since in this instance the linear portion of the S-response curve should extend for equal distances above and below the zero base line.

In most sweep generators containing blanking, there is simply an "on-off" switch whereby the blanking voltage may be brought into operation or turned off. In a few instruments, the amount of blanking voltage may be controlled, regulating the extent of the visible pattern on the screen. Usually no more blanking voltage than is necessary should be employed.

It is entirely possible that the oscilloscope may possess its own blanking circuit and generally, if one is employed, the one on the other instrument should not be. In the oscilloscope, the blanking control is usually a combined "on-off" switch and potentiometer. The switch brings the blanking voltage into the system while the potentiometer determines its phase. This control is necessary because in the oscilloscope the blanking circuit usually applies a sine wave to the control grid of the cathode-ray tube. This acts to intensify the trace during the positive portion of the applied sine wave and to reduce the intensity or blank out the trace entirely during the negative half cycle. With the aid of the phasing control, the applied sine wave (that the control grid of the cathode-ray tube receives) can

be shifted in phase until the undesired portion of the screen trace is blanked out. Without this phase control, it could happen that some or all of the desired portions of the response curve would be blanked out, leaving the undesired or unnecessary sections visible.

It should be noted that while the blanking controls in the sweep generator and in the oscilloscope perform essentially the same function, there is one difference between them as far as the visual pattern is concerned. That is, when the blanking circuit is turned on in the scope, one trace of a response pattern is eliminated but with no reference line produced instead. The reason, of course, stems from the fact that the blanking control voltage

here removes the second pattern by cutting off the CRT beam. When the blanking circuit in the sweep generator is used, the beam of the CRT is not cut off and so it is able to produce a base line.

Sweep phase reversal: On one or two sweep generators a sweep reversal switch has been incorporated. What it does is reverse the phase of the 60-cycle sine voltage that is sweeping the frequency of the generator back and forth. The purpose in providing such a switch is to permit the response curve to be presented with the low frequency section of the curve appearing at the left-hand side of the screen and the high-frequency section at the right-hand side. See Fig. 8B.

SEE LEO FIRST FOR . . .

hallicrafters

I can SAVE you money . . . Liberal Trade-ins



LEO I. MEYERSON
W6GFG

SEE US FIRST FOR THE NEW SX-88 RECEIVER . . . \$499.95



\$199.95

S-76 RECEIVER

Extra selectivity with double superheterodyne circuit. One RF, two conversion and 3 IF stages. Range 550-1550 Kc, 1.7-34 Mc in four bands. 8 tubes plus voltage regulator and rectifier. Complete with tubes, less speaker.



\$249.95

SX-71 RECEIVER

Double Conversion sharp selectivity, plus built-in NBFM at moderate cost. 11 tubes plus voltage regulator and rectifier. Low down payment.

NAME YOUR TERMS • LOW DOWN PAYMENTS • PERSONALIZED SERVICE

HALLICRAFTERS RECEIVERS AVAILABLE FOR IMMEDIATE SHIPMENT

S-81	\$59.95	S-40B	\$129.95	ST-83	\$129.95
S-82	\$59.95	S-53A	\$ 99.95	S-78A	\$ 89.50
A-84	\$99.50	S-72L	\$119.95	SX-62	\$349.95
S-38C	\$59.95	S-77A	\$129.95	S-72 Portable	\$109.95
R-46 Speaker	\$24.95	HT-20 XMTR	\$449.50		

JUST OFF THE PRESS!

Big New WRL 1954 Catalog

Offering the greatest selection of radio & television equipment, parts, and supplies, from "The World's Largest Distributor of Amateur Radio Transmitting Equipment." Order with confidence from WRL—the world's most personalized radio supply house.



Send for **FREE** Copy

WRITE—WIRE
PHONE 7795

WORLD RADIO LABORATORIES
764 West Broadway
Council Bluffs, Iowa

R-10

Please send me:

- Radio Map 25¢
- New Catalog
- Used Equipment List
- WRL XMTR Info
- SX-71 Info
- S-76 Info
- New Log Book

Name

Address

City

State



WHEN YOU ORDER WELLS COMPONENTS...

HERE'S WHAT
YOU GET



- ☑ IMMEDIATE DELIVERY FROM STOCK
(in any quantity)
- ☑ FINEST QUALITY OF FAMOUS BRANDS
- ☑ GENERALLY LOWER PRICES
- ☑ RETURN PRIVILEGE FOR FULL
CREDIT IF NOT SUITED TO YOUR
REQUIREMENTS

The valuable service Wells provides to the industry is being used by many of our greatest manufacturers as a matter of course.

Our vast stock (the world's largest) may contain just the components you need to fill urgent orders — at a substantial savings in time and cost.

ADEL CLAMPS • ANTENNAS, Insulators, Mast Sections • BINDING POSTS • BLOWERS • CABLE ASSEMBLIES • CHOKES • COILS • CONDENSERS Oil Filled, Bathub, Hearing Aid, Transmitting Micas, Silver Micas, Ceramic, Variable, Trimmer • CRYSTALS • FILTERS • FUSES & MOUNTINGS • GENERATORS • GROUND RODS • HEADSETS • I.F. COILS • JACKS • JACK BOXES • KEYS, Telegraph KNOBS • LAMPS • LORD MOUNTS • LUGS MOTORS & BRUSHES • PLUGS • RECTIFIERS Selenium, Copper Oxide, Meter, Diode • RESISTORS—All Types • SELSYNS • SOCKETS • SWITCHES Aircraft, Micro, Switchettes, Toggle • TIMERS • TUBING—Flexible • TUNING SHAFTS • TRANSFORMERS All Types • VIBRATORS • WALKIE TALKIES

DYNAMOTORS



OVER 100,000
NEW DYNAMOTORS
IN STOCK!

DM 32A — DM 53A — PE 86 — PE 101C
DM 33A — D 101 — PE 94, etc.
Large quantities of brushes for all
types of dynamotors and motors.

Write us for quotations. Advise us
your requirements.

A complete Signal Corps stock number listing of items in our stock. Write for listing No. 5G-200. (For government agencies and contractors only.)

Manufacturers and distributors—write for new Condenser Catalog C-10 now available.

Write, Wire, Phone Your Requirements
all phones: **SEeley 8-4143**

WELLS SALES, INC.

833 W. Chicago Ave., Dept. R, Chicago 22, Illinois

202

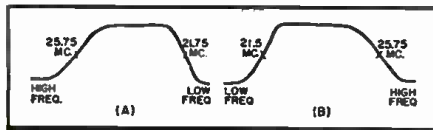

Fig. 8. A sweep phase reversal switch can reverse pattern obtained on screen. See text.

It can happen, because of the manner in which the test equipment is designed, that the response curve obtained on the screen will have the high-frequency section on the left and the low-frequency portion on the right. See Fig. 8A. There is, of course, nothing wrong with this pattern and it may be used during an alignment job. However, response curves are ordinarily shown in textbooks with the low-frequencies at the left and being able to switch a pattern from the form of Fig. 8A to that of Fig. 8B may be helpful to the technician. This is the purpose of the phase reversal switch or control.

It may sound repetitious to note that some scopes possess the same facility, here, too, with the purpose of assisting the technician. Whether or not the technician avails himself of this convenience, when it is present, is purely a matter of personal preference. Some men do not mind working with a reversed pattern; others find it helpful to set the curve up in its more traditional form.

It is interesting to note that if you have an oscilloscope which can supply its own 60-cycle sine-wave deflection voltage, you can reverse the phase of a response pattern *without* a special phase reversal switch. Here is how this is done. Set up the instruments for the alignment but have the scope provide its own 60-cycle sine-wave deflection voltage. Then observe the response pattern on the scope screen and if it is reversed, simply reverse the scope's power plug in the line socket. This will turn the pattern around to the desired form.

Sweep generators with internal variable markers: Sweep generators must always be used with two other instruments: an oscilloscope, of which we have already spoken, and an AM signal (or marker) generator. The scope is needed to present visually the shape of the response curve. Because of the dependence of the sweep generator on the marker generator, the two are often combined. In some instruments, the marker generator is definitely an auxiliary unit, serving simply to provide identification signals in the i.f. range. This, for example, is true of the *Hickok Model 610A* where the marker range is from 19 to 48 mc. In other instruments, the marker generator is a full-fledged partner, being similar to any of the separately contained r.f. television signal generators available on the market. In this category fall the *Jackson, Simpson, Triplett*, and *Philco* instruments. In each instance the AM generator can independently supply r.f. signals ranging from three or four megacycles up to 250 mc. (216 mc. in one instance).

This enables these marker generators to develop signals that will cover all of the FM and v.h.f. television i.f. and r.f. ranges.

The advantage of incorporating the marker and sweep generators in one cabinet is, of course, greater ease in combining the marker voltage with the sweep signal. With the instruments merged, we do away with any connecting wires between them. Combination of the two signals is accomplished automatically while the strength of each signal can be independently adjusted for best results. Of course, placing two generators in one cabinet means that you pay for both, although the increased cost is seldom as much as it would be if each generator were packaged individually.

Some manufacturers prefer to keep their marker generators separate from the sweep generator, feeling that this unit is an instrument in its own right. The separate packaging, too, enables the manufacturer to enlarge the scope of the marker generator's applications, something which is generally not feasible when this unit is combined with the sweep generator. Thus, *RCA* in its marker generator has such extra features as a heterodyne frequency meter with amplifier and speaker, a bar-pattern generator for making linearity adjustments, and a dual-crystal standard with three crystals supplied.

So the instrument you choose depends upon the extent of your funds and how much you feel the unit should be able to perform.

Sweep Generator Application

The successful application of any test instrument is a twofold affair. First, the controls must be properly set in accordance with the use to which the instrument is to be put. Second, the proper connections must be made between the unit and the test point. In the case of the sweep generator, the second step is frequently the more difficult one. A man may be perfectly able to tell you what each control does and yet get weird patterns on the scope screen (if, indeed, he gets any at all) when the instruments are set up.

In view of this difficulty, let us proceed, step-by-step, through an actual sweep alignment of the video i.f. system of a television receiver. First the receiver is set up on its side on the bench so that the various i.f. adjustments are accessible. Next, an oscilloscope is placed beside the receiver and a lead is run from the video second detector load resistor, through a 10,000-ohm isolating resistor, to the vertical input terminal of the oscilloscope. Also, the ground post of the scope is connected to the chassis of the receiver. See Fig. 5.

(Here is the first point where trouble can be encountered. Make certain the connection is made to the load resistor of the video second detector. It is generally not advisable to

go into the video amplifier system for your connection because in many sets, the response to 60 cycles is only fair. Since the response curve has a 60-cycle repetition rate, a poor response to this frequency can seriously affect the shape, i.e., the tilt of the curve.)

The sweep generator is brought in next. Connection is made from the generator output to the grid of the mixer stage. In the widely-used *Standard Coil* tuner, for example, there is a special terminal available to which such connection can be readily made. In other tuners it may be necessary to make contact directly with the mixer grid terminal on the tube socket. If this point is difficult to reach, an alternative method is to lift the shield on the mixer tube and connect the sweep generator signal lead to it. By tilting the shield sideways slightly it can be made to rest on the glass of the tube. If this is done carefully, the shield will be supported by the tube envelope and hence prevented from contacting the chassis and grounding the signal.

To complete the generator connection to the set, a wire is run from the ground terminal of the instrument to the receiver chassis.

The next step is to bring some of the generator's sweeping voltage to the horizontal input terminals of the oscilloscope. The thing to watch out for here is the proper setting of the scope controls. Just making the interconnection between the two instruments is not enough, for unless the scope is set up to receive this deflection voltage, the beam will continue to be driven by the saw-tooth voltage developed internally by the scope. So here is another possible trouble point.

Before the equipment is placed in operation, the receiver oscillator must be disabled to keep it from feeding any voltage to the mixer during the alignment period. Without doubt, this has caused more confusion than any other single item.

We are almost ready to go, but one more preparatory step remains. The setting of the bias on those stages that are a.g.c. controlled. Most manufacturers recommend a value of -3 volts and this can be obtained from a separate bias supply or from a couple of flashlight batteries.

The power is now turned on and the equipment is permitted to warm up. Set the sweep generator to the mid value of the frequency range to be covered; adjust the sweep width control to a value of from 5 to 8 mc. (for a video i.f. system). Generator output is initially turned to its maximum position. On the scope screen, some sort of indication should be observed. Initially, this will most likely be a double pattern, of the type shown in Fig. 4B. Adjust the phase control until a single pattern is obtained. If blanking of the second trace is desired, now is the time to do it. Make sure the signal is not overloading the video i.f. stages; this can be checked by the following simple test. Rotate

the output control on the sweep generator. If the video system is not being driven too hard, the amplitude of the curve will vary in step with the rotation of the output control.

The final step in this alignment setup is the introduction of the marker signal. However, never take this step until the response curve itself has been obtained. In this way, swamping of the response curve (which can readily occur) will be immediately apparent. Also, by following the foregoing sequence, the number of different variable factors that you have to deal with at one time is reduced, thereby lessening the number of possible sources of trouble. A slow, methodical approach is always the fastest way

to carry out a sweep alignment, especially when the equipment is not completely familiar to you.

The foregoing discussion, of necessity, was kept brief. However, the most important obstacles were pointed out and if the proper precautions are observed, no major difficulty should be encountered. Remember: Never do too many things at one time; introduce each step in turn and you will seldom find yourself lost.

From the points outlined in this article it is easy to see why the television sweep generator is such a valuable adjunct to the test bench equipment for the technician. Its proper use can speed service jobs and result in a more profitable operation. —50—

Best TV Buy You've Ever Seen!

NORTH AMERICAN
PHILIPS
COMPANY, INC.



235 SQUARE INCH PICTURE BIGGER·SHARPER·RICHER!

NEW Norelco TELEVISION

- BIGGER than a 17-inch Tube!
- BIGGER than a 19 or 20-inch!
- ★ Yes—It's Equal to a 22½-inch Tube!

The new NORELCO television receivers give you pictures that are life-like in size and quality, free of glaring whites, rich with velvety blacks and soft grays. Eye-strain free picture.

On NORELCO television receivers you see the whole picture, just as the TV camera sees it. Nothing is cut away. Movie-screen type picture.

With a NORELCO television receiver you enjoy such features as:

TRULY LIFE SIZE PICTURE • AUTOMATIC BEAM SUPPRESSOR • FLAT VIEWING SCREEN • FULL FOCUS • BUILT-IN ANTENNA • HIGH-FIDELITY SOUND SYSTEM • AUTOMATIC GAIN CONTROL • NEW IMPROVED PROTELGRAM (ADVANCED SCHMIDT) BIG-PICTURE SYSTEM DEVELOPED BY PHILIPS, WORLD FAMOUS ELECTRONICS LEADER • 23 TUBES PLUS 1 GERMANIUM DIODE • STANDARD TOP QUALITY COMPONENTS, INCLUDING "STANDARD COIL" TUNER • EXCELLENT UHF RECEPTION WITH CONVERTER • FULL SIZE CONSOLE—40½" HIGH, 25" WIDE, 21" DEEP • SHIPPING WT.: 124 LBS.

NORELCO'S new, superior TV receivers are engineered for those who demand only the very best!

Write for FREE illustrated, full-color brochure. Send \$1.00 for COMPLETE TECHNICAL MANUAL (Credited against order), or return manual to us and we will refund your dollar. No obligation of course.

LIMITED QUANTITIES AVAILABLE—ORDER NOW!

TERMS: F.O.B. N.Y.C. Full remittance with order or 25% —Balance C.O.D. Due to this special low price offer, we cannot allow refunds.



"The Irvington"—MODEL PT 200—Superb open front, mahogany console cabinet.

GUARANTEED BRAND NEW!

SHIPPED IN ORIGINAL FACTORY SEALED CONTAINER
Our Price, Only **\$179⁵⁰** Complete

Original List Price\$399.95
(ATTRACTIVE DEALER DISCOUNTS)

ELECTRONIC SPECIALTY SUPPLY CO.
58 Walker Street, New York 13, New York

This book will save you
30 Minutes
 a day



ONLY 35¢

- COMPLETELY NEW
- FIRST EDITION
- JUST OFF THE PRESS

FIND TUBE RATINGS, CONNECTIONS IN SECONDS

This big new Westinghouse *Ready-Guide* is a completely new kind of handbook of receiving tube data. Designed to save time for busy servicemen and engineers. Eliminates "squinting" at tiny data listings.

BIG — BOLD — CLEAR

Just 9 tube types are listed on each 8½" x 11" page. Not 30 or 40 tiny type listings as in most condensed data books. Best of all, large clear base diagrams are located on the same page as ratings. Bothersome cross referencing, footnotes cut to the bone.

COMPLETE, ACCURATE, UP-TO-DATE

This new Westinghouse *Ready-Guide* lists complete data on receiving tubes which account for more than 98% of tube usage. 48 pages. 385 pictures and diagrams. 342 types listed.

SPECIAL: 3 for \$1.00

This *Ready-Guide* is being sold at less than cost as an introductory offer only. Price is only 35¢—3 for \$1.00. Order from your nearest RELIATRON Tube Distributor or mail coupon below.

ET-95038



Westinghouse Electric Corporation
 Electronic Tube Division, Dept. G-210
 Box 284, Elmira, N. Y.

..... Enclosed is \$1.00 for 3 copies of
Ready-Guide
 Enclosed is 35¢ for 1 copy

NAME.....
 ADDRESS.....
 CITY.....STATE.....
 Please Print

NEW TV PRODUCTS on the Market.....

REPLACEMENT PARTS

The *Standard Division of Chicago Standard Transformer Corporation*, Addison and Elston Avenues in Chicago, has released five new TV replacement components in the *Stancor* line.

The new components include an exact replacement flyback transformer,

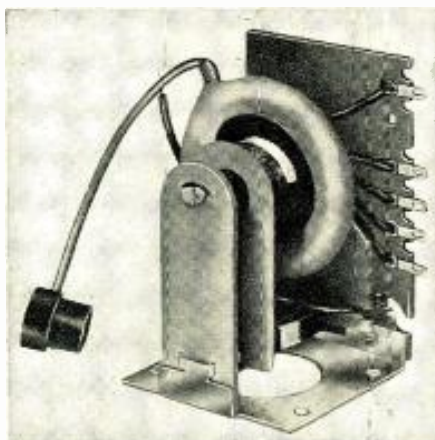

A-8137, duplicate of the *Hoffman* #5035 used in 25 *Hoffman* models and chassis; and the A-8126, universal *Philco* replacement vertical blocking oscillator transformer. The A-8126 can be used in all *Philco* TV models and chassis built up to the spring of 1953.

Two width controls, WC-1 and WC-4, and a tapped linearity coil, WC-2, have also been added.

Bulletin #468 listing specifications and replacement information on these units is available from *Stancor* distributors or from the company direct.

NEW TV ANTENNAS

General Antenna Mfg. Co., 1652 Rockwell Ave., Cleveland 14, Ohio is now offering a new u.h.f. antenna which is said to be effective up to 50 miles, depending on local conditions. The 500-U is described as covering all u.h.f. stations, having low vertical radiation angle, low standing-wave ratio, and 300-ohm terminal impedance. The antenna is all aluminum and heavily constructed.

Television Hardware Mfg. Co., 919 Taylor Avenue, Rockford, Ill. is now introducing an indoor u.h.f. antenna which performs well when within range of the TV station or where an indoor antenna is practical for u.h.f. reception. This "UHF Butterfly" is designed to be placed on top of the set for use on any channel from 14 to 83.

Trio Manufacturing Company, Griggsville, Ill. has made a radical improvement in its line of "Zig-Zag" antennas which boosts performance on every channel. The improvement is accomplished by the use of a new re-

entrant network which provides an almost perfect impedance match to the line on every channel. Current shipments of these antennas will include the re-entrant network and a phasing harness for use when stacking two models for all-channel, single feed-line operation.

Wells & Winegard, Burlington, Iowa has introduced the Model CP-1 "Clipper" to its line. The "Clipper," a high-gain fringe area unit engineered for complete coverage of all v.h.f. channels, offers high uniform gain, 300-ohm match, one major forward lobe, a narrow beam to reduce ghosts and noise pickup, and high signal-to-noise ratio. Details are available from the manufacturer.

PORTABLE TOWER

A new portable tower of aluminum alloy is currently being marketed for u.h.f. communications applications by *Up-Right, Inc.* of 1013 Pardee, Berkeley, California.

The tower is built by setting individual sections one on top of the other. Of patented one-piece construction, each folding section is assembled without tools. Innovations in the guying systems eliminate the use of turnbuckles, cable clips, and other guy hardware. The base may be rapidly leveled on a simple foundation.

Portable towers up to 300 feet in height are available from the company. Full details may be obtained on request.

NEW G-E TUBE

The Tube Department of *General Electric Company*, Schenectady 5, New York is offering a new, 24-inch aluminized glass rectangular television picture tube which is shorter



than most 21-inch glass rectangular tubes available today.

The Type 24CP4-A has a deflection angle of 90 degrees, a major factor in making it shorter than standard 21-

inch tubes of the same type. It measures only 21 1/4 inches over-all.

The tube's aluminized screen is said to increase light output and picture contrast. It also incorporates a high-quality gray faceplate to improve picture detail under high ambient light conditions. The tube operates with magnetic focus and deflection and incorporates an external conductive coating which is used as a filter condenser when grounded.

Recommended operating conditions include an anode voltage of 16,000 volts, a grid 2 voltage of 300 volts, a grid 1 voltage of from -33 to -77 volts, a focusing coil current of 119 ma., and an ion trap intensity of 40 gausses.

The company will supply further details on request.

TUBE "BRITENER"

Perma-Power Company, 4727 North Damen Ave., Chicago 25, Ill. is marketing a new tube "Britener" for use



with television tubes having either parallel-wired or series-wired heaters.

The unit relieves cathode heater short problems, its isolating type transformer giving normal 6.3 volts to the heater to relieve the cathode short problems or 7.8 volts to increase cathode emission and restore lost brightness. A simple switch allows selection of the correct voltage.

Illustrated literature on the "Universal TV Tube Britener" is available on request.

TV BOOSTERS

Grayburne Manufacturing Co., Inc. of 4-6 Radford Place, Yonkers, New York is now offering a new i.f. signal booster for u.h.f. and v.h.f., the Model TSB-1.

The unit, now available at parts distributors, provides an extra stage of i.f. to amplify both u.h.f. and v.h.f. signals without switching. The booster, which is supplied in adapter form, is installed in an existing tube socket and requires but one wire connection to ground.

TESTING YOKE

A new magnetic deflection yoke which cuts production time in testing cathode-ray tubes is now available from Syntronic Instruments, Inc., 100 Industrial Road, Addison, Illinois.

According to the company, from 150,000 to 250,000 tubes may be continuously tested without yoke damage or failure. The yoke is unconditionally guaranteed for one year.

Damage to the yoke from the tube's

MONEY-SAVING OFFER

ON THE LATEST AND GREATEST GHIRARDI TV-RADIO SERVICE TRAINING BOOKS

... only \$12 for the 2-book set

10-day FREE examination ... 4 months to pay

Radio-TV CIRCUITRY AND OPERATION

by Ghirardi and Johnson

688 pages, 417 clear illustrations

Price \$6.50 separately

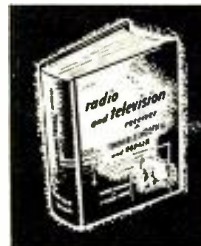

Radio-TV TROUBLESHOOTING AND REPAIR

by Ghirardi and Johnson

820 big pages, 419 clear illustrations

Price \$6.75 separately

Complete training for FASTER, BETTER SERVICE on any TV or radio ever made!

Ideal for beginners ... a gold mine of time-saving methods for experienced service men

LEARN CIRCUITS FULLY ... and watch service "headaches" disappear!

It's a whale of a lot easier to repair ANY television or radio receiver when you know all about its circuits and how and why they work. You locate troubles faster. You work more efficiently. What's more, the basic training you get from Ghirardi's TV & Radio Receiver CIRCUITRY AND OPERATION book is just the thing to fit you for dozens of other TV-radio-electronic jobs.

Actually, it's simpler than you may think. There are only a few BASIC circuits used in modern equipment—but each of these has many variations. You learn to know and recognize them instantly. You learn to locate troubles faster and with less testing.

MAKES THE TOUGH JOBS EASY!

Here's what this great book on modern circuits covers: 1-Amplitude Modulation; 2-Frequency Modulation; 3-RF Amplifiers and TRF Receivers; 4-AM Superhets; 5-AM Detectors and AVC Systems; 6-Push-button Tuning and AFC Systems; 7-AF Amplifiers; 8-Loudspeakers; 9-Radio Power Supplies; 10-Television Receivers; 11-Phone Pickups and Record Players; 12-Automatic Record Changers; 13-Mechanical Construction of Receivers; etc.

Summaries at the ends of every chapter help you locate the data you want in a jiffy. 417 clear illustrations help make circuits easy to learn.

See for yourself how much this great book can help you—in dozens of ways! Use coupon for 10-day FREE examination.



You can't go wrong

... on a Ghirardi training book! For years, Ghirardi books have been more widely used in schools, for military training and home study than any others of their kind ... because they make things so amazingly easy to understand. The two new books described above are this famous author's very latest—up-to-the-minute in every respect!

THE HOW-TO-DO-IT GUIDE to modern service methods

For beginners, Ghirardi's NEW 820-page Radio & TV TROUBLESHOOTING AND REPAIR book makes all parts of the work amazingly easy to understand. For experienced servicemen it is the ideal way to "brush up" on specific types of work; to find fast answers to specific problems; or to develop better, faster and more profitable troubleshooting methods.

Modern test methods are fully explained. From quick, visual analyses of common troubles, you proceed to learn all about "static" tests and "dynamic" signal tracing and signal injection techniques. Special problems in hard-to-fix sets are greatly simplified. Step-by-step charts explain PROFESSIONAL service procedures almost at a glance.

Throughout, Ghirardi's TROUBLESHOOTING AND REPAIR is a book that paves your way to better-paying service jobs! Receiver alignment is made easier than you might have thought possible. Tuning problems, speaker troubles, components and dozens of other subjects are covered fully AND CLEARLY.

Every step of television repair work is simplified to the utmost degree! You learn to analyze TV picture patterns accurately, to locate troubles faster—even fading and tracing down "intermittents." Handy summaries with every chapter make the book invaluable for reference whenever you are "stumped" by a job.

See for yourself! Use coupon today for 10-day FREE examination of this newest Ghirardi book!

10-DAY EXAMINATION OFFER

Dept. RN-103, Rinehart Books, Inc., Technical Division, 232 Madison Ave., New York 16, N. Y.

Send books indicated for 10-day FREE examination. In 10 days, I will either send you price indicated or return books postpaid and owe nothing.

Radio & TV Receiver CIRCUITRY and OPERATION Price \$6.50 Radio & TV Receiver TROUBLESHOOTING and REPAIR Price \$6.75

SPECIAL COMBINATION OFFER ... SAVE \$1.25! Both books only \$12 for the two. Regular price \$13.25—you save \$1.25!

Combination offer payable at rate of \$3 after 10 days if you decide to keep books, and \$3 per month thereafter until total of \$12 has been paid.

Name

Address

City..... Zone..... State.....

(OUTSIDE U.S.A.—\$1.25 for TROUBLESHOOTING & REPAIR; \$7.00 for CIRCUITRY & OPERATION; \$13.00 for both books. Send cash with order. Money refunded if you return books in 10 days.)

FACTS YOU SHOULD KNOW ABOUT UHF CONVERTERS

Many converters on the market today are unsatisfactory in fringe and shadow areas where signal strength is low. Before you install a UHF converter in these areas you should know these facts:

- 1 Signal power loss in the preselector seriously affects picture quality. Most UHF converters use sliding-contact shorted line tuners in the preselector with a fixed power loss of 6 db. The Turner converter uses High Q coaxial cavity tuners with no sliding contacts. Signal power loss is cut to 3 db. The resulting low noise figure keeps picture quality high.
- 2 Oscillator radiation often causes disturbing interference with neighboring sets. In the Turner converter the oscillator tube socket and all associated circuits are inside the coaxial cavity, self-shielded. Removable covers provide a second shield against radiation.
- 3 High amplifier noise figure can further damage picture quality. The Turner converter uses a special broadband amplifier with Cascode circuit. It retains the preselector signal savings without appreciably increasing the noise figure. The Turner amplifier noise figure is only 4 db.

Whether you're selling converters for installations in shadow or fringe areas or putting one in your own home, remember . . . the Turner converter often means the difference between good reception and bad.

EXCLUSIVE TURNER FEATURES

- Higher sensitivity
- Extremely low noise figure
- Exceptional frequency stability
- Double shielding
- Hi-Q silver plated coaxial cavities
- No sliding contacts

OTHER MAJOR TURNER FEATURES

Continuous single-knob tuning. Illuminated slide-rule dial. Smaller size: 8"x6"x6". Use with UHF or combination antennas. Self powered, uses channels 5 or 6. Complete installation instructions for 110-120 volts 50-60 cycles AC. Schematic included.



List price \$49.50

In VHF fringe and shadow areas, the Turner Booster is a superior performer, too.

THE TURNER COMPANY

900 17th St., N.E., Cedar Rapids, Iowa
Export: Ad Auriamo, Inc.,
89 Broad St., New York 4, N. Y.
Canada: Canadian Marconi Co.,
Toronto, Ont. & Branches

prongs is prevented by the smooth, heavy-walled bakelite lining in the yoke's center and by the stainless steel funnel. Loading is made easier by a special funnel design and the ample internal neck diameter. Tubes slide in and out quickly and easily for continuous testing.

The company will supply full details to interested manufacturers.

DAMPER DIODE

A completely new damper diode, 6AU4GT, designed for use with large screen 90 degree deflection picture tubes is in production at *Tung-Sol Electric Inc.*, 95 Eighth Ave., Newark 4, N. J.

The wider deflection angles and the increased second anode voltage required to maintain picture brightness call for higher deflection power and increased circuit efficiency. The 175 ma. rating of the *Tung-Sol*-designed and developed 6AU4GT is more than adequate, with ample safety factor, for these new designs.

Complete technical data is available from the company on request.

PLASTIC SPRAY

Acrolite International, Dept. T-3, Hillside, New Jersey, has released a new plastic protective coating for radio and television service work.

This heavy-duty acrylic plastic is compounded to insulate, waterproof, and stop rust and tarnish. The coating is packaged in a spray bottle. A press of the button and the spray may be applied directly to the part to be treated.

Free literature on additional uses for this product will be sent by the company on request.

U.H.F. CONVERTER

A low-cost u.h.f. all-channel television converter, the "Star," is now being offered to the trade by *Granco Products, Inc.* of 36-17 20th Avenue, Long Island City 5, New York.

The unit incorporates coaxial tuned cavity elements to insure low noise, high gain, and good frequency stability. The converter is simple to install and requires no i.f. adjustments. A selector switch turns the TV set on and



off and provides instant changeover between u.h.f. and v.h.f.

The converter is housed in a mahogany plastic cabinet. It uses a 6AF4 oscillator tube, a 6CB6 i.f. amplifier

STAN-BURN E-P-A-R-K-E

CATHODE RAY TUBE SPECIALS			
One Year Guarantee			
G. E.		STAN-BURN	
*5TP4	\$44.95	*10BP4	\$11.00
*71P4	17.10	*12LP4	14.20
*10BP4A	19.25	*14CP4	17.00
*10FP4A	24.00	*15DP4	19.50
*12KP4A	27.10	*16AP4	21.60
*12LP4A	21.70	*16FP4	19.60
*12UP4B	28.25	*16GP4	21.60
*14CP4	24.50	*16HP4	22.60
*16AP4A	30.95	*16DP/HP4	19.60
*16DP4A	28.20	*16DP/HP4A	20.60
*16GP4	31.25	*16KP4	18.50
*16KP4/16RP4	28.20	*16LP4	20.60
*17BP4A	23.90	*16LP4A	21.60
*17CP4	23.90	*17BP4	18.50
*19AP4A	39.45	*17CP4	21.60
*20CP4	32.50	*19AP4	23.90
*20LP4	37.50	*19AP4A	25.90
*21EP4A	37.35	*20CP4	29.50
*24AP4A	78.50	*21EP4	32.50

ANTENNE SPECIALS			
*RED DOUBLE HV" Antenna	1-5	6 or more	
*10 ELEMENT CONICAL	\$2.19	\$1.98	
*DOWELED INSERTS	2.98	2.79	
*Folded Hi Straight Low Quick Rig			
element	4.25	3.25	
*WINDOW CONICALS	4.95	3.75	
*5 FOOT SWEGED MASTS	1.79	.69	
*10 FOOT PLAIN	1.39	1.29	
*NEPCO MASTS	1.69	1.49	
*42 Mil.		\$ 9.95 M Ft.	
*55 Mil. 300 OHM		11.95 M Ft.	
*72 OHM COAXIAL		35.00 M Ft.	
*12" Heavy Slug Speaker		Special \$3.98	
*CHASSIS 630 REGAL with Cascode Tuner	\$149.50		
*OPEN FACE CABINET	42.00		

WIRE RECORDERS IN STOCK			
*PENTRON - Model 9T3C - 2-speed Tape Re-corder			Write for Price.
*RADIO CRAFTSMAN			
Model C400 - Hi-Fi Amplifier	Net	42.90	
Model C10 - AM-FM Tuner	Net	131.50	
Model C500 - Williamson Amplifier	Net	99.50	
*We also carry MASCO-BOGEN-PILOT, etc., Amplifiers, Pre-Amps, FM Tuners and WEBSTER Tape Recorders.			
*6x9 PM Speaker	\$ 3.98	630 Vert. output	1.29
*7" PM Speaker	3.98	potted	1.29
*7J1 G.E. Flyback	1.98	630 Vert. Blocking	.89
*70° Yoke	1.98	OSC. Xform	1.95
*630 Vert. output		Cascode Tuners	17.95
upright	1.98	Dumont 21.25 mc.	14.95

AUTHORIZED DISTRIBUTORS for General Electric, Kenrad, Tung-Sol, National Union, De Wald, Regal, Automatic and General Motors.

Automatic Custom-Built Radios for Plymouth, Ford, Chevrolet and many others, always in stock.

We carry a Complete line of HI-FIDELITY and sound equipment. Send us your requests.

We also carry a complete line of popular makes of Radio Tubes at 50/10 discount. Also many other special transmitters and transmitting types, and all electronic parts and equipment at lowest prices. Send us a list of your requirements for prompt quotations.

Terms: 20% with order. Balance C.O.D. All prices F.O.B. NEW YORK Warehouse. Minimum order \$5.00. Write for our latest price list and Hi-Fi catalog to Dept. RN-10.

STAN-BURN RADIO and ELECTRONICS CO.

(C.B.S. THEATRE BLDG.)
1697 BROADWAY • NEW YORK 19, N.Y.

THE NEW TV DYNATRACER

\$495

ppd.
or C.O.D.
+ Chgs.

TRACES TV SIGNALS and VOLTAGES

LOCATES DEFECTIVE COMPONENTS INSTANTLY

REQUIRES NO ADDITIONAL EQUIPMENT

Makes Television Servicing Easier, Faster and More Accurate — AT LOW COST



Ideal for trouble-shooting television in the field or on the bench. Used under actual operating conditions, will out-perform more expensive testers.

A MUST FOR EVERY ALERT TV TECHNICIAN!

SPECIFICATIONS: The "DYNATRACER" is a self-powered quality instrument designed to trace TV signals through any Video, Sound, Sync, AFC or VERTICAL AND HORIZONTAL Sweep Circuit—will isolate trouble to a stage or component.

ADDED FEATURE: The "DYNATRACER" will also trace voltages and instantly locate open, shorted or intermittent condensers, resistors, coils, speakers, transformers, etc.

COMPLETE INSTRUCTION BOOK ENCLOSED

10-DAY MONEY BACK GUARANTEE

Clip adv., write name and address in margin, attach \$5.00 Bill, Check or M.O. and mail to

Century ELECTRONICS CO.

8509-21st Ave., Dept. 205, Brooklyn 14, N. Y.

tube, and a crystal mixer. It is shipped ready to install and operate at 117-120 volts, 60 cycles a.c.

WALSCO U.H.F. CONVERTER

Walasco Electronics Corporation, Los Angeles 18, California is now in production on a new u.h.f. converter for which the company claims outstanding performance.

The new unit, which has been trademarked the "Imperial," features an exclusive new turret-type bandspread unit with a double-tuned preselector.



This "Turrettune" feature provides a constant LC ratio.

The "Imperial" covers the entire u.h.f. frequency spectrum from 450 to 900 mc. It has perfect tracking on more than eight points for maximum gain and lowest noise figure. A "balanced line" oscillator keeps frequency drift to a minimum. Input antenna terminals are provided for separate u.h.f. and v.h.f. antennas but can be used with combination antennas.

COAX TUNED ELEMENTS

Granco Products, Inc., 36-17 20th Avenue, Long Island City, 5, New York now has available two types of u.h.f. coaxial tuned elements.

The Model UHO is an oscillator element with a built-in 6AF4 tube. The Model UHR is a preselector element. Both models incorporate resonant cavity tuning which features a moving plunger permitting coverage of the entire u.h.f. television band. All elements are completely wired and tested.

CR TUBE ADAPTER

Superelex Electronic Corporation, 23 Atherton Street, Yonkers, N. Y., is currently marketing a picture-tube adapter that can be used with any make of tube tester and all picture tubes.

One end of the adapter plugs into the tube tester and the other end plugs into the picture tube without removing the tube from the cabinet. Any tube, electrostatic or magnetic from 10" to 30", can be checked for cathode emission, shorts, etc.

PORTABLE ANTENNA

Snyder Manufacturing Company of Philadelphia 40, Pa., is currently marketing a new portable television antenna for u.h.f. and v.h.f. reception.

Trademarked the "3D," the new antenna covers all channels from 2 to 83 and affords maximum adjustments to

take advantage of weaker-than-normal indoor signals. With two 3-section, gold tone brass staffs, the antenna features the company's "Directronic" 6-position beam selector which uses a new criss-cross phasing element in a variety of circuit arrangements. This helps to provide proper impedance matching, orientation, and ghost elimination.

A catalogue describing this and other antennas in the company's line is available from the firm on request.

24-INCH PICTURE TUBE

National Union Radio Corporation, Hatboro, Pennsylvania is in production on a 24-inch rectangular picture tube, the Type 24C/VP4.

The new tube is magnetically deflected and magnetically focused and employs a tinted gray faceplate. Minimum over-all length is achieved through the use of a 90 degree deflection angle. Picture size is approximately 17 1/4" x 21 3/4". The tube is rated for operation with second anode potentials up to 18 kv. Typical operation calls for 300 volts on G2 and 17 kilovolts on the second anode.

TVI ANALYZER

A TVI analyzer, which has been designed to identify interference signals to speed servicing, is now in production at Tele-Matic Industries, Inc., 1 Joralemon Street, Brooklyn 1, New York.

Only ROHN TOWERS

ARE PROVED IN CONSTRUCTION, DESIGN, USE & SALES

3 standard self-supporting ROHN steel towers for your every need!

Famous ROHN FOLD-OVER TOWER
(Pat. Pending)

Fold-Over Tower uses standard tower sections plus an inexpensive easy-to-use "fold-over" kit. The perfect answer to this type tower requirement.

ROHN TELESCOPING MASTS

Come in 20, 30, 40 and 50 ft. sizes. Easily erected, heavy-duty seamless steel tubing throughout.

PLUS A COMPLETE LINE OF ACCESSORIES:

- UHF Antenna Mounts For Towers For Masts
- Wall Mounts

Also House brackets, guy brackets, etc., all Rohn designed!

ROHN

MANUFACTURING COMPANY

DEPT. RTN
116 LIMESTONE
BELLEVUE,
PEORIA,
ILLINOIS

Contact your ROHN distributor for FREE catalog and Prices or write:

The new "Telco" unit has no lugs to break and no wires to strip. It will mount on a wall with two screws or on pipes and masts with a strap.

Catalogued as part No. 8642, the new unit comes complete with mounting straps and screws. It is available at parts distributors or additional information may be obtained by writing the company at 919 Taylor Ave. in Rockford.

U.H.F. SWEEP GENERATOR

New London Instrument Co., P.O. Box 189, New London, Conn. has announced the availability of its Model 130 u.h.f. sweep generator.

Featuring single-range tuning and a 0-30-mc. sweep width, the unit is designed for either laboratory, production, or service use.

It also features at least one volt output in 75 ohms, continuously variable attenuator, a blanked signal on the return sweep to provide a reference base line, no beating, no multiplication, and simplicity of operation. A low-cost balun is available for conversion to 300-ohm load.

U.H.F. TRIMMER

JFD Manufacturing Company, Inc., 6101 Sixteenth Ave., Brooklyn 4, N. Y. is in production on a "Mighty Midget" piston-type variable trimmer condenser, Model VC3-G for u.h.f. television set manufacture and replacement requirements.

The trimmer measures 1" over-all at maximum capacitance. The capacitance range is 1 to 8 μf . The universal mounting design fits any u.h.f. set.

The Edison Radio Amateur Award which will be given by General Electric Company next February to the amateur judged to have performed the "outstanding public service of 1953," is inspected by, left to right, George E. Sterling, FCC commissioner and one of the award judges; G. A. Bradford, advertising manager of the company's Tube Department; and Goodwin L. Dosland, ARRL president and another award judge. Other judges are E. Roland Harman, president of the American Red Cross and Gardner Cowles, editor of "Look."



October, 1953

PERSONAL MUSIC

CHROME MUSIC BOX—Containing 5" Speaker and Coin Timer Motor. Can be used for remote speaker in Home, Car, Boat, Shop, Office, etc. Timer Motor operates from 24 Volt 60 cycle. Prices:
With 5" Dynamic Speaker\$3.95
With 5" PM Speaker\$4.95
TRANSFORMER—24 Volt—to operate Timer Motor from 110 Volt 60 cycle\$1.50

BLOWERS—115 VAC 60 CYCLE



SINGLE TYPE: (Illustrated at left) 100 CFM. 2 1/2" intake; 2" outlet. Complete size: 5" x 6". Order No. IC939\$8.95

DUAL TYPE: 100 CFM. 4" intake; 2" Dis. Each Side. Complete Size: 8" x 6". Order No. IC880\$13.95

COMPACT TYPE: 108 CFM. Motor built inside squirrel cage. 4 1/2" intake; 3 3/4" x 3" Dis. Complete size: 4 1/4" W x 8 3/4" H x 8 3/4" D. Order No. 2C067\$14.50

FLANGE TYPE: 140 CFM. 3 1/2" intake; 2 1/2" Dis. Complete size: 7 1/2" W x 7 1/4" H x 6 3/4" D. Order No. IC807\$13.95

FLANGE TWIN: 275 CFM. 4 1/2" intake; 3 1/4" x 3" Dis. Complete size: 11 3/4" W x 8 3/4" H x 8-1/16" D. Order No. 2C069\$21.95

AERIAL WIRE—Phosphorus Bronze #16 Strand- ed, 200 lb. test. Weatherproof, 150 Feet on Reel. RL-3 with Clips\$1.50

Telephone Wire—3 Cond. copper & steel, 525 Ft.\$4.75

BC-709 PORTABLE AMPLIFIER—One Tube uses 6 1/2 V. and 1.5 Volt Batt.—NEW\$4.95

POGO-STICK

TRANS.—REC.—PORTABLE, READY TO OPERATE. BC-745 TRANS.—REC.: Crystal Controlled. covers Freq. 3 to 6 MC. by use of Plug-in Coil. With PE-157 Power Supply, BB-54 2 Volt Battery, Speaker, Antenna, Mic., and Crystal for 5030 KC. Set size: 5"x5"x6", mounted on Staff 30" Lp. Power Supply operates from 2 Volt Wet Battery rechargeable from 6 Volts and houses Speaker. Price: Used—\$49.95 Tested—Complete.....\$49.95

T-39 CHEST SET—Has Speaker & Space for Dry Cells\$4.95

BC-745 TRANS. & REC.—CHASSIS ONLY—No Cover. Staff or Antenna. but w/Tubes\$14.95

NEW ANTENNA—Telescoping, for above set.....\$2.00

RECEIVER AND TRANSMITTER

RECEIVER BC-229 or 429—TRF Receiver with 3 Plug-in Coils to cover Freq. Range 201 to 398. 2500—4700, 4150—7700 KC. With 6 Tubes: 1/37—1/38—3/39. Power Supply required, 6 or 12 Volt & 250 Volts. Size: 16"x8"x7". Schematic includedUSED: \$8.95

TRANSMITTER BC-230—Voice modulated Trans. with 5 Plug-in Coils to cover Freq. Range 2500 to 7700 KC. With 4 Tubes: 2/10y—2/45 & RF Meter 0-1.5 Amps. Power Supply required, 6 or 12 Volt & 350 Volts. Size: 13"x8"x7". Schematic includedUSED: \$8.95

Special Buy—Both Rec. & Trans.: \$15.00

TRANS. CONTROL BOX BC-232 w/Plug.....\$1.50
REC. CONTROL BOX BC-231 w/Plug.....\$1.50
PLUG f/Rec. PL-61...75c. F/Trans. PL-64... 75c

Address Dept. RN • Minimum Order \$5.00 • Prices F.O.B., Lima, O. • 25% Deposit on C.O.D. Orders

FAIR RADIO SALES

132 SOUTH MAIN ST. LIMA, OHIO

SOUND POWERED HEAD AND CHEST SET

Navy Type—No Batteries Required—Ideal for TV Antenna Installations and many other uses. 20 Ft. Cord. Used—
Tested:\$5.95 EA.



TELEPHONE WIRE FOR THE ABOVE

COMBAT TYPE—2 Cond. Twisted. Rubber Covered. Medium Weight, W-130.....@ .01c per Ft.
FIELD WIRE—2 Cond. Twisted. Weather-Proof. Heavy Duty. W-110—525 Ft. Roll.....\$4.75
COPPER WELD WIRE—Weatherproofed, 2 Cond. Solid. 1200 Ft. Roll. \$10.00. Per Ft. @ .01c per Ft.

COAXIAL CABLES:

RG-8/U (SPECIAL) 51.5 ohms. Same size as RG-8/U. Prices: 1 to 100 Ft. @ 8c per ft.—100 to 500 Ft. @ 7 1/2c per ft.—500 to 1000 Ft. @ 7c per ft.—1000 Ft. Rolls @ 6 1/2c per ft.
RG-34/U 71 ohms, 145 ft. length.....\$15.00

DYNAMOTORS:

INPUT:	OUTPUT:	STOCK No.:	PRICE:
14 V.D.C.	330 V. 135 MA.	DM-330	\$7.95
2 V.D.C.	250 V. 50 MA.	DM-25	8.95
12 or 24 V.D.C.	500 V. 50 MA.	USA/0515	4.95

PE-101C DYNAMOTOR

6 OR 12 VOLT (Reprints of original CQ conversion articles—Oct. and Dec., 1952 issues furnished.)
• This is the Dynamotor the Hams have been talking about! Easily adapted to supply 625 V. @ 150 MA. and 325 V. 125 MA. at 12 Volts—or 300 V. @ 90 MA. and 160 V. 110 MA. at 6 Volts. NEW \$4.95

BATTERY SWITCHING UNIT and METER

Used to switch load from one battery to another—or 6 to 12 Volts. Contains 2" Meter—0-15 Volt DC Scale for reading battery voltage. 20 Amp DPDT Switch and Indicator. Case size: 4" x 6 1/4" x 2 3/4".NEW: \$2.95

ANTENNA EQUIPMENT

MAST BASES—INSULATED:

MP-132 BASE—Illustrated at left—1" heavy coil spring, 2" insulator. Overall length: 11 1/2". Weight: 2 3/4 lbs. Price\$3.95

MP-S-33 BASE—Insulated type with heavy coil spring and 5" dia. insulator. Requires 2" hole for mounting. Weight: 9 lbs.\$5.95

MAST SECTIONS FOR ABOVE BASES
Tubular steel, copper coated, painted, in 3 ft. sections, screw-in type. MS-53 can be used to make any length with MS-52-51-50-49 for taper. Any section50c Each
Larger Diameter Section: MS-54.....\$1.25

TRANSFORMERS

110 V. 60 Cycle Primaries

5 Volt CT-25A—10,000 V. Ins. OPEN FRAME—6" x 5" x 4 1/2"\$7.95
6.3 V. 1 Amp.....1.25 24 V. 1 Amp..... 1.95
24 V. 1/2 Amp.....1.50 24 V. 6.5 Amp..... 5.95
6-24—or 30 Volt 8 Amp..... 5.95

RCA INSTITUTES, INC.

A service of Radio Corporation of America
50 West 4th St., New York 14, N. Y.

OFFERS COURSES IN ALL TECHNICAL PHASES OF RADIO, TELEVISION, ELECTRONICS

Approved for Veterans
Write Dept. RN-53 for Catalog

ON-THE-SPOT BATTERY RECORDER

WALKIE-RECORDALL 1/2 lb. miniature BATTERY RECORDER-PLAYBACK
Continuous, permanent, accurate, indexed recording at only 5c per hr. Instantaneous, permanent playback. Picks up sound up to 60 ft. Records conferences, lectures, dictation, 2-way phone & sales talks; while walking, riding or by air. Records in closed briefcase with "hidden mike". Write for Detailed Literature.

MILES REPRODUCER CO., INC.

812 BROADWAY Dept RN-9, NEW YORK 3, N. Y.

CORONA RADIO KITS

• Easy Assembly • Excellent Reception

SINGLE BAND SUPER

Rocket 115K—Latest superhet circuit for ultimate in sensitive reception and tonal quality. Kit includes all necessary parts, punched chassis, attractive lake-lite mahogany cabinet, built-in loop antenna, iron core IFA, big 5" Alnico V spkr.; tubes: 12SK7, 12SA7, 12SQ7, 50L6, 35Z3. Automatic vol. control, beam power output. Tunes 640 to 1700 Kc. Simple step-by-step instructions included.Net \$14.75

2 BAND AC-DC SUPER

Plaza 812K—Excellent sensitivity. Tunes standard broadcast 535 to 1800 Kc. foreign short-wave 6 to 18 Mc (16.6 to 50 meters). Features iron core IFA, bass-treble tone control, 5" Alnico PM Spkr., phone jack. Handsome lake-lite mahogany cabinet, 11 1/2"x8"x6 3/4". Tubes: 12SK7, 12SA7, 12SQ7, 50L6, 35Z3. All parts, punched chassis, easy step-by-step instructions included.Net \$20.75

3-BAND SUPER Globemaster 814K Complete KitNet \$24.75
All kits supplied less wire and solder. Please include 25% deposit with C.O.D. Orders. Dept. N-10

CORONA RADIO & TV CO.
136 LIBERTY ST., NEW YORK 6, N. Y.

listening quality is everything . . .

(another music lover sees light)

" . . . I used to buy every new pick-up that came out, but no more. Your slogan, "LISTENING QUALITY IS EVERYTHING," has saved me quite a few dollars. I have yet to find a cartridge that could approach, even remotely, the listening quality of my AUDAX CHROMATIC. I was beginning to feel a bit jittery about when to replace the diamond, and your STYLUS-DISK came as a great relief. I want to thank you for making this ingenious stylus testing device available . . ." (From a letter)

It is the number one MUST. Without it everything else becomes meaningless. The AUDAX CHROMATIC has that quality to a degree not equalled by any other pickup" . . . so says violinist David Sarsar, of MUSICIAN's amplifier fame (Toscanini's NBC Symphony).

Be it diamond or sapphire, every stylus has a limited life-span: the diamond lasts the longer. Obviously, then, replaceability of the stylus—at home—is of the greatest importance.

But . . . only YOU can decide what sounds best to you. Therefore, See and Hear the Audax CHROMATIC and—You be the judge . . . yet Audax costs no more than ordinary magnetic pickups.

ONLY AUDAX PROVIDES HOME REPLACEABILITY OF EITHER STYLUS, INDEPENDENTLY OF THE OTHER



Ask for 1953 ELECTRONIC PHONO FACTS from your dealer

A microscope will show a tiny flat on any diamond after 40 or so hours of play—yet, the jewel is in good playing condition. Hence, in diagnosing wear, it is not the flat but detection of actual cutting edges that is of vital importance. This makes a microscope—(\$15.00 to over \$100.00)—almost useless to an untrained observer. He can see, but he can't judge. The Audax Company has developed the STYLUS-DISK which makes home-testing of any jewel point very simple. If worn or defective the stylus will scrape the delicate surface of the STYLUS-DISK, leaving a visible indication. With proper care, this new STYLUS-DISK should have a life-span of at least 20 styli. Yet it costs only \$6.50 list, \$3.90 net.

If your favorite store hasn't yet received a shipment of STYLUS-DISKS, write to us.

AUDAX COMPANY
500 Fifth Avenue New York City 36

Creators of Fine Audio-Electronic Apparatus
for over 25 years

"The Standard by Which Others Are
Judged and Valued"

SERVICE HINTS ON G-E TV SETS

810, 811, & 814

Buzz in audio.

This may occur in strong signal areas because the peaks of the signal, which are the vertical pulses, cause the converter grid (V_{2B} , $\frac{1}{2}$ 12AT7) to draw grid current which, in turn, frequency modulates the oscillator voltage at vertical pulse rate of 60 cps.

To remedy this, add bias to the converter grid (pin 7) by the addition of R_{120} and R_{121} , 1-megohm, $\frac{1}{2}$ -watt resistors, and C_{113} , a

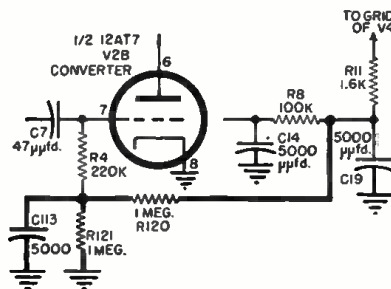

5000- μ fd. ceramic condenser, as shown in the accompanying diagram.

Proceed as follows:

1. Add a terminal board to the underside of the main chassis near the r.f. unit. This board should be mounted so that short leads can be used.
2. Remove R_1 from ground under the oscillator trimmer, C_{50} , and connect it to the junction of R_{120} and R_{121} on the new terminal board.
3. Connect C_{113} from the junction of R_{120} and R_{121} to the ground point on the r.f. chassis under the oscillator trimmer, C_{50} .
4. Dress C_{113} as far away as possible from the oscillator trimmer, C_{50} .

Vertical retrace lines visible.

If vertical retrace lines appear when the contrast control is used on a low setting, or the brightness

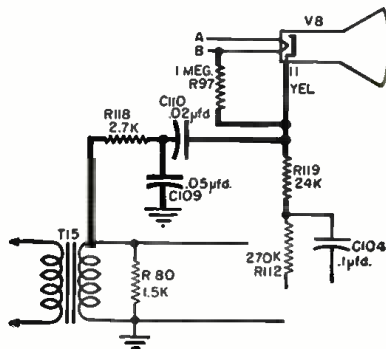

control is used at a high setting, do the following:

1. Add a 24,000-ohm resistor, R_{119} ,

between the junction of R_{112} - C_{104} , and pin 11 of the CRT. (See accompanying diagram.)

2. Add resistor R_{118} , and condensers C_{109} and C_{110} , as shown in the diagram, between pin 11 of the CRT and vertical sweep output transformer secondary.

811, 814, 820, 830, & 835

Click in speaker as tuning control is adjusted.

This is an indication of audio regeneration, and can be eliminated by connecting a 500- μ fd. ceramic condenser across the audio i.f. "B+" lead. This connection is made on the terminal board located between the 6SH7 limiter tube socket, V_{18} , and the discriminator transformer, T_{19} . The condenser is connected between the "B+" and ground terminals at this terminal board.

814

Wiggle at top left of picture.

To remove this effect, add a 330-ohm, $\frac{1}{2}$ -watt resistor in parallel with C_{83} , the 5- μ fd. paper condenser from horizontal size control to horizontal deflection coils.

818

Flutter on strong TV signals.

This appears as intermittent flutter of the picture brilliance of a few cycles duration, similar to airplane flutter, at very strong signal strength which requires minimum setting of contrast control.

To correct this condition, change C_{235} in the grid circuit (pin 1) of the 6AU6 first i.f. tube, from a .05- μ fd. to a 5- μ fd., 200-volt paper condenser.

Also change R_{230} in the plate circuit (pin 1) of the 12AU7 first video amplifier tube from a 39,000-ohm resistor to an 18,000-ohm, $\frac{1}{2}$ -watt unit.

17T10, 17T11, & 17T12

Picture height varies with change in brightness control setting.

To eliminate this condition, remove R_{250} , the 150,000-ohm resistor from the cathode (pin 11) of the CRT to the brightness control. Replace it with a 220,000-ohm unit.

Compression on top of picture.

To eliminate this, remove the 82,000-ohm resistor, R_{330} , in series with C_{318} , .002- μ fd. condenser across the vertical output transformer, and replace it with a 180,000-ohm unit.

Horizontal instability.

To improve the horizontal sync of

these receivers, remove R_{275} , the 180,000-ohm feedback resistor, connected from the grid (pin 4) of V_{11b} , the 6SN7GT horizontal oscillator tube, to the plate (pin 7) of V_{12} , the 6AL5 discriminator. Replace it with a 330,000-ohm unit.

17T10, 17T11, 17T12, & 21T2

Poor vertical linearity.

To improve the vertical linearity, change the vertical output tube (V_{10}) from a 25L6GT to a 25W6GT. These tubes are interchangeable, and no wiring change is necessary.

20T2, 20C105, 20C106, & 21C200

Bright picture with black lines.

This may occur when C_{275} , the .1- μ fd. condenser in the grid circuit (pin 2) of the picture tube is shorted. If this is the case, the picture control, R_{251} , will not work. Replace this condenser if defective.

Dim picture, insufficient width and height. Check C_{371} , the 5- μ fd., 200-volt paper condenser, between the horizontal deflection coils and terminal 6 of T_{252} , the horizontal output transformer. Replace this condenser if defective.

20C150 & 24C101

Excess contrast in picture.

This is indicative of circuit overload, and is primarily due to a loss of a.g.c. control by the 6AU6 keyer tube.

To improve the a.g.c., increase the screen voltage on the 6AU6 keyer tube by replacing the 5U4GT's. The latter may be giving low emission, resulting in decreased screen voltage to the keyer.

ALL STRATOPOWER "E" & "EE" CHASSIS

Weak or critical audio tuning.

This may be caused by poor grounding of the shield on the 6CB6 audio i.f. tube (2nd tube from the back in the center strip on the chassis).

Broad black vertical bar on left half of raster.

This may be due to an open tap on the high-voltage horizontal output transformer (tap 8 on "E" chassis transformer only).

This may also occur when the coupling condenser from the width control to pin 7 of V_{11ab} , the 12AX7 horizontal blanking tube, is open. This condenser is C_{351} on the "E" chassis, and C_{368} on the "EE" chassis.

Intermittent operation.

Intermittent operation may be due to pin 1, of the 6AK5 second r.f. tube, shorting to the shield directly below the socket. Rocking the 6AK5 will reveal whether this is the cause of the intermittent condition.

To cure this condition, clip about $\frac{1}{16}$ " off pin 1 on the 6AK5 tube, and re-insert it in its socket.



70% to 90% off list!
TOP TUBE BUYS

All Tubes Individually Boxed! Same Day Service!
Check this list for Fully 1-Year Guaranteed Tubes.

Type	Price	Type	Price	Type	Price	Type	Price	Type	Price
1A5GT	.30	6AF4	.90	6M6GT	.41	12A8	.61	25BQ6GT	.62
1A7GT	.47	6AG5	.43	6J5GT	.37	12AL5	.37	25L6GT	.39
1B3	.65	6AJ5	.90	6J6	.52	12AT6	.37	26	.45
1B7GT	.30	6AK5	.75	6J7G	.43	12AT7	.56	27	.39
1C5GT	.43	6AL5	.38	6K5	.47	12AU6	.38	32L7	.89
1E7	.29	6AQ5	.39	6M6GT	.37	12A7	.43	35	.58
1G4GT	.24	6AQ6	.37	6K7	.44	12AV6	.39	35B5	.40
1G6	.30	6AR5	.37	6L6	.64	12AV7	.59	35C5	.39
1H4G	.30	6AS5	.50	6O7	.45	12AX4	.48	35L6GT	.41
1H5GT	.40	6AT6	.37	654	.38	12AX7	.48	35W4	.37
1J6	.24	6AU4	.68	658	.53	12BA6	.38	35Z4	.39
1L4	.46	6AU6	.38	6SA7GT	.43	12BA7	.60	35Z5GT	.37
1N5	.46	6AV5	.83	6SD7GT	.41	12BD6	.45	36	.60
1P5	.57	6AV6	.37	6SF5GT	.46	12BE6	.39	41	.42
1Q5	.58	6AX4	.53	6SG7GT	.41	12BF6	.39	42	.42
1R5	.45	6AX6G	.24	65H7	.73	12BH7	.63	43	.55
1S5	.39	6B4G	.64	65J7GT	.41	12BY7	.65	45	.55
1T4	.45	6BA6	.39	65K7GT	.41	12BZ7	.65	45Z3	.44
1T5	.53	6BA7	.57	65L7GT	.48	12C8	.34	45Z5	.49
1U4	.45	6BC5	.44	65N7GT	.52	12J5GT	.42	50B5	.39
1U5	.39	6BD5GT	.59	65Q7GT	.37	12J7GT	.34	50C5	.39
1V	.60	6BD6	.45	65R7GT	.45	12S8	.70	50L6GT	.41
1X2A	.63	6BE6	.39	65S7	.42	12SA7GT	.44	50Y7	.50
2A3	.70	6BF5	.41	6T8	.56	12SF5	.50	53	.24
2A4G	.24	6BF6	.37	6U4	.60	12SG7GT	.52	56	.24
2W3	.38	6BG6G	1.25	6U5	.44	12SH7GT	.48	57	.58
2X2	1.50	6BH6	.46	6U6	.63	12SL7GT	.47	58	.60
3A4	.45	6BJ6	.39	6U8	.61	12SN7GT	.52	70L7GT	1.09
3E5	.46	6BQ6GT	.59	6V6GT	.39	12S07	.44	71A	.60
3Q4	.48	6BQ7	.95	6W4GT	.44	12SR7	.49	76	.44
3Q5GT	.49	6BZ7	.95	6W6GT	.44	12V6GT	.46	77	.57
3S4	.46	6C4	.37	6X4	.37	14J7	.30	78	.47
3V4	.47	6C5GT	.39	6X5GT	.37	14A7	.44	80	.35
5U4G	.45	6C6	.58	6X8	.61	14W7	.30	83V	.68
5W4	.50	6CB6	.44	6Y6G	.48	14H7	.44	85	.59
5Y3G	.32	6CD6G	1.11	7A4	.47	19B6G6	.95	117L7	.99
5Y3GT	.32	6D6	.45	7B4	.44	19C8	.70	117Z3	.37
5Y4G	.35	6E5	.48	7C6	.40	19T8	.79	807	1.19
5Z3	.46	6F5GT	.39	7E6	.30	19V8	.89	1274	.99
6A7	.59	6F6	.37	7N7	.46	24A	.63	2050	1.85
6AB	.62	6GG6	.52	7X7	.70	25AV5	.83	6113	1.00
6AB4	.44								

NOW! RAD-TEL PARTS AT BIG SAVINGS!

Here's your big opportunity to save as never before on parts you need now. Look at the savings.



NATIONAL TURRET TV BOOSTER
Brand New Factory Boxed
Model TVB-20
\$9.95

ARMY-NAVY HEADSETS
Individually Boxed. Very sensitive. Meets both Army and Navy specifications.
List \$16.00
\$2.95 each per set



12" Magnavox P.M. SPEAKER
Heavy Magnet
List \$11.50
\$5.95



5" UTAH AUTO SPEAKER
3-4 Ohm V.C. - 4 Ohm Field
List \$5.05
79c



4 X 6 INCH QUAM P.M. SPEAKER
Lowest Price Oval Speaker
Alnico 5 Field
List Price \$4.75
\$1.95

RAD-TEL SUPER BUY! RESISTORS 200 TO PKG.

Standard RTMA Coded or Value Printed, Uninsulated, $\frac{1}{2}$ Watt, 1 Watt, 2 Watt and some 10 Watt

ASSORTMENT OF 200 for \$13.99



70° YOKE (Mfg. by Todd)
List \$7.50 **\$1.95**



RCA TYPE FLYBACK TRANSFORMER
Type 215T1 **95c**



FILTER CONDENSERS KITS* 150 V.
*(10 to 10 pkg., minimum)
20-20 **\$2.95**
40-40 **\$3.25**
50-30 **\$3.25**

DRY ELECTROLYTIC CAPACITOR
10 MFD 500 WVV 600 Peak
Box of ten (10) **\$2.95**

HI-VOLTAGE CERAMIC CONDENSERS
500 mmtd 10 KV **39c** ea.
500 mmtd 15 KV **49c** ea.
500 mmtd 20 KV **49c** ea.

VERTICAL OUTPUT TRANSFORMER
10-1 Ratio RCA Type
List \$4.50
95c

100 INSULATED RESISTORS Box of 100
50 $\frac{1}{2}$ & $\frac{1}{2}$ Watt, 25 $\frac{1}{2}$ Watt, 25 2 Watt **\$265**

50 ASSORTED MICAS Box of 50
Regular & Silver Type **\$195**

ANODE CAP 19c each
List \$7.75

TERMS: A 25% deposit must accompany all orders—balance C.O.D. All shipments F.O.B. Irvington warehouse. Orders under \$10—\$1.00 Handling Charge. Subject to prior sale.



"Integrity Is Our Chief Asset!"
Phone: Essex 5-2947 115 Coit Street
Dept. RN-10 Irvington 11, N.J.

Surplus Sellout Sale!

Radio Afti meter—AN/APN-1. New complete \$65.00 ea.
 * CARBON VOLUME CONTROLS—1d for \$1.25

RES. OHMS	* STOCK NO.	SHAFT LENGTH	MFR.	PRICE
.1K	700A	3/16 S.D.		.18
.13K	701A	3/16 S.D.		.18
.5K	702A	1/2 S.D.	CTS	.18
1K	703A	9/32 S.D.	CTS	.18
1.5K	704A	1/2 S.D.	IRC	.18
2K	705A	1/2 S.D.		.18
4K	706A	S.D.	Stack	.15
6K	708A	7/16 S.D.	IRC	.18
7K	709A	1/2 S.D.	CTS	.18
10K	710A	1/2 S.D.	CLARO	.18
15K	712A	S.D.	IRC	.15
15K	713A	1/2 S.D.	IRC	.15
20K	714A	S.D.	CTS	.15
20K	716A	S.D.	Stack	.15
20K	717A	S.D.	Stack	.15
20K	718A	1/2 S.D.	Stack	.18
20K	719A	1/2 S.D.	IRC	.18
22K	720A	S.D.	IRC	.15
50K	722A	9/16 S.D.	CIR.	.18
60K	723A	S.D.	IRC	.15
75K	724A	1 1/32 S.D.	CLARO	.18
75K	725A	2 S.D.	CIRAO	.19
100K	728A	1/2 S.D.	Stack	.17
100K	729A	S.D.	RE909-1 Mdg.	.15
100K	730A	S.D.	CENTRA	.15
100K	731A	S.D.	Stack	.15
150K	732A	1/2 S.D.	CRL	.18
200K	733A	1/2 S.D.	W.L.	.25
200K	735A	2 S.D.	IRC	.20
200K	736A	2 S.D.	IRC	.20
300K	737A	1 1/8 S.D.	IRC	.18
500K	738A	1 1/16 S.D.	IRC	.18
500K	740A	7/8	CROS.	.18
500K	741A	S.D.	CIR.	.15
500K	742A	S.D.	IRC	.15
600K	744A	S.D.	CIR	.15
800K	745A	Special	Stack	.15
1 MEG	746A	S.D.	CIR	.15
1 MEG	747A	1 1/4 S.D.	CTS	.25
2 MEG	748A	1 1/2 S.D.	IRC	.18
2 MEG	750A	3/4 S.D.	IRC	.18
200 MEG	751A	1/2 S.D.	NETER TYPE	.40

S.D. Indicates Screwdriver Slot
 * CARBON VOLUME CONTROLS WITH SWITCHES FOR \$1.75

RES. OHMS	* STOCK NO.	SHAFT LENGTH	SWITCH MFR.	PRICE
1.5K	753A	1/2 S.D.	S.P.S.T. CRL	.29
10K	754A	3/4 S.D.	S.P.S.T. CRL	.29
25K	755A	1/2 S.D.	S.P.S.T. CTS	.29
75K	756A	3/4 S.D.	S.P.S.T. IRC	.29
75K	757A	3/4 S.D.	S.P.S.T. IRC	.29
100K	758A	7/8 S.D.	S.P.S.T. CRL	.29
100K	759A	1 1/8 S.D.	S.P.S.T. STACK	.29
1 MEG	760A	1/2 S.O.	S.P.S.T. CRL	.29
5 MEG	761A	1/2 S.O.	S.P.S.T. CRL	.29
10 MEG	762A	1/2 S.O.	S.P.S.T. CRL	.29
10 MEG	763A	1/2 S.O.	S.P.S.T. CRL	.29
10 MEG	764A	1/2 S.O.	S.P.S.T. CRL	.29
300 DUAL	765A	1 1/16 S.D.	S.P.S.T. IRC	.40

* TRANSFORMERS—ALL ARE 50-60 CYCLE
 * TRANSFORMER, Power, Filament, and Plate: 2 Pri 115V/230V, 50/70CPS; 5 sec: 590V at 55ma; 525V at 1.5ma; 6.4V at 3 amp; 6.4V at 0.6 amp; 2.5V at 1.75 amp. Stock No. 500A. PRICE EA. \$5.50
 CHICAGO TRANSFORMER, Radio Power Trans. Pri. V. 210-20-30-40-50. Sec. 110V V.C.T. Amp. 0.212. Test V. 2500. Size 7" H x 8" x 8". Stock No. 501A. PRICE \$10.50
 CHICAGO TRANSFORMER, Radio Power Trans. Pri. V. 230. Sec. 110V at 1.5 Amps. Size 5 1/2" x 4 1/2" x 4 1/2". Stock No. 502A. PRICE \$3.50
 CHICAGO TRANSFORMER, Radio Power Trans. Pri. V. 105-10-15-20-25. Sec. 1-1-15.5 at 1 Amp. Sec. 2-V. 12.6 C.T. at 3.5A. Size 4 1/2" x 3 1/2" x 3 1/2". Stock No. 503A. PRICE \$4.50
 CHICAGO TRANSFORMER, Radio Power Trans. Pri. V. 210-20-30-40-50. Sec. V 500 C.T. at 430A. Size 4 1/2" x 3 1/2" x 3 1/2". PRICE \$2.25
 Stock No. 504A. PRICE \$2.25
 COLLINS RADIO, Plate Transformer, Pri. 115V 230V. Sec. 500V.C.T. at 106A. Size 4 1/2" x 3 1/2" x 3 1/2". Stock No. 505A. PRICE \$5.00
 CHICAGO TRANSFORMER, Radio Power Trans. Pri. V. 210-20-30-40-50. Sec. V 5V.C.T. at 6A. Size 4 1/2" x 3 1/2" x 3 1/2". Stock No. 506A. PRICE \$2.50

* OIL FILLED CONDENSERS
 3 sec. 3X .2mfd at 400VDC. 3 5/8" x 3 1/2" x 2 1/2". Elec. Util. Porc Term. Stock No. K400A. PRICE EA. \$2.55
 3 section 1MFD-400V, 2MFD-400V, 1.5 MFD-100V. 2 5/8" x 3 1/4" x 1 1/2". Elec. Util. Stock No. K770A. PRICE EA. \$0.70
 Dual 2.5MFD, 1MFD 400VDC. PRICE EA. \$0.90
 Util. Stock No. K767A. PRICE EA. \$0.90
 Dual 2x2 .5MFD, 200VDC 1 3/4" x 2 3/4" x 1 3/4". Stock No. K771A. PRICE EA. \$0.60
 1MFD-400VDC, 1 3/4" x 3" x 1". Ind. Cond. Porc. Term. Stock No. K418A. PRICE EA. \$0.50
 Stock No. K327A. PRICE EA. \$0.40
 1MFD-600VDC, 1 3/4" x 3" x 1". Ind. Cond. Porc. Term. Stock No. K327A. PRICE EA. \$0.40
 4.5MFD, 400VDC, 2 1/4" x 1 1/2". Aerovox. Stock No. K321A. PRICE EA. \$1.00

* G.E. PYRANOL CONDENSERS—10 for \$3.50

Stock No.	Mfd.	WVDC	G.E. Part No.	Price Each
100A	.05	1000	23F270G3	\$0.38
101A	1.0	500	23F217G3	.38
102A	.25	1000	22F286	.45
103A	2x .25	400	23F310	.45
104A	1.5	1000	22F287	.50
105A	2x .875	400V	28F307	.55
106A	1.0	500	26F545	.42
107A	1.0	500	23F315	.42
108A	1.0	500	26F446	.42
109A	1.0	115VAC	25F463	.38
110A	2x .60	130VAC-400cy	23F452	.50
111A	1.5	140VAC-120cy	25F769	.50
112A	2.75	400	26F544	.85

* Rotating Loop Antenna MN20E. PRICE EA. \$7.95
 * Antenna Changeover Switch 3PDT. PRICE EA. .85
 * Plug PL6B. PRICE EA. .85
 * Antenna Mast AN 104B New. PRICE EA. 5.95
 * Items indicate these part(s) will be found in our SURPLUS CATALOG with 1,000's of others. SEND FOR Surplus Catalog No. RN10.
 SEND FOR our Standard Radio & TV Parts and Hi-Fidelity Cat. No. RNS10.

TERMS: All prices F.O.B. Chicago. Send 25% Deposit with order. Balance sent C.O.D.

Electronic Expeditors
 2909 West Devon Avenue Chicago 45

Within the Industry (Continued from page 30)

and engineering activities . . . *Sylvania Electric Products Inc.* has named **EDWARD P. ATCHERLY** to the post of merchandising manager of renewal tube sales. He will headquarter in the New York office . . . **HARRY GOODSTEIN** has been appointed manager of the precision control division of *Claro-stat Mfg. Co., Inc.* He has been with the firm since 1944 . . . *CBS-Columbia* has named **BERNARD M. DOVER** to the post of project engineer. He joins the firm from *Emerson Radio & Phonograph Corp.* where he headed the tuner engineering department . . . **REAR ADMIRAL THOMAS F. HALLORAN, USN** (ret) has been named general manager of the *Blair Associates Transistor Development Laboratory* in Cambridge, Mass. . . **JEROME J. KAHN**, founder and president of *Standard Transformer Corporation* from 1930 until its recent merger with *Chicago Transformer Corp.*, has announced his withdrawal from active management in the newly-formed *Chicago Standard Transformer Corporation* . . . *The Andrew Corporation* has appointed **ROBERT P. LAMONS** to the post of sales manager with headquarters in Chicago. He joined the company in 1945 . . . **HUGH J. DALY** has returned to *Eicor, Inc.* as sales manager of the tape recorder division. He was with the firm 1946-1948 . . . *DeJur-Amsco Corporation* has appointed **GEORGE WEINMAN** to the post of director of industrial and government sales. He will handle the company's line of potentiometers, panel instruments, and electrical connectors . . . **THOMAS W. MASSOTH** has been named to the newly-created post of operations control manager of the Engineering Products Department of the *RCA Victor Division*. He has been with the firm since 1930 . . . **DOUGLAS CARPENTER** has been named chief antenna development engineer of the *JFD Manufacturing Company Inc.* of Brooklyn. He was formerly chief engineer for the "Vee-D-X" division of *LaPointe Electronics*, the *Summit Engineering Company*, and *McMurdo Silver Company*, all of the Hartford, Conn. area . . . **JOHN W. HINES** has been named director of sales of *Magnecord Inc.*, Chicago manufacturer of professional magnetic tape recording equipment. He succeeds **C. G. BARKER** who resigned . . . **RICHARD H. DORF**, audio consultant, has been named editorial director of *Electronic Handbook Company* of 255 W. 84th St., New York City.

NATA of Seattle, Washington, is holding its first annual "Profit Clinic" at the Norseland in Seattle September 27th and 28th.
 The Northwest Appliance & Television Association has obtained the services of several well-known speakers who will address the meet. Included

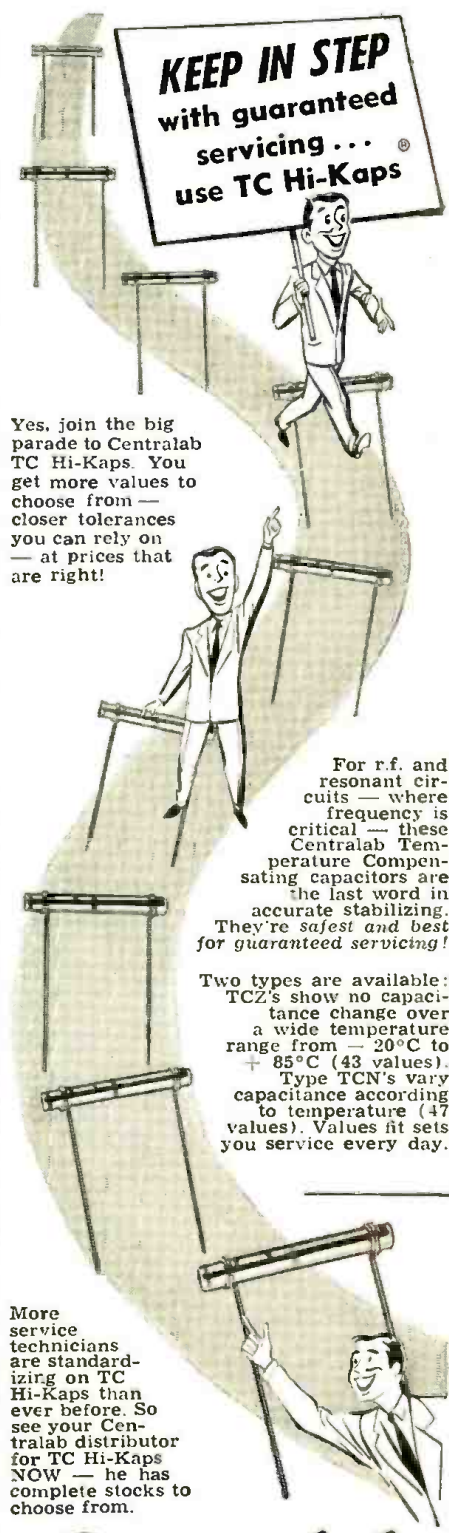

Yes, join the big parade to Centralab TC Hi-Kaps. You get more values to choose from — closer tolerances you can rely on — at prices that are right!

For r.f. and resonant circuits — where frequency is critical — these Centralab Temperature Compensating capacitors are the last word in accurate stabilizing. They're safest and best for guaranteed servicing!

Two types are available: TCZ's show no capacitance change over a wide temperature range from — 20°C to + 85°C (43 values). Type TCN's vary capacitance according to temperature (47 values). Values fit sets you service every day.

More service technicians are standardizing on TC Hi-Kaps than ever before. So see your Centralab distributor for TC Hi-Kaps NOW — he has complete stocks to choose from.

Centralab

CENTRALAB,
 A Division of Globe-Union Inc.
 910-J E. Keefe Ave., Milwaukee 1, Wis.
 Please send latest technical data on Centralab's TC Hi-Kaps.

Name.....
 Firm.....
 Address.....
 City.....Zone.....State.....

NEXT TIME BE SURE!

Next time insist on
PEERLESS transformers

Peerless quality is
ECONOMICAL

Peerless quality is
UNIFORM

Peerless quality is
DEPENDABLE

For years Peerless engineers have designed transformers to meet the most unusual and stringent specifications submitted by civilian manufacturers and government contractors, and have manufactured these transformers with tight quality control. The small difference in price means a BIG difference in performance.

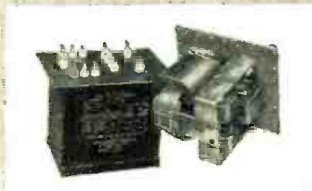

Next time let us quote on your transformer requirements.

PEERLESS
Electrical Products

A DIVISION OF



9356 Santa Monica Blvd., Beverly Hills, Calif.
161 Sixth Avenue, New York 13, New York

are Kip Anger, national promotion manager of *Motorola, Inc.*; Mort Farr, past-president of NARDA; A. W. Bernsohn, managing director of NARDA; and Wallace Johnson, president of NARDA.

Those wishing additional information about the "Clinic" are invited to write Ed Smith, executive secretary of NATA, 714 American Bldg., Seattle 4, Wash.

* * *

GEORGE B. FRASER has been elected president of *The Astatic Corporation*, Conneaut, Ohio. He was formerly vice-president and general manager of the firm. He has served as treasurer since he joined the company in 1936 and retains this title along with the top post.



Mr. Fraser was made assistant general manager in 1944 and vice-president and general manager in 1950.

He is the third *Astatic* president since the company was established in the early thirties. Floyd W. Woodworth, one of the founders, was president until his retirement in 1950.

* * *

RUFUS P. TURNER, a regular contributor to *RADIO & TELEVISION NEWS*, has been awarded the honorary degree of Doctor of Science by Golden State University in Hollywood in recognition of his contributions to radio literature and his simplification of electronic test instruments.

Mr. Turner will serve as a visiting lecturer at the college during the current school year.

* * *

JOHN T. CAVIEZEL has been appointed manager of the television sales section of the *Crosley Division of Avco Manufacturing Corporation*.

He joined the company in 1951 as sales promotion manager in the Kansas City zone. He later was made zone manager of electronics in Kansas City and for the past year has been manager of new market development for television, working out of the central office of *Crosley* in Cincinnati. He will be succeeded by DeWitt Suplee, who has been in charge of the new market development program in the Eastern division.



INTERNATIONAL RESISTANCE COMPANY of Philadelphia has started construction of a plant located in Boone, Watauga County, North Carolina. The plant, to be situated on a 20 acre tract will provide 40,000 square feet of work space. The plant is the company's second to be located in North Carolina. . . **GATES RADIO COMPANY** has opened a new office and stock distributing warehouse at 7501 Sunset Boule-

TRAIN FOR A SUPERVISORY POSITION IN **ELECTRONICS**

Thorough 2-year course covers electrical circuits and machinery, basic electronics and industrial electronics. Franklin Technical Institute graduates are in demand as junior engineers for research and test work, sales engineering, supervisory work on production lines and drafting room design work. Other engineering and technical courses. Coed. Day, evening. 45th year. Write for catalog.

FRANKLIN TECHNICAL INSTITUTE
46 Berkeley Street Boston 16, Mass.

**CODE SENDING
RECEIVING SPEED**

Be a "key" man. Learn how to send and receive messages in code by telegraph and radio. Commerce needs thousands of men for jobs. Good pay, adventure, interesting work. Learn at home quickly through famous Candler System. Quality for Amateur or Commercial License. Write for FREE BOOK.
CANDLER SYSTEM CO.
Dept. 2L, Box 928, Denver 1, Colo., U.S.A.

BARGAIN HUNTING? **RADIO SERVICEMEN!**

Write for SENSATIONAL CATALOG
HENSHAW RADIO SUPPLY
3619 TROOST KANSAS CITY, MO.

AUDELS **TV-RADIO SERVICE LIBRARY**

HERE IS LATE INFORMATION IN A HANDY FORM FOR RADIO & TELEVISION REPAIRMEN, SERVICEMEN & STUDENTS



2 VOLS. \$6 COMPLETE \$1 A MONTH. PAY ONLY 1 MO.

IT PAYS TO KNOW!

AUDELS T.V.-RADIO SERVICE LIBRARY presents the important subjects of Modern Radio, Television, Industrial Electronics, F.M. Public Address Systems, Auto, Marine & Aircraft Radio, Phonograph Pick-Ups, etc. Covers Basic Principles—Construction—Installation—Operation—Repairs—Trouble Shooting. Shows How to get Sharp, Clear T.V. Pictures. Install Aerials—How to Test. Explains Color Systems & Methods of Conversion. 1001 Facts—Over 1260 Pages—625 Illustrations—Parts & Diagrams—Valuable for Quick Ready Reference & Home Study. Tells How to Solve T.V. & Radio Troubles—Answers T.V. & Radio Questions.

Get this information for Yourself.
7 DAY TEST—ASK TO SEE IT!

MAIL ORDER

AUDELS Publishers, 49 W. 23 St., N.Y. 10
Mail AUDELS T.V.-RADIO SERVICE LIBRARY 2 Vols. \$6 on 7 days free trial. If O.K. I will remit \$1 in 7 days and \$1 monthly until \$6 is paid. Otherwise I will return them.

Name _____
Address _____
Occupation _____
Employed by _____

RADIO & TELEVISION NEWS

vard, Los Angeles, California. Robert Kuhl is in charge of the new operation . . . **HUDSON RADIO & TELEVISION CORP.** with headquarters at 48 West 48th Street, New York City, has opened a new salesroom in Newark, New Jersey, at 35 William Street. The new salesroom will feature a complete stock of radio and electronic components and sound equipment.

VINTON K. ULRICH has joined the *David Bogen Company* as general sales manager, replacing W. Walter Jablon who has resigned as the company's vice-president in charge of sales.



Mr. Ulrich, formerly renewal sales manager of the *National Union Radio Corporation*, brings to his new position an unusual combination of sales and engineering experience. He is a graduate of MIT and served as chief commercial engineer for *CBS-Hytron*. He is a director of the Radio Parts Show, a senior member of the IRE, a member of the AIEE, and a member of the Radio Club of America.

PHILIP S. RAND, a project engineer at the *Remington-Rand Laboratory of Advanced Research* in South Norwalk, Conn., has been awarded the ARRL's "Merit Award" in recognition of his "advancement of the welfare of amateur radio through outstanding leadership and technical accomplishment in reduction of TV interference."

Mr. Rand has done extensive research in the field of TVI elimination for several years from his home in Redding Ridge, Conn. His call is W1DBM.

PHOTO CREDITS

Page	Credit
47, 122	Walter Ashe Radio Company
48	G & H Wood Products Co. (Cabinets)
51, 60, 61, 62	Radio Corporation of America
52	Emerson Radio & Phonograph Corp.
56	Magne-Pulse Corporation
58	Skintron Electronics & Television Corp.
63, 64, 66, 152, 154, 180, 209	General Electric Co.
78, 79	Regency Div., I.D.E.A., Inc.
107	The Radio Craftsmen, Inc.
156	Allied Radio Corporation
188	Mohawk Business Machines Corp.

ERRATA

In the parts list accompanying Fig. 2, page 41, of the July issue ("125-Watt Audio System with Clipping") the value of T₄, the modulator plate transformer, was omitted. Any plate transformer delivering 1000 volts d.c. at 250 ma. may be used.

In the third column of the article appearing on page 49 of the August issue ("Trouble-shooting TV High-Voltage Supplies") the following sentence appears: "If an arc is obtained, touch the screwdriver to the plate cap of the horizontal output tube." This should read "If an arc is NOT obtained . . ."

Two of the dimensions given in the side view of the Electro-Voice "Regency" (page 51 of the August issue) are incorrect. The 5 3/4" dimension shown in the lower right-hand corner of the diagram should be 8 1/8" while the 2 1/2" dimension at the lower left should be 3 1/8". These dimensions are not critical and may be varied ± 10% without affecting performance.

RADAR—COMMUNICATIONS—TEST EQUIPMENT

- WE HAVE THE LARGEST STOCK OF MILITARY EQUIPMENT IN THE WORLD. ALL RECONDITIONED AND CHECKED OUT TO ORIGINAL SPECS. IN OUR OWN COMPLETELY EQUIPPED SHOP.
- APS-2 S-band search radar
 - APS-3 X-band search & homing radar
 - APS-4 X-band search & homing radar
 - APS-6 X-band search & gun laying radar
 - APS-10 X-band search & navigation radar
 - APS-15 X-band navigation & blind bombing radar
 - SO-13 S-band marine radar
 - SQ-10 CM portable radar
 - TPS-1 portable search radar
 - TPS-3 long range early warning ground radar
 - VC-VE-VF-VG remote PPI radar indicators
 - UPN-1&2 S-band paratripp radar beacon
 - SCR-602 early warning portable radar
 - APN-19 airborne S-band radar beacon
 - APQ-5 low alt. bombing attachment
 - APA-10 panoramic adaptor
 - APA-11 pulse analyzer used with APR equip.
 - APA-17 automatic bearing indicator used with APR equip.
 - APA-23 automatic sig. strength & time recorder
 - APA-38 panoramic adaptor 30 MC input used with APR equip.
 - APR-1 radar search rec. 38-1000 MC
 - APR-2 radar search rec. 85-1000 MC
 - APR-4 radar search rec. 38,4000 MC
 - APR-5 radar search rec. 1000-3100 MC
 - APR-6 radar search rec. 6000-10000 MC
 - APT-4 radar jammer 165-780 MC
 - APT-5 radar jammer uses 3C22 osc.
 - APN-4 airborne loran
 - APN-9 airborne loran
 - CPN-8 10 CM high pwr. ground radar beacon
 - APN-1 altimeter
 - CR-3 du 1 freq. victory girl
 - PPN-1 Rebecca transponder used with APN2
 - ARQ-5 automatic panoramic rec. 18-80 MC
 - ARN-7 automatic radio direction finder
 - SCR-555 direction finder 18-65 MCS
 - SCR-284 portable field radio station
 - AN/TRA-2 remote control equipment
 - SCR-619 freq. mod. field radio 120 channel
 - AN/ARC-1 radio tele. trans/rec.
 - SCR-522 V.H.F. trans/rec. 100-156 MCS
 - SCR-269G automatic R.D.F.
 - AN/ARN-7 automatic R.D.F.
 - SCR-291 radio direction finder
 - AN/TRC-1 V.H.F. radio tele. relay station
 - RC-261 radio remote control with RM-53, 52
 - BC-639 rec. 100-156 MC with RA42 power supply
 - BC-902 port. marker beacon xmitter 75 MCS
 - RC-103 instr. landing system
 - SCR-718C high altitude radio altimeter
 - SCR-536 handi-talkies 3-6 MC band oper.
 - AN/CRG-7 V.H.F. handi-talkies 112 MC
 - BC-191 transmitter
 - BC-325 airport high pwr. xmitter
 - BC-640 xmitter 100-156 MC 50 watt
 - DAK automatic direction finder marine
 - RAK-7 rec. w/p.s. 15-500 KC 110 v. 60 cyc
 - TCS marine equipment 1.5-12 MCS
 - BC-348 rec. 1700 KC-18 MC & 200-400 KC
 - BC-342 rec. 1700 KC-18 MC 115 v. 60 cyc
 - TS-3/AP S-band pwr. & freq. mtr.
 - TS-10/AP altimeter test set
 - TS-12/AP X-band VSWR test set
 - TS-13/AP X-band sig. gen. pwr. & freq. mtr.
 - TS-14/AP S-band sig. gen. & pwr. mtr.
 - TS-15/AP fluxmeter
 - TS-16/AP altimeter test set
 - TS-23/APN SCR-718 test set
 - TS-24/ARR2 test set
 - TS-32/AP TRC-1 test oscillator
 - TS-33/AP power test meter
 - TS-34/AP portable oscilloscope
 - TS-35/AP X-band sig. gen. pwr. & freq. mtr.
 - TS-36/AP X-band pwr. mtr. batt. oper
 - TS-45/AP X-band sig. gen. pwr. mtr.
 - TS-56/AP I-band slotted line
 - TS-59/APN altimeter test set
 - TS-51/AP S-band echo box
 - TS-62/AP S-band echo box
 - TS-67/AP ARN5 I.L.S. test set
 - TS-69/AP cavity type freq. mtr. 400-1000 MC.
 - TS-89/AP voltage divider
 - TS-98/AP pulse voltage divider
 - TS-102/AP precision range calibrator
 - TS-111/AP S-band wave meter
 - TS-114/AP AFS2 radar test set
 - TS-125/AP S-band precls. pwr. mtr.
 - TS-127/UP freq. meter 300-750 MC.
 - TS-148/UP 3 CM spectrum analyzer
 - TS-155/UP S-band sig. gen. pwr. mtr.
 - TS-170/ARNS I.L.S. hold test set
 - TS-184/AP echo box & attenuator
 - TS-226/AP pw. mtr. 300-1000 MC to 1 kw
 - TS-268/UP crystal diode test set 1-100 radio compass test set
 - I-208 tank radio test set
 - CW-60/ABM S-band freq. meter
 - BC-221 Freq. mtr. mod. & uhmod.
 - IE-19 ARC-1/SCR522 comp. test set
 - IE-36 SCR-522 test set

FAMOUS MAKE PANEL METERS

2 1/2" sq., any range milliammeter, d.c. voltmeter, r.f. ammeter. Large selection available.

\$2.95 EA.

WHILE THEY LAST!!

SPECIAL Give Away Offer

EIMAC TYPE 100TH TUBES

3 FOR \$15.50

NEW - - - GUARANTEED

ONE MILLION TUBES

In Stock At Low Prices

Receiving, Transmitting, Special Purpose, Cathode Ray, Klystrons, Magnetrons, Crystal Diodes, New, Standard Brands, Guaranteed.

EXPORTERS • GOVERNMENT AGENCIES • LABORATORIES • SCHOOLS!!

Consult us. Come to the source. Warehouses of our own stock. We will buy, sell or swap in any quantity. Space limits complete listings. Write for our catalog.

RADIO HAM SHACK, INC.

Cable: "Hamshack N. Y."
New York 13, N. Y.

CAnal 6-8446-7-8-9

368 Greenwich St.

Why Count Profits in Small Change?

WHEN YOU CAN STACK IT IN \$\$\$

Dealers and TV Service Organizations selling DAVIS SUPER-VISION ALL-CHANNEL TELEVISION ANTENNAS do count their PROFITS IN DOLLARS



SOLD TO YOU WITH A MONEY-BACK GUARANTEE



\$34.95

BUILT BY AMERICA'S FASTEST GROWING ANTENNA MANUFACTURER

Copyright 1953



DON'T WAIT! . . . Get the "BIG DOLLAR PROFIT FACTS" from our Jobber's Salesman in your area. We will get him in touch with you. USE COUPON.

DAVIS ELECTRONICS 1-39
BOX 1247, Burbank, California

SIRS: RUSH INFORMATION TO ME AS CHECKED:

- Send Complete Information and Technical Data on New SUPER-VISION ANTENNA.
- Send Name and Address of NEAREST JOBBER.

Name _____

Street _____

City _____ State _____

REAL SALE TUBE WHOLESALE PRICES!

Tube Orders Over \$15.00 with full remittance, Prepaid to you in U.S.A.

Stock up now on these amazing tube values! All tubes are of popular brands and fully guaranteed.

TYPE	NET	TYPE	NET	TYPE	NET
0A2	\$.90	6AT6	\$.55	12SQ7GT	\$.55
0A3/VR75	1.05	6AU6	.65	12SR7	.69
0B2	.80	6AV6	.49	12SX7GT	1.10
0C3/VR105	.95	6B8	.75	14F7	.75
0D3/VR105	.95	6BE6	.55	25AV5	1.70
0Z4/OZ4A	.55	6BH6	.75	25B06GT	1.00
1A7GT	.77	6B0GGT	1.13	25L6GT	.82
1B3GT/8016	.88	6BZ7	1.20	25Z6GT	.59
1E27	12.00	6C4	.50	28D7	1.55
1L4	.85	6C6	.58	35B5	.59
1L6	.85	6F4	3.95	35C5	.55
1N21B	1.95	6F5	.68	35L6GT	.60
1N23A	2.05	6F6M	.70	35Z3	.70
1N23B	2.25	6F8G	.85	35T(Eimac)	2.75
1N34A	.75	6G6G	.85	35Z5GT	.53
1N48	.50	6H6	.52	50A5	.77
1N54	.79	6J4	5.75	50B5	.55
1N54A	1.05	6J5GT	.50	50C5	.60
1N69	.60	6J6	.62	50L6GT	.65
1N70	1.25	6J7M	.75	.80	.66
1N81	1.00	6K4(Sylv)	3.00	.83	1.15
1U4	.55	6K4A	3.75	8M, 6Z4	.65
1R4/1299	.59	6K6GT	.55	117Z6	.98
1X2A	.90	6K7M	.60	211/VT4C	.88
1Z2	3.25	6L5G	.75	250TH	16.50
2C39A	14.75	6L6G	1.10	250TL	16.50
2C40	7.95	6L6GA	1.10	274A & B	3.00
2C51	3.95	6L6M	1.55	300B(WE)	7.95
2D21	1.20	6L7	.90	304TH	7.75
2E30 (Hyt)	2.05	6N7M	.80	304TL	7.75
2J39	7.95	6P7G	.88	310A(WE)	1.95
2J61	39.95	6Q7GT	.90	407A(WE)	4.50
2J62	39.95	6S7GT	.90	408A(WE)	2.50
2K25/723AB	23.95	6SD7GT	.80	700D	44.00
3A2	.44	6S6T	.66	717A	.88
3A4	.59	6S7J	.60	725A	4.70
3BP11	9.50	6SK7GT(Sylv)	.57	803	3.50
3B7/1291	.39	6SL7GT	.65	805	3.25
3C22	85.00	6SN7GT	.73	807	1.55
3C23(GE)	3.65	6V6GT	.66	811A	3.55
3C24/24G	1.35	6W4GT	.55	812A	3.95
3I6/1299	.35	6W6GT	.75	816	1.20
3E29/829B	9.95	6V6G	.88	829	7.05
3Q5GT	.99	6X5GT	.47	829B	12.70
3S4	.75	7A7	.75	832A	9.95
3L4	.90	7A8	.69	861	15.90
3K2500-A3	135.00	7B7	.76	866A(JAN)	1.55
4B24	4.95	7B8	.78	866A(CBS)	1.55
4B28/CE225	2.95	7C4	.29	869B	65.00
4C35	19.95	7C5	.69	872A	3.75
4E22	18.50	7C6	.69	931A	4.75
4-400A	33.00	7C30	85.00	955	7.95
4L50A	29.95	7E5	.39	958A	2.05
4S00A	79.95	7F7	.85	991/NE16	.50
5C22	39.00	7BP7	4.25	CK1005	.75
5D1(WE)	15.00	7H7	.75	1622(6L6M)	1.95
5H6Y	1.20	7J4(CBS)	19.95	1625	.25
5I4G	.55	10B4A(CBS)	19.95	1826	.18
5V4G	.95	12A17	.80	1629	.25
5W4	.80	12A07	.65	2050	1.55
5X4G	.75	12A6W	.88	5516(Hyt)	7.25
6AB7	.95	12A7	.75	5528/C8L	11.75
6AC7	.80	12A77	1.30	5551/FG271	57.50
6AF4	1.39	12B4A	.60	5806A	7.30
6AG5	.70	12B06	.75	5654	1.75
6AG7	1.25	12B6E	.60	5656	10.35
6AJ5	1.30	12B7	.98	5670	3.50
6AK5	.77	12S47	.69	5687	2.95
6AL5	.98	12S75	.70	5691	6.25
6ALS	.53	12S67	.80	5693	7.50
6AN4	1.50	12S7	.53	5800(Vict)	6.50
6AQ5	.55	12S7	.55	5814	2.20
6AS5	.70	12S7	.60	8020	1.98
6AS6	1.95	12S7GT	.65	9002	.85
6AS7G	3.95	12S7GT	.70	9004	.95

Above is a partial listing of our large stock. You may order types not listed at approx. the same savings.

SELENIUM RECTIFIERS

BUY DIRECT FROM MFR.
Full-Wave Bridge Types

Current (Continuous)	18/14 Volts	36/28 Volts	54/42 Volts	130/100 Volts
1 Amp.	\$1.35	\$2.15	\$3.70	\$6.50
2 Amps.	2.20	3.00	5.40	10.00
2 1/2 Amps.	3.00	4.50	7.50	13.00
4 Amps.	4.25	6.00	10.50	20.00
5 Amps.	4.75	6.75	11.50	22.75
6 Amps.	4.75	6.75	11.50	23.00
8 Amps.	6.75	10.00	17.50	33.00
10 Amps.	8.50	12.50	22.50	44.25
12 Amps.	11.25	16.25	29.00	57.50
20 Amps.	16.25	23.50	45.00	90.00
30 Amps.	20.00	28.50		
35 Amps.	24.00	48.50		

We can manufacture other Selenium Rectifiers, Selenium Rectifier Supplies, XFMRs., & Chokes.

* New Selenium Rectifier Transformers
PRI 115 V., 60 cycles in. } 4 Amps. \$6.75
SEC. 0, 12, 18, 24, and } 12 Amps. \$16.75
36 volts } 24 Amps. \$35.75
Continuous Ratings } 50 Amps. \$97.75

• New Selenium Rectifier Chokes
4 Amps.—.07 Hy.—.6 ohm \$7.95
12 Amps.—.01 Hy.—.1 ohm \$14.95
24 Amps.—.04 Hy.—.025 ohm \$29.95

BARRY ELECTRONICS CORP.

136 F Liberty Street, N.Y. 6, N.Y. REctor 2-2562

Terms: 25% with order, balance C.O.D. All merchandise guaranteed, F.O.B. N.Y.C.

INDEX OF Advertisers

OCTOBER 1953

While every precaution is taken to insure accuracy, we cannot guarantee against the possibility of an occasional change or omission in the preparation of this index.

ADVERTISER	PAGE	ADVERTISER	PAGE
Adelman, Nat	186	L. A. Ham Shack	164
Airex Radio Corp.	155	LaPointe Electronics Corp.	90, 91
Aermotor Co.	142	Leeds Radio Co.	176
All Channel Antenna Corp.	147, 151	Leotone Radio	128
Allied Electronic Sales	191	McGee Radio Company	120, 121
Allied Radio Corp.	9	McGraw-Hill Book Co., Inc.	206
Altec Lansing Corp.	190	McIntosh Engineering Labs., Inc.	176
American Distributing Co.	184	Mallory & Company, P. R.	4th Cover
American Phenolic Corp.	144, 145	Mattison Television & Radio Corp.	208
American Television & Radio Co.	129	Midwest Radio & Television Corp.	157
Amplifier Corp. of America	164	Miles Reproducer Co.	209
Angle Gesette Corp.	141	Milwaukee School of Engineering	110
Arco Electronics, Inc.	217	Mosley Electronic Inc.	18
Arkay Radio Kits	200	Moss Electronic Distributing Co., Inc.	143
Arrow Electronics	106	National Electric Products	20, 21
Arrow Sales, Inc.	169	National Electronics of Cleveland	158
Ashe Radio Company, Walter	119, 122	National Radio Institute	3
Atlas Sound Corp.	135	National Schools	31
Audak Company, Inc.	210	Newark Surplus Material Co.	208
Audel, Publishers	214	Nichols Wire & Aluminum Co.	152
Barry Electronics Corp.	216	Ohmite Mfg. Company	135
Bell Telephone Labs., Inc.	40, 200	Olson Radio Warehouse	130, 131
Boulevard Electronics, Inc.	177	Peak Electronics Co.	148
British Industries	148	Perma Power	106
Brook Electronics, Inc.	158	Philo Corporation	34
Brooks Radio & Television Corp.	154	Phillips Tube Company, Incorporated	192
Buchan Company, R. J.	186	Photocon Sales	161
Burstein-Applebee Company	160	Pickering & Company	22
C B S Hytron	10, 11, 25	Platt Electronics Corp.	173
Candler System	214	Premier Radio-TV Supply	139
Cannon Electric Company	112	Progressive Electronics Co.	112
Capitol Radio Engineering Institute	125	Punim Surplus	172
Centralab	19, 28, 148, 164, 174, 182, 186, 213, 217	RCA Audio Equipment	127
Century Electronics Co.	206	RCA Institute, Inc.	39, 209
Channel Master Corporation	36, 37	R W Electronics	199
Cleveland Institute of Radio Electronics	137	Radiart Corporation	24
Collins Audio Products Co., Inc.	133	Radio City Products, Inc.	188
Columbia Electronics Sales	114	Radio Corporation of America	2nd Cover
Commercial Trade Institute	189	Radio, Craftsmen, Inc.	165
Commissioned Electronics Co.	195	Radio Electric Service Co.	214
Communication Equipment Co.	108	Radio Products Service	200
Concord Radio	114	Radio Shack Corporation	215
Corona Radio & T V Co.	209	Radio Receptor Co., Inc.	171
Coyne Electrical School	166	Radio Shack of Boston	175
Davis Electronics	215	Radio-Television Training Association	23
DeCray & Assoc., Frank W.	198	Rad-Tel Tube Co.	211
DeForest's Training, Inc.	5	Rauland Corporation	93
Delco Radio Corporation	3rd Cover	Raytheon Mfg. Company	15
Eastern Telephone Co.	192	Reeves Soundcraft Corp.	189
Editors & Engineers Limited	116	Rinehart Books, Inc.	108, 170, 205
Electronic Chemical Corp.	162	Rohn Mfg. Co.	207
Electronic Expeditors, Inc.	213	Sams & Co., Inc., Howard W.	118, 134
Electronic Instrument Co., Inc.	134, 146, 150, 191	Sangamo Electric Co.	35
Electronic Specialty Supply Co.	88, 203	Scott Company, Walter L.	158
Electro Voice	8	Scott, H. H.	138
Espey Manufacturing Co., Inc.	167	Shields Labs., Inc.	180
Fairchild Recording Equipment	167	Shure Brothers, Inc.	130
Fair Radio Sales	209	Simpson Electric Co.	148
Falcon Electronics Co.	32, 33	South River Metal Products Co., Inc.	128
Federal Telephone & Radio Corporation	87	Sprague Products Company	16, 17
Fisher Radio	30, 153	Sprayberry Academy of Radio	29
Franklin Technical Institute	214	Stan Burn Radio & Electronics Co.	206
G & G Radio Supply Company	181	Standard Surplus	179
G & H Wood Products Co.	192	Standard Transformer Corp.	195
G. L. Electronics	136	Stephan Sales Corp.	208
General Cement Manufacturing	14	Steve-El Electronics Corp.	161
General Electric	41, 123	Stevens Walden, Inc.	178
Good, Inc., Don.	191	Sun Parts Distributors, Ltd.	198
Goodheart, R. E.	189	Supreme Publications	167
Greenlee Tool Co.	161	Suprex Electronics	168
Halicrafters	7	Sylvania Electric Products, Inc.	89
Harjo Sales Co.	150	TAB	218
Harrison Radio	212	Technical Appliance Corp.	150
Harvey Radio Company	172	Tech-Master Products Co.	124
Hawkins Name Plate Company	189	Tee-Vee Supply Co.	159
Heath Company	94, 105	Television Communication Institute	154
Henry Radio Stores	128	Television Materials Corporation	150, 200
Henshaw Radio Supply	214	Teraco Company	156
Hi-Lite Electronic Sales Co.	184	Terminal Radio	184
Hollywood Technical Institute	114	Transvision, Inc.	183
Hudson Radio & TV Corp.	187	Triad Transformer Mfg. Co.	196
Hughes Research & Development Laboratories	92, 110	Tri-Manufacturing Company	26, 27
I. E. Manufacturing Co.	171	Triplett Electrical Instrument Co.	12
Indiana Technical College	195	Tri-State College	200
Instructograph Company	192	Tung-Sol Electric Inc.	198
International Correspondence Schools	13	Turner Company, The	194
International Resistance Co.	107, 109, 111, 113, 115, 117	United Technical Laboratories	142, 198
J. J. Glass Electronics Co.	190	Utah Radio Products Co.	88
J S H Sales Co.	176	V-M Corp.	171
Jensen Industries	162	Valparaiso Technical Institute	146
Jersey Specialty Co.	168	Video Electric Co.	172
Jones & Laughlin Steel Corporation	149	Ward Products Corp.	6
Kaar Engineering Company	126	Weller Electric Corp.	197
Kay-Townes Antenna Company	140, 141	Wells Sales, Inc.	202
Kester Solder Company	124	Weils & Winegard	185
Kirk, Jim	186	Western Electronics Co.	146
		Westinghouse Electric	38, 204
		Windsor Electronics Tube Co.	162
		Wholesale Radio Parts, Inc.	193
		World Radio Laboratories, Inc.	201

TOP TV SERVICE REQUIRES

TOP Quality COMPONENTS

and for TOP QUALITY ask for

Elmenco Paper Tubulars



That white, ceramic-cased paper tubular is appearing in more and more TV circuits as new models roll off the lines... your assurance that this unit excels those which preceded it.

Follow the lead of these manufacturers by offering your customers complete satisfaction with components which will require no further replacement during the life of their sets.

Air-Tight, Water-Tight, Y at Reasonably Priced

Just Wind in and Forget.

And you can keep a stack of Elmenco Capacitors or hard without worry of deterioration on the shelf. They have unlimited shelf life.

Contact your local jobber for full information and ask him about our handy paper tubular kits.



STANDARD PAPER KIT

5 Each of 25 Capacities

.004 to .1—600V; .25—40V & .5—200V List Price \$37.50

Write for Our Descriptive Catalog of Complete Elmenco Line

ARCO ELECTRONICS INC.
103 LAFAYETTE ST., N. Y. 13, N. Y.

Classified

Rate 50c per word. Minimum 10 words

RADIO ENGINEERING

COMPLETE radio, electronics theory & practice: television; broadcasting; servicing; aviation, marine, police radio. 12 or 18 months. Catalog. Valparaiso Technical Institute, Dept. N, Valparaiso, Ind.

FOR SALE

RECONDITIONED Televisions, \$30 up. W4API, 140 South Randolph, Arlington, Va.

RECONDITIONED TV sets \$30.00. Jones, 1115 Rambler Ave., Pottstown, Pa.

ATTENTION Bargain Hunters! Complete transmitter and receiver installations for USAF airplanes. Also includes 6 coils, dynamotors, all control boxes, filters, antenna switching relays, remote tuning controls, etc. Estimated government cost over \$2000.00 each. While they last, only \$59.00 Gaare Supply Company, Box 277-Q, Weatherford, Texas.

ISOLATION transformer 35w 117v sec. 117 or 135 plus 6.3v .45a tap. 3 lbs. \$2.45 plus postage. Send for flyer. Surplus bought. Empire Electronics Co., 409a Ave. L, Brooklyn 30, N. Y.

DIAGRAMS—Radio \$1.00; record changers, recorders \$1.25. Television with service data \$2.00. Where model unknown, give part numbers. Kramer's Radio Service, Dept. S53, 36 Columbus Ave., New York 23, N. Y.

TV-FM antennas. All types including UHF. Mounts, accessories. Lowest prices. Wholesale Supply Co., Dept. H, Lunenburg, Mass.

TUBES and equipment bought, sold, and exchanged. For action and a fair deal, write B. N. Gensler, W2LXI, 136-F Liberty, New York 6, N. Y.

NEW RCA 3AP1A original cartons, \$8.75 each. Tubes, surplus—bought, sold. Free list. Write, Mark, Box 14, New York City 72.

TAPE Recorders, Tapes, Accessories. Unusual Values. Dressner, 624-R East 20th St., N.Y.C. 9.

WANTED

WANTED: Signal Corps Supply Catalogs, APR-4 Parts. Jerrell Electronic Inc., 1970 Neva Drive, Dayton 4, Ohio.

AN/APR-4, other "APR-," "ARR-," "TS-," "TE-," ARC-1, ARC-3, ART-13, everything surplus; Tubes, Manuals, Laboratory equipment. Describe, price in first letter. For Sale: Reconditioned Walthour Meters, four for \$10.00. Engineering Associates, 434 Patterson Rd., Dayton 9, Ohio.

WILL buy all ART-13/type T-47A \$200.00; ART-13/type T-47, \$150.00; RC-348 unmodified \$65.00, RC-348 modified \$50.00; APN-9 \$200.00; ARC-3 complete \$600.00; R77 Receivers \$300.00; ARC-1 \$300.00; BC-312 \$60.00; RC-342 \$60.00. Ship via Express C.O.D., subject to inspection to: H. Finnegan, 49 Washington Avenue, Little Ferry, N. J.

CORRESPONDENCE COURSES

USED correspondence Courses and Books sold and rented. Money back guarantee. Catalog free. (Courses bought.) Lee Mountain, Pisgah, Ala.

USED Correspondence Courses and Educational Books bought, sold, rented. Free catalog. Educational Exchange, Summerville, Ga.

YOU can prepare yourself for a high-paying position as Technical Writer. Sample lesson, \$1. Write Box 421, Hatboro, Pa.

BUSINESS OPPORTUNITIES

BUY Wholesale 25,000 items. Catalog 25c. Matthews, 1472-R1 Broadway, N. Y. C. 36.

MISCELLANEOUS

SPEAKERS repaired, wholesale prices, guaranteed workmanship. Amprite Speaker Service, 70 Vesey St., New York City 7.

CALL Letters: 25c a set. Dress up your rig, car, etc. Write for sample. Nickcon, Box 272, Cincinnati 1, Ohio.

BUSINESS Cards \$2.50, Stickers \$1.50, 1,000, Signal, 927AC, Los Altos, Calif.

TEST Equipment Repaired and Calibrated by Factory Staff. All makes Solar, Simpson, Triplett, Heath, etc. Immediate service. Douglas Instrument Laboratory, 176 Norfolk Ave., Boston 19, Mass.

AUDIOPHILES—Music Hobbyists. Carry on exchanges between other HI-FI enthusiasts via wire-telephone or tape talk. Registration \$3.00 year. Global Talkwire Club, Box 630, Marvista 79, Calif.

Hi-fi COMPENTROL*

... sweet-sounding business builder

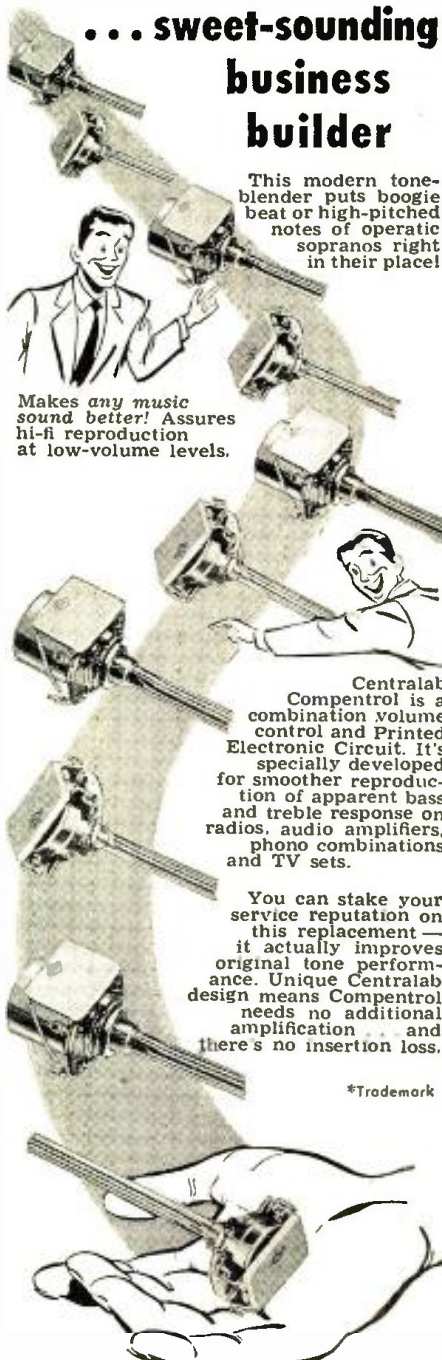

This modern tone-blender puts boogie beat or high-pitched notes of operatic sopranos right in their place!

Makes any music sound better! Assures hi-fi reproduction at low-volume levels.

Centralab Compentrol is a combination volume control and Printed Electronic Circuit. It's specially developed for smoother reproduction of apparent bass and treble response on radios, audio amplifiers, phono combinations and TV sets.

You can stake your service reputation on this replacement — it actually improves original tone performance. Unique Centralab design means Compentrol needs no additional amplification — and there's no insertion loss.

*Trademark

Your Centralab distributor has Compentrols in stock, in 1/2 and 1 meg, plain or switch types. See him for your supply and complete information.

Centralab

CENTRALAB, A Division of Globe-Union Inc. 910-J.E. Keefe Ave., Milwaukee 1, Wis.

Please send me additional technical data on Compentrol.

Name.....

Firm.....

Address.....

City.....Zone.....State.....

Valuable 3-way aid for Auto Radio Repair Men!

Once you're on the Delco Radio team you're in line for this three-way help: a reliable source for Delco Radio *original* equipment replacement parts and *universal* replacement parts; a complete and comprehensive Delco Radio Service Manual; monthly issues of "Testing Tips," a bulletin giving the very latest factory information on testing and repairing Delco car radios—even the sensational new "Favorite Station" Signal-Seeking model! To get going with Delco Radio contact your nearest United Motors *Electronics* Parts Distributor. Don't delay—act today!



DELCO RADIO

DIVISION, GENERAL MOTORS CORPORATION, KOKOMO, INDIANA

A GENERAL MOTORS PRODUCT  A UNITED MOTORS LINE

DISTRIBUTED BY *ELECTRONICS* WHOLESALERS EVERYWHERE

GOOD FOR
A
**LONG
TIME**

Mallory Vibrators

are your answer for long, dependable service... that you can be sure of. Their precision quality and uniformity means longer life... satisfied customers... an end to the call-back problem.

There are other advantages, too. The patented, tuned mechanism in Mallory Vibrators gives you these exclusive performance features:

- ← **Less wear... because of slow contact make**
- ← **Low resistance... because of high contact pressure**
- ← **Reduced arcing... because of fast clean break**

These are reasons why 5 out of 6 service men prefer Mallory Vibrators for all their service work... and why more are used as original equipment than all other makes combined.

Order Mallory the next time you call your distributor. The line is complete and meets original equipment specifications. You'll get better vibrators that cost no more. Every job you turn out will be right the first time.



P. R. MALLORY & CO. Inc.
MALLORY
CAPACITORS • CONTROLS • VIBRATORS • SWITCHES • RESISTORS
RECTIFIERS • POWER SUPPLIES • FILTERS • MERCURY BATTERIES
APPROVED PRECISION PRODUCTS
P. R. MALLORY & CO., Inc., INDIANAPOLIS 6, INDIANA

*Depend on Mallory
for
Approved Precision Quality*