

RADIO & TELEVISION NEWS

**JUNE
1953**

IN THIS ISSUE

**MOBILE FM RADIO OF
HIGH SELECTIVITY**

FLEXIBLE WAVE GUIDE

**MAGNETIC AMPLIFIER
TEMPERATURE CONTROLLER**

TRAVELING-WAVE TUBE

TESTING VACUUM TUBES

**V. H. F. COMMUNICATIONS
IN KOREA**

ELECTRO-VOICE ARISTOCRAT

**KNOW YOUR 1953 PHILCO
TV RECEIVERS**

TRANSISTOR BAND SPOTTER

INTERNATIONAL SHORT-WAVE

(See Page 69)



How's your

"welcome" rating?

YOU can measure your "welcome rating" on the basis of how many times you have to visit a customer to satisfactorily complete one service call. The *less frequently* you are called back, the *more* your good services are appreciated. Fewer call-backs cut overhead . . . build confidence . . . leave you *more* time for *more* satisfied customers. Cutting call-backs is the most effective way of snowballing your profits.

The RCA trade-mark makes your call doubly effective. First, because customers have confidence in products bearing the RCA trade-mark. Second, because experience has proven that the superior quality of RCA Receiving Tubes and Kinescopes is your best measure of protection against costly call-backs due to premature tube failures. You can be sure that, with RCA Tubes, the job is well done.

Helping you to safeguard your reputation is a vital, everyday service of RCA Tubes. And that protection is yours at no extra cost.

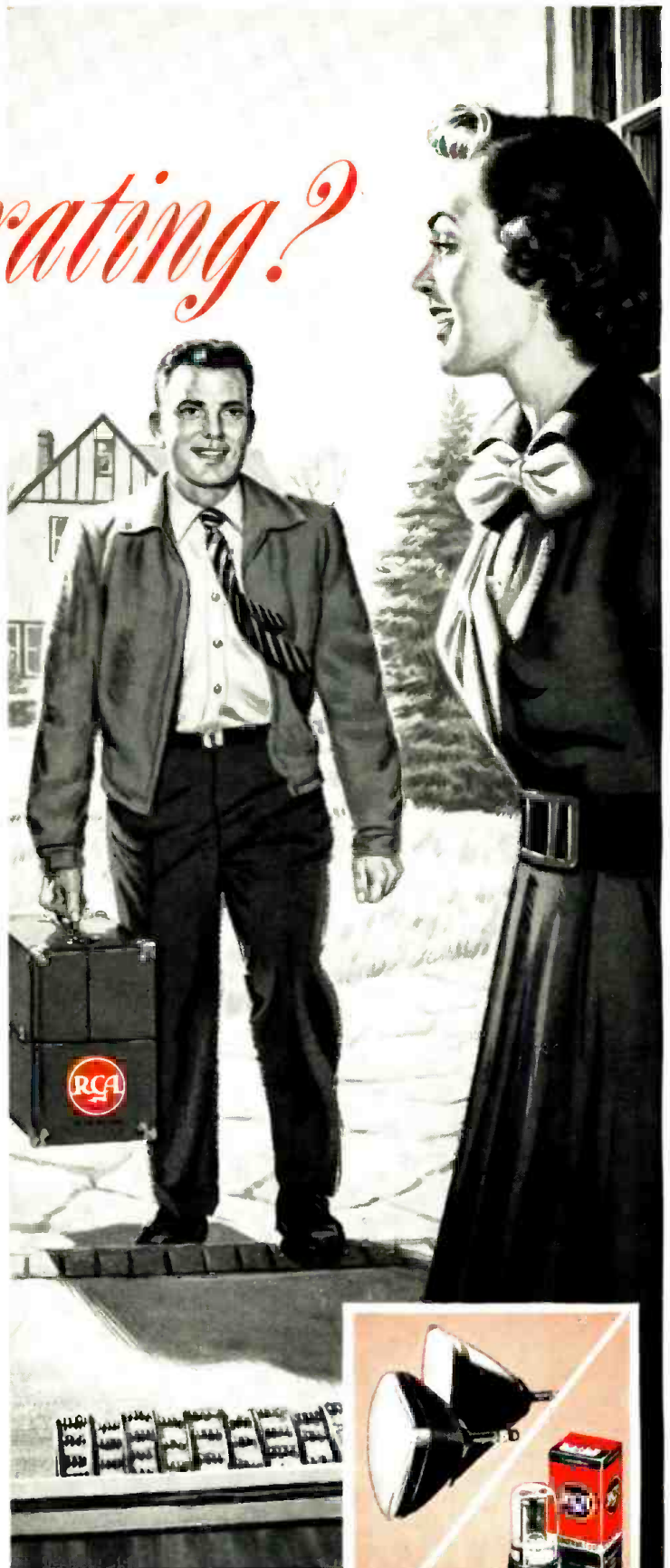

Unlock the
door to
bigger profits

Here's *your* key to better business . . . RCA's dynamic Dealer Identification Program. Ask your **RCA Tube Distributor** for your copy of the colorful, 16-page booklet "A Magic Pass-Key to Customer Confidence." It tells you how—for the first time—you can become a Registered Dealer . . . and get *extra* sales benefits.



RADIO CORPORATION of AMERICA
ELECTRON TUBES

HARRISON, N. J.

NEW



I'LL TRAIN YOU FOR YOUR FCC LICENSE

A Federal Communications Commission Commercial Operator's License puts you in line for a good job in Radio or Television Broadcasting, Police, Marine, Aviation, Two-way, Mobile or Micro-wave Relay Radio. Mail coupon below for 64-page book FREE. It will give you complete facts about my NEW Communications course.

YOU BUILD THIS TRANSMITTER

with parts I send. With this Transmitter you practice how to put a station "on the air." You perform procedures demanded of Broadcast Station Operators, conduct many experiments, make many practical tests.

LEARN COMMUNICATIONS by PRACTICING at Home in Spare Time

Get Practical Experience on Circuits Common to Radio & TV

Ever think HOW FAST Radio-Television Communications is changing, developing, growing? Have you considered what this amazing progress can mean to you? Even without Television the industry is bigger than ever before. 105 million home and auto radios, 2900 Radio Broadcasting Stations, 108 TV Stations with 1800 more now authorized. Expanding use of Aviation and Police Radio, Micro-Wave Relay, Two-Way Radio for buses, taxis, etc. makes opportunities for Communications Technicians and FCC Licensed Operators. New jobs, more jobs for beginners! Better jobs, better pay for experienced men!

Television Is Today's Good Job Maker

In 1952, over 18,000,000 homes had TV sets. More are being sold every day. The "Freeze" on building new TV stations has been lifted. The time to act is NOW! Start learning Radio-TV communications. America's fast growing industry offers good pay, a bright future, security. If you are a beginner, my course can help you get FCC License, prepare for the job you

J. E. SMITH, President
National Radio Institute
Washington, D. C.

For 38 years, the leader
in training men for
Radio-Television.



MY COURSE INCLUDES TELEVISION

want. If you've had some training in Radio or Radar, or as a Licensed Operator, my course modernizes, increases the value of your knowledge.

Includes New Developments

Mail coupon now for facts about my practical course in Radio-Television Communications. Let me send you my FREE book. See the nine big Kits of Parts I send that "bring to life" theory you learn. You get practical experience by working on circuits common to both Radio and Television; also lessons on TV principles. Read about the Transmitter you build and operate, about the Electronic Multitester you get. All equipment is yours to keep.

My graduates are filling jobs, making good money in both Radio and Television. Remember, the way to a successful career in Television is through experience in Radio.

Mail Coupon for Book FREE

Send today! See what my Communications course is like. Find out how I get you ready for a brighter future, better earnings, more security in Radio-Television. Send coupon now in envelope or paste on postal. NO OBLIGATION, NO SALESMAN WILL CALL! My book, sent to you FREE, tells the full story. J. E. SMITH, President, Dept. 3 CE, National Radio Institute, Washington 9, D. C. Our 39th year.



YOU BUILD this Transmitter Power Supply used in the basic experiments in RF and AF amplifiers, frequency multipliers, buffers, etc.



YOU PRACTICE setting up code, amplitude and frequency modulation circuits (put voice, music, etc., on "carrier signals" you produce). You learn how to get best performance.



YOU MEASURE current, voltage (AC, DC and RF), resistance and impedance in circuits with Electronic Multitester you build. Shows how basic transmitter circuits behave; needed to maintain station operation.

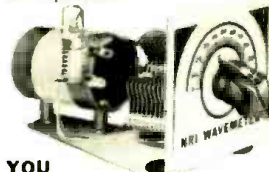

YOU BUILD this Wavemeter and use it to determine frequency of operation, make other tests on transmitter currents.

Training Leads to Jobs Like These

BROADCASTING
Chief Technician
Chief Operator
Power Monitor
Recording Operator
Remote Control Operator
SHIP AND HARBOR RADIO
Chief Operator
Assistant Operator
Radiotelephone Operator

GOVERNMENT RADIO
Operator in Army, Navy, Marine Corps, Coast Guard
Forestry Service
Dispatcher
Airways Radio Operator
POLICE RADIO
Transmitter Operator
Service Technician

AVIATION RADIO
Plane Radio Operator
Airport Transmitter Operator
TELEVISION
Pick-Up Operator
Voice Transmitter Operator
TV Technician
Remote Control Operator

I TRAINED THESE MEN



"My position with WNBT is video control engineer on the RCA color project. I owe a lot of my success to your textbooks."—Warren Deem, Malverne, N. Y.



"I am a technician at WTOP in Washington and I like it very much. Most of my radio knowledge was from N. R. I."—John Britto, Hyattsville, Md.



"A former employer recommended N. R. I. training. Now employed as transmitter operator at WKBO."—Albert Herr, New Cumberland, Pa.

AVAILABLE TO
VETERANS
UNDER G. I. BILLS

Servicing Training Also Offered by N. R. I.

If you prefer a good-pay job in Radio-Television Servicing or your own money-making Radio-Television Sales and Service Shop, I'll train you at home. My famous Servicing Course also includes many Kits of Radio Parts. You use them to get PRACTICAL EXPERIENCE with circuits common to Radio and Television. I also show you how to make \$5, \$10 a week or more EXTRA MONEY fixing neighbors' Radios while training. Full information in my 64-page book. Mail coupon.

MAIL NOW-BOOK FREE

MR. J. E. SMITH, President, Dept. 3 CE
National Radio Institute, Washington 9, D. C.

Mail me Sample Lesson and 64-page Book, FREE. (No salesman will call. Please write plainly.)

Name _____ Age _____
Address _____
City _____ Zone _____ State _____

VETS write in date of discharge

Publishing Company at 64 E. Lake St., Chicago 1, Ill. Entered as second-class matter July 31, 1948, at the Post Office, Chicago, Ill., under the act of March 31, 1879. Authorized by Post Office Department, Ottawa, Canada, as second-class matter. **SUBSCRIPTION RATES:** Radio & Television News—one year, U. S. and Possessions, Pan-American countries, and Canada, \$4.00; all other foreign countries \$5.00. Radio-Electronic Engineering Edition—one year, U. S. and Possessions, Pan-American countries, and Canada \$6.00; all other foreign countries, \$7.00. Postmaster—Please return undelivered copies under form 3580 to 64 E. Lake St., Chicago 1, Ill.

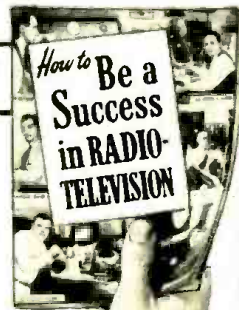

Editor and Asst. Publisher
OLIVER READ, D.Sc., WIETI

Managing Editor
WM. A. STOCKLIN, B.S.

Technical Editor
H. S. RENNE, M.S.

Service Editor
CHARLES TEPFER

Amateur Radio Editor
N. ROSA, W1NOA

Assistant Editors
P. B. HOEFER
M. C. MAGNA

Television Consultant
WALTER H. BUCHSBAUM

Short-Wave Editor
KENNETH R. BOORD

Staff Artist
FRANK SAYLES

Draftsmen
A. A. GANS, W2TSP
J. A. GOLANEK

Advertising Manager
L. L. OSTEN
Midwest Adv. Manager
JOHN A. RONAN, JR.

Western Adv. Manager
JOHN E. PAYNE

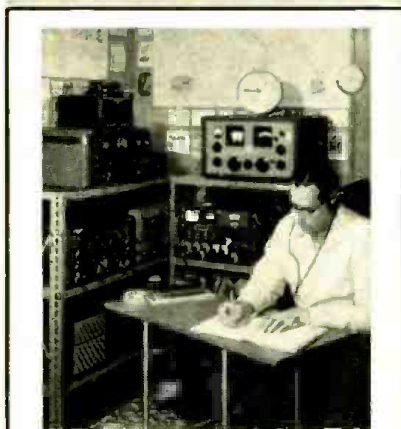

COVER PHOTO: Ken Boord, RADIO & TELEVISION NEWS' Short-Wave Editor, logs another station at his Listening Post in Morgantown, W. Va. (Ektachrome by David Creel)

ZIFF-DAVIS PUBLISHING COMPANY

Chairman of the Board and Publisher
WILLIAM B. ZIFF

President
B. G. DAVIS

Secretary-Treasurer
G. E. CARNEY

Vice-Presidents
H. J. MORGANROTH
Production Director
LYNN PHILLIPS, JR.
Advertising Director
H. G. STRONG

Circulation Director

BRANCH OFFICES

CHICAGO (1)
 64 E. Lake St., AN 3-5200
 LOS ANGELES (14)
 Staller Center, 900 Wilshire Blvd., Mich. 9856

RADIO & TELEVISION NEWS

REG. U.S. PAT. OFF.

First in
radio-television-electronics
 Average Paid Circulation over 200,000

Radio News Trademark Reg. U. S. Pat. Office • Television News Trademark Reg. U. S. Pat. Office.

CONTENTS

JUNE, 1953

V.H.F. Communications in Korea.....	<i>1st Lt. Richard G. Gould</i>	35
Using a Transistor to Increase Relay Sensitivity.....	<i>Louis E. Garner, Jr.</i>	39
Why Use a Condenser?.....	<i>Rob Wagner, W6WGD</i>	40
Tunable Hum in Broadcast Receivers.....	<i>Sidney Wald</i>	42
Equalizer-Preamp.....	<i>Arthur J. Rose</i>	43
A \$5 Low-Pass Filter.....	<i>J. G. Rountree, W5CLP</i>	47
D.C. Distribution in TV Receivers.....	<i>Walter H. Buchsbaum</i>	48
TV Parts Replacement Guide.....		51
Transistor Band Spotter.....	<i>Peter G. Sulzer, W3HFW</i>	52
Noise Immunity Circuits (Part 2).....	<i>Milton S. Kiver</i>	54
Lie Detector.....	<i>Edwin Bohr</i>	56
Know Your 1953 Philco TV Receivers.....	<i>Dan Lerner</i>	58
The Fisher Master Audio Control.....	<i>John R. Russell</i>	62
Electro-Voice Aristocrat.....	<i>Howard Souther</i>	64
Three Watts in a Coffee Can.....	<i>Jim Fahnestock, W2RQA</i>	66
Mac's Radio Service Shop.....	<i>John T. Frye</i>	68
An Oscilloscope Calibrator.....	<i>Richard Graham, W1VJV</i>	70
A Novel Probe Switch.....	<i>Milton White</i>	72
G-E's Internal Magnetic Focus System.....		82
New TV Grants Since Freeze Lift.....		84
Time Compressor.....		96
4-Channel Continuous Recorder-Reproducer.....		100
Service Hints on Philco TV Sets.....		120
New TV Stations on the Air.....		124
Radio-TV Service Industry News.....		154

DEPARTMENTS

For the Record..... <i>The Editor</i>	8	What's New in Radio.....	77
Spot Radio News.....	14	Manufacturers' Literature.....	88
Within the Industry.....	24	New TV Products.....	134
Short-Wave..... <i>K. R. Boord</i>	69	Technical Books.....	149



COPYRIGHT 1953
 (All Rights Reserved)
ZIFF-DAVIS PUBLISHING COMPANY
 Editorial and Executive Offices
 366 Madison Ave., New York 17, N. Y.
VOLUME 49 • NUMBER 6



Member
 Audit Bureau of
 Circulations

SUBSCRIPTION SERVICE: All communications concerning subscriptions should be addressed to Circulation Dept., 64 E. Lake St., Chicago 1, Ill. Subscribers should allow at least two weeks for change of address.

CONTRIBUTIONS: Contributors are advised to retain a copy of their manuscripts and illustrations. Contributions should be mailed to the New York Editorial Office and must be accompanied by return postage. Contributions will be handled with reasonable care, but this magazine assumes no responsibility for their safety. Any copy accepted is subject to whatever adaptations and revisions are necessary to meet the requirements of this publication. Payment covers all author's, contributor's, and contestant's rights, title, and interest in and to the material accepted and will be made at our current rates upon acceptance. All photos and drawings will be considered as part of the material purchased.

RADIO & TELEVISION NEWS

NOW...from D.T.I.'s MILLION DOLLAR TRAINING CENTER

Learn to master **TELEVISION**

RADIO - ELECTRONICS
by getting **EVERYTHING YOU NEED!**

**NOW—
get training
to suit your NEEDS**

**TAKE YOUR
CHOICE**

**Come to
D.T.I.'s
great CHICAGO
LABORATORIES**

...one of the Nation's FINEST!

Now, in the heart of the nation's TV Center, you can get all of your preparation in D.T.I.'s big, modern, wonderfully equipped training laboratories. Loads of commercial equipment and ample, well qualified instructors help you get a thorough, practical preparation in the **SHORTEST POSSIBLE TIME**. Part time student Employment assistance can help you pay your way while in training.

EMPLOYMENT SERVICE

As soon as you complete either the Chicago Laboratory or Home Training, you'll find D.T.I.'s grand Employment Service ready to help you start earning real money. Get full facts. Mail coupon today.

MILITARY SERVICE: If subject to military service, the training information we have for you should prove very helpful. Mail coupon today.

**89 WAYS
TO
EARN
MONEY
IN TELEVISION
RADIO-ELECTRONICS**

ACT NOW! MAIL COUPON TODAY
Get this publication **FREE!**

DeFOREST'S TRAINING INC.
2533 N. ASHLAND AVE., CHICAGO 14, ILL.

I would like your Opportunity News Bulletin showing "89 Ways to Earn Money In Television-Radio-Electronics"; also, complete facts about the training opportunity made possible by your organization.

Name _____ Age _____
Address _____ Apt. _____
City _____ Zone _____ State _____

**Get ALL of your training
AT HOME!...including setting
up your own HOME LABORATORY**

America's amazing multi-billion dollar Television field now offers you a chance of a lifetime to get started toward a grand job or your own business. With TV station limit now raised from over 100 to 2053, Television is headed for almost every community. Mail coupon today. See how you may prepare to cash in on the coming TV BOOM.



ABOVE: You build and keep this big 5 INCH commercial-type oscilloscope — one of the most useful test units used in TV today.

See how you may now get one of today's most complete, effective combinations of major home training aids—including (1) well illustrated lessons, (2) the wonderful aid of HOME TRAINING MOVIES and (3) 21 big shipments of electronic parts for setting up your own HOME LABORATORY. You work over 400 construction and test procedures to get the practical experience you need. This includes building and keeping a 5 INCH "SCOPE", jewel bearing MULTI-METER and a big 21 INCH TV SET. (D.T.I. offers another home training in Television-Radio-Electronics, but without the TV set.) Mail coupon today for exciting facts.



21 INCH

You build and keep this outstanding 21 INCH—sharp image—D.T.I. quality—engineered TV set. Can be readily converted to receive U.H.F.

Use 16 mm. MOVIES Only D.T.I. provides you with the loan of visual training movies at home to help you master important basic points faster... easier... better!



"ONE OF AMERICA'S FOREMOST
TELEVISION TRAINING CENTERS"
— Established 1931 —



De FOREST'S TRAINING, INC.
AFFILIATED WITH
De VRY Technical INSTITUTE
CHICAGO 14, ILLINOIS

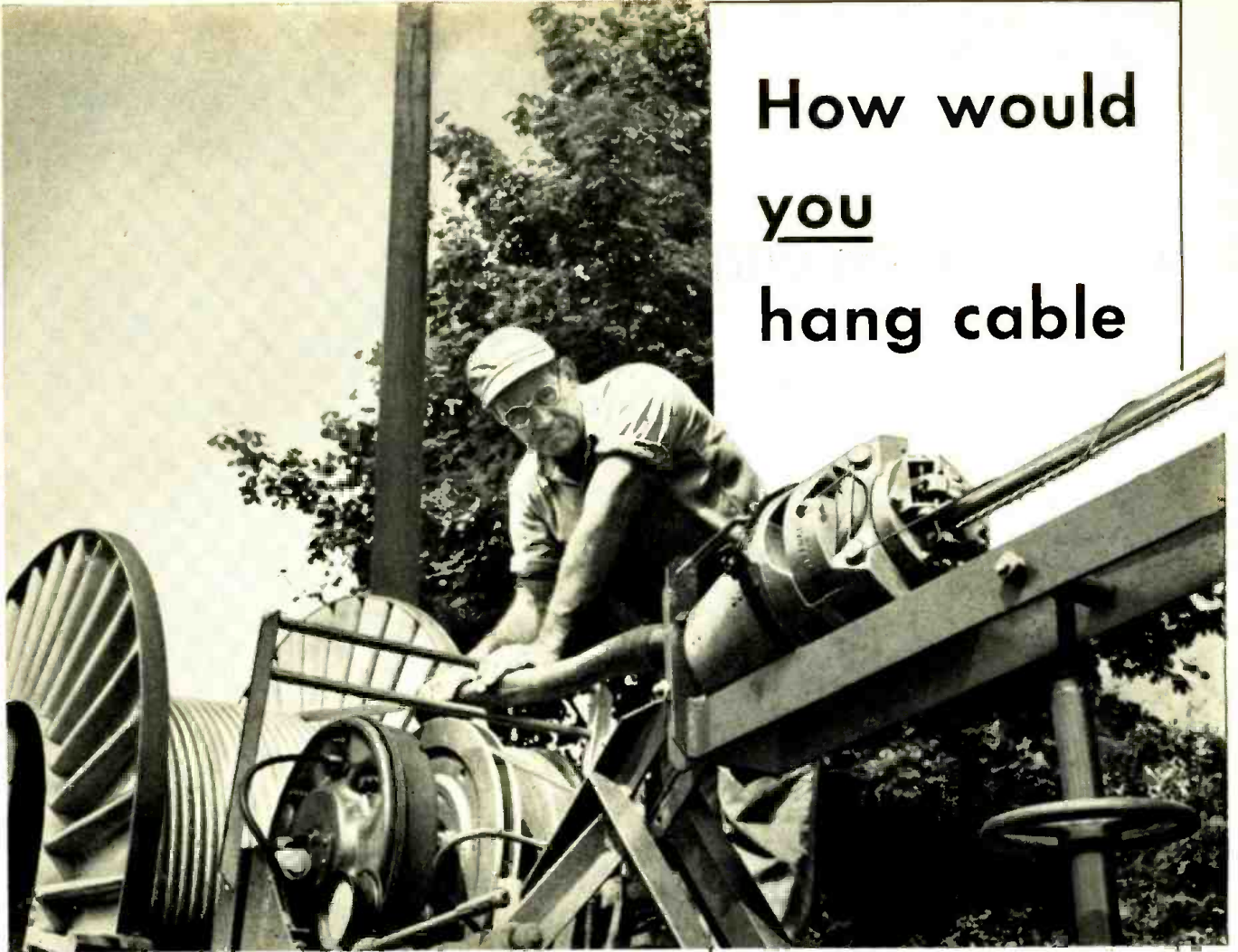

How would
you
hang cable

Cable lasher appears to right of workman. As the cable and supporting strand feed through, the machine rotates, binding them together with steel lashing wire. Meanwhile, a winch hauls the lashed cable into position.

...by the
mile?

It is a job your telephone company faces every day. Thousands of miles of cable go up each year—all secured to steel strand running from pole to pole. The best way to secure cable is to *lash* it to the strand with a spiral binding of wire.

One way to do this is to raise cable and strand separately, then lash them together by a rotating machine pulled along by workmen on the ground. This produces a strong, tight support for the cable. But each pole has to be climbed as many as four times. So Bell Laboratories engineers devised an easier way.

Now, lashing can be done *on the ground* so that cable, strand and lashing wire may be pulled into position as a complete assembly. Usually workmen need make only two trips up each pole.

For telephone users, the new way means that cable can be installed faster, while costs are kept down. It shows again how work at Bell Telephone Laboratories improves each part of your telephone system.

Bell Telephone
Laboratories



IMPROVING TELEPHONE SERVICE FOR
AMERICA PROVIDES CAREERS FOR CREATIVE
MEN IN MECHANICAL ENGINEERING

QRK?*

ALWAYS TOPS WITH A hallicrafters



You'll have the best QRK 100 watts can give with Halli-crafters HT20 transmitter—and you'll *listen* to more and hear it better on a Hallicrafters receiver. You be the judge—you hear the difference!

It's value like this—and more of it dollar-for-dollar in every price class—that has made Hallicrafters equipment the unchallenged first choice of the world's most critical

expert, the American amateur radio operator, for 19 years.

Hallicrafters equipment is designed specifically for the ham operator—planned to meet his problems—planned to fit his pocketbook. The measure of Hallicrafters success is in the reputation this group of experts extends to this equipment. You can *hear* the answer every night of the year on the air—just listen!



Top Selectivity—Low Price! Model S76—Dual Conversion Super with 50 kc amplifier for tops in selectivity. 500 C.P.S. at 6 db down—3.5 kc at 60 db down. Giant 4-in. "S" meter. 540-1580 kc. 1.72-32 Mc in 4 bands. 1 r-f, 2 conversion. 2 i-f stages. 5 pos. selectivity. Phono input jack. 3 watt output. **\$179.50**



A Ham's Dream! Model SX71—Com. Rcvr. especially designed for top ham performance. Double conversion, built-in NBFM limiter stage. 538 kc to 35 Mc, 46-56 Mc in 5 bands. Temp. Comp., voltage reg. 1 r-f, 2 conversion, 3 i-f stages. Xtal. filter, 4-pos. selectivity, 18½" x 8⅞" x 12" deep. Ship. wt. 51 lbs. 115V, A.C. 11 tubes, reg., rect. **\$224.50**



Model S-40B—Covers Broadcast Band 540-1700 kc and three short-wave bands. 1.7-43 Mc. One r-f, two i-f stages. Electrical bandspread tuning. Switches for automatic noise limiter, code reception and three-position tone control. CW pitch control. Built-in PM speaker. 115V, A.C. Only **\$119.95**



TVI Suppressed 100 Watter—Model HT20—Here's the transmitter you've been waiting for! Continuous coverage from 1.7 Mc to 30 Mc. Full band switching, no more plug-in coils; choice of 10 crystals. Shielded, filtered r-f compartment plus low-pass 52 ohm co-axial line output filter assures at least 90 db suppression of all harmonics above 40 Mc. Only **\$449.50**



QRK—International "Q" Signal for—
"What is my readability?"

hallicrafters

Chicago 24, Illinois

*World's Leading
Manufacturer of Precision
Radio and Television*



Matched Speaker, Model R46—The perfect speaker for SW. Includes transformer of 500/600-ohm input. Voice coil impedance 3.2 ohms. 10" cone. Black finish. 15" x 10⅞" x 10⅞" deep. Only **\$19.95**

**NEWEST
FASTEST SELLER
in the field!**



**CDP
COMPOUND
DIFFRACTION
PROJECTOR***

**Public Address
Loudspeaker System**

**setting new standards for
VOICE PENETRATION
AND MUSICASTING**

- Greatly outperforms comparably sized reentrant horns
- Tremendous penetrating power and coverage at very low unit energy cost
- Exclusive E-V coaxial design and diffraction principle
- Peak-free response ± 5 db to 10,000 cps
- Delivers $2\frac{1}{2}$ octaves more musical range
- Weather-proof, blast-proof, splash-proof
Virtually indestructible

Model 848 CDP. 25 watts. 16 ohms.
List Price, \$59.00 Net, \$35.40

**COMPARE
POLAR PATTERN**
Sound distribution of CDP exceeds 120° at all frequencies up to 10,000 cps.



**COMPARE
RESPONSE AND
EFFICIENCY**
Note extended high frequency range of CDP. Response is smooth, peak-free ± 5 db to 10,000 cps.

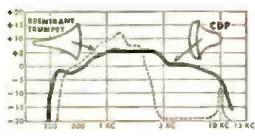

Write for Free
Bulletin No. 197

*Pat. Pend.

Electro-Voice

410 CARROL ST. • BUCHANAN, MICHIGAN
Export: 13 E. 40th St., New York 16, U.S.A. Cables: Arlab

For the RECORD.

BY THE EDITOR

ELECTRONICS AND RELIABILITY

WE HAVE all heard a great deal in recent years about the importance of "reliability" in electronic equipment. All too often, though, this factor is minimized in new equipment design and engineering with the major emphasis being placed on immediate performance. This has resulted in unreliable equipment being placed in service.

There are many different degrees of reliability to be considered. For example, there is seldom any danger to life and limb when the television set ceases to operate, or when a p.a. system quits. But when the navigation equipment on an intercontinental bomber fails, it can result in the loss of the plane and many lives. In the first case, the problem is an economic one—we must build in as much reliability as the customer is willing to pay for. In the second case, we must approach 100% reliability as closely as possible, regardless of cost. It is interesting to note that a flight of 30 large bombers on a 15-hour mission involves about 1 million tube-hours of operation!

There are several possible approaches to the problem of "reliabilizing" electronic equipment. Any final design should incorporate all of these approaches, as well as any others which are available.

Simplifying equipment will, in general, make it more reliable because of the fewer number of components, fewer soldered joints, and the greater dependence on "tried and true" techniques. Many times a piece of equipment is designed to do things which may be convenient but not necessary. The added complexity tends to decrease reliability, requiring further protective equipment, or units to take over in case of failure. This results in greater complexity, calling for still more protective equipment, and so on. Every function of the equipment must be considered carefully, and if not necessary, such a function should be eliminated. Extra frills and reliability are not compatible.

Improving the reliability of individual components is also a fertile approach. Great strides have been made in this direction in recent years. Hermetic seals, improved insulation, new dielectric materials—all have been used to increase the life expectancy of coils, condensers, resistors, transformers, and other components. Ruggedizing has been applied to vacuum tubes with highly satisfactory results. However, the practice of over-rating components still exists. Thus, a 600

volt condenser is used where a 200 volt unit should do the job and a 2 watt resistor is specified when the actual dissipation never exceeds $\frac{1}{4}$ watt. Components are designed to give optimum life when operated at or near their ratings and such over-rating is not necessary. In this connection, it should be noted that many failures in electronic equipment have been traced directly to misuse of components.

The use of "failure prediction" tests or "marginal checking" has increased rapidly in recent years. Such tests can be used to predict the imminent failure of a tube or other component so it can be replaced before failure actually occurs. This method has been used to increase the reliability of complex equipment (such as electronic computers) by a large factor.

Transistors can be used very advantageously in "reliabilizing" equipment. Previous limitations of temperature, frequency response, uniformity, and power handling capacity are rapidly being overcome. One manufacturer has demonstrated a transistor operating satisfactorily at the temperature of boiling water; another has developed a tetrode junction transistor which will oscillate above 250 mc.; another has developed techniques for air-cooling transistors so that dissipations of one watt or more are permissible; several manufacturers are mass-producing transistors with satisfactory uniformity.

Improved reliability does not depend solely on the increased life and ruggedness of the transistor itself. Less power is required, resulting in less heat dissipation and lower operating temperatures. Because of the low power requirements, the equipment can be operated on batteries, placing less dependence on external sources of power, plugs, and connectors. Lower voltages can be used, with less strain on insulation and other components such as condensers, resistors, etc.

Too much emphasis cannot be placed on this concept of reliability, particularly with respect to military and industrial electronic equipment. Many people outside our field (and inside, too!) feel that electronic equipment is essentially fragile and unreliable and should be used only as a last resort. Overcoming this basic philosophy will require a great deal of intensive engineering on the reliability problem. When electronic equipment has attained the reliability now achieved with mechanical equipment, we can truly say that our industry has reached maturity . . . O.R.

**big values
new releases**

in ALLIED'S latest Catalog & Supplement!

FREE: SEND FOR BOTH



KNIGHT PORTABLE RADIO KIT

Build this powerful 3-way superhet portable for AC, DC or battery operation. Tunes 535-1650 kc broadcast band; has built-in antenna, PM speaker, printed audio circuit, handsome carrying case. Easy to assemble from illustrated manual. High-quality kit includes all parts, tubes and case (less batteries). Shpg. wt., 6 lbs.
83-730. Only... \$18.75
Battery Kit... \$3.64

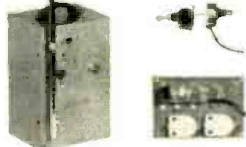

PHILMORE RADIO CONTROL KIT

Build your own remote-control transmitter and receiver. Operates model airplanes, boats, autos, etc. Crystal-controlled transmitter for 27.255 mc (requires easily obtained FCC operating permit). High-gain super-regenerative receiver. Easy to build. Complete with all parts, telescoping antenna, crystal and cabinet (less batteries). 4 1/2 lbs.
83-034. Only... \$41.47
Complete Set of Batteries... \$7.15



KNIGHT SELF-CHARGING PORTABLE

Deluxe superhet portable for AC, DC or battery operation. With battery "Rejuvenator" circuit which extends normal "B" battery life 2 to 4 times! Covers full broadcast band; has tuned RF amp, loop antenna, AVC, 5" PM speaker. Attractive carrying case, 10 x 12 3/4 x 4 3/4". Complete with tubes, less batteries. 9 lbs.
6K-718. Only... \$35.75
80-652. Battery Kit... \$4.36



WELLER SOLDERING GUNS

Squeeze the trigger—you're ready to solder in 5 seconds. Latest heavy-duty, instant-heat gun; with 2 spotlights that light up working area. Air-cooled transformer. 3 lbs.
46-642. Single-heat, only... \$9.75
46-641. Dual-heat, only... \$11.71



PET 1/4" DRILL VALUE

Precision gear-type chuck drill with pistol grip. Instant-release lock-type trigger switch built into grip. Forced ventilation; runs cool. Speed: no-load, 1600 rpm; full-load, 900 rpm. Capacity: 1/4" in steel, 1/2" in hardwood. 6-ft. cord. For 110-120 v. AC or DC. 4 lbs.
46-280. Only... \$17.21



TV BOOSTER BARGAIN

Famous Standard Coil printed circuit TV booster at less than half original price. Provides uniform gain on all 12 VHF channels. Easy to tune; use with indoor antenna in primary areas, with outdoor antenna in near-fringe areas. Improves reception markedly. For 110-120 v., 60 cy. AC. Shpg. wt., 4 lbs.
97-233. While they last, Only... \$9.95

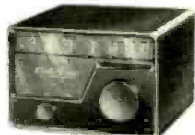

ELECTRO-VOICE UHF CONVERTER

New! Micrometer tuning for smooth, continuous reception of all UHF channels. Just connect to antenna input of any VHF TV set and plug in. Operates with all-channel antenna or separate VHF and UHF types. Single-knob, easy control. Uses VHF channels 5 or 6 as IF. 300 ohms input and output imp. Complete with tubes. For 110-120 v., 60 cy. AC. 5 lbs.
98-097. Only... \$33.96

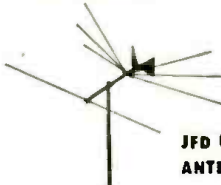

JFD UHF-VHF ANTENNA

Wonderfully efficient; uses conical element and reflector for VHF and "bow-tie" for UHF. Equipped with printed circuit antenna coupler for excellent signal transfer into single transmission line. Easy to install. (Less mast and 300-ohm twin line.) Shpg. wt., 6 lbs.
98-368. Only... \$11.20



EQUIPTO "LITTLE GEM" CABINET

New! Drawer cabinet for small parts. Contains 4 drawers, with dividers for 48 compartments (dividers adjustable on 1 1/2" centers). Each drawer 1 1/2" h, 11" w, 11" d. Cabinet overall, 6 1/2 x 11 x 11". Olive green baked enamel finish. Shpg. wt., 20 lbs.
86-066. Only... \$17.80



TRAV-ELECTRIC SENIOR CONVERTER

Ultra-compact 60 cycle converter for changing 6 volts DC to 110 volts AC. Capacity: 30 watts continuous, 40-45 watts intermittent. Simply plugs into auto cigarette lighter. Permits mobile use of broadcast and SW radios, recorders, dictating machines, fluorescent lamps, etc. Fully filtered. Only 2 1/2 x 2 1/2 x 3 1/2". 3 1/2 lbs.
80-272. Only... \$10.63



TV CASTER BASE

Easy to install under any TV console—permits quick and easy rolling to any desired location. Rolls smoothly in any direction. Steel frame is adjustable to 30" wide, 27" deep to fit practically any console. No tools required for installation. Shpg. wt., 11 1/2 lbs.
98-989. Only... \$5.95

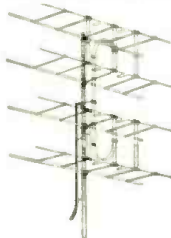

FINNEY 400 A UHF-VHF ANTENNA

New! Double coil lateral UHF-VHF antenna featuring 32 driven elements for high gain and directivity, with superior signal-to-noise ratio. Superb for fringe-area reception—good for VHF up to 150 miles or more. Rugged; corrosion-proof; pre-assembled, lightweight. Requires 10-ft. mast and 300-ohm twinline. 14 lbs.
97-104. Only... \$32.34



TAP-A-LINE

New type electrical line outlet, powering as many as 8 separate appliances from any wall outlet. Plastic cased; 12" long, 1" square. With 6-ft. cord and plug. Rated 1000 watts. 1 1/2 lbs.
52-636. Only... \$1.47



KNIGHT VT VOLT-OHM-MILLIAMMETER KIT

Terrific Value! Response to 2.5 mc. Bridge-type circuit; 1% resistors. Input res.: DC, 20 megs; AC, 1.5 megs. 4 1/2" meter. Ranges: AC p-to-p volts, 0-8-28-84-280-840-2800; AC rms & DC volts, 0-3-10-30-100-300-1000; DC ma. 0-3-10-30-100-300-1000; res. 0-1000-10K-100K ohms & 0-1-10-1000 megs; cap. .005-.5, .05-.5, .5-50, 5-500, 50-5000 mfd. With tubes, leads, case, instructions. For 110-120 v. DC or 60 cy. AC.
83-120. Only... \$24.95
83-121. Hi-V Probe; extends DC range to 30 KV \$6.95
83-122. Hi-Frequency Probe for AC range to 200mc \$5.95

**FREE
Catalog and
Supplement**

ALLIED RADIO CORP., Dept. 1-F-3
833 W. Jackson Blvd., Chicago 7, Ill.

Send FREE ALLIED Catalog and Supplement
 Enter order for _____ \$ _____ enclosed.

Name _____
Address _____
City _____ Zone _____ State _____

ALLIED RADIO

To help you sell
EVEN MORE
of the easiest-to-sell Rotors

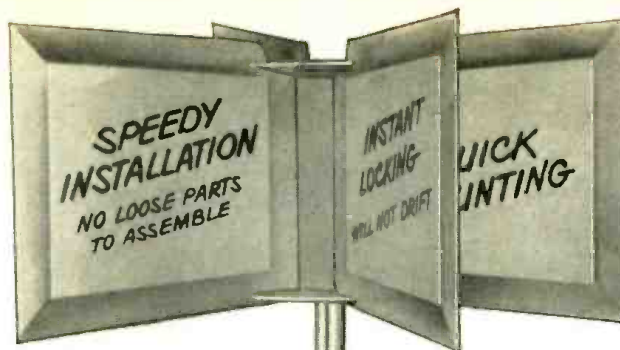

The C-D-R Rotor Moving Display

NOW... customers in YOUR STORE... will SEE and USE this ANIMATED and ILLUMINATED display to see for themselves the fast selling CDR ROTOR! Colorful... it's a silent salesman that does the job on its own! Be the first in your area with this new device... and SELL EVEN MORE CDR ROTORS... faster! After all... it's easy when the display demonstrates the greatest rotor value on the market today!

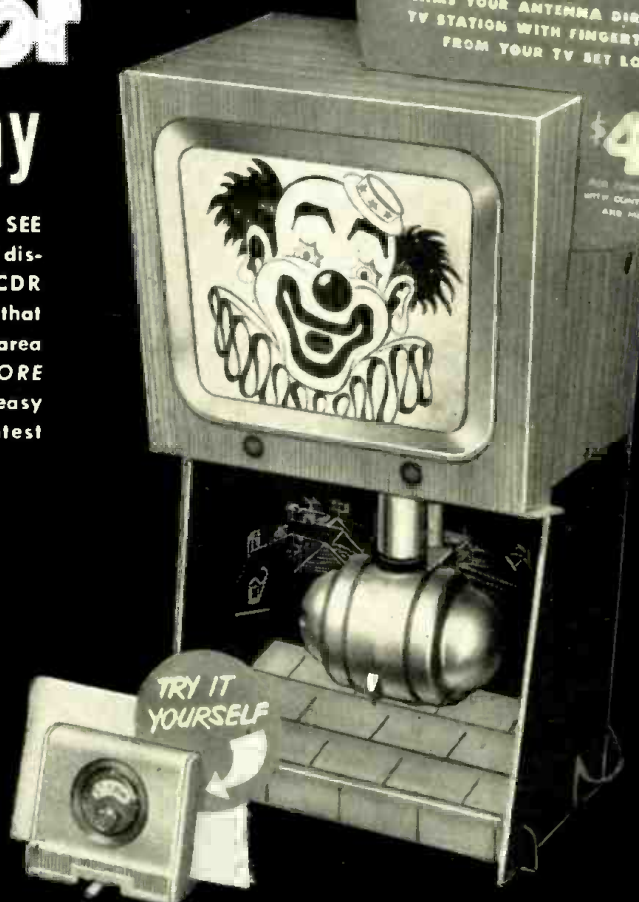

TRY IT YOURSELF

TR-12 Rotor... complete rotor unit including thrust bearing, handsome modern design plastic cabinet with meter control dial, uses 4 wire cable
\$47.95



THE **RADIART** CORPORATION
CLEVELAND 13, OHIO



CORNELL-DUBILIER
SOUTH PLAINFIELD, NEW JERSEY

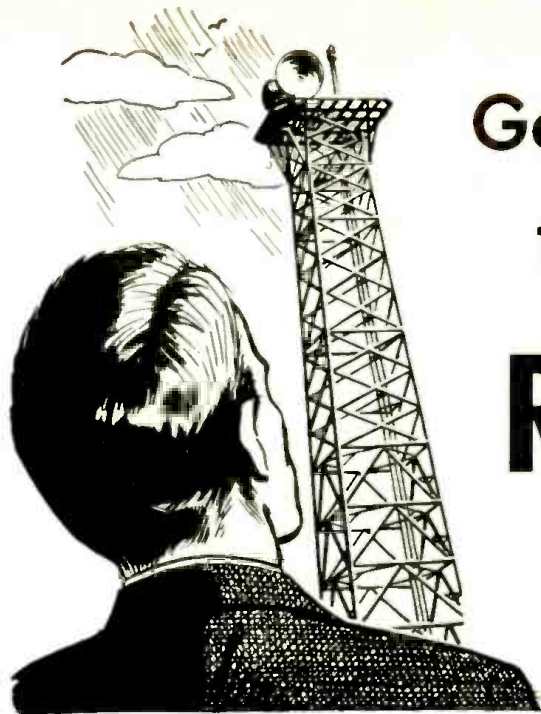

Get yourself on the beam to the BIG MONEY in RADIO AND TV

THAT'S the way to become an expert Radio or Television service man. Study the bedrock theories and principles. These are vitally important. Nothing can take their place—not even the most elaborate kits.

Listen to what radioman R. G. Hamlin of Bay City, Michigan, says, "There's no royal road to learning. I am convinced more than ever after examining the lessons of friends who were lured by the alleged short-cut methods of competitors . . . 'understandability' and 'rememberability' are of utmost importance and I.C.S. lessons qualify on both counts."

I.C.S. offers you two new courses in radio and television servicing—one for beginners, the other for experienced amateurs.

The beginner's course, Radio and Television Servicing with Training Equipment, is extremely thorough. You get extra texts featuring experiments and job assignments. You get equipment second to none. Matched parts for an excellent 5-tube superheterodyne receiver. Your own professional-quality multimeter. A complete single generator kit. High-grade servicemen's tools. "Rider's Perpetual Trouble-Shooter's Manual." The principles of Television including the most-up-to-date developments (VHF and Color TV, for example).

The second course quickly reviews the essentials then goes step by step into advanced phases of Radio and Television, including modern methods of installation and repair. Course contains valuable supplementary material. For example, you get a special book giving characteristics of all tubes used in Radio and Television receivers.

Learn by doing! That's the world-famous I.C.S. method. Thoroughly practical. Completely modern. Success proved. The coupon below brings you full details—on Radio and Television Servicing or any of the more than 400 I.C.S. Courses. Mark and mail it today!

INTERNATIONAL CORRESPONDENCE SCHOOLS

BOX 2251-B SCRANTON 9, PENNA.

Without cost or obligation, send me "HOW to SUCCEED" and the booklet about the course BEFORE which I have marked X:

<p>ART</p> <input type="checkbox"/> Commercial Art <input type="checkbox"/> Magazine and Book Illustrating <input type="checkbox"/> Cartooning <input type="checkbox"/> Show Card and Sign Lettering <input type="checkbox"/> Fashion Illustrating <p>AUTOMOTIVE</p> <input type="checkbox"/> Automobile, Mechanic <input type="checkbox"/> Auto-Elec. Technician <input type="checkbox"/> Auto Body Rebuilding and Refinishing <input type="checkbox"/> Diesel—Gas Engines <p>AVIATION</p> <input type="checkbox"/> Aeronautical Engineering Jr. <input type="checkbox"/> Aircraft Engine Mechanic <input type="checkbox"/> Airplane Drafting <p>BUILDING</p> <input type="checkbox"/> Architecture <input type="checkbox"/> Arch. Drafting <input type="checkbox"/> Building Contractor <input type="checkbox"/> Estimating <input type="checkbox"/> Carpenter and Mill Work <input type="checkbox"/> Carpenter Foreman <input type="checkbox"/> Reading Blueprints <input type="checkbox"/> House Planning <input type="checkbox"/> Plumbing	<input type="checkbox"/> Heating <input type="checkbox"/> Steam Fitting <input type="checkbox"/> Air Conditioning <input type="checkbox"/> Electrician <p>BUSINESS</p> <input type="checkbox"/> Business Administration <input type="checkbox"/> Certified Public Accountant <input type="checkbox"/> Accounting <input type="checkbox"/> Bookkeeping <input type="checkbox"/> Stenography and Typing <input type="checkbox"/> Secretarial <input type="checkbox"/> Federal Tax <input type="checkbox"/> Business Correspondence <input type="checkbox"/> Personnel and Labor Relations <input type="checkbox"/> Advertising <input type="checkbox"/> Retail Business Management <input type="checkbox"/> Managing Small Business <input type="checkbox"/> Sales Management <input type="checkbox"/> Salesmanship <input type="checkbox"/> Traffic Management <p>CHEMISTRY</p> <input type="checkbox"/> Chemical Engineering <input type="checkbox"/> Chemistry <input type="checkbox"/> Analytical Chemistry <input type="checkbox"/> Petroleum—Nat'l Gas <input type="checkbox"/> Pulp and Paper Making <input type="checkbox"/> Plastics	<p>CIVIL, STRUCTURAL ENGINEERING</p> <input type="checkbox"/> Civil Engineering <input type="checkbox"/> Structural Engineering <input type="checkbox"/> Surveying and Mapping <input type="checkbox"/> Structural Drafting <input type="checkbox"/> Highway Engineering <input type="checkbox"/> Reading Blueprints <input type="checkbox"/> Concrete Construction <input type="checkbox"/> Sanitary Engineering <p>DRAFTING</p> <input type="checkbox"/> Aircraft Drafting <input type="checkbox"/> Architectural Drafting <input type="checkbox"/> Electrical Drafting <input type="checkbox"/> Mechanical Drafting <input type="checkbox"/> Structural Drafting <input type="checkbox"/> Sheet Metal Drafting <input type="checkbox"/> Mine Surveying and Drafting <p>ELECTRICAL</p> <input type="checkbox"/> Electrical Engineering <input type="checkbox"/> Electrician <input type="checkbox"/> Electrical Maintenance <input type="checkbox"/> Electrical Drafting <input type="checkbox"/> Electric Power and Light <input type="checkbox"/> Lineman <p>HIGH SCHOOL</p> <input type="checkbox"/> High School Subjects
<input type="checkbox"/> College Preparatory <input type="checkbox"/> Mathematics <input type="checkbox"/> Commercial <input type="checkbox"/> Good English <p>MECHANICAL AND SHOP</p> <input type="checkbox"/> Mechanical Engineering <input type="checkbox"/> Industrial Engineering <input type="checkbox"/> Industrial Supervision <input type="checkbox"/> Foremanship <input type="checkbox"/> Mechanical Drafting <input type="checkbox"/> Machine Design-Drafting <input type="checkbox"/> Machine Shop Practice <input type="checkbox"/> Tool Design <input type="checkbox"/> Industrial Instrumentation <input type="checkbox"/> Machine Shop Inspection <input type="checkbox"/> Reading Blueprints <input type="checkbox"/> Toolmaking <input type="checkbox"/> Gas—Electric Welding <input type="checkbox"/> Heat Treatment—Metallurgy <input type="checkbox"/> Sheet Metal Work <input type="checkbox"/> Sheet Metal Pattern Drafting <input type="checkbox"/> Refrigeration <p>POWER</p> <input type="checkbox"/> Combustion Engineering <input type="checkbox"/> Diesel—Electric <input type="checkbox"/> Electric Light and Power	<input type="checkbox"/> Stationary Steam Engineering <input type="checkbox"/> Stationary Fireman <p>RADIO, TELEVISION, COMMUNICATIONS</p> <input type="checkbox"/> General Radio <input type="checkbox"/> Radio Operation <input type="checkbox"/> Radio Servicing—FM <input type="checkbox"/> Television <input type="checkbox"/> Electronics <input type="checkbox"/> Telephone Work <p>RAILROAD</p> <input type="checkbox"/> Locomotive Engineer <input type="checkbox"/> Diesel Locomotive <input type="checkbox"/> Air Brakes <input type="checkbox"/> Car Inspector <input type="checkbox"/> Railroad Administration <p>TEXTILE</p> <input type="checkbox"/> Textile Engineering <input type="checkbox"/> Cotton Manufacture <input type="checkbox"/> Rayon Manufacture <input type="checkbox"/> Woolen Manufacture <input type="checkbox"/> Loom Fixing <input type="checkbox"/> Finishing and Dyeing <input type="checkbox"/> Textile Designing	

YEAR OF THE SIX MILLIONTH STUDENT

Name _____ Age _____ Home Address _____

City _____ Zone _____ State _____ Working Hours _____ A.M. to _____ P.M.

Occupation _____

Special tuition rates to members of the Armed Forces. Canadian residents send coupon to International Correspondence Schools Canadian, Ltd., Montreal, Canada



140 Prizes for Service Dealers!



FOR YOU... \$2500!

Win it in cash! Tell in 50 words or less how you would spend \$2,500 to increase your service business! 139 other cash prizes. Total \$7,125.

This is a real big-money contest—and ABC-easy to enter! No figures to put down, no reports, no documents to attach. You win dollars simply by telling how to spend them wisely and profitably. You "Write your own ticket"!

Contest is open to all TV-radio service dealers and their employees. Rules are easy:

- Between June 15 and August 31, secure an entry blank from your G-E tube distributor. One blank with every purchase of 25 G-E receiving tubes or 1 G-E picture tube.
- Tell in the space provided on the blank how you would spend \$2,500 to increase service business. Would you buy new equipment... remodel your store... run a hard-hitting advertising campaign... or invest the money in some other way?
- Fill out and mail as many entries as you choose. They must be postmarked not later than midnight, August 31, 1953.

- Winners will be selected on the basis of originality, business judgment, and clear thinking. An impartial board of judges will make the selections.

First prize, \$2,500
 4 prizes, each \$500
 10 prizes, each \$50
 25 prizes, each \$25
 100 prizes, each \$15

All prizes are cash!

Use the helps G.E. makes available!

If you're looking for ideas, they're waiting for you in G.E.'s new 12-page promotion catalog, ETR-589-A. Learn what you can obtain in identification and advertising aids of all types... business helps... service aids... technical manuals and publications.

Get your copy from your G-E tube distributor when you obtain your contest entry blank. *Tube Department, General Electric Company, Schenectady 5, N. Y.*

101-1A5



Diamond Anniversary

GENERAL ELECTRIC

for every
audio
need

CANNON PLUGS

you can hear
the difference



P SERIES



XL SERIES



D SERIES



UA SERIES



O SERIES



K (TV) SERIES

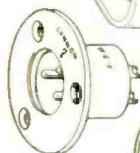

X SERIES



XK SERIES

CANNON ELECTRIC

Since 1915

FACTORIES IN LOS ANGELES, TORONTO, NEW HAVEN
Representatives in principal cities. Address inquiries to Cannon Electric Co., Dept. F-145, Los Angeles 31, California.

Spot Radio News

* Presenting latest information on the Radio Industry.

By RADIO & TELEVISION NEWS'
WASHINGTON EDITOR

COLOR TV, the perennial problem child of industry and Congress, too, whose committees have investigated and re-investigated its "delayed" full-scale debut, found itself on Washington's hottest griddle a few weeks ago, when members of the House opened a sizzling inquiry into the exact reasons for the prolonged hibernation of the reds, greens, and blues.

Three factors were cited as the cause for the latest outburst and hunt for information: A color TV test report, issued during the summer of '52, disclosing that superior performance was now available on an industry-approved compatible scheme; the contradictory M-90 ruling of NPA declaring that defense commitments made it necessary to halt any production of disc-type chassis (no quantity production was under way in any plant at the time); and particularly a letter from Senator Edwin C. Johnson to Senator Charles W. Tobey, stating that "powerful interests" were deliberately delaying widespread use of colorcasting. Noting that . . . "it is a little less than three years ago since the Federal Communications Commission, the arm of Congress mandated to act in the public interest, adopted the standards for color television, and stated that it was here and that it should be made available to the public," the Senator asked why, in view of this official verdict, there still was no color TV. And he followed this query with four more direct questions: "Is this delay in manufacturing color receivers deliberate? Are the standards adopted by the Commission unsound? If so, in what manner? Have new standards been developed? If so, why are they not submitted to the FCC?"

It had been assumed that an immediate reply, in the form of a full-scaled inquiry, would be staged by a Senate committee. Instead, the House Interstate Commerce Committee, chaired by Rep. Charles A. Wolverton, raced onto the scene and declared that it would hold a public hearing on color TV to determine the basis for the repeated delays. Supported by Congressmen Carl Inshaw and James I. Dolliver, Rep. Wolverton began his session shortly after the Johnson letter appeared. Five of the industry's leading lights on colorcasting were summoned to Washington for a gruel-

ing "Q and A": Dr. E. W. Engstrom, RCA lab headman; CBS Prexy Frank Stanton; picture tube pioneer, Dr. Allen B. Du Mont; Chromatic Lab President Richard Hodgson; and G-E's electronics division general manager, Dr. W. R. G. Baker, who is also chairman of the NTSC.

Appearing as the first witness, Dr. Engstrom testified that his company believed that compatible color TV was here and the Commission could legally approve such a system now. He pointed out that the FCC and its staff have been kept continually advised of the extensive research and development work which has been done on the system, not only by his company but by members of the NTSC. It would be wise, he felt, to authorize commercial broadcasts of not only compatible color signals now, but reinstate incompatible colorcasting too, so that the public could evaluate the two techniques.

Declaring that RCA had invested substantial sums in the establishment of a pilot operation for tri-color tube production in Lancaster, Dr. Engstrom noted that this manufacturing unit will have a production capacity of 2000 color tubes per month, and can serve as the prototype for other units in the establishment of factory facilities for large-scale, high-speed production.

Two color transmitting studios were said to be available for programming. One is located at NBC headquarters in Radio City and another in a theater which has been completely converted for color work.

Debonair Frank Stanton followed Engstrom and frankly admitted that CBS would support any color television system which works well, is practical, and has a reasonable cost. Such support would be forthcoming, even if the system were developed by a competitor. But, he added: "I cannot tell . . . whether we shall support the NTSC system . . . simply because we do not know enough about it, and hence we must reserve judgment."

And then, in a statement which rocked industry, he declared that . . . "reluctantly but realistically," CBS had no plans under present circumstances to broadcast or manufacture under the approved field-sequential system. Many factors were said to be responsible for this decision, particu-

SPRAGUE

presents...

THE NEW

SERVICEMAN'S DIARY... by Ben Grim

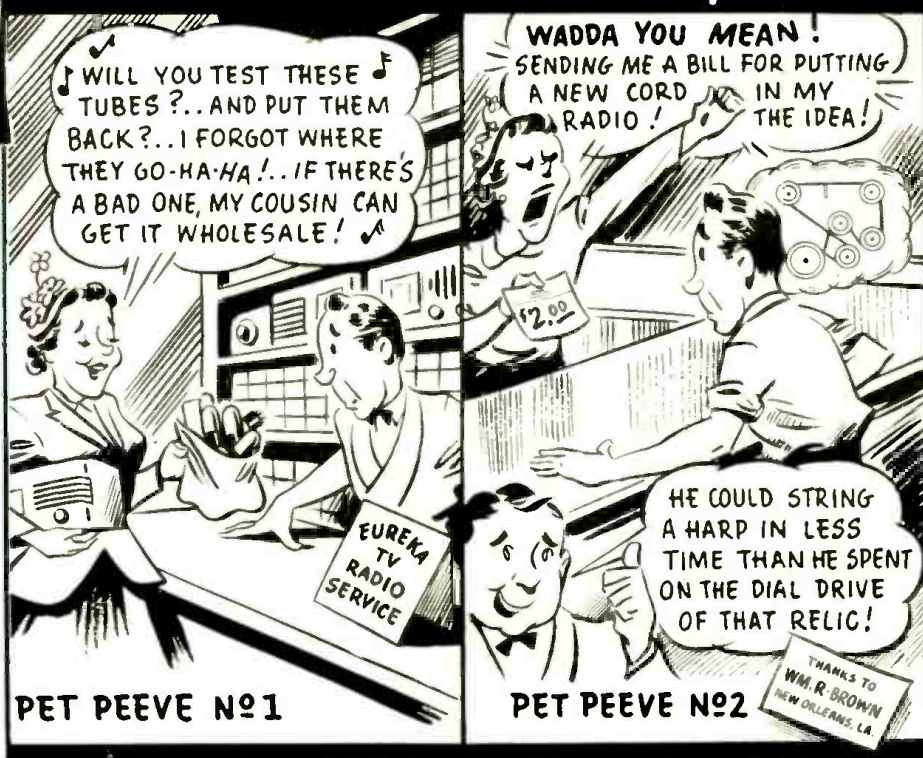

TO-4 TEL-OHMIKE[®]

CAPACITOR-RESISTOR ANALYZER



Here's a compact, reliable, and simple-to-use instrument designed for general laboratory use, yet priced right for every TV and radio service technician. The New TO-4 is made for testing every capacitor from the lowest to the highest capacitance units. Modern service shops find the New TO-4 a must with its instant push-button range selection, magic-eye bridge balancing, direct meter readings of leakage current and insulation resistance, and the continuously adjustable test voltage for checking electrolytics at exact rated voltage.

Three especially valuable *new* features of the TO-4 include, (1) provision of a special low capacitance circuit for checking small ceramic and "gimmick" capacitors down to 1 mmf (in addition to a top capacitance range of 2000 mmf), (2) a simplified insulation resistance circuit with high reading of 20,000 megohms, (3) Safety-First! Automatic discharge of capacitors after test by releasing all push-buttons.

See a demonstration of this sparkling new instrument at your distributors without delay. Or write for descriptive circular M-499 to Sprague Products Company, 51 Marshall Street, North Adams, Massachusetts.

ONLY \$ **73⁵⁰**

SPRAGUE

WORLD'S LARGEST CAPACITOR MANUFACTURER

SPRAGUE PRODUCTS COMPANY IS THE DISTRIBUTORS' DIVISION OF SPRAGUE ELECTRIC COMPANY

June, 1953

15



MODEL 50-R

IT'S
HERE!
IT'S THE
BEST!

FISHER

FM-AM TUNER

■ We haven't the space here to give you *all* the details on the new FISHER 50-R. However, we can tell you *there is no other like it, anywhere, and at any price!* FEATURES IN BRIEF: Armstrong system, dual limiters, two IF stages, cascade RF stage, full limiting even on only 1 microvolt signal. Sensitivity, 2 microvolts for 30 db of quieting. AFC on switch and adjustable for locality. *Adjustable selectivity* on AM. Separate AM and FM front ends, fully shock-mounted. Response uniform, 20 to 20,000 cycles. Distortion less than 0.04% for 1 volt output. Hum level more than 100 db below two volts output. Cathode follower output. Fully shielded; bottom cover. Aluminum chassis. 12 tubes plus tuning eye and rectifier. **\$159.50**

"The very best!" —HIGH FIDELITY
MAGAZINE

FISHER

PREAMPLIFIER EQUALIZER

■ "Either of these two units is of the very best," says *High Fidelity Magazine* of the FISHER 50-C Master Audio Control and 50-A Amplifier. The 50-C can be used with *any* amplifier. Intermodulation distortion is virtually unmeasurable. Complete phono equalization, loudness control, 5 inputs, 5 input level controls, cathode follower outputs. Self-powered.

Chassis, \$89.50
With cabinet, \$97.50



FISHER

40-WATT AMPLIFIER

■ THE FISHER Laboratory Standard Amplifier Model 50-A is, beyond a shadow of a doubt, *the world's finest all-triode amplifier*—and yet moderately priced. FEATURES: High output—less than .3% harmonic distortion at 40 watts (.08% at 10 watts.) Intermodulation distortion below .8% at 40 watts. Uniform response within .1 db, 20-20,000 cycles; 1 db, 5 to 100,000 cycles. Hum and noise more than 96 db below full output. Quality components and beautiful workmanship throughout. **\$159.50**

Write for illustrated brochure

FISHER RADIO CORPORATION
39 EAST 47th STREET • NEW YORK

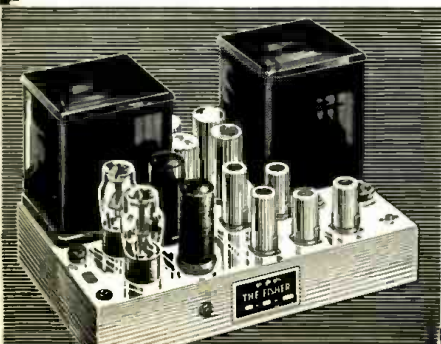

larly the lack of industry support. "I think we would be tilting at windmills to undertake now . . . to try to pick up again where we were forced to leave off in October, 1951," he added.

His company had thought, Stanton went on, that the FCC decision would bring . . . an end to the conflicting claims (as the FCC black and white decision had done in '41) and to the public's confusion and bewilderment which resulted from such claims. We had thought, and we had hoped, that our broadcasting and manufacturing efforts which cost us enormous energies and millions of dollars would supply enough impetus and competitive incentive for other broadcasters and other manufacturers to begin to follow our lead."

But the sequential system has been "completely becalmed" for the last year and a half, Stanton said, and black and white sets have increased to almost 23,000,000.

"I cannot minimize the problems which this creates," the CBS prexy continued. "I do not think that the problem of incompatibility is necessarily fatal. But I do think that the problem . . . has grown to such proportions that in combination with other factors, it becomes quixotic and economically foolish for us single-handedly at this time to resume a large-scale broadcasting and manufacturing program."

The imminence of a compatible system was stressed as a key factor in arriving at such a decision. Explaining this situation, Stanton declared: "I think it would be wholly unrealistic for us to expect that no matter how vigorously or exhaustively we engaged in broadcasting or manufacturing under the field-sequential system, any other manufacturer would make sets under that system, or any substantial number of the public would buy such sets even if made, so long as there is the expectation that a new compatible system will momentarily be perfected and will be brought before the FCC."

To sprinkle the occasion with more confusion, NPA then announced that at long last it had decided to revoke its M-90 rule, making it possible for set makers to produce sets designed to receive sequential signals, that no one was broadcasting. Commenting on the revocation, Acting NPA Administrator H. B. McCoy pointed out that since June '52, manufacturers have been allowed to produce color TV sets under certain conditions, but no applications for such permission had been received.

"M-90 was invoked originally in November '51 to conserve both materials and engineering manpower for the nation's defense effort," McCoy declared. "With the easing of the materials situation in mid-'52, we amended the order to permit the manufacture of color TV sets by companies whose defense contracts were on schedule or by companies having no defense contracts who could show such

(Continued on page 143)

NO OTHER UHF ANTENNA COMBINES ALL

- 1 Extra high gain
- 2 All channel reception
- 3 Sharp vertical and horizontal directivity

3

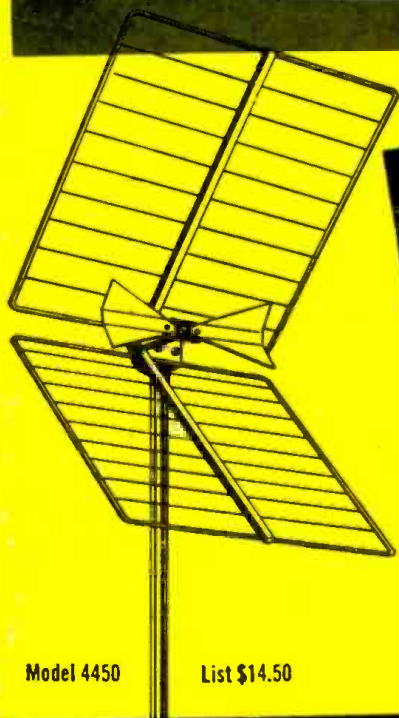

Model 4450

List \$14.50

WALSCO

CORNER REFLECTOR

Not 1... Not 2... but all 3 combined
for amazing picture clarity

NOTHING . . . *absolutely nothing* compares with Walsco's Corner Reflector. It's the only UHF antenna that offers a 3-way *combination* that produces sharper, clearer TV pictures. Truly a masterpiece in precision electronic engineering.

WALSCO *A Model to Fit Every Installation*

Walter L. Schott Co.
3225 Exposition Place
Los Angeles 18, California

COMPARISON CHART

	High Gain	All channel Performance	Sharp Directivity
WALSCO CORNER REFLECTOR	YES	YES	YES
ANTENNA B	NO	YES	NO
ANTENNA C	NO	YES	NO
ANTENNA D	YES	NO	YES

Overseas Representative: Ad Auriema, Inc., 89 Broad St., New York 4, New York

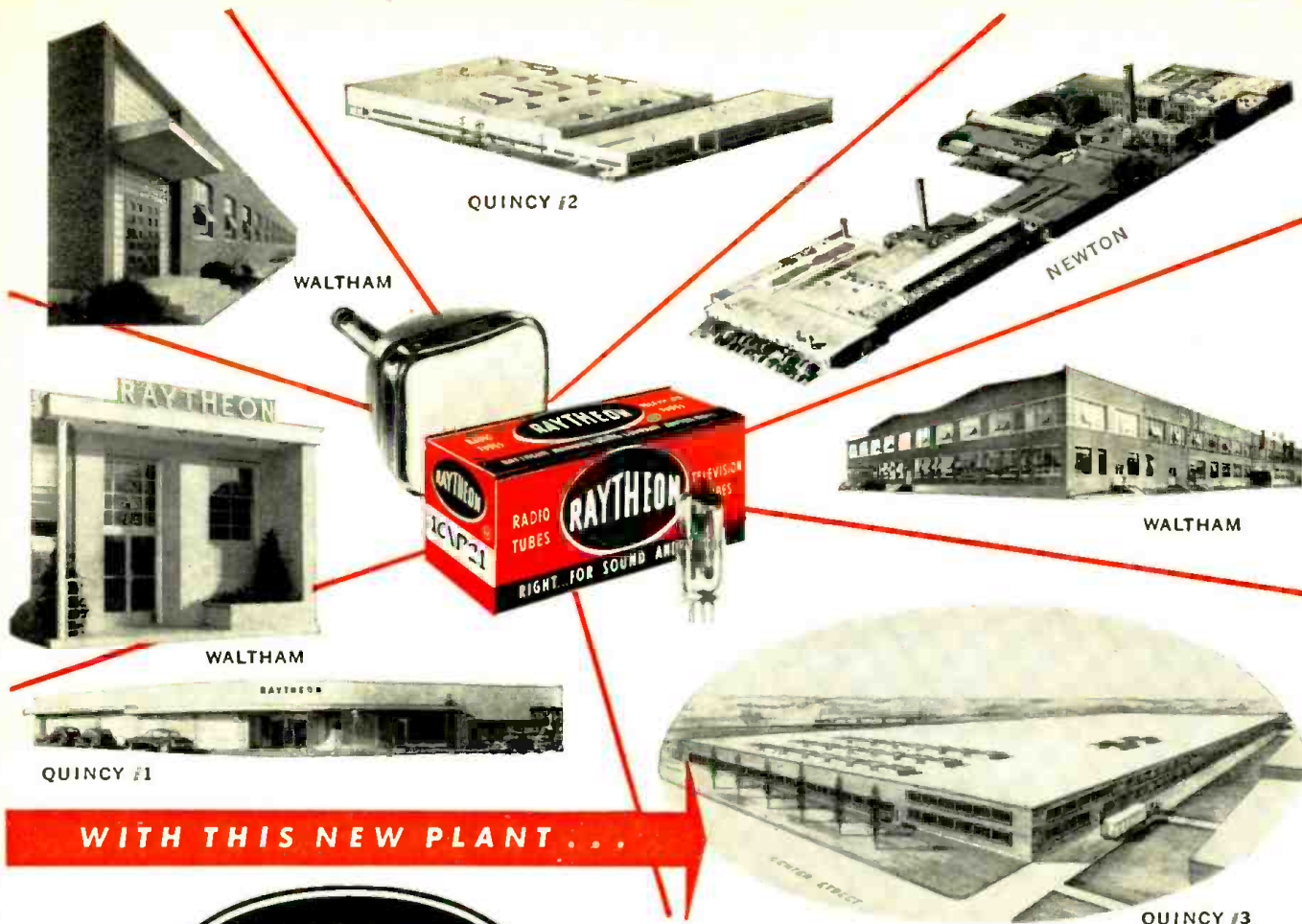

WITH THIS NEW PLANT...

the **RAYTHEON** resources

DEVOTED EXCLUSIVELY TO ELECTRON TUBES

- consist of • **more than 1,000,000 sq. ft. of manufacturing area**
- **more than 10,000 skilled tube craftsmen**
- **backed by 30 years of tube engineering, development and production experience**

Raytheon's newest plant at Quincy, Massachusetts is expressly designed to economically manufacture 24 inch and larger Raytheon Picture Tubes. It will employ the very last word in modern engineering and manufacturing techniques. It will be devoted exclusively to the making of tubes worthy of the Raytheon reputation for quality and dependability. With Raytheon Radio and Television Tubes you are Right . . . for Sound and Sight.



RAYTHEON MANUFACTURING COMPANY

Receiving Tube Division
 Newton, Mass., Chicago, Ill., Atlanta, Ga., Los Angeles, Calif.

Excellence in Electronics

RAYTHEON MAKES ALL THESE:
 RECEIVING AND PICTURE TUBES • RELIABLE SUBMINIATURE AND MINIATURE TUBES • GERMANIUM DIODES AND TRANSISTORS • NUCLEONIC TUBES • MICROWAVE TUBES

RADIO-ELECTRONIC *Engineering* SECTION

**RADIO &
TELEVISION
NEWS**

Reg. U.S. Pat. Off.

TELEVISION • RADAR • ELECTRONICS • RESEARCH • COMMUNICATIONS • MICROWAVES



JUNE, 1953

MOBILE FM RADIO
OF HIGH SELECTIVITY

3

FLEXIBLE WAVE GUIDE

7

MAGNETIC AMPLIFIER
TEMPERATURE CONTROLLER

10

THE TRAVELING-WAVE TUBE

12

TESTING VACUUM TUBES

15

CINCINNATI IRE TV CONFERENCE

32

DEPARTMENTS

LOOKING AT TUBES	18
NEW TUBES	20
NEWS BRIEFS	22
NEW PRODUCTS	24
CALENDAR	26
PERSONALS	26
TECHNICAL BOOKS	27
NEW LITERATURE	28



Copyright, 1953, by Ziff-Davis Publishing Co.

RADIO-ELECTRONIC ENGINEERING is published each month as a special section in a limited number of copies of RADIO & TELEVISION NEWS, by the Ziff-Davis Publishing Company, 368 Madison Avenue, New York 17, N. Y.

Edited by H. S. RENNE
and the Radio & Television News Staff

Dr. D. A. Jenny of the David Sarnoff Research Center, RCA, examines several experimental transistors designed with cooling fins or with liquid coolant tanks so that they can be operated at powers as high as 1 watt—compared to .05 watt for uncooled units.

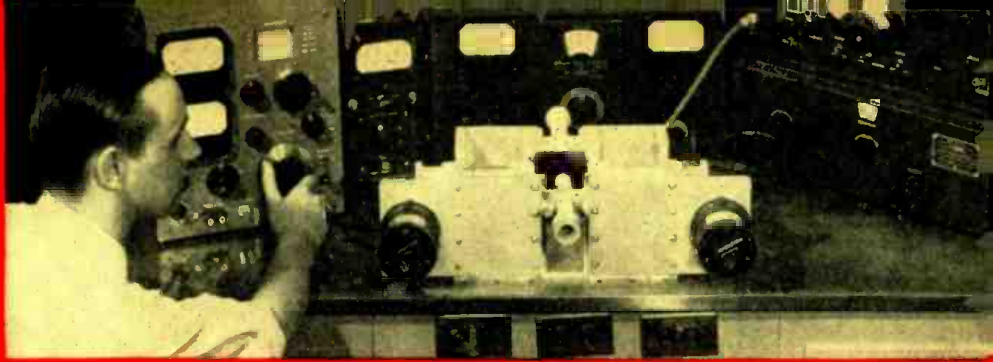

for SPECIALIZED FILTERS

Decades of experience in the design and production of specialized filters have resulted in UTC being a first source for difficult filters. Fifteen years ago UTC was already the largest user of permalloy[®] dust toroids in the world (exclusive of the telephone system). Present designs include a wide variety of core materials, structures, and winding methods to provide maximum performance in electrical requirements and stability. Illustrated below are a few of the thousands of special filter designs in present production.

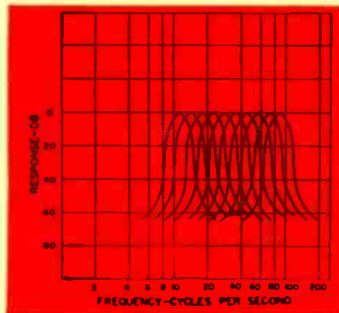

These low frequency band pass filters are held to 1 DB tolerance at the 3 DB crossover ... 600 ohm ... 4 filters per 7½" rack panel.

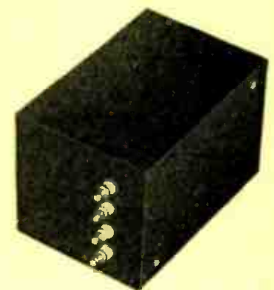
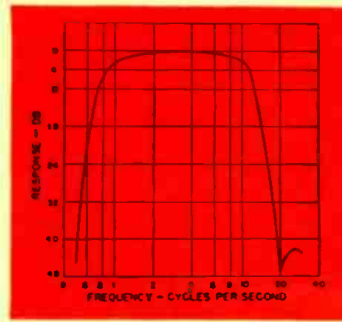

This ultra low frequency filter has a band pass range of one cycle to 10 cycles ... 50,000 ohms ... 700 cubic inches.

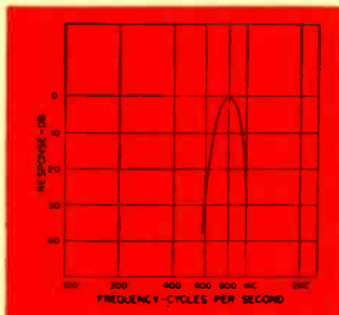
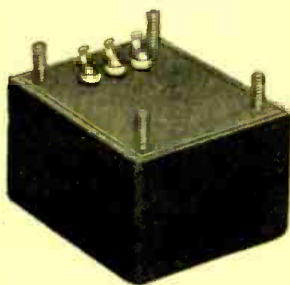

This 600 ohm miniaturized 1 KC band pass filter is housed in a case only 1" x 1¼" x 2½".

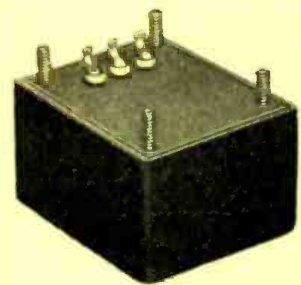
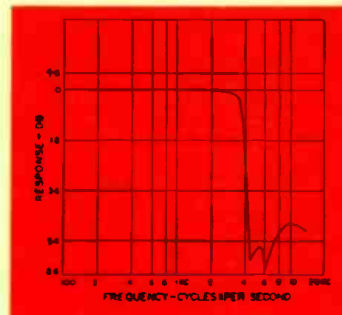

This 600 ohm miniaturized low pass filter is housed in a case only 1" x 1¼" x 2½".

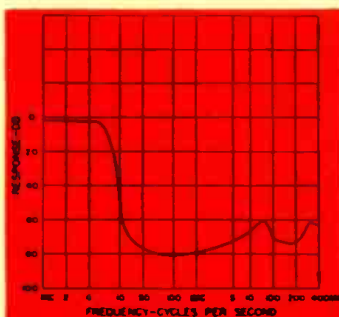

This power line filter provides correct output voltages from sources of 50 to 400 cycles ... noise attenuation is from 14 KC to 400 MC ... 29 cubic inches.

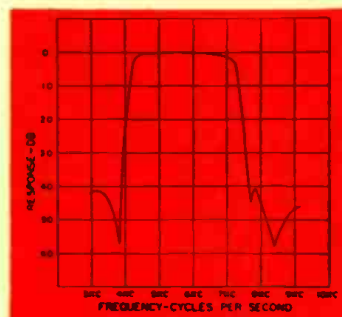

This band pass filter is designed for sharp cut-off at both ends of the range ... 10,000 ohms ... case dimensions 1¾" x 2½" x 3¼".



United Transformer Co.

150 VARICK STREET

NEW YORK 13, N. Y.

EXPORT DIVISION: 13 EAST 40th STREET, NEW YORK 16, N. Y.

CABLES: "ARLAB"

www.americanradiohistory.com

MOBILE FM RADIO OF HIGH SELECTIVITY

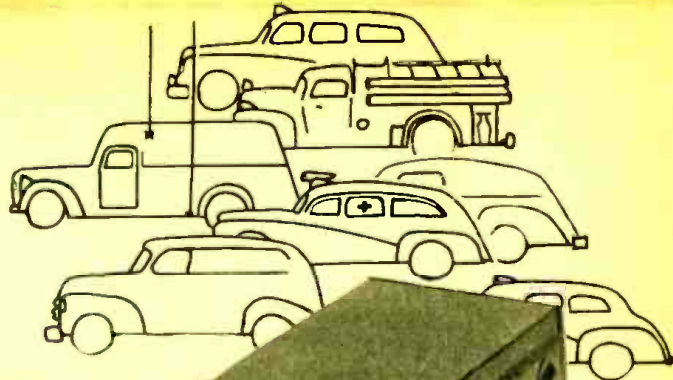

TWO-WAY RADIO, which in the beginning was practically limited to police service applications, has suddenly developed into a national necessity—an invaluable and indispensable aid to law enforcement agencies, fire departments, ambulance and other emergency services as well as a dollar-saving, time-saving, life-saving tool for the maintenance of highways, railroads, transit utilities, power utilities, petroleum-gas pipelines, taxis and limited common carriers. The mobile communications industry has outgrown its three-corner pants and cramped play-pen. It now has a legitimate, justifiable need for ample space in which to work and serve.

Space presents the critical problem which must be solved; abstractly, there is a need for space in the spectrum in which to work, and mechanically, space is required in the vehicle—whether it be a passenger car or industrial truck—in which to mount the radio unit.

The spectrum space situation must be relieved by devising methods for increased efficiency in the utilization of existing channels. Channels are commonly assigned on an alternate basis to provide a guard band for protection against mutual interference. The recent advent of more selective receivers and transmitters with controlled modulation has allowed the FCC to grant adjacent-channel assignments, with a resultant increase in spectrum utilization. Obviously, the removal of technical limitations in this area has doubled the number of channels available to many sorely pressed mobile services.

One of the primary objectives in the design of the two-way radio to be discussed here was the advance of the electrical performance beyond the existing state of the art in order to remove what were previously considered inherent obstacles along the road toward adjacent-channel assignments. Further, as a qualification to the design specifications, it was necessary that the final design not only provide full adjacent-channel performance but include facilities for easy adaptation to the still narrower split-channel allocations.

The over-all receiver selectivity characteristic is one of the major factors



Fig. 1. Dash-mount (left) and trunk-mount (right) versions of a compact FM two-way mobile radio unit.

By **HAROLD A. JONES**

Technical Information Center
Motorola Inc.

Adjacent-channel operation on 20-kc. channels is feasible as a result of improvements in design.

in the design for adjacent- and split-channel operation. According to the current minimum performance standards established by the RTMA, the desired degree of selectivity for successful 152-174 mc. band adjacent-channel reception is at least 85 db down at ± 60 kc., center of adjacent channel. (See Fig. 7A.) Results of recent field tests have conclusively determined a level of -70 db to -100 db at ± 30 kc., edge of adjacent channel, to be highly desirable.

To answer the demand for equipment capable of meeting the extreme technical requirements of adjacent-channel operation, completely new and specialized transmitter and receiver units have been developed. To attain the goal of practicable adjacent-channel systems, each of the operational obstacles was considered as a separate and major problem. Emphasis should be given to the fact that a completely satisfactory solution is impossible unless all disturbing elements are controlled. For example, the simple expedient of providing an extraordinary degree of selectivity in the receiver is not the answer since the preselection cannot be made at the antenna or at other r.f. stage levels. Along with superprecision i.f. selectivity, there must also exist absolute control of frequency stability, intermodulation interference, desensitizing, spurious

and image response, temperature drift, nuisance noise, and audio quality. The associated transmitter must exhibit markedly improved characteristics, over and above those of conventional units, with respect to spurious and harmonic radiations, frequency stability, and instantaneous deviation control.

Receiver Circuit Achievements

From the design principles employed in this narrow-band receiver, now a production unit, came several outstanding engineering achievements which may well set future operational standards. The parameters used to maximize the effectiveness of the r.f. selectivity circuits are ribbon-wound permeability-tuned coils. A total of five such elements precede the first mixer stage, with a sixth serving to resonate the local oscillator plate circuit. Each resonant circuit is silver-plated to improve efficiency, and temperature-compensated with negative-coefficient ceramic capacitors. The winding process is easily accomplished in production since the rectangular cross-section wire eliminates critical spacing and associated distributed capacitance problems. As a measure of improved performance, the special coils provide loaded Q 's of the order of 60 to 80 as compared to Q 's of from 10 to 30 in conventional permeability-tuned circuits.

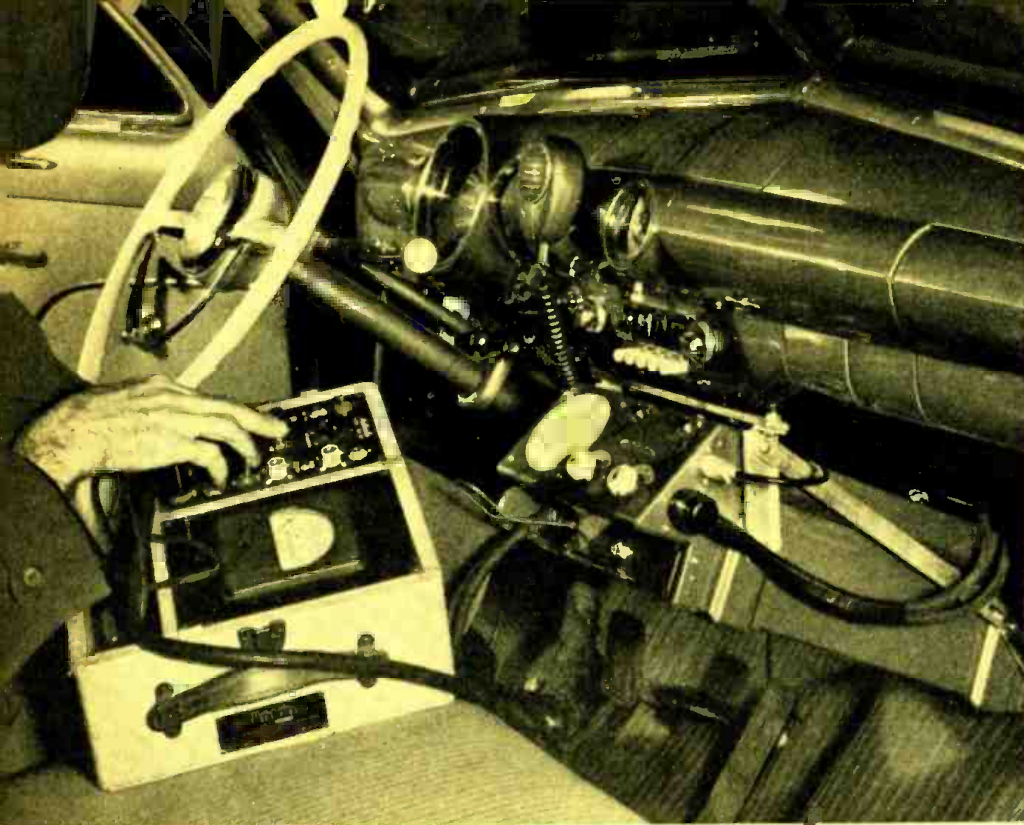

Fig. 2. The front-mount unit is shown as alignment is being checked.

The improved r.f. performance exhibited by the ribbon tuners—together with improved interference characteristics realized from the introduction of special design considerations into the r.f. amplifier and first mixer stages—provides unusual control of out-of-band desensitizing, intermodulation, and spurious response.

Spurious responses can be reckoned with and attenuated to a level of insignificance, but the elements of desensitizing and, more prominently, intermodulation interference have been steadily growing in importance until today they rate separate consideration.

By definition, a receiver's "intermodulation spurious response attenuation characteristic" is the measured amount of its ability to receive a desired signal to which it is resonant. This characteristic is measured in the presence of two interfering signals so separated from the desired signal and from each other that "nth" order mixing of the two desired signals can occur in the nonlinear elements of the receiver, producing a third signal whose frequency is equal to that of the desired signal.

Adequate suppression of both desensitizing and intermodulation interferences has been slighted in many receiver units now commercially available—even in a few of those units presumably designed for close channel occupancy. Practically, both types of interference have been dominant obstacles in the road toward successful adjacent-channel operations, particularly same-area operations. Any attempt to side-step the issue inevitably results in equipment incapable of pro-

viding completely satisfactory adjacent-channel service.

The over-all selectivity of this receiver is determined predominantly by a radically new device—a separately packaged i.f. wave filter. Permeability-tuned coils and compensating capacitors assembled in a specially modified constant K and m -derived network comprise a total of ten tuned circuits which are permanently sealed, fixed electrically and mechanically, by casting the entire bandpass filter structure in a solid block of polymerized resin.

Thus, those circuits which regulate the frequency rejection capabilities of the unit to a controlling degree are rendered impervious to the extreme heat, humidity, and vibration conditions common in the mobile services. This technique not only prevents degradation of performance through shock or exposure to the elements, but also removes

Fig. 3. Oven type, temperature-controlled quartz crystal assembly with cover removed.



the possibility of tampering or misalignment as a result of field service without proper test equipment. The finished unit is guaranteed for the natural life of the associated receiver.

Electrically, the basic polyester-styrene cast filter provides at least 100 db attenuation at ± 35 kc., in the adjacent channel. Recent investigations indicate that characteristics as exhibited by this unit are suitable for same-area adjacent-channel operations in the 152-174 mc. band (60-kc. channels) and for adjacent-area adjacent-channel operations in the 25-50 mc. band (40-kc. channels). See Fig. 7B.

Split-Channel Operation

Similar filters have been designed, tested and placed in production to provide 100 db attenuation at ± 20 kc., edge of adjacent channel, for the 25-50 mc. band and ± 30 kc., edge of adjacent channel, for the 152-174 mc. band. Rigorous field tests employing mobile units, with this particular type filter installed, prove conclusively that same-area adjacent-channel operations are practicable in the bands' allocated channels of only 40 kc. bandwidth. Further, successful test systems have been operating for over a year with this type filter, with mobile units in the 160-mc. band on frequencies separated by only 20 kc. In other words, a normal 60-kc. channel has been split into three adjacent 20-kc. channels and each successfully utilized. Thus, the packaged i.f. system allows easy and economical transition to the inevitable split-channel operations.

The basic receiver circuit has a 14-tube complement. A total of 27 tuned circuits is employed: eight permeability-tuned circuits (with specially designed ribbon-wound coils in the 152-174 mc. band) in the r.f. and oscillator stages, followed by 19 tuned circuits in the i.f. amplifier sections—including 10 plastic-cast circuits in the i.f. bandpass filter.

A special tunable local oscillator makes possible the simplification of receiver maintenance since tuning is now accomplished by adjusting the tunable crystal oscillator rather than by the more complex technique of i.f. stage alignment. It is a recent circuit development which provides the necessary electronic tuning control while maintaining precision frequency stability.

A thermally balanced crystal oven (Fig. 3) provides the extreme stability required for successful adjacent-channel operation. The oven assembly includes a controlled heater element and separately replaceable hermetically sealed crystal and bimetal thermostat elements. Assembled in a thermally balanced arrangement, the bimetal switch and heater elements maintain

the actual crystal oven temperature practically constant over an outside ambient temperature range from -30°C to $+60^{\circ}\text{C}$, resulting in a frequency stability of better than $.06$ cycle / mc. / $^{\circ}\text{C}$. The design and construction of the thermostat is such that the bimetal element is not depended upon as the primary current-carrying path through the unit. Extreme care is taken to see that no materials, finishes or sealing compounds are used which may, over a period of time, give off corrosive or otherwise undesirable gases or fumes within the hermetically sealed case. The contacts are set to open on a rising temperature between 64°C and 66°C , with a differential of less than 4°C and more than 1°C . Ambient temperatures of -40°C to $+100^{\circ}\text{C}$ do not affect the initial setting and differential of the element. Life expectancy of the thermostat exceeds 4000 operating hours.

The discriminator is a patented, frequency-modulation detector utilizing a balanced type circuit. A major stage in the high quality audio recovery system, this circuit maintains unexcelled sensitivity and linearity over the desired frequency bandwidth with stability over a wide temperature range and varying operating conditions.

The squelch system features adjustable sensitivity and noise-compensated

characteristics to provide maximum reduction of nuisance noise during standby periods—a positive-acting device with a threshold sensitivity sufficient to allow operation with only 2 db of receiver noise quieting.

The unit is designed to allow easy addition of facilities for crystal-controlled multiple-frequency operation on either side of two switch-selected channels (having a maximum frequency separation of 240 kc.) without degradation of the single-frequency operating characteristics.

Additional circuit features include automatic gain control, inverse audio feedback, and special coil construction employing positive locking devices on all tuning adjustments.

Transmitter Design

The attainment of extraordinary receiver characteristics will not solve the problem of adjacent-channel or even alternate-channel operations unless the radiated energy of stations occupying these nearby channels is also adequately controlled. Spurious radiations must be eliminated or at least attenuated to safe levels of 70-100 db below the desired carrier level, with harmonics suppressed to at least -60 db. In addition, carrier deviation due to modulation must be limited in order to



Fig. 4. Front-mount model showing removal features.



Fig. 5. Complete receiver chassis.

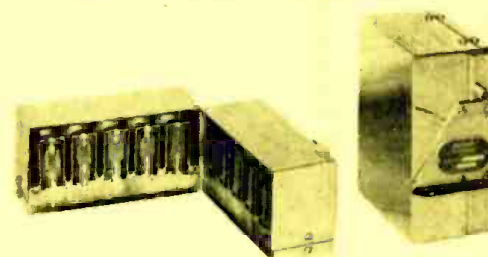

Fig. 6. Cutaway and assembled views of i.f. wave filter.

Fig. 7. (A) Comparison of minimum industry standards and performance of receiver. (B) Evolution of i.f. selectivity.

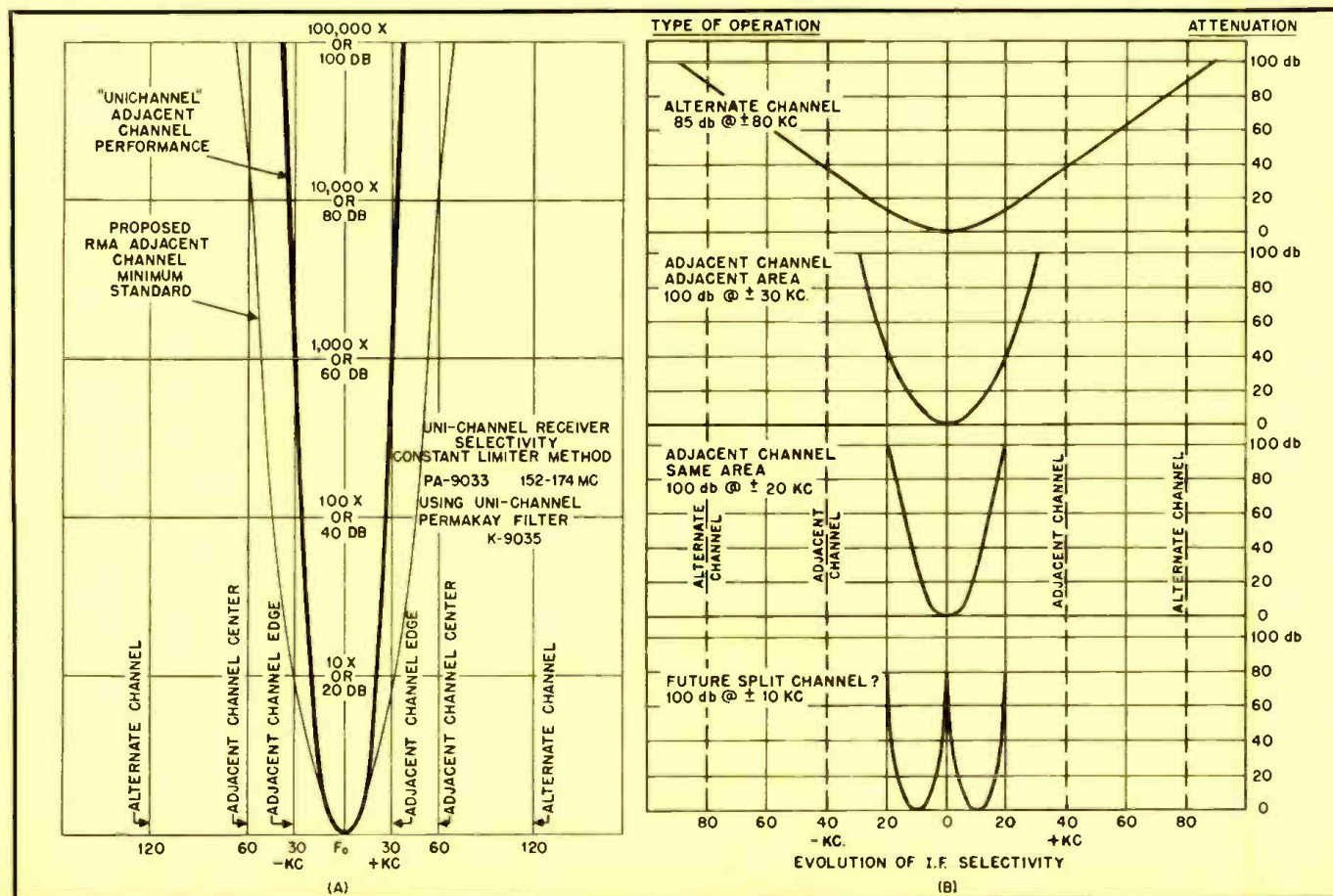



Fig. 8. Bottom view of the front-mount transmitter-receiver drawer.

insure operation which does not exceed the authorized channel limits.

In phase modulation, the instantaneous deviation excursion is determined by both the amplitude of the modulating wave and the steepness of the wavefront, or the slope of the modulating wave. This means that an ordinary amplitude limiter will not control the instantaneous deviation maximums, and in order to gain control it becomes necessary to add a slope limiter to the control circuit.

In order to comply with the requirements of adjacent-channel operations and—more recently—with existing FCC rulings governing deviation control, an instantaneous deviation control has been designed which provides amplitude-limiting and positive slope-limiting without introducing time constants for the attack and release time of the limiter. The circuit is simple enough to include in the usual types of base station and mobile communications equipment.

Operation of the deviation control (Fig. 9) requires the differentiation of the modulating wave, followed by a clipping action and then by an integration operation. The initial differentiation process emphasizes voltages associated with steep wavefronts or steep slopes, so that the clipping action clips

off that portion of the wave directly related to steep wavefronts. Since the differentiation has resulted in an emphasis of the high frequencies in relation to the low frequencies, it follows that undesirable voice pre-emphasis has occurred, and there also remains a distribution of frequency characteristics of the wave which would result in overmodulation. Since the clipper is followed by an integration circuit, the wave characteristics are restored to normal and any undesirable transients introduced by the clipping action are further reduced. Observing the action of this system on an oscilloscope, while subjecting the transmitter modulator input to approximately 30 db overload, the voice wave as shown on the oscilloscope seems to strike an invisible barrier. The scope is connected to a calibrated discriminator circuit, so that the excursion viewed is a direct indication of the instantaneous deviation.

The control of deviation in a phase-modulation system does not prevent the formation of products of modulation which will extend beyond the limits of the instantaneous deviation maximum. In other words, there will appear beyond the limits of deviation sidebands or products of modulation which may extend into the adjacent or into the alternate channel. Field tests show,

however, that because the energy content in a voice wave is low, and interference capabilities of these transient modulation products in the adjacent and alternate channels are very low, and while under certain conditions a degree of monkey chatter and some undesired noises may be produced, there is little or no actual interference with the reception of the desired station. Where the instantaneous deviation is not controlled, the excursion of the carrier outside of the passband of the receiver not only decreases the signal-to-noise ratio in the receiver but also adds considerably to the interference energy in the adjacent and alternate channels. The combination of superior receiver characteristics in a system where instantaneous deviation control is employed appreciably enhances the practicability of maximum channel utilization.

A maximum of ± 15 kc. is allowed under present FCC rules for optimum 100% modulation levels. Generally speaking, energy in the modulation excursion beyond the normal band acceptance of the receiver is rejected and, therefore, wasted. It is a fair "rule of thumb" to say that energy beyond the 10-db down limit of the selectivity curve is not useful energy. Obviously, then, as the bandwidth of the associated receiver becomes narrower, the transmitter deviation must be held within tighter limits. The narrow-band receivers exhibiting -100 db at ± 20 kc. characteristics require only ± 7.5 kc. deviation at 100% modulation for full audio output. Most assuredly, future split-channel operations will decrease the deviation limit still further.

Mechanical Design

The basic mobile unit is designed for the ultimate in compactness, featuring a three-unit type of chassis assembly installed drawer-fashion in a sturdy, metal, welded-construction housing. Intended to meet any mounting requirement encountered in the safety, industrial and commercial mobile services, it is made in two versions—front and rear mount—to provide complete installation versatility. The same basic drawer unit, comprised of a transmitter, receiver and power supply, can be assembled to make up either version with only the attachment of the appropriate front panel. Each of the two types has separate and distinct features to solve specific application problems.

The basic chassis (Fig. 5) contains the controlling elements of r.f. selectivity, frequency stability, intermodulation and desensitizing control, as well as single- and multiple-channel operation. The i.f. wave filter (Fig. 6), containing the

(Continued on page 29)

Fig. 9. Circuit for instantaneous deviation control used in receiver.

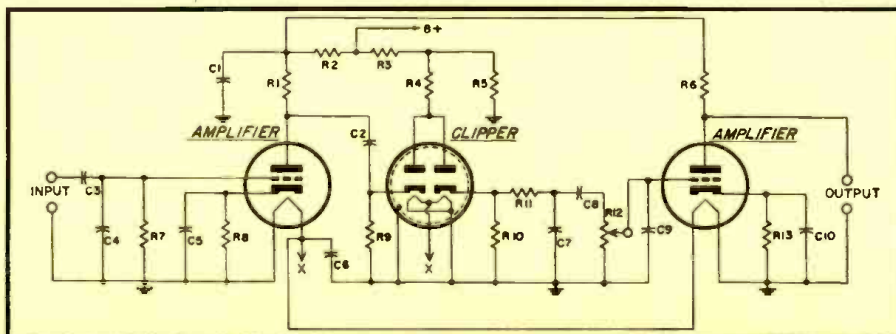

FLEXIBLE WAVE GUIDE

By **SAMUEL FREEDMAN**

Sightmaster of California Company

A representative sample of flexible wave guide bent in several tight turns.

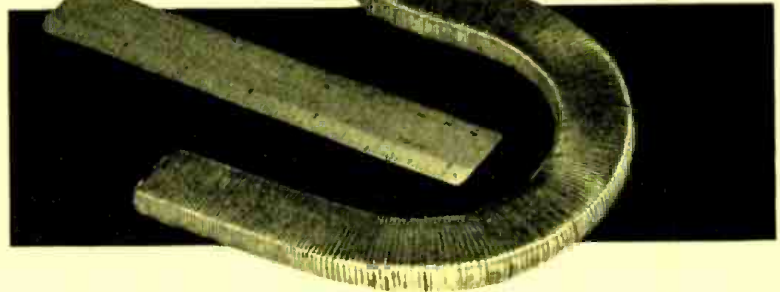

Sharp bends and twists with low VSWR's are feasible with this versatile tool for the microwave engineer.

THE development of improved flexible wave guide is expected to resolve the inadequacies of rigid wave guide which have been prevalent in the past. These inadequacies have been due to the problem of changing the direction of the wave guide run between equipment and the antenna system as well as between sections of microwave or radar apparatus—particularly where longitudinal, lateral or transverse stresses exist as a result of contraction and expansion caused by weather, temperature, vibration or shock. Practically all airborne radar installations must use flexible wave guide between the apparatus and the antenna system because of relative motion and vibration. In the past, many types of flexible wave guide have been subject to short life at maximum electrical efficiency due to the mechanical breakage and distortion developed under severe conditions of military flight.

Figure 4 shows six of the innumerable conditions under which a straight wave guide run cannot suffice. When an elbow such as one of those illustrated in Fig. 4 is used, it is limited to either the wide E plane or the narrow H plane of a wave guide. Manufacturers normally do not provide other than 45° or 90° bends. Since bends have a tendency to "buckle" in their forming, many prefer to use the costly mitered joint type of elbow shown in Figs. 4C and F. Actually, in practice, there may be a temporary, intermittent, or permanent need for angles or distortions other than those illustrated in Fig. 4 and not normally fabricated out of rigid wave guide. The unfeasibility of obtaining wave guide elbows suitable for every installational and operational condition likely to exist or occur in practice has heretofore made it necessary to lay out systems to fit the existing straight wave guide or elbows available, often complicating layout planning and installation. When the *Bell System* microwave network went into initial service between New York and Boston, much

time and expense were saved without sacrifice in performance by the use of flexible wave guide between the rigid wave guide coming to the roof from the equipment below and the electromagnetic horns on the roof. It also simplified changing the angle of the horn as required for beaming to the next relay station, as well as simplifying small section replacements for the part exposed in severe weather. On many radar-equipped vessels, the wave guide run from the equipment to the antenna may lead up a mast that vibrates and sways with respect to the rest of the ship or the microwave radar equipment. Here, flexible wave guide can render important service in improving electrical performance under adverse or unstable conditions.

The need for flexible wave guide sections to augment rigid wave guide sections became particularly acute when microwave radar was installed on military aircraft in World War II. The development and manufacture of wave guide having flexibility was taken up

by existing manufacturers of flexible metal hose or shielding. However, such hose or shielding was always round whereas the desired wave guide was rectangular. As the production of rectangular flexible hose or tubing appeared to pose difficult problems, particularly with regard to the exceptionally close dimensional tolerances required, flexible wave guide manufacture narrowed down to a small handful of individuals and firms. Figure 2 shows the type of work and machinery used to produce round flexible hose at the *Flexible Metal Hose Manufacturing Company* which led to the method used in the production of the flexible wave guide described in this article.

During 1952, having the cooperation of *Sightmaster of California Company* of Santee, Calif., with its microwave know-how and test facilities, this company developed facilities, techniques and new types of flexible wave guide convolutions that represent an advance over previous known versions. Specifically, they succeeded in producing wave guide that was flexible to the maximum likely to be needed in the narrow H plane as well as in the wide E plane. Whereas, in the past, flexible wave guide was considered satisfactory if it could be bent 180° or more in the E plane and only a very few degrees in the H plane, this new product could be flexed in all planes and could even be bent more than 360° in a 12" length, as illustrated in Fig. 3. Tests

Fig. 1. Uncompressed shape showing two soldered serrations or convolutions.

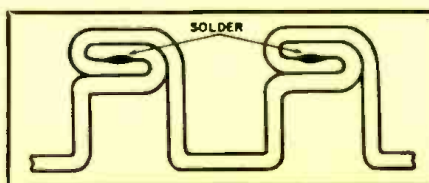

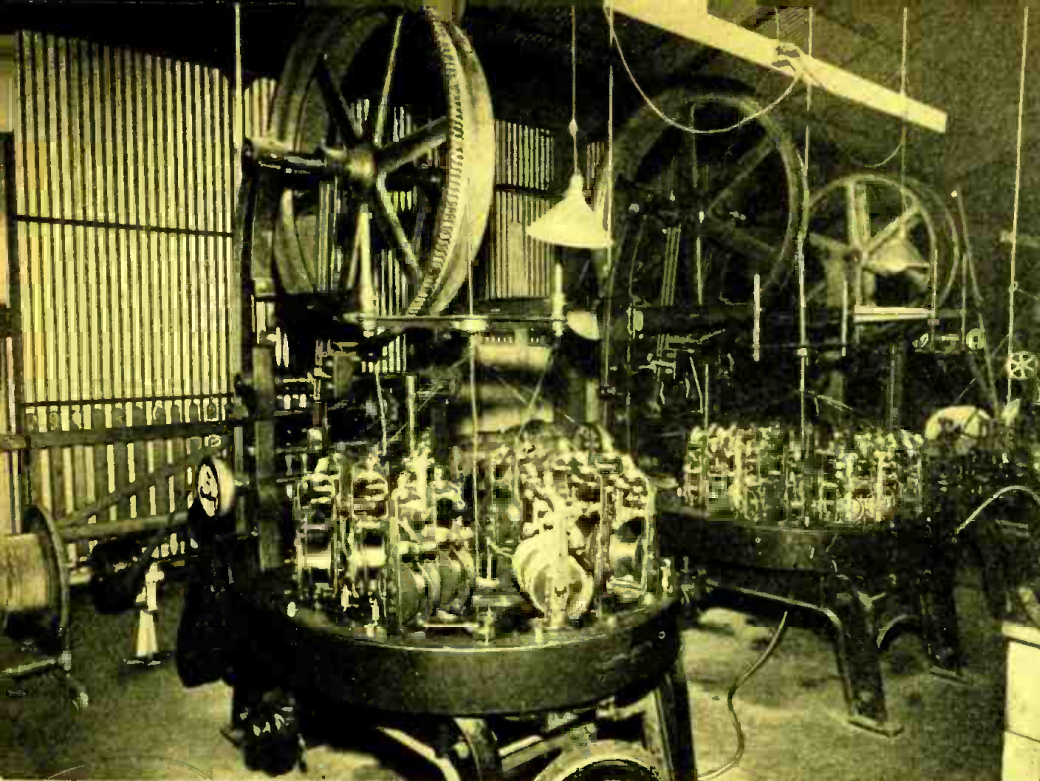

Fig. 2. Production of round flexible hose at the Flexible Metal Hose Mfg. Co. factory.

made on such bends have given a VSWR of 1.1 or lower, with readings as low as 1.04 for less severe bends (up to 180°).

Much of the credit for this development work is attributable to the ingenuity and initiative of William K. Herbst, whose mechanical and electronic experience began in 1906—when he was associated with *Crocker Wheeler Company*, gained impetus in the flexible metal hose field with *Titeflex, Inc.*, between 1916 and 1924, and continued with various firms and undertakings during the ensuing 30 years. His experience has now culminated in the wave guide illustrated in Fig. 3, plus additional refinements.

Figure 5 shows a typical in-the-plant or in-the-laboratory use of flexible wave guide. In this example, an SL-1 radar at 3000 mc. has been connected to a microwave calorimeter for power measurement. The flexible wave guide shown makes a quick, simple connection possible between the radar and the calorimeter for a quick final calibration of the latter.

The life of flexible wave guide under conditions of motion, notably on aircraft, has formerly been short. Many airborne radar systems are no doubt operating, or have operated, with deformations or mechanical damage inside flexible wave guide—cracked or deformed serrations which might cause electrical mismatches and malperformance. Being hard to reach for inspection or replacement, they may be allowed to operate at less than optimum while still rendering substantially good performance. By increasing the flexibility and the amount of “give” per serra-

tion, great progress has been made in extending the life of flexible wave guide and improving electrical performance.

Flexible wave guide normally consists of many closely spaced serrations made from a flexible metal, with each serration soldered to the adjacent one to form a tight seal.

Production Technique

The basic method of producing flexible wave guide is shown in Fig. 1. Steps involved are as follows:

1. A suitable metal is selected for the requirement; this may be cartridge brass or a bimetal such as silver-copper.
2. The metal is unrolled as a coiled strip and fed into forming rolls and dies to produce a convoluted or serrated rectangular tube, with each ridge or serration being locked to the next to form a seam. This seam is similar to the type of seam used in tin cans, being made with soft

Fig. 3. A demonstration of the flexibility of flexible rectangular wave guide manufactured by Flexible Hose Mfg. Co.



solder. The soft solder seals the seam, as shown in Fig. 1.

3. The flexible wave guide is formed to the required length by the use of a sufficient number of convolutions or serrations. It is then cut off.
4. Flanges are attached.
5. The assembly is inspected and tested.
6. The wave guide is then covered with protective material, such as rubber. Dipping, wrapping or spraying may be used in lieu of molding.

The heart of any flexible guide is the individual serration or convolution and the way it is interlocked with the adjacent serration or convolution. Figure 1 shows soldered serrations. The solder is fed in simultaneously with the serrations in wire form, being heated as it comes off the arbor. Methods of forming serrations, feeding the solder and otherwise making the flexible wave guide structure are closely guarded by each manufacturer.

Production Problems

The many problems to be considered in making good flexible wave guide tend to discourage manufacturers from entering the field. Among the major considerations are:

1. Keeping a sharp corner radius inside the rectangular section requires special die shape and inside arbor.
2. Depth of the serration is determined by the design of the form. The effective wave guide size is the net inside dimension for the tops of the serrations. Gaps between serrations and depths of serrations are small compared to the wavelength, and the inside of the guide theoretically presents a solid surface.
3. In flexing the individual serrations, it is highly desirable that the height of one should not appreciably change with respect to the others, so as not to change the cutoff frequency of the wave guide or its electrical characteristics for a stated frequency. It should return to normalcy of dimension when tension is released.
4. It is necessary to allow for the effect of an angle or a circular bend.
5. The effect of a transverse twist must be calculated.
6. Alignment of the flanges is a principal source of trouble as misalignment adversely affects the VSWR. Too much attention cannot be given to this detail and the greatest skill is needed in attaching flanges properly to maintain optimum alignment. The heavy stock of which the flanges are made has to be soldered to the thin material of the serrations.
7. The wide dimension tends to flex better than the narrow dimension.
8. There are complex forces which de-

velop when a flexible wave guide is twisted instead of merely bent.

- The limit of flexing present in every flexible wave guide must be determined. Within this limit, a flexible wave guide must return to normalcy when relaxed. Limit of flexing is determined by size, depth of convolution, serration rate per inch, and material used. The lap and solder do not form a pertinent part of the rectangular inside dimension of the wave guide.

As defined in the military specifications of the Armed Services Electro-Standards Agency, a flexible wave guide is a flexible transmission line, with associated flanges attached, which mates electrically and mechanically with standard rigid wave guide. Various flexible wave guide characteristics are defined as follows:

Relaxed Position: horizontal position under no stress except that of gravity.

Minimum Bending Radius: the radius to the center line to which the flexible wave guide can be bent without causing mechanical damage or causing electrical properties to deviate from specified values.

E Plane: the longitudinal plane which bisects the wide sides of the wave guide.

H Plane: the longitudinal plane which bisects the narrow sides of the guide.

Axial Twist: maximum angle through which one flange can be rotated with respect to the other flange without causing mechanical damage or causing electrical properties to exceed specified values.

Flexure: number of cycles through which a flexible wave guide assembly can be bent without causing mechanical damage or causing electrical properties to exceed specified values.

Repeated Twist: number of cycles through which an assembly can be twisted without causing mechanical damage or electrical properties to exceed specified values.

Attenuation: one-way power transmission loss through a flexible wave guide in decibels per foot.

Safe Extension (static): extension from relaxed position length to which the assembly can be stretched without causing mechanical damage or causing the electrical properties to exceed specified values.

Flexible wave guide is second only to rigid wave guide in efficiency of power transmission and will be increasingly used wherever fully stationary straight wave guide runs are not possible or convenient. It is expected to replace elbows and rigid wave guide bends, and has already been extensively used for that purpose.

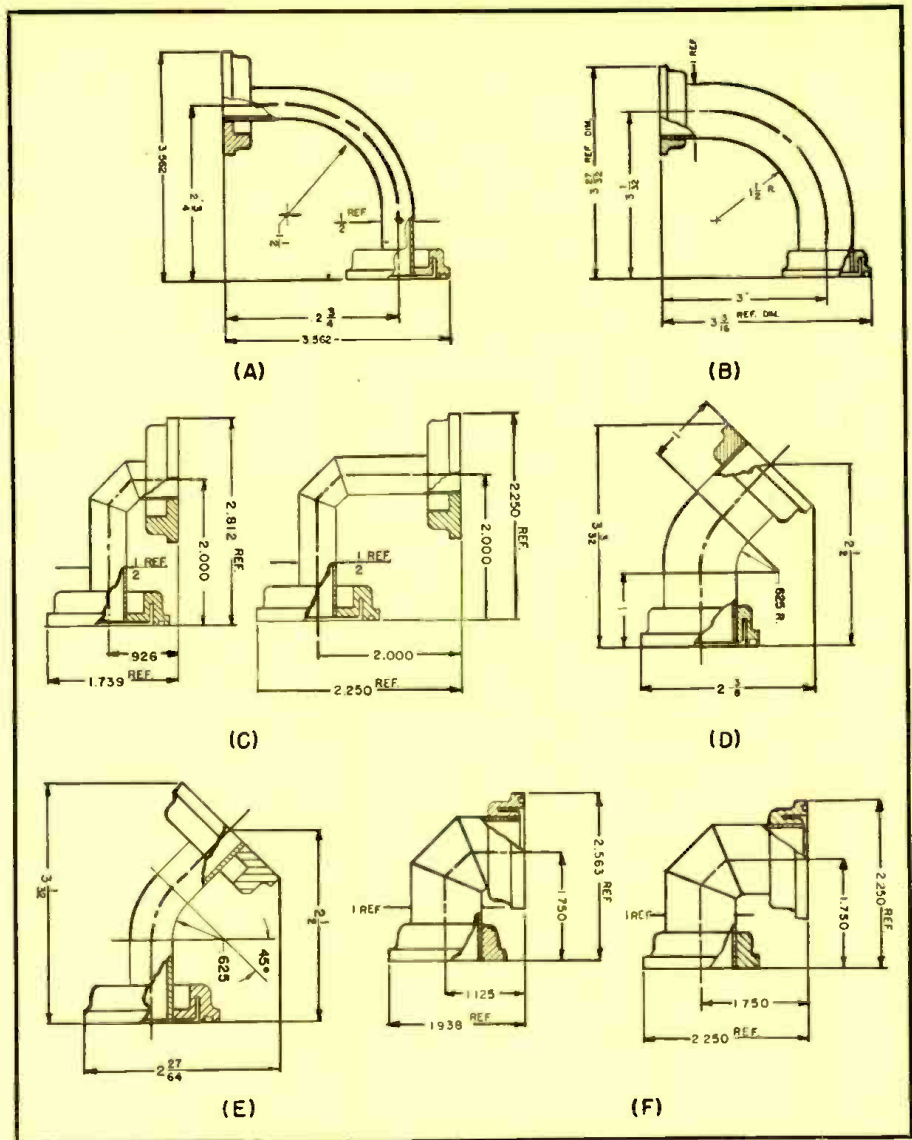
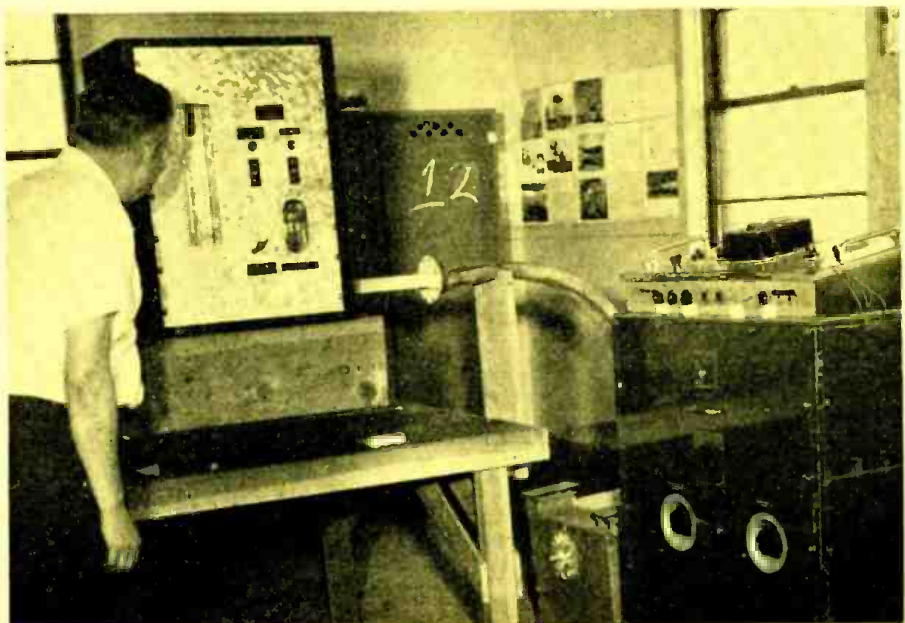

Fig. 4. Various types of bends using 1" x 1/2" wave guide suitable for the 10,000-10,500 mc. band: (A) E plane 90° bend. (B) H plane 90° bend. (C) E plane 90° mitered elbows. (D) H plane 45° bend. (E) E plane 45° bend. (F) H plane 90° mitered elbows.

Fig. 5. Radar equipment connected to a microwave calorimeter by flexible wave guide.



MAGNETIC AMPLIFIER TEMPERATURE CONTROLLER

By **DAVID FELDMAN**

Bogue Electric Mfg. Co.

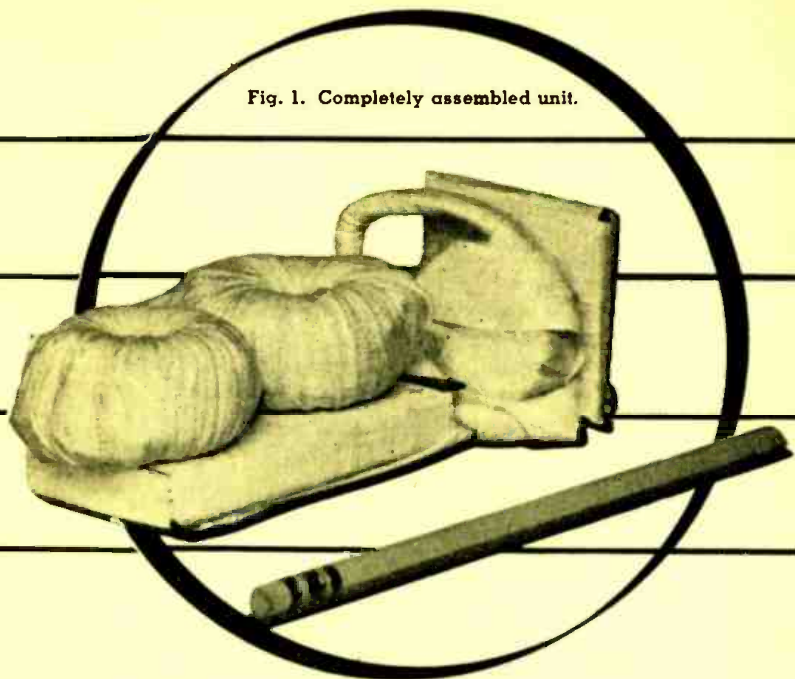

Fig. 1. Completely assembled unit.

A temperature-sensitive bridge controls the power to the heating element by means of a magnetic amplifier.

PROBLEMS of temperature control have long been of interest to engineers and for a considerable period of time have been solved by the use of thermostats and other similar transducers. Temperature regulators have been available for many years and, for applications requiring precise control, have consisted of electronic voltage and power amplifiers. The performance of such systems has in general been quite good.

Requirements of the temperature controller to be described here were dictated by the customer. This application called for a regulating system which would contain no moving parts, have long life, be maintenance-free, resist mechanical vibration and shock, and be of minimum size and weight. Magnetic amplifiers are ideally suited to such general requirements. Comparison between electronic and magnetic amplifiers has often been made and need not be discussed here.

The following requirements were specified for the regulator. Temperature of the body was to be adjustable between $140^{\circ} \pm 10^{\circ}\text{F}$ and, at any temperature in the adjustable range, controlled to within $\pm 0.1^{\circ}\text{F}$ —under conditions of constant load, varying line voltage and frequency, and varying ambient temperature. The available power was 115 volts $\pm 1\%$ at 400 cycles $\pm \frac{1}{2}\%$; the ambient temperature variation was specified at $68^{\circ} \pm 10^{\circ}\text{F}$. The regulator was to maintain temperature to within $\pm 0.1^{\circ}\text{F}$ for a period of at least 48 hours and within $\pm 1.5^{\circ}\text{F}$ over a period of one year. Efficiency of the system at full load was to be at least 80%.

Dimensions of the body whose temperature was to be controlled were: volume—approximately 300 cubic

inches; weight—approximately 60 pounds. Thermal conductivity of the body was approximately 29 btu per hour per square foot per inch $^{\circ}\text{F}$.

The basic elements of any system for providing close temperature regulation are as follows:

1. Heating element
2. Temperature-sensing element, reference element
3. Controllable heat supply
4. Object or space to be temperature-controlled
5. Heat conducting medium

The system to be described here is commonly considered to be a proportional type of controller such that the quantity of heat supplied to a body is varied in proportion to the losses in the system. The losses in this system are a function of the temperature gradient between the controlled body and the surrounding ambient temperature.

A Nichrome resistance strip heater, constructed in such a manner that it would be in contact with the entire radiating surface of the body, was

chosen as the heating element. Its approximate resistance was 65 ohms.

Since the heating element could be powered with a.c., a single-phase self-saturating magnetic amplifier circuit was chosen, consisting of the minimum number of components. A schematic of the magnetic amplifier circuit, often called a doubler circuit, is shown in Fig. 3A. In this circuit, the output power to the heating element is controlled by varying the d.c. current in the control winding.

The requirements for a high gain magnetic amplifier such as the one used in this development dictated the use of core material having a high saturation flux density, high residual flux density, and low coercive force; also essential was the use of a self-saturating rectifier having a high reverse resistance, a high blocking voltage, and a high forward current capacity.

Selenium rectifiers available today can be manufactured to meet the above specifications. As will be discussed later, the specific application dictated the development of special techniques in order to employ selenium rectifiers.

A circuit for temperature-sensing, incorporating both the reference and the detector, was designed. This circuit is essentially a Wheatstone bridge consisting of two temperature-insensitive resistance arms, two temperature-sensitive resistance arms and an adjustable resistance. Reference arms of the bridge were constructed of Karma (331 alloy) resistance wire; the temperature coefficient of resistance for Karma wire

Fig. 2. Block diagram of a closed-loop system applied to a magnetic amplifier.

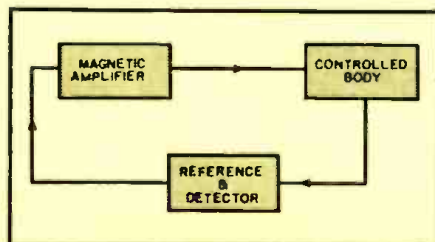

is negligible over the temperature range being considered. Detector arms of the bridge were constructed of ballast nickel resistance wire; the temperature coefficient of resistance for ballast nickel wire is 0.0067 parts per °C in the temperature range of 0-100°C.

The temperature controller was designed so that the temperature-sensitive arms of the sensing bridge were located around the controlled body (in contact with the entire body surface), this being the only practical location for the sensing elements in the application at hand. The fixed bridge arms were located outside of the controlled body and mounted on the magnetic amplifier package. In order to approach the minimum over-all size of the regulator, keeping self-heating effects of the temperature-sensing elements to a minimum and keeping the fixed load on the customer's power supply to a minimum, a ratio of approximately 20 for the maximum output of the magnetic amplifier to the power being supplied to the temperature-sensitive arms was chosen. Actual values of these two quantities were 95 watts and 5 watts, respectively.

With the Wheatstone bridge as described above for temperature-sensing, the sensitivity of the detector when referred to the control winding of the magnetic amplifier was approximately 0.565-ampere turn per °F. The control winding on the magnetic amplifier consisted of 1000 turns having a resistance of approximately 10 ohms. Resistance of each of the arms of the Wheatstone bridge was 10 ohms.

Shown in Fig. 3C is the transfer characteristic of the magnetic amplifier. Figure 3B shows the final circuit. Measurements indicated that a power gain of about 1.4×10^6 from cutoff to saturation and a voltage gain of approximately 700 could be obtained with this detector and amplifier. The calculated power gain per cycle was approximately 1000.

The magnetic amplifier is energized

from the 115-volt 400-cycle bus and the controlled temperature is selected by adjustment of the rheostat R_s . Control current in the magnetic amplifier control winding at this time is such as to saturate the amplifier fully. This provides maximum power to the heating element and thus begins to raise the temperature of the controlled body. As the temperature of the body increases, the resistance of the temperature-sensitive arms also increases and the bridge is slowly brought to balance. The bridge will reach a balance point at the desired controlled temperature, at which time the magnetic amplifier need provide only that power necessary to overcome losses in the system. The temperature-time and power-time characteristics and the temperature variations encountered are indicated in Fig. 4.

The major difficulty in this development concerned size. The size of the desired package, to include the magnetic amplifier cores and rectifiers, was established at approximately 20 cubic inches. Core design, the total volume occupied by the windings, and the rectifier size had to be kept to an absolute minimum. This fact, coupled with expected heat dissipation within the package, presented several problems to be solved. Because of the expected temperature rise within the package, normal practice would dictate use of perhaps a class H insulation. However, reduced space and winding factors inherent in the use of certain high-temperature insulated magnet wire required that the choice of suitable wire be a subject of investigation. Spacing between normal rectifier plates of a size suitable for the power requirements of the regulator dictated use of a rectifier assembly in which the cells would be in intimate contact, in order to reduce the package size. This entailed a great deal of investigation and development. While the maximum power requirements of the amplifier are utilized for a relatively short time, in this case approximately 1 hour, the

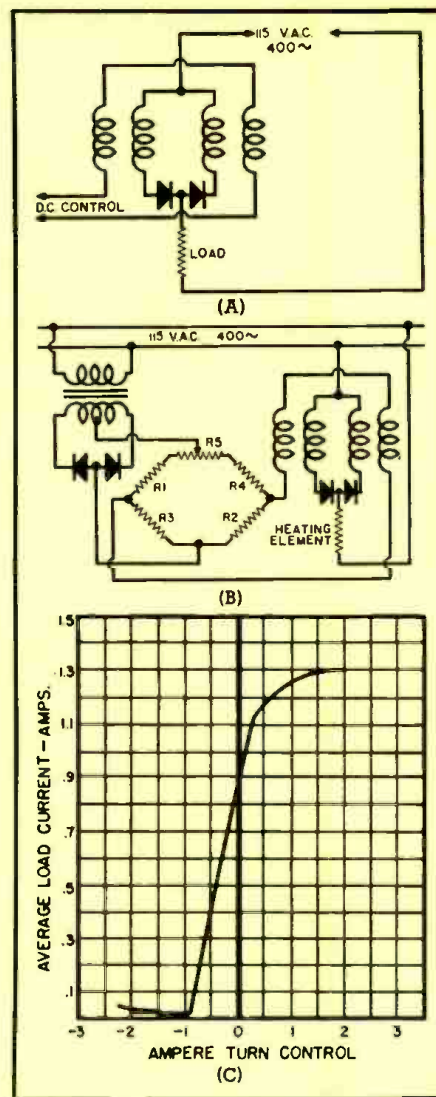
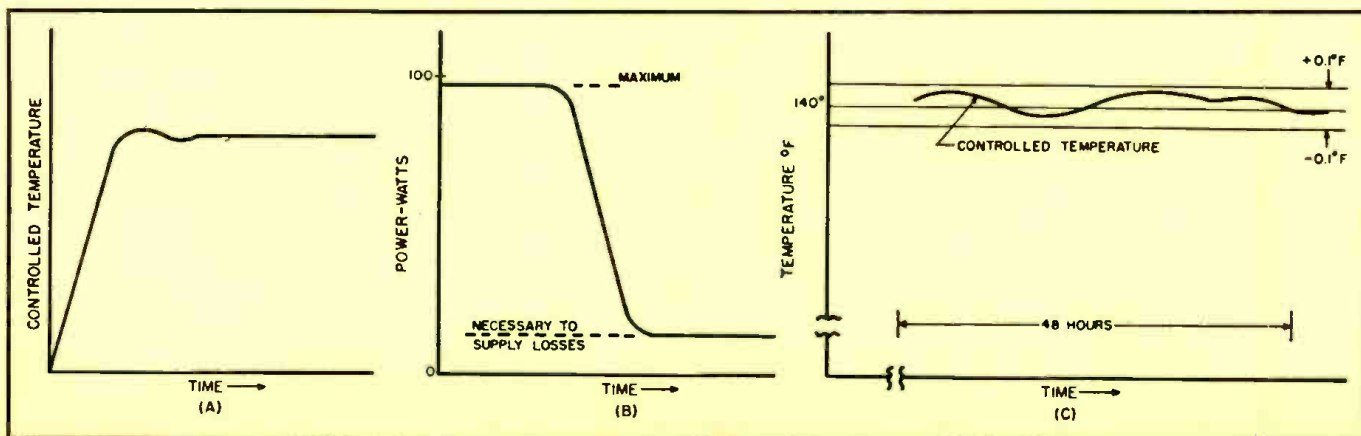

Fig. 3. (A) Schematic of magnetic amplifier circuit. (B) Final circuit of the complete controller. (C) Transfer characteristic of the magnetic amplifier.

usual ratings based on small duty cycles could obviously not apply.

A determining factor in this application was the need for a selenium rectifier of the magnetic amplifier type cap-
(Continued on page 29)

Fig. 4. (A) Temperature-time characteristic of system. (B) Power-time characteristic. (C) Temperature variations encountered.



THE TRAVELING-WAVE TUBE

By

M. E. HINES

Bell Telephone Laboratories, Inc.

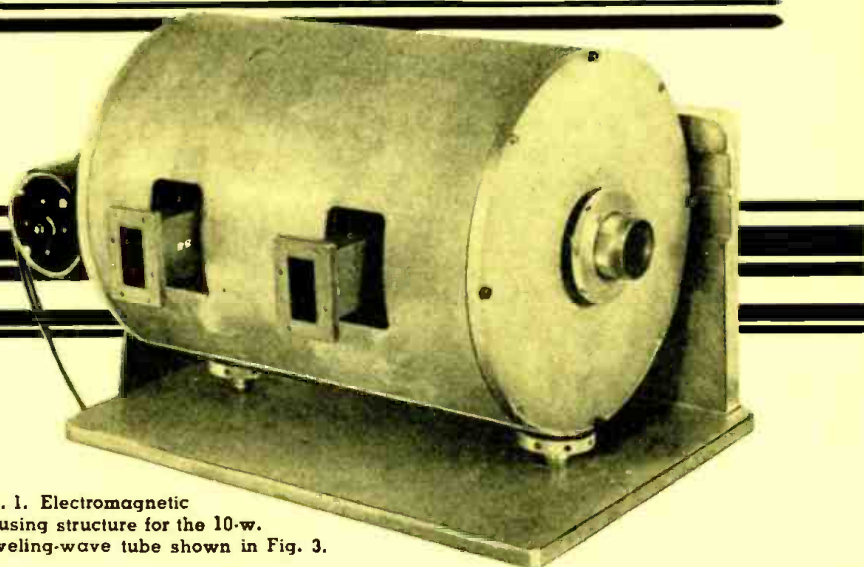

Fig. 1. Electromagnetic focusing structure for the 10-w. traveling-wave tube shown in Fig. 3.

SOME OF the most important recent advances in communication engineering have been due to the exploitation of the microwave and u.h.f. ranges for telephone and television relay and the substantial increases in the message-handling capabilities of these and other communications channels. Many thousands of miles of microwave relay are now in operation in the United States and abroad, and rapid expansion of these facilities is continuing. Some of these microwave relay channels have sufficient bandwidth to transmit a television signal or several hundred simultaneous telephone messages. With further improvements, it is expected that still wider band signals will be transmitted, with more and more telephone messages or television signals per channel.

The traveling-wave tube, now coming into use, promises to increase greatly the bandwidth capabilities of this type of transmission system. This tube is an amplifier suitable for use in the u.h.f. and microwave frequency ranges. It is capable of giving very high gain, with bandwidths of several hundred to several thousand megacycles. This is a very much wider bandwidth than can be amplified by any other tube type now available, and it is this feature which makes the traveling-wave tube so important for communications. It has long been recognized that the greater the bandwidth of a communication channel, the greater the possible information transmission rate. This can mean more telephone messages per radio channel, higher definition television transmission, higher telegraph pulse rates, etc.

One of the earliest experimenters with the traveling-wave tube was Dr. Rudolph Kompfner, working in England in 1944. The importance of this tube was quickly realized, and since that time intensive development has been carried out in many laboratories to bring the tube to its present practical state for communication systems.

Bandwidths of hundreds and even thousands of megacycles at u.h.f. and microwave frequencies can now be realized.

Many types of traveling-wave tubes have been built and tested, some of which appear to have only superficial resemblances between them. The basic feature which characterizes all traveling-wave tubes is that amplification occurs gradually along an extended wave-guiding circuit adjacent to an extended electron stream, with energy being transferred from the electron stream to the signal wave propagating on the circuit. This energy transfer may occur continuously all along the electron stream, or repeatedly at a number of specific interaction gaps where signal voltages appear. Both types of tubes have been successfully used. The helix is the most common circuit for continuous interaction.

Figure 5 illustrates, somewhat schematically, a typical helix type of traveling-wave tube together with its external connecting wave guides. The helix is rather long and slender and is enclosed by a glass tube which is, in this case, the vacuum envelope. Four thin ceramic rods extend longitudinally between the helix and the glass to keep the helix straight and properly spaced away from the envelope. The helix itself is simply a long coil-spring which acts as a special form of wave guide. It is coupled at each end to the more conventional rectangular input and output wave guides. The short tubular sections at the ends of the helix act as antennas within the wave guides to perform the coupling. When properly adjusted, all of the input signal power is transferred

to the helix wave. Similarly, all of the amplified output power on the helix is transferred out of the wave guide at the other end, the glass envelope not seriously interfering. The enlarged section of the envelope to the left of the input wave guide contains the electron gun, and the electron collector is sealed to the glass tube at the opposite end. In the gun, the electron stream emitted by the cathode is accelerated toward the gun anode or accelerator, which is at a positive potential with respect to the cathode. The stream passes through a hole in this electrode and is thence transmitted down the axis of the helix to the collector, ideally without appreciable interception of any electrons on the helix itself. All along the helix, there is an interaction effect which causes the electrons to lose some of their kinetic energy, and this energy reappears as increased signal power propagating on the helix.

Not shown in Fig. 5 is the magnet which is required to focus the electron beam so that it will be transmitted down the helix without serious interception. In most traveling-wave tubes, the beam current is too large to permit the use of beam-focusing methods of the type used in cathode-ray tubes. The internal space charge causes the electrons to repel each other, so that a continuous magnetic field parallel to the axis must be used to hold the beam together. Electrons which try to move laterally are spiraled back toward the axis and continue on.

Figure 2 shows an enlarged section of the helix and the electron stream, and illustrates the bunching action which occurs during amplification. The electric field lines shown are those associated with a propagating signal wave on the helix. This field pattern has a strong longitudinal component along the axis, and it is periodically oriented forward and backward, with one region of forward and one region of backward field in each wavelength. This field pattern of the wave moves more or less smoothly forward from the input toward the output, but the forward component of the wave velocity is greatly reduced by the helical form of the guiding wire—usually to between 1/10th and 1/20th the velocity of light. With this reduced wave velocity, it is easily possible to adjust the electron drift velocity so that it will be equal to the wave propagation velocity. The electron velocity depends only upon the voltage difference between the cathode and the helix. The helix wave velocity depends upon its geometry and surroundings, and may be designed to correspond to the appropriate voltage desired—usually in the range of a few hundred to a few thousand volts.

Imagine in Fig. 2 that the electrons are initially moving at exactly the speed of the wave. The electrons in the regions of retarding electric field are decelerated, and conversely, those in accelerating field regions are pushed ahead. As the wave and electrons move forward together, there will be a tendency for the local charge density in the electron stream to increase in those null field regions where the electric field just ahead is decelerating and that just behind is accelerating. Actually, for an amplifier, the electrons are always transmitted at a velocity slightly higher than that of the wave being propagated. This causes the bunches of electrons to form so that the zones of maximum charge density are in the regions of decelerating field just ahead of these nulls. There are corresponding regions of reduced local charge density in the regions of accelerating field. In this way, more electrons are decelerated than accelerated and the loss of kinetic energy appears as increased electromagnetic power in the signal wave. Near the input end of the tube, where the wave may be quite weak, the electron beam will have only slight variations in local charge density; but at the output, after amplification, the wave is much stronger and the bunching effect may be very marked, with most of the electrons being redistributed into sharply peaked groups.

The basic requirement for obtaining gain is that the wave velocity and the electron velocity be nearly equal, with the electron velocity slightly the greater

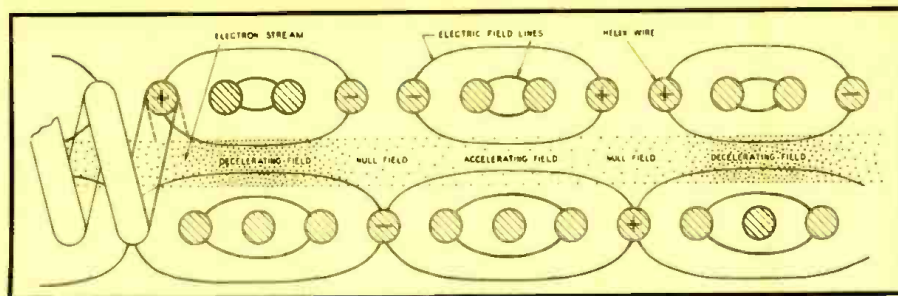

Fig. 2. Enlarged section of helix and electron stream, illustrating bunching action.

of the two. The helix is a smooth type of line exhibiting only gradual slow changes in wave velocity with frequency, so that the conditions for gain are satisfied over a very wide frequency range for a fixed electron velocity. As no resonant circuits are required, such as those for r.f. klystrons, triodes, pentodes, etc., the useful bandwidth for signal amplification may be very great indeed. Often it is found that the bandwidth is limited more by the methods of coupling the signal into and out of the tube than by the internal electronic behavior.

The fact that amplification will occur at frequencies where the helix and wave guide are not perfectly coupled will result in oscillation at such frequencies unless steps are taken to prevent it. Noise generated by the electron stream will be amplified in passing forward; then—if this power is not coupled out or absorbed—it will be reflected back to the input and then forward again, where additional gain will occur. If this process were to continue, after several round trips an oscillation would appear. This is ordinarily prevented by intentionally making a short central portion of the helix very lossy to r.f. waves. Any waves traveling backward are absorbed and essentially disappear, but forward waves have an opportunity to bunch the electron stream somewhat before being absorbed. These bunches constitute an a.c. current corresponding to the signal, and after passing beyond the region of high loss start a new wave train on the far side which subsequently grows to a magnitude greater than that at the tube input. With this internal attenuation, the de-

vice has the very desirable property of stability under all conditions of line termination. The tube then acts as a piece of transmission line with high gain in the forward direction and high loss in the backward direction.

Figure 3 shows a *Bell Telephone Laboratories* experimental 4000-mc. traveling-wave tube suitable for use as an output tube for a radio relay transmitter. It will produce 10 watts of r.f. power with a gain of 25 db and a 500-mc. bandwidth between 3700 and 4200 mc. At smaller signal outputs, the gain is approximately 10 db higher. The beam current is 40 ma., with 1800 volts potential difference required between the helix and the cathode. The helix proper is 6" long and the beam must pass through its inner diameter of .080". Because of this high current density, a magnetic focusing field of 600 gauss is needed over a length of 7.5". This requires a rather large magnet, either of the permanent or electromagnetic type.

Figure 1 shows one type of "circuit" which, with the traveling-wave tube inserted, constitutes a complete amplifier. Within the large cylindrical tube are the coils for the magnetic focusing field. The rectangular tubes entering from the side are the wave guide connections, and the traveling-wave tube is inserted into the end of the large cylinder along its axis. Permanent magnets have also been successfully used to focus the beam of this tube.

The magnetic field requirements are rather stringent, particularly with regard to straightness and uniformity of the field, in order to prevent the electron beam from striking the helix. This

Fig. 3. Experimental 4000-mc. traveling-wave tube which provides a 10-watt output.

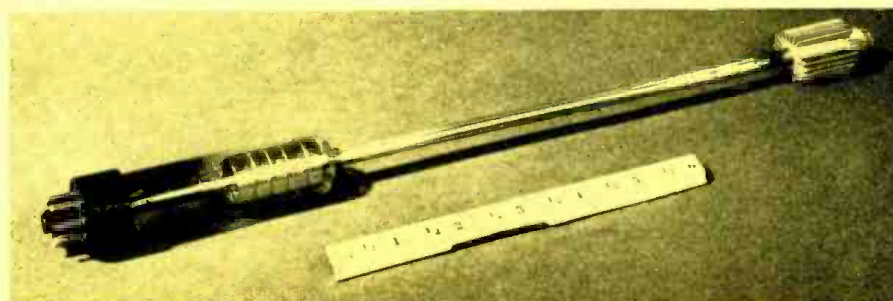

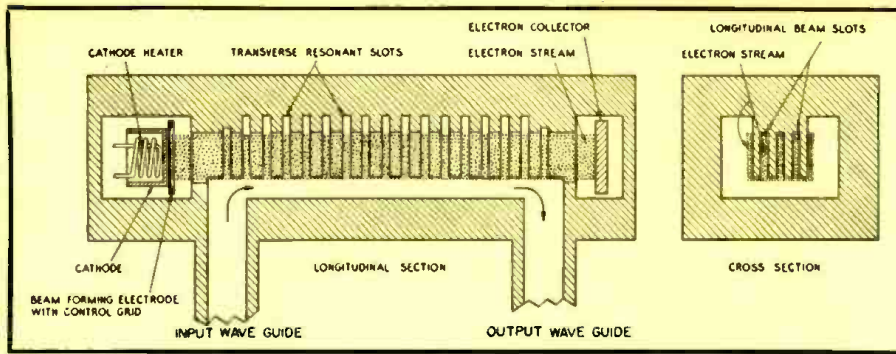

Fig. 4. Schematic of Millman's 6-mm. filter type of traveling-wave tube.

tends to make the initial installation somewhat more expensive than it would be with some other types of amplifiers.

The tube just described is only one example of the many types of helix tubes experimented with at a number of laboratories both in the United States and abroad. At the present state of development, helix tubes are usually preferred for the roughly defined frequency range between 500 mc. and 10,000 mc. for small or moderate power capacity. Tubes for the lower frequency ranges can use large-size helices, but at the higher frequencies small-diameter helices of fine wire must be used in order to obtain efficient interaction and high gain. Power dissipation becomes a serious problem at such frequencies, as the helix is not an easily cooled structure. As a type, however, the helix is a very efficient circuit, giving high gain and broad bandwidth, and it is used wherever possible.

Filter Type Tubes

Most circuits other than the helix fall into the class of "filter" circuits, where the wave is propagated along a cascaded wave filter of many sections consisting of intercoupled resonant elements. One example of this kind of circuit is that used by S. Millman in his 6-mm. (50,000 mc.) amplifier. The

internal structure of this tube is illustrated in Fig. 4.

Here, the wave propagates along a kind of loaded ridged wave guide. The loading is accomplished by cutting a series of transverse slots into the ridge which are approximately $\frac{1}{4}$ wavelength deep and therefore have resonant properties. Another series of slots, cut longitudinally, carries the multiple electron streams. As these streams drift down the tube, they encounter r.f. voltages in crossing the transverse resonant slots, and by repeated interaction with the r.f. wave, kinetic energy is gradually transferred from the electron stream in a manner similar to that of the energy transfer in the helix type tube. The wave grows exponentially and emerges from the output wave guide with greater power than when it entered the tube. Millman's 6-mm. wave amplifier will give 20 db of gain at 50,000 mc. with 1500 mc. of bandwidth.

Design Considerations

Some of the features desired in a "good" traveling-wave tube are high gain, adequate bandwidth, small size and weight (including, of course, the focusing magnet), high efficiency in a power tube, and low noise-figure for a receiver tube. As is often the case, these cannot all be optimized in one tube type.

To obtain high gain per unit length and high efficiency, it is desirable to use a helix of high impedance and a low voltage, high current electron stream. A high impedance helix means small diameter and fine wire, but small size makes for greater difficulty in beam transmission and power dissipation. Large magnetic fields are also required for high density beams. As is usual in such cases, a compromise between all of the important parameters is necessary to achieve a balanced, conservative design.

Low-noise tubes are usually of special design with very low beam currents, which may make them unsuitable for producing more than a few milliwatts of power.

The many different types of traveling-wave tubes which have actually been built and successfully tested are too numerous to describe here. They run the gamut from milliwatt to kilowatt power capacity and from frequencies below 100 mc. to over 50,000 mc. Low-noise receiver tubes have been made which degrade the signal-to-noise ratio less than any other type of microwave amplifier. Electronically tunable oscillators, whose frequency can be varied by changes in the beam voltage to cover frequency ranges greater than 20% of the center frequency, have also been the subject of experimentation.

This new tube type is an extremely versatile one indeed. Probably its most useful function is that of amplifying u.h.f. and microwave power. Its most immediate application will be in microwave radio relay communication systems where its wide bandwidth and adequate power output are most important. Actually, the bandwidth of these tubes is much greater than can now be used, because there is no practical system at present which can combine the very large number of possible communications channels into a single modulated signal for transmission or separate

(Continued on page 26)

Fig. 5. Schematic sketch of a helix type traveling-wave tube and its connecting wave guides.

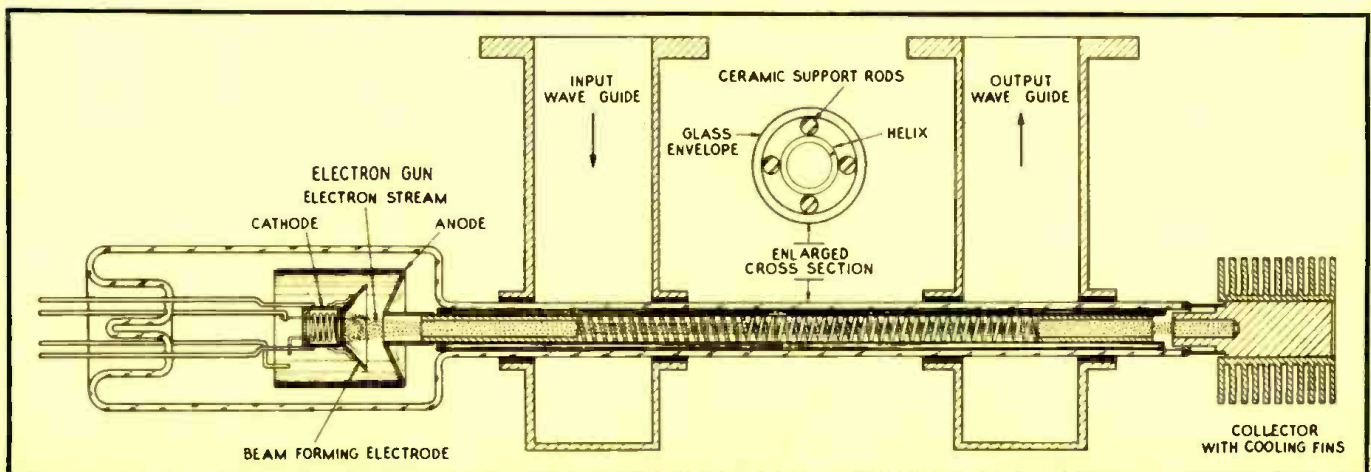



Fig. 1. A bench test setup for checking accurately the characteristics of various types of broadcasting and industrial power tubes.

ELECTRONIC equipment manufacturers and users of their equipment sometimes have occasion to stock large quantities of tubes supplied by other manufacturers. Usually, sample tubes have been tried out by the project engineers in prototype equipment, and specifications have been drawn up which the tubes and equipment must meet before the production line can be set up.

When trouble occurs, one of the most immediate questions to be answered is whether it is due to the tube or to some other component. The simplest approach to the problem is to take samples of the tubes from stock and try them in the equipment. In this process of elimination, it may become evident that certain quantities of the tubes will work while the rest will not.

There then remains the question of why some of the tubes will not work. It is possible that these tubes meet the original specifications but that some changes have occurred in other components, so that all of the tubes no longer operate properly in the equipment. The tubes that will not work can, of course, be returned to the manufacturer, who has the proper test equipment to see what—if anything—is wrong with them.

Other than the mere saving of time, there are many advantages in an engineer's being able to make tests on the tube itself. He can report more fully

in his correspondence with the tube manufacturer, he can prevent damage to the equipment, or he may obtain results that indicate trouble in other components of the equipment. Another, and probably the greatest, advantage is that such testing will allow the engineer to extend his knowledge of tube behavior.

Commercial tube testers are in many instances satisfactory for detecting defects in a large number of receiving tubes. Their operation is very well covered in articles and instruction manuals'. The concern here, however, is with tubes that are not adaptable to these testers and for which auxiliary test equipment must be utilized.

In general, tube defects may be classified into three categories:

1. Mechanical
2. Electrical
3. Operational

For the sake of simplicity, a breakdown of the above defects in a triode will be made and discussed in detail, including the ways of checking for them

By

WILLIAM M. COUCH, JR.

Techniques for checking vacuum tubes which cannot be checked on a commercial type of tube tester.

as expeditiously and as cheaply as possible.

Mechanical Defects

Leakers

Especially after long stock periods, one can expect that some tubes will have lost their vacuum, either entirely or partially. This trouble is evinced in equipment when high voltage is applied either by (1) the tube glowing pink (the characteristic color of air when ionized),² accompanied by a high plate current, (2) unusually high filament current due to the filament being convection- and conduction-cooled, or (3) oxidization and burning open of the filament.

If the problem is serious enough to warrant checking the whole stock, and the tube is not metal-covered, the quickest method is to lay the unpacked tubes out on a table in a semidarkened room and run over them with a spark coil, such as is pictured in Fig. 2. This coil, or any Tesla coil, will ionize the gas in a tube when the pressure lies between

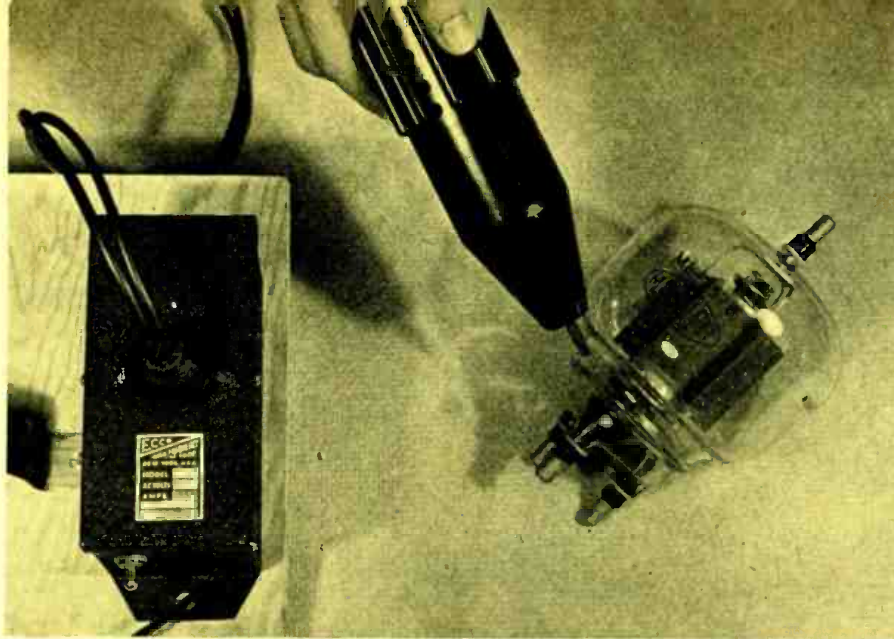

Fig. 2. The Ecco high-frequency spark-vacuum tester and gas indicator.

10 and 10^{-2} mm. Tubes which exhibit the pinkish glow should be rejected. If a tube is "down to air," i.e., pressure above 10 mm. of mercury, it will not glow but one may see white sparks jumping between the electrodes. A word of caution is in order here. On small high-frequency or high-perveance tubes with close-spaced electrodes, the arc may jump between the electrodes even with satisfactory vacuum. Aside from misleading the tester, this may severely damage the tube by sparking off its emitter coating. To guard against this, the voltage of the spark coil should be carefully adjusted and the point of the arc played only on the glass envelope.

If each tube has a getter flash visible on its envelope, the "air" tubes can be picked out from the rest, since most getters turn white in the presence of oxygen.

Filament Defects

Filaments in many tubes are more fragile than the glass envelopes, and shocks such as received in dropping may break a filament, even though the tube still looks intact. The simplest method of testing for open, or intermittently open, filaments is to check the

contacts with an ohmmeter while gently tapping the tube. The main precaution that should be taken with small tubes is to make sure that the voltage supply of the ohmmeter is not above the rated filament voltage of the tube. This is not an adequate test if there are several filament strands in parallel. For such a case, and for the defect of partially shorted filaments, the tubes may be set up in a test socket as outlined in Fig. 3A. After setting the filament to the proper voltage and waiting a minute or two for thermal equilibrium to be reached, the voltmeter is removed from the circuit with switch S_1 , so that the ammeter will read filament current only.

Mechanical Damage

Although the filament is usually the most fragile component of a vacuum tube, almost any other part may be damaged during shipment or by improper handling. Most tube manufacturers recommend that tubes be inspected on receipt so that a joint inspection report may be filed if they have suffered damage in transit. This would be evinced by loose particles "floating" within the tube, open filaments (as covered above), damaged

contact pins, distorted or shorted electrodes, or broken envelopes.

Electrical Defects

Gassy Tubes

Somewhere between a condition of satisfactory vacuum and leaking lie gassy tubes. They do not show up on the spark coil test but may affect operation of the equipment to the extent of kicking out circuit breakers or causing unstable operation. (It goes without saying that many other circuit defects could be a source of this type of trouble.)

A test set such as outlined in Fig. 3A may be set up to check the tubes for high gas current. The plate voltage should be at the manufacturer's suggested value and the grid bias voltage sufficient to limit the plate current to the suggested value. After voltages are applied, the microammeter, which is hooked up in the grid circuit with polarity shown, is switched into the circuit. Since the grid is negative, it will capture the positive ions created by electrons bombarding free gas molecules. Thus, the magnitude of the microammeter reading is an indication of the gassiness of the tube. As all vacuum tubes show some reading, the engineer should check with the manufacturer as to what constitutes an acceptable limit for the gas reading.

The microammeter reading will also include grid emission and interelectrode leakage currents. The latter are usually very small, smaller in fact than the leakage through the socket itself. This may be checked for with the bias and plate voltages applied and the filament turned off. There are two acceptable methods of separating grid emission current from the total grid current. One method is to take the microammeter reading as outlined above with the proper voltages applied and the proper plate current flowing. The filament is then switched off and allowed to cool below visible temperature. It is then switched on again and, as the emission recovers, the plate current and grid current will rise steadily. At some point the grid current will pause momentarily in its upward rise, and then rise to its final value. This final increment in grid current can be attributed to grid emission due to the warming up of the grid. Another method is to raise the grid bias, after taking the grid current reading at the proper voltages, until no plate current is flowing. Thus, there are no ionizing electrons and the microammeter reading consists of grid emission and leakage currents alone.

A possible source of error in these measurements is that a high amplification factor tube will tend to break into oscillation, in which case the microam-

(Continued on page 30)

Fig. 3. (A) Checking tube characteristics. (B) Measuring cathode emission.

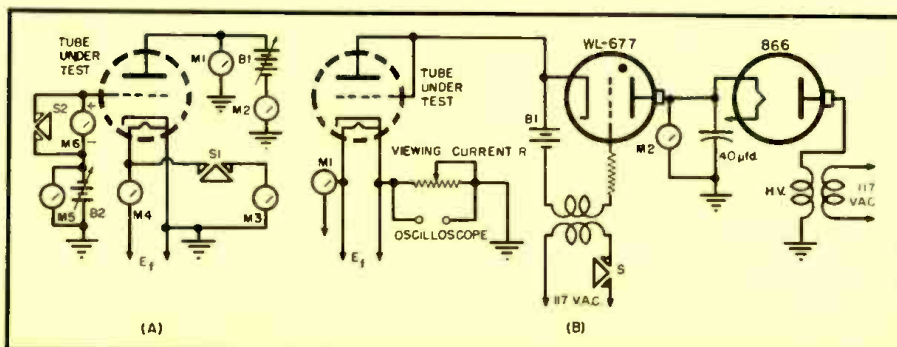



CM-15 EL-MENCO CAPACITORS are only
 $9/32'' \times 1/2'' \times 3/16''$. . . but they're
TWICE AS TOUGH AS
YOU NEED 'EM!
El-Menco MICA TRIMMER
 MOLDED MICA CAPACITORS

MEMO
 To Research -
 lets test these
 Capacitors
 - page 23 -
 HM.

ALL fixed mica El-Menco Capacitors are factory-tested at double their working voltage. Yet, you pay no premium for their superior performance. Meeting all significant specifications of JAN-C-5, they are being used in more and more military and civilian electronic applications.

Type CM-15, our tiny silvered mica capacitors, includes capacities from 2 to 420 mmf. at 500vDCw — 2 to 500 mmf. at 300 vDCw. Our other types — silvered and regular — offer ranges up to 10,000 mmf. Why not test them? *The Electro Motive Manufacturing Co., Inc., Willimantic, Conn.*

Jobbers and distributors are requested to write for information to Arco Electronics, Inc., 103 Lafayette St., New York, N. Y. — Sole Agent for Jobbers and Distributors in U. S. and Canada.

WRITE FOR FREE SAMPLES AND CATALOG ON YOUR FIRM'S LETTERHEAD



MOLDED MICA **El-Menco** MICA TRIMMER
CAPACITORS

Foreign and Electronic Manufacturers Get Information Direct from our Export Dept. at Willimantic, Conn.
THE ELECTRO MOTIVE MFG. CO., INC. **WILLIMANTIC, CONNECTICUT**

LOOKING at TUBES

By **WILFRID B. WHALLEY**

Adjunct Professor of Electrical Engineering
Brooklyn Polytechnic Institute

Pickup tubes in subcarrier color systems.

THE field sequential color television system was introduced commercially for broadcast entertainment purposes during 1950. A few months later it was suspended. Some reasons given for the suspension included the then pressing need for engineers in defense projects and the need to conserve vital materials, particularly fractional horsepower motors such as those used in scanning with color discs.

Opinions were also expressed in some parts of the industry that a commercial color television system should be "all electronic" and "compatible." The first of these definitions was aimed at the elimination of mechanical scanning at the receiver, now possible with tricolor picture tubes. The second suggested that the millions who had already purchased television sets should be able to receive color signals in monochrome without any changes being made in existing monochrome receivers.

Because of these opinions, intensive work has been directed toward the development of subcarrier color systems that are very interesting from an engineering viewpoint.

Subcarrier Systems

Experimental color systems such as

the dot sequential system or the recently developed NTSC system presently require three pickup tubes in the television camera. This is due to the very high-speed color switching in the dot sequential system, and to the arrangement of three color signals—one corresponding to each of the primary colors. These signals control the three guns in one type of tricolor picture tube.

At very high switching speeds—and for parallel color signal operation in which each signal is produced by sequential scanning, as in monochrome—mechanical movement of the filters and the use of one pickup tube are not possible at present.

Lens System

The light from the camera lens assembly is refracted in three directions by a pair of crossed dichroic mirrors. A dichroic mirror is made by vapor deposition of a very thin film on one surface of a glass sheet. When the metal film is of a thickness comparable to one-quarter wavelength in a given region of the visible spectrum, light over a certain color range will pass through the filter while other light frequencies are reflected.

In the three-tube camera, the two dichroic mirrors are designed to pass light in the green region to the first image orthicon and to reflect—respectively—the red and blue regions. Other plane mirrors bend the red light to a second image orthicon and the blue light to a third image orthicon. All of the mirrors must have accurate surfaces and must be mounted as rigidly as possible with respect to the axis of the main focusing lens. Any deviation in the mirrors produces optical misregistration of a complete red, green or blue image, or of portions of the image.

The three image orthicons are carefully selected to be as nearly alike in their characteristics as possible. Since a photosensitive surface can vary in sensitivity over its area, lack of similar area sensitivity variations between one pickup tube and the other two causes errors in hue in the output signal. Each pickup tube is held in position by a precision mechanical device which allows very fine adjustment of the horizontal and vertical location, so that the three tubes can be mechanically aligned with the three optical images from the mirror system.

Electrical Assembly

It is also necessary to construct the three deflection yokes with great precision so that the electromagnetic field distributions in both the horizontal and vertical directions will be as similar as possible over the full range of scanning current, and so that the horizontal axis will have the same angle with respect to the vertical axis within a few minutes of arc. Even a very small difference between one yoke and another will cause electrical misregistration of the three images over one or more portions of the scene. The three focusing coils are also accurately positioned with respect to the axes of the three tubes. Each assembly is enclosed in a special Mumetal shield to reduce, as far as possible, the field of one pickup tube assembly from that of the other two tubes, and to reduce any extraneous interfering magnetic fields which might move one electron beam with respect to the other two.

After all of the components have been physically aligned and clamped in position, the electrical adjustments are made. First, the subdivision of the currents to the three horizontal windings is adjusted from the common horizontal deflection amplifier to give amplitudes and linearities as nearly alike as possible. At the same time, centering currents are carefully adjusted to bring the three scans into the same position with respect to each optical image. This procedure is also followed for the vertical deflection circuits, and any nec-

(Continued on page 26)

A 1951 version of an RCA color camera in initial stage of assembly.

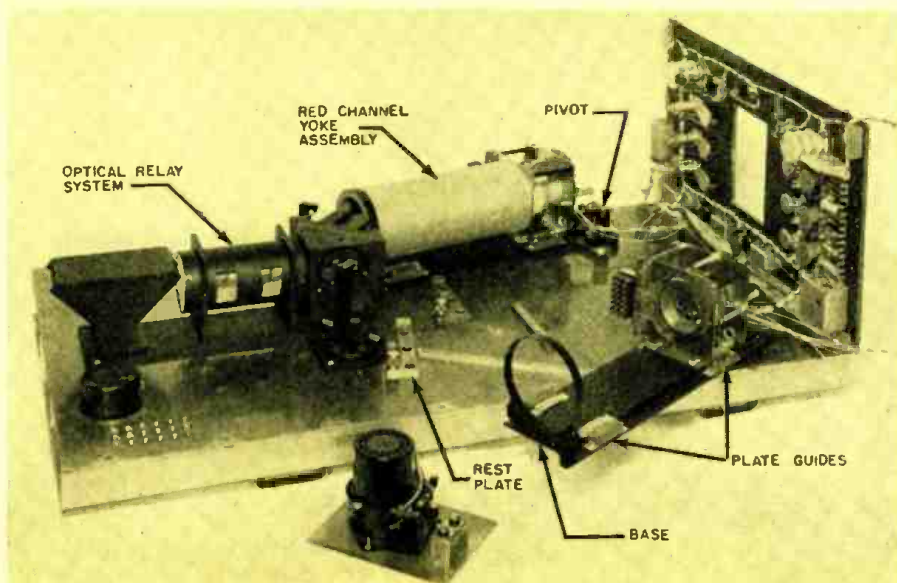

Improve Picture Tube Performance with Sylvania Components!

Seven out of ten of the world's leading television set manufacturers now use Sylvania Picture Tubes.

This outstanding popularity is due in large part to the super quality of Sylvania Tungsten and Chemical Components. The scientific purity of these products results from Sylvania's controlled production techniques and special skills which, in turn, are based on more than 15 years experience and research.

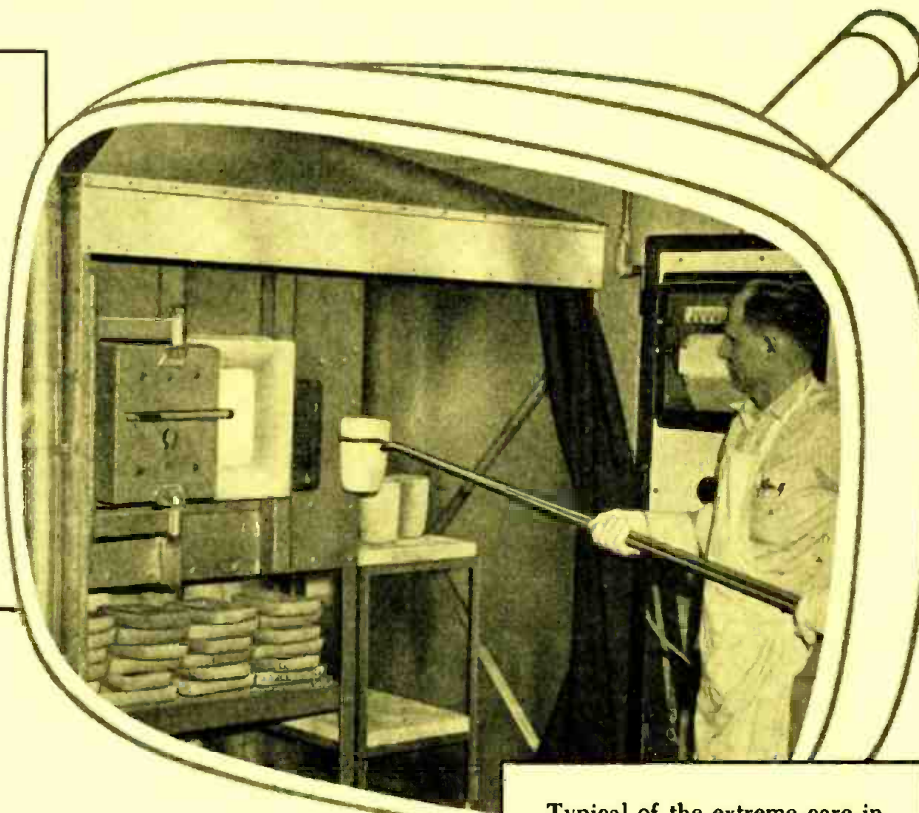

Typical of the extreme care in manufacture of Sylvania's chemical products is this hand firing of Sylvania phosphors under accurately controlled temperatures.

Now Yours . . . the Tungsten and Chemical Components which help make Sylvania Picture Tubes World-Wide Favorites!

Picture Tube Phosphors by Sylvania are superior because they are checked for proper particle size, for brightness, and for uniformity of color. Sylvania offers a number of these quality phosphors for black and white television. Of special interest is the phosphor blended for maximum cross-burn resistance. Also available are phosphors for color television picture tubes and cathode ray tubes. All may be obtained in 1000 lb. lots to eliminate any color-matching problems.

Potassium Silicate is produced by Sylvania with exact control of the ratio of the two elements involved, thus assuring optimum wet-screen strength. Its high chemical purity helps maintain screen brightness and good color. Each container of this Sylvania quality chemical guaranteed to contain 28% total solids.

Tungsten Coils for Vacuum Metalizing. With Sylvania Tungsten Coils, you can depend on highest performance at lowest cost. These coils provide a uniform deposit of aluminum or other metals where needed. They're sturdy too . . . reduce mechanical breakage in the loading of filaments. Sylvania Tungsten Coils also give you more shots from each

filament, and the best heat for evaporation.

Tungsten Wire for Cathode Heaters. Sylvania controls and quality checks its tungsten wire production, from ore to finished products. With Sylvania Tungsten Wire, you can be sure of good retention of shape and other desirable characteristics after treating and coating.

Triple Carbonate Cathode Emission Coatings. These Sylvania coatings comply with the highest standards of purity. Made by Sylvania's improved methods, these coatings are offered in a range of exact chemical compositions and particle sizes to meet the requirements of any manufacturer.

For further information concerning the quality and money-saving advantages of Sylvania's Tungsten and Chemical Components for TV Picture Tubes, write to: Sylvania Electric Products Inc., Dept. 3T-3506, 1740 Broadway, N. Y. 19, N. Y.



When you're settling TV screens, you want a phosphor you can depend on — a Sylvania Picture Tube Phosphor.



SYLVANIA



TUNGSTEN & CHEMICAL PRODUCTS; RADIO TUBES; TELEVISION PICTURE TUBES; ELECTRONIC PRODUCTS; ELECTRONIC TEST EQUIPMENT; FLUORESCENT TUBES, FIXTURES, LIGHT BULBS; PHOTOLAMPS; TELEVISION SETS

NEW TUBES

MULTIPLIER PHOTOTUBES

High amplification and signal-to-noise ratio are featured in the two 10-stage multiplier phototubes announced by *Allen B. Du Mont Laboratories, Inc.*, 760 Bloomfield Avenue, Clifton, N. J. These tubes are identical in electrical characteristics, varying only in physical dimensions. Type 6291 is 1½" in diameter while Type 6292 is 2" in diameter.

The *Du Mont* phototubes are of the end-window type with a spectral response predominantly in the visible region. A highly sensitive photocathode has an average sensitivity of 60 µa./lumen. Optimum photoelectron collection, resulting in excellent signal-to-noise ratio at low light levels, is accomplished by adjusting the potential between the shield and the photocathode by means of individual exterior connections.

POWER TETRODES

Two new power tetrodes have been developed by the *General Electric Company*: Type GL-6283, a 250-watt tube for use as a driver tube in u.h.f. television transmission, and Type GL-6182, a 5-kw. transmitting tube for operation over the entire u.h.f. spectrum. Additional information on these tubes may be obtained from the *General Electric Tube Department*, 1 River Road, Schenectady, N. Y.

Type GL-6283 (at left) is designed to drive *G-E's* two 1-kw. u.h.f. transmitting tubes—types GL-6183 and GL-6019—as well as the company's 15-kw. klystron tubes. It has a ceramic-and-metal envelope construction which min-

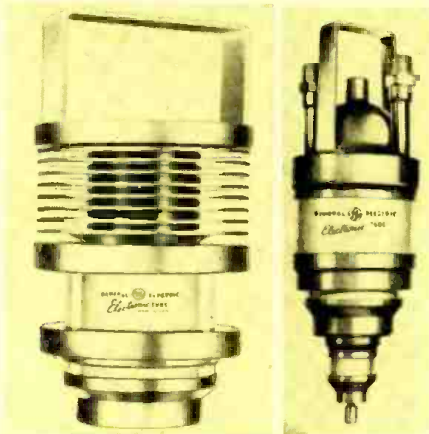

imizes r.f. losses and gives it a high degree of mechanical strength; this envelope will resist seal temperatures as high as 200° C.

Type GL-6182 (right) is the newest and most powerful addition to the *G-E* line of ceramic-and-metal envelope transmitting tubes, and has an operating range of up to 900 mc. The GL-6182 is designed for use as a broadband amplifier in Class B television service. It may also be used as a Class C amplifier or oscillator in grounded-grid circuits with both grids at r.f. ground potential.

HYDROGEN THYRATRONS

Ampere Electronic Corporation has announced two improved versions of the standard hydrogen thyratrons Types



4C35 and 5C22. Known as Types 6268 and 6279 respectively, they are completely interchangeable in every respect with the 4C35 and 5C22 tubes.

Incorporating self-contained and self-regulating sources of hydrogen, these new tubes exhibit a minimum life expectancy of over 1000 hours—at least twice that of standard types. Data sheets are available on request from *Ampere Electronic Corp.*, 230 Duffy Avenue, Hicksville, L. I., N. Y.

SYLVANIA TUBES

Damping Diode

Shown in the photograph is the *Sylvania* Type 6V3, a miniature cathode-type high-voltage half-wave rectifier now being produced by the Radio Tube Division of *Sylvania Electric Products Inc.*, Emporium, Pa. Designed for use as a damping diode in television receivers, Type 6V3 is contained in a miniature T-6½ envelope and has a coated unipotential cathode connected to the top cap.

In new equipment applications, this tube is capable of withstanding a peak inverse voltage of 6000 volts and a steady state peak current of 600 ma.,

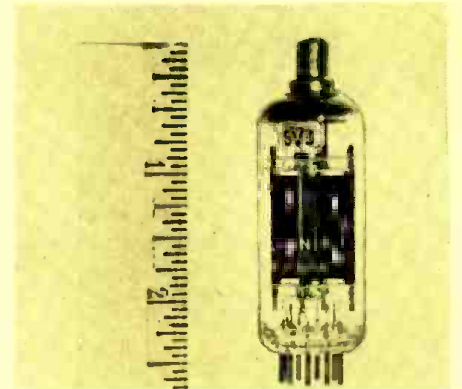

when it is used within its maximum ratings.

Deflection Stabilizer

Sylvania's Type 40B2, a horizontal deflection stabilizer tube, is similar in application to the previously released *Sylvania* Type 40A1. However, the 40B2 has different voltage and current ratings, thus providing more versatile circuit design.

Type 40B2 is contained in a T-9 bulb. Average operating conditions are 40 volts at 150 ma.

NOISE-FREE GAS TUBES

Because of inherent noise, gas tubes have long been barred from many important applications where their superior efficiency has made them desirable. According to a technical paper presented at the IRE Convention by E. O. Johnson, W. M. Webster and J. B. Zirker, of the David Sarnoff Research Center, *Radio Corporation of America*, Princeton, N. J., properly designed gas tubes can now be operated so as to generate a minimum of noise.

If a tube structure is designed so that the arc discharge inside the tube is made to occur in a narrow region so close to the anode surface that the anode appears to glow, the low noise level can be compared to that of an equivalent high vacuum tube. Several experimental tube structures were described which make use of this so-called "anode-glow mode," with particular reference to the design of low-noise rectifier units for electronic circuits.

CBS-HYTRON TUBES

Filter Reactor

The *CBS-Hytron* 6216 is an electron tube of beam power design with miniature 9-pin construction. It may be used in Class A, B, and C amplifier applications, as a passing tube in electronic voltage-regulated power supplies, in

(Continued on page 30)

What means most to an Engineer?



**PROFESSIONAL
RECOGNITION**

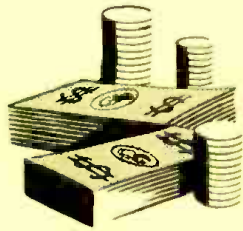

**GOOD
SALARY**



**UNEXCELLED
FACILITIES**



**SUBURBAN
LIVING**

A Career at RCA offers all Four!

RCA offers opportunities now—real career opportunities—for qualified **ELECTRONIC, COMPUTER, ELECTRICAL, MECHANICAL and COMMUNICATIONS ENGINEERS . . . PHYSICISTS . . . METALLURGISTS . . . PHYSICAL CHEMISTS . . . CERAMISTS . . . GLASS TECHNOLOGISTS.**

Positions are open in research, development, design and application. Long range work in many fields is being carried on both for commercial developments and military projects for war and peace.

At RCA you'll work in an exciting professional atmosphere, with technical and laboratory facilities unsurpassed anywhere in the radio-electronic industry. You are in close and constant

association with leading scientists and engineers. Individual accomplishment is not only recognized, it is sought out. Delightful suburban living is easily available for your family. And there's ample opportunity for income and position advancement.

Plus, Company-paid hospitalization for you and your family . . . accident and life insurance . . . progressive retirement plan . . . fine recreational program . . . modern tuition-refund plan at recognized universities for advanced study.

Join the team at RCA, world leader in electronic development, first in radio, first in recorded music, first in television. Rest easy in the knowledge that your future is secure, the rewards many and varied.

Personal interviews arranged in your city.
Please send a complete resume of your education and experience to:

MR. ROBERT E. McQUISTON, Manager
Specialized Employment Division, Dept. 204-F
Radio Corporation of America
30 Rockefeller Plaza, New York 20, N.Y.

**Positions Open In: RESEARCH—
DEVELOPMENT—DESIGN—APPLICATION**
in any of the following fields:

RADAR—Circuitry—Antenna Design—Servo Systems—Information Display Systems—Gear Trains—Stable Elements—Intricate Mechanisms

COMPUTERS—Digital and Analog—Systems Planning—Storage Technique—Circuitry—Servo Mechanisms—Assembly Design—High Speed Intricate Mechanisms

COMMUNICATIONS—Microwave—Aviation—Mobile—Specialized Military Systems

MISSILE GUIDANCE—Systems Planning and Design—Radar and Fire Control—Servo Mechanisms—Vibration and Shock Problems

NAVIGATIONAL AIDS—Loran—Shoran—Altimeters—Airborne Radar

TELEVISION DEVELOPMENT—Receivers—Transmitters and Studio Equipment

COMPONENT PARTS—Transformer—Coil—Relay—Capacitor—Switch—Motor—Resistor

ELECTRONIC TUBE DEVELOPMENT—Receiving—Transmitting—Cathode-Ray—Phototubes and Magnetrons

ELECTRONIC EQUIPMENT FIELD ENGINEERS—Specialists for domestic and overseas assignment on military electronic communications and detection gear.



RADIO CORPORATION of AMERICA

NEWS BRIEFS

WESTINGHOUSE TRANSISTORS

Transistors are now being manufactured in limited quantities for application and equipment development at the Electronic Tube Division plant of *Westinghouse Electric Corporation* in El-



mira, N. Y. Some of the developmental models were unveiled at the Institute of Radio Engineers Convention, including the one shown here beside a standard vacuum-type electronic tube. According to *Westinghouse* engineers, these transistors are expected to have almost unlimited life.

"LOW-COST" COMPUTER

The *ELECOM 100*, a "low-cost" electronic computer available commercially for general use, was accepted by Army Ordnance officials at Aberdeen Proving Ground after it successfully completed



60 hours of nonstop tests. This "robot brain" made 4,212,000 computations without a single mistake in the first 42 hours of operation, thereby proving its capacity to handle the complex calculations required in the solution of fire control problems.

According to the *Underwood Corporation*, 1 Park Avenue, New York 16, N. Y., manufacturer of the computer, the *ELECOM 100* can store for immediate use over 100,000 words of nine

digits each, and can solve a 10-digit mathematical problem several hundred times faster than conventional desk calculators. It consists of three units: a conventional office desk, a compact "memory" unit, and the computer proper which is housed in five steel cabinets joined in a semicircle.

CORONATION IN COLOR

The Coronation of Queen Elizabeth will be televised in color in Great Britain through the facilities of *Chromatic Television Laboratories, Inc.*—an affiliate of *Paramount Pictures Corporation*—and *Pye, Ltd.*, one of the leading TV manufacturers in England. The Lawrence color television tube developed by *Chromatic* will be used to display the special color program with special color television cameras developed by *Pye, Ltd.*, to be used in picking up the historic event.

This will be the first showing of the Lawrence tube—invented by Dr. Ernest O. Lawrence of the University of California—in England; it has been widely demonstrated in New York and at *Chromatic's* laboratory in Oakland, Calif.

ELECTRONIC DIVISION

An Electronic Instruments Division has been established in Philadelphia, Pa., by *Burroughs Adding Machine Company* which will produce a line of electronic laboratory apparatus and other special devices. It will also offer to business a scientific computation service, employing the *Burroughs* electronic digital laboratory computer and other advanced computation apparatus. In addition, it will make its facilities available to the armed services for the fabrication of electronic instruments.

Perry C. Smith, formerly a department manager in the *Burroughs* Research Activity, has been appointed director of the new division.

TRANSISTOR REPEATER

Engineers at *Bell Telephone Laboratories* have developed an experimental ultraminiature transistor repeater, shown in the photograph along with a house fly for comparison. Over-all length is about 1½", and the diameter is only 0.15".

The repeater utilizes the recently developed h.f. tetrode junction transistor, which is contained in the tubular case along with 14 other components. Power consumption is 0.1 watt, and maximum undistorted power output is 10 mw. into a 75-ohm load. Gain is 22 db flat within ± 0.1 db from 0.4 mc. to 11 mc. Over the 10-mc. bandwidth, the output noise level is about 72 db below 1 mw. Power



can be obtained by an extra wire or by the coaxial cable conductors.

Although still in the experimental stage, this unit is capable of handling high quality television signals. Integration of the unit into complete transmission systems is under investigation.

FLIGHT SIMULATORS

North American F-86D Sabrejet flight simulators are now operational at five U. S. Air Force bases and are well integrated into training programs requiring 8 to 18 hours-per-day operation. Schedules are being prepared which will require round-the-clock usage to train pilots in instrument flight procedures,



radio and navigational aids procedures, and radar interception procedures.

These 22,000-pound units, manufactured by the *Engineering and Research Corporation*, Riverdale, Md., reproduce ground-handling, flight and power plant characteristics of the all-weather version of the famous North American F-86 Sabrejet fighter. The F-86D simulators are the first to reproduce the entire operational problem of the radar fire control system in the aircraft, including both normal tactical use and various emergency conditions.

MICROWAVE PATH TESTING

In a paper presented before the Southern District Meeting of the AIEE

in April, Mr. R. D. Campbell, an AT&T engineer, stated that because of the substantial sums necessary to erect permanent towers for microwave radio relay systems, extensive tests of possible paths should be made before final sites are selected.

Although selection of sight-to-sight relay paths largely depends on observation and study of contour maps and the terrain over which the waves will pass, several other factors must be taken into consideration, namely, trees, buildings, water, the type of land involved and atmospheric conditions. Mr. Campbell pointed out that initial testing before permanent towers are built can be of great assistance to the engineer in selecting sites and determining optimum tower heights.

CONDUCTIVE CERAMIC

High power dummy loads of a new conductive ceramic have been developed to meet the demand for a matched wave guide termination capable of absorbing high powers without the necessity for water cooling. The conductive ceramic is "Caslode," recently developed by *The Plessey Company Limited*, Ilford, Essex, England. A white, homogeneous material, it is capable of absorbing power at centimeter and millimeter wavelengths.

Wedge-shaped components have been designed to operate in the common sizes of wave guides, and recent measurements have indicated that units originally developed to give a match of about 0.95 and to dissipate about 100 watts mean power at 3 cm. wavelength can absorb 250 watts mean power without any appreciable change in matching properties.

SRI NEWS

Dr. John V. N. Granger, assistant chairman of Stanford Research Institute's Engineering Department and head of its Aircraft Radiation Systems Laboratory, was chosen by the ETA KAPPA NU as "The Outstanding Young Electrical Engineer of 1952." The award of this national honor society of electrical engineers, which has been presented each year since 1936, is based on service to community as well as professional achievement.

Dr. Cleo Brunetti—who, incidentally, received the ETA KAPPA NU award for 1941—has resigned his position as associate director of Stanford Research Institute to accept an executive research post with the Mechanical Division of *General Mills, Inc.* In his new connection, Dr. Brunetti will be concerned with setting up a new general research laboratory and with the industrial development of this division.



THE NEW WORKSHOP Offset Feed Microwave Antenna 1750 to 2110 mc

Frequency Range — 1750 to 2110 mc
 Feed — Pyramidal horn with fiberglas radome, nonpressurized
 Reflector Diameter — 6 feet
 Gain — 28 db (over 1/2 wave dipole), side lobe level — better than 23 db
 Half Power Angle — H plane — 6°, E plane — 5.7°
 VSWR — 1.2 (1750-1990 mc); 1.25 (1990-2110 mc)
 Crosstalk — decoupling greater than 78 db
 Polarization — horizontal or vertical

Write for Bulletin RE-1

WORKSHOP ASSOCIATES DIVISION

THE GABRIEL COMPANY
 Endicott Street, Norwood, Mass.



This new WORKSHOP microwave antenna incorporates two revolutionary features which result in outstanding performance.

OFFSET FEED. Conventional center fed antennas employ a symmetrical paraboloid of revolution as a reflector. The Workshop design, however, uses a parabolic reflector with the vertex 9 inches above the rim. The feed is placed at the focal point of the paraboloid but is aimed to provide peak intensity of illumination at the optimum angle above the vertex. This location removes the horn feed from the radiated field of greatest intensity and results in better overall performance: — higher gain, lower side lobes, improved system impedance match and maximum decoupling.

Radiation is practically identical in both horizontal and vertical planes, polarity can be changed by rotating the feed 90°.

LAMINATED FIBERGLAS REFLECTOR. The 6-foot offset feed reflector is made of fiberglas laminations with a polyester resin. The total laminate is composed of a surface layer of fiberglas and a layer of fine wire mesh screening backed by four layers of fiberglas. The result is a strong, low cost reflector, accurate to $\pm 1/8$ inch. No painting is necessary, but if color is desired it may be added to the resin to produce a permanent finish.

NEW PRODUCTS

"TELEDUCER"

The "Teleducer" Type 24A automatically converts analog voltages into decimal digits with an accuracy of 0.1% (1000 counts full scale). Developed by



the *Telecomputing Corporation*, Burbank, Calif., it operates on demand, digitizes an input voltage and holds the digital representation for a controllable period of time for purposes of display, recording or any desired read-out form.

This instrument digitizes low voltage without d.c. amplification and high voltage by means of attenuators. It uses a simple bridge-balancing circuit which does not hunt or oscillate, and requires only 0.8 second or less to reach balance.

DUAL-PURPOSE TEST SET

"American Wavemeter" Model AET-117—a complete portable frequency meter—has been announced by the Electronics Division of *American En-*



caustic Tiling Co., Inc., Lansdale, Pa. Designed for measuring operating frequency and making relative power measurements of microwave transmit-

ters or signal sources, it covers a range of from 2400 to 3400 mc. It is applicable to pulsed transmitters as well as continuous wave systems.

A novel feature of this test set is its ability to register either transmission or reaction type measurements. Measurements can be made by coupling the wavemeter directly to the signal source or at a remote point by means of a self-contained directive antenna.

COIL BOBBINS

Multiflange coil bobbins for r.f., i.f. coils, push-pull solenoids, switching, timing and reversing circuits, etc., are now available in any size, shape, I.D.



or O.D., and in any quantity from the *Precision Paper Tube Company*.

Spirally wound under pressure, these multiflange bobbins are subjected to rigid tolerance control to insure strict adherence to specifications and maximum winding space. They are said to possess 15-20% greater strength, yet are light in weight. Cores are made from dielectric kraft, fish paper, acetate or combinations of these papers. For further information, write to *Precision Paper Tube Co.*, 2051 W. Charleston Street, Chicago 47, Ill.

V.H.F. UNIT OSCILLATOR

Capable of producing frequencies from 50 to 250 mc. over a single continuous range, the Type 1215-A unit oscillator is an addition to the unit line of building-block instruments being introduced by *General Radio Company*, 275 Massachusetts Avenue, Cambridge 39, Mass. It can be modulated at both audio and radio frequencies, and plugs directly into the previously announced Type 1203-A unit power supply.

Frequency is read directly from a 6" dial with a calibrated slow-motion drive. The tuned circuit of this oscil-

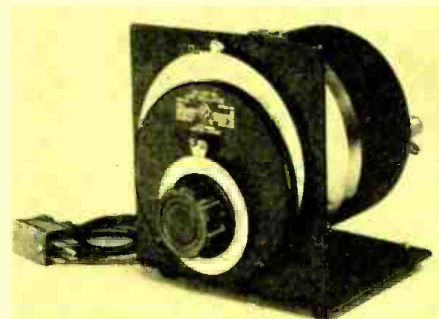

lator is a semibutterfly type which has no sliding contacts. At least 80 milliwatts can be delivered at any frequency into a 50-ohm load.

ACCELEROMETERS

A series of accelerometers has been designed by the *Gulton Manufacturing Corporation* to meet the need for lightweight, high sensitivity pickups. Designated as *Glennite* series A310, A311 and A312, these units are particularly useful as general-purpose laboratory instruments and as transducers.

The three units are mechanically interchangeable, and are usable over a wide range of acceleration—from 0.01G to 500G. They are equipped with quick-disconnect interchangeable shielded cables four feet in length. For complete information on these accelerometers, write for Bulletin A310, available from the *Gulton Manufacturing Corporation*, Metuchen, N. J.

COMPARISON BRIDGE

Designed for production-line operation but capable of laboratory accuracy, the Model E-1 comparison bridge pro-



vides a low-cost means of securing uniform characteristics in resistors, capacitors, and a.f. inductances. It has just been placed on the market by *Southwestern Industrial Electronics Co.*, 2831 Post Oak Road, Houston 19, Texas.

Model E-1 features simplified controls and an easy-to-read inclined meter, enabling unskilled operators to check thousands of components per hour. Five scales allow components to be matched

or compared with standards within limits of 1%, 2.5%, 5%, 10%, and 25% of full-scale deflection. The 1% scale may be read accurately to indicate differences between components as small as .1%.

LINE FAULT ANALYZER

Sierra Electronic Corporation, San Carlos 2, Calif., has announced an analyzer which is said to eliminate virtually all the time, work and hazard concerned with locating power line faults. Operating from any powerhouse, transformer bank or substation, the Model 124 instantly pinpoints



shorts, grounds or open circuits at ranges of from 1/2 to 200 miles.

This instrument is direct-reading and simple to operate. It can be attached quickly and easily to any line, using

regular carrier coupling capacitors. Tests can be made phase-to-phase or phase-to-ground. The Model 124 is lightweight, weatherproof and portable, and unaffected by change in line spacing.

CHAIN AMPLIFIER

The SKL Model 202C wide-band chain amplifier has an extended bandwidth of 1 kc. to 210 mc. Twelve 6AK5 tubes in a chain circuit provide a gain of 20 db uniform within ± 1.5 db over the bandwidth. The rise time of this new untuned chain amplifier is less than .0026 microseconds (10% to 90% amplitude). Input and output impedance is 200 ohms, with a stabilized power supply preventing fluctuations of gain due to line voltage changes.

Model 202C has an unusually low noise figure of 9 db, making it useful in narrow-band as well as in wide-band applications. For further information on this amplifier, address *Spencer-Kennedy Laboratories, Inc.*, Dept. RT, 186 Massachusetts Ave., Cambridge, Mass.

DIODE TESTER

Static characteristics of germanium and low power selenium diodes, including power type germanium diodes, can be measured with the Model DT-100 diode tester now available from *Tele-*

tronics Laboratory, Inc. Inquiries on this instrument should be addressed to

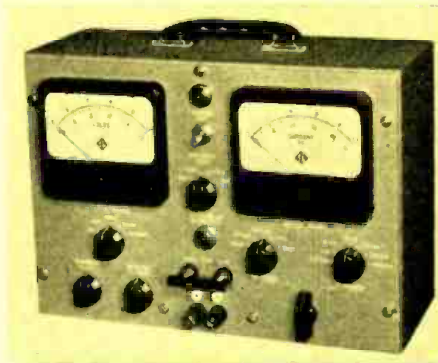

Dept. RT, *Teletronics Laboratory, Inc.*, 54 Kinkel Street, Westbury, N. Y.

Separate forward and reverse power supplies having continuously variable outputs or preset regulated reverse potentials permit complete measurements or checks at selected operating points. The arrangement of controls and connectors and the circuits employed provide accurate results with a minimum of operations.

"TWIST & TURN" ELBOW

General Precision Laboratory, Inc., 63 Bedford Road, Pleasantville, N. Y., has announced an improved "twist & turn" (Continued on page 27)

SKL WIDE-BAND DISTRIBUTION SYSTEM FOR TELEVISION

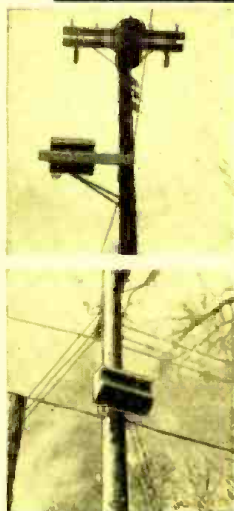

Two views of SKL Model 212TV Amplifier mounted in Model 420 Amplifier Cabinet, mounted on a telephone pole crossarm (top), pole (bottom). Courtesy Vermont Television, Inc.

The -SKL- Distribution System provides simultaneous distribution of up to thirteen television channels, FM signals, and, if required, broadcast signals. Although the -SKL- system is inexpensive in initial cost, no effort has been spared to provide high quality, long lasting, low obsolescence designs and equipment. An unusual feature of the -SKL- system is the Model 212TV Chain Amplifier. These broadband amplifiers continue to operate even though a tube fails, which insures the high reliability so necessary in such a system. The -SKL- system is designed to have the lowest maintenance cost of any system on the market today, not only because of the reliability of the amplifiers which require no tuning or adjustment, but also because vacuum tubes have been eliminated in all other parts of the system. Only the -SKL- system can offer the long life, low obsolescence and low maintenance costs that are required for the long, profitable operation of distribution systems.

Write today for further information.

Right: Photo of erection of one of the two Horn Antennas at Barre, Vermont, for Vermont Television, Inc. These antennas, having 20 db gain, provide good signals from WBZ-TV Boston, 140 air miles, and WRGB Schenectady, 130 air miles.

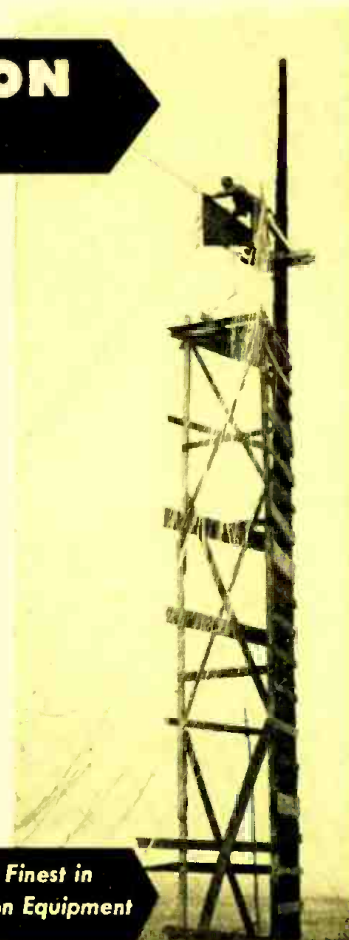

SKL SPENCER-KENNEDY LABORATORIES, INC.
186 MASSACHUSETTS AVE., CAMBRIDGE 39, MASS.

The Finest in
Precision Equipment

Personals



FRANCIS J. GAFFNEY, widely known for his work in the field of microwave measurement and pulse circuit techniques, is now director of engineering for the Guided Missiles Division of the *Fairchild Engine and Airplane Corporation*, Wyandanch, L. I., N. Y.; he was formerly general manager of the *Polytechnic Research and Development Company*. During World War II, Mr. Gaffney headed the Test Equipment Group in the MIT Radiation Laboratories.



MARVIN HOBBS, who recently joined *Harvey-Wells Electronics Inc.*, Southbridge, Mass., as director of engineering, has been elected vice-president and a member of the board of directors. From 1950 to 1952, Mr. Hobbs was the Defense Department member of the Electronics Production Board and director of the Electronics Division of the Munitions Board. Prior to 1950, he held various engineering positions with *RCA, Scott, General Motors* and *Zenith*.



LAWRENCE A. HYLAND, discoverer of the principle of radar detection of aircraft, was elected vice-president in charge of engineering of *Bendix Aviation Corporation*. With *Bendix* since 1937, and a vice president since 1949, Mr. Hyland will now have charge of the \$50,000,000-a-year engineering program. In 1950 he received the Navy's highest civilian honor, the Distinguished Public Service Award, for his contribution to the development of radar.



ANGUS A. MacDONALD was appointed assistant chief engineer in charge of two-way radio development at the Communications and Electronics Division of *Motorola Inc.*, Chicago, Ill. Prior to joining *Motorola*, Mr. MacDonald was a section manager for *Westinghouse Electric Corporation*. Recently he has been responsible for design and development of v.h.f. mobile equipment, medium and h.f. point-to-point transmitters, and broadcast equipment.



DR. ELMER H. SCHULZ has been promoted to director of research at the Armour Research Foundation of Illinois Institute of Technology; he was formerly manager of the Physics and Electrical Engineering Division. The author of numerous technical articles, Dr. Schulz has held many high offices in professional societies, including the presidency of the National Electronics Conference in 1951. He received his doctorate at Illinois Tech. in 1946.



GENE B. SPAULDING, previously guidance group engineer at *TEMCO Aircraft Corporation*, Dallas, Texas, has been promoted to superintendent of electronics. At one time an electronics technician and instructor in the Navy, Mr. Spaulding was with *Luscombe Airplane Corporation* before he joined *TEMCO* in 1950 as an engineering designer. He then became supervisor of the electrical, radio and instrument group, and a guidance group engineer in 1952.

Traveling-Wave Tube

(Continued from page 14)

them all again at the point of reception. For radio transmission also, signal bandwidth must always be limited because of frequency-space allocations.

At the *Bell Telephone Laboratories*, studies are being made regarding the possibility of long-distance wave guide transmission of millimeter-wavelength signals. Because the signal is not radiated in this case, it may be possible to utilize the full bandwidth capabilities of these new tubes at some future date. By use of parallel facilities, the available frequency space can become virtually unlimited. The old dream of private television transmission with long-distance telephone calls no longer seems an idle dream.

Looking at Tubes

(Continued from page 18)

essary readjustment of the horizontal is then made.

Much credit should go to those engineers who have undertaken research and development work on such three-pickup-tube color television cameras.

Each camera tube output signal should correspond in amplitude to the variations in the brightness, in the scene, of its respective primary color. The outputs of the three video pre-amplifiers may be connected to a high speed electronic switch, as in the older dot sequential system, or to a matrix of amplifiers and attenuators to give amplitude- and frequency-modulated signals, as in the NTSC system.

In the dot sequential system, for example, the three signals were successively sampled and commutated at a frequency of 3.58 mc., so that each tube was coupled to the line amplifier for approximately .02 μ sec. and disconnected for about .08 μ sec. This gave an output signal consisting of a series of pulses with amplitudes corresponding to the color and to the brightness of each color. In effect, this switching technique has produced a pulse-amplitude modulated or PAM signal in which spaces between the pulses are constant but the amplitude varies.

CALENDAR of Coming Events

JUNE 22-26—American Society for Engineering Education, University of Florida, Gainesville, Fla.

AUGUST 19-21—Western Electronic Show and Convention, Civic Auditorium, San Francisco, Calif.

SEPTEMBER 28-30—National Electronics Conference, Hotel Sherman, Chicago, Ill.

TECHNICAL BOOKS

"SERVOMECHANISM ANALYSIS" by

George J. Thaler and Robert G. Brown. Published by McGraw-Hill Book Co., Inc., 330 W. 42nd Street, New York 36, N. Y. 414 pages. \$7.50.

This text presents the mathematical and graphical methods developed for one type of automatic control system—servomechanisms. The presentation is from the point of view of analysis, since the authors believe that analysis must precede design. Those items which are basic are treated in considerable detail, while more specialized topics are discussed briefly.

After an introduction to the basic principles of the subject and the basic concepts involved, the mechanics of applying the Laplace transform are treated, followed by a discussion of the equations of physical systems. Chapters 4 through 12 contain the principal tools for the analysis and design of servomechanisms. Relay servomechanisms are then covered, as well as the fundamental principles of the root-locus method of analysis.

The appendices, while abbreviated, contain a good deal of factual information about components not heretofore assembled in any one book. Numerous bibliographical references are also included.

"TELEVISION RECEIVER DESIGN—

Monograph 1—I.F. Stages" by A. G. W. Uijtens. Published by N. V. Philips' Gloeilampenfabrieken, Eindhoven, Holland. Distributed in the United States by Elsevier Press Inc., 155 East 82nd Street, New York 28, N. Y. 179 pages. \$4.50.

Part VIIIA in the Philips Technical Library series of books on electronic valves, this monograph deals with the application of the pentode in the i.f. section of a superheterodyne receiver and the h.f. stages of a TRF receiver. It is the first of the series which treats the subject of television receiver design.

Topics covered are: gain and bandwidth with two-terminal coupling networks; response curve of the complete amplifier; distortion; gain, bandwidth and distortion with four-terminal coupling networks; noise; and feedback. The last chapter shows how the preceding material can be used in designing circuits for i.f. amplification in television receivers.

Derivations of formulas used in some parts of the text are given in the appendices, followed by several tables and a list of symbol definitions.

New Products

(Continued from page 25)

turn" elbow for microwave systems. This X-band component combines the functions of both a 90° elbow and a 90° twist section in one compact unit. It is available in RG 51/U, RG 68/U,

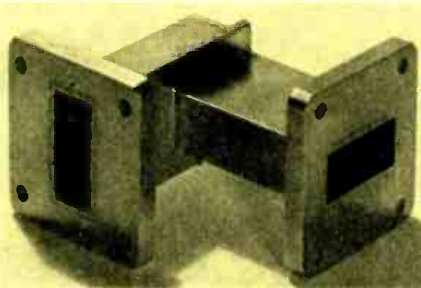

RG 52/U and RG 67/U wave guide, with arm lengths and terminations to customers' specifications.

Representative electrical data are as follows: VSWR design center—1.03; maximum VSWR for 400-mc. bandwidth—1.10; for RG-52/U and RG-67/U wave guide, maximum VSWR over 10% bandwidth—1.40, power handling capacity—100 kw., peak; for RG-51/U and RG-68/U, maximum VSWR over 10% bandwidth—1.30, power handling capacity—500 kw., peak.

MAGNETIC TRANSIENT RECORDER

One-shot or irregular frequency phenomena containing components from d.c. to 30 kc. can now be recorded and displayed on an oscilloscope through the use of the Type 103 magnetic transient recorder developed by Magne-Pulse Corporation, 140 Nassau Street, New York 38, N. Y.

The low frequency characteristic of this recorder, which makes possible reproduction of square waveforms with

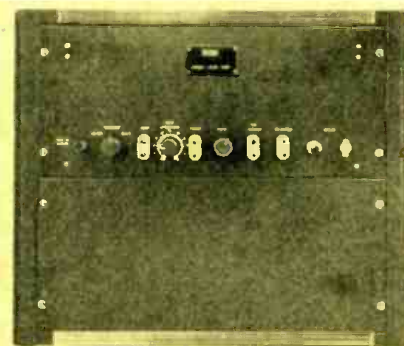

duration periods as long as 20,000 microseconds, is achieved through pulse-time modulation—the sync pulse permits examination of any portion of a waveform. Type 103 can be used for recording Geiger pulses, recording heart beats in hospitals, and for various applications in laboratories conducting research on radar, television, atomic phenomena, and computing.



RELAYS

Our stock of more than a million relays—in over a thousand different types—is the world's largest. Don't delay your production for want of large or small quantities of relays of any type.

Telephone, wire or write for quotations.

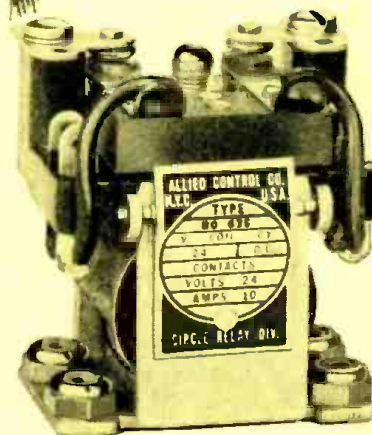

NEW AND MORE COMPREHENSIVE

1953 RELAY SALES CATALOG

NOW READY

Be sure to send for your copy



Telephone

SEely 8-4146



833 W. CHICAGO AVE.
DEPT. 8, CHICAGO 22, ILL.

NEW LITERATURE

PRINTED CIRCUIT COMPONENTS

Printed circuit components designed for use in television receivers utilizing intercarrier sound systems and having picture i.f. and sound i.f. carriers of 45.75 mc. and 41.25 mc., respectively, are described in an eight-page booklet released by the *Radio Corporation of America*. It may be obtained on request from Commercial Engineering, RCA Tube Department, Harrison, N. J.

Employed in properly designed circuits, these printed circuit i.f. components feature high gain, full bandpass response, and excellent skirt sensitivity. They can provide an over-all sensitivity of 70 microvolts at 44 mc. with accurate control of the response-curve shape.

TELEMETERING

Bulletin M1710, just published by *The Bristol Company*, Waterbury 20, Conn., contains material on the use of the company's Metameter telemetering instruments for remote recording, indicating, and totalizing of electric variables over distances ranging from a

few feet to many miles. A number of typical installations in use at generating stations, on tie lines, and on dispatching boards are illustrated and described.

Timely information and engineering data on the subject of modern telemetering methods are included in this bulletin, and *The Bristol Company's* electronic Dynamaster transmitters and receivers are also described.

ELECTRICAL INSULATIONS

"Quinterra—Quinorgo" is the title of a 32-page publication just issued by *Johns-Manville*. It gives complete information about these electrical insulations made of purified asbestos . . . why they were developed, what their characteristics are, and where they may be used to advantage.

This publication is both a manual of facts and a descriptive brochure. For the designer of electrical equipment there are tables giving test data on physical and electrical properties. For the production man there is advice on

HIGH-SPEED ELECTRONIC DIGITAL COMPUTER

Shown below is the "ERA 1103" general-purpose electronic digital computing system recently announced by the *Engineering Research Associates Division of Remington Rand Inc.*, 315 Fourth Avenue, New York 10, N. Y. It was originally developed for the United States Government, but commercial models will be available in 1954.

The computer features: a high-speed electrostatic storage system with an access time of 6 to 10 microseconds; a medium-speed magnetic drum storage with a transfer speed of 30,000 words a second (one word consisting of 36 binary digits); and a relatively low-speed magnetic tape storage of about 200,000 words, with a transfer speed of about 750 words (or 27,000 binary digits) per second. Any or all of these systems can be used in a given computation.

High speed operation has been achieved in this unit. It will add 16,700

ten-digit numbers in one second, and the average time for a two-address multiplication is 266 microseconds. The complete unit weighs ten tons, occupies a floor area of about 20' x 60', and contains 4500 tubes. Marginal checking during preventive maintenance is employed to improve reliability.

Input-output equipment consists of a photoelectric punched paper-tape reader, a high-speed teletype paper-tape punch, an electric typewriter, and magnetic tape. Card readers can also be provided.

Major applications of the "ERA 1103" include automatic process control, air traffic control and air defense, aircraft design and development, general industrial and economic planning, and scientific-mathematical computation. The development of this computer represents a major stride toward the completely automatic control of industrial processes.

An over-all view of the "ERA 1103" high-speed digital computer.

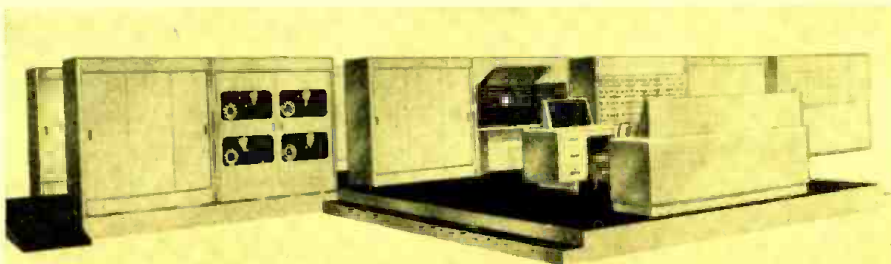

application techniques and equipment, including step-by-step photographic coverage of methods now in use.

Copies of "Quinterra—Quinorgo" are available from *Johns-Manville*, 22 East 40th Street, New York 16, N. Y.

R.F. MEASUREMENT METHODS

Controlled utilization of r.f. power necessitates accurate methods of measurement. In Circular 536, entitled "Radio Frequency Power Measurements," the National Bureau of Standards presents a comprehensive survey of the methods currently in use and a brief discussion of the theoretical background, practical limitations and advantages of these methods.

This 16-page circular, which contains sections on calorimetry, substitution methods, single-variable devices, two-variable devices, and directional couplers, may be ordered from the Government Printing Office, Washington 25, D. C., for 15 cents a copy.

MAGNETS

Thomas & Skinner Steel Products Company, Inc., has released a catalog which lists its complete line of standard permanent magnets. Available in Alnico 2, 3 and 5, for use in a wide range of industrial applications, *Thomas & Skinner* standard magnets may be ordered from stock to aid designers and engineers who need magnets quickly in order to produce working models for experimental purposes, to fulfill moderate production requirements, or to adapt to a standard application without tooling delays.

For Standard Magnet Catalog No. 1252, write to *Thomas & Skinner Steel Products Company, Inc.*, 1180 East 23rd Street, Indianapolis 5, Indiana.

POLYESTER FILM

Up-to-date information on the physical, electrical, and chemical properties of "Mylar" polyester film—together with suggested applications—has been issued by the Film Department of *E. I. du Pont de Nemours & Company*. "Mylar," one of the newest products of *Du Pont* research, is now being produced in limited quantities only for market development purposes.

Bulletin #1-2-53 consists of 17 pages, complete with charts, diagrams and tables. Copies may be obtained from the *Du Pont* Film Department's Sales Development and Technical Service Section, Wilmington 98, Delaware.

POLYETHYLENE

Information on the properties, applications and methods of fabricating *Bakelite* polyethylene plastic is set forth in a revised 24-page booklet published

by the *Bakelite Company*, a division of *Union Carbide and Carbon Corporation*. One of the applications of this plastic is in the sheathing of coaxial wire and cable widely used for radio, radar and television installations. As a coating for copper and steel tubing, polyethylene prevents external corrosion due to abrasion or the mishandling of liquid chemicals.

Copies of this booklet may be obtained by writing to the *Bakelite Company*, 300 Madison Avenue, New York 17, N. Y.

PHOTOELECTRIC RECORDER

A two-color, fully illustrated, 12-page bulletin on photoelectric recorder applications is available from the *General Electric Company*, Schenectady 5, N. Y.

GEA-5536 describes applications of the Type CE recorder with seismology, psychology, textile, metals, fatigue and research testing equipment; as an aid in the quick detection of pipeline corrosion; and in development and machinability testing, medical research, light-intensity study, and paper-machine-speed measuring.

Temperature Controller

(Continued from page 11)

able of operating at an ambient temperature of 110°C. To produce such a unit, a new approach to the field of barrier layers was necessitated in order to obtain a rectifier whose reverse resistance would not vary appreciably with increasing temperatures. A new counter-electrode composition was also required in order to prevent melting at hot-spot temperatures. Solutions to these problems were obtained after several months of investigation.

Within the package there was no room for mounting brackets. As a result, the components were wrapped with special thermosetting tape. Thermal conductivity of several potting compounds was investigated, and it was decided that a potting compound of the "cold pouring" type was most suitable. This type provided adequate thermal conductivity. It was necessary to use a potting compound which could be easily handled and did not require high oven temperature for proper baking; the life of the components might have been seriously shortened if exposed to temperatures of 300°F and higher.

Before final assembly, the unit appeared as shown in Fig. 1. This package occupied approximately 34 cubic inches. Inspection of Fig. 3B suggests that the package might be made smaller by eliminating the stepdown transformer which supplies power through the rectifier to the Wheatstone bridge. Further examination reveals, however, that for the same sensitivity the resist-

ance of the temperature-sensitive arms must increase to approximately 1200 ohms, and the control winding turns must increase to approximately 9000. There are several disadvantages to this increase in resistance which should be considered. The length and diameter of a ballast nickel resistance wire needed to meet the new value of resistance make this a poor alternative. Winding 9000 turns with an AWG #37 Hi-temperature insulated magnet wire on a toroid leads to unreliability in addition to presenting manufacturing difficulties. These considerations led to a change in the original specifications with respect to the desired package size.

As a result of this development work, a compact temperature controller was produced which regulates the temperature of the load at a specified point to within $\pm 0.08^\circ\text{F}$ and is adjustable over the range of 130° to 150°F. The initial warm-up period is approximately 1½ hours; maximum overshoot of controlled temperature is approximately 3%. The controlled temperature is in the regulation band within 15 minutes.

Cooperation of the *Belcon Rectifier Division of the Bogue Electric Manufacturing Company* and the *Selenium Research Corporation* in developing the rectifiers used in this application is gratefully acknowledged.

Mobile FM Radio

(Continued from page 6)

selectivity-determining elements, is mounted as a separately replaceable item. Interchangeability is thereby introduced to allow 60-kc. channel, 40-kc. channel, or even narrower-band operation as desired. In the event split-channel operations become standard practice, the alternate- or adjacent-channel equipment owner need only replace his i.f. wave filter unit to achieve the desired degree of selectivity.

An r.f. oscillator kit including the frequency-stabilizing crystal assembly is provided with the associated transmitter to allow two-frequency operation. In such operation, the change from one channel to another is accomplished by simple switch action. Crystal assemblies utilized are of the heated oven type with thermostat temperature control.

Tremendous strides have been made in the radio communications industry during the last few years. Two-way radio is now truly mobile—on wings and wheels. It is no longer a restricted implement available only to Army, Navy and police. It has become a tool of industry and an everyday aid to citizenry.

better all around...

Precision COIL BOBBINS

because PRECISION Coil Bobbins are quality controlled you can be sure they'll improve your coils all-around. Every PRECISION Coil Bobbin is precision-engineered to give you:

- Greater Insulation
- Better Heat Dissipation
- Higher Moisture Resistance
- 15 to 20% Greater Strength
- Lighter Weight
- More Winding Space

All at lower unit cost!

PRECISION Coil Bobbins can be designed to your exact specifications . . . any size or shape in dielectric Kraft or Fish Paper, Cellulose Acetate or Combinations. Flanges are supplied plain or fitted with leads, slots, holes flat, recessed or embossed to fit any mounting.

Send specifications for free sample and ask for new Arbor list of over 1500 sizes.

PRECISION PAPER TUBE CO.

2063 W. Charleston St. Chicago 47, Ill.
 Plant No. 2, 79 Chapel St., Hartford, Conn.
 Also Mfrs. of PRECISION Paper Tubes

New Tubes

(Continued from page 20)

wide-band video amplifiers, and in passive switching applications.

When used in appropriate circuits, this tube replaces the iron-core filter choke in airborne and vehicular electronic equipment, thus materially reducing the weight and space normally required for the choke. It is equivalent in performance to a 12-henry filter choke of 360 ohms resistance, rated to carry 100 ma.

U.H.F. Oscillator Triode

Also announced by the Hytron Radio & Electronics Co., a division of Columbia Broadcasting System, Inc., Danvers, Mass., is Type 6T4, a u.h.f. oscillator triode with a small-button miniature 7-pin base and a heater rating of 6.3 v. at .225 amp. When it is used as an oscillator at 950 mc., with 100 d.c. volts on the plate, a useful power output of 160 mw. can be obtained. The tube also can be operated as a Class A amplifier.

TWIN TRIODES FOR IBM COMPUTERS

About 2700 of General Electric Company's Type GL-5965 high-perveance twin triodes are being used in each of

the new electronic data processing machines now being produced by the International Business Machines Corporation. The twin triodes make up nearly two-thirds of the total complement of tubes used in the IBM computer, which is the largest all-purpose computer being built in quantity—it will make 14,000 mathematical calculations per second.

Although the Type GL-5965 tube was first announced last summer, it was designed in conjunction with IBM engineers and its use in this computer represents its first major application. It is used in a wide variety of circuit functions, an important factor in multitube equipment in which it is necessary to control the variety of tubes employed, and is expected to have wide application in other types of computers.

Testing Vacuum Tubes

(Continued from page 16)

meter may read backwards or may waver unsteadily as one's hand is brought near the tube. This can be eliminated by placing bypass condensers from grid to ground or otherwise loading the circuit down. Another source of error may be detected by switching off the plate voltage and noting whether or not the microammeter reads backwards. With a.c. filament voltage and low grid bias, the cathode may swing negative with respect to the grid, resulting in grid current flow.

Low Emission

Under normal operating conditions,

the end of life of a vacuum tube is determined by loss of emission. Tungsten filament tubes suffer loss of filament diameter until they burn open; oxide-coated cathodes lose emission due to evaporation of the barium and poisoning from liberated gases; thoriated tungsten filaments lose emission due to the evaporation of thorium and also due to poisoning. Emission capabilities of cathodes always exceed the static operating conditions of electrode currents, so that emission readings cannot be taken on a test such as is shown in Fig. 3A without overheating the electrodes and damaging the tube. The emission must be read at reduced values of filament voltage and results correlated with normal operating conditions, or the voltage must be applied in pulses so that overheating does not occur. This latter method is better for weeding out bad tubes and may be performed in a test circuit such as is outlined in Fig. 3B. As shown, the grid and plate are tied together and positive voltage pulses from the condenser circuit are applied. Normal filament voltage is applied, but the condenser should be charged to a voltage recommended by the tube manufacturer. Oxide coated and thoriated tungsten cathode emission does not saturate at higher voltages as does pure tungsten. If the pulse voltage is too high, oxide-coated cathodes will spark and be destroyed.

Transconductance

Commercial bridges are available for measuring the μ and G_m of tubes but are, however, fairly expensive. The test set of Fig. 3A can be used for

PLANS INTO PLASTICS

PRECISION MACHINING OF ALL THE PLASTICS

including

POLYSTYRENE	COPOLYMER 1422
BUTYRATE	TEFLON
NYLON	KEL-F

PLASTIC FABRICATING

Printloid is equipped for the complete production of a wide variety of consumer and industrial items in any quantity. We work with any plastic material in sheets, rods and tubes. Die-cutting, deep drawing, stamping, forming, finishing, and assembling in our own plant.

PLASTIC PRINTING

LETTERPRESS . . . SILK SCREEN
HOT STAMPING

for Containers, Displays, Dials,
Charts, Machined Parts, Etc.

Ask for brochure illustrating various plastic products fabricated to specification by Printloid.

PRINTLOID, INC.

95 Mercer St., N. Y. 12, N. Y.

VERSATILE MULTIVIBRATOR

By JOHN M. WILDER

Although originally designed as a training aid, the three-way multivibrator shown schematically in Fig. 1 may be used for any application in which a choice of waveforms and/or modes of operation is desired.

With both switches in the downward position, the circuit operates in the conventional symmetrical, free-running, plate-coupled mode. S_1 grounds the cathodes of both V_1 and V_2 and connects the plate of V_2 to the grid of V_1 . The symbols V_1 and V_2 refer to the first and second halves respectively of the dual triode. S_2 returns the bottom of R_1 to ground.

When the unit is employed as a cathode-coupled, free-running multivibrator, S_1 should be left in the downward position and S_2 moved to the upward position. This disconnects the grid of V_1 from the plate of V_2 and connects the cathode resistor in the circuit.

For either mode of operation, a synchronizing voltage may be applied to the grid of V_1 through C_1 .

For operation of the unit as a triggered or "one-shot" multivibrator, S_1 and S_2 should both be in the upward position. A positive trigger pulse must then be applied to the grid of V_1 , for the

circuit to operate. One cycle of operation will result from each pulse applied, provided that the rate of application of these pulses does not exceed the natural frequency of the multivibrator. For the values given, this frequency will be approximately 800 cps.

Fig. 1. Schematic of the multivibrator.

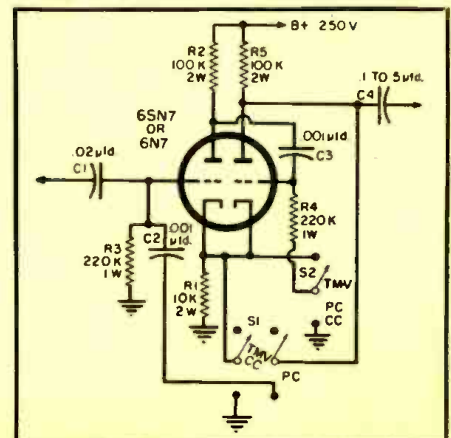

making measurements of this sort if the engineer wants to take the time to make them. For a G_m measurement, he should start at a grid bias value approximately 20% higher than normal, maintain the plate voltage constant at its normal value, and read plate current. The grid bias is then lowered in convenient steps and the plate current read at each step with the plate voltage maintained constant at its normal value. The slope of the curve of E_c vs. I_p at the point of normal current flow will give the G_m measurement, i.e.,

$$G_m = d(I_p) / d(E_c)$$

The G_m of a triode varies proportionally as the one-third power of the plate current, so the current must be specified for each value of G_m .

An amplification factor measurement can be made in much the same way except that the plate current should be maintained constant and the plate and grid voltages varied.

$$\mu = d(E_p) / d(E_c)$$

It should not be necessary to run these lengthy tests on all the tubes. If a few samples of "good" and "bad" tubes are so tested, enough information should be acquired to determine if differences in G_m or μ are the source of trouble.

When taking these readings, it is well worth while to compare the values of grid voltages for the different tubes at specific values of plate current and voltage. Tubes whose grids have had holes burned in them or have been otherwise distorted or damaged will show up with abnormally high grid bias voltage; tubes with low emission may show up with low grid bias.

Operational Defects

Needless to say, operational defects in tubes are detected in the equipment itself. However, since the object is to disassociate the tube from the equipment in difficulty, some sort of test unit simulating the operational stage wherein the tube works is in order.

Low Power Output

Utilizing a self-oscillating or an amplifier circuit driven by another oscillator at the maximum frequency for which the equipment is designed, the power from the tube may be measured

in many conventional ways. At the low frequencies, a properly tuned load resistor with a vacuum tube voltmeter across it will suffice: $P_o = V^2/R$. Some engineers prefer an ordinary electric light bulb of the proper wattage with the base removed for a dummy antenna. It can be calibrated with a photoelectric cell and milliammeter so as to indicate watts output.

Above 50 mc., more elaborate equipment is required, such as tuning stubs, water-cooled resistors, and bolometers.

Plate voltage, grid bias, and other parameters should correspond as nearly as possible to those in the equipment. The feedback from the oscillator, or grid drive to the amplifier, should be adjusted so that the rectified grid drive current corresponds to that in the equipment. The antenna coupling should be adjusted so that each tube draws the same plate current. Thus, their plate efficiencies may be directly compared.

Frequency Shift

The amplifier circuit above could lend itself to checking thermal frequency shifts in a tube. If the tank circuit and antenna tuning circuit both have high Q and are well tuned for maximum power output at the beginning of the test, any large frequency shift will

be accompanied by a reduction in power output. Similarly, by tuning the circuit to optimum for the average of several "good" tubes, the engineer can determine if the "bad" ones require major re-tuning to achieve maximum output.

Sparking

The more seriously defective tubes showing sparking and intermittent shorts can be picked up on the static test set, especially if the tube is tapped gently while the voltages are applied. However, the most severe operation is in the oscillator or amplifier circuit, and at this time any such phenomena can be observed as instability in the plate current meter, or—if the tube is not

enclosed within a cavity—as flashes within the tube itself.

Conclusion

The above analysis does not, by any means, include all the tube defects that are possible, although the major ones have been discussed—especially the ones for which an equipment manufacturer might most readily test. Nor is each defect clearly separable. A low power output tube could very well have low emission or be gassy—a simple power output test would not indicate the specific defect.

It should not be assumed from this discussion that in equipment problems it is the tube that is usually at fault. As a matter of fact, each tube is subjected to most of the tests discussed here and several more before being placed in the carton. Allowances should be made by the equipment designer for the manufacturing variations in tube characteristics and, in cases of potentially large orders, "limit" tubes should be tried in the prototype equipment.

REFERENCES:

1. Flanagan, James L., "Vacuum Tube Testers," *Electronics*, June, 1952, p. 139.
2. Guthrie, A., and Waperling, R. K., "Vacuum Equipment and Techniques," McGraw-Hill Book Co., Inc., pp. 139-141.



ZOPHAR

WAXES COMPOUNDS

Zophar waxes, resins and compounds to impregnate, dip, seal, embed, or pot, electronic and electrical equipment or components of all types; radio, television, etc.

Cold flows from 100°F. to 285°F.

Special waxes non-cracking at —76°F.

Compounds meeting Government specifications, plain or fungus resistant.

Let us help you with your engineering problems.

ZOPHAR MILLS, INC.

112-130 26th Street,
Brooklyn 32, N. Y.

Photo Credits

- 3, 4, 5, 6..... Motorola Inc.
7, 8, 9. Flexible Metal Hose Mfg. Co.
10..... Bogue Electric Mfg. Co.
12, 13.... Bell Telephone Labs, Inc.
16.... Ecco High Frequency Corp.
18.. Radio Corporation of America

CINCINNATI IRE TV CONFERENCE

Highlights of the nine technical papers presented in Cincinnati at the Seventh Annual Spring Technical Conference on Television.

THE ANNUAL Spring Technical Conference on Television, sponsored by the Cincinnati Section, IRE, in cooperation with the Professional Group on Broadcast and Television Receivers, was held in Cincinnati on April 18. Paid registrations totaled 328, in spite of bad weather.

Given below is a brief abstract of each of the nine technical papers presented at the Conference.

TELEVISION AND THE BELL SYSTEM, David Younger, *American Telephone and Telegraph Company*

The Bell system had 35,000 channel miles of television networks in operation the first of this year, permitting 93% of set owners in the United States to have network programs available. Approximate cost of a coast-to-coast TV relay circuit for a half-hour program is \$600. Synchronization between sight and sound in TV relaying is held to within 60 microseconds.

Coming improvements include the use of amplifiers of much greater bandwidth and closer spacings on the coax lines to triple the number of telephone circuits which can be provided. A new microwave system is under development which will operate at 6000 mc. instead of the present 4000 mc. Work is also progressing on wide-band transmission through wave guides over long distances.

A 12-KW. U.H.F. TELEVISION TRANSMITTER, F. J. Bias, *General Electric Company*

The *General Electric Company* is currently offering a u.h.f. TV transmitter which has an output of 12 kw. When used with a five-bay helical antenna, an effective radiated power of 300 kw. can be obtained.

Specially designed water-cooled linear klystron amplifiers are used to provide the 12-kw. output. The cathode is of the "bombarded type," and is stabilized by feedback to provide the proper operating temperature. The life of this cathode is expected to approach 10,000 hours, and may be replaced when it fails.

SELECTION AND AMPLIFICATION OF U.H.F. TV SIGNALS, W. P. Boothroyd and J. Waring, *Philco Corporation*

A study of the u.h.f. allocation plan has resulted in certain fundamental requirements for u.h.f. tuner design with

respect to such factors as selectivity, intermodulation, and local oscillator radiation.

A passive preselector has been designed giving an image rejection of more than 40 db over the entire u.h.f. band and an i.f. signal rejection of over 60 db. An r.f. amplifier may be used in place of the passive preselector, although this presents many problems. Three factors that must be considered are noise figure, gain and selectivity.

A crystal mixer appears to give the best noise figure performance, and has been chosen along with a passive preselector tuner. The required selectivity calls for a double-tuned preselector. The unit which has been designed and developed has a noise figure of 12-13 db, and adequate selectivity for future field conditions.

TRANSIENT CONSIDERATIONS IN THE NTSC COLOR SYSTEM, Bernard S. Parmet, *Motorola Inc.*

By means of a detailed analysis, it is possible to calculate the adjustment of filters and channel specifications accurately in color TV systems. The transient response of both the luminance and chrominance channels is related to their respective bandwidths and cutoff frequencies.

DESIGN OF TV RECEIVERS USING NONSYNCHRONOUS POWER, George D. Hulst, *Allen B. Du Mont Laboratories, Inc.*

TV receivers that are to receive U. S. standard broadcasts and to utilize 50-cycle or other nonsynchronous power sources require special design considerations to minimize interaction effects in the picture. The principal source of interference is the power transformer.

Copper banding is practical and effective in minimizing magnetic radiation, but is not sufficient. The transformer positioning is critical, and after a long series of tests, a location was found which reduced undesirable effects to well below an acceptable minimum.

APPROACH TO MECHANIZED ASSEMBLY OF ELECTRONIC EQUIPMENT APPLICABLE TO TV RECEIVERS, R. F. Newton and L. K. Lee, *Stanford Research Institute*

Engineers at Stanford have developed equipment and techniques for mounting components on a printed circuit sub-

assembly automatically, so that the whole assembly can be dip-soldered. Such a system represents a big step towards the completely automatic factory, with the advantages of increased uniformity and reliability, greater production per man-hour, etc.

The base pattern may be produced by spraying, etching, or embossing.

USE OF ELECTRONIC "MASKING" IN COLOR TV, R. P. Burr, *Hazeltine Corporation*

In most subtractive color processes for color transparencies, there is some cross-coupling between the various colors. When transmitting a color transparency image over a color TV system, it is possible to devise an electrical network to remove this cross-coupling partially, if the film characteristics are known. In some cases, this will improve the appearance of the reproduced image.

A FOUR-GUN TUBE FOR COLOR TV RECEIVERS, John L. Rennick and Charles H. Heuer, *Zenith Radio Corporation*

A four-gun tube with proper associated circuitry may produce better color pictures than the conventional three-gun type. The fourth gun and associated phosphor is for black and white. The tube contains the familiar shadow mask assembly with its pattern of holes, while the phosphor cluster corresponding to each hole consists of four dots: red, blue, green and white.

Several experimental tubes of this type have been manufactured and have given results substantially as expected.

OPTIMUM UTILIZATION OF THE R.F. CHANNEL FOR COLOR TV, R. D. Kell and A. C. Schroeder, *Radio Corporation of America*

The subjective aspects of color vision are utilized in the proposed color TV standards to keep the information to be transmitted to a minimum. For example, the eye cannot distinguish fine detail in color, thus reducing the amount of information needed. The only color information needed involves hue and saturation; brightness is essentially a black and white characteristic. Thus, only the three characteristics of brightness, hue and saturation need be transmitted. A subcarrier is introduced to carry the color information as phase and amplitude modulations. —●—

ADVANCE! Raise your earning power—learn RADIO-TELEVISION-ELECTRONICS by SHOP-METHOD HOME TRAINING

GOOD JOBS AWAIT THE TRAINED RADIO-TV TECHNICIAN

There is a place for *you* in the great Radio-Television-Electronics industry when you are trained as National Schools will train you at home!

Trained technicians are in growing demand at good pay—in manufacturing, broadcasting, television, communications, radar, research laboratories, home Radio-TV service, and other branches of the field. National Schools Master Shop-Method Home Training, with newly added lessons and equipment, trains you in your spare time, right in your own home, for these fascinating opportunities. **OUR METHOD IS PROVED BY THE SUCCESS OF NATIONAL SCHOOLS TRAINED MEN, ALL OVER THE WORLD, SINCE 1905.**

EARN WHILE YOU LEARN

Many National students pay for all or part of their training with spare time earnings. We'll show you how you can do the same! Early in your training, you receive "Spare-time Work" Lessons which will enable you to earn extra money servicing neighbors' and friends' Radio and Television receivers, appliances, etc.

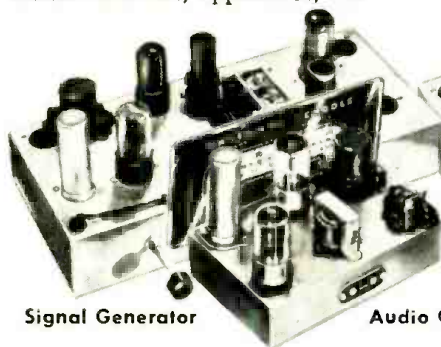

Signal Generator



T. R. F. Receiver

Audio Oscillator

National Schools Training is All-Embracing

National Schools prepares you for your choice of many job opportunities. Thousands of home, portable, and auto radios are being sold daily—more than ever before. Television is sweeping the country, too. Co-axial cables are now bringing Television to more cities, towns, and farms every day! National Schools' *complete* training program qualifies you in all fields. Read this partial list of opportunities for trained technicians:

- Business of Your Own • Broadcasting
- Radio Manufacturing, Sales, Service • Telecasting
- Television Manufacturing, Sales, Service
- Laboratories: Installation, Maintenance of Electronic Equipment
- Electrolysis, Call Systems
- Garages: Auto Radio Sales, Service
- Sound Systems and Telephone Companies, Engineering Firms
- Theatre Sound Systems, Police Radio
- And scores of other good jobs in many related fields.

TELEVISION TRAINING

You get a complete series of up-to-the-minute lessons covering all phases of repairing, servicing and construction. The same lesson texts used by resident students in our modern and complete Television broadcast studios, laboratories and classrooms!



MASTER ALL PHASES!

Get Master Shop-Method Home Training from an Established Practical Resident School with its own Training — almost 50 Years of Successful Experience in Training Ambitious Men.
We Bring National Schools To You!



You also receive this Multitester

Superheterodyne Receiver

LEARN BY DOING

You receive and keep all the modern equipment shown above, including tubes and valuable, professional quality Multitester. *No extra charges.*

FREE! RADIO-TV BOOK AND SAMPLE LESSON!

Send today for National Schools' new, illustrated Book of Opportunity in Radio-Television-Electronics, and an actual Sample Lesson. No cost—no obligation. Use the coupon now—we'll answer by return airmail.

APPROVED FOR VETERANS AND NON-VETERANS
Check coupon below

Both Resident and Home Study Courses Offered!



NATIONAL SCHOOLS

LOS ANGELES 37, CALIFORNIA • ESTABLISHED 1905
IN CANADA: 193 E. HASTINGS STREET, VANCOUVER, B.C.

FIND OUT NOW—MAIL COUPON TODAY!

NATIONAL SCHOOLS, Dept. RH-63
4000 South Figueroa Street
Los Angeles 37, California

Mail in envelope or paste on postal card.

Send FREE Radio-TV Electronics book and FREE sample lesson. I understand no salesman will call on me.

NAME _____ AGE _____
ADDRESS _____
CITY _____ ZONE _____ STATE _____

- Check here if released from service less than 4 years ago.
- Check here if interested in Resident School Training.

Now... One Name... One Source... for Top Quality TV Hardware!

ONLY **TELCO** STAND-OFFS
HAVE 6 DISTINCT ADVANTAGES

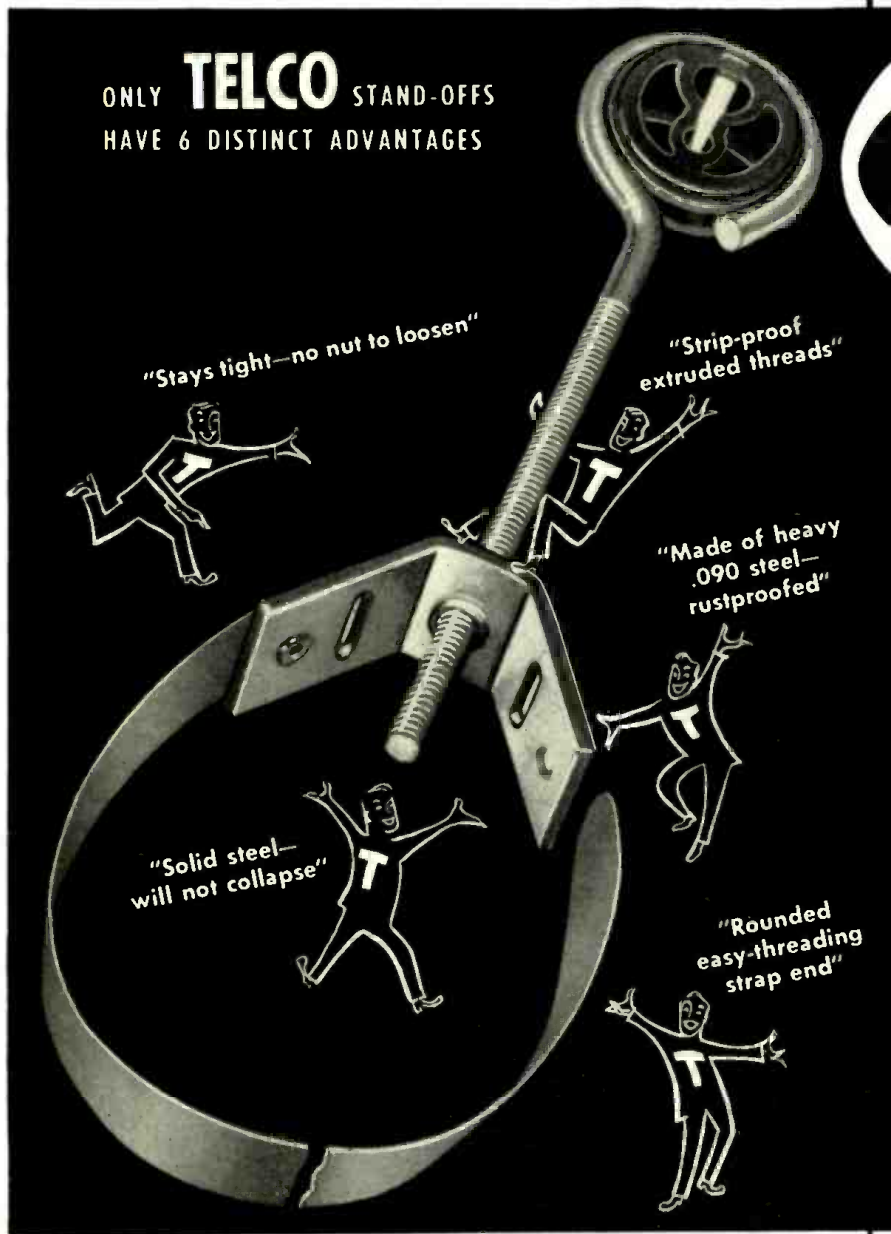

"Stays tight—no nut to loosen"

"Strip-proof
extruded threads"

"Made of heavy
.090 steel—
rustproofed"

"Solid steel—
will not collapse"

"Rounded
easy-threading
strap end"

TELCO



TELCO means Television Hardware . . . hundreds of finest quality items needed for TV installation. Here's everything you need in antenna mounts; also every type of antenna, both UHF and VHF and more real value for your money than ever before. Ask your parts distributor about **TELCO** . . . he's got these money-saving products.

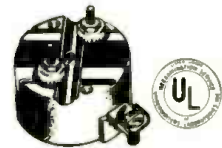

TELCO No. 8642
UNIVERSAL UHF LIGHTNING ARRESTOR
This one arrester fits all twin leads, mounts anywhere. UL approved. Hi-dielectric bakelite. All hardware included. List \$1.25

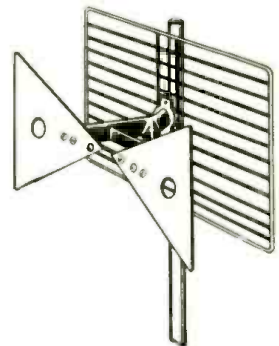

TELCO UHF WISHBONE BUTTERFLY ANTENNA
Newest design for all-channel reception. Tested and proved best in actual UHF areas. Highly directional. Rugged aluminum construction. low wind resistance. No. 8965 Telco Wishbone Butterfly Antenna. Single Bay with Tie Bar. List \$7.75

OVER 135 MILLION TELCO STAND-OFFS NOW IN USE

- Finest Polyethylene Insert
- Smooth, Rounded Bracket Slots . . . Never Cut Strap
- 29 Telco Stand-Off Styles Available
- The Strongest Stand-Offs Ever Made



WRITE TODAY for your free copy, new **TELCO** Catalog
TELEVISION HARDWARE MFG. CO.
904 TAYLOR AVENUE ROCKFORD, ILLINOIS
DIVISION OF **GENERAL CEMENT MANUFACTURING CO.**



*In capacitors, your best bet,
your best buy, is*



PYRAMID

PYRAMID ELECTRIC COMPANY
NORTH BERGEN, NEW JERSEY

Write for free literature

now get all TV stations UHF and VHF better

WITH THE PRECISION BUILT

VEE-D-X

Antenna Rotator

finest

IN DESIGN
IN CONSTRUCTION
IN PERFORMANCE



A PRODUCT OF *LaPointe* ELECTRONICS INC.
ROCKVILLE CONNECTICUT

PREDICTION

THE VEE-D-X ROTATOR WILL SOON BE THE NATION'S BEST SELLER!

Seeing is Believing!

Study this cutaway view. See for yourself why it is truly the finest of all rotators.

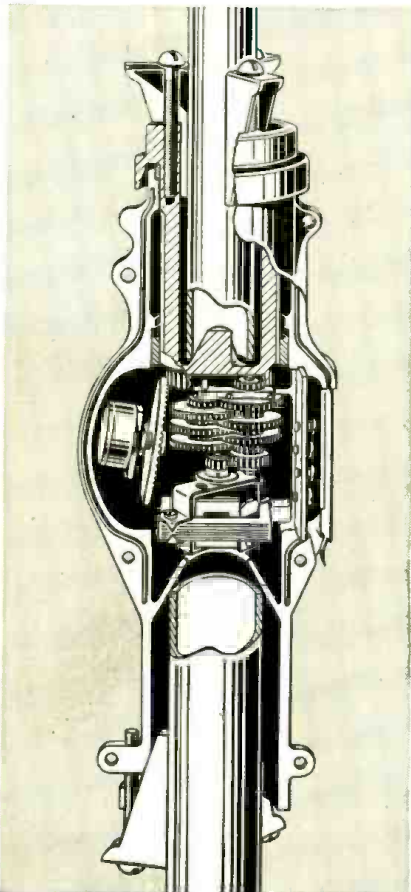

THE MAGNIFICENT DECORATOR STYLED CONTROL CONSOLE

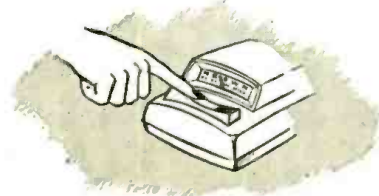

Here is the perfect companion to the finest of all rotators. The unique fingertip-action control operates with a convenient downward pressure that completely eliminates any need to hold console to prevent its sliding. It is engineered for instantaneous clockwise and counterclockwise action. Its easy-to-read dial gives both compass and numerical points. Available in two popular colors: Heather Green for light colored cabinets, Cordovan Mahogany for dark.

This forecast is not given lightly — nor do we expect it to be accepted lightly. It is backed by sound business reasoning and the awareness that VEE-D-X engineering, in collaboration with other world famous manufacturers, have jointly produced the finest of all rotators. It is so far in advance of anything on the market that a comparison with existing rotators will only serve to substantiate these (not lightly given) claims.

Many months of research, planning and testing were spent on the VEE-D-X Rotator. Its many exclusive and precision incorporated features assure pin-point accuracy and complete dependability under all weather conditions. The VEE-D-X Rotator is precision made for precision performance — designed to provide TV reception at its very best.

VEE-D-X OFFERS YOU RIGHT NOW ALL THE FEATURES YOU'VE DREAMED OF IN A FINE ROTATOR

PRECISION-BUILT—The VEE-D-X Antenna Rotator is built with the same precision with which it was engineered. Nothing has been spared in quality construction to provide the utmost in dependability and long trouble-free operation.

ADVANCED STYLING — Streamlined case design — better looking, less wind resistance.

FINEST GEARING OF ANY ROTATOR — Unique. Compact. Efficient. The self-contained, flanged spur gear train of the VEE-D-X Rotator puts it in a class by itself. Flanged reinforced gear teeth cannot be stripped. Designed and developed in cooperation with world famous small gear specialists. It provides most dependable performance under all conditions.

BALANCED MOUNTING — In-line (axial) mounting. Relieves strain on mast and guy wires. Equalized load distribution—no cumbersome offset—improved rooftop appearance.

WEATHER-RESISTANT FINISH—Entire unit is completely finished with new weather-resistant Luster-On #15 that meets rigid Army Signal Corps specifications. Stays bright—will not corrode.

FINEST MAST CLAMPS OF ANY ROTATOR — The positive three jaw chuck-type mast clamp is a VEE-D-X feature that provides simplest installation and the largest clamping surface of any rotator.

POSITIVE MAST ALIGNMENT — Is assured with built-in, self-centering mast guides both top and bottom.

FAST, EASY LINE CONNECTIONS—Accommodate four wire line. Exclusive snap-in cover, slides into place—no screws to drop when installing.

FULL 365 DEGREE TRAVERSE — Eliminates necessity of reversing rotation at critical points at end of normal 360 degree traverse.

POSITIVE ANTENNA BRAKE—No over travel, assures pin-point accuracy the moment control actuator is released.

EXTREMELY POWERFUL — Will support a load of over 200 pounds—thereby eliminating any need for the extra expense of an auxiliary thrust bearing.

GUYED AT TOP—Three guy ring lugs are cast as an integral part of the case for maximum strength. Spaced 120 degrees apart—permits three or four wire guying.

DECORATOR STYLED CONTROL CONSOLE — Smaller, more compact, more beautiful than any other. Unique control actuator. Dial gives both compass and numerical reference points. Plastic case in choice of beautiful decorator colors — Heather Green or Cordovan Mahogany.

ACCURATE COMPASS INDICATION AT ALL TIMES — No screw driver adjustment required to compensate for voltage fluctuation.

FACTORY TESTED AND GUARANTEED—Every Rotator and Control Console is thoroughly tested electrically and mechanically and fully guaranteed.

Write For Literature!

LaPointe Electronics Inc.
Rockville, Connecticut

Mail copies of Rotator literature.

Name

Street

City Zone State

For sound trucks • parades
carnivals • resorts • busses
outdoor meetings

ECONOMICAL MOBILE AMPLIFIERS

by
Newcomb



MODEL E-25MP

Newcomb mobile amplifiers are carefully built for the rugged conditions of mobile use and to deliver consistently the top quality performance you expect from any Newcomb amplifier. Dollar for dollar they give you more good service, more convenient operational features and more all around, long-time satisfaction.

MODEL E-25MP delivers 25 watts from either 6 volt battery or 117 A.C. It has a standby switch, separate power and phono switches and inputs for 2 mikes and 1 phono. Heavy duty plugs. 2000 volt hermetically sealed buffer condenser. Phase correction capacitor for phono motor.

MODEL E-25M is the same amplifier without phono top.

MODEL E-10M is a rugged, low cost, 10 watt unit also for either battery or A.C. power. Has standby switch, inputs for 1 mike, 1 phono. Special mounting simplifies installation and removal.



E-10M

*Send for full
information
today!*

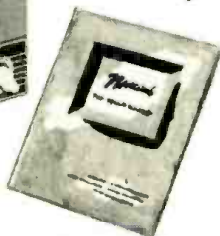

NEWCOMB AUDIO PRODUCTS CO.

Dept. F, 6824 Lexington Ave., Hollywood 38, Calif.

Within the INDUSTRY

HENRY F. ARGENTO has been appointed vice-president and general manager of *Raytheon Television and Radio Corporation*, Chicago subsidiary of *Raytheon Manufacturing Co.*



He has been with the company since 1932 and has most recently served as assistant vice-president and assistant manager of the company's power tube division. He entered business as a research engineer at the *Radio Frequency Laboratory* in Boonton, N. J. in 1931 and a year later joined *Raytheon* where he engaged in test work in the receiving tube division at Newton, Massachusetts.

ALLEN B. DU MONT LABORATORIES, INC. has opened a new plant for the manufacture of cathode-ray instruments for industrial and defense use. It is located at 760 Bloomfield Avenue in the Allwood section of Clifton, New Jersey. **GENERAL INSTRUMENT CORPORATION** has acquired a fourth plant in its current expansion program. The new facility is located in Danielson, Conn. and will be used for assembly work. **U.S. WIRE & CABLE CORP.** has moved into a modern plant at Progress Avenue and Monroe Street in Union, N. J. The new plant will permit the firm to triple its production of all types of wire for radio, television, and electronics. **THE POLARAD ELECTRONICS CORP.** has acquired 20,000 square feet of manufacturing space in a newly constructed building at 2 Franklin Ave., Brooklyn, N. Y. Research and development activities as well as production line facilities can be accommodated at the new location. **PIONEER ELECTRONICS CORP.** of Santa Monica is building a new plant for the manufacture of television picture tubes. The new factory will have 30,000 square feet of enclosed space and 20,000 square feet of paved ground for parking, loading, and potential expansion. **ALPRODCO, INC.** of Dublin, Georgia has announced plans for the construction of a new building. The new structure will have 10,000 square feet of floor space. **EMERSON RADIO AND PHONOGRAPH CORPORATION** has taken title to the ten-story building located at 524 West 23rd Street, New York City. It will be used as administrative and engineering headquarters for the radio and television firm. **RADIO CITY PRODUCTS CO.** has leased a 2½ acre tract of land at Easton, Pa. and will erect a new one-story manufacturing plant to ad-

join their present production center. An additional 13,000 square feet of production area will thus be available. **WESTINGHOUSE ELECTRIC CORP.** has dedicated two new tube plants, in Elmira and Bath, New York. The Elmira plant produces TV picture tubes, power tubes for transmitters and electronic devices, and x-ray tubes. The Bath plant is making some 60 types of small receiving tubes. **ROHN MANUFACTURING CO.**, tower and tower accessory maker, has a new mailing address—116 Limestone, Bellevue, Peoria, Illinois.

HARRY C. CRAWFORD has been elected president of *Radiart Corporation*, replacing L. K. Wildberg in the post.



Mr. Crawford has been associated with *Cornell-Dubilier* and *Radiart* for the past eight years as works manager as well as controller and assistant treasurer for both the affiliated firms.

Before joining *C-D* and its subsidiary he was an industrial engineer with *Douglas Aircraft* and spent five years as vice-president and sales manager of *International Piston Ring Co.*, joining that firm from *Thompson Products* where he served twenty years as business manager of the automotive parts replacement division. He will make his headquarters in Cleveland.

CAMPBELL RUTLEDGE, JR. has been named to the newly-created post of assistant general manager of the electrical products division of *Corning Glass Works*, and **FORREST E. BEHM, JR.** is the new manager of the division's Pressware Plant which produces television bulbs. **JOHN F. QUIRK** has assumed the duties of director of purchases for the five outlets of *Federated Purchaser, Inc.* **General Precision Laboratory, Inc.** has appointed **NATHANIEL M. MARSHALL** manager of television equipment sales. He has been with the firm since 1950. **C. KENNETH HERSEY** is the new sales manager of the downtown sound department of *Hudson Radio & Television Corp.* of New York City. He will make his headquarters at 212 Fulton Street. **THOMPSON H. MITCHELL** has been elected president of *RCA Communications, Inc.*, succeeding **H. C. INGLES** who retired recently. **JEROME M. HOLLANDER**, formerly associated with *Allen B. Du Mont Laboratories, Inc.*, has been appointed senior engineer of *Radio City Products Com-*



Leonard C. Lane, B.S., M.A.
 President of Radio-Television
 Training Association, Exec. Dir.
 of Pierce School of Radio and
 Television.



I GIVE YOU
MORE EQUIPMENT
 TO TRAIN YOU BETTER

Set up your own home laboratory with the 15 BIG TV-Radio kits we send you. You build AND KEEP your own complete BIG SCREEN TV RECEIVER, Super-Het Radio Receiver, R.F. Signal Generator, Combination Voltmeter-Ammeter-Ohmmeter, C-W Telephone Receiver, AC-DC Power Supply. Everything is furnished complete, including all tubes, plus big TV picture tube.



GET MORE!
 LEARN MORE!
 EARN MORE!

THOUSANDS OF NEW JOBS IN

TELEVISION

I PREPARE YOU AT HOME IN YOUR SPARE TIME

TRAINING TO FIT YOU
 FOR THE BETTER PAY JOBS

Thousands of new jobs will open up right in your own state, now that the government has lifted restrictions on new TV stations. My simple, successful methods have helped hundreds of men — most of them with NO PREVIOUS TRAINING — find places in America's booming TELEVISION and Electronics industries. You too can get the success and happiness you always wanted out of life within months... studying at home... as I train you to become a full-fledged TV TECHNICIAN. Many of my students make as much as \$25.00 a week repairing Radio-TV sets in their spare time while learning... pay their entire training almost from the very beginning from spare time earnings... start their own profitable service business. But I don't stop after I qualify you as a TV Technician... although right there you can choose from among dozens of fascinating careers! I continue to train you — AT NO EXTRA COST — to qualify for even better pay in the BETTER JOBS that demand FCC licenses, with my...

MORE VALUE!
 YOU GET A ROUND TRIP TO
 NEW YORK CITY
 AT NO EXTRA COST

FROM ANYWHERE IN THE U.S. OR CANADA — I pay your way to New York and return, PLUS 2 FREE weeks, 50 hours of advanced instruction and shop training at the PIERCE SCHOOL OF RADIO & TELEVISION. You use modern electronics equipment, including student-operated TV and Radio stations. You go behind the scenes of New York's big Radio-TV centers, to study first hand. And I give you all this AT NO EXTRA COST! (Applies to complete Radio-TV course only.)

Only RTTA makes this amazing offer.

I GET MY
 GRADUATES GOOD PAYING JOBS

"Thanks to your training, I qualified for a good job as a Receiver Tester at Federal Telephone and Radio."
 — Paul Frank Seier



"I'm making good money in my own business, repairing and installing radio and TV sets — thanks to your training."
 — Irwin Polansky



"Your excellent instruction helped me get my present job as an airport radio mechanic for American Airlines."
 — Eugene E. Basko



"I'll always be grateful to your training which helped me get my present fine position as Assistant Parts Manager."
 — Norman Weston



Many others working at NBC, RCA, CBS, DuMont, Philco, Emerson, Admiral and other leading firms.

FREE FCC COACHING COURSE
 PREPARES YOU AT HOME FOR YOUR FCC LICENSE.

THE BEST JOBS IN TV AND RADIO REQUIRE AN FCC LICENSE. Given at NO EXTRA COST after TV Theory and Practice is completed.

NOW! ADVANCED FM-TV TRAINING

If you have previous Armed Forces or civilian radio experience—my ADVANCED COURSE can save you months of training. Full theory and practical training... complete with kits, including BIG SCREEN TV RECEIVER and FREE FCC License Coaching Course.

FREE EMPLOYMENT ASSISTANCE

My vocational adviser will help you obtain a good-paying job in the locality of your choice.

RADIO-TELEVISION TRAINING ASSOCIATION
 1629 Broadway, Radio City Station, New York City 19, N. Y.
 LICENSED BY THE STATE OF NEW YORK

VETERANS!

MY SCHOOLS FULLY APPROVED TO TRAIN VETERANS UNDER NEW G.I. BILL! If discharged after June 27, 1950 — CHECK COUPON BELOW!

Also approved for RESIDENT TRAINING in New York City... qualifies you for full subsistence allowance up to \$160 per month.

MAIL COUPON TODAY!

BOTH FREE! New Illustrated Book and Sample Lesson. Learn How My Simple Methods Make Success Easy!



NO SALESMAN WILL CALL!

Mr. Leonard C. Lane, President
 RADIO-TELEVISION TRAINING ASSOCIATION
 1629 Broadway, Radio City Station
 New York 19, N. Y. Dept. T-6

Dear Mr. Lane: Mail me your NEW FREE BOOK and SAMPLE LESSON that will show me how I can make BIG MONEY in TELEVISION. I understand I am under no obligation and no salesman will call.

(PLEASE PRINT PLAINLY)

Name _____ Age _____
 Address _____
 City _____ Zone _____ State _____

I am interested in: Radio-TV Advanced FM-TV.
 VETERANS: If qualified under new G.I. Bill, check your choice: Home Study Resident Study.

THE PLUS VALUE ANTENNA

for perfect

ULTRA VISION TV!

Rytel

**DOUBLE "O"
UHF ANTENNA**



UHF stations are springing up all across the country. Demand is terrific. Start right with a performance antenna that can't give you "customer headaches."

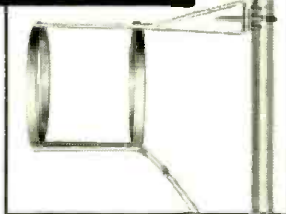

NOT ONLY IN PORTLAND BUT ALL OVER THE COUNTRY THE DOUBLE-O CONSISTENTLY GIVES THE BEST PERFORMANCE. Thousands in use in Arkansas, Maine, Massachusetts, New Jersey, Wisconsin, Pennsylvania—and all other UHF areas. The Best Performer PLUS

SIMPLICITY . . . NO ELECTRICAL OR MECHANICAL BREAKDOWNS

PLUS ECONOMY . . . simple, tough aluminum construction means low price, no maintenance, long life.

PLUS RUGGED CONSTRUCTION . . . simplicity of design avoids fragile, expensive insulators, no chance of electrical or mechanical breakdown. Supported at current node (ground potential).

PLUS APPEARANCE . . . no more monstrosities on the roof . . . just simple, attractive . . . perfect Double-O.

PLUS INSTALLATION . . . no more "servicemen's nightmares" . . . Double-O is a serviceman's dream . . . comes completely assembled, just a "U" clamp to tighten, no "adjustments."

It's the DOUBLE-O for PERFECT ULTRA VISION . . . ACT NOW
AND BE READY WITH A UHF ANTENNA THAT
NEEDS TO BE SOLD JUST ONCE.

List Price \$3.49

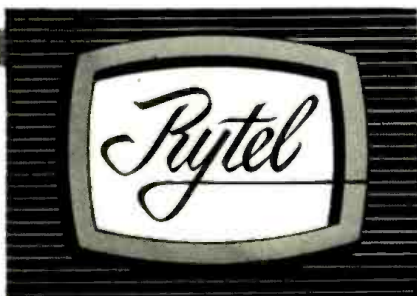

RYTEL ELECTRONICS MFG. CO.
9820 Irwin Avenue • Inglewood, California

Also connector clips, impedance matches, tube reactivators, tube-pullers, etc. Over 800 Rytel distributors in the United States. Write for further information.

Represented in Canada by:
NORRIS BURGESS CO.
571 Yonge St., Toronto, Canada

pany . . . *Littelfuse, Inc.* of Chicago has named **H. A. TRIPLETT** research director for the firm . . . **DONALD A. STEWART** is the new distribution manager for the television transmitter division of *Allen B. Du Mont Laboratories, Inc.*

* * *

PAUL W. TANNER is the new general sales manager of the radio and television division of *Arvin Industries, Inc.*



He succeeds Raymond P. Spellman who has requested a less demanding assignment because of a recent serious illness. Mr. Spellman's new duties will enable him to contribute from his long experience and wide acquaintance to the company's sales and marketing problems.

The new sales manager is a twenty-year veteran with the company, having joined *Arvin* upon his graduation from Indiana University in 1933. Since 1949 Mr. Tanner has served as merchandising manager of the radio and TV division of the company.

* * *

GENERAL ELECTRIC COMPANY has changed the name of its receiver department to the radio and television department as being more descriptive of the nature of the work being done . . . **ACCURATE ELECTRONICS CORP.**

1312 Ontario Street, Cleveland 13, Ohio has been formed to manufacture components for original equipment and jobbers in the radio, television, and electronic industry. Jos. F. Seybold, formerly product design engineer for **RADIART CORP.**, is the organizer and president of the new firm . . . **FREED RADIO CORPORATION** has changed its corporate name to **FREED ELECTRONICS AND CONTROLS CORPORATION**. The new name more nearly reflects the scope of the company's business, hence the change . . . **UNIFORM TUBES** of Collegeville 2, Pa., has been incorporated and will henceforth be known as **UNIFORM TUBES, INC.** Albert H. Mainwaring is president and chairman of the board . . . **BRENNA & BROWNE**, a manufacturers' representative firm with headquarters in Honolulu, has been formed by Dr. Burton Browne, head of *Burton Browne Advertising*, and Lennie Brenna. Mr. Brenna is an engineering graduate of the University of Minnesota and well-known in Hawaii. He will head the Honolulu operation. Dr. Brown will handle the stateside affairs of the firm from his office at 619 N. Michigan, Chicago.

* * *

RTMA reports that total television and radio set production for 1952 was valued at nearly \$1.3 billion at the factory level. The manufacturers' value of all radio-TV receivers produced during the year was estimated as \$1,298,847,000 by the Association. The 1952 dollar volume was based on an estimated production of 6,096,279 (Continued on page 159)

* * *

The 1952 dollar volume was based on an estimated production of 6,096,279 (Continued on page 159)

(Continued on page 159)

RADIO & TELEVISION NEWS

**BUY DIRECT
AND SAVE**

Sweeping the Country!

'PRE-FAB' COLLINS TUNERS and RECEIVERS
AUDIO PRODUCTS CO.

Collins Audio Products Co. is in no way affiliated with Collins Radio Co.

Two ALL NEW Complete Kits for Every High-Fidelity Need



FM Tuner Kit \$55

The FM-11 tuner is available in kit form with the IF Amplifier mounted in the chassis, wired and tested by us. You mount the completed RF Tuning Unit and power supply, then after some simple wiring, it's all set to operate. 11 tubes: 6J6 RF amp, 6AG5 converter, 6C4 oscillator, 6BA6 1st IF, (2) 6AU6 2nd and 3rd IF, (2) 6AU6 limiters, 6AL5 discriminator, 6AL7-GT double tuning eye, 5Y3-GT rectifier. Sensitivity 6 to 10 microvolts, less than 1/2 of 1% distortion, 20 to 20,000 cycle response with 2DB variation. Chassis dimensions: 12 1/2" wide, 8" deep, 7" high. Illustrated manual supplied. Shipping weight 14 lbs.

Each Collins Tuner Kit is complete with punched chassis, tubes, power transformer, power supply components, hardware, dial assembly, tuning eye, knobs, wire, etc., as well as the completed sub-assemblies: FM tuning units, AM tuning units, IF amplifiers, etc., where applicable. Since all these sub-assemblies are wired, tested and aligned at the factory, Collins Pre-Fab Kits are easily assembled even without technical knowledge. The end result is a fine, high quality, high fidelity instrument at often less than half the cost — because you helped make it and bought it direct from the factory. Bring your present reproducing system up to date with a new Collins Tuner.



FM/AM Tuner Kit \$77.50

The original 15 tube deluxe FM/AM pre-fab kit redesigned on a smaller chassis. The tuner now measures 14" wide by 12" deep by 7 1/2" high. This attractive new front and dial assembly opens up new applications where space is at a premium. Kit includes everything necessary to put it into operation—punched chassis, tubes, wired and aligned components, power supply, hardware, etc. Kit comprises FMF-3 tuning unit, IF-6 amplifier, AM-4 AM tuning unit, magic eye assembly and complete instructions. All tubes included. Shipping weight 19 lbs.

Selected Basic Components For Special Applications

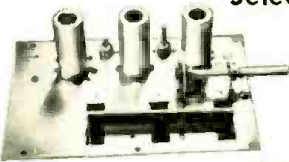

FMF-3 Tuning Unit \$15.25

The best for FM. The most sensitive and most selective type of "front end" on the market. 6 to 10 microvolts sensitivity. Image ratio 500 to 1. 6J6 tuned RF stage, 6AG5 converter, 6C4 oscillator. Permeability tuned, stable and drift-free. Chassis plate measures 6 1/2" x 4 1/2". In combination with the IF-6 amplifier, the highest order of sensitivity on FM can be attained. Tubes included as well as schematic and instructions. Draws 30 ma. Shipping weight FMF-3: 2 1/2 lbs. Dial available @ \$3.85.

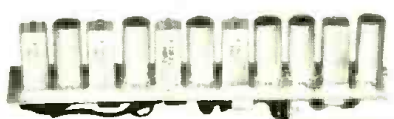

IF-6 Amplifier \$19.75

A remarkable value! 6 tubes are used in the IF amplifier: 6BA6 1st IF, (2) 6AU6 2nd and 3rd IF's, (2) 6AU6 limiters and 6AL5 discriminator. High gain, wide-band response (200 KC) for highest fidelity. 20 to 20,000 cycles. Distortion less than 1/2 of 1%. Draws 40 ma @ 220 volts. Chassis plate dimensions: 11-5/16" x 2 1/2" Shipping weight: 3 lbs.



AM-4 Tuning Unit \$24.50

Tops in AM superhet performance! A 3-gang tuning condenser gives 3 tuned stages with high sensitivity and selectivity. Assembly is completely wired, tested and aligned ready for immediate use. Frequency coverage 540 KC to 1650 KC at a sensitivity of 5 microvolts. Tubes 6BA6 RF amplifier; 6BE6 converter; 6BA6 IF amplifier and 6AT6 detector. Draws 30 ma @ 220 volts. Mounts on a chassis plate measuring 4" x 7 3/8". Shipping weight 2 1/2 lbs. Dial available at \$3.85.



RD-1C Tuner & Dial \$28.50

The COLLINS RD-1C FM tuner chassis is unique in the field. A whole, compact FM tuner and dial that fits in the palm of your hand. Convert AM sets to FM/AM receivers for only a few dollars! Unlimited applications where space is at a premium. Use in conjunction with your phonograph amplifier. Full frequency response to 20,000 cycles. Sensitivity 20 microvolts, permeability tuned. Tuning unit and IF amplifier on the same chassis plate. Draws 40 ma @ 100 volts. Tubes: 6AG5 converter, 6C4 oscillator, (2) 6AU6 IF amplifiers, 6AL5 in new ratio detector circuit. Shipping weight tuner and dial 5 lbs.

MAIL COUPON TODAY

To: Collins Audio Products Co. Inc.
P.O. Box 368, Westfield, N. J.
Tel. Westfield 2-4390

FM Tuner Kit FM/AM Tuner Kit Slide Rule Dial Assembly
 FMF-3 Tuning Unit IF-6 Amplifier RD-1C Tuner and Dial
 AM-4 Tuning Unit

NAME

ADDRESS

CITY..... STATE.....

Amount for Kit \$..... See weights, add shipping cost \$.....

Total amount enclosed \$..... Check Money Order

WHEN YOU THINK OF TUNERS, THINK OF COLLINS AUDIO PRODUCTS

10 TIMES MORE POWERFUL THAN STACKED 10 ELEMENT YAGIS

PHILCO *All-Purpose TV Antenna*

NEW Design and Principle

By far the most powerful TV antenna on the market today . . . a sales value unsurpassed at its popular price. With the mere flip of a switch this exclusive all-purpose Philco antenna without rotor or moving parts of any kind instantly and automatically beams the set to the best possible signal for both UHF and VHF reception. No attenuators are necessary in strong signal areas since an off position of the switch will automatically attenuate the signal. Available in preassembled aluminum dowel reinforced elements of single bank and stacked arrays for metropolitan and fringe areas at your Philco distributor now.

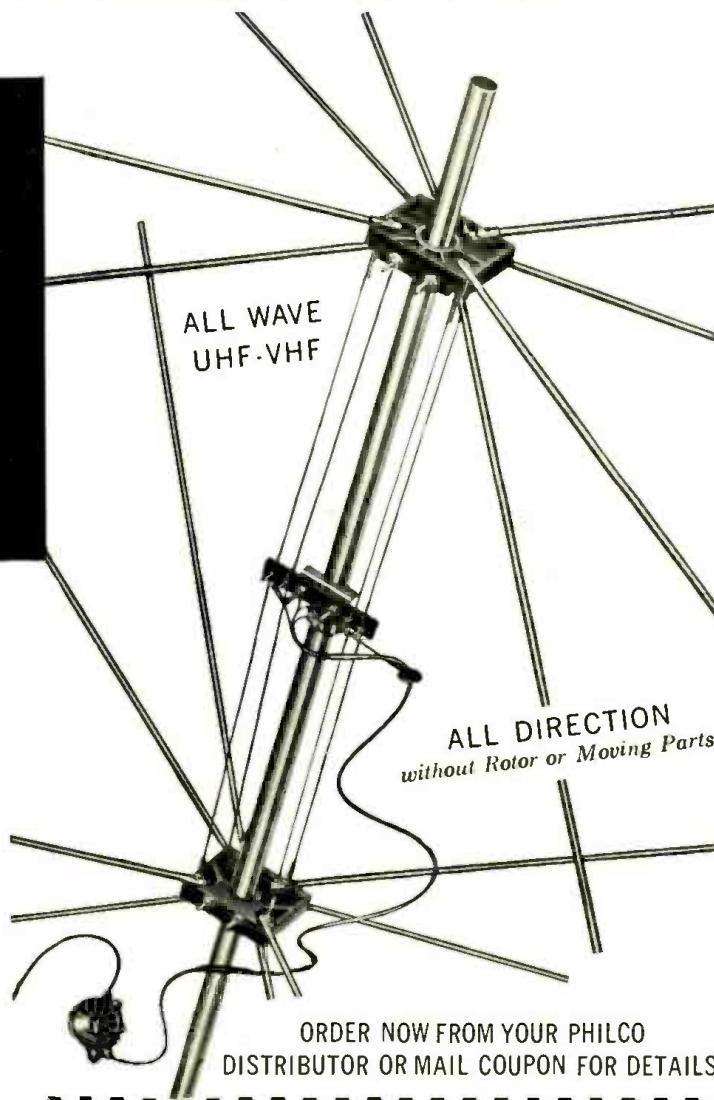

ORDER NOW FROM YOUR PHILCO
DISTRIBUTOR OR MAIL COUPON FOR DETAILS

Up to 22.3 DB Gain over Tuned Dipole

DB GAIN OVER A TUNED DIPOLE CUT FOR EACH CHANNEL FREQUENCY

	2	3	4	5	6	7	8	9	10	11	12	13
Single Array	7.8	14.0	6.7	-1.7	16.3	2.5	6.0	9.6	12.1	10.8	15.0	12.8
Gain Chart	36"	18.8	3.5	7.4	17.3	0.0	-1.3	6.0	8.4	11.5	13.0	12.5
using	45"	6.5	14.3	6.0	-6.0	18.6	6.7	8.5	18.2	18.1	13.2	14.3
different	60"	5.8	2.2	9.6	-1.0	-2.0	1.5	-4.0	10.3	4.0	15.4	7.0
spacing	82"	8.4	15.5	13.0	10.5	21.3	3.0	14.0	-2.0	1.6	10.0	6.0
between	98"	2.5	8.0	9.5	-4.5	17.0	6.0	2.0	4.0	1.0	10.0	7.0
two single	114"	21.0	19.0	7.4	22.3	0.0	6.0	8.2	10.4	11.5	14.0	14.1
arrays	122"	7.4	17.0	13.4	2.5	21.5	8.5	17.3	16.2	12.1	14.8	15.6

The above tests were made using a 40-foot lead-in. However amazing results have been obtained on installations using a lead-in up to 150 feet without any appreciable difference in gain. These tests were made in real fringe areas.

For maximum gain in outer fringe areas, orient the antenna for the weakest channel desired. Location will determine the number of elements to be used.

PHILCO CORPORATION, Accessory Division
Allegheny and A Streets
Philadelphia 34, Pa.

Please send me information about the Philco All Purpose
Antenna, with current trade price list.

NAME

STORE NAME

CITY ZONE STATE

Please check in space below

I am a Retail Dealer

I am a TV Serviceman



**TRAIN FASTER—TRAIN BETTER—TRAIN EASIER
IN 10 MONTHS—OR LESS—FOR
RADIO-TELEVISION**

Our 21st Year Training Men for Greater Incomes and Security in Radio-Television

**I SEND YOU
18 BIG KITS**

of Radio Television parts and equipment. Much of your training will be actual construction and experimentation . . . the kind of truly PRACTICAL instruction that prepares you for your Radio-Television career.



Frank L. Sprayberry
President
Sprayberry Academy
of Radio

NEW! NO OBLIGATION PLAN

**You Have No Monthly Payment Contract to Sign
Pay For Your Training as You Earn and Learn**

You can get into Radio-Television, today's fastest growing big money opportunity field, in *months* instead of years! My completely new "package unit" training plan prepares you in as little as 10 months or even less! *No monthly payment contract to sign—thus NO RISK to you!*

This is America's finest, most complete, practical training—gets you ready to handle any practical job in the booming Radio-Television industry. Start your own profitable Radio-Television shop . . . or accept a good paying job. I have trained hundreds of successful Radio-Television technicians during the past 21 years—and stand ready to train you, even if you have no previous experience! Mail coupon and get all the facts—FREE!



**Valuable Equipment Included
With Training**

The new Sprayberry "package" plan includes many big kits of genuine, professional Radio-Television equipment. You perform over 300 demonstrations, experiments and construction projects. You build a powerful 6-tube 2-band radio set, multi-range test meter, signal generator, signal tracer, many other projects. All equipment and lessons are yours to keep . . . you have practically everything you need to set up your own profitable Radio-Television service shop.

Earn Extra Money While You Learn!

All your 10 months of training is IN YOUR HOME in spare hours. Keep on with your present job and income while learning. With each training "package" unit, you receive extra plans and "Business Builder" ideas for spare time Radio-Television jobs. New television stations everywhere, open vast new opportunities for trained Radio-Television Technicians—and those in training. If you expect to be in the armed forces later, there is no better preparation than practical Sprayberry Radio-Television training.

YOU BUILD the Television set and the powerful superhet radio receiver shown above. IN ADDITION to the other test units shown here (many are not shown because of lack of space). All equipment I send you is **YOURS TO KEEP.**

Approved for Veterans under the G.I. Bill

**SPRAYBERRY ACADEMY OF RADIO 111 NORTH CANAL ST.
Dept. 25-X, Chicago 6, Ill.**

**MAIL COUPON
TODAY!
NO OBLIGATION**

**SPRAYBERRY ACADEMY OF RADIO, Dept. 25-X
111 North Canal St., Chicago 6, Ill.**

Please rush to me all information on your 10-MONTH Radio-Television Training Plan. I understand this does not obligate me and that no salesman will call upon me. Be sure to include 3 books FREE.

Name..... Age.....

Address.....

City..... Zone..... State.....

**I invite you to get all the facts—
FREE TO YOU 3 BIG
RADIO-TELEVISION BOOKS**

I want you to have ALL the facts about my new 10-MONTH Radio-Television Training—without cost! Rush coupon for my three big Radio-Television books: "How to Make Money in Radio-Television." PLUS my new Illustrated Television Bulletin PLUS an actual sample Sprayberry Lesson—ALL FREE. No obligation and no salesman will call. Mail coupon NOW!



PICKERING

PROFESSIONAL AUDIO EQUIPMENT

BALANCED COMPONENTS / MAXIMIZE PLAYBACK PERFORMANCE

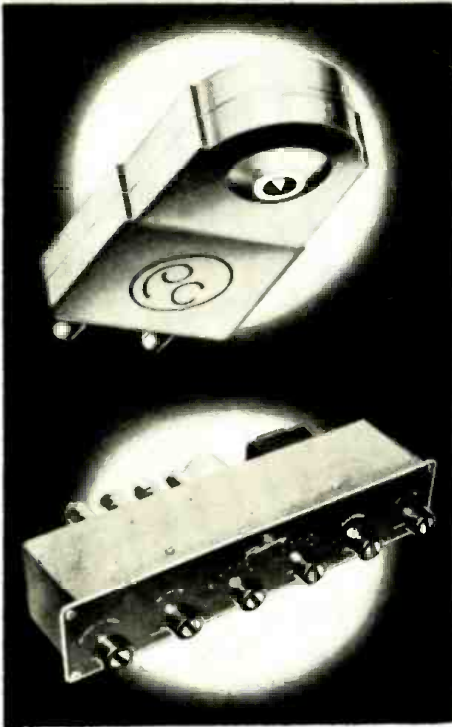

PICKERING CARTRIDGES . . .

are the choice of audio engineers throughout the world. They are universally acclaimed because of their high output, wide range performance and low distortion. They are used wherever a fine cartridge is required in radio stations, recording studios and for purposes of quality control by leading record manufacturers.

MODEL 410 AUDIO INPUT SYSTEM . . .

is designed to provide a complete audio control center. Model 410 may be used in any high quality playback system. Three input channels are provided—one for magnetic cartridges and 2 "flat" channels for other audio circuits. A 3-position equalizer network is built into the magnetic cartridge channel and provides accurate equalization for LP, AES and 78 rpm recording characteristics. Separate bass and treble controls are also provided. These are of the step-type and permit bass and treble adjustments in 2 db increments. The tone control circuits are intended to compensate for record characteristics and for listener-environment acoustical conditions. They are not intended to compensate for amplifier and/or loudspeaker deficiencies. Model 410 is intended for use with the highest quality professional type playback equipment. The output of the Model 410 is fed from a cathode-follower circuit and will work into any high quality audio or line amplifier having a high impedance input. It may also be used with a transformer for the purpose of feeding a 500 ohm line. Because of its flexibility, low noise and low distortion level, it is ideally suited for bridging and monitoring purposes and for critical listening applications.



THE MODEL 190 ARM . . .

is designed primarily for use with microgroove records. Its design has been recognized by leading audio engineers as that which incorporates all of the desirable tracking characteristics. Analysis has shown that for maximum performance with LP records the vertical mass of the moving arm element must be held to a minimum and further, that the arm must be counterbalanced about the vertical axis. This permits minimum stylus or tracking force and provides maximum record life. The Model 190 Arm embodies these all important features necessary for proper microgroove record playback.

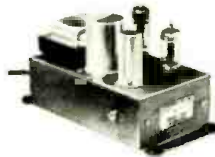

MODEL 230H EQUALIZER-PREAMPLIFIER . . .

is unique in its accuracy of equalization and frequency response. The intermodulation distortion is .2 per cent at normal output level. It is intended for use with high quality amplifiers having gain and tone controls. When used with the Pickering Model 132E Record Compensator the 230H is ideal for radio station and recording studio use and for applications requiring accurate low noise and distortion free playback.



MODEL 132E RECORD COMPENSATOR . . .

is designed to be used in conjunction with a magnetic cartridge preamplifier such as the Pickering 230H or any preamplifier which provides 6 db per octave bass boost. Six playback positions are incorporated:

- 1—European 78 rpm Records
- 2—Victor 45 rpm and Decca 78 rpm Records
- 3—No high frequency roll-off, 500 cycle turnover
- 4—All Capitol Records, new Victor 33 $\frac{1}{2}$, Audio Engineering Society Curve
- 5—Columbia, London and most LP Records
- 6—To remove the hiss from old noisy records

Precision elements are used in its construction to give accurate compensation. The 132E is inherently a low distortion R-C device.

PICKERING PROFESSIONAL AUDIO EQUIPMENT

"For those who can hear the difference"

... Demonstrated and sold by Leading Radio Parts Distributors everywhere.
For the one nearest you and for detailed literature, write Dept. C-2



PICKERING and company incorporated • Oceanside, L. I., New York

\$10,000.00 IN PRIZES

ENTER RAYTHEON'S TRANSISTOR APPLICATION CONTEST!

Here's the chance-of-a-lifetime to win a big cash prize while gaining valuable "know-how" on the latest electronic development — transistors. Raytheon is offering 17 cash prizes to the seventeen contestants who produce the most ingenious applications of the Raytheon CK722 Junction TRANSISTOR.

Here's all you have to do! Simply build equipment that uses one or more Raytheon CK722 Transistors which you have purchased from your local Raytheon Tube Distributor. Then send a photograph of the unit you have built, a completed official entry blank and a 500 word minimum, 1000 word maximum constructional article on the equipment to Raytheon, P. O. Box 6, Newton 58, Mass. All entries will be carefully judged and prizes will be awarded on the basis of ingenuity of application. Duplicate equipment to be judged on basis of descriptive material. Decision of the judges is final and all entries and their ideas become the exclusive property of Raytheon.

Here's how to enter! Go to your nearest Raytheon Special Purpose Tube Distributor. Get your official entry blank which *must* accompany each entry and which contains complete contest rules or get the official entry blank by writing directly to Raytheon, P. O. Box 6, Newton 58, Mass. Enter today — the contest closes on Midnight August 31, 1953.

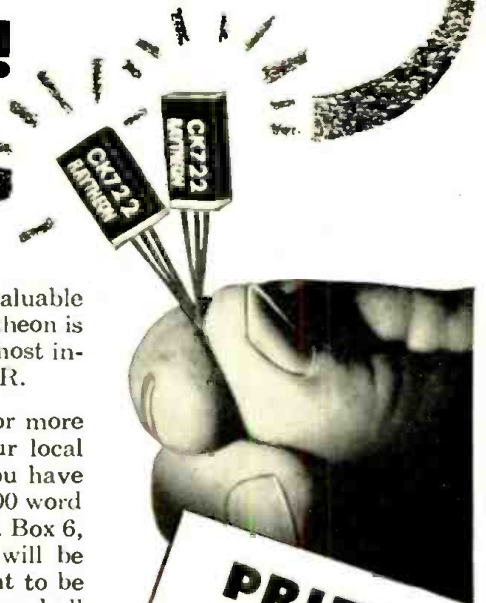

PRIZES	
1st	\$5000.00
2nd	2000.00
3rd	1000.00
4th	500.00
5th	300.00
6th to 17th	100.00



Excellence in Electronics

RAYTHEON MANUFACTURING CO.

Receiving Tube Division

POST OFFICE BOX 6, NEWTON 58, MASSACHUSETTS

FREE!

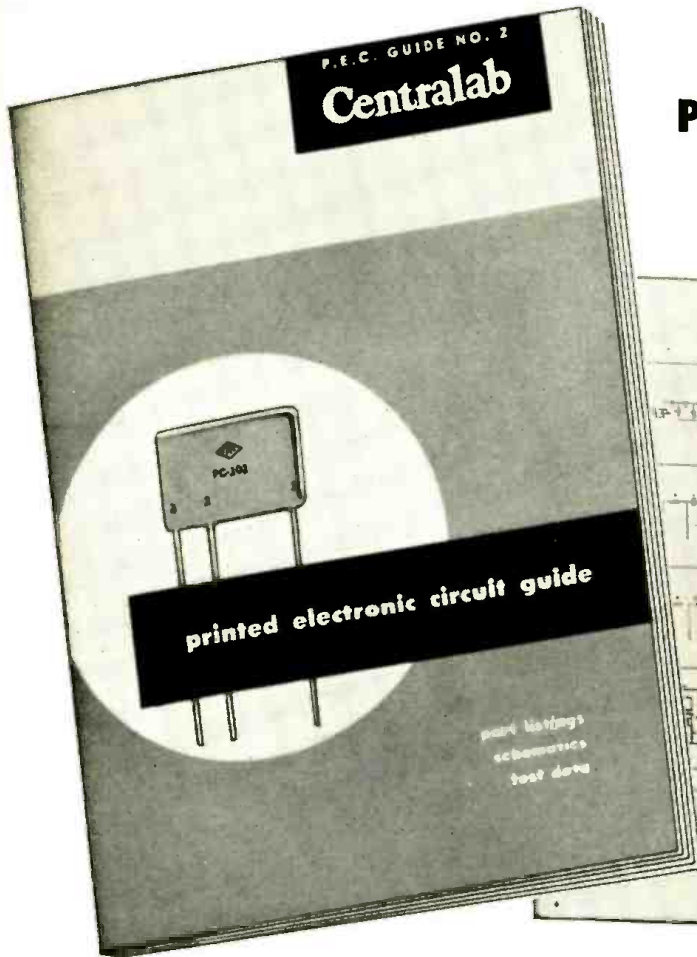

PRINTED ELECTRONIC CIRCUIT GUIDE NO. 2

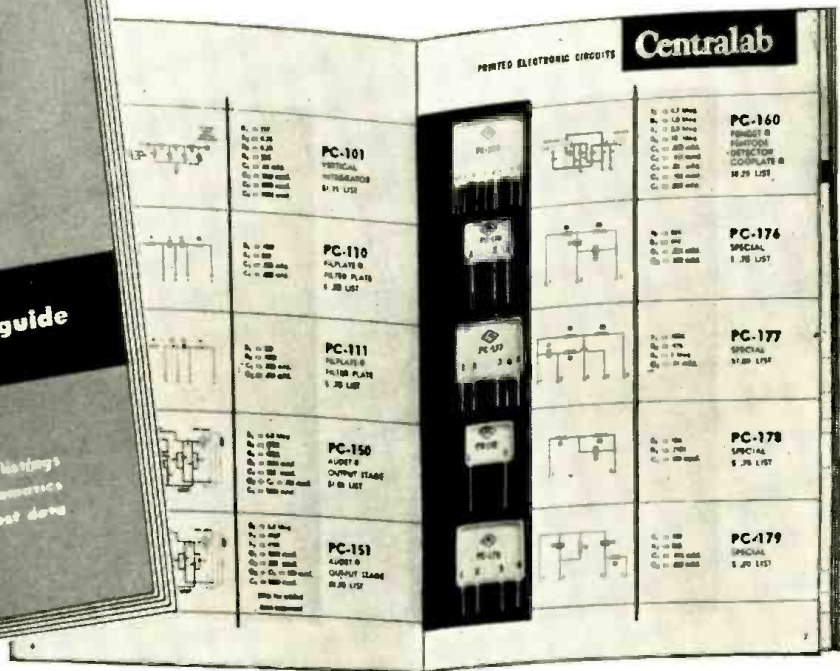

1953 CENTRALAB PEC GUIDE BIGGER — EVEN MORE COMPLETE

includes 445 PEC applications — 21 stock parts covering
25,000,000 PEC's now in use — lists 119 set manufacturers

HERE'S the only practical PEC service guide. It's a must for every service shop. And it's yours absolutely free.

Original equipment manufacturers have marveled at the extremely low failure percentage of PEC units as compared to individual standard components. But there are many millions of older sets in use that were produced prior to the use of PEC. Standard components in these sets can be replaced quickly and inexpensively by a single Printed Electronic Circuit Plate. *If trouble is located in a certain section of a circuit, for instance, the vertical integrator in a TV set, or the Audio Detector in a radio set, instead of taking costly time to locate the exact component failure, replace the entire section with a vertical integrator or audio detector PEC plate.*

Printed Electronic Circuits, originated and developed by Centralab, are in use on 60% of today's radio and television sets. Be sure you have the new 1953 guide for fast, positive information — where and when you need it.

Centralab

A Division of GLOBE-UNION INC., Milwaukee 1, Wisconsin
In Canada, 635 Queen Street East, Toronto, Ontario

Your parts distributor has this guide — ask him for a copy. If he can't supply you — use the coupon.

FOR FREE GUIDE, CLIP THIS COUPON AND MAIL TODAY

CENTRALAB, Division of Globe-Union Inc.
910 F. E. Keefe Avenue, Milwaukee 1, Wisconsin

Please send me without delay, a copy of Centralab's Printed Electronic Circuit Guide No. 2.

Jobber's Name.....

Jobber's Address.....

Name.....

Firm.....

Address.....

City.....Zone.....State.....

Sylvania's New 1954 Calendar

for Service Dealers.... sells all through the Year!

They'll read your super-service story every month!

Filled with ideas and recipes your prospects will want to keep



It's your personal Christmas greeting, too

Don't miss this Dramatically Different Business Builder!

Here's the hardest-selling, custom-made Home Calendar ever offered to Radio-TV Service Dealers! It's tailor-made just for you! Features an appealing illustration painted exclusively for Sylvania by a famous cover artist. Reproduced in full color and imprinted with your name and address.

Your prospects simply can't overlook this calendar. It's filled with timely hints and valuable household suggestions they'll want to keep handy. And, every time they turn the page they'll be reminded of your dependable service, skill, and experience.

Order now . . . supply limited! At only 1½¢ per customer per month (in lots of one hundred or more), this calendar

is truly the smartest advertising buy ever offered. But don't delay, the supply is limited! Order a couple of hundred from your regular Sylvania distributor . . . TODAY! If he is out of stock, write to: Sylvania Electric Products Inc., Dept. 3R-2106 1740 Broadway, N. Y. 19, N. Y.

SYLVANIA



RADIO TUBES; TELEVISION PICTURE TUBES; ELECTRONIC PRODUCTS; ELECTRONIC TEST EQUIPMENT; FLUORESCENT TUBES, FIXTURES, SIGN TUBING, WIRING DEVICES; LIGHT BULBS; PHOTOLAMPS; TELEVISION SETS*



145K SIG. TRACER
KIT \$19.95 WIRED \$28.95

950K R-C BRIDGE &
R-C-L COMP. KIT \$19.95
WIRED \$29.95

360K SWEEP GEN.
KIT \$34.95 WIRED \$49.95

New 214K VTVM KIT
\$34.95 WIRED \$54.95

320K SIG. GEN.
KIT \$19.95 WIRED \$29.95

OVER 1/4 MILLION

EICO INSTRUMENTS

in use the world over!



EICO new modern facilities for research,
development and production—your greater
assurance of . . .

LABORATORY PRECISION AT LOWEST COST



New 377K SINE & SQUARE
WAVE AUDIO GEN. KIT \$31.95
WIRED \$49.95



1040K BATTERY ELIM.
KIT \$25.95 WIRED \$34.95



1171K RES. DECADE BOX
KIT \$19.95 WIRED \$24.95



625K TUBE TESTER
KIT \$34.95 WIRED \$49.95



CRA PIX TUBE ADAPTOR
for Tube Tester \$4.50



New 565K MULTIMETER
KIT \$24.95 WIRED \$29.95
20,000Ω/v; 31 ranges



315K DELUXE SIG. GEN.
KIT \$39.95 WIRED \$59.95



HIGH VOLTAGE
PROBE \$6.95



221K VTVM KIT \$25.95
WIRED \$49.95



470K KIT \$79.95 WIRED \$129.50



425K 5" PUSH-PULL SCOPE
KIT \$44.95 WIRED \$79.95



NEW! Mode 95-K
SCOPE VOLT-
AGE CALIBRATOR
IN KIT AND WIRED FORM.

You Build EICO Kits in One Evening, but . . . They last a Lifetime! and You SAVE OVER 50%

YOU be the judge. See the famous EICO line TODAY — in stock at your local jobber — and SAVE!

Write NOW for FREE newest Catalog 6-R.

America's greatest instrument values bear the name—



ELECTRONIC INSTRUMENT CO., Inc., 84 Withers Street, Brooklyn 11, N. Y.

VHF

COMMUNICATIONS IN KOREA

By 1st Lt. RICHARD G. GOULD
Asst. Radio Officer, Eighth U. S. Army, Korea

A MAJOR entered the tent of the Division Commander waving a mud-spattered piece of paper. "The Chinese" he read, "have the regiment surrounded, General. There's no wire communication left between our headquarters and theirs." The General reached for the field phone on his desk. "Give me —" he said, using the telephone code name of the regiment. Within seconds he was talking to the regimental commander. He spoke quickly about the situation and the immediate action the reserve unit was taking. He outlined his orders for the trapped regiment and hung up after receiving assurance from the regimental commander that they could make the plan work. Not long thereafter the regiment was reunited with the division and was fighting again as an effective part of our forces in Korea.

This quick, personal call between the two commanders, and the other vital messages that followed, directing artillery, guiding air support, and controlling troop movements actually took place during the big pull-back of the Eighth Army after the Chinese intervention in Korea. Without the use of v.h.f. radio relay equipment, these calls would have been impossible. Without these calls the General and his staff would have had to rely on tactical high frequency radio equipment. They would not, though, have been able to give the detailed instructions, or told exactly what they wanted done and received the immediate response possible only over a direct telephone circuit. Just as a picture is worth a thousand words, a personal conversation is worth a hundred written messages.

Since the first days of the Korean campaign, very-

The author checks circuits at the 556th radio relay station, somewhere in Korea.



An ingenious radio relay system is saving time, money, and equipment for our troops.

high-frequency radio relay equipment has been one of the mainstays of the UN communications network. Now under the direction of Brigadier General Wesley T. Guest, Eighth Army Signal Officer, the v.h.f. network blankets Korea from the Peace Camp at Munsan-ni to the Prisoner of War camps on Cheju Island. At this time there is even one infantry division operating v.h.f. down to a forward observation post overlooking the enemy lines. Chinese mortar and artillery fire kept chopping all the wire circuits as quickly as they were installed; v.h.f., however, provided telephone circuits without wire. To install this system the v.h.f. equipment was mounted in a bunker with the carrier equipment lying on its back nearby. The standard antennas are also inside, pointing out of holes just a little wider than the arrays. This system has been so reliable that units slightly to the rear actually run their lines forward to this bunker to get circuits back to

Sgt. Kenneth Hartman, station chief, v.h.f. site, Korea, changes a tube while the author, in background, oversees the operation.



Jeep-mounted v.h.f. terminal equipment. Telephone contact with any unit in Korea is possible with this particular installation.



Sgt. James C. Cooper, station chief, v.h.f. site in Korea, repairs a transmitter at the 581st signal relay co. station.



Pfc. Phillip Tesone, v.h.f. radioman in Korea, makes adjustments on a transmitter at the 556th signal radio relay site.

higher headquarters. A near miss on the bunker showered rocks and dirt on the equipment without causing a minute's outage.

From the very beginning of the Korean campaign the units operating v.h.f. equipment have been hampered by the same factors that affect all the operations of an army in the field. To the usual problems of shortages of equipment, lack of sufficiently trained personnel, and the eternal requirement for getting the job done "yesterday," the rugged peninsula of Korea has added worries. The terrain was, at first, a severe limitation on the use of v.h.f. systems. This equipment, known as the AN/TRC 3 and 4, transmits a frequency modulated signal in the 70 to 100 megacycle band. According to conventional propagation theory, transmission in this frequency range is supposed to be "line-of-sight" with only a slight bending effect beyond the optical horizon.

The technical manual for the equipment states that distance between relay stations should be limited to under 30 miles to maintain a high signal-to-noise ratio. If these restrictions held fast, few of the existing v.h.f. systems in Korea could have ever been installed. On most of the peninsula, rugged mountains bring the horizon "into your backyard." Overcoming this limitation meant that the v.h.f. stations had to be located atop these mountains. Once on the peaks, the "hop" lengths rose from 30 miles to 70, 80, and 90 miles, far surpassing the ranges possible with 40-foot antennas on level ground. Without such distances, the Signal Corps could not have supplied the radio relay systems to link the Eighth Army with its Corps, using equipment on hand, during the 300-mile long drive which

took the UN from the Pusan Perimeter to the Yalu River. There simply was not enough equipment or personnel to install and operate relay stations every 30 miles. In addition, due to cumulative tube and set noise, the quality and readability of circuits decreases as additional relays are placed in the system. Extending the lengths of individual transmission paths resulted in better circuits.

At Army level the main problem was distance: at Division level it was speed. It can take up to three days to install a station on a mountain top and the division teams could not afford this delay at a time when their headquarters would be moving every four or five days. Their solution in many cases, was to direct the transmitted beam to a distant mountain so that it would be reflected to the far terminal beyond the actual line-of-sight. Many times the direction of advance was up long river valleys. In these cases the beam would be directed slightly towards one side of the valley and it would be reflected from side-to-side as it faithfully followed the winding valley to the distant terminal. Receiving tests were later conducted to determine if this "bouncing" was actually taking place. A receiver mounted in a truck indicated that every few miles it would "pass through the beam" as the truck was driven down a road through the valley. Many times at the distant terminal it was noticed that moving the antennas laterally as little as a few hundred feet caused the received signal strength to drop 75 per-cent. This situation can be compared to a rudimentary wave guide operating at a lower frequency than conventional fabricated guides. The dead spots in the receiver tests were caused by non-parallel "guide"

Fig. 1. Profile chart of line-of-sight path between Relay 1 and Relay 3. Note the two obstructions in this path.

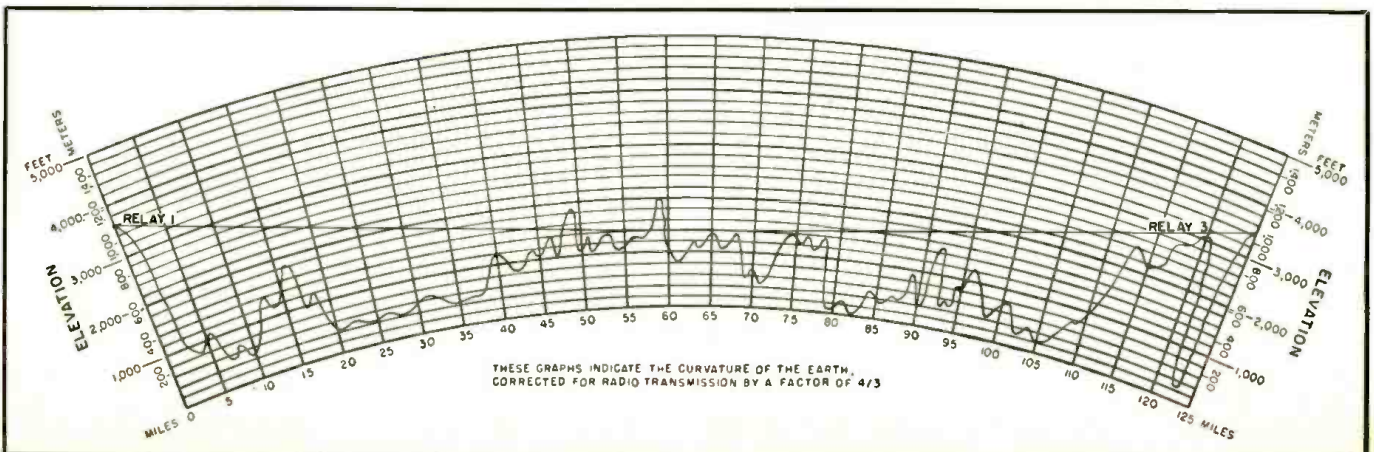



View of one of the cloud-topping relay stations. Korean guards, operating personnel, and antennas are visible among the boulders.

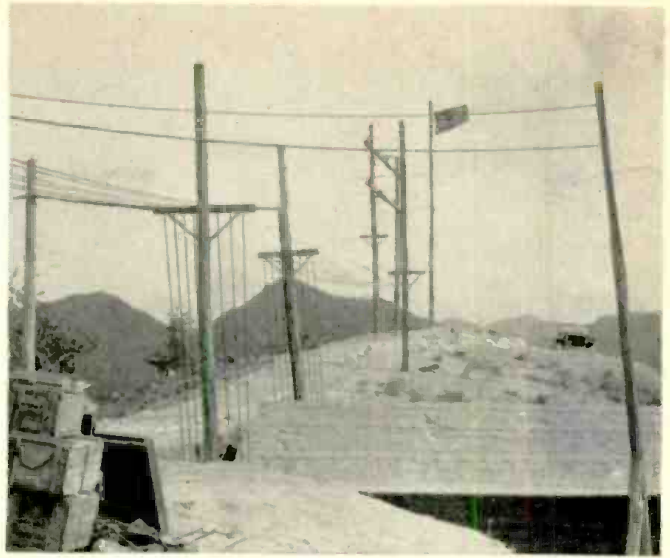

A v.h.f. terminal station. Coaxial cables are laid to separate transmitting and receiving fields. Poles carry the cables.

walls and gaps in the line of mountains on both sides of the valley.

Recently even transmission distances of 90 miles have been exceeded. The 8189th Signal Service Battalion that operates all the v.h.f. systems for the Eighth Army had several systems between Seoul and Taegu which utilized three relay stations. These stations were all well over 3000 feet in height and air-line distances between them averaged 65 miles. It was decided to eliminate the middle relay leaving a 126-mile span between relays one and three.

As the first step, a profile chart was run assuming line-of-sight transmission. The accepted figure for the earth's radius of four thirds the actual one was used on this profile to account for the "bending" that takes place beyond the horizon. This chart (Fig. 1) showed two masks directly in the path of the beam. One is 400 feet high and the other 600 feet. Antennas at each site were oriented with a compass to point towards the distant station as determined from maps of the area. The sets were turned on, and on only ten watts of final power to the three-element yagi arrays, the limiter stages of the distant receiver were saturated. This meant that all amplitude variations on the incoming signal were eliminated and a noise-free system would result.

These test shots were operated for a period of two weeks to determine if fading would occur at certain times of the day or if there was a fade cycle over a period of several days. Even a severe thunderstorm during this period, which caused interference to high frequency radio circuits did not affect the received signal strength. The pattern of received signal vs antenna orientation is shown in Fig. 2.

To obtain this curve the transmitting antenna at the distant station was rotated through 360 degrees and the value of grid current in the first limiter stage of the receiver was recorded. Thus the current value is proportional to signal strength since no limiting action has yet taken place. These current readings have been reduced to relative values. The zero degree point was chosen as the azimuth of the distant station as determined from a map. The difference between the right and left hand lobes is explained on the basis of the inherent unbalance of the array, one side of the dipole being grounded as are all the parasitic elements. This curve agrees closely with the theoretical curve for this type of antenna. The lack of sharply defined minor lobes is due to lack of accuracy in the metering stage and also to "residual" carriers from other transmitters on the same and adjacent frequencies operating at the same time. The curve of signal strength taken with the transmitting antenna stationary and the receiving antenna rotated is similar. This curve indicates that the beam is following



Repairing a receiving antenna at the v.h.f. antenna site somewhere in Korea. This is a 581st radio relay co. station.

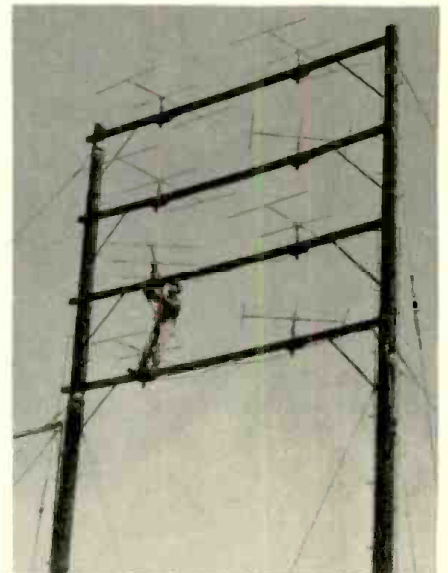

Lonely Korean guard sits by his machine gun overlooking the antenna field of a v.h.f. relay station somewhere in Korea.





Pfc. Lawrence R. Jackson and Sgt. Gorver W. Potter, radio-men, switch receiving antennas at a v.h.f. relay station site.

a direct path and that very little energy is reaching the receiver through reflected paths. The "shot" was then incorporated into the operating systems and it was discovered that, not only were the systems quiet, but quality was improved due to the elimination of the one relay. Outage time dropped markedly due to the fact that there was less equipment in the system subject to failure and that troubleshooting procedures were simplified since there were only two relay stations to coordinate while isolating a specific trouble. These systems have been in operation for over five months with less than 3% outage: twenty-four hours a day, seven days a week, through winter storms, driving mountain rains, and a series of typhoons with winds up to 65 miles an hour.

The next attempt at extended range involved shooting between two peaks, each over 3000 feet high and separated by 170 air-line miles.

The profile chart for this shot passes through a mask 2400 feet high and 57 miles deep as shown in Figure 3. Even if the earth were a perfect sphere the wave would hit the earth's surface during its path. Nevertheless, signal strengths received at both stations showed the

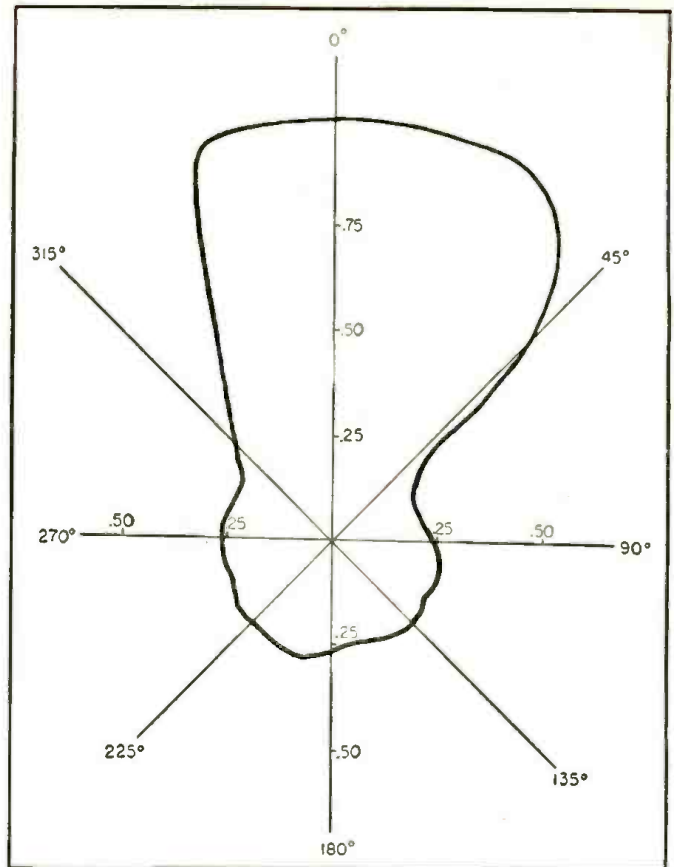

Fig. 2. Signal strength at Relay 3. See text for full details. These directive patterns are taken for each antenna location.

circuit to be satisfactory using fifty watts final power and the system was established. Rotation of antennas gave essentially the same curve as the 126-mile "shot." See Figure 2. This path too, stood up day and night through the weeks that it was needed. (In this case the men operating the station not only had to keep their equipment on the air but had to work with their weapons handy in case of guerrilla attack. The guerrillas eventually did attack the guards assigned to help defend the station but were driven off after a small-arms battle.) Since this 170-mile shot also had a pattern of received signal similar to Figure 2, it indicated a straight line transmission path with no alternate reflection paths. In this case the receiver, although located on a high peak, was still far below the horizon and far beyond the range expected using the conventional formula for bending effect.

Additional inconsistencies have appeared during the months in Korea: Since there are many more transmitters operating in Korea than there are frequency assignments for the equipment, there may be three and
(Continued on page 151)

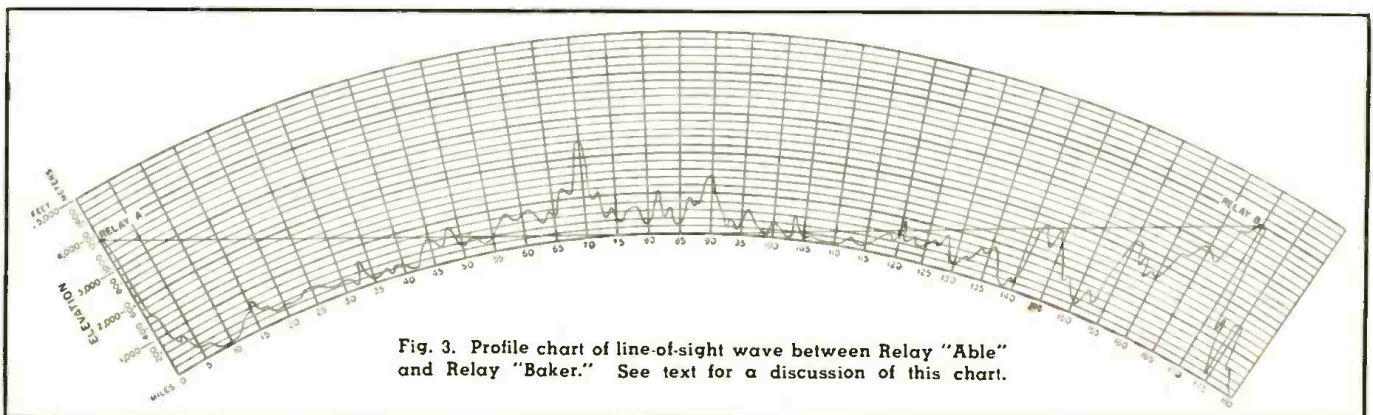

Fig. 3. Profile chart of line-of-sight wave between Relay "Able" and Relay "Baker." See text for a discussion of this chart.

USING A TRANSISTOR TO INCREASE RELAY SENSITIVITY

By
LOUIS E. GARNER, JR.



Fig. 1. Transistor setup for increasing relay sensitivity. Author's unit was built on Bakelite strip but may be housed in a standard Bud "Minibox" if desired.

THE experimenter will occasionally require a relay with contacts capable of handling an ampere or more current at 117 volts a.c. while, at the same time, not requiring more than a fraction of a milliampere to operate. Although there are relays available that are sensitive enough to operate on only a few hundred microamperes, such relays are not only very expensive (sometimes costing two to four times as much as less sensitive relays), but, for the most part, their current handling capacity is small.

Often, the electronics worker is forced to use *two* relays in such circumstances—a very sensitive relay connected to operate a less sensitive relay of greater power handling capacity. Such a procedure is not only expensive, but requires considerable space.

With the ready availability of the transistor, it is now practical to assemble an extremely sensitive relay capable of handling reasonable amounts of power, and utilizing *only one* relay of moderate sensitivity. Such an assembly is shown in Fig. 1. The schematic diagram of the circuit is shown in Fig. 2.

In some cases, the cost of the components required for the complete assembly illustrated will be less than the cost of a relay of the desired sensitivity, even with the present comparatively high cost of the transistor itself. The more sensitive relay will often not have the power handling capacity of this assembly.

The assembly shown in the illustration, using the components specified in the parts list, will handle currents as high as 1.5 amperes (at 117 volts a.c.), yet requires a control current of only a fraction of a milliampere, that is, only a few hundred microamperes.

Increase the sensitivity of relays and widen their application by using this simple transistor circuit.

(From 0.2 to 0.4 ma. control current is required, depending on the adjustment of the relay.)

Circuit Description

The operation of the basic circuit depends on the fact that the transistor may be used as a simple "current amplifier."

Referring to the schematic diagram of Fig. 2, a relay of moderate sensitivity is connected in the emitter-collector circuit, together with a source of voltage, B_2 . The base-emitter circuit is used for control purposes, with B_1 acting as a "bias" voltage and re-

sistor R_1 as a current limiting resistor (to prevent damaging the transistor). R_2 is the "base return" resistor.

Under "normal" conditions, with the *control line* open, there is no base current flow and the collector current flow is negligible. For practical purposes, the collector current flow may be considered as "zero" in this case.

When the *control line* is closed, a small base current may flow, depending upon the resistance of the line, the values of R_1 and R_2 (Fig. 2), and the bias voltage, B_1 . Generally, this base current flow will be on the order of a few hundred microamperes (it should not exceed 500 microamperes). This base current flow permits collector current to flow, with an amplification of approximately ten. Thus, a 250 microampere base current flow (0.25 ma.) permits a collector current flow of about 2.5 milliamperes—enough to operate the relay (Fig. 2).

Should the *control line* be opened again, base current will cease and the collector current will drop to its previous low value (almost zero), permitting the relay to drop out.

Construction Hints

No attempt was made to miniaturize the model shown in the photograph (Fig. 1) and all parts were simply mounted on a piece of surplus Bakelite. The batteries, B_1 and B_2 , are held in place by small standard brackets, found in an inexpensive hardware assortment. However, if the builder
(Continued on page 140)

Fig. 2. Complete circuit diagram of unit.

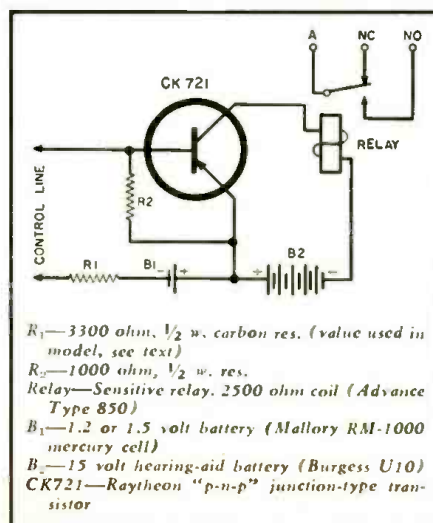

WHY USE A CONDENSER?



By **ROB WAGNER, W6WGD**
R. F. Lab., Dalmo-Victor Co.

AT ONE TIME or another during the activities of the average 2-meter ham, the construction of that "red-hot" converter becomes a practical necessity. When Joe Ham listens to another amateur giving that 200-mile DX an S-9 report and Joe can't even hear the beat-note, he usually starts throwing parts into a can while heating up the iron.

In most cases, this action results in somewhat better performance than was forthcoming from the piece of war surplus machinery Joe had been using in lieu of a receiver. However, the DX may still prove elusive, due in part to high-noise r.f. stages, low conversion efficiency and, to a great extent, upon an oscillator which refuses to stay put.

Two alternatives are available: (1) To build a crystal-controlled front end which holds still but requires mixer peaking or complex broadband i.f. stages preceding the receiver, or (2) to construct a v.h.f. oscillator which is ridiculously simple, quite stable, and costs practically nothing. In order to find such a machine, the writer has dug into the deep past and come up with some determinations which should greatly assist the reader in building his new converter.

First, let's look at some advantages and disadvantages of various systems of tuning the v.h.f. oscillator. The condenser method is dandy but unhandy; a suitable v.h.f. condenser using ball-bearing shaft mountings costs more than a dollar or three and, at the present time, is almost unavailable. Its size necessitates construction which in some cases is prohibitive for mobile applications. Mechanically, the condenser-tuned oscillator must be built on the order of a Sherman tank to obtain the desired mechanical and electrical stability. To retain this stability while tuning, it is the usual practice to employ a gear reduction drive in conjunction with a vernier dial mechanism. The net result is good, providing one has the money, the time, and the mechanical ingenuity.

Instead of this costly and intricate

machinery, let us appraise other methods of tuning the oscillator. A slug-tuned circuit is excellent, and combines mechanical stability with good bandspread linearity. However, a slug tuning mechanism requires that one have the equivalent of a degree in mechanical engineering in order to convert 180° of dial rotation to plus and minus one-quarter inch of linear motion! This application is presently being used in another converter, but necessitates a home brewed dial mechanism operating on the lead-screw principle, including several dial twists to cover the band and an ingenious pulley and string method of frequency indication. The slug performance is excellent electrically, but the problem still remains of attaining extreme mechanical simplicity.

What's this? An old Donald B. Duck catalogue, published at the time when 5 meters fell into the OYGRWHF ("Oh ye gods, what high frequencies!") category, and here is a 5-meter receiver using the ancient method of tuning an inductance with a rotating shorted turn! Similar in principle to the variometer method but using no electrical connections, this begins to look good—the shorted turn, rotating within an inductance causes a change in frequency.

Although design engineers state that this method is a "Q" destroyer, the writer has found empirically that a laboratory "Q" meter would be required to determine the losses. At the same time, an oscillator has been devised which is hard to beat from the

standpoint of electrical and mechanical stability, very small size, and practically zero investment!

Note that an ultra-audion circuit is employed in Fig. 3, resulting in good electrical and mechanical symmetry; Fig. 1 shows placement of the components. A 6AB4 h.f. triode is used, so that if the tube goes bad, a 6J6 may be plugged into the socket to perform the same functions, the 6AB4 pin connections being identical with one-half of a 6J6. Acorn types were discarded for this application due to their inherent tendencies toward microphonics.

The assembly consists of a rigid front panel, suitable vernier dial, and solid subpanel, to which is firmly bolted a heavy box-shield surrounding the oscillator components. Good design practice dictates the use of heavy metal construction not only to afford electrical shielding, but to provide rigid support for other circuit parts.

The bandset condenser C_1 , a 25 μfd . APC-type air trimmer, is mounted upon the left side of the box shield. L_1 , a two-turn, $\frac{1}{2}$ inch i.d. coil, is wound of #10 copper wire, and is soldered directly to the bandset trimmer. The coil is so mounted that its linear axis forms a 45° angle with the axis of the dial shaft (see Fig. 2). A 7-pin miniature tube socket mounts upside down at the right of the dial shaft, so that grid and plate connections are as short as possible (Fig. 1). Two 82 μfd . tubular ceramic condensers (C_2 - C_3) serve to connect grid and plate pins to each end of the oscillator coil at

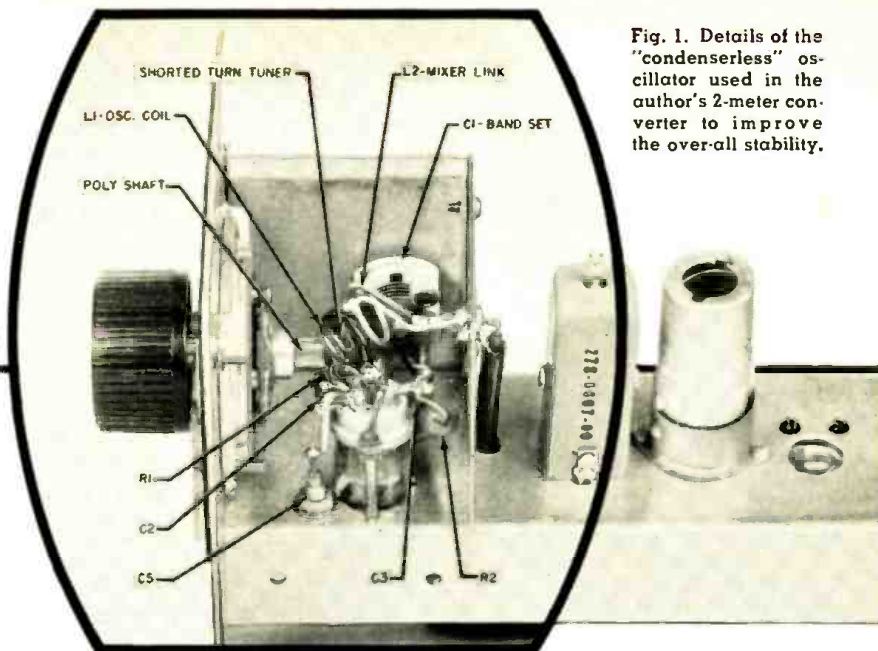

Fig. 1. Details of the "condenserless" oscillator used in the author's 2-meter converter to improve the over-all stability.

The tuning condenser in a v.h.f. oscillator is a source of headaches because of problems of stability and cost. The author cured these headaches by eliminating the condenser.

the handset condenser. The r.f. choking function is performed by R_2 , a 1000 ohm, $\frac{1}{2}$ -watt carbon resistor mounted between the plate pin and C_4 , a 1000 μfd . feedthrough condenser mounted directly beneath and beside the inverted tube. The feedthrough condenser serves as a rigid solder-mount for the resistor and helps to mechanically stabilize the plate wiring. A 22,000 ohm, $\frac{1}{2}$ -watt carbon resistor (R_1) between the tube grid terminal and ground provides grid bias. Inasmuch as the cathode and one heater terminal are common to "B-minus," this terminal serves as tie-point for all ground returns of the circuit. The opposite 6.3-volt heater lead is fed to the power plug through another 1000 μfd . feedthrough condenser located beneath the tube socket. The mixer voltage is taken from the oscillator coil with a single-turn loop supported by a feedthrough insulator mounted above and behind the coil, Fig. 1. All that remains is the method of tuning the oscillator.

The tuner, Fig. 2, consists of a one-inch length of $\frac{1}{4}$ -inch o.d. "poly" shaft (clip a few from the bottom of your ladder line) with a $\frac{1}{4}$ -inch i.d. single-turn loop of solid hookup wire attached thereon at a 45° angle. In order to effect an inductance change equivalent to 4 mc. of bandspread over 180° of dial rotation, it is necessary to mount the coil at a 45° angle with respect to the axis of the tuning shaft. Since the tuning loop is also mounted upon the shaft at 45°, the plane of the loop is at a right angle to the coil axis at zero degrees of rotation; this position results in the lowest frequency reading on the dial.

At a rotation of 180°, the loop becomes parallel to the coil's lines of flux, thereby reducing the coil's inductance and resonating it at its highest frequency. A complex angle of rotation occurs during the 180° rotation, at each degree of which the inductance of the coil is varied by a correspondingly larger amount. The rate of inductance change is linear for all practical purposes. This is a major difference from older and constructionally simpler versions of the shorted turn, such as a tab or vane of copper moving across the end of a coil or between two turns. The inadequacy of these older methods kept amateurs from using the principle enough to bring out its full possibilities.

A brass washer attached to the tuning shaft comprised the first shorted-turn tuner. It was thought that bandspread could be adjusted by moving the washer closer to or farther from the end of the oscillator coil; this assumption was erroneous and resulted in a complex vectorial relationship which caused stations to repeat at various places on the tuning dial.

The washer was then placed within the coil, at its center; immediately the 2-meter band, in addition to police, aircraft, and other services were tuned over a wide frequency range, but with extreme selectivity due to

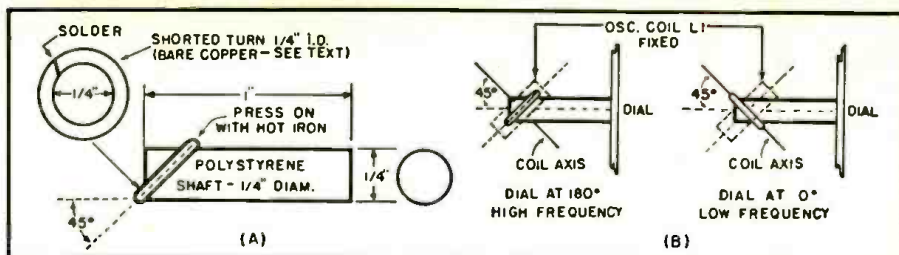
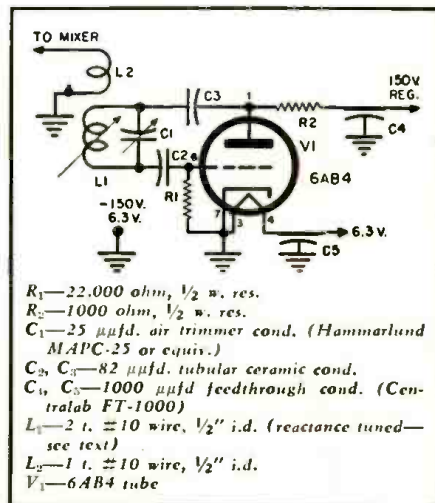

Fig. 2. (A) The heart of the "condenserless" tuning system. Several can be made up at negligible cost using wire of different sizes to get the proper degree of bandspread. "Ring" diameter ($\frac{1}{4}$ ") should be the same for each one tried (see text). (B) Shows the relationship of the fixed oscillator coil and the movable shorted turn as the dial mechanism is turned through 180°, varying coil's inductance.

lack of bandspread. It became evident that bandspread is a function of reduction of loop mass rather than one of removing the mass from the vicinity of the coil.

Several tuning shafts should be constructed, having a loop of different wire size (not loop diameter) attached thereto. In a matter of minutes, it is simple to determine the degree of bandspread by changing the entire tuning shaft and listening over the band. The bandspread should, of course, be trimmed so that the 2-meter band appears in the center of the dial with your particular converter i.f. The loops are rigidly attached to the shaft by pressing them into the plastic with a hot iron, using a dime-store 45° triangle as a guide, as shown in Fig. 2.

There is nothing really new in the design of this oscillator, but its application has not been used extensively in amateur circles. If the oscillator is constructed rigidly enough, one may beat upon the converter with an old binder of radio magazines with vigor, without frequency shift; stability is limited only by the mechanical construction of the oscillator tube. The linearity of the tuning depends upon the precision with which the loop and coil axes are centered, although an angular tolerance of plus or minus



R_1 —22,000 ohm, $\frac{1}{2}$ w. res.
 R_2 —1000 ohm, $\frac{1}{2}$ w. res.
 C_1 —25 μfd . air trimmer cond. (Hammarlund MAPC-25 or equiv.)
 C_2 , C_3 —82 μfd . tubular ceramic cond.
 C_4 , C_5 —1000 μfd feedthrough cond. (Centralab FT-1000)
 L_1 —2 t. ≈ 10 wire, $\frac{1}{2}$ " i.d. (reactance tuned—see text)
 L_2 —1 t. ≈ 10 wire, $\frac{1}{2}$ " i.d.
 V_1 —6AB4 tube

Fig. 3. Schematic of the "condenserless" oscillator. L_1 is varied by rotating the shorted turn within it; L_2 is also fixed.

five degrees is acceptable. Even though the small physical size of the design makes this circuit extremely interesting to mobile operators, its functioning is so satisfactory that the writer anticipates using no other circuit at his home station. As the photographs show, it has been installed in an experimental converter in use here at W6WGD.

Fig. 4. The oscillator is in the shield box at right; the other components belong to the converter with which it is used. The oscillator is adaptable to any tunable converter. The chassis and shield are of heavy material for mechanical rigidity. Inside the shield, the 6AB4 is mounted upside down (Fig. 1) for short wiring leads.

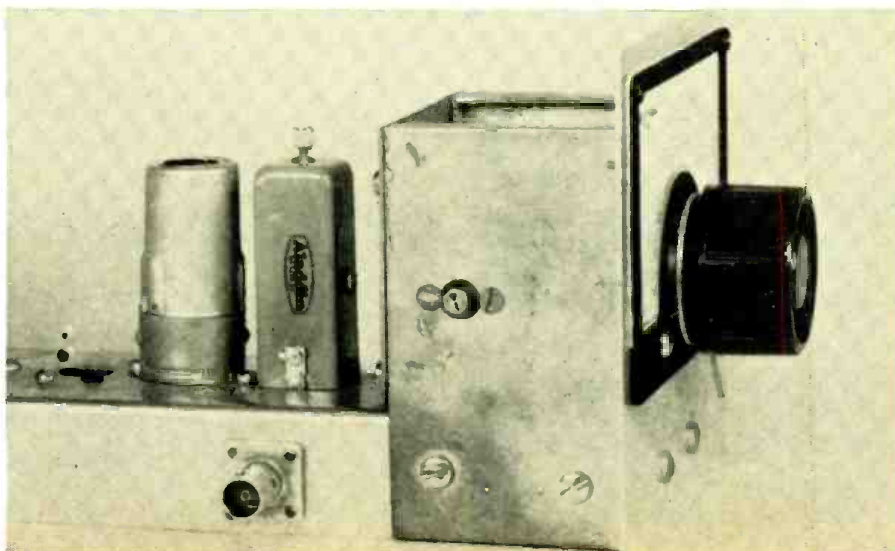

TUNABLE HUM

IN BROADCAST RECEIVERS

By SIDNEY WALD

Apply this method of tracing and eliminating an annoying hum in radio receivers to other types of interference.

SIXTY-CYCLE cross-modulation, popularly known as "tunable hum," has for a long time been a thorn in the side of the radio technician. Unlike the hum resulting from a defective or inadequately filtered a.c. power supply, this annoying form of interference may frequently frustrate the best efforts of well-trained service technicians to eliminate it.

For the benefit of those few technicians who have never come up against this problem the following is a brief description of this malady.

"Tunable hum" is an affliction which may develop gradually or occur suddenly in an AM radio receiver. It is characterized by a strong distracting power line frequency hum which perversely enough appears only when the receiver is tuned to a broadcast station carrier. Between channels, the hum disappears completely, and, to complete the discouraging picture, the stronger the desired station's signal, the louder is the hum.

We may filter the power supply until we have piled up sufficient microfarads to buckle the legs on the service bench, but to no avail. As a matter of fact it is frequently possible to substitute a battery power supply without affecting the hum.

Of course, this last experiment, that

Fig. 2. Overhead a.c. power lines as shown in (A) pick up broadcast signals and re-radiate them with added 60 and 120 cps hum modulation. (B) is the equivalent circuit for the hum generator shown in (A) and in Fig. 1.

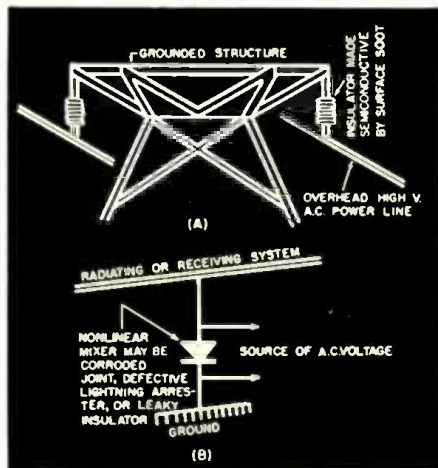

of eliminating the a.c. power supply completely, furnishes us with a clue as to the origin of one of the most stubborn forms of tunable hum. Its cause must lie outside the receiver and the hum must, therefore, be a true modulation of the broadcast carrier frequency.

The writer's interest and curiosity in this subject was aroused a number of years ago, when, while visiting a friend, he was asked to apply some of his electrical engineering "know-how" to a troublesome line hum in the family radio receiver. It didn't take very long to discover that additional filtering of the power supply had absolutely no effect. Then, to further complicate the situation, it was observed over a period of several days that for hours at a time the receiver would be perfectly normal and free from interference and suddenly there would be a click and the same old hum would come on again, virtually ruining reception on all stations.

By this time rooting out this interference had assumed the nature of a technical challenge which the writer could not ignore.

During the ensuing investigation it was found that:

1. A second receiver, which was known to be in good condition, was subject to the same trouble when installed in the affected area.
2. This second receiver was battery-operated and immune to ordinary power line interference.
3. The interference was strongest when the outside antenna (located on the roof of the apartment house) was connected.

From here on, it was a matter of amateur detective work. A portable, battery-operated receiver, used to "sniff out" regions of highest hum intensity, pointed the way to the roof along the path of the antenna lead-in wire.

On the roof, the region of maximum intensity of tunable hum was found adjacent to a neighboring antenna, some 20 feet from the antenna belonging to the set with the initial complaint. The lead-in wire of the offending antenna was traced visually and the location of the apartment into which it entered was determined.

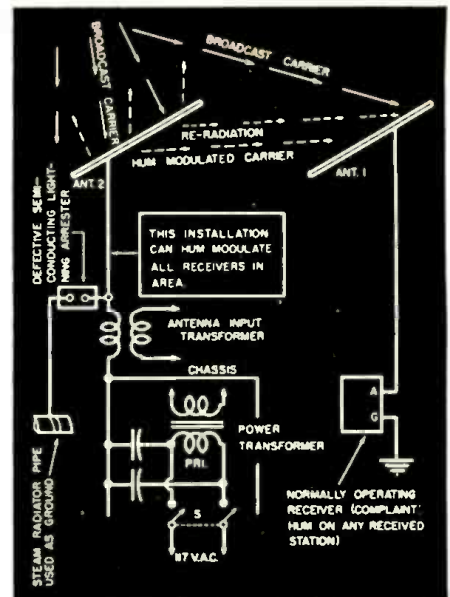

Fig. 1. 60-cycle hum originating in leaky lightning arrester at offending radio set is radiated by antenna to neighboring ones.

Gaining access to the receiver in this apartment with the co-operation of the occupant was not so simple but was finally accomplished. A glance at the broadcast receiver here disclosed nothing unusual until the set was turned on. A loud hum issued from the loudspeaker mingled with the broadcast signal; a turn of the tuning dial and it was gone. There was our old arch-enemy the tunable hum again. The writer asked the owner of the receiver, did she always have hum trouble? "Of course," came the answer, "we're used to it!" Immediately, the portable battery-operated receiver was turned on and from it, too, issued the annoying sound.

The next action proved to be the key to the whole problem. The receiver was turned off with the portable still operating. Amazingly enough, the hum disappeared leaving the broadcast signal clear and undistorted. There was no doubt about it, each time the receiver in question was switched on the hum would be present on the carrier received by the portable monitor. A quick check with the receiver owned by the writer's friend in the front apartment also showed his hum to come and go as the offending set was turned on and off in the second apartment.

An examination of the suspicious receiver installation disclosed nothing unusual except for a lightning arrester connected between the antenna post and a nearby steam radiator pipe. Disconnecting the lightning arrester proved to be the solution to the hum that had been plaguing the area. This defective unit was tested for leakage resistance and was found to have a resistance of about 50,000 ohms, whereas a good lightning arrester should be completely open between antenna and ground terminals.

Apparently what happened was this: When the receiver was turned

(Continued on page 102)

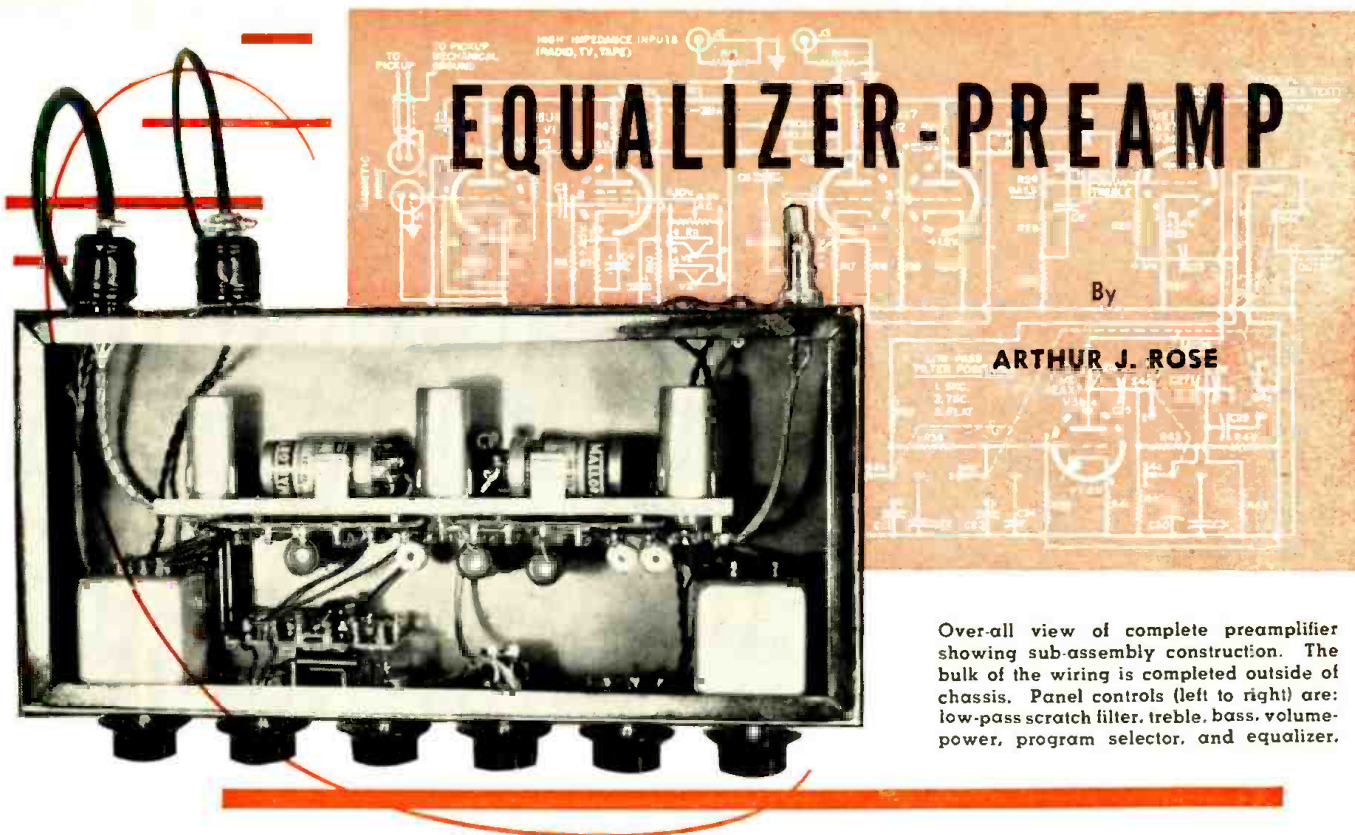

Over-all view of complete preamplifier showing sub-assembly construction. The bulk of the wiring is completed outside of chassis. Panel controls (left to right) are: low-pass scratch filter, treble, bass, volume, power, program selector, and equalizer.

MUCH of the information included in this article is presented in answer to the many inquiries submitted by those who read the author's earlier article¹ and towards fulfillment of a need for a universally applicable equalizer-preamplifier.

A summarization of the features deserving inclusion in the final design provides a basis for circuit development. Diversified opinions concerning certain auxiliary appliances are manifest among professionals and laymen alike. Therefore, it is not without some degree of subjectiveness that selections are given. However, it is felt that the majority of readers will regard them as the minimum necessary for consistency with the highest grade of equipment used to form the complete audio system. The design "check list" includes:

- (a) Provision for incorporating and matching phono cartridge, radio, television, and tape inputs
- (b) Control of over-all amplification
- (c) Easily switched recording playback equalization
- (d) Continuously variable bass compensation
- (e) Continuously variable treble compensation
- (f) Low-frequency rumble filter
- (g) High-frequency noise filter
- (h) Low impedance output

Along with desirable inclusions, other effects are subject to consideration. Instability, superfluous noises, and distortion are equally important as undesirables. Readers of the previous article will recall the blanket solution to the hum and noise problem. Wirewound resistors and a direct current heater supply are applicable

Design details on a modern control unit engineered to provide flexibility and high quality performance.

in any design. If it were not for reasons to follow shortly, d.c. would be recommended for all applications. As will be appreciated by many, the final circuit permits a.c. operation in many cases. Distortion is maintained at a very low figure by proper tube operation and generous amounts of feedback. It should be noted that every stage, with the exception of the first, uses feedback.

Attention is directed to the schematic of Fig. 1. Preliminary inspection will reveal its sectionalization into a magnetic pickup preamplifier feeding a two-stage feedback amplifier. Tone controls follow this section into a cathode follower. In addition, there is the sharp cut-off low-pass filter that was described in the earlier article. More detailed study shows a six-position equalizer, rumble filter, and the method of using the cathode follower as a buffer between the low-pass filter and the balance of the circuit. When the filter is in the "flat" position, output is taken directly from the cathode follower. Otherwise, the output is taken from the filter where there is no need for a very low impedance output because of the deliberate attenuation of the higher frequencies. The low impedance source of the feedback amplifier and the high impedance loading of the cathode follower form an ideal condition for the tone controls. A direct approach to each section will greatly facilitate an

understanding of the complete unit.

Playback Equalizer Section

There is no question in the writer's mind that feedback type equalizers are much to be preferred over "between the stages" types that offer no outstanding advantage such as reduction of distortion. As low as 20 cps, feedback types have distortion reduction factors great enough to be readily appreciated. Distortion at higher frequencies defies measurement; however, most feedback types are necessarily of the breed that introduces noise because of unbypassed cathodes. The equalizer stage to be presented does not have this difficulty nor does it have another drawback, to be mentioned shortly, that is common to the other types—even those with grounded cathodes. It is no more troublesome to construct although it requires more components.

It has come to be accepted that recordings need to be *exactly* equalized if the maximum of realistic reproduction is to be obtained. Because acoustic systems are subject to such wide variations, all equipment leading to the amplifier output terminals must be of unquestionable performance. This permits adjustment of the acoustic system. With properly equalized recordings, subsequent frequency-selective tone controls can be used effectively in co-ordinating differences in loudness levels and playback *vs* re-

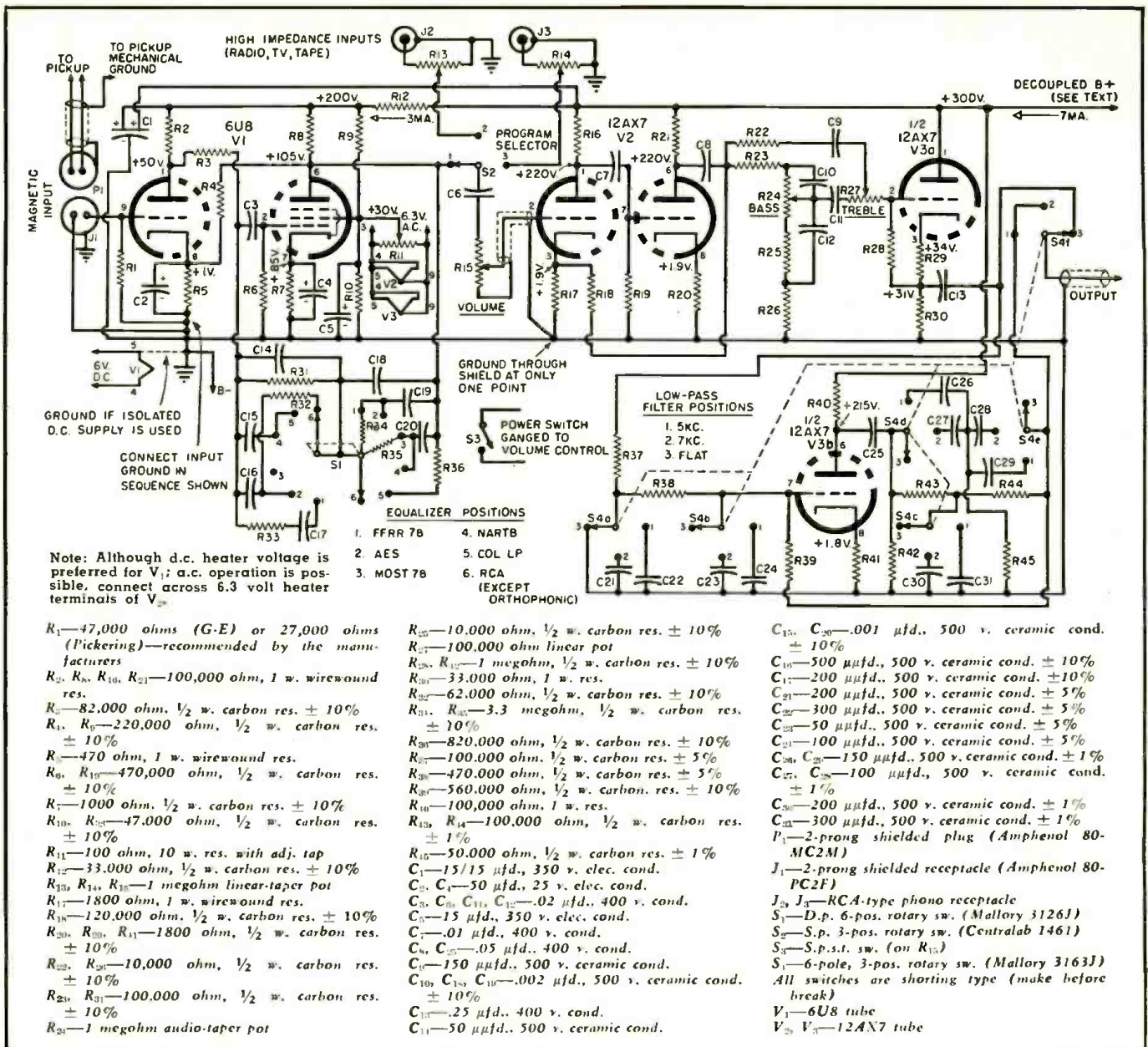

Fig. 1. Complete schematic diagram of equalizer-preamplifier. Precision parts are used throughout to insure quality performance.

ording acoustics. Lack of bass, especially at low levels, is sometimes the fault of the speaker or its acoustic environment. Often, however, it is due to insufficient bass equalization in the recording equalizer stage, in which circumstance even full use of the bass tone control will not prove to be enough.

Familiar twin-triode feedback equalizers are incapable of the 6 db-per-octave rate necessary in many playback requirements for proper bass equalization. This may come as a surprise to many because of the popularity of the various arrangements using triodes. The main reason for this is insufficient loop gain. Under ideal conditions, a gain of 2500 or so can be expected from cascaded 12AX7 sections and about 900 for a 12AY7. This in itself is poor. Aggravation of the situation appears with an unbypassed first cathode resistor that cuts these values by more than 50%. Since this

situation has not been well publicized, it is desirable to present a brief supporting analysis.

An important factor in the maximum available rate of boost from any feedback equalizer is the ratio of mid-band loop gain (gain without feedback) to the over-all midband gain (gain with feedback). Examination of Fig. 2 will show the response that can be expected for different values of the ratio, A_0/G_0 . These curves are based on stages with sufficient coupling and bypassing well below 10 cps. The 12AX7 example with the commonly used over-all midband gain of 50 can, at best, produce a curve somewhere between the ones shown for ratios of 20 and 40. In like fashion, the 12AY7 will produce the 20 curve. Because the feedback can be considered almost purely reactive (at lower frequencies) and therefore double in value every octave is no cause for a 6 db-per-octave rate here. In fact, for any cir-

cuit to produce this rate, an infinite ratio is required as the equation in Fig. 2 shows. At 50 cps, with a 500 cps turnover, 20 db boost ($C = 10$) corresponds to 6 db-per-octave from the turnover. Substitution of these values in the equation will cause the denominator to go to zero with a subsequent impossible gain requirement.

With this in mind, several alternatives are possible. Ratios in the neighborhood of 80:1 can be obtained by dropping the over-all gain with more feedback or by raising the loop gain by the use of pentodes. To drop the over-all gain with triodes would entail using feedback components that would load the stage to excess and would require condensers of physical proportions too staggering for space requirements. Chances are that the requisite G_0 would be too small for application.

A compromise using a high gain pentode with a sufficient A_0/G_0 ratio and an unfeedback triode first stage

gives proper compensation and permits bypassing of the first cathode—a threefold advantage. Bypassing greatly lowers first stage noise, permits a.c. heater operation and gives higher gain. Attenuation due to the feedback isolation resistor requires that the triode precede the pentode for maximum signal-to-noise ratio.

"Natural" for this application is the 6U8 triode-pentode. Designed primarily for r.f. use, 6U8's are newcomers to audio. They have microphonic tendencies, but no more so than other types used often in similar circuits. Some selection at the parts dealer will help: hold the tube by the pins and tap it with a fingernail while listening for various *blings* and *bongs*. After about ten hours use, many of these tubes will become much quieter. Their thermal noise naturally varies from tube to tube, but has been found to be quite low especially with the circuit shown. 6AU6's with extremely low hum and noise levels can be substituted where one envelope is not deemed advantageous or where higher gain is desired. This will be further discussed with the next section.

An over-all midband gain of 25 to 30 can be expected from the first section. The pentode has a loop gain of 185 and is reduced by feedback to about 1.25. The triode stage has a gain of 20.

Equalization is provided for what the writer believes to be the majority of the recordings in use. Rather than use a separate network for each position, the switching uses a minimum of parts to achieve the correct values. For those with special requirements, a table is provided in Fig. 3 that will enable quick selection of components. These have been derived by network transformations of values generally given for "between the stages" equalizers.²

Wirewound resistors are specified in all places where their use contributes to lowered noise. Bypassing of R_{10} is effective only above 20 cps, therefore this resistor must be wirewound to prevent low frequency noise. C_{11} has been added to prevent high frequency instability. It has no attenuating effect in the audible region.

A single resistor, R_{11} , does a lot of work in this circuit. The addition of this component completes the rumble-filter scheme. First coupling constants throughout the unit were chosen to give roll-off below 20 cps. R_{10} and C_{11} are similarly chosen. Feedback from the pentode stage via R_{11} is operative only when the impedance of the triode cathode rises—at very low frequencies. The combined effect is to give a fairly rapid attenuation below 20 cps without altering response above that frequency. Experiments with parallel-T networks have shown that while the attenuation rate is greater, the improvement does not justify the added complication.

Second Section

Input requirements of the various

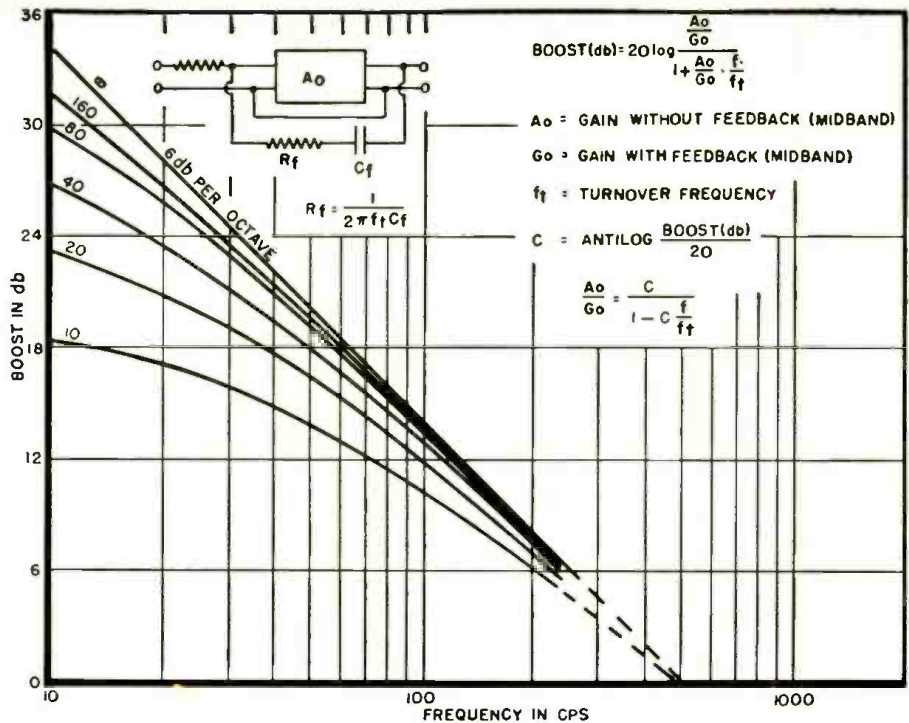

Fig. 2. Rate of bass boost of feedback equalizers depends largely upon the ratio of midband gain with and without feedback. Text points out shortcomings of many equalizers using degeneration and offers basis for development of unique circuit.

final amplifiers vary from 0.5 to 1.5 volts. The output of the preamplifier is largely determined by the second section.

Again feedback has been called upon to provide amplification that is distortionless and virtually independent of tube characteristic or supply voltage variations. To ensure this, the loop gain must be high enough to have A_0/G_0 large compared to one. The feedback must not, however, be great enough to excite oscillation and some caution is advised. As shown, the gain is nearly 67 and is determined

almost solely by R_{10}/R_{11} . For lower gain, R_{10} has to be lowered and a 12AU7 should be used. For higher gain, bypassing of R_{10} may be required in addition to increasing the value of R_{10} . If higher gain is contemplated, it should be borne in mind that tube noise from this section, as well from the first section, will increase proportionately. 6AU6's will have to be used in the first section with a d.c. heater supply. The d.c. is recommended there, as shown in Fig. 1, because the gain is high by usual preamplifier standards. Lower gains will suffice with cartridge-

Fig. 3. Response of equalizer positions shown in Fig. 1. Special arrangements can be designed by referring to the basic circuit and table of components.

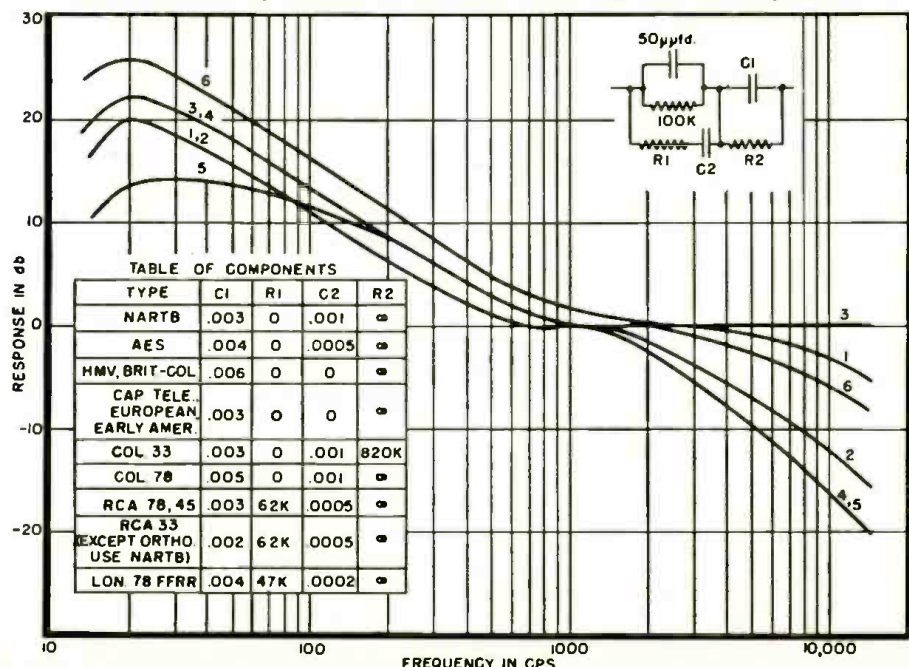

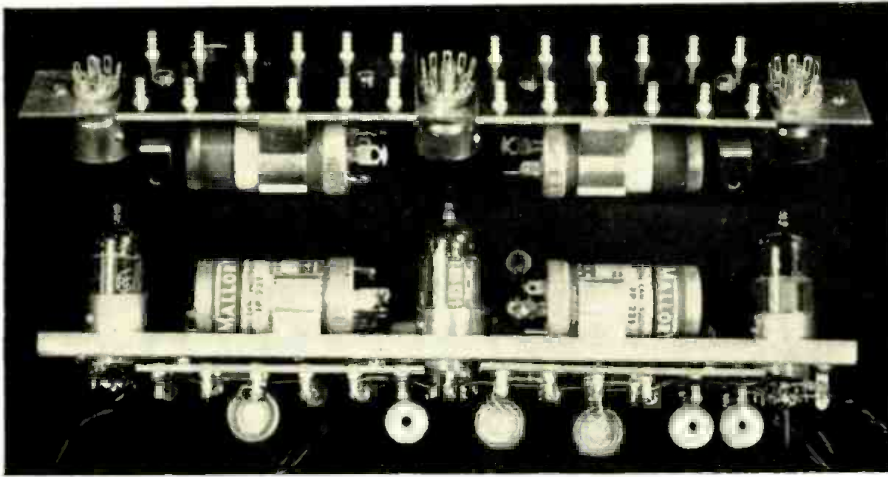

Two views of the sub-assembly at different stages of its construction. See text.

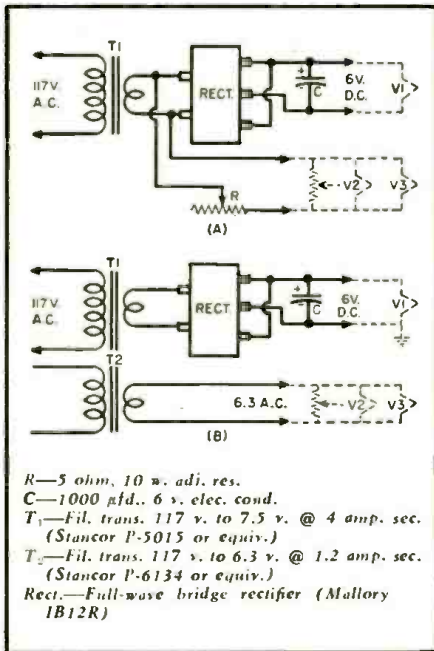
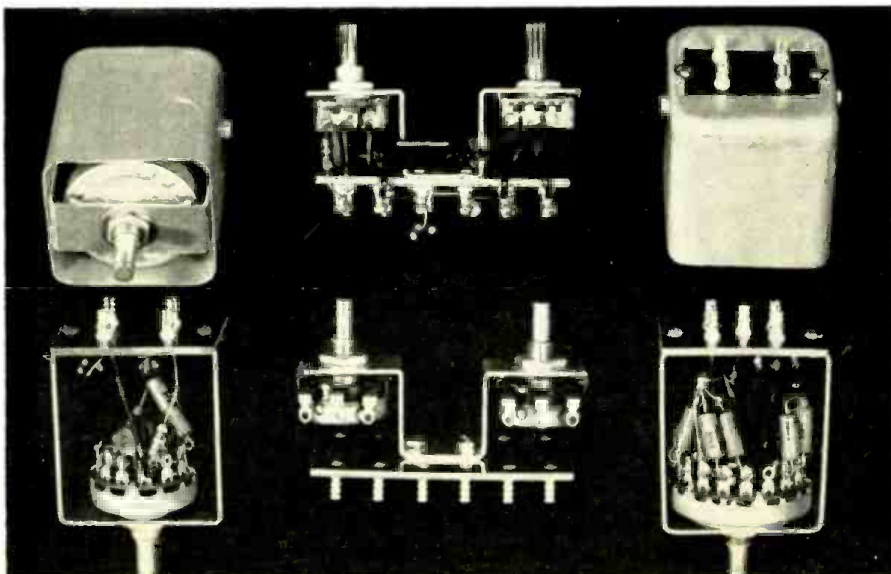

Fig. 4. Two easily-built d.c. heater supplies designed to be used with the first stages of the high-gain preamplifier unit.

Circuits associated with equalizer, tone controls, and low-pass scratch filter are wired to control assemblies. Protective shield cans are not too essential.



es such as the *Pickering* which has an output of over 50 millivolts. With the lower output types, such as the *General Electric*, a gain of 50 or more is needed in this section unless the final amplifier is more sensitive than those ordinarily encountered.

Maximum output from the second section is slightly more than 40 volts. After subsequent attenuation by the tone controls and cathode follower, the available preamplifier output is over 3.5 volts.

High impedance inputs should be preset to permit full use of the volume control without overloading the feedback amplifier. Maximum input to the volume control is approximately $60,000/R_{11}$ volts.

Tone Controls

An unusual combination of bass and treble controls was chosen because of its smooth action. The treble circuit gives only boost and is entirely satisfactory when de-emphasis is correctly applied in the equalizer stage and when the low-pass filter is available. Experience has shown that this is true with input material other than phono

provided the source is properly balanced. Usually it is the predominance of a maladjusted tweeter that is to blame when highs cannot be brought under control with a treble control of this type. Known as variable "degree" as opposed to variable "slope," its effect is to lift the middle as well as the top highs, thereby giving a more balanced action. Boost and droop are more applicable to the bass end with a variable slope control. This is to be preferred in that region.

Output from the cathode follower is about 0.85 times its input. The output impedance is nearly 500 ohms. Because of the elevated cathode, heater returns should be made to a similar potential. The pentode screen grid is an ideal place.

Low-Pass Filter

Comment about this stage is limited to information not mentioned in the earlier article. R_{15} and R_{16} have been chosen to bring the gain to unity so there will be no change in level when the filter is switched from flat to cut-off.

Bypassing R_{11} is not recommended as it produces a peak in the response. The loop gain has been increased by the use of a 12AX7 section instead of a 12AU7 and produces an optimum cut-off characteristic for the given component tolerances with a gain of about 25.

Experimenters who wish to investigate the possibilities of a variable slope filter can try variations of the loop gain by placing a potentiometer in the loop or by bridging the T-network with a variable resistor, etc. A wide variation of slope is possible, but full variation from flat to extreme cut-off would seem difficult to obtain. At present, sufficient data is not available to quote definite capabilities.

Power Supply

Duplication of the voltages shown on the schematic is probable within 10% with a supply of 300 volts. Voltages as low as 250 volts can be successfully used. In any event, the supply must be isolated by a resistance greater than 10,000 ohms if the main amplifier is to furnish the plate power. Ideally, a well decoupled point should be chosen in the final amplifier that will supply at least 370 volts with the additional 7 ma. loading of the pre-amplifier.

A separate power supply need only furnish 250 to 300 volts and in the interest of flexibility and sure-fire simplicity this is to be recommended. Self-powered preamplifiers are coming more into their own because of the desire of most experimenters to try their units with many different final amplifiers.

Heaters must be supplied with a separate winding and preferably a separate transformer. Conditions for a.c. or d.c. operation of the playback-equalizer (first) section heaters have been stated. Since the 6U8 draws 450

(Continued on page 112)

A \$5 LOW-PASS FILTER

By J. G. ROUNTREE
W5CLP

A good low-pass filter for medium-power rigs can be had at reasonable cost.

IN SPITE of anyone's wishful thinking to the contrary, television is here to stay. As a result, greater demands than ever are now put on the amateur to achieve purity of signal, so that any interference will not be the result of harmonic or spurious emissions from the amateur transmitter. We are all painfully aware of the shortcomings in the design and fabrication of some television receivers and we should give due credit and strong support to those few courageous amateurs who have outspokenly challenged the shoddy practices of many TV receiver manufacturers. We must also give credit and support to those manufacturers who have installed high-pass filters in receivers already sold and have improved their designs to correct deficiencies.

The position of each of us and of amateur radio as a whole can be strengthened through our being certain that our own equipment is designed and working properly. It was with this in mind that the writer recently purchased a new TVI-proofed transmitter. It was decided that, as a further safeguard against harmonic radiation, some sort of filter should be placed between the transmitter and the antenna to attenuate any possible harmonics. Having already invested a goodly sum in the transmitter, it was with some dismay that we examined the prices of suitable low-pass filters for transmitters. There seemed to be no reason why a satisfactory home-grown filter could not be built at relatively low cost.

Reference to a radio engineering handbook showed that a three-section pi network should be relatively effective and quite simple to build. The question arose as to whether close tolerances would need to be observed in the component parts, but a little pencil work with the handbook formulas showed that a reasonable degree of tolerance could be allowed. Since the lowest-frequency television allocation in the Dallas-Fort Worth area is Channel 4, it was considered that the simple low-pass pi network would achieve a suitably high attenuation at this channel. This proved to be the case. Where the lowest-frequency allocation is Channel 2, an M-derived filter would provide higher attenuation at Channel 2.

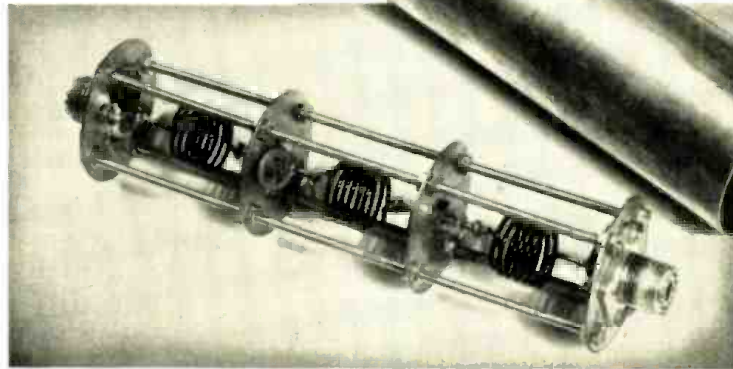

The internal view of the low-pass filter shows its simplicity. The 2" brass-pipe case gives perfect shielding. Note the ceramic condensers.

As a starting point the frequency 40 mc., approximately midway between the upper end of the 10-meter band and the lower end of Channel 2, was chosen as the cut-off frequency. The network was designed to work in a 52-ohm line, such as type RG/8-U. Design values for the shunt condensers were worked out from handbook formulas; and commercially-available disc ceramics, nominally rated very close to the design values, were purchased. These condensers are rated at 500 volts and should stand up very well in service for transmitter powers of up to 200 watts or so, provided that the standing-wave ratio of the transmission line is kept within reason. Design values for the coils were likewise worked out, and parameters of the coils were determined by use of a "Lightning Calculator." See Fig. 1 for the circuit diagram of the filter.

The pi network was built in a three-section chassis made of four circular brass shields spaced on four 1/8-inch brass rods, each seven inches long. The rods were threaded with 1/16 threads for their entire length. The shields were cut from 20-gauge brass, carefully trimmed to fit smoothly inside a two-inch brass tube, and were spaced at equal distances along the brass rods. The two end shields contain coaxial fittings, while the two intermediate shields contain National TPB feedthrough bushings. The end coils of the network were soldered between the coaxial fittings and the adjacent bushings, while the center coil was

Fig. 1. Schematic of the low-pass filter.

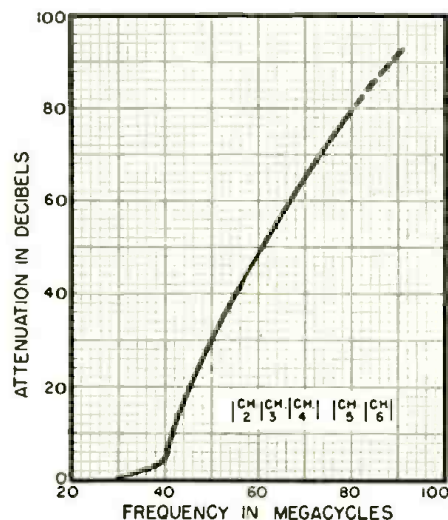
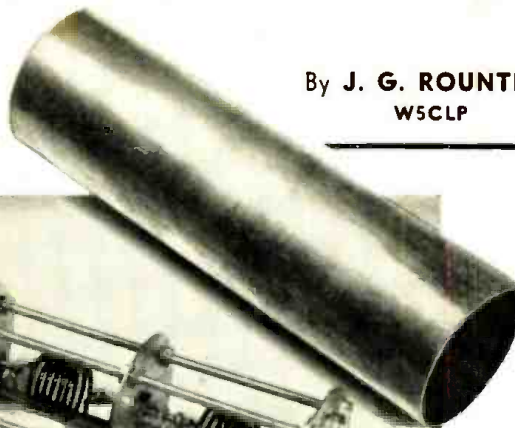
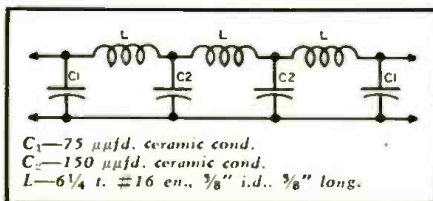

Fig. 2. Attenuation curve of the S5 filter.

soldered in place between the feed-through bushings. The shunt condensers were soldered in place between the coils and the shields by as short a path as possible.

The entire assembly was slipped into a seven-inch length of two-inch brass pipe. Before the end shields were soldered in place, the assembled unit was baked at a moderate temperature for about fifteen minutes to drive out any moisture remaining in the unit. While the filter could be mounted in several ways, it has been found that two U-bolts, made of 1/2-inch brass rods, provide a simple way of bolting the filter to the back of the transmitter cabinet.

After completion of the unit, a test was made to determine the effectiveness of the filter. Fig. 2 is a graph showing the results of this test. It will be noted that the attenuation is negligible below 30 mc., and that it increases to more than 40 db for Channel 2, 50 db for Channel 3, and 59 db (Continued on page 102)

D.C. Distribution in Over-all Receiver

In addition to being able to perform d.c. tests on individual stages the technician must also know how the over-all d.c. network in a TV set works and what voltages and currents can be expected in each section.

The basic d.c. system for any TV set is equivalent to that of a power supply and a load. The power supply converts the a.c. power into a d.c. voltage, usually much higher than the 117-volt a.c. line, and a certain amount of current which then operates the various tubes in the receiver. Fig. 2 shows the schematic diagram of a typical power supply and its equivalent circuit. The equivalent circuit of the transformer full-wave rectifier and pi-type filter is a simple battery with the voltage V , supplying a current I . In this example we assume that the entire TV receiver is supplied by this same voltage and the total of the currents drawn by each tube is equal to I . Some TV receivers have a d.c. system where only a single "B+" voltage is used for all stages, but the majority of sets employ more complicated schemes.

The i.f. amplifier tubes are rated at about 150 volt plate and screen voltage, while some of the sweep oscillators and video and sweep amplifiers require between 250 and 400 volts plate supply. One simple solution to the problem of supplying two widely different plate voltages is the scheme used in the original 630 type receivers. This is shown in Fig. 3, and consists mainly of a resistive voltage divider which supplies the various correct voltages and currents to each section. The excess power is dissipated in the bleeder resistors which are usually of the wirewound type. While this circuit results in fairly good regulation and certainly is convenient and simple to understand, it is not very economical. Because of the power dissipated in the bleeder resistors, more d.c. power must be supplied than the tubes actually use. This requires an expensive power transformer, two 5U4 rectifiers, extra components and results in extra heat in the chassis.

To utilize the "B+" power more fully, modern TV receivers use a number of schemes for eliminating dropping resistors whenever possible. One very widely used economy circuit is shown in Fig. 4A. As mentioned before, the i.f. stages require between 120 and 150 volts for the plate and screen supply. Similarly, the audio output amplifier can be designed to use approximately the same voltage. If the main "B+" voltage was 270 volts the simplest arrangement would be the one in Fig. 4C, where resistors R_1 and R_2 drop the voltage down to the level required and dissipate the excess power. In Fig. 4C, the power delivered by the power supply is 270 volts at 70 ma. or about 19 watts. Almost half of this power is dissipated in the bleeder resistors.

Now look at the circuit in Fig. 4A. Here the audio amplifier is in series

with the three i.f. stages as far as d.c. is concerned. The 6V6 output tube serves as a dropping resistor to lower the voltage for the three i.f. stages. Both of these loads use the same current and, in effect, the 6V6 output tube serves to regulate the i.f. plate voltages.

Assume that the "B+" voltage drops slightly due to line voltage variations. This means that the cathode bias of the 6V6 is reduced, allowing this tube to pass more current and therefore maintain the voltage on the three i.f. tubes. Similarly, an increase in "B+" voltage means an increase in 6V6 bias which again keeps the "B+" voltage for the i.f. section relatively constant. Because the total gain in the i.f. section is large, variations in plate supply voltage of the i.f. tubes have much more effect than "B+" variations in the 6V6 audio amplifier.

A very important feature of the circuit in Fig. 4A, is the two condensers C_1 and C_2 . These condensers provide low a.c. impedance paths for the audio signal and for the i.f. signal, keeping the "B+" for both series loads a true d.c. voltage. If either was open, motorboating in the audio, and audio variations in the i.f. signal would result. If C_2 was leaky or even shorted, the entire 270 volts would be applied to the 6V6 tube. Because the tube has a self-bias arrangement and is capable of handling such a high plate voltage, the 6V6 would not burn out. However, there would be very little or no plate and screen voltage for the i.f. stages, cutting off the picture signal and, in an intercarrier set, the sound signal as well. If condenser C_1 is shorted, the excessive plate voltage on the i.f. tubes could cause oscillation, overloading of the last stage due to excessive gain in the first two and, eventually, the i.f. tubes would burn out, one by one.

The third electrolytic condenser failure which can cause trouble involves C_3 , the 6V6 cathode bypass condenser. If this condenser opens, the sound output will be greatly reduced and some audio may appear in the picture, but otherwise nothing will

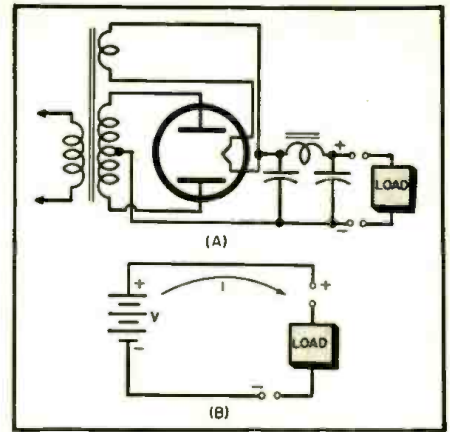

Fig. 2. (A) Typical low-voltage power supply with its equivalent circuit (B).

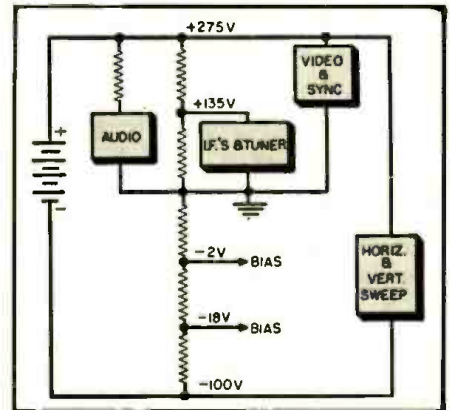

Fig. 3. Simplified 630-type d.c. circuit.

burn out or be damaged. If C_3 shorts, however, considerable damage can result. Such a short would result in the 6V6 being operated with almost zero bias. This will increase the current through the 6V6 considerably and will raise the "B+" voltage available to the i.f. stages. While the sound will be quite distorted, the excessive "B+" may cause the i.f. stages to become regenerative. The a.g.c. system may be unable to control the gain of the i.f. stages with such high plate voltages and cause overloading, i.f. oscillation, or picture distortion in the video amplifiers.

The circuit shown in Fig. 4A repre-

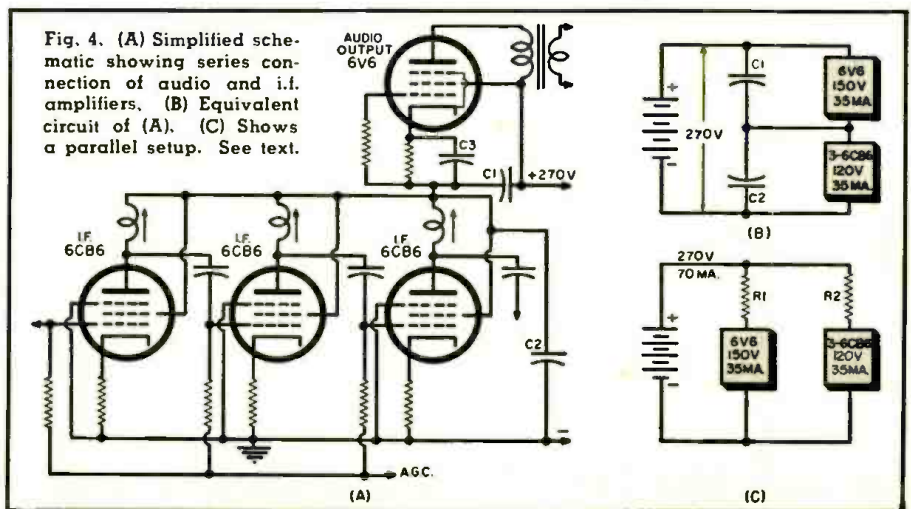

Fig. 4. (A) Simplified schematic showing series connection of audio and i.f. amplifiers. (B) Equivalent circuit of (A). (C) Shows a parallel setup. See text.

check first if the cathode of the audio amplifier is returned to ground. Measure the voltage between the cathode and ground, then measure the voltage between the cathode and the i.f. "B+". If the latter measurement turns out to be only a few volts, a series circuit is employed and can be checked as described here.

One other section in most TV receivers is particularly prone to d.c. troubles and lends itself well to the d.c. troubleshooting procedure. That is the voltage boost portion of the horizontal flyback supply.

Boost Voltage

The operation of flyback circuits is quite complex since it involves impedance transformation from the horizontal output amplifier to the deflection yoke, HV step-up and rectification, and voltage boosting due to the damper tube action. For this discussion attention is focused only on the boost voltage portion of the circuit. However, it must be understood that the boost voltage is directly affected by and, in turn, has a different effect on the other two portions. A simple explanation of the boost supply is provided by Fig. 6A.

The flyback circuit shown here is typical of a majority of sets now in use. Many later models use an autotransformer, requiring that the damper tube connections be reversed, with the plate providing the boost voltage instead of the cathode. This does not change the operation or the results at all.

At point A, the damper plate, the large positive pulses due to the flywheel effect of the transformer and yoke cause the damper tube to conduct, passing the pulses to the cathode. These pulses are superimposed on the 250-volt "B+". Actually, these pulses will be filtered out somewhat at the cathode due to the action of the first filter condenser C₁, but for bet-

(Continued on page 116)

Fig. 6. (A) Typical damper and voltage boost circuit with its equivalent shown in (B). (C) Waveforms for points in (A).

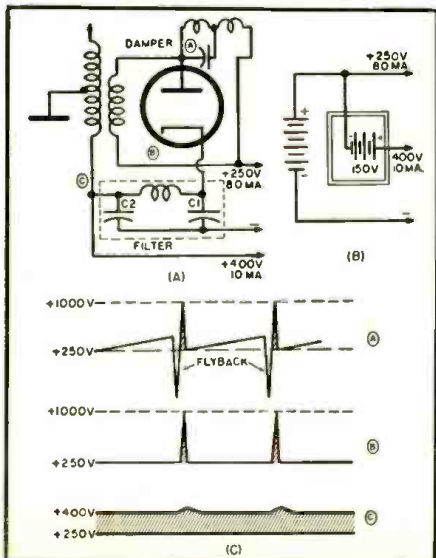

TV PARTS REPLACEMENT GUIDE

TV POWER TRANSFORMERS

Continuation of list of power transformers used in TV sets and their replacements; to be concluded next month.

All data was furnished by the parts manufacturers listed.

RECEIVER MFR. Part No.	CHICAGO Part No.	HALLDORSON Part No.	MERIT Part No.	TRIAD Part No.	THORDARSON Part No.
CAPEHART					
94231	PH-90	P9307	P-3066	R-11B	T5-24R04
94264		F5516		F-21A	T-21F12
94269		P9727	P-3066		
650243A-1		F5530	P-3097	F-50X	
750019B-1				R-37BC	T-26R00
750019C-1		P9727	P-3067		
750121A-1		P9711	P-3059		
750144A-1	TP-409	P9719	P-3067	R-37BC	T-26R00
750144B-3	TP-409		P-3067*	R-33BC	T-26R19
CROSLLEY					
B-144460	TP-355	P9713	P-3059	R-35BC	T-26R19
C-146683	TP-392	P9711	P-3078	R-38BC	T-26R00
C-147504		P9723	P-3078	R-42B & F-52X	T-26R00
C-147682	PH-145 & FO-63	P9731	P-3066	R-38BC	T-26R00
C-148282	PH-200 & FO-63	P-9711	P-3059	R-20B & F-16X	T-26R23
C-148562			P-3067, 3074		
C-148950				R-39BC	T-26R21
C-148975		P9713	P-3078	R-42BC	T-26R25U
C-149559		P9711	P-3063		
C-151612	TP-356†	P9713	P-3059		
C-152433	TP-370†		P-3063		
D-145609				R-50A	
D-160011		P9721		R-31A	T-26R00
D-160318	PH-70	P9311	P-2952	R-11B	T5-24R04
D-160490				R-40A	
DEWALD					
1050	TP-365	P9721	P-3061	R-31BC	T-26R00
1130A	TP-370†	P9705	P-3070	R-38BC	T-26R21
DU MONT					
20D-12404, 20D-12926	PH-70	P9311		R-40A	
20003891	TP-365		P-3166	R-31A	T-26R00
20004283		P9728			
20004341				F-52X	T-21F60
20004771	TP-360	P9321	P-3059	R-35BC	T-26R19
20004811		F5529	P-3074	F-51X	
20004961			P-3166		
20005011		F5529		F-52X	T-21F60
20005012		F5529		F-52X	T-21F60
20005840		F5506†	P-3040†	F-7X	T-21F03
EMERSON					
730007	PH-40			F-30A	
730014			P-3059		
730014-1			P-3059*	R-20B & F-7X	
730018		P9731	P-3066	R-38BC	T-26R00
730022			P-3070	R-39B	T-26R21
730023		P9731	P-3063		T-26R00
730024		F5530	P-3097	F-50X	
730026	TP-392 & FO-63	P9731	P-3078	R-33BC & F-16X	T-26R00
730026-7		P9731	P-3067, 3074		
730029		P9731	P-3078	R-38BC & F-16X	T-26R00
730031	TP-370 & FO-63	P9731	P-3078	R-38BC & F-16X	T-26R00
730032		P9737	P-3076, 3074		
FADA					
42.12	TP-365	P9721	P-3061	R-31BC	T-26R00
42.58	TP-356	P9727	P-3059	R-37BC	T-26R00
42.61	TP-360	P9727	P-3067*	R-36BC	
Models 54C20, 54C40, 54T15, 54T30	TP-370*		P-3077, 3074		T-26R31
GENERAL ELECTRIC					
RTF-002		F5529	P-2944		
RTP-035			P-3076, 2944	R-42BC	T-26R25U
RTP-062				R-35BC & F-16X	T-26R00
RTP-066		P9723	P-3066		
RTP-300		P9723	P-3066	R-50BC	
HALLICRAFTERS					
52-170	TP-410**	P9731	P-3169	R-35BC	T-26R19
52C170	TP-410**	P9731	P-3169	R-35BC	T-26R19
52C170-2	TP-410**	P9731	P-3169	R-33A	T-26R19
52C185	TP-225**	P9702	P-3169†	R-42A	TV-24R98

*Add Series Resistor to Reduce "B+" Voltage. † Drill New Mounting Holes.

** Use Universal Mounting Brackets.

(Continued on page 148)

TRANSISTOR BAND SPOTTER

By PETER G. SULZER, W3HFW



Notice that the transistor band spotter has no power cord and needs no ventilation holes. The terminal posts, potentiometer, lettering, etc., give an idea of its size.

Any amateur can now have a transistor frequency standard at low cost. Simple, stable, with no warmup drift, this unit runs continuously off its internal flashlight cell.

THE availability of "p-n-p" junction transistors¹ has opened many interesting possibilities in the field of compact test equipment. One example of such equipment is the small frequency standard to be described here. Although compactness is in itself a virtue in the crowded ham shack or service shop, the low power consumption of the transistor provides an additional benefit, of value in the fixed station as well as for portable operation.

Consider a typical a.c.-powered frequency standard used for locating band edges, calibrating receivers and v.f.o.'s, and for checking service-type signal generators. It contains a rectifier tube, a 100-kc. crystal oscillator, and perhaps a multivibrator to produce markers at 10-kc. intervals. It consumes about 30 watts, and runs hot because it is built in a small box. As a result, its frequency drifts as it warms up, and its multivibrator may have to be readjusted to compensate for circuit-element changes during the heating cycle. A better design with a sufficient provision for heat dissipation would improve matters, but a crystal oven would really be necessary to complete the job of stabilizing the oscillator. Unfortunately, however, the equipment, and particularly the crystal oven, would have

to be in operation at all times to avoid the warmup problem which would run up the power bill and constitute a fire hazard.

Here is where the additional benefit of the low-powered transistor comes in. The total power required by the band spotter is 300 microwatts, 1.5 volts at 200 microamperes. This is so small that a single flashlight cell should operate the unit for years, and therefore an "on-off" switch is not required. Since the band spotter operates at all times there is no warmup problem, and an accurate frequency calibration is available at all times, particularly if there is no hot equipment nearby. An additional point worth mentioning is the lack of a power cord to add to that ever-

Fig. 1. Cross-sectional representation of a "p-n-p" transistor, used in this circuit, and standard transistor diagram symbol.

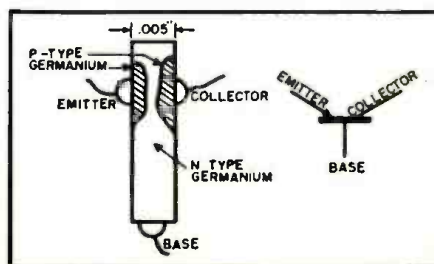

growing "tree" at the power outlet.

The band spotter contains a 100-kc. crystal oscillator and a 10-kc. synchronized blocking oscillator, each using a "p-n-p" junction transistor. Two outputs are provided at 100 kc.: a clipped sine wave at Terminal 1, which provides usable receiver-calibration markers up to 30 mc., and a sine wave at Terminal 2 for oscilloscope frequency comparison. The 10-kc. output at Terminal 3 is a 1-microsecond pulse having strong harmonics beyond 30 megacycles.

The "P-N-P" Transistor

In order to discuss the circuits used in the band spotter, a brief and much simplified description of the "p-n-p" junction transistor² is in order. This type of transistor contains a small (0.08 inch by 0.12 inch by 0.005 inch thick) wafer of "n"-type germanium. It will be recalled that most of the conduction in an "n"-type semiconductor takes place *via* electron flow, in contrast to the "p"-type, in which conduction effects occur through the flow of holes (places where electrons are missing in the crystal structure). A small dot of indium is placed on the two opposite flats of the wafer, which is then heated, permitting a portion of the indium to diffuse into the germanium. In this manner the diffused portions of the germanium are converted to the "p"-type. The heating process is continued until the thickness of the remaining "n"-type germanium at the wafer center is small, perhaps 0.001 inch, as shown in the drawing. Small wires are soldered to the dots, which become the emitter and collector connections and a third wire is soldered to one end of the wafer, which is the base connection.

Suppose, now, that the collector is made negative with respect to the base. A very small current will flow because of the direction of the electric field across the "p-n" junction. Here the negative charge on the collector will tend to repel electrons back into the "n"-type base, while the positive

charge on the base will repel holes (which behave something like positive charges) back into the collector. A similar situation would exist in an imaginary vacuum tube containing an electron emitter at its cathode and a positive-ion emitter at its anode. With the anode negative with respect to the cathode, cathode-current cut-off would occur because the electrons would be repelled back toward the cathode, and anode cut-off would occur because positive ions would be repelled back toward the anode. Since cathode current must flow through the anode, and *vice versa*, cut-off in a double sense is obtained.

If, while keeping the collector negative, the emitter is made slightly positive with respect to the base, a heavy emitter current will flow as electrons are drawn out of the "n"-type base by the positively-charged emitter, and holes are drawn out of the "p"-type emitter by the negatively charged base. It is seen, therefore, that the emitter behaves as a rectifier biased in the conducting direction, while the collector behaves as a rectifier biased in the non-conducting direction, and therefore the emitter has a low dynamic (a.c.) resistance, and the collector has a high dynamic resistance. However, according to this simple theory most of the holes drawn out of the emitter can pass right through the thin base region, and they will do so because they behave as positive charges, and are accelerated by the negatively-biased collector. These holes then constitute the collector current, which is almost independent of the collector voltage as long as the collector is negative. This is another way of saying that the collector dynamic resistance is very high.

It is not immediately apparent that such a device will amplify, but it does, and this is because of the large ratio of collector impedance to emitter impedance. If a small a.c. voltage is applied between the emitter and base, an alternating emitter current will be produced and, in a good transistor, most of this current will pass through the base and appear across a much higher impedance in the collector circuit producing a comparatively high voltage between the collector and base.

To consider some typical figures, suppose that the input (emitter-base) dynamic resistance is 100 ohms, the output (collector-base) dynamic resistance is 100,000 ohms, and suppose that 95% of the emitter signal current appears in the collector circuit (α , the short-circuit current gain = 0.95). Suppose, also, that a 100,000-ohm collector load resistance is used. If a 0.1-volt a.c. signal is applied to the emitter, the emitter signal current will be 1 milliampere, and therefore the collector signal current will be 0.95 milliampere. One half of this will go to ground through the collector dynamic resistance, while the other half will produce a useful signal of 47.5 volts across the 100,000-ohm load.

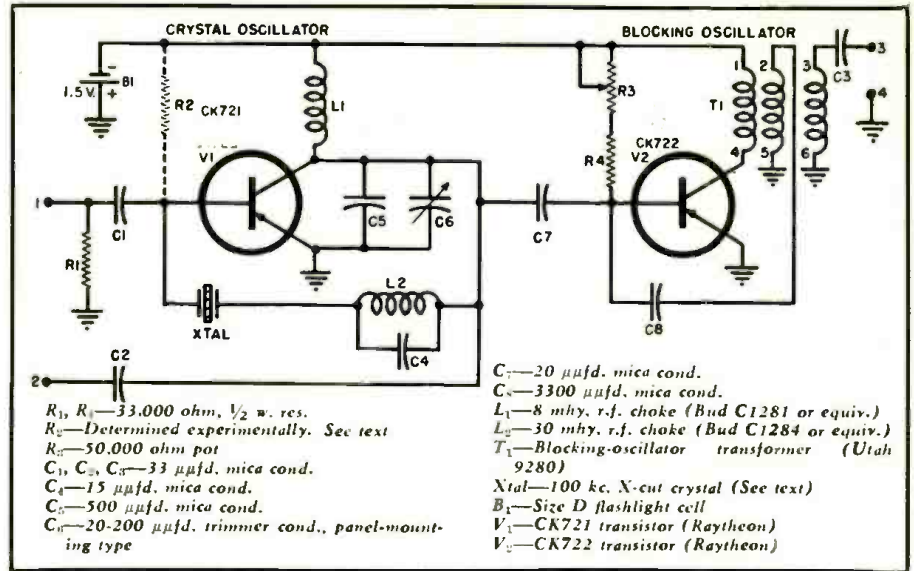

Fig. 2. The schematic shows the remarkable simplicity of the transistor frequency standard. R_2 is used if the measured current through L_1 is less than the normal value (see text). C_6 , a trimmer, is the final front-panel adjustment. The economy of parts more than offsets the "expense" of using transistors rather than tubes.

The voltage gain is thus 475, a very substantial figure.

It has been seen, then, that the grounded-base connection can produce a large voltage gain at the expense of a very low input impedance. A more useful amplifier is obtained if the emitter is grounded, so that the base can be driven.³ Since most of the current leaving the emitter passes through the base to the collector, the base current itself is much smaller than the emitter current. Consequently the base-driven circuit can produce a current gain as well as a voltage gain, and a much more versatile amplifier of higher input impedance is obtained. The current gain, which depends critically upon the value of α , may be 10 or more, while typical

values for the input and output impedance are 1000 ohms and 100,000 ohms respectively.

It should be pointed out that the base-driven connection produces a phase reversal, as does the grounded-cathode vacuum tube. In fact, the properties of a small voltage-amplifier pentode with a resistance on the order of 1000 ohms connected between grid and cathode resemble those of the base-driven transistor, although the transistor will operate with a much smaller power supply.

The base-driven connection is used in the crystal oscillator and blocking oscillator in the band spotter.

Considering the crystal oscillator, one might be tempted to "borrow" the
 (Continued on page 126)

This internal view shows that the construction, while compact, is "roomy." There is no chance of overheating; the unit is left running continuously for its maximum stability, without danger of breakdown or running up the power bill. It is as nearly independent of external conditions of temperature, etc., as it is of power lines.

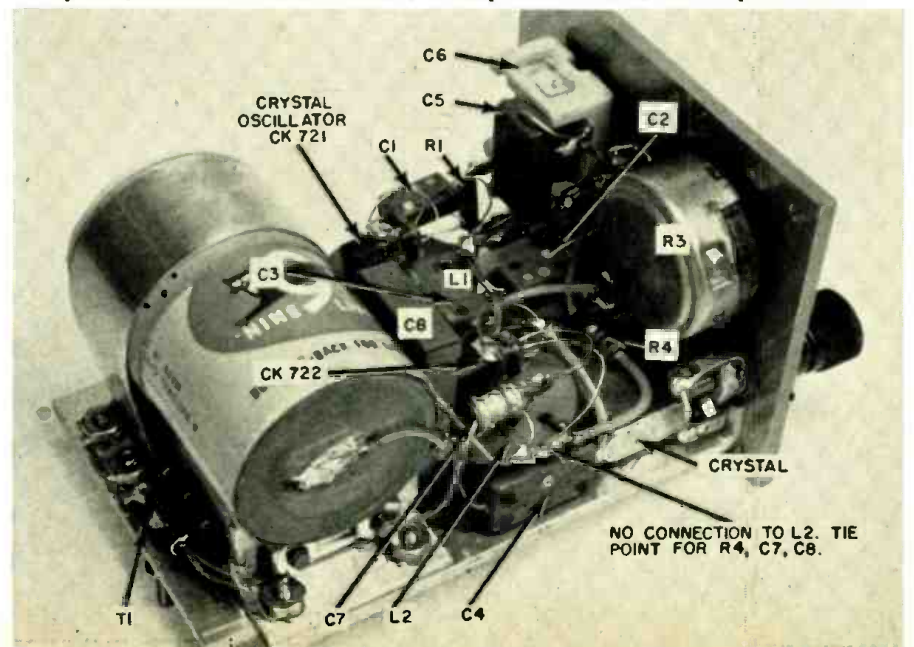

NOISE IMMUNITY CIRCUITS

By MILTON S. KIVER

Pres., Television Communications Institute

IN THE previous article, a number of television noise immunity circuits was described. It was noted there that while noise pulses may have only a momentary disturbing effect on the picture elements, they can be particularly destructive to the receiver's sweep systems, causing picture roll or picture break-up. It is to avoid this annoyance to the observer that noise immunity circuits are employed. In this article, a number of additional approaches to this problem will be examined.

The use of a noise gate placed in the path of the signal is one approach taken by Philco to minimize the effect of noise pulses on the sweep systems. A portion of the composite signal is taken from the plate of the first video amplifier and applied to a cathode follower. See Fig. 1. This stage is labeled as the first sync separator and it represents the first step in the separation process. In the signal applied to this tube, the sync pulses are positive. Now, the cathode resistor of this tube possesses the high value of 10,000 ohms, which means that the tube is operating quite close to cut-off. The sync pulses and portions of the video signals near the sync level will cause current to flow through the tube and hence this portion of the signal will pass through the stage. The more negative portions of the signal, however, will drive the tube into cut-off and these will be eliminated.

Since V_1 is a cathode follower, the output signal is taken from the cathode and transferred to the next stage which is a noise gate. This noise gate is diode connected and is in series with the path of the signal. As long as the diode conducts, signals from V_1 will reach V_2 . However, should the diode cease conducting, the signal path is effectively opened and all signal flow ceases.

Part 2. The operation of more noise suppression circuits used in modern TV receivers for better sync and picture.

Examination of the diode circuit reveals that a voltage divider, formed by R_{606} and R_{607} , places a positive voltage of approximately 7 volts at the plate of V_2 . The sync signal from V_1 also possesses a positive polarity and it is applied to the cathode of the diode. As long as the cathode positive voltage is less positive than the plate voltage (as it is for all normal signals), the diode will conduct. However, when a noise signal greater than the sync signal is received, the diode cathode is driven more positive than the plate. This cuts the diode off, preventing the noise from reaching V_3 and the sweep oscillators beyond.

In order to make the diode effective over a wide range of incoming signal amplitudes, its plate voltage should change as the signal level varies. This is done in this system by connecting R_{606} to the end of a resistor (not shown here) which also supplies "B+" to the video i.f. amplifiers. As in a previous circuit (Part 1), the a.g.c. level will vary with signal strength and this, in turn, will vary the amount of current drawn by the controlled i.f. stages. The current, passing through the i.f. plate supply resistor, will change the voltage drop across that resistor and the positive voltage applied to V_2 will likewise vary.

The next stage in this system is V_3 , the second sync separator. The sync pulses reaching V_3 are still positive since the noise gate diode did not invert them. V_3 is grid-leak biased, developing a biasing voltage across R_{605}

and C_{601} which is established by the level of the sync tips. The remaining video signal is ineffective in producing plate current and it is therefore substantially eliminated.

The sync pulses are amplified and inverted by V_4 and then transferred to V_5 . This stage is inserted for the purpose of changing the negative sync pulses to positive polarity so that they will be in position to trigger the vertical and horizontal sweep oscillators. At the same time, this stage also functions as an amplifier and serves to remove any video signal that might still be present at this point. It accomplishes this latter job by the way the tube is biased. A one-megohm resistor, R_{608} , is connected between plate and grid, applying a small positive voltage to the grid. The resulting grid current, flowing through R_{609} and R_{608} , brings the actual grid potential (with respect to ground) to zero or close to it. (Here the voltage is slightly negative).

The tube under these conditions is operating close to saturation and any further positive voltage applied to the grid (by the signal, say) would not cause much change in plate current. This, in effect, prevents such positive (or relatively positive) signals from passing through the tube. However, when the negative sync pulses are active, the current through the tube is decreased. This change raises the tube's plate voltage, producing a positive sync pulse at the output of V_4 . By this method a fairly clean sync pulse is presented to the vertical and horizontal sweep systems.

Fig. 1. Philco's noise immunity circuit using a diode-connected gating tube.

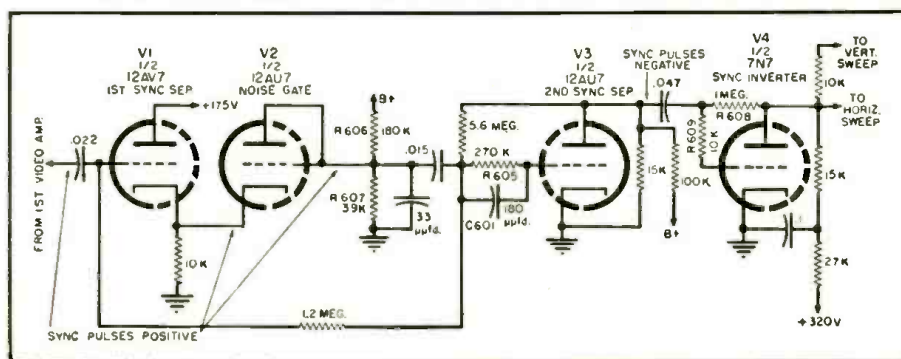

Multi-Element Tubes

Since the primary objective of a noise immunity circuit is to prevent noise pulses from affecting the operation of the sweep oscillators, most noise immunity circuits work closely with the stages just prior to the sweep oscillators. These, of course, are the sync separators. Multi-element tubes have also been drawn into the battle against noise pulses and the circuit of Fig. 2 is one example of how such tubes are employed.

The composite video signal with the

LIE DETECTOR

By
EDWIN BOHR

EVERYONE can probably think of a few choice uses for a "lie detector." These uses may have a humorous twist—a lie detector is fine for parties—or they may have a more serious application. Whatever the purpose, this lie detector is the genuine article. It is not just another toy.

Our emotions greatly affect the physiological function of our bodies. Some of these effects can be quite drastic. We have all heard of people being "scared stiff" from fright. However, there are other, more subtle changes that can be measured and used to indicate mental tension. To improve their validity, commercial detection units measure and record simultaneously several types of change. Increased emotional tension, for example, is accompanied by increased blood pressure. Changes in the skin's electrical resistance also accompany emotional strain. This change in skin resistance is used to indicate a "lie" in the unit to be described.

Detector Circuit

The lie detector circuit is a resistance bridge followed by a balanced d.c. amplifier. There are several reasons for using the balanced (push-pull) d.c. amplifier circuit. For one thing, the balanced amplifier does not need the complicated voltage regulator tube circuits and divider networks required by single-ended amplifiers.

Secondly, the balanced amplifier is inherently more immune to fluctuations in heater and plate supply voltages. Finally, the balanced circuit, as we planned it, would need no initial adjustments to place each tube within its proper operating range. In this respect, the amplifier is self-compensating. You build it and it works—no fuss, no muss.

A simple resistance bridge precedes the amplifier. Two variable resistors (coarse and fine) are used to "balance out" the resistance of the person to whom the detector is connected. A closed circuit jack inserts a substitute resistance in the circuit whenever the electrode plug is removed. This maintains a reasonable circuit balance and provides a standard resistance against which to check the circuit when the plug is pulled.

A small 15-volt hearing-aid battery supplies the voltage for the bridge. This voltage could probably be tapped from the plate supply. We used the battery (it is stable and reliable) in preliminary experiments with the de-

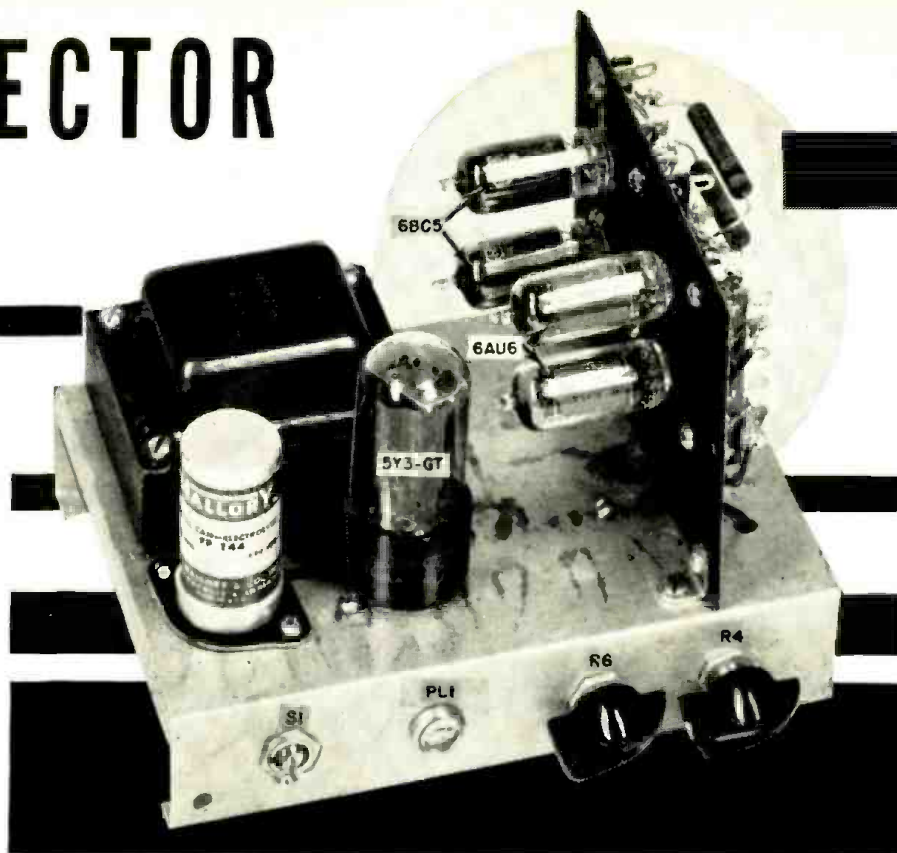

Over-all view of the home-built lie detector. Skin resistance changes are measured.

An easily-built instrument which measures changes in skin resistance—indicating whether or not subject is lying.

tor, so it was included in the final version. The drain on the battery is small, only about .06 milliamp, and the power switch removes even this load when the unit is turned off.

The bridge places a positive bias on the control grids of the first two amplifier tubes. This is compensated for by the higher-than-usual common cathode resistor (R_1 in the diagram).

A balanced signal is not fed to the 6AU6 grids from the bridge. Never-

theless, a balanced condition is achieved by virtue of the voltage developed across R_1 . To illustrate this action let's take a specific example.

Suppose the person undergoing a detector test has a lowered skin resistance as a result of telling a lie. By looking at the bridge diagram, we see that this lowers the positive bias on V_2 . Thus it constitutes a negative signal swing. Since the V_1 side of the bridge has experienced no resistance change, there is no signal applied to the grid of V_1 . However, as the grid of V_2 swings negative, the cathodes of V_2 and V_1 also swing negative since the plate current of V_1 decreases. This makes the grid of V_1 more positive with respect to its cathode—the equivalent of applying a positive signal swing to V_2 . This same circuit is often found in oscilloscopes.

Both screen grids are fed from a single dropping resistor. As the screen current increases in one side of the circuit, it decreases in the other side, maintaining the screens at essentially the same voltage during signal variations. This gives a bypassing effect down to "zero cycles." In single-ended circuits, VR tubes must be used for bypassing.

Each 68C5 control grid is direct-coupled to the plate of the preceding 6AU6. This places the grids more than 100 volts above ground. However, the

Fig. 1. (A) How electrode is connected to the subject. (B) Closeup view of electrode unit.

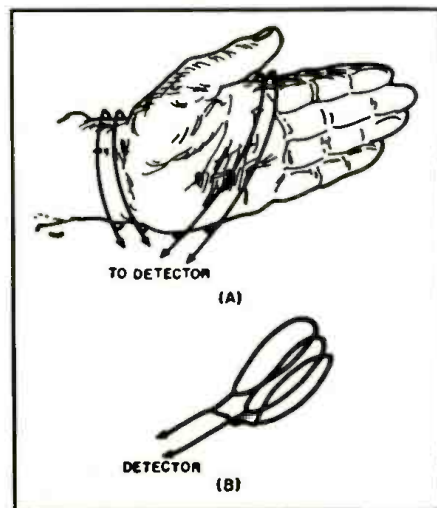

KNOW YOUR 1953 PHILCO TV RECEIVERS

By **DAN LERNER**
Philco Corporation

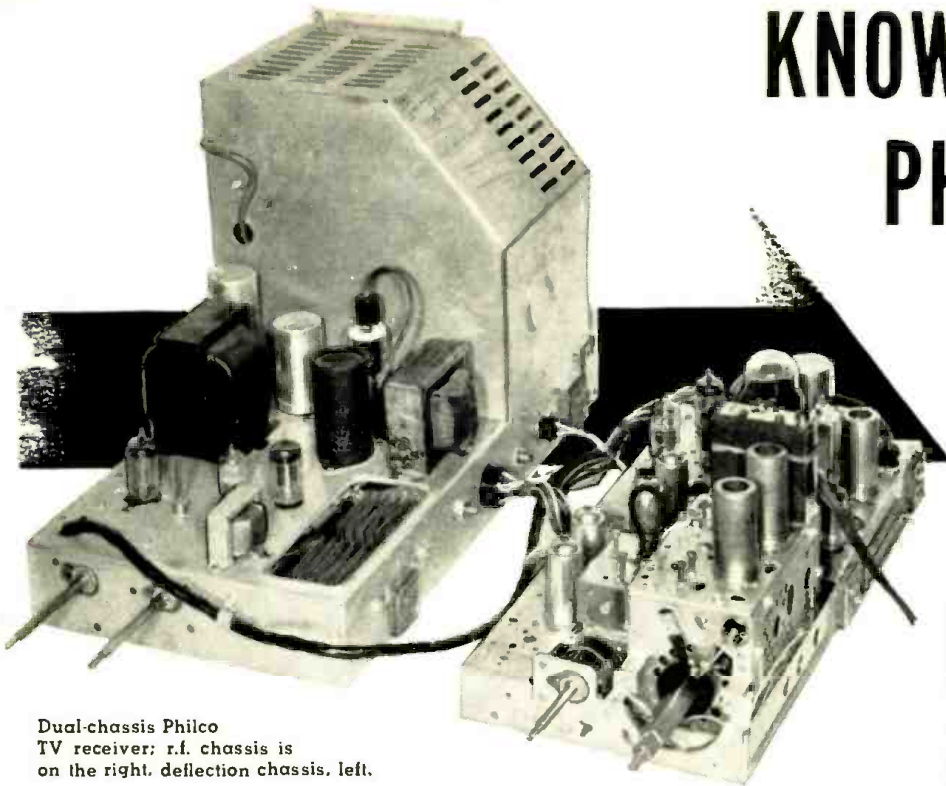

Dual-chassis Philco TV receiver: r.f. chassis is on the right, deflection chassis, left.

Circuit explanation and service data for the new Philco TV receivers, including the complete schematic diagram.

THE LATEST in the series of Philco's duplex line of TV receivers uses chassis containing some unique and interesting circuits. Although most of these new circuits are on the r.f. chassis, some will be found on the deflection chassis which drives a 27-inch picture tube, a 27LP4A. (See Fig. 7.) To simplify a discussion of the new circuits, they will be treated individually.

First let us look at the front end. (See Fig. 8.) The incoming signal is not applied directly to the 6BZ7 r.f. amplifier grid but, instead, is coupled through inductively. For this purpose a tapered line is used which matches the relatively low impedance of the antenna to the high impedance of the tube. Two traps are used in the tapered-line system—one, the i.f. trap, eliminates 40 mc. interference, and the other, FM interference around 100 mc. The tapered line provides a uniform match to the input grid at all v.h.f. frequencies.

The first section of the 6BZ7 serves

to match the input system to the second section of the 6BZ7. The signal is coupled from the first section plate directly to the second section cathode. This section functions as a grounded-grid r.f. amplifier. The over-all r.f. stage with this arrangement has the gain of a well designed pentode r.f. amplifier with much superior noise figure.

A 12AZ7 is used as an oscillator and mixer. The output of the mixer at 40 mc. is fed through a low impedance system (link coupling) to the first i.f. stage.

A four stage video i.f. system with high gain 6CB6 tubes is used in these sets. (See Fig. 8.) Transformer coupling is used throughout in order to obtain wide bandpass and freedom from interference. The average over-all bandpass in the i.f. system is 3.5 mc. at the 70% response point.

The A.G.C. System

The a.g.c. system used in the receiver is somewhat novel as far as

normal Philco practice is concerned. It provides an a.g.c. voltage completely independent of the picture modulation and random noise insertion.

The a.g.c. gate tube, a 6AU6, functions in a keyed a.g.c. system. Picture signal of a certain amplitude, see Fig. 1, is obtained from the plate of the video amplifier, one-half of a 6U8, across R_{osc} , a 4700-ohm resistor. This signal is fed to the control grid of the gate tube. A gating or keying pulse (Fig. 2) is obtained from the horizontal output transformer. This pulse, at a frequency of 15,750 cps, is applied to the noise gate plate. (See Fig. 7 for a.g.c. winding on flyback transformer.) It has an amplitude of about 500 volts peak-to-peak. Because of a large "B+" bias on the cathode of the a.g.c. tube, the plate is normally negative with respect to the cathode. Since the flyback pulse is generated only during retrace time, that is, horizontal sync and blanking time, the a.g.c. tube plate will be positive and, therefore, will be able to conduct only during this short time, about 10 microseconds. However, the tube will conduct in proportion to the amplitude of the positive sync pulse tips on its control grid and then only if the keying pulses occur at the same time as the sync pulses. Therefore, since the amplitude of the plate keying pulses is fixed, that is, about 500 volts, the amplitude of the sync pulses on the control grid determines the amount of conduction in the gate tube. Since the a.g.c. gate tube conducts only during flyback time, noise disturbances that occur during any other time will have no appreciable effect on the a.g.c. voltage.

The plate current of the keyed a.g.c. tube develops a negative voltage in its plate load circuit which is used to control the receiver i.f. and r.f. gain.

The Sync System

Composite video for the sync system is taken from the plate circuit of the video amplifier. The voltage developed across R_{osc} and R_{res} is fed to the grid of the noise inverter. $\frac{1}{2}$ of a 12AU7,

Fig. 1. Signal from plate of video amplifier fed to a.g.c. tube control grid.



Fig. 2. Gating pulse from horizontal output transformer fed to a.g.c. tube plate.

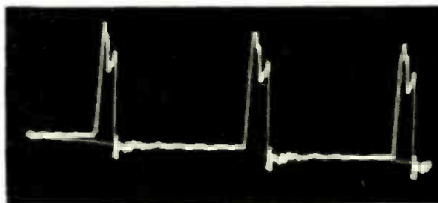

and to the grid of the sync separator, $\frac{1}{2}$ of a 6U8, through R_{605} . See Fig. 8. The noise inverter tube is operated as a modified clipper tube, that is, with a low level of plate voltage, about 34 v., and with a high negative grid voltage, 6.6 v. This keeps the tube normally operating beyond plate current cut-off.

When the composite video signal is applied to the grid of the noise inverter from the video amplifier, the sync signal is positive. Thus, any noise accompanying the sync signal will also appear positive. Most noise pulses have amplitudes far greater than that of the sync pulses. These, being highly positive, drive the inverter tube to conduction during the time of the noise pulse. To establish the proper bias on the noise inverter for a given signal level, so that the sync tips are just below cut-off, another tube called the gated leveler is used. The gated leveler conducts only when the gating pulses occur. Note that the grid of the leveler is tied back to the a.g.c. gate pulse source through condenser C_{606} and the divider R_{606} , and R_{601} . (See Fig. 6.) Plate current flows in the gated leveler when sync pulses from the video signal reach the plate through C_{601} at the same time that positive gating pulses reach the grid. This current flow through V_{11A} charges condenser C_{601} setting a bias on the grid of V_{11B} .

The output of the noise inverter consists of negative noise pulses. This is mixed with the picture signal and then fed to the grid of the sync separator. The noise present in the positive composite video signal fed to the sync separator is effectively cancelled out by the negative noise signal from the conducting noise inverter. (See Figs. 3 and 4.)

The Phase Comparator

The output of the sync separator (see Fig. 5) is fed to the phase splitter, $\frac{1}{2}$ of a 12AU7. (See Fig. 7.) This tube provides two polarities of sync, a positive one at the plate, and a negative one at the cathode.

As can be seen from Figs. 9 and 10, the outputs from the phase splitters are of opposite polarity but of equal amplitude. The positive pulses are fed to the plate of one section of the phase comparator, V_{17A} on Fig. 7, and the negative pulses to the cathode of the second section. A part of the horizontal sweep output pulse (see Fig. 12), is taken from a special winding in the output transformer and fed to the plate of the second section and the cathode of the first section through a saw-tooth forming network, $R_{617}-C_{602}$ (see Fig. 11A). In these tube sections the horizontal sync and sweep signals are compared. When the horizontal sweep and sync signals are in-phase, the current flow through the two diode sections is balanced; that is, the resulting voltage at the top of the plate divider resistor R_{601} is zero. When the two signals are out-of-phase in any manner, some dif-

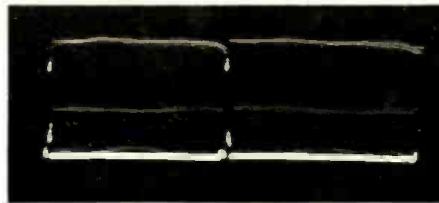

Fig. 3. Signal fed to the sync separator.

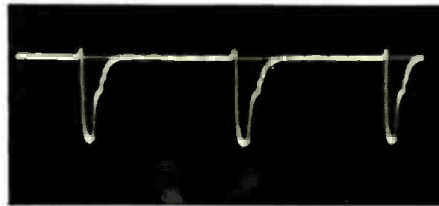
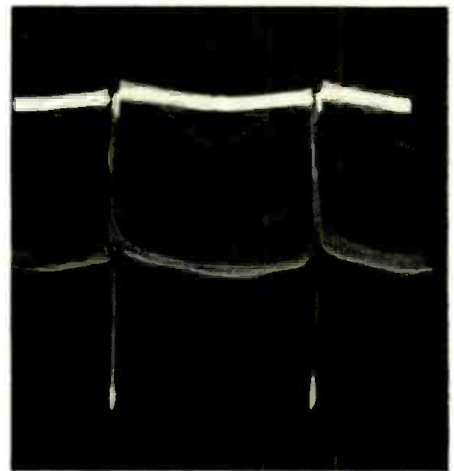

Fig. 4. Output from V_{11B} (scope 15,750 cps.).

Fig. 5. Output from the plate of the sync separator shown with the scope at 60 cps.



ference voltage is developed across R_{601} . This reference point, that is, the top of R_{601} , is connected to the horizontal oscillator grid through the network of C_{602} , R_{601} , and C_{601} . If the reference point voltage is positive, it makes the oscillator come out of cut-off faster and thus increases its frequency. When the voltage is negative, it takes

(Continued on page 61)

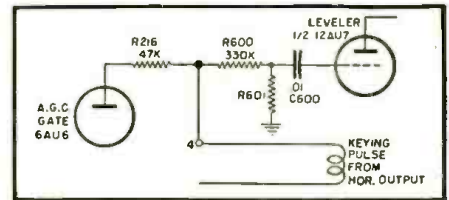
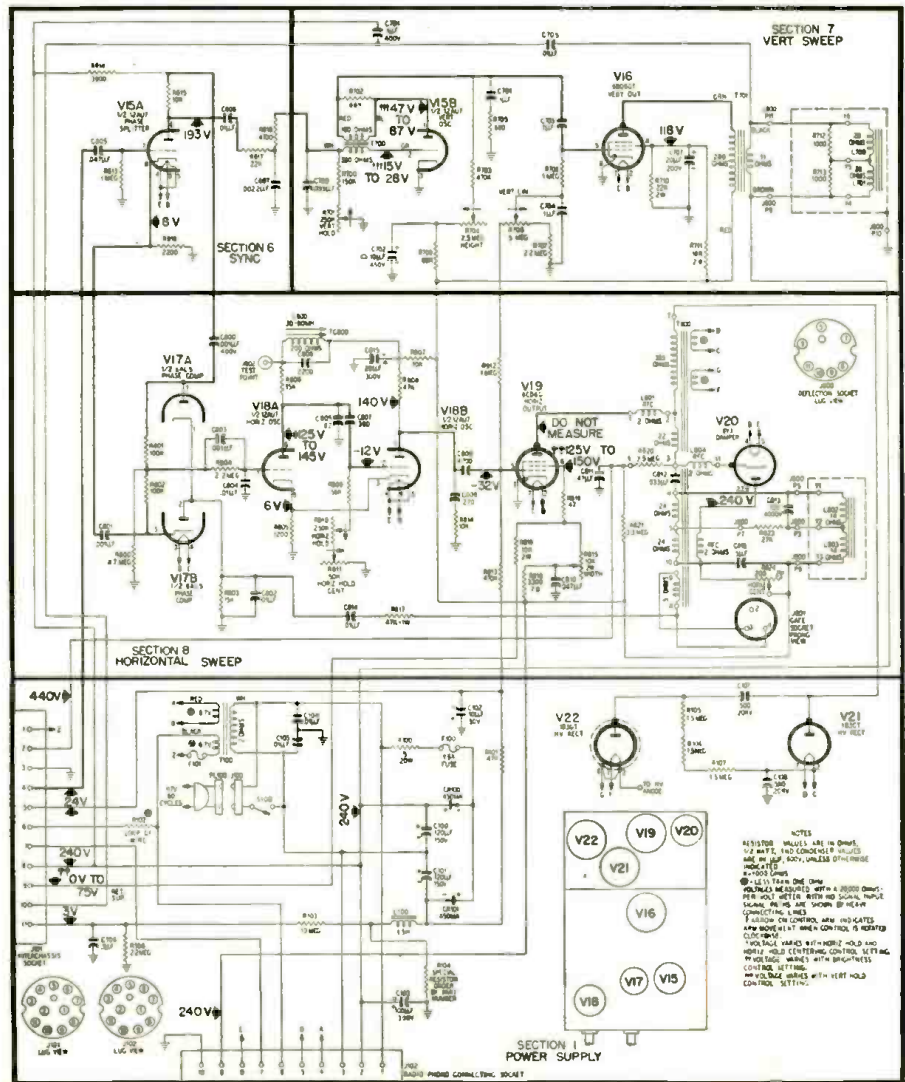

Fig. 6. Gated-leveler tube grid circuit.

Fig. 7. Schematic of the Philco deflection chassis, J-7, used in 1953 receivers.



longer for the oscillator to come out of cut-off and thus, the frequency is decreased. Therefore, the horizontal oscillator can be said to be frequency stabilized by the phase comparator action.

The horizontal oscillator and output circuit is conventional except for one feature. The output from the horizontal oscillator is fed to the grid of the output tube. (See Fig. 7.) The screen circuit of the 6CD6 output tube is unique in that the width and brightness controls are interacting. The screen is tied back to the brightness control through the 10,000 ohm resistor R_{516} . If the width control is varied so that the screen voltage is reduced, the plate current reduction will result in a corresponding width reduction. When the brightness control is advanced, the slight reduction in high voltage will cause the width to increase. The circuit arrangement is such that as the brightness control is advanced, the screen voltage of the horizontal output tube is reduced slightly and thus compensates for the width increase.

Special Service Techniques

Unstable horizontal sync: Since the phase comparator serves as a balanced phase circuit, any change in individual circuit components may cause unbalance and faulty action. The balanced phase comparator plate load resistors, R_{800} , R_{801} , and R_{802} are especially critical in this respect.

By using a test oscilloscope, the phase of the sync pulses at the plate and cathode may be checked. As was explained previously, they should be of opposite phase. It would be wise to change the .01 μ f. condenser C_{501} if the trouble appears in this circuit.

Extremely black picture, tearing: A test oscilloscope will save much time in troubleshooting the a.g.c. circuit, source of this trouble. Checks should be made at the grid and plate of the a.g.c. gate tube for proper waveform and amplitude.

Also check the action of the 1st

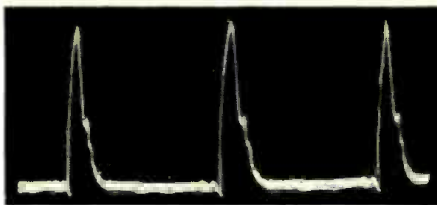

Fig. 9. Positive sync signal from the plate of the phase splitter tube, V_{15A} .

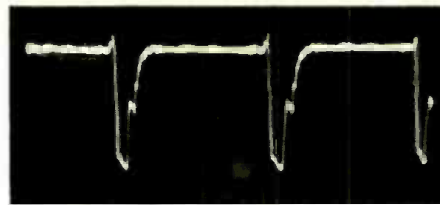

Fig. 10. Negative sync signal from the cathode of the phase splitter.

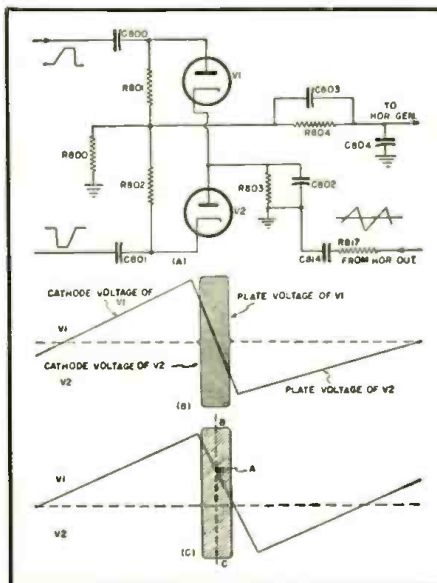

Fig. 11. (A) Simplified schematic of phase comparator circuit. (B) Horizontal oscillator and sync pulse in-phase. (C) Horizontal oscillator running fast.

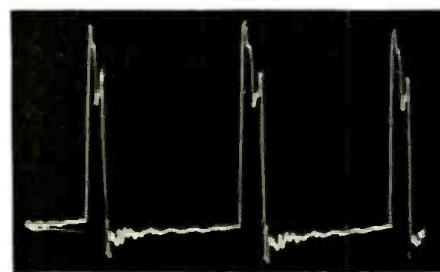

Fig. 12. Horizontal sweep output pulse from special output transformer winding.

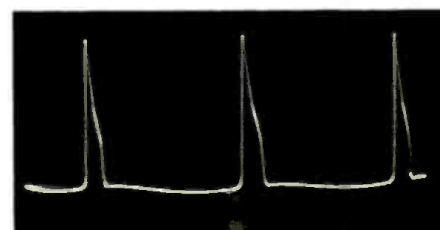

Fig. 13. Waveshape of the voltage at the horizontal oscillator cathode. A similar (but inverted) waveshape at the plate is fed to the output tube grid.

sound i.f. amplifier since the a.g.c. gate derives its bias from the plate load resistor of the video amplifier in series with the 1st sound i.f. tube.

It should also be remembered that defects in the horizontal output circuit will affect the a.g.c. gate plate keying pulse and, thus, over-all a.g.c. operation.

Aligning the r.f. chassis: The most practical method for oscillator slug alignment is to utilize the station signals available. With this system it must be ascertained that the video i.f.

strip is correctly aligned. To adjust the slugs, use the following method:

1. Turn the fine tuning control so that it is in the center of its range.
2. Tune in the highest frequency channel to be received and adjust the oscillator slug starting with sound in the picture and turning until the sound just disappears from the picture. (The video carrier i.f. set to the 50% point on the response curve.) Repeat this operation for all channels to be received.

(Continued on page 92)

Fig. 14. Top view of the r.f. chassis showing trimmer locations and video i.f. alignment procedure.

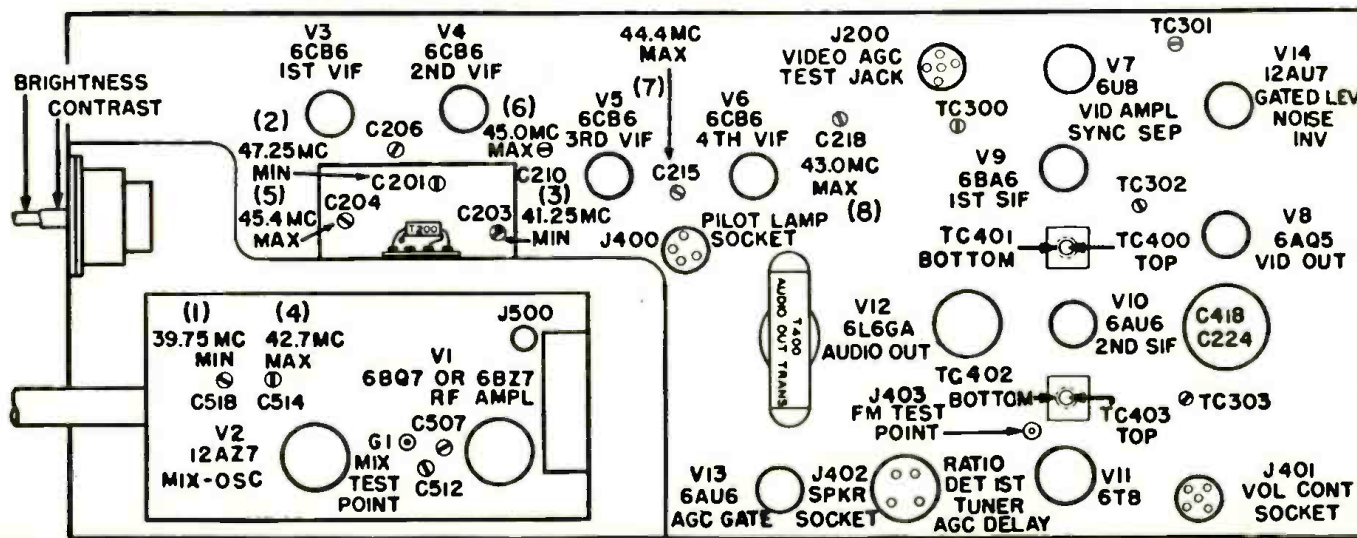

THE FISHER MASTER AUDIO CONTROL

By
JOHN R. RUSSELL

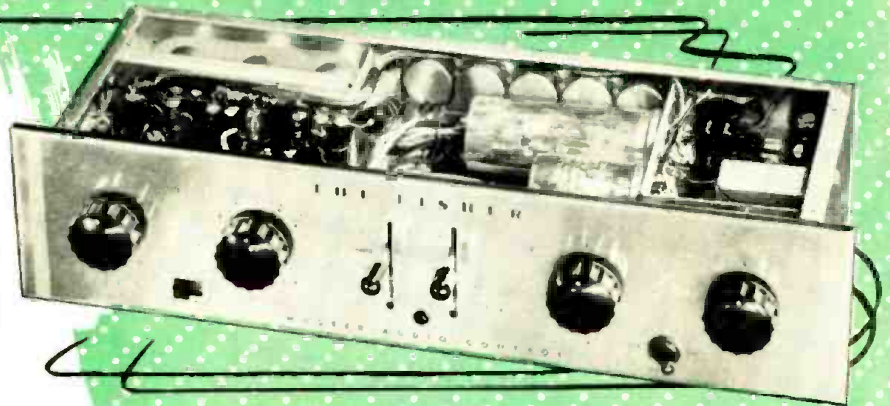

Fig. 1. Front panel view of the Fisher Model 50-C master audio control unit.

THE TREND in recent years has been to incorporate centralized audio control into circuitry embracing the selection of various circuits, and with the provision for complete equalization of all circuits included in one unit. The Fisher Model 50-C (Fig. 1) is typical of audio units now available having self-contained facilities for channel selection, tone control, and phono equalization. Besides possessing other features found in custom units, such as "Loudness Control," this equipment provides an extremely low hum level due, principally, to its use of triodes and a well-engineered power supply.

The circuit, Fig. 4, uses three dual-purpose tubes. One is utilized for phonograph and microphone preamplification in the main circuit. One-half of the 12AU7 is used as an input cathode follower to produce a low impedance source, both to the recorder output jack and to the loudness control. This is followed by one-half of the 12AX7 to provide voltage amplification. This stage operates with a comparatively low value of plate load resistor and is followed by the principal tone control circuits. The second half of the 12AX7 follows the tone circuits and provides additional voltage amplification. Distortion is greatly reduced by utilizing a degenerative circuit. The second section of the volume control follows this stage, and operates into the remaining half of the 12AU7 tube. This latter stage functions as a cathode follower to obtain low impedance output and to provide a low input loading to the volume control.

Relatively low impedances are used throughout the circuit to obtain the

lowest possible noise level. Crosstalk is effectively eliminated by providing an additional section on the "Selector Switch" to short out unused inputs.

The phonograph preamplifier circuit comprises both halves of a second 12AX7 connected as a cascaded triode amplifier. Low frequency boost for proper record turnover is achieved with conventional RC networks. The turnover frequency is selected by switching various values of capacitance in the circuit. Conventional RC networks follow the second section of the 12AX7 to accomplish high frequency roll-off. This results in reduction of noise arising from the preamplifier tubes and their components. The circuit is so arranged that, by means of a simple wiring change, the microphone input can be converted to a second magnetic phonograph input.

Switching transients have been effectively reduced by proper design, and no "clicks" or "pops" are perceptible when either the "Selector" or "Equalization" switches are operated. Close tolerance components are used in all frequency-sensitive circuits to assure close adherence to published specifications. Extensive shielding and the use of a common ground bus, keep hum to an absolute minimum.

The 50-C control is completely self-contained (Figs. 1 and 6) and no external power supply facilities are required. Power is provided by a filtered bridge-type selenium rectifier which provides d.c. for all heaters. It also provides plate voltage using a full-wave selenium rectifier and a four-section RC filter. The entire unit draws but 15 watts.

Five inputs and five independent in-

Fig. 2. Bass and treble control range for the Model 50-C.

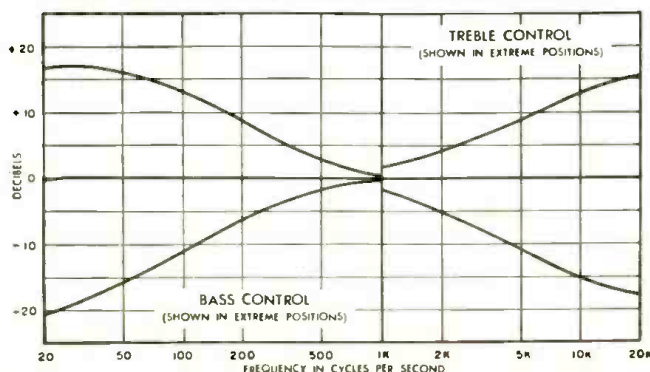
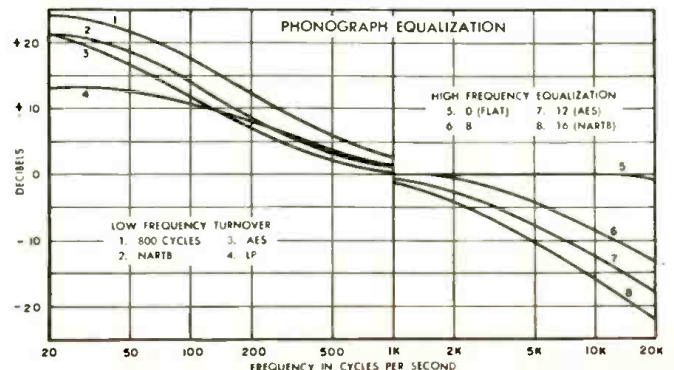

Fig. 3. Phonograph equalization curves for the control unit.



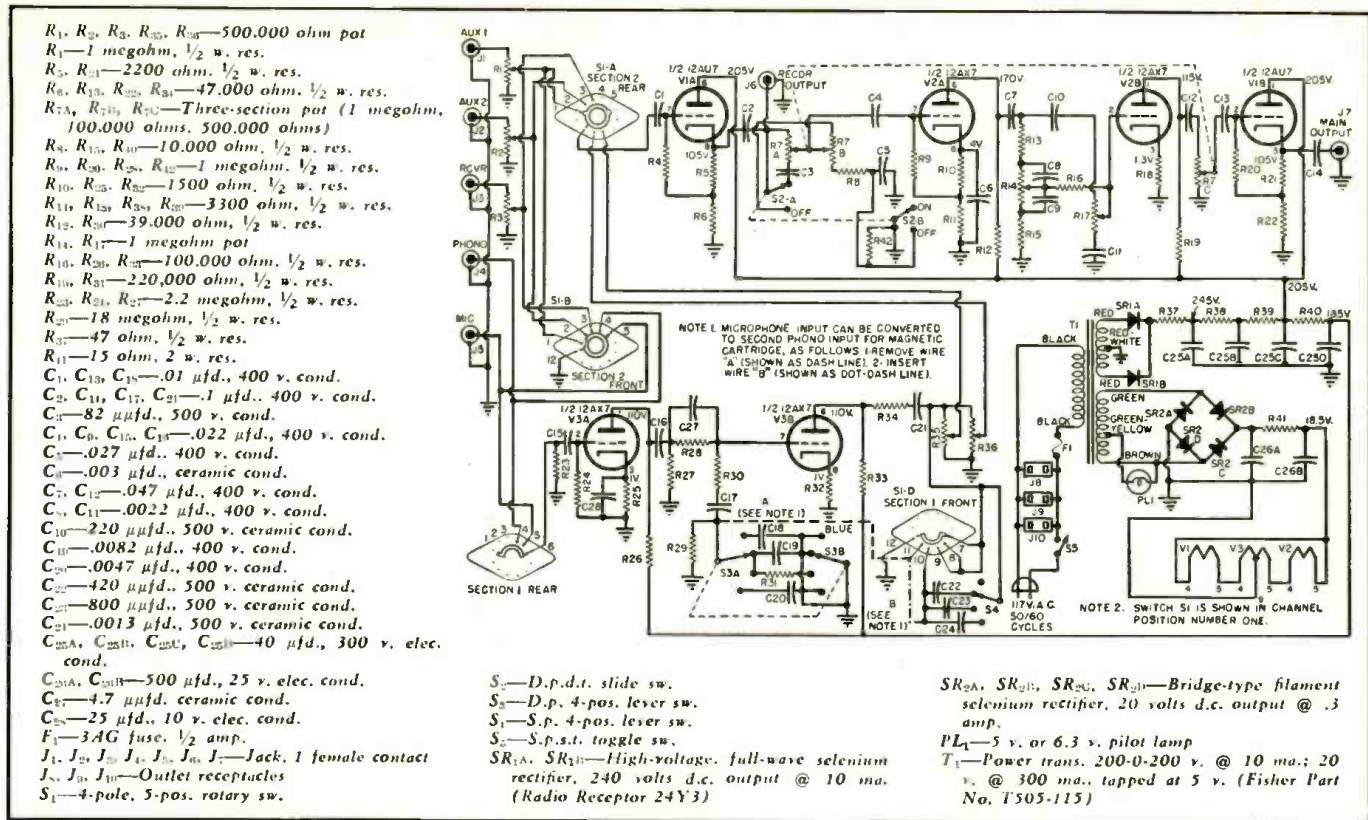

Fig. 4. Complete circuit diagram of the Fisher Model 50-C "Master Audio Control."

put level controls are available by means of the "Selector Switch." The input level controls perform the further function of permitting correct level settings for proper performance of the "Loudness Control."

Two output channels are provided. Both of these employ cathode-follower circuitry. The "Main Output" can be connected to any amplifier having an input impedance of 100,000 ohms or greater. Because of the low internal impedance of this output circuit, the connecting cable length will not be critical and runs up to 200 feet may be used. The same condition would apply to the "Recorder Output." The latter circuit is taken preceding all tone controls and is used to furnish a signal to a tape or wire recorder. It also provides simultaneous monitoring from the "Main Output."

Panel Controls

1. **Volume Control.** All essential controls are mounted conveniently on an etched panel to facilitate the operator's job. They include a three-section volume control incorporating the loudness control compensation facilities. This compensation is based on the Fletcher-Munson curves.

2. **Loudness Control Switch.** This control will be found adjacent to the volume control. In the "Off" position, the volume control becomes a two-section gain control.

3. **Selector Switch.** This has five positions, including two auxiliary inputs plus receiver, phonograph, and microphone settings. This arrangement thus provides a common central switching point for the entire system.

4. **Bass and Treble Tone Controls.** The mid-range position of these controls provides an essentially flat response. Up to 16 db of cut or boost are provided at approximately 50 and 10,000 cycles respectively. See Fig. 2.

5. **"On-Off" Switch.** The capacity of the switch is 6 amperes. The handling capacity is sufficient to take care of the normal requirements of a conventional audio system. Three auxiliary a.c. receptacles are provided and are all operated by the "Control Switch."

6. **Phonograph Equalization Switches.** Separate lever-type switches are included for both bass and treble equalization and each is provided with four distinct positions. The bass provides turnover frequencies for AES, NARTB, LP, and 800 cycles. The treble switch includes 0 db, 8 db, AES, and NARTB roll-off points. Thus

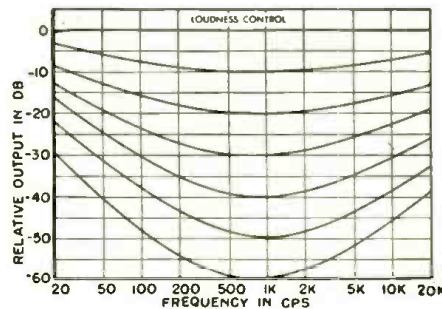

Fig. 5. Loudness control curves of unit.

there are sixteen possible combinations for full equalization. Fig. 3.

Specifications

Specifications on the Model 50-C include:

(Continued on page 94)

Fig. 6. Rear chassis view of the Model 50-C, a self-contained audio control unit.

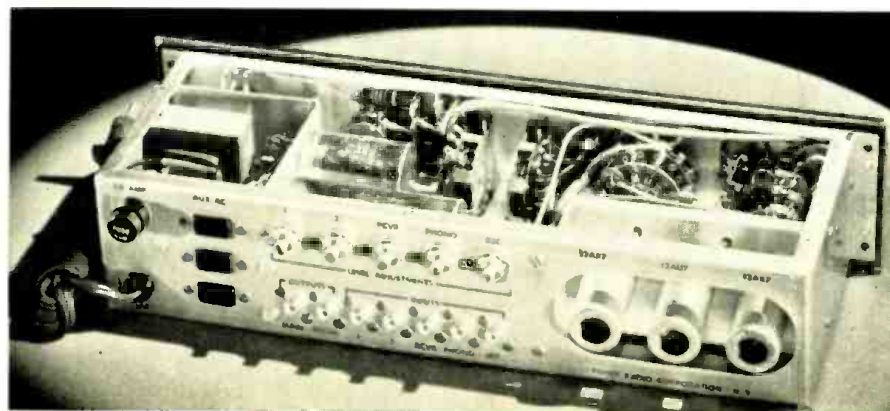

ELECTRO-VOICE

Aristocrat

By HOWARD SOUTHER
Electro-Voice, Inc.

Construction details and performance data on a folded corner horn enclosure. It will accommodate any high quality, low resonant frequency, 12-inch loudspeaker.

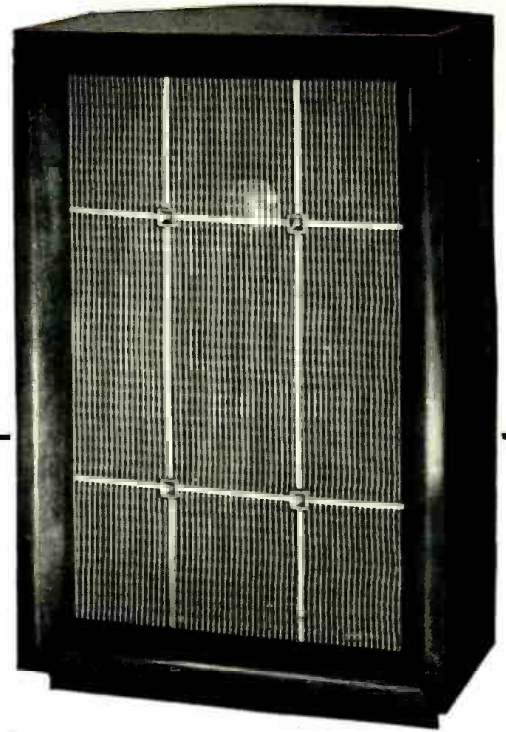

The E-V "Aristocrat" enclosure. The performance data covered in article was obtained using the E-V SP12-B "Radax" unit.

THE mind through the ear delights in the stimulus caused by sounds which are mathematically related. The generation of such sounds is called music. It is generally conceded that the widest variety of these sounds causes the greatest satisfaction; thus, we find that loudspeaker systems of the widest response range are the most pleasing, granting good source material of low distortion as an understood prerequisite.

Where space is limited there is no particular problem in achieving excellent response in the treble ranges. Generating mechanisms for producing the rapid, delicate pulses of the higher frequencies are inherently small in themselves. But not so the bass range, comprised of the first two octaves from 30 to 120 cycles-per-second.

The area near a sound generator, in this case the cone of a loudspeaker, is what engineers term a region of high acoustical impedance. To achieve useful transfer efficiency of motion into acoustical energy, we must build up considerable air pressures.

To deliver these sound pressure waves to the listening area, a region of very low pressure or low acoustical impedance, a transformer of some kind is required, just as it is in an electrical circuit.

The recognized scientific means of accomplishing this transformer action is through the use of a horn. This horn must expand in area at a constantly accelerating rate to accomplish its function, the ideal horn being one of infinite length and infinite mouth size.

The Horn Design

This last requirement almost stops the design project before it begins. But let us examine first the requirements of a suitable horn. Fundamental tones of even the largest bass instru-

ments, such as monstrous drums and 16 foot organ pipes, start at 30 cycles per second. The mouth requirement for a horn capable of reproducing a 30 cycle tone is $\frac{1}{4}$ the wavelength of this tone, or 111 inches. For a 50 cps tone, this dimension decreases rapidly to 80 inches.

The next thing to consider is the length of the horn. The formula governing horn design says that the taper rate, or the flare, governing the expanding cross section of the horn, shall double every $1\frac{1}{2}$ feet of its length in order to reproduce a 30 cps tone at the mouth (whose cross section we have already computed to be 111 inches).

The Design Takes Form

Our design still has impossible dimensions for the living room: something having a length of 6 to 10 feet, according to the throat size we select at the start of the horn, and a mouth 10 feet across! On the other hand, certain things are in our favor:

Ideally, the lowest tones in frequency lend themselves easily to propagation in a closed cavity of a size such as our living room. Examination reveals a partial horn available in the corner of the room, the mouth of which is in most cases more than 111 inches across! Some years ago, Paul Klipsch, the noted acoustics authority, seized upon the idea of housing only the throat of the required horn in a furniture cabinet and placing it in this corner. In the design of the "Aristocrat," we find that by keeping the driver unit itself small, we have such a throat assembly of very compact proportions. There now results a clean, extended low-frequency response to the 30 cps region, surprisingly free from peaks and valleys in its characteristic curve. But, although the range is well extended and satis-

factory, the efficiency in the first octaves is still too low to accomplish a pleasing musical balance. This is true, in the main, because our driving cone is only a piece of parchment, and a far cry from the ideal acoustical requirement for a piston of infinite lightness and infinite rigidity.

Building the Efficiency

By exploiting a phenomenon involving acoustic resonance, the efficiency in the bass range may be augmented as much as 4 to 8 times. Observe the cross-sectional drawing of the "Aristocrat": By utilizing the reactance of the small air mass directly behind the speaker, in conjunction with the high compliance or capacitive factor of the specialized driver cone, the combination can be used to reinforce the sound over a four-octave band with the large air mass, due to the horn, which is presented by the corner.

Performance

If the "Aristocrat" is carefully constructed, and care is taken to effect a complete seal of the front baffle board to prevent air leaks from front to back, rather startling bass performance will be realized. Response range will be as shown in the curve (Fig. 2) revealing a response within 5 db of flat to about 30 cps. This operation is supported by evidence disclosed in the impedance characteristic (Fig. 1) denoting a satisfactory reactive component in the voice-coil system well into the first octave. The high impedance at 120 cps is fortunately not reflected adversely in the frequency response curve.

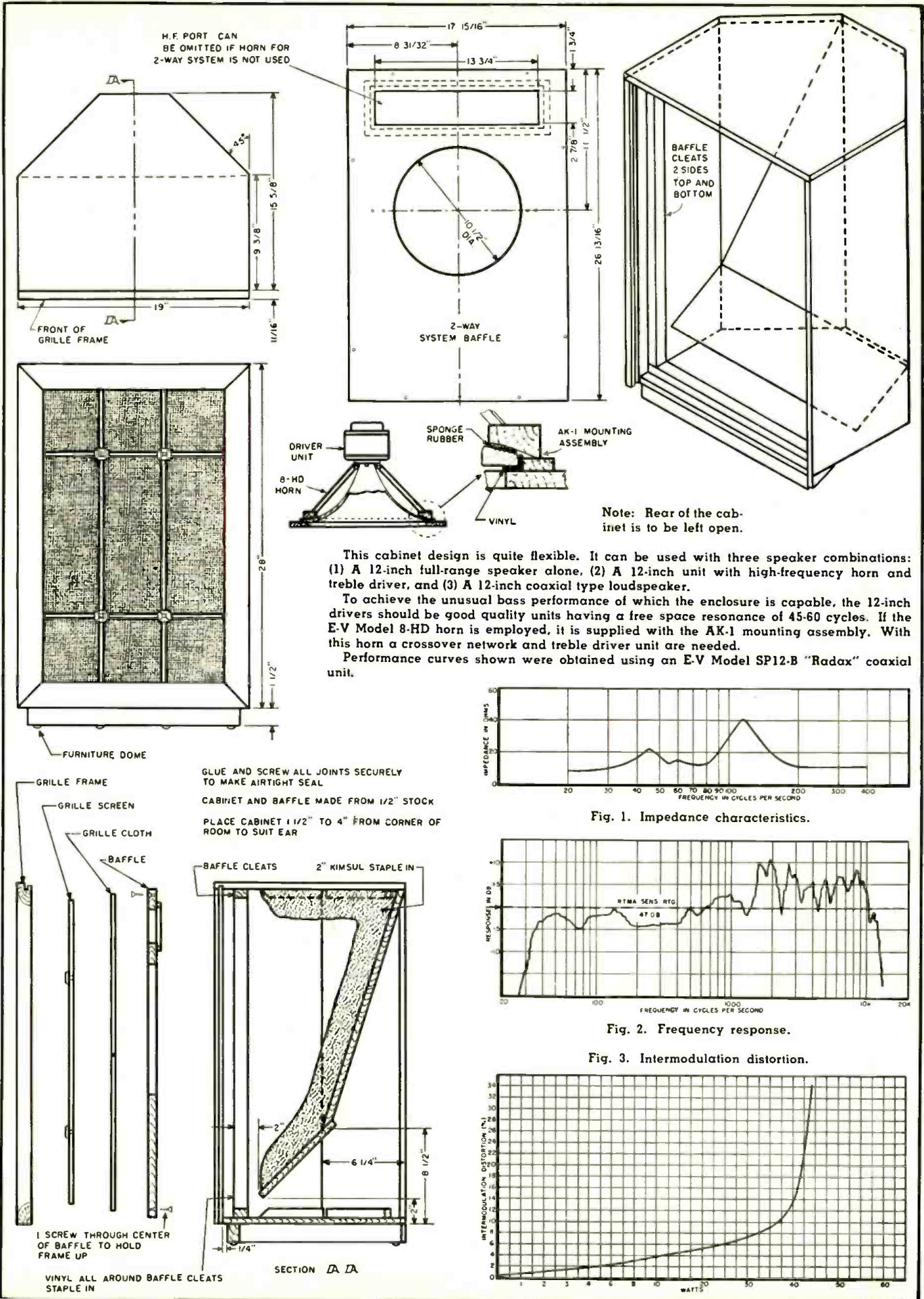

This cabinet design is quite flexible. It can be used with three speaker combinations: (1) A 12-inch full-range speaker alone, (2) A 12-inch unit with high-frequency horn and treble driver, and (3) A 12-inch coaxial type loudspeaker.

To achieve the unusual bass performance of which the enclosure is capable, the 12-inch drivers should be good quality units having a free space resonance of 45-60 cycles. If the E-V Model 8-HD horn is employed, it is supplied with the AK-1 mounting assembly. With this horn a crossover network and treble driver unit are needed.

Performance curves shown were obtained using an E-V Model SP12-B "Radax" coaxial unit.

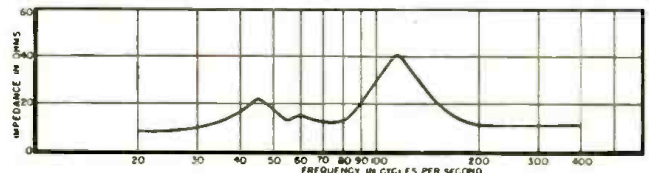

Fig. 1. Impedance characteristics.

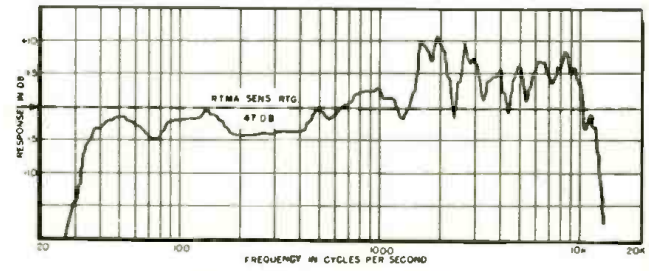

Fig. 2. Frequency response.

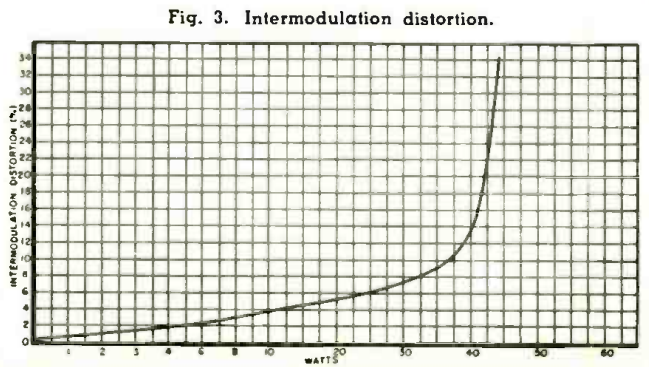

Fig. 3. Intermodulation distortion.

THREE WATTS

IN A

COFFEE CAN

By
JIM FAHNESTOCK,
W2RQA

The components for the 3-watt transmitter are mounted on a coffee-can lid. The r.f. tank assembly shown is from a BC-746 tuning unit; equivalent parts may be used.

Built for less than five dollars, this three-watter brings back the simplicity, economy, and ingenuity of "the good old days." A challenge to operating skill, and some real fun.

IN AUTOMOBILE racing, midget racers draw the most consistent crowds. In sailboating, the greatest spirit is displayed in the small boat classes. The true sport comes from competition where equipment used is standard to all contestants, and the simpler the equipment, the more the fun.

The coffee-can transmitter described in this article was designed to be a contest midget for hams. The idea was conceived at a meeting of the Wantagh (Long Island) Radio Club after an evening of the usual argument over ways to stimulate operating activity among club members. Club nets and contests were discussed, but it was not until the coffee-can rig was suggested that these ideas took hold.

To make the idea of building a low-power transmitter attractive to the greatest number of members, low cost was placed at the top of the list of design requirements. The final circuit chosen, after a painstaking, penny-conscious investigation of every conceivable combination of available parts, is shown in Fig. 2. With a little shopping around in the surplus ads, all the parts including tube, crystal, power supply, and key can be purchased for less than a five-dollar bill. To a man with a good junk box and the standard "odds and ends" of surplus, this can nearly be a "no-cost" transmitter.

The pentode portion of a 117L7GT

is connected as a modified Pierce oscillator running about three watts input in the 80-meter c.w. band. The diode portion of the tube serves as a half-wave rectifier and provides approximately 125 volts d.c. through a simple RC filter. The crystal socket and plate tank condenser and coil can

Fig. 1. Alternate ways of feeding power to the antenna (see Fig. 2). (A) "Pi" network for random-length wires or a coaxial feeder. (B) Simpler "L" coupler, somewhat less efficient but still useful (see text).

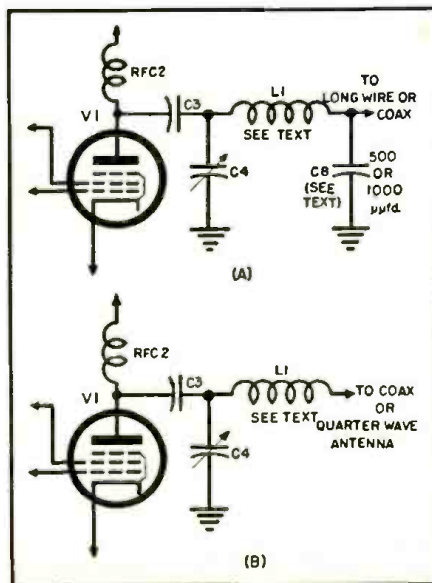

be obtained already mounted on a convenient subchassis from a BC-746 tuning unit available at surplus. Only a handful of readily available parts are required to complete the circuit.

The top of the coffee can serves as a chassis and the can itself provides an air tight (and incidentally a TVI-proof) cabinet. Placement of parts can be seen in the photographs. The BC-746 tuning unit is mounted as close to the edge of the can lid as possible after all the original wiring and the fiber jack strip that comes attached to each unit is removed.

The octal tube socket for the 117L7GT is mounted on a pair of right-angle brackets and furnishes convenient tie points for the small parts of the power supply and r.f. section. A two-terminal strip mounted on the can top directly beneath the tube socket furnishes feedthrough connection for the keying leads (a jack may be substituted, if desired) and an RCA phonograph plug serves as a feedthrough for the antenna. The line cord passes through a $\frac{3}{8}$ -inch hole in the can top fitted with a rubber grommet.

Power Supply Precautions

In order to keep cost at a minimum, a transformerless a.c.-d.c. type power supply is used. This introduces a shock hazard unless proper care is taken to plug the line cord into the wall socket in such a way that the wire connected directly to the coffee-can ground is the wire that connects to the grounded side of the a.c. line.

One procedure for orienting the plug in the correct manner is as follows: Connect a small 117-volt light bulb between the coffee-can chassis and a good external ground, such as a water pipe. The plug is then inserted in the wall outlet. If the bulb lights, the plug has been inserted incorrectly and should be reversed. Once the correct orientation has been determined, plug and socket can be marked in some convenient way to insure correct insertion

each time the rig is plugged in. A dab of paint on one side of the plug and alongside the corresponding socket hole will serve as a permanent guide.

Tuning Procedures

In tuning the rig initially, a 0 to 100 ma. meter may be connected across the key terminals to indicate a dip in cathode current when C_1 is adjusted to resonance with L_1 . An alternate tuning procedure is to tune C_1 until maximum "S"-meter reading is indicated on a nearby receiver. A single-turn link with a 0.25-ampere pilot lamp placed around L_1 will also provide an indication of resonance.

Some of the Wantagh gang who made these rigs found that sluggish crystals would refuse to oscillate or follow keying in this circuit. This was easily remedied by the insertion of a 250 μ fd. condenser, C_7 , shown in dotted lines on the diagram, from the screen grid of the 117L7GT to ground. New and active crystals ought to take right off, and C_7 can be eliminated, saving fifteen cents or so in the overall cost.

If the BC-746 tuning unit is used, either the 3825 or 5500 kc. coil may be used without modification if the link output arrangement shown in Fig. 2 is used. This arrangement will match coax or a 300-ohm twin-lead line.

Two alternate systems for coupling energy to the antenna are shown in Fig. 1. By experimenting with values for C_4 , L_1 and C_5 in the π network shown in Fig. 1A practically any length of wire can be made to take power from the rig. To match low-impedance antenna systems with the π network (coax or quarter-wave antennas) the tuning unit coils should be pruned to about 30 turns for best results. For coax output C_5 should be somewhere between 500 μ fd. and 1000 μ fd. After the value of C_5 has been determined for best results for one crystal in the 80-meter band, no further changes in that value are required for other frequencies in that band. C_1 is adjusted for resonance at each new frequency in the band.

The L network shown in Fig. 1B is admittedly not ideal from the standpoint of harmonic attenuation, but with the low power level involved, no trouble has been noticed and good transfer of power is obtainable.

If TVI is noticed emanating from the coffee can, it is a fairly safe bet that r.f. is being fed back through the line via the direct connection in the power supply. This can be eliminated completely by inserting a small u.h.f. choke in series with the "hot" side of the line inside the coffee can and bypassing the rectifier plate connection with a small .005- μ fd. mica or disc ceramic condenser.

Operation

Experience in operating the coffee-can rigs shows very clearly that they get reports that compare quite favorably with rigs running considerably more power. It is interesting to note

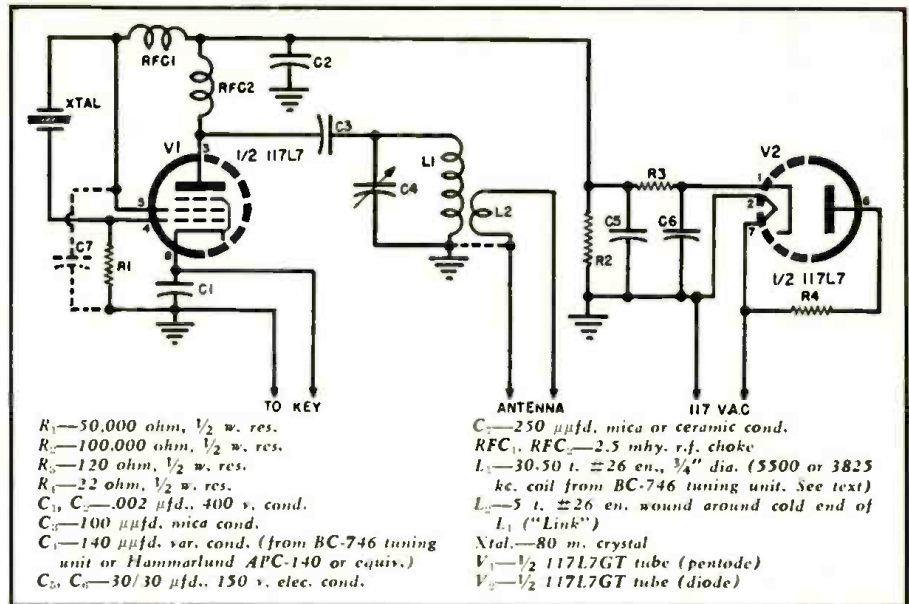

Fig. 2. Complete schematic of the 3-watt "coffee can" transmitter. It is complete with its power supply inside a one-pound coffee can. "Phono" jacks may be used for the key and antenna. C_7 (dotted lines) is added for sluggish crystals (see text).

reactions from operators on the other end when you explain that you are running *three watts*. On regular Wednesday night gab fests around town surprisingly little trouble from QRM has been observed, and it is comforting to know that you are actually complying with the FCC regulation that says, "Ye shall use only enough power to accomplish the desired communication."

If a group of locals can be talked into building coffee-can rigs, a great amount of pleasure can be derived from rag chews, practice CD nets, and local contests. If a common frequency is adopted, it is usually a simple matter to get into a relaxing chat without firing up the big "TV eliminator," and considerable satisfaction results from the realization that you are doing very little to contribute to the retirement

fund of the local power company officials.

Since the birth of the coffee-can rigs in Wantagh, the number of idle kilowatts has risen considerably, but the number of operating hours has also gone up. Contests to see who can work the most states or the most distant station in a given period of time are sometimes quite revealing, since they show who is the best operator, and not who has the fattest pocketbook.

A variety of modifications of the basic design is possible for different requirements. By appropriate wiring changes and tube substitutions, battery operation is feasible for CD work and local field days. The main thing is to get the gang started, and this is best accomplished by keeping cost and complexity to a minimum. —30—

Enclosing the transmitter in its coffee can affords good shielding for TVI and, like any cabinet, protects the circuit. Unless the line plug is polarized correctly, the can will be "hot" with a.c. (see text). The antenna jack is at upper left.



Mac's RADIO SERVICE SHOP

By JOHN T. FRYE



TEST EQUIPMENT TALK

THE doors of Mac's Radio Service Shop were opened wide to the soft June breeze, and Mac and his red-headed helper, Barney, were displaying strong symptoms of belated spring fever as they sat on the service bench drinking their mid-afternoon Cokes. Neither seemed in a hurry to get back to work. Mac was lazily leafing through the current issue of a radio magazine, and Barney was dreamily practicing his imitation of the river steamer *Robert E. Lee* saluting a friend of the pilot standing on the Friar Point levee. Of course, if you were a dull clod you might have thought he was just blowing across the mouth of an empty Coke bottle, but to admit this would have been to brand yourself as a person of no imagination.

"You know, Flame-head," Mac drawled, "a lot of us have been so busy trying to keep up with the progress of the radio and TV sets we work on that we have failed to notice the improvements made in the instruments we work with."

Barney gave a final mournful toot on the deep-throated whistle of the *Robert E. Lee* and asked, "What brought that on?"

"I was just looking at this ad for a 20,000-ohms-per-volt volt-ohmmeter, which happens to be the same one we use here, and thinking what a far cry it is from that old 1000-ohms-per-volt tester I used for so many years. A funny thing is that many technicians have gone directly from that old-fashioned v.o.m. to the exclusive use of a v.t.v.m., and they still think that all v.o.m.'s are as insensitive and load circuits being tested as heavily as did that old-fashioned job."

"Well, volt-ohmmeters still have a

lot less resistance than vacuum tube voltmeters," Barney argued.

"That depends upon what scale of the v.o.m. you use. I'll grant you that when both instruments are used on the low-range scales, the vacuum tube job is much superior, for the typical v.t.v.m. has a fixed resistance of ten megohms in the instrument and one megohm in the probe for a total of eleven megohms on all scales. The 20,000-ohms-per-volt meter, on the other hand, has a variable resistance that is always equal to twenty thousand times the full-scale voltage of the range being used. That means that on the five volt range its hundred thousand ohms compares very poorly with the v.t.v.m.'s eleven megohms; but on the 500 volt range the v.o.m.'s ten megohm resistance is nearly equal to that of the v.t.v.m., and at 1000 volts the v.o.m. has surged far ahead with a resistance of twenty megohms. When high voltage probes are used with both instruments to increase their range to say 30,000 volts, the resistance of the v.t.v.m. is raised to only about 300 megohms, while the resistance of the 20,000-ohms-per-volt meter is 600 megohms. That means if it is used to check the high voltage of a picture tube, it will draw only half as much current as will the v.t.v.m."

"Say, how about that!" Barney exclaimed with sudden interest. "I never realized that was true. Any old time you get above about 500 volts, the loading of a modern v.o.m. is actually less than that of a v.t.v.m."

"True, and I might add that the bearings used in the 50 microampere meter movements employed in these 20,000-ohms-per-volters are so good that the readings obtained on the

lower parts of the scales are quite accurate and dependable. That means you can use a high range scale to insure minimum loading and still be able to depend upon the readings obtained."

"Looks as though there's not much sense in buying a v.t.v.m. at all," Barney observed.

"Now let's not get carried away," Mac warned. "I still think that the v.t.v.m. is the ideal service instrument, for bench use. When measuring such things as oscillator bias, a.v.c. and a.g.c. voltages, etc., it can't be beat; and as long as you are around, I am greatly comforted by the thought that it is practically impossible to damage the meter by accidentally using the wrong scale. On the other hand I think that every shop should have a good 20,000-ohm-per-volt v.o.m. These meters are quite rugged and will stand up under portable use better than the v.t.v.m.'s. They are always ready for instant use in any location, requiring neither a warm-up period nor external power source. You do not have to worry about changes in line voltage or aging tubes affecting their accuracy; consequently, you always feel a little more confident about the accuracy of readings you obtain with a v.o.m. Both types of meter have their good and bad points that supplement each other. The technician needs both of them."

"That's just one instrument that has been improved," Barney pointed out. "Are there others?"

"Sure thing. Take the oscilloscope for example. Just before the Second World War was when the scope really moved out of the laboratory into the service shop. That was when a lot of technicians bought their first scopes, and the instruments they bought were very limited in both sensitivity and frequency range. That job we use for checking vibrators is typical of those early oscilloscopes, and you will recall that when we checked it out with the voltage calibrator and square-wave generator a while back we found that the deflection sensitivity was .65 volt per inch and that the response of the amplifiers fell off very rapidly above 50,000 cycles; furthermore, the setting of the amplifier gain control had a tremendous effect on the response of the amplifier itself.

"A few of the fellows," Mac went on, "who think 'an oscilloscope is an oscilloscope,' are still trying to use these ancient jobs for TV service. Others who have bought modern instruments for TV alignment purposes still think of the *general* uses of the oscilloscope in terms of the very limited possibilities they discovered when they experimented with those early models. They do not realize that the modern scope with its ten or twenty millivolts-per-inch sensitivity, its frequency range extending up into the megacycles, and its step-type nonfrequency-affecting attenuator will do dozens of jobs in radio and TV service

(Continued on page 110)



International SHORT-WAVE

Compiled by KENNETH R. BOORD

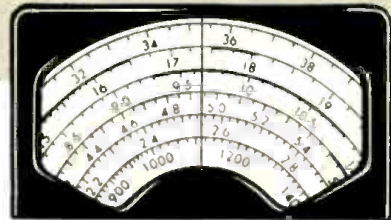

THIS month's cover features your short-wave editor, Ken Boord, at the *ISW DEPARTMENT* Listening Post at his home, 948 Stewartstown Road, Morgantown, West Virginia, USA.

The equipment in the photograph includes a *Hammarlund SP-600-JX* (Super Pro); a *Hallicrafters SX-73*; a *National NC-183-D*; a *Hallicrafters SX-28*; an *RME DB22A* preselector; a Panadaptor; and a *BC-221-AH* frequency meter. The tiny receiver atop the Panadaptor is your short-wave editor's first radio—a crystal set dating to the mid-1920's.

The Listening Post employs straight-wire antennas and doublets cut to the popular short-wave bands. Best overall results have been obtained with a 300-ft. straightwire. Lead-ins are of 100-ohm shielded twin-lead transmission line.

Your short-wave editor began SWLing in the early 30's, first using a converter, and then a four-tube short-wave receiver with plug-in coils and a speaker made from an old automobile horn and a headphone set. He was a contributor to *RADIO & TELEVISION NEWS'* short-wave department in the 30's and to leading radio organizations. He began the *ISW DEPARTMENT* with the June 1944 issue.

* * *

Around the World

(NOTE: Some stations may have changed to *summer* schedules since this was compiled; in such cases, you may hear them *one hour earlier* than listed herein.—K. R. B.)

Algeria—Algiers now uses only 6.160 at 0700-1745. (Scheiner, N. J.)

Anglo-Egyptian Sudan—Radio Omdurman noted now near 7.655 signing on 1115 in *English* on Wed.; reported also using 6.437 now. *English* is scheduled Sun., Wed. 1115-1130, Fri. 1230-1300. (Pearce, England)

Argentina—LRA, 9.69, Buenos Aires, has strong signal 2000A. (Dadson, Mich.) Noted to North America East Coast now on 15.345 (moved from 17.720) at 1700-1930. (Balbi, Calif., others)

Australia—VLC11, 11.840, is now used to Eastern North America 0700-0845; DX session Sundays 0830.

Belgium—Brussels noted to North America daily over 9.767, in French 1900, *English* from 2030; on Wed. has DX session 2100. (Morrison, R. I., others) Noted closing 2200. (Matherly,

Ohio) ORU5, 6.000, strong 1305. (Catch, England)

Belgian Congo—OTH, 9.215, Leopoldville, good level 1200, native. (Catch, England) *Radio College*, OQ2AC, Elisabethville, lists schedule daily 1130-1230 (Sun. 0200-0400) on 7.2, 4.98, 3.39 with 250 watts each; mostly French but on Fri. uses Flemish (or Dutch) and closing announcements include *English*. Hopes to increase power of at least the 4.98 outlet to 500 watts soon. (Scheiner, N. J.)

Bolivia—CP38, 9.497, La Paz, noted on *measured* channel 0645 with religious service in Spanish. (Ferguson, N. C.)

Brazil—PRL7, 9.72, Rio de Janeiro, good level signing on 1930. (Morrison, R. I.) *Radio Jornal do Commercio*, 15.145, noted closing 1433A in *English*, Portuguese; said continuing over 9.565. (Pearce, England) PRK5, 6.000A, Belo Horizonte, noted 1930 with QRM, weak. (Washington, N. J.) ZYC8, 9.610, Rio de Janeiro, fair level 2020; PRC5, 4.865, Belem, good level 2000 with news in Portuguese; ZYY9,

4.97575, Sao Luiz, heard at fair strength 2045. (Catch, England) ZYK2, 9.565, Recife, noted from 1530 at good level in Sweden. (Friberg)

British Honduras—Occasionally, Belize, 4.950A, is in the clear around 1900. (Black, Pa.)

Bulgaria—Sofia, 9.700A, good in *English* to North America 2000-2030. (Klein, Va.) Noted on 6.070 in *English* 1600-1630. (Hanel, Sweden)

Burma—Rangoon, 4.774A, is heard in Sweden 0900-1000 in *English*. (GDXX-aren, Sweden)

Cape Verde Islands—CR4AA, 7.130A, Praia, noted 1557-1700 when closed with "A Portuguesa." (Pearce, England) More recently has moved to 7.395A. (Washington, N. J.; Mercier, France, others)

Ceylon—Radio Ceylon, 11.975, noted closing Thur. 1215; Fri. 1230, other days 1145. (Fuller, R. I., others)

China—Wahun, 6.645, heard 0618, had CWQRM. (Ballou, Calif.)

Colombia—HJEF, 4.768, Cali, noted 2308-2332. (URDXC) *Radio Pacifico*, HJEX, 6.054, Cali, good around 2100-2130. (Norman, N. C.) HJAE, Cartagena, noted close to 4.9665 around 2300. (Gaylord, Washington State) HJQC, 11.680, Bogota, carries "English by Radio" 1930. (Niblack, Ind.)

Costa Rica—Radio Athena, San (Continued on page 130)

(Note: Unless otherwise indicated, all time is expressed in American EST; add 5 hours for G.T. "News" refers to newscasts in the English language. In order to avoid confusion, the 24 hour clock has been used in designating the times of broadcasts. The hours from midnight until noon are shown as 0000 to 1200 while from 1 p.m. to midnight are shown as 1300 to 2400.) The symbol "V" following a listed frequency indicates "varying." The station may operate either above or below the frequency given. "A" means frequency is approximate.

Eduardo Lopez Juarez, CE3CB, of San Miguel, Chile is shown in his radio "shack." Equipment includes a 50-watt transmitter, a three-tube receiver, and a "Little Giant Station." Mr. Lopez Juarez is a Major Sub-Officer in the Chilean Air Force in the Radio Communications Branch. At the present time he is stationed at the Central Airfield of the Air Force. CE3CB is one of the world's best-known calls, having been on the air for over 15 years and participating in thousands of successful QSO's.



AN OSCILLOSCOPE CALIBRATOR

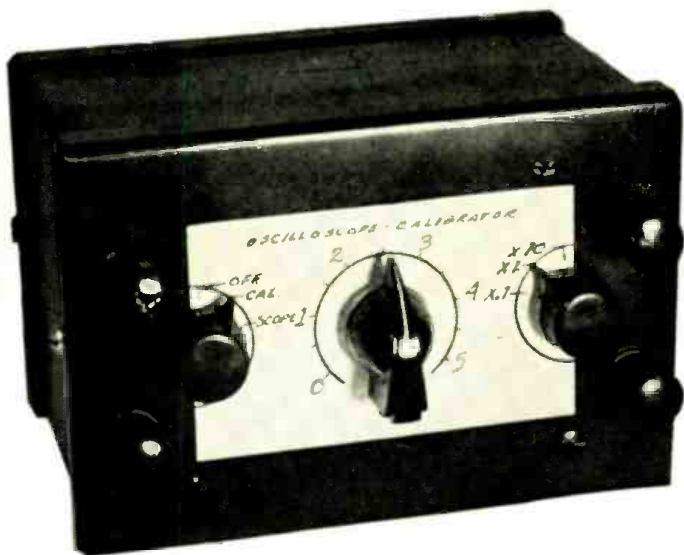

Front view of scope calibrator. It is housed in a compact case.

An easy-to-build accessory unit that will increase the versatility and usefulness of your shop oscilloscope.

VERY often service technicians, experimenters, and hams use their oscilloscopes just for the observation of waveforms. When they do, they're only getting half the value of their scopes. With the addition of the easily constructed oscilloscope calibrator described herein, the scope can be used for actual voltage and current measurements as well as for waveform observation.

The oscilloscope calibrator is nothing more than an a.c. voltage standard, the output of which is independent of line voltage variations. It would be very convenient if we could use a battery or other such stable d.c. source for scope calibration, just as in the usual d.c. meter calibration, but unfortunately we can't since the oscilloscope, or at least the usual one, responds only to a.c. Thus it becomes necessary to construct some sort of device that will produce a constant a.c. signal regardless of any external varying conditions. For oscilloscope calibrating, a square wave provides the most convenient waveform since the top and bottom of the wave are at definite places, not like, for example, a sine wave with its gradually sloping sides. Another advantage is that a square wave is all "top and bottom with nothing in between." Thus because the transition time between the bottom peak and top peak is so very rapid, there appear to be only two lines on the scope when the sweep

frequency is greater than the input square-wave frequency. This provides a very convenient pair of reference lines for calibrating the oscilloscope screen. This effect is shown in Fig. 2.

To make an a.c. voltage standard it is convenient to revert back to a d.c. source which can be more easily and economically controlled. This regulated d.c. source must then be converted back to a.c. This can be accomplished with a simple multivibrator supplied with power from a d.c. regulated power supply. The output of this multivibrator is then fed into an attenuator and calibrated potentiometer to provide a.c. outputs in steps for ease in measuring waves of different amplitudes.

In the unit constructed and shown in the accompanying photographs, this is accomplished simply by using an a.c.-d.c. type of power supply using a 65 ma. selenium rectifier and an OB2 voltage regulator tube. This then makes the multivibrator output independent of line voltage changes. A word of caution for those living in very low voltage areas might be advisable here. The OB2 voltage regulator tube requires a minimum d.c. anode supply of 133 volts to insure starting throughout the tube life. Thus if your line voltage drops below 96 volts, there is the possibility that the OB2 will not fire or may be erratic in operation. In such a case the principles discussed here still apply,

however a standard type of transformer supply will have to be substituted. This would, of course, necessitate a change in the voltage regulator dropping resistor, the exact size depending upon the power supply voltage used.

This regulated d.c. is then used for the plate supply of a simple multivibrator using a 12AU7. The actual frequency that is produced by the multivibrator is relatively unimportant, the important considerations being its constancy of amplitude with varying line voltages and with time. However, for the values shown, the multivibrator is free running at approximately 500 cycles.

By taking the output from the multivibrator from plate-to-plate of the 12AU7, an almost perfect square wave is obtained. This output is fed into a calibrating potentiometer, R_1 ; then to an attenuator consisting of resistors R_2 , R_3 , and R_4 ; then into a calibrated potentiometer, R_5 . This latter pot is the one which is mounted on the front panel of the calibrator.

The actual peak-to-peak voltage appearing from plate-to-plate on the 12AU7 is approximately 90 volts—not quite 100. Therefore, to provide a convenient voltage scale for the potentiometer R_5 , it was decided to make the output read 0 to 5 and in multiples of 10, i.e., X1, X10, X.1.

To obtain the greatest accuracy, the attenuator should have the values shown on the parts list as R_2 , R_3 , and R_4 . In the actual unit constructed, these were selected from standard values of 100,000, 10,000, and 1000 ohms respectively. However, if it is intended to purchase these parts (where selection of resistor values isn't too practical) sufficient accuracy can be obtained by using standard 5% resistors of the values 91,000, 9100, and 1000 ohms respectively for R_2 , R_3 , and R_4 . The calibrated potentiometer which is placed in parallel with these resistors has enough greater resistance

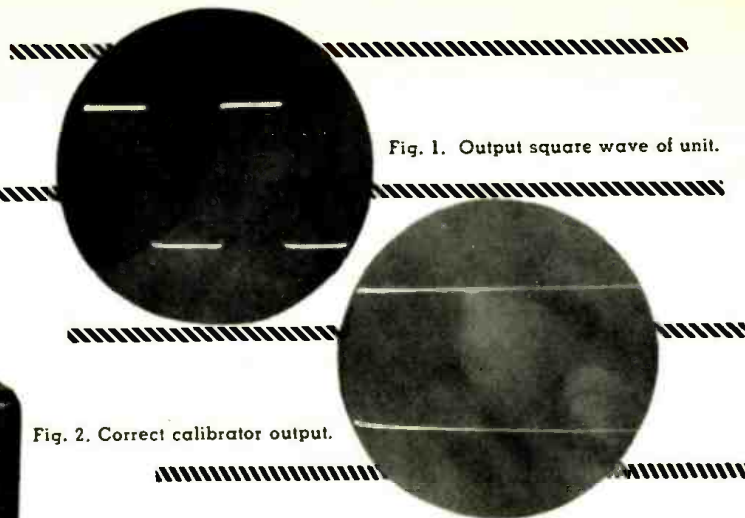

Fig. 1. Output square wave of unit.

Fig. 2. Correct calibrator output.

By

RICHARD GRAHAM, W1VJV

value so as to have a negligible effect on the accuracy.

For the operator's convenience, the switch S_1 is included. It is a three-position, four-pole switch that does a little more than just turn the calibrator on and off. In the "Off" position, S_1 disconnects the a.c. line from the unit and also provides a continuous circuit from the terminals on the left (the input terminals) to the terminals on the right (the output terminals). In use the calibrator output terminals are wired permanently to the vertical input terminals on the scope. Thus, in effect, the input terminals of the calibrator now become the input terminals of the scope.

When switch S_1 is in the position marked "Scope," the input and output terminals are still tied together, except that the a.c. is turned on and the "B+" is turned off. It was found necessary to remove the "B+" in this position to keep from feeding any of the calibrator output into the scope through the wiring and switch capacities.

The calibrate position of switch S_1 opens up the input terminals of the calibrator and feeds the multivibrator output into the output terminals for calibrating purposes.

The initial calibration performed after the unit is completed is simple and involves merely setting the calibrating pot R_4 . This potentiometer sets up the standard voltage fed into the attenuator, which in this case is 50 volts peak-to-peak. Other methods of calibrating may suggest themselves to the builder, but the method to be described is easy, accurate, and involves only the use of an a.c. meter in addition to the calibrator and scope. This procedure is as follows. The line voltage is measured as accurately as possible with the a.c. meter. This value is then multiplied by 2.83. This gives the peak-to-peak value of the line voltage. The line voltage is then applied to the input terminals of the calibrator, the output terminals being connected to the input of the scope. Switch S_1 on the

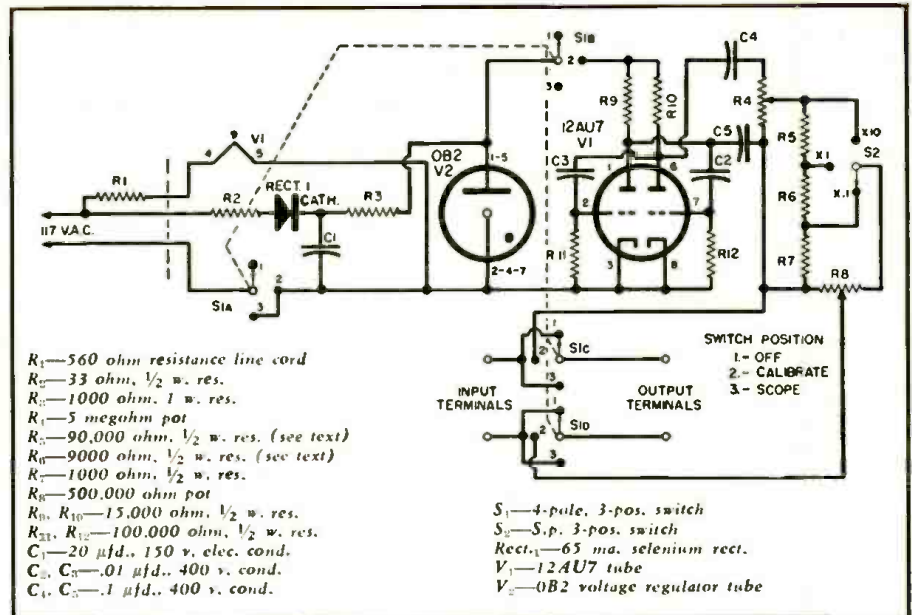

Fig. 3. Complete schematic diagram of the oscilloscope calibration accessory.

calibrator is set to the "Scope" position. The vertical gain control on the scope is then adjusted for any convenient height on the scope screen. Now by proportion:

$$\frac{E_1}{H_1} = \frac{50}{H_2}$$

where E_1 is the peak-to-peak line voltage, H_1 the height of scope trace with E_1 applied, and H_2 is the height of calibrator output on the scope.

Since we are interested in finding what should be the height of the calibrator output, we can restate the above and say:

$$H_2 = \frac{50H_1}{E_1}$$

Now with the calibrator dials set at X10, the potentiometer on the panel (R_4) set fully clockwise, and switch S_1 on "Cal," the calibrating pot located on the chassis (R_4) is turned to produce the height found by the equation. The calibrator is now putting

out a standard 50 volt peak-to-peak signal.

The next step is to calibrate potentiometer R_4 . With the switches set in the same positions as before, adjust the scope vertical gain to produce any height or number of squares conveniently divisible by 5 or 10. This height represents 50 volts. Adjusting potentiometer R_4 to 4/5, then 3/5, then 2/5, etc. of the 50-volt height would give calibration points at 40, 30, and 20, etc. volts respectively. As potentiometer R_4 is set at these points, calibrating marks are made in pencil on a paper scale. When the calibration is complete, the dial can be inked in. To give the paper scale a more durable surface, a coating of colorless nail polish can be applied.

Now the calibrator is all set for use. There are two common methods of using a device such as this. The first method is simply to calibrate the screen of the scope for a certain number of volts-per-square, or volts-per-

(Continued on page 106)

Top chassis view of the home-built oscilloscope calibrator.

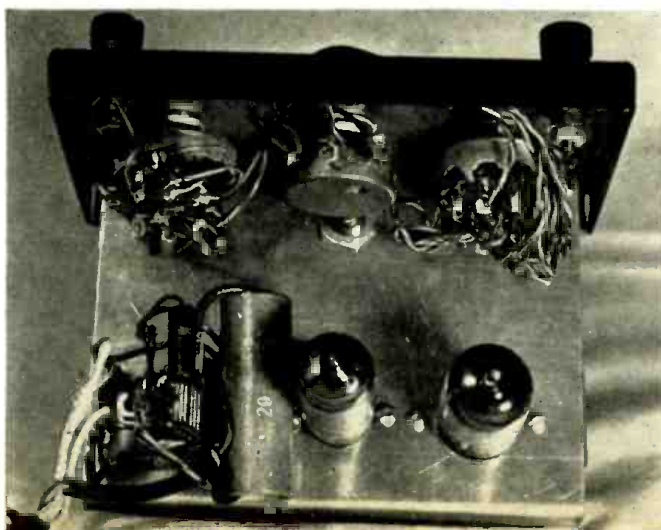

Under chassis view showing uncluttered layout of components.

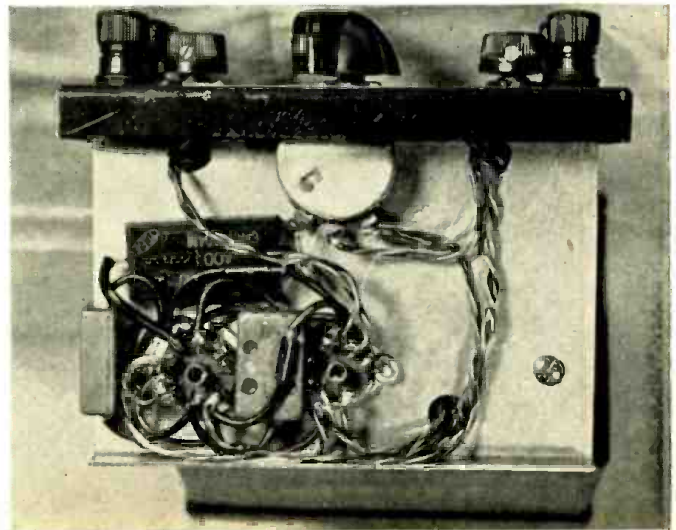

BUILD YOUR OWN Heathkits

- TEST INSTRUMENTS
- AMPLIFIERS
- RECEIVERS, etc.

- 1 Save by ordering direct from manufacturer.
- 2 All high quality standard band components
- 3 Increased knowledge through actual construction
- 4 Sound engineering insures excellent performance
- 5 Kit construction is fascinating and enjoyable

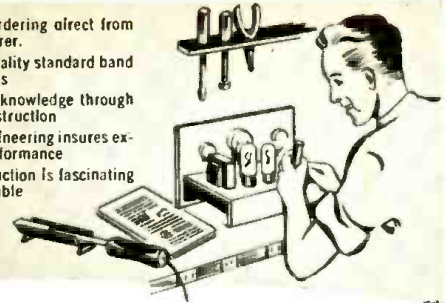

\$43.50

Shipping
Wt. 26 lbs.

Heathkit MODEL O-8 OSCILLOSCOPE KIT

The outstanding new 1953 model O-8 Heathkit Oscilloscope features the finest performance ever offered in this extremely popular kit instrument. Primarily intended as a general purpose oscilloscope for the faithful reproduction of actual wave forms and other electrical phenomena, it's vastly improved band width, good 100 KC square wave reproduction, three step vertical input attenuator, .025 volts per inch vertical sensitivity, etc., admirably qualify this instrument for TV and radio servicing, laboratory use, ham application and all general electronic development work. Improved vertical band width is obtained through the use of shunt peaking chokes with proper cathode compensation in the push-pull output stage. For additional flexibility of operation, provisions have been made for direct connections to the deflection plates, a Z axis input and a spot shape control for really fine focusing.

This beautiful kit is complete with all 10 tubes, including a 5" cathode ray tube, calibrated graph screen and flexible test leads. All necessary construction components, such as hardware, chassis, transformer, etc., and a detailed step by step construction manual, greatly simplify the assembly of this instrument.

Heathkit VOLTAGE CALIBRATOR KIT

The use of a Voltage Calibrator will greatly increase oscilloscope usefulness. Provides a convenient method of making peak to peak voltage measurements by establishing a relationship between the unknown wave shape and the Voltage Calibrator. Voltage ranges .01-100 volts peak to peak. The Voltage Calibrator features direct reading scales and a regulated power supply system.



MODEL VC-2
\$11.50

Shipping Wt. 4 lbs.

Heathkit ELECTRONIC SWITCH KIT

The Heathkit Electronic Switch Kit will further extend scope usefulness by permitting simultaneous observation of two individually controlled traces. Continuously variable switching rates 10 cps to 2,000 cps in three ranges. Will also serve as a square wave generator over the range of switching frequencies.

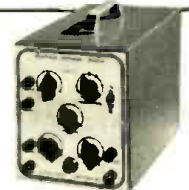

MODEL S-2
\$19.50

Shipping
Wt. 11 lbs.

Heathkit VACUUM TUBE VOLTMETER KIT

The beautiful new 1953 Heathkit Model V-6 VTVM, the world's most popular kit instrument, now offers many outstanding new features in addition to retaining all of the refinements developed and proven through the production of over 70,000 VTVM kits. The Heathkit VTVM now features extended voltage ranges with 50% greater coverage on the DC range. New 1 1/2 volt low scale provides well over 2 1/2 inches of scale length per volt permitting faster measurements with greater accuracy. AC and DC ranges are 0-1.5-5-15-50-150-500-1500 volts (1,000 volts maximum on AC). Ohmmeter ranges are X1, X10, X100, X1,000, X10K, X100K X1 meg. Measures .1 ohm to 1,000 megohms. Other features are db scale, center scale zero adjust and polarity reversal switch. High 11 megohm input resistance virtually eliminates circuit loading.

The low anti-inflation price of this tremendously popular kit includes all tubes, necessary constructional material, test leads and the construction manual.

MODEL V-6

\$24.50

Shipping
Wt. 6 lbs.



Heathkit AC VACUUM TUBE VOLTMETER KIT

MODEL AV-2

\$29.50

Shipping
Wt. 5 lbs.

A new amplifier type AC VTVM that makes possible those sensitive measurements so essential in laboratory or audio work. Ten voltage ranges covering from .01 RMS full scale to 300 volts RMS full scale. Input impedance 1 megohm with frequency response 20-50,000 cycles. Ten DB ranges from -52 to +52 DB. Four diodes in meter bridge circuit for maximum linearity.



Heathkit HANDITESTER KIT

MODEL M-1

\$13.50

Shipping
Wt. 3 lbs.

The ever popular Handitester is now supplied with a Simpson 400 microampere meter movement. Provides AC and DC voltage ranges 0-10-30-300-1,000-5,000 volts. Ohmmeter ranges 0-3,000 and 0-300,000 ohms. DC current measurements 0-10 and 0-100 milliamperes. A completely self contained portable instrument.



HEATH COMPANY • Benton Harbor 15, Mich.

HEATHKITS for the ENGINEER

Heathkit VISUAL AURAL SIGNAL TRACER KIT



MODEL T-3
\$22⁵⁰
 Shipping
 Wt. 10 lbs.

Designed especially for service applications in AM-SW-FM-TV repair work. RF and audio two channel input. More than adequate sensitivity—new noise locator circuit—calibrated wattmeter—substitution speaker—visual signal indication. Can be used with scope and VTVM, checks phono cartridges, phono mechanisms, microphones, tuners, etc. Let the Heathkit Visual Aural Signal Tracer help you.

Heathkit RESISTANCE SUBSTITUTION BOX KIT



Choice of 36 switch selected resistance values 15 ohms to 10 megohms. All standard RTMA 1 watt 10% resistors. Buy several for those lab and service applications.

MODEL RS-1
 Ship. Wt. **\$5⁵⁰**
 2 lbs.

Heathkit AMATEUR TRANSMITTER KIT

MODEL AT-1
\$29⁵⁰

Shipping Wt. 15 lbs.



Here is the long awaited Heathkit entry into the amateur radio field. The Heathkit AT-1 Transmitter kit is a well designed basic transmitter incorporating many desirable features and providing maximum over-all performance.

Convenient band switching eliminates the bother and annoyance of plug in coils. It is merely necessary to switch to the desired frequency and plug in your favorite crystal or VFO. This transmitter features a self-contained power supply mounted on the same chassis and cabinet enclosed to minimize TVI. AC line by-passed to reduce radiation.

The coils supplied with the Heathkit AT-1 are pre-wound and adjusted for the necessary frequency coverage of 80-40-20-10 meters. The entire kit is supplied complete with all tubes, coils, punched and formed chassis and cabinet, as well as all constructional material required. A detailed assembly and operation manual is also furnished.

Heathkit CONDENSER CHECKER KIT

An instrument designed solely for its particular job. Not a "sideline" of a multiple function instrument. Measures value and quality of unknown condensers and resistors. Capacity range .0001 mfd to 1,000 mfd. Resistance range 100 ohms to 5 megohms. Sensitive electron beam indicator—five polarizing test voltages—safety spring return leakage test switch. An amazingly accurate instrument at this low price.



MODEL C-3
\$19⁵⁰ Shipping
 Wt. 8 lbs.

Heathkit SIGNAL GENERATOR KIT



MODEL SG-7
\$19⁵⁰
 Ship. Wt. 8 lbs.

A service "must" is a reliable source of modulated (400 cycles) or unmodulated RF output. Frequency range 150 KC to 150 MC. Step attenuated and variable output—internal or external modulation. High output level and performance with low cost.

Heathkit GRID DIP METER KIT



World's largest selling Grid Dip Meter. Five pre-wound coils—frequency coverage 2-250 mc. Simplified construction and operation.

MODEL GD-1A
\$19⁵⁰
 Ship. Wt. 4 lbs.

Heathkit TUBE CHECKER KIT



MODEL TC-1
\$29⁵⁰
 Shipping Wt. 12 lbs.

Revised Roll Chart .50

Make those all important tube tests quickly and accurately. Checks all tube types encountered in radio and TV work. Simplified setup and switching system provides fast checks for shorts, opens, individual elements and over-all quality. Portable cabinet available at slight additional cost. TV picture tube adapter also available. See order blank.

Heathkit LABORATORY REGULATED POWER SUPPLY KIT



MODEL PS-2
\$29⁵⁰
 Ship. Wt. 17 lbs.

A regulated variable 160-450 volt DC output power supply for the lab or service shop. Accurate voltage and current measurements with large Simpson meter. AC supply 6.3 volts at 4 amperes—standby switch eliminates warmup time. Low hum content—5 tube circuit. AC and DC output voltages isolated from panel for maximum operational flexibility.

Heathkit VIBRATOR TESTER KIT

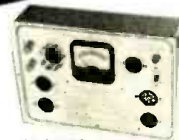

MODEL VT-1
\$14⁵⁰
 Shipping Wt. 6 lbs.

Checks for starting and quality of interrupter and self rectifier type vibrators. Five sockets—checks hundreds of types. Operates from continuously variable type battery eliminator.

Heathkit SQUARE WAVE GENERATOR KIT



MODEL SQ-1
\$29⁵⁰ Ship. Wt. 12 lbs.

True square wave output with frequency range 10 cycles to 100 KC. High variable output voltage level 0-20 volts at 600 ohms output impedance. Provisions for external synchronization. The ideal instrument for TV service work and wide band amplifier circuit development.

HEATH COMPANY • Benton Harbor 15, Mich.

SERVICEMAN · AMATEUR · STUDENT

Heathkit IMPEDANCE BRIDGE KIT

Provides choice of Wheatstone, Capacitance Comparison, Maxwell or Hay bridge circuits. Measurement of resistance-capacity-inductance-dissipation factor-storage factor. 1% precision silver mica capacitance standard 1/2% precision resistors.

MODEL IB-1B
\$69.50

Shipping Wt. 15 lbs.

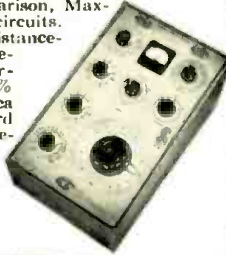

Heathkit INTERMODULATION ANALYZER KIT

Intermodulation distortion analysis is one of the most satisfactory methods of checking audio equipment. The IM-1 features two self contained high frequency generators (3,000 and 7,000 cycles) a 60 cycle low frequency source, intermodulation section, AC VTVM, and power supply all in one complete unit. Direct reading IM percentages on 3 calibrated scales 30% - 10% - 3%.

MODEL IM-1
Shipping Wt. 17 lbs. **\$39.50**

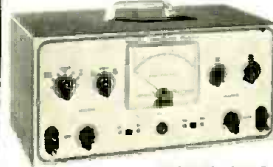

Heathkit AUDIO OSCILLATOR KIT

MODEL AO-1
\$24.50

Ship. Wt. 11 lbs.

Features sine or square wave coverage from 20-20,000 cycles in 3 ranges. Variable 10 volt output level at 600 ohms impedance. Thermistor controlled linearity—precision multiplier resistors—distortion less than .6%. An outstanding instrument value at this amazing low price.



Heathkit DECADE RESISTANCE KIT

MODEL DR-1
\$19.50

Ship. Wt. 4 lbs.

Individual switch selection of twenty 1% precision resistors in 1 ohm steps from 1 to 99,999 ohms. Sturdy ceramic wafer switches featuring silver plated contacts and smooth positive detent action.



Heathkit Q METER KIT

A typical Heathkit invasion of the laboratory instrument field. Here is the first successful low priced Q meter ever offered in kit form. Oscillator supplies RF in the range of 150 KC to 18 mc. Reads Q directly on calibrated meter scales. Measures Q of condensers, RF resistance and distributed capacity of coils. Calibrate capacitor with range of 40 mmf to 450 mmf with vernier ±3 mmf. All measurements made at the operating frequency.

MODEL QM-1
Shipping Wt. 14 lbs. **\$39.50**



Heathkit AUDIO FREQUENCY METER KIT

Indicates audio frequency on large 4 1/2" Simpson meter. Ranges 10 cycles to 100 kc at input voltage level of 3-300 volts RMS. The input wave shape is not at all critical. Useful in production line testing—indicating square wave frequency—determining generator output. Operation entirely electronic, no vibrating reeds.

MODEL AF-1
\$34.50

Ship. Wt. 12 lbs.



Heathkit BAR GENERATOR KIT

MODEL BG-1
\$14.50

Ship. Wt. 6 lbs.



The Heathkit BG-1 Bar Generator represents another welcome addition to the fast growing line of popular Heathkits. The station transmitted test pattern is rapidly disappearing and the Bar Generator is the logical answer to the TV serviceman's problem in obtaining quick accurate adjustment information.

The Bar Generator produces a series of horizontal or vertical bars on the TV screen. These bars are equally spaced and will quickly indicate picture linearity of the receiver under test. Since picture linearity is independent of transmitting frequency, it is unnecessary to provide coverage throughout the VHF range, thereby holding down instrument cost.

The Heathkit Bar generator is simple to use and is extremely portable, providing a quick means of checking the television receiver either in your workshop or in the customer's home.

Heathkit DECADE CONDENSER KIT

Switch selected 1% silver mica precision condensers providing capacity range of 100 mmf. to 0.111 mfd. in steps of 100 mmf.

MODEL DC-1
\$16.50

Shipping Wt. 4 lbs.



Heathkit AUDIO GENERATOR KIT

A new extended range 18 cycles - 1 megacycle audio instrument at a remarkably low price. Five continuously variable output ranges—600 ohm output impedance—low distortion figure, less than .4% from 100 cps through audible range.

MODEL AG-8
\$29.50

Ship. Wt. 11 lbs.



Heathkit TELEVISION SWEEP GENERATOR KIT

Frequency coverage 10-90 mc and 150-230 mc. Variable sweep width 0-12 mc. built in absorption type marker, step and continuously variable output and blanking circuit.

MODEL TS-2
Ship. Wt. 20 lbs. **\$39.50**

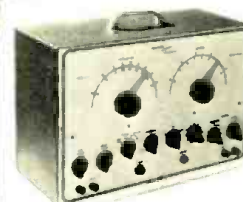

Heathkit BATTERY ELIMINATOR KIT

A variable 0-8 volt DC supply source rated at 10 amperes continuously and up to 15 amperes intermittently. Voltmeter, ammeter, automatic overload relay, fuse protection—heavy duty Mallory 17 disc rectifier.

MODEL BE-3
Ship. Wt. 17 lbs. **\$24.50**



WRITE FOR *Free* CATALOG

New 32 page 1953 Catalog lists all kits, specifications, schematics and latest price information.

HEATH COMPANY · Benton Harbor 15, Mich.

Heathkit
SUPERHETERODYNE
RECEIVER KITS



Broadcast Model BR-1 5 Tube-Broadcast Band 550 to 1600 KC coverage. Shipping Weight 11 lbs.
\$19.50

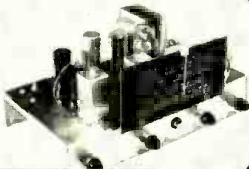

Three Band Model AR-1 6 Tube all wave circuit 3 Ranges, continuous coverage 550 KC to over 20 MC. Shipping Weight 11 lbs.
\$23.50

**NEW HEATHKIT WILLIAMSON TYPE
AMPLIFIER KIT**

The ideal amplifier for custom high fidelity audio installations. Tops in performance, value, and flexibility of operation. Either Altec Lansing Peerless or Acrosound output transformers available. First Williamson type amplifier supplied with a matching preamplifier.

PRICES OF VARIOUS COMBINATIONS

- W-2 Amplifier Kit (Incl. Main Amplifier with Peerless Output Transformer, Power Supply and WA-P1 Preamplifier Kit) Shipping Weight 37 lbs. Shipped express only **\$69.50**
- W-2M Amplifier Kit (Incl. Main Amplifier with Peerless Output Transformer and Power Supply) Shipping Weight 29 lbs. Shipped express only **\$49.75**
- W-3 Amplifier Kit (Incl. Main Amplifier with Acrosound Output Transformer, Power supply and WA-P1 Preamplifier Kit) Shipping Weight 37 lbs. Shipped express only **\$69.50**
- W-3M Amplifier Kit (Incl. Main Amplifier with Acrosound Output Transformer and Power Supply) Shipping Weight 29 lbs. Shipped express only **\$49.75**
- WA-P1 Preamplifier Kit only. Shipping Weight 0 lbs. Shipped express or parcel post. **\$19.75**



Heathkit
ECONOMY 6 WATT
AMPLIFIER KIT

MODEL A-7
\$14.50
Dual inputs—separate bass and treble tone controls—output impedances 4, 8-15 ohms.
Ship. Wt. A-7A
10 LBS. Amplifier with pre-amplifier stage for low level inputs... **\$16.50**

Heathkit
HIGH FIDELITY 20 WATT
AMPLIFIER KIT

MODEL A-8
\$33.50
Shipping Wt. 16 lbs.

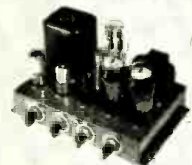

A high fidelity full 20 watt general purpose amplifier. Dual inputs and separate tone controls for maximum flexibility. Peerless output transformer 4, 8 and 16 ohms. A-8A with additional preamplifier stage for low level cartridge, microphone, etc. **\$35.50**

**Heathkit FM
TUNER KIT**

MODEL FM-2
\$22.50
Shipping Wt. 9 lbs.

Sensitive transformer operated 8 tube circuit. Frequency coverage 88-108 mc. Pre-assembled and tuned "front end." Vernier tuning with slide rule type dial.

HEATH COMPANY • Benton Harbor 15, Mich.

ORDER BLANK



From _____

SHIP VIA

- Parcel Post
- Express
- Freight
- Best Way

(PLEASE PRINT)

QUANTITY	ITEM	PRICE	QUANTITY	ITEM	PRICE
	Heathkit Oscilloscope Kit—Model O-8 (26 lbs.)	\$43.50		Heathkit Square Wave Generator—Model SQ-1 (12 lbs.)	29.50
	Heathkit Amateur Transmitter Kit—Model AT-1 (15 lbs.)	29.50		Heathkit AC VTVM Kit—Model AV-2 (5 lbs.)	29.50
	Heathkit Bar Generator Kit—Model BG-1 (6 lbs.)	14.50		Heathkit Intermodulation Analyzer Kit—Model IM-1 (17 lbs.)	39.50
	Heathkit Voltage Calibrator Kit Model VC-2 (4 lbs.)	11.50		Heathkit Regulated Power Supply Kit—Model PS-2 (17 lbs.)	29.50
	Heathkit Electronic Switch Kit—Model S-2 (11 lbs.)	19.50		Heathkit Handitester Kit—Model M-1 (3 lbs.)	13.50
	Heathkit TV Alignment Generator Kit—Model TS-2 (20 lbs.)	39.50		Heathkit Decade Resistance Kit—Model DR-1 (4 lbs.)	19.50
	Heathkit Q Meter Kit—Model QM-1 (14 lbs.)	39.50		Heathkit Decade Condenser Kit—Model DC-1 (4 lbs.)	16.50
	Heathkit Grid Dip Meter Kit—Model GD-1A (4 lbs.)	19.50		Heathkit Impedance Bridge Kit—Model IB-1B (15 lbs.)	69.50
	Heathkit VIVM Kit—Model V-6 (6 lbs.)	24.50		Heathkit Resistance Substitution Box Kit—Model RS-1 (2 lbs.)	5.50
	Heathkit Visual-Aural Signal Tracer Kit—Model T-3 (10 lbs.)	22.50		Heathkit F.M. Tuner Kit—Model FM-2 (9 lbs.)	22.50
	Heathkit Condenser Checker Kit—Model C-3 (8 lbs.)	19.50		Heathkit Broadcast Receiver Kit—Model BR-1 (11 lbs.)	19.50
	Heathkit RF Signal Generator Kit—Model SG-7 (8 lbs.)	19.50		Heathkit Three Band Receiver Kit—Model AR-1 (11 lbs.)	23.50
	Heathkit Tube Checker Kit—Model TC-1 (12 lbs.)	29.50		Heathkit Amplifier Kit—Model A-7 (10 lbs.)	14.50
	Heathkit Portable Tube Checker Kit—Model TC-1P (15 lbs.)	34.50		Heathkit Amplifier Kit—Model A-7A (10 lbs.)	16.50
	Heathkit Portable Tube Checker Cab. only No. 365 (8 lbs.)	7.50		Heathkit Amplifier Kit—Model A-8 (16 lbs.)	33.50
	Heathkit TV Tube Adapter No. 355 (1 lb.)	4.50		Heathkit Amplifier Kit—Model A-8A (16 lbs.)	35.50
	Heathkit Battery Eliminator Kit—Model BE-3 (17 lbs.)	24.50		Williamson Type Amplifier Kit (Type:)	
	Heathkit Vibrator Tester Kit—Model VT-1 (6 lbs.)	14.50		Shipped express only	
	Heathkit Audio Generator Kit—Model AG-8 (11 lbs.)	29.50		WA-P1 Preamplifier Kit (6 lbs.) (Shipped exp. or p.p.)	
	Heathkit Audio Oscillator Kit—Model AO-1 (11 lbs.)	24.50			
	Heathkit Audio Frequency Meter Kit—Model AF-1 (12 lbs.)	34.50			

Enclosed find () check () money order for _____ pounds.
Please ship C.O.D. () postage enclosed for _____

On Express orders do not include transportation charges—they will be collected by the express agency at time of delivery.

ON PARCEL POST ORDERS include postage for weight shown. ORDERS FROM CANADA must include full remittance for merchandise.

WHAT'S *New in Radio*

For additional information on any of the items described herein, readers are asked to write direct to the manufacturer. By mentioning RADIO & TELEVISION NEWS, the page and the issue number, delay will be avoided.

AM-FM TUNER

The Sargent-Rayment Co., 1401 Middle Harbor Road, Oakland, California is offering a new "building block" series of high-fidelity components, one of which is the SR68 AM-FM tuner.

The tuner has two AM positions permitting sharp or broad tuning. In the "broad" tuning position response is flat from 15 cycles to 9 kc. ± 1 db with a 10 kc. filter in the circuit



(measured at 1000 kc.). In the "sharp" tuning position response is limited to 5 kc. to permit reception of rural or hard-to-receive stations. The unit also features two-position FM, with or without a.f.c. Better than 5 μ v. sensitivity is achieved on both AM and FM with at least 30 db of quieting on FM.

Since all of the company's equipment is designed to be used in any combination the user desires, the physical dimensions and housing of the AM-FM tuner follow the style of the other units.

A booklet covering all of the equipment in the "building block" series is available on request.

INSULATED TEST CLIPS

A new model of the company's nylon-insulated test clips is currently being offered by Industrial Devices, Inc. of Edgewater, New Jersey.

The Model #1410B (1)-(2) provides positive clip connection to all standard phone-tip test prods. The new units incorporate a phosphor bronze spring collar which accepts the standard prod with an electrically and mechanically positive grip. The clip is fully nylon insulated to allow shock-proof, short-circuit proof operation in excess of 600 volts.

The clips are available in either red or black. The black is designated by the (1) while the red models are marked (2).

G-E TRANSISTORS

General Electric Company, Syracuse, New York has introduced a new hermetically-sealed junction transistor which is said to eliminate tempera-

ture and humidity restrictions which have prevented wide use of transistors in commercial and military electronic equipment.

The new transistor operates efficiently in temperatures as high as 212 degrees F and under the most adverse humidity conditions, according to the company.

Small quantities of the new transistor will be made available to development laboratories and engineering groups in the near future. The product will be mass produced at the company's germanium products plant at Clyde, N. Y. beginning this fall.

TRANSISTOR TRANSFORMERS

Standard Transformer Corporation, 3580 Elston Avenue, Chicago 18, Ill. is in production on a line of transistor transformers which weigh less than 1/10 ounce.

Although designed primarily for transistor audio applications, they can be used wherever low power is involved.

At the present five models are available: UM-110 interstage; UM-111 output or matching; UM-112 high impedance mike input; UM-113 interstage; and UM-114 output or matching.

A data sheet giving specifications on all these units is available from the company on request.

NEW BENDIX PACKSET

A new portable FM radio receiver-transmitter which weighs less than



10 pounds and provides increased power output per pound, is now in production at the Baltimore, Maryland plant of the Bendix Radio Communications Division.

Designed to operate in the 152-174 mc. band, the unit provides one watt of r.f. output and can be supplied for communication on either one or two channels.

An important feature of the new MRT-9 is the adjacent channel selec-

get out ahead in uhf

THESE PRACTICAL BOOKS GIVE YOU THE "KNOW-HOW"

"UHF ANTENNAS, CONVERTERS AND TUNERS"



Milton S. Kiver gives you all the answers on:

UHF Antennas: Full analysis of each UHF type—design, operation, directional characteristics, input impedance, gain—tells you type best suited for any given location and conditions.

Transmission Lines, Matching Networks: tells how to select proper line to deliver maximum signal to receiver.

Installation Practices: Practical advice on proper antenna location and routing of line to set; tells how to check for antenna mismatch, how to determine whether system is properly installed.

UHF Converters: Full analysis of all existing self-contained types, including turret tuner strips.

UHF Tuners: Covers tuner design and operation, ranging from parallel-wire to "butterfly" types—tells how they work.

This book keeps you ahead in TV, makes you a UHF expert, for extra profits. Get your copy today.

ORDER UHF-1 Only\$1.50

"UHF CONVERTERS"

Covers 21 Models

Be among the first to understand the design and operation of the new UHF converters and tuners. This book describes all the popular units and tells how they work with present VHF sets. Covers the following makes:

Arvin, Crosley, Dumont, G.E., Mallory, Motorola, RCA, Raytheon, Regency, Sarks-Tarzian, Standard Coil, Stromberg, Sutco, Sylvania. To stay ahead in TV, you'll want this essential book.

ORDER UC-1. Only\$1.00



ORDER THESE BOOKS TODAY!

HOWARD W. SAMS & CO., INC.

Order from your Parts Jobber today, or write direct to Howard W. Sams & Co., Inc. 2203 E. 46th Street, Indianapolis 5, Ind.

My (check) (money order) for \$..... enclosed. Send the following books.

UHF-1 (\$1.50) UC-1 (\$1.00)

Name

Address

City..... Zone..... State.....

tivity characteristic which eliminates interference from transmissions on adjacent channels. The packset also employs a "power on" warning device which sets off a tone signal should the operator forget to turn off the power when the set is not in operation.

Complete specifications and performance data are available from the company.

PHILCO TEST EQUIPMENT

The Accessory Division of *Philco Corporation*, Philadelphia 34, Pa. is currently introducing three new instruments in its line of test equipment for the service technician.

Now available are the Model 7052 mutual conductance dynamic tube

checker, the Model 7053 cathode-ray tube checker, and the Model 7020 3-inch oscilloscope.

The Model 7052 tests and measures mutual conductance of tubes including miniature, subminiature, and low-power transmitting tubes; provides a means of forecasting remaining tube life; checks shorts and leakages between elements; and determines noise characteristics.

The Model 7053 for cathode-ray tubes checks the action of the electron gun using a neon lamp to indicate shorts and open elements in the electrodes of the gun.

The scope, Model 7020, is adaptable to either bench or field use. The vertical deflection amplifier is a wide-

band, d.c.-coupled, highly-sensitive amplifier. The sweep oscillator has, in addition to its variable sweep ranges, four preset sweep frequencies for black and white and frame sequential color television servicing.

COMMUNICATIONS RECEIVER

Hammarlund Manufacturing Company, Inc., 460 W. 34th Street, New York 1, N. Y. has introduced a new, general-purpose superheterodyne com-



munications receiver, the "HQ-140-X", for use by commercial and amateur radio operators and short-wave listeners.

The receiver is a table-top model with continuously tunable frequency coverage from 540 kc. to 31 mc. in six bands and includes a self-contained power supply.

Bandspread tuning is available on the four higher frequency ranges with direct calibration for the 80, 40, 20, 15, and 10 meter amateur bands.

WATERSEALED JACKS

P. R. Mallory & Co., Inc., 3029 E. Washington Street, Indianapolis 6, Ind. has announced the development of two new watersealed jacks, the types WS-1A and WS-A2B.

The new units can be used in many types of communications systems where rapid electrical connections must be made by the use of phone plugs and which are subjected to high humidity conditions.

The Type WS-1A is a phono jack with terminals for one circuit and

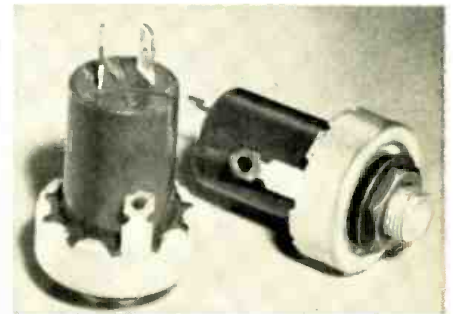

ground. The WS-A2B is a microphone jack with terminals for two circuits and ground. Dielectric strength of the new jacks is 500 volts r.m.s. with contact resistance of .02 ohm maximum. Insertion force is approximately 6 pounds.

CROSSOVER NETWORK

British Industries Corporation, 164 Duane Street, New York 13, N. Y. is currently marketing a new three-way crossover network, Model HS/CR/3, (Continued on page 98)

SPECIAL BUYS!

WOBULATOR

BUILD TV-FM-AM SWEEP GENERATOR

You can build "Versatile Sweep Frequency Generator" with APN-1 magnetic units. \$5.95
 BC-1206 Beacon Receiver 200-400KC. \$ 9.95
 MN-26LB Receiver exc. 59.50
 RCA Sound Powered Phones brand new. 12.95
 two for 24.95
 R44/ARH-5 Receiver 119.50
 TS3/AP S-Band Power Frequency Meter 195.00
 TS-184/AP Test Set 69.50
 APR-2 Radar Search Receiver, 85-1000MC. 195.00
 APR-4 Radar Search Receiver, 38-4000MC. 450.00
 TS100 Oscilloscope 175.00
 IE 10A-SCR522 Test Unit 295.00
 MG-153 Inverter Used 69.50

MIKES and HEADSETS

HS-33 Low Impedance Headset.
 HS-23 Headset exc. \$2.95 new \$5.95
 used \$2.95 new \$4.95
 CD-307 EXT. cord for HS 23-33
 like new79
 Throat Mike-T 30 New .98
 Lip Mike-Navy Type New .98
 Extension Cord and Switch Assembly for lip and throat Mikes. New .98
 CW 49505 High Impedance headset complete with leather headband and rubber cushions. Used 98c
 HS-18 Headset used \$1.29 new \$1.98
 HS-38 exc. 1.95 new 2.29
 HS-30, miniature headset. used 1.49 new 2.49



DYNAMOTORS

The best dynamotor for conversion to 6v. Multiple windings! After conversion you get choice of 100 or 350 v. at 50 MA or 250 v. at 100 MA. Complete dope sheet furnished. \$4.65
 BRAND NEW (See "CQ" Aug. issue).

Surprise Package!

SURPRISE PACKAGE. 15 lbs. of assorted good radio parts \$1.95
 A real value at

RT7 APN1 TRANSCEIVER UNIT—Used as an altimeter. It may be converted for signaling control circuits, etc. Complete with 14 tubes and dynamotor they are in good used condition at the amazingly low price of \$29.95
 Used, less tubes, as is. 4.95

MISCELLANEOUS EQUIPMENT

FL 8 used, exc. \$1.19 BC 347 each. used 95c
 BC 906 each. 9.95

YE-4B

General Electric Delay Line Unit 1000 ohms + or - 10% band pass 0 - 2 mc. 4 micro-second delay time. Brand new \$1.98

SELSYN TRANSMITTER

Autosyn Transmitter Assembly for matching to I-82 Indicator. Used, excellent condition. ONLY \$10.95. Complete with Indicator. \$19.95

RL-42 Reversible Motor with antenna reel and clutch. Used \$ 2.95
 BC-433 RADIO COMPASS RECEIVER, 200 to 1700 KC, used, excellent condition, with tubes 39.95
 used, exc., less tubes 24.95
 used, as is, less tubes and cover, exc. for parts 8.95

Shipments F.O.B. warehouse. 20% Deposit on orders. Minimum order \$5.00. Illinois residents, add regular sales tax to remittance.
 Prices subject to change without notice.

BROADCAST BAND & AERO



Ideal for Use in Boats, etc.
 MN-26-C Remote Controlled Navigational Direction Finder and communications receiver. Manual DF in any one of three freq. bands, 150 to 1500 KC. 24 V. Self contained dynamotor supply. Complete installation, including receiver, control box, loop, azimuth control, left-right indicator, plugs, loop transmission line and flex. shafts. \$89.50
 BRAND NEW \$69.50
 LIKE NEW

MN-26-Y 150 to 325 KC. 325 to 695 KC. 3.4 to 7 megacycles, comp. installation. \$69.50
 Receiver alone 35.95
 MN-26-C alone, like new. 39.50
 MN-26-C or MN-26-Y as is less tubes. 13.95
 With tubes. Used good. 24.95
 MN-24-E Loop, Brand New. 6.95
 MN-52 Crank drive, New. 2.50

TS10 TEST UNIT

Complete with attenuator, indicators and 350 feet of coaxial cable. Original cost \$300.00. \$14.95
 New Condition. ONLY

SCR-274N COMMAND and ARC-5 EQUIPMENT

	AS IS	EXC. USED (With tubes)	NEW
BC-450 Control Box (3 Receiver)		\$1.95	\$3.95
BC-456 Modulator	\$2.95	4.95	
BC-451 Control Box (Transmitter)		1.95	3.95
BC-442 Relay Unit ANT With Condenser		3.95	
Without Condenser		1.29	2.95
Flexible Shafting with Gear to fit receivers.			2.45
3 Receiver Rack		2.29	2.98
2 Transmitter Rack		2.39	3.97
Single Transmitter Rack		2.25	2.95
DM-32 Dynamotor for Command Set		3.25	9.95
DM-33 Dynamotor for Command Set		2.95	3.95
Shock Mts. for 3 Receiver Rack, 2 Trans. Rack, Modulator or Ant. Relay Unit		1.95	2.45

BC457 TRANSMITTER—4 to 5.3 mc and
 BC458 TRANSMITTER—5.3 to 7 mc and
 BC455 RECEIVER—6 to 9 mc (as is, less tubes and crystals) ONLY \$4.95 each
 Any two units for \$8.95

HAND SETS

TS9, excellent condition. \$4.95
 TS13, excellent condition 5.95
 TS Type, exc., less cord. 2.95

WANTED!

All TS, APR, AP5, ARC, ARM, ART, SCR, R89 and BC equipment write today!
 Quote lowest prices in your first letter

RT/34 AP5 13 Transceiver used as a tall warning radar on 415 MC. Containing a 30MC IF Strip and various other parts, these units have been stripped of RF sections and all tubes, but are an excellent buy if only for parts and IF Strip. used \$ 4.95
 BC 624 receiver (SCR 522), less tubes. 14.95
 100-156MC used 14.95

"MONTHLY SPECIAL"

TRANSCIVER—140-144 mc, 2 meter, used, excellent condition, less dynamotor, less tubes only \$17.95

R W ELECTRONICS

Dept. N, 1712-14 S. Michigan Ave., Chicago 16, Ill.
 PHONE: HARRISON 7-9374

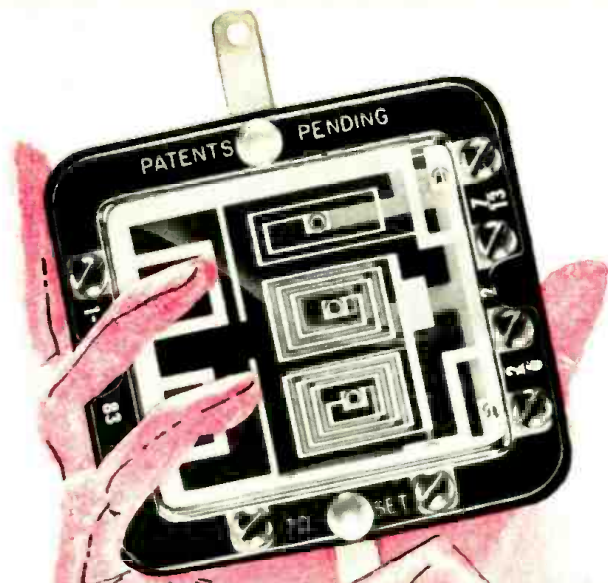

JETenna • JET 283 and now . . .

JFD introduces the revolutionary

JeTie Coupler, Q283

**for VHF and UHF antennas
first of its kind!**

- joins one UHF and one VHF antenna
 - joins two VHF antennas
 - joins two VHF antennas and one UHF antenna
- ... all with only ONE down-lead!



JFD gives you a direct line to profits with the amazing new JeTie coupler. Here's "single transmission line" reception on such disparate channels as 4 and 61—a miracle of engineering know-how that will pay off for you in countless sales. Made with a new silver printed circuit for ideal conductivity, the JeTie is hermetically sealed in a transparent moisture-resistant, dust-proof Butyrate case—the only one of its kind. Light weight, easy-to-attach, the JeTie coupler is the easy-to-sell answer to the new UHF and VHF stations in your territory.

LIST PRICE \$5.30

For more information on the JFD JeTie, write to JFD Manufacturing Company, Inc.

Brooklyn 4, New York
Bensonhurst 6-9200
World's largest manufacturer of
TV antennas and accessories

Burton bromer advertising



Two heads are better than one!

And that's exactly why
CHANNEL MASTER'S
 amazing new

TWIN CORNER REFLECTOR (Model No. 406)

is the most sensitive fringe-area antenna ever developed for UHF!

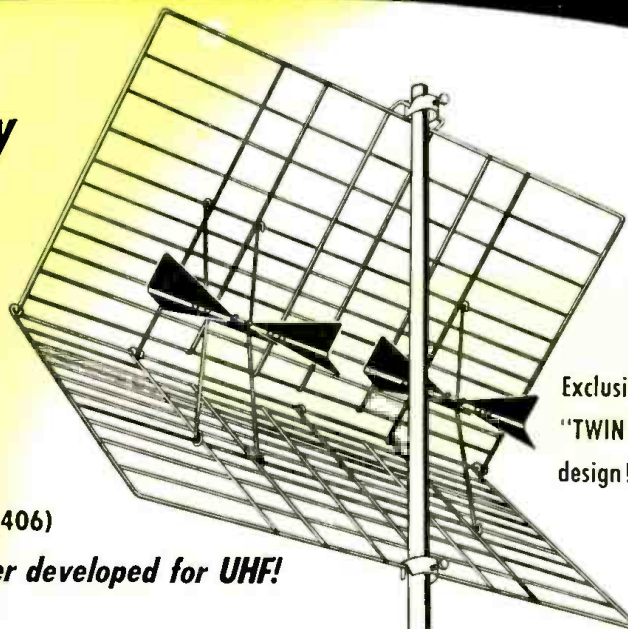

Exclusive
 "TWIN DIPOLE"
 design!

TWO DIPOLES—HIGHER GAIN

The two dipoles of the Twin Corner Reflector provide TWICE as much gain as standard-type Corner Reflectors!

This two-dipole construction is an original Channel Master idea which successfully combines two separate Corner Reflectors into ONE ANTENNA STRUCTURE — requiring ONE simple installation.

This 2-in-1 combination gives you:

- ... the economy of one antenna.
- ... the convenience of one antenna.
- ... BUT the combined performance of TWO separate high gain antennas.

Model No. 406 furnishes far better picture quality — at far greater distances — on every UHF channel.

Eliminates UHF's "Twin Terrors." 100% vibration-proof construction prevents picture flicker. "Free space" terminals prevent dirt and rain water from shorting out the picture.

up to
16 DB gain

gain above tuned
 reference dipole

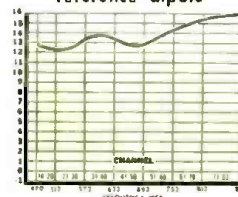

horizontal
 polar pattern
 (relative voltage)

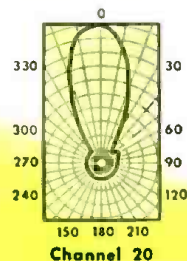

Extremely narrow
 "Yagi-type" forward
 lobe; no side lobes;
 very high front-to-
 back ratio.

2 antennas in 1

The Twin Corner Reflector furnishes the performance of 2 antennas because it really is 2 separate antennas . . .

stacked side
 by side . . .

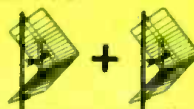

into 1 simple
 structure . . .
 with just a
 single down-
 lead to the
 set.

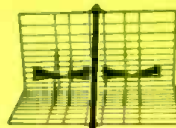

CHANNEL MASTER
 engineering
 pays off on **UHF!**



CHANNEL MASTER CORP.
 ELLENVILLE, N. Y.

At Last! a YAGI for the ENTIRE LOW BAND!

CHANNEL MASTER'S Newest futuramic

Completely covers every low band channel-2 through 6

Now the extraordinary high gain of a Yagi . . . the razor-sharp directivity of a Yagi . . . Not on just one channel — but clear across the entire Low Band!

Designed for service TODAY and TOMORROW in these 3 booming VHF markets:

Areas in which present VHF stations are changing channels (on the Low Band).

The Futuramic Yagi provides better reception than conventional Yagis on the present channels — and when the shift occurs this superior reception will continue on the new channel WITHOUT INTERRUPTION. And you can make your change-over installations NOW.

Areas in which a new VHF station is being added to the present one (on the Low Band).

The great number of single channel Yagis now in use will not bring in the new channel. If an additional Yagi is installed it will have to be tied into the present installation with separate leads and a switching system. However, one Futuramic will do the job of BOTH antennas — at lower cost — with better results on BOTH channels.

Areas served at present by two or more VHF stations on the Low Band.

You no longer have to compromise between conventional broad band antennas, and separate Yagis for each channel. The Futuramic gives you the full advantages of both. It combines highest gain and sharpest directivity with simple, economical installation.

horizontal polar pattern (relative voltage)

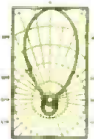

gain above tuned reference dipole

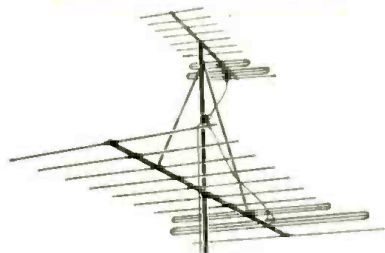
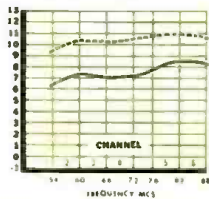

A high-low Futuramic combination is the most sensitive array ever designed for all-channel VHF reception. Just combine models 1173 and 1126.

Now — 6 great Futuramic models, designed for every reception area:

model no.	channels covered	list price
1173	7 — 13	\$20 ⁸³
1124	2, 3, and 4	\$40 ⁹⁷
1125	2, 3, 4, and 5	
1136	3, 4, 5, and 6	
1146	4, 5, and 6	
1126	2, 3, 4, 5, and 6	



CHANNEL MASTER CORP. ELLENVILLE, N. Y.



H.V. FILAMENT XFMR



NO. FT-38A—
PRIMARY: 115V 60 CY. 1 PH.
SEC. 2 WDGs. 2.5V AT 7 AMPS
EACH. AND 1 WDG. 6.3V @ 2.5A
TESTED AT 7500 VDC BETWEEN
ALL POINTS.
HERM. SEALED. SIZE: 5 1/2" H x 3 1/2"
D x 4" W. HAS 4 STUDS, 1/8" L on
2 7/8" x 3" CENTERS. \$2.79

BAND PASS FILTERS

INPUT IMPEDANCE: 2000 OHMS. OUTPUT: TO GRID. AVAILABLE IN FOLLOWING RANGES:

CHANNEL	Fr.	F1°	F2°
5	1155	830	1620
7	2270	1620	3180
8	3180	2270	4450
9	4450	3180	6230
10	6230	4450	8720

* Fr.: Center Freq. in CPS; F1 and F2 are lower and upper limits (CPS) respectively, at -20 db points. Price, \$4.95 Each

DYNAMOTORS

Type	Input Volts	Input Amps	Output Volts	Output Amps	Radio Set
PER6	28	1.25	250	.060	RC 36
DM416	14	6.2	330	.170	RU 19
DM33A	28	7	540	.250	BC 456
PE1016	13/26	12.6	400	.135	SCR 515
		6.3	800	.020	
BD AR 93	28	3.25	375	.150	APN-1
Z3350	27	1.75	285	.075	MARK 11
Z40515	12/24	4.2	500	.050	
B-19 pack	12	9.4	275	.110	MARK 11
			500	.050	
DA-3A	28	10	300	.060	SCR 522
			150	.010	
			14.5	.5	
5053	28	1.4	250	.060	APN-1
PE73CM	28	19	1000	.350	BC 375
CW21AAX	13	12.6	400	.135	
	26	6.3	800	.020	
			9	1.12	
PE94	28	10	300	.200	SCR 522
			150	.101	
			14.5	.5	

INVERTERS

PE-218-H: Input: 25/28 vdc, 92 amp. Output: 115 v, 350/500 cy 1500 volt-amperes. New \$44.50
PE-206: Input: 28 vdc, 38 amps. Output: 80 v 800 cy, 500 volt-amps. Dim: 13" x 5 1/2" x 10 1/2". \$22.50 New
LELAND No. 10536: IN: 28 VDC, 12A. OUT: 115V, 115VA, 400 CY 3 PHASE. EXC. COND. \$70.00

RECTIFIER TRANSFORMERS

Pri: 115V, 60 Cy. Sec: 28V/3.1A, 26V/8.4A 7.3V/14A \$12.95
Pri: 210/215/220/225/230/235/240V, 60 Cy, 1 Phase. Sec: 11/10/7.5/5VCT @ 35A \$19.50
Pri: 115V 60 Cy. Sec: 8.1V @ 1.5A \$1.39
Pri: 115V 60 Cy. Sec: 18.5V @ 5A \$2.79

APN-4 COILS

352-1585 \$0.49 352-1549 \$1.00
352-1269 \$0.49 352-1550 \$1.00

EE-89 REPEATER

Extends range of EE-8 field phone up to 20 miles of dry or wet wire operation. Extremely rugged, portable and lightweight. Uses hybrid coils and V. T. Amplifier, with extreme long-life characteristics.
Brand New, Complete With Tube \$12.75 each
& Tech. Manual, only.

HELMHOLTZ PHASE-SHIFTER

Stator consists of 4 loops oriented at 90 degrees to each other. Total stator inductance is 40 MH. rotor: 10MH, total phase shift 0-360 deg. Designed for range unit of SCR-268. \$3.95 each



BIRTHEY TUBE CLAMPS

926B-16 926C-19 926C-24
926B-15 926C-15 926K-2
PRICE: 18c EACH OR-\$16.50/100

SUPERSONICS

MODEL M1-2 CRYSTAL HEAD: Consists of mosaic of 3 crystals encased in oil-filled disk approx. 4" diam., 1" thick. Entire assembly is attached to 1" mtg. flange. Frequency: 17-27KC. Approx. 50 watts out. Completely watertight. \$27.50

MODEL JR HYDROPHONE: Rubber sheath 4" long, 4" diam., in which is enclosed a lattice of 7 crystals and 50-ohm matching transformer. The sheath is filled with mineral oil for acoustic damping. Frequency: 22-32 KC. \$24.50

Send M.O. or Check. Shipping Chgs. C.O.D.

COMMUNICATIONS EQUIPMENT CO.

131 Liberty St. Dept. N-6 New York City 7, N. Y.

G-E's INTERNAL MAGNETIC FOCUS SYSTEM

Improved TV set performance is anticipated with the use of these new permanent, factory-focused picture tubes.

THE development of an "internal magnetic focus" gun which will permit the elimination of the external focus coil and ion trap magnet on television picture tubes has been revealed by General Electric Company's Tube Department.

Use of the new gun is said to make possible sharper picture definition across the entire face of television screens.

The elimination of the necessity for manufacturers to add a focus coil, ion trap, or bulky mounting brackets to picture tubes will mean a major saving in parts and assembly operations.

The new gun contains an internal compensating focusing lens which maintains focus over a wide range of operating voltages. A simple shunt may be used to increase this range. No external focus control requiring set-owner adjustment is necessary,

according to spokesmen for the company.

The focusing and ion trap devices in the new gun employ four tiny Carboloy "Alnico 5" magnets made of the most powerful permanent magnetic material now being produced. Three of the magnets, measuring a quarter of an inch in diameter and five-eighths of an inch in length, are used in the focus assembly and the fourth, measuring one-eighth of an inch in diameter and length, is used in the ion trap unit.

Tubes incorporating the new "internal magnetic focus" feature (i-m-f) are permanently focused at the factory for optimum viewing. The focus quality is said to be higher than that found in present electrostatic tubes and at least equal to that obtained with magnetic-focus tubes.

-30-

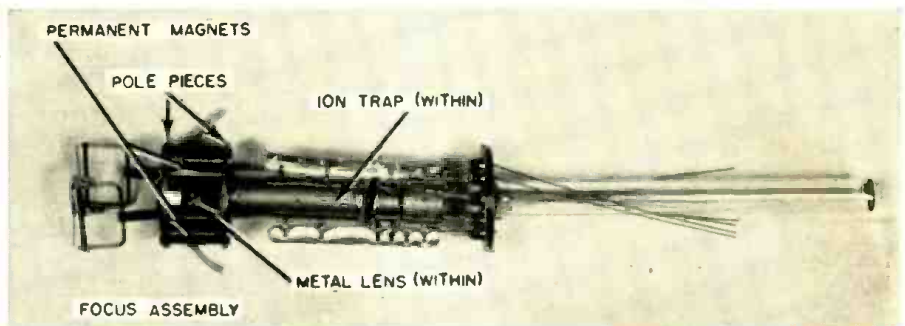

Gun structure used in General Electric's "internal magnetic focus" picture tubes.

Simplicity of installation is demonstrated using the two types of guns as examples.

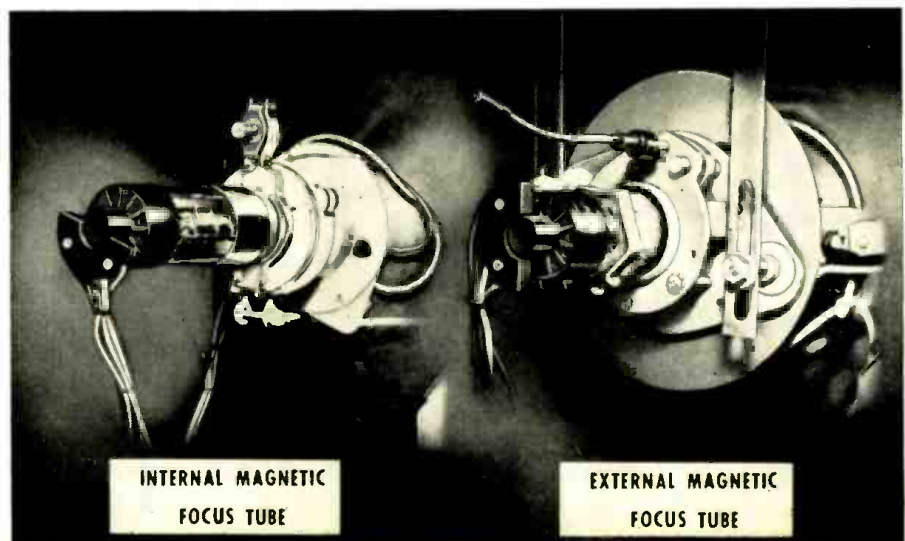

A N O T H E R C B S - H Y T R O N F I R S T

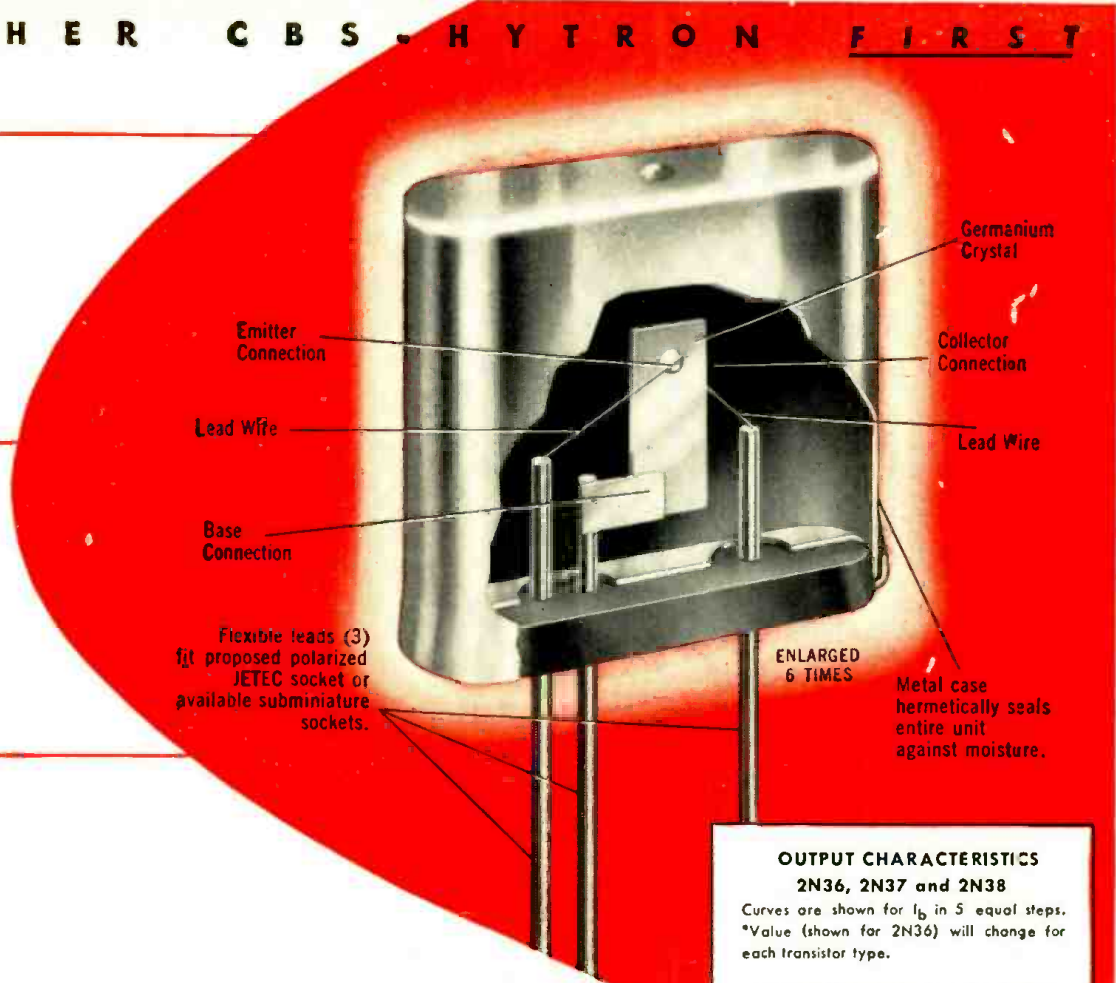
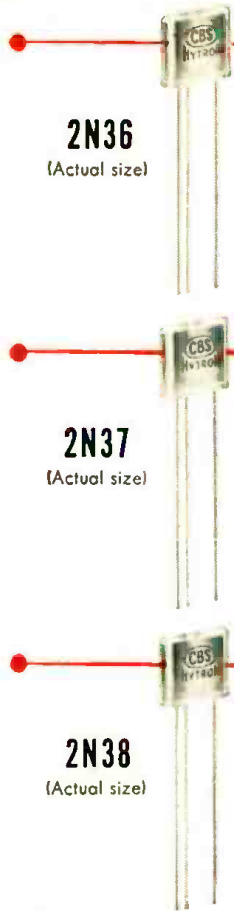

NOW...HERMETICALLY SEALED CBS-HYTRON JUNCTION TRANSISTORS

In junction transistors, the surfaces are extremely sensitive to moisture. For dependability, they must be completely moisture-proofed. CBS-Hytron, recognizing this, is the first to offer you the new *hermetically sealed* 2N36, 2N37, and 2N38 junction transistors. Each is uniquely sealed in a metal case . . . moisture-proof, contamination-proof, light-proof. (See drawing.)

You can buy these new hermetically sealed P-N-P junction types immediately. All are amplifier types. Have similar characteristics, except for current amplification and power gain. You may operate the 2N36, 2N37, 2N38 up to 55°C. Their in-line design gives you: Compact, flat mounting . . . easily identified polarity . . . solder-in or plug-in (with clipped leads) convenience.

In addition to their unique moisture-proof feature, these CBS-Hytron junction types offer: (1) High gain. (2) Low noise figure. (3) Operation at low voltages. As well as other advantages characteristic of transistors: Compactness . . . light weight . . . ruggedness . . . instantaneous operation . . . and long life.

Remember, CBS-Hytron hermetically sealed 2N36, 2N37, 2N38 transistors are available at once. Write for complete data. Or order now for prompt delivery.

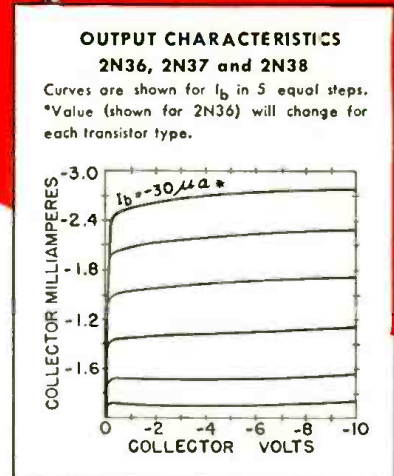

ELECTRICAL CHARACTERISTICS †
CBS-Hytron P-N-P Junction Transistors

Characteristic	2N36	2N37	2N38
Collector voltage	-6	-6	-6 v
Collector current	-1	-1	-1 ma.
Current amplification factor ‡	45	30	15
Power gain ‡	40	36	32 db

†Typical values at 25°C. ‡Grounded emitter connection.

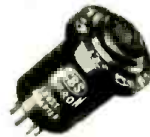
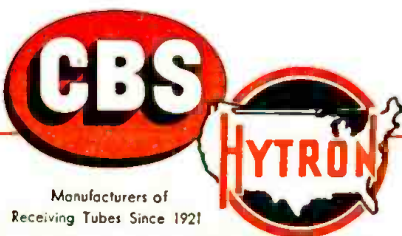

NOW 3 CBS-HYTRON TEST ADAPTERS. By popular demand. Three sizes now available at these net prices: 7-Pin Miniature, \$1.45; 8-Pin Octal, \$2.25; 9-Pin Miniature, \$1.75. Take advantage of e-a-s-y "topside" testing. Order your Test Adapters today from your CBS-Hytron jobber.

CBS-HYTRON Main Office: Danvers, Massachusetts

A Division of Columbia Broadcasting System, Inc.

are you
**BURNED
UP?**



**TRIAD
DEFLECTION
YOKES**

*will cool
you off*



If you are tired of blasting cooked yokes off of picture tubes — then switch to Triad Deflection Yokes. They have a molded high-temperature plastic insulation between vertical and horizontal coils, reducing chances of cooking and simplifying servicing. Triad's new 1953 Catalog features 18 new items which have been added to an extensive line of TV replacements — every item designed for long trouble-free service, and to ease and speed the serviceman's job.

Write for Catalogs TR-53A and TV-53A



4055 Redwood Ave. • Venice, Calif.

NEW TV GRANTS SINCE FREEZE LIFT

Continuing the listing of construction permits granted by FCC since lifting of freeze. Additional stations will be carried next month.

STATE	CITY	CALL**	CHANNEL	FREQUENCY (mc.)	POWER (Video)*
Arizona	Yuma	11	198-204	29
California	Chico	KHSL-TV	12	204-210	12.3
"	San Diego	KFSD-TV	10	192-198	316
"	San Francisco	20	506-512	94
"	San Luis Obispo	KVEC-TV	6	82-88	20
"	Yuba City	KGAR-TV	52	698-704	91
Delaware	Dover	40	626-632	195
Florida	Fort Myers	WINK-TV	11	198-204	9.6
"	Panama City	7	174-180	10.5
Georgia	Columbus	WDAK-TV	28	554-560	89
"	Warner Robins (Macon)	WMAZ-TV	13	210-216	300
Idaho	Nampa	KFXD-TV	6	82-88	19.5
Illinois	Bloomington	15	476-482	18
"	Harrisburg	22	518-524	10.5
Indiana	Indianapolis	26	542-548	95
"	Indianapolis	67	788-794	125
"	Marion	WMRI-TV	29	560-566	15
"	Princeton	WRAY-TV	52	698-704	95
Iowa	Davenport	36	602-608	15
"	Des Moines	17	488-494	180
Maryland	Salisbury	WBOC-TV	16	482-488	110
Massachusetts	Boston	50	686-692	255
"	Cambridge	WTAO-TV	56	722-728	20
Minnesota	Austin	6	82-88	18.5
"	St. Paul	WCOW-TV	17	488-494	180
Mississippi	Columbus	WCBI-TV	28	554-560	210
Montana	Missoula	KGVO-TV	13	210-216	11
New Mexico	Albuquerque	KGGM-TV	13	210-216	89
"	Clovis	12	204-210	10.2
New York	Rochester	WHEC-TV	10	192-198	118
"	Rochester	10	192-198	118
"	Rochester	WVET-TV	10	192-198	118
North Carolina	Greenville	WNCT	9	186-192	100
"	Hendersonville	WHKP-TV	27	548-554	20
"	Mt. Airy	WPAQ-TV	55	716-722	21
North Dakota	Bismarck	KFYR-TV	5	76-82	100
"	Bismarck	12	204-210	60
Oregon	Medford	5	76-82	19
Pennsylvania	Chambersburg	WCHA-TV	46	662-668	105
Tennessee	Knoxville	26	542-548	21
Texas	Fort Worth	20	506-512	270
"	Lufkin	KTRE-TV	9	186-192	11
"	Sherman	46	662-668	20.5
"	San Antonio	35	596-602	230
"	Victoria	19	500-506	20
Virginia	Harrisonburg	WSVA-TV	3	60-66	12.5
West Virginia	Charleston	WKNA-TV	49	680-686	228
Utah	Salt Lake City	2	54-60	27.5

*ERP = (effective radiated power). **Call letters without TV suffix from application files and subject to change; except where included in calls such as KKTU or WTVT. .. = Call letters to be announced

World's most powerful TV ANTENNA!

22 Db gain

over tuned dipole!

motorless all-direction
UHF-VHF-FM
reception

MONEY BACK GUARANTEE

to outperform all other
antennas using rotor motors on
UHF-VHF & FM

- Guaranteed 10 times more powerful than stacked 10 element Yagis.
- Receives channel 2-83 from all directions without a rotor.
- Broadband UHF-VHF and FM, motorless all direction reception.
- All aluminum flip-out assembly.

The only TV antenna that instantly beams the television set directly to the signal without a rotor. This antenna brings strong UHF & VHF signals from all directions to weak signal areas instantly . . . with a flick of the nine position switch located near the television set.

MONEY BACK GUARANTEE To out-perform all other antennas (using rotor motors) on both UHF and VHF, including stacked ten element Yagis, stacked corner and bow-tie reflectors, four bay conicals, etc.

see us at . . .

THE ELECTRONIC PARTS SHOW, CHICAGO ROOMS 647A & 648A

ALL CHANNEL ANTENNA CORP.

70-07 Queens Blvd.,
Woodside 77, N.Y. Hickory 6-2304

June, 1953

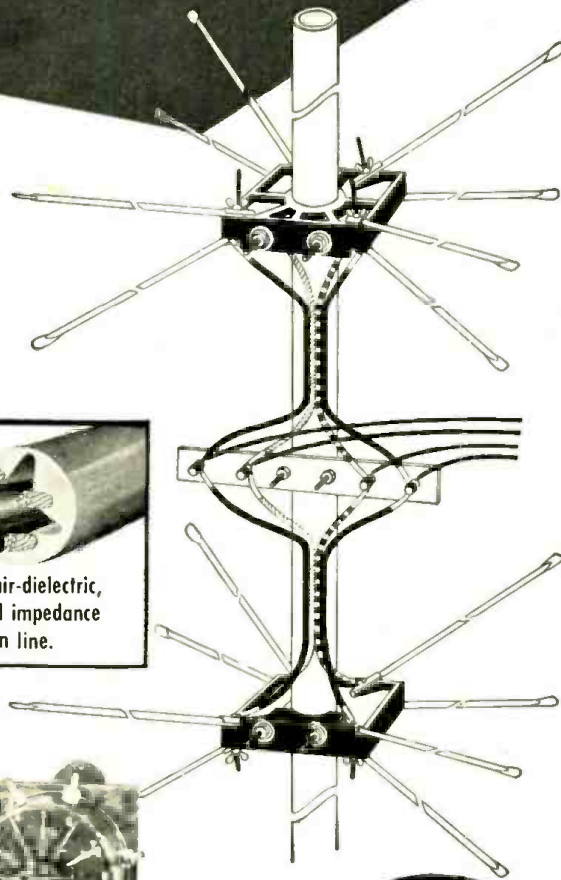

Model A D 2-8

Includes Stacked Antenna Array.
9 Position Switch. Completely
Wired Stacking Harness. A.I.M.—
Automatic. Impedance Matching
Coupler.

List Price
\$36.50

AMERICA'S FINEST 28 WATT—50 WATT AND 10 WATT P.A. VALUES



50-WATT PORTABLE P.A. ON SALE \$99.95 3-SPEED PHONO TOP—TWO 12" SPEAKERS

(Illustration A)

10-tube portable 50-watt public address system. 4-6L6G (rush-hull parallel) output tubes. Inputs for 2 microphones, either crystal or dynamic, with separate mixing volume controls. Twin bass and treble tone controls. High fidelity wide range output transformer with taps at 4, 8, 16, 125, 250 and 500 ohms. Complete with 2 super heavy duty 12" PM speakers and 25 ft. cables mounted in separate leatherette-covered carrying cases, 21"x21"x13". The amplifier fits in one of the cases for carrying. This amplifier will put out 40 watts all day long and 50 to 60 watts peak with ease. 3-speed turntable and pickup arm to play all records 33 1/3, 45 and 78 RPM is mounted in the top of the amplifier. Stock No. AP-60X, 50 watt portable P.A. system similar to the 28-watt model pictured above, less microphone. Sale price, \$99.95. Shipping weight, 100 lbs. Shipped via Express or Truck only. Regular \$145.00 list Electro-Voice 610 dynamic microphone with 20 ft. cable and desk stand, \$11.95 extra. For floor stand instead of desk stand, add \$4.95.

\$69.95 BUYS A 28 WATT \$150.00 LIST VALUE PORTABLE P.A. SYSTEM

(Illustration B)

3-SPEED PHONO TOP—TWO 12-INCH SPEAKERS 7-TUBES PUSH PULL 6L6'S HEAVY LEATHERETTE COVERED PLYWOOD PORTABLE CASES CRYSTAL MIKE \$8.95 EXTRA

STOCK No. AP-28X. Portable 28 watt public address system. You get a 7-tube heavy duty push-pull 6L6 amplifier with inputs for 2 mikes either crystal or dynamic with separate mixing volume controls. One 100 ohm input. Fully variable tone control with facility, wide range frequency response. The heavy duty output transformer has taps for 4, 8, 16, 125, 250 and 500 ohm speaker connections. Two heavy duty 12 inch Alnico V PM speakers, each with 25 feet of speaker cable. Each speaker is mounted in separate carrying case. Each case has a strap on back and is large enough to give good speaker baffling. Each case is 21 x 16 x 13 inches. One is used to carry the amplifier. A 3-speed phono motor and pickup is mounted in the top of the amplifier to play 33 1/3, 45 and 78 RPM records.

This portable PA system will put out 20 watts all day long and 25 to 30 watts peak audio. McGee offers you this \$150.00 list portable PA system at a terrific saving.

STOCK No. AP-28X complete portable PA system with 3-speed phono and speakers as pictured (less mike) ship. wt. 71 lbs. \$69.95.

Electro-Voice model 610 \$28.50 list crystal mike with 20 feet of cable and desk stand \$8.95 extra.

Floor type mike stand instead of desk stand \$4.95 extra.

10-WATT PORTABLE P.A. ON SALE \$42.95 3-SPEED PHONO TOP—10" ALNICO PM SPEAKER

(Illustration C)

5-tube portable 10-watt (14-watt peak) public address system. (Push-pull 7C5) U. L. improved amplifier with wide range response. Inputs for microphone and phono, with separate mixing type volume controls. Tone control. 10" Alnico V PM speaker is housed in a leatherette case 21"x16"x13" which holds the amplifier for carrying. 3-speed turntable and pickup arm to play all records 33 1/3, 45 and 78 RPM is mounted in the top of the amplifier. List value, \$90.00. Stock No. AP-10X, 10-watt portable P.A. system has only one case and one 10" speaker, less microphone. Sale price, \$42.95. Shipping weight 41 lbs. Shipped via Express or Truck only. Crystal microphone with non-removable desk stand, \$3.95 extra when ordered with the AP-10X portable P.A. system.



BRUSH CRYSTAL EAR PHONE With Control \$5.49

Simply clip on to the speaker voice coil of any radio or TV set or to an audio amplifier. No soldering necessary. Listen in privately to your favorite programs. The tiny Brush crystal ear phone fits your ear just like a regular ear A small remote control box enables using 20 ft. of the radio or TV set. Has its own separate volume control and small matching transformer built-in to operate the crystal from any speaker voice coil. Ideal for hospitals, homes, hundreds of other uses. 10 times more comfortable to wear than conventional earphones. Stock No. BH-500 includes Brush crystal ear piece, remote control box, 20 ft. of cable and instructions. Sale price, \$5.49 complete. Brush crystal earphone with 30' cord. Stock No. BH-51, \$2.95. (You connect it like any crystal earphone. Diagram furnished.) Accessory kit includes volume control with switch plus coupling capacity and instructions. 99c extra.

phone fits your ear just like a regular ear A small remote control box enables using 20 ft. of the radio or TV set. Has its own separate volume control and small matching transformer built-in to operate the crystal from any speaker voice coil. Ideal for hospitals, homes, hundreds of other uses. 10 times more comfortable to wear than conventional earphones. Stock No. BH-500 includes Brush crystal ear piece, remote control box, 20 ft. of cable and instructions. Sale price, \$5.49 complete. Brush crystal earphone with 30' cord. Stock No. BH-51, \$2.95. (You connect it like any crystal earphone. Diagram furnished.) Accessory kit includes volume control with switch plus coupling capacity and instructions. 99c extra.

INDIVIDUALLY CARTONED ELECTRONIC RADIO & TV TUBES

McGee offers you a wide selection of good quality TV and Radio tube types. Individually cartoned. Our private brand. These are not set mfg's. culis, but a carefully inspected private line of tubes with a full 6 months' guarantee. Types listed are in stock in good quantity at this time. Thousands sold. Order 50 tubes and take 10% off the listed prices.

024	50	59	6AT6	49	6G7	1.09	12AL5	59	1257GT	69
147GT	59	6AV6	49	6L6G	59	12A8GT	69	125L7GT	79	
183GT	79	6AX4GT	69	6SA7GT	59	12AT7	69	25B0GT	99	
1H5GT	59	6BA6	49	6S17GT	59	12AV7	59	25L6GT	59	
1L	59	6BR7	69	6SF5GT	59	12AU6	59	32L7GT	79	
1R3	59	6BC5	59	6SK7GT	39	12A7	59	35B5	59	
155	59	6BD6	49	6SL7GT	59	12AV7	59	35C5	59	
174	59	6BE6	59	6SU7GT	69	12AX4GT	59	35W4	39	
1U4	59	6BF6	59	6T7	79	12AY6	59	6X4	69	
1U5	59	6BG6G	1.29	6V6	79	12BA6	59	43	79	
1U6	59	6BR6	59	6V6GT	59	12BE6	59	47	89	
1U7	59	6B7	99	6W6	59	12BF6	59	50B5	59	
1U8	59	6B8GT	99	6X4	39	12R6	79	50C5	79	
1U9	59	6C4	39	6X5GT	49	12K8GT	59	50E5	59	
1U10	59	6C5	49	6X6	59	12L6GT	59	50G5	59	
1U11	59	6C6	49	6C8GT	1.59	12MT	59	70L7GT	59	
1U12	59	6C8	49	6C8GT	1.59	7B6	69	11723	39	
1U13	59	6C9	49	6M6GT	59	7H7	79	1257J7M	59	

UHF TELEVISION CONVERTER \$34.95

Sureco UHF television converter with built-in booster. Continuously variable for channels 14 thru 83. Built-in wide band VHF booster for channels 2 thru 13. Self powered for 110 volt, 60 cycle AC operation. Selector switch gives choice of VHF or UHF antenna. VHF antenna may be fed thru the broad band booster or direct to the TV set. Stock No. 21A, shipping weight 7 lbs. Net price \$34.95.



50-WATT BOOSTER AMPLIFIER



50-WATT BOOSTER AMP. \$39.95
2-Mike Pre-Amp \$12.95 Extra.
Not a Kit, but a Manufactured Amp.

50-WATT BOOSTER A sensational value. 50 watt booster amplifier with push-pull handle 6L6 output tubes. Connect to your present amplifier as a booster or use with the PR-2X Pre-amp to add the use of 2 mikes and one input jack on your 1 volt input. Gives 50 watts of audio. Booster has a 6 lb. potted case high fidelity output transformer. Matches speaker with 4-8-16 ohm voice coil, also 60 ohm and 250 ohm line. Booster has a 255 mill power supply with 5U4 rectifier. Price includes tubes: 4 6L6, 7N7 and 5U4. Size 8 x 6 1/2 x 14 1/2. Stock No. PA-55N. Shipping weight 26 lbs. Sale price \$39.95 ea.

2-MIKE PRE-AMP. Pre-amplifier plugs in directly to the PA-55N Booster amplifier. The two variable controls are for master volume control and bus boost tone control. Size 8 x 6 1/2 x 14 1/2. Input, furnished with 4 foot cables, and plugs for remote control of the 55 watt Booster Amplifier. Small chassis size 5 x 3 1/4 x 4". Stock No. PR-2X, with tubes 7F7 and 7N7. Net price \$12.95 ea.

REGENCY RC-600 \$37.46

Carefully engineered and of highest quality construction. Features extreme stability, air dielectric in the tuning element. Image rejection of VHF stations down 50 to 60 db. Converts all sets and is highly recommended for those having split sound and video. Tubes are 6AR4 oscillator, crystal diode mixer, 6BK7 dual triode IF amplifier and selenium rectifier. Front panel change-over switch for UHF or VHF. Input and output impedances 300 ohms. For 110 volt 60 cycle AC operation. Shipping weight 8 lbs. Stock No. RC-600, price \$37.46 each.



UHF-VHF ANTENNAS

VEE-D-X Ultra Q-TEE. One antenna for all channels 2 thru 83 with a single transmission line (tubular 300 ohm recommended, your cost 4c per ft.) List Price \$14.25, your cost \$8.38.
Two stack Ultra Q-TEE antenna for fringe area. List price \$29.55, your cost \$17.58.



UHF ADAPTING BRACKET

Permits addition of UHF antenna to existing VHF installation. Mounts three different ways to mast or antenna boom. List \$1.50. Your Net Cost... 88c



VEE-D-X MIGHTY MATCH

Model MM-30. Provides best method of combining VHF-UHF antenna systems with single transmission line. Automatic action. Printed circuit fit ers. List \$4.00. Your Net Cost... \$2.35

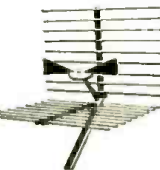

CORNER REF.

UHF ANT. \$8.95

Corner reflector antenna (less mast) for UHF only. As high as 10 db gain on channels 14 thru 83. (Tubular lead recommended, your cost 2c per ft.) With a Mighty Match, you can connect this antenna with your present VHF antenna using only one lead to your set.

McGEE'S \$62.50 LIST 15" COAXIAL SPEAKER, \$21.95

21 OZ. ALNICO V MAGNET—5" TWEETER
This is the finest 15" coaxial PM speaker value that we have ever offered. New 1953 production, of a famous manufacturer of fine speakers. The 15" speaker has a 2 1/2 oz. Alnico magnet, equal to 68 oz. of the Alnico 3 type magnet. The cone is free floating, of one piece construction. Will reproduce low frequencies down to 20 cps. The 5" tweeter is coaxially suspended and has a rifled cone to reproduce only the high frequencies. It will respond up to 17,500 cps. The high-pass filter is concealed under the pot cover, leaving only two wires to connect both the tweeter and woofer to any 8 ohm output transformer of a radio, or high fidelity amplifier. Stock No. P13-CR, shipping weight 13 lbs. Net price \$21.95.



12" COAXIAL SPEAKER, \$12.95

McGee offers the new 1953 model 12" coaxial PM speaker. Quality you would put in your finest sets if you were a high fidelity audiophile. It has 6.8 oz. Alnico V magnet. Tweeter is coaxially suspended and has a metal diffuser. High pass filter is under the pot cover. Only two wires to connect to your radio or audio amplifier. 8 ohm with 18 watt peak and 10 watt average. Shipping weight 8 lbs. Response from 30 to 17,500 cps. Stock No. P14-CR, Sale price \$12.95 each; 2 for \$25.00.



12" JENSEN PM, \$15.95

Another McGee Scoop! Jensen Concert 12", 14 1/2 oz. Alnico V magnet PM speaker, 8 ohm. Will take 25 watt amplifier. You save dollars on this speaker. Just 100 to sell. Shipping weight 8 lbs. Stock No. P-12P. Sale price \$15.95; 2 for \$30.00.



G.I. 3-SPEED CHANGER WITH G.E. \$22.95

VARIABLE RELUCTANCE TURN-ABOUT CARTRIDGE
Another tremendous McGee Scoop! Brand new General Instrument variable reluctance turn-about record changers. Complete with RP-500 G.E. variable reluctance cartridge with turn-about stylus. Plays all 3 speeds automatically: 7 1/2, 10" or 12" records. Has reset button. Repeat last record. Base size: 12"x12 1/2"x4". Shipping weight 14 lbs. Stock No. 700-GE. Scoop price, \$22.95.

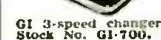

GI 3-speed changer same as above, but with Webster flip-over twin needle cartridge. Stock No. GI-700. Sale price, \$21.95 each.

McGEE RADIO COMPANY

Prices F.O.B. K.C. Send 25% Deposit with Order, Balance Sent C.O.D. With Parcel Post Orders, Include Postage

TELEPHONE VICTOR 9045. WRITE FOR FLYER
1422 GRAND AVE., KANSAS CITY, MISSOURI

TELEVISION BOOSTERS AND CONVERSION KITS ON SALE AT McGEE

GENUINE STANDARD COIL T.V. BOOSTER \$10.95

Not Surplus, But Right From the Factory

Latest Model B-51 Standard Coil Television Booster. McGee makes another lucky purchase and as usual, passes the saving on to you. The famous Model B-51, 12 Channel Standard Coil TV booster, which lists for \$14.00, is offered to you for only \$10.95 each. Brand new, factory cartoned and fully guaranteed by McGee. This top quality single stage booster utilizes printed high frequency circuits, for improved performance on all channels. Uses 6AK5 tube. Average gain, 6 to 7 volts on low channels and 5 or 6 on high channels. No distorting of picture or sound. Has extremely low noise factor. Continuous one-knob tuning and channel selector on-off and by-passing 300 ohm lead-in to set. Modern design, dark brown plastic cabinet and by-passing 300 ohm lead-in to set. Shipping weight 5 lbs. Model B-51. Sale Price, \$10.95 each, or buy 2 for only \$20.00.



FRINGE AREA TV RECEPTION IS BETTER WITH OUR McMURDO SILVER TV BOOSTER \$10.95—TWO FOR \$20.00

Read the article on pages 52 and 53 of the December "Radio & TV News." You will see now a booster like the McMurdo Silver Super Sonic was used for fringe area TV reception. We can't say that this unit is a receiver, but we can say it is a sensational value. Continuously variable inductance tuner from channel 2 including the FM band through channel 13. Self-powered for 110 volts AC operation. Incorporates a 6J6 tube. Input for 300 ohm TV line and 300 ohm output to TV set. Single knob tuning. Attractive plastic case. McMurdo Silver Super Sonic TV-FM booster. Stock No. GB-6B, shipping weight 5 lbs. Sale price, \$10.95 each or two for \$20.00.



20 INCH CONVERSION KIT \$29.95

YOU GET—

- 20HP4—20" PICTURE TUBE
- 20-INCH PLASTIC MASK
- 14 K.V. FLYBACK AND 70" YOKE

Our 20" conversion kit includes a 6-month guaranteed 20HP4, 20" rectangular blackface picture tube, plus a 14,000 volt G.E. built high voltage flyback transformer, plus a matched 70" cosine yoke, plus a 20" rectangular gold trimmed plexiglass mask and suggested diagram. The picture tube is the latest electro-static focus type that requires no focus coil. Shipped via express or truck only. Ship. weight, 40 lbs. Stock No. 20-T, net price, \$29.95. Price with Raytheon or GE 1 year guarantee picture tube, \$10.00 extra.

14-Inch Conversion Kit \$25.95 WITH G.E. TUBE

14-inch conversion kit: You get a 14-inch black face, 1 year guarantee G.E. 14CP4 picture tube, a 70" deflection yoke with matching 14,000 volt G.E. flyback and a 14" plexiglass gold trim safety mask, plus conversion instructions. Stock No. 14CC-G. Sale price, \$25.95.

17-INCH CONVERSION KIT \$25.95 You Get—17BP4A 17" Picture Tube 17-inch Plastic Mask 14 K.V. Flyback and 70" Yoke

17-inch conversion kit with a 17BP4A, 17" rectangular blackface electro-magnetic focus picture tube with 6 months' guarantee, plus a matched 70" cosine yoke, a G.E. built 14,000 volt flyback and a 17" rectangular gold trimmed plexiglass mask and safety shield, suggested diagram furnished. Shipping weight, 30 lbs. via Express or Truck only. Stock No. 17-431. 17" conversion kit. Sale price, \$25.95. Kit Price with GE or Raytheon 1 year guarantee picture tube, \$5.00 extra.

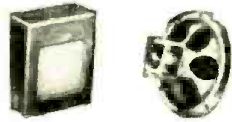

SPEAKER AND BAFFLE SALE 8" SPEAKER AND BAFFLE \$4.95

Stock No. 818. Tan leatherette covered, plywood slant type wall baffle, plus an 8" Oxford, 2-15 oz. Alnico 5 permanent magnet speaker. \$25.95. Kit Price only \$4.95 each, or \$4.70 each in lots of 3 or more.

10" SPEAKER AND BAFFLE \$6.95 Stock No. CA-10. Tan leatherette covered plywood slant type wall baffle, plus 10" Permanent, 3-16 oz. Alnico V PM speaker. Only a few hundred to sell at \$6.50 each, or \$6.25 each in lots of 3 or more.

12" SPEAKER AND BAFFLE \$7.95 Stock No. CA-12. Tan leatherette covered plywood slant type wall baffle, plus a 12" Quin, 4-04 oz. Alnico V magnet PM speaker. (Popular Alnico model.) A terrific McGee value for only \$7.95 each, or \$7.50 each in lots of 3 or more.



RCA 201E1 T.V. TUNER \$7.95

Terrific buy on this RCA tuner. We have a limited quantity of the famous original 201E1, 13 channel completely wired and tested TV front end tuners. Ready to connect to your TV video I.F. strip. Offered at a sacrifice. Price was \$44.00. Now only \$7.95 each, with tubes. Each tuner in good condition but has been repaired. Stock No. RCA-13P. TV front end tuner. Converter coil type for separate sound as used in the famous 630 chassis. Complete with 3-630 tubes, \$7.95. Specify shaft length desired, either 2" or 4".

RCA 201E-1 T.V. TUNER

Same as pictured above only new—with 2 7/8" shaft. Stock No. 2201. Sale Price, \$11.95.



3-TUBE SARKES-TARZAN T.V. TUNER \$9.95

This popular Sarkes-Tarzan Type 3 tuner is widely used. 13 channel rotary type switch with individually tuned coils. Price as complete with diagram and three tubes: 6C4 osc., 6BH6 R.F. and 6AG5 mixer. Regular factory cost is twice our price. Each tuner is wired ready to hook up to a video and sound I.F. strip. May be used with either inter-carrier or separate sound I.F. circuits. Has built-in converter coil, built in the frequency control. Sarkes-Tarzan TV Tuner, with 3 tubes. Net price, \$9.95 each. Specify shaft length, either 2 7/8" or 4 3/4".

STANDARD COIL SUPER CASCADE TUNER \$19.95 UHF STRIPS \$9.40 EXTRA

The Cascade Circuit of the Standard Tuner offers a new development of the famous TV front end assembly which affords a 2-to-1 improvement in gain and a 35% to 50% reduction of noise over the pentode tuner. Other advances include: easy conversion to UHF reception by interchanging of channel inductors; increased sensitivity for TV sets in fringe areas; elimination of loose used and a high profit item for the serviceman as a replacement unit sale. Brand new factory TV-2000 TV tuner, complete with tubes 6BK7 or 6H47 and a 6J6. Shaft length 2 7/8" or 4 3/4". Price as complete with diagram and UHF strips for other models of the Standard Coil tuners specify channel and series; either F, G, K, Q, R, H or M as printed on the tuner, \$9.40 per set.



3 STATION INTERCOM MASTER \$16.95 SUB STATION \$3.95

3-station intercom master housed in chrome plated metal cabinet. 7 1/2" x 8 1/2" sloping front. Full 3-tube amplifier for 110 volt AC-DC operation. Press-to-talk switch is on top of the cabinet and volume control with on-off switch and station selector switch are on either side. May be used with from one to 3 sub-stations. (See matching cabinet chrome plated sub-station No. PM-A5). Master is quiet at all times except when press-to-talk switch is pressed at the master or call-back switch is pressed at the sub. Uses 3-wire intercom cable. 3-station intercom master MPM-A3, shipping weight, 10 lbs. Sale price, \$16.95 each, sub-stations extra. 3-wire plastic intercom cable, 100 ft. for \$1.95, 500 ft. for \$8.95.



INTERCOM SUB STATIONS \$3.95

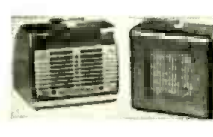

Chrome plated, with call back switch for a 3-wire intercom master. Size 7 1/2" x 8 1/2" sloping front. 3 Alnico V PM speaker in intercom cabinet, but at less than present production cost. Limited quantity. Stock No. PM-A5. Sale price, \$3.95 each or 3 for \$10.00. Special 3-wire plastic intercom cable, 100 ft. for \$1.95, 500 ft. for \$8.95.

Brown leatherette covered intercom sub-station with call back switch for use with 3-wire intercom masters. 5 square inch cabinet. Has new plastic grill cloth. Alnico V PM speaker. A true McGee value. \$1.00 each. No. NE-3, ship. weight, 1 1/2 lbs. Sale price, \$3.95 each or 3 for \$10.00. Special 3-wire plastic intercom cable, 100 ft. for \$1.95, 500 ft. for \$8.95.

CAPEHART CABINET FOR 1000 SET—ONLY \$99.95



Beautiful, finest quality walnut combination radio-phonograph cabinet, 42" high, 42" wide and 22" deep. Made for Capehart's finest combination, selling for \$200.00 and up. Cabinet cost, manufacturer over \$200.00. Has highly polished matched walnut panels. Made of 3/4" material. Top 1 1/2" solid stock. This cabinet weighs approximately 175 lbs. The changer radio and speaker grill all have hinged doors. Radio compartment on right hand side is 14" high and 1 1/2" wide. Mount chassis vertically. Changer compartment is 14" high by 26 1/2" wide. Large enough to hold any record changer or recorder mechanism. Front of top over the changer compartment is hinged to fold back for easy access to the changer. Both radio and changer compartments come with urethane panels. Speaker baffle is cut for a 12" speaker and the speaker compartment is completely enclosed. Shipping weight, 275 lbs. Stock No. K-275W Capehart combination cabinet. Net price, \$99.95. Walnut.

COMPLETE RADIO, TELEVISION AND AMPLIFIER KITS AT McGEE

3-WAY PORTABLE KIT

\$15.95

New 1952 Model 3-way portable radio kit. Operates on 110 Volts AC-DC or 67 1/2 V plus 1 1/2 volt self-contained batteries. Leatherette covered case size, 5 1/2 x 5 x 8 1/2. Receives broadcast 550 to 1650 KC. A conventional 2-gang superhet circuit with 456 KC iron core IP's. Incorporates the new super gall shell loop antenna. All plated chassis. Lab. approved circuit—matched parts. Includes all parts, tubes, diagram, Alnico V PM speaker. A factory quality kit. Stock No. PN-37, shipping weight 1 1/2 lbs. Includes 2 sets of batteries. \$15.95. 67 1/2 V. B. \$1.59; 1 1/2 V. A. .39c extra.

8-Tube Hi-Fi Amplifier Kit \$29.95

A complete kit including tubes: 7E5, 2-12AX7, 3-triode plus rectifier, dia. X-Ram and photos. Inputs for radio, diode tuner and any kind of audio pickup (crystal or G.E. variable reluctance) and either crystal or dynamic mike. Output matches 8 ohm voice coil. Twin electronic bass and treble tone controls with range selector switch for either juke box quality with heavy bass response or brilliant complex range. Response 18 to 20,000 cps. 8 tube all triode amplifier kit, complete with tubes. Shipping weight 25 lbs. Model 7X3. Net \$29.95.

10-TUBE RADIO KIT \$29.95

10 tube broadcast receiver with 518 K.I.T. complete with tubes: 2-6BK7, 2-6X4, 1-6X4, 1-6X1, 2-6V6 plus 5Y3 rectifier, diagram and instructions. 3 gang superhet with 8" slide rule dial. Chassis size, 12 1/2" x 10" x 6 1/2". Features push-pull 6V6 high fidelity audio. Output matches 3 to 8 ohm voice coil speakers. Inputs for G.E. variable reluctance or crystal pickup and any kind of audio pickup. Heavy duty power transformer. Model BK-110 kit less speaker, shipping weight 18 lbs. Net \$29.95.

6-TUBE 2-BAND KIT \$14.95

Popular with schools and colleges for training. 6 tube AC-DC, 2 band radio kit with plastic cabinet. Receives broadcast and 6 to 18 mc shortwave. Full 6 gang superhet with 5" speaker and slide rule dial. A complete kit with tubes: 12SK7, 12K8, 12SK7, 12SQ7, 50L6 and 35Z5. Diagram and instructions. Factory quality. Cabinet size 13" x 8 1/2" x 8 1/4". Shipping weight 12 lbs. Model REG-2. Net \$14.95.

Build Your Own Phono-Mike Broadcaster \$7.95

Kit Model DE-6R. With this simple kit you can build a 3-tube phono oscillator that also has a mike input. Will broadcast over any radio within your home, about 75 feet, from 1000 to 1500 kc. Inputs for crystal mike or crystal phono pickup. Fader control fades from mike to record. Ideal for a home P.A. system, baby listener and home entertainment. A complete kit of parts including tubes. Kit Model DE-6R. Net price, \$7.95. DE-6RW, wired and tested. \$8.95. Crystal mike and desk stand, \$4.95 extra. Concealed microphone unit, only 1" in diameter and 1/2" thick. Specify hidden mike when ordering. Stock, T-001. Net, \$3.95 extra.

10-Watt Hi-Fi Amplifier Kit \$14.95

A complete kit of parts including tubes: 6X4, 12AX7, 12AU6, 2-60L6, plus rectifier, diagram and instructions. 10 tube all triode amplifier kit with bass and treble boost. Inputs for radio tuner, crystal or G.E. variable reluctance or dynamic mike. Output matches 8 ohm voice coil. Response from 40 to 15,000 cps. Chassis ready punched. Ventilated cover. Straight forward circuit with twin triode gain stages and 2-50L6 tubes in push-pull. Size, 5 1/4" x 10" x 5 3/8". High fidelity AP-10R, ship. wt. 8 lbs. Sale price \$14.95.

17, 20" T.V. Kit \$59.95 Less Tubes

A complete kit of parts to build an AC transformer operated television chassis for use with a 17" or 20" rectangular picture tube. The 3 channel Sarkes-Tarzan tuner is ready wired, plus the 4 tube video I.F. strip. Circuit is of the conventional design. Do not buy this unless you understand television. It is diluted with wire. We furnish schematic. Kit Model NH-20. Ship. wt. 40 lbs. less all tubes. Net \$59.95. Cascade tuner \$10.00 extra. 12" speaker \$2.95 extra. Kit of 23 tubes, less picture tube \$16.95. 17" 17BP4A, \$19.95. 20HP4, \$25.00.

5-TUBE AC-DC KIT \$12.95

Model RS-5. A 5 tube AC-DC straight broadcast kit, housed in the same cabinet as REG-2 above, complete with tubes. Shipping weight 10 lbs. Net \$12.95.

AC POWERED BROADCAST TUNER KIT \$12.95

A self-powered, 3-gang superhet tuner kit with R.F. stage. This complete kit is furnished with a diagram, photos and tubes. 6BA8 R.F., 6BE6 oscillator R.F., 6BA8 I.F. detector, 6AL5 diode AVC, plus rectifier. Connect to any audio amplifier. Ideal for use with our S-2020 or 7x3 amplifier kits. Chassis size, 9 1/2" x 4 1/2" high. Shipping weight, 7 lbs. Broadcast tuner kit Model BT-38X. Net price, \$12.95.

McGEE RADIO COMPANY

Prices F.O.B. K.C. Send 25% Deposit with Order. Balance Sent C.O.D. With Parcel Post Orders. Include Postage

TELEPHONE VICTOR 9045. WRITE FOR FLYER 1422 GRAND AVE., KANSAS CITY, MISSOURI

ASK YOUR JOBBER for

Carleo

PARTS KITS



Display Rack
FREE to
Parts Jobbers

**BEST
BUY**
IN THE
BUSINESS

RESISTORS
TUBULARS
MICAS
CERAMICS
ELECTROLYTICS

BRAND
NEW
STANDARD
BRANDS

Only
\$1.98
Per Kit
DEALER
NET

GUARANTEED PERFECT

All assortments are carefully selected to include the most popularly used sizes by Servicemen, Amateurs, Laboratories, Dealers, Experimenters, Hams, Engineers . . . and as replacements in all Electronic Equipment, including recent and current models.

Carleo RESISTOR KIT . . . No. RK-100 . . . Contains 100 Resistors, brand new, standard brands, guaranteed perfect. 35 different ohmages (minimum), 1 ohm to 20 megohms. Assortment: 10 two watt; 20 one watt; 70 one-half watt.

Carleo CERAMIC CAPACITOR KIT . . . No. CK-35 . . . Contains 35 Ceramic Condensers, brand new, standard brands, guaranteed perfect. 15 different capacities (minimum). Complete ceramic capacitor detachable Color Code Chart included on every package.

Carleo MICA KIT . . . No. MK-50 . . . Contains 50 Mica Condensers, brand new, standard brands, guaranteed perfect. 10 different capacities (minimum) 5 MMF. to 1000 MMF. Each condenser STAMPED with easily read value in MMF.

Carleo MOLDED TUBULAR CAPACITOR KIT . . . No. TK-25 . . . Contains 25 Molded Tubular Condensers, brand new, standard brands, guaranteed perfect. 400 and 600 volts. 12 different capacities (minimum) up to 1 MFD. Complete molded tubular condenser detachable Color Code Chart included on every package.

Carleo LOW VOLTAGE ELECTROLYTIC KIT . . . No. LV-10 . . . Contains 10 assorted brand new, standard brands, guaranteed perfect. Low Voltage Electrolytics including FP's. Each condenser clearly stamped with value. Voltages up to 50 v.

JOBBERS—our GUARANTEED SALES PLAN assures you that if, for any reason, you find our items do not move as fast as you would like, we will accept return of unsold portion for full credit —NO QUESTIONS ASKED!

IF YOUR JOBBER does not as yet have these order to us. We will arrange to fill your needs and inform your Jobber.

CARL CORDOVER & CO., 100 Warren St., N.Y.C. 7

MAIL THIS COUPON TODAY

CARL CORDOVER & CO., Dept. RN63
100 Warren St., New York 7, N. Y.

Please rush me the following Carleo KITS @ \$1.08

Name

Street or RFD

City State

My Jobber is:

MANUFACTURERS' LITERATURE

Readers are asked to write directly to the manufacturer for the literature. By mentioning RADIO & TELEVISION NEWS, the issue and page, and enclosing the proper amount, when indicated, delay will be prevented.

HI-FI CATALOGUE

Mark Simpson Mfg. Co., 32-28 49th Street, Long Island City 3, N. Y. has available for distribution a new catalogue describing its "Concert Master" high fidelity amplifier with remote preamplifier, the Model CMR-20.

This four-page catalogue contains full technical specifications and highlights as well as photographs of the unit itself.

When writing for copies of this publication, please specify catalogue #CM-53.

U.H.F. EQUIPMENT

General Radio Company, 275 Massachusetts Avenue, Cambridge 39, Massachusetts has recently issued a six-page bulletin covering its line of u.h.f. measuring equipment and accessories.

Illustrated and described are such units as coaxial elements, attenuators, modulators, mixer rectifiers, voltmeter rectifiers and indicators, baluns, constant-impedance adjustable lines, component mounts, insertion units, adapters, the company's standard signal generator, a bolometer bridge, a heterodyne frequency meter, and a unit u.h.f. oscillator.

A copy of this data sheet is available on request.

MIKE MIXER DATA

A new electronic microphone mixer and preamp, the Masco Model EMM-6, is described in a catalogue sheet currently available from Mark Simpson Mfg. Co., Inc., 32-28 49th Street, Long Island City 3, N. Y.

The new unit is designed for electronically mixing the outputs of up to four microphones and two phonographs or radio tuners into any amplifier, p.a. system, tape, disc or wire recorder, or broadcast input channel.

The catalogue sheet provides full specifications and is available on request.

CABINET CATALOGUE

G & H Wood Products Co., 75 North 11th St., Brooklyn 11, N. Y. has issued a revised catalogue on its "Cabinart" line of custom-styled high-fidelity cabinets and kits.

Fully illustrated, the new catalogue is a complete resumé of cabinet design information. Each unit is illustrated to give a good idea of its period and styling. Individual specifications and spot illustrations highlight each cabinet's layout and equipment requirements.

Copies of this compact catalogue are available from local parts distributors or from the company direct.

TOWER BROCHURE

Rohn Manufacturing Co., 116 Limestone, Bellevue, Peoria, Illinois has announced the availability of a two-color brochure covering its entire line.

The publication lists three types of self-supporting steel towers, the fold-over tower kit, telescoping masts, and new TV service table. In addition, it lists, illustrates, and fully describes the company's full line of TV and tower accessories. Catalogue numbers are given for easy ordering.

Dealers may obtain copies from their representatives or distributors or by writing the company direct.

MUSIC SYSTEMS DATA

Audak Company, 500 Fifth Avenue, New York 36, New York has announced the availability of a 1953 edition of its popular booklet "Electronic Phono Facts" by Maximilian Weil.

This 20-page, pocket-sized publication contains the answers to more than 100 important questions relating to audio-electronic music systems. Stripped of all technical verbiage, the answers are given in layman's English.

Copies of this booklet are priced at \$1.00 each and may be obtained either from Audak dealers or from the company direct.

KAAR CATALOGUE

Kaar Engineering Corp., Middlefield Road, Palo Alto, California has just issued a comprehensive "summary" catalogue covering its line of mobile equipment.

All mobile radiotelephone units manufactured by the company are included with the information being presented in capsule form to provide quick reference with a minimum of effort.

The company's line includes mobile and station equipment for use in the 152-174 mc. band, the 25-50 mc. band, and the 1600-6000 kc. band. In addition, the complete line of the company's accessories is included.

Copies are available without charge from the manufacturer.

NEDA BATTERY INDEX

The second edition of the "NEDA Battery Index" is currently available from the National Electronic Distributors Assn., 228 N. LaSalle Street, Suite 1114, Chicago 1, Ill.

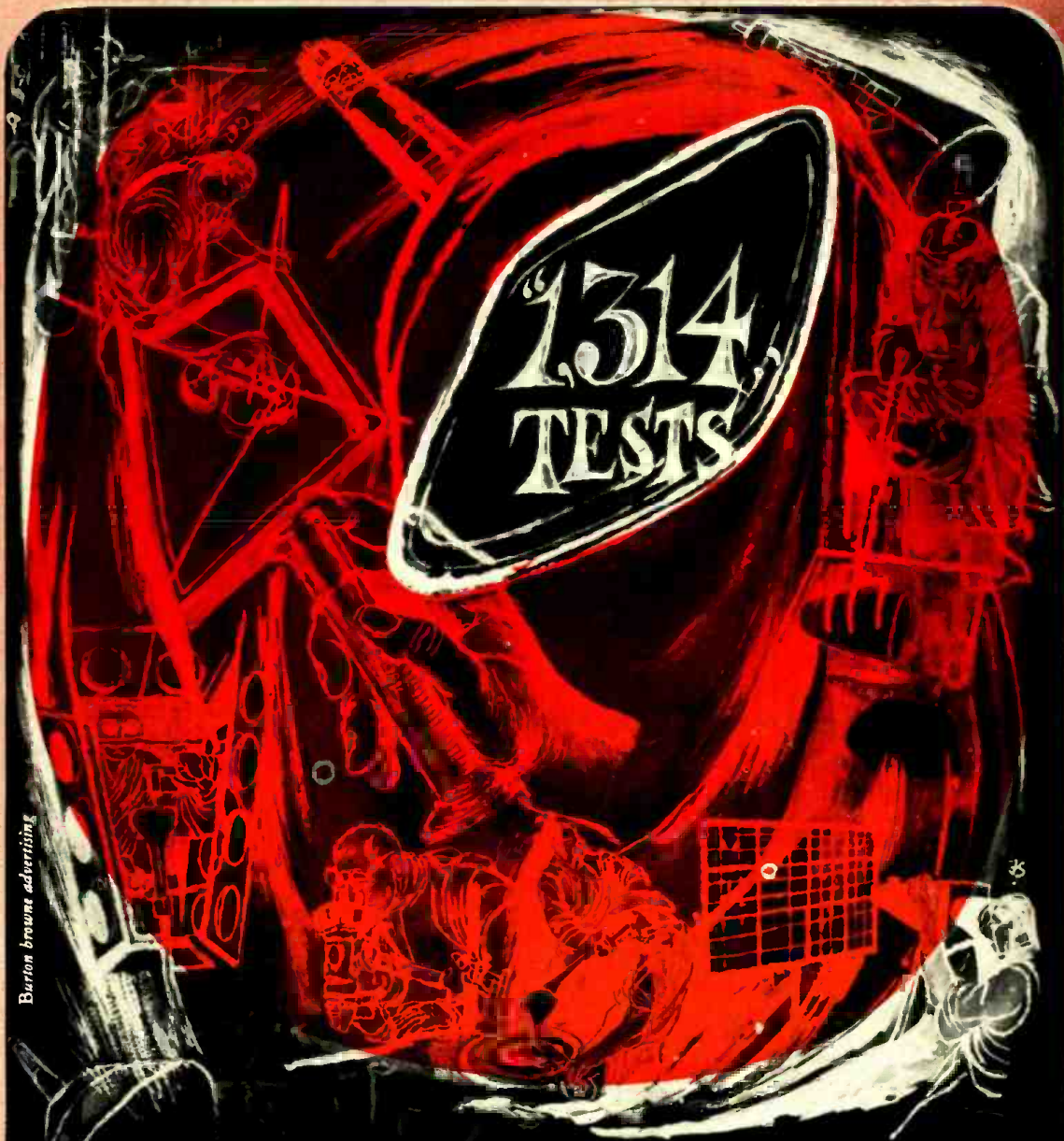

Burton Browne advertising

Quality-checks are a full-time job with Rauland—all the way down the line. From spectrographic analysis of tube components to ionization test for vacuum—1,314 tests are your assurance that Rauland meets the highest engineering standards. Test-proved in our factories and laboratories, performance-proved in countless homes...it's plain to see why Rauland is the *proved* profit-getter, too. *The Rauland Corporation, 4245 N. Knox Avenue, Chicago 41, Illinois—Mulberry 5-5000.*

ZENITH Subsidiary

RAULAND

PERFECTION THROUGH RESEARCH

BARGAINS · BARGAINS · BARGAINS

You can depend on STEVE-EL to come up with "terrific buys"!
Our latest catalog is chock full of 'em. WRITE TODAY!

BARGAINS · BARGAINS · BARGAINS

BARGAINS · BARGAINS · BARGAINS

TUBE REJUVENATOR \$1.49

CASCADE TUNER \$19.95

Factory aligned ready to use. Complete with tubes and instructions.

8-Element Super Fan Conical Antenna, Heavy Aluminum construction. \$2.95

SUPREME TESTERS
World's finest equipment.
#600 Tube and Set Tester. \$8.995
#616 Tube and Battery Tester. \$6.995

WEN Soldering Gun \$9.71
250 Watts
WEN Soldering Gun, UL Approved. Choice of colors: Red, Green and Black. (Minimum Order \$5.00)

STEVE-EL ELECTRONICS CORP.

Dept. N-6 61 Reade St., New York 7, N. Y. COrtlandt 7-0086

Steve-El Brand TUBES

Brand new, individually boxed. Many FAR BELOW WHOLESALE COST!

1A7	50.62	6SL7	52
1B3	63	6SN7	52
1P5	64	6S07	42
1R5	49	6T8	74
1T4	49	6U6	57
1U4	48	6U7	78
1U5	48	6V6	46
5U4	47	6V8	83
5W4	46	6W4	45
5Y3	51	6W6	52
6A7	52	6X4	34
6A8	51	7C5	42
6AG5	52	7X7	62
6AK5	1.14	12AT6	48
6AK6	64	12AU6	48
6AL5	41	12AU7	56
6AU6	43	12AV6	52
6AX4	59	12AX4	59
6BA6	48	12X7	54
6BC5	58	12BA6	47
6BC7	86	12BE6	47
6BE6	48	12SA7	52
6BG6	1.21	12SK7	49
6BM6	62	12SL7	57
6BJ6	53	12SN7	54
6BK7	86	12SO7	42
6BQ6	76	14AF7	59
6BQ7	86	19T8	78
6C86	48	2806	77
6CD6	1.79	25W4	48
6F6	49	25L6	48
6J6	78	25Z6	42
6K6	41	32L7	51
6L6CA	89	35Z5	33
6L6G	89	35L6	48
6SA7	52	50L6	48
6SG7	49	80	38
6SK7	49		

SPECIAL DISCOUNTS

50 Ass't. **5%** 100 Ass't. **10%**

This new edition, revised to show new batteries and to correct errors on the original, is a practical cross-reference volume for both wholesalers and dealers.

Compilation of the material included in this new edition is the result of almost a year's work by a special NEDA committee.

Details on how copies of this new index may be obtained will be supplied by NEDA on request.

MAGNETIC TAPE BOOKLET

A new four-color, 16-page illustrated booklet entitled "A New Horizon in High Fidelity Recording" has been issued by *Minnesota Mining and Manufacturing Co.*, 900 Fauquier St., St. Paul, Minn.

The booklet tells the story of "Scotch" brand "High Output" magnetic tape No. 120 recently introduced by the manufacturer. Included are the major advantages of the tape, an explanation of the significance of these advantages in terms of the recording and broadcast engineer as well as the hi-fi enthusiast, and bias requirements and frequency response characteristics in graph form.

The booklet is available on request. Write direct to the company.

ELECTRON TUBE NOTES

A summary of data-sheet rating interpretations and a series of notes concerning means of improving electron-tube service life are included in a new leaflet, Form 153, covering "Los Gatos" brand electron tubes.

The publication also includes a field-engineering location map and list of the company's field-engineering representatives.

Copies of Form 153 are available from *Lewis and Kaufman, Ltd.*, 76 El Rancho Ave., Los Gatos, California.

RCA SERVICE BOOKLET

The Tube Department of *Radio Corporation of America* has prepared a 33-page booklet which outlines ways of achieving greater profits and increased efficiency in radio and TV service operations.

The booklet also includes descriptions of business practices and essential test equipment used by successful service organizations throughout the industry.

Sections of the booklet are devoted to illustrations and descriptions of the company's test equipment designed specifically for use in radio and TV servicing. Complete specifications are given along with hints on applying the equipment most effectively.

The business-guide sections cover such important management subjects as budget planning, wage and salary considerations, materials, stock control, employee training, customer relations, and methods for reducing operating expenses and costs.

Entitled "This Business of Radio and TV Servicing," the new booklet is now available from *RCA tube, parts, and test equipment distributors.*

SAVE MONEY ON INSTRUMENTS!

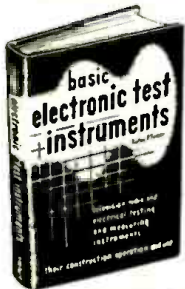

- How to test with fewer instruments . . .
- How to use old instruments in new ways . . .
- How to select the instruments you need . . .
- How to evaluate instrument readings and put them to practical use.

BASIC ELECTRONIC TEST INSTRUMENTS

by Rufus P. Turner
254 pages, 171 illus., Price \$4.00

Written especially for servicemen, amateurs and experimenters, this new book is a complete training course in instruments. Over 60 instruments—from the most modern TV pattern generators to grid-dip oscillators and special-purpose bridges—are fully explained. Work-saving shortcuts are outlined. You learn how to put your old instruments to new uses and thus avoid buying costly new ones. Tells all about current & voltage meters; ohmmeters and V-O-M's; V-T voltmeters; power meters; oscilloscopes; r-f test oscillators; signal tracers; tube testers; TV linearity pattern generators and dozens more.

READ IT 10 DAYS . . . at Our Risk

Dept. RN-63, Rinehart Books, Inc.,
Technical Division,
232 Madison Ave., New York 16, N. Y.

Send Turner's BASIC ELECTRONIC TEST INSTRUMENTS for 10-day examination. If I decide to keep book, I will then remit \$4.00 plus postage in full payment. Otherwise, I will return book postpaid and owe you nothing.

Name
Address
City, Zone, State

ELECTRON TUBE TECHNICIANS

We now have several openings for technicians to work in the fabrication and processing of advanced type electron tube research models.

To qualify for one of these openings you should be experienced in experimental work for research and development in vacuum tubes, which includes the fields of mechanics, electronics, chemistry and high-vacuum techniques.

ADDRESS RESUME OF TRAINING AND EXPERIENCE TO

HUGHES

RESEARCH AND DEVELOPMENT LABORATORIES

Technical Personnel Department
CULVER CITY,
LOS ANGELES COUNTY,
CALIFORNIA

Field Engineers

FOR INSTALLATION AND MAINTENANCE OF LINK ELECTRONIC JET TRAINING EQUIPMENT



Here is an unparalleled opportunity for men with a College or Technical Institute Training and a sound background in electronic engineering. The training and experience provided will open up increasing opportunities for earnings and advancement in the fast approaching age of jet air transportation.

You will work in close contact with key personnel of the U.S. Air Force and Naval Aviation. Your responsibilities will include supervising the installation and long range maintenance of highly specialized Link Electronic Jet Training Equipment. After three months' special training at the Binghamton, N. Y. plant of Link Aviation, you will be assigned to a U.S. Air Force or Navy jet training base in the U.S., Europe or the Far East!

In addition to excellent base pay and unusual company benefits, you will be placed on a liberal expense account and receive a 20% bonus if you receive an overseas assignment.

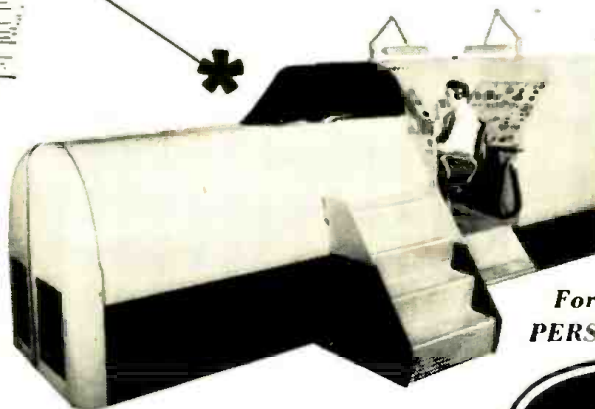

Immediate Openings
are available
ACT NOW—
for a career
with a future!

For Interview write to
PERSONNEL MANAGER

the connecting link between ground and sky

Manufacturers of the famous World War II LINK TRAINER,
now producing Electronic Jet Training Equipment
in quantity for the U.S. Armed Services



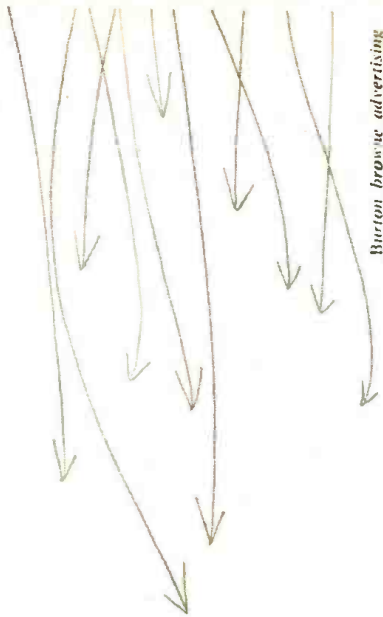

Burton bronze advertising

Bob Henry

to all radio hams and hobbyists—
Over!

Yes—you're at the controls when you do business with Bob Henry! As one radio fan to another, Bob knows what equipment and services you want—and he's made both his stores to-the-order of the radio ham or hobbyist. Dealing with Bob, you get 90 days FREE service—really liberal trade-ins—and a payment plan that just can't be matched! Write, wire, phone or visit either store today. Find out all the "extras" you get with Bob Henry—the world's largest distributor of short wave receivers.

Bob Henry has

a complete line of new Hallicrafter receivers and transmitters.



MODEL SX-71...Double superheterodyne circuit plus built-in Narrow Band FM reception. Temperature compensated, voltage regulated. 5 position band selector for 538-1650 Kc, 1600-4800 Kc, 4.6-13.5 Kc, 12.5-35 Mc, 46-56 Mc. 11 tubes plus voltage regulator and rectifier, \$224.50.

Also available — Hallicrafters Model HT-20, \$449.50 • Model S-76, \$179.50 • Model SX-62, \$299.50 • And all other models.

HENRY RADIO STORES
LARGEST DISTRIBUTORS OF SHORT WAVE RECEIVERS
LOS ANGELES OFFICE: 11240 Olympic Blvd.,
LOS ANGELES 64. BRADSHAW 2-2917

BUTLER OFFICE: Butler 1, Missouri. Phone: 395

Probe Switch (Continued from page 72)

tube at the point this nut will rest when in place. Then, holding the rotary contact one-half way between the limits of its rotation, insert it into the tube midway between the stator contacts. When the adhesive sets, the switch is finished.

From the experience gained building the original switch, here are some pointers. Select a heavily knurled nut for the part, Fig. 2C, because the ridges formed by the knurling help to hold the adhesive, and the slightly enlarged diameter of a heavy knurl gives a good fit against the tube wall, while allowing the necessary clearance to the smooth section of the following nut. The enlarged diameter of the knurling mentioned is indicated by the heavy outlines in the drawings, as noted in Fig. 2C.

The diameters of the stator support bar, Fig. 2D, apparently difficult to produce without a lathe, are easily made on a drill press. This part was made by putting a 3/8 in. o.d. Bakelite rod into the drill and running it at about 750 rpm. Then, using a flat file, the two diameters were brought to size. The shoulder on the nut, Fig. 2C, was made by the same process. With a little patience these jobs can be done on a hand drill clamped in a vise.

It is not necessary to follow the dimensions given in Fig. 2. Use them only as a guide. The important thing is to dimension the parts so that the rotor contact will slip smoothly into place with the type of stator contacts used. These dimensions may vary with the make of switch from which the stator contacts are taken.

A study of Fig. 2B will make the switch operation clear. Setting the switch to either position is accomplished by a half turn on the nut *H*: clockwise for a.c. voltage and resistance measurements, and counter-clockwise to place the resistor in the circuit for d.c. voltage readings. As the electrical contact is made, a frictional switch lock is also applied by the phone tip threads. As drawn, the pressure for this locking action is applied between the shoulder *J* of the phone tip *A*, and the contacting surface of the nut *C*. Turning the nut, *H*, clockwise will release the pressure by moving the shoulder away from the nut, and as the opposite electrical contact is made, the locking action pressure will take place between the meeting surfaces of the nuts, now shown separated by one-half the pitch of the phone tip threads. *Caution*, do not turn the switch too hard, for the fine pitch of the phone tip threads will multiply the applied pressure the same as a lever. Only light pressure is required to lock the switch. Heavy pressure may only make it hard to operate.

Considering the fact that the direction of the applied turning movement

on the nut *H* will indicate the function for which the switch is set and that the switch stops will indicate the full engagement of the contacts, practically automatic operation is obtained.

Electronically, a slight increase in the stray capacity of the probe, due to the stator contact assembly, can not be avoided. However, by holding the probe above the engraved white line, indicated in Fig. 2E, to avoid any body capacity when measuring sensitive circuits, the effect of the additional probe capacity will not be noticeable. —30—

1953 Philco TV Sets (Continued from page 61)

Video i.f. alignment:

1. Preset the contrast and brightness controls to the maximum counterclockwise position.
2. Preset the channel selector to Channel 4.
3. Connect an oscilloscope to the video detector test point on J_{200} (see Fig. 14) through a 15,000-ohm resistor.
4. Connect the negative side of a 6-volt battery to the a.g.c. test point on J_{200} . Connect the positive side to ground.
5. Connect the AM generator to the mixer grid test point, G_1 .
6. Refer to Fig. 14. Adjust the various trimmers shown on this diagram of the r.f. chassis in the order given and for the response indicated, changing the frequency of the AM signal generator for each trimmer adjustment.
7. Connect a sweep generator and r.f. marker generator to the antenna terminals through a 72-ohm to 300-ohm matching jig. Connect a 7.5-volt battery to the a.g.c. test jack, with the negative terminal to the bias lead and the positive terminal to the ground lead. Set the channel selector to Channel 4, and tune the sweep generator for output on Channel 4. Tune the r.f. marker generator for the video carrier frequency of Channel 4 (67.25 mc.) and tune the i.f. marker generator (connected to mixer grid) to 45.75 mc. Note that two marker generators are used for this procedure. The r.f. marker generator is connected to the antenna terminals, while the i.f. marker generator is connected to the mixer-grid test point, G_1 .
8. A jig constructed from a piece of fiber tubing, with 3/16-inch inside diameter, and a brass machine screw which fits tightly into the tubing, is used to connect the generator to the test point. The screw is adjusted so that it clears the test point by approximately 1/64 inch. The output cable of the marker generator is connected to the head of the brass screw in the jig and to the chassis near the mixer tube. Both marker generators should be adjusted for the minimum output required to make the markers barely visible. Failure to observe this precaution, or the use of excessive output from the sweep generator, will cause misleading results. After the equip-

RADIO & TELEVISION NEWS



The Picture Tells the Story

TV Antennas exist for one reason — to provide a clear, strong, sharp picture!

TRIO ZIG-ZAG* TV Antennas perform so well in this all important respect that they are America's most wanted.

Yes, a picture — the TV picture — tells the TRIO story more eloquently than anything else! Where all other antenna designs fail, high gain TRIO ZIG-ZAG TV Antennas consistently lock in sharp, clear pictures — from Maine to Texas, in city or country!

TRIO TV antennas look different, work different — provide a magnificent DIFFERENCE in picture quality!

*Patent Pending

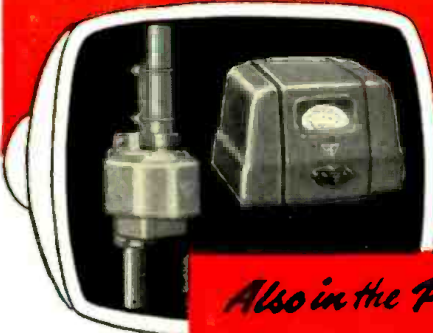

*New insulating sleeve, with long, air leakage path and elimination of slit, does away with assembly errors — elements cannot show out. For maximum strength, new steel, electro-plated element clamps have been introduced.

Also in the Picture
 The TRIO Rotator and Direction Indicator are the most dependable ever built. Developed after \$50,000 research. Fully guaranteed for a FULL two years!

Best Buy in UHF Antennas LOW IN COST — HIGH IN PERFORMANCE

NEW TRIO UHF BOW-TIE with reflector

Sturdy, broadband antennas of uniformly high gain that have been thoroughly field tested. Phasing strips installed, pre-assembled — a jiffy to attach reflector screen. Available in one, two and four bay models. Usual high-quality TRIO construction.

Model UBT-4
 Supplied With
 4 Foot Mast

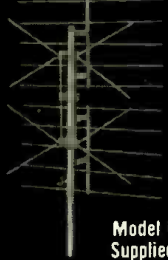

Model UBT-1
 Supplied With
 2 Foot Mast

Model UBT-2
 Supplied With
 3 Foot Mast

NEW TRIO UHF MULTI-CHANNEL YAGI ANTENNAS

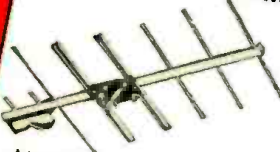

Broadband yagis developed by TRIO now successfully applied to UHF. Four models cover all UHF channels, rarely more than two needed for any one area.

- Model 6-UBY 14-26 for Channels 14-26
- Model 6-UBY 27-42 for Channels 27-42
- Model 6-UBY 43-60 for Channels 43-60
- Model 6-UBY 61-83 for Channels 61-83

These high gain six element yagis have sharper directivity, thereby eliminating ghosts. Thoroughly field tested. End of mast removes metal from field of reflectors or antenna elements. Mast clamp supplied. Completely assembled.



TRIO MANUFACTURING CO.

GRIGGSVILLE, ILLINOIS

Insure Yourself FASTER, EASIER Installations AT LOWEST COST

NEW SUPER-FRINGE MOTORLESS DIRECTRONIC

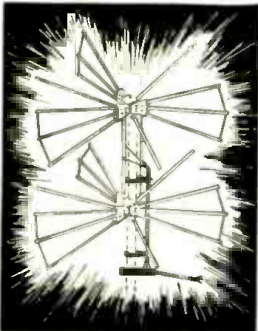

- 24 Elements
- New High Gain
- Clearer, Sharper Pictures
- Electronically Beamed in All Directions
- New Low-Loss Tubular Tri-X Cable
- Eliminates Ghosts—Interference

New Improved Hi-Gain Super Directronic offers sensational advantages over motorized antennas—less installation cost—less upkeep. The new 24-element Directronic is beamed to any transmitter in fringe range by new 6-position Directronic switch located at receiver. Twenty-four elements protruding cable minimizes attenuation. New Tri-X low-loss contains 24 hi-tensil aluminum elements, including 6 tubular Tri-X, 3 matched stacking bars. Universal U-Clamps.

Model AX-524 \$26.95

Switch located at receiver. Twenty-four elements protruding cable minimizes attenuation. New Tri-X low-loss contains 24 hi-tensil aluminum elements, including 6 tubular Tri-X, 3 matched stacking bars. Universal U-Clamps.

For Ultra-Fringe Reception, Use the "Power Master"

New 48-element Motorless Directronic provides higher gain than any other broad band antenna. Proved reception at 100 miles from transmitter in average location. Serviceman's kit provides 48 aluminum elements, 150' tubular Tri-X, 6-position Beam Selector, matched stacking harness, Universal U-Clamps.

Model AX-548 \$44.95

SAVE WITH ROCKET 35-FT. MAST KITS

From my mast kit contains 2-10' seamless TRI-COATED 1 1/2" O.D. masts, one 5' mast, 500 feet of 6-20 galvanized steel guy wire, and everything else needed including guy lines, mast connectors, insulators, cable clamps, guy hooks, and swivel mounting line.

35-foot Mast Kit \$15.95 25-foot Mast Kit \$11.95

LOWEST PRICES ON ANTENNA ACCESSORIES

- Mast Steel (Dunlacted 5' crimped) 1 1/4" O.D. \$1.05
- Mast Steel (Dunlacted 10' 1 1/4" O.D. 1.95
- Mast Connectors for 1 1/4" O.D. Mast .59
- Chimney Mount Complete with Straps 1.19
- Peak Roof Saddle (will take up to 1 1/2" O.D.) 1.59
- Linking Arrester-TV .69
- Galvanized Steel Guy Wire 2/30 .36ct.
- Rocket Twin-Lead-7/28 stranded .26ct.
- Mast Stand-off Insulators-3" .10
- Screw Tube Stand-off Insulators-3" .03

Buy From NATIONAL ELECTRONICS

—Country's Leading TV SPECIALIST

SENSATIONAL NEW HI-GAIN

UHF YAGI

Good UHF reception in fringe areas now assured with new Rocket Broad-band UHF Yagis. Compact, easy to slack for all the gain required anywhere. Three models cover all UHF channels. Rocket UHF Yagis are completely pre-assembled—you simply tighten a mast clamp. Serviceman's array includes two reflectors, 2 dipoles, 4 directors and Universal mast clamp.



Model UHF-1A—Ch. 14 thru 48
UHF-1B—Ch. 27 thru 62
UHF-1C—Ch. 47 thru 83
Single Lots of 6 \$4.25
Matched stacking bars—wave .75 pr.

ROCKET BROAD BAND YAGIS

- SENSATIONAL GAIN
- SENSATIONAL PICTURES IN FRINGE AND ULTRA FRINGE AREAS



Switch to Yagi Broad Band Hi-Gain Antenna! These new Yagis give you Yagi reception on the 5 low-band and 7 hi-band channels—no restriction to one single channel. A two-bay array will outperform even a 10 or 12-element single channel Yagi. Price is sensationally low. Complete serviceman's array includes 1 double reflector, 2 folded dipoles, 3 directors, Universal mast clamp. Easy-to-assemble quick rig construction.

Model R1128 Ch. 2 thru 6 \$10.95 Ea.

Model R1119 Ch. 7 thru 13 \$9.95 Ea.

Matched stacking bars 1.25 Pr.

Hi-Gain Single Channel Yagis

5 element—Ch. 2, 3, 4, 5, 6 \$7.95 Ch. 5 or 6 \$6.95

Ch. 7-13 \$3.95

Specify exact channel desired

NEW SPRING SUMMER CATALOG AVAILABLE

ALL PRICES F.O.B. CLEVELAND, OHIO
Do not permit more than complete purchase price. Pay shipping charges on receipt of goods. 25% deposit on all C.O.D. orders, please. Money-back guarantee. Prices Subject to Change Without Notice.

National Electronics OF CLEVELAND

THE HOUSE OF TV VALUES
106 Delco Building Cleveland 3, Ohio

ment is properly connected, adjust the fine tuning control for zero beat of the two markers, as observed on the oscilloscope. When zero beat is obtained, remove the i.f. marker.

9. If the response curve does not fall within the proper limits, the adjustment of the trimmers may be touched up slightly. Do not touch the setting of C₂₁₅, C₂₀₁, C₂₀₂, or C₂₀₄. To change the curve, first adjust C₂₁₅ and C₂₁₆ alternately, until maximum improvement has been obtained. Trimmer C₂₁₅ affects the tilt of the curve, and C₂₁₆ affects the dip of the curve. After C₂₁₅ and C₂₁₆ have been adjusted, turn C₂₁₁ for the proper slope at the 42.25-mc. side of the curve, then adjust C₂₀₁ and C₂₁₀ for the proper level at the video carrier frequency (47.75 mc.).

CAUTION: Do not turn any of the trimmers excessively. To retouch, make only a slight adjustment. —30—

Master Audio Control

(Continued from page 63)

Distortion. Harmonic: 0.02% at 1 volt, 0.05% at 5 volts, 0.15% at 10 volts, 0.4% at 15 volts.

Intermodulation: 0.08% at 1 volt, 0.2% at 5 volts, 0.5% at 10 volts, 1.6% at 15 volts.

Frequency Response. ± 1 db, 20-20,000 cycles with the tone controls in the uniform response position.

Hum and Noise Level. Receiver Input: 100 db below normal signal (2 volts output) with volume control at zero. Better than 90 db below normal signal with volume control at maximum.

Phono Input: 68 db below output with a 10 mv. input signal.

Maximum Gain. From High Level Input: 22.5 db.

From Low Level Input: in excess of 53 db.

The Fisher "Master Audio Control" was designed, from its inception, to meet the need for a complete, yet compact, self-powered unit for controlling any self-contained power amplifier, as well as to provide complete phonograph equalization facilities. It provides an ample number of inputs and two cathode-follower outputs. Possessing extremely low hum and noise level, it represents one of the finest audio control units that has as yet been offered to the high-fidelity enthusiast or audio engineer. —30—

ALUMNI ORGANIZE

THE Alumni Association of RCA Institutes has been formed recently in New York with monthly meetings scheduled for the 3rd Thursday of each month at the school building, 350 West 4th St., New York City.

Officers include P. Genduso, president; T. R. Coniskey, recording secretary; S. Schiffman, corresponding secretary; J. Troop, treasurer; and P. Stein, faculty advisor.

WANT THE BEST IN CAPACITORS?

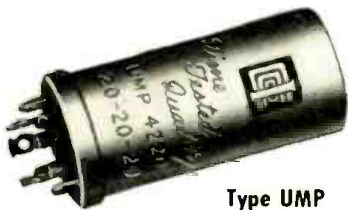

Type UMP

• Many, many notable advances in the art of capacitor design and manufacture have been made by the ILLINOIS CONDENSER COMPANY. As an example, ILLINOIS CONDENSER COMPANY has recently been awarded a patent on their unique and exclusive molded capacitor construction as featured in the UMP types.

For almost two decades, ILLINOIS CONDENSER COMPANY has been building quality capacitors and regular users include most all of the largest manufacturers of TV and radio sets. Their names literally comprise the "blue book" of electronics.

To meet the ever increasing demand for ILLINOIS electrolytic capacitors, ILLINOIS CONDENSER COMPANY has built new plants and greatly increased production. Why don't you, too, discover why ILLINOIS capacitors are "first choice" of so many!

Write for Catalog!



ILLINOIS CONDENSER CO.
1616 NORTH THROOP STREET • CHICAGO 22, ILL.

MERIT PLATE TRANSFORMERS

- 1100 VCT/150MA \$ 6.47
- 1320, 1100VCT/250MA, 40V Bias Tap 8.08
- 2140VCT/125MA; 1000VCT/150MA 9.97
- 1800, 1600VCT/225MA 9.70
- 2900, 2350VCT/300MA 24.11
- 4200, 3600 VCT/300MA 30.58
- 5800, 4770VCT/300MA (Sq. Cse) 47.04

MERIT FILAMENT TRANSFORMERS

- 2.5VCT/10AMP/10KV INS \$ 3.67
- 5VCT/3AMP/2500V INS 2.50
- 5VCT/30AMP/2500V INS 6.47
- 4.3VCT/1AMP/2500V INS 1.65
- 4.3V/1.2AMP/5KV INS (TV REPL) 2.12
- 6.3VCT/3AMP; 4.3VCT/3AMP/2500V INS 4.06
- 5VCT/3AMP; 4.3VCT/3AMP/2500V INS 4.06
- 10VCT/10AMP/3KV INS 5.88
- 12.6VCT/2AMP/2500V INS 2.64
- 25.2VCT/1AMP/2500V INS 2.64
- 12.6V/7AMP or 25.2V/3.5AMP/2500V INS 5.88

MERIT FILTER CHOKES

- 15HY/85MA/1500V INS \$ 2.94
- 10HY/110MA/1500V INS 2.94
- 12HY/150MA/1500V INS 3.53
- 15HY/150MA/2KV INS 5.14
- 5HY/200MA/1500V INS 4.11
- 10HY/150MA 3.82
- 10HY/200MA 3KV INS 4.70
- 10HY/250MA 4.47
- 8HY/300MA 6.76

MERIT UNIVERSAL MODULATION

- PRI-2000-20000/50MA Per Side; SEC-2000-20000/50; 100MA* 15 WATTS \$ 6.32
- PRI-2000-20000/150MA Per Side; SEC-2000-20000/150; 300MA* 60 WATTS 9.41
- PRI-2000-20000/220MA Per Side; SEC-2000-20000/220; 440* 125 WATTS 13.23

*SERIES—PARALLEL

STEEL BOXES—BLACK CRACKLE FINISH

- 4 x 4 x 2 \$.70 15 x 9 x 7 \$2.38
- 4 x 5 x 3 .80 12 x 7 1/2 x 6 1/2 2.40
- 6 x 6 x 6 1.10 15 x 7 1/2 x 6 1/2 2.48
- 12 x 7 x 6 2.08

SLOPING FRONT CABINETS

- 8 x 8 x 8 \$3.53 8 x 14 x 8 \$4.23
- 8 x 10 x 8 3.93 12 x 18 x 12 7.70
- 8 x 12 x 8 4.08

All prices F.O.B. our warehouse New York

LEEDS RADIO CO.

75 Vesey St. Dept. A New York City 7

*What you do now
will decide your*

SUCCESS IN RADIO- TELEVISION- ELECTRONICS

Send for this FREE CREI Booklet and see
----->
the opportunities—and how to seize them!



THERE is a vacancy coming up. It means a boost in pay, prestige and security. Can you fill it? The answer is "No," if you postpone your preparation for success.

The answer is "Yes," if opportunity finds you ready. "Ready" means "TRAINED." And your training must start now, if you expect to be big enough for a bigger job. You ask "What can I do *now*?" You will find many valuable suggestions in a free booklet, "Your Future in the New World of Electronics." Not only does it picture fabulous opportunities . . . it tells you what to do to grow with an industry desperately seeking trained men. Expansion is phenomenal: In the defense build-up alone, many billions in electronics contracts have been awarded. It is estimated that by 1961 the radio-electronics industry will do no less than \$10 billion per year, excluding defense orders. Growing civilian markets include radio-equipped police cars, fire-equipment, taxis, planes, ships—in increasing numbers. There are industrial radio network installations, medical applications, and countless others.

There are 152 TV stations now on the air, and 2000 more expected. Already it is estimated there are over 23,000,000 TV sets and over 100,000,000 radios in operation. How these figures will increase in the next few years, the most daring experts are reluctant to predict. This much is certain: Limitless numbers of positions must be filled—in development, research, design, production, testing, inspection, manufacture, broadcasting, telecasting, and servicing. To fill these posts, trained men are needed—men who somewhere along the line are alert enough to improve their knowledge and skills. "Your Future in the New World of Electronics" shows how CREI Home Study leads to greater earnings, by helping get you ready for the openings described above.

CREI promises no short cuts. In an accredited technical school such as this, *you must study* to transform your ambition and energy into knowledge that pays off. Since its founding in 1927, CREI has provided thousands of professional radio men with technical educations. During World War II CREI trained thousands more for the Armed Serv-

ices. Leading firms choose CREI courses for group training in electronics at company expense; among them are United Air Lines, Canadian Broadcasting Corporation, Trans Canada Airlines, Bendix Products Division, All American Cables and Radio, Inc., RCA Victor Division, Mochlett Laboratories, Canadian Marconi and Heppner Mfg. CREI's practical courses are prepared by recognized experts. You get up-to-date material; your work is under the personal supervision of a CREI staff instructor, who knows and teaches you what industry needs. Training is accomplished on your own time, during hours chosen by you. As a graduate, you'll find your CREI diploma the key to success in Radio, TV and Electronics. At your service is the CREI Placement Bureau, which finds positions for advanced students and graduates. Although CREI does not guarantee jobs, requests for personnel far exceed current supply. CREI alumni hold top positions in America's leading firms. Now is the time to decide—to act. When opportunity knocks, knowledge must be "at home." You supply the willingness to learn. We supply the technical training. This combination of ambition and knowledge is unbeatable in the new Age of Electronics. Fill out the coupon and mail it now. We'll promptly send you your free copy of "Your Future in the New World of Electronics."

CREI resident instruction (day or night) is offered in Washington, D. C. New classes start once a month. VETERANS: If you were discharged after June 27, 1950—let the new G.I. Bill of Rights help you obtain CREI resident instruction. Check the coupon for full information.

MAIL COUPON FOR FREE BOOKLET

CAPITOL RADIO ENGINEERING INSTITUTE

Dept. 116, 3224 16th St., N.W., Washington 10, D. C.

Send booklet "Your Future in the New World of Electronics" and course outline.

CHECK TV, FM & Advanced AM Servicing Aeronautical Radio
FIELD OF Practical Television Engineering Engineering
GREATEST Broadcast Radio Engineering (AM, FM, TV)
INTEREST Practical Radio Engineering

Name

Street

City Zone State

Check Residence School Veteran

— TELEMARINE —

The Best in Electronic Surplus!
**BARGAINS FOR HAMS,
 EXPERIMENTERS, INDUSTRIALS,
 AND EXPORTERS!**

Most of the items listed below were illustrated and described in our February and April '53 ads of Radio & Television News. If you see anything you need more information on, don't hesitate to write us—we'll be more than glad to try and oblige.

SPECIAL: MOBILE TRANSMITTER. 3 Watts output, present range 2500 to 7700 KC using 4 plug-in tuning units which can be easily modified for higher frequency operation. Excellent VFO puts you right on frequency, or convert to crystal control. Uses 2 type 10 and 2 type 45 (mod.) tubes. Dimens. 11" x 6 1/2" x 8". Supplied with tubes (not guaranteed), tuning units, connectors, less dynamotor (operates from 12 or 24 V. DC, rewire tube filaments for 6 V. operation). Part of SCR-283 equipment. Excellent condition. SHIP. EACH \$9.95

MOBILE or MARINE RECEIVER. Full superheterodyne covering 200 to 400 KC and 3,150 to 7,710 KC with 2 plug-in tuning units. With 6 tubes (not guaranteed), 4 type 39, 1 type 37, and 1 type 38. Excellent condition with remote tuning dial and scale, connector cable, and shock mounting. Use with 12 or 24 V. Dynamotor (below listed) or 6 V. Vibrator Pack—after rewiring tube filaments in parallel. Part of SCR-283. Dim. 13" x 14" x 5". Ship. wt. 20 lbs. PRICE, EACH \$9.95

DYNAMOTOR. for either or both above. 24/28 V. DC input. 377 ma. at 150 ma. output. Excellent condition. EACH \$3.95

RADIOSSONE TRANSMITTER. AN/AMQ-1A to J. N.W. with lens, antenna, and pressure instruments incorporated. EACH \$5.95

2-STAGE AUDIO AMPLIFIER. WITH 90 & 150 CYCLE FILTERS. See April '53 ad in Radio & Television News for complete specs. NEW equip. With diagram. Shock mounted. With 6C6G and 6F8G. SHIP. WT. 1 lb. PRICE, EACH \$8.95

50-60 WATT VE SPEAKER UNIT. For horn or baffled-board mtg. Shock and blast-proof diaphragm. Resonance to 7,000 cps. 13 ohms imped. Dim. 6 7/8" x 1 1/2" deep. Throat opening 1 3/4" dia. New units, with 6 lb. Alnico 5 magnet. SHIP. WT. 15 lbs. PRICE, EACH \$18.75

ROTARY CONVERTER. 32 V. DC to 110 V. AC. Shd. by Kato. Shock mounted, with in and out filtering. Conservatively rated, 22 1/2 watts, good for 300 watts. SHIP. WT. 40 lbs. PRICE, EACH \$39.95

AUDIO OSCILLATOR. 5 lines, for servicing, test, or cycle practice. See Feb. '53 Radio News ad. NEW, with 12-6 tube. With diagram. SHIP. WT. 1 lb. PRICE, EACH \$5.95

VOLTAGE REGULATOR & POWER SUPPLY. Uses 8 tubes (not supplied) to supply regulated 7.50 V. DC at 10 ma. or less from voltage divider. Has switch for "regulated" or "non-regulated" output. Operates from 110 V., 60 cy. AC. With diagram and operational data. SHIP. WT. 5 lbs. PRICE, EACH \$15.95

BC-604 HF FM TRANSMITTERS. 20-28 MC. 35 Watts phone output, 10 channels, dial-controlled. Switch for mobile. NEW units, with tubes, less dynamotor. SHIP. WT. 40 lbs. PRICE, EACH \$39.95

BC-684 HF FM TRANSMITTERS. Same as above, but 28 to 38 MC. PRICE, EACH \$44.50

DM-25 DYNAMOTOR. 12 V. DC input, for above Transmitters. Output 625 V., 227 ma. Like New units. SHIP. WT. 10 lbs. PRICE, EACH \$25.00

LUMINOUS TAPE. glows in dark—after exposed to light. For clear signal switches, photometric dark-room applications, etc. 100 ft. x 1 1/2" width per package. SHIP. WT. 10 lbs. for 10 PACKAGES—\$4.75

ELEMENTS FOR DYNAMIC PHONES. Permalloy moving coil elements for dynamic phones, hand-talkies, or for home-made dynamic mikes. Each with matching output transformer. 2" dia., 3/4" deep. FOUR for \$2.95

SOUND-POWERED MIKE ELEMENTS. Shure Controlled Transducer type, for dynamic phones. 1/2" dia., 5/8" deep. FOUR for \$2.95

MAGNETIC PHONE ELEMENTS. Aviometer all-aluminum shielded, ribbon type, readily and strongly rewound. Dim. 1 1/2" x 1/2" deep. FOUR for \$2.25

HS-23 HEADPHONES. hi-impedance, with PL-54 Plug and Headband. Like-New condition. SHIP. WT. 2 lbs. PRICE, EACH \$3.95

HS-33 HEADPHONES. 600 ohms impedance, with PL-54 Plug and Headband. Like-New condition. SHIP. WT. 2 lbs. PRICE, EACH \$3.35

TU-6B, 7B, and 8B TUNING UNITS. Ham's delight for conversion and valuate parts. NEW units. SHIP. WT. 10 lbs. PRICE, EACH \$4.95

WAVEMETER & FIELD STRENGTH METER. 20-40 MC. with calibration curve. Has 184 tube, retunes only 1 1/2 V. battery. Incorporates 100 microampere (100) meter for sensitive deflection. See our Feb. '53 ad in Radio News. NEW units. SHIP. WT. 2 lbs. PRICE, EACH \$14.95

INFRA-RED SNOOPERSCOPE TUBES. British type requiring lens system for focusing. For labs, schools, and industrial work. With full technical data and diagrams. SHIP. WT. 3 lbs. for SIX Tubes for \$15.00

FRONT-END LENS ASSEMBLY for above. Baugh & Lomb. EACH \$10.00

PLAIN, MOUNTED TYPE LENS ASSEMBLY. for front or rear. EACH \$7.00

PYRANOL CAPACITORS. 50-50-50 MFD. ac/dc connected. 90 V. AC. for industrial applications. NEW units. SHIP. WT. 25 lbs. EACH \$6.95

WE BUY Communications and Test Equipment, such as ARC-1, ARC-3, ART-13, BC-312, 342, 348, TDE, TCP, TDB, ET-8019, ET-8012, ET-8506 (Receiver), BC-221 or SCR-211 Freq. Meters, BC-610 Transmitters, LM Freq. Meters, ETC. Must be Excellent Condition, no modifications. Let us know what you have; we will answer promptly with our best offer.

EXPORTERS, GOVERNMENT AGENCIES, INDUSTRIALS!
 We have a large stock of Transmitters, Receivers, Walkie-Talkies, VHF Equipment, Ship & Shore Communications, FM Broadcast Stations, Radar, Accessories, etc. Write and tell us of your requirements. Descriptive literature and prices available upon request.

MINIMUM MAIL ORDER \$5.00
 include remittance for ship-inn charges, otherwise orders will be sent Ry. Exp. transportation collect. All packages over 20 pounds sent Ry. Exp. All Above Material Subject to Prior Sale. 25% Minimum Deposit with All C.O.D.'s. All Prices F.O.B. Our Address.

— TELEMARINE —
COMMUNICATIONS CO.
 3040 W. 21st Street, Brooklyn 24, N. Y.
 Phone: ES 2-4300

TIME COMPRESSOR

Developed by the University of Illinois, this new device has almost unlimited possibilities in diversified fields.

THE University of Illinois has developed and demonstrated a "time compressor" which speeds up words or music without changing tone or ease of understanding. An hour's program material can easily be compressed into 45 minutes' time.

Inventors of the new unit are Prof. Grant Fairbanks, director of the University's Speech Research Laboratory; Dean W. I. Everitt of the College of Engineering; and R. P. Jaeger, formerly at Illinois, now with a commercial laboratory.

The development is based on the fact that the ear is faster than the mouth. Words can be understood more rapidly than they can be spoken. Attempts to speed up speech causes the speaker to slur or trip over his words. The new invention overcomes this by recording speech in condensed form without changing the pitch, as happens when an ordinary recording is speeded up.

The machine incorporates a mechanism consisting of a continuous loop of recording tape and a set of four pickup heads in a revolving drum around which the tape makes a right-angle turn.

The pickups are arranged like the spokes of a wheel. Only one pickup touches the tape at a time, but just as it moves off, the next comes into contact with the tape. As far as the sound output is concerned, the playback is continuous, but actually that part of the original sound which was between the "spokes," and untouched by them, is left out.

The tape and drum run at different speeds and these can be varied independently to obtain any degree of compression desired.

Alternately, the drum can revolve the other way so that each pickup overlaps somewhat on sound the previous head covered. This repeats the bit of sound and thus the machine becomes a "time expander."

The output of the machine is recorded at a rate adjusted so that the result has the true pitch of the original.

The machine has another important potentiality. Instead of compressing time, it can be used to compress the tones of a voice, and then expand them back to original understandability. This is an almost instantaneous process which may permit a telephone or radio circuit to carry many conversations where one is now carried.

The problem of "bandwidth reduction" has interested engineers for a long time. They have found various

ways of making circuits do multiple duty, and now the compressor may offer another possibility of carrying more messages without building additional transmission facilities.

The present "time compressor" is still a laboratory model in the University's Speech Research Laboratory, although it is the fourth model. Soon such machines will be available for radio stations and recording studios.

In addition to the more obvious applications for this device, it has already been suggested that the device be used for recording talking books for the blind to present the maximum material in the minimum amount of time; recording music for unbelievable rapidity and precision; for recording conferences, conversations, airport control directions, etc. on less tape so that they can be reviewed in less time; for a faster presentation of facts in broadcasts beamed to countries behind the Iron Curtain with less danger to listeners; faster reports over long distance telephone or radio; new production opportunities for motion pictures and television; new techniques for teaching; and new approaches to study of speech, music, and languages.

According to reports, compressions of 10 per-cent or even 20 per-cent pass unnoticed. Up to 50 per-cent does not destroy understanding of speech. Music put through the machine has its tempo stepped up, but pitch and clarity are unchanged.

Prof. Fairbanks and Dean Everitt, two of the "time compressor" inventors, look over the laboratory model of unit at U. of Ill.



RADIO & TELEVISION NEWS

Valuable 3-way aid for Auto Radio Repair Men!



Once you're on the Delco Radio team you're in line for this three-way help: a reliable source for Delco Radio original equipment replacement parts and universal replacement parts; a complete and comprehensive Delco Radio Service Manual; monthly issues of "Testing Tips," a bulletin giving the very latest factory information on testing and repairing Delco car radios—even the sensational new "Favorite Station" Signal-Seeking model! To get going with Delco Radio contact your nearest United Motors Electronics Parts Distributor. Don't delay—act today!



DELCO RADIO

DIVISION, GENERAL MOTORS CORPORATION, KOKOMO, INDIANA

A GENERAL MOTORS PRODUCT  A UNITED MOTORS LINE

DISTRIBUTED BY ELECTRONICS WHOLESALERS EVERYWHERE

Let me show you how EASY it is to

LEARN TV

the practical way--

ASSEMBLE A TRANSVISION TV KIT



Pay as You Wire **\$39**
Down Payment

I WILL HELP YOU to start learning TV the practical way — by assembling a TRANSVISION TV KIT in EASY STAGES. For only \$39 you get PACKAGE #1 (standard first pkg. for all of our kits). This package gives you the BASIC CHASSIS and over 450 TV COMPONENTS with complete Instructions. When ready, you order the next stage (pkg. #2), etc. All stages (or packages) are low priced, making your complete kit a terrific buy! Your completed chassis is a superb 25 tube set (22 tubes and 3 rectifier tubes) with 6" x 9" p.m. speaker — a custom-chassis worth up to 100% above your investment.



FEATURES
given only in new Transvision TV Kits:
No previous technical knowledge required . . . Easiest to assemble . . . New A4 circuit gives finest picture and sound . . . Ideal for fringe areas . . . Has Automatic Frequency Control . . . Automatic Gain Control . . . Retrace Elimination . . . Never obsolete because color and other developments can be added easily . . . Choice of 6 Kits.

UHF and REMOTE CONTROL may be had at small additional cost.

EXPORTERS: Foreign system of 625 lines can be accommodated.
For complete line of TV Cabinets, ask for folder.



EDUCATIONAL:
No previous technical knowledge required.
With PACKAGE #1, you get my handy 70-page plastic-bound *Instruction Book* which includes a 20-page *Service Section*. Also 12 full size (17" x 22") *Drawings and Photographs*, a 64 page *Service Booklet*, and 1 year's subscription to my "TV and Electronics Notes".

AIDS CAREER:
Do you plan to be a TV Technician, Service-Dealer, or Engineer? You'll benefit by assembling a Transvision TV Kit.

PROFIT 3 WAYS:
You profit by gaining valuable practical knowledge . . . by saving on servicing costs . . . and by producing a TV chassis worth up to 100% above your cost.

Used in Naval Reserve Training Program.
FAMOUS EDITOR of a national science magazine says: ". . . my own assembly (of the kit) produced top-quality results, comparable with any set I've seen and better than most . . ."

FREE CATALOG describes 6 great new Transvision TV Kits.

Write to D. GNESSIN, EDUCATIONAL DIRECTOR, at: TRANSVISION, INC., Dept. RN6K NEW ROCHELLE, N. Y.

MAIL THIS COUPON TODAY

Mr. D. Gnessin, Educational Director
TRANSVISION, INC., NEW ROCHELLE, N. Y. Dept. RN6K

I'm enclosing \$_____ deposit. Send standard kit PACKAGE #1, with all Instruction Material. I'll pay the balance C.O.D.

Send FREE copy of your new TV Kit Catalog, Cabinet Folder, and Price Lists.

Name _____
Address _____
City _____ State _____

What's New in Radio

(Continued from page 78)

as part of the *Wharfedale* line of loudspeakers and associated equipment.

The new network is designed to be used with three-speaker sound systems. Its purpose is to properly divide and separate frequencies between the woofer, mid-range speaker, and tweeter. The three loudspeakers should be of similar sensitivity.

Crossover points are at 800 and 5000 cycles and the network is of constant resistance half-section construction. It is also fitted with a volume control across the high-end output terminals to suit upper frequencies to the listeners' individual tastes.

For literature and additional information on the crossover network write Dept. W of the company.

SELENIUM RECTIFIER KIT

A new "build-your-own" selenium rectifier kit that enables the assembly of a wide range of selenium stacks at substantially reduced cost has been introduced by *Federal Telephone and Radio Corporation* of Clifton, N. J. for the electrical-radio-television market.

Designed to meet the rectifier requirements of a variety of users, ranging from radio hams and hobbyists to service technicians and electrical repairmen, the kit includes all the necessary components for assembling any one of four different types of selenium rectifiers—half-wave, full-wave center-tap, full-wave bridge-type, and full-wave battery charger.

Complete and simple step-by-step instructions are included with each kit.

TRANSISTOR SOCKET

Super Ear Products Co., 675 Merri-
rick Road, Lynbrook, New York is

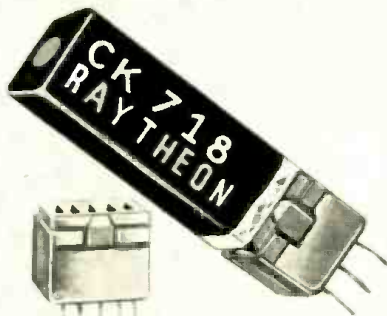

now offering a new subminiature socket for use with the new *Raytheon* transistors.

The three-prong socket measures approximately 1/4" wide and 3/8" high and is molded of mica-filled Bakelite—a high-impact resistant material. The prongs are of phosphor bronze, silver-plated. The sockets are also available with the prongs pre-tinned for assembly-line applications.

L. Veltri, busy service-dealer of Westchester, N. Y., reports:

I SAVED \$940*

by making a \$59 INVESTMENT
in a Transvision
FIELD STRENGTH METER

* Says Mr. Veltri: ". . . The way I figure, in the last 6 months I saved that much money in installation time alone . . ."



FIELD STRENGTH METER
Saves 50% of Installation Cost
Pays for itself on 3 or 4 jobs

NO TV SET NEEDED

Works from antenna . . . Measures actual picture signal strength directly from antenna. Shows antenna orientation maxima. Compares gain of antenna systems. Measures TVI on all channels. Checks receiver re-radiation (local oscillator). Permits one man antenna installation.



PREVENT WASTE OF SERVICING TIME! By checking antenna performance with the *Field Strength Meter*, the serviceman can determine whether the TV set or antenna, or both, are the source of trouble. Call backs are eliminated.



Wide range: Measures field strength from 10-50,000 microvolts. Has *Fringe Area Switch* for weak signal areas. 13 channel selector. Individually calibrated on every channel.

ADAPTABLE for UHF

Model FSM-2, for 110V AC only. Complete with tubes. Wt. 13 lbs. . . . net \$59.

Model FSM-3B, for 110V AC and Battery Operation (all batteries and cables included). Wt. 22 lbs. . . . net \$79.

Order direct from factory:
TRANSVISION INC., NEW ROCHELLE, N. Y.

FREE: Sample copy of "TV and Electronics Notes". Or send 50¢ for year's subscription.



10 DAY TRIAL

Buy and try this fine instrument for 10 DAYS. Then, if you wish, you may return it. Your purchase price less 10% (our cost of handling and re-packaging) will be promptly refunded.

TRANSVISION, INC., NEW ROCHELLE, N. Y.

DEPT. RN-6F

() Send me _____ Model FSM-2; _____ FSM-3B

() Enclosed find \$_____ deposit. Balance C.O.D.

() Enclosed find \$_____ in full.

I accept your 10 Day Trial terms.

Name _____

Address _____

City _____ State _____

BIG PROFITS:

Repair CRTs

the Easy Way



EVERY SERVICE SHOP CAN MAKE BIG MONEY

- with these PATENTED INSTRUMENTS for
1. TESTING picture tubes accurately.
 2. REACTIVATING dim or worn out tubes.
 3. SPARKING OUT electrical leakage.

CRT TESTER—REACTIVATOR—SPARKER

3 Instruments in 1, making a complete CRT testing and repair unit... It's a combination of the Transvision Tester-Reactivator and a Sparker in one handy unit. It TESTS picture tubes—measures Cathode emission, locates shorts between elements, locates high resistance shorts or leakage as high as 3 meg-ohms. REACTIVATES dim tubes. SPARKS OUT electrical leakage.



\$34.95 net

Featured in N. Y. Times article

CRT TESTER—REACTIVATOR

2 Instruments in 1... As a REACTIVATOR it renews brightness and detail of dim CR Tubes, without removal of tube from set. It's also an accurate TESTER same as the above. 110V-60 cycles; wt. 3 lbs.



only \$19.95 net

CRT TESTER—SPARKER

2 Instruments in 1... As a SPARKER, it sparks out electrical leakage between

elements. Saves many picture tubes and small tubes which would usually be discarded. Cathode-grid leakage is an especially common occurrence. The Sparker also gives a rapid check of gas condition of the tube.



As a TESTER it provides a variable 8,000-14,000 V D.C. supply—useful for analyzing hard-to-solve deflection problems... \$25.95 net

Order direct from factory:

TRANSVISION INC., NEW ROCHELLE, N. Y.

FREE: Sample copy of "TV and Electronics Notes". Or send 50c for year's subscription.

10 DAY TRIAL: Buy and try these fine instruments for 10 DAYS. Then, if you wish, you may return them. Your purchase price less 10% (our cost of handling and re-packaging) will be promptly refunded.

TRANSVISION, INC.
DEPT. RN-6R NEW ROCHELLE, N. Y.

() Send me _____

() Enclosed find \$_____ deposit. Balance C.O.D.

() Enclosed find \$_____ in full.

I accept your 10 Day Trial terms.

Name _____

Address _____

City _____ State _____

A five-prong socket for the Raytheon DX series of subminiature vacuum tubes is also available. The company will supply full details on request.

R-J FLOOR MODEL ENCLOSURE
R-J Audio Products, Inc., 164 Duane Street, New York 13, New York has recently added a new smooth-sanded, unfinished mahogany floor model enclosure to its line.

The new model is made to the same

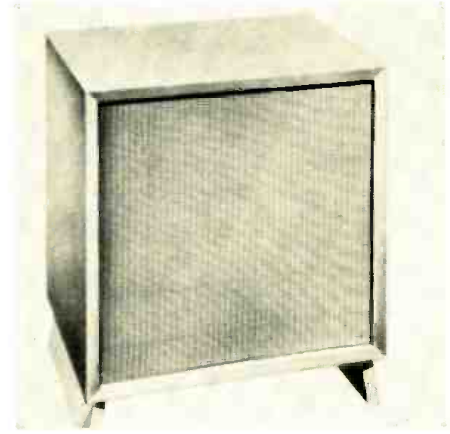

dimensions and will perform the same as the regular floor model enclosures the company is currently marketing. The enclosure is cut to fit any standard 12" or 15" speaker, permitting maximum bass performance.

Additional information on the new unfinished model or other units in the company's line is available from Dept. R-J of the company.

TURNER MIKE

The Turner Company of 900 17th St., N.E., Cedar Rapids, Iowa is in production on a new dynamic microphone, the ADA 95D.

The new unit follows the trend toward slender, modern styling yet provides rugged service for quality p.a., recording, and broadcast uses.

Frequency response is 70 to 10,000 cps with an output level of 58 db below one volt/dyne/sq. cm. A standard 1/2"-27 coupler swings the mike in a 60-degree arc. It is finished in satin chrome and comes equipped with a 20 foot removable cable set. A choice of 50,200,500 ohms or high impedance is available, as well as various switching arrangements.

TINY RESISTORS

Dale Products, Inc. of Columbus, Nebraska has placed a new deposited carbon resistor with silicone coating on the market.

According to the company, the tiny DCS 1/2 offers accuracy, stability, dependable performance, and economy in high frequency applications. The resistance range is from 5 ohms to 2 megohms.

New illustrated literature and price lists on the DCS 1/2 are available from the company on request.

Now... INSURE BEST RECEPTION with the

FINEST TV CHASSIS EVER DESIGNED

TRANSVISION

630 De Luxe

TYPE TV CHASSIS

with High-Fidelity Sound

Mfr. licensed under RCA patents

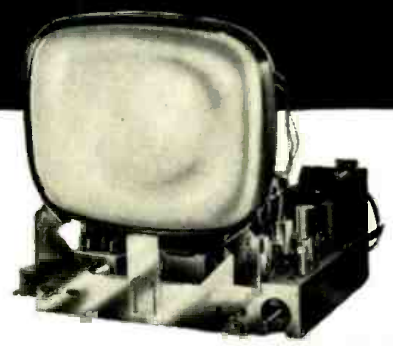

Embodies the latest and finest improvements, notably:

- Super Fringe Area Circuit
- Redesigned for Peak UHF Performance
- Hi-Fidelity Push-Pull Audio (40-13,000 Cycles)
- 12" Hi-Fidelity Speaker

\$139 net Plus 10% Fed Tax CRT EXTRA

In this space we can mention only a few of the other great features of this DeLuxe Chassis: 31 tubes (28 tubes, 3 rectifier tubes—plus CRT in a ke's 32 tubes)... Only Sprague "Black Beauty" Mottled Condensers used throughout... Allen Bradley and IRC RESISTORS... Handles up to 24" picture tube... Layout of most efficient type for ease of servicing... Carries standard RMA Guarantee... The choice of those who want the finest in chassis.

CABINETS: For details on Transvision's famous beautiful line of TV Cabinets, write for information on Agent's Program.

1 YEAR GUARANTEE ON CRTs

- 17" Rectangular Glass CRT.....net \$22.25
- 20" Rectangular Glass CRT.....net \$31.95
- 21" Rectangular Glass CRT.....net \$36.95

Order direct from factory:

TRANSVISION INC., New Rochelle, N. Y.

FREE: Sample copy of "TV and Electronics Notes." Or send 50c for year's subscription.

MONEY-BACK GUARANTEE:

10-DAY TRIAL: Buy and try the Transvision 630 Type De Luxe Chassis for 10 days. Then, if you wish, you may return it. Your purchase price less 10% (our cost of handling and re-packaging) will be promptly refunded.



TRANSVISION, INC.
DEPT. RN-630 NEW ROCHELLE, N. Y.

() Send me 630 Circuit and Technical Data.

() Enclosed find \$_____ deposit. Balance C.O.D. Ship _____ chassis. _____ CRTs.

() Enclosed find \$_____ in full.

I accept your 10 Day Trial terms.

Name _____

Address _____

City _____ State _____

**"In music,
listening quality
is
everything..."**

It is the No. 1 MUST. Without it everything else becomes meaningless. The AUDAX CHROMATIC has that quality to a degree not equalled by any other pickup" . . . so says the violinist David Sarser, of amplifier fame (Toscanini's NBC Symphony).

Be it diamond or sapphire, every stylus has a limited life-span; the diamond lasts the longest. Obviously, then, replaceability of the stylus—at home, is of the greatest importance. AUDAX is engineered for easy replaceability of the stylus—at home. **Of further importance is the fact that each AUDAX CHROMATIC stylus is replaceable independently of the other.**

The magnetic attraction between pickup and a steel turntable is known as the "Hidden-Pull."SM Today, with point-pressure under 10 grams, an additional 10 or 20 grams of "Hidden-Pull" becomes a very serious factor . . . The Magnetic Audax CHROMATIC has no "Hidden-Pull."

Only YOU can decide what sounds best to you. Therefore, See and Hear the Audax CHROMATIC and—You be the judge . . . Audax costs no more than ordinary pickups.

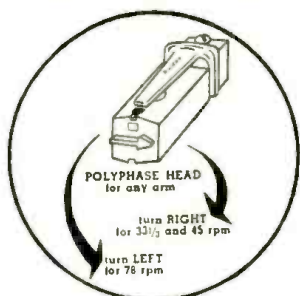

Available with the new Compass-Pivoted Audax arms and to fit the high quality record changers.

Only in Audax is each stylus replaceable independently of the other. Send for free facts on jewel styli.

* #34 in 1953 ELECTRONIC PHONO FACTS now obtainable from your dealer

AUDAX COMPANY
500 Fifth Avenue, New York 36
Creators of Fine Audio-Electronic apparatus for over 25 years

"The Standard by Which Others Are Judged and Valued"

4-CHANNEL CONTINUOUS RECORDER-REPRODUCER

New communications network monitoring system makes possible a permanent and continuous record of radio or phone messages.

MAGNECORD, Inc. of Chicago has developed a unique four-channel, continuous recorder-reproducer system for the Civil Aeronautics Authority to CAA specifications for communications network monitoring.

The system consists of an enclosed, rack-mounted recorder, separate playback unit, portable test equipment for adjusting components, a movable table and storage unit, and a portable continuous bulk eraser. The recorder will operate continuously for eight hours without tape changing and uses standard 1/4 inch recording tape.

Mounted in the rack are two tape transports, each independently removable while the other remains in operation. Each tape transport contains a four-track recording head assembly and a movable monitoring head which may be indexed to any of the four recording channels for monitoring purposes.

Automatic controls provide switching from one recorder unit to the other two minutes before the end of the tape. The first unit automatically stops at the end of the tape. In case of tape break, the unit shuts off and the second unit begins immediately while a light indicates the tape breakage. The entire unit may be remotely operated if desired.

The associated multi-channel playback unit is a four-track reproducer with provisions for manual or foot-switch operation. It has both normal and high speed operation in either forward or rewind directions. The reproducer amplifier has simultaneous inputs for two channels which may be selected from any one of the four tape tracks which are available.

The rack-mounted, multi-channel "record" tape transport cabinet.

The multi-channel "reproduce" tape transport unit of the new system.



The portable bulk eraser, which is part of the system, is designed for constant operation and has a built-in blower system to keep the large internal reactors cool. Because of this feature, the unit is able to handle large quantities of tape without difficulty.

The various accessory units used in conjunction with the recorder and playback unit are designed to make the unit self-contained and self-sustaining.

-30-

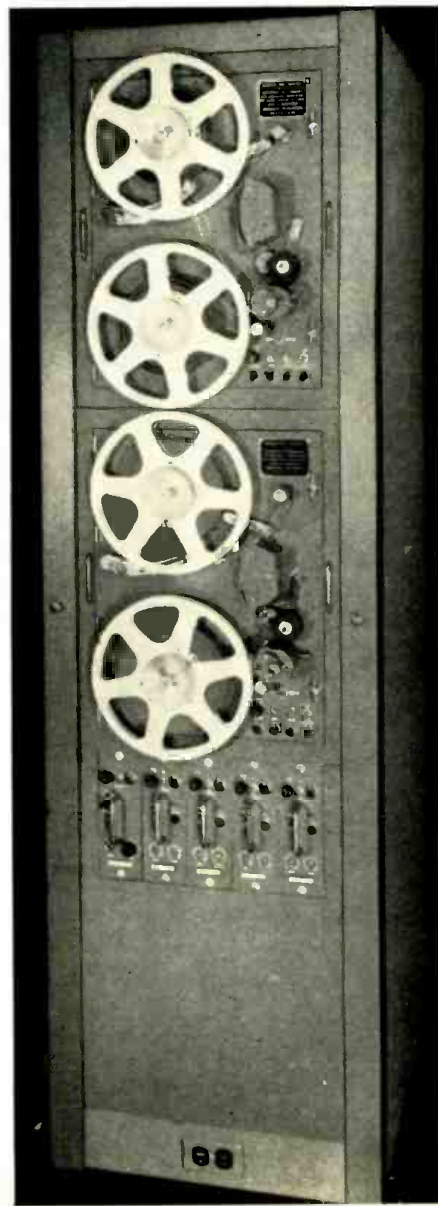

BUY TEST EQUIPMENT ON THIS RADICALLY NEW TIME PAYMENT PLAN

NO INTEREST!! - NO CARRYING CHARGES!!

USE CONVENIENT TIME PAYMENT ORDER BLANK BELOW

Superior's New
Model 770

VOLT-OHM MILLIAMMETER

Sensitivity—1000 ohms per volt

Uses latest design 2% accurate 1 Mil. D'Arsonval type meter. • Same zero adjustment holds for both resistance ranges. It is not necessary to readjust when switching from one resistance range to another. This is an important time-saving feature never before included in a V.O.M. in this price range. • Housed in round-cornered, molded case. • Beautiful black etched panel. Depressed letters filled with permanent white. Insures long-life even with constant use.

SPECIFICATIONS:

- 6 A.C. VOLTAGE RANGES: 0-15/30/150/300/1500-3000 Volts.
- 6 D.C. VOLTAGE RANGES: 0-7.5/15/75/150/750/1500 Volts.
- 4 D.C. CURRENT RANGES: 0-1.5/15/150 MA. 0-1.5 Amperes.
- 2 RESISTANCE RANGES: 0-500 Ohms. 0-1 Megohm.

\$14.90 NET The Model 770 comes complete with self-contained batteries, test leads and all operating instructions.

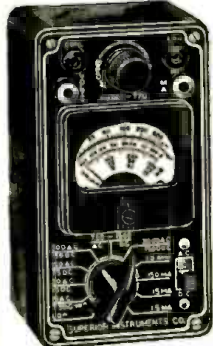

Model 770 is an accurate pocket-size V.O.M. Measures on 1 y 3/4" x 5 7/8" x 2 1/4".

Superior's New
Model TV-11

TUBE TESTER



Operates on 105-130 Volt 60 Cycles A.C. Hand-rubbed oak cabinet complete with portable cover

\$47.50 NET

• Uses the new self-cleaning Lever Action Switches for individual element testing. Because all elements are numbered according to pin number in the IMA base numbering system, the user can instantly identify which element is under test. Tubes having tapped filaments and tubes with filaments terminating in more than one pin are truly tested with the Model TV-11 as any of the pins may be placed in the neutral position when necessary. • Uses no combination type sockets. Instead individual sockets are used for each type of tube. Thus it is impossible to damage a tube by inserting it in the wrong socket. • Free-moving built-in roll chart provides complete data for all tubes. • Phono jack on front panel for plugging in either phones or external amplifier detects microphonic tubes or noise due to faulty elements and loose external connections.

Superior's New
Model 670-A

SUPER-METER

A COMBINATION VOLT-OHM MILLIAMMETER PLUS CAPACITY REACTANCE INDUCTANCE AND DECIBEL MEASUREMENTS

SPECIFICATIONS:

- D.C. VOLTS: 0 to 7.5/15/75/150/750/1,500/7,500 Volts.
- A.C. VOLTS: 0 to 15/30/150/300/1,500/7,500 Volts.
- OUTPUT VOLTS: 0 to 15/30/150/300/1,500/7,500 Volts.
- D.C. CURRENT: 0 to 1.5/15/150 Ma. 0 to 1.5/15 Amperes
- RESISTANCE: 0 to 1,000/100,000 Ohms 0 to 10 Megohms
- CAPACITY: .001 to 1 Mfd. 1 to 50 Mfd. (Quick test for electrolytics)
- REACTANCE: 50 to 2,500 Ohms. 2,500 Ohms to 2.5 Megohms
- INDUCTANCE: .15 to 7 Henries 7 to 7,000 Henries
- DECIBELS: -6 to +18 +14 to +38 +31 to +58

ADDED FEATURE: The Model 670-A includes a special GOOD-BAD scale for checking the quality of electrolytic condensers at a test potential of 150 Volts.

\$28.40 NET



Comes housed in rugged, crackle-finished steel cabinet complete with test leads and operating instructions. Size 6 1/4" x 9 1/2" x 1 1/2".

Superior's Model 660-A—A NEW A.C. OPERATED

SIGNAL GENERATOR

Provides Complete Coverage for A.M.—F.M. and TV Alignment

• Generates Radio Frequencies from 100 Kilocycles to 80 Megacycles on fundamental and from 60 Megacycles to 220 Megacycles on powerful harmonics. • Accuracy and stability are assured by the use of permeability trimmed III-C coils. • R. F. available separately or modulated by the internal audio oscillator. • Built in 400 cycle sine wave audio oscillator used to modulate the R. F. signal also available separately for audio testing of receivers, amplifiers, band of hearing aids, etc. • R. F. Oscillator Circuit: A high transconductance heptode is used as an R. F. oscillator mixer and amplifier. Modulation is effected by electron coupling in the mixer section thus isolating the oscillator from load changes and affording high stability. • A. F. Oscillator Circuit: A high transconductance heptode connected as a high- μ triode is used as an audio oscillator in a high-C Colpitts Circuit. The output (over 1 Volt) is nearly pure sine wave. • Attenuator: A 5 step ladder type of attenuator is used.



• Tubes used: 1-6BE6 as R. F. Oscillator, mixer and amplifier. Audio Oscillator: 1-6H6 as Power Rectifier. The Model 660-A comes complete with coaxial cable test lead and instructions. **\$42.95 NET**

Superior's New

TV BAR GENERATOR

THROWS AN ACTUAL BAR PATTERN ON ANY TV RECEIVER SCREEN!!



TV Bar Generator comes complete with shielded leads and detailed operating instructions. Only

\$39.95 NET

CONNECTS DIRECT TO ANTENNA POST

NO CONNECTION INSIDE RECEIVER

Features.—Can be used when no stations are on the air. • Provides linear patterns to adjust vertical and horizontal linearity. • Provides vertical and horizontal sweep signals. • Provides signal for testing video amplifiers.

NEW TIME PAYMENT PLAN ORDER BLANK

MOSS ELECTRONIC DISTRIBUTING CO., INC.
Dept. B-61, 38 Murray Street, New York 7, N. Y.

Please send me the units checked below. I am enclosing the down payment with order and agree to pay the monthly balance as shown. It is understood there will be no carrying interest or any other charges, provided I send my monthly payments when due. It is further understood that should I fail to make payment when due, the full unpaid balance shall become immediately due and payable.

- MODEL 770 Total Price \$14.90
\$2.90 down payment. Balance \$2.00 monthly for 6 months.
- MODEL TV-11 Total Price \$47.50
\$11.50 down payment. Balance \$6.00 monthly for 6 months.
- MODEL 670-A Total Price \$28.40
\$7.40 down payment. Balance \$3.50 monthly for 6 months.
- TELEVISION BAR GENERATOR Total Price \$39.95
\$9.95 down payment. Balance \$5.00 monthly for 6 months.
- MODEL 660-A Total Price \$42.95
\$12.95 down payment. Balance \$5.00 monthly for 6 months.
- I enclose \$..... as down payment.
- Ship C.O.D. for the down payment.

Signature.....

Name.....

Address.....

City..... Zone..... State.....

NEW

IT'S TERRIFIC!

EICO

7

MODEL 470

-INCH

PUSH-PULL SCOPE



KIT
\$79⁹⁵
Factory Wired
\$129.50

- **BOOSTED VERT. SENSITIVITY:** 10 mv rms/in.
- **EXTENDED FLAT FREQ. RESPONSE:** 10 cps—1 MC (± 2 db).
- **3-STEP FREQ.-COMPENSATED ATTENUATOR;** cathode follower input.
- **INTERNAL VOLTAGE CALIBRATOR;** dir.-cal. screen.
- **EXTENDED SWEEP RANGE:** 15 cps—100 kc.
- **INT. POS. OR NEG., EXT. & LINE SYNC.**
- **ON FRONT PANEL:** sawtooth, 60 cps outputs; intensity mod. & ext. sync inputs.
- **VAR. PHASING** of int. 60 cps sweep.
- **DIRECT CONNECTION** TO CRT PLATES.

ORDER NOW!

For full specifications on Model 470 and the complete EICO line, write for latest catalog.

hrc **Harvey RADIO COMPANY, INC.**
 103 W. 43rd St., New York 36, N. Y. • LU 2-1500

Editors and Engineers PUBLICATIONS

IT'S NEW!

IT COVERS ALL YOU WANT TO KNOW ABOUT EQUIVALENT TUBES, AMERICAN AND FOREIGN.

ASK FOR WORLD'S EQUIVALENT RADIO TUBES

(Equivalents Vade Mecum)

A simple index marker makes it easy to find direct replacement tubes for a given type, either completely equivalent or tubes having a few differences and, in the latter case, what these differences are.

\$5.00 PER COPY plus any tax



A COMPANION VOLUME WORLD'S RADIO TUBES (Radio Tube Vade Mecum)

Lists over 15,000 transmitting and receiving tubes from 253 manufacturers. The only book of its kind in the world. Available in 16 languages.

\$5.00 PER COPY plus any tax

For Additional Coverage

Write for free folder describing these famous books: Radiotelephone License Manual, Better TV Reception, Antenna Manual, Radio Handbook and Surplus Radio Conversion Manuals.



BUY FROM YOUR DISTRIBUTOR

ADD 10% ON DIRECT MAIL ORDERS TO EDITORS and ENGINEERS, Ltd., BOX 689A, SANTA BARBARA, CALIF.



Nationally Famous
T.V. SETS

Check these luxury features: Ultra sensitivity, dynamic range control, UHF adaptability. Duo power supply. Acousticlear Sound system... all in a beautiful Mahogany finish cabinet.

20" CONSOLETTÉ
\$149⁹⁵
 Pl. \$15.00 Fed. Excise Tax

17" Table **\$122.68** **20" Table** **\$134.50**
 Pl. \$12.27 Fed. Excise Tax Pl. \$13.45 Fed. Excise Tax

Also Available T.V. CHASSIS

READY TO OPERATE

Complete with Picture Tube and Speaker

Featuring above outstanding qualities. Ideal for custom built installations, den, playrooms, etc. Perfect for taverns, clubs, etc.

17" SET **\$99.95** **20" SET** **\$112.50**
 Pl. \$9.99 Fed. Excise Tax Pl. \$11.25 Fed. Excise Tax

All sets have full 1 yr. factory picture tube warranty, and standard 90 day RTMA parts warranty. Mail and Phone Orders Filled. \$25 deposit, balance C.O.D., Shipping Charges Add'l.

STEPHEN Sales Corp.

45 Crosby St., N. Y. 12, N. Y. Phone WO 4-8233

Dealer Inquiries Invited

Low-Pass Filter

(Continued from page 47)

for Channel 4. The attenuation continues to increase with frequency. The effectiveness of the filter is further demonstrated by the fact that no interference is observed on the writer's TV set on any channel. This is true even though the transmitter operates with 150 watts' input power on all bands from 160 to 10 meters and the transmitting antenna is located only a hundred feet from the television receiving antenna. It might be mentioned in passing that the writer's TV set, a *General Electric* Model 818, includes an effective high-pass filter as a part of its design.

After the work was all done, the cost of the components entering into the construction of this unit was added up. It came to less than five dollars, a most gratifying development. The most modern, "perfectly TVI-proofed" transmitter will still generate some harmonics, and this is a very small price to pay to keep them home.

-30-

Tunable Hum

(Continued from page 42)

on, (refer to Fig. 1) 117 volt 60 cycle a.c. was impressed across the lightning arrester terminals through the antenna primary coil and line bypass condenser. The leaky lightning arrester, acting like a nonlinear resistor, became a modulator and caused the amplitude of any broadcast signal coming down the lead-in to vary at a 60 cps rate. Enough carrier, now hum modulated, was re-radiated from the antenna connected to this lead-in to affect all receivers in the apartment house area.

Another way of looking at the phenomenon is to visualize the offending antenna as being connected to a device whose impedance varies at a line frequency rate. This might cause absorption of all r.f. signals in the vicinity. This again could be equivalent to hum modulating these carriers.

To summarize then, external hum modulation will occur in an area when:

1. An a.c. power line voltage is impressed across a semiconductor like a leaky insulator or a corroded electrical joint.
2. The leaky insulator is at the same time connected to a radiating system like a long wire or an antenna. If the power line is of the external overhead type it constitutes an excellent radiating system. See Fig. 2.

The diagnosis of tunable hum is much simpler than its localization and cure. With a portable receiver and the co-operation of the local power company and the community, this type of interference can be entirely eliminated.

-30-

Six months from today

Which Will You Hold?

this-

or this

REGRET TO ADVISE YOU FAILED YOUR FCC EXAMINATIONS-

1st CLASS RADIO TELEPHONE OPERATOR'S LICENSE

Add Technical Training To Your Practical Experience - **GET YOUR FCC LICENSE IN A HURRY!**

Then use our Amazingly Effective **JOB-FINDING SERVICE**

Money-Making **FCC** Commercial Radio Operator **LICENSE** Information

TV ENGINEERING INCLUDED IN OUR TRAINING & COACHING

Get This Valuable Booklet **FREE!**

● TELLS HOW -

Here Is Your GUARANTEE
 If you fail to pass your Commercial License exam after completing our course, we guarantee to continue your training without additional cost of any kind, until you successfully obtain your Commercial license, provided you first sit for this examination within 90 days after completing your course.

We Guarantee TO TRAIN AND COACH YOU AT HOME IN SPARE TIME UNTIL YOU GET Your FCC License

If you have had any practical experience—Amateur, Army, Navy, radio repair, or experimenting.

● TELLS HOW -

Employers make **JOB OFFERS** Like These to Our Graduates Every Month

Letter from nationally known manufacturer of high quality AM and FM transmitters. "We are very much in need at the present time of radio-electronics technicians and would appreciate any helpful suggestions that you may be able to offer." Salary up to \$112 per month to start.

Letter from nationally known airplane manufacturer. "We need men with electronic training or experience in radar maintenance to perform operational check-out of radar and other electronics systems . . . starting salary . . . amounting to \$329.33 per month." These are just a few samples of the job offers that come to our office periodically. Some licensed radioman filled each of these jobs . . . it might have been you!

HERE'S PROOF FCC LICENSES ARE OFTEN SECURED IN A FEW HOURS OF STUDY With OUR Coaching AT HOME in Spare Time.

Name and Address	License	Lessons
Lee Worthy 2210 1/2 Wilshire St., Bakersfield, California	2nd Phone	16
Clifford E. Vogt Box 1016, Dania, Florida	1st Phone	20
Francis K. Foerch 38 Heuveler Pl., Bergenfield, New Jersey	1st Phone	38
S/Sgt. Ben W. Davis 317 North Roosevelt, Lebanon, Illinois	1st Phone	38
Albert Schoell 110 West 11th St., Escondido, California	2nd Phone	23

Carl E. Smith, E.E., Consulting Engineer, President
CLEVELAND INSTITUTE OF RADIO ELECTRONICS
 Desk RN-53, 4900 Euclid Bldg., Cleveland 3, Ohio

● TELLS HOW -

Our Amazingly Effective **JOB-FINDING SERVICE** Helps **CIRE** Students Get Better Jobs
 Here are a few recent examples of Job-Finding results:

- GETS CIVIL SERVICE JOB**
 "Thanks to your course I obtained my 2nd phone license, and am now employed by Civil Service at Great Lakes Naval Training Station as an Equipment Specialist."
 Kenneth R. Leiser, Fair Oaks, Mt. Del., Meffery, Ill.
- GETS STATE POLICE JOB**
 "I have obtained my 1st class ticket (thanks to your school) and since receiving same I have held good jobs at all times. I am now Chief Radio Operator with the Kentucky State Police."
 Edwin P. Healy, 264 E. 3rd St., London, Ky.
- GETS BROADCAST JOB**
 "I wish to thank your Job-Finding Service for the help in securing for me the position of transmitter operator here at WCAE, in Pittsburgh."
 Walter Koschik, 1442 Ridge Ave., N. Braddock, Pa.
- GETS AIRLINES JOB**
 "Due to your Job-Finding Service, I have been getting many offers from all over the country, and I have taken a job with Capital Airlines in Chicago, as a Radio Mechanic."
 Harry Clare, 4537 S. Drexel Blvd., Chicago, Ill.

Your FCC Ticket is recognized in all radio fields as proof of your technical ability



Get All 3 Free

MAIL COUPON NOW

CLEVELAND INSTITUTE OF RADIO ELECTRONICS
 Desk RN-53-4900 Euclid Bldg., Cleveland 3, Ohio
 (Address to Desk No. to avoid delay)

I want to know how I can get my FCC ticket in a minimum of time. Send me your **FREE** booklet, "How to Pass FCC License Examinations" (does not cover exams for Amateur License), as well as a sample FCC-type exam and the valuable booklet, "Money-Making FCC License Information." Be sure to tell me about your Television Engineering Course.

NAME

ADDRESS

CITY ZONE STATE

Paste on two-cent postcard or send air mail

RECEIVER AND TRANSMITTER

RECEIVER BC-229—TRF Receiver with 3 Plug-in Coils to cover Freq. Range 201 to 398, 2500—4700, 4150—7700 K.C. With 6 Tubes: 1/37—1/38—3/39. Power Supply required, 6 or 12 Volt & 250 Volts. Size: 16"x8"x7". Schematic included. **\$8.95**

TRANSMITTER BC-230—Voice modulated Trans. with 5 Plug-in Coils to cover Freq. Range 2500 to 7700 K.C. With 4 Tubes: 2/10—2/45 & RF Meter 0-1.5 Amps. Power Supply required, 6 or 12 Volt & 350 Volts. Size: 13"x8"x7". Schematic included. **\$8.95**

SPECIAL BUY—BOTH RECEIVER AND TRANSMITTER \$75.00

ANTENNA EQUIPMENT

MAST BASES—INSULATED:

MP-132 BASE—Illustrated at left—1" heavy coil spring, 2" insulator. Overall length: 11 1/2". Weight: 2 3/4 lbs. Price \$3.95

MP-S-33 BASE—Insulated type with heavy coil spring and 5" dia. insulator. Requires 2" hole for mounting. Weight: 9 lbs. Price \$5.95

MAST SECTIONS FOR ABOVE BASES

Tubular steel, copper coated, painted, in 3 ft. sections, screw-in type. MS-53 can be used to make any length with MS-52-51-50-49 for taper. Any section 50c Each
Larger Diameter Section: MS-54 \$1.25

DYNAMOTORS

DYNAMOTOR and BLOWER: 9 Volts DC input; output 450 Volts 60 MA. 4500 RPM. At 6 Volts DC input; output 260 Volts 65 MA. 3000 RPM. Price **\$4.95**

INPUT:	OUTPUT:	STOCK No.:	PRICE:
14 V. DC	600 V. 300 MA.	BD-86	\$9.95
12 V. DC	220 V. 70 MA.	DM-24	6.95
12 V. DC	220 V. 100 MA.	DM-18	4.95
14 V. DC	375 V. 150 MA.	DM-375	8.95
14 V. DC	330 V. 135 MA.	DM-330	7.95
14 V. DC	500 V. 500 MA.	PE-59	14.95
12 or 24 V. DC	275 V. 110 MA.	USA/0516	3.95
12 V. DC	250 V. 50 MA.	DM-25	8.95
12 or 24 V. DC	500 V. 50 MA.	USA/0515	3.95
12 or 24 V. DC	440 V. 200 MA.		
	225 V. 100 MA.	D-104	14.95
28 V. DC	250 V. 60 MA.	PE-86	5.95

TELEPHONE WIRE

3 Conductor, copper & steel, 525 ft. \$4.75

REVERSIBLE MOTOR

Motor Reversible—3.7 RPM. 40 lb. torque. 24 Volt DC or AC. Motor size: 5 1/2" x 4-1/32" x 3-5/16". Shaft size: 21/32" x 5/16". Philco No. 441-1008 NEW: \$5.95

110 Volt AC TRANSFORMER to operate above motor. NEW: \$4.95

COMMAND EQUIPMENT

BC-459 Transmitter—7 to 9 MC.—Used 14.95
BC-455 Receiver—6 to 9 MC.—Used 10.95
BC-456 Modulator. NEW: \$5.95—Used 2.95
Transmitter Rack—Single: \$1.50—Dual 2.00
Rec. Rack—Triple: \$2.50. Modulator—Mig. 1.50
Rec. Dyn.—Used: \$2.95. Trans. Dyn.—Used 2.95

TRANS.—REC.—AMPLIFIERS

RA-10 DA RECEIVER NEW: 40.95
RT7/APN-1 Transceivers—120 MC. Complete with Tubes & Dyn. NEW: \$24.95—USED: \$19.95
ARC-4 Transceiver—140-144 MC. w/Tubes—Used: \$29.95
BC-1206—200-400 KC. Delco. w/Tubes 9.95
BC-605—With Tubes, Used 3.95
BC-709—W/Tubes—New: \$4.95—Used: 3.95
BC-347—Less Tubes—New: \$2.95—Used: 1.95

Address Dept. RN • Minimum Order \$5.00 • Prices F.O.B., Lima, O. • 25% Deposit on C.O.D. Orders

FAIR RADIO SALES

132 SOUTH MAIN ST.
LIMA, OHIO

TRAIN FOR A SUPERVISORY POSITION IN ELECTRONICS

Through 2-year course covers electrical circuits and machinery, basic electronics and industrial electronics. Franklin Technical Institute graduates are in demand as junior engineers for research and test work, sales engineering, supervisory work on production lines and drafting room design work. Other engineering and technical courses. Coed. Day, evening, 45th year. Write for catalog.

FRANKLIN TECHNICAL INSTITUTE

46 Berkeley Street Boston 16, Mass.

PE-101C DYNAMOTOR

6 or 12 Volt



(Reprints of original CQ conversion articles—Oct. and Dec., 1952 issues, furnished.)

This is the Dynamotor the Hams have been talking about! Easily adapted to supply 625 V. @ 150 MA. and 325 V. 125 MA. at 12 Volts—or 300 V. 90 MA. and 160 V. 110 MA. at 6 Volts. (Illustration shows modified.) NEW: \$4.95

BATTERY SWITCHING UNIT and METER

Used to switch load from one battery to another—or 6 to 12 Volts. Contains Weston 2" Meter—0-15 Volt DC Scale for reading battery voltage. 20 Amp DPDT Switch and Indicator. Case size: 4" x 6 1/4" x 2 3/4" NEW: \$2.95

POWER SUPPLIES

VIBRATOR TYPE—6 Volt DC input; output 230 Volt DC 50 MA.—not filtered—w/Tube. Ideal for Command Receiver operation as receiver is filtered internally. Size: 4 1/2" x 4 1/4" x 3 1/2" \$5.95

PE-157 POWER SUPPLY—2 Volt Vibrator Supply, operates from BB-54 2 Volt Battery mounted in Case. Output voltage 1.4 V. 1/2 Amp. 125 V. 50 MA. Less Battery, Speaker, & External Power Cord—with Vibrator Used: \$4.95

MP-28 BA Power Supply & Modulator \$2.95
f/TA-12—New: 20.95

AIRCRAFT CONTROL CABLE

3/32"—7x7 Strand. Weatherproofed. Galvanized, Preformed, 920 lb. test. Ideal for Television Guying and many other uses. Prices:

4 1/2c per Ft.—1000 Ft. or more @ 4c per Ft.

BLOWERS—115 VAC 60 CYCLE



SINGLE TYPE: (Illustrated at left) 108 CFM. 2 1/2" Intake; 2" outlet. Complete size: 5" x 6". Order No. IC939 \$8.95

DUAL TYPE: 100 CFM. 4" Intake; 2" Dis. Each Side. Complete Size: 8" x 6". Order No. IC880 \$13.95

COMPACT TYPE: 108 CFM. Motor built inside squirrel cage. 4 1/2" Intake; 3 1/2" x 3" Dis. Complete size: 4 1/4" W x 8 1/2" H x 8 1/2" D. Order No. 2C067 \$14.50

FLANGE TYPE: 130 CFM. 3 1/2" Intake; 2 1/2" Dis. Complete size: 7 1/2" W x 7 1/4" H x 6 3/4" D. Order No. IC807 \$13.95

FLANGE TWIN: 275 CFM. 4 1/2" Intake; 3 1/2" x 3" Dis. Complete size: 11 1/4" W x 8 1/2" H x 8-1/16" D. Order No. 2C069 \$21.95

TRANSFORMERS AND CHOKES

TRANSFORMERS—110 V. 60 CYCLE PRIMARIES: 5 Volt CT-25A—10,000 V. Ins. OPEN FRAME—6" x 5" x 4 1/2" \$7.95

6.3 V. 1 Amp. 1.25 24 V. 1 Amp. 1.95
24 V. 1/2 Amp. 1.50 24 V. 6.5 Amp. 5.95
6-24 or 30 Volt 8 Amp. 5.95

Two 12 V. 4 A. windings, gives 12 V. 8 A. or 24 V. 4 A. 5.95

325-0-325 V. 50 MA—Shell 3 V. 2.5 A; 6.3 V. 6 A (Rect. 6x5) Half Sizing—2 1/2"x3 1/2"x3"—No. T-23-28 2.75

175-0-175 V. 40 MA—6.3 V. @ 2.4 A; 6.3 V. @ .6 A; Halfshell 2 1/2"x2 3/16"x2 3/16"—No. T-23-40 1.75

350-0-350 V. 90 MA—6.3 V. @ 3 A; 5 V. @ 3 A; Upright—3 1/2"x3 1/2"x3 1/2" 3.25

CHOKES

15 Henries—165 MA. 125 ohms \$2.95

5 Henries—150 MA. 85 ohms DC—Res. Cased 1.95

8 Henries—150 MA. 200 ohms 1.95

5-20 Henries—300 MA. 110 ohms, 1000 V. Ins. 3.95

Address Dept. RN • Minimum Order \$5.00 • Prices F.O.B., Lima, O. • 25% Deposit on C.O.D. Orders

FAIR RADIO SALES

132 SOUTH MAIN ST.
LIMA, OHIO

TRAIN FOR A SUPERVISORY POSITION IN ELECTRONICS

Through 2-year course covers electrical circuits and machinery, basic electronics and industrial electronics. Franklin Technical Institute graduates are in demand as junior engineers for research and test work, sales engineering, supervisory work on production lines and drafting room design work. Other engineering and technical courses. Coed. Day, evening, 45th year. Write for catalog.

FRANKLIN TECHNICAL INSTITUTE

46 Berkeley Street Boston 16, Mass.

CODE SENDING RECEIVING SPEED

HIGH SPEED WITHOUT NERVOUS TENSION

REVEALING BOOK shows how "crack" operators develop high speed and proficiency. Learn code for Amateur or Commercial Radiotelegraph License, or improve your sending and receiving.

with the Candier System which develops radio-telegraph experts and code champions.

CANDLER SYSTEM CO. FREE BOOK

Box 928, Dept. 2-G, Denver, Colo.

ISOLATED LOW VOLTAGES

By RONALD L. IVES

IN MAINTENANCE, repair, and experimental work, the need frequently arises for low a.c. voltages which are isolated from ground. The standard method of securing these voltages is by use of an isolation transformer and a Variac. This combination works excellently, is highly dependable and convenient, and costs about \$35.00.

To reduce costs, many experimenters connect two small filament transformers "back to back," inserting a rheostat or potentiometer in the low-voltage intermediate circuit to permit variation of the output voltage, as in Fig. 1A. Within the ratings of the transformers and resistor, this expedient works quite well, and costs less than \$10.00 in most instances.

Most service shops, however, already have available a tapped isolation transformer, equipped with means for varying the output voltage both in steps and continuously! Such a transformer is an integral part of most tube checkers of better manufacture, and an additional expenditure of less than \$1.00 will make these voltages available for test and experimental work. All that is needed is a means of tapping into the filament circuit of the tube checker.

A generalized circuit of a tube checker filament supply is shown in Fig. 1B. To obtain the various voltages, a plug connector can be wired to fit any socket, such as the octal, with lead wires connected to the 2 and 7 pins. When the controls are set for a 6J5, or any other octal tube with similar filament connections, the voltage across these leads will be that produced by the filament transformer, the actual value being a function of the setting of the filament voltage switch and of the line adjustment.

A slightly more elegant method is to mount a terminal, such as an Eby 21-R or a National R-39, at some convenient place on the panel, and then to wire it directly across the filament leads of the checker. Voltage will be determined by filament voltage switch and line adjuster settings, and will be independent of the other settings.

If the tube checker is not already equipped with a fuse, one should be installed, to prevent transformer burnout in event of an accidental short circuit. Replacement fuses cost three cents; replacement transformers cost \$8.00 and up, mostly up.

Fig. 1. (A) Standard method of varying output voltage. (B) Tube checker filament supply with the adaptations to permit its use as a variable output low voltage source.

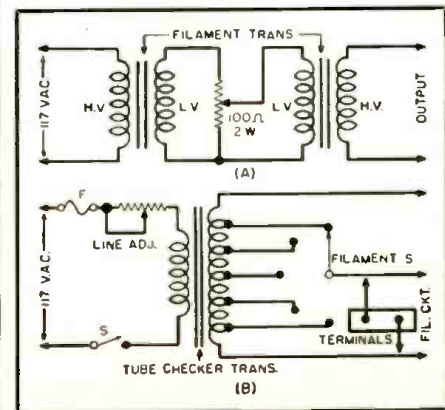

WINNERS BOTH! * See Foot Note



* FOOT NOTE: Ole Timer For Operating And WALTER ASHE For "Surprise" Trade-Ins!



ELMAC Model A-54 Wired for 10, 11, 20, 40 and 75 meters. Net \$143.00
 Model A-54H. Same as above but for crystal or dynamic mike. Net \$153.00



ELMAC New Mobile Receiver. Model PMR-6-A. Dual conversion, 10 tubes, BFO, noise limiter, covers all amateur bands, 10 through 160 meters plus BC band. Measures only 4 1/2" H. x 6" W x 8 1/2" deep. Net \$134.50



JOHNSON VIKING VFO Kit. Less tubes. Shpg wt. 6 lbs. Net \$42.75
 Wired and Tested. Net \$59.75



STANCOR Mobile Kit. Model ST-203A. 10-11 meters. Simple conversion instructions for other bands. Less tubes. Net \$47.50. Wired and tested. Less tubes. Net \$66.75



JOHNSON VIKING II Transmitter Kit. Shpg. wt. 85 lbs. Net \$279.50
 Wired and tested. Net \$336.50



NATIONAL HRO-60T. Less speaker. Shpg. wt. 90 lbs. Net \$483.50

All prices f. o. b. St. Louis • Phone Chestnut 1125

Walter Ashe
RADIO CO.
 1125 PINE ST. • ST. LOUIS 1, MO.

FREE CATALOG!

R-53-6

WALTER ASHE RADIO COMPANY
 1125 Pine Street, St. Louis 1, Missouri

Rush "Surprise" Trade-in-offer on my _____
 for _____
(show make and model No. of new equipment desired)

Send new 1953 Catalog.

Name _____
 Address _____
 City _____ Zone _____ State _____

Send for your copy today

THE NEW

McINTOSH

30 WATT AMPLIFIER

COMPANION TO THE
McINTOSH 50

Here in a lower power amplifier McIntosh has incorporated all of the features that have made the McIntosh 50 tops in the high fidelity field. The same patented McIntosh output transformer circuit which assures distortion free performance is used in this 30 watt amplifier. The same in every way except wattage and price. Here is an economically priced high fidelity amplifier designed for the finest home sound reproduction systems.

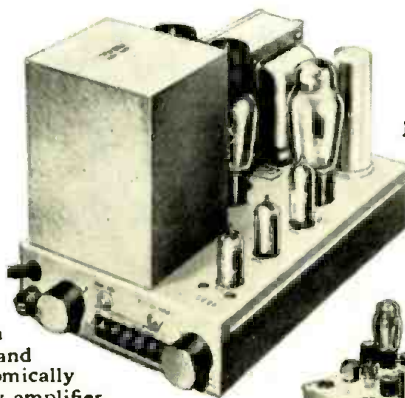

McIntosh 30

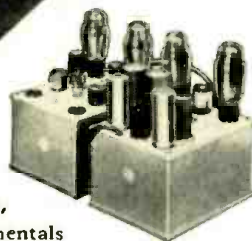

McIntosh 50



Write today for **LOST INSTRUMENTS**, a booklet explaining the fundamentals of high fidelity sound enjoyment.



322 WATER STREET • BINGHAMTON, NEW YORK

ON-THE SPOT BATTERY RECORDER

WALKIE-RECORDALL 8 lb. miniature BATTERY RECORDER-PLAYBACK
Continuous, permanent, accurate, indexed recording at only 5c per hr. Instantaneous, permanent playback. Picks up sound up to 60 ft. Records conferences, lectures, dictation, 2-way phone & sales talks; while walking, riding or flying. Records in closed briefcase with "hidden mike." Write for Detailed Literature.

MILES REPRODUCER CO., INC.
812 BROADWAY Dept. RN-5, NEW YORK 3, N. Y.

New Electronic Headquarters—
VAN SICKLE RADIO SUPPLY CO.
1320 So. Calhoun St. Phone E-4136
FORT WAYNE 2, IND.

Please note new address. Eugene Van Sickle, Owner

Oscilloscope Calibrator

(Continued from page 71)

inch, etc. However, if the user is dealing with waveforms of widely varying amplitudes, this method is inconvenient and can easily lead to errors. A second method, and one which makes more use of the calibrator, involves observing the waveform under measurement with the scope gain set to view the waveform at any convenient height. The calibrator can then be switched from the "Scope" position to the "Cal" position whereupon the calibrated pot is adjusted to produce the same height as the previously observed waveform. The dial and multiplier readings on the calibrator when multiplied together give the peak-to-peak voltage of the observed waveform.

The use of this instrument is readily extended to make it even more useful. By adjusting the grid resistor and coupling condensers of the multi-vibrator to produce a specific frequency, a convenient signal source for square-wave testing of audio amplifiers is obtained. The device can also be used for both r.f. and a.f. signal tracing since the square-wave output is so rich in harmonics. However, if it is used for this purpose, it is essential that condensers be included in series with both leads connected to the output of the calibrator.

Probably even more uses, other than its intended purpose will suggest themselves to the constructor, thus making this unit a very worthwhile addition to anybody's shack, shop, or laboratory.

WORLD RADIO USE TOTALS

OVER half the radio receivers in the world are located in the U.S., according to the recently-published United Nations Statistical Yearbook for 1952. As of 1951, the latest year for which totals were available, there were an estimated 105,000,000 home and public-entertainment sets in operation here, exclusive of TV and other special receivers. Since the totals for the various countries include individual loudspeakers fed by central distributing receivers (of the type used for public information and entertainment in some countries) the American portion of the world total is probably greater than it appears statistically.

Some nations, including the U.S., have shown an enormous gain over available statistics for 1938. In this country the 1951 figure is two and a half times the 1938 estimate. In 1951 there were twice as many radios as prewar in Japan, Czechoslovakia, Australia, and Canada and nearly twice as many in Sweden. France and the United Kingdom showed increases of 57 and 50 per-cent respectively. The most striking increase was recorded by Italy, the 1951 figure being 280 per-cent higher than in 1938.

No figures on set ownership were available from the USSR.

This report again underlines the importance of radio in disseminating information.

opportunities AT BELL TELEPHONE LABORATORIES

A career for you with one of the nation's leaders in research and development in communications and military electronics.

ELECTRONIC TECHNICIANS DRAFTSMEN
ELECTROMECHANICAL TECHNICIANS

Openings require previous training at high school, armed service school, or technical institute level and in general 2 or more years of applicable industrial or military experience.

Other positions generally open for experienced Wiremen and Machinists for experimental development work.

Send your name and address for application, telephone collect within 100 miles for information, or visit us Monday through Saturday. Evening interviews arranged.

BELL TELEPHONE LABORATORIES

WHIPPANY, N. J. (Near Morristown) EXTS. 326, 300
MURRAY HILL, N. J. (Near Summit) EXTS. 3259, 3387
SUMMIT 6-6000

Tools, GARRARD Changers, LENK Solder Irons, DON MCGOWEN Amplifiers, MERIT Transformers, QUAM Speakers, RIDERS Publications, SIMPSON Meters, STANDARD Coil Tuners, SAMS Photo-

TUBES

ALL TUBES are guaranteed for one year individually boxed. Very BEST BRANDS available for immediate delivery!

02A	59c	2X2/879	.74	6AV6	.59	6G6G	.95	6S07GT	.59	7G7	1.19	12F5GT	.85	
02AG	31P4	1.25	6AX4	.69	6H6GT	.89	6S7GT	.59	7H7	1.05	12H6	.89		
1A5GT	79	304	.69	6AX5	.79	6J5GT	.59	6SS7	.99	7J7	1.29	12J6GT	.75	
1A7	69	305GT	.89	6AX6	.69	6J6	.79	6I7G	1.15	7K7	1.19	12K7GT	.69	
1A7GT	.79	354	.69	6AY5GT	.89	6J7G	.69	6I8	.89	7L7	.79	12K8	.89	
1B3GT	.95	3V4	.95	6B4G	1.44	6J8G	1.15	6I8	.69	7N7	.69	12O7GT	.89	
1B5	.29	5T4	1.40	6B8GT	1.15	6K5GT	.69	6I8GT	.69	7O7	.79	12S8	.89	
1H5GT	.59	5Y4G	.59	6BA5	.59	6K6GT	.59	6I7G	.59	6U7G	.59	12S7GT	1.05	
1J6GT	5V4G	.87	6BA7	.79	6B7GT	.69	6I8	.89	7S7	1.19	12S7GT	.69		
1L4	69c	5W4	59c	6BC5	69c	6L8GT	1.19	6V3	1.29	7V7	.79	12S7GT	.99	
1L4	1.19	5W4GT	.45	6BD5GT	.89	6L6G	.95	6V6GT	.69	7W7	1.19	12S7GT	.99	
1L4A	1.19	5Y3GT	.45	6BD5GT	.89	6L6G	.95	6V4GT	.59	7X6	1.05	12S7GT	.89	
1L4A	1.19	5Y4G	.54	6BE6	.59	6L6GA	.95	6W6	.69	7X7	.79	12S7GT	.89	
1L4C5	.89	5Y4G	.81c	6BF5	.69c	6L7	1.19	6X4	1.19	7Z4	.59	12S7GT	.89	
1L4C6	1.19	6A3	1.68	6BG6G	1.69	6N7GT	1.19	6Y6G	.69	12A7	1.59	12S7GT	.89	
1L4D5	1.19	6A7	1.21	6BH6	69c	6P5GT	.69	6Z4	.84	12A8	.69	12S7GT	.89	
1L4E3	1.19	6A8GT	1.19	6BK7	1.19	6R7GT	.69	7A5	.69	12A15	.54	12S7GT	.89	
1L4H4	1.19	6A8GT	1.19	6BL7	.79	6S4	.59	7A6	.59	12A16	.59	12S7GT	.89	
1L4N5	1.19	6A8GT	1.19	6B16	1.19	6S7GT	1.19	7A7	.69	12A17	.89	12S7GT	.89	
1N5GT	6A8GT	1.15	6B17	.79	6S8GT	.85	6S8GT	1.25	7A8	.79	12A18	.69	12S7GT	.89
1P5GT	6A7	1.45	6B06GT	.85	6S8GT	.85	6S8GT	1.25	7A8	.79	12A18	.69	12S7GT	.89
1Q5GT	6A5	1.05	6B07	1.29	6S7GT	.69	6S7GT	.69	7B4	.89	12A17	.69	12S7GT	.89
1R5	6A7	1.49	6B27	.59	6S7GT	.69	6S7GT	.69	7B5	.89	12A16	.59	12S7GT	.89
1S4	6A6	1.89	6C4	.59	6S7GT	.69	6S7GT	.69	7B6	.89	12A17	.69	12S7GT	.89
1S5	6A5	.89	6C5GT	.59	6S7GT	.69	6S7GT	.69	7B7	.89	12A16	.59	12S7GT	.89
1T4	6A6	1.08	6C6	.59	6S7GT	.69	6S7GT	.69	7B8	.89	12A17	.69	12S7GT	.89
1U5	6A5	.81	6C6/78	1.10	6S7GT	.69	6S7GT	.69	7C4	.69	12A17	.69	12S7GT	.89
1V	6A5	.88	6C6GT	1.69	6S7GT	.69	6S7GT	.69	7C5	.69	12A17	.69	12S7GT	.89
1X2A	6A6	.89	6D6/78	1.10	6S7GT	.69	6S7GT	.69	7C6	.69	12A16	.59	12S7GT	.89
2A6	6A5	.79	6D8G	1.15	6S7GT	.69	6S7GT	.69	7C7	.69	12A17	.69	12S7GT	.89
2A7	6A6	.59	6E5	.69	6S7GT	.69	6S7GT	.69	7E5	.69	12B6	.69	12S7GT	.89
2B3	6A5	.90	6F6GT	.59c	6S7GT	.69	6S7GT	.69	7E6	.69	12B7	.69	12S7GT	.89
2B7	6A5GT	1.29	6F7	1.59	6S7GT	.69	6S7GT	.69	7E7	.69	12B7	.69	12S7GT	.89
2C34	6A6	.60	6A16	.59	6S7GT	.69	6S7GT	.69	7F7	.89	12B7	.69	12S7GT	.89
2E5	6A5GT	.89	6F8G	1.59	6S7GT	.69	6S7GT	.69	7F8	1.47	12B7	.69	12S7GT	.89

FREE—FREE—FREE

5 SMALL SCREWDRIVERS with rotating handle and handy case with purchase of \$20.00 or more—or 5 lbs. of good usable radio service parts with order of 100 tubes or more—or a kit of assorted radio repair hardware free with purchase of 50 tubes or more.

"SERVICE SHORT-CUTS"

There are a number of glib generalizations in servicing that too many men accept at face value. Take the oft-repeated advice that the fastest way to check a capacitor in a set is by bridging another one across it. If you stop to think about this you will see that it can be valid for only one condition: when the defective capacitor is open. If a capacitor is shorted or leaky, bridging will reveal little or nothing because the basic trouble remains. The surest test for any capacitor is to disconnect one end and then check it with a suitable instrument.

Write to us for the reprint of the informative scope article that appeared in the JANUARY 1953 issue of RADIO & TELEVISION NEWS. If you want a copy, drop us a line and one will be shipped to you post haste.

MODEL 300 PRECISE OSCILLOSCOPE

Here Is the Buy

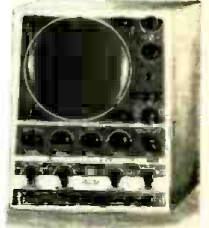

7" tube size. Sweep magnifier, complete push-pull from input through output. Vertical sensitivity better than 10 millivolts. Bandpass 0 — 3db., 0 to FIVE mc, complete with phasing control, blanking control, intensity mod. and self-measurement peak to peak feature, with DC amplifiers throughout as found only in scopes selling for over \$950.00. Exclusive, easy maintenance feature.

In kit form **\$94.95**

TELEVISION PICTURE TUBES

SEND US YOUR ORDER AND WE WILL SHIP FROM STOCK IMMEDIATELY	SIZE	PRICE	SIZE	PRICE
	7 inch	\$17.95	16 inch	\$19.95
	8 inch	\$15.50	17 inch	\$20.95
	10 inch	\$12.95	19 inch	\$23.95
	12 inch	\$16.95	20 inch	\$24.95
	14 inch	\$17.95	21 inch	\$26.95
	15 inch	\$19.95	24 inch	\$49.95

METAL TUBES \$1.50 extra per tube
Electrostatic Tubes \$1.50 extra per tube



ONE FULL YEAR WARRANTY ON ALL TYPES

WE PAY FOR YOUR DUD

Your worn out picture tube is worth money if it is not broken.

SIZE WE PAY	SIZE WE PAY	SIZE WE PAY
7" \$1.00	14" \$3.00	19" \$4.00
8" 1.00	15" 3.00	20" 4.00
10" 2.00	16" 4.00	21" 5.00
12" 3.00	17" 3.00	24" 9.50

These allowances apply when you purchase the same size picture tube.

RADAR TYPE TV ANTENNA

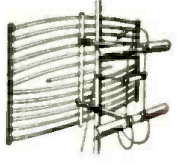

For UHF and VHF Receives All 82 Channels

WE FINALLY DID IT

You ordered so many thousands of these radar type TV Antennas, that the cost has come down through the savings of mass production.

WE ARE PASSING THESE SAVINGS ON TO YOU!

The only TV antenna with the money-back guarantee with the new Electronic Dipole Separators. Unbeatable for fringe area and DX at this low, low price we cannot mention manufacturer's name.

Less Mast **\$18.75**

5 ALUMINUM MAST heavy gauge 1 1/4" diam. with interlocking end. Slip two sections together for a ten-footer each **\$1.00**

TV Antennas 10 Element conical rugged throughout. only \$3.95

Double bay array, with stacking bars. \$7.75

4 Bay array, with harness and stacking bars \$14.95

6 Element Conical. only \$2.95

TV ANTENNA KIT Fringe Area DOUBLE "V" High Gain, Best Pictures Possible... complete with 300 ohm line. Insulators, Guy wire, hardware, full size antenna with double length 9-ft. mast. **\$6.95** Complete

MISCELLANEOUS BUYS

- I. F. TRANSFORMER—456 Kc. 29c
- PILOT LIGHTS, Type No. 47 10 for 39c; 100 for \$2.95
- VOLUME CONTROLS with SWITCH, 2" shaft, 3 meg., 1/2 meg., 1/4 meg. ea. 34c
- SINGLE ION TRAPS for 50L6, 29c
- OUTPUT TRANSFORMER for 50L6, 29c
- for 6V6, 39c
- UNIVERSAL OUTPUT TRANSFORMER, 12 watt 99c
- CHIMNEY MOUNT for TV ant. 98c
- 6-foot LINE CORD UL 10 for \$1.95
- TV INTERLOCK CORDS ea. 49c

300 OHM TWIN LEAD

- 55 Mil, 100 ft. \$ 1.59
- 1.000 ft. 11.95
- 20 Ga. 80 Mil, 100 ft. 1.89
- 1.000 ft. 16.95
- TUBULAR 300 OHM LINE 1.000 ft. \$34.50
- 100 ft. \$4.95

Radelco Ultra High Gain TV Antenna

with famous director bar for single and multiple bay stacked arrays—Model RS-751 BAR X **\$438**

RADELCO HI-LO Model RM-40-S High Channel Dipole & Reflector, Low Channel Dipole & Reflector, Five foot mast, U-Bolt Mtg. **\$576**

All Channel

TUBE KITS BEST BRANDS AT BEST PRICES

- 3V4, 1T4, 1R5, 1S5 \$2.19
- 3Q4, 1T4, 1R5, 1S5 \$1.98
- List Value \$8.00. Tube Kit only \$1.98
- 354, 1T4, 1S5, 1R5, 1S5 \$1.98
- List Value \$7.80. 4-Tube Kit \$1.98
- 1U4, 354, 1S5, 1R5, 1T4 \$2.49
- List Value \$7.80. 4-Tube Kit \$2.49
- 117Z3, 1U5, 354, 1R5, 1T4 \$2.59
- AC-DC Portable Kit. All for \$3.22
- 12AT6, 12BA6, 12BE6, 35W4, 50B5 \$3.22
- 5 Tubes for \$3.22
- 50L6GT, 35Z5GT, 12S07GT, 12SK7G, 12SA7G. 5 Tubes for \$3.22

21" TV CONVERSION KIT

Consisting of rectangular tube, 70 DEGREE YOKE, Beautiful Mask and FLY-BACK TRANSFORMER.

- complete \$31.95
- 20" TV Conversion Kit, as above, complete \$28.95
- 17" TV Conversion Kit, as above, complete \$23.95
- 24" Conversion Kit, complete \$69.95

P. M. SPEAKERS \$12.95

12" COAXIAL PM SPEAKERS High Fidelity with high pass filter attached. 20 watts; 40-17500 cps. response. 8 ohm Voice-Coil.

8" COAXIAL PM SPEAKERS ea. \$9.95

Very best quality—NATIONAL BRANDS. Individually Packed.

- 3" ea. \$1.39
- 4" ea. 1.59
- 5" ea. 1.59
- 6" SPECIAL PRICE ea. \$1.79
- 8" ea. \$3.23
- 10" ea. 5.10
- 12" ea. 5.95

RESISTOR KITS

Insulated 1/2, 1 and 2-watt assortment of most used values, I.R.C. Ohmite, Stackpole, Speer, etc., 100 for **\$2.95**

REGENCY UHF Converter

UNIVERSAL-CONVERTERS ALL SETS—the only converter recommended for the 5,000-000 split sound and video TV sets now in use as well as all intercarrier TV sets. **\$37.46** NET

PREMIER T.V. RADIO SUPPLY

Division of Continental Corp. 3237 W. North Ave. Chicago 47, Ill. ARmitage 6-5550

TV PICTURE BRITENER For correcting soft, dark or weak picture tubes. **\$165** ea. ONLY

TERMS 20% DEPOSIT with order, balance C.O.D. All shipments F.O.B. Chicago. ORDERS LESS THAN \$5.00—\$1.00 SERVICE CHARGE. CABLE ADDRESS: CONTULAB.

These prices supersede all previously advertised prices, subject to change without notice.

Teleron TV Wave Trap For VHF Channels 2 through 13. Clears VHF picture, stops interference at once, 30 seconds to attach—net **\$1.75**

UHF Tubular 300 Ohm Twin Lead 1,000 ft. \$34.50

100 ft. \$4.95

UHF WAVE TRAP Teleron printed circuit for channels 14-83 in UHF waveband, clearest picture—30 seconds to attach. net ea. **\$2.32**

Lafayette presents the **MIRACLE** **ALL-CHANNEL ANTENNA!**

22 Db gain
over tuned dipole!

motorless all-direction
ONE INSTALLATION FOR
UHF-VHF-FM
reception

World's Most Powerful TV Antenna

- Guaranteed 10 times more powerful than stacked 10 element Yagis.
- Receives channel 2-83 from all directions without a rotor.
- Broadband UHF-VHF and FM, motorless all direction reception.
- All aluminum flip-out assembly.

The only TV antenna that instantly beams the television set directly to the signal without a rotor. This antenna brings strong UHF & VHF signals from all directions to weak signal areas instantly... with a flick of the nine position switch located near the television set.

Approx. 300 Ohms between every two of the four conductors.

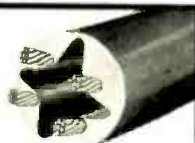

Four conductor air-dielectric, tubular, matched impedance transmission line.

4 Conductor Tubular Wire 10¢ per foot
\$8.90 per hundred feet

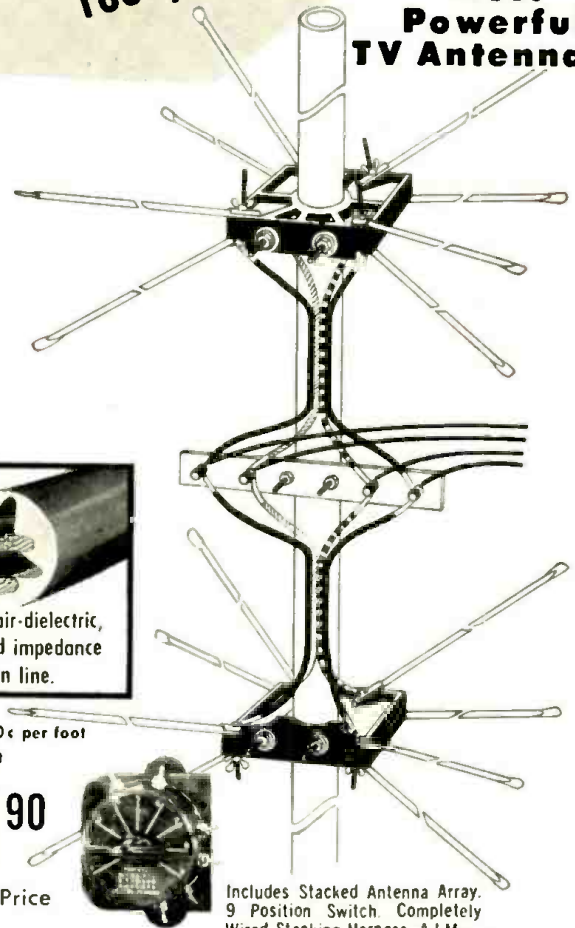

Includes Stacked Antenna Array, 9 Position Switch, Completely Wired Stacking Harness, A.I.M.—Automatic Impedance Matching Coupler.

\$21⁹⁰

Dealer Price

LIST PRICE **\$36⁵⁰**

Mfg. solely by

ALL CHANNEL ANTENNA CORP.

Woodside, N.Y. under license Pat. No's 2,585,670.
2,609,503. 2,625,655. others pending.

MONEY BACK GUARANTEE To out-perform all other antennas (using rotor motors) on both UHF and VHF, including stacked ten element Yagis, stacked corner and bow-tie reflectors, four bay conicals, etc.

WRITE FOR FREE CATALOG

Lafayette Radio

NEW YORK, N.Y.	100 Sixth Ave.
BRONX, N.Y.	542 E. Fordham Rd
NEWARK, N.J.	24 Central Ave.
PLAINFIELD, N.J.	139 West 2nd St.
BOSTON, MASS.	110 Federal St.

Lafayette Radio 100 Sixth Ave. NEW YORK 13, N. Y.

Please send me..... amount at \$36.50 list price.
Please send me..... amount at \$21.90 dealer net.
Dealers order on letterhead.
Please send me..... feet of 4 conductor tubular at 10¢ per foot.

Name.....
Address.....
City..... State.....

Check Enclosed Money Order Enclosed
 C.O.D. enclosed please find 25% of total purchase price... check... Money Order.
 Please put my name on your "Special Bargain" mailing list.

() Enclosed find \$..... in full. Send prepaid

Mac's Service Shop
(Continued from page 68)

absolutely impossible with the older instruments.

"For instance, a scope with a ten-millivolt sensitivity will produce an inch-high trace with only one one-hundredth of a volt r.m.s. applied to the vertical amplifier. That means it is many times more sensitive than the a.c. meters usually found around a service shop. A very tiny voltage, such as that put out by a crystal microphone, is more than sufficient to drive the trace beyond the limits of the screen. In working on an amplifier, such a scope can be used to trace the signal from the input to the output.

"And high-frequency waveforms can be examined as easily with our modern scope, that has a sweep generator going up to 100,000 cycles, as could the line voltage sine wave with the older instruments. You proved that the other day when you were looking at the r.f. waveform put out by our signal generator. Even when the generator was working at several hundred kilocycles you were able to display just a few cycles on the screen."

"Yes," Barney broke in, "and I remember your using that scope to show George what was wrong with his sweep generator when he kept hollering because when he lined up a set with the sweep generator so that the response curve of the i.f.'s looked perfect, the set would not work right, and when he looked at the i.f. pass-band curve of a set that was OK, the curve bore no resemblance to anything living or dead. You put the crystal probe on the scope and looked at the voltage produced across the output of the signal generator while the wide sweep was being used and found a bad hump in the output around twenty-four megacycles because of a wrong terminating resistor. When George adjusted the i.f. trimmers so that this hump did not show, he was actually producing a deep dip in the true response curve at the hump frequency. You could not have made this test with an insensitive scope."

"You get the idea," Mac complimented him. "Technicians should remember that service instruments are like little girls; they grow up and often improve greatly, and just because you were acquainted with one away-back-when is no sign that you would even recognize an up-to-date version."

"Yeah man!" Barney said with the enthusiasm he always displayed when the subject of girls was mentioned. "Not to change the subject, though, what is that new little shelf for over there in the corner?"

"You're not changing the subject," Mac said with a grin. "That is for our 'new' second-hand test instrument: a small communications receiver."

"And that is a test instrument?" Barney marvelled.

SIMPSON MODEL 480 GENESCOPE FOR ACCURATE TESTING

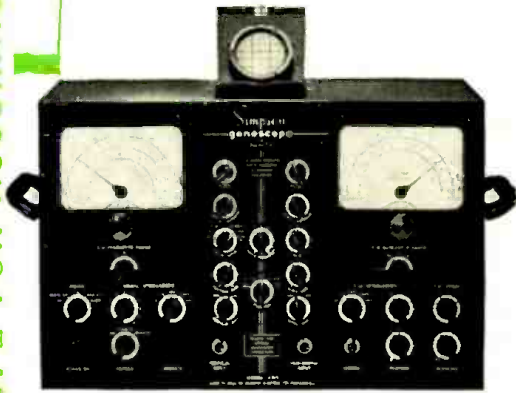

- All the necessary signal sources for alignment of FM and TV receivers • Includes the Simpson High Sensitivity Oscilloscope and high frequency crystal probe for signal tracing • Independent, continuously variable attenuators and step attenuators for both AM and FM units offer complete control of output at all times • 0-15 megacycle sweep is provided by a noiseless specially designed sweep motor based on D'Arsonval meter movement principles • The exclusive Simpson output cable (illustrated) includes a variable termination network, quickly adapted to provide open, 75 or 300 ohm terminations — the addition of a pad provides attenuation and isolation. Use of appropriate resistors across certain terminals will provide any other termination required. A .002 MFD blocking condenser can be added on any termination for use on circuits containing a DC component • The FM generator output voltage is constant within .2 DB per MC of sweep.

dealer's net \$475.00

BURTON BROWNE ADVERTISING

approved by
service managers of:

admiral

zenith

motorola

emerson

hoffman

hallicrafters

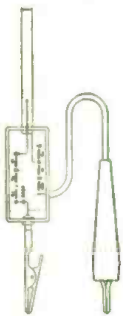

SIMPSON ELECTRIC COMPANY

5200 W. Kinzie St., Chicago 44, Illinois • Phone: EStebrook 9-1121 • In Canada, Bach-Simpson, Ltd., London, Ont.

GET INTO ELECTRONICS



You can enter this uncrowded, interesting field. Defense expansion, new developments demand trained specialists. Study all phases radio & electronics theory and practice: TV; FM; broadcasting; servicing; aviation, marine, police radio. 18-month course. Graduates in demand by major companies. U.S. or equivalent required. Begin Jan., March, June, Sept. Camous life. Write for catalog.

VALPARAISO TECHNICAL INSTITUTE
Dept. RD Valparaiso, Indiana

PEN-OSCIL-LITE

Extremely convenient test oscillator for all radio servicing; alignment • Small as a pen • Self powered • Range from 700 cycles audio to over 600 megacycles u.f. • Output from zero to 125 v. • Low in cost • Used by Signal Corps • Write for information.

GENERAL TEST EQUIPMENT
38 Argyle Buffalo 22, N. Y.

SCHEMATICS—CONVERSIONS FOR SURPLUS GEAR

NEW LIST! MANY ADDITIONS!

Send stamped, self addressed envelope for List C. Add 25c for chart explaining AN nomenclature.

R. E. BOX 1220
GOODHEART BEVERLY HILLS, CAL.

For opportunities within your reach

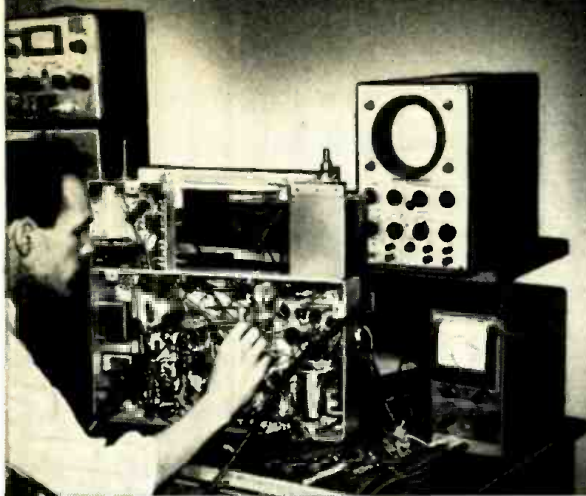

See what the RCA TV Servicing Course offers you

Good-pay jobs. A business of your own.

OPPORTUNITIES FOR GOOD-PAY JOBS in Television are within your reach when you study TV Servicing by the RCA Institutes Home Study Method. Or perhaps you would like to start a TV Service business of your own.

If you are not satisfied with the way your future now stacks up, see how easily

you can change the course of your career. RCA Institutes Home Study Course in TV Servicing is helping thousands of other people to better jobs. It can help you. Right now thousands of opportunities are going begging. There is a critical shortage of trained TV servicemen. This is *your* big opportunity.

Easy-to-understand, illustrated lessons



The entire course is divided into ten units of several individual lessons. You study them at home in your spare time.

Lesson-by-lesson you learn the theory and step-by-step procedures of installing TV antennas, of servicing and trouble-shooting TV receivers. Hundreds of pictures and diagrams help you understand the how-it-works information and the how-to-do-it techniques. You will be amazed how easily you absorb the knowledge of each lesson, how quickly you train yourself to become an experienced technician.

RCA Institutes conducts a resident school in New York City offering day and evening courses in Radio and TV Servicing, Radio Code and Radio Operating, Radio Broadcasting, Advanced Technology. Write for free catalog on resident courses.

Experienced engineers and faculty prepared the course, grade your lessons



The RCA Institutes course was written and planned by instructors with years of specialized

experience in training men by home-study and resident-school methods. The course embodies RCA's background of television experience plus knowledge gained in training several thousand technicians. A study of the course parallels an apprentice's training. Your lessons are carefully examined and accurately graded by friendly teachers who are interested in helping you to succeed.

One of the leading and oldest Radio-Television training schools



Founded in 1909, RCA Institutes, Inc. has been in continuous operation for the past 44 years. Its wide experience and extensive educational facilities give students, just like you, unsurpassed technical training in the highly specialized field of radio-television-electronics.

RCA Institutes is licensed by the University of the State of New York . . . an affiliate member of the American Society for Engineering Education . . . approved by the Veterans Administration . . . approved by leading Radio-Television Service Organizations.

It costs so little to gain so much

RCA Institutes makes it easy for you to take advantage of the big opportunities in TV Servicing. The cost of the TV Servicing Home Study Course has been cut to a minimum. You pay for the course on a pay-as-you-learn unit lesson basis. No other home study course in TV Servicing offers so much for so little cost to you.

SEND FOR FREE BOOKLET—Mail the coupon—today. Get complete information on the RCA INSTITUTES Home Study Course in Television Servicing. Booklet gives you a general outline of the course by units. See how this practical home study course trains you quickly, easily. Mail coupon in envelope or paste on postal card.



MAIL COUPON NOW!

RCA INSTITUTES, INC., Home Study Dept. RN653
350 West Fourth Street, New York 14, N.Y.

Without obligation on my part, please send me copy of booklet "RCA INSTITUTES Home Study Course in TELEVISION SERVICING." (No salesman will call.)

Name _____ (please print)

Address _____

City _____ Zone _____ State _____



RCA INSTITUTES, INC.
A SERVICE OF RADIO CORPORATION of AMERICA
350 WEST FOURTH STREET, NEW YORK 14, N.Y.

The C-800 is here
to bring you new
record performance!

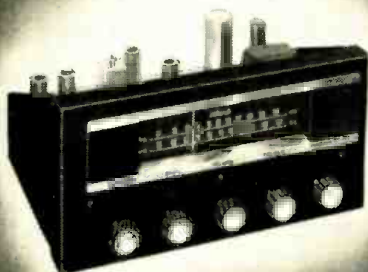

the new
craftsmen 800
FM-AM TUNER

with built-in phono
preamplifier and
record equalizer

Now—Craftsmen brings you a tuner that matches all your finest records... is setting new records for versatility, too. The C-800 is further evidence that Craftsman leadership in high fidelity is something you can put your finger on, something you can hear.

- Front-panel-selected equalization for AES, LP or EUROPEAN recording characteristics. Inverse feedback compensated dual-tri-diode phono preamp for correct turnover and roll-off characteristics.
- Improved AM reception. Wider bandwidth for better fidelity, and sharper IF bandpass "skirts" for greater selectivity.
- Double-shadow tuning eye and AFC (no drift) on FM simplifies tuning. Front-panel AFC cut-out for tuning weak stations.
- Efficient new layout. Bottom plate, completely shielded chassis minimize oscillator radiation, assure tuner isolation.
- Cathode follower audio output for remote installations; 2 volts at less than 1/2% dist. Detector output also has cathode follower for recording applications.
- Bass and treble controls continuously variable from attenuation to boost—flat position clearly marked. Selector positions: FM, FM with AFC, AM, TV, LP, AES, EUR, and SPARE.
- Mahogany-finish wood cabinet available.

HIGH FIDELITY — LOW COST! C-800 audio amplifier offers 10 watts \pm 1 db., 15—20,000 cps., less than 1% distortion. New streamlined chassis design.



Write today for information
THE RADIO
craftsmen INC.
Dept. R-6, 4401 N. Ravenswood Ave.
Chicago 40, Ill.

"It will be as we use it. In the first place the good engineering and the complete shielding of the set will make it an 'ideal' broadcast receiver with which we can compare house receivers we work on. When we want to know if a certain noise or interference is originating outside of the set, a quick check with this communications job will tell us. Then, too, you will notice the small coaxial cable that runs from the bench over to the set and can be either connected to the antenna terminals or to the plug in the 'phones' jack. That enables us to run a signal from the bench into the receiver or a signal from the receiver back to the bench."

"What's the good of that?"

"The bench-to-receiver connection will allow us to check our r.f. generators for accuracy whenever we wish. For rough checks, we can flip on the receiver's beat-frequency-oscillator so we can hear the generator output and depend upon the dial calibration itself, which will be plenty good enough for most of our uses. When we want

really accurate checks, we can tune in WWV on 2.5, 5, 10, 15, 20, 25, 30, or 35 megacycles—the receiver tunes from 540 kc. to forty megacycles—and then beat either generator fundamentals or harmonics against the standard frequency stations to produce checks on almost any frequency we want.

"When the receiver-to-bench connection is in use, we can use the 440 and 600 cycle tone modulation of WWV to check our audio generator by comparing its output with these standard frequencies when the two outputs are combined in Lissajous figures on the scope."

"Yeah, and if a customer wants to hear his set before he pays for it, and if someone in the neighborhood happens to be running an electric drill at that particular moment, we can prove to him that the noise is not just in his set," Barney pointed out.

"And of course," Mac remarked, "it will come in mighty handy for picking up the ball games—but of course you would never think of that."

"Of course not," Barney agreed. —30—

Preamp-Equalizer
(Continued from page 46)

ma., a dry disc rectifier supply with a 7.5 volt transformer, as shown in Fig. 4A is most applicable when d.c. is required. The remaining heaters should not be operated from the d.c. side of the supply as the ripple would substantially increase. An alternative, shown in Fig. 4B, may appeal to some experimenters. 12AU6's can be series operated from a 150 ma. source if this type is used instead of the 6U8.

Construction

An infrequently used method of construction is shown in the accompanying illustrations. This method greatly facilitates wiring and maintenance as well as ensuring a professional appearance. Along with many others, the writer experiences as much, if not greater, satisfaction from the building process as from the performance of the completed unit. Even so, wiring

does become tedious and much thought was given to correcting some of the wiring and parts placement difficulties with a mechanical arrangement that permits simpler and more positive techniques. The sub-assembly method permits the bulk of the parts mounting and wiring to be negotiated in the open with a freedom uncommon to point-to-point chassis wiring.

The writer wishes to thank the many persons who have expressed their interest in the preamplifiers heretofore described and who have offered suggestions for their improvement.

Special gratitude is offered to Mr. Uolevi Lahti of Ann Arbor, Michigan, whose unusual interest and activity in the high fidelity sound reproduction field has made possible the many listening tests and inspiration resulting in the unit described in this article.

REFERENCES

1. Rose, Arthur J.: "Front End Control Unit for Williamson Amplifier." RADIO & TELEVISION NEWS, June 1952.
2. Read, Oliver: "The Recording and Reproduction of Sound." Howard W. Sams & Co., Inc., Indianapolis. Page 478. —30—

Fig. 5. Response of bass and treble controls. Curves closely approach their theoretical counterpart because of ideal circuit conditions. See discussion.

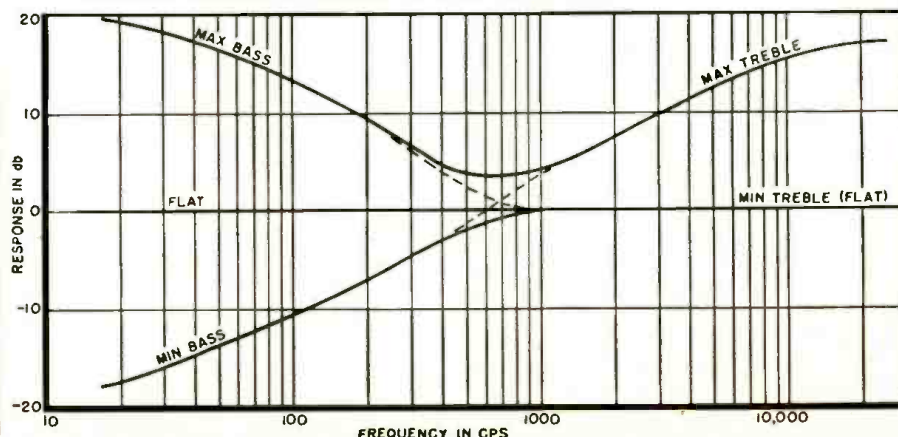

Noise Immunity Circuits (Continued from page 55)

nal. Thus, this system can adapt itself to both weak and strong signals, as required.

Bendix Circuit

Bendix TV receivers have a noise suppressor system which attacks the problem from still another angle. The entire circuit revolves about a twin-triode 12AT7. See Fig. 4. The first section, V_1 , actually is placed in shunt with the screen dropping resistor, R_1 , of the video output amplifier, V_1 . The bias for V_1 is established by the voltage divider network R_2 (22,000 ohms), R_3 (100,000 ohms), and R_4 (a 10,000-ohm potentiometer). The cathode of V_1 connects directly to the screen grid of the video amplifier and since the screen grid is not bypassed to ground, a certain amount of voltage variation will occur across R_1 as the signal changes. The bias chosen for the grid of V_1 will permit this tube to conduct varying amounts depending upon the signal reaching the cathode of V_1 . This, in turn, will vary V_1 's shunting effect on R_1 with the net result that the voltage at the screen grid of V_1 will remain fairly constant until a strong noise pulse comes along.

Also coupled to the screen grid of V_1 is the grid of V_2 . This is accomplished through C_1 , a 5000 μ fd. condenser. V_2 will therefore receive the voltage variations present at the screen grid of V_1 , but its cathode voltage has a sufficiently high positive voltage so that V_2 is normally non-conductive. R_4 , the noise inverter control, establishes the positive voltage of the cathode.

The circuit is now set for the arrival of a strong noise pulse and when this occurs, it drives V_1 sharply into cut-off. (Sync pulse polarity at the grid of V_1 is negative.) This allows

Fig. 4. Noise suppressor circuit used by Bendix in its models OAK3, 21K3, 21KD, 21T3, and 21X3 television receivers.

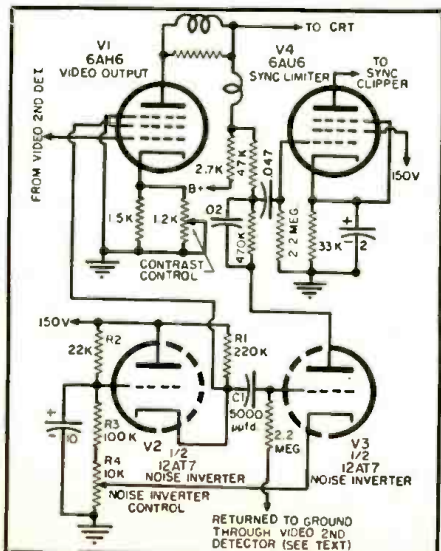

ANNOUNCING THE NEWEST, MOST ADVANCED MOBILE RADIO EQUIPMENT EVER DESIGNED!

Now being made by Platt Manufacturing Corp. Get all the facts. Write for illustrated catalog sheets today!



Special-of-the-Month! Radio City Products Model 449

VOLTOHMMETER

5000 ohms per volt, AC-DC output, 1000 V. Ohmmeter up to 2 megohms. In metal case with zero adjusting knob on front panel. Ready for use. (List Price \$24.95)

OUR SPECIAL PRICE \$9.95

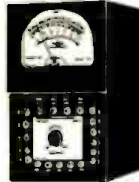

ELECTRIC MEGAPHONE SYSTEM



For Rural Areas, Hotels, Commercial Steamers, Ball Parks, Etc.

U. S. NAVY Type PA-1 Electric Megaphone equipment is designed for voice reinforcement in much the same manner as, but to a greater degree than, the familiar acoustic megaphone. Consists of Megaphone Unit which combines a microphone and reproducer in a single assembly. Portable Amplifier which electrically amplifies the output signal of the microphone section of the megaphone and feeds this amplified signal to the reproducer section. Charging Rack for recharging the self-contained storage battery of the portable amplifier. BRAND NEW & THEMENOS VALUABLE DEMONSTRATION GIVEN AT EITHER OF THE PLATT'S STORES \$149.50

HEADSETS

HS-23 Hi-imp. impedance. BRAND NEW with ear pads. \$5.95
HS-23 Low impedance. BRAND NEW with ear pads, cord and PL-4 plug. BRAND NEW—Western \$6.45
HS-23—Electric. BRAND NEW—Western \$7.25
CD-107A Cords, 6 ft. NEW \$1.49
H-10 U high impedance. Includes two receive. units. \$3.95
HS-16 High impedance—used. \$1.98



ARC-5/R-28 2 MTR RCVR \$25.95

Here is the 2-meter superhet you have been looking for! Absolutely one of the BEST available today! Tunes from 100 to 150 Mc. in four crystal channels. (Easily converted to continuous tuning.) Tube lineup is as follows:
717A—R.F., 717A—Mixer, 2-12SH7—1st and 2nd I.F. 10.9 Mc.,
12SL7—Det., AVC Spuetic, 12SL7—1st audio-spuetic amplifier,
12A6—2nd audio, 12SH7—R.F. Osc.—4th Harmonic Gen.
717A—Trip, 12th Harmonic Gen. 717A—Dbl.—12th Harmonic.
Excellent, used \$25.95

MN-26C INSTALLATION



A 12 tube remote control manual direction finder desirable for commercial type navigation on boats and planes. Has a frequency range of 150 kc to 1500 kc in 3 bands. This frequency covers the beacon and standard broadcast bands. Operates on 28 V DC input. Complete installation consists of:

MN-26C Receiver—Brand New \$39.95
MN20E Rotable Loop \$9.95
MN28 Remote Control Unit \$19.95
2 Flex. Shunt \$7.00
1 Antenna Cable \$3.95
2 Plugs \$5.00
1 MN52 Azimuth Control Box \$3.95

SPECIAL! Complete Installation \$79.95 (You save \$9.80)

MINIMUM ORDER \$2.00
Immediate Delivery—Send 25% deposit on C.O.D. orders. All shipments F.O.B., N.Y.C. (N.Y.C. residents add sales tax to your remittance.)

TUBES BRAND NEW! JAN! BOXED! TUBES

1B22	.69c	39/44	.29c	89B	.39c
1B23	\$.375	100B	.49c	8A1	.29c
2C26	.49c	114B	.29c	8A3	.17c
2C26A	.09c	21A	.09c	8A4	.19c
3C22	\$1.19	304TH	\$5.95	102B	.19c
3D6	.19c	318A	.29c	316A	.19c
7C4	.39c	388A	.59c	9002	.69c
10Y	.99c	471A	\$1.19	E1148	.49c
12K8Y	.39c	532A	\$1.19	RR34	.99c
15H	.39c	722A	.99c	VR92	.14c
		801A	.19c	VT127	15c



RECEIVERS USED EXCELLENT USED NEW
BC-453—190 to 550 KC \$29.95 \$49.95
BC-454—3 to 6 MC 24.95
BC-455—6 to 9 MC \$13.95 19.95
1.5 to 3 34.95

TRANSMITTERS
A-95B—2.1 to 3 MC 29.95
BC-457—4 to 5.3 MC 14.95
BC-458—5.3 to 7 MC 7.95 9.95 17.95
ARC5-T-19—3 to 4 MC 24.95 34.95
BC-459—7 to 9.1 MC 24.95 24.95
T-15 ARC 5—500 to 800 KC 29.95

ADDITIONAL EQUIPMENT
BC-456 Modulator 7.29
BC-450 Control Box (3 Receiver) 1.49 1.95 2.75
BC-451 Control Box (Transmitter) 1.29 1.79 2.39
BC-412 Relay Unit (AMT) 5.69
Plugs, PL-147, 148, 151, 152, 153, 154, 156—EACH 1.25
Flexible Shafting with gear to fit receivers 2.69
3 Receiver Rack 1.79 2.29 2.98
2 Transmitter Rack 1.69 2.39 3.97
Single Transmitter Rack 3.97
DM-33 Dynamotor for Command Set 2.95 3.95
Mounts for 2 Trans. Rack, 3 Rec. Rack, Modulator, & Antenna Relay Unit 1.95

BEACON RECEIVER

BC-1206

Frequency Range—195 KC to 420 KC. IF Frequency—125 KC. Receiver Sensitivity—3 Microvolts for 10 Milliwatts output. Output Impedance—500 Ohms and 400 Ohms to be selected internally. Power Output—250 Milliwatts. Volume Control—10 Gain Control. Power Supply—24-28 Volts Acropilare Battery. Current—75 Amperes. BRAND NEW—ONLY \$16.95



PRE-AMPLIFIER MODEL K-1
The K-1 is used to amplify output level for microphones and phonographs. Operates on 24-28 VDC. can be converted to 110 AC. Comes complete with PL 55 plug and 2-foot 119-B cord. 2 terminal blocks and instruction book. BRAND NEW... SPECIAL! \$3.95



FL-8 RADIO FILTER

Range of Voice for 1020 cycles. Audio switch mounted on Filter. Excellent for CW. Brand New... SENSATIONALLY PRICED AT ONLY \$1.79
FL-5 Radio Filter—\$1.29

TURBO AMPLIFIER

4 tube Amplifier used by U. S. Air Force. 115 V. input at 400 cycles. Without tubes—EXCELLENT. \$1.19

BC-221 Frequency Meter

Real Value! QUANTITY IS LIMITED—so first come, first served. They are just like new, with original calibration charts. Range 125-20,000 KC with crystal check points in all ranges. Complete with crystal and tubes... \$129.50
MODULATED TYPE \$159.50
Power Supp. 179.50
These Frequency Meters are factory tested, checked for frequency alignment and GUARANTEED.



ARMY TEST UNIT 1-236
Meter is contained in a metal box 5 1/2" long x 3 1/2" wide x 3 1/4" deep. Comes complete with test leads and instruction book. Can be used for testing between AC and DC measuring resistance of circuits, checking fuses and testing capacitors. SPECIAL \$4.19

VISIT PLATT'S BRANCH STORE at 159 GREENWICH ST., N.Y.C. You'll find many bargains not listed here.

PLATT ELECTRONICS CORP.

DEPT. A, 489 BROOME ST., NEW YORK 13, N. Y.
PHONES: WO 4-0827 and WO 4-0828

YOU SAVE...

On These Audio Specials

AT NEWARK

1 NEWARK LOW-COST AMPLIFIER

Compact 8-watt amplifier using 2-6V6 or 6K6 push-pull output tubes. Employs 6SN7 as Audio Driver and Phase Inverter; 5Y3GT is rectifier. Response, 50 to 12,000 cycles. Has continuously variable tone and volume controls. Outlet for AC phono motor plug on back. Output impedance, 8 ohms. Chassis size, 6x8 1/2 x 5 3/8". 7 lbs. **81F000. NET..... 21.50**

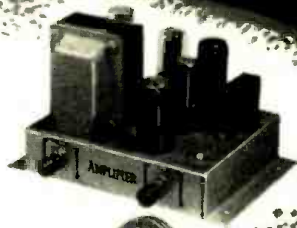

2 NEWARK COAXIAL SPEAKERS

Outstanding high-fidelity values! These low-cost speakers provide good high frequency response and bass reproduction. All have high-frequency tweeter unit and crossover network. Av. wt., 8 lbs.

83F994. 8" Speaker. Rated 6 watts. Has 2.15 oz. Alnico V magnet. Imped., 6 ohms. **NET..... 8.95**

83F995. 12" Speaker. Rated 12 watts. Has 10 oz. Alnico V Magnet. Imped., 8 ohms. **NET..... 12.95**

83F996. 15" Speaker. Rated 14 watts. Has 10 oz. Alnico V magnet. Imped., 8 ohms. **NET..... 19.95**



3 BRUSH BA-116 MIKE-PRICE REDUCED!

Originally sold for \$8.61! Now available, while quantities last, at the low, low price of \$5.95. This rugged microphone is ideal for tape recording, PA, or Amateur use. Response, 50 to 6,000 cycles. Output level, -53 db. High impedance. Shock-mounted, crystal cartridge. Has 3/8"-27 thread. Brown. Wt., 1 1/2 lbs. **54F350. Special..... 5.95**



Order from Dept. R-6

Save! Low Price!
WESTERN ELECTRIC
 MODEL 134-B-3 HEARING AID
 Regularly \$185.00 Now **2450**
 Brand new units, packed in original case. Complete with receiver, cord, battery cord less ear plug and batteries. Wt., 1 lb.
54G501. Special 24.50
BATTERIES FOR ABOVE
 49F124. Burgess 8R..... .23
 49F176. Burgess XX22..... 1.35

Send for Catalog

NEWARK
 ELECTRIC COMPANY

223 W. Madison St.

Chicago 6, Ill.

ARKAY

world's finest radio kits
 Write for free Brochure
 RADIO KITS, INC., 120 Cedar St., N. Y. 6

GET INTO TV SERVICING

Send for free 24-page illustrated booklet which tells you how to become a successful TV technician. America's leading TV servicing school offers you a specialized training program that omits non-essential math & design theory. You concentrate on radio & TV servicing only. You get professional training & experience right in our fully-equipped shops & laboratories. Send for this booklet today. Write Dept. R-63. No obligation—no salesman will call. Approved for Veterans.

WESTERN TELEVISION INSTITUTE
 341 W. 18th St. Los Angeles 15, Calif.

PAY LESS FOR TUBES

INDIVIDUALLY BOXED • FULLY TESTED • EACH TUBE GUARANTEED FOR SIX MONTHS

Type	Price	Type	Price	Type	Price	Type	Price
1B3GT	\$.69	6A55	\$.50	6K6GT	\$.41	12A27	\$.70
1H5GT	.46	6A76	.38	6L6C	.38	12BA6	.45
1L4	.57	6AUG	.43	6L6GA	.80	12BE6	.47
1N5GT	.57	6AV6	.38	6S4	.46	12BH7	.63
1R5	.56	6B4G	.96	6SA7GT	.52	12BZ7	.75
1S5	.47	6BA6	.45	6S7GT	.47	12SA7GT	.52
1T4	.56	6BC5	.53	6SK7GT	.50	12SK7GT	.50
1T5GT	.71	6BD5GT	.89	6SL7GT	.62	12SL7GT	.61
1X2	.67	6BE6	.47	6SN7GT	.54	12SN7GT	.54
3Q5GT	.65	6BF5	.60	6SQ7GT	.42	12S07GT	.44
354	.55	6BG6	1.34	6T8	.78	198G6	1.39
3V4	.56	6BH6	.57	6U8	.85	19C8	.94
5U4C	.43	6B16	.48	6V6GT	.46	19T8	.79
5W4C	.73	6BK7	1.10	6WA4GT	.45	25B06	.89
5Y3C	.34	6BL7	.83	6W6GT	.57	25L6GT	.48
5Y3GT	.30	6B06	.89	6X4	.34	25Z6GT	.42
6AB4	.46	6B07	1.10	6X5GT	.33	35A5	.48
6AF4	1.40	6BZ7	1.10	6Y6C	.59	35B5	.47
6AG5	.54	6C4	.34	7N7	.52	35C5	.47
6AK5	.95	6CB6	.53	12AT6	.38	35L6GT	.47
6AK6	.63	6CD6	1.85	12A7	.68	35W4	.31
6AL5	.40	6CF6GT	.45	12AU6	.43	35Z5GT	.30
6AN4	1.30	6H6GT	.49	12AV7	.38	50B5	.47
6AQ5	.46	6J5GT	.40	12AX7	.61	50C5	.47
6AQ6	.42	6J6	.62			50L6	.47
6AR5	.38					117Z3	.39
						117Z6	.68

Motorola Ballast Tube = 17A4K5459..... .30

Each tube is performance-proven. 25% deposit must accompany all orders. Balance C.O.D. All prices F.O.B., N.Y.C. If remittance is made with order, you can deduct 2%—\$1.00 handling charge for orders under \$10.00. Subject to Prior Sale. Importer Inquiries invited.

PHILLIPS TUBE COMPANY

2281 Nostrand Ave.
 BROOKLYN 10, N. Y.
 CLOverdale 3-8010-1-2

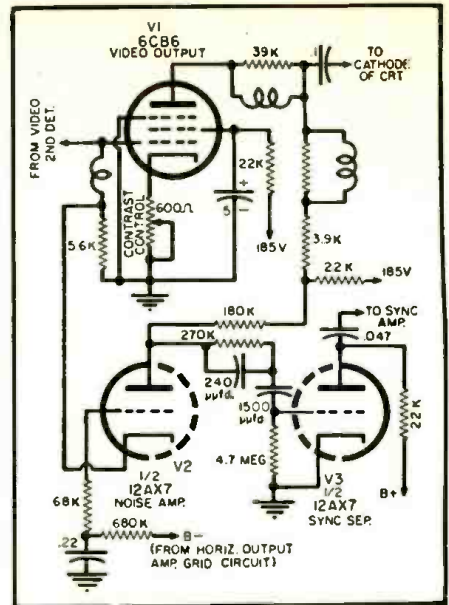

Fig. 5. Noise suppression circuit used by Magnavox. Noise pulses traveling through two paths to the sync separator grid meet there out-of-phase and cancel each other.

the voltage at the screen (and plate) of V_1 to rise sharply. The screen grid positive pulse, reaching V_2 , drives this tube into cut-off, removing its shunting effect and, in essence, raising the screen-grid potential still farther. The grid of V_3 also receives this positive pulse, bringing it sharply out of cut-off. The resulting negative pulse at the plate of V_3 combines with, and tends to cancel out, the positive noise pulse which is traveling from the plate of V_1 to the grid of V_3 , the sync limiter.

Thus, the circuit has achieved the basic goal of reducing and even preventing strong noise pulses from reaching the sync limiter.

The setting of the noise inverter control will determine when V_3 is brought out of cut-off. Too low a setting could result in picture instability because some of the sync pulses will be depressed or even removed. Too high a setting will prevent V_3 from acting except on extremely strong noise pulses. Hence the control must be set carefully to obtain full benefit from this system.

Part of the bias on V_3 is controlled automatically because the grid is returned to ground through the video detector circuit. Signal polarity in the video detector circuit is negative which means that the average negative voltage that the grid of V_3 receives will vary with signal strength. This merely means that it will require a stronger noise pulse to bring V_3 out of cut-off when the video signal is strong and a weaker pulse when the incoming signal is weak.

Magnavox Circuit

The versatility of vacuum tubes and the ingenuity of engineers result in an almost endless variety of circuits. A noise suppressor circuit developed by Magnavox is shown in Fig. 5. The noise amplifier, V_2 , is one-half of a 12AX7 which functions as a grounded-

Iraq—Baghdad, 6.135, noted 1415-1500 closedown with *English* session, "Date With Baghdad;" announces 11.724 as parallel. (Pearce, England)

Italy—Rome noted in *English* to Western North America 2145-2200 closedown on 9.57; announces 15.4, 11.9, 11.81, 9.71 in parallel. (Mesard, D. C.)

Japan—JKL, 9.603, noted 2120, fair in Ohio. (Arp)

Radio Japan, 7.180, noted 0600 with news, parallel 9.675; JKM, 4.940, noted 0510 with news and *English* lesson. (Sanderson, Australia) Now heard to Western North America over 11.705 (best) and 15.135 at 0000-0100. (Gay, Calif.) *Radio Japan* hopes to extend broadcasts later this year to Europe (French, German) and to Brazil. (WRH)

Kenya Colony—Nairobi, 4.855, takes BBC news relay 1300. (Pearce, England) Good level in Australia 1430. (Sanderson) FBS, 7.265, Nairobi, signs off 1500 but signal is erratic. (N. Z. DX Times)

Kuwait—"Huna Kuwait," 5.000, noted in Arabic 1330. (Pearce, Catch, England)

Liberia—ELBC, now 6.022A, Monrovia, is scheduled 1045-1845. (ISWC, London) Heard one Sun. until after 2000. (Saylor, Va.)

Luxembourg—Radio Luxembourg will shortly have a new 50 kw. transmitter in operation. (WRH)

Malaya—BFES, Singapore, noted on 11.955 at 0945 with BBC relay. (Pearce, England) On 7.120 around 0630 with native program, *English* announcements. ((Saylor, Va., others) *Radio Malaya*, noted in *English* 0945, good level. (Riggs, Calif.) Over 6.135 at 0600, fair level in N. J. (Washington) Kuala Lumpur, 6.025, has BBC news relay 0600. (Riggle, Ohio)

Mexico—Despite persistent overseas reports that the Mexican on 15.205A is an outlet of "La Voz de Mexico" (XEXE), it really is—and always has been—XESC (relaying m.w. XEMC) and its slogan sounds like "Heraldos de la Tela de Junco." Announcements do not indicate any affiliation with "La Voz de Mexico." (Stark, Texas, others) XEUW, 6.020, Vera Cruz, noted to 0042 recently. (Patterson, Ga.)

Monaco—Calls of *Radio Monte Carlo* are 3AM3, 6.035; 3AM4, 7.349. (WRH)

Mozambique—Portuguese outlet, 4.870, noted 1200 with chimes, closing 1514 with "A Portuguesa." (Pearce, England)

Laurenco Marques good lately in *English* session weekdays 2300-0030 on 9.766A. (Riggs, Calif.; Norman, N. C., others) Sundays at 0000-0100, fair level. (Balbi, Calif.) Noted parallel over CR7BU, 4.916, and on 3.490 (has QRM). (Washington, N. J.)

New Zealand—Revised schedules are to Australia 1300-1645, ZL7, 6.080; 1700-0045, ZL3, 11.780; 0100-0545, ZL7, 6.080. To Pacific Islands 1300-1645, ZL8, 9.62; 1700-0045, ZL9, 11.810; 0100-0545, ZL8, 9.620; closedown is 0545 weekdays, 0620 Sat., 0500 Sun.

Nicaragua—*Radio Sport*, 7.850A, is strong with Spanish 1800-2200. (Dexter, Iowa)

Nigeria—*Radio Nigeria*, Lagos, noted on 4.800A to 1500 closedown; BBC news relay 1300. (Pearce, Catch, England)

Outer Mongolia—Ulan-Bator is now heard on 6.328A from around 0400 to closedown 1000. (Japanese Short Wave Club)

Pakistan—*Radio Pakistan* has news 2130 over 15.335, 11.845. (Radio Australia) Noted with news 1015 over 9.484, 11.885. (Pearce, England) Heard on 11.885 with Home Service 1915, on 17.750 at 2315; 11.674 noted with news 0645; 15.335 has news 1930; noted parallel 1430-1600 over 6.235, 7.010.

Panama—HO50, 5.996, noted in Australia 0645 with Spanish news, music. (Sanderson)

Peru—OAX6E, *Radio Continental*, Arequipa, noted back on 6.336A from 6.305; news in Spanish 2015; weak. CWYRM. (Mercier, France) OAX4X, 15.105, Lima *Radio El Sol*, is fair around 1645. (Niblack, Ind.)

Philippines—DZH3, 9.500, *Radio Philippines*, now uses 1 kw., 1600-1000. (ISWL, England) *Radio Free Asia* relay over DZ15, 11.940, Manila, is strong in Britain with news 0950, off 1014A. (Pearce) DZH9, 11.855, Manila, noted recently with special program (*English*) at 1000 to USA. (Pearce, England; Riggs, Calif., others)

Portugal—*Radio Nacional*, Lisbon,

STANCOR *Exact* REPLACEMENT

FLYBACK TRANSFORMERS

A-8135—Replaces Admiral #79D41-1 and #79D41-2 in over 500,000 sets. For all 19" and 21" sets built since early 1951 and for current production.

A-8132—Replaces Muntz #TO-0031; used in 1951 and 1952 production. Covers approximately 300,000 Muntz sets.

A-8136—Replaces Philharmonic #80-263, #80-265-2 and #80-265. Used in all sets built since early 1951 including AMC, Pothe, Silvertone, and other "private label" sets.

Ask your distributor for Stancor bulletins 461 and 465, listing replacement applications of these transformers—or write directly to Stancor for your free copy.

Stancor Transformers are listed in Howard W. Sams' Photofact Folders, John W. Rider's Tek-Files, and the Howard Company's Counterfacts.

STANDARD TRANSFORMER CORPORATION

3584 ELSTON AVENUE • CHICAGO 18, ILLINOIS

EXPORT SALES—
Roburn Agencies, Inc., 39 Warren St., New York 7, N.Y.

Yes . . . of course Radio Receptor Co.
is producing . . .



The taper of the diode case allows polarity identification at a glance or at a touch thus speeding up assembly and reducing the possibility of error in connecting the diode into the circuit.

Featuring
polarity at
a glance!

current ↑
flow ↑

- | | |
|---------------------------|--|
| 1N72
Germanium | Noise figure as a mixer better than 15DB @ 750 MC with 43.5 MC-IF circuit having a noise bandwidth of 3 MC and a noise figure of 4 DB. |
| 1N82
Silicon | Noise figure as a mixer better than 12DB @ 750 MC with 43.5 MC-IF circuit having a noise bandwidth of 3 MC and a noise figure of 4 DB. |
| 1N110
Germanium | Noise figure as a mixer better than 12DB @ 750 MC with 43.5 MC-IF circuit having a noise bandwidth of 3 MC and a noise figure of 4 DB. |

Radio Receptor Co. is one of the major producers of Standard Germanium Diodes, Germanium Transistors and Seletron Selenium Rectifiers for radio, TV and other electronic circuits. Write for information!

SELETRON & GERMANIUM DIVISION

RADIO RECEPTOR COMPANY, Inc.

RR Since 1922 in Radio and Electronics RR

SALES DEPARTMENT: 251 WEST 19TH STREET • NEW YORK 11, N. Y.
FACTORY: 84 NORTH 9TH STREET • BROOKLYN 11, N. Y.



For a Heavenly Soldering Job, Insist on

Ungar's little Angels

Need we say more?

Write for Catalog RN-6

Ungar ELECTRIC TOOLS, INC., Box 312, Venice, Calif.

has been asking for reports on its North American frequencies of 5.976, 6.373, 9.746 at 1900-2100. (Boepple, Ohio)
Portuguese Guinea—CQM, 5.838, Bissau, noted 1650 with news in Portuguese. (de Mesquita e Sousa, Portugal)
Portuguese India—Radio Goa, 9.610, often carries "Bringing Christ to the Nations" (*English*) 1030. (Svensson, Sweden) Lists transmitters in the 31-, 49-, and 85-m. bands (probably 9.610, 6.025, 3.425), daily 2030-1130.
Reunion—Lists channels of 4.820, 7.170; heard on 4.820 at 0900-1310 (to 1345 Wed., Sat.) (Ridgeway, South Africa)

Roumania—Bucharest, 9.254, noted 1600-1645, poor level in Pa. (Black)

Saudi-Arabia—Djeddah noted around 2250 in Arabic over 6.102A parallel 7.200A. (Washington, N. J.)

South Africa—SABC, Johannesburg, noted closing 1130 on 11.937; reopening 1145 on 9.595A. (Pearce, England) Heard closing on 9.595A channel 1505. (Bellington, N. Y.) Heard in Britain on 4.895 from 1430. (URDXC)

South Korea—HLKA, 7.935A, Pusan, noted opening 0257, weak. (Gay, Calif.) HLKB, 9.555, Seoul, is scheduled 2130-0030, 0500-0900, 1600-1830. (ISWC, London) Noted by Sanderson, Australia, 0400 with Korean news, then Western music.

Spain—Radio Merida is now near 7.140 to 1800 close-down. (Pearce, England) Malaga, 6.979, good level 1335. (Catch, England) Madrid, 15.625, closes 1155 with anthem. (NNRC)

Syria—Damascus, 17.865, noted in *English* 1000-1045 to India-Pakistan. (Svensson, Sweden)

Switzerland—Berne, 9.655, noted with *English* for Western Europe 1345-1430; in Italian 1430. (Morrison, R. I.) Heard at good level on 6.165 to North America 2030-2115 and later. (Carroll, Me.)

Taiwan—BED6, 11.735, Taipeh, heard 2315 with news; BED32, 9.778A, noted 0500 with Western music, Chinese news; BED7, 7.130A, heard 0700 with Western music; BED26, 10.080, noted 1745, fair level in Chinese news, music. (Sanderson, Australia)

Tangier—Although *Radio International*, 6 110, is now using its new 50 kw. transmitter, signals are still badly QRM'd and detailed reports are requested to 34, Rue Goya, Tanger. QSL's will be accompanied by photo of new transmitter. (*Radio Amateur*, London)

Thailand—Bangkok, 11.910, noted with news 0500, on 6.240 with news 0615. (Sanderson, Australia) Heard over 7.105 at 0643, weak, native. (Ballou, Calif.)

Trinidad—Radio Trinidad, 9.625, noted with news 0700, BBC news 0800. (Saylor, Harold, Wisc., others)

Turkey—Ankara, 17.825, noted closing *English* for Far East 0915; opens 0830. (Pearce, England) TAS, 7.285, heard closing *English* 1645. (Harris, Mass.) Teknik University, Istanbul, 7.030, is good strength in Britain 1315-1500. (*Short Wave Listener*, England)

Uruguay—CXA19, 11.835, Montevideo, fair around 1700.

USI (Indonesia)—"Voice of Indonesia," 9.710, Djakarta, noted 0930-1030 in *English* to Southeast Asia; announces 4.910 parallel; heard over 11.770 at 1400-1500 to Europe, New Zealand; news 1430. (Pearce, England) With news 0615. (Sanderson, Australia) Makassar, measured 9.550, noted 0520, fair level, swishing QRN. (Ballou, Calif.)

USSR—Khabarovsk, 5.940, noted 0420, fair level, nice music; Alma Ata, 9.380, heard 0820, fair. Moscow noted opening to North America in *English* 1820 on 7.24. (Bullock, Duddy, Ind.)

Venezuela—Radio Rumbos, 4.970, Caracas, fair with news 1845. (Maynard, Ky., Richmond, N. Y., others) YVMS, 4.850, Barquisimeto, noted 2109-2130; CWQRM, YVKF, 4.880, heard 2350-0012. (Patterson, Ga.)

Yugoslavia—Radio Yugoslavia, Box 97, Belgrade, tested recently to the Americas 2030-2130 on channels of 6.100, 9.505, 7.200, 11.735; by this time probably will have settled down on one or more of these outlets. (Bellington, N. Y., others)

* * *

Press Time Flashes

Myron Smith, N. Y., reports a station announcing as "Radio Germany," broadcasting from Berlin, at 1300 with *English* on about 9.800.

RADIO & TELEVISION NEWS

VL7, Port Moresby, British New Guinea, by this time will have vacated 9.520 and 7.280 in favor of 6.130; schedule is VL7 6.130. Sat. to Wed. 1545-1745; Thur. 1545-1730; Fri. 1645-2000; Sun.-Thur. 2100-2245, 0100-0745; Fri. 2100-0800; Sat. 2100-2300, 0100-0700.

Radio Peking, China, lists English for 1730-1800, 6.100, 7.500, 9.040, 10.260, 11.690, 15.060, 15.170; 0400-0430, 6.100, 10.260, 11.690, 5.060; 0830-0900, 11.690, 15.060. (Boepple, Ohio)

TGWA, Guatemala, now has "The Belize Program" (English) one hour earlier—1800-1900 on 9.760 on Mon., Wed., Fri. only; TGNA is now heard to 2200 in Spanish on 5.9525; 2200-2300 (Sun. to 2330) uses 5.9525 and 9.668 for English session. (West, Va.)

The French-speaking station on 9.430A at 1745-2000 appears to be "Ici Basse Terre, Radiodiffusion Française," Guadeloupe; has much CWQRM and some QRM from Brazzaville on 9.440. Frequency varies around measured 9.4353. (Rastorfer, N. Y.; Niblack, Ind.; Washington, N. J., others)

Suva, Fiji Islands, noted back on 5.995 (varies), closing 0500 with "God Save the Queen;" relays ABC news from Australia 0400. (Saylor, Va., Rosenauer, Calif.)

A new Costa Rican has been heard on 6.008 announcing "Emisoras de Radio Cristal en San Jose," heard 2030-2200 at good strength; call seems THV, m.w., and TIHVC, s.w.; commercials. ZPA3, Radio Teleco en Asuncion, 11.853A, Paraguay, noted opening 1700 with news in Spanish; on Tue. has religious broadcast 1745-1800. 4VWA, Radio Citadelle, Cap Haitien, Haiti, is heard in France as early as 1700 on 6.301; announces "Ici Radio Citadelle, Poste 4VWA au Cap Haitien, capitale touristique de la Republique d'Haiti, Grandes Antilles;" news in French 1800. A new Haitian is 4VGF, Radio Independence, Gonaves, a seaport and chief town of Northwest Province; uses 6.340, heard around 1850-2015 closedown; news in French 1900. Haiti is to commemorate the 150th anniversary of its national independence (1804) next year—which event occurred in Gonaives.

Peking—China, or relay thereof is heard on 9.76A as early as 1025 and to after 1230 in parallel with 7.50, 9.04, 10.26. (Gay, Calif.)

Radio Ceylon now uses 9.57 to relay VOA to Southeast Asia in English 1030-1230. (Gay, Calif.)

A new station in Malaya is "The Forces Broadcasting Service, Singapore," heard on 5.010 at 0700-0900 when closes with "God Save the Queen;" only English is at opening, closing. (Paris, Gillett, Australia)

Cairo should be testing its new 100 kw. transmitters to the Americas soon.

A letter from the Government of Aden says that no broadcasting station is operated there, but that Cable and Wireless, Ltd., makes available a transmitter on request on 6.045, 250 watts; no new developments in radio are contemplated. (Scheiner, N. J.)

Rangoon, Burma, plans to expand both its internal and external services—including an increased staff, four new powerful transmitters, and a new Broadcasting House. (Scheiner, N. J.)

The Japanese Short Wave Club says HLKB, Pusan, is now using 2.510 and 7.935 with 1 kw. at 2100-2400, 0300-1030, 1600-1830; Seoul, 9.555, is parallel.

Pan-American Radio, Tangier, plans to extend its schedules soon; has been licensed to increase power of its transmitters. (Scheiner, N. J.)

"La Voz de la Democracia," Quito, Ecuador, announces channels of 5.970 and 9.560; signs off 2335. (Vilella, Md.)

A letter from Radio Vila Verde, Macau, Pt. China, says there is no short-

wave station operating in that colony at present, but that the Radio Clube may use its 1 kw. short-wave transmitter on 9.500 later on. Radio Vila Verde, while awaiting a new m.w. transmitter, did use the Radio Clube's 9.500 station in March-April 1951 only; there has been no short-wave transmission from Macau since then. (Scheiner, N. J.)

The VOA relay Base at Salonika, Greece, is to have a new, small short-wave transmitter. (Cushen, N. Z.)

Acknowledgment

Please keep those FB reports coming in to 948 Stewartstown Road, Morgantown, West Virginia, USA. Thanks, fellows K.R.B.

ORDER BY MAIL FROM WHOLESALE RADIO

Low Prices • Complete Stocks • Fast Shipments

Equal to \$175 TV Aerial Systems

360° SUPER DIRECTRONIC

Electronically Rotates in All Directions

Exclusive Snyder Engineering and Design \$44.95 cuts cost to

Especially for ultra-fringe areas where signals arrive from more than one direction. Extra high gain over any other broadband aerial. No motors or electric power. 48 elements. COMPLETE WITH 4-POSITION DIRECTRONIC BEAM SELECTOR, 150' TUBULAR TILTING CABLE, UNIVERSAL U CLAMPS. Order Snyder Model AX 538.

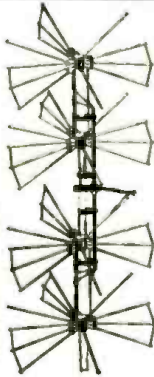

UHF YAGI TV ANTENNAS

- Model UHF 3A—Channels 14-28
- Model UHF 3B—Channels 27-62
- Model UHF 3C—Channels 49-83

\$375 each

TV ANTENNAS

YOUR CHOICE

\$395 each

\$2.95 each in lots of 6

Was \$4.95 **CONICAL ARRAY**



All channels. 8 hi-tensil aluminum alloy elements. Snyder Model XA44. (Less Mast.)

Was \$4.95 **DOUBLE V ARRAY**



Hi-gain for fringe. 4 hi-tensil 3/8" aluminum alloy elements. Completely pre-assembled. Model AR-55 (less mast).

Was \$4.39 **HI-LO ARRAY**



2 folded dipoles (hi-lo) with reflectors. The best folded dipole anywhere. Near 4:1 is exceptionally low price. All-21. (Less mast.)

Immediate Shipment!

"PRECISE" 300K 7" SCOPE KIT

Sensitivity—Less than 10 mv.

Has true electronic sweep margin. Astigmatism control. Push-pull vertical from input thru output; push-pull horizontal. Internal blanking and Z modulation with blanking amplifier. Driven and non-driven sweep. Over 5 MC flat response sweep. 3 db. DC amplifiers. Cathode follower input on vert. and horiz. Internal calibrator. Horiz. and vert. stepping attenuator. "NEW 7" tube. Highest sensitivity. COMPLETE WITH ALL TUBES, HARDWARE AND STEP-BY-STEP CONSTRUCTION BOOK.

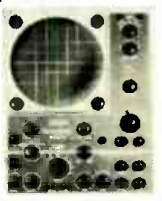

MODEL 300 K **\$94.95**

More Famous PRECISE Kits!

- 630K RF-AM-FM & MARKER GENERATOR KIT. \$33.95 (630K pre-assembled head \$38.95) (630V wired \$53.95)
- 635K UNIVERSAL AF SINE, SQUARE & PULSE GENERATOR KIT. \$33.50 (635 wired \$52.50)
- 610K RF SIGNAL GENERATOR KIT. \$23.95 (610KA pre-assembled head \$28.95) (610 wired \$38.95)
- 907K VTVM KIT WITH 7 1/2" METER. \$38.98 (907 wired \$57.98)

RESISTOR & CONDENSER BARGAINS

- 100 ASS'T RESISTORS. 1/2-1-2 W. \$1.95
- 50 ASS'T MICA COND. 5mmf to .001 mf. 1.95

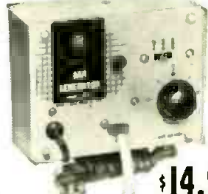

Why Waste Time Waiting for Test Pattern

RMS TV BAR GENERATOR

Makes Actual Bars on Any TV Screen. Make accurate, on-the-spot linearity adjustments. No chassis removal necessary. Operates directly into ant. terminals. Adj. number of horiz. & vert. bars. Complete unit. Order RMS BAR-1. **\$14.95**

PIC TUBE BRIGHTENER \$149

Gives new life to old pic. tubes. For use in parallel filament circuits. Model P-5

"SUTCO" UHF CONVERTER & VHF BOOSTER IN 1 UNIT

Enables any TV now being made to receive UHF and also boost VHF in fringe area. Has own power supply, a crystal mixer, a 6AF4 and a 6J6. Booster has 75-300 ohm input and output. Operates on 110-125 V AC. Terminals for UHF and VHF antennas. Model 21A. **\$35.70**



FREE! Write for new Value-Packed FYI bulletin #103.

FREE! Hi-Fi minded? Write for "High Fidelity Magic" Big Audio Guide!

WHOLESALE RADIO PARTS CO., Inc.

311 W. BALTIMORE ST., BALTIMORE 1, MD.



How to use KRYLON[®] to cut down contract service calls

Krylon is a tough, quick-drying Acrylic coating with many important TV applications. To apply, just push the button on the aerosol can and spray—that's all you do!



Because of its high dielectric strength, Krylon helps prevent corona. Here technician Bernard Vanella—on the staff of dealer Mort Farr, Philadelphia—"Krylon-izes" high voltage coil and insulation, the socket of the high voltage rectifier, component parts of the rectifier circuit.



Edward Weigand, Farr service man, sprays Krylon on entire antenna. Krylon shuts out moisture, rain, salt spray—prevents corrosion and pitting—keeps picture quality at peak.

"Krylon-izing" increases your customer's satisfaction and jumps your own profits! Nationally advertised to your customers!

TECHNICAL CHARACTERISTICS

Dielectric constant—3.8 to 2.4cm

(1,000 cycles)

Dielectric strength—400 to 800 (number of volts necessary to cause electric arc through Krylon coat one mil thick)

Electrical resistance — 10^{10} ohms/cm³

See your jobber, or write direct.

KRYLON, Inc., Dept. 2706
2038 Washington Ave., Phila. 46, Pa.

NEW TV PRODUCTS on the Market.....

SIGNAL GENERATOR

Receiver and amplifier gain, selectivity, sensitivity, and image rejection are a few of the u.h.f. television measurements that can be made with the new signal generator recently an-



nounced by *Hewlett-Packard Company* of 395 Page Mill Road, Palo Alto, Cal.

This master oscillator power amplifier generator is designated as the Model 612A. It offers continuous coverage between 450 and 1200 mc. Frequency and output are directly set and read on large dials. No charts or interpolation are necessary. Maximum output is .5 volt into 50 ohms throughout the frequency range.

Full details and price information are available from the company on request.

"SERVICE CARD FILE"

Oelrich Publications, 4135 N. Lawler Ave., Chicago, Ill., is now offering its #700 "Master Service Card File" business control system.

Designed specifically for radio and television service dealers, the "file" consists of a metal file box, 500 5" x 8" master service cards, and one set of alphabetical index cards. The card functions as a customer account card on which customer information, service details, sales details, warranty, and service contract expiration dates are entered. Cards have spaces for details of 15 service jobs per customer and are printed in brown on buff ledger stock.

A sample card and catalogue are available on request. Parts jobbers will handle this item.

NEW CAMERA COMPONENTS

A package of five electronic components especially designed to complement the RCA-6198 "Vidicon" industrial television camera tube has been announced by the tube department of *Radio Corporation of America*, Harrison, New Jersey.

The new components include a deflection yoke (216D1), focusing coil (217D1), alignment coil (218D1), horizontal-deflection-output transformer (233T1), and vertical-deflection-output transformer (234T1). These parts are engineered to provide good sweep linearity, high deflection sensitivity, efficient coupling between circuits, proper focusing, and accurate alignment of the electron beam.

The new "Vidicon" industrial television camera tube with which these components are used is only one-tenth the size of a standard broadcast camera tube. It makes possible the design of compact, simple, lower-cost camera equipment for non-broadcast use.

CR TUBE SHIELD PAINT

Micro-Circuits Company of New Buffalo, Michigan is in production on a new conductive shielding paint for static shielding of CR tubes, meters, high-voltage power supplies, high-voltage generator windings, etc.

The new paint, RS12, is low in cost, has high conductivity, excellent adhesion and durability, heat resistance, and viscosity suitable for spraying, according to the company.

For data and price sheet, MR11, contact Dept. RN of the company.

SERVICE TOOL

Rytel Electronics Mfg. Co. of 9820 Irwin Ave., Inglewood, Cal. is currently offering its new "Glo-Aid," a dual purpose tool that is designed to speed up repair jobs for radio and TV technicians.

Both ends of the new tool have solder-resistant tips. One end has a slot



for securing wire to be soldered. The other end is a high-voltage probe with a neon glow bulb for testing high voltages without danger of shock.

The plastic handle is 5" long and the total over-all length of the tool is 8 3/4".

U.H.F. LIGHTNING ARRESTER

JFD Manufacturing Co., Inc. of 6101 16th Avenue, Brooklyn 4, N. Y. has brought out a new u.h.f. lightning ar-

rester that minimizes stray capacitances and inductances.

The new unit, the Model #AT103, through improved mechanical and electrical design, lowers impedance to the same uniform 300 ohms which the antenna and receiver offer. This uniformity of impedance over the entire u.h.f. band prevents loss of signal and produces a clearer picture.

The manufacturer will furnish literature on request.

INDUSTRIAL TV CAMERA

A miniature television camera unit, the "Tel-Eye," which is completely self-contained has been introduced by the television transmitter division of the Allen B. Du Mont Laboratories, Inc.

The new unit, designed for closed-circuit television, is a complete camera chain with all associated power,



synchronizing, r.f., monitoring and output equipment, plus the camera itself, contained in a small camera head about the size of a portable typewriter case.

It is simple, highly portable, and can be used with any standard v.h.f. television receiver by simply plugging the unit into a standard wall socket and attaching the camera's output cable to the television receiver. It will feed multiple TV receivers with excellent pictures at distances up to 200 feet.

The complete unit measures 14" long, 9 3/4" high, and 4 1/2" wide. It operates with any standard 16 mm lens and is fitted for mounting to any standard camera tripod. It weighs 18 pounds and uses 17 tubes. It is available for immediate delivery.

TV ATTENUATOR

Blonder-Tongue Laboratories, Inc. of 526-536 North Ave., Westfield, New Jersey has introduced a laboratory-engineered unit which provides precise attenuation ranging from 0 to 42 db, in 6 db steps, over the entire v.h.f. band.

Technicians and installers will find the Model AT-1 attenuator a useful guide in planning TV installations. The unit provides proper attenuation levels for equalizing signal strengths in multi-antenna installations, for reducing TV signals to prevent overloading, and to simulate fringe area reception.

Three switches on the AT-1 allow variable attenuation of 6, 12, 18, 24, 30, 36, or 42 db. The unit requires no power and may be used for testing or



FOLLOW ARROW FOR BIGGEST STOCK AT LOWEST PRICES

- RADAR—TRANSMITTERS
- RECEIVERS — TUBES — PARTS

AN/APS-4
Airborne radar. New. Complete P.U.R.

AN/APS-6
Airborne radar set. New. Complete P.U.R.

AN/APR-4
RECEIVER & TUNING UNIT P.U.R.

AN/APS-3
AIRBORNE RADAR SET. Now Complete.... P.U.R.

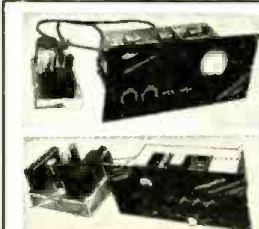

C.A.P. SPECIAL COMBO

BC-624 VHF RECEIVER

Freq. range 100-156 MC. Less tubes & crystals, with conversion dope. Used, good cond. **\$19.95**

BC-625 VHF TRANSMITTER

Freq. range 100-156 MC. Less tubes & crystals, with conversion dope. Used, good condition.. **\$12.95**

BOTH TRANSMITTER & RECEIVER. \$29.95
Per set

Monthly Specials!

RT-34/APS-13 420 MC. TRANSCEIVER with 5 stages of 30 MC. 1F amplifier strip. Less tubes & R.F. section. With dynamotor. **\$6.95**

BC-604 30 W. FM TRANSMITTER. For 20-27 MC. band. Ideal for 10-11 meters. Complete with tubes, temperature controlled crystal oven and technical manual with all instructions for BC-603 and BC-604. Less dynamotor and crystals. Excel. cond. **\$12.95**

INTERPHONE AMPLIFIER BC-709-B

A 2-position single stage audio amplifier. Uses 1 tube and operates from self-contained batteries. With Instruction Manual and Schematic. **\$3.95**
NEW (less batteries)

SCR-625 FAMOUS MINE DETECTOR

For prospectors, miners, oil companies, plumbers, etc. New. **\$59.50**
WHILE THEY LAST!

COMMAND EQUIPMENT (SCR-274N)

	Used	New		Used	New
BC-442 ANTENNA RELAY. Less cond.	\$1.95	3.95	BC-453 With tubes	\$19.95	30.95
BC-451 TRANSMITTER CONTROL BOX	1.50	2.95	MC-211 90° ANGLE COUPLING UNIT.	2.95	3.50
BC-450 2-RECEIVER REMOTE CONTROL BOX	2.95	3.95	FT-234 MOUNTING RACK for single transmitter	2.95	3.50
MC-215 MECHANICAL DRIVE SHAFT. Per length	2.95	3.95	FT-226 MOUNTING RACK for 2 Command Antnrs.	3.95	1.50
BC-496 2-POSITION RECEIVER CONTROL BOX	2.95	2.25	FT-221 MOUNTING PLATE for FT-220	2.25	2.25
BC-455 6-9 MC RECEIVER. With tubes	9.95	14.95	FT-220 MOUNTING PLATE for 3 receivers	4.50	4.50
BC-454 (3-6 MC) With tubes	9.95	1.25	BC-456 MODULATOR. For SCR-274. Complete set of 4 tubes for transmitter	1.25	1.25

RADAR TEST EQUIPMENT

TS-3, TS-12, TS-13, TS-15, TS-33, TS-34, TS-35, TS-36, TS-45A/MB.

ARC-4 TRANSCEIVER

140-144 MC. Complete with control box, tubes, 12/24 VDC dynamotor with schematic. This is a special reduction for this month only. **\$32.50**
Like new \$6.00
MT 101 ARC-4. Rack

234-258 MC RECEIVER

11-tube UHF tunable receiver with schematic. Like new. **\$17.95**
Rack \$3.50
Control Box.. 1.50

Miscellaneous Specials!

H5-18 HEADSET. 8,000 ohms. New **\$2.45**

H5-23 HEADSET. High Imp. New **4.95**

H5-30 HEADSET. Featherweight type. Low Imp. NEW **\$2.49** USED **1.49**

H5-33 HEADSET. Low Imp. New **6.95**

H5-3R HEADSET. USED. excel. cond **1.49**

T-26 CHEST TYPE MIKE. New **2.75**

T-32 DESK STAND MIKE. New **5.95**

LIP MIKE. Navy type. New **.98**

PE-125 POWER SUPPLY: Operates on 12 or 24 v. battery. NEW **\$17.95**

CO-307 EXTENSION CORD. For HS-23-33. NEW **.95**

RS-38 MIKE. NEW **4.95**

Used Per Pair **1.75**

BC-605 INTERPHONE AMPLIFIER. With dual mike input circuit. NEW **5.95**

RM-13 COMPLETE REMOTE CONTROL BOX. With EF-B ringer unit. 110 V. AC operated. Excel. cond. **29.50**

FL-8 RANGE FILTER. **1.95**

TUBES!	TUBES!	TUBES!	TUBES!	TUBES!
14BP4 \$19.95	304TH \$8.95	5CP1 \$4.95	3F1P7 \$2.23	8002 \$.85
18AP4 24.95	304TL 8.95	5BP4 4.95	3AP10 1.49	800198
18DP4 19.95	830-B 2.75	5FP7 2.25	211D69	9003 1.65

MP-22 MOBILE ANTENNA. MOUNTING RACK. Comp. with hardware. New. Per Pair **\$4.95.** Ea. **TU-17 TUNING UNIT.** (2-3 MC.) For BC-223 Amtr. Used **2.95**

I-70 "S" TUNING METER. NEW **2.50**

WOBLATOR. New. P. 45. Dec. '51. RADIO NEWS **BC-1023 75 MC. MARKER BEACON RECEIVER.** Complete with tubes, mtg. rack. NEW **10.95**

TU-25 TUNING UNIT. (3.3-5.2 MC.) For BC-223 Amtr. Used **2.95**

IN-4A L R TUNING METER. Used **\$ 3.95**

FL-5 RANGE FILTER. **1.25**

TS-10 SOUND POWERED HAND SET—Used. excel. cond. Per Pair **14.50**

PE-55 DYNAMOTOR 12 V input. 500 VDC @ 200 mA output. New **\$24.50**

FIELD TELEPHONE. EE-8. Complete BRAND NEW. SPECIAL. ONLY **27.50**

TUBES! NEW! ORIGINAL BOXES!
Limited Quantities Available
250TL.....Ea. \$11.50 250TH.....Ea. \$14.50

INDUSTRIAL CORPORATIONS

We carry one of the most complete stocks in U. S. of Military Electronic Equipment, Test Equipment, and Aircraft Electronics. Call or write for free catalogue.

\$5.00 MINIMUM ORDER ACCEPTED. All items subject to prior sale. All shipments F.O.B. warehouse. Calif. residents add tax with remittance. 20% deposit required. Please specify shipping instructions with order. **EQUIPMENT WANTED!** Highest prices paid for all types of Electronic Gear!

ARROW SALES, INC.

Mailing Address: P. O. Box 3878-R, N. Hollywood, Calif.
Office-Warehouse: 7460 Varner Ave., N. Hollywood, Calif.

Cable Address: ARROWSALES POplar 5-1810

**IMPOSSIBLE
BUT TRUE!**

**SINGLE CHANNEL
5 ELEMENT DELTA-MATCH
YAGIS**

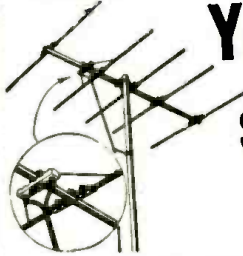

**ONLY
\$200**
each
LOTS OF 5

We know it's hard to believe, and we hardly believe it ourselves — but here it is, so make the most of it! These beautifully fabricated Yagis usually sell for 3 to 5 times our price!

Delta-Match principle insures flat response over entire channel bandwidth, providing maximum fidelity in both picture and audio portion of TV signal. These Yagis available for channels 2, 3, 4, 5 and 6, together with detailed instructions for cutting to channels 7, 8, 9, 10, 11, 12 or 13. Sorry, no less than 5 antennas of one channel. SPECIFY CHANNEL WHEN ORDERING.

Free with each order of 5 antennas 1 all-purpose hack-saw with blade and complete instructions for simple conversion at lower frequency Yagis to high frequency Yagis.

Stock No. YDM5—Packages of 5 Yagis. Net \$10.00
Wt. 40 lbs.

Concord Radio
55 Vesey Street, New York 7, N. Y.
Phone DLgby 9-1132

**REVOLUTIONARY
RADAR-TUNED**

GRANCO



**UHF
CONVERTER
BOOSTER**
DEALERS' NET
MODEL CTU
\$29.97

Adds all 70 channels to Television Receivers. Proved best by field tests and side-by-side comparisons, the Coaxial Resonant Cavity Tuned Granco UHF Converter employs engineering advances that made Radar possible. Design features continuous tuning over entire UHF range 465 to 900 Mc; avoids moving contacts; minimizes oscillator radiation by inherent shielding. Self contained in handsome cabinet 7 1/4 x 5 1/2 x 5 1/2". Wt. 5 lbs. No. CTU.....Net \$29.97

Minimum Order \$5.00 25% Deposit with C.O.D. orders. All shipments F.O.B., N.Y.C.

CONCORD RADIO, 55 Vesey St., N. Y. 7, N. Y. Dept. N6

- Send FREE literature on Granco UHF Converter.
- Put my name on your "Special Bargain Mailing List."

Name _____
Address _____
City _____ State _____

permanent installation at any point in a TV line. The 75-ohm terminal strip and the 75- and 300-ohm terminal strip are interchangeable as the input or output.

24" ALL-GLASS TUBES

The television picture tube division of Sylvania Electric Products Inc. has developed two new 24-inch rectangular, all-glass television picture tubes which are now available in limited production quantities.

The new tubes have gray filter glass spherical face plates that provide for glare reduction. They are magnetically focused and deflected with an ion trap gun requiring a single external magnet. The tubes are supplied either with or without external conductive coating. They weigh about 32 pounds.

Using a 90-degree deflection angle, the over-all length of the new tubes is 21 3/8". Total picture area of 327 square inches is provided by a screen area approximately 17" high by 21 1/2" wide.

The Type ST-1491 is without the external coating while the ST-1491A has the external coating. Tentative data on these tubes is available from the company at Seneca Falls, New York.

IMPROVED GENERATOR

Radio City Products Co., Inc. of 152 West 25th Street, New York 1, N. Y. has announced that its "Do-All" Model 740 generator has been improved to provide increased performance at ultra-high frequencies.

The new model has been designated



as the Model 740A and is being shipped on all orders calling for the Model 740 at no increase in price.

NEW U.H.F. ANTENNAS

Channel Master Corp., Ellenville, N. Y. has developed a twin corner reflector, Model No. 406, an all-channel u.h.f. antenna that is said to provide up to 16 db gain.

Danforth Manufacturing Co., Monmouth, Illinois is offering the "Little Jewel," a u.h.f. antenna of rugged construction. The unit is matched to 300-ohm lead-in and comes completely assembled for easy installation.

Hi-Lo TV Antenna Corporation, 3540 N. Ravenswood Ave., Chicago 13, Ill. is marketing a u.h.f. "Spiral-Tenna"

FREE

FREE — the latest issue of our "TV and ELECTRONICS NOTES". It presents

IMPORTANT FACTS EVERY SERVICEMAN MUST KNOW about

UHF

Vital Serviceman's information regarding Installation, Reception, Converting existing Sets, Timers, etc.

FRINGE AREA RECEPTION

How to get best results at lower costs, improve performance, AND— OTHER IMPORTANT SUBJECTS

Get this special FREE copy, or for regular subscription to "TV and Electronics Notes" send 50c.

RUSH THIS COUPON NOW

TRANSMISSION, INC., NEW ROCHELLE, N. Y. Dept. RN

- Send FREE, the latest issue of "TV and Electronics Notes" on UHF, Fringe Area Recep., etc.
- Enclosed find 50c for regular subscription.

Name _____
Address _____
City _____ State _____

New TUBES Standard Brands

OA2	\$1.00	SCP1	4.50	813	11.95
OA3 VR75	1.10	SC22	37.50	814	2.95
OB2	1.40	SD21	18.50	815	2.90
OC3 VR105	1.00	SFP7	1.95	828	9.95
OD3 VR150	.90	SR4GY	1.40	829	8.95
IA3	1.00	GALSW	1.75	830	9.95
IB23	8.95	GAMS	2.90	830B	2.75
IB24	9.50	GA56	2.30	832A	9.95
IB27	12.50	GBL6	9.50	836	3.45
IN21B	2.50	GBW6	99.50	837	1.45
IN22	1.25	GF4	4.50	845	8.50
IN23	1.25	G14	6.95	849	29.50
IN23A	2.25	GH4	3.50	851	39.50
IN23B	3.49			852	19.95
IN34A	.79			860	4.50
IN38	1.50			865A	1.50
IN40	8.50			872A	2.75
IN58A	1.25			884	1.40
IN63	2.39			9310A	5.50
IN69	2.89			954	.33
2AS15	4.25			955	.49
2C39	19.95			959A	.60
2C40	7.77			959	2.45
2C42	19.95			1005	.69
2C43	12.50	15E	1.75	1616	1.90
2C44	1.19	15R	.89	1624	1.45
2C46	19.95	100TH	9.50	1625	.39
2C51	4.50	250TH	16.50	1626	.39
2C52	2.50	304TH	7.95	2050	1.40
2D1	1.35	304TH	7.95	2051	1.10
2D21W	2.49	307A/RK75	4.25	5635	8.95
2E22	1.95	310A	4.95	5637	1.40
2E23	32.50	350A	3.95	5638	8.50
2K25	28.50	393A	8.95	5645	8.95
2K26	75.00	394A	3.95	5646	8.95
2K28	27.00	417A	8.50	5651	2.75
2K29	23.95	446A	1.19	5654	2.00
2K45	150.00	703A	4.50	5670	4.30
2K48	99.50	705A	1.50	5672	1.20
3A4	1.75	707B	14.95	5676	1.65
3A5	1.25	715B	8.95	5686	4.25
3B23	4.95	717A	.90	5687	4.25
3B24	4.95	717A	.90	5694	2.60
3B24W	7.50	723A/B	16.95	5702	3.50
3B26	7.50	724A	2.95	5704	2.25
3B28	7.50	728	2.95	5718	8.95
3BP1	4.95	726A	12.50	5719	8.95
3C22	72.50			5725	2.00
3C23	9.95			5744	1.95
3C24	240.			5749	2.25
3C33	1.50			5814	2.50
3C45	14.95			5823	2.50
3DP1	3.95	50-15	55.95	5844	4.50
3E29	11.95	50-20	10.00	8012	1.95
3F7	3.95	50-32	12.50	8005	2.45
3GP1	3.95	100-20	14.50	8025A	4.95
3HP7	3.95			9001	1.25
3K23	349.50			9002	1.95
4B24	6.95	726B	45.00	9003	1.50
4C35	22.00	801A	.39	FG17	3.95
4-65A	17.50	804	10.95	FG32	1.95
4-125A	25.00	805	3.25	FG57	14.95
4X150A	22.50	807	1.65	FG95	22.00
4K500A	75.00	807W	9.95	FG104	2.45
5BP1	4.50	809	2.95	VT-127A	2.95
5BP4	4.50	811	2.90	RK60, 1641	1.95

WE PAY HIGHEST PRICES FOR YOUR SURPLUS!

Vacuum Capacitors

Complete line of Receiving Tubes. Thousands of other types of Transmitting Tubes. If you don't see it, WRITE. Prices subject to change without notice. Californians add sales tax. Add postage to order.

Jsh ELECTRONICS
Dept. R-22
7552 Melrose Ave.
Los Angeles 46,
California

which is designed to provide u.h.f. and v.h.f. reception. This indoor antenna is 20" high and 32" wide. It is finished in a gold color, has a Bakelite base, and aluminum bars.

JFD Manufacturing Co., Inc., 6101 16th Ave., Brooklyn 4, N. Y. is in production on a stacked u.h.f.-v.h.f. conical antenna, the JeT283S. It comes completely pre-assembled. Performance data is available from the manufacturer on request.

Kay-Townies Antenna Co., Rome, Georgia, has announced its BJU series of high-gain antennas, assembled in kits of 2-bay, 3-bay, and 4-bay units to provide reception on all TV channels. Special features of this series include the company's fixed impedance point system which eliminates isolation filters, matching pads, coils, condensers, or other boosters.

LaPointe Electronics Inc., Rockville, Conn. has released a u.h.f. bow-tie and reflector unit, the Model BT-U. This *Vee-D-X* engineered antenna eliminates insulators and permits all metal construction, thus providing higher gain and flatter response across the entire u.h.f. band.

Radion Corporation, 1130 W. Wisconsin Ave., Chicago, Ill. is in production on a new indoor u.h.f. antenna, the "Bullseye." The antenna is a full-wave loop engineered for broadband coverage, low standing wave ratio, and low "Q". It measures 10" high and 9" wide and weighs less than one pound.

Snyder Manufacturing Co., Philadelphia 40, Pa. has introduced an "all-in-one" TV antenna, the UHF-2 "Bow Screen." The new unit covers all u.h.f. and v.h.f. bands. A catalogue illustrating this unit is available from Dick Morris, sales manager of the company.

Television Hardware Manufacturing Co., a division of *General Cement*, Rockford, Ill. has released a series of sensitive u.h.f. TV antennas for all-channel reception. Known as the *Telco*

"Butterfly," these new units are said to be highly directional. Single- and two-bay models are currently available.

Telrex, Inc., Asbury Park, N. J. has added an "ultra bow-tie" series of u.h.f. antennas to its line. These units feature high gain, directivity, and good impedance characteristics over the entire u.h.f. band. By means of "sectionalized" design the basic "bow tie" dipole assembly can be used as a primary area antenna without further accessories. Various elaborations may be achieved by use of the company's modification kit or its line of standard components.

Trio Manufacturing Co. of Griggsville, Ill. is offering a new line of low-cost u.h.f. antennas to the trade. The line features two general types—the bow-tie with reflector design and the yagi type. The bow-tie version is available in three all-channel models while the yagi type comes in four models for Channels 14-26, 27-42, 43-60, and 61-83.

DEMODULATOR PROBE

A voltage-doubling crystal demodulator probe for use with a scope or v.t.v.m. in television alignment and troubleshooting is now being offered by *Scala Radio Co.* of 2814 19th St., San Francisco, California.

The BZ-4 probe virtually doubles the deflection on a scope screen, thus providing increased utility in signal tracing low-level i.f. stages and in calibrating generators against crystal oscillator harmonics.

The probe is designed to provide a high degree of 60-cycle hum rejection so that effective tests can be made in heater, a.g.c., and d.c. supply lines for the presence of spurious high-frequency voltages. The probe can be used to localize dead or weak i.f. stages, to calibrate the base line of a scope for ratio detector alignment, to demodulate a video amplifier sweep

STAN-BURN E-P-A-R-K-E

CATHODE RAY TUBE SPECIALS One Year Guarantee			
G. E.		STAN-BURN	
*5TP4	544.95	*10BP4A	\$11.00
*7JP4	17.10	*12LP4A	14.20
*10BP4A	19.25	*14CP4	17.00
*10FP4A	24.00	*15DP4	19.50
*12KP4A	27.10	*16AP4	21.60
*12LP4A	21.70	*16FP4	19.60
*12UP4B	28.25	*16GP4	21.60
*14CP4	24.50	*16HP4	22.50
*16AP4A	30.95	*16DP/HP4	20.60
*16DP4A	28.20	*16DP/HP4A	20.60
*16GP4	31.25	*16KP4	18.50
*16KP4/16RP4	28.20	*16LP4	20.60
*17BP4A	23.90	*16LP4A	21.60
*17CP4A	23.90	*17BP4	18.50
*19AP4A	24.75	*17CP4	21.60
*20CP4	24.75	*19AP4	19.60
*20LP4	37.50	*19AP4A	25.90
*21EP4A	37.35	*20CP4	29.50
*24AP4A	78.50	*21EP4	32.50

ANTENNAE SPECIALS			
*DOUBLE V 3/4"	1.11	12 or more	
*DOUBLE V 1/2"	52.98	52.20	
*10 Element Conical 3/4"	3.45	2.45	
*10 Element Conical 3/8"	3.95	2.95	
*Folded Hi. Straight Low Quick Rig	3.55	2.55	
*1/2 elements	4.25	3.25	
*WINDOW CONICALS	4.95	3.75	
*5 FOOT SWAGED	.79	.69	
*10 FOOT PLAIN	1.39	1.29	
*42 Mil.		\$ 9.95 M Fl.	
*55 Mil. 300 OHM		14.95 M Fl.	
*72 OHM COAXIAL		38.00 M Fl.	
*4 Prong Vibrators, each		\$ 1.79	
*Lots of 12 or more		Special 3.98	
*12" Heavy Slug Speaker			
*CHASSIS 630 REGAL with Cascode Tuner		\$149.50	
*OPEN FACE CABINET		42.00	

WIRE RECORDERS IN STOCK			
*PENTRON - Model 9T3C - 2-speed Tape Recorder			Write for Prices
*RADIO CRAFTSMAN			
*Model C400-III-FI Amplifier		Net	42.90
*Model C10-AM-FM Tuner		Net	131.50
*Model C500-Williamson Amplifier		Net	99.50
*We also carry MASCQ-ROGEM-PILOT, etc. Amplifiers, Pre-Amps, FM Tuners and WEBSTER Tape Recorders.			
*6x9 FM Speaker	\$ 3.98	630 Vert. output	
*7x7 PM Speaker	3.98	potted	1.29
*7711 G.E. Flyback	1.98	630 Vert. blocking	.89
*70" Yoke	1.98	OSC. XForm	
*630 Vert. output		Casco Tuners	19.95
*upright	1.98	Standard Tuners	17.95
		Dumont 21.25 mc.	14.95

AUTHORIZED DISTRIBUTORS for General Electric, Kenrad, Tung-Sol, National Union, De Wald, Regal, Automatic and General Motors.

We carry a Complete line of HI-FIDELITY and sound equipment. Send us your requests.

We also carry a complete line of popular makes of Radio at 50% discount. Also many other special purpose and transmitting types, and all electronic parts and equipment at lowest prices. Send us a list of your requirements for prompt quotations.

Terms: 20% with order. Balance COD. All prices FOB: NEW YORK Warehouse. Minimum order \$5.00. Write for our latest Price list and Hi-Fi catalog to Dept. RN-6.

STAN-BURN RADIO and ELECTRONICS CO.
(C.B.S. THEATRE BLDG.)
1697 BROADWAY • NEW YORK 19, N.Y.



burton brown advertising

BECOME AN ELECTRICAL ENGINEER

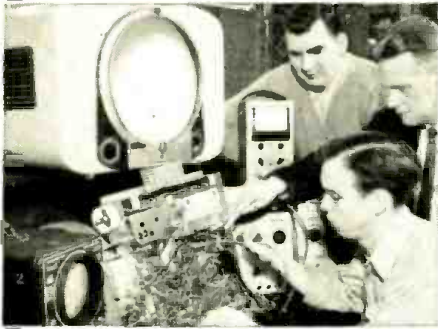

**Bachelor of Science Degree
in 36 months.**

Major in Electronics or Power.
Now, prepare for a career in
these rapidly expanding fields.

This school will prepare you to be-
come an engineer, technician or ser-
vice man. Previous military, academic
or practical training may be evaluated
for advanced credit.

Enter Both Radio and Television

In 12 months you can attain the *Radio-
Technician's* certificate. An added 6
months course qualifies you for the
Radio-TV Technician's certificate and
the Degree of "Associate in Applied
Science." The Technician's course is the
first third of the program leading to
a Bachelor of Science Degree in Elec-
trical Engineering with a major in
Electronics.

Also offered: 12-month Radio-TV ser-
vice course; 12-month Electronics or
Electro Technician Courses; 6-month
Electrical Service Course and 3-month
refresher and general preparatory
classes.

Terms Open April, July, Oct., Jan.

Famous for its Concentric Curriculum.
Faculty of specialists. 50,000 former
students. Annual enrolment from 48
states and 23 overseas countries. Non-
profit. 50th year. Courses approved for
Veterans.



MILWAUKEE

SCHOOL OF ENGINEERING

MILWAUKEE SCHOOL OF ENGINEERING
Dept. RN-653, 1025 N. Milwaukee
Milwaukee 1, Wisconsin

Send: Free 160-page Catalog describing Elec-
trical Engineering Courses; Booklet on Careers
in Radio-TV.

I am interested in _____
name of course

Name _____ AGE _____

Address _____

City _____ Zone _____ State _____

If veteran, indicate date of discharge _____

response curve, to check the output of
a sweep generator, and to test for
sync buzz pulses in a 4.5 mc. sound
channel.

ELECTRO-VOICE CONVERTER

A new Model 3300 continuous-tuning
u.h.f. television converter has been an-
nounced by *Electro-Voice, Inc.* of
Buchanan, Michigan.

A non-slip micrometer type tuning
mechanism provides smooth, contin-
uous tuning of all u.h.f. channels, 14



through 83. No bandswitches, strips,
or coils are incorporated. A large
fingertip knob with flywheel action
operates a legible, slide-rule dial.

Housed in a dark brown cabinet, the
unit measures 7 $\frac{3}{4}$ " x 5 $\frac{1}{4}$ " x 6 $\frac{1}{4}$ ". In-
put and output impedances are 300
ohms. The converter is connected to
the antenna input of the v.h.f. televi-
sion receiver and plugged into an a.c.
outlet. No other installation proce-
dures are required.

WARD "DIPLEXER"

The Ward Products Corp., 1148 Eu-
clid Avenue, Cleveland, Ohio now has
available a compact antenna coupler
which has been tradenamed the "Di-
plexer."

The unit may be used when present
v.h.f. installations are converted for
u.h.f. and two antennas are required.
With the coupler a single lead-in will
feed the set from both antennas.

The "Diplexer" is a printed circuit
using a "Twin-Tee" filter on which a
patent is pending. This circuit gives
uniform response over all TV chan-
nels, both v.h.f. and u.h.f., and keeps
insertion loss at a minimum. Physical-
ly, the unit measures less than two
inches square. It is factory-sealed in
a waterproof plastic case. A mast
mounting strap is included with each
unit.

TV WAVE TRAP

Non-Linear Systems of Del Mar,
California has introduced a television
interference filter which is said to ef-
fectively eliminate adjacent channel
interference as well as FM, amateur,
or other interference on any given
channel in a TV receiver.

The "NOLS" wave trap features
highly selective attenuation of 100 to
1 or better at the frequency tuned.
Selectivity is such that the rejected
bandwidth is only 2-3 mc. wide, per-
mitting elimination of interference
even when it is extremely close to the
desired channel.

WANTED!

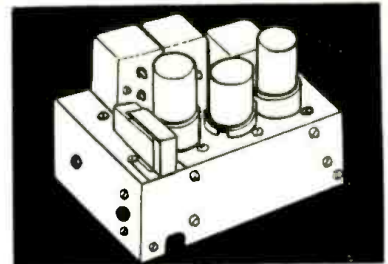

CASH REWARD

For ART-13 XTAL CALIBRATORS

Also need ART-13 Xmitters (or any
parts or spares), BC-348 Q and R,
BC-788A, AM, B, C and I-152A, AM,
B, C.—Plus any other gear.

IF IN YOUR POSSESSION
PLEASE NOTIFY US IMMEDIATELY!

V & H RADIO & ELECTRONICS

2033 W. Venice Blvd., Los Angeles 6, Calif.
Phone Collect: REpublic 3-1127

ACROSS THE TV-RADIO SERVICE LIBRARY

HERE IS LATE INFORMATION IN A
HANDY FORM FOR RADIO & TELEVISION
REPAIRMEN, SERVICEMEN & STUDENTS

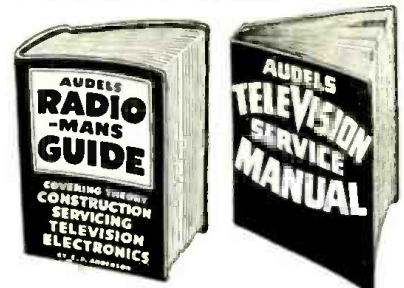

**2 VOLS. \$6 COMPLETE \$1 A
PAY ONLY 1 Mo.**

IT PAYS TO KNOW!

AUDE'S T.V.-RADIO SERVICE LIBRARY
presents the important subjects of Modern
Radio, Television, Industrial Electronics,
F.M. Public Address Systems, Auto, Marine
& Aircraft Radio, Phonograph Pick-Ups, etc.
Covers Basic Principles—Construction—In-
stallation—Operation—Repairs—Trouble
Shooting. Shows How to get Sharp, Clear
T.V. Pictures. Install Aerials—How to Test.
Explains Color Systems & Methods of Con-
version. 1001 Facts—Over 1260 Pages—625
Illustrations—Parts & Diagrams—Valuable
for Quick Ready Reference & Home Study.
Tells How to Solve T.V. & Radio Troubles—
Answers T.V. & Radio Questions.

Get this information for Yourself!
7 DAY TEST—ASK TO SEE IT!

MAIL ORDER

AUDE, Publishers, 49 W. 23 St., N.Y. 10
Mail AUDE'S T.V. RADIO SERVICE LIBRARY 2 Vols. \$6
on 7 days free trial. If O.K. I will remit \$1 in 7 days and
\$1 monthly until \$6 is paid. Otherwise I will return them.

Name _____
Address _____
Occupation _____
Employed by _____ RN

RADIO & TELEVISION NEWS

The trap has balanced input and output circuits for use in a 300-ohm line. It has one simple tuning adjustment and is packaged in a case meas-



uring 4" x 4" x 3". One trap is required for each interfering signal and units may be cascaded for more complex problems.

The traps have a tunable range of from 20 to 40 mc. depending on the model and have been engineered for specific interference problems. The company will supply full details on request.

SIGNAL GENERATOR

A signal generator covering the v.h.f. to u.h.f. frequency range has been developed by Connecticut Telephone & Electric Corporation of Meriden, Conn. to meet the needs of engineers and technicians engaged in television and other electronic work.

The instrument covers the range of 54 to 330 mc. in the first band and from 300 to 950 mc. in the second band. The entire generator measures 9½" wide, 11" high, and 14" deep. The instrument is provided with a calibrated frequency dial, a power output meter, calibrated output attenuator (wave guide beyond cut-off), and regulated power supply.

A data sheet giving complete specifications is available on request.

VIDAIRE'S ATTENUATOR

Vidaire Electronics Mfg. Co. of Lynbrook, New York has introduced a new television attenuator that eliminates overloading due to strong signals.

Known as "Tel-Atten," the new unit was designed to reduce buzz in inter-carrier sets and most cross-modulation effects. It also features a 1000 to 1 change in signal reaching antenna posts and vernier adjustment for all signal areas.

The Model A-2 measures only 3½" x 2½" x 1¼" and is housed in a two-color cabinet. It may be mounted on the set itself or on a nearby wall.

UNIVERSAL ANTENNA MOUNT

Walnut Machine, Inc. of South Bend, Indiana has been granted a patent on its universal antenna roof mount, the Wamco No. 177 "Uni-base."

Designed to permit any type of roof

or side mounting, the unit's compound universal joint swivels 360 degrees for mounting on any pitch of roof, for ridge mounting to fit any pitch of roof, or for vertical mounting to the side of a building. The holding clamps are adjustable to accommodate all masts ¾" x 2" and have full hinge action for raising the mast and guying.

It may be installed by one man. Of steel construction, all parts are weather-resistant treated.

NEW CRANK-UP TOWER

Alprocco, Inc. of Mineral Wells, Texas has introduced a new crank-up television tower, the CV-56S.

Featuring low erection cost, safety,

and light weight, the new unit comes completely assembled ready to install. No ground base is necessary. All that is required is that the antenna be mounted, a set of guys attached, and the unit fastened to the house with the company's special stand-off bracket. The unit may then be cranked up to a height of 56 feet.

The tower is made of spring-tempered, hot-dip galvanized steel with rustproof aircraft cable throughout. It is equipped with easy climbing steps.

BOGEN CONVERTER

A new u.h.f. converter, designed to permit reception of all u.h.f. stations on standard v.h.f. television sets, is

SEE LEO FIRST FOR . . .

hallicrafters

I can SAVE you money... Liberal Trade-ins



LEO I. MEYERSON
WØGFQ

JUST ARRIVED! THE NEW 100 WATT HT-20 XMTR—\$449.50



\$179.50

S-76 RECEIVER

Extra selectivity with double superheterodyne circuit. One RF, two conversion and 3 IF stages. Range 550-1550 Kc, 1.7-34 Mc in four bands. 8 tubes plus voltage regulator and rectifier. Complete with tubes, less speaker.



\$224.50

SX-71 RECEIVER

Double Conversion sharp selectivity, plus built-in NBFM at moderate cost. 11 tubes plus voltage regulator and rectifier. Low down payment.

NAME YOUR TERMS • LOW DOWN PAYMENTS • PERSONALIZED SERVICE

HALLICRAFTERS RECEIVERS AVAILABLE FOR IMMEDIATE SHIPMENT

S-81	\$49.50	S-40B	\$119.95	ST-83	\$129.95
S-82	\$49.50	S-53A	\$ 89.95	S-78A	\$ 89.50
A-84	\$99.50	S-72L	\$119.95	SX-62	\$299.50
S-38C	\$49.50	S-77A	\$119.95	S-72 Portable	\$109.95
R-46 Speaker	\$19.95	SX-73	\$975.00		

Famous WRL RADIO REFERENCE MAP 25c



CU on 10-20 & 75 Meters

NEW LOG BOOK 25c

For mobile or fixed station. Spiral binding. Full column log listing all FCC required info. Will accommodate 1,525 stations. Q signals, phonetic alphabet, amateur international prefixes.

PHONE 7795

WRITE—WIRE



IT'S NEW! IT'S FREE! WRL 1953 CATALOG

Send for your copy today. Contains everything new in radio and television. Jam-packed with bargains. Leo I. Meyerson, WØGFQ



Send For FREE Copy

WORLD RADIO LABORATORIES
744 West Broadway
Council Bluffs, Iowa

R-6

Please send me:

- Radio Map 25c SX-71 Info
 New Catalog S-76 Info
 Used Equipment List New Log Book 25c

Name
 Address
 City State

World RADIO LABORATORIES INCORPORATED
 COUNCIL BLUFFS, IOWA

THE
Original
WRENCH
WITH THE
SCREWDRIVER ACTION!

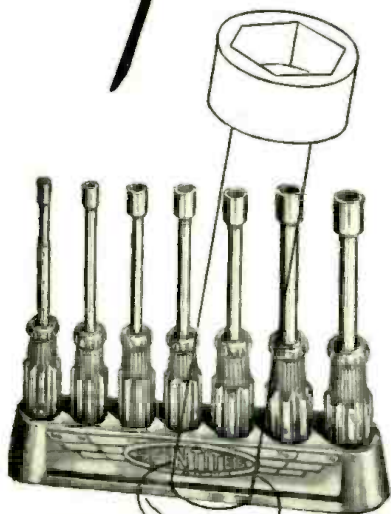

SPINTITE
REG. U. S. PAT. OFFICE

120 STYLES and SIZES

for

- ASSEMBLY WORK
- REPAIR WORK
- RADIO
- TELEVISION
- INDUSTRIAL
- AIRCRAFT



STEVENS WALDEN, Inc.
WORCESTER 4, MASS.

currently being offered by *David Bogen Company*, 29 Ninth Avenue, New York 14, N. Y.

Known as the UCT, the converter is easily installed by connection to the antenna input of the television receiver. It is completely self-contained in a compact, brown-plastic cabinet that can be placed atop the set.

The new unit features a single knob for continuous tuning over the entire



u.h.f. band from Channel 14 to Channel 83. Its broadband output operates through either Channel 5 or 6 on the TV set. Input and output impedances are 300 ohms.

The UCT measures 4 $\frac{7}{8}$ " x 4 $\frac{3}{4}$ " and is supplied complete with tubes, instructions, and a 300-ohm twin-lead for connection to the TV set.

TWO-SET COUPLER

Snyder Mfg. Co., Philadelphia 40, Pa. is marketing a two-set coupler which permits two television receivers to be operated from a single antenna.

The Model AC-800 is fully automatic and needs no adjustments or switching operations. For permanent installation, it mounts on either receiver or any convenient place between the receivers. It can also be placed in the basement of the home or building.

The unit is housed in a Bakelite case and comes complete with lead-in terminals for quick and easy installation.

FRINGE AREA CHASSIS

Video Products Corporation, 370 Seventh Ave., New York 1, New York has added a new unit to its line of television chassis.

The Model 530 DXC-27 is designed to operate 90 degree deflection tubes. It incorporates a horizontal output transformer of advanced design which, in conjunction with the 6CD6, gives increased high voltage with full deflection for the CR tube. The special yoke used in this chassis gives safe and cool operation for 30" round, as well as 27" and 24" rectangular tubes.

The chassis was also designed to give maximum sensitivity for fringe areas as well as good performance in strong signal areas. It has a four-stage i.f. system with a bandpass wide enough to provide a good picture with sound sensitivity consistent with a good picture.

The company will supply full details on the Model 530 DXC-27.

Relay Sensitivity
(Continued from page 39)

prefers, the components may be mounted in a standard metal utility box, such as the popular "Miniboxes" manufactured by *Bud*.

When mounting and wiring the components in a closed box, there is no need to worry about heat dissipation, and parts may be mounted as close together as practical. The only precautions necessary are (a) to prevent jamming the relay armature, and (b) to avoid electrical short circuits.

Since the battery current drain is small, the battery life should approximate the normal shelf life of the batteries, under usual operating conditions (where an "open" control line is used).

Parts Substitutions: The parts list need not be followed exactly and should be taken only as a general guide. A relay other than the one listed may be used, and other batteries may be substituted for B_1 and B_2 . Let us discuss each component in turn.

The relay chosen should be capable of operating on a few milliamperes coil current. The more sensitive the basic relay, the more sensitive the final assembly. Coil resistance is not too important, although some adjustment in the voltage of B_2 may be desirable. For example, a relay coil of high resistance may require a greater supply voltage to obtain a satisfactory operating current. A relay coil of low resistance may make it possible to use a lower voltage battery for B_2 . However, in no case should the maximum ratings of the transistor be exceeded. (For transistor ratings, refer to "Build This Transistor Receiver" by R. K. Dixon, February, 1953, *RADIO & TELEVISION NEWS*.)

Where the relay available in the workshop has almost, but not quite, the desired sensitivity, it is often possible to improve its sensitivity by the standard techniques of reducing the armature spacing and weakening the spring.

As far as battery B_2 is concerned, the choice of this component will be determined, to some extent, by the resistance of the relay coil (as outlined previously). The battery chosen for the model was picked because of its small size, low cost, and ready availability.

The builder may follow his own inclinations in choosing a battery for B_1 . The *Mallory* RM-1000 mercury cell used in the model was picked because of its small size and long shelf life. Any of the other mercury "A" batteries will serve as well, however, and the more conventional zinc-carbon batteries may be used if preferred. A penlight cell is a good choice because of its small size, but even a standard flashlight battery may be used.

Series resistor R_1 is chosen for optimum circuit operation, as described

below; however, since the resistor represents a minor item, the builder should experience no difficulty here. The value of R_2 is not critical and any resistance from 300 to 1200 ohms should work well here.

The only remaining electrical part in the circuit is the transistor. Even here substitutions may be made, but where a transistor having different characteristics is employed, these must be taken into account when choosing a relay and operating voltages.

Circuit Adjustment: The relay itself should be adjusted for maximum sensitivity in keeping with good contact pressure. Care must be taken here, and if the builder is unfamiliar with relay adjustment, it may be best not to change the factory adjustment.

Once the wiring is completed, the value of R_1 may be chosen experimentally. The required value will depend upon relay sensitivity, the resistance of the *control line* (if large), and the value of B_1 . The author found that the following technique gave satisfactory results.

A decade resistor box was connected in the circuit in place of R_1 . It was adjusted for a total of 20,000 ohms resistance. The *control line* was connected and closed.

The resistance was then reduced until positive closure of the relay was obtained. Too large a value for R_1 will either prevent relay operation or make the operation erratic. Too small a value will permit excessive base current flow (as R_1 is reduced, the base current flow increases, as well as the collector current).

A fixed resistor of the nearest RTMA standard value was then substituted for the value indicated on the decade box.

If a long *control line* of fine wire is employed, the resistance of the line may be appreciable. In such a case, the value of R_1 should be reduced for positive relay operation.

Where a general purpose unit is desired, for use with either high or low resistance *control lines*, R_1 may be replaced with a 5000 or 10,000 ohm rheostat, and readjusted as necessary for operating conditions.

In addition to the usual applications of a sensitive relay in electronic control circuits, there are a number of applications in which the relay may serve in its own right. While the builder can undoubtedly think of many of these himself, outlining one or two special applications might be of benefit to the reader.

Burglar Alarm: By installing door and window contacts and fine wire, (or tape foil) a room or area may be completely enclosed by a continuous electrical circuit. This circuit may be used as the *control line* of the schematic diagram, and the relay kept in a "normally closed" position. Any break in the circuit (including battery or relay failure), such as a door or window being opened, will permit the relay to "drop out."

The closure of the relay contacts

TURNER'S NEW UHF CONVERTER

Gives clearer
sharper TV pictures

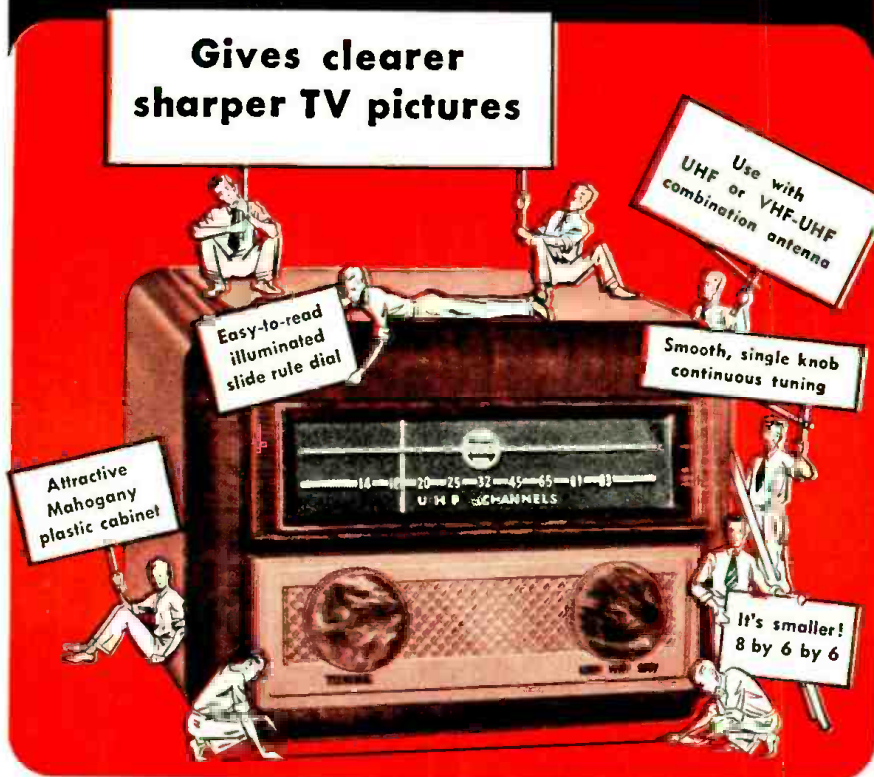

Get the best UHF-TV reception . . . get the UHF Converter shown to give sharper, clearer pictures than other leading converters in actual comparison tests . . . get the new Turner UHF Converter.

Turner's Converter is smaller than most . . . takes less room on the receiver. Its handsome mahogany plastic cabinet is an attractive addition to any room. The unit is self powered and complete with all tubes and instructions. Silver-plated coaxial tuning elements for longer wear. Lowest noise figure possible. The finest Converter you can buy for the sharpest, clearest UHF-TV reception.

TURNER UHF CONVERTER, List price-----\$57.50



THE TURNER COMPANY

900 17th Street N.E., Cedar Rapids, Iowa

EXPORT: Ad. Auriemo, Inc.

IN CANADA: Canadian Marconi Co.

89 Broad St., New York 4, N. Y. Toronto, Ont., and Branches.

You have to **HEAR** it to believe it!

Full symphonic level high-fidelity sound from the amazing BARUCH-LANG loudspeaker system.

- The phenomenal BARUCH-LANG high fidelity corner loudspeaker system is the successful result of research at one of the leading university acoustic laboratories to achieve high quality, wide-range response in a compact, low-cost unit.
- Complete, ready for connection to any amplifier, radio, or television set, this amazingly efficient speaker system is ideal not only as the main high-fidelity speaker in your living room, but also as a second or third speaker placed at other points in your home.
- Only from KLOSS INDUSTRIES, the original manufacturer of this famous, nationally advertised speaker, can you buy direct and thus save dealer markup. Kloss industries offers you an unconditional 10 day refund guarantee in order that you may listen to the KLOSS BARUCH-LANG system in your own home without obligation.

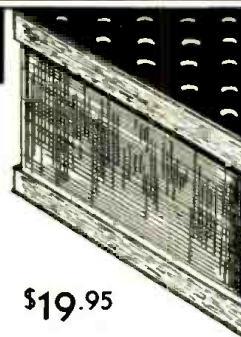

\$19.95

Shipped by express only, shipping charges collect. C.O.D. if you wish. Specify birch or mahogany. 4 or 16 ohms impedance.

**KLOSS
INDUSTRIES**

10 Arrow Street, Cambridge 38, Mass. Dept. B



be an expert on AUTO RADIO SERVICING!

Get the only authoritative compilation of its kind—complete Auto Radio Service Data coverage of all important models since 1946—in 3 great PHOTOFACT Manuals! All data complete, accurate, uniform—based on lab analysis of the actual auto radios covered. Helps you service any model quicker, easier—for greater profits. Get the complete Library!



VOL. 1. AUTO RADIO SERVICE MANUAL

Covers over 100 models made from 1946 to 1949 by 24 manufacturers. Each receiver is completely covered in uniform format; includes schematics, chassis photo views, replacement parts data, serv-

ice hints, etc. All data based on actual lab analysis. 396 pages, 8½ x 11".

ORDER AR-1. Only \$4.95



VOL. 2. AUTO RADIO SERVICE MANUAL

Covers 60 different chassis (40 models) used in 1948, 1949 and 1950 auto radio receivers. Authoritative, complete service data that makes your work quicker, easier and more profitable. 288 pages, 8½ x 11".

ORDER AR-2. Only \$3.00



VOL. 3. AUTO RADIO SERVICE MANUAL

Covers 47 different chassis (80 models) used in 1950, 1951 and 1952 auto radio receivers. Absolutely the most complete, accurate and easy-to-use data available—uniform and practically presented to

make you an expert on the repair of any auto radio. 288 pages, 8½ x 11".

ORDER AR-3. Only \$3.00



SPECIAL OFFER!

All 3 Volumes, Yours for Only \$9.95
Save on the Complete Library—see your PHOTOFACT Distributor

HOWARD W. SAMS & CO., INC.

Order from your Parts Jobber today, or write direct to HOWARD W. SAMS & CO., Inc. 2203 E. 46th Street, Indianapolis 5, Ind.

My (check) (money order) for \$.... encl. Send:

- AR-1 \$4.95 AR-2 \$3.00 AR-3 \$3.00
 Complete 3-Volume Library \$9.95

Name

Address

City State

may be used to turn on an alarm bell, turn on lights, or carry out almost any desired function (the relay contacts are used as a simple switch).

Temperature Control: In cases where it is impractical to use a bimetallic thermostat type of temperature control (due to arcing of the contacts), as in an explosive atmosphere or in liquids, the sensitive relay described may be used in conjunction with a special thermometer.

The "special" thermometer consists of a mercury thermometer in which contact leads have been inserted along the length of the tube. As temperature variations take place, the expanding and contracting mercury column alternately makes and breaks contact between the two leads. The current carrying capacity of such an arrangement is small, however, but it is sufficient to operate a sensitive relay which may, in turn, control heavier circuits.

Other applications: In addition to the two applications already described, there are many other practical applications of a sensitive relay to commercial and industrial work.

But these are not the only applications. A sensitive relay may often be used in novelty control circuits and to operate toys.

NEW RADIO RELAY

THE Long Lines Department of A. T. & T. has announced plans to construct a radio-relay route between Buffalo and Cleveland.

The proposed 180-mile system, which is needed to handle increased requirements for telephone message service and television channels, is scheduled for completion late this year.

The new system will augment cable and open wire lines as well as provide another link in a planned second radio-relay route between New York and Chicago.

The new Buffalo-Cleveland link will employ five radio-relay stations. Each station will be equipped with lens-type antennas mounted atop steel towers, 162 to 235 feet in height.

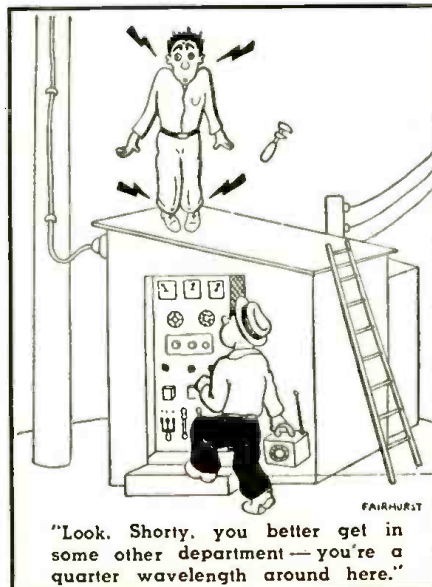

WALDOM TV Conversion Kit Mask and Escutcheon Assemblies

For a professional conversion or custom installation

- 1 Metal Mask tailored for perfect fit. Green Sprayed Finish.
- 2 ¼" Tempered Safety Glass.
- 3 Beautiful Gold Finished Metal Escutcheon.

All popular sizes: 14", 16", 17", 20" and 21". Rectangular Tubes only. Easy to install instructions included.

See your distributor

Send for COMPLETE CATALOG

Waldom carries a complete line of Electronic Components and Crame Products.

WALDOM ELECTRONICS, INC.

911 N. Larrabee St. Chicago 10, Illinois

What to look for in a record changer...

INTERCHANGEABLE SPINDLES...

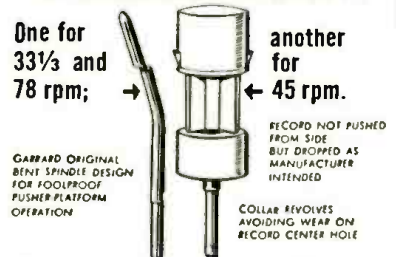

For greater convenience and longer record life; Eliminates "spiders"
One of many features which make

GARRARD The World's Finest 3 Speed Record Changer

Fully automatic with automatic stop

Can be used with your present set.



MODEL RC 80

Garrard Sales Corp., Dept. R-6
164 Duane St., N. Y. 13, N. Y.
Send GARRARD Fact Sheet.

\$42.30 net
less cartidges

Name.....
Address.....
City.....Zone.....State.....

Spot Radio News
(Continued from page 16)

production would not impair the defense effort."

"Among other conditions," he continued, "applicants had to show that there would be no diversion from defense activities of electronic technicians, design engineers, draftsmen, professional engineers, physicists, or tool and die makers, as a result of engaging in color TV set production."

It was noted that this provision was dictated by the critical need at that time for engineers to develop new electronic equipment for the rapidly expanding programs of the military and the Atomic Energy Commission. Due largely to the cooperation of industry, McCoy added, this development activity proceeded much more rapidly than originally thought possible. Now, it was said, engineering for the defense electronics programs has passed its peak, and producers are meeting current military needs. "With the emphasis now falling on production," McCoy said, "we felt it no longer necessary for NPA to screen applications for permission to produce color television equipment."

With sequential telecasting shelved, compatible broadcasting a purely experimental and unapproved system, the revocation was viewed as simply a policy move of no significance to industry.

CBS received a boost from Richard Hodgson, who during the third day of the hearing declared that manufacturers had actually boycotted the sequential system, a point of view expressed earlier by Senator Johnson.

Dr. Du Mont, who appeared next on the stand, took a dim view of the immediate prospects of a color TV system for the public. He did not agree with others who thought the system was practical. "As far as we are concerned," he said, "we would like to see color tomorrow, if the public would buy it. We are in the business to sell sets . . . but we would not make one we didn't think we could sell. I don't think the manufacturers have color to sell to the public." In his opinion, commercial color is still years away.

The last days of the inquiry were highlighted by the appearance of Dr. Baker, as chairman of the National Television Systems Committee, and ex-FCC Headman Paul Walker.

Baker described how the NTSC came into existence and reported on the present status of the committee's work on color. Noting that the committee's membership includes scientists of the highest standing in a number of different fields of technology, such as electronics, physics, colorimetry, optics, and mathematics, he said that these experts have concerned themselves solely with a significant and highly challenging technical problem; how best to achieve the optimum



"Boy... Have I Got the Lines!"

You, too, can have the lines—that meet your exact leadline conditions — whether you are a TV Set Dealer or Service Organization making the finest television reception installations, or a TV fan that demands sharp, "SNOW-FREE" pictures.

We specialize in the manufacture of television transmission lines — built with only one idea in mind: "THE FINEST TELEVISION RECEPTION!"

For UHF and VHF

"SHEATH-LEED" — the all-weather leadline for the toughest conditions: Salt spray in coastal areas; hot, humid weather, or for frosty, icy, wintry wind-whipping conditions which impose a severe tax. . . Pure Polyethylene Tubing encasing Standard GOODLINE AIRLEAD.



"GOODLINE" AIRLEAD — standard of leadline excellence — with 80% of the loss producing wax removed. Correct impedance for sharp, "snow-free" pictures. Of pure polyethylene with flexible stranded copper-clad conductors. MANY IMPORTANT FEATURES.

NEW FULL-WEB "SHEATH-LEED" — the pure polyethylene of "SHEATH-LEED" and full characteristics of GOODLINE AIRLEAD — but NO PERFORATED WEB. No 20 (7 strand 28) copperweld wire in pure electronic golden clear polyethylene — with a pure silver-gray polyethylene sheath overall — for Maximum Weather Protection.

Don Good, INC.

SOLD BY LEADING
JOBBER & DEALERS

Send coupon NOW!
Get samples "in your hands"
—you'll realize why
Don Good Products make
the finest television
reception possible.

DON GOOD, INC. 1-5
1014 Fair Oaks Ave., So. Pasadena, Calif.
Please rush Samples and Complete Information covering Don Good Products.

Name _____
Street _____
City _____ State _____

USED RECORDING TAPE (PLASTIC BASE)



\$1.99 for 7"—1200 foot
1.09 for 5"— 600 foot
.59 for 4"— 300 foot
.29 for 3"— 150 foot
Plastic reels included with all above sizes.

Money cheerfully refunded if you do not find this tape cleanly erased and as good as new. (If you are skeptical and from Missouri) send us 12c in stamps and we'll roll you a sample.)

New empty plastic reels in boxes for easy labeling. 3"-10c; 4"-22c; 5"-24c; 7"-30c ea. EMPTY BOXES: 3"-3c; 4"-5c; 5"-5c; 7"-10c ea.

We carry new recorders, recording blanks, tape, tape recorders, etc. All large savings. PLEASE INCLUDE SUFFICIENT POSTAGE.

COMMUNIONED ELECTRONICS CO.
2503 Champlain St. N. W., Washington 9, D. C.

FREE! U.H.F. and "THE VERSATILE CRYSTAL PROBE"

Solve your U. H. F. ANTENNA PLACEMENT and ORIENTATION problems the easy way!

Get maximum picture strength - eliminate ghosts - no more roof-top shouting - no expensive field strength meters needed!

ONE MAN CAN DO IT!

Write for FREE bulletin today and other information about KLIPZON products.

UNITED TECHNICAL LABORATORIES
203 LITTLETON RD. ★ MORRISTOWN, N. J.

HARVEY

The House
of Audio



THE ORIGINAL WILLIAMSON HR-15 AMPLIFIER KIT



The famous, original Williamson HR-15... still acclaimed the leader... in kit form, with the original Partridge output Transformer. Assemble this kit, and in 3 hours or less, enjoy the finest sound you ever heard. Operates from a tuner, phono-preamp, crystal pick-up, or other signal source. Absolute gain is 70.8 db with 20 db of feedback. Frequency response: $\pm .5$ db, from 10 to 100,000 cps. Output impedances to match all speakers from 1.7 to 109 ohms. Kit is complete with 5 tubes (1-5V4, 2-6SN7, and 2-5881 (or 807 if requested), 2-Punched Chassis, 2-Resistor Mounting Strips, Sockets, Partridge WWFB Output Transformer, Assembly Instructions, and All Other Necessary Parts for Amplifier and Power Supply. \$76.50

PARTRIDGE OUTPUT TRANSFORMERS - Available Separately. WWFB.....\$26.00

NOTE: HR-15 and HR-15T Kits may be had with British KT-66 Output tubes for \$3.00 additional.

The NEW MAGNECORD VOYAGER One-Case Portable TAPE RECORDER Model PT6-VAH



A professional-quality portable unit designed for use wherever top-quality recording and reproduction is required. Operates at either 15"/sec. or 7 1/2"/sec., with a frequency response at 15"/sec. from 50 to 15,000 cycles within 3 db. Has high as well as low impedance inputs. Output is 600 ohms. Provided with earphone monitor jack which is in the circuit for both record and playback. Dimensions: 7 3/4" x 17 3/4" x 19 1/4". Weight: 42 lbs. Power requirements: 110v. 60 cycle AC. \$499.50

The NEW McINTOSH 30 Watt AMPLIFIER Model A-116



Incorporates famous patented McIntosh output circuit for extremely high quality performance. Frequency response at 30 watts: 10 to 50,000 cycles $\pm .5$ db. Harmonic Distortion: less than .5% at 30 watts, 20 to 20,000 cycles. Intermodulation Distortion: less than 1% with peak below 60 watts. Has two high impedance inputs for .25 and 2.5 volt signals. Four outputs: 4, 8, 16, and 600 ohms. Power supply is built-in, with provision for furnishing power to McIntosh and other preamplifiers. Uses 6BG6 tubes.

Complete with Tubes.....\$139.50

Visit the Harvey AUOIOtorium
See, hear, and compare sound equipment from the largest selection available anywhere.

NOTE: Prices Net, F.O.B., N.Y.C.
Subject to change without notice.



Harvey

RADIO COMPANY, INC.

103 W. 43rd St., N. Y. 36. N. Y. • LU 2-1500

in terms of a color television system.

Reviewing the background of the group, Baker declared that the idea for such a committee was born in '40, as the result of a conference with former FCC Chairman Fly who was then concerned with problems of standards for a monochrome system. Within six months from the establishment of the first NTSC, Baker said, 168 members and assorted panels had produced reports and minutes totaling 600,000 words, had devoted 8000 manhours to meetings and travel, and had witnessed 25 demonstrations in an effort to find a common ground for black and white system specifications. Despite the fact that then, as now, the NTSC headman added, there were conflicting proprietary interests involved, a substantial concurrence was reached on all important technical considerations. The group's work was so outstanding that Fly paid the following tribute to them: "This is another example of the best that is in our democratic system, with the best in the industry turning to a long and difficult job in an effort to help the government bodies in the discharge of their functions so that a result may be achieved for the common good of all."

Declaring that the problems involved in the '49-'50 color hearings were very similar to those which faced the Commission and industry a decade ago, Baker said that it seemed as if history were repeating itself and there appeared a need for the services of an NTSC. It was hoped that the Commission would request the help of the group, as they did in '40, but the FCC did not, Baker said. Nevertheless the group was formed, but in the absence of any request for assistance from the Commission, relatively little could be done during the hearings (which resulted in the adoption of sequential color).

In April, '51, an *ad hoc* committee report disclosed that there were in existence practically all of the elements essential to the creation of a color system having none of the inherent limitations of the field-sequential plan, the Congressional committee was then told. Both the FCC and chairman of the Senate Committee on Interstate and Foreign Commerce were apprised of this report. However, it was noted, being conscious of the Commission's position with respect to *paper* systems, the committee felt that the proposed idea should be translated into an operating reality. And at all times, it was emphasized, the committee has kept in mind the fact that any proposed standards, must if conceivably possible, be expressed so broadly as to permit the development by individual manufacturers of distinct gear capable of performing under those standards.

To establish such standards, Baker said, engineering committee members have been studying and determining on the basis of demonstrated facts, personally observed, when as a matter

!!WANTED!!

In order to supply government and industrial requirements, we are paying top dollar for all types of radio and electronic surplus. We specialize in test equipment and complete radios, such as:

APA, APN, APQ, APR, APS, APT, ARB, ARC, ARN, ART, ATC, BC, DY, I, IE, LM, MG, PE, PU, SCR, TCS, TN, TS, and many others.

WE ESPECIALLY NEED: APA10, APN9, APR4, APS4, ARC1, ARC3, ART13, ATC, BC271, BC342, BC348, BC611, BC721, DY12, DY17, I100, LM10, MG149F, MG149H, PU14, R5/ARN7, R5A/ARN7, SCR718C, TCS, TN16, TN17, TN18, TN19, TN54, TS3, TS13/AP, TS33, TS35, TS45, TS75, TS76, TS102, TS147/UP, TS148/UP, TS173, TS174, TS175, TS250, TS251, TS323, (ICT, IF, IG, 5CT, 5DG, 5F, 5G, 6DG, 6G 115V, 60 c.p.s. Selsyns), and all types of Hewlett Packard, General Radio Co., Measurements Corp., Boonton Radio, Ferris, Leeds & Northrup, and other test equipment.

Please state accurate description, condition, and your lowest price. Explain modifications, if any. We pay freight charges.

PURCHASING AGENTS, ENGINEERS, EXPORTERS, INDUSTRIAL BUYERS, DEALERS, AND INDIVIDUALS, Please send us your requirements.

New Catalog Now Available

PHOTOCON SALES

417 N. Foothill Blvd.
Pasadena 8, California

Sycamore 2-4131
RYan 1-6751

COMPARISON PROVES

EICO OFFERS

GREATEST V-O-M values!



GET the MOST for your money — Before you buy, see chart below!

World-renowned EICO
VOLT-OHM-MILLIAMMETERS

* # 536 KIT \$12.90. Wired \$14.90
526 KIT (with 1% multipliers)
only \$13.90. Wired \$16.90

VERIFY AT YOUR DEALER'S	EICO				EICO price range
	\$12.90 up (KIT)	Co. A	Co. B	Co. C	
31 ranges?	YES	No	No	No	No
Full-size 3-inch meter?	YES	Yes	Yes	Yes	No
400 μ o sensitivity?	YES	Yes	Yes	Yes	No
Zero to 1 v. range on both AC and DC?	YES	No	No	No	No
5000 v. range on both AC and DC?	YES	Yes	No	Yes	No
AC/DC sens: 1000 μ /v.?	YES	Yes	Yes	Yes	No
DC and AC Current Ranges?	YES	No	No	No	No
In KIT and Wired Form?	YES	Wired Only	Wired Only	Wired Only	Wired Only
Lowest cost in the industry?	YES * See Above	No	No	No	No

Write for FREE Catalog MR-6 & name of local dealer.
Prices 3% higher on West Coast.

ELECTRONIC INSTRUMENT CO., Inc.
84 WITHERS STREET, BROOKLYN 11, N. Y.

RADIO & TELEVISION NEWS

of technical judgment, adequate solutions have been arrived at to engineering problems, or when the point of diminishing returns has been reached in the pursuit of a line of scientific inquiry.

"The NTSC, as such, makes no inventions; it designs and makes no apparatus . . . has no licenses and holds no patents," Dr. Baker added.

Summarizing, the NTSC chief said that after more than twenty months of work by some 200 top engineers, after countless combinations of elements and possibilities have been painstakingly analyzed and evaluated, after the accumulation of a library of reference material for the engineers of the industry, and after hundreds of lab tests and experiments in scores of plants, the NTSC is unanimously convinced that under its supervision there has been prepared a set of standards capable of producing a superlative system of color television . . . a system which is completely compatible with the receivers now in the hands of the public, and in fact produces a superior monochrome picture, as well as a superior color image.

To be sure that there are no flaws in the system, an intensive field-testing program has been initiated, the Congressmen were told. After these tests have been completed, and all of the NTSC members are satisfied that the system is foolproof, then the Commission will be asked to adopt the standards, by a formal order, based on procedures followed by the FCC in establishing the monochrome standards in '40-'41.

NTSC hopes, it was said, that the Commission recognizes its existence, and lends its active support, and does nothing to interfere with completion of the current field-testing program.

The sincerity of Baker's statement prompted Representative Wolverton to praise his comments and applaud the work of NTSC. "Certainly during the years that have elapsed," the Congressman said, "this committee of which you are chairman, has given unquestioned evidence of a very keen desire upon its part to accomplish something that would be worthwhile to the public and, stripping your work from all thought of commercial advantage to any one individual or set of individuals, until there has been a completion of the work and the objectives that have been set in the early days by your committee."

Approving the recommendations made and the help offered, the Congressional chairman declared that the NTSC has over a period of years given that service that is so highly commendatory that it would be . . . "difficult to find words to adequately express the appreciation of the high purpose that has guided and directed . . . the group . . . through all these years of trial and error; sometimes undoubtedly tribulations, sometimes success; in season and out of season."

Continuing his enthusiastic appraisal of Dr. Baker and the committee,



Sangamo's dry tubular electrolytic capacitor *that fits anywhere*

Type MT and MTD electrolytic capacitors, "Chieftains" of the Sangamo line, are contained in hermetically-sealed round aluminum cans and are tightly encased in heavy cardboard sleeves on which polarity is clearly indicated. Double, pure paper spacers assure adequate breakdown characteristics and all sections are tightly held in place within the container. Multiple staking connects the terminal tabs to

the electrodes, providing permanent low resistance contact throughout the life of the capacitor. The low voltage units are supplied with etched cathodes to maintain uniform capacity when the capacitor is subjected to heat and high ripple currents. The small size of the "Chieftains" makes them a "natural" for application in tight spots beneath a chassis, and the bare tinned-copper wire leads make them easy to mount.



Arrowhead



Warrior



Mohican

Your own trial-use will convince you that new standards of dependability and longevity have been built into Sangamo Electrolytics. Order from the new Sangamo Capacitor Catalog No. 800A which is yours for the asking, and without obligation.

Those who know... choose Sangamo



SANGAMO ELECTRIC CO. MARION ILLINOIS

Unlimited Opportunities in **RADIO ENGINEERING**

DEGREE IN 27 MONTHS

Complete Radio Engineering course, including Telev., U.H.F. and F.M. Bachelor of Science Degree also in Mech., Civil, Elect., Chem., and Aero. Eng.; Bus. Adm., Acct. Extensive campus, modern buildings, well equipped labs. Low cost. Prep courses. Personalized, practical instruction. Founded 1884. Placement service. Growing shortage of engineers. Prepare now for unlimited opportunities ahead. Approved for Korean vets. Enter June, September, January, March. Write for catalog.



TRI-STATE COLLEGE

1663 College Avenue, ANGOLA, INDIANA

BRAND NEW • FULLY GUARANTEED **SENSITIVE MICROAMMETER**

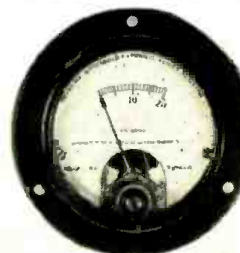

WESTON 301
Original
Weston
Boxes
0-20 Micro-
amps DC

3 1/2" Round Flush
Mount Bakelite
Mfr. for Test Set
TS82—No. K58410
\$9.95 FOB NY
EACH
Rated Accounts 10
Days. Others 25%
with Order. Balance
COD

**GREENWICH
Sales Company**
59 Cortlandt St.
N. Y. 7
Olbyg 9-3813

MFRS QUANTITY AVAILABLE
Spot Delivery
"An" Inspected & Approved

to the

E. E. or PHYSICS GRADUATE

with an interest
or experience in

RADAR or ELECTRONICS

Hughes Research and Development Laboratories, one of the nation's large electronic organizations, are now creating a number of new openings in an important phase of operations.

Here is what one of these positions offers you

OUR COMPANY

located in Southern California, is presently engaged in the development of advanced radar devices, electronic computers and guided missiles.

THESE NEW POSITIONS

are for men who will serve as technical advisors to the companies and government agencies purchasing Hughes equipment.

YOU WILL BE TRAINED

(at full pay) in our Laboratories for several months until you are thoroughly familiar with the equipment that you will later help the Services to understand and properly employ.

AFTER TRAINING

you may (1) remain with the Laboratories in Southern California in an instruction or administrative capacity, (2) become the Hughes representative at a company where our equipment is being installed, or (3) be the Hughes representative at a military base in this country—or overseas (single men only). Adequate traveling allowances are given, and married men keep their families with them at all times.

YOUR FUTURE

in the expanding electronics field will be enhanced by the all-around experience gained. As the employment of commercial electronic systems increases, you will find this training in the most advanced techniques extremely valuable.

How to apply

If you are under 35 years of age and have an E.E. or Physics degree and an interest or experience in radar or electronics,

write

to **HUGHES**

**RESEARCH AND DEVELOPMENT
LABORATORIES**

*Scientific and Engineering Staff
Culver City,
Los Angeles County, California*

Assurance is required that the relocation of the applicant will not cause the disruption of an urgent military project.

the Congressman said: "I feel that you have performed a great and outstanding service to your country and its people, and I wish to assure you that there can be no finer recognition of the fine work that has been done by your committee than for this committee to consider carefully and well the recommendations that you have made, and insofar as it has jurisdiction and power to support and sustain you in the recommendations that you have made. They all seem so reasonable. They all seem so logical and certainly they come with force to this committee, because of the quality of the committee that has given the study and made the recommendations."

The calm of the hearing room was shattered by the testimony of ex-FCC Headman Paul Walker, who served notice that the Commission would adhere to its original decision and approval of the disc color system. Thus far, he said, no one has displayed or demonstrated a system that was superior or equal, or as practical. But, he added, the moment anybody presents evidence of a satisfactory compatible system, the Commission will certainly hold hearings and recommend adoption, if the system merits such a move. Walker then declared that the NTSC certainly has standing to request a revision of the Commission's standards, and any proposal which it advances to the FCC will receive the most careful and objective consideration. However, he continued, it is not possible for the Commission to recognize that the NTSC is entitled to any special recognition over other industry groups, or that the Commission is committed in advance to an endorsement of future NTSC findings, or that the Commission should abdicate in any way to the color committee . . . "the exercise of its judgment, critically and objectively, as to the public interest."

Before the Commission alters its view and issues a new set of standards, it was said, its members and staff will insist on full data and information concerning all conditions under which any tests are conducted, and in addition perhaps demonstrations of side-by-side comparisons resulting from different systems of transmission. According to Walker, the principal factors determining acceptance of a new system will be . . . "the extent to which there is opposition to or competition with any system advanced for our consideration, and the extent to which any such system is shown to achieve that degree of excellence which would warrant its acceptance as the basic color television standard."

NEW-STATION authorization activity continued to romp along at the Commission's offices, as examiners worked assiduously to process applications.

Nearly fifty more were on the approval list, as this column was being prepared; see page 84.

ELECTRONIC'S LATEST TROUBLE-SHOOTER

A compact—complete—
circuit analyzer



ONLY
\$24.95

THE AMAZING TV SERVISSET

Model E-C
(Pat.
Pending)

A precision engineered professional quality electronic test instrument. Ideal for field or bench servicing of Radio, Television, Radar, Communications gear, etc.

Now—Quickly—Conveniently—At Low Cost

CHECKS: sync, sweep, video, audio circuits, TV high voltage supplies (HT, RT, or Full-Set), low voltage supplies, coils, condensers, resistors, tubes, transformers, speakers, etc. Will localize trouble to a particular stage, determine defective component and can actually be clamped in circuit to restore circuit operation temporarily in 80% of component or tube defects. Ideal for locating and continuing intermittent.

SPECIFICATIONS:

RF & AF Signal Tracer, RF & AF Signal Injector, AC & DC Voltage Indicator 0-60/550/20,000, DC Polarity Indicator, 60/550/20,000 volts, Lo ohms 0-5, Hi ohms 0-500k-20 megohms, Tests Condensers .00025-12 mfd., Tests Resistors 2 ohms-20 megohms, 2 Capacitance Sub ranges 01-1 & 4-40 mfd., 3 Resistance Sub ranges 50-500 ohms, 5k-25k, 100k-1 meg.

Will complement your existing equipment and will outperform other testers costing many times more.

A MUST FOR THE MODERN TV AND ELECTRONICS SERVICE ENGINEER.

Comes in handy cloth pouch, complete with all accessories including ALNICO phone, TV high voltage adapter, phone extension cord, test lead, Klipzon adapter and complete detailed Instruction Manual, disclosing latest TV trouble-shooting techniques.

See Serviset at your distributor today. If he can't supply, order direct from factory, \$24.95 postpaid.



LEE ELECTRONIC LABS., INC.
Dept. RN-6
233 Dudley Street Boston 19, Mass.



HIGH
IMPACT
PLASTIC

CONNECTOR

**NOT A REMODELED
CLOTHESPIN**

HAS PROVISIONS FOR THE NEW
R.C.A. - PHILCO PIN TYPE CONNECTION

Also Mfgs. of

**ANTENNAS • TUBE COVERS
REACTIVATORS • SPEAKER GRILLES
TUBE PULLERS • CLAMPS**



ELECTRONICS MFG. CO.
Inglewood, Calif.

SEE YOUR
LOCAL
DISTR.

RADIO & TELEVISION NEWS

Thus far, forty-nine new outlets have actually begun operation since the freeze lift. Of these twenty-nine are now on the very-highs and twenty on u.h.f. as of April 20th. It is expected that at least a dozen more will be on the air when this issue goes to the mailroom at the printers.

According to some estimates, well over a hundred new telecasters will be in operation before the year is over, bringing the total number of TV stations on the air to over 200. In '54 the experts say, at least 400 stations will be operating on commercial basis, with most telecasting on the bands upstairs.

A NEW COMMISSIONER has joined the ranks of the FCC, replacing recess appointee, Eugene M. Merrill, who was named by former President Truman. His name, John C. Doerfer, and his former post, chairman of the Wisconsin Public Service Committee.

Rosel H. Hyde, veteran member of the Commission, has been named FCC chairman for one year, succeeding Paul A. Walker who will remain a Commissioner until his term expires in June.

Mr. Hyde served on the old Federal Radio Commission and then successively as an attorney, hearing examiner, assistant general counsel, and general counsel.

Everyone in Washington feels that Mr. Hyde is more than well qualified to serve as the official spokesman for the Commission and his appointment is a popular one in the Capitol City with both political parties.

EDUCATIONAL TV, which has been tossing about in a stormy sea of politics, will soon undergo the official scrutiny of the Senate Commerce Committee, under the guidance of Senator Tobey, the committee's chairman. Debated will be the knotty problem of channel-reservation continuation for schools, who faced by financial and legislative problems, have been unable to receive official permission to ask for a channel or build if a channel were set aside. The hearing room will undoubtedly be a lively one, for commercial interests will certainly be there to stake a claim for these precious frequencies. . . . L.W.

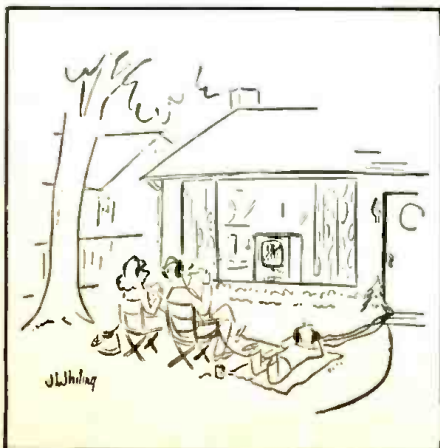

FOR THIS MONTH ONLY—

10TH ANNIVERSARY SPECIAL!
Free delivery anywhere in the U. S. of chassis, tube or cabinet or combination thereof.

**ONLY AT
AIREX**

MOST POWERFUL FRINGE AREA CHASSIS
THE NEW 1953 CO-CHANNEL "630 FA-2"
With Genuine Armstrong FM Sound System

The CHASSIS That Television Engineers and Servicemen Are Buying for Themselves . . .

This amazingly advanced 31-tube TV chassis is years ahead in engineering and gives you the ultimate in TV viewing and listening pleasure. To assure you trouble free TV our engineering staff has incorporated into the "630 FA-2" design the experiences of hundreds of TV servicemen and engineers. Receiving range includes stations up to 200 miles away. Don't confuse our co-channel chassis with cheaper inter-carrier models. Only the best and most expensive parts are used. There is no other chassis that compares with the "630 FA-2"* for fringe area reception.

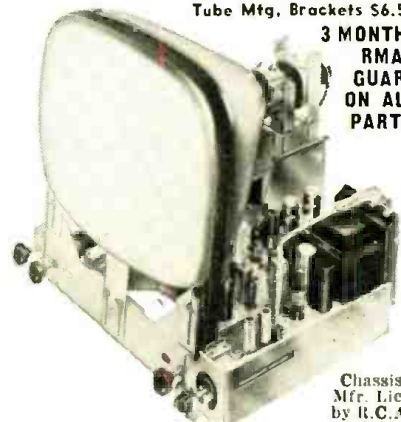

Tube Mtg. Brackets \$6.50

**3 MONTHS
RMA
GUAR.
ON ALL
PARTS**

Chassis
Mfr. Lic.
by R.C.A.

**THE ONLY CHASSIS WITH
PUSH-PULL AUDIO OUTPUT AT**

\$169⁹⁵

Less C.R. Tube
and Brackets

Complete with 12" ROLA Hi-Fi Speaker
(Fed. Tax Incl.)
Detailed Service Manual & Schematic—\$1

CHECK THESE EXCLUSIVE FEATURES

- 10 WATT push-pull audio output. Frequency range from 40 to 12,000 cycles • Standard Coil Cascade Tuner prevents radiation • Retrace Blanking Circuit allows you to raise the brightness without the annoying vertical retrace lines • Heavy duty front focus control • Automatic gain control potentiometer allows you to adjust the threshold sensitivity as low as 4 microvolts & still keep the full 4MC band width • Improved sync amplifier • Improved automatic brightness control • Set aligned for 21.9 MC. New Ham band will not interfere • Improved fused high voltage power supply gives full 14.5 KV under load. Will handle all picture tubes up to 24 inch with full sweep • Improved video amplifier has a gain of 40 • All moulded plastic condensers give long life & trouble-free operation • Easily adapted to new UHF stations in 2 minutes by just changing a strip in the tuner • Extra heavy duty power transformer with large safety factor • 6CB6 tubes in Video IF to give full gain • Extra filtering in power supply for hum & ripple-free operation • Phono Connection & switch on chassis allows you to play your phonograph or tuner through the built-in 10 watt hi-fidelity amplifier • Extra heavy duty focus coil, which runs cool • Full focus cosine yoke.

- Improved video amplifier has a gain of 40 • All moulded plastic condensers give long life & trouble-free operation • Easily adapted to new UHF stations in 2 minutes by just changing a strip in the tuner • Extra heavy duty power transformer with large safety factor • 6CB6 tubes in Video IF to give full gain • Extra filtering in power supply for hum & ripple-free operation • Phono Connection & switch on chassis allows you to play your phonograph or tuner through the built-in 10 watt hi-fidelity amplifier • Extra heavy duty focus coil, which runs cool • Full focus cosine yoke.

TV GOLD PLASTIC MASKS
16" and 17" . . . \$ 4.95
20" and 21" . . . \$ 7.95
24" \$14.95

OVER 100 BARGAIN-PRICED CABINETS FOR TV & AUDIO INSTALLATIONS Send for FREE folder and price list. Full line table models, consoles, consolelets and TV-Radio Phono combinations. Many styles, Mahogany, blonde, etc.

Complete Service Manual For "630FA-2" or Super G30DX—\$1

SEND FOR FREE NEW TV PARTS & HI-FIDELITY EQUIPT. CATALOG

TV PICTURE TUBE SALE
Standard Brands • Factory New
GUARANTEED 1 FULL YEAR

- 10" Tube \$18.95
- 12" Tube \$22.95
- 16" Tube \$25.94
- 17" Tube \$27.95
- King and Sleeve for 24" \$ 7.50
- 19" Tube \$36.95
- 20" Tube \$34.95
- 21" Tube \$39.95
- 24" Tube \$79.95

All merchandise is brand new, factory fresh & fully guaranteed. Mail & phone orders filled upon receipt of certified check or money order for \$25 as deposit on TV chassis. 20% on other items. Balance C.O.D. P.O. O.K. N.Y. Prices & specifications subject to change without notice. No Fed. taxes in N.Y. Prices lower than O.R. SHOWROOM: 171 Washington St., N.Y. 7. N.Y. Gramercy 7-9245. MAIL ORDER DEPT.: 400 Lafayette St., N.Y. 3

AIREX RADIO CORP.

**ONLY
\$395
COMPLETE**

**IT'S EASY TO CHECK ALL TV
RADIO & PICTURE TUBES
WITH THIS
FOOLPROOF TUBE CHECKER**



Get an immediate, positive check on all bi-cath. octal, miniature and picture tubes with this great, new Visulite Tube Checker. Most set failures are due to burnt-out filaments or inter-element shorts. Glow tube on Tube Checker provides instant check of either condition on ALL tubes. Operates on 117 volts AC or DC—completely safe, no shock hazard, cannot damage tube under test. Complete with instructions and pair test leads.

PERFORMS 1001 ELECTRICAL CHECKS
You can also check for continuity on fuses, resistors, iron, broilers, camera flash guns, clocks, fans, heaters, fluorescent starters, door chimes, bells, buzzers, motors, etc. Molded bakelite case, sturdy built for long life of trouble shooting.

MONEY BACK GUARANTEE
Sold on 10-day money back guarantee. This Visulite Tube Checker will save you many times its low cost. SEND NO MONEY—Just send name and address on postcard with words "Tube Checker", and pay postman \$3.95 plus postage and C.O.D. (or remit with order and we pay postage—same guarantee.)

**VISULITE CO. 423 Broome St., Dept. R-6
New York 13, N.Y.**

NOW! BECOME EXPERT AT

RADIO-TELEVISION IN 4 EASY STEPS!

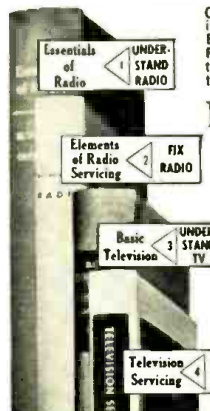

Complete Self-Training Library in RADIO and TV by Famous Experts — Takes You BY SIMPLE STEPS From Basic Theory to Problems of Repair, Installation, Color TV, etc.

NOW you can do ANY Radio-TV installation, service, or repair job like an expert; operate field-testing equipment; understand problems of TV, FM-AM transmission, etc. Step into a good-paying job—or start your own service business. Train yourself AT HOME... IN SPARE TIME... with the McGraw-Hill Radio and Television Servicing Library.

**2296 Pages—
1611 Illustrations**

The men who wrote this complete 4-volume Library are among the outstanding radio and TV instructors in America today. Every detail is clearly explained in over TWO THOUSAND PAGES of step-by-step instruction and over SIXTEEN HUNDRED "how-to-do-it" illustrations, cross-section diagrams, etc. The review questions and answers "nail down" everything you learn. At-a-glance "trouble-shooting" charts show how to diagnose instantly any radio or TV breakdown... and how to repair it expertly and quickly.

The Library will pay for itself many times over. It gives all you need to know for FM and TV in the FCC's 1st-class license exam; gives an experienced technician more confidence and skill.

SEND NO MONEY

Mail coupon below to examine complete four-volume Library FREE for 10 days. No obligation. Or you may examine individual books FREE for 10 days by checking the proper boxes in coupon.

PARTIAL CONTENTS ESSENTIALS OF RADIO.

800 pages, 433 illus. Circuit Analysis • Vacuum Tubes • Circuits: Detector • Amplifier • Tube Oscillator • Power Supply • Transmitting, Receiving • Etc.

ELEMENTS OF RADIO SERVICING.
475 pages, 375 illus. Multimeters AC Power Supply • Speakers • Antennas • Auto Radio • Push-Pull Output Stage

BASIC TELEVISION.
592 pages, 415 illus. Scanning • Synchronizing • Video Signal • Reliability Control • DC Reinsertion • Picture • FM Alignment • Picture Tubes • VHF and UHF transmission • Reception

TELEVISION SERVICING.
429 pages, 388 illus. Antennas • Transmission Lines • Test-pattern and Picture Analysis • Localizing Reception Troubles • Interference Remedies • Deflection Circuits
AND MUCH MORE!

FREE 10-DAY TRIAL COUPON

**McGraw-Hill Book Co., Inc., Dept. RTN-6
327 West 41st St., New York 18, N. Y.**

Send me for 10 day free examination the Radio and TV Servicing Library, 4 Vols. (Regular retail price is \$26.75; Special Course Price only \$21.95 in easy installments.) If not satisfied with Course, I will return it, pay nothing. Otherwise, I'll send \$1.95 plus delivery then and only \$4.00 in monthly installments. If you wish to examine any of these books individually, check below the ones you wish us to send you for 10 Days' FREE EXAMINATION:

- Essentials of Radio, \$7.50
 Elements of Radio Servicing, \$5.25
 Basic Television, \$7.50
 Television Servicing, \$6.50

For any book I keep, I'll send \$2.00 plus delivery in 10 days, balance in easy monthly installments.

Name
Address
City Zone State
Position RTN-6
Company

WE PAY FOR DELIVERY if you send first payment of \$1.95 when ordering Library or full price when ordering individual books (prices above). Same return privilege. (Offer applies to U.S.A. only.)

TV PARTS REPLACEMENT GUIDE

TV POWER TRANSFORMERS

(Continued from page 51)

RECEIVER MFR. Part No.	CHICAGO Part No.	HALLDORSON Part No.	MERIT Part No.	TRIAD Part No.	THORDARSON Part No.
52C196		P9702	P-3169	R-42A	TV-24R98
52C199-C		P9708			
52C204		P9715	P-3073	R-40B	T-26R23
52C204-C		P9715	P-3073		
52C223		P9703	P-3071		
52C224			P-3151		
HOFFMAN					
T5000		P9721	P-3063		
T5002	TP-365	P9721	P-3063	R-31BC	T-26R00
5012	PV-70A	P9302		R-7A	
5015			P-3165	R-34A	TV-24R94
5016			P-3165	R-34A	TV-24R94
5023	TP-360 & FO-615	P9731	P-3078	R-38BC	T-26R00
5027	TP-360 & FO-615	P9731	P-3078	R-38BC	T-26R00
5117			P-3169		
MAGNAVOX					
300045G1	TP-410	P9713	P-3059	R-33BC	T-26R19
300045-1	TP-410	P9713	P-3059	R-37BC	T-26R00
300059-1	TP-382		P-3069	R-38BC	T-26R00
300059G2	TP-382		P-3069	R-38BC	T-26R00
300060-1	TP-355 & PH-50A		P-3067, 2950, 3076, 3074	R-33BC	T-26R19
300064-1					
MAJESTIC					
D9.235		P9731	P-3067	R-33BC	T-26R19
D9.252 (D-9252)	TP-370	P9711	P-3070	R-39BC	T-26R21
D-9252A	TP-370*		P-3076, 3074		T-26R21
Models 12C4, C5, T2, T3; 16C4, C5, T2, T3; 16K1		P9711	P-3067	R-38BC	T-26R00
MECK					
FA-10001		P9731			
TP-10002		P5511†	P-2944†	F-13X	T-21F08
TP-10003	TP-400** & FO-63	P9707	P-3059	R-33BC	T-26R19
TP-10003B	TP-400 & FO-63	P9711	P-3059	R-38BC	T-26R00
TP-10004A		P9711	P-3059	R-38BC	T-26R00
Models MM614C, T; MM616C, T; MM619C; X5B	TP-400 & FO-63		P-3067		T-26R19
MOTOROLA					
25B600684	PV-60†	P9204		R-8A	
25B790140		F5511	P-3074	F-52X	T-21F60
25C90025	TP-400	P9707	P-2956*	R-33BC	T-26R19
25C90026	TP-400	P9707	P-2955	R-33BC	T-26R19
25C484095	TP-450	P9725	P-3067	R-40BC	
25C700161	TP-315	P9715	P-3069	R-39BC	T-26R21
25C700161-9			P-3069		
25C700169	TP-315	P9715	P-3069	R-39BC	T-26R21
25C701025	TP-315	P9715	P-3069	R-39BC	T-26R21
25C701127		P9715	P-3069	R-37BC	T-26R00
25C710656		P9715	P-3069		
25K700882	TP-315	P9715	P-3069	R-39BC	T-26R21
Models 16F1, 16K2, 16T1		P9715	P-3074		T-21F60
MUNTZ					
D-9252	TP-405*		P-3070		
TP-0015-C	TP-370†		P-3059	R-33BC	T-26R19
TP-0018	TP-380† & FO-63	P9705	P-3069	R-35BC	T-26R19
TP-0019	TP-380 & FO-615				
TP-14			P-3070	R-38BC	T-26R00
TP-15			P-3070	R-38BC	T-26R00
TP-15C			P-3070	R-38BC	T-26R00
TP-16	TP-370	P9705	P-3070	R-42BC	T-26R25U
TP-17		P9705	P-3070	R-42BC	T-26R25U
OLYMPIC					
TR-1351	PH-200	P9405	P-2955†	R-20B	T-26R23
TR-1474	TP-355	P9713	P-3059	R-35A	T-26R19
TR-1688	TP-355†	P9713	P-3059	R-38BC	T-26R00
TR-1966	TP-360	P9713	P-3059	R-35BC	T-26R19
Models 762, 783, 967, 968, 970	TP-355	P9713	P-3070		T-26R19
PACKARD-BELL					
86036	TP-370 & FO-63	P9731	P-3066	R-38BC & F-52X	T-26R00
89027A			P-3166	R-31A	T-26R00
89030			P-3166	R31-A	T-26R00
89032	TP-360**	P9708	P-3169	R-33A	T-26R19
89033			P-3166	R-32A	T-26R00
89035	TP-370*	P9705	P-3067	R-42BC	T-26R25U
89036B	TP-370 & FO-63		P-3066	R-38BC	T-26R00

*Add Series Resistor to Reduce "B+" Voltage. †Drill New Mounting Holes.
**Use Universal Mounting Brackets.

(To be concluded next month)

Technical BOOKS

"TV TEST INSTRUMENTS" by Milton S. Kiver. Published by *Howard W. Sams & Co., Inc.*, Indianapolis 5, Indiana. 148 pages. Price \$3.00. Paper bound.

As the author states in the preface, this book is designed to foster a better understanding between the service technician and the test instruments with which he works. By making "friends" of his servicing aids the technician can do more work in less time and, as a result, become a better service technician.

The book is divided into seven sections covering the v.t.v.m., AM signal generators, sweep signal generators, oscilloscopes, special TV test instruments, TV and FM receiver alignment, and the use of test instruments in TV servicing.

Each of the sections covering specific equipment includes a general discussion, an explanation of the operation of the unit, and then applications of the equipment are discussed. Photographs and circuit diagrams of commercially-available units have been used to amplify the text material.

The book is clear, down-to-earth, and easy-to-understand. The "old hand" at the servicing game will derive as much benefit from this text as will the apprentice technician.

"UHF CONVERTERS" by the Sams Staff. Published by *Howard W. Sams & Co., Inc.*, Indianapolis 5, Indiana. 42 pages. Price \$1.00. Paper bound.

This information-packed little book tells how u.h.f. converters are designed and how they work. It provides a detailed description of all the popular converter designs and explains how they work with present v.h.f. sets.

The book covers twenty-one converters produced by *Arrin, Crosley, Du Mont, General Electric, Mallory, Motorola, RCA, Raytheon, Regency, Sarkes-Tarzian, Standard Coil, Stromberg, Sutco, and Sylvania.*

A TV allocation table for all 82 channels is also included for ready reference.

"SOUND REPRODUCTION" by G. A. Briggs. Published by *Wharfedale Wireless Works*, England. 364 pages. Price \$6.75. Third Edition. Available in the U. S. at *The British Book Centre*, 122 E. 55th Street, New York, N. Y.

The popularity of the first two editions of this work has dictated the release of this revised and enlarged third edition.

New material in this edition includes data on high fidelity, room acoustics, cone resonance, resonators, vented enclosures, transient response, response curves by oscillogram, the ear, interference, magnetic recording, recording technique, pickups, and home recording.

The book is divided into two main

Linearity adjustments in the palm of your hand...

with the CREST TV BAR GENERATOR

Provides actual bar pattern on TV receiver screen

A highly efficient, portable, lightweight unit provides servicemen with the sensibly engineered Television Bar Generator. On the spot accurate linearity adjustments.

- Can be used when no stations are on the air.
- Produces horizontal or vertical bars.
- Adjustable number of vertical and horizontal bars.
- Simple self-powered plug-in unit... fits picture tube... no tools required for this 10-second installation.
- Vest pocket size... stow conveniently in tool box.



Model MA-4

\$10⁹⁵

LIST PRICE



\$17⁹⁵

LIST PRICE

When ACCURATE voltage boost is required
CREST LVB-117

The LVB 117 is engineered to safely and accurately restore required voltage to any TV set or electrical appliance. Insures full strength and proper width and height of TV picture when low line voltage weakens and shrinks picture. Corrects low line voltage sync and oscillator drift troubles.

6 unique features for the ultimate in accurate voltage boost!

- ✓ 350-Watt Rating... ample for most requirements on line voltages from 90 to 135 volts.
- ✓ Simple External Plug-in... 10-second installation.
- ✓ Automatically Operated... turns on and off with set or appliance.
- ✓ Multi-Tap Selector Switch... permits exact voltage boost.
- ✓ Overload Fuse Protection... protects against unsafe line voltage increase.

Now available in the **CREST LVB "Jr."**
Single Switch Control... for 10 volt boost or straight-thru line. 350 watts rating.

Inadequate picture width	Tube failures
Insufficient height	Low sensitivity in fringe areas
Weak picture brightness	When caused by low line voltage.
Poor sync and oscillator drift	

Catalog No. 3021



LIST PRICE

\$9⁷⁵

CREST

LABORATORIES INC.

See us at the Electronics Parts Show, Chicago, Booth 120

84-11 Rockaway Beach Blvd., Rockaway Beach, N. Y.

The HIT of the Chicago May Parts Show



JSC progress in Tubular, UHF, Perforated, Open Line TV transmission wire and many other items warmly cheered at the big '53 show!

Always Look For The JSC Orange and Blue Disc Of Quality.

EASY TO LEARN CODE

It is easy to learn or increase speed with an Instructograph Code Teacher. Affords the quickest and most practical method yet developed. For beginners or advanced students. Available tapes from beginner's alphabet to typical messages on all subjects. Speed range 5 to 40 WPM. Always ready—no QRM.



ENDORSED BY THOUSANDS!

The Instructograph Code Teacher literally takes the place of an operator-instructor and enables anyone to learn and master code without further assistance. Thousands of successful operators have "acquired the code" with the Instructograph System. Write today for convenient rental and Purchase Plans.

INSTRUCTOGRAPH COMPANY

4711 SHERIDAN ROAD, CHICAGO 40, ILLINOIS

WORLD'S LARGEST MANUFACTURER
OF CUSTOM BUILT TELEVISION

MATTISON

SILVER ROCKET 630 CHASSIS

• with TUNEABLE •

BUILT-IN BOOSTER

for Better DX Reception

Featuring NEW CASCODE TUNER
made for UHF interchangeable
tuning strips and 70° COSINE YOKE

Tube
Complement:
28 tubes
3 rectifiers
1 CRT

32

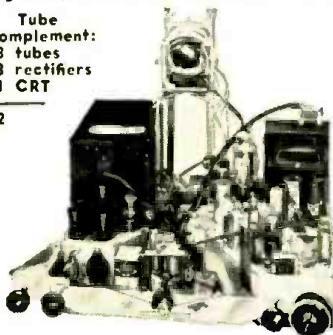

All Channel Booster

• Broad band single knob control pre-amplifier built in to eliminate long leads which may cause regeneration and attenuation of signal.

• ONLY THE MATTISON 630 CHASSIS HAS AN ALL CHANNEL TUNEABLE BUILT-IN BOOSTER THAT INCREASES SIGNAL STRENGTH UP TO 10 TIMES. THE SILVER ROCKET WILL OUTPERFORM ANY CHASSIS MADE AND IS PRICED RIGHT TO SELL FAST WITH AN EXTRAORDINARY MARGIN OF PROFIT FOR YOU. WRITE FOR CONFIDENTIAL PRICE SCHEDULE.

ALL CABINETS MADE IN MATTISON'S OWN CABINET FACTORY!

ANNOUNCING
the New
AMBASSADOR
for 1953

The only open
face console
made in every
expensive
decorator
finish . . . on
guaranteed
genuine ma-
hogany, walnut,
oak and other
rare woods!



The AMBASSADOR 17" and 21"
Best Looking . . . Best Value, Too!

Full size console for eye level television. Available in every expensive decorator finish. Featuring removable safety glass. Dimensions height 42 inches, width 26 inches, depth 23 inches.

DEALERS! SERVICE DEALERS! Here is your opportunity to become the "important" TV Dealer in your area for THE FINEST CUSTOM-BUILT LINE OF TV RECEIVERS. FREE!! Write for Mattison's merchandising portfolio explaining the "UNASSEMBLED PLAN" and "\$1,000,000 FLOOR PLAN."



Manufactured with integrity

When you buy from Mattison you need only one source of supply! You can buy a Mattison Chassis, a Mattison Cabinet or a complete Mattison TV Set!

Mattison Television & Radio Corp.

10 West 181st St., Dept. RN, N.Y. 53, N.Y.

sections and 28 chapters. The first 18 chapters in Part 1 deal with loudspeakers, their application, performance, and design. The balance of the material appears in Part 2 under the general heading of recording.

Since this work is addressed to the layman, the treatment is non-technical but much of the data would be of considerable value to the audiophile or the technician working with high-fidelity equipment. The book is lavishly illustrated with actual oscillograms, performance graphs, circuit diagrams, and photographs.

The author's style is refreshingly witty so that the book makes good as well as informative reading.

"TV SERVICING SHORT-CUTS" by Milton S. Kiver. *Howard W. Sams & Co., Inc.*, Indianapolis 5, Indiana. 98 pages. Price \$1.50. Paper bound.

This handy, pocket-sized book contains a wealth of practical information in its relatively few pages. The approach to troubleshooting is straightforward and informal.

The material is presented as "Case Histories" with actual receiver chassis and service faults being discussed. Each "Case History" first lists the complaint as the set-owner might report it to the technician. The discussion then outlines the technical reasons behind the complaint and then a series of steps the technician should follow to cure the fault.

A cross-referenced index permits the service technician to find data on a specific complaint irrespective of the chassis make and model involved. The text is well illustrated with CR tube patterns and circuit diagrams of portions of the circuits involved in the specific fault.

As is the case with all of Mr. Kiver's writings, the material is clear, easy-to-read, and authoritative.

"HOME MUSIC SYSTEMS" by Edward Tatnall Canby. Published by *Harper & Brothers Publishers*, New York. 296 pages. Price \$3.95.

How can a layman select a satisfactory high-fidelity sound system which will meet both his economic and aesthetic requirements? The author, a well-known record columnist, has provided the answer in this informal and easy-to-read handbook for the non-technical music enthusiast.

The author discusses the various components comprising a home high-fidelity system and then outlines the desirable performance characteristics which the equipment should possess. Various commercial models are illustrated and described with prices being included as a guide to assembling systems in different price classes. Separate chapters on amplifiers, the speaker, the record player, speaker enclosures, etc. provide a "guide book" for those making excursions into the high-fidelity field for the first time. Correct placement of the equipment and other pertinent data is also included.

NOW — Real HI-FI LOW COST TAPE RECORDING EQUIPMENT

PT-3M
DUAL-TRACK
DUAL-SPEED
3.75 & 7.5 i.p.s.
TAPE
MECHANISM
\$59.75



PRE-7 PRE-AMP
\$39.75

This high quality, low cost tape recording combination by Pentron is ideal for all custom installation work. Can be mounted on slides, or built into present phono drawer. Easily built into your present system — or design your new system around this great pair. Frequency response 50 to 11,500 at 7.5 i.p.s. Immediate delivery — from stock!

PMC — Portable Carrying Case with both units above, complete \$114.50

ARROW ELECTRONICS



BEAUTY IN SOUND

65 CORTLANDT ST., NEW YORK 7, N. Y., DIGBY 9-4714

Now! HANDLE UP TO 90% OF TV TROUBLES

by the easy

PICTURE
ANALYSIS
METHOD!



PIX-O-FIX
TV TROUBLE
FINDER GUIDE

By
Ghirardi & Middleton

WHAT TO DO —
HOW TO DO IT

Step-by-step repair instructions follow. Components likely to be faulty are specified. Quick tests are outlined. PIX-O-FIX guides you every step of the way! Remember! PIX-O-FIX is NOT a "fix-it-yourself" gadget for consumers. It is a truly professional device for servicemen, apprentices and students — prepared by two of the nation's foremost service instructors — A. A. Ghirardi and R. G. Middleton.

MONEY BACK IF YOU'RE NOT SATISFIED!

Simply pin a \$1 bill to this ad. Mail with your name and address to the publisher. If not satisfactory, return PIX-O-FIX in 10 days and your \$1 will be refunded promptly. (Price outside U.S.A. \$1.25. Same money-back guarantee).

Only \$1.

Covers 24 common troubles identified by actual screen photos

• • • 190 possible causes of these troubles localized to receiver stage or section where they are most likely to occur.

• • • 253 step-by-step remedies for these troubles.

• • • 4,500 words in CAUSE AND REMEDY section to show just what to do.

Dept. RN-63, RINEHART BOOKS, Inc., Technical Div., 232 Madison Ave., New York 16, New York

Communications in Korea
(Continued from page 38)

four stations assigned to the same frequency. These are carefully chosen considering the distance between each and the direction in which the antenna will be pointed. However, many times frequency assignments that appeared "clear" have been blocked by stations 200 and 300 miles away with antennas close to sea level. In some of these cases the interfering station has had its transmitting antenna oriented at right angles to the receiving antenna yet the interfering signal would be just as strong as that produced by the desired transmitter only 15 or 20 miles away. This may be explained on the basis of sporadic "E" layer, skip, or multiple reflections from intervening terrain features.

There is much more, though, to installing the station than drawing profile charts of the transmission paths. After the preliminary engineering of the system has been completed, survey teams are sent out to each proposed site to conduct a reconnaissance of the area. These teams usually carry a receiver and small power unit with them to test the shots that will be used on the system. Plans have been drawn to equip a helicopter with v.h.f. equipment and dispatch it to the proposed mountain top. The "Chopper" will then hover at standard antenna height and conduct transmitting and receiving tests with the distant station.

When the survey teams (or helicopter) return, their reports are studied carefully to see if the terrain is such that the station can be installed and maintained throughout the year. If the site appears suitable, the full team is sent out with all the necessary equipment and supplies. The team will then set up a base camp as close as possible to the mountain and arrange for laborers at the nearest village. Working with Korean "papasans" the thousands of pounds of gear are hand-carried up rocky, winding trails cut in the side of the mountain. Take the case of "Boston" relay station located in central Korea on a high peak. This station has over 20,000 pounds of operating equipment not including the buildings that house the men and equipment. Each day, all year round this station requires 1500 pounds of gas, oil, and rations. Every day a line of laborers starts up the steep trail with gas cans or cases of food. Heavier loads are carried on "A" frames strapped to their backs. The climb takes about three-and-a-half hours but "papa-san" takes it in his stride. The loads that these men carry are staggering: During the installation of a station these laborers carry complete 315-pound power units to the peak in little more time than it takes a G.I. to climb it with no load. The record, however, belongs to one aged "Chige" bearer that

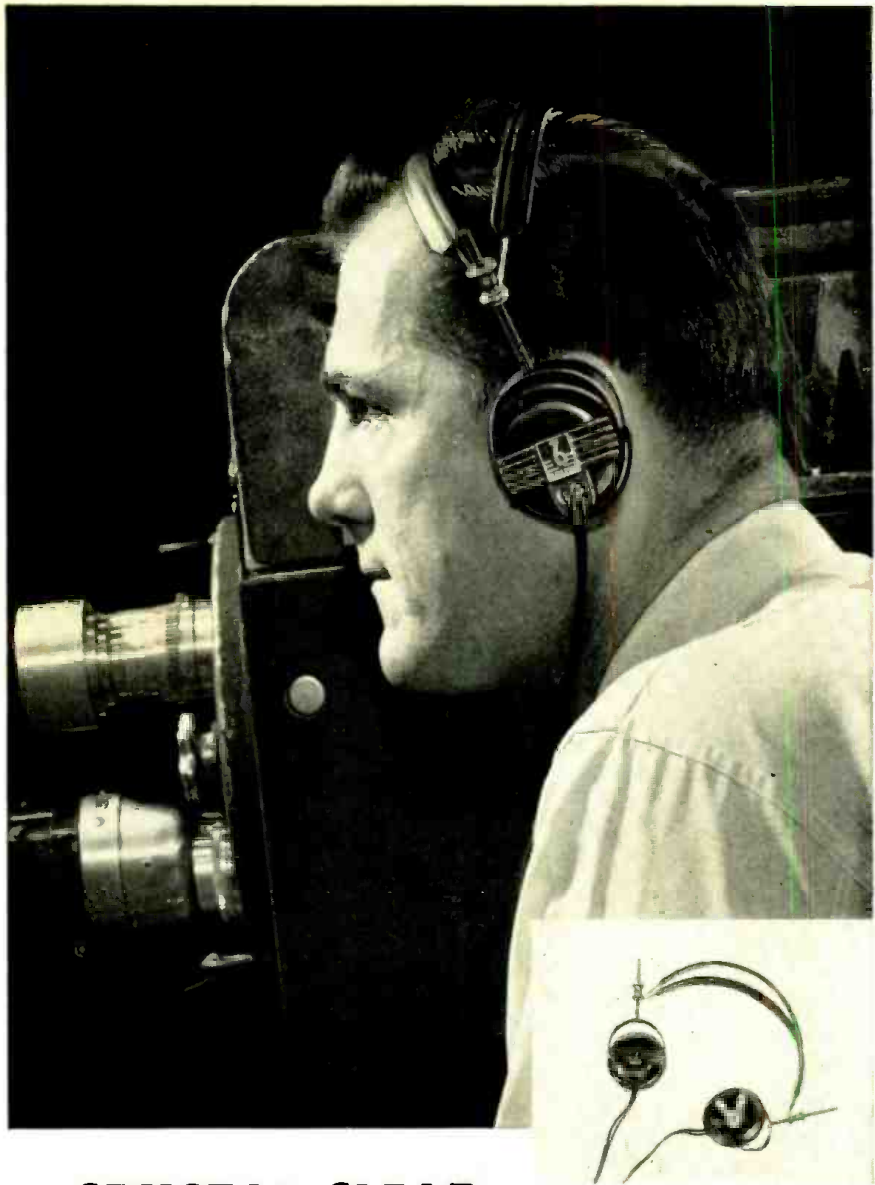

CRYSTAL CLEAR . . .
here's the best by Brush!

These Brush Model BA-206 Headphones, designed around the exclusive BIMORPH® crystal-drive element, are your best choice for high fidelity and smooth frequency response. By their nature they draw negligible power and only require modest driving voltages. Hence, these headphones are ideal for monitoring applications...may be used in either high or low impedance circuits and are extremely well suited for multiple installations. They are of rugged, shock-proof construction...light-weight yet powerful. Advanced design gives your ears a smooth, comfortable air-tight fit for excellent bass response. Here is the ultimate in headphone quality at a fraction of the price you'd expect.

Brush crystal products are leaders in their fields because for many years Brush has specialized in research, development and applications of piezo-electric crystal materials. Write for bulletin. Brush Electronics Company, Dept. UU-6, 3405 Perkins Avenue, Cleveland 14, Ohio.

BRUSH ELECTRONICS

INDUSTRIAL AND RESEARCH INSTRUMENTS
PIEZO-ELECTRIC MATERIALS • ACOUSTIC DEVICES
MAGNETIC RECORDING EQUIPMENT
ULTRASONIC EQUIPMENT



COMPANY

formerly
The Brush Development Co.
Brush Electronics Company
is an operating unit of
Clevite Corporation.

CREATED FOR

the
Discriminating

MODEL 2430

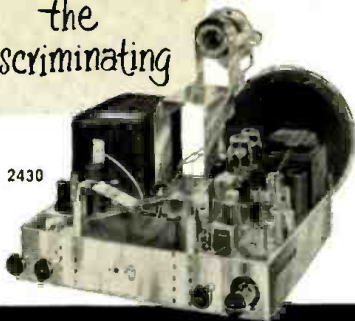

TECH-MASTER Custom-Built TV CHASSIS

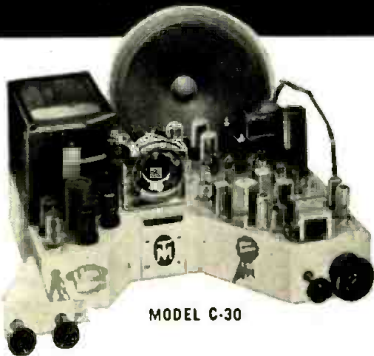

MODEL C-30

Model 2430: GOLD MEDAL TV Chassis

World's most powerful, most dependable TV receiver. Custom-designed and custom-built to provide the ultimate in sight, sound and value.

- Improved 630 type chassis.
- Advanced Cascode Standard turret tuner, adaptable to UHF without tools.
- Full 4 Mc. bandwidth.
- Quick action keyed AGC circuit.
- New, HI-sweep auto-transformer system.
- 5 Microvolt sensitivity.
- Phono-input circuit.
- For all picture tubes from 16" to 24".

MODEL 2430: with quality PM speaker, all tubes less picture tube, universal picture tube mounting brackets. Equipped with audio take-off to feed sound through external amplifier, if desired **\$189.50**

MODEL 2431P: Same as 2430, (less sound take-off), but with true fidelity Push-Pull audio amplifier **\$199.95**

MODEL 2430-9: For new 90" kinescopes, (24" rectangular, 27" and 30"). Features similar to 2430, but incorporates new high voltage horizontal and vertical sweep circuits. Less picture tube and mounting brackets **\$262.50**

Model C-30: BLUE RIBBON TV Chassis

Custom designed, custom built, yet economically priced no higher than mass-produced models.

- Retains the outstanding characteristics of RCA-630 circuitry, namely 4-stage, full bandwidth picture IF strip, and 3 stage FM sound section.
- Latest synch and sweep circuits.
- Advanced Cascode turret tuner adaptable to UHF without tools.
- 5 Microvolt sensitivity.
- Permanent magnetic focuser.
- Double time constant AGC.
- 29 tubes (including 3 rectifiers).
- Phono-input jack (with front panel switch.)
- For all picture tubes from 16" to 24".

MODEL C-30: With quality PM speaker and all tubes (less picture tube), completely wired, aligned and tested. **\$149.50**

At all Leading Radio Parts Distributors



TECH-MASTER PRODUCTS CO.
443-445 BROADWAY, NEW YORK 13, N. Y.

packed a 400-pound squad tent up a rugged peak and turned right around to bring another load up the mountain that same day.

Now well established, "Boston" relay is a beautiful spot. An operations shack houses all the equipment and neat runs of coaxial cable fan out to the transmitting and receiving fields. Power is supplied by five 1000 watt gasoline driven generators dug into the side of the mountain and protected from the weather by a bunker constructed of local timber. The antenna arrays are mounted on masts up to 50 feet in height and guyed every 5 feet to withstand winds up to 80 miles-an-hour.

At some of the larger terminals, the standard antennas are mounted on fixtures constructed of 70-foot poles and 20-foot crossarms. This arrangement reduces the space requirements where many antennas must be erected and simplifies both the job of "cutting" the elements to frequency and maintaining them periodically.

The men at the different stations have simplified the job of replacing equipment by the addition of ingenious switching systems that transfer antenna coax, power, and input cables from one unit to another. The terminals in Seoul have such an arrangement, and, in addition, a monitor phone that can be patched into any circuit of any system to aid in troubleshooting. A bank of indicator lamps shows at a glance which equipment is operating in any circuit at any given time and to which circuit the monitor phone is patched.

Not only can helicopters be used for survey purposes, as mentioned previously, but they can be used to install the station itself by acting as a flying elevator from the base camp to the mountain peak. This method was actually attempted several times during the past two years.

While it would be possible for a lightly loaded "Chopper" to hover some distance above the peak for a reception test, experience has shown that the wind at high altitudes and the thinness of the air make it dangerous to carry the heavy loads required close enough to the peak so that they may be lowered by winch. Air drops, however, have been made several times to stations that have been isolated by storms. One Air Force station was kept supplied for an entire winter in such a manner with everything from 55-gallon drums of gas to fragile crystal units.

An unusual solution to the problem of a unit commander keeping in telephone contact with his headquarters while he was touring the front was solved very neatly by the use of v.h.f. equipment. As shown in one of the photographs, the transmitter, receiver, and one antenna are mounted in a jeep and the other antenna and power unit were installed in the trailer behind. Through the use of voice frequency ringing equipment the operator of any switchboard in Korea could

NEW, UHF BOW-TIE ANTENNA

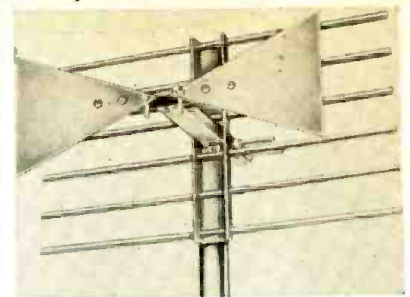

The only flexibly constructed Bow-Tie and Reflector Antenna made for all UHF channels. Average 7 db gain for all UHF channels.

\$395 lots of 3

\$4.45 ea.

ANTENNA SPECIALS

Double "V" .. ea. \$2.95	300 ohm wire, per 100 ft. \$ 1.95
10-element conical ... ea. 3.95	300 ohm wire, per 1,000 ft. 14.95
New UHF-VHF conical "V," very hi-gain. ea. 8.95	UHF Hi-gain wire... per ft. 5c
	72 ohm wire, per ft. 5c
60° Yoke ... ea. \$1.29	U.L. Approved Lightning Arrester ... ea. \$.69
70° Cosine yoke. ea. 3.95	Chimney Mount. Pr. 1.79

Latest Model 630 DX CHASSIS

Complete, with all tubes, \$12" speaker and Cascode tuner. **\$145.50** (less CRT)

Don't Throw Your Old Picture Tube Away!
PICTURE TUBE BRIGHTENER lots of **\$149** EA.
Adds to new life and extends life of picture tube. For clearer, sharper pictures!

FREE: Ask for new catalog. Min. Order: \$5. 25% deposit with order. All mds. subject to prior sale, F.O.B. N. Y. Prices subject to change without notice.

New address: 76 Vesey St., Dept. R-6
New York 7, N. Y.
Cortland 7-6195

The ROSE Co.

Looking for ELECTRONIC VALUES Harjo Has 'Em!

Ceramic Condensers! \$10 Value. **\$1**
Kit of 50 asstd. Brand new, standard brands. Postpaid

BRAND NEW 67 1/2 V. BATTERY—Standard Type. Army Surplus. Fine for portable radios, Geiger counters, Test equipment. Dealers ask for quantity prices. **98c**

\$2.65 Value. Only **\$3.95**

METER SPECIAL. 0-1 MA Meter, 2" round, new, boxed. **\$3.95**

TEST EQUIPMENT
DRASTICALLY REDUCED!
TS-47/APR TS-183/U IE-19
TS-89/AP TS-184/AP I-56
TS-126/AP TS-204/AP I-72-J
TS-131/AP IE-17 710A UHF Slg. Gen.

LOOKING FOR RADAR EQUIPMENT?
Parts Also Available!
APS-3 SN AN PPN2 APQ-13
APS-4 SA ARQ-8 APS-15
APT-5 AN/PPN1 TPN-2 APA-17
APA-23

IN STOCK RIGHT NOW!
BC-348 BC-342 BC-611
ARC-3 ARC-1 ARC-13
BC-22 1 APN-9 LM

SPECIAL VALUE!
Acorn Tubes 954 and Sockets. Brand New. Per set, 29c. 4 sets. **\$1**

Attention: Schools, Labs, Hams!
WE PAY MORE for Radio Parts, Equipment! Cash in surplus—or trade. Write now.

Write for FREE Surplus Catalog
HARJO SALES CO., Dept. R-2
4109 Burbank Blvd., Burbank, Calif.
P. O. Box 1187, Magnolia Park Sta.
Cable: HARJO Phone: Rockwell 9-2411

ring the telephone in the jeep, and, conversely, the commander could establish a direct telephone circuit through his home switchboard while moving or stationary. The voice frequency ringer converts the 20-cycle output of the standard switchboard into a 1000-cycle note interrupted 20 times a second which can be transmitted over a voice circuit. At the distant terminal, in this case the jeep, another ringer converts the 1000-cycle ring back to 20-cycle ringing current which can be accepted by a switchboard or local telephone. The antennas in this case are polarized vertically and have the reflector and director removed to minimize directional effects.

To give an idea of the extent of v.h.f. systems now in use in Korea, it would require at least 30,000 miles of wire circuits to duplicate the facilities provided by the v.h.f. radio relay systems. This figure is based on the air-line "lengths" of transmission paths. The wire figure would undoubtedly be much higher due to the fact that wire routes usually follow existing roads or valleys which do not usually run in a straight line to the distant headquarters.

In World War II v.h.f. was used only as far down as Corps headquarters and only rarely to Divisions. Now, in Korea, v.h.f. serves every American regiment on the line. This means that each regiment has three voice circuits and four teletype circuits that can not be cut by the enemy, that will not break under the weight of heavy ice loads, and, most important: that will "follow" the headquarters as fast as a 3/4 ton weapons carrier with the equipment installed can be driven to the new site.

The work necessary to install, operate, and maintain a chain of v.h.f. stations has been proved to be only a fraction of that required for similar wire routes when extended distances are involved. Under the conditions encountered in Korea where communications are subjected to severe winters, guerrilla attacks, and flash floods that sweep over wide areas, v.h.f. radio relay systems have provided high quality, efficient, noise-free telephone and teletype circuits for the UN Command.

BRITISH SCOUT STATIONS

SPECIAL licenses have been authorized in Great Britain for low-power stations to be used in the training of Boy Scouts in radio telegraphy, according to "Wireless World."

Frequencies have been assigned in the amateur two-meter band for training nets made up of five-watt fixed stations working a given number of one-watt portable stations within a ten-mile radius. All stations in the net operate under the call sign of the fixed station with added suffixes "/1," "/2," etc. Contacts may be made only within the net and on e.w. only; other operating conditions are generally the same as stipulated for amateur stations.

Let MILTON S. KIVER Help You Prepare For U.H.F.-TV And...



Easy to TRAIN AT HOME This Practical Way!

Men with the right training in Television Servicing are in big demand . . . pull down big pay. T.C.I. TRAINS YOU RIGHT with easy-to-follow technical training designed by servicemen, for servicemen! You learn practical, professional type Television Servicing without leaving your present job. Included are money-making extras such as set conversion, master antenna installation, U.H.F.-TV and field servicing short cuts. You can start earning Television money after the first few lessons. You learn to test, trouble shoot and repair all types of TV sets the proven, practical way!

HERE'S HOW YOU GET EXPERIENCE!

You train on your own large screen modern television receiver, furnished as part of your course. This set is yours to keep! As an optional feature you can get two weeks of actual field experience out on service jobs and on the repair bench for Chicago's largest independent servicing organization. You learn Television Servicing by actually doing Television Servicing . . . you get the practical know-how you need to qualify for BIG MONEY in this fast-growing field! Age is no barrier, Many TCI students are over 40!

VETERANS!
T.C.I. is approved for G.I. training under Public Law 550. Check coupon.

ACT NOW! Mail coupon for FREE Catalog and SAMPLE LESSON. Write TODAY!

TELEVISION COMMUNICATIONS INSTITUTE
205 W. Wacker Dr., Dept. L-AL Chicago 6, Ill.

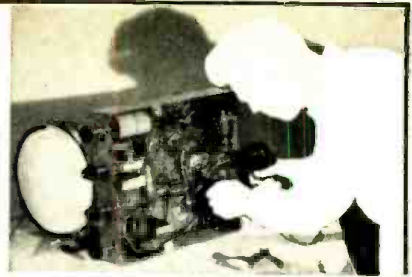

YOU GET and keep modern large screen Television receiver.

YOU DO actual testing, servicing, trouble shooting and repairing

TV BROADCASTING COURSE READY NOW!
Train at home for these big pay studio jobs! Video engineers, cameramen, microwave engineers, etc. Easy non-mathematical training covers all phases. Write!

MAIL NOW FOR FREE BOOKLET

MILTON S. KIVER, President
TELEVISION COMMUNICATIONS INSTITUTE
205 W. Wacker Dr., Dept. L-AL, Chicago 6, Ill.

Hurry fill facts on the course checked below. I am not obligated. Salesman will not call.

TV Servicing TV Broadcasting

Veterans: check here

Name

Address

City..... Zone..... State.....

BEGINNERS check here for information on Pre-Tel Radio Course.

!!EVERYONE CAN DO IT!! . . . SAVE \$\$\$ REPAIRING YOUR OWN SPEAKERS!!!
Use LEOTONE precision-made CONE & VOICE COIL ASSEMBLIES, complete with Shilder, leads & instructions. Give all specs. or sample.
Any 4" or 5" Ass'd. \$1.10; Any 6" Ass'd. \$1.50; Any 4"x8" \$1.50; Any 6"x8" \$1.80
!!SPECIAL!! KIT OF 10 ASSTD. CONE & VOICE COIL ASSEMBLIES (2 each) \$12.50 (Ready to install)
CONE CENTERING SHIMS . . . 16 coded plastic in leather case39
SPEAKER CEMENT & SOLVENT . . . 3 oz.89 each & brush89

!!SUPER \$\$\$ SAVINGS!! with the NEW "JUMBO RADIO - ELEC. TRONICS KIT" - a "Old Mine" of inventory odds & ends. WIRE SOCKETS, CONTROLS, SWITCHES, RESISTORS, CONDENSERS, ETC. ETC. (shpr. wt. 20 lbs.). **\$3.95**

OIL CAPACITORS hermetically sealed . . .
.05mf 100V-15c25mf 400V-39c
1mf 200V-39c10mf 500VAC-99c
2x.5mf 200V-29c2mf 600V-59c
3x.5mf 100V-29c3mf 600V-79c

12 1/2 FT. WHIP ANTENNA . . . 4 steel sections. \$1.98
RADIO HARDWARE TREASURE FULL LB. CAN of Nuts, Screws, Washers, Lugs, Etc. .89
"DUNCAN" OUTPUT TRANSFORMER (1 1/2" x 7/8" x 1") any beam power tube for voice coil. .98
5" SCOPE FRONT PANEL & BEZEL (12V) (10" x 14" punched & etched for all controls. 1.98
5 1/2" CLEAR CONVEX LENS to fit above. ea. .39
5" SCOPE GRID . . . 300 radial calibrated. ea. .39
5" SCOPE VISOR . . . moulded vinylite. ea. 98c; 6/5.00

HI-FI CRYSTAL HAND MIKE . . . Hi-Impedance, moulded bakelite case, 5 1/2 ft. cable. \$3.95
CARBON RESISTORS . . . 2-watt Kit (100 ass'd.) 1.98
MOULDED BAKELITE CONDENSERS (Micomold) . . . 200mf. 2mf. 200-600V. . . 70 ass'd. \$1.98; 100/2.98

!!TUBE CLEARANCE SALE!! 90-DAY GUARANTEE Standard brands, unsealed cartons.
= 24.98, 27.25, 41.42, 55.55, 65.80 or 687. 29c
= 1J14, 1H6, 146, 6B7, 6E5, 6G5, 6SD7, 6SH7, 6H7, 78 or 80. 39c
= 35.30, 45.71, 77, 114, 5Y3, 5Y4, 5U4, 6AU6, 6E6, 6T5, 6J6, 6C5, 6K6, 6SA7, 6SK7, 6SQ7, 6U7, 6W4, 74, 4-788 or 707. 59c
= 74-4-788 or 707. 59c
= 1A7, 1LC6, 1LH, 2A5, 2A6, 6A3, 6A6, 6A8, 6H8, 6SC7, 6SF5, 6SN7, 7A7, 7AG7, 7C5, 7C6, 7Y4, 12AU7, 12SN7, 47, 50, 57, 58 or 81. 69c

"DIRECT FACTORY SPEAKER REPAIRS SINCE 1927"
Min. order \$2.00. 20% deposit req. on all C.O.D.'s. Full remittance with foreign orders. Please add sufficient postage-excess refunded.

LEOTONE RADIO CORP.
67 Dey Street
New York 7, N. Y.

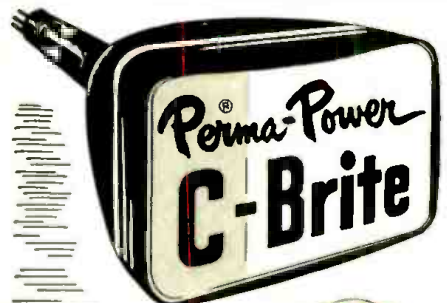

to add increased brilliance to any TV PICTURE TUBE

manufactured by
Perma-Power COMPANY
Chicago 25, Illinois
Manufacturers of Electronic Equipment Since 1928

**ONLY ONE
OF ITS KIND!**

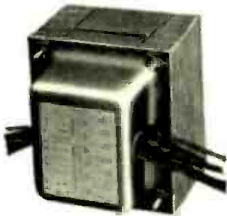

**THE THORDARSON-MEISSNER
T-26R00**

■ Here is the only truly universal replacement power transformer made!

The T-26R00 is the perfect replacement power transformer for OVER 1200 existing TV models and will serve as replacement in over 90% of present and proposed TV sets! No longer is it necessary for the serviceman-dealer to stock 25 or 30 different power transformer types to cover the replacement field. Although the T-26R00 was designed primarily for TV use, it also fully meets requirements in many other applications.

TAPPED SECONDARY WINDINGS

The T-26R00 has tapped secondary windings with output voltages of 600 volts c/t, 720 volts c/t, 840 volts c/t at 295 ma. One 5V, 6A, and one 5V, 3A rectifier windings and four 6.3V, 3A, heater windings.

THORDARSON-MEISSNER advanced design combines new non-hygroscopic insulation with new improved silicon steel core laminations to reduce size, increase efficiency and provide higher voltage protection. The T-26R00 contains dual electrostatic shields, heavy copper flux-shorting band and external steel end shields.

SPEEDS REPLACEMENT JOBS

The T-26R00 has long UL approved color-coded leads and a coded diagram is printed on the shell to facilitate the replacement connections and trouble shooting. Four auxiliary brackets are furnished, for easy up-right or flat mounting above or below chassis.

USE THE BEST—THORDARSON-MEISSNER T-26R00. Your Jobber stocks them. Ask him for a copy of the THORDARSON-MEISSNER TV Replacement Guide.



THORDARSON-MEISSNER

MT. CARMEL, ILLINOIS

SPEAKER RECONING

Complete line Cones, Spiders, Rings and Voice Coils, Custom Built Voice Coils. Low prices. Write for Parts List and Reconing information.

WESTERN ELECTRONICS CO.

3164 West Colfax Denver 4, Colo.



**BARGAIN
HUNTING?**

**RADIO
SERVICEMEN!**

Write for SENSATIONAL CATALOG

HENSHAW RADIO SUPPLY

3619 TROOST KANSAS CITY, MO.

RADIO-TV Service Industry News

AS REPORTED BY THE
TELEVISION TECHNICIANS LECTURE BUREAU

IT HAS BEEN an interesting experience to observe the transition of the electronics servicing activity from basically technical thinking to the primary considerations of good management practices. Paced by the rapidly shifting requirements for television service, electronics service business operators found that a large volume of service work was no assurance of profitable operations. In an inefficiently managed service business a large volume of business hastened the day of failure. The service business operator of today who enjoys good credit from his suppliers has learned to apply good management practices in the operation of his business. He may be a top-flight technician in his own right but he devotes the bulk of his time and attention to the business phases of his activity.

Back in radio service days it was an outstanding shop that was able to do \$25,000 worth of service business per year. The average annual volume of business for radio service shops before the war was less than \$6000 per year. Very few radio service shop operators were able to keep as much as \$200 per month for themselves after paying the various costs involved in their service work.

Today it is not uncommon to find electronic service businesses that are handling an annual volume of \$150,000 in service work and quite a few shops are doing a quarter of a million or more per year. Where that much service volume is handled the chances of losing money through inefficient management are plenty. If ten men are employed and their time not carefully scheduled and supervised an hour a day per man can easily be lost. For a year's time this would add up to the incredible total of 2600 hours for an organization of that size at a cost to the business of more than five thousand dollars.

This is but one facet of a major service business that can leech away operating income to the point that the business ends up with an operating loss instead of a profit. Many TV service contractors went broke while they were doing a land-office business

because they failed to maintain proper operating controls on their businesses.

The management of a modern electronics service business is a very complex operation. It requires substantial financing; advertising and service sales promotional programs must be used regularly and they must be effective in keeping a reasonably consistent volume of business coming in; accounting records must reflect the general "health" of the business through regular operating statements; and there must be a service business control system in operation that will insure prompt handling of customers' calls, maximum employment of technicians' time in productive work, proper accounting of monies handled by employees and adequate records on the use of parts, supplies, and tubes.

Opportunities in the electronics service business will grow with the expanding industry. The service shop operators who aspire to grow with the industry will be buying future business insurance by utilizing good business operating practices while they are still small. Accounting, customer handling, stock control, and employees' time control systems should be both efficient and sufficiently flexible to grow with the business.

Progress of U.H.F.

The first and paramount lesson the industry has learned about u.h.f. TV is that it is no "business bonanza." It is not a fast-dollar business like v.h.f. was in the early days. But it is a business that will add stable volume to the efficiently managed and technically competent service organization that prepares now to understand the peculiar quirks of u.h.f. in its own section.

Every u.h.f. channel will present its own individual reception problems and each section of the country will have to whip its local tropospheric and terrain problems. The glowing reports of u.h.f. reception in Portland, Oregon, resulted in over-selling u.h.f. in Atlantic City. Everybody in the latter city over-bought and over-sold—but the consumers did not "buy" u.h.f. in a hurry. The Atlantic City debacle

RADIO & TELEVISION NEWS

BUILD 15 RADIOS

AT HOME ONLY

With the New Improved 1953 Progressive Radio "EDU-KIT" \$19.95

NOW INCLUDES

**SIGNAL TRACER
and
CODE OSCILLATOR**

- FREE TOOLS WITH KIT
- ABSOLUTELY NO KNOWLEDGE OF RADIO NECESSARY
- NO ADDITIONAL PARTS NEEDED
- EXCELLENT BACKGROUND FOR TELEVISION
- 10-DAY MONEY-BACK GUARANTEE

WHAT THE PROGRESSIVE RADIO "EDU-KIT" OFFERS YOU

The Progressive Radio "Edu-Kit" offers you a home study course at a rock-bottom price. Our Kit is designed to train Radio Technicians, with the basic facts of Radio Theory and Construction Practice expressed simply and clearly. You will gain a knowledge of basic Radio Principles involved in Radio Reception, Radio Transmission and Audio Amplification.

You will learn how to identify Radio Symbols and Diagrams; how to build radios, using regular radio circuit schematics; how to mount various radio parts; how to wire and solder in a professional manner. You will learn how to operate Receivers, Transmitters, and Audio Amplifiers. You will learn how to service and trouble-shoot radios.

You will learn code. You will receive training for F.C.C. license. In brief, you will receive a basic education in Radio exactly like the kind you would expect to receive in a Radio Course costing several hundreds of dollars.

THE KIT FOR EVERYONE

The Progressive Radio "Edu-Kit" was specifically prepared for any person who has a desire to learn Radio. The Kit has been used successfully by young and old in all parts of the world. It is not necessary that you have even the slightest background in science or radio.

The Progressive Radio "Edu-Kit" is used by many Radio Schools and Clubs in this country and abroad. It is used by the Veterans Administration for Vocational Guidance and Training.

The Progressive Radio "Edu-Kit" requires no instructor. All instructions are included. All parts are individually boxed, and identified by name, photograph and diagram. Every step involved in building these sets is carefully explained. You cannot make a mistake.

PROGRESSIVE TEACHING METHOD

The Progressive Radio "Edu-Kit" comes complete with instructions. These instructions are arranged in a clear, simple and progressive manner. The theory of Radio Transmission, Radio Reception, Audio Amplification and servicing by Signal Tracing is clearly explained. Every part is identified by photograph and diagram. You will learn the function and theory of every part used.

The Progressive Radio "Edu-Kit" uses the principle of "Learn by Doing." Therefore you will build radios to illustrate the principles which you learn. These radios are designed in a modern manner, according to the best principles of present-day educational practice. You begin by building a simple radio. The next set that you build is slightly more advanced. Gradually, in a progressive manner, you will find yourself constructing still more advanced radio sets, and doing work like a professional Radio Technician. Altogether, you will build fifteen radios, including Receivers, Transmitters, Amplifiers, Code Oscillator and Signal Tracer.

The Progressive Radio "EDU-KIT" Is Complete

You will receive every part necessary to build 15 different radio sets. Our kits contain tubes, tube sockets, chassis, variable condensers, electrolytic condensers, mica condensers, paper condensers, resistors, line cords, selenium rectifiers, test strips, coils, hardware, tubing, hook-up wire, solder, etc.

Every part that you need is included. These parts are individually packaged, so that you can easily identify every item. Tools are included, as well as an Electrical and Radio Tester. Complete, easy-to-follow instructions are provided.

In addition, the "Edu-Kit" now contains lessons for servicing with the Progressive Signal Tracer, F.C.C. instructions, quizzes. The "Edu-Kit" is a complete radio course, down to the smallest detail.

TROUBLE-SHOOTING LESSONS

Trouble-shooting and servicing are included. You will be taught to recognize and repair troubles. You will build and learn to operate a professional Signal Tracer. You receive an Electrical and Radio Tester. You learn to use it for radio repairs. While you are learning in this practical way, you will be able to do many a repair job for your neighbors and friends, and receive money which will exceed the cost of the "Edu-Kit." Here is your opportunity to learn radio quickly and easily, and have others pay for it. Our Consultation Service will help you with any technical problems which you may have.

FREE EXTRAS IN 1953

- Electrical and Radio Tester • Electric Soldering Iron • Book on Television • Radio Trouble-Shooting Guide • Membership in Radio-Television Club • Consultation Service • Quizzes • Training for F.C.C. License.

The Progressive Radio "Edu-Kit" is sold with a 10-day money-back guarantee. Order your Progressive Radio "EDU-KIT" Today, or send for further information.

We pay shipping charges all over the world, if you send check or money order for \$19.95 with your order. On C.O.D. orders, you pay cost of delivery.

PROGRESSIVE ELECTRONICS CO.
497 UNION AVE., RN-19, Brooklyn 11, N. Y.

June, 1953

threw a cold, wet blanket on u.h.f. enthusiasm in many areas.

However, u.h.f. has been sold more sensibly and sanely in areas that have followed Atlantic City with stations on the higher channels. These u.h.f. TV station promotions have been tempered to avoid over-selling and industry elements are accepting the fact that only experience in working with propagation in the new channels will solve the vexatious problems that are a part of it. Such things as complete dead spots within what should normally be the primary signal area of a u.h.f. station can only be solved by much experimentation with broadcast antennas and associated equipment. Converter manufacturers are very conscious of the difficulties encountered from the beats that are set up between converter oscillators and the set oscillators which at some u.h.f. frequencies completely override the signal. New circuitry will be developed to overcome such difficulties.

It may prove to be a boon to v.h.f. TV reception that indoor antennas have not proven universally acceptable in u.h.f. primary signal areas. The mad scramble to sell v.h.f. sets as a quickly installed "package" item certainly has not given the public the quality of pictures that are possible on present-day receivers. Perhaps the set manufacturers will join with dealers and service people to make the public "antenna conscious" for best picture quality.

These developments augur well for the service industry and especially so for the adequately financed, business managed service companies. But they do pose a responsibility for service business management to get acquainted with the eccentricities of u.h.f. before they have to work with it.

Chicago PR Service Plan

A few months ago a number of the leading television service contractors in Chicago asked the National Appliance and Radio Dealers Association to call a meeting of service people in the Chicago area to discuss ways and means of financing a public relations program to the set owning public that would erase the average user's misconceptions about the simplicity of TV servicing. Since more than five hundred major service contractors have joined NARDA in recent months and the NARDA Service Committee is headed up by Harold Chase, president of the outstanding Television Service Association of Michigan, NARDA leaders accepted the proposal and called a meeting.

Out of this and subsequent meetings the temporarily named Chicago CTIS committee was formed. Its president *pro tem* is Howard Shapiro, head of the CET service organization in Chicago, and the chairman of its advertising and public relations committee is Norman Foster of Foster TV.

The important facts this committee plans to get across to the set owning public are:

WHEN YOU ORDER WELLS COMPONENTS...



HERE'S WHAT YOU GET

- 1 IMMEDIATE DELIVERY FROM STOCK (in any quantity)
- 2 FINEST QUALITY OF FAMOUS BRANDS
- 3 GENERALLY LOWER PRICES
- 4 RETURN PRIVILEGE FOR FULL CREDIT IF NOT SUITED TO YOUR REQUIREMENTS

The valuable service Wells provides to the industry is being used by many of our greatest manufacturers as a matter of course.

Our vast stock (the world's largest) may contain just the components you need to fill urgent orders — at a substantial savings in time and cost.

ADEL CLAMPS • ANTENNAS, Insulators, Mast Sections • BINDING POSTS • BLOWERS • CABLE ASSEMBLIES • CHOKES • COILS • CONDENSERS Oil Filled, Bathtub, Hearing Aid, Transmitting Micas, Silver Micas, Ceramic, Variable, Trimmer • CRYSTALS • FILTERS • FUSES & MOUNTINGS • GENERATORS • GROUND RODS • HEADSETS • I.F. COILS • JACKS • JACK BOXES • KEYS, Telegraph KNOBS • LAMPS • LORD MOUNTS • LUOS MOTORS & BRUSHES • PLUGS • RECTIFIERS Selenium, Copper Oxide, Meter, Diode • RESISTORS—All Types • SELSYNS • SOCKETS • SWITCHES Aircraft, Micro, Switchettes, Toggle • TIMERS • TUBING—Flexible • TUNING SHAFTS • TRANSFORMERS All Types • VIBRATORS • WALKIE TALKIES

DYNAMOTORS



OVER 100,000
NEW DYNAMOTORS
IN STOCK!

DM 32A — DM 53A — PE 86 — PE 101C
DM 33A — D 101 — PE 94, etc.

Large quantities of brushes for all types of dynamotors and motors.

Write us for quotations. Advise us your requirements.

A complete Signal Corps stock number listing of items in our stock. Write for listing No. SG-200. (For government agencies and contractors only.)

Manufacturers and distributors—write for new Condenser Catalog C-10 now available.

Write, Wire, Phone Your Requirements
all phones: **SEELEY 8-4143**

WELLS SALES, INC.

833 W. Chicago Ave., Dept. R, Chicago 22, Illinois

CRYSTALS

FOR ALL PURPOSES

LOW FREQ.-FT 241A for SSB, lattice filter, 1/2" spc. 54th or 72nd harm channels listed by fund. Fractions omitted.

374	395	418	487	511	400	464	5910	2030	2435
375	396	419	488	514	440	466	6370	2045	2442
377	397	420	490	515	441	468	6450	2105	2532
379	398	422	491	516	442	470	6470	2125	2545
380	401	423	492	518	446	472	6497	2145	2557
381	403	424	493	519	447	474	6522	2155	2602
383	404	425	494	520	450	475	6547	2220	3215
384	405	426	495	522	452	476	6610	2258	3237
385	407	427	496	525	461	477	7350	2280	3250
386	408	431	497	526	462	479	7580	2282	3322
387	409	433	498	530	463	480	7810	2290	3510
388	411	435	503	531	99¢ ea.	\$1.29	2300	2320	3520
390	412	436	504	533	10 for \$9.00	each	2305	2350	3550
391	413	481	506	537	10 for \$9.00	each	2320	2350	3580
392	414	483	507	538	10 for \$9.00	each	2350	2360	3945
393	415	484	508	538	10 for \$9.00	each	2390	2390	3995
394	416	485	509	539	10 for \$9.00	each	2415	2415	

49¢ each. 10 for \$4.50

10 for \$4.50

FT243-1/2" spc.

4190	6175	7773	1015	5725	5840	6306	6475	6640	7506	7706
5030	6206	7806	2045	5740	5850	6325	6506	6673	7540	7973
5485	6773	7840	3735	5760	5873	6340	6540	6706	7573	8240
6040	6873	7873	5305	5773	5906	6373	6573	6740	7606	8250
6073	6906	7906	5677	5800	5940	6406	6575	7440	7640	8273
6140	7740	7940	5706	5806	5973	6450	6600	7506	7650	
			5825	6273	6473	6606	7673			

49¢ ea. for \$4.50

99¢ ea. 10 for \$9.00

10 for \$9.00

Special Purchase! FM Radio Chassis



88-108 MC—Complete with 6 tubes, built-in antenna and speaker. Product of famous radio and TV maker whose name we promised not to mention \$16.95
Maroon plastic cabinet for above \$5.95.

TWO-STATION INTERCOM SYSTEM



Consists of master and remote station, 20-ft. of 3 wire cable, 115 V. operation, AC or DC. Extra wire .05 per ft. . . \$16.97

TV CHASSIS NOT A KIT

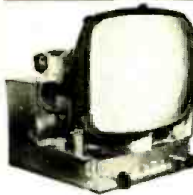

Complete with picture tube and speaker. 20 tubes. Standard coil high gain cascade front end.

20-INCH: \$157 | 17-INCH: \$143

Sun

PARTS DISTRIBUTORS, LTD.

520 TENTH ST., N.W. - WASHINGTON, D.C.

THE NEW DYNATRACER*

Designed To **DOUBLE YOUR PROFITS** CHECK SETS IN THE HOME Makes TV servicing easier, faster and more accurate at **LOW COST.** Trace signals and voltages—Locate defective components instantly.



Requires No Additional Portable "DYNATRACER" is a portable self-powered quality instrument that is used under actual operating conditions. "DYNATRACER" is designed to trace signals through any video, sound, sync, AFC, vertical or horizontal sweep circuit and instantly isolate trouble to a stage or component.

ADDED FEATURE:—

With a tick of the switch, the "DYNATRACER" will also trace voltages and instantly locate open, shorted or intermittent condensers, resistors, coils, speakers, transformers, etc. Complete Instructions and Trouble-Shooting Methods Enclosed. Satisfaction guaranteed. Century instruments are quality engineered for accurate and efficient servicing.

CENTURY ELECTRONICS CO.
8509-21st Ave., Dept. 201, Brooklyn 14, N. Y.

\$4.95

Postpaid or COD plus postage

(1) Your television set is one of the most intricate mechanisms in the world. To give you a perfect picture, its 1000 delicate, interdependent parts must work in complete harmony. With an instrument of such amazing complexity, it is entirely normal to expect occasional trouble. Moreover, there is no possible way of detecting all weak and failing parts. That's why a tube can be operating perfectly one minute and fail the next.

(2) Only a skilled technician should be trusted to adjust or replace parts in your television set. Your television service engineer is a trained electronic specialist, thoroughly qualified in all phases of TV servicing. He is a professional in every sense of the word, and performs a vital service at a modest price. Welcome him into your home.

The Greater Chicago service industry plans to use every medium to sell its services and contributions to the public. Radio, television, newspapers, direct mail, give-aways, billboards, posters, and even car ads are scheduled to be used to tell the public the truth about the television service industry to gain their understanding and good will.

To finance the program the Committee proposed an unusual plan that will permit each service operator to contribute in proportion to his volume of service business. In brief, the committee asks each member of the Greater Chicago TV service industry to notify his suppliers to add an additional charge of 1% to the wholesale cost of the TV parts he buys.

Following the development of this program by the Chicago Committee, the Television Service Association of Michigan for the Detroit area adopted the plan as did the Television Contractors Association of Philadelphia.

A complete service public relations program has been created for the Chicago Committee by *W. B. Doner and Company*, Chicago advertising agency. Material developed for this program is offered to service groups throughout the country through NARDA by the agency and the Chicago organization, the agency specifying only that it be retained by service groups in cities where it has offices.

Important Aspects of Plan

The most important factor about this plan is that it is completely financed by the service industry and thus can be a public relations program created for the service industry entirely in the interests of service business operators. Created and administered by a professional advertising agency, it will be employed in ways that will produce maximum effectiveness. It will do much to elevate the stature of service as a business by demonstrating in a practical way that service is able to stand on its own feet and fight its own battles.

It will not, of course, eliminate the necessity for each service business to advertise and promote its own indi-

"Advertisement"

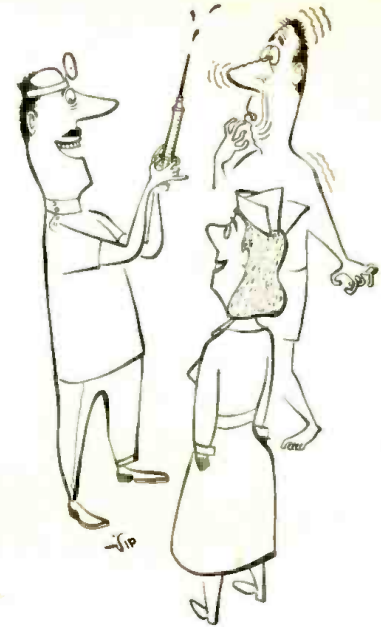

"That reminds me . . .
Order a new JENSEN NEEDLE
for my record player."

NEW for Hi Fidelity

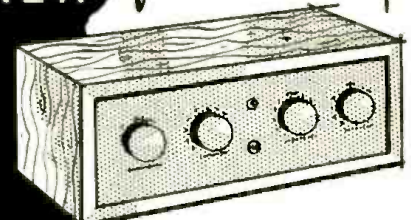

the New **McGOHAN**
PRE-AMPLIFIER, WA-300

- Radio and Auxiliary Inputs.
- Phono Compensation to LP, AES and Foreign Records. • Built-In Power Supply. • +15 DB to -15 DB.
- Less than .2% Distortion.
- 20-20,000 CPS.

the **NEW McGOHAN 300 SERIES**
for High Fidelity

- WA-300 Pre-Amp.
- WA-301 Pre-Amp.
- WA-310 10 watt Amplifier with Controls.
- WA-312 12 watt Amplifier.
- WA-325 25 watt Amplifier.



See your Distributor or write to
DON McGOHAN INC.
3700 W. Roosevelt Road
Chicago 24, Illinois

RADIO & TELEVISION NEWS

vidual facilities. But it will remove much of the tension between set owners and service technicians by wiping out misconceptions of TV service and service pricing.

The IRE Convention

Developments in transistors were considered to be the highlights of the annual IRE convention and exhibition but closed circuit television almost "stole the show."

Midget transistor-equipped transmitters and receivers were demonstrated. The *Bell Telephone Labs* exhibited the step-by-step progress in the development of transistors together with many of their applications in telephony. *Bell* engineers pointed out that they did not expect transistors to replace vacuum tubes in telephony electronic applications but that they would make possible new electronic devices that would have been too expensive with vacuum tubes. As an illustration they showed a miniature telephone line amplifier that would fit into the regular telephone line cord.

The television camera for closed circuit applications has captured widespread industry interest since the introduction of the *Dage* camera about six months ago. It is expected that closed circuit television will eventually be a much larger business than television for home entertainment. *Du Mont* displayed a portable Vidicon-equipped camera at the show; *RCA* is said to be readying a new unit which will soon be unveiled and it is rumored that a number of other manufacturers will soon be announcing TV cameras for closed circuit work.

New G-E Picture Tube

One product of interest to all TV service technicians introduced at the IRE show was *G-E's* new picture tube with the "internal magnetic focus" gun.

The new gun contains an internal compensating focusing lens which maintains focus over a wide range of operating voltages, according to Mr. Grady L. Roark, manager of *G-E* equipment tube sales. A simple shunt may be used to increase this range. No external focusing control requiring set owner adjustment is necessary. See page 82 of this issue for additional details.

NIESA at Convention

The National Industrial Electronic Service Affiliates, Inc., which was organized last Fall, were contacted by many manufacturers interested in the kind of top-flight maintenance such an organization of independent service companies can provide. More than twenty-five major service companies located in as many cities are now affiliated in the NIESA organization.

Manufacturers of nucleonic instruments for medical use, induction and dielectric heating apparatus, color and black-and-white television for closed circuit work, and other electronics equipment for industrial applications



70% to 90% off list! TOP TUBE BUYS

All Tubes Individually Boxed! Check this list for Rigidly-Tested, Full One-Year Guaranteed Tubes.

Type	Price	Type	Price	Type	Price	Type	Price	Type	Price
1A5GT	.30	5V4	.73	6BL7	.59	6W6GT	.44	19T8	.79
1A6G	.30	5W4	.50	6B06GT	.59	6X4	.37	19V8	.89
1A7GT	.47	5X4	.40	6B07	.95	6X5GT	.37	24A	.63
1AB5	.40	5Y3GT	.32	6BZ7	.95	6X8	.61	25AV5	.83
1B3	.65	5Y3GT	.32	6C4	.37	6Y6G	.48	25B06GT	.62
1B5	.30	5Y4G	.35	6C5GT	.39	7A4	.47	25L6GT	.39
1B7GT	.30	5Z3	.46	6C6	.58	7AF7	.53	25W4	.56
1C5GT	.43	6A7	.59	6C8G	.24	7B4	.44	25Z5	.40
1E7	.29	6A8	.62	6C8E	.44	7C6	.40	25Z6GT	.37
1G4GT	.24	6AB4	.44	6CD6G	1.11	7E6	.30	26	.45
1G5	.30	6AG5	.43	6D6	.45	7X7	.70	27	.39
1H4G	.30	6AJ5	.90	6E5	.39	12A8	.61	32L7	.89
1H5GT	.40	6AK5	.75	6F5GT	.48	12AL5	.37	35B5	.40
1H6	.24	6AL5	.38	6F6	.37	12AT7	.56	35C5	.39
1J6	.24	6AQ5	.39	6F8G	.24	12AT7	.56	35L6GT	.41
1L4	.46	6A0G	.37	6G6G	.52	12AUG	.38	35W4	.37
1LCS	.51	6AR5	.37	6H6GT	.41	12AU7	.43	35Z4	.39
1N5	.46	6AS5	.50	6J5GT	.37	12AV6	.39	35Z5GT	.37
1P5	.57	6AT6	.37	6J6	.52	12AV7	.59	36	.60
1Q5	.58	6AU6	.38	6J7G	.43	12AX4	.48	41	.42
1R5	.45	6AV5	.83	6J8	.30	12AX7	.48	42	.42
1S5	.39	6AV6	.37	6K5	.47	12AZ7	.69	43	.55
1T4	.45	6AX4	.53	6K6GT	.37	12BA6	.38	45	.45
1T5	.53	6AX6G	.24	6K7	.44	12BA7	.60	45Z5	.49
1U4	.45	6B4	.64	6L5	.24	12BD6	.45	50B5	.39
1U5	.39	6BA6	.39	6L6	.64	12BE6	.39	50C5	.39
1V	.60	6BA7	.57	6Q7	.45	12BF6	.39	50G6	.59
1X2	.63	6BC5	.44	6S4	.38	12BH7	.63	50L6GT	.41
2A3	.70	6BC7	.34	6S8	.53	12B7V	.65	50V7	.50
2A4G	.24	6BD5GT	.59	6SA7GT	.43	12C8	.34	53	.24
2X2	1.50	6BD6	.45	6SD7GT	.41	12F5GT	.34	56	.24
3A4	.46	6BE6	.39	6SF5GT	.46	12J5GT	.42	57	.58
3E5	.46	6BE5	.41	6SG7GT	.41	12J7GT	.34	58	.60
3Q4	.48	6BF6	.37	6SH7	.73	12K7GT	.34	70L7GT	1.09
3Q5GT	.49	6BG6G	1.25	6S7G	.41	12L7	.70	75	.44
3S4	.46	6BH6	.46	6SK7GT	.41	12SA7GT	.44	76	.41
3V4	.47	6BJ6	.39	6SL7GT	.48	12SF5	.50	77	.57
5U4G	.45	6BK7	.59	6SN7GT	.52	12SG7GT	.52	78	.47
				6SO7GT	.37	12SJ7	.44	80	.35
				6SR7GT	.45	12SK7GT	.48	83V	.68
				6S7G	.42	12SL7GT	.47	85	.59
				6T8	.56	12SN7GT	.52	117L7	.99
				6U4	.60	12S07	.44	117Z3	.37
				6U5	.44	12SR7	.49	807	.99
				6U6	.63	14J7	.30	1274	.99
				6U8	.61	14W7	.30	2050	1.85
				6V6GT	.39	19BC6G	.95	6113	1.00
				6W4GT	.44	19C8	.70		



"Integrity is Our Chief Asset"
Phone: Essex 5-2947

TERMS: A 25% deposit must accompany all orders—balance C.O.D. All shipments F.O.B. Irvington warehouse. Orders under \$10—\$1.00 Handling Charge. Subject to prior sale.

Don't Delay . . . Order Today!
115 COIT STREET
Dept. RN-6
IRVINGTON 11, N. J.

L. A. HAM SHACK SELLS FOR LESS



METERS—WESTON • SANGAMO
ALL NEW • ALL D. C. • 2" SQUARE
0-5 Ma } \$3.29
0-15 Ma } EACH
0-50 Ma } or
0-100 Ma } 3 for
0-200 Ma } \$9.00
0-300 Ma }
0-500 Ma }

Mfg's inquiries: lots over 100
Voltmeter. 2" sq.—0 to 20 Volts. . . . \$3.29
DC Voltmeter. 2" sq.—0 to 300 Volts w/Ext. resistance. Complete \$3.95. . . . 3 for \$9.95
RF Ampmeter. 2" sq.—0 to .5 Amp. . . . \$3.95
Ampmeter. 2" rd.—0 to 50 Amps. . . . \$3.29
Ampmeter. 2" sq.—0 to 50 Amps. . . . \$3.29
3" Round Meters. DC. All New. 0-15, 0-30, 0-300 Mills. \$4.95 Each. . . . 3 for \$11.95
Milliampermeters. 2 1/2" rd. 0-30 Mills. Each \$3.95
Milliampermeters. 2" rd. 0-50 Ma. 0 to 5 Ma. movement. Each \$3.29. . . . 3 for \$9.00
Thermocouple. 2" rd. 350 Milliamp. HF. . . . \$3.29
"S" METER. Illuminated face. Full scale reading of 5 m. A standard value for most "S" Meter Circuits. 2 3/8". Black face. New . . . \$2.49
Amp Meter. No. 60-0-60. New . . . \$1.29

MODULATORS Used
BC-456 with Tubes, less dyn. . . . 2.95
COMMAND AND/OR ARCS TRANSMITTERS and RECEIVERS
3-6 MC Receiver New \$17.95
6-9.1 Receiver Used 7.95—New 12.95
Triple Receiver Rack. 1.95
V.H.F. ARCS Transmitter or Receiver, Complete w/tubes Used 24.95
ARC-4 w/tubes. Good. Used 22.95
4-5.3 MC Transmitter with tubes \$ 8.95
5.3-7 MC Transmitter with tubes 8.95
7-9.1 MC Transmitter with tubes 10.95 \$19.95
3-4 MC Transmitter with tubes 18.95
28V Receiver Command
Dynamotors 1.95
CIVIL AIR DEFENSE or 2 METERS
Modulation Transformer. BC-375. New \$3.95
BC 306 Antenna Loading New 3.95
FL8 Filters—A's, B's, C's New 1.95
FL5 Filters New .95
TRANSFORMERS
12V 24V 2 am 110V primary \$2.95
Cade Tapes for TG-10 15 rolls. New 7.95
DYNAMOTORS
PE-103 New Case \$29.95
HEAD SETS HS-33 New \$4.95
HS-30, single only New .95
HS-23 Used \$2.95
Matching Transformer for HS-30 69

Cash with order. Prices subject to change without notice. California orders please include 3 1/2% Sales Tax. Please include approximate postage—Excess will be refunded. What Have You in Surplus? Submit

L. A. HAM SHACK 1306 BOND STREET, at PICO
LOS ANGELES 15, CALIFORNIA

Columbia
GEM OF THE SURPLUS

CRYSTALS!
LOWEST PRICES!

ONLY 79¢ EA. **ACT NOW**

In FT 241-A Holders—1/2 in. Pin SPC. These are designated 54th or 72nd Harmonic MC freq. Listed by fundamental freq. with fractions omitted.

370	396	420	445	469	494
372	397	422	446	470	495
374	398	423	447	472	496
375	400	424	448	473	497
376	401	425	449	474	498
377	402	426	451	475	501
379	403	427	452	476	502
380	404	429	453	477	503
381	405	430	454	479	504
383	406	431	455	480	505
384	407	433	456	481	506
385	408	434	457	483	507
386	409	435	458	484	508
387	411	436	459	485	509
388	412	437	461	486	511
390	413	438	462	487	512
391	414	439	463	488	513
392	415	441	464	490	514
393	416	442	465	491	515
394	418	443	466	493	516
395	419	444	468	493	516

5 CRYSTALS Assorted ONLY \$2.75
10 for \$4.50; 20 for \$8.50
COMPLETE SET!!!!—80 crystals covering above basic
freq. including a 500 Kc crystal. All for \$16.50

SPECIAL 500 Kc. Crystal \$1.25
1000 Kc. Crystal 2.25
All above crystals sent postpaid. Also available in
complete sets for SCR-608, SCR-528, SCR-62R, and
TRC. Foreign, wholesale, and dealer inquiries invited.
Write for LARGE QUANTITY DISCOUNTS.

ARC-5 OR 274-N TRANSMITTERS

2.1-3 mcs. Brand new..... \$19.95
4-5.3 mcs. With tubes..... 6.95
5.8-7 mcs. With tubes..... 6.95
7-9.1 With tubes..... 14.50

ARC-5 OR 274-N RECEIVERS

Equipped with tuning knob..... \$19.95
1.5-3 mcs. Brand new..... 24.50
3-6 mcs. Less tubes..... 9.95
3-6 mcs. With tubes..... 10.95
6-9.1 mcs. With tubes. Used..... 10.95
New..... 22.50
6-9.1 mcs. Less tubes..... 8.95

MO-7 ARC-5 PLATE MODULATOR, Excel.
cond. 14.95
BC-476 274-N Modulator. Less 487A
motor. Excel. cond. 3.95
RACK FOR DUAL TRANSMITTER (274-N) 2.95
RACK FOR DUAL TRANSMITTER ARC-5 2.95
TUPLE RECEIVER RACK 5.00
DUAL RECEIVER CONTROL BOX BC-406. 2.95

BC-422 ANTENNA RELAY with 50
mfd. condenser. Excel. cond. 3.95
COMMAND RECEIVER FLEX CABLE.
9-12 Ft. 2.95
12 V. COMMAND RECEIVER DYNAMO-
TOR. New 12.95
COMPLETE AIRCRAFT INSTALLATION
AVAILABLE P.U.R.

DYNAMOTORS

PE-73: 24 V. In. 1,000 VDC output @ 350 ma.
Excel. cond. only. \$5.95
PE-101: 12 or 24 V. input @ 130 ma. output. Done
furnished for conversion to 6 V. Excel. cond. \$4.95
LEAR: 11 V. input. 500 V. output @ 250 ma.
New \$17.50
4 FT. ANTENNA BALLOON. New in can. 1.19
PROP PITCH MOTOR: Like new. Only \$17.95

MARINE EQUIPMENT

COLUMBIA'S NEWEST HI-POWERED 1953 MA-
RINE TRANSMITTER. Puts out max. power
allowed by F.C.C. Contains all latest im-
provements & meets newest F.C.C. spec-
ifications. Specify whether 12 or 24 V., frequency de-
sired, and positive or negative ground. Full
90-day, unconditional guarantee. Free-
ready to install. \$349.50

BC-223 25 W. TRANSMITTER & ARB RE-
CEIVER: For 24 V. inst. Receiver covers
decim. standard, and 8' and marine frequen-
cies and amateur bands. This combo makes
the finest LOW-COST marine installation on
the market. Complete, checked out, ready to
go. The whole deal ONLY \$185.00
Write in for conversion info for 12 V. inst.

DU-1 LOOP makes AHB RECEIVER one of the
best radio compass units made. With con-
version dope. \$32.50

JEFFERSON-TRAVIS MARINE 5 W. RADIO-
TELEPHONE: Made by Emerson Radio Corp.
2-channel, crystal controlled receiver &
transmitter. P.S. for small boats with 6 V.
system or sail boat. Will run 48 hrs. on
standard 6V. car battery. Complete with
tubes, instructions, but less crystals and
battery. NEW \$79.50
CRYSTALS FOR ABOVE: Specify freq. Set of
4 needed. Per Set \$22.50

MOBILE ANTENNA: With MP-22 Mount. 9 Ft. \$3.95
BATTERY OPERATED MEGAPHONE AMPLIFIER:
Approx. 3 W. With tubes. Fair cond. \$4.95
RESISTOR ASSORTMENT: 100 for \$2.95
CONDENSER ASSORTMENT: Postage stamp, mica,
silver, etc. 100 for \$3.95
10 MFD. OIL FILLED CONDENSER: 600 V. \$2.95
PE-104 VIBRATOR: Part of BC-654 Trans. Rec. 6 or
12 V. input. Output, positive: 6, 14 and 84 VDC.;
negative: 1, 4, 6, 12, 51 VDC. NEW with spare
parts \$10.95
All orders F.O.B. Los Angeles. 25% deposit required.
All items subject to prior sale.
COLUMBIA ELECTRONIC SALES
522 South San Pedro St. Los Angeles 13, Calif.

have shown a keen interest in the facilities available to them through NIESA. Independently owned and managed service businesses with the trained personnel, facilities, and equipment for handling a wide variety of electronic service work, can handle maintenance contracts far more efficiently and economically than factory-operated branches.

Under the NIESA plan, manufacturers can deal directly with one organization which can handle the arrangement details for installation and maintenance of their products either in selected areas or on a fully national scale.

RTTG of New England

In a recent letter to technicians who attended the initial meeting leading toward the formation of a strong sectional association of television technicians, A. C. W. Saunders lauded the men who attended for their fine spirit of cooperation. Mr. Saunders, who has long been associated with movements intended to improve the position of electronics servicing work as a professional activity, said:

"I want to congratulate all those who participated in the meeting of radio and television technicians from various sections of New England held in Providence recently. It impressed me to such an extent that I am compelled to put my feeling into words.

"Here I witnessed a gathering of honest, sincere, unselfish men of our industry lay the foundation for the formation of a Radio Television Technician Guild of New England.

"As the meeting progressed, I witnessed the laying of the foundation—A Code of Ethics—on which the Guild is to be built. In this foundation I could see the ties of friendship and public relations going into place with a corner stone dedicated to the general public.

"The team work of those present in preparing this foundation spelled success. It was the first time in my 25 years of organization work that I have observed constructive criticism without heated debate. This mutual accord, I am sure, cemented the flawless foundation.

"I witnessed the supports of this ideal being erected on the foundation when the purpose of the organization was read and I saw the beginning of a six-state Guild taking shape. Then welcome was extended to all those in the industry who subscribe to the principles laid down in the foundation—*The Code of Ethics*, and the strength of its structure—*The Purpose*.

"I write this message appealing for all who subscribe to the completion of such an ideal, because it is the brotherly feeling among us that will give guidance and solution to our many problems.

"This infant institution should strike a harmonious chord with all technicians who are ambitious to increase their technical skill and improve their standards of living."

TV Receiver Sensitivity Measurements made Simple with

The New "SensiMeter" *
Portable
... a "must" in fringe areas



Net \$129.50
*Pat. Applied for

- * Takes the guesswork out of TV service
- * Checks receiver from antenna terminals to picture tube
- * Microvolt scale is divided into 3 sections as a guide for the servicemen
- * Sensitivity testing is accepted by servicemen as the best method of determining the cause of bad pictures

Approved by leading television manufacturers!
Consult your Jobber or write for further information

SI SERVICE INSTRUMENTS COMPANY
422 South Dearborn Street, Chicago 5, Illinois

OSCILLOSCOPES

ARE "GOLD MINES"!
... if you learn how to use them fully on all types of service jobs!

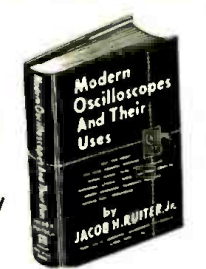

Learn to handle the oscilloscope fully on all types of AM, FM and TV service work—and watch your efficiency and earnings soar!
MODERN OSCILLOSCOPES AND THEIR USES, a fact-jammed 326-page book by Jacob H. Ruitter, Jr., of the Allen B. DuMont Laboratories contains exactly the help you need—written in a way you can clearly understand. It shows you how to use your scope for fast accurate work on all types of jobs from troubleshooting to realigning; how to make connections; how to adjust circuit components; how to set controls and how to analyze patterns fast and accurately. 370 helpful illustrations including dozens of pattern photos make things doubly clear.
No other type of specific service training stands to mean so much to you in terms of being able to do better, faster and more profitable work!

- ✓ When, where, why and exactly how to use oscilloscopes
- ✓ How to interpret oscilloscope patterns
- ✓ How to handle tough jobs in less time

MAIL ORDER 10-DAY FREE EXAMINATION

Dept. RN-63, RINEHART BOOKS, Inc., Technical Division,
232 Madison Ave., New York 16, N. Y.
Send MODERN OSCILLOSCOPES AND THEIR USES for 10-DAY EXAMINATION. If I decide to keep the book, I will also remit \$6.00 plus a few cents postage in full payment. If not, I will return book postpaid and owe you nothing.

Name

Address

City, Zone, State

Employer's Name & Address

OUTSIDE U.S.A.—Price \$6.50 cash only. Money back in 10 days if book is returned.

Within the Industry
(Continued from page 26)

television sets and a revised radio production estimate of 10,934,872 units. This compares with 5,384,798 TV sets and 12,627,362 radios in 1951. The dollar value in 1951 was set at approximately \$1,272,922,897.

LEON PODOLSKY has been appointed to the newly-created post of technical assistant to the president of *Sprague Electric Co.*, North Adams, Mass. He was formerly manager of field engineering.



Among his new duties will be that of consultant on field engineering problems, supervision of the company's carrier-current development program, and representation of the company in the national trade association and international standards work.

MASSACHUSETTS INSTITUTE OF TECHNOLOGY has announced that it will offer a special summer program in transistors and their applications from July 20 to 31 during the 1953 summer session.

Enrollment will be limited with preference being given to those having college specialization in physics or electrical engineering.

Further information and application blanks may be obtained from the Director of the Summer Session, Room 3-107, Massachusetts Institute of Technology, Cambridge 39, Mass.

DON'T PASS THIS BUY

LINK & BOSCH MOBILE POLICE RECEIVERS, 8 tubes (IF stage) fixed tunable 2-3 mc. adj. squeal control, w/6 volt power supply, 270W/100 ma. IDEAL/Ham. C.D. MARS & MARINE services. Makes not receive w/10' converter used operating cond. With new 5' PM speaker... \$12.95

HERE'S YOUR ANSWER TO LOW ANGLE PROB. LEM. radiotelephone everywhere. **VERTICAL WHIP ANTENNA ASSY.** for 10, 15, 20, 30, 40, 50 M. 91 1/2 ft., \$1.45; 24 ft., \$3.75; 16 ft. \$2.45; 32 ft. \$4.75

NEW 6 & 12 VOLT DYNAMOTOR 180 V/50 ma, 300 V/150 ma, higher ratings on 12 V. **COMPACT ELYSON VIBRATOR PACK**, 6v 10, 90V/20 ma output, will operate on 12 V. cells, 2 1/2" dia x 3 1/2" H. Swell for portables. **JAEGER 6 V DC CLOCK** (made for Kaiser-Franzer) 5" face w/3 panel lamps, draws 3 ma will run on dry cells, I.P. \$17.00... 5.95

HAYDON SYNCHRONOUS MOTOR, 24 volts 60 cy will operate on 110V line with series capacitor, high torque geared shaft output, 5 RPMR with capacitor... 1.25

SENSITIVE RELAYS
SIGMA 5A8 3000 ohm/2ma. plug-in... 54.95
SIGMA 5A8 10,000 ohm/1ma. plug-in... 6.95
SIGMA 5R1 5000 ohm/1.5ma. sealed... 6.95
SIGMA 5R 130 ohm. operates 2-24 VDC... 2.45
KURMAN BK-35 10,000 ohm/1.5ma SPNO... 4.95
C.E. COMPACT, 10,000 ohm/1.5ma SPNO... 1.65

COMPACT GEAR BOX ASSY 800/1 ratio high torque suitable model controller, wt 1 1/2 lb., 1.95
RACHET RELAY, 4 position, 6-12 VDC... 3.95

SPECIAL 90 VAC SYNCRO CAPACITORS
8x 0 mf... \$2.75 8x 3 mf... \$3.75
8x10 mf... 5.95 3x50 mf... 7.95
10 mf/800 VDC/220 VAC round met. case... 1.95
20 mf/285 VAC/600 VDC rect. met. case... 2.95
50 mf/600 VDC rect. metal case... 6.95

EVEREADY #467, 67 1/2 V. B. battery outlived but good as new, stock up at giveaway 5 for 1.95

ELECTRONIC SPECIALTY SUPPLY CO.
38 WALKER STREET, NYC 13, N. Y. WALKER 5-8187

RADIO & TV TUBES

70 to 90% Off

Write today for complete price list

HI-LITE ELECTRONIC SALES CO.

Dept. RN, 837 18th Ave., Irvington 11, N. J.

PHOTO CREDITS

Page	Credit
35, 36, 37, 38	U. S. Army Photo
38, 39, 60, 61	Philco Corporation
62, 63	Fisher Radio Corporation
64, 65	Electro-Voice, Inc.
69	Eduardo Lopez Juarez, CE3CB
82	General Electric Company
95	University of Illinois
100	Magnecord, Inc.
130	Peter Hildeweg

ERRATA

In the circuit diagram, Fig. 2, appearing on page 58 of the April issue (Modified Childs' Amplifier-Power Supply) the VR75 next to ground should be a VR105 tube. Condenser C₁ should be a .05 µfd. molded plastic condenser instead of the mica unit specified in the parts list.

Fig. 5, page 45, of the April issue (20-Watt 6 Band Mobile) should be corrected as follows: the parallel combination of PL₁ and R₁ should be in series with the plate lead of the 2E26, between C₁₀ and RFC₁ with condenser C₁₁ connected to the cold end of RFC₁. C₃ should be connected to pin 4 of the 6BQ6GT.

In the parts list accompanying the article appearing on page 71 (The Modern Booster) of the April issue, the coil form for L₁ and L₂ was incorrectly listed as 1/4" o.d. This should be 3/8" o.d., with fitting slug.

Only ROHN TOWERS
ARE PROVED IN CONSTRUCTION, DESIGN, USE & SALES

3 standard self-supporting ROHN steel towers for your every need!

Famous ROHN FOLD-OVER TOWER
(Pat. Pending)

Fold-Over Tower uses standard tower sections plus an inexpensive easy-to-use "fold-over" kit. The perfect answer to this type tower requirement.

ROHN TELESCOPING MASTS

PLUS A COMPLETE LINE OF ACCESSORIES:

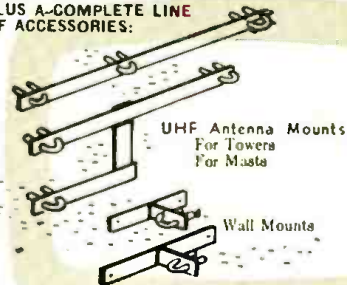

Also House brackets, guy brackets, etc., all Rohn designed!

Contact your ROHN distributor for FREE catalog and Prices or write:

ROHN MANUFACTURING COMPANY

DEPT. RTN
116 LIMESTONE
BELLEVUE,
PEORIA,
ILLINOIS

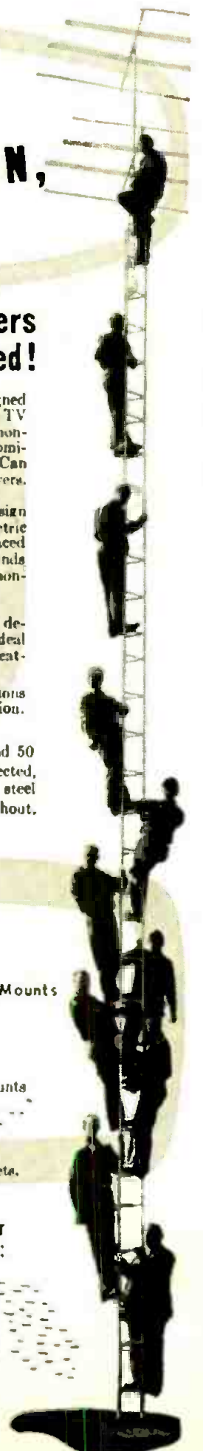

RADIO Surplus Buys

CRYSTALS

... in FT 241-A Holders— $\frac{1}{2}$ " Pin SPC. Marked 54th OR 72nd Harmonic MC Freq. Listed below by fundamental frequency with fractions omitted.

500 KC Crystals ea. **\$1.95**
1000 KC Crystals ea. **\$3.95**
200 KC Crystals ea. **\$3.95**

370	407	444	476	509
372	408	445	477	511
374	409	446	479	512
375	411	447	480	513
376	412	448	481	514
377	413	450	483	515
379	414	451	484	516
380	415	452	485	518
381	416	453	486	519
383	418	454	487	520
384	419	455	488	522
385	420	456	490	523
386	422	457	491	525
387	423	458	492	526
388	424	459	493	527
390	425	461	494	529
391	426	462	495	530
392	427	463	496	531
393	429	464	497	533
394	430	465	498	534
395	431	466	501	536
396	433	468	502	537
397	434	469	503	538
398	435	470	504	540
400	436	472	505	
401	437	473	506	
402	438	474	507	
403	440	475	508	
404				
405	442			
406	443			

\$100 EACH

10 for \$8.00, Postpaid

FOLLOWING CRYSTALS AVAILABLE IN FT 243 HOLDERS $\frac{1}{2}$ " PIN SPACING

4165	5127.5	6875
4240	5205	6975
4280	5285	7350
4310	5435	7450
4330	5485	7750
4335	5587	7875
4350	5660	7950
4370	5730	8273.3
4440	5852.5	8350
4445	5915	8450
4540	6073.3	
4635	6140	
4710	6350	
4880	6525	
4980	6550	
4995	6700	
5035	6825	

\$100 EACH

11 for \$10.00, Postpaid

PLEASE ENCLOSE FULL AMOUNT WITH ORDER QUANTITIES AVAILABLE WRITE FOR YOUR REQUIREMENTS

C & H SALES CO.

BOX 356-MT EAST PASADENA STA. • PASADENA 8, CALIF.

CORONA RADIO KITS

Designed for: ★ Excellent Reception ★ Easy Assembly ★ Educational ★ Perfect Tone

Rocket 115K— Latest superhet circuit designed for the ultimate in sensitive reception and tonal quality. Beautiful slide rule dial. Consists of all necessary parts, punched and stamped chassis, attractive bakelite mahogany cabinet, built-in loop antenna, iron core I.F. transformer, large 5" Alnico V speaker, 1-12SK7, 1-12SA7, 1-12SQ7, 1-50L6, 1-35Z5. Tunes standard AM broadcast from 540 to 1700kc. Automatic volume control and beam power output. **\$14.75**

Plaza 812K— Deluxe 2-Band AC/DC superhet receiver. Designed for excellent sensitivity and signal pickup. Covers standard American Broadcast Band 535 to 1800kc and foreign short wave transmissions 6 to 18Mc (116.6 to 50 meters). Features: Impregnated matched coils, iron core I.F. transformer, bass-treble tone control, large 5" Alnico V speaker of excellent tonal quality, and Piano Jack. Handsome cabinet in mahogany bakelite-veneers 1 1/2" x 8" x 13 1/2". Complete with tubes, 1-12SK7, 1-12SA7, 1-12SQ7, 1-50L6, 1-35Z5. Finest quality parts, stamped and punched chassis for quick-easy assembly. **\$20.75**

Globemaster 814K— Super-sensitive 3-Band receiver featuring latest in Broadcast and short wave reception. Uses impregnated matched coils, permeability tuned I.F. transformers, shielded tube sockets, special lead-in distance and socket position for superb foreign and domestic reception. Bass-treble tone control, Phono input jack, heavy duty 6" Alnico V speaker. Covers standard broadcast from 535kc to 1800kc. Two short wave bands include: 1.8Mc to 6Mc and 6Mc to 18Mc. Kit is complete with all necessary parts, tubes (1-12SK7, 1-12SA7, 1-12SQ7, 1-50L6, 1-35Z5). Punched and formed chassis, coils, dial and pointer, knobs and distinctive mahogany bakelite cabinet: size—15" x 10" x 7". **\$24.75**

All kits supplied less wire & solder. See Your local Distributor or write.

CORONA RADIO & TV CO.

136 LIBERTY ST., NEW YORK 6, N. Y.

INDEX OF

Advertisers

JUNE 1953

While every precaution is taken to insure accuracy, we cannot guarantee against the possibility of an occasional change or omission in the preparation of this index.

ADVERTISER	PAGE	ADVERTISER	PAGE
Ace Television	128	McGraw-Hill Book Co., Inc.	148
Airex Radio Corp.	147	McIntosh Laboratory, Inc.	106
All Channel Antenna Corp.	85	Mallory, P. R. & Company	4th Cover
Allied Radio Corp.	9	Mattison Television & Radio Corp.	150
American Television & Radio Co.	123	Michel Mfg. Co.	126
Amplifier Corp. of America	118	Miles Reproducer Co., Inc.	106
Arkay Radio Kits, Inc.	114	Milwaukee School of Engineering	138
Arrow Electronics	150	Moss Electronic Distributing Co., Inc.	101
Arrow Sales Inc.	135	National Company	127
Asco Sound Corporation	161	National Electronics of Cleveland	94
Ashe, Walter, Radio Company	105	National Radio Institute	3
Audak Company	100	National Schools	19
Audel, Publishers	138	Newark Electric Company	114
Bell Telephone Laboratories	6, 106	Newark Surplus Materials Co.	122
Boulevard Electronics, Inc.	129	Newcomb Audio Products Co.	24
Brook Electronics, Inc.	126	Olson Radio Warehouse	125
Brush Electronics Company	151	Olympic Electronics Supply	122
C & H Sales Co.	160	Peak Electronics Co.	120
Candler System Co.	104	Perma-Power Company	153
Cannon Electric Co.	14	Philco Corporation	28
Capitol Radio Engineering Institute	95	Phillips Tube Company	114
CBS-Hytron	83	Photocon Sales	144
Centralab	32	Pickering & Company Incorporated	30
Century Electronic Co.	154	Platt Electronics Corp.	113
Channel Master Corporation	80, 81	Premier TV Radio Supply	107
Cleveland Institute of Radio Electronics	103	Progressive Electronics Co.	155
Collins Audio Products Co., Inc.	27	Pyramid Electrical Company	21
Columbia Electronic Sales	158	RCA Institutes, Inc.	111, 127
Commissioned Electronics Co.	143	R W Electronics	78
Communications Equipment Co.	82	Radiart Corporation, The	10
Concord Radio	136	Rad Tel Tube Co.	157
Corlover, Carl & Co.	88	Radio City Products Co., Inc.	130
Corona Radio & TV Co.	160	Radio Corporation of America	2nd Cover
Coyne School	108	Radio Craftsmen Inc.	112
Crest Laboratories, Inc.	149	Radio Products Sales Co.	126
DeForest's Training, Inc.	5	Radio Receptor Company, Inc.	132
Delco Radio	97	Radio-Television Training Association	25
Editors & Engineers Limited	102	Rauland Corporation, The	89
Electronic Instrument Co., Inc.	34, 144	Raytheon Manufacturing Co.	137
Electronic Specialty Supply Co.	119, 159	Regency	15
Electro-Voice	8	Rinehart Books, Inc.	90, 150, 158
Fair Radio Sales	104	Rohn Manufacturing Company	159
Federal Telephone & Radio Corporation	3rd Cover	Rose Co., The	152
Fisher Radio Corporation	16	Rytel Electronics Mfg. Co.	26, 146
Franklin Technical Institute	104	Sams, Howard W. & Co., Inc.	77, 142
Garrard Sales Corp.	142	Sanagamo Electric Co.	145
G. L. Electronics	116	Schott, Walter L., Co.	17
General Electric Company	12, 13	Service Instruments Company	158
General Test Equipment	110	Simpson Electric Company	110
Good, Don, Inc.	143	South River Metal Products Co., Inc.	118
Goodheart, R. E.	110	Sprague Products Company	15
Greenlee Tool Co.	108	Sprayberry Academy of Radio	29
Greenwich Sales Company	145	Stan-Burn Radio & Electronics Co.	137
Hallierafters	7	Standard Transformer Corporation	131
Harjo Sales Co.	152	Stephen Sales Corp.	102
Harvey Radio Company, Inc.	102, 144	Steve-El Electronics Corp.	90
Heath Company	73, 76	Stevens Walden, Inc.	140
Henry Radio Stores	92	Sun Parts Distributors, Ltd.	156
Henshaw Radio Supply	154	Sylvania Electric Products, Inc.	33
Hi-Lite Electronic Sales Co.	159	TAB	162
Hudson Radio & Television Corp.	118	Tech-Master Products Co.	152
Hughes Research & Development Laboratories	90, 146	Technical Appliance Corporation	128
Illinois Condenser Co.	94	Telemarine Communications Co.	96
Indiana Technical College	161	Telephone Engineering Company	128
Instructograph Company	149	Television Communications Institute	153
International Correspondence Schools	11	Television Hardware Mfg. Co.	20
International Resistance Company	115	Television Materials Corp.	128
JFD Manufacturing Company, Inc.	79	Television Remote Control Co.	127
JSH Sales Co.	136	Terado Company	124
Jensen Industries, Inc.	154	Thordarson-Meissner	154
J. S. C.	149	Transvision, Inc.	98, 99, 136
Jones & Laughlin Steel Corporation	121	Triad Transformer Corp.	84
Kaar Engineering Company	117	Trio Manufacturing Co.	93
Kirk, Jim	127	Tri-State College	145
Kloss Industries	141	Tung-Sol Electric, Inc.	122
Kryon, Inc.	134	Turner Company, The	141
L. A. Ham Shack	157	Ungar Electric Tools, Inc.	132
LaFayette Radio	108, 109	United Technical Laboratories	143
LaPointe Electronics Inc.	22, 23	Valparaiso Technical Institute	110
Lee Electronic Lab., Inc.	146	Van Sickle Radio Supply Co.	106
Leeds Radio Co.	94	V & H Radio & Electronics	138
Leotone Radio Corp.	153	Visulite Co.	147
Link Aviation, Inc.	91	Waldom Electronics, Inc.	142
McGee Radio Company	86, 87	Weller Electric Corp.	161
McGohan, Don, Inc.	154	Wells Sales, Inc.	155
		Western Electronics Co.	154
		Western Television Institute	114
		Wholesale Radio Parts Co., Inc.	133
		Windsor Electronic Tube Co.	126
		World Radio Laboratories	139

Classified

Rate 50c per word. Minimum 10 words

RADIO ENGINEERING

COMPLETE radio, electronics theory & practice: television; broadcasting; servicing; aviation, marine, police radio. 12 or 18 months. Catalog. Valparaiso Technical Institute, Dept. N, Valparaiso, Ind.

FOR SALE

TRU-SONIC Hi-Frequency driver, and Cellular Horn (with network); only \$50.00. B. K. Balch, 514 Jefferson Ave., Rahway, N. J.

RG11U-2000 feet, 12c. G. R. Watts, 1601 Stratford, Nashville, Tenn.

CRAPTSMEN C-800 Tuner and C-500 Amplifier, unused, \$150. Christian, 819 Blair, Flint, Mich.

TELEVISION receivers (used). Increase your revenue thru selling used Television Sets. Prices, \$10-\$15-\$20 and up. Send forty cents for price lists and descriptions. Ace TV, 401 N. Burdick, Kalamazoo, Michigan.

FACTORY Wired Mobile Transmitter ST 203A. Never used, perfect condition; less tubes—\$45.00. Box 534, % Radio & Television News, 64 E. Lake St., Chicago 1, Illinois.

CAPEHART, 2 used, originally sold for \$1000. \$1400; only \$100 each. Carl Fischer, Inc., 165 W. 57th St., New York 19, N. Y.

USED Television receivers, \$35 to \$75. Spitz, 1420 S. Randolph St., Arlington, Va.

ALL types of Antennas for Amateur and TV. Aluminum Tubing, Willard Radcliff, Fostoria, Ohio.

JENSEN Bass-Reflex Speaker Cabinet, walnut. Excellent condition. Only \$25.00. A. R. Niblack, 420 Shelby St., Vincennes, Indiana.

TAPE Recorders, Tapes, Accessories. Unusual Values. Dressner, 624-R East 20th St., N.Y.C. 9.

TUBES and equipment bought, sold, and exchanged. For action and a fair deal, write B. N. Gensler, W21N1, 136 Liberty, N. Y. 6, N. Y.

NEW RCA 3AP1A original cartons, \$8.75 each. Tubes, surplus—bought, sold. Free list. Write, Mark, Box 14, New York City 72.

DIAGRAMS Radio, Record Changers, Recorders, 75c; Television with Service Data, \$1.25 up. State manufacturer and model number. Kramer's Radio Service, Dept. F53, 36 Columbus Ave., New York 23, N. Y.

ISOLATION transformer 35w 117v sec 117 or 135 plus 6.3v 45a 2 1/2 x 2 1/2 x 3. \$2.45 includes postage 3 lbs. Bulletin available. Empire Electronics Company, 409a Avenue L, Brooklyn 30, N. Y.

WANTED

LORAN 1D6 APN4 A or B indicators. R9 A or B receivers. State price and condition. Lawrence Smith, 418 N. New Jersey Ave., Atlantic City, N. J.

WANTED—Top Prices Paid—Navy Selsyns 1D6, 1E, 1CT, 1G, 5DG, 5D, 5CT, 5G, 6G, 7G, etc. and RC-348, BC-221, AN/ART-13, AN/ARC-1, AN/ARC-3, RTA-1B, AN/AIR-1. Lectronic Research, 719 Arch St., Philadelphia.

AN/AIR-1, other "APR," "ARR," "TS," "IE," ARC-1, ARC-3, AIR-13, everything surplus; Tubes, Manuals, Laboratory equipment. Describe, price in first letter. For Sale; Reconditioned Watthour Meters, four for \$10.00. Engineering Associates, 134 Patterson Rd., Dayton 9, Ohio.

WILL buy all Art-13/type T-47A, \$200.00, Art-13/type T-47, \$150.00, BC-348 unmodified, \$75.00, BC-348 modified, \$55.00, APN-9, \$200.00, ARC-3 complete, \$750.00, R77 Receivers, \$400.00, ARC-1, \$600.00, RC-312, \$65.00, BC-342, \$60.00. Ship via Express C.O.D., subject to inspection to: H. Finnegan, 49 Washington Ave., Little Ferry, N. J.

CORRESPONDENCE COURSES

USED correspondence Courses and Books sold and rented. Money back guarantee. Catalog free. (Courses bought.) Lee Mountain, Pisgah, Alabama.

USED Correspondence Courses and Educational Books Bought, Sold, Rented. Catalog free. Educational Exchange, Summerville, Ga.

MISCELLANEOUS

MORE profit in television service with our unit. Write for details. Evans Specialty Works, 1414 Lake Ave., Lake Worth, Fla.

ELECTRONIC Instruments Reconditioned. Radio, Television, Industrial and Electromedical Testing Equipment repaired. Factory Warranty Depot for: DuMont, Hickok, Jackson Instruments. Missouri Electronics Corp., 6058 Maple Ave., St. Louis 12, Missouri.

WANT Houston Location? Excellent for electronics or electrical wholesaler or distributor. Close in. Good road net. Parking. Also have some good retail locations. McCause Realtors, 314 Winkler Drive, Houston, Texas.

1000 THERMOGRAPHED (embossed) Business Cards, \$4.50. Free sample. Klein, 980 Simpson St., New York 59, N. Y.

SPEAKERS repaired, wholesale prices, guaranteed workmanship. Anprite Speaker Service, 70 Vesey St., New York City 7.

THIS **NEWEST** WELLER GUN INVITES COMPARISON

NOW 275 WATTS

COMPARE It To The Soldering Tool You Now Use

COMPARE It To Any Soldering Tool On The Market

Here's the professional tool with all the features you've wanted for fast, dependable soldering.

- **COMPARE the soldering capacity.** This newest Weller Gun handles up to 275 watts. Four new models from 100 to 275 watts give full coverage of heavy or light soldering.
- **COMPARE the performance.** Instant heating saves time and current. Dual heat feature provides extra soldering capacity when needed. Two spotlights on all models locate the work quickly.
- **COMPARE the comfort.** This newest Weller Gun floats in your hand. Perfect wrist-action balance and streamlined design, with pistol grip centered under housing, provide easier operation.
- **COMPARE the versatility.** There are 4 new Weller models—heavy duty, light duty, single heat and dual heat. And 2 new accessory tips are available for all models. A hot knife-blade cutting tip and a trowel-shape smoothing tip add to the practical uses of a Weller Gun.
- **COMPARE the reputation.** This newest Weller gun is backed by the first name in the soldering gun field. Over a half-million Weller Guns are used by professional servicemen and craftsmen. See this newest Weller Gun at your Distributor or write for Bulletin direct.

Weller

SOLDERING GUNS

Better from Grip to Tip!

810 Packer Street
Easton, Pa.



GIFT...

from America's most advanced Hi-Fi studios... Come in or write for your copy of "Sound Advice" by Irving Greene, 124 pages of vital Hi-Fi data... It's FREE!

ASCO SOUND CORPORATION
115 WEST 45th STREET, NEW YORK 36

RADIO ENGINEERING DEGREE IN 27 MONTHS

Radio engineering is a big field. There's room for you in it—if you're good. Get first-class training at Indiana Tech. Intensive specialized course, including strong basis in mathematics and electrical engineering, advanced radio theory and design, television, electronics, Modern Laboratories. Low rate. Also B.S. DEGREE IN 27 MONTHS in Aeronautical, Chemical, Civil, Electrical and Mechanical Engineering. C.I. Government approved. Enter June, September, December, March. You can earn part of your expenses right here in Fort Wayne while you are studying.

INDIANA TECHNICAL COLLEGE
963 E. Washington Blvd., Fort Wayne 2, Indiana

Please send me free information on B.S. Engineering Degree in 27 months as checked.

Radio-Television
 Civil Mechanical Aeronautical
 Electrical

Name

Address



The man who brought back a smile

EXCITED? Cynthia was practically bursting! Last thing Dad said was "Now you look close, Cindy.

You'll see me right there in the audience tonight, and I'll wave to you." (They always do!)

Long about three o'clock Cynthia's mother turned on the set . . . "just to make sure."

Well, there was a picture, if you could call it that . . . but so dim and fuzzy they'd never even recognize Dad that evening. And Cindy . . . disappointed? She was brokenhearted!

But, you know the happy ending . . . the serviceman's competent analysis . . . replacement of a worn-out tube with a Federal "Best-in-Sight" Picture Tube . . . and there are smiles again.



Line of Popular-Size Picture Tubes will take care of over 90% of all TV replacements.

Write for free copy of Federal's TV Picture Tube Data Book, Dept. N-259

THE SERVICEMAN gives his customers years of experience and expert technical ability. His business is knowing what's best . . . and giving the best. Customers rely on his judgment just as thoroughly as he relies on Federal "Best-in-Sight" Picture Tubes for the sharpest, brightest, clean-cut pictures possible. He *knows* that when he picks up the carton with the blue and white Federal label, he's going to make some customer a lot happier for a long, long time.



Consult your local Federal Distributor or write to

Federal Telephone and Radio Corporation

VACUUM TUBE DIVISION

100 KINGSLAND ROAD, CLIFTON, N. J.

In Canada: Federal Electric Manufacturing Company, Ltd., Montreal, P. Q.
Export Distributors: International Standard Electric Corp., 67 Broad St., N. Y.



The Time **YOU SAVE** ... is **ALL PROFIT!**

Every job is in a hurry around a busy service shop . . . and minutes saved add up to more work done and greater profits, to say nothing about satisfied customers.

When you use Mallory Midgetrols®, you'll find them fast and easy to install in any TV or radio set.

Round tubular shafts can be cut accurately and quickly . . . fit split-knurled or flatted-type knobs.

AC switches can be attached instantly without disassembling the control.

Unique design simplifies inventory problems . . . makes them quickly available from your distributor.

Midgetrols are engineered to match the electrical characteristics of the original equipment of any TV or radio set. They will give equal, and often better, performance than the original control . . . your assurance of precision quality on every job.

This will save time, too. Ask your Mallory Distributor for a copy of the Mallory Control Guide. It is a complete cross reference between set manufacturers' part numbers and the equivalent Mallory control.

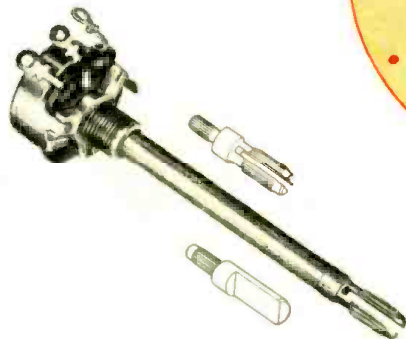

Mallory Dual Control Kits

Three kits of controls and switches, selected to meet varying requirements in different parts of the country, will serve 50 different models of radio and television sets. You pay only for the controls and switches; attractive 3-drawer metal cabinet is free of extra cost. Get details from your Mallory Distributor.

P. R. MALLORY & CO. Inc.
MALLORY
 CAPACITORS • CONTROLS • VIBRATORS • SWITCHES • RESISTORS
 RECTIFIERS • POWER SUPPLIES • FILTERS • MERCURY BATTERIES
APPROVED PRECISION PRODUCTS

P. R. MALLORY & CO., Inc., INDIANAPOLIS 6, INDIANA

*Depend on Mallory
 for
 Approved Precision Quality*