

RADIO & TELEVISION NEWS

**FEBRUARY
1953**

IN THIS ISSUE

**GUIDED MISSILE DATA
RECORDING**

**A THERMOCOUPLE
A.C. WATTMETER**

ULTRASONIC MICROSCOPE

COMPUTER RELIABILITY

**CHARACTERISTICS OF
DIGITAL AND ANALOG UNITS**

**BUILD THIS
TRANSISTOR RECEIVER**

**IMPROVING THE
WILLIAMSON AMPLIFIER**

**COMPACT BANDSWITCHING
V.F.O. MULTIPLIER**

**V.H.F. - U.H.F.
ANTENNA DESIGN** ▶

(See Page 42)



Thirteen NEW CRL Printed Electronic Circuits for replacement service!

Brand new Centralab PEC units that cover over two million radio and TV sets now in use. Get your supply for easy servicing. The new PEC Guide No. 2 covers all replacements.

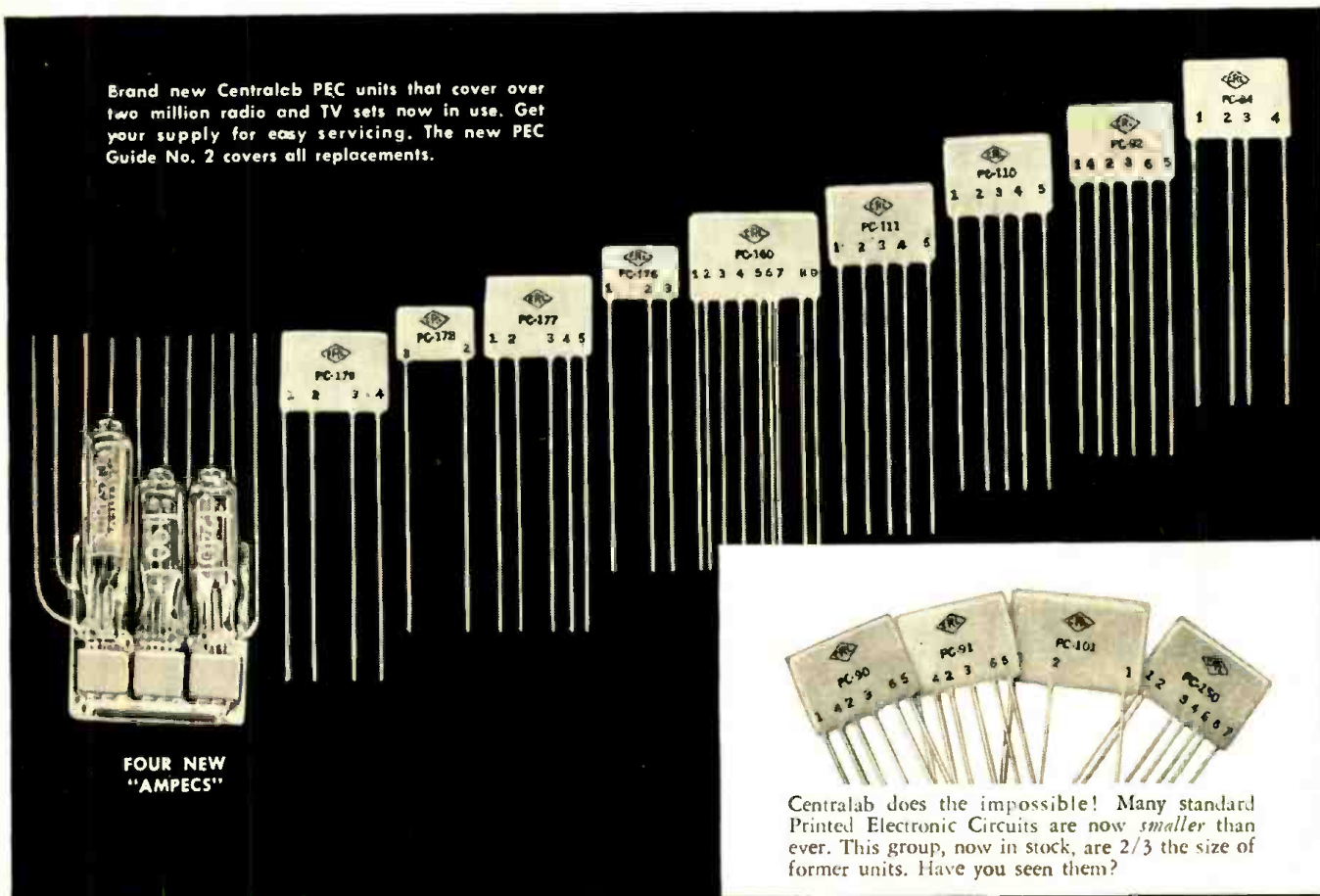

FOUR NEW "AMPECS"

Centralab does the impossible! Many standard Printed Electronic Circuits are now *smaller* than ever. This group, now in stock, are 2/3 the size of former units. Have you seen them?

Now Available from your Centralab Distributor

THESE thirteen new Printed Electronic Circuits are now in use in thousands of radio and TV sets. You should have a complete stock on hand for shop work and service calls. Centralab Circuits are safest and easiest for servicing. In most cases, the replacement PC number is the same as shown on the original part.

These new PEC units replace whole Pentode Coupling, TV I. F., Triode Coupling, or Pentode Detector networks. Four new plates, too, to replace *special* manufacturer's parts. Together with the other CRL stock Printed Electronic Circuits, these parts will cover 95% of all PEC replacements. Over 15 million circuits are now in use . . . are you ready to service them?

Don't overlook the new smaller sizes in older PEC units. Small size is not enough . . . Centralab makes Printed Electronic Circuits even smaller! For complete information on parts, replacements, and test data, see the *new* Printed Electronic Circuit Guide No. 2. Ask your distributor for a copy, or use the coupon.

**Make your Centralab distributor
headquarters for
exact electronic replacements**

Centralab

A Division of Globe-Union Inc.

Milwaukee 1, Wisconsin

In Canada, 635 Queen Street East, Toronto, Ontario

Centralab Printed Electronic Circuits are among the more than 470 *new* items listed in Centralab's new Catalog 28. Get your copy of this 32-page index to the latest developments in the fast-changing electronic field, plus the 20 page Printed Electronic Circuit Guide No. 2. See your distributor or use coupon.



CENTRALAB, A Division of Globe-Union Inc.
910 E. Keefe Avenue, Milwaukee 1, Wisconsin

Please send me my copy of:

P.E.C. Guide No. 2 Centralab Catalog 28

Name..... Position.....

Company.....

Address.....

City..... State.....

RADIO & TELEVISION NEWS is published monthly by the Ziff-Davis Publishing Company at 185 N. Wabash Ave., Chicago 1, Ill. Entered as second-class matter, July 21, 1948 at the Post Office, Chicago, Ill., under the act of March 3, 1879. Authorized by Post Office Department, Ottawa, Canada, as second-class matter. SUBSCRIPTION RATES: Radio & Television News—one year, U. S. and Possessions, Pan-American countries, and Canada \$4.00; all other foreign countries \$5.00; Radio-Electronic Engineering Edition—one year, U. S. and Possessions, Pan-American countries, and Canada \$8.00; all other foreign countries, \$7.00. Postmaster—Please return undelivered copies under form 3589 to 64 E. Lake St., Chicago 1, Ill.

Editor
OLIVER READ, D.Sc., WIETI

Managing Editor
WM. A. STOCKLIN, B.S.

Technical Editor
H. S. RENNE, M.S.

Service Editor
CHARLES TEPFER

Amateur Radio Editor
NICHOLAS ROSA, W1NOA

Assistant Editors
P. B. HOEFER
M. C. MAGNA

Television Consultant
WALTER H. BUCHSBAUM

Short-Wave Editor
KENNETH R. BOORD

Staff Artist
FRANK SAYLES

Draftsman
A. A. GANS, W2TSP

Advertising Manager
L. L. OSTEN

Midwest Adv. Manager
JOHN A. RONAN, JR.

Western Adv. Manager
JOHN E. PAYNE



COVER PHOTO: Every new antenna that reaches the market represents hours of engineering time and exhaustive testing like this new "Vee-D-X" unit by LaPointe-Plascomold Corp. (Ektachrome by James Pickands)

Chairman of the Board and Publisher
WILLIAM B. ZIFF

President
B. G. DAVIS

Secretary-Treasurer
G. E. CARNEY

Vice-Presidents
H. J. MORGANROTH
Production Director

LYNN PHILLIPS, JR.
Advertising Director

H. G. STRONG
Circulation Director

BRANCH OFFICES
 CHICAGO (11)
 185 N. Wabash, AN 3-5200
 LOS ANGELES (14)

Staller Center, 900 Wilshire Blvd., Mich. 9850

First in
radio-television-electronics
 Average Paid Circulation over 220,000

RADIO & TELEVISION NEWS

Reg. U.S. Pat. Off.

Radio News Trademark Reg. U. S. Pat. Office • Television News Trademark Reg. U. S. Pat. Office.

CONTENTS

FEBRUARY, 1953

Build this Transistor Receiver.....	Robert K. Dixon	35
Oil-Cooled Load Wattmeter.....	Robert M. See, W9OCL/5	38
Care of Transistors.....	Rufus P. Turner, K6AI	40
V.H.F.-U.H.F. Antenna Design.....	L. F. B. Carini	42
Improving the Williamson Amplifier.....	David Hafler & Herbert I. Keroes	43
TV Signal Distribution Methods.....	Edward M. Noll	46
An Improved Corner Horn Speaker System.....	George L. Augspurger	48
Current TV Topics.....	Walter H. Buchsbaum	50
A Compact Bandswitching V.F.O. Multiplier.....	Earl Snader, W0ZFO	52
Sound System for Your TV Set.....	John Potter Shields	54
U.H.F. Antennas (Part 3).....	Milton S. Kiver	56
Writing for Profit and Prestige.....	Louis E. Garner, Jr.	59
A Vest-Pocket Receiver.....	E. G. Louis	60
Single-Channel Remote Broadcast Amplifier.....	Leon A. Wortman	62
Mac's Radio Service Shop.....	John T. Frye	64
3-Element 14 mc. Rotary Beam Antenna.....	C. A. West, W2IYG	66
New TV Grants Since Freeze Lift.....		70
Eliminating Oscillator Hum in FM Receivers.....	Herbert Michels	82
Radio-TV Service Industry News.....		104

DEPARTMENTS

For the Record.....	The Editor	8	What's New in Radio.....	85
Spot Radio News.....		16	Manufacturers' Literature.....	116
Within the Industry.....		24	Technical Books.....	155
Short-Wave.....	K. R. Boord	65	New TV Products.....	158



COPYRIGHT 1953
ZIFF-DAVIS PUBLISHING COMPANY
 Editorial and Executive Offices
 366 Madison Ave., New York 17, N. Y.
 VOLUME 49 • NUMBER 2



Member
 Audit Bureau of
 Circulations

SUBSCRIPTION SERVICE: All communications concerning subscriptions should be addressed to Circulation Dept., 64 E. Lake St., Chicago 1, Ill. Subscribers should allow at least two weeks for change of address.

CONTRIBUTIONS: Contributors are advised to retain a copy of their manuscripts and illustrations. Contributions should be mailed to the New York Editorial Office and must be accompanied by return postage. Contributions will be handled with reasonable care, but this magazine assumes no responsibility for their safety. Any copy accepted is subject to whatever adaptations and revisions are necessary to meet the requirements of this publication. Payment covers all author's, contributor's, and contestant's rights, title, and interest in and to the material accepted and will be made at our current rates upon acceptance. All photos and drawings will be considered as part of the material purchased.

RADIO & TELEVISION NEWS

Prepare Now... in spare time at Home ... for a New,

PROFITABLE, INTERESTING FUTURE

TELEVISION
RADIO - ELECTRONICS

RADIO CHIEF OF ILE DE FRANCE
FRENCH LUXURY LINER PRAISES D. T. I.

Radio Chief—Jean Desmas Says:

"DeForest's Training, Inc., of Chicago, is known not only throughout Europe, but also in many parts of the world as one of America's finest Television, Radio and Electronic training centers."



JACK DEMPSEY

Former World's Heavyweight Champion

TELLS WHY HE'S PROUD

TO BE WITH **D.T. I.**

- I have been greatly impressed with D.T.I.'s wonderful spirit of friendliness and sincere determination to help its students make good in Television-Radio-Electronics.
- I admire its remarkable 20 year record of helping men build brighter futures.
- I also admire the business policy of its management and the thoroughness of its large faculty of instructors.
- Never have I heard young men praise a school as enthusiastically as do the students and graduates of D.T.I. They are its best boosters.



Prepare At Home Or In Our Chicago Laboratory!

See for yourself how readily you may prepare at home, or in our modern Chicago laboratories, for a better job or business of your own in one of America's fastest-growing fields—TELEVISION-RADIO-ELECTRONICS.

If you train at home you get (1) the use of a 16-mm. movie projector and 16 reels of animated movies to help you learn important points faster . . . easier, (2) modern lessons and (3) sixteen shipments of electronic parts enabling you to get valuable practical experience from over 300 projects—including building and keeping the electronic equipment shown below. And upon completing training, you have the optional privilege of building and keeping a big 17-INCH TV set at moderate added cost. Get the full story. Mail coupon today!

LAUD D. T. I.'s HOME MOVIES IN CONGRESS

D.T.I.'s remarkable home training benefit of visual training MOVIES has been praised from the floor of the House of Representatives in Washington, D. C. and recorded in The Congressional Record.

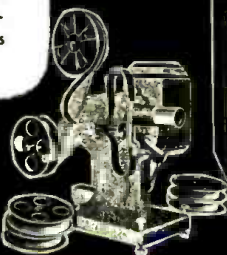

HOME MOVIES

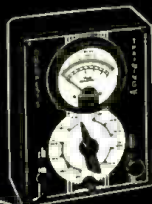

MULTIMETER

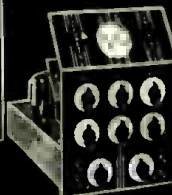

OSCILLOSCOPE



R-F SIGNAL GENERATOR



6-TUBE RADIO

MILITARY SERVICE!

If subject to military service, the information we have for you should prove very helpful. Mail coupon today.



De FOREST'S TRAINING, INC.

AFFILIATED WITH

De VRY Technical INSTITUTE

CHICAGO 14, ILLINOIS



MAIL COUPON TODAY!

Dept. RN-2-J
DE FOREST'S TRAINING, INC.
2533 N. Ashland Ave., Chicago 14, Ill.

I would like your Opportunity News Bulletin showing "89 Ways to Earn Money in Television-Radio-Electronics"; also, the folder showing how I may prepare to get started in this thrilling field.

Name _____ Age _____

Address _____ Apt. _____

City _____ Zone _____ State _____

G-C HAS MADE... 125 MILLION STAND-OFFS FOR THE TELEVISION INDUSTRY

125 MILLION STAND-OFFS! Yes, G-C recently completed the manufacture of its 125,000,000th Stand-Off... made possible by the fact that the entire radio-TV service industry recognizes the value, the top quality built into every G-C Stand-Off—available from your jobber in 24 popular styles.

All G-C Stand-Offs are supplied with genuine Polyethylene insulators like this... featuring the exclusive G-C reinforcing rib that keeps the insulator from collapsing.



G-C KANT-STRIP MAST STAND-OFFS

Exclusive, improved mast stand-offs with strip-proof extruded threads. Extra strong; no flimsy light metal used; no loose nuts to fall out. Galvanized strap has round end for easier threading. Genuine Polyethylene insulator, unique G-C design.

No.	Size
8253	3 1/2" Single
8257	7 1/2" Single

 <p>G-C UNIVERSAL STAND-OFFS (Machine Screw Type)</p> <table border="0"> <tr> <th>No.</th> <th>Length</th> </tr> <tr> <td>8031</td> <td>3 1/2"</td> </tr> <tr> <td>8032</td> <td>5 1/2"</td> </tr> <tr> <td>8035</td> <td>7 1/2"</td> </tr> </table>	No.	Length	8031	3 1/2"	8032	5 1/2"	8035	7 1/2"	 <p>G-C UNIVERSAL STAND-OFFS (Wood Screw Type)</p> <table border="0"> <tr> <th>No.</th> <th>Length</th> </tr> <tr> <td>8027</td> <td>3 1/2"</td> </tr> <tr> <td>8028</td> <td>5 1/2"</td> </tr> <tr> <td>8029</td> <td>7 1/2"</td> </tr> <tr> <td>8030</td> <td>12"</td> </tr> </table>	No.	Length	8027	3 1/2"	8028	5 1/2"	8029	7 1/2"	8030	12"	 <p>G-C NAIL-IN STAND-OFFS</p> <p>New, speed-type nail-in stand-offs save installation time, labor and cost on each job. Easy to use. Genuine Polyethylene insulators.</p> <table border="0"> <tr> <th>No.</th> <th>Length</th> </tr> <tr> <td>8343</td> <td>3 1/2"</td> </tr> </table>	No.	Length	8343	3 1/2"	 <p>G-C DUPLEX IN-LINE STAND-OFFS</p> <p>Two styles, wood screw and machine screw types. Heavily zinc plated to prevent rust.</p> <table border="0"> <tr> <th>No.</th> <th>Size and Type</th> </tr> <tr> <td>8225</td> <td>7 1/2" Wood Screw</td> </tr> <tr> <td>8226</td> <td>7 1/2" Machine Screw</td> </tr> </table>	No.	Size and Type	8225	7 1/2" Wood Screw	8226	7 1/2" Machine Screw
No.	Length																														
8031	3 1/2"																														
8032	5 1/2"																														
8035	7 1/2"																														
No.	Length																														
8027	3 1/2"																														
8028	5 1/2"																														
8029	7 1/2"																														
8030	12"																														
No.	Length																														
8343	3 1/2"																														
No.	Size and Type																														
8225	7 1/2" Wood Screw																														
8226	7 1/2" Machine Screw																														
 <p>G-C SNAP-ON STAND-OFFS</p> <p>NEW, improved snap-on that is easier to install, then stays on. Snap... and it's on; that's all there is to it! Two standard sizes. Feature exclusive G-C reinforced insulators.</p> <table border="0"> <tr> <th>No.</th> <th>Size</th> </tr> <tr> <td>8797</td> <td>For 1" Masts</td> </tr> <tr> <td>8798</td> <td>For 1 1/4" Masts</td> </tr> </table>	No.	Size	8797	For 1" Masts	8798	For 1 1/4" Masts	 <p>G-C "WIRE-GRIP" GUY WIRE STAND-OFFS</p> <p>TV lead-ins and rotator wires can be brought down long guy wires. Fasten permanently; easy to use. Genuine Polyethylene insulators.</p> <table border="0"> <tr> <th>No.</th> <th>Size and Type</th> </tr> <tr> <td>8255</td> <td>3 1/2" Single</td> </tr> <tr> <td>8256</td> <td>Double Type</td> </tr> </table>	No.	Size and Type	8255	3 1/2" Single	8256	Double Type	 <p>G-C DUPLEX KANT-STRIP MAST STAND-OFFS</p> <p>Heavy steel stand-off with strip-proof extruded threads. A deluxe stand-off at a really low price. Galvanized strapping. For both 300-ohm and coaxial lines.</p> <table border="0"> <tr> <th>No.</th> <th>Type</th> </tr> <tr> <td>8258</td> <td>Double</td> </tr> </table>	No.	Type	8258	Double	 <p>G-C EAVE TYPE CLAMP-ON STAND-OFFS</p> <p>New type, clamp-type stand-off that quickly fastens to eaves. Easy to install. Genuine Polyethylene insulators.</p> <table border="0"> <tr> <th>No.</th> <th>Type</th> </tr> <tr> <td>8811</td> <td>Single</td> </tr> <tr> <td>8812</td> <td>Double</td> </tr> </table>	No.	Type	8811	Single	8812	Double						
No.	Size																														
8797	For 1" Masts																														
8798	For 1 1/4" Masts																														
No.	Size and Type																														
8255	3 1/2" Single																														
8256	Double Type																														
No.	Type																														
8258	Double																														
No.	Type																														
8811	Single																														
8812	Double																														
 <p>G-C TEE-TYPE STAND-OFFS</p> <p>Heavy zinc plated for permanent installation. Two types, wood screw and machine screw. For both 300-ohm and coaxial lines.</p> <table border="0"> <tr> <th>No.</th> <th>Size and Type</th> </tr> <tr> <td>8809</td> <td>7 1/2" Wood Screw</td> </tr> <tr> <td>8810</td> <td>7 1/2" Machine Screw</td> </tr> </table>	No.	Size and Type	8809	7 1/2" Wood Screw	8810	7 1/2" Machine Screw	<p>FREE G-C's big, illustrated Catalog, chock-full of hundreds and hundreds of radio-TV service aids. Send a postcard for your copy today!</p> <div style="text-align: center;">  <p>GENERAL CEMENT MANUFACTURING CO. 904 TAYLOR AVENUE ROCKFORD, ILLINOIS</p> </div> <div style="text-align: right;">  </div> <p style="text-align: right;">RADIO & TELEVISION NEWS</p>																								
No.	Size and Type																														
8809	7 1/2" Wood Screw																														
8810	7 1/2" Machine Screw																														

**Accepted and praised by
the most critical expert in the world**

...the American Amateur Radio Operator



hallicrafters



A Ham's Dream—The SX-71—Planned with you, the advanced amateur, in mind, Communications Receiver SX-71 is a double conversion set, built-in NBFM limiter stage. 538 kc to 34 mc. in 5 bands. Plus A 46 to 55 mc band. Temperature comp.; voltage regulator. 1 r-f, 2 converters, 3 i-f stages. Xtal. filter, 3-position selectivity. 115 V AC, 11 tubes, regulator, rectifier **\$224.50**



Precise Selectivity—The S-76—Amazingly selective! Crisp station separation. Double conversion with 50 kc 2nd i-f. Giant 4-in. "S" meter. 540-1580 kc, 1.72-32 mc in 4 bands. 1 r-f, 2 converters, 2 i-f stages. 5 position selectivity. Phono input jack, 3 watt output. 115 V AC, 9 tubes, regulator, rectifier **\$179.50**



Low Price—High Performance!—S-40B—540 kc to 43 mc in 4 bands. Electrical band spread. Temperature compensated. 1 r-f, 2 i-f. 3 watt output. Built-in speaker. 115 V AC only, 7 tubes, plus rectifier. (S-77—same as S-40B, for 115 V AC or DC) **\$119.95**

The first Hallicrafters radio was built specifically for the ham operator more than twenty years ago. Today, Hallicrafters sell more communications sets to the armed forces, professionals and hams, than *all other manufacturers combined*. Yet today, these Hallicrafters sets are still designed *specifically* for the most critical expert in the world—the American amateur operator. There is no higher standard.

hallicrafters

"The Radio Man's Radio"

World's Leading Manufacturer of Precision Radio and Television • Chicago 24, Illinois

The Finest Buy in SW!—The S-38C—Best performance per dollar you'll find, the S-38C is the outstanding low priced set on the market. 540 kc to 32 mc in 4 bands. Maximum sensitivity per tube,—far outperforms ordinary broadcast sets. Built-in speaker. 115 V AC or DC. 4 tubes plus rectifier **\$49.50**



for PA LIKE ON TV

636
Slimair
DYNAMIC MICROPHONE

Gives you features similar to those in the famous E-V Slim-Trim TV Microphones. That's why it is so outstanding for Public Address, Recording and other general-purpose use.
List Price \$70

SMOOTH RESPONSE
60-13,000 CPS
HIGH OUTPUT
OMNIDIRECTIONAL
ACOUSTALLOY DIAPHRAGM
BUILT-IN BLAST FILTER

Can be used in the hand, on a stand or overhead

SEND FOR BULLETIN

Electro-Voice
410 CARROLL ST. • BUCHANAN, MICH.
Export: 13 E. 40th St., N. Y. 16, U.S.A.

For the RECORD.

BY THE EDITOR

THE TELEVISION SERVICE OPERATOR

MANY letters coming to our desk are from technical trainees attending classes in our trade schools and colleges. These students, generally, state that they are learning radio or television theory and practice as preparation for a career in the servicing business. Typical questions asked include: "What do I need to start a service shop?", "Should I specialize in television service exclusively or should I consider both radio and television?" and "What test equipment will I need for television servicing?"

It is a well established fact that television installation and service requires considerably more test instruments and other equipment than does radio. Such equipment can be very costly and, in the case of the independent service technician, almost prohibitive in areas of limited clientele. TV test equipment must be sensitive and accurate. In many cases it is too massive or heavy for home servicing and belongs on the test bench where it can be conveniently and effectively used. A well-equipped shop is a prerequisite for television servicing.

The service shop, however well equipped, is but one link in the chain of equipment required by the progressive service operator. Successful TV service contractors have learned that to cope with the many problems that arise in TV areas they must not only have a well trained staff of technicians but that their men must be properly equipped with the tools of the trade.

Paul Forte of the *Television Contractors Association* recently named several important components that are required to render good service. They include a panel truck or specially fitted car. In it must be carried a supply of tools, equipment, and spare parts that are in most common need. When a television set can't be repaired with these facilities, the car or truck must be suited so that a chassis and/or cabinet can be brought back to the shop for bench work. Such vehicles cost money and represent another investment on the part of the service contractor.

Since there are, roughly, about eighty different makes of television sets and thousands of models, the effectively operating contractor must have a complete library of diagrams, schematics, and service notes. These cost money, and taking care of them, adding to them, and using them costs time and money. Without them no man can claim that he is ready to service television.

A service operator cannot properly

function unless he has records of all service calls. These are not things he keeps in his wallet. He's got to have files and forms and he's got to have somebody work on them to keep them up-to-date. That means he has to have an office and someone in it to handle service requests and dispatch them promptly. These things cost money, a cost that can't be borne by the independent technician. If he does bear them, then he isn't an independent technician any longer; he's either a contractor or a service operator.

He must have special equipment and facilities for installations which include the erection of antennas. This, definitely, requires a truck. He can contract the antenna installation to someone else but that is hardly a good method of conducting a business. Trucks, too, cost money and are an integral part of the investment that must be put into a television service operation, as well as into the cost of service.

Since he's dealing with expensive television equipment in the customer's home, he has to carry Public Liability and Property Damage Insurance. He has to carry other insurance on his vehicles, test equipment, parts stock, and other facilities. It costs more money! It's all part of the investment that goes into a properly handled service business.

If the so-called independent technician says he doesn't need these things in order to maintain himself in the television service business, he is kidding himself. Certainly he won't kid the public, upon whom he depends for business.

There is little time, if any, for the aggressive technician to relax and sit back with a hope that he can keep pace with the fastest growing industry in our time. Instead, he must constantly keep abreast of new developments, in addition to performing his routine tasks as each day passes. He must continually study new circuits, new products, new applications, and new techniques.

He must learn all that he can about u.h.f. behavior, circuitry, antenna theory, and troubleshooting. He must employ common sense in his relationship with the public he serves. He must conduct himself as a successful business man and be ethical.

If he trains himself *NOW* and if he builds a firm foundation based on the experience of other technicians—the television service operator can certainly look to a future of interesting opportunities in this industry we choose to call electronics. O.R.

THE ONLY COMPLETE CATALOG FOR
EVERYTHING IN TV, RADIO AND
INDUSTRIAL ELECTRONICS

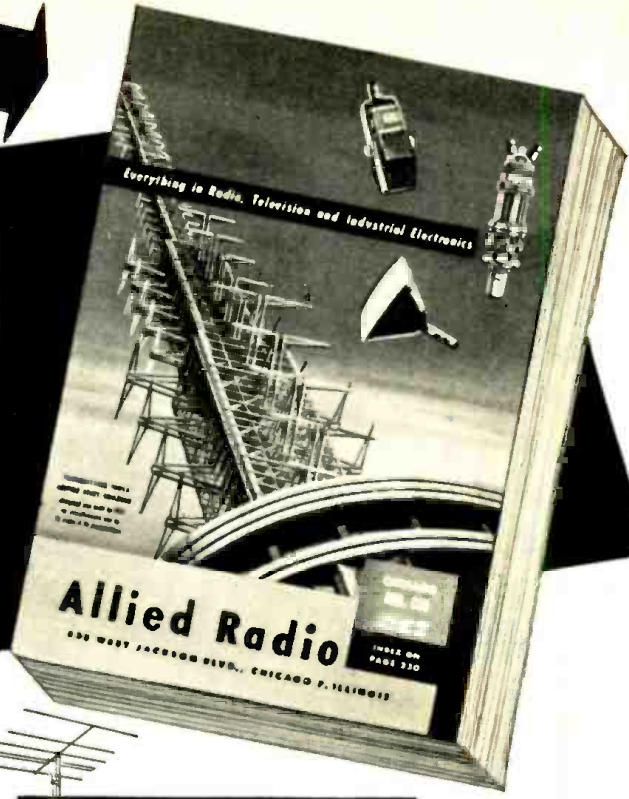

get your 1953 **FREE**

ALLIED

236-PAGE CATALOG

it's complete
it's value-packed

THE WORLD'S LARGEST STOCKS

- TV and Radio Parts
- Test Instruments
- Hi-Fi and P.A. Equipment
- Custom TV Chassis
- AM, FM Tuners & Radios
- Recorders and Supplies
- Amateur Station Gear
- Builders Supplies
- Equipment for Industry

**QUICK
EXPERT
SERVICE**

Send for it today!

Here's the *one* authoritative, complete Buying Guide to *Everything in Electronics*—packed with the world's largest selections of quality equipment at lowest money-saving prices. See the latest in TV custom chassis, TV antennas and accessories; AM and FM tuners and radios; High-Fidelity Custom Sound components; latest P.A. Systems and accessories; recorders; Amateur receivers, transmitters and station gear; specialized industrial electronic equipment; test instruments; builders' kits; huge listings of parts, tubes, tools, books—your choice of the world's *most complete stocks* of quality equipment.

ALLIED gives you every buying advantage; speedy delivery, expert personal help, lowest prices, liberal time payment terms, assured satisfaction. Get the latest 1953 ALLIED Catalog. Keep it handy—and save time and money. Send for your **FREE** copy today!



**EVERYTHING IN
ELECTRONICS**

**SEND TODAY FOR RADIO'S
LEADING BUYING GUIDE**



ALLIED RADIO
World's Largest Electronic Supply House

EASY-PAY TERMS

Take advantage of ALLIED's liberal Easy Payment Plan—Radio's best terms—only 10% down, 12 months to pay—no interest if you pay in 60 days. Available on Hi-Fi and P. A. units, recorders, TV chassis, test instruments, Amateur gear, etc.

TV & HI-FI SPECIALISTS

To keep up with developments in TV and High-Fidelity, look to ALLIED! Count on us for *all* the latest releases and largest stocks of equipment in these important fields. If it's *anything* in Television or High-Fidelity equipment—we have it in stock!

ALLIED RADIO CORP., Dept. 1-B-3
833 W. Jackson Blvd., Chicago 7, Illinois

Send **FREE** 236-Page 1953 ALLIED Catalog.

Name

Address

City Zone State

In a Class
by Itself

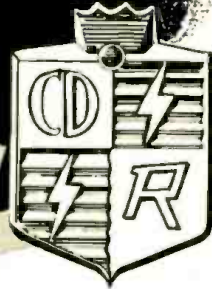

the
CDR Rotor

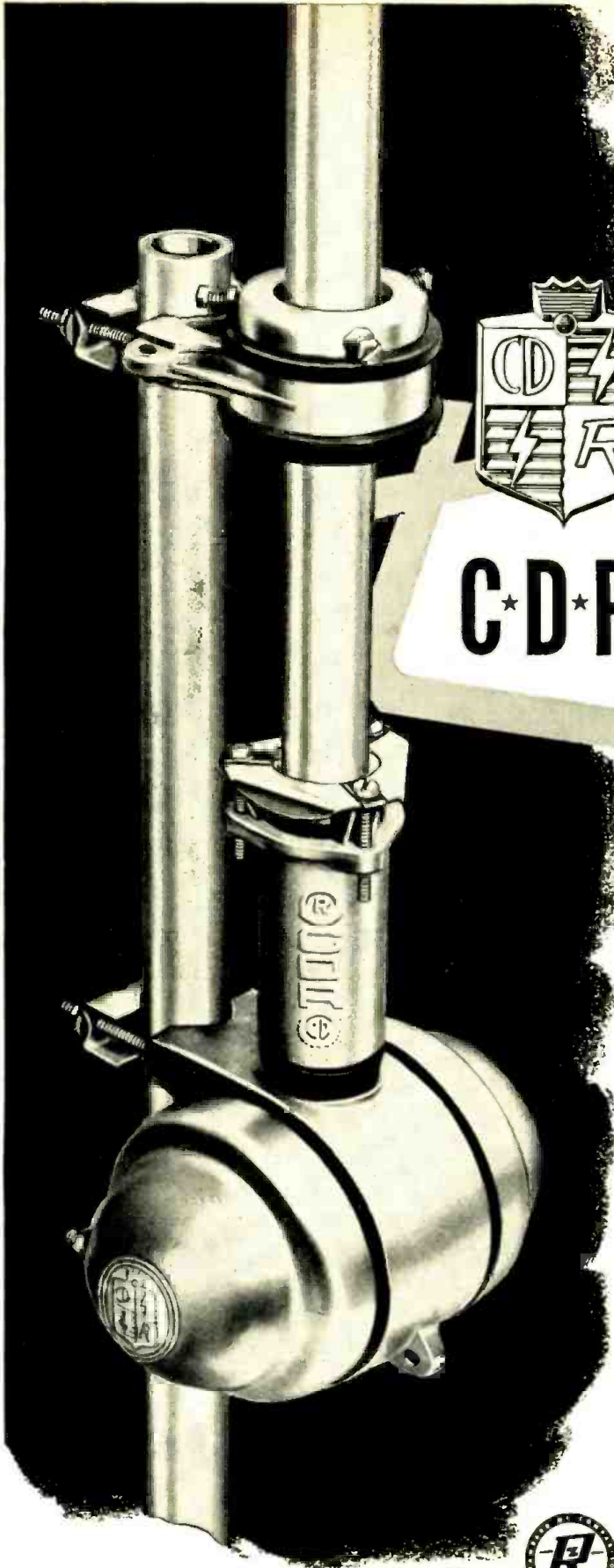

Speedy Installation ... the servicemen's dream come true! No loose parts to assemble ... no kits with loose washers, nuts and bolts ... quick mounting antenna mast collet plus four wire cable hookups!

Dependable ... experience has proven that once a CDR ROTOR is up ... it's THERE TO STAY! No costly call-backs! Completely weather-sealed and streamlined ... it's the outstanding value in the field!

Powerful ... sturdy in design to support and TURN ANY TV ANTENNA array ... never a worry about the CDR rotor working! Locking instantly it will not drift! Instantly reversible ... makes a complete revolution in 45 seconds!

MODEL TR-12 A special combination value consisting of complete rotor including thrust bearing ... handsome modern design plastic cabinet with meter control dial, only \$47.95

MODEL TA-6 Thrust bearing accessory, separately \$4.95

MODEL TR-11 Same as TR-12 without thrust bearing.. \$44.95

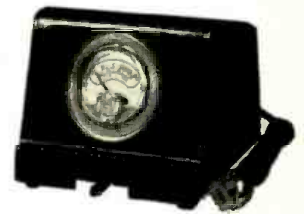

SUBSIDIARY OF



THE **RADIART** CORPORATION
CLEVELAND 13, OHIO

CORNELL-DUBILIER
SOUTH PLAINFIELD, NEW JERSEY
RADIO & TELEVISION NEWS

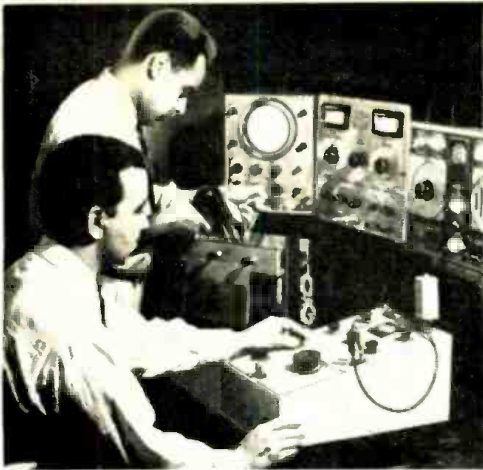

EARN MORE MONEY AS AN EXPERT

Get Shop-Method
Training at Home in

RADIO TELEVISION ELECTRONICS

One Master Course - One Low Tuition
LEARN ALL PHASES - EARN WHILE YOU LEARN

AS A NATIONAL SCHOOLS GRADUATE THERE'S A PLACE FOR YOU IN THIS EXPANDING INDUSTRY...*Never before* such a demand for you! For *never before* such a *growing* industry as today's Television, Radio and other Electronic fields. This industry needs you... TODAY... and it needs you as a *trained* man... the kind of man you will be as a National Schools graduate. So don't wait. Start your National Schools training NOW...and enjoy big money, job security, SUCCESS!

LEARN from EXPERTS! BE A SUCCESSFUL MAN YOURSELF! You learn from men who are themselves successful Radio, Television and Electronics technicians. You learn the *practical* way... by *doing*... with equipment we send you. And you *advance* quickly, step by step. Get ALL the facts from FREE book and sample lesson. Mail coupon below NOW. Absolutely no obligation.



All yours at
no extra cost!

You can qualify **FAST** for these big-pay jobs...plus many more

Radio Station Technician • Your own Sales and Service Shop • District Service Manager • Inspector Technician • Aircraft Radio Inspector • Special Govt. Positions • Service Specialist • Sound Truck Operator • and many others!

ONLY NATIONAL SCHOOLS
GIVES YOU THIS PROFESSIONAL



MULTI-TESTER
Ready to use.
Easy to operate. Light enough to carry on service calls.

DRAFT AGE? National Schools training helps you get into special service classifications—get higher grades, better pay!

GET YOUR TRAINING FROM
THE RADIO-TV CAPITAL OF
THE WORLD

Let National Schools—a resi-



dent technical trade school for nearly 50 years—train you at home for today's unlimited opportunities in Radio-TV.



FREE!

Radio-TV Book
& Sample Lesson
JUST MAIL
COUPON!

NATIONAL SCHOOLS GRADUATES IN BIG DEMAND. You'll find National Schools graduates in good jobs everywhere. For these are the jobs National Schools *trains* you for. Such complete, shop-method home training can be *your* ticket to success...your key to the job happiness you've always wanted. It's up to you. Mail coupon NOW!

FRIENDLY GUIDANCE AS STUDENT AND GRADUATE. Our special Welfare Department is constantly at your service. Helps you with your technical and personal problems. Gives you the benefit of its wide industry contacts and experience in helping you after graduation. **BOTH RESIDENT AND HOME STUDY COURSES OFFERED.**

NATIONAL SCHOOLS APPROVED FOR G. I. TRAINING

Los Angeles, Calif. • Est. 1905 • In Canada: 193 Hastings St., Vancouver, B.C.

YOU GET ALL THE PARTS INCLUDING TUBES for this superheterodyne receiver... and lots of other equipment...to keep!

NATIONAL SCHOOLS, Dept. RH-23
4000 South Figueroa Street
Los Angeles 37, California

Mail in envelope
or paste on
postal card

Send me FREE book "My Future in Radio-Television and Electronics." Also a FREE sample lesson. I understand no salesman will call on me and that there is no obligation.

NAME _____ AGE _____

ADDRESS _____

CITY _____ ZONE _____ STATE _____

VETS! Check here if you are a veteran.

**ACT
NOW**

Don't put it off! Mail coupon NOW!

DEALERS GETTING WESTINGHOUSE TUBES PROFIT FROM HEAVY LOCAL ADVERTISING AT NO COST

Service dealers are getting powerful local advertising support from new Westinghouse RELIATRON™ Tube Distributors. In cities now served by Westinghouse Distributors, dealers get local newspaper advertising, a complete kit of store display and imprinted mailing material.

All of it—local ads and kits—are designed to build TV-radio service business in the dealer's local area.

Best of all, none of it costs the dealer a penny!

You can get your store listed in two local newspaper ads at no charge, and get a kit to boot. If Westinghouse Tubes are now sold in your area, see your Westinghouse Distributor and take advantage of this \$900-worth-of-advertising-at-no-cost offer.

NEWSPAPER ADS



COMING YOUR WAY

If Westinghouse Tubes are not yet distributed in your area, be patient. Distributors are being established in all market areas as fast as product availability and good service permit.

You'll soon have the chance to buy RELIATRON Tubes. Keep this tremendous opportunity in mind: you'll get newspaper advertising at no cost! Imprinted material for mailings! Imprinted signs for your window!

All of it is local advertising which sells your service in your own area where it counts.

For the name of your Westinghouse Distributor, or the approximate date when Westinghouse Tubes will be available in your area, drop a postal card to Dept. G-202 or have your regular distributor contact Dept. G-202 for information on how he can better serve you.

YOU CAN BE SURE... IF IT'S
Westinghouse

RELIATRON TUBES
TM

WESTINGHOUSE ELECTRIC CORPORATION, ELECTRONIC TUBE DIVISION, ELMIRA, N. Y.



**TRAIN FASTER—TRAIN BETTER—TRAIN EASIER
 IN 10 MONTHS—OR LESS—FOR
RADIO-TELEVISION
 Our 21st Year Training Men for Greater Incomes and Security in Radio-Television**

**I SEND YOU
 18 BIG KITS**

of Radio Television parts and equipment. Much of your training will be actual construction and experimentation . . . the kind of truly PRACTICAL instruction that prepares you for your Radio-Television career.



Frank L. Sprayberry
 President
 Sprayberry Academy
 of Radio

NEW! NO OBLIGATION PLAN

**You Have No Monthly Payment Contract to Sign
 Pay For Your Training as You Earn and Learn**

You can get into Radio-Television, today's fastest growing big money opportunity field, in months instead of years! My completely new "package unit" training plan prepares you in as little as 10 months or even less! *No monthly payment contract to sign—thus NO RISK to you!* This is America's finest, most complete, practical training—gets you ready to handle any practical job in the booming Radio-Television industry. Start your own profitable Radio-Television shop . . . or accept a good paying job. I have trained hundreds of successful Radio-Television technicians during the past 21 years—and stand ready to train you, even if you have no previous experience! Mail coupon and get all the facts—FREE!

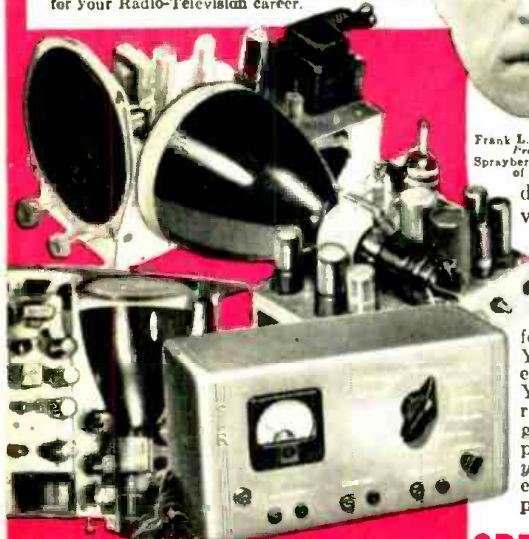

**Valuable Equipment Included
 With Training**

The new Sprayberry "package" plan includes many big kits of genuine, professional Radio-Television equipment. You perform over 300 demonstrations, experiments and construction projects. You build a powerful 6-tube 2-band radio set, multi-range test meter, signal generator, signal tracer, many other projects. All equipment and lessons are yours to keep . . . you have practically everything you need to set up your own profitable Radio-Television service shop.

Earn Extra Money While You Learn!

All your 10 months of training is IN YOUR HOME in spare hours. Keep on with your present job and income while learning. With each training "package" unit, you receive extra plans and "Business Builder" ideas for spare time Radio-Television jobs. New television stations everywhere, open vast new opportunities for trained Radio-Television Technicians—and those in training. If you expect to be in the armed forces later, there is no better preparation than practical Sprayberry Radio-Television training.

YOU BUILD the Television set and the powerful superhet radio receiver shown above. IN ADDITION to the other test units shown here (many are not shown because of lack of space). All equipment I send you is **YOURS TO KEEP.**

Approved for Veterans under the G. I. Bill

**SPRAYBERRY ACADEMY OF RADIO 111 NORTH CANAL ST.
 Dept. 25-S, Chicago 6, Ill.**

**MAIL COUPON
 TODAY!
 NO OBLIGATION**

I invite you to get all the facts—
**FREE TO 3 BIG
 RADIO-TELEVISION BOOKS**

I want you to have ALL the facts about my new 10-MONTH Radio-Television Training—without cost! Rush coupon for my three big Radio-Television books: "How to Make Money in Radio-Television." PLUS my new illustrated Television Bulletin PLUS an actual sample Sprayberry Lesson—ALL FREE. No obligation and no salesman will call. Mail coupon NOW!



**SPRAYBERRY ACADEMY OF RADIO, Dept. 25-T
 111 North Canal St., Chicago 6, Ill.**

Please rush to me all information on your 10-MONTH Radio-Television Training Plan. I understand this does not obligate me and that no salesman will call upon me. Be sure to include 3 books FREE.

Name..... Age.....
 Address.....
 City..... Zone..... State.....



**We rest our case
on evidence
you can hear**



Words can't prove the performance of this superb High Fidelity Tuner. Neither can witnesses. When it's time for a decision, your judgement of the CRAFTSMEN 10 is based on one thing: evidence you hear with your own ears. Listen—and the conclusive evidence of incomparable sensitivity and flexibility will turn your trial into a lifetime of distinctly better listening.

the
craftsmen 10
high fidelity
FM-AM tuner

- Two cathode followers furnish both audio output and detector output for remote installations.
- Built-in pre-amplifier, compensated for variable reluctance pick-ups.
- Automatic Frequency Control entirely eliminates drift, simplifies tuning.
- 5 microvolts sensitivity on both FM and AM.
- 10 kc filter on AM eliminates inter-station squeal.
- Bass and treble tone controls for boost, cut, or 20-20,000 cycle flat response.

**JUDGE
THE C-500 TOO!**
Williamson all-
triode circuit—
99.99% distortion-free!

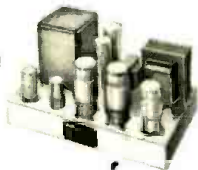

high fidelity by craftsmen
means distinctly better listening

For information, write to:

The radio CRAFTSMEN, Inc.

Dept. R-2, 4401 N. Ravenswood Ave.,
Chicago 40, Ill.

Spot Radio News

* Presenting latest information on the Radio Industry.

By RADIO & TELEVISION NEWS'
WASHINGTON EDITOR

THE PROJECTED TV SPAN across the nation, with stations in practically all of the states, often enthusiastically described by many in Washington and industry, seemed to be well on its way to becoming a firm reality, as the closing days of '52 appeared. With nearly 140 grants already issued to new TV operators in four-fifths of the states, and sincere promises from the Commission that hundreds more in all states would soon receive building permits, the prospects for the robust growth of TV looked bright indeed to everyone.

Whereas, only a few months ago, a few states seemed to be favored in the allocation race, nearly all were now receiving a share of the rich prize. The interesting expansion is illustrated in the partial listing of grants issued, at this writing, in the table on page 70.

In studying the table it will be noted that some existing TV areas, with v.h.f. stations, have received new stations which will be operated on the higher bands. One such market is Philadelphia, which now has three stations, and will soon have a u.h.f. station operated by WIP on Channel 29. Other cities in the new and old role are Greensboro, North Carolina and Johnstown, Pennsylvania. Here, Channels 57 and 56, respectively, will compete with the present very-high installations. The Channel 29 grant to the "City of Brotherly Love" was the first u.h.f. authorization to a major metropolitan center and represented an important trend in approvals from the processing staff. It had been felt that grants of this type would be delayed and perhaps not issued until '53. The earlier issuance was described as a major change in philosophy toward large city high-low band operation which would serve to spark sales of TV sets in areas believed riding close to a saturation point among viewers. In Philadelphia, dealers and distributors beamed when the high channel announcement appeared in the local papers. Notwithstanding the fact that the new station will not be placed in operation for some time, interest soared and sales jumped.

THEATER TV, which had a very brief airing during the late winter months of '52, became steeped in gloom as the official hearings began in '53. Many in

the theater industry felt very doubtful about the ultimate success of allocations of channels for theater circuits.

According to the general counsel for motion picture exhibitors, the Commission has shown little enthusiasm for the assignment of channels to the theater. He indicated that most of the questions asked by the Commission during the hearing seemed to indicate that the legislators were not too keen about the proposed system. It was hoped, he said, that the facts presented during the lengthier hearings will convince the Commission that the theaters should have the requested channels, and as soon as possible.

THE ROARING DEBATE in the hearing offices of the Commission concerning the merger of ABC and Paramount, which it was generally felt would taper off with the release of Hearing Examiner Leo Resnick's approval of the merger, flared up with the objections filed by the broadcast bureau of the Commission.

The Resnick report was an extremely interesting document, covering every phase of the case and revealing some intriguing data on Paramount's role in the television industry. It was noted that the motion picture producer began to study the possibilities of TV as early as 1937, when it invested in *Du Mont*. They then applied for experimental television licenses in both Los Angeles and Chicago from which developed the present stations KTLA and WBKB. The transmitters for these stations were said to be among the first built, and the antenna and transmitter at Mount Wilson near Los Angeles was noted as being the first to be established at that focal point.

The report also indicated that the flicker maker has been instrumental in the development of video recording and large-screen TV, too. They have developed a camera and projector which can record TV images almost instantaneously, after they are received, on film said to be suitable for almost immediate projection on large screens used in theaters. In addition to these activities in TV, it was said, the company has become interested in color TV, through participation in the company formed by Dr.

RADIO & TELEVISION NEWS



Here's The New

Model TO-4 **TEL-OHMIKE**[®] CAPACITOR-RESISTOR ANALYZER

- You'll be proud to have this completely new instrument on your service bench!
- The result of a nationwide survey of radio and television technicians makes the new TO-4 Tel-Ohmike meet your capacitor test needs to a capital "T". Trim and trustworthy, it has instant push-button range selection, magic-eye bridge balancing, safety discharge feature, direct meter readings of leakage current and insulation resistance, and a continuously adjustable test voltage for checking electrolytics at exact rated voltages.
- Two especially valuable features are the provision of a special low capacitance circuit for checking small ceramics and "gimmick" capacitors down to 1 mmf (in addition to a top capacitance range of 2000 mf) and the simplified insulation resistance circuit with a top reading of 20,000 megohms.
- See a demonstration of this new instrument at your distributor without delay!
- And the price of this new improved Tel-Ohmike is still the same Only **\$73.50** NET.



Write for full descriptive bulletin today

SPRAGUE PRODUCTS COMPANY

(Distributors' Division of Sprague Electric Co.)

51 MARSHALL STREET, NORTH ADAMS, MASS.

ANOTHER NEW DEVELOPMENT BY THE WORLD'S LARGEST CAPACITOR MANUFACTURER

EVERYBODY'S TALKING ABOUT NEWCOMB'S "AUDI-BALANCE"

PATENT APPLIED FOR

"The greatest amplifier improvement in recent years" . . . A godsend to both owner and service man." . . . "It used to take me hours to do what Audi-balance does in seconds." . . . "Does even better than I've been able to do with meters, this balances tubes dynamically." . . . "The problem has plagued us for years, it is now possible to keep perfect balance in output tubes consistently for lowest distortion." . . . "Audi-balance is the perfect solution."

Just one of the features that make the brand new Classic amplifiers by Newcomb so exciting. Write for catalog of 8 completely new home music amplifiers priced from \$39.50 to \$269.50 audiophile net.

The Classic 25

For the sound thrill of a lifetime this superb new 25 watt custom amplifier has every practical operational feature electronic engineering can offer you. Even more important is the incomparable listening pleasure it provides.



The Classic 15

This outstanding 15 watt amplifier is unique in luxury features and technical perfection at a surprisingly moderate cost. Its smartly designed remote control unit is a superlative piece of engineering, beautifully finished in brushed brass.

Substantial Installation Savings

Savings of as much as, or more than, the entire cost of these fine amplifiers are being reported by enthusiastic purchasers. This is due to their unique design which removes the usual necessity of a remote control being near the amplifier, tuner and changer. These items can now be installed in a hall closet or any similar out of the way location leaving only the beautiful remote control and

the speaker, with no messy confusion of wires, in the living room. No accessories connect directly to the remote control. All inputs connect only to the main amplifier. The savings in cabinetry and of installation labor are obvious and very real to those who take advantage of this new complete remote control design.

NEWCOMB

DEPT. F 6824 LEXINGTON AVENUE, HOLLYWOOD 38, CALIF.

15 years of quality leadership

Write for Catalog



Ernest Lawrence, who has developed a simplified tri-color tube, which will soon be demonstrated in New York again; the original model was shown a year ago. According to Resnick, *Paramount* has invested well over a half-million dollars in this color tube, and \$300,000 in another TV development, a subscription system, which employs a coin box to unscramble scrambled pictures as they are received over a wire or otherwise.

As this column is being prepared, the merger issue is still deadlocked and appears to be a long way from settlement.

LONG DISTANCE overseas transmission is not only a project of our Voice of America, but many European countries, too. In Belgium, two 100-kilowatt transmitters are used for French and Flemish transmissions.

Several types of antennas are used; curtains directed toward the Belgian Congo and rhombics also directed to this zone and to this country, too. A reversible rhombic is also used to beam signals to Scandinavia.

TV is attracting the attention of many new European countries, reports from the continent indicate. In Norway, a substantial sum of money has been appropriated for experimental tests on a 7-megacycle and 625-line system. It is expected that the tests will last about two years.

Extensive tests are also being conducted in Spain over the Chamartin de la Rosa station. Under consideration are the erection of TV stations at Barcelona and Bilbao.

France will expand its TV activities, and by 1958 will probably have a nationwide service featuring their 819-line system.

A NOVEL LISTENING plan is in use in Northern Rhodesia, according to *EBU*. About ninety community receivers are hooked up for group listening in the Lusaka area.

In the early summer of '52 a 15-kilowatt short-wave transmitter was placed in service in Rhodesia. In addition, a mobile recording unit was sent out and covered over sixteen-thousand miles, making over 1300 discs of tribal choirs and other native music.

Community listening has also been reported to be very popular in Ceylon. By the end of September of 1950, 825 receivers had been installed at different community centers, rural development society offices, preaching halls, schools, temples, cooperative stores, etc.

Community broadcasting has also been used in Bombay, Madras, and Delhi. Today there are over 4000 receivers in operation all over the country.

Most receivers are operated from batteries and thus maintenance is a problem. To provide battery power, a network of battery-charging centers is used. In Madras, there are 67 such
(Continued on page 147)

RADIO & TELEVISION NEWS

NOW AVAILABLE!

PNP GERMANIUM JUNCTION



TRANSISTORS

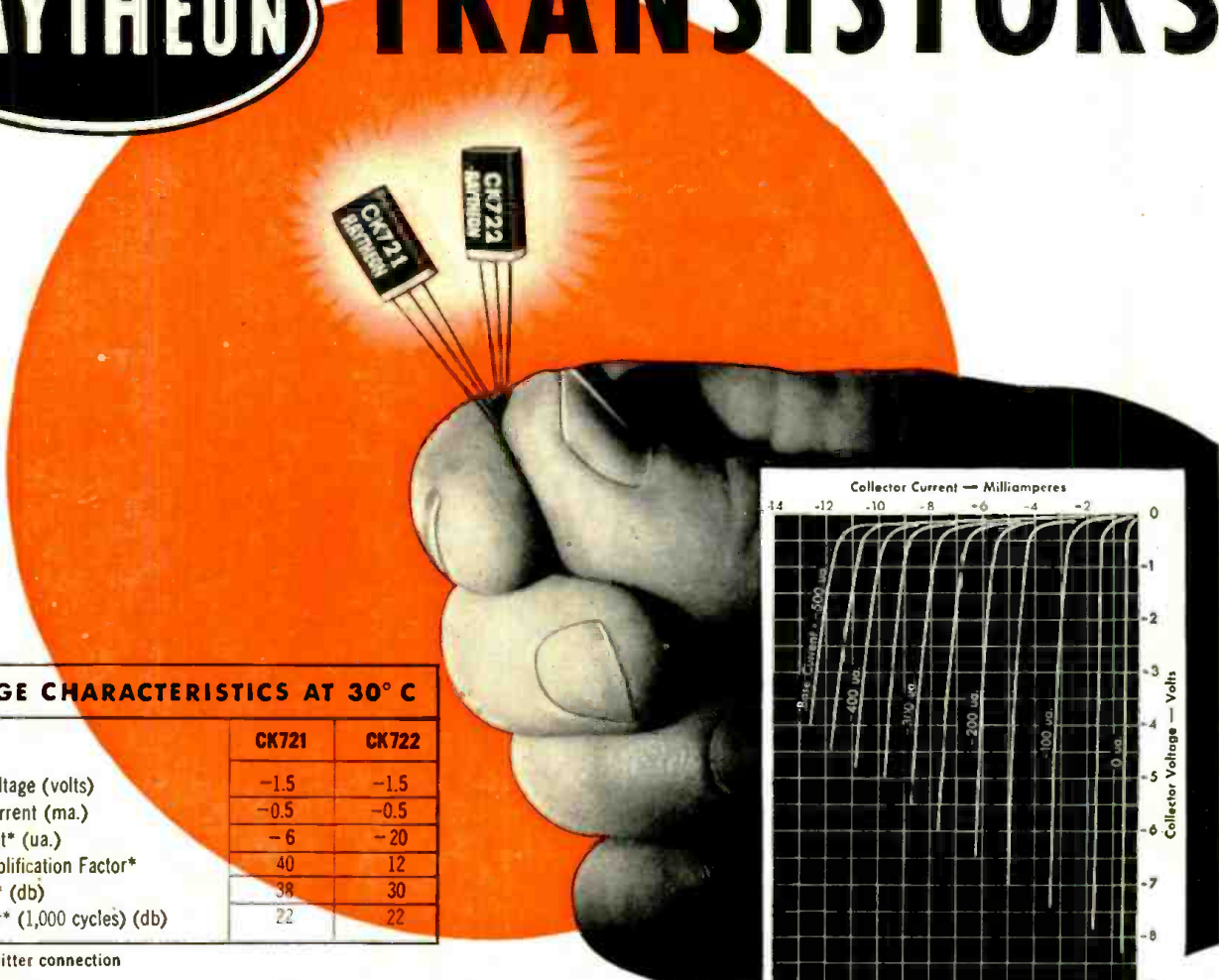

AVERAGE CHARACTERISTICS AT 30° C

	CK721	CK722
Collector Voltage (volts)	-1.5	-1.5
Collector Current (ma.)	-0.5	-0.5
Base Current* (ua.)	-6	-20
Current Amplification Factor*	40	12
Power Gain* (db)	38	30
Noise Factor* (1,000 cycles) (db)	22	22

*Grounded Emitter connection

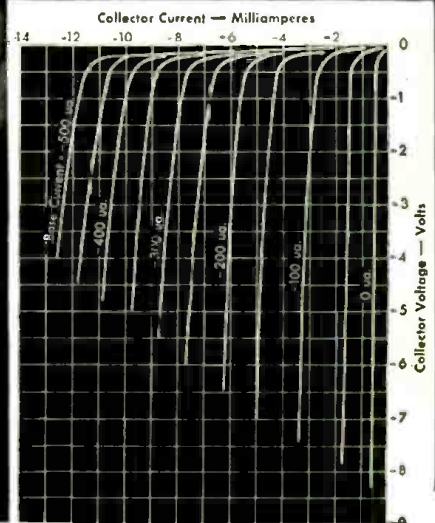

TYPICAL COLLECTOR CHARACTERISTICS CK721

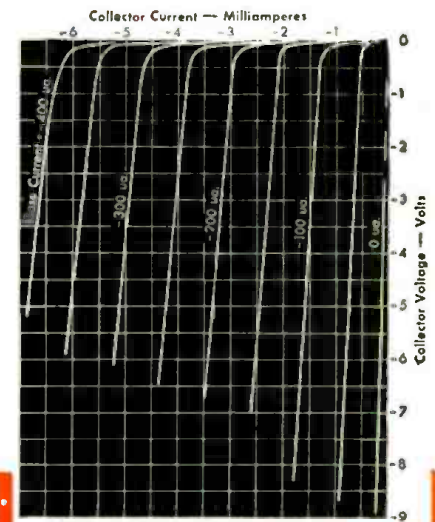

TYPICAL COLLECTOR CHARACTERISTICS CK722

For the first time in history, Germanium Junction Transistors are commercially available. Raytheon Junction Transistors, types CK721 and CK722 can now be obtained for your experimental and developmental use.

Here's another first for Raytheon! Leaders in the development and production of Electron Tubes and Germanium Products, Raytheon now leads the way in production of this important new electronic development.

For price and delivery information of Raytheon Germanium Junction Transistors, write, phone or wire your Raytheon Tube distributor.



RAYTHEON MANUFACTURING CO.
Receiving Tube Division

Excellence in Electronics

Newton, Massachusetts • Chicago, Illinois • Atlanta, Georgia • Los Angeles, California

RAYTHEON MAKES ALL THESE:

RECEIVING AND PICTURE TUBES • RELIABLE SUBMINIATURE AND MINIATURE TUBES • GERMANIUM DIODES AND TRANSISTORS • NUCLEONIC TUBES • MICROWAVE TUBES



did you know . . .

that Rauland made the first rectangular tube in 1945?
everybody knows . . . that engineering leadership means
sales leadership . . . and that means RAULAND

THE RAULAND CORPORATION, 4245 N. KNOX AVENUE, CHICAGO 41, ILLINOIS • MULBERRY 5-5000

RAULAND

did you know...



that Rauland was the first company to produce the
electrostatic low focus voltage tube?
everybody knows . . . that engineering leadership means
sales leadership . . . and that means RAULAND



THE RAULAND CORPORATION, 4245 N. KNOX AVENUE, CHICAGO 41, ILLINOIS • MULBERRY 5-5000



DID YOU KNOW

that Rauland was the first company to manufacture
aluminized tubes on a production basis?
everybody knows . . . that engineering leadership
means sales leadership . . . and that means RAULAND.

THE RAULAND CORPORATION, 4245 N. KNOX AVENUE, CHICAGO 41, ILLINOIS • MULBERRY 5-5000

Burton Browne advertising

GET DEPENDABLE PERFORMANCE IN TV TEST EQUIPMENT!



...Accurate Measurements and Increased Profits, Too!

COMBINED use of these G-E units takes guesswork out of test measurements. With good linearity and amplitude characteristics G-E equipment eliminates misleading results from distorted patterns. Your technicians will handle more work...handle it more efficiently...add to your profits and your reputation!

Oscilloscope ST-2A. Reports from thousands indicate this scope does the job they need in TV circuit work. Used in conjunction with the G-E Sweep and Marker you have an unbeatable combination. Special features include wide frequency response plus DC amplifier to adapt the equipment to other applications.

Marker Generator ST-5A. Marks all the critical frequencies on a pass band as well as having continuous coverage. Designed to give fast manipulation with crystal controlled accuracy for outstanding performance. Features separate crystal on each TV channel with simultaneous picture, audio and trap markers on both channel and intermediate frequencies.

Sweep Generator ST-4A. Outstanding in performance and varied in application. Adjustable linear sweep that is all-electronic...no moving mechanical parts. Covers all broadcast TV channels. Good attenuation and extremely low leakage plus continuously variable center frequency.

Balanced Output Adaptor ST-8A. Converts single-ended Sweep Generator output to balanced output for 300 ohm television receiver work.



Model ST-2A

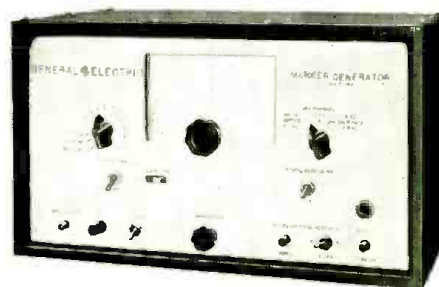

Model ST-5A



Model ST-4A



GENERAL  ELECTRIC

General Electric Company, Section 923
Electronics Park, Syracuse, N. Y.
Please send me complete specifications on G-E
TV Test Equipment.

NAME.....
COMPANY.....
ADDRESS.....
CITY.....STATE.....

teamed together for Better TV Picture Quality

AMPHENOL
INLINE*
 ANTENNA

AMPHENOL
 TUBULAR
 TWIN-LEAD

The combination of the famous Amphenol Inline Antenna with the extremely low-loss Amphenol Tubular Twin-Lead permits any TV set to present the best picture it possibly can.

In addition to a strong forward reception lobe, the Inline has uniform gain over the entire range of VHF channels—less variation than the 3 decibel change which causes “fuzziness.” The Inline is also available in stacked array for those fringe or trouble areas which require additional signal strength.

The Amphenol Tubular Twin-Lead provides very low-loss and constant impedance. The tubular construction minimizes the effect of moisture and dirt deposits on the concentrated field of energy and ends weather interference. Because of these characteristics, Amphenol Tubular Twin-Lead has been recommended by leading TV manufacturers and authorities for any installation where UHF is, or will be available.

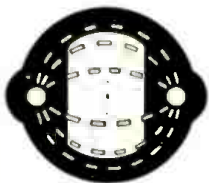

This illustration clearly shows that the concentrated field of energy between the two conductors, which are 7 strands of #28 copper weld wire, is contained by the tubular construction. This important field of energy is unaffected by any exterior conditions.

Your free copy of this book is available from your Authorized Amphenol Distributor. It contains complete factual and test data on the factors which determine Better TV Picture Quality.

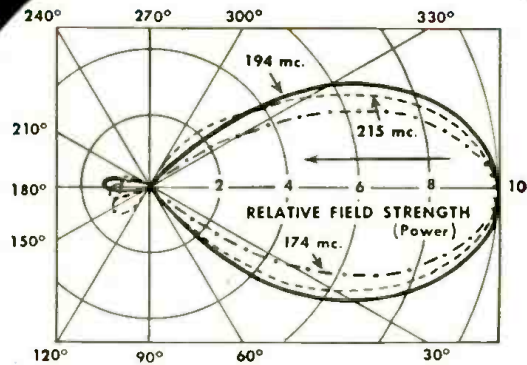

consider the evidence...

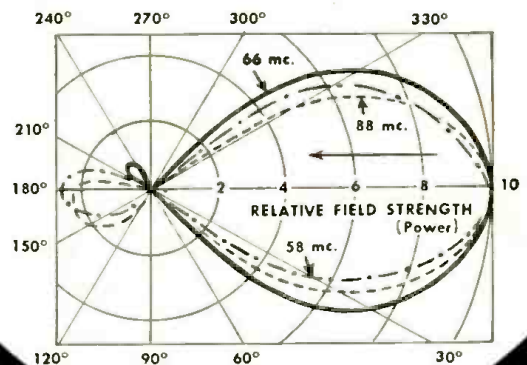

The test patterns on both high and low bands reveal the Amphenol Inline Antenna's superior uni-directional reception lobe. This single forward lobe intercepts the TV signal at its maximum available strength. It also rejects unwanted reflected signals or side interference that cause “ghosts” and unsteady pictures.

No other broadbanded antenna can present as favorable a reception pattern on all the VHF channels as does the Amphenol Inline Antenna.

Let's forget the "glittering generalities" about quality.

Let's Check 4 specific ways CBS-HYTRON cuts your call-backs



1. BY MAKING CBS-HYTRON TV ORIGINALS BEST.

Longest experience with production . . . with applications . . . with improvements . . . all count. CBS-Hytron-built 1AX2, 1X2A, 6BQ6GT, 12A4, 12B4, 12BH7, 12BY7, 12BZ7, 25BQ6GT, 16RP4, etc. are more trouble-free. Prove it to yourself.



2. BY ENDLESSLY IMPROVING STANDARD TV TYPES.

Close co-operation with leading set makers alerts CBS-Hytron daily to needed betterments. Take one of endless examples: the CBS-Hytron 6CB6. You will find its clear, non-carbonized bulb eliminates undesirable loading effects at vhf.



3. BY APPLYING "RELIABLE" TUBE TECHNIQUES.

CBS-Hytron 6AL5 is typical. Experience with the military 6AL5 family (JAN 6AL5, 6097/CT, 5726) is passed on to you. You profit by a commercial CBS-Hytron 6AL5 made truly reliable.



4. BY MATCHING EACH TUBE TO THE SET.

Daily, CBS-Hytron analyzes leading TV chassis. Dynamic socket-by-socket checks, plus continuous field experience, pay off. Give you

CBS-Hytron matched-to-the-set performance . . . with the accent on trustworthy replacements.

Take advantage of CBS-Hytron extras like these. Keep your customers happy. Guarantee yourself against profit-slicing call-backs. Demand dependable CBS-Hytron tubes.



\$1.45 net

NOW...TEST THE EASY TOPSIDE WAY!

Wish you could test a chassis topside? Without first pulling and wrestling with the heavy chassis? Without disturbing wiring and parts by digging underneath for buried sockets? How much faster, easier, safer you could work! New CBS-Hytron Test Adapter does the trick. Just replace a 7-pin miniature tube with the Test Adapter. Plug tube into Test Adapter. Presto, all socket connections are topside . . . within instant reach of your test prod or clip. Just one job pays for this new CBS-Hytron Test Adapter. Get yours today!

HERE'S HOW! With the CBS-Hytron Test Adapter, you quickly measure voltage, resistance, gain. You inject and trace signals . . . monitor intermittents. You check oscillating stages. Or the effect of adding a bypass condenser or shunt resistor.

With several CBS-Hytron Test Adapters you make stage-by-stage circuit checks . . . fast. You do all this dynamic testing the e-a-s-y way . . . topside. With no ill effects at a-f frequencies. And only slight capacitance and inductance effects at much higher frequencies.

You will like: The positive contact of the low-resistance, silver-plated base pins and test points. The plainly marked pin connections. The easy insertion and tight grip. CBS-Hytron Test Adapter is another designed-by-and-for-you "must" you must have. See your CBS-Hytron jobber today.



DANVERS, MASSACHUSETTS

THE Original

WRENCH
WITH THE
SCREWDRIVER ACTION!



SPINTITE
REG. U. S. PAT. OFFICE

120 STYLES and SIZES

for

- ASSEMBLY WORK
- REPAIR WORK
- RADIO
- TELEVISION
- INDUSTRIAL
- AIRCRAFT



STEVENS WALDEN, Inc.
WORCESTER 4, MASS.

Within the INDUSTRY

JACK A. BERMAN, in charge of sales for *Shure Brothers, Inc.* for the past thirteen years, will head his own manufacturers' sales representative firm in Southern California.



Mr. Berman, who is resigning as *Shure Brothers'* vice-president in charge of sales and as treasurer of the Radio Parts & Electronic Equipment Shows to establish his own firm in Los Angeles, will represent *Shure Brothers* and other manufacturers' lines in the Southern California territory.

* * *

THE HAMMARLUND MANUFACTURING COMPANY has leased an additional 12,000 square feet of factory space at 541 West 34th Street in New York for use in sub-assembly manufacturing, spare parts packing and shipping, and for stocking standard condensers . . .

PYROFERIC COMPANY has acquired new space at Bronx Boulevard and 216th Street in New York in order to increase production facilities for iron cores and other powdered metal components . . .

COMMUNICATION MEASUREMENTS LABORATORY, INC. has moved into its own modern one-story plant at 350 Leland Avenue, Plainfield, New Jersey. The company had had its headquarters at 120 Greenwich Street in New York City for fourteen years . . .

HYTRON RADIO AND ELECTRONICS CO. has begun construction on a new 150,000 square feet of additional space for manufacturing and warehousing at Newburyport, Massachusetts . . . **PREMIER T.V. RADIO SUPPLY** has moved to new quarters at 3239 West North Avenue, Chicago 47, Illinois. The new location provides four times as much space as the company formerly occupied . . .

SYLVANIA ELECTRIC PRODUCTS INC. has dedicated its new radio receiving tube plant at Burlington, Iowa. The multi-million dollar, 150,000 square foot plant will be an important supplier of radio tubes to the armed forces . . .

HYTRON RADIO AND ELECTRONICS COMPANY has moved its eastern sales office to 32 Green Street in Newark, New Jersey . . . **TRIAD TRANSFORMER MANUFACTURING CO.** has opened its new plant at 4055 Redwood Avenue in Venice, California. The company recently celebrated its 6th anniversary . . .

WESTINGHOUSE ELECTRONIC TUBE DIVISION is now in production at two new tube plants in Elmira and Bath, New York. Virtually all types of tubes will be produced in the two new facilities . . . **INTERNATIONAL RESISTANCE COMPANY** of Philadelphia has purchased 66.4 acres

in Asheville, N. C. and will construct a \$200,000 plant for the purpose of expanding the company's manufacturing facilities . . . **RADIO CITY PRODUCTS CO., INC.** has moved all of its test equipment production to its Easton, Pa. plant. The engineering, sales, purchasing departments, and the general offices will remain in New York . . . **STRONGHOLD SCREW PRODUCTS, INC.** has purchased a one-story, 80,000 square foot factory building at 1801 W. Winnemac Avenue, Chicago. The company plans to take possession by April 1, 1953.

* * *

THE CINCINNATI SECTION of the Institute of Radio Engineers is sponsoring the Seventh Annual Spring Technical Conference which will be held in Cincinnati on April 18th.

R. W. Lehman, *Baldwin Piano Company*, 1801 Gilbert Avenue, Cincinnati, Ohio is in charge of exhibits and advertising in connection with the conference. Reuben Nathan, *Crosley Division, Arco Manufacturing Corporation*, 1329 Arlington Street, Cincinnati 25, Ohio is in charge of publicity.

A diversified program of papers is being planned by the committee in charge.

* * *

BERNARD L. CAHN, since 1949 general sales manager of the *Insuline Corporation of America*,



has been elected vice-president of the company. He assumed his new duties on December 1st of last year.

A graduate of New York University where he majored in business administration and management, Mr. Cahn joined *Insuline* in 1946 after four years of Army service. Entering as a private and emerging as a major, he spent twenty-seven months in the European Theater of Operations.

As assistant to the president and then as sales manager, he has traveled widely throughout the U.S. and is well known in the electronic parts business. He is a member of the Show Corporation Board, the organization responsible for the annual Parts Show.

* * *

B & L RADIO AND TV SUPPLY has recently been opened in Lubbock, Texas to wholesale electronic parts. E. W. Bland and Ogle T. Lemon are partners in this new venture . . . Announcement of the formation of the **HIGH VACUUM EQUIPMENT CORPORATION** has been made by Joseph B. Merrill, president and general manager of the firm. The general offices and factory of the com-

RADIO & TELEVISION NEWS

AMAZING NEW TRAINING PLAN

THOUSANDS OF BETTER PAY JOBS IN TELEVISION

I PREPARE YOU AT HOME WITHIN MONTHS!



Leonard C. Lane,
B.S., M.A.
President of Radio-Television
Training Association,
Exec. Dir. of Pierce School
of Radio and Television

**AT NO EXTRA COST!
YOU GET A ROUND TRIP TO
NEW YORK CITY**

FROM ANYWHERE IN THE U.S. OR CANADA—I pay your way to New York and return, PLUS 2 FREE weeks, 50 hours of advanced instruction and shop training at the **PIERCE SCHOOL OF RADIO & TELEVISION**. You use modern electronics equipment, including student-operated TV and Radio stations. You go behind the scenes of New York's big Radio-TV centers, to study first hand. And I give you all this AT NO EXTRA COST! (Applies to complete Radio-TV course only.)

Only RTTA makes this amazing offer.

EXTRA FEATURES THAT MEAN MORE MONEY FOR YOU!
Thousands of new job opportunities will be available for you right in your own state, now that the government has lifted restrictions on new TV stations. My simple, successful methods can PREPARE YOU NOW to take your place in America's booming TELEVISION and Electronics industries... help you get the success and happiness that you always wanted out of life. You learn the practical, easy way by using actual parts and equipment in the 15 big Radio-TV kits I send you, including a COMPLETE TV RECEIVER... yours to build and keep.

My Advanced Training Prepares You For Better Jobs
Then, after you finish your training for a position as a full-fledged TV Technician—where you can write your own ticket and choose from dozens of fascinating careers—I don't stop there! I continue to train you—AT NO EXTRA COST—to qualify for even better pay in the BETTER JOBS that demand FCC licenses, with my...

FREE FCC COACHING COURSE
PREPARES YOU AT HOME FOR YOUR FCC LICENSE
THE BEST JOBS IN TV AND RADIO REQUIRE AN FCC LICENSE
Given to every student at NO EXTRA COST after TV Theory and Practice is completed.

SET-UP YOUR OWN HOME LABORATORY WITH THE 15 BIG TELEVISION-RADIO KITS WE SEND YOU (At No Extra Cost)

YOU BUILD AND KEEP ALL THESE UNITS

- INCLUDING BIG SCREEN TV RECEIVER,
- plus Super-Hot Radio Receiver,
- R.F. Signal Generator, Combination
- Voltmeter-Ammeter-Ohmmeter,
- C-W Telephone Receiver, AC-DC
- Power Supply.
- Everything
- Furnished
- Including
- All Tubes, and
- Big TV Tube



NOW! Advanced FM-TV Training For Men Who Know Radio
Prepares You For Higher Pay Jobs In A Few Months
COMPLETE theory and practical training course... complete with kits including large screen TV receiver.
FCC License Coaching Course Included FREE.

VETERANS!

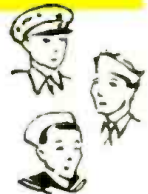

MY SCHOOLS FULLY APPROVED TO TRAIN VETERANS UNDER NEW G.I. BILL! If discharged after June 27, 1950—CHECK COUPON BELOW! Also approved for RESIDENT TRAINING in New York City... qualifies you for full subsistence allowance up to \$160 per month.

I GET MY GRADUATES GOOD PAYING JOBS

"As Merchant Ship Radio Officer, I receive \$867. for 40-day trip. Your training helped me get this fine position."
—Stanley Nawrocki

I now hold a fine airlines position at LaGuardia Field, New York City, thanks to your excellent training."
—Joseph Rosenberg

"Your excellent instruction helped me get my present job as an airport radio mechanic for American Airlines."
—Eugene E. Basko

"Thanks to your training, I qualified for a good job as a Receiver Tester at Federal Telephone and Radio."
—Paul Frank Seier

Many others working at NBC, RCA, CBS, Dumont, Philco, Emerson, Admiral and other leading firms.



BOTH FREE
New Illustrated Book plus Sample Lesson

NO SALESMAN WILL CALL!

Mr. Leonard C. Lane, President
RADIO-TELEVISION TRAINING ASSN.
1629 Broadway, Radio City Station
New York 19, N. Y.

Dept. T-2

Dear Mr. Lane:

Mail me your NEW FREE BOOK and SAMPLE LESSON that will show me how I can make BIG MONEY in TELEVISION. I understand I am under no obligation and no salesman will call.

Name _____ Age _____

Address _____

City _____ Zone _____ State _____

I am interested in: Radio-TV Advanced FM-TV
VETERANS: If qualified under new G.I. bill, check here Resident Study

RADIO-TELEVISION TRAINING ASSOCIATION

1629 Broadway, Radio City Station, New York City 19, N. Y.

Approved as a Correspondence School under the laws of the State of New York

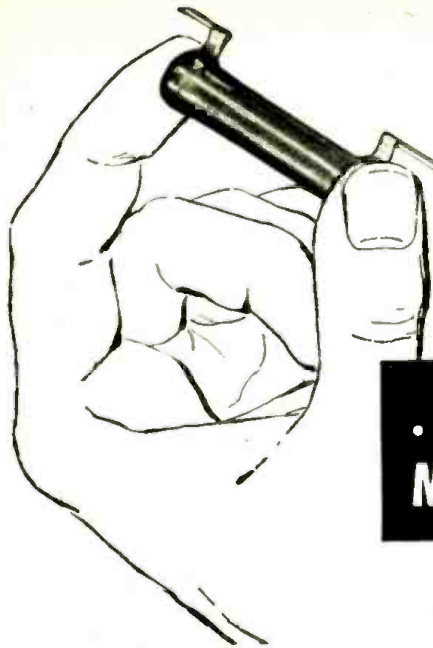

OHMITE *resistors*

**... for that EXTRA
MARGIN OF SAFETY!**

Customers judge your service by the results they get. If a radio or TV repair job fails to stand up, they blame *you*, not the parts you used.

Don't jeopardize your business reputation with "just-as-good" replacement parts. OHMITE resistors provide an extra margin of safety. You can depend on these quality resistors—wire-wound or composition—to give years of trouble-free service.



OHMITE MANUFACTURING COMPANY

4883 Flournoy Street, Chicago 44, Illinois

Send for stock catalog

*Be Right
with...*

OHMITE®

DEPENDABLE RESISTANCE UNITS

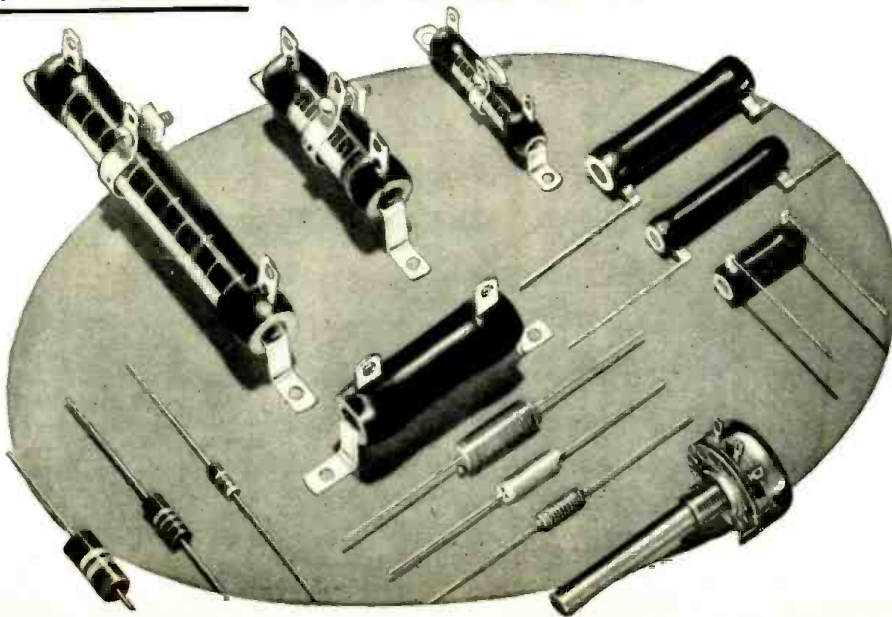

pany are located at 349 Lincoln Street, Hingham, Mass. The company will specialize in the development, design, and manufacture of high vacuum equipment used in the fields of electronics, metallurgy, plastics, and metals . . . **ELECTRO-VOICE, INC.** of Buchanan, Michigan has purchased **RADIO MFG. ENGINEERS, INC. (RME)**, nineteen-year-old amateur communications equipment firm. The subsidiary company will remain under the present management of E. G. Shalkhauser and Russ Planck and all RME business will be conducted from the company's Peoria, plant . . . **LEWIS AND KAUFMAN, INC.** has changed its name to **LEWIS AND KAUFMAN, LTD.** The change is concurrent with the absorption of personnel and facilities of the 20,000 square foot Satiocy, California plant of **PACIFIC ELECTRONICS** . . . **LOUIS BROS.,** West Coast television antenna manufacturer, has formed a new division called **CONCERT HALL.** This division will manufacture bass reflex cabinets, speaker baffles, and television cabinets. The company is located at 3543 E. Sixteenth Street, Los Angeles 23, California . . . **CROSLEY DIVISION** has contracted to purchase the manufacturing facilities of the tube divisions of **SARKES TARZIAN, INC.** at Batavia, Illinois. The plants produce television picture tubes and miniature receiving tubes . . . **ACME ELECTRONICS, INC.** is the new name of **PEERLESS ELECTRONICS DISTRIBUTORS, INC.** The firm will continue to do business at 74 Willoughby Street in Brooklyn where it has been located for the past 5 years.

FRED J. LEMKE has been appointed operating manager at the Akron, Ohio headquarters of *Olson Radio Warehouse.*



Mr. Lemke was formerly Merchandise Division Superintendent for mail order at *Montgomery Ward and Company,* an association

which lasted for more than eighteen years.

In his new post he will be responsible for expediting the handling of all mail orders received by the Ohio parts firm.

JULIUS HABER has been appointed director of public relations for the *RCA Victor Division of Radio Corporation of America,* succeeding **JAMES M. TONEY** who has been appointed director of consumer products distribution . . . *Sangamo Electric Company* has made three new appointments in its Capacitor Division which are of interest to the industry. **WILLIAM W. TAYLOR** has been named assistant sales manager, **BRUCE E. VINKEMULDER** is the new sales promotion manager, while **A. E. McCLUSKEY** is now serving as distributor sales manager. All of these men will make their headquarters at the company's Marion, Illinois plant . . .

(Continued on page 90)

RADIO & TELEVISION NEWS



*How far ahead can you be
next year...*

IN TV AND ELECTRONICS?

◀ **Send for this free CREI booklet today . . .
and find out!**

THIS BOOKLET can mean the difference between small, w-i-d-e-l-y s-p-a-c-e-d salary increases—and rapid advancement. Between routine work—and challenging opportunity. Between constantly defending your job against better-trained men—and dynamic confidence. Between short-circuited hopes—and high-powered ambition.

An exciting new world has opened up with such super-speed that even the most optimistic electronic experts fall short in their predictions of expansion.

Think of the 1,110 TV stations now on the air and the 2,500 stations made possible by the FCC unfreeze. Think of the over 18,000,000 TV sets now in use. That's 5,000,000 more than we were supposed to have by 1954. Think of the 100,000,000 radios in current operation. (95% of the nation's homes have one or more sets.) Think of the tremendous defense orders now being placed for electronic equipment and installations.

Think of the thousands of radio-equipped fire and police departments throughout the U.S. Of the many radio-equipped railroads, of the hundreds of cities with 2-way radio service for cars and cabs. Think of the wide-ranging field of aviation communications—radio-controlled aircraft, navigation-and-traffic control, airport stations.

Think of the maritime world with its navigational aids, fathometers, ship-to-shore and ship-to-ship communications and radar. Think of electronic heating, fax and ultra-fax, of electronic medicine, and all the other applications of electronic know-how.

Countless positions must be filled—in development, research, design, production, testing and inspection, manufacture, broadcasting, telecasting and servicing. Who will get those positions? You—if you prepare today—if you are alert and have the ambition to advance your knowledge. You—if you take 2 minutes to send for a free copy of "Your Future in the New World of Electronics."

This helpful book shows you how CREI Home Study leads the way to greater earnings through the inviting opportunities described above.

However, being an accredited technical school, CREI does not promise you a "bed-of-roses." You have to translate your willingness to learn into saleable technical knowledge

—via study. Since its founding in 1927, CREI has provided thousands of professional radiomen with technical educations. During World War II, CREI trained thousands for the Armed Services. Leading firms choose CREI courses for group training in electronics at company expense, among them United Air Lines, Canadian Broadcasting Corporation, Trans Canada Airlines, Bendix Products Division, All-American Cables and Radio, Inc., RCA-Victor Division, and the Machlett Laboratories.

CREI courses are prepared by recognized experts, in a practical, easily-understood manner. You get the benefit of time-tested materials, under the personal supervision of a CREI Staff Instructor. This complete training is the reason why CREI graduates find their diplomas keys-to-success in Radio, TV and Electronics. CREI alumni hold top positions in America's leading firms.

At your service is the CREI Placement Bureau, which finds positions for students and graduates. Although CREI does not guarantee jobs, requests for personnel currently exceed supply by far.

Talk to men in the field and check up on CREI's high standing in electronics instruction. Determine for yourself right now that your earnings are going to rise with your knowledge—and that you get your rightful place in the Age of Electronics. All this CREI can promise you, provided you sincerely want to learn. Fill out the coupon and mail it today. We'll promptly send you your free copy of "Your Future in the New World of Electronics." The rest—the future—is up to you.

MAIL COUPON FOR FREE BOOKLET

CAPITOL RADIO ENGINEERING INSTITUTE

Dept. 112, 16th & Park Rd., N.W., Washington 10, D. C.

Send booklet "Your Future in the New World of Electronics" and course outline.

CHECK TV, FM & Advanced AM Servicing Aeronautical Radio
FIELD OF Practical Television Engineering Engineering
GREATEST Broadcast Radio Engineering (AM, FM, TV)
INTEREST Practical Radio Engineering

Name.....

Street.....

City..... Zone..... State.....

If residence school in Wash., D. C. preferred, check here

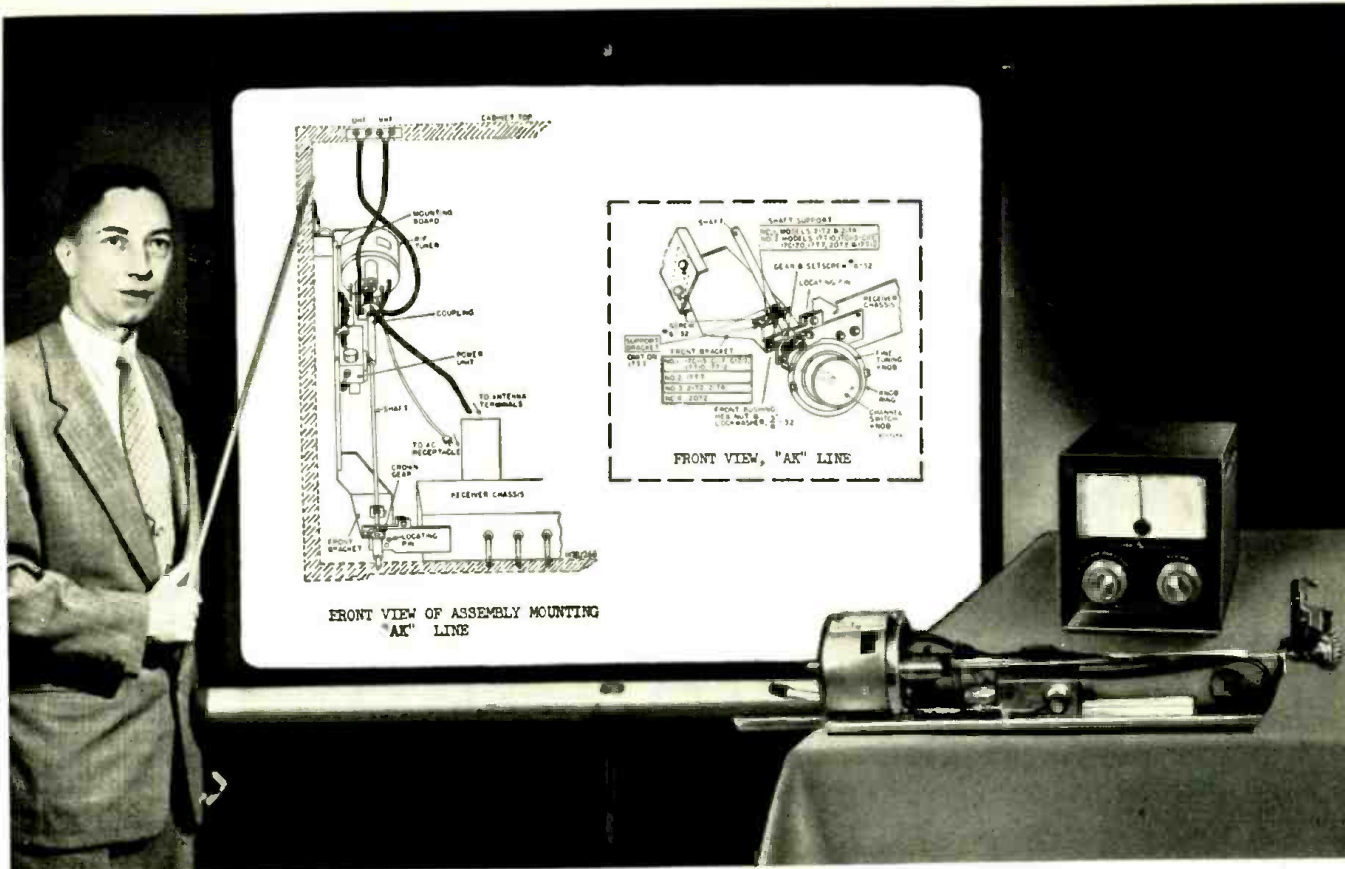

GENERAL ELECTRIC ANSWERS YOUR QUESTIONS ON *UHF* SERVICE

G-E Field Engineers are holding UHF clinics throughout the country—open to all TV servicemen—without charge.

TV servicemen in practically every area will soon face problems connected with UHF. General Electric technicians from Electronics Park are now holding UHF field clinics all over the country.

The G-E field men will explain continuous tuner converters, switch channel converters, turret head-end conversions—the various kinds of UHF antennas, where they should be used, their installation.

You will see how to install and adjust various kinds of UHF tuners—for new and older sets. With the knowledge you gain from these G-E UHF Field Clinics—you'll be prepared to handle all kinds of UHF service.

Get in touch with the TV service manager at your General Electric TV distributor's right away. Tell him to sign you up for the first clinic that hits your area.

General Electric Company, Receiver Department, Syracuse, New York

You can put your confidence in—

GENERAL  ELECTRIC

UHF Broad Band
Triangular Dipole
("Bow Tie") Antenna

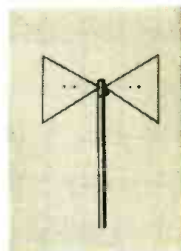

UHF Broad Band
Stacked "V" Antenna



UHF Six Element
Yagi Antenna



Sylvania's New 1954 Calendar for Service Dealers.... sells all through the Year!

They'll read your super-service story every month!

Filled with ideas and recipes
your prospects will want to keep



SERVICE

Only 1½¢

PER MONTH PER PROSPECT...
YOUR GREATEST
ADVERTISING BUY!

Don't miss this Dramatically Different
Business Builder!

It's your personal
Christmas
greeting, too

Here's the hardest-selling, custom-made Home Calendar ever offered to Radio-TV Service Dealers! It's tailor-made just for you! Features an appealing illustration painted exclusively for Sylvania by a famous cover artist. Reproduced in full color and imprinted with your name and address.

Your prospects simply can't overlook this calendar. It's filled with timely hints and valuable household suggestions they'll want to keep handy. And, every time they turn the page they'll be reminded of your dependable service, skill, and experience.

Order now . . . supply limited! At only 1½¢ per customer per month (in lots of one hundred or more), this calendar

is truly the smartest advertising buy ever offered. But don't delay, the supply is limited! Order a couple of hundred from your regular Sylvania distributor . . . TODAY! If he is out of stock, write to: Sylvania Electric Products Inc., Dept. 3R-2102 1740 Broadway, N. Y. 19, N. Y.

SYLVANIA



FAR BETTER RECEPTION

IN EVERY LOCATION

with Sensational New

TRIO ZIG-ZAG

Patent Pending

TV ANTENNAS

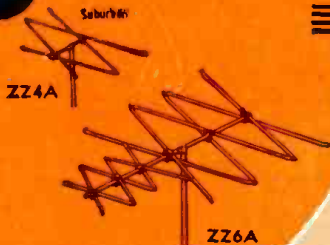

SUBURBAN MODELS

Models ZZ4A and ZZ6A give you all-channel (2 thru 13) reception in ONE SINGLE BAY ANTENNA. The Model ZZ4A has excellent gain and is designed for suburban areas. Model ZZ6A has even greater gain and provides excellent all-channel reception in near fringe areas.

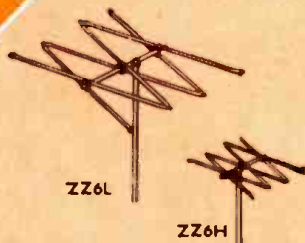

NEAR FRINGE MODELS

For near fringe area reception, the Models ZZ6L and ZZ6H are recommended. Model ZZ6L covers Channels 2 thru 6, Model ZZ6H is for Channels 7 thru 13. Both antennas offer high gain with patterns and front-to-back ratios similar to cut-to-channel yagis.

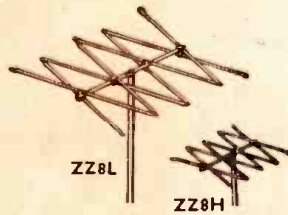

FRINGE MODELS

Models ZZ8L and ZZ8H were designed for normal fringe area reception and provide clear, snow-free pictures. Forward lobe patterns and front-to-back ratios are similar to a good single channel, multi-element yagi.

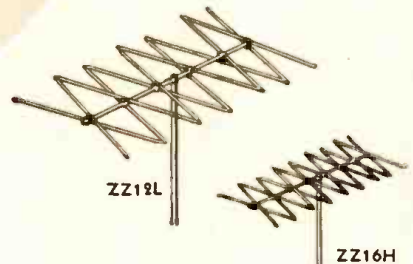

ULTRA FRINGE MODELS

The extremely high gains of the ZZ12L and the ZZ16H models provide unequalled reception in ultra-fringe areas. Model ZZ12L covers Channels 2 thru 6 and Model ZZ16H, Channels 7 thru 13. These two models when stacked, are fed with only one 300 ohm line and provide ALL VHF CHANNEL RECEPTION. Line match is excellent and front-to-back ratios are unusually high.

ZZ12L and ZZ16H are stacked for all VHF Channel Reception

* To provide even greater strength, TRIO Antennas now have stamped steel element clamps.

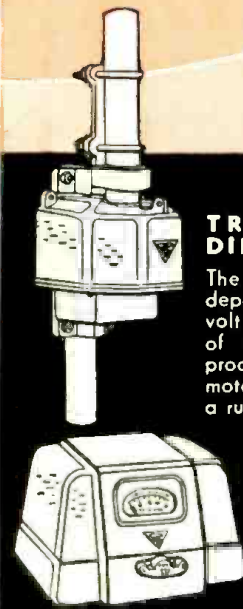

TRIO ROTATOR AND DIRECTION INDICATOR

The TRIO Rotator is America's most dependable — has two powerful 24 volt motors — one for each direction of rotation. Absolutely weather-proof, permanently lubricated. All motors, shafts and gears mounted on a rugged, one-piece casting for true alignment, strength and longer life. Every TRIO Rotator fully guaranteed for two years! Beautiful Direction Indicator has "finger tip" control — no need to hold knob for rotation. A touch of the finger starts it — a touch stops it!



TRIO

TRIO MANUFACTURING COMPANY

GRIGGSVILLE, ILLINOIS

RADIO & TELEVISION NEWS

**BUY DIRECT
AND SAVE**

Sweeping the Country!

'PRE-FAB' COLLINS TUNERS and RECEIVERS AUDIO PRODUCTS CO.

Collins Audio Products Co. is in no way affiliated with Collins Radio Co.

Two ALL NEW Complete Kits for Every High-Fidelity Need



FM Tuner Kit

\$55

The FM 11 tuner is available in kit form with the IF Amplifier mounted in the chassis, wired and tested by us. You mount the completed RF Tuning Unit and power supply, then after some simple wiring, it's all set to operate. 11 tubes: 6J6 RF amp, 6AG5 converter, 6C4 oscillator, 6BA6 1st IF, (2) 6AU6 2nd and 3rd IF, (2) 6AU6 limiters, 6AL5 discriminator, 6AL7-GT double tuning eye, 5Y3-GT rectifier. Sensitivity 6 to 10 microvolts, less than 1/2 of 1% distortion, 20 to 20,000 cycle response with 20dB variation. Chassis dimensions: 12 1/2" wide, 8" deep, 7" high. Illustrated manual supplied. Shipping weight 14 lbs.

Each Collins Tuner Kit is complete with punched chassis, tubes, power transformer, power supply components, hardware, dial assembly, tuning eye, knobs, wire, etc., as well as the completed sub-assemblies: FM tuning units, AM tuning units, IF amplifiers, etc., where applicable. Since all these sub-assemblies are wired, tested and aligned at the factory, Collins Pre-Fab Kits are easily assembled even without technical knowledge. The end result is a fine, high quality, high fidelity instrument at often less than half the cost—because you helped make it and bought it direct from the factory. Bring your present reproducing system up to date with a new Collins Tuner.



FM/AM Tuner Kit

\$7750

The original 15 tube deluxe FM/AM pre-fab kit redesigned on a smaller chassis. The tuner now measures 14" wide by 12" deep by 7 1/2" high. This attractive new front and dial assembly opens up new applications where space is at a premium. Kit includes everything necessary to put it into operation—punched chassis, tubes, wired and aligned components, power supply, hardware, etc. Kit comprises FMF-3 tuning unit, IF-6 amplifier, AM-4 AM tuning unit, magic eye assembly and complete instructions. All tubes included. Shipping weight 19 lbs.

Selected Basic Components For Special Applications

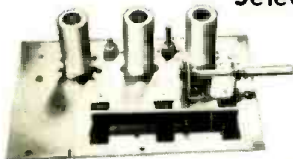

FMF-3 Tuning Unit

\$1525

The best for FM. The most sensitive and most selective type of "front end" on the market. 6 to 10 microvolts sensitivity. Image ratio 500 to 1. 6J6 tuned RF stage, 6AG5 converter, 6C4 oscillator. Permeability tuned, stable and drift-free. Chassis plate measures 6 1/2" x 4 1/2". In combination with the IF-6 amplifier, the highest order of sensitivity on FM can be obtained. Tubes included as well as schematic and instructions. Draws 30 ma. Shipping weight FMF-3: 2 1/2 lbs. Dial available @ \$3.85



IF-6 Amplifier

\$1975

A remarkable value! 6 tubes are used in the IF amplifier: 6BA6 1st IF, (2) 6AU6 2nd and 3rd IF's, (2) 6AU6 limiters and 6AL5 discriminator. High gain, wide-band response (200 KC) for highest fidelity. 20 to 20,000 cycles. Distortion less than 1/2 of 1%. Draws 40 ma @ 220 volts. Chassis plate dimensions: 11-5/16" x 2 1/2" Shipping weight: 3 lbs.

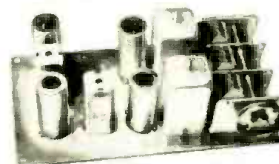

AM-4 Tuning Unit

\$2450

Taps in AM superhet performance! A 3-gang tuning condenser gives 3 tuned stages with high sensitivity and selectivity. Assembly is completely wired, tested and aligned ready for immediate use. Frequency coverage 540 KC to 1650 KC at a sensitivity of 5 microvolts. Tubes 6BA6 RF amplifier; 6BE6 converter; 6BA6 IF amplifier and 6AT6 detector. Draws 30 ma @ 220 volts. Mounts on a chassis plate measuring 4" x 7 3/8". Shipping weight 2 1/2 lbs. Dial available at \$3.85.



RD-1C Tuner & Dial

\$2850

The COLLINS RD-1C FM tuner chassis is unique in the field. A whole, compact FM tuner and dial that fits in the palm of your hand. Convert AM sets to FM/AM receivers for only a few dollars! Unlimited applications where space is at a premium. Use in conjunction with your phonograph amplifier. Full frequency response to 20,000 cycles. Sensitivity 20 microvolts, permeability tuned. Tuning unit and IF amplifier on the same chassis plate. Draws 40 ma @ 100 volts. Tubes: 6AG5 converter, 6C4 oscillator, (2) 6AU6 IF amplifiers, 6AL5 in new ratio detector circuit. Shipping weight tuner and dial 5 lbs.

**MAIL
COUPON
TODAY**

To: Collins Audio Products Co. Inc.
P.O. Box 368, Westfield, N. J.
Tel. WEstfield 2-4390

- FM Tuner Kit FM/AM Tuner Kit Slide Rule Dial Assembly
- FMF-3 Tuning Unit IF-6 Amplifier RD-1C Tuner and Dial
- AM-4 Tuning Unit

NAME.....

ADDRESS.....

CITY..... STATE.....

Amount for Kit \$..... See weights, odd shipping cost \$.....

Total amount enclosed \$..... Check Money Order

WHEN YOU THINK OF TUNERS, THINK OF COLLINS AUDIO PRODUCTS



New "500" telephone. It has already been introduced on a limited scale and will be put in use as opportunity permits, in places where it can serve best. Note new dial and 25 per cent lighter handset.

It adds miles to your voice

For years the telephone you know and use has done its job well—and still does. But as America grows, more people are settling in suburban areas. Telephone lines must be longer; more voice energy is needed to span the extra miles.

Engineers at Bell Telephone Laboratories have developed a new telephone which can deliver a voice ten times more powerfully than before. Outlying points may

now be served without the installation of extra-heavy wires or special batteries on subscribers' premises. For shorter distances, the job can be done with thinner wires than before. Thus thousands of tons of copper and other strategic materials are being conserved.

The new telephone shows once again how Bell Telephone Laboratories keeps making telephony better while the cost stays low.

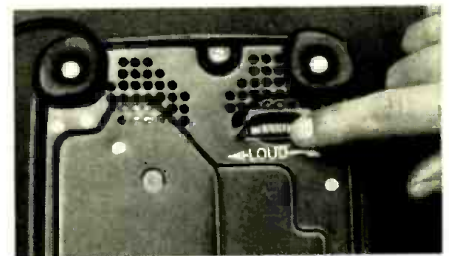

Adjustable volume control on bottom of new telephone permits subscriber to set it to ring as loudly or softly as he pleases. Ring is pleasant and harmonious, yet stands out clearer.

QUICK FACTS ON NEW TELEPHONE

Transmitter is much more powerful, due largely to increased sound pressure at the diaphragm and more efficient use of the carbon granules that turn sound waves into electrical impulses.

Light ring armature diaphragm receiver produces three times as much acoustic energy for the same input power. It transmits more of the high frequencies.

Improved dial mechanism can send pulses over greater distances to operate switches in dial exchange.

Built-in varistors equalize current, so voices don't get too loud close to telephone offices.

Despite increased sensitivity of receiver, "clicks" are subdued by copper oxide varistor which chops off peaks of current surges.

BELL TELEPHONE LABORATORIES

Improving telephone service for America provides careers for creative men in scientific and technical fields.



ENGINEERED FOR BRILLIANT PERFORMANCE

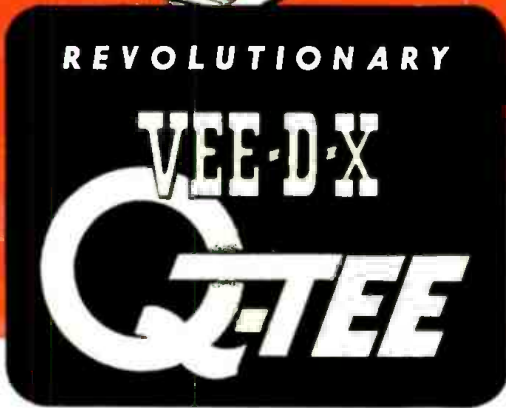

BY ANY STANDARD OF COMPARISON

The Finest All-Channel Antenna

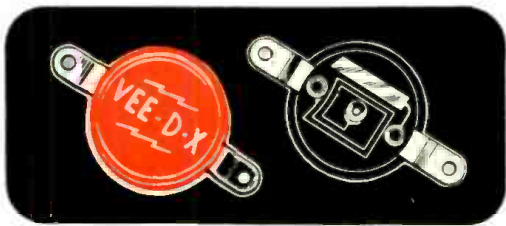

Secret of the Q-Tee all-channel operation is the patented printed circuit electronic channel separator in this colorful red plastic housing. Lic. A.A. K. Pats. 2,422,458; 2,282,292; 2,611,086, others pending.

Easy stacking makes the Q-Tee a pleasure to install especially when in combination with new UHF antennas. Three series: Q-Tee single bay for primary areas; Q-Tee double (two-bay) for near-fringe areas; Q-Tee quad (four-bay) for fringe areas.

There is only one Q-Tee! It's powerful — it's revolutionary — it's patented — it's made only by Vee-D-X. Embodying an entirely new engineering approach to all-channel reception, the Q-Tee has met with sensational success. Its brilliant performance, ease of installation, ease of stacking and clean-cut appearance have won for it the reputation of "Antenna of the Year". Ideal for all multi-channel areas (primary, near-fringe and fringe), the Q-Tee provides the high front-to-back ratio found in no other broadband antenna. In areas of co-channel interference this often means the difference between a good picture and none at all. The Q-Tee is an excellent basic VHF antenna for use in combination with UHF antennas.

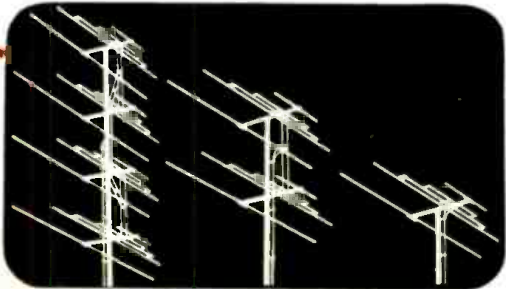

THE LaPOINTE-PLASCOMOLD CORPORATION
ROCKVILLE, CONNECTICUT N-2

Send full information on Q-Tee

NAME

STREET

CITY ZONE STATE



IMPS are TOPS!

IMPS ARE REALLY RUGGED!

The tough thermo-setting plastic will take an astounding amount of abuse —yet IMPS will still look and perform like new!



IMPS WON'T FREEZE OR MELT!

They'll operate faithfully in temperatures ranging from -40°C . to $+100^{\circ}\text{C}$. (212°F .)—and that's the boiling point of water!



IMPS ARE MOISTURE-PROOF!

No moisture can get through the varnished plastic case, or even through the lead anchor points.



IMP LEADS CAN BEND AND BEND!

Tinned leads that are really securely anchored—you'll be amazed at how much punishment they'll take without breaking!

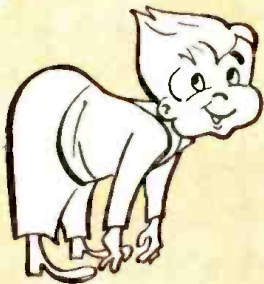

All over the country service-engineers are praising the newest and finest molded tubular paper capacitor—the Pyramid IMP!

IMPS are available in all popular ratings in 200, 400 and 600 volt ranges. See your local distributor.

For free, attractive catalog on IMPS, write Dept. R1

PYRAMID ELECTRIC COMPANY

1445 HUDSON BOULEVARD • NORTH BERGEN, NEW JERSEY

BUILD THIS TRANSISTOR RECEIVER

By
ROBERT K. DIXON

Receiving Tube Division
Raytheon Manufacturing Company

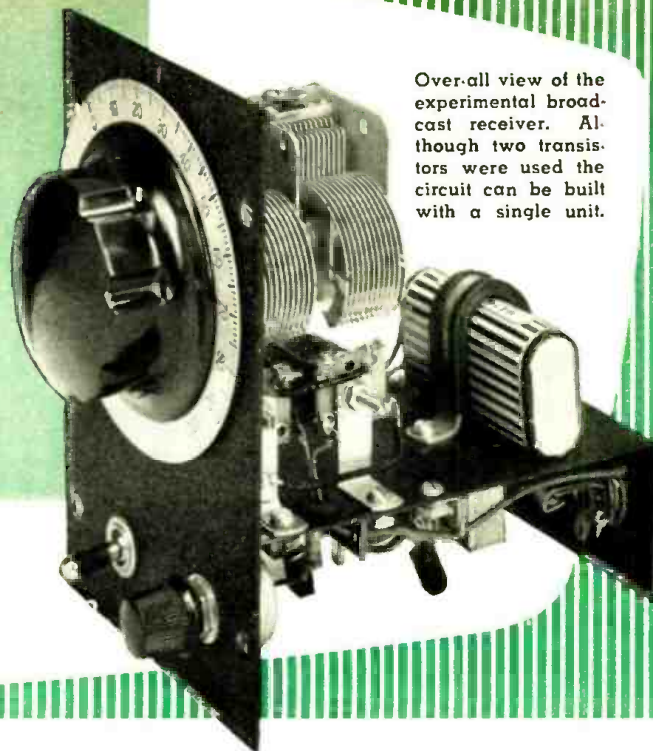

Over-all view of the experimental broadcast receiver. Although two transistors were used the circuit can be built with a single unit.

Transistors are now within the reach of all. Here is a simple receiver you can build—other types of equipment using transistors will be covered in subsequent issues.

ABOUT four years ago, the transistor was first announced. Since that time, a considerable amount of effort has gone into the design and production of transistors and much has been written about them.

Transistors are semiconductor devices capable of acting as amplifiers, oscillators, and performing other functions now performed by vacuum tubes and with greater efficiency. The basic material in most transistors today is germanium and the devices are made in two different types: the point contact, which was the original, and the junction.

A semiconductor is any material which is neither a good conductor nor a good insulator, thus its name. Germanium has a simple atomic structure with the inter-atomic spacings in the crystals forming relatively straight corridors or paths. The basic lattice of the crystal has eight atoms per cell, four of which form the corners of a small cube while the other four are wholly within the cube. There are relatively large spaces between the atoms. In this pure form germanium is basically a stable material and does not exhibit a surplus or deficiency of electrons.

By the introduction of certain selected elements, the germanium can be made to exhibit an excess of electrons and thus become a negative or "n" type material, or by the introduction of other impurities or chemical elements there may be a deficiency of electrons and the material will be considered a positive or "p" type material.

If electrical pressure is applied to a piece of "n" type germanium material, current flow will exist by virtue of the free electrons existing therein. Similarly, if electrical force is applied to the positive type material, conduction appears by virtue of the phenomenon

called hole conduction. The application of electrical potential causes electrons to move from the negative and toward the positive end, the presence of holes facilitating the electron flow.

The point-contact transistor consists

EDITOR'S NOTE: Obviously no attempt has been made to "miniaturize" this unit. It is more important to familiarize oneself with the design and limitations of transistors. Miniaturization is then not too difficult a task. These transistors are new items; however, they are available at a suggested retail price of \$7.60.

of a block or crystal of material such as germanium with two properly spaced pointed electrodes making contact with the surface of the germanium. In many respects, it resembles the well-known crystal diode with the exception of the additional electrode. During manufacturing, the position of the two point contact electrodes (including the relative spacing of these elements) is adjusted for proper operation of the transistor as an amplifying device.

Fig. 1. Internal construction of the (A) point contact and (B) junction transistor.

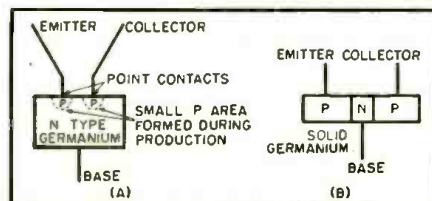

The basic block of germanium is normally "n" type in the point-contact device. Small areas of the germanium adjacent to the pointed electrodes are converted to "p" type material during production. (See Fig. 1A.)

Junction transistors consist of a block of material in which "n" and "p" type materials are arranged in alternate layers. The end sections can be either "n" or "p" material with the center zone being the opposite type. (See Fig. 1B.)

The point-contact transistor finds wide application in switching circuits and oscillator circuits at frequencies normally not possible with the junction type units. The point-contact transistor has inherently higher noise output than the junction units.

The junction transistor, on the other hand, is a more efficient amplifier while operating at low voltages. They are extremely rugged and have exceptionally long life. The normal noise voltage generated in a junction type is lower than that of the point-contact type transistor. Since the electrons travel somewhat slower through the germanium material in transistors than in a vacuum and due to the high internal capacities of junction transistors as we know them today, operation is normally limited to the lower frequencies.

This article deals with a "p-n-p" junction transistor recently announced by the Raytheon Manufacturing Com-

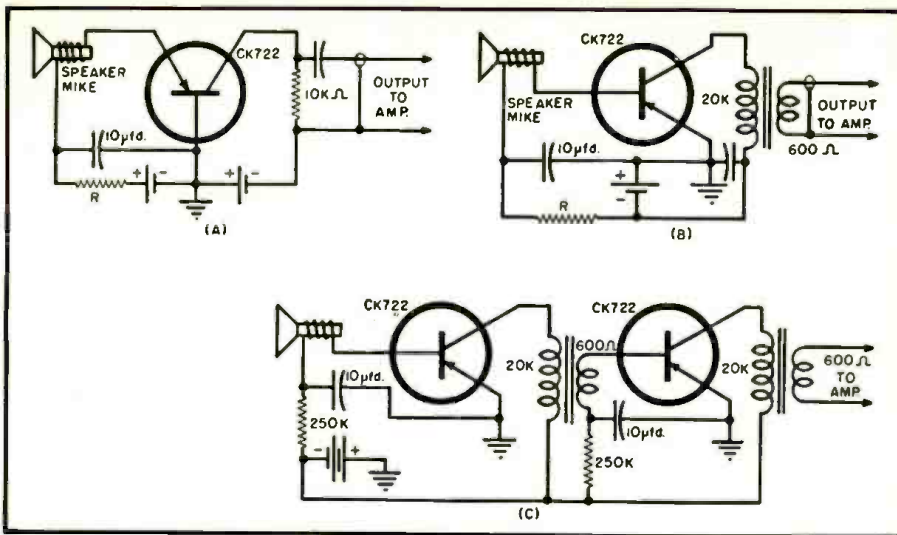

Fig. 2. Microphone preamplifiers using transistors. (A) grounded base, (B) grounded emitter, and (C) a two-stage, transformer-coupled amplifier. See text for details.

MECHANICAL DATA

CASE: Plastic and Glass
 BASE: None (0.016" tinned flexible leads. Length: 1.5" min. Spacing: 0.08" center-to-center)

TERMINAL CONNECTIONS: (Red dot is adjacent to lead 1)
 Lead 1 Collector
 Lead 2 Base
 Lead 3 Emitter

WEIGHT: 0.025 ounce
MOUNTING POSITION: Any

ELECTRICAL DATA

RATINGS—ABSOLUTE MAXIMUM VALUES:

Collector Voltage	-20 volts
Collector Current	-5 ma.
Collector Dissipation (at 30°C)	30 mw.
Emitter Current	5 ma.
Ambient Temperature	50 °C

AVERAGE GAIN CHARACTERISTICS—GROUNDED EMITTER: (at 30°C)

Collector Voltage	-1.5 volts
Collector Current	-0.5 ma.
Base Current	-20 μa.
Current Amplification Factor	12
Power Gain*	30 db
Noise Factor † (1000 cycles)	22 db

* Source: 1000 ohms; Load: 20,000 ohms
 † At -1.5 volts (-1.0 ma.) to the collector.
 ** Socket types: Cinch Nos. 14148 & 14273 or equivalent.

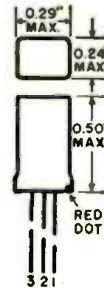

Table 1. Tentative data on the Raytheon CK722 germanium junction transistor.

pany, identified as the CK722. The characteristics and ratings of the CK722 are shown in Table 1. It is extremely rugged and when operated at normal ratings has exceptionally long life.

Basically, the "p-n-p" junction transistor may be compared to the vacuum tube with the emitter resembling the cathode, the base resembling the grid, and the collector resembling the plate. There are several basic differences, however, which are outstanding.

In the "p-n-p" junction transistor,

conduction is accomplished in a solid instead of in a vacuum. The collector is operated with a negative bias instead of the customary positive voltage applied to the plate. Another outstanding difference lies in the input impedance. The vacuum tube has almost infinite input impedance over a considerable range of frequencies. The transistor, on the other hand, is a current-operated device and has a rather low input impedance in the grounded base or grounded emitter connection which is analogous to the

grounded grid and grounded cathode type amplifiers.

The graphic symbol for the "p-n-p" junction transistor is shown in Fig. 3. Since the transistor is a three-terminal device, several combinations of connections may be used, namely, the grounded emitter, the grounded base, and the grounded collector.

Fig. 5 is a typical set of characteristic collector curves for the CK722. These curves may be compared to the plate characteristics of a pentode amplifier except that instead of grid voltage we use various values of base current. A load line of 1000 ohms has been drawn in and examination of the curve will show that operation is linear over almost the full range from zero to maximum collector current. The slow increase in collector current with increasing collector voltage at any fixed value of base current is typical of junction transistors and is indicative of the high collector resistance.

An additional characteristic which is little known but of considerable importance is the "Zener" effect. If the transistor is operated with positive base current so that normally there is no collector current, the collector voltage can be increased to a point where conduction will occur. This is the "Zener" point and may be an important consideration in operation of transistors. "Zener" current flowing during the peak a.c. voltage cycle could cause excessive limiting and consequent high distortion in an amplifier.

Many applications for the CK722 junction transistor will become apparent to the experimenter. Since junction transistors had up to now been available on only a limited basis, very little application and circuit work has been done.

Three basic type circuits immediately suggest themselves. These are: switching circuits, oscillator circuits, and amplifier circuits.

We shall discuss in some detail, the CK722 as a small-signal, low-voltage amplifier.

The small size and relatively high efficiency at low operating voltage coupled with the absence of any heater voltage make the transistor ideally suited for preamplifier use. A further advantage is the fact that transistors are not microphonic, thus no special precautions in mounting need be taken.

Fig. 2 includes several suggested circuits for transistors used as microphone preamplifiers. The microphone

Fig. 3. Equivalent graphic circuits. (A) Graphic symbol of CK722 "p-n-p" junction transistor. (B) Common base amplifier, with low input impedance and high output impedance. Requires two batteries. (C) Common emitter circuit having medium input impedance and high output impedance. Permits single battery operation. (D) Common collector with high input impedance and low output impedance.

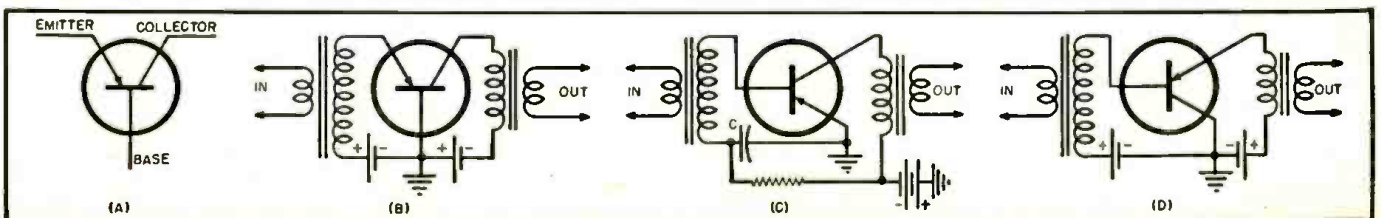

may be a small 2 or 3 inch dynamic speaker. Notice that it is directly connected to the transistor without use of an impedance matching transformer. With a voice coil impedance of 6 ohms and with R adjusted for a collector current of 100 microamperes, the sensitivity will be approximately equal to a good carbon mike with much better fidelity and less noise. The circuit of Fig. 2B may be used to eliminate the need of a tapped battery, however, the gain will be slightly less. If a long shielded cable is required, a transformer should be used instead of a resistor load in the collector of the transistor as in Fig. 2B. This can be a small plate-to-line transformer of 20,000/600 ohms impedance.

Because the operating current is low, battery life is good. The supply for the transistor can be obtained from the standard high voltage plate supply of the amplifier and, in fact, this circuit has the advantage of supplying a more constant current to the transistor. The important factors in these circuits are the low input impedance of the emitter, on the order of 100 ohms with the grounded base connection, and the high output impedance of the collector, on the order of 500,000 ohms. With grounded emitter connection, the input impedance of the base is a function of other operating parameters so no value can be given for it.

Several stages of transistor amplifiers can be cascaded and the use of coupling transformers will assure maximum gain. Plate-to-line transformers may be used as shown in Fig. 2C. Resistance coupling can be used but with some loss in gain (approximately 6 db). Large coupling condensers must be used to obtain good low frequency response because of the low impedance levels.

Push-pull operation of transistors is entirely feasible, permitting greater power dissipation with consequent greater power output. Class A operating efficiencies on the order of 50 percent are obtainable while class B operating efficiencies to nearly 80 percent are possible. Matched units should be used in this application and degeneration can be applied to improve performance.

The audio amplifier type operation lends itself admirably to a simple broadcast receiver. To investigate this application more thoroughly, such a receiver has been built. For those interested in duplicating it, a description follows:

Transistor Receiver

One or two transistors may be used in this receiver (Fig. 4). The first unit is utilized as a detector/amplifier. The second transistor is connected as a grounded emitter amplifier.

The first unit is capable of delivering adequate earphone volume so that the second stage can be eliminated if it is desired to reduce the cost of the receiver. Although the experimental receiver shown has been built on

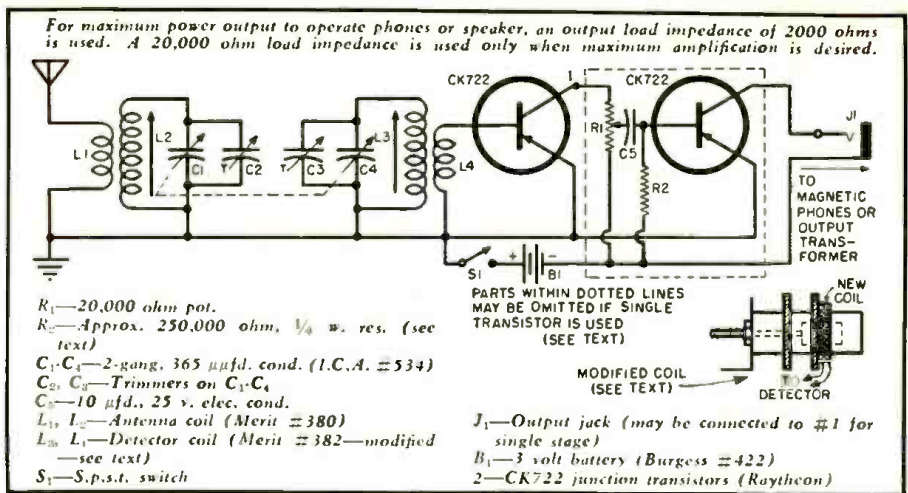

Fig. 4. Diagram of transistor receiver. A single unit may be used if desired. See text.

metal, obviously it could be built using a wooden case without affecting its performance.

In the Boston area where this receiver has been operated, the two tuned circuits have given more than adequate selectivity to separate the local stations. An antenna of 50 feet and a good ground made possible reception of stations over approximately a 15 mile radius. The importance of a good antenna and ground, particularly in an area somewhat remote from high power broadcast stations, cannot be overemphasized.

The two circuits are coupled through mutual coupling existing by physically placing the coils close together, one inch separation center-to-center is recommended. The detector coil must be modified to connect to the transistor detector/amplifier. The antenna coil portion of the Merit type 382 should be carefully removed. It can be slid off the end of the form without damage to the coils after unsoldering the leads. The wire from this antenna coil may be used to scramble wind 50

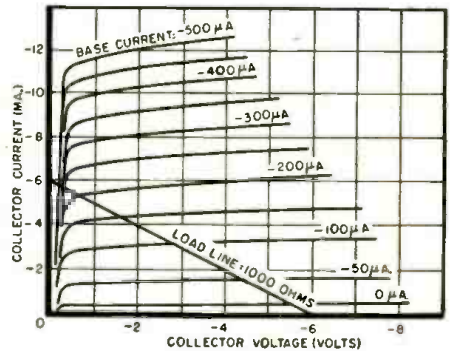
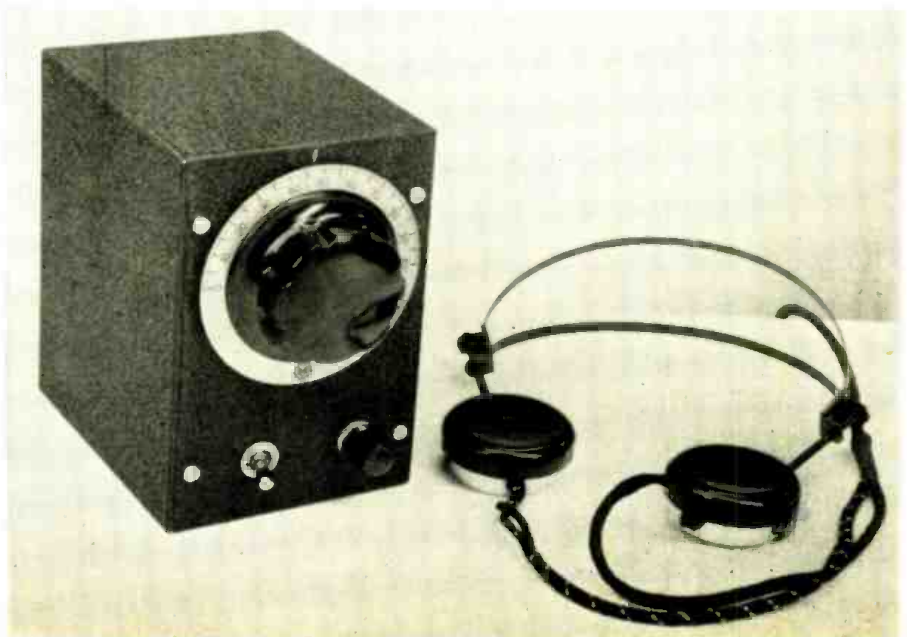

Fig. 5. $I_c/E_b/I_b$ curves for the CK722.

turns on the 382 form, tight against the first pi of the tuning coil. (See Fig. 4). This detector coil can be cemented in place with a good coil dope, such as Amphenol 912.

The amplifier is connected in the grounded emitter type circuit. The advantages of this circuit are that only one battery is required and that it has a higher input impedance than the
 (Continued on page 132)

Over-all view of the experimental transistor receiver showing accessory headphones.



OIL-COOLED LOAD WATTMETER

By

ROBERT M. SEE, W9OCL/5

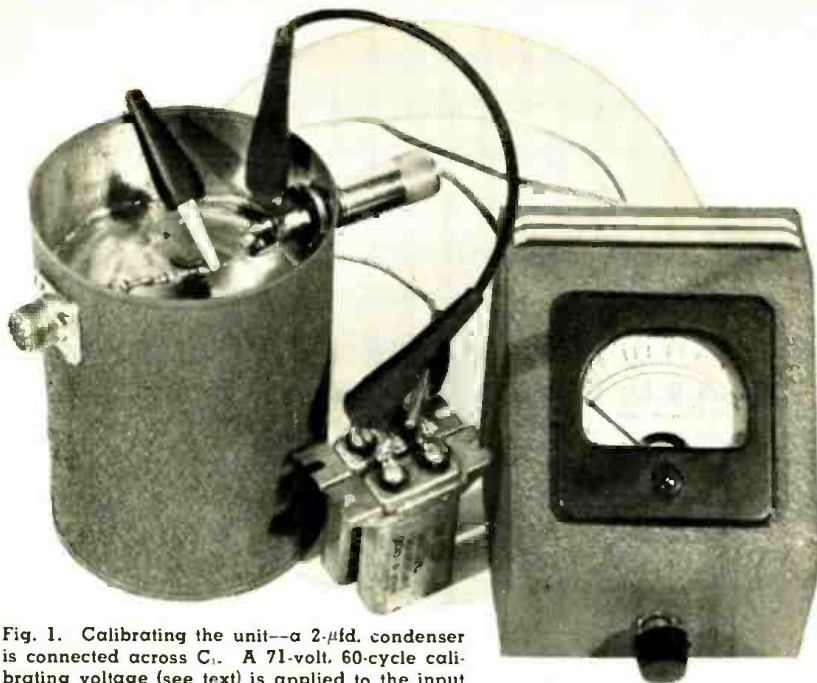

Fig. 1. Calibrating the unit—a 2- μ fd. condenser is connected across C₁. A 71-volt, 60-cycle calibrating voltage (see text) is applied to the input and R₃ set for full-scale deflection of the meter.

Your rig's r.f. output, not the rated d.c. input, is the important factor. Old Timer and Novice can make good use of this simple direct-reading output meter.

IN ALMOST any ham shack, Novice or otherwise, there comes a time when the operator wishes for a simple means of checking the output of his rig to determine whether it is op-

erating as efficiently as it should. The wattmeter described here is the result of such a desire at W9OCL. It will be particularly useful to the Novice in helping him to get acquainted with the factors involved in amplifier efficiency.

Aside from simplicity of calibration, two other requirements were considered to be desirable. These were a 100-watt dissipation rating and a comparatively flat load up to 30 mc.

Although the metering circuit is good up to approximately 40 mc., the voltage standing wave ratio of the load has been measured up to 400 mc. and found to be less than 1.5. If a wattmeter is needed for higher frequencies it would be simple to substitute another metering circuit for the one shown in the circuit diagram. The metering circuit here was chosen because of the fewer parts required and its ability to read power at 60 cycles as well as at 30 mc.

The 100-watt dissipation requirement was satisfied by using twelve 150-ohm, 2-watt Allen Bradley resist-

ors in series-parallel, cooled by being immersed in ordinary #10W motor oil.

Mechanical Construction

A general idea of the construction of the wattmeter can be seen by studying the photographs. The "chassis" is simply a one-quart motor oil can. Save the oil so it may be used later. When opening the can of oil use an opener which will cut smoothly so that the lid will fit comfortably inside the can. Later this lid will be soldered into place to form a completely sealed oil-cooled load, so clean the can well.

The twelve 150-ohm resistors are mounted between three thin brass plates in a sandwich-like manner, six in each "deck." Each deck will then have a resistance of 25 ohms, and the two decks in series a resistance of 50 ohms. The three 2 $\frac{1}{2}$ x 1 $\frac{1}{8}$ inch plates are used for mechanical support and electrical bond. To keep the lead inductance to a minimum, holes are drilled into the plates just large enough to slip in the resistor leads. In this way only a one-eighth inch lead is used. The resistors are fitted flush with the plates and soldered into place. Fig. 2 shows the resistor load in its finished form.

Now the total resistance between outside plates will be approximately 50 ohms. One of the outside plates may be electrically joined to the oil-can lid by soldering a strong L-shaped piece of metal to the plate and lid. This junction should be made so that the lid is suspended above the 50-ohm load about one-half inch. The other outside plate of the load may be connected to a feedthrough insulator which is mounted on the lid.

Fill the oil can about two thirds full of the #10W motor oil and slip the 50-ohm load down inside until it is about half an inch from the bottom of the can. Make certain that the oil completely covers the resistors of the load but leaves some air space below the lid. The lid should now be soldered to the inside of the can to form a good electrical contact as well as a leak-proof seal.

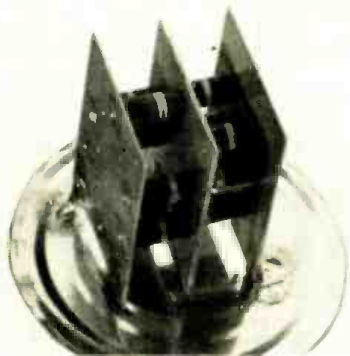
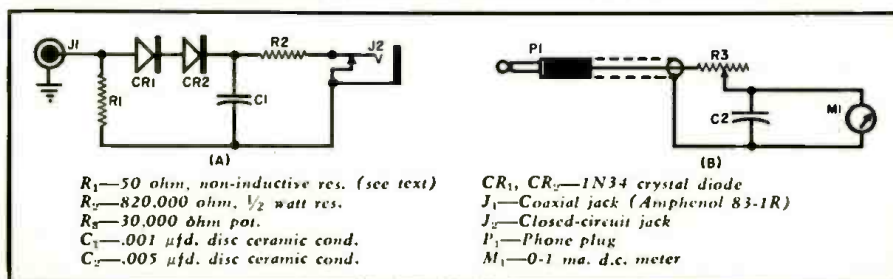

Fig. 2. The 50-ohm load, showing the twelve 150-ohm resistors connected in series-parallel. The plate on the left is soldered to a feedthrough on the can lid. The right-hand plate is grounded to the lid by an L-shaped piece of metal.

Fig. 3. (A) Wiring diagram of oil-cooled load assembly. (B) Meter-case assembly.



The foregoing will take a little care. To find that half-an-inch of clearance it is best not to try to use a half-inch piece of wood or other material, even as a temporary spacer, because once you have placed the 50-ohm load in the can it may be very difficult to get it out again. Of course, no spacer is used in the finished unit. Sliding the can lid in and out also produces wear and the lid may refuse to stay in place when you finally try to solder it.

Do your measuring and marking with a ruler and avoid any temptation to measure by "eye 'n' try" although it may seem quicker.

When you pour the oil, pour it gently into the center, because if the sides are oily, they will not take solder. Use as large a soldering iron as possible for this job.

These points may seem elementary but many hams learn their construction techniques through unhappy experience and these suggestions are intended as tips for the novice who may not have had too much shop work.

None of this is to imply that the work is ticklish, but it should be carefully done and well organized.

The r.f. input is brought into the load by means of a coaxial connector. It should be placed so that the lead to the feedthrough insulator will be as short as possible. A hole is cut on the other side of the can for a closed-circuit type of phone jack. Between the coax connector and the jack are connected the two 1N34 crystals and R_2 in series. These should be placed so that the leads will be as short as possible. C_1 should be a disc type ceramic condenser which is wired into the circuit with a minimum lead length.

The 0-1 milliammeter with C_2 and R_1 are mounted separately in a meter case. Connection from the meter to the load is made by shielded wire which plugs into the jack on the load.

Circuit Considerations

It has been found that by immersing Allen-Bradley 2-watt composition resistors in oil, the power dissipating capabilities can be increased approximately four times with negligible change in the resistance. This fact makes it possible to build the 50-ohm load with only twelve 2-watt resistors. To prove this point to yourself, take two 1500-ohm, 2-watt resistors and measure their resistance on a bridge or by some other accurate method. Now apply 117 volts, 60 cycles to both. Lay one of the resistors in a small dish filled with oil while leaving the other resistor in the open air. After about fifteen minutes disconnect the voltage and measure the resistances again. You will find that the resistor immersed in oil will have changed less than 3% while the other resistor has increased in value at least 20% and is showing visible signs of breaking down. The power being dissipated was eight watts, or four times the rated dissipation of the resistors!

To insure against your load changing value it would be wise not to run

your transmitter into the wattmeter for periods exceeding ten or fifteen minutes at a time without allowing it to cool.

The metering circuit is simply a diode voltmeter of the peak-reading type. C_1 determines the lowest frequency which the meter will read accurately. By using a .001 μ fd. disc-type condenser for C_1 a signal with a frequency as low as 500 kc. may be read with accuracy. However, to calibrate the meter with a 60-cycle voltage a condenser of higher capacitance is needed. This will be discussed later.

Two crystals of the 1N34 class are required in the circuit in order to keep the voltage applied to the crystal within the manufacturer's rating; the peak voltage is equally divided between the two crystals. Another circuit was tried using resistor voltage dividers so that only one crystal would be needed. This was found impractical since the resistor's lead length introduced a resonant circuit which made the higher frequency readings low.

Calibration

Since the voltage across the load will vary directly with the power being dissipated, the meter can be calibrated to read directly in watts (See Fig. 4). However, since this meter is used in other test equipment it was easier to read the power from a curve than to make a new scale for the meter. The curve in Fig. 4 was calculated from the constants of the circuit. A full-scale deflection of 1 ma. on the meter would indicate on the curve that 100 watts was being delivered to the load.

To calibrate the meter, connect a 2- μ fd. condenser across C_1 and apply a 60-cycle, 71-volt source to the input connector of the load. Plug the meter into the jack and set R_1 so that the meter reads full scale. The calibrating voltage may be obtained from your 117-volt line and dropped by means of

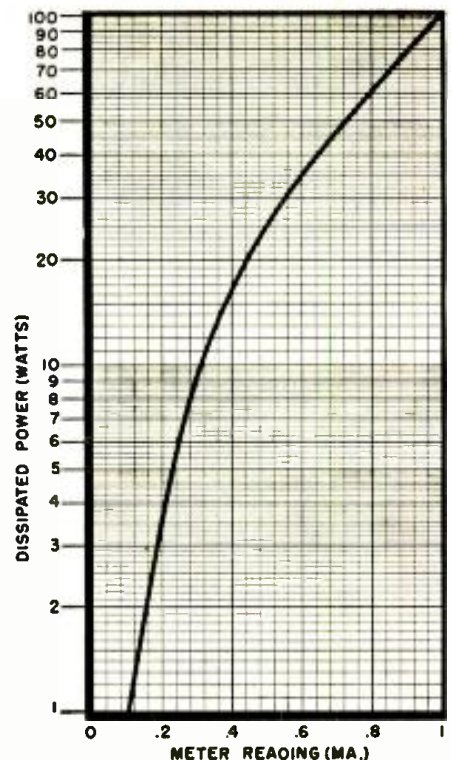

Fig. 4. Calibration curve for the 50-ohm load, calculated from circuit constants. It can be used as a conversion chart or for calibrating the meter face directly.

a Variac or some other method. A v.t.v.m. should be used to determine that the voltage is exactly 71 volts. Now the 2- μ fd. condenser may be disconnected and a cover put on the load can. Your wattmeter is now ready for use.

Extensive tests have shown that the wattmeter will give approximately 5% accuracy up to 30 mc. The accuracy will depend largely on the accuracy of the calibrating voltage and the lead lengths of the components.

-50-

Fig. 5. The r.f. input jack is located on the left and the phone jack for the shielded cable to the meter is on the right. The knob on meter case is R_1 .

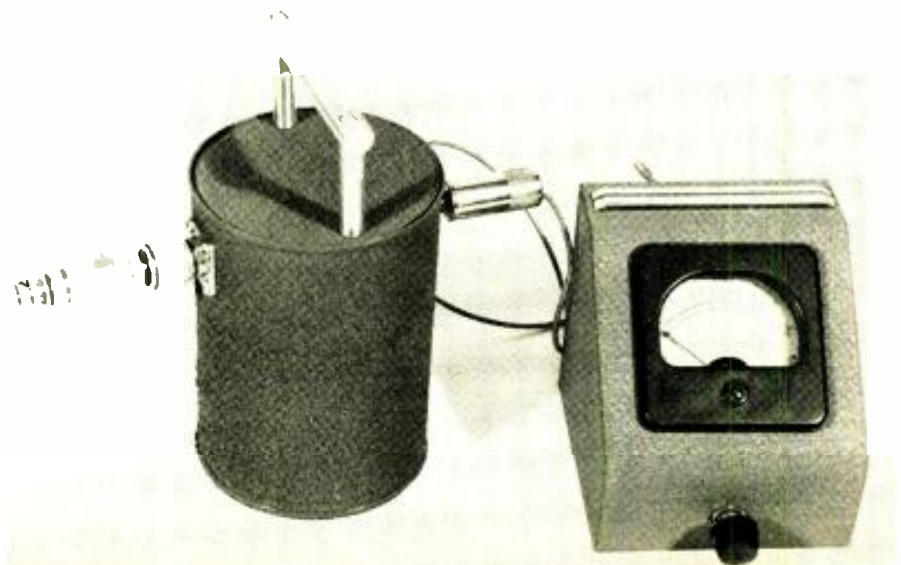

CARE OF TRANSISTORS

By

RUFUS P. TURNER, K6AI



Fig. 1. The CK721 and CK722 junction-type transistors. To the right is shown the CK716 in its specially-designed molded socket housing.

Transistors are still expensive and may be easily damaged. Here are some practical pointers on caring for these units.

TODAY'S prices place transistors definitely into the category of expensive components. Every experienced radio technician knows that a natural law seems to be that the most costly parts are the most easily damaged. The danger signal is up. Persons setting out to do transistor circuit work are giving serious forethought to protective measures. This writer knows first-hand the horror of burning out an expensive transistor even before securing the required test data.

For future guidance, a careful study has been made of the ways in which these crystal devices can be damaged, and the findings are presented in this article in hope that they will be of service to other technicians. If you know how you can get into trouble with these units, avoiding the pitfalls will be easier.

Supply Potential Polarity

Correct polarity of applied voltages is very important in transistor circuits. Reversing the high-voltage supply in a tube circuit means nothing more than making the plate negative and stopping circuit operation. But reversing the comparable collector voltage in a transistor circuit means a quick burn-out.

It is worthwhile noting that use of the wrong polarity is an easy matter for the newcomer to transistor circuitry, although he may have had years of experience in tube applications. In fact, the more experience he has had with tubes, the more apt he will be to make the mistake with point-contact transistors because it has become his habit to make the grid negative and plate positive. The reverse is correct in *point-contact* transistor circuitry (See Fig. 2A). The emitter, which is comparable to the tube grid, is biased positive, while the collector, which is

comparable to the tube plate, is made *negative*. Both emitter and collector voltages are viewed with respect to the base (germanium wafer) which is comparable to the tube cathode.

In the point-contact transistor, maximum current flow (crystal forward current) occurs when either the emitter or collector whisker is made posi-

EDITOR'S NOTE: An announcement has just come through from Raytheon that they are in production on the CK722 junction-type transistor. The CK721 junction type is available only in limited quantities at the present time. Their suggested price on the CK722 has been dropped to \$7.50 each. For additional information on the design and application of transistors, see the article "Build This Transistor Receiver" on page 35 of this issue.

tive with respect to the base, just as in crystal diodes. The emitter supply voltage, being normally "whisker-positive," is low (on the order of $\frac{1}{2}$ volt) so that emitter current, while higher than collector current, is held to a safe value. Reversing the emitter voltage polarity will impair circuit operation but will not damage the transistor. When the collector voltage polarity is reversed, a large forward current flows, due to the much higher collector voltage, and burnout occurs quickly.

In the junction-type transistor, shown in a basic amplifier circuit in Fig. 2B, the supply potential polarities are the *same* as in a tube circuit—emitter negative and collector positive. While this reduces the chance of a mistake when transferring the attention from tubes to *junction* transistors, a very good likelihood of error is present when working back and forth between point-contact and junction transistors. Reversing the polarity of the junction transistor collector supply voltage is just as disastrous as in the case of the point-contact unit.

While on the subject of polarity, at-

tention should be called to the fact that a polarized circuit component such as an electrolytic condenser or d.c. meter normally is connected "backward" in some transistor circuits, especially those using point-contact transistors. To tube circuit technicians, long accustomed as they are to grounding the negative terminal of an electrolytic condenser, the necessity for grounding the positive in point-contact transistor circuits may be overlooked.

Mounting and Soldering

When the *Raytheon* CK703 point-contact transistor first appeared on the market in 1949, the ingenuity of technicians was taxed regarding a satisfactory way to make contact with the tiny base pins of that unit. Soldering to the pins was strongly discouraged. The size and construction of the CK703 was the same as the CK716 shown in Fig. 1. This writer devised a socket (See "A Crystal Receiver with Transistor Amplifier" by Rufus P. Turner, *RADIO & TELEVISION NEWS*, January 1950) which, though small in size, turned out to be bulky by comparison with the transistor.

At present, a tiny molded phenolic socket (*Cinch* Exp. 8749) is available for the CK716. The *Cinch* 8672 subminiature socket accommodates *Western Electric* Type A1698 and *Bell Laboratories* Types M1725 and M1729. The 3-pinned *General Electric* Types G11 and G11A may be plugged into a 5- or 7-pin subminiature tube socket. Each of the junction types examined thus far by the writer (typical example: *Germanium Products Corp.-Fedevated Semi-Conductor, Inc.* No. RD2517) have pigtail leads.

If the transistor is not provided with pigtail leads, no attempt should be made to solder or weld connections to its terminals unless the transistor manufacturer specifically sanctions this method of connection. It is fairly easy to damage germanium devices with heat such as that from a soldering iron or welding device. When soldering to the pigtail leads of transistors provided with such leads, hold the pigtail tightly with long nose pliers as close as possible to the body of the transistor and continue to grip the lead for a short time after the joint appears to have cooled. The pliers will conduct the heat away, preventing its entry into the interior of the transistor. Two good rules are to complete the soldering job as quickly as possible and to use as long a pigtail in the construction as possible.

Transistors may be mounted in any position. This is a convenience, since full exploitation of their small size often favors mounting transistors in whichever is the most convenient position.

Protection from Transients

Transistors must be protected from large voltage surges. A very sensible precaution before inserting the transistor is to examine a circuit thoroughly for possibility of surges. Damaging transients may be set up by steep signal waveforms, circuit switching, kickback from inductive components, sudden application of steady operating potentials, and similar causes.

Each circuit should be analyzed as an individual case and necessary remedial steps taken to reduce transients to, or lower than, the maximum potentials specified for the transistor to be used.

When theoretical investigation of transients must be supplemented with experimental data, the tests often can be made satisfactorily with an equivalent 3-terminal resistor network substituted in the circuit for the transistor.

Sudden switching of steady operating potentials on or off is to be avoided in new test circuits which have not been investigated fully. In a strange transistor circuit, it is advisable to increase the various operating potentials, in a stepless manner, slowly and simultaneously from zero to the design level. Only in this way can certain transistor damage be averted.

Current Limiting

Care must be taken to keep transistors in some circuits from becoming d.c. unstable and running to destruction. One such circuit is the oscillator (Fig. 3) in which a parallel resonant circuit is inserted between base and ground. Sufficient resistance must be present at R_1 and R_2 to limit emitter and collector currents to safe values.

A good precaution is to install a current limiting resistor, selected to conform to the type of transistor and circuit operating conditions, in series with the emitter of any transistor oscillator. If a collector load resistor is not employed normally in the circuit, another resistor should also be connected in series with the collector. Current limiting resistors are desirable also in many transistor amplifier and control circuits, especially in those circuits employing external base resistors or in which a coil or transformer is used instead of a load resistor in the output. In Fig. 2, points A and B are the proper locations for current limiting resistors.

External resistance connected between the transistor base and ground tends to make the transistor unstable. Hence, any attempt to "cathode bias" a transistor must be approached with caution. When it is imperative to employ such external resistance in a circuit, its value must be kept as low as

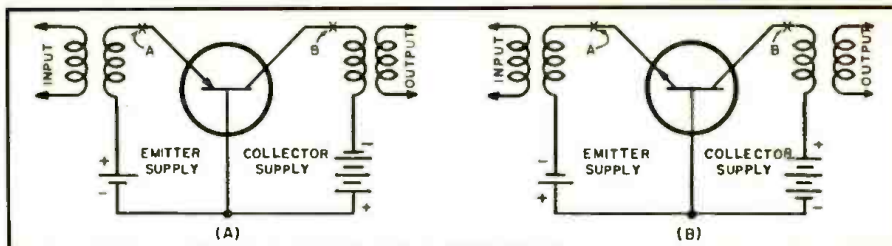

Fig. 2. Single-stage amplifiers (A) point-contact, and (B) junction types.

possible to prevent instability. "Cathode-biased" transistor amplifiers frequently oscillate or "sing" unless the base resistors are bypassed adequately.

In all transistor circuits, care must be taken to avoid excessive peak currents. Such current peaks can occur easily when high capacitances effectively are in series with either electrode of the transistor. The situation is very much the same as that in which a large filter condenser follows a metallic rectifier. Current limiting resistors must be provided for reduction of the peak currents.

Temperature Environment

While germanium transistors show negligible self-generation of heat, they are sensitive to ambient temperature, the junction type to a greater extent than the point-contact type. In fact, temperature dependence is one of the unsolved shortcomings of the transistor.

It is inadvisable, for that reason, to operate transistors at full ratings at high temperature. While +80 degrees centigrade has been stated as the top operating temperature for some transistors, it is best to consult the ratings of the individual type to be used. A warm chassis is not a good place to install transistors. The junction type particularly must be kept well away from hot tubes, resistors, and similar components.

It is correct to regard transistors as rugged, since they have given good account of themselves in vibration and shock tests, appearing better than vacuum tubes in some instances. But

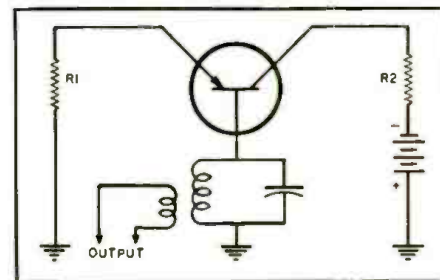

Fig. 3. Circuit of a "base" oscillator.

this is no reason to be unduly careless in handling them. Possible damage should not be risked by tapping or hammering on transistors or by dropping them from considerable heights. To prevent possible internal deformations, the transistor should not be pinched excessively by its mechanical mounting.

With transistors, we are in very much the same position as with vacuum tubes during the 20's. In those days, tubes were expensive and fragile and we just did not throw them around. Every circuit was checked and its "bad acting" possibilities thoroughly considered before tubes were plugged into their sockets.

If for no other reason, the present cost of transistors should put us on guard. The best procedure is to become fully aware of the possibilities for damage to the units, and then to check and double check all circuitry. Finally, care must be exercised in the initial operation of an experimental transistor circuit.

-30-

This portable, battery-operated television receiver uses transistors and no tubes except the 5" picture tube (at the right). This unit was one of the series of transistor equipment demonstrated recently by RCA at its Princeton, N. J., Laboratories.



V.H.F.-U.H.F.

Evaluating antenna performance—a "Megamatch," scope, and GDO are used.

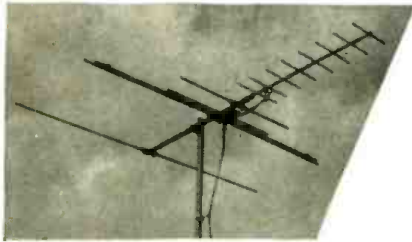

"Suburban Ultra Q-Tee"



"Ultra Q-Tee"

ANTENNA DESIGN

By

L. F. B. CARINI

Assistant Chief Engineer
The LaPointe-Plascomold Corp.



"Q-Tee" model.

Engineering criteria in developing an all-channel antenna for both u.h.f. and v.h.f. video bands.

TELEVISION at u.h.f. has presented the engineering laboratories with a host of new and unusual problems. Among these, one of the most interesting has been the design and development of effective u.h.f. antennas.

The majority of v.h.f. antennas of past design and in current use are unsuited inherently for the reception of u.h.f. Directivity patterns are poor and, more important, these antennas fail to produce the gain required to pick up elusive u.h.f. signals.

Designing an antenna capable of providing a uniform gain over the entire u.h.f. spectrum is, in itself, an inordinate technical challenge. With v.h.f. the dozen channels ranging from 54 mc. to 216 mc. presented no serious problem, and indeed, many of the so-called all-channel antennas gave satisfactory response for average service. The problem of designing an antenna that has a reasonably linear response for all the u.h.f. channels and for v.h.f. as well, becomes complicated by the inability to decide upon compatible values in compromising between theoretical and physical ideals. The new

band of ultra-high frequencies is so broad, comparatively speaking, that many antenna types which were entirely satisfactory at v.h.f. cannot be adapted for u.h.f.

The accompanying chart (Table 1) shows the relative gain of various types of u.h.f. antennas as compared to a simple dipole used as reference. Note that, as in v.h.f., the highest gains are furnished by the more directional arrays.

Theoretical considerations have dictated and practical tests have proven that the best policy is to combine a u.h.f.-designed element or antenna with a v.h.f. antenna for optimum all-channel reception. Such an antenna is shown on the cover. Resonant filters, or channel separators, in the form of printed circuitry may be employed to effectively separate the v.h.f. portion of the antenna from the u.h.f. elements. The use of printed circuits permits filters to be applied directly to the antenna where the division of elements actually defines the limits of channel segregation. Printed circuitry makes possible small, compact LC units

of light weight, which when properly encapsulated, are electrically stable and weatherproof as substitutes for the usual large inductances and condensers.

For metropolitan service, it was found that the average 2 to 3 db gain supplied by a simple broadband "V" cut for u.h.f. when added to a v.h.f. antenna would provide adequate gain within city limits. In fringe areas where maximum signal gain must be obtained, the v.h.f. antenna is used in conjunction with a u.h.f. multi-element yagi. Gain as high as 14 db is obtained to satisfactorily pick up a signal in the most difficult locations. This type of antenna was extensively employed in the Portland area.

Other considerations of what constitutes good u.h.f. antenna design reflect the importance of physical construction. At u.h.f., any slight physical displacement of the antenna, or its constituent components, is sufficient to introduce noise, picture fluctuation, or ghosts. Therefore, one of the primary precautions to observe in engineering development is rigidity in design and permanence of construction. Vibration proofing and a freedom from any movement of the antenna elements become particularly important because they contribute to maintaining a steady signal input to the receiver. For this reason, large metal surfaces which offer considerable high wind resistance are objectionable and should be made of screen or perforated sheet metal. Use of a *Fiberglas* boom for the yagi antenna increases the strength and rigidity of the array. Noise generation at u.h.f. is serious enough as a result of tube noises and it should not be augmented by defective and loose mechanical connections as contributed by corrosion and rubbing of parts during high winds.

Table 1. Comparative gain for several types of antennas suitable for u.h.f. reception.

TYPE	FREQUENCY RANGE	GAIN (in db)
Dipole (1/4 wave center fed)	Broadband	0
V (single)	Broadband	2.3
V (2-bay)	Broadband	5-6
Double Dipole	Broadband	3-4
Bow Tie	Broadband	3
Folded Dipole*	Broadband	5
Helical	Broadband	8
Rhombic	Broadband	9
Corner Reflector	Broadband	10
Yagi (single 12-element)	Single Channel	14
Yagi (2-stack 12-element)	Single Channel	17
Colinear	Multiple Channels	9
Colinear (4-bay array)	Multiple Channels	14
Colinear (8-bay side-by-side)	Multiple Channels	17

* With reflector

IMPROVING THE WILLIAMSON AMPLIFIER

By

DAVID HAFLER and HERBERT I. KEROES

Acro Products Company

THE Williamson amplifier circuit is undoubtedly the most popular amplifier circuit ever developed for high quality audio reproduction.¹ It has become famous throughout the world, and its popularity is certainly justified. It provides amazingly clean, clear reproduction of a quality which sets a new standard of performance against which all newer circuits have been judged. The circuit permitted the home constructor or experimenter to achieve audio quality surpassing that which was commercially available at the time.

The high quality of the amplifier is due to several design principles. All stages are designed for minimum distortion and maximum bandpass. Class A triodes are used throughout. A push-pull, resistance-coupled driver stage is used to provide adequate signal at low distortion to the push-pull output stage. This stage consists of triode connected tetrodes which furnish a very important advantage over conventional low mu triodes. They require grid signal voltages of approximately 40 volts for full output as contrasted with 60 or 70 volts for triodes of the 2A3 and 6B4 type and 80 to 90 volts for a tube like the 6AS7G. In many triode amplifiers, there is more distortion generated in the attempt to drive the output stage than there is in the output stage. In the Williamson circuit there is sufficient drive available, and the limiting factor is the distortion inherent in the output stage. This is kept to low levels through the use of a feedback loop encompassing the entire four-stage circuit, including the output transformer.

These distinctive features of the amplifier make for a truly high grade circuit. The basic principle of the design is that there is no skimping. For example, Mr. Williamson stipulated design specifications and operating

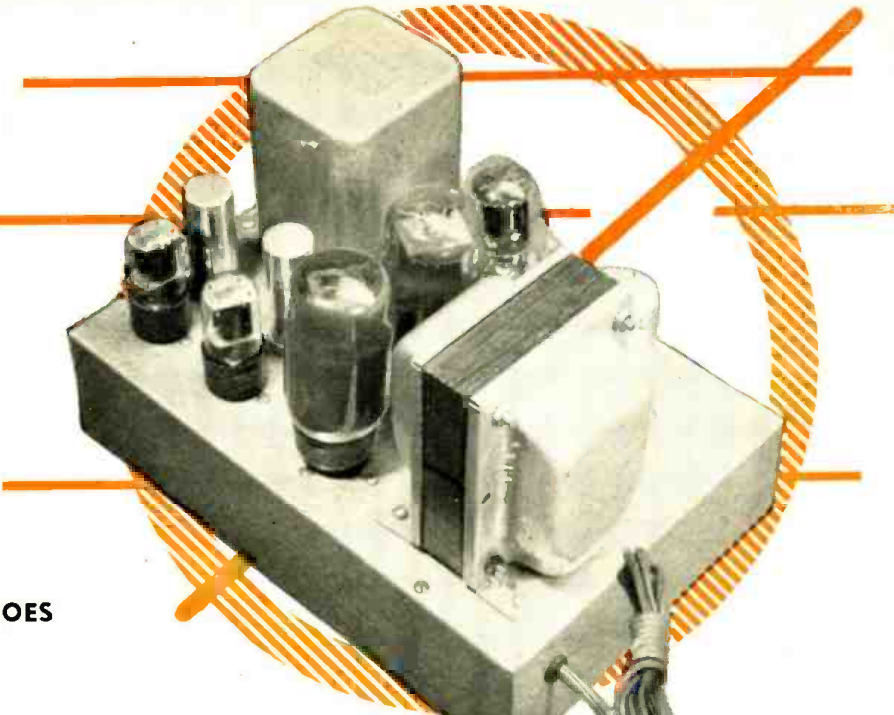

Top chassis view of the "ultra-linear" Williamson amplifier. A specially-designed output transformer is required in this circuit.

A variation on the Williamson circuit which provides "ultra-linear" operation and a minimum of distortion.

parameters for the output transformer to be used to insure that this critical component had frequency response far in excess of the audio band and could handle 20 watts of undistorted power even though the power rating of the complete circuit was less than 15 watts.

This combination of attributes makes an outstanding amplifier with frequency response from 10 cps to 100 kc. (a wide bandpass provides good transient response) and intermodulation distortion of less than 1% at 10 watts of output. It has the elusive quality of "presence" which cannot be reflected in measurements but only in listening tests.

Improving the Williamson circuit is obviously a difficult task. It seems that conventional designs using conventional components are unlikely to excel the Williamson either in listening quality or in laboratory tests.

However, a recent *unconventional* circuit development has made possible a simultaneous reduction in distortion and increase in efficiency in the output stage of the Williamson (and many other circuits). This new circuit arrangement, on which patents are pending, is termed "ultra-linear"² operation—a name chosen because the circuit represents the most linear possible mode of operation of a pair of output tubes. It is neither triode nor tetrode tube operation but borrows the advantages of both without the disadvantages of either.

"Ultra-Linear" Operation

Arguments concerning triodes *versus* tetrodes have been carried on for many years without any definitive conclusions. Each tube type has its advantages and its disadvantages, and those who favor either will find many reasons to justify their choice while disparaging the other type. The present status of the battle seems to be that the tetrode advocate is in the minority. The triode with feedback, such as is used in the Williamson circuit, has surpassed it in popularity among home constructors and custom builders of audio equipment although not among commercial manufacturers. The commercial interests are motivated by the fact that the efficiency of tetrodes is higher than triodes, and the distortion of a tetrode amplifier can be made lower over a greater operating range than can be done with triodes.

Since there are arguments on each side, the choice between the two must be based on the relative weights of the various factors by which they differ. One person prefers triode low impedance; another likes tetrode power sensitivity. Similarly, the triode proponent likes the sound of triodes; the tetrode man likes tetrode sound. Each rejects the elusive and minute distortions which characterize the other tube type.

The basic cause of the whole argument seems to be that neither tube type is close enough to perfection.

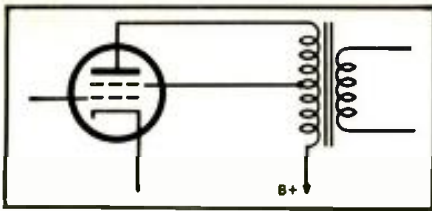

Fig. 1. "Ultra-linear" connection of a tetrode.

Each has its faults. Conventional tubes are essentially nonlinear circuit elements. As such, they generate audible distortion. Acceptance of one type is not necessarily because of its quality—often it stems from rejection of the other type. Choice resolves to the lesser of two evils. The remedy for this basic situation can only come from either a new tube type or from a new method of operating existing tube types.

The tetrode output tube can be operated as a triode by connecting screen to plate as is done in the Williamson circuit. If the screen is *partially* connected to the plate, we have what is effectively a new type of tube. This can be accomplished by connecting the screen grid to a point on the primary winding of the output transformer as is illustrated in Fig. 1. If the primary tap is at the top of the winding, we have a triode tube with plate characteristic curves concave upward. If the tap is at the low end, the "B plus" point, we have a tetrode with plate characteristic curves concave downward. At a critical intermediate point, we obtain a plate characteristic which is essentially a straight line. This is the point of "ultra-linear" operation and the point of minimum distortion.

Fortuitously, the "ultra-linear" point also has several additional operating advantages. It maintains the full efficiency and power sensitivity of the tetrode along with its high power capabilities. Simultaneously, it has low internal impedance like the triode. It combines the most advantageous features of each and has lower harmonic and intermodulation distortion than either of the two basic tube types.

Fig. 2, for example, shows a comparison of the intermodulation distortion of a push-pull stage without feedback for triode connection, "ultra-linear" connection, and tetrode connection. These curves show that the triode cannot handle high powers while the tetrode has relatively high distortion at lower operating levels. The "ultra-linear" stage obviously is an improvement over either of the others over most of the useful power range. Evidently, with other things held equal, an "ultra-linear" output stage must make a better amplifier than can be realized with any triode or tetrode circuit.

One of the more subtle advantages of "ultra-linear" operation lies in the inherent regulation of this type of output stage. There is practically no change in tube current drain from

quiescent operation up to full output. This permits the use of a minimum power supply. With other operating arrangements there is a loss of low frequency power handling capacity if the power supply regulation is inadequate.

"Ultra-linear" tube operation cannot be utilized with standard output transformers. It is necessary to have a tapped primary winding, and the conventional units of multiple impedance have taps at positions which do not give optimum results. The primary tap for tube types such as are commonly used in the Williamson circuit must be at a point so that the load impedance in the screen circuit is 18.5% of the load impedance in the plate circuit. In order to carry through the optimum conditions, a special transformer, the *Acrosound* TO-300, has been developed to be used for "ultra-linear" operation of beam power tubes of the 6L6, 807, 5881, and KT-66 type. It is a unit which has a tapped primary of 6600 ohms total impedance with the screen-to-screen load impedance 1220 ohms—the ratio of plate-to-screen load which provides most linear tube characteristics. The transformer also has a frequency characteristic of plus or minus 1db from 10 cps to 100 kc. and the ability to handle 40 watts of audio power over a very wide frequency range.

The specifications of this transformer exceed those stipulated by Mr. Williamson. The operating conditions of the output stage exceed those of his triode-connected tubes. Therefore, since the Williamson circuit using the "ultra-linear" output stage will have a more linear characteristic in that portion of the amplifier which is its weakest link and the prime source of distortion, the combination of "ultra-linear" stage and the Williamson circuit can be expected to be an improvement over the original. Actually, the power output of the "ultra-linear" Williamson is about doubled for the same distortion as compared to the triode Williamson and auditory quality is also improved.

Combining the Two Circuits

Fig. 3 shows the complete circuit of the Williamson amplifier with the "ultra-linear" output stage. Several minor changes have been made from the original circuit for optimum integration of the two circuits. All of the changes from the original circuit are

Fig. 2. Comparison of distortion characteristics of triode, "ultra-linear," and tetrode stages. See text for full details.

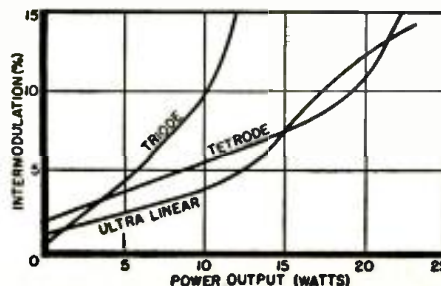

shown within dotted lines on the schematic. The change in the output transformer is the major change. The other deviations from the original involve only a few condensers and resistors. These changes readjust the feedback to maintain it at the desired 20 decibels, and they also improve on the stability margin of the original circuit.^{3, 4}

The circuit requires a power supply furnishing between 425 and 450 volts at 130 to 140 ma. This is obtained most simply by using a standard 400 volt, 200 ma. power transformer with 5V4G rectifier and condenser input. Operation of the power transformer at the lower drain provides higher-than-rated output voltage along with cool operation. The input filter condenser should have at least a 500 working volt rating while the later condensers can be 450 or 475 volt types. The use of a cathode-type rectifier limits the initial voltage surge so that higher rated condensers are not required.

In order to get equal output signals from each half of the phase inverter, the plate and cathode resistors should be matched to within 1%. If equipment for measuring this closely is not available, the use of 1% deposited carbon resistors (made by *Continental Carbon, IRC, or Wilcor*) is suggested. This also applies to the plate load resistors of the push-pull driver stage which should be matched so that the drive to the output stage is equal on both sides.

The output tubes can be 807's, 5881's, WE350A's, or the British KT-66's. All of these can take the recommended voltage without exceeding tube dissipation. Though the difference in performance is not substantial, the authors have found that the KT-66 provides the lowest distortion at low power levels (around one or two watts), and its power capabilities are somewhat better than the others.

It is highly recommended that, as shown, the output cathode resistors be bypassed with a condenser in excess of 100 μ f. This avoids third harmonic distortion and consequent intermodulation distortion particularly under conditions of high level dynamic operation.¹

Negative feedback is carried around the output transformer and all four stages. This negative feedback reduces distortion, hum, noise, and output impedance by a factor of 10. In connecting the feedback loop, the color coding of the plate and screen leads of the output transformer should be observed. As indicated on the schematic, the plate and screen leads marked with a white tracer should be paired and connected to the *lower* output tube; this tube is on the side of the circuit which is energized from the cathode of the phase inverter. The other plate and screen leads go to the side of the circuit which comes off the plate side of the phase inverter. In this way, feedback phasing is correct, and there will be no oscillation of the amplifier at either high or low fre-

quencies if the remainder of the circuit has been wired correctly.

The feedback connection is made from the 16-ohm tap irrespective of the tap used to connect the speaker. This arrangement saves having to reconnect the output winding and change the feedback resistor should a speaker of different impedance be connected to the amplifier.

A bias balancing network is shown in the cathode circuit of the output stage. This cannot compensate for badly mismatched tubes, but it does permit adjusting for normal variations from tube to tube. A milliammeter should be inserted in each cathode circuit at the points marked "X", and the cathode currents should be balanced by adjusting the potentiometer. Each tube should draw in the neighborhood of 60 ma. if the plate supply voltage is 450 volts. If the plate voltage is 400 volts, the current drain will be approximately 50 ma.

Amplifier Performance

Maximum undistorted output of the "ultra-linear" Williamson amplifier is about 30 watts. This output is achieved with an input signal of one volt. In the triode Williamson, close to two volts of drive are required, and maximum output is not over 15 watts.

The comparative intermodulation data for the triode and "ultra-linear" Williamsons is shown in Fig. 4. It can be seen that the "ultra-linear" circuit provides about double the power before the distortion becomes serious. At levels of one or two watts, the intermodulation is in the vicinity of .06%. At 13 watts of output, it is only .3%, and it reaches the 1% point at about 20 watts.

The high power handling capacity of the amplifier is well demonstrated by the power curve of Fig. 5. It represents the maximum *undistorted* power available at various frequencies. The amplifier puts out 25 watts at 20 cps and nearly 30 watts past 20 kc. This power curve is *not* a response curve. It would be possible for response to be flat and for power to be down considerably at the ends of the frequency spectrum. The *undistorted*

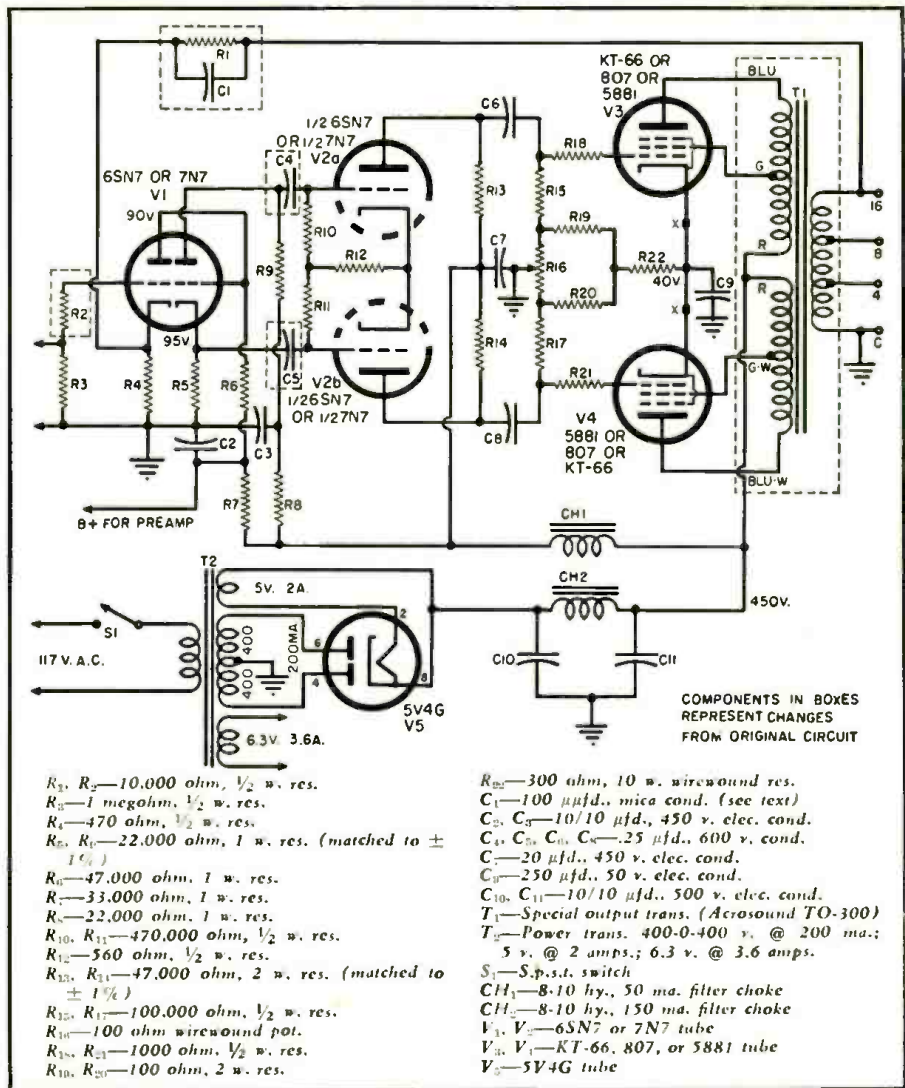

Fig. 3. "Ultra-linear" Williamson circuit. Dotted sections are changes from original.

power measurement is a much more rigid test of amplifier performance than a response curve run at a 25 watt level where the distortion is ignored. Little publicized data makes the distinction between a true power curve of undistorted power and a high level response curve.

Fig. 6 shows the response curve which is broad beyond normal re-

quirements. The response of plus or minus 1 db from 2 cps to 200 kc. is required to minimize phase shift in the audio band since very small variations in gain are correlated with comparatively large variations in phase even at points far removed from where the response is first observed to vary. In this circuit, the response is flat from
(Continued on page 98)

Underchassis view of the "ultra-linear" Williamson amplifier.

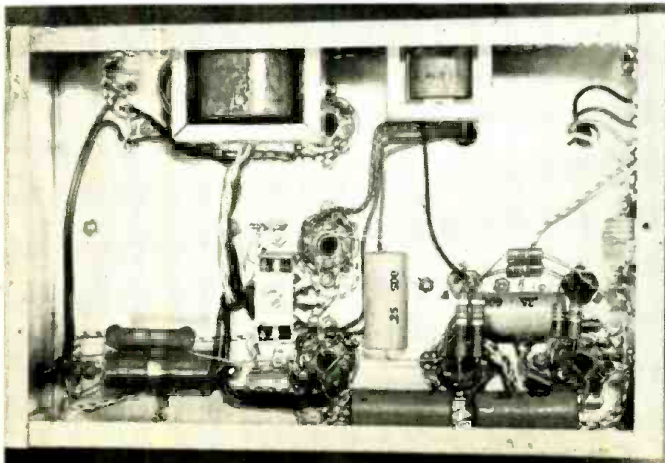

Top chassis view showing specially-designed output transformer.

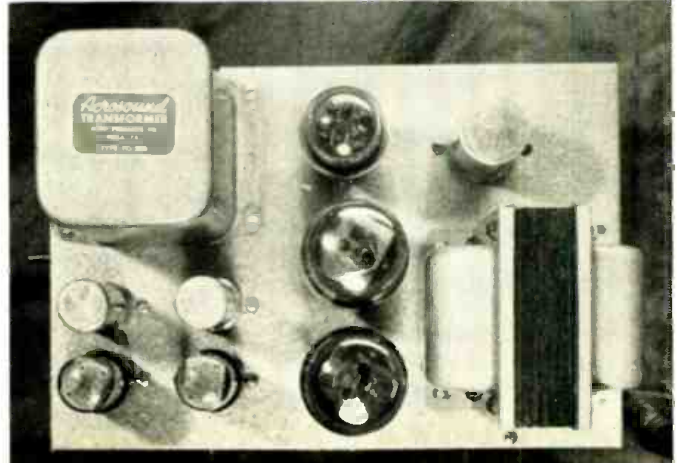

TV SIGNAL DISTRIBUTION METHODS

By EDWARD M. NOLL

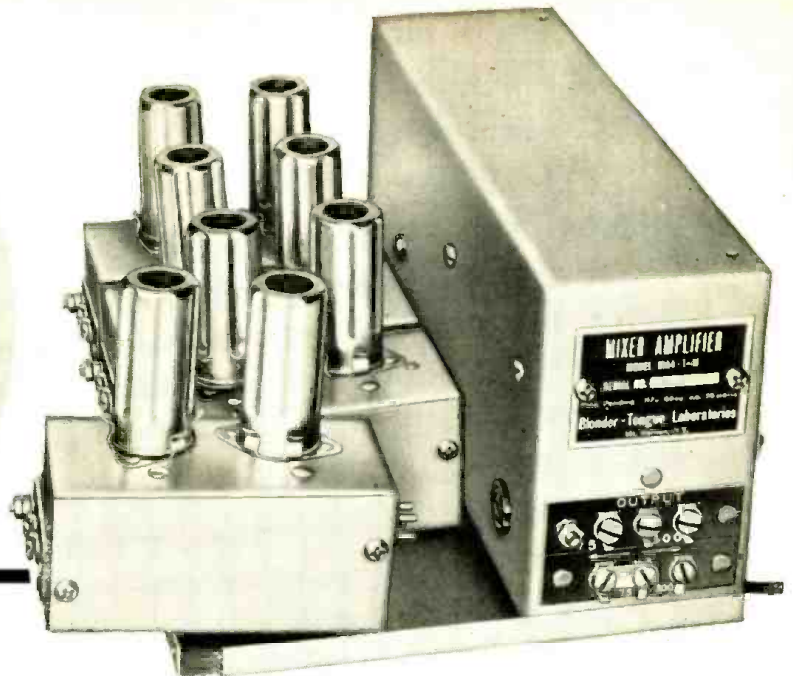

Fig. 1. Blonder-Tongue MA4-1-M mixer-amplifier. Unit has four channel amplifiers and supplies two sets or one set and a distribution line.

MULTI-RECEIVER systems can be simple or very elaborate depending on the number of outlets, signal levels, and distribution requirements. Outlet arrangement can vary from a simple outlet box for supplying two receivers to an apartment house installation serving hundreds of receivers. The objective of an outlet system is to supply as good or better signals to each receiver than could be obtained from a separate antenna for each receiver. This objective is obtained with ease for some installations but only with difficulty for others. Outlet system criteria are as follows:

1. *Signal Level.* Sufficient signal level should be delivered to each receiver input for each desired station. Levels should correspond to what could be obtained from a conventional antenna system for each receiver at the same location. Some tolerance can be extended in a strong signal area in regards to signal level because of the receiver a.g.c. facility. Amplitude must not be allowed to decline to a level where noise and interference become more apparent on the picture. In weak signal areas it is

Several ways of handling multi-receiver TV installations including strong-fringe, all-strong, or all-fringe signals.

advisable that the multi-outlet system give a boost to the signals so stronger signals are available at each receiver.

2. *Signal-to-Noise Ratio.* A distribution system should have a high signal-to-noise ratio. Although amplification is advisable, amplifiers need to establish a signal-to-noise ratio comparable to or better than a high quality tuner. Terminations are exacting in feeding receiver groups since mismatches open such lines to high noise levels and interference.

3. *Interaction.* A difficult multi-outlet problem is the elimination of such interference between receivers as local oscillator radiation, other spurious beats, and loading. Thus a distribution system must have definite one-way characteristics—transfer of signals to receivers but maximum rejection of signals attempting to leave the receivers. Again, terminations must be exacting as any standing waves on

lines can be shifted by receiver channel switching, changing ratios and loading at other receivers on the line.

4. *Signal Level Range.* Still another difficult multi-outlet problem is the ability to handle wide signal level ranges (both fringe and local) on the same distribution system. Both weak and strong signals on the line can be trying, presenting such problems as overload, picture superimposition, oscillations, and beat interference. It is difficult to hold down the strong signals (without sacrificing their quality) and, at same time, permit maximum amplification of weak signals.

Basic Methods

A simple multi-outlet box is satisfactory when sufficient signal is available. There is a substantial signal loss in almost all outlet boxes and—if any one of the desired channels is low in level, picture quality declines. Often on the high-band channels a particular channel can be peaked by experimenting with the lengths of line between the outlet device and each receiver. A sliding, two-foot length of tinfoil on each lead is helpful in peaking line length for optimum performance on a given weak channel.

If signal levels are weak a wide-band booster should be used ahead of the outlet device (Fig. 2A). Here, on occasion, we must cope with the difficult problem of handling both weak and strong signals. Some possible solutions to this simple outlet method are:

a. Use the attenuator included with wide-band amplifier or employ an external attenuator. Adjust control

Fig. 2. (A) Wide-band booster and outlet box arrangement. (B) Method for combining local and fringe area signal distribution. (C and D) Reducing receiver interaction.

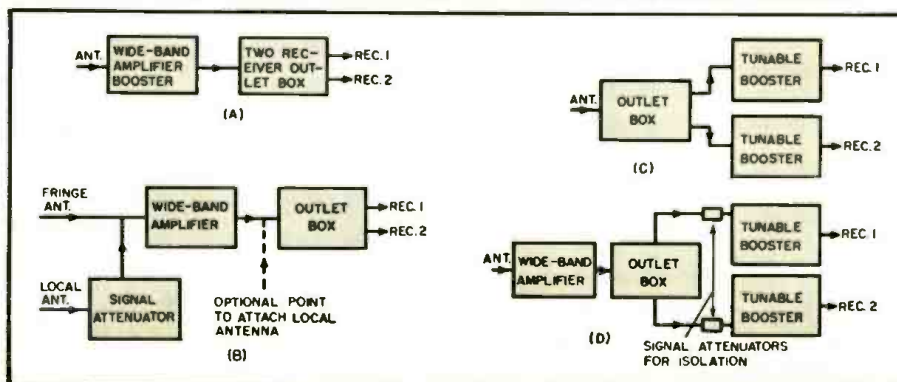

until strong signal does not overload amplifier—no oscillation or superimposition of strong signal on some other weak channel.

b. If there is a great level differential between strong and weak stations (local and fringe reception from a distance greater than 35-40 miles) the control setting method is not adequate because fringe level is sacrificed. Careful antenna orientation can often reduce the problem. Set the antenna for peak or near-peak fringe reception in combination with minimum pick-up of local channels. This is often a tedious adjustment as improper orientation on local channels can also cause loss of picture resolution or reflections. This task must be performed carefully and critically.

c. A more elaborate and sometimes the only solution to the difficulty is to use separate antennas. Choose a high-gain and sharp-pattern antenna for fringe reception and a simple antenna for local reception. Apply separate transmission lines to the antennas. Connect line from local antenna, Fig. 2B, to output of wide-band booster or through attenuator to input of wide-band amplifier. The length of the line from the local antenna must be adjusted critically so as not to act as a suppression stub for one of the fringe channels. This can be done by cutting off three-inch lengths and observing its influence on fringe station level. Pieces of tinfoil on each line can help in obtaining optimum adjustment.

The outlet box has as a second major function, the minimization of interaction between receivers. This can be in the form of loading (change of signal levels at one receiver when a second receiver is switched from channel to channel) or local oscillator feedthrough (interference pattern formed on one receiver as a result of the admission of local oscillator signal from the second receiver). Consequently, the outlet device should act as a one-way device as much as possible—least attenuation of the signal passing through to the receiver but maximum rejection of signals attempting to leave the receiver.

This can be a severe problem in trying to connect a multi-outlet receiver with strong local oscillator feedthrough to the antenna terminals. A few possible solutions are:

a. Insert tunable boosters between outlet device and individual receivers (Figs. 2C & 2D). A booster of adequate design is an excellent one-way device, providing amplification of the signal in one direction and good rejection of any signal attempting to move in the other direction.

b. The first solution can result in a somewhat poorer signal-to-noise ratio as signals are divided before amplification. A better plan is to include a wide-band booster ahead of the outlet device and separate tunable boosters for individual receivers. This is a practical means of multi-outlet installations for fringe areas.

c. If strong signals are available,

signal attenuators can be inserted in the receiver lines and adjusted for maximum attenuation of the local oscillator signal without a degrading loss of the station signal level.

Distribution Amplifiers

The plan of amplification-before-division is employed in most of the commercial types of multi-receiver systems. This expedient retains a better signal-to-noise ratio than is possible if the signal is first divided (reduced in level) and then amplified. Commercial systems can supply from two to hundreds of outlets depending on the design and number of units used. A small four-position arrangement consisting of a wide-band amplifier and two multi-outlet boxes (or a single four-receiver box) is effective in serving four receivers for duplex and semi-detached housing (either four apartments or two families with receivers on each floor).

With a good high-gain antenna and proper installation, good fringe area reception is possible with this arrangement. Critical performance checks must be made and all problems reduced as much as possible, using techniques mentioned previously. The use of a separate tunable booster at each receiver can improve fringe results.

Commercial systems generally consist of four basic units which can be arranged in numerous combinations to supply from 2 to 2000 TV sets. These units are:

a. Small distribution outlet amplifier to supply two individual receivers. The function of this unit is the same as the ordinary outlet box. However, this type of vacuum tube outlet box has a circuit that has little or no loss (some few with gain) and provides thorough isolation between receivers.

b. Larger distribution amplifiers with a number of individual receiver outlets (four to ten) with thorough isolation between outlets and very little signal loss. On most distribution amplifiers there are separate line outlets available to permit continuance of the coaxial line path to succeeding distribution amplifiers. Some slight loss

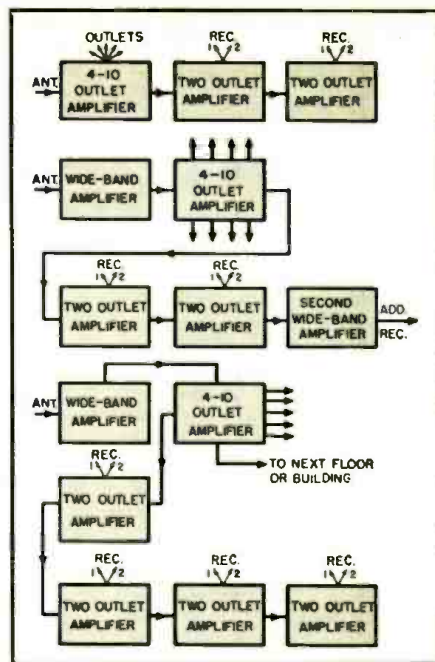

Fig. 3. Three ways in which the distribution amplifiers can be connected. See text for complete application information.

is encountered at these low impedance line outlets. Regular receiver outlets have a 300-ohm impedance.

c. Wide-band amplifier with a high gain is used to bring up signal level for a fringe-area or weak-signal distribution installation. For least difficulty in a distribution system, the signal level for each channel should reach a 10,000 microvolt level. When signal levels are lower, the line runs must be planned carefully to avoid noise pick up. Signal is attenuated rapidly as line lengths are increased and it is possible to have the signal fall off so seriously that poor signal-to-noise ratios are established at the input of the next distribution unit. This poor ratio will continue through the succeeding units of the distribution system.

d. High-gain amplifiers in the form of individual channel amplifiers associated with a central distribution am-

(Continued on page 121)

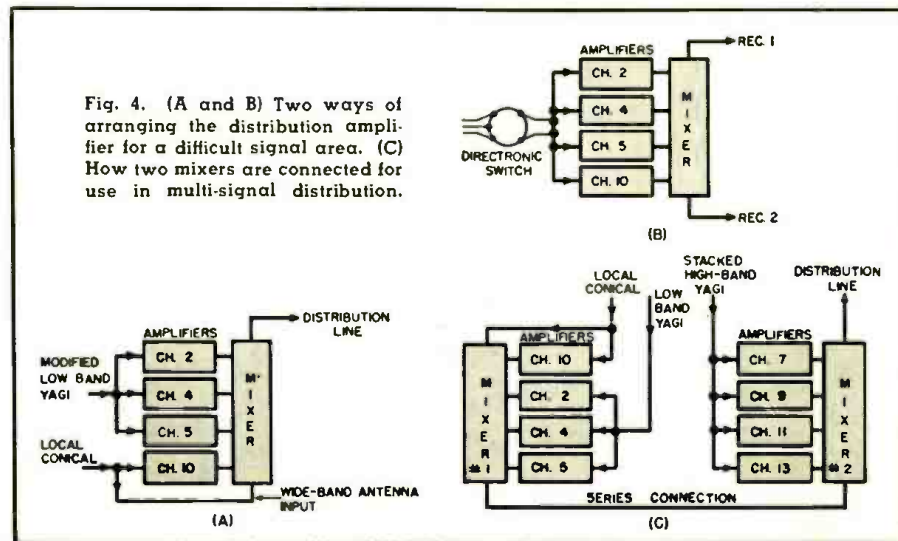

Fig. 4. (A and B) Two ways of arranging the distribution amplifier for a difficult signal area. (C) How two mixers are connected for use in multi-signal distribution.

AN IMPROVED CORNER HORN SPEAKER SYSTEM

By

GEORGE L. AUGSPURGER

Audio Research Laboratories

A new version of the integral space transducer originally described in the November 1949 issue.

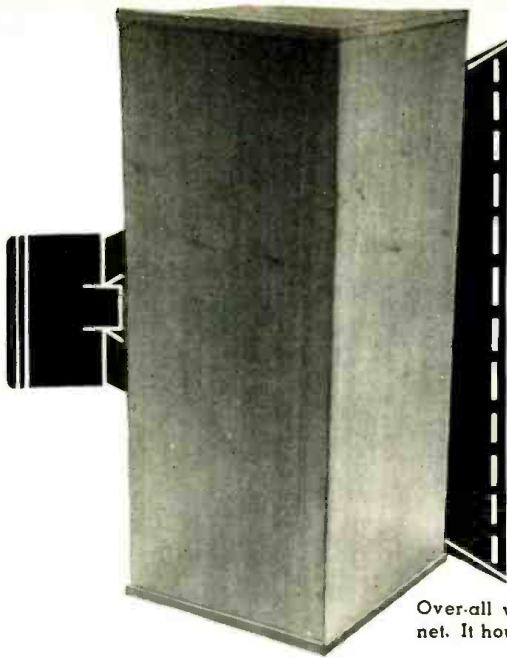

Over-all view of IS-800 corner horn cabinet. It houses an ordinary 8" p.a. speaker.

"SOMETHING for nothing" is a slogan that usually leads to disappointment in audio work. However, recent developments such as the reluctance pickup and the Williamson amplifier circuit have served to give us something really worth listening to at a cost that does not preclude the purchase of food and clothing. It is only the speaker system, the most uncooperative and contrary link in the whole audio chain, that has so far refused to satisfy the most critical listener for anything less than several hundred dollars.

In the November 1949 issue of *RADIO & TELEVISION NEWS* Ray Doby and the writer described a corner horn speaker system which attempted to coax full-range response from smaller, less expensive speakers. The "integral space transducer," as it was called, was a step in the right direction, but it suffered from several unfortunate deficiencies. It presented a rather startling appearance (most people thought it was a portable bar), and was devilishly tricky to build. It also developed that the "I.S.T." was almost entirely at the mercy of its bass driver. Speaker selection was so critical that the total system "... when she was good, was very, very good; but when she was bad, she was horrid!"

The unit to be described here retains the basic features of the previous design while gaining the advantages of greatly-increased bass efficiency, simplified construction, non-critical driver selection, and lower cost. This new design, using an ordinary p.a. speaker (*Stromberg-Carlson RC-24*) as a driver, can easily outperform a good twelve-inch bass-reflex system. With higher quality eight-inch speakers such as the *Altec 400B*, the IS-800 will satisfy the most critical musical ear. The secret of its remarkable quality lies in the fact that, whereas its predecessor had merely helped the speaker achieve its best

performance, the IS-800 gives its driver no choice. In other words, the horn loading, coupling chamber, back-wave enclosure, and reflex ports are all worked out to give such a degree of control over the speaker cone that, regardless of its own attitude, improved transient characteristics, extended bass response, and more linear transfer qualities cannot help but result.

The IS-800 is basically a vertical corner horn of square cross-section. The driver is mounted at the base of the cabinet and is coupled to the horn by a small compression chamber and a concrete reflector block of the type used so successfully by P. G. A. H. Voigt. The horn expands along two adjacent sides of the square from a 36 square-inch throat to a mouth area of 288 square inches.

The completed cabinet looks somewhat like a glorified office wastebasket. All four sides are alike and all taper toward the base of the unit. The slanting sides not only offer a pleasing appearance, but clearance space is provided for baseboards and moldings. Moreover, the driver back-wave is vented through the space between the room walls and the sloping sides of the cabinet.

The finished system is capped with a mahogany frame, and the horn mouth is protected by a perforated metal grille. The eye appeal of this simple design is quite favorable when compared with the usual visible louvers, ports, and ornate grille treatments. Of course, there is no reason why the front panels of the IS-800 cannot be decorated in any manner that the builder happens to like. We personally prefer the cabinet shown because it is harmonious and unobtrusive in any furnishing scheme.

The actual construction of the horn and cabinet may seem tricky and unfamiliar. Actually, there is nothing really difficult to worry about, but a

good job will take time... a good deal more time than a bass-reflex cabinet for example. The proper sequence of assembly is as follows:

The two back panels (B_1 , B_2) should first be cut out and fastened together. The panels are glued and screwed to the quarter-round joining strip and the triangular plywood base (F). The two curved horn sides (C_1 , C_2) are then cut and fastened to their struts (D_1 , D_2). The struts, in turn, are fastened to the rear panels and the flared pieces joined with a section of quarter-round as was originally done for B_1 and B_2 . The front length of quarter-round, however, should be planed in such a way that the straight edges make an angle greater than ninety degrees toward the upper end.

This bit of doctoring is necessary since the joint is not vertical. If the joining strip is used without modification, the front walls of the horn will be pulled out of square and trouble will result.

The speaker mounting board (G) can now be installed and the coupling chamber completed by the addition of (H), which must be cut and fitted carefully to make a tight seal between the compression chamber and the horn throat.

The horn proper needs the addition of a concrete reflector block for its completion. This task is perhaps the most satisfying and creative part of the whole proceeding. The builder, suddenly supplied with a fascinating batch of wet concrete, will probably spend a happy afternoon finding other uses for the messy stuff. The I.S.T., however, need only be tilted back at an angle of 45 degrees, and a small quantity of the mixture poured into its gullet. Pre-mixed dry concrete, available from almost any lumber company, is inexpensive and easy to use for this operation.

The front panels (A_1 , A_2) are mitred and fitted together, tacked and glued to another joining strip. Two $\frac{1}{2} \times 1$ inch strips are glued one-quarter inch from the outside edges of the front panels, and a thin mahogany strip is

CURRENT TV TOPICS

By

WALTER H. BUCHSBAUM

Television Consultant
RADIO & TELEVISION NEWS

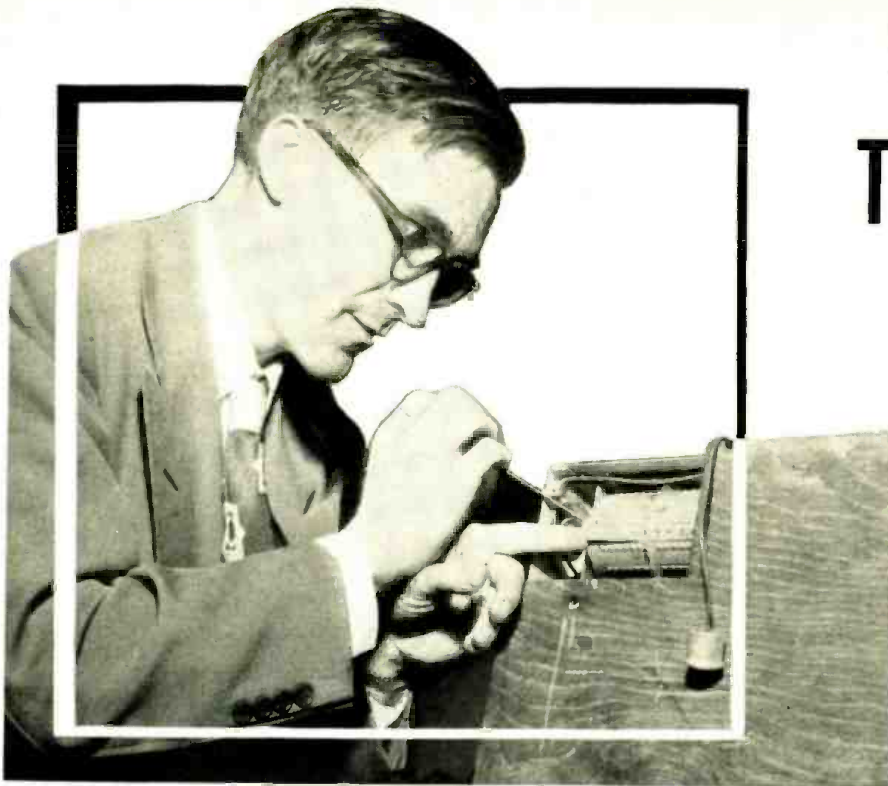

Inserting u.h.f. strips into a turret type tuner in a TV receiver.

Data on four TV service problems: spot blanking, foldover, vertical retrace lines, and installation of u.h.f. strips.

MANY of our readers have presented common service problems and since quite a few are similar, we are going to cover four of these topics here. One of the most frequently asked questions is about a bright spot on the screen after the set has been turned off. This phenomenon contributes to shorter tube life and therefore concerns both the service technician and the set owner. The appearance of retrace lines, on weak stations especially, is also a cause of frequent inquiries. Foldover at either side of the picture is another recurring problem. As a sign of TV's rapid progress we have also been asked about the installation of u.h.f. strips into some v.h.f. turret tuners and the difficulties encountered there. In this article all four topics will be discussed individually and circuits shown which can be applied to almost all sets to remedy the various defects.

Spot Blanking

In some receivers, especially recent models using higher anode voltage and electrostatic focus, a circular spot appears on the screen after the set is turned off. This spot fades away gradually, becoming larger as it gets dimmer. When analyzed carefully the reason for it is found in the fact that the HV condenser or the external and internal conducting surfaces on the picture tube retain the HV charge even after the deflection circuit is shut

down. With HV still on the second anode and no deflection power applied, a circular spot appears. Electrons flow from the cathode to the second anode, lighting up the screen and at the same time discharging the condenser. When finally the charge drops below the voltage required to light up the screen, the spot disappears. Because each time the set is turned off only the center of the screen is hit by the electron beam, the screen wears out faster at that point and eventually a yellow or brownish spot may appear.

An ideal solution to this problem is to connect a resistance across the condenser at the moment the set is turned off. This would mean HV present at a switch contact and a chance of arcing as the switch is closed. The difficulty of such a scheme prevents its use in commercially available receivers.

Next to switching in a discharge resistance we could attempt to connect a very high resistance across the HV condenser permanently. In order not to load down the HV supply only about 10 microamperes could be drawn by this bleeder. This would mean a 1000 megohm resistor, able to stand a voltage of at least 10 kv. The only type of resistor applicable is the spiral, carbon-coated HV type used as a bleeder for HV meter multiplier probes. The size and expense of such a resistor obviously limits its usefulness.

There are, however, two different usable methods for removing this undesirable spot. One is to utilize the picture tube as a discharge resistor, the other is to move the electron beam to the side so that it hits the anode directly without reaching the screen. The first system is fairly simple to install and operates reliably and smoothly. When the picture tube is adjusted to give maximum brightness, maximum current flows through it. In the case of a shut-off spot simply adjusting the brightness control to maximum will remove the spot, because the large current passing through the picture tube discharges the HV condenser quickly. Many customers are willing to make this adjustment manually every time the set is turned off. For those who do not want to be bothered with this additional adjustment, an automatic circuit can be added. Fig. 1 shows four such circuits—all based on the principle of maximum brightness on the CRT when the set is turned off.

The brightness is mainly a function of the d.c. voltage between cathode and grid of the picture tube. In some receivers the cathode gets the picture signal and then the grid is at a d.c. potential, adjustable by the brightness control. Other models use grid drive with the cathode as the d.c. brightness-controlling element. Maximum brightness occurs when the grid is either at the same potential as the cathode or slightly more positive than the cathode. The purpose of each of the four switches *S* is to effect this condition at "Off" without interfering with the video signal. In order to function correctly, switch *S* must be part of the "Off-On" a.c. switch. Some receivers use a double-pole, single-throw switch mounted at the end of some other control, but the majority use only a single-pole switch. Fortunately most of the potentiometer manufacturers also market double-pole, single-throw switches which will fit in the same spot as the single-pole switch. It is necessary to ascertain the exact make and type of potentiometer and then buy a suitable switch.

Fig. 1A illustrates a case where the cathode is directly connected to the video amplifier and the grid receives its d.c. voltage through the divider network *R₁*, *R₂*. As the set is turned

off, switch *S* connects the grid to "B plus", making the grid momentarily more positive than the cathode. In the next instant the "B plus" voltage is shut off, the HV source is also removed, and the charge on the HV condenser has passed through the picture tube during the brief moment when the grid was more positive than the cathode. The same principle is used in case Fig. 1B where the grid is essentially at "B plus" and the cathode is connected to ground through switch *S*. Figs. 1C and 1D show arrangements where the grid is at ground potential or the cathode is at about one-half the "B plus" voltage. In either case the spot blanking is accomplished by switching the d.c. element to give maximum brightness. Although actual circuits will vary, most TV receivers will use some scheme similar to one of these four circuits for driving the picture tube. If one remembers to make connection only to the d.c. element, the one having condenser *C*, going to ground, no difficulties should be encountered.

The second method for removing the spot is to cause the electron beam to move either sideways or up or down right after the set is turned off. In the electromagnetic-focus type sets the d.c. flowing through the focus coil as the "B plus" was shut off often accomplished this deflection. In addition, the loss of focus current prevented a focused spot from appearing, resulting in such a dispersed electron beam that it was hardly noticeable. New, automatic-focus picture tubes retain focus much longer, therefore the spot is more visible. One of the simplest methods of deflecting the spot consists of mounting a small permanent magnet either on the flared portion of the tube or at some convenient point on the cabinet or tube mounting. Locate the magnet at either top or side so that it deflects the picture slightly. When the set is turned off, the deflection-yoke power is gone, less HV is applied, and only the magnet affects the electron beam. In this condition the effect of the magnet is usually enough to move the spot completely off the screen. When operating normally the deflection yoke has much more control than the magnet and keeps the picture properly centered. Where a PM centering magnet is used this should not be disturbed or used to recenter the picture because it will counteract the additional small magnet. Twisting the deflection yoke slightly will be sufficient to overcome the small decentering due to the new magnet. Taping the magnet in place after its best location is determined, cures the spot appearances once and for all.

Vertical Retrace Lines

The photograph, Fig. 2, shows the appearance of vertical retrace lines when either insufficient blanking, a weak picture, or a slightly weak picture tube prevent perfect reception. In the last instance a picture tube rejuvenator may help for a while, but

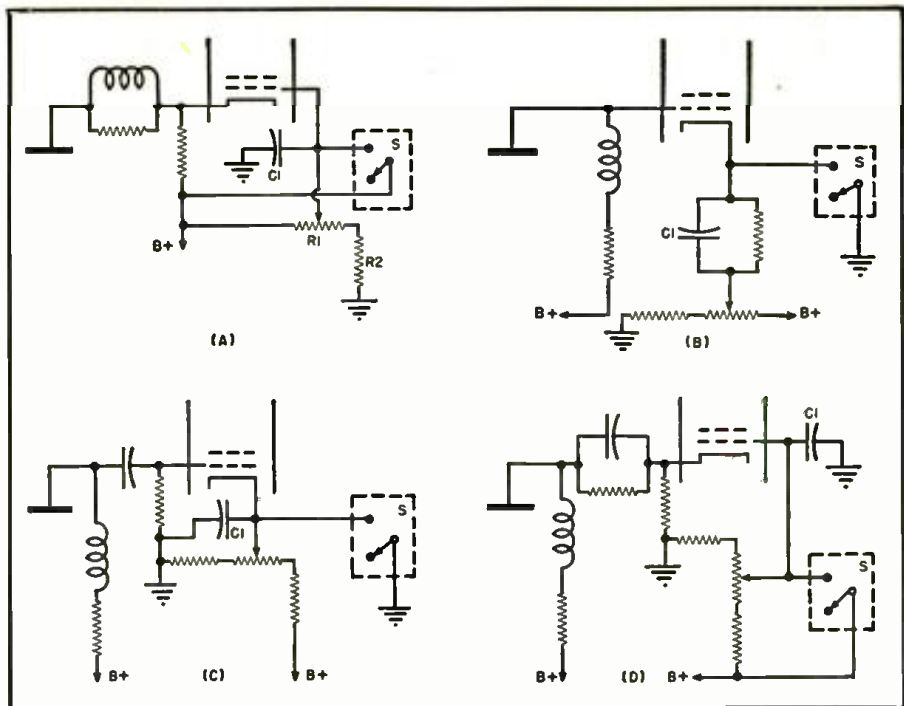

Fig. 1. Four switching methods to remove the spot on the cathode-ray tube. All switches are to be ganged with the "Off-On" switch. (A) Circuit where cathode is directly connected to video amplifier. (B) Circuit where grid is at "B plus" and cathode is grounded through *S*. (C and D) Circuit where grid is at ground potential or the cathode is at about one-half the "B plus" voltage.

the best permanent solution is, of course, a new picture tube. There are, however, various other reasons for the appearance of these retrace lines. Usually it is due to either insufficient video signal or excessive brightness. Normally the blanking pulses extend into the "blacker than black" region of the video signal and cut the picture tube off during the retrace period. If the video signal is so weak that it does not go sufficiently negative to cut the tube off at the retrace period, the lines will appear. Even with a fairly strong picture the brightness control may be set so far that the blanking pulses cannot reach the cut-off voltage of the picture tube. It may even be necessary for the brightness control to be advanced that far in order to overcome the ambient light. In those instances where the picture is satisfactory with the exception of vertical retrace lines, a simple auxiliary blanking circuit can be added. Several major manufacturers include these circuits in their designs.

The principle used here requires that in addition to the blanking pulse contained in the video signal, a strong

pulse be applied to the picture tube during the vertical retrace time. This additional pulse is obtained from the vertical output section and, in order to cut the picture tube off, must be positive when applied to the cathode and negative when applied to the grid. For simplest circuitry the additional pulse should always be applied to the element not driven by the video signal. Three basic circuits are shown in Fig. 4. In Fig. 4A the grid of the picture (Continued on page 148)

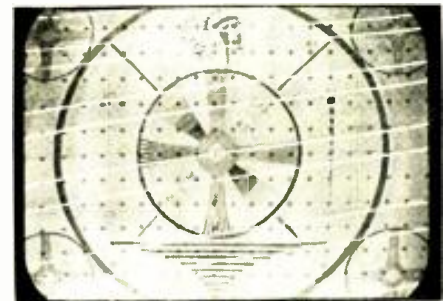
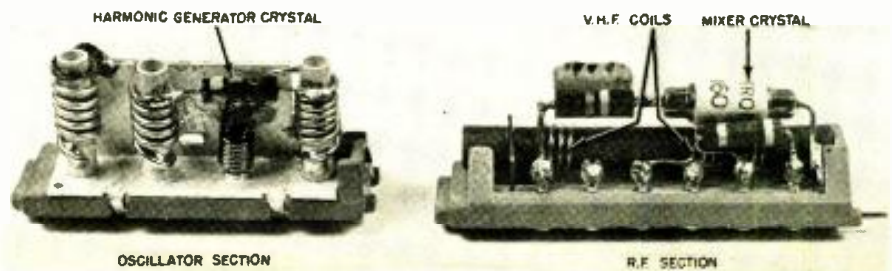

Fig. 2. The appearance of vertical retrace lines when there is insufficient blanking, a weak picture, or a weak picture tube.

Fig. 3. Close-up view of the u.h.f. strips used in the Standard Coil tuner.





A COMPACT BANDSWITCHING V.F.O. MULTIPLIER

Front chassis view of the home-built v.f.o.-multiplier. Three type 6AG7 tubes are used in this compact unit.

By **EARL SNADER**, WØZFO

Construction details on a low-power driver for 80-75, 40, and 20 meters. Power output is about .2 of a watt.

IF YOU are looking for a compact v.f.o.-controlled bandswitching multiplier for that new pint-sized medium power rig you are building, here is something that may fill the bill. This unit delivers two-tenths of a watt output on 80-75, 40, and 20 meters, enough to drive a 2E26. Frequency control is by means of a built-in v.f.o. operating in the 3.5 to 4.0 megacycle range. A Clapp oscillator circuit is used in the v.f.o. Interstage coupling is by means of broadband couplers, eliminating the need for any separate multiplier tuning controls. The tuning condenser for the v.f.o. is mounted with a *National* type SCN dial drive mechanism. One gang of a three-gang, five-position, two-circuit-per-gang bandswitch projects out the rear of the chassis, to be used for bandswitching in circuits independent of the multiplier. The entire v.f.o.-multiplier assembly is mounted on a chassis $7\frac{3}{4}$ " wide by 4" deep by 3" high. Power requirements include 6.3 volts a.c. at 2 amperes for heaters, 75, 105, and 180 volts regulated for the v.f.o. screen, plate, and multiplier screens respectively, and 300 volts for the multiplier plates. Three type 6AG7 tubes are used.

Since no commercially-built chassis could be found with the right dimensions, one was constructed out of heavy gauge aluminum. It was made in three parts: the top plate measuring $7\frac{3}{4}$ " by 4"; the base measuring $7\frac{3}{4}$ " wide, 3" high, and 4" deep; and a small partition 3" high by 4" wide. In the finished assembly this partition divides the v.f.o. and multiplier com-

partments and provides a mounting surface for the v.f.o. tuning condenser and the broadband coupler trimmers. The chassis base and the partition were both made with $\frac{1}{2}$ " flanges on the bottom and the top. Since the partition is fastened to the top plate before the top plate and chassis base are assembled, notches must be cut in the top flanges of the chassis base to pass the partition for assembly. It will be necessary also to cut small pieces out of the front edge of the partition to clear parts of the *National* SCN dial drive mechanism. Otherwise the partition should fit fairly snug inside the chassis base.

All the coils and the tube sockets are mounted on the top plate, and the location of each can be seen from the photograph. Since the v.f.o. tuning condenser is mounted on the partition, the condenser shaft should be aligned with the dial drive mechanism in the front of the chassis before the partition is permanently fastened in place. A *Hammarlund* type MC-50 variable condenser was used because it is ruggedly built and well suited for v.f.o. applications. Any good 50 μ fd. variable condenser could be used, provided it is equipped with double bearings and brass plates. This condenser is mounted with enough clearance between it and the top plates to allow room for the wiring associated with the v.f.o. tube socket. The v.f.o. tube socket is mounted directly above the v.f.o. tuning condenser. The trimmers for the broadband couplers are mounted on the opposite side of the partition from the v.f.o. tuning con-

denser. They can be mounted on a small bracket first and then fastened to the partition as a unit. Care must be taken to provide a good path for r.f. from the one lug of each trimmer to the chassis because they are grounded in that way.

The bandswitch must be partially disassembled for mounting to the chassis base. The sleeves separating the second from the third gang on this switch must be shortened. A hole is drilled for the shaft to pass through the front of the chassis, and the shaft is mounted securely in this hole with a panel bearing. Three holes, carefully aligned with the shaft hole in the front, are drilled in the rear of the chassis. One of these is for the shaft. The other two are for the switch assembly screws. The rear gang of the switch is then mounted on the back of the chassis, separated from the chassis by $\frac{1}{8}$ " fiber washers. Since the front mounting of the bandswitch will be some distance inside the front of the chassis base, a small aluminum bracket is provided to anchor the front of the switch to the chassis base.

The v.f.o. trimmer is mounted on the rear of the chassis base, directly behind the v.f.o. tuning condenser. There is nothing particularly critical about the location of this trimmer. There should be just enough room to mount it without crowding.

The v.f.o. tank coil consists of 60 turns of No. 28 plain enameled wire, closewound on a slug-tuned ceramic coil form $\frac{1}{2}$ " in diameter. A *Millen* type 69045 form was used in the original model. This is mounted in one corner of the v.f.o. compartment, behind the v.f.o. tube socket and about $\frac{7}{8}$ " from the edge of the chassis. The cathode choke in the v.f.o. circuit, a *National* 2.5 mhy., type No. R-100S, is mounted in the front corner. The v.f.o. plate choke, a pigtail r.f. choke with an inductance of 2.5 mhy., is mounted between the plate lug of the v.f.o. tube socket and a terminal tie strip which also serves to terminate the plate power lead to the v.f.o. and provide a ground connection to the chassis.

The broadly resonant coil in the plate of the first buffer-multiplier tube is closewound on an *Amphenol* type No. 24 polystyrene form $\frac{3}{4}$ " in diameter and $2\frac{1}{4}$ " long. The winding consists of 85 turns of No. 30 plain enameled wire. Single hole mounting is used, and the coil is located about $\frac{5}{8}$ " behind the first multiplier-buffer tube socket.

The two broadband couplers are also wound on *Amphenol* type No. 24 polystyrene forms $\frac{3}{4}$ " in diameter. The 40-meter coupler consists of two coils of 27 turns of No. 28 plain enameled wire. These coils are closewound, and spaced $\frac{7}{16}$ " from each other. The center leads go to the "cold" connections of the coil (the bypass to ground and the 300 volt plate supply lead). The 40-meter coupler can be seen in the photograph showing a bottom view of the v.f.o.-multiplier unit. It is located just behind the bandswitch shaft. The 20-meter broadband coupler is not visible in the photograph, being hidden from view by the bandswitch. It is wound exactly like the 40-meter coupler with the exception that the coils each consist of 16 turns of No. 24 plain enameled wire. Both couplers are mounted with their axes parallel to the top plate but at right angles to each other. The 40-meter coupler is located along the rear edge of the top plate, far enough in from the edge to clear the flange on the chassis base. The 20-meter coupler is mounted along the side of the top plate and near the front. Small brackets were made from heavy gauge aluminum to mount the coupler coils to the top plate in the proper position. When mounted, the couplers should be spaced at least $\frac{3}{8}$ " from the nearest metal, whether it be the bracket or the top plate. This is extremely important and should be carefully noted.

Most of the wiring can be completed before the top plate is put in place. The wiring to the v.f.o. tuning condenser and trimmer, the broadband coupler trimmers, and the bandswitch is done last, after the top plate and

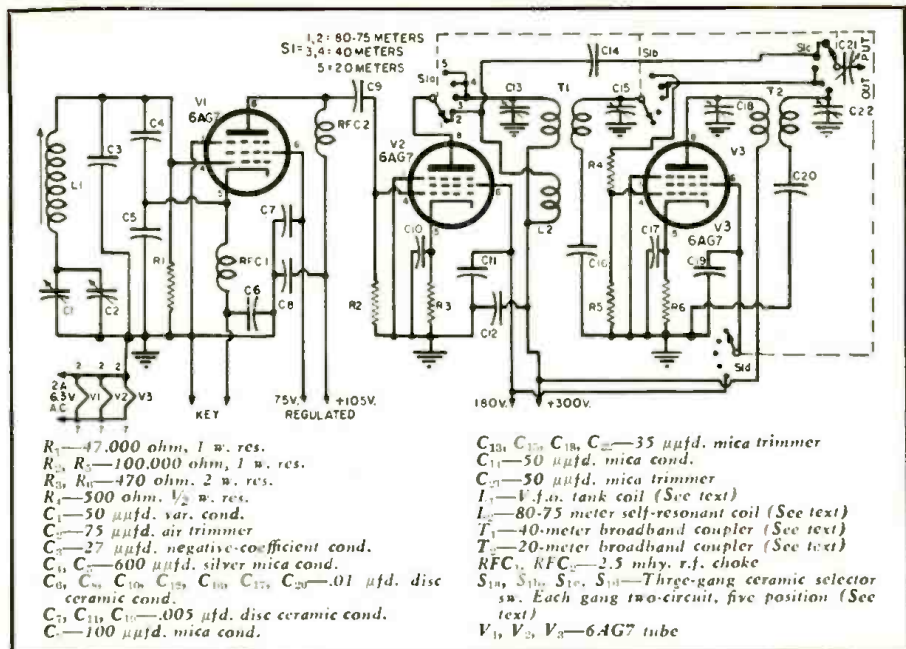

Complete circuit diagram of the bandswitching v.f.o.-multiplier. Two switch positions are provided for the 80-75 meter band and the 40-meter band to allow for switching external circuits to cover the different portions of each of the bands.

chassis base have been assembled together. Wire the filaments first, followed by the cathode and grid resistors and bypass condensers, and then finally the power leads. Condenser C_9 is mounted between a feedthrough insulator in the partition and the grid connection on the first multiplier-buffer tube socket (lug No. 4). Disc bypass condensers are used throughout, to save space and to reduce stray capacitances in the wiring. All bypass condensers and ground leads should come together at one place, to be grounded to the chassis at one place in the multiplier compartment and at one place in the v.f.o. compartment. A single bypass condenser serves to provide a path for r.f. to ground at the "cold" end of each of the three plate coils in the multiplier section. C_{12} performs this function, and coil leads to this condenser should be made

as short and direct as possible. Grid and plate leads in the v.f.o. should be No. 14 bus wire. It is particularly important that all connections in the oscillator circuit be sweated together, because even a slight resistance in any of them may render the oscillator inoperative. This is particularly true of the connections between the rotor of the v.f.o. tuning condenser and the v.f.o. tube itself.

In wiring the bandswitch and the broadband coupler trimmers, connect the lead from each coil to the bandswitch first. Then run the trimmer lead from the bandswitch connections rather than from the coils themselves. The screen lead to the second multiplier tube can be connected to the least accessible section of the bandswitch. This is the underside of the second gang. The other half of that
(Continued on page 152)

Under chassis view of unit. The compact aluminum chassis was constructed in three parts and measures $7\frac{3}{4}$ " by 4" by 3".

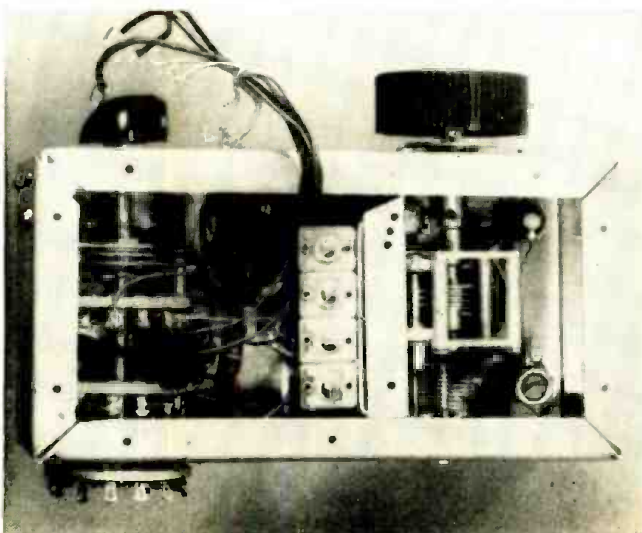

Rear view of v.f.o.-multiplier. The rear gang of the switch is mounted on the back and separated from the chassis by washers.

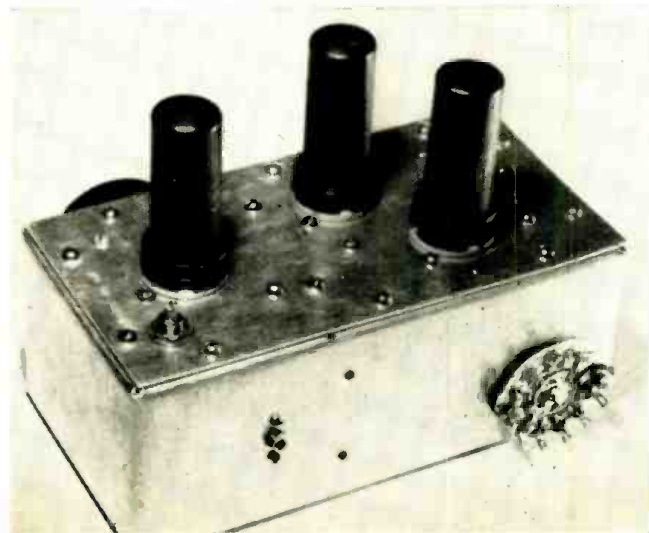

SOUND SYSTEM

FOR YOUR TV SET

By JOHN POTTER SHIELDS

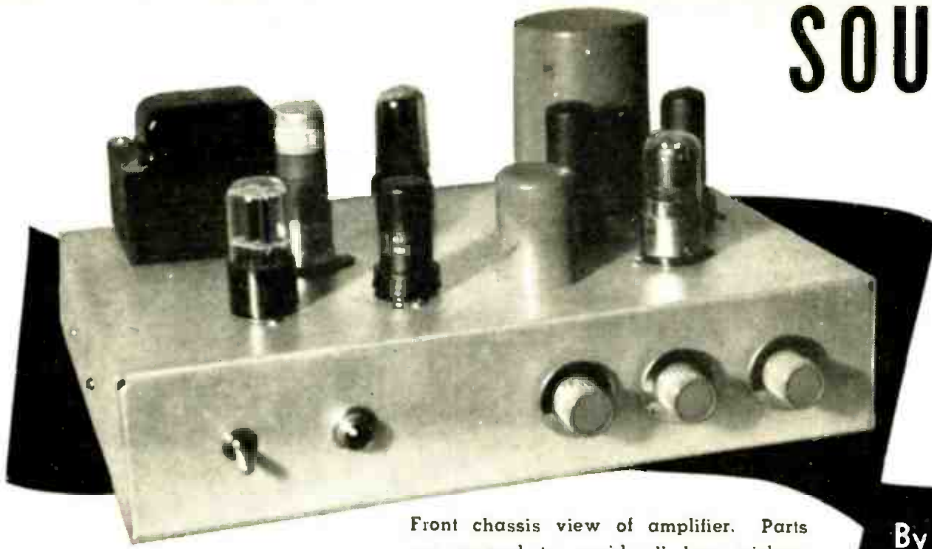

Front chassis view of amplifier. Parts are spaced to avoid all hum pickup.

Design and construction data on a compact unit and its speaker enclosure. Quality parts are used throughout.

MODERN television receivers, with their large picture tubes and improved circuitry, are capable of producing pictures of excellent size and quality. However, the sound sections of all too many of the television receivers currently in use have been sadly neglected. The audio stages in many of the receivers are no better than those found in the cheap "garden variety" a.c.-d.c. sets, and their speakers are often placed where they receive insufficient baffling. In an effort to overcome these shortcomings, the writer designed the amplifier and speaker combination described in this article. While this combination is capable of producing excellent results,

Over-all view of the author's unit showing amplifier and associated speaker cabinet.



its price is not excessive and it can be easily constructed without resorting to trick circuits. The amplifier can be connected to an existing television receiver without "major surgery," and the speaker enclosure can be used as a convenient stand for a table model receiver or placed alongside a console.

Fig. 2 is the schematic diagram of the amplifier. The power supply section is conventional, consisting of a 5Y3 full-wave rectifier followed by a single-section LC filter. The bleeder resistor (R_{22}) is used to absorb power from the rectifier while the other tube heaters are reaching operating temperature, thus preventing excessive voltage from appearing across the filter condensers. If a slow-heating rectifier, such as a 5V4, is used the resistor can be eliminated.

Much consideration was given as to the type of output tubes to use in

this amplifier. Although triodes are usually preferred because of their excellent speaker-damping qualities and stability, they are relatively expensive and, more important, they are hard to drive, usually requiring a push-pull driver stage. After consulting the tube manuals, it was decided to use a pair of 6F6's pentode connected, operating strictly class A. When operated in this manner, 6F6's require a grid-to-grid driving voltage of 58 volts for a power output of 10.5 watts. Although 6F6's can be operated as triodes, they then require a grid-to-grid driving voltage of 123 volts for a power output of 13 watts.

The split-load type of phase inverter was chosen to drive the output stage as it will easily provide the 58 volts grid-to-grid required by the pentode-connected 6F6's, with low distortion and good balance throughout the audio range. The cathode and plate load resistors in this stage should be a matched pair in order to have equal output voltages. The cathode and plate-load resistors were made rather low in value in order to assure good high frequency response and also to keep the cathode-to-heater voltage as low as possible, thus reducing hum difficulties.

A 6J5 is used as a voltage amplifier and is direct-coupled to the split-load phase inverter. This is possible due to the high positive voltage on the phase-inverter cathode. This direct coupling extends the response of this stage down to d.c. and since there is no coupling condenser, one source of phase shift is eliminated. It should be noted that there are only two coupling condensers in the circuit between the grid of the 6J5 voltage amplifier and the output transformer.

Negative feedback is applied to the unbypassed cathode of the 6J5 from the secondary of the output transformer. The amount of feedback that can be applied depends, to a large extent, upon the characteristics of the output transformer used. Therefore, a

Fig. 1. Method for connecting amplifier into television set without major rewiring.

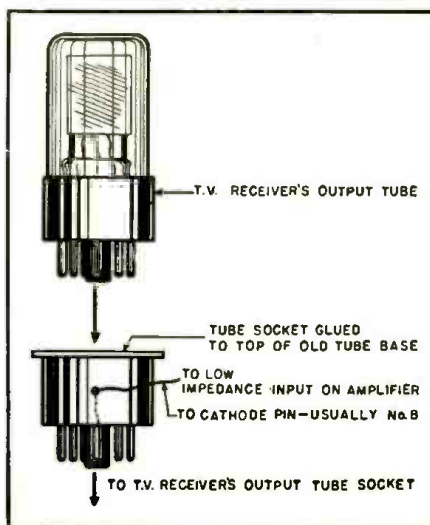

good quality transformer should be used. The UTC CG-19 output transformer is recommended. Although not as expensive as many of the larger units, it is capable of excellent performance. With feedback, the amplifier is flat from 20 cps to over 20 kc. with no sign of instability. When installing the feedback resistor (R_{11}) a scope should be connected to the amplifier to make sure that no ultrasonic oscillations exist when the desired amount of feedback is obtained. If a loud squeal or motorboating is heard with the feedback loop connected, reverse either the primary or secondary connections (not both) to the output transformer. The value of the feedback resistor shown in the schematic is correct when using the CG-19 output transformer. If a different transformer is used, it is recommended that a pot. be installed temporarily in place of the feedback resistor, and adjusted for the proper amount of feedback. After setting the pot. for the proper amount of feedback, measure the resistance across the pot. and install a fixed resistor in its place.

The tone control stage uses the Thordarson degenerative tone control circuit employing one half of a 6SN7. The operation of this circuit is as follows: The cathode resistor in this stage is higher in value than the plate resistor, hence most of the signal appears across the cathode resistor. The circuit being resistive, the stage gain is equal for all frequencies. For bass boost, the cathode resistor is shunted with a suitable inductance. Degeneration of the lower frequencies is greatly reduced due to the low impedance of the inductance at low frequencies, consequently the gain of the stage is greatly increased at the lower frequencies. To attenuate the bass, the same inductance is introduced into the grid circuit of the following stage. In this case, the low impedance of the inductance at low frequencies bypasses the low frequencies to ground. For treble boost, a condenser is shunted across the cathode resistor of the tone control stage. The lowered impedance of the condenser at high frequencies causes a decrease in degeneration at the higher frequencies, consequently the stage has more gain at the higher frequencies. The highs are attenuated by shunting a condenser across the next stage grid resistor, thus bypassing the high frequencies to ground.

The input stage uses the other half of the 6SN7 connected either as a grounded-grid amplifier (for low-impedance inputs) or as a conventional amplifying stage (for high-impedance inputs). For low impedance inputs, the jack of the amplifier is connected across the 1000-ohm cathode resistor R_2 . As long a connecting cable as desired can then be connected to the cathode resistor of the audio output tube in the television receiver. In order to avoid elaborate surgery on the receiver, an adapter such as is shown in Fig. 1 can be made. Then it

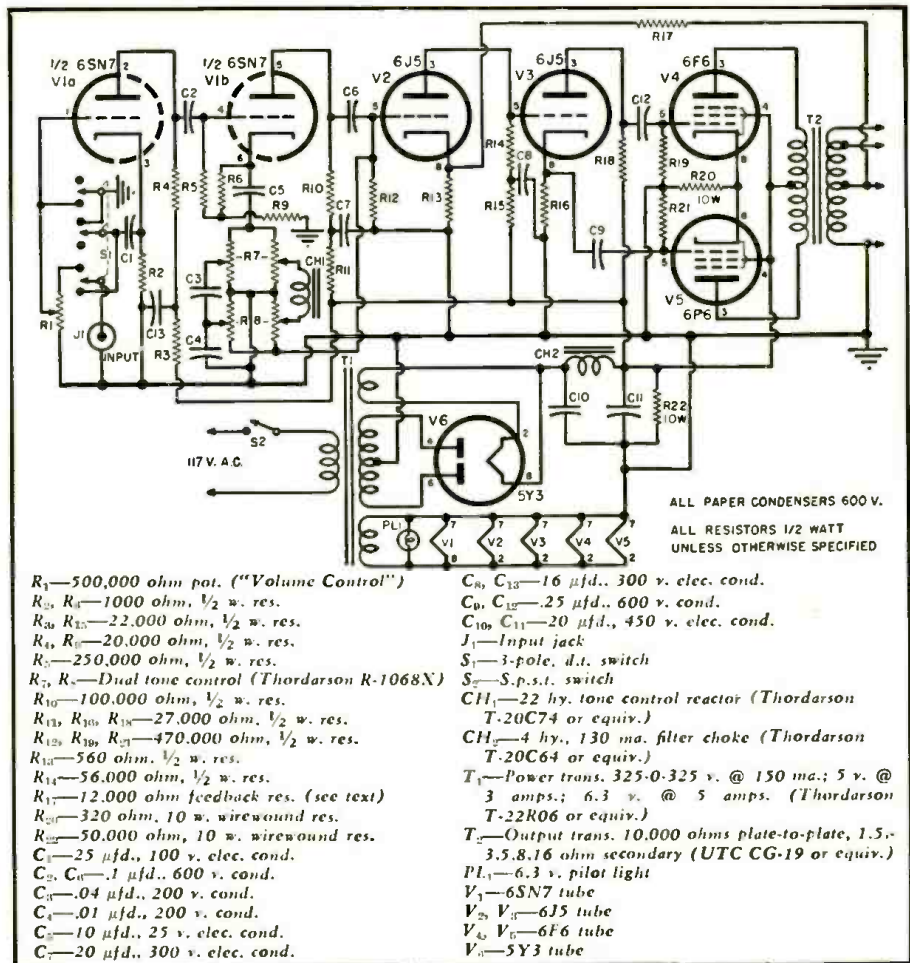
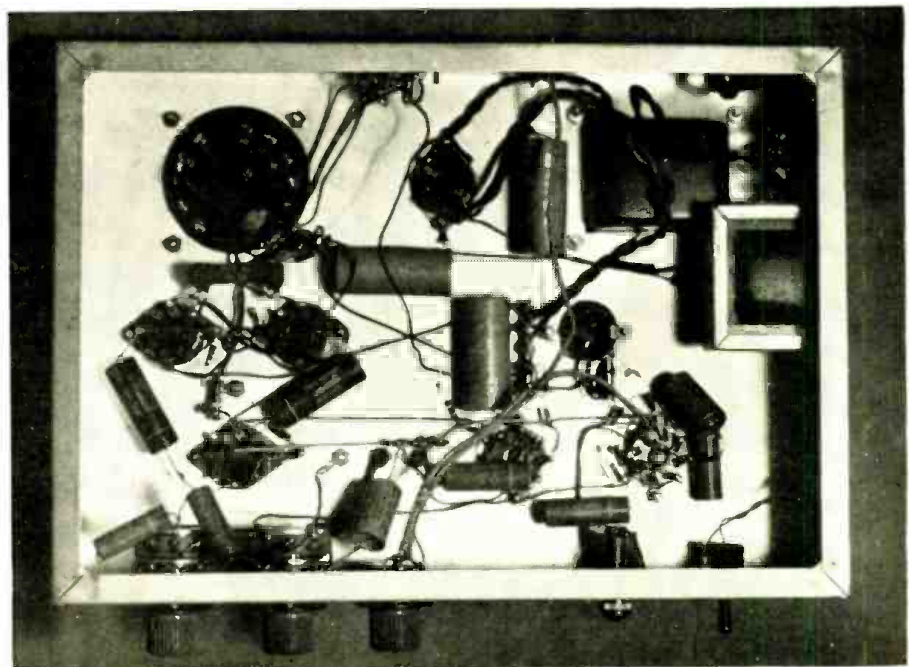

Fig. 2. Complete circuit diagram of amplifier. Quality parts are used throughout.

is only necessary to remove the audio output tube in the receiver, insert the adapter in the socket, and then insert the output tube into the adapter. It is necessary that any cathode bypass condenser connected across the output tube's cathode resistor be removed.

This may mean a slight decrease in output due to degeneration, however the response of the stage will be improved. If it is desired to silence the receiver's speaker when using the amplifier, it can be disconnected from the (Continued on page 94)

Under chassis view of amplifier. Careful placement of parts avoids interaction.



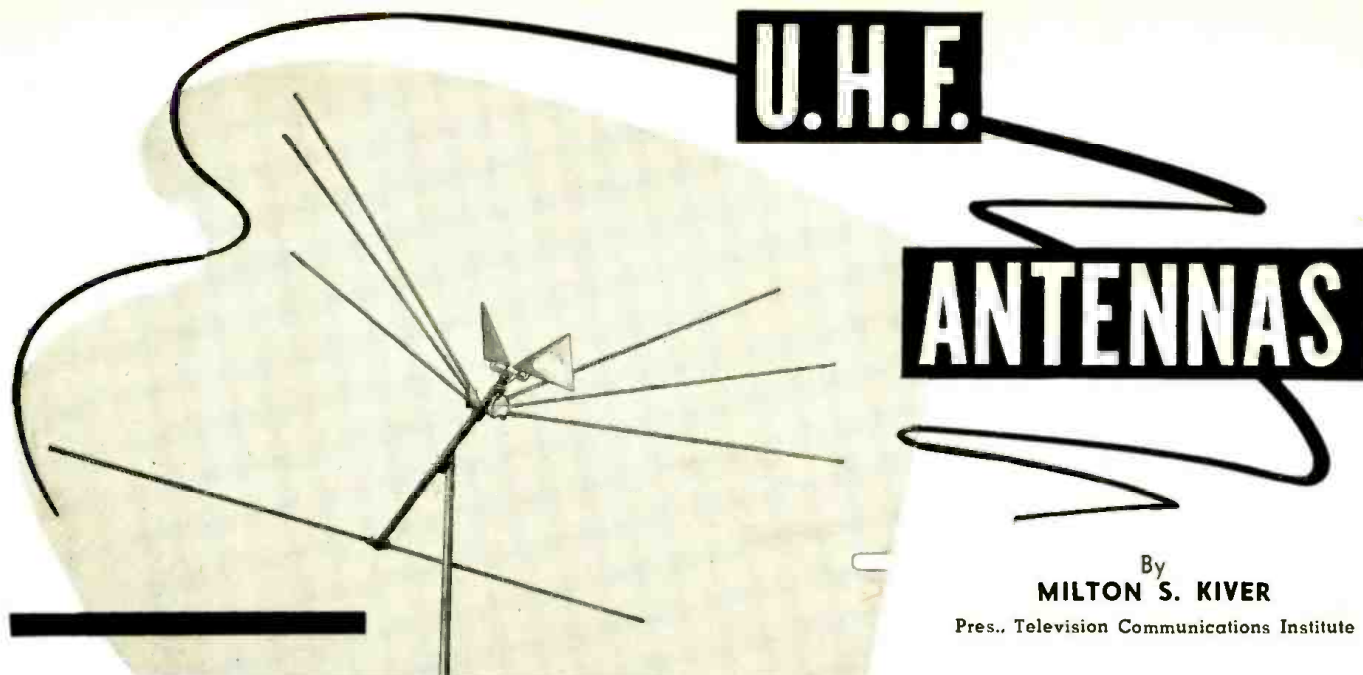

Fig. 1. A combination v.h.f.-u.h.f. antenna. This is the "Jetenna 283" made by JFD Manufacturing Co.

By
MILTON S. KIVER

Pres., Television Communications Institute

Part 3. Details on some of the combination v.h.f.-u.h.f. arrays which are now being marketed by antenna companies.

A PROBLEM that will soon be facing many TV set owners and technicians is that of choosing the u.h.f. antenna best suited to their location and station frequency. In areas where only u.h.f. stations are assigned, the choice will be between the various u.h.f. antennas available. But in many parts of the country there will be both u.h.f. and v.h.f. signals and for these locations the following choice will exist.

1. To use one all-v.h.f. antenna and one u.h.f. antenna, each with its own lead-in line.

2. Or, to use a combination v.h.f.-u.h.f. array with a single lead-in.

Choice No. 1 is the more flexible of the two and generally will provide the set with stronger signals. Whenever you combine two arrays possessing widely differing responses, a certain

amount of loss will be incurred by both sections. If the combination antenna stems from the basic "V" array, then the angle of the antenna rods which is best for v.h.f. reception will not be best for u.h.f. reception. By the same token, the best adjustment for u.h.f. reception is not the most desirable for v.h.f. signals. And, as is most common, when you choose a compromise position, then reception suffers in both regions.

If the combination array is of the type shown in Fig. 1, some sort of decoupling network must be inserted between the u.h.f. and v.h.f. elements. In essence, what we are principally trying to do with this decoupling or filter network is to prevent the v.h.f. assembly from affecting u.h.f. response. (The u.h.f. antenna will usually have little effect on the v.h.f. response and for

most practical purposes may be disregarded.) Signals passing through the decoupling network will suffer some attenuation and, in this respect, less than optimum operation will be obtained.

On the other hand, whatever loss is occasioned by combining v.h.f. and u.h.f. elements in strong and medium signal areas will have little noticeable effect on the picture. Furthermore, combination arrays will be more economical, both from the standpoint of initial cost and of subsequent installation, and cost is a very potent factor in sales.

The consensus among antenna engineers is that while better results are generally obtainable from separate v.h.f. and u.h.f. arrays, a substantial market will exist for combination arrays and these will be manufactured in quantity.

The opening of the u.h.f. band has only just begun and the number of combination arrays is still quite limited. Many manufacturers, when asked about their plans, indicated a "wait-and-see" attitude. However, several combination arrays have already been marketed and it may be of interest to

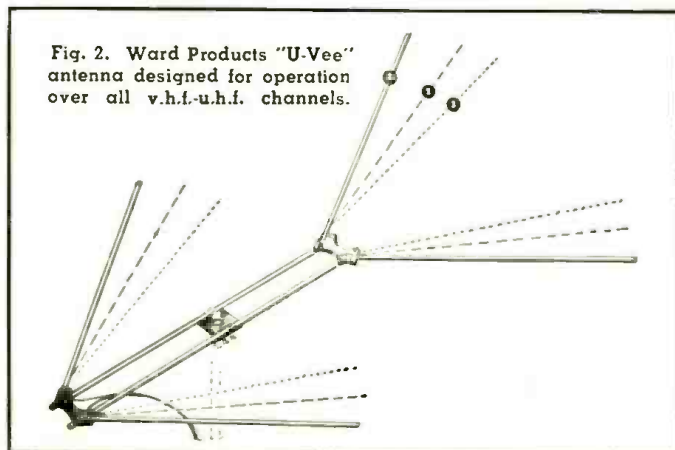

Fig. 2. Ward Products "U-Vee" antenna designed for operation over all v.h.f.-u.h.f. channels.

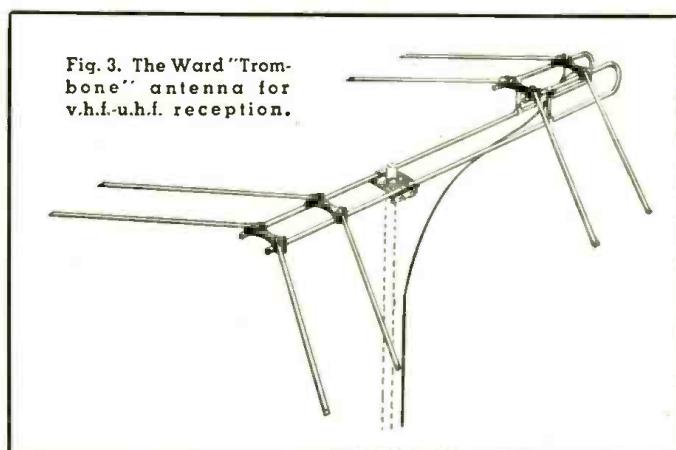

Fig. 3. The Ward "Trombone" antenna for v.h.f.-u.h.f. reception.

examine these to see what form they take and how they operate.

JFD's "Jetenna 283". JFD has recently announced an array to operate over all v.h.f. and u.h.f. channels. Shown in Fig. 1, it is seen to consist of a low band conical for v.h.f. signals and a broadband triangular (or fan) dipole for u.h.f. signals. A single lead-in line delivers signals to the receiver through the use of a special coupling device mounted directly at the antenna itself.

By virtue of the positioning of the various elements, the active rods of the v.h.f. array serve as reflectors for the u.h.f. dipole. The v.h.f. elements, in turn, have their own reflector. A gain close to 9 db is available from the v.h.f. section while the u.h.f. section gain will be on the order of 4 db. The u.h.f. plates are stamped of aluminum, with a tip-to-tip length of 16 inches. The array will match a 300-ohm line. Finally, the two triangular plates of the u.h.f. array will have a forward angle of 35 degrees to match the forward inclination of the v.h.f. elements.

Vertical directivity of this u.h.f. array is quite broad but the horizontal directivity, with the reflector elements, is good. For local areas surrounding a u.h.f. station where ground reflected signals are low, good results may be obtained with this array.

"V" Type Combination Antennas. The ability of a "V" type of antenna to receive v.h.f. and u.h.f. signals was briefly mentioned in the first article of this series. Several antenna companies have taken advantage of this property to devise modified "V" antennas which will operate over all channels with good gain.

The modified array which all manufacture in one form or another is shown in Fig. 2. Basically, the array consists of four rods; two at the front and two at the rear. The lead-in line to the receiver (300-ohm twin-lead) connects to the two rear rods. Comparing this arrangement with arrays with which we are familiar, the only conclusion we can draw regarding the front two rods is that they serve here as directors. This they do. However, closer examination of the array indicates that unlike more conventional arrays, the two front rods are electrically

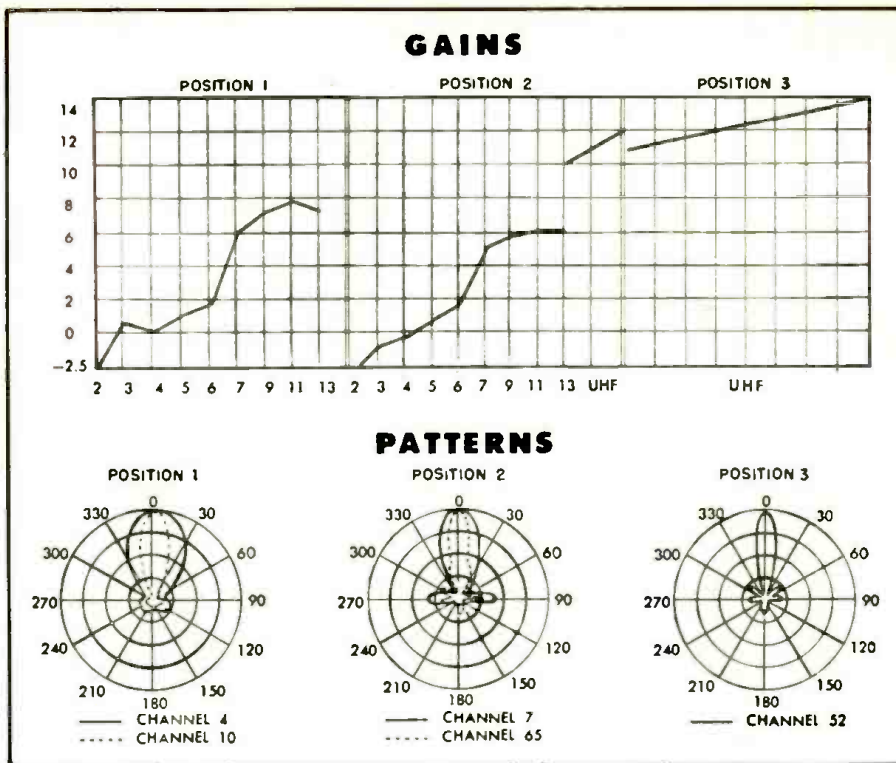

Fig. 4. A comparison of the response curves and the antenna gain for each of the three positions of the Ward Products' "U-Vee" antenna. See Fig. 2.

ally connected to the two rear units through the two rods comprising the "boom". The purpose of these connecting rods is two-fold.

First, the two connecting rods serve as a transmission line to conduct whatever signal is picked up by the two front rods to the two rear rods. In addition, the two rear rods also pick up that portion of the signal which passed over the front rods and combine this with the energy received from the front rods via the connecting rods. Obviously, to obtain maximum results from this combination, the length of the connecting rods must be carefully chosen. Signal pick-up from the rear of the array is low because the energy which approaches the array from the rear is captured by the front and rear rods and combines out-of-phase and is therefore cancelled out.

The second purpose of the connecting rods is to support both front and

rear dipoles and produce a mechanically sturdy array.

It is characteristic of "V" type antennas that the longer each side of the "V" becomes as compared to the operating frequency of the signal, the narrower the angle between the sides must be for an optimum high-gain, single-lobe pattern. Thus, if we use the same "V" for operation on low- and high-band v.h.f. and for the u.h.f. region, then the angle to which the bars must be set depends upon the conditions in your locality.

In position No. 1, Fig. 2, reception is best on the v.h.f. band. The included angle between the rods is 90°. The manufacturer also suggests application of this antenna with the 90° angle for scattered u.h.f. stations in a metropolitan area. In such strong-signal u.h.f. service areas a careful check at the time of antenna installation can determine a fixed position for the 90° array that will allow good re-

Fig. 5. The JFD "Ultra V-Beam" antenna for v.h.f.-u.h.f. use.

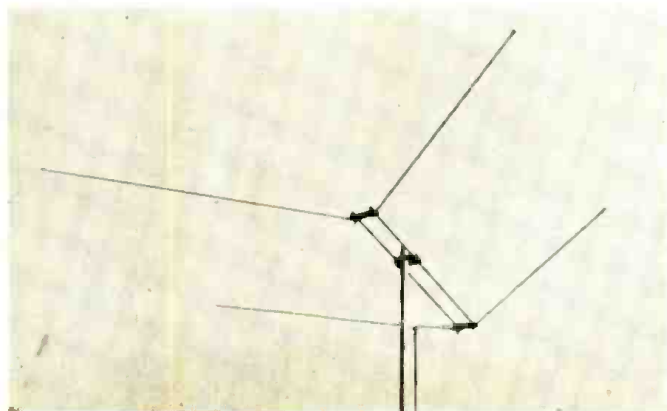
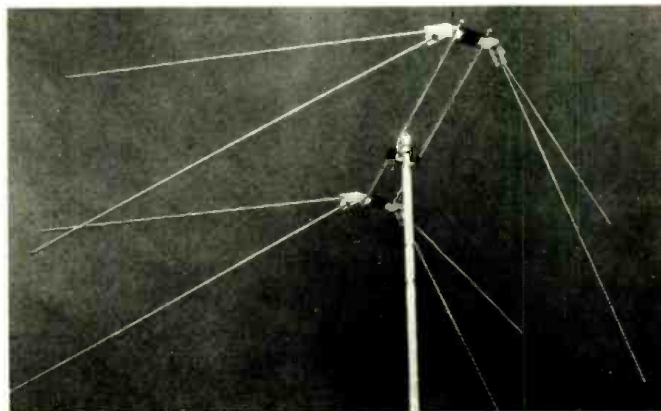

Fig. 6. Another combination v.h.f.-u.h.f. array, made by RMS.



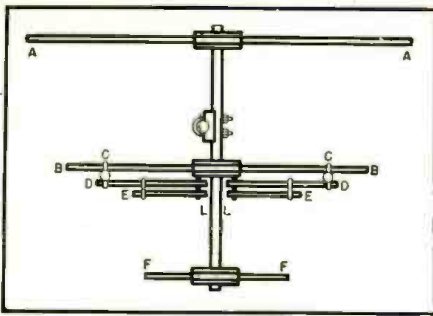

Fig. 7. The v.h.f. portion of the "Ultra Q-Tee" antenna shown below in Fig. 9.

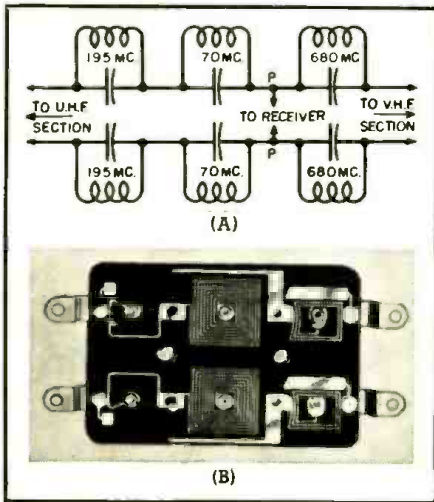

Fig. 8. (A) Low-frequency equivalent circuit filter which prevents interaction between v.h.f.-u.h.f. sections of "Ultra Q-Tee". (B) Actual appearance of filter.

ception on all nearby u.h.f. channels together with both near and distant v.h.f. channels.

In position No. 2, Fig. 2, the included angle is now 60°. Reception is divided between v.h.f. and u.h.f. channels, with the highest u.h.f. channels suffering the most due to lobe break up.

In the final position, No. 3, Fig. 2, the included angle between the dipole rods is 45° and now best reception is obtained on the u.h.f. channels, especially those located above 750 mc. The v.h.f. reception in this position is below normal and likely to be unsatisfactory except in strong v.h.f. signal areas.

A comparison of the response curves and the antenna gain for each of the

three positions is given in Fig. 4. Note in all instances how much better this array performs as the frequency rises. This is an especially desirable characteristic for u.h.f. reception.

The "U-Vee" antenna, as this array is called by its manufacturer (*The Ward Products Company*), can be obtained stacked for improved reception. (*JFD* produces a similar antenna but calls it the "Ultra V-Beam." See Fig. 5. Its rods also have provision for altering the included angle to suit the frequency or frequencies of the stations to be received.)

Ward Products has a variation of the "V" antenna which it calls the "Trombone." See Fig. 3. Use of this antenna on the u.h.f. channels is similar but not identical in principle to the "U-Vee" array. The 90° angle for all four "V's" that gives best fringe-area performance on both v.h.f. bands will produce multiple lobes over the u.h.f. range. This can still be useful in the primary service area of u.h.f. stations but it will prove unsatisfactory in weak signal areas or where there are multiple reflections.

According to the manufacturer, the "Trombone" is not peaked for a single lobe over the u.h.f. band by using the 60° angle (mid-position) for all four "V's". This arrangement gives highest gain on only the lowest u.h.f. channels (near 500 megacycles) and reduces the gain in the v.h.f. band. A better choice for good low-channel "Trombone" performance is to set only the forward pair of "V's" to 60°, leaving the back pair (on the "Trombone" loop) at 90°. When the high end of the u.h.f. band comes into use, above Channel 62, the forward pair of "V's" can be set at 45° included angle for top performance with minimum reduction in v.h.f. gain.

The best choice for the majority of the u.h.f. channels is to set the three forward "V's" to 60° and the back "V" at 90° (widest angle). This gives optimum gain at u.h.f., with a partially-split forward lobe that is said to allow considerable latitude in lining up different u.h.f. stations, but still giving a good front-to-back ratio and minimum side lobes for ghost rejection. Performance on the v.h.f. channels is still good, with a fairly narrow main lobe and good front-to-back rejection.

Variations on the basic "V" are end-

less and it may be expected that different manufacturers will put other twists in it. The *RMS* array is shown in Fig. 6 and it is seen to possess two rods at each point where the "V" of Fig. 2 uses one. Stacking of the "V's" is shown in Fig. 10. "Q" bars are used to connect the upper and lower stacks and are so designed to raise the apparent impedance of each section so that the antenna will work effectively into a 300-ohm load.

The "Q-Tee and "Ultra Q-Tee". The "Ultra Q-Tee" antenna, Fig. 9, is another combination v.h.f.-u.h.f. array that possesses a number of features which differ from the other combination antennas we have just discussed. The u.h.f. portion of this array consists of the two foremost rods that are tilted forward. The straight rod just behind them serves as the reflector. The same straight rod also serves as a director on the upper v.h.f. band for the array of rods that are positioned behind it. These other rods form the v.h.f. section of this array.

In order to understand the reason for using this particular form of antenna, let us first consider the v.h.f. section. This is shown in Fig. 7. Dipole B-B is cut for a half-wavelength at 63 mc. (Channel 3) and this rod is designed to receive all of the low-band Channels (2-6). Rod A-A is the reflector for dipole B-B and its length is somewhat greater than B-B's.

Dipole D-D is cut for a full wave at the center of the high v.h.f. band C,C are printed circuit isolation filters, resonant at 195 mc. and designed to isolate the low-channel dipole (B-B) from the high channel dipole (D-D). Rod E-E, a matching and phasing section, performs a dual function and accounts for the operational characteristic of this antenna. On the high v.h.f. channels elements E-E are "T" match sections which tap the dipole (D-D) and provide a 300-ohm termination at (L-L). The high channel antenna is, therefore, a full-wave antenna "T"-matched, with a half-wave director (F-F).

On the low channels the isolation filters (C,C) have a low-inductive impedance since they operate below their resonant frequency. The high channel dipole (D-D), combined with element (E-E), forms a double "T" matching section which taps dipole (B-B) to

(Continued on page 120)

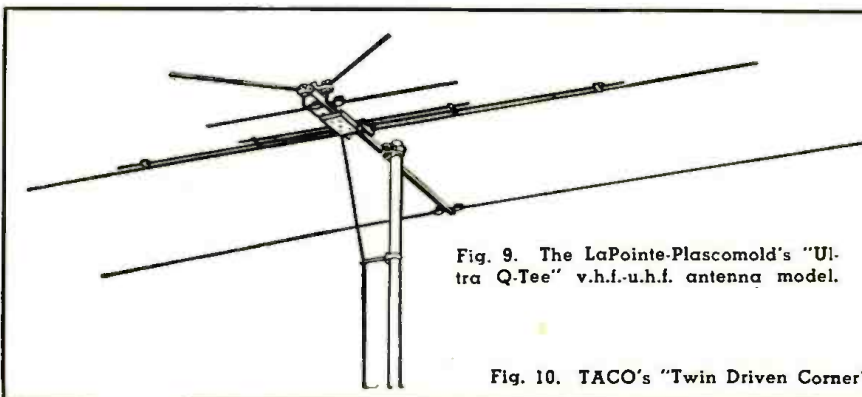

Fig. 9. The LaPointe-Plascomold's "Ultra Q-Tee" v.h.f.-u.h.f. antenna model.

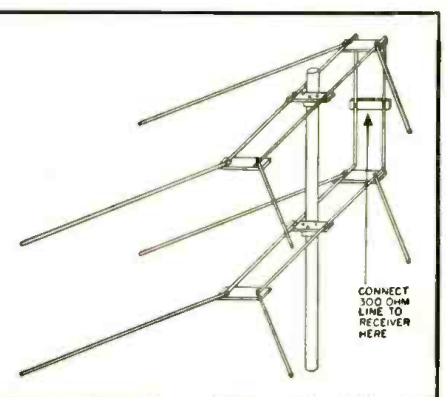

Fig. 10. TACO's "Twin Driven Corner" unit.

WRITING FOR PROFIT AND PRESTIGE

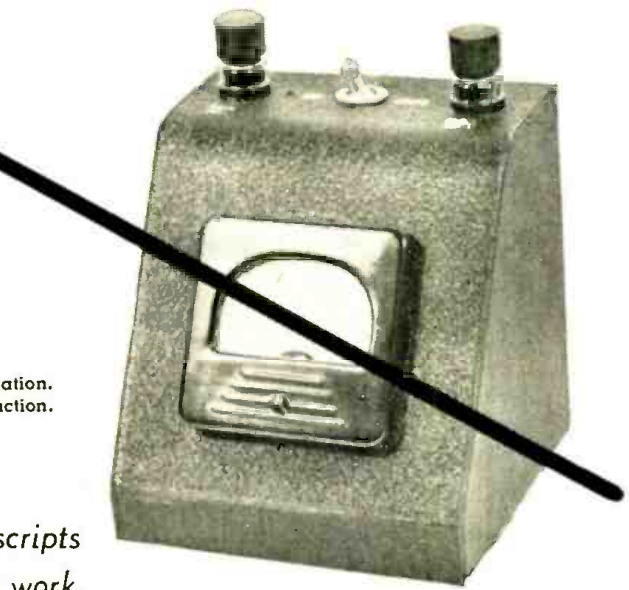

Fig. 1. A sharp, crisp photograph of the type acceptable for publication. (Right) A fuzzy, out-of-focus picture such as this is not suitable for reproduction.

By
LOUIS E. GARNER, JR.

Tips from an "old hand" on how to prepare manuscripts to insure acceptance and highest rates for your work.

CONSIDERING the number of experimenters, technicians, and radio amateurs in the nation, the variety of available subjects, and the excellent rates paid by technical magazines, it is indeed surprising that more of these men don't turn to writing for prestige and profit. Technical writing offers a way for experimenters to make their hobby self-supporting, for radio-TV technicians to profitably fill in their "no-work" time, and for beginning engineers to gain professional recognition.

Probably every ham or engineer who has worked on or designed a new test instrument, an interesting control device, or a "gadget," and every technician who has developed a new "kink" in his service technique, could write an interesting and salable article—*provided* he took the time to do so and, equally important, went about the job in the right way. For good technical articles don't just "happen"—there is a definite technique to writing articles that will sell; a technique that may be applied equally well by the beginner or the experienced man, and a technique that will go a long way towards insuring success irrespective of the comparative writing skill of the individual.

Before starting an article, or even an outline, for that matter, the prospective writer should make an import-

ant decision—whether the article is to be written primarily as a means of securing additional income, or primarily for professional recognition (although both types of compensation may result). This decision will determine to a large extent the available market, the possible subjects, and the type of presentation.

Articles published by the official organs of professional groups and societies carry the greatest prestige value, although the monetary compensation may be very low. In fact, many professional journals accept the articles as "contributions" without any cash payment whatsoever. This does not

imply that their standards are low. Often, it will prove quite difficult to prepare an article measuring up to the high standards enforced. However, junior engineers find that preparing papers for professional journals offers an excellent means of gaining recognition and prestige.

Professional journals often have stringent rules for submitting manuscripts and prospective authors should obtain all the necessary information from the editors before starting an article or paper. In many cases, manuscripts must be typed in a certain manner, must be submitted in duplicate or triplicate, and all drawings must be finished ink drawings suitable for reproduction.

The more popular technical magazines, on the other hand, are not as strict concerning the mechanical preparation of the article, but may be many times more critical on the style of presentation—they all insist on an informative, easy-to-read, easy-to-understand, and, above all, interesting article. Since writing an interesting article is often more difficult than writing a "letter-perfect" but dull article, the compensation is greater. A technical writer, preparing an article for the more popular technical magazines, may be able to average as much as \$15 to \$30 an hour for actual writ-

(Continued on page 133)

Fig. 2. Neatly and clearly drawn diagrams, with all of the components properly identified, add value to your manuscript.

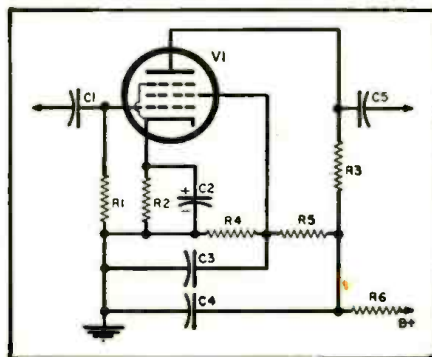



Fig. 1. The "Vest-Pocket Receiver" housed in a small plastic box.

A VEST-POCKET RECEIVER

By

E. G. LOUIS

Complete construction details on a compact unit which incorporates a commercially-available printed circuit.

THERE are two basic approaches that may be used in designing a radio receiver. The more popular approach is to provide considerable r.f. (or i.f.) gain, together with comparatively little audio gain after the detector. This approach is mandatory in the case of sensitive receivers, where weak r.f. signals must be picked up, and where the signal-to-noise ratio is important.

In the case of receivers to be used only on local broadcast stations, where high signal levels are usually encountered, a different design technique may be employed. Little or no r.f. gain may be provided, together with considerable audio gain. A receiver may consist of no more than an antenna, a tuned circuit, a detector, and a high-gain audio amplifier. This approach was used successfully in designing and building the small receiver shown in Fig. 1.

Although a very short antenna is used, the receiver is sufficiently sensitive to give ample earphone volume with local AM broadcast stations (5-15 mile radius).

As can be seen in the "close-up" view (Fig. 3) the receiver is completely self-contained, with both "A" and "B" batteries within the plastic case. The extremely small size of the receiver is evident in both Figs. 1 and 3. Compare the complete receiver with the size of the standard penlight battery used as the "A" supply!

Because of its small size and light weight, this receiver is handy for use when working in the garden, mowing

the grass, hiking, cycling, or when attending sports events.

The layout and construction is such that the average skilled technician should have no difficulty assembling and wiring the complete receiver in an afternoon and evening.

Circuit Description

The complete schematic diagram for the receiver is given in Fig. 2. The circuit enclosed by the dashed line is a complete *Centralab* printed circuit amplifier and is mounted and wired as a single component. Hence, the individual resistors and condensers in this circuit are identified only by parts values.

The r.f. signals picked up by the antenna are coupled through C_1 to a tuned circuit consisting of L_1 and C_2 , where the desired station is selected. The r.f. signal appearing across the tuned circuit is coupled, in turn, to the grid of the first CK512A amplifier tube through C_3 , appearing across R_1 . Grid-leak detection takes place at this point (due to the high value of R_1), and hence there is only an audio signal to consider in the remainder of the circuit.

The amplified audio signal appearing across the 1-megohm plate load resistor of the first CK512A amplifier is coupled through a .001 μ fd. condenser to the volume control, R_2 . From here the signal is applied to the grid of the second amplifier, another CK512A tube.

Only two stages of voltage amplification are provided, so the signal appearing across the 1-megohm plate

load resistor of the second CK512A tube is applied directly to the grid of the CK525A power amplifier stage through another .001 μ fd. coupling condenser.

The output signal appears across a subminiature choke, L_2 , and is coupled through C_4 to the output jack.

Operating voltages are obtained from a 1.5 volt standard penlight cell, which acts as the "A" battery, and a 30-volt hearing aid "B" battery. If desired, one of the new mercury cells may be substituted for the "A" battery to provide longer life—a *Mallory* type RM-1200 mercury cell is suggested.

Construction Hints

The layout used by the author is readily apparent from the photo (Fig. 3). However, this layout need not be followed exactly—in fact, some modification will be mandatory unless the case used by the builder is exactly the same shape and size as that used by the author. When modifying the layout, take care to keep the output and input connections to the printed circuit amplifier well separated to prevent oscillation.

A suitable case for the receiver can generally be found at a dime store or at a plastic "hobby" shop. The one used by the author was obtained in an assortment purchased from the *Olson Radio Warehouse* (Akron, Ohio). Dimensions are approximately $2\frac{1}{2}$ " x $3\frac{1}{2}$ " x $\frac{7}{8}$ ".

Most of the major parts are mounted simply by cementing them in place using *Duco* cement. However, a pair of small cable clamps is used to hold the antenna in place along the side of the receiver case. The batteries are held in place by the spring tension exerted by U-shaped pieces of phosphor bronze cemented to the case. These "clips" also serve to make contact with the battery terminals.

The "antenna" was salvaged from the upper section of a damaged auto antenna. The length is not too critical but at least a 12" length should be used and a 14" or 16" length will give somewhat better results.

RADIO & TELEVISION NEWS

A standard "Ferri-Loop" antenna which has been modified to fit into the small space available serves as the tuning coil (L_1). This coil, as supplied by the manufacturer, is fairly long, with most of the length represented by a cardboard tube and the mounting bracket. The excess tube length was cut off using a sharp pocket knife and the remaining coil (with its core) cemented in place. In Fig. 3, this coil is located below the trimmer condenser and at the end of the "A" battery.

Station tuning is provided by a mica compression trimmer (C_2) which may be adjusted by means of a small screwdriver. Only a portion of the band is covered by the trimmer and it becomes necessary to choose a value that will permit tuning the desired station(s). The value given in the parts list covers the upper portion of the broadcast band (1000 to 1500 kc.). To cover lower portions of the band, use a trimmer having a greater maximum capacity—values of 270 $\mu\text{fd.}$, 360 $\mu\text{fd.}$, 480 $\mu\text{fd.}$, etc. are satisfactory. The exact portion of the band covered will depend not only on the trimmer size but also on the exact positioning of the iron core in the coil.

A miniature output jack was obtained by cutting a Walsco type 791 jack to almost half its normal length and cementing it in place in the plastic case. This component is visible in Fig. 3 and is located just above the output choke. The phone plug supplied with the Telex midget earset was removed and a Walsco type 790 plug used instead (to match the miniature jack).

The output choke, L_2 , may be replaced by a 50,000 ohm, $\frac{1}{4}$ watt resistor if desired, giving somewhat less gain, but saving considerable space as well as reducing the cost of the completed receiver. In fact, in the model shown, the choke was accidentally damaged and later developed an "open." Rather than attempt to remove the choke, a 50,000 ohm resistor was simply soldered in parallel with the choke connections, giving satisfactory results.

Somewhat higher over-all gain may be realized by using a crystal headphone in place of the 2000-ohm magnetic earset shown. However, when this is done it may become necessary to shield the case to prevent feedback and oscillation.

Adjustment and Tuning

Since the wiring and assembly of the small receiver are straight-forward, little or no difficulty should be encountered. There are two points on which some builders may run into a little trouble, however.

First, if care is not taken in layout and wiring, it may be found that over-all oscillation takes place. In such a case, better separation between the output and input is advisable. In a few instances it may become necessary to shield the entire receiver, either by assembling it in a small metal case (such as a cigarette case)

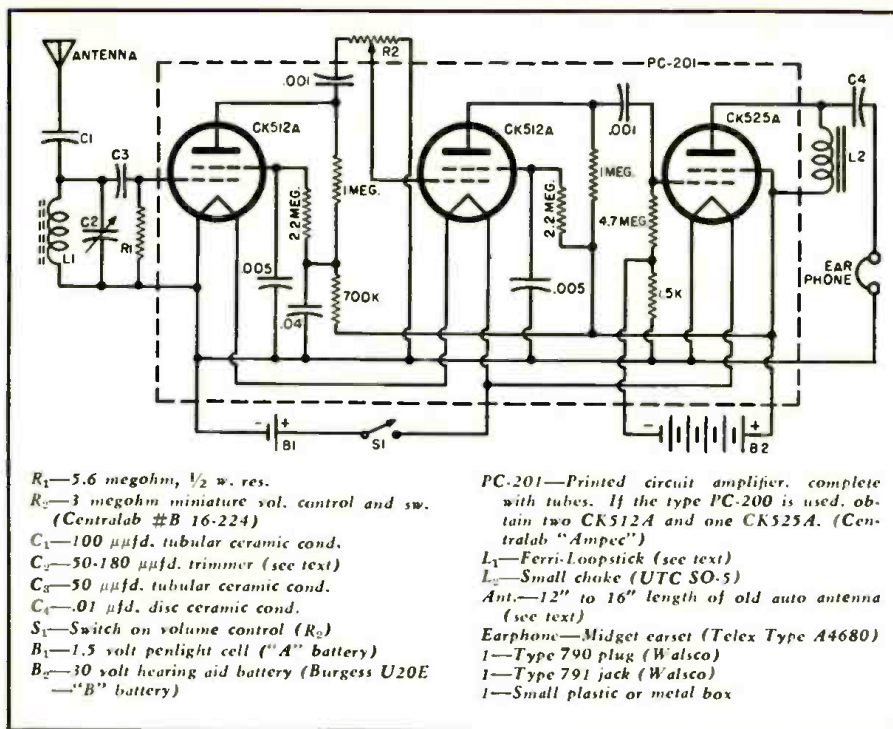

Fig. 2. Circuit diagram. The printed circuit is shown within the dotted lines.

or by cementing aluminum foil to the outside of the plastic case, connecting it to circuit "ground."

If over-all shielding proves necessary, care should be taken that no wiring connections are shorted, that the antenna is not shorted, and that the mounting screws of the "switch-volume control" are not shorted.

If the receiver is assembled in a metal case, slightly different construction techniques will be necessary in order to avoid shorts. One technique is to wire the entire receiver on a plastic "sub-chassis" which, in turn, is mounted in the metal case. A feed-through insulator should be used for mounting the antenna.

Another minor difficulty that may be encountered is an apparent lack of gain, in other words, insufficient "pick-

up." This will be noticed if the signal level of the local stations is low in the locality where the receiver is to be used—in another location, ample volume might be obtained.

While the over-all gain of this receiver is many times that of a simple detector, it must be remembered that the antenna length has been kept extremely short to increase portability. Because of this, the ability of the receiver to "pull-in" stations is not appreciably greater than a crystal receiver with a good outside antenna and earth ground.

If desired, a longer antenna may be used to increase signal pickup.

Touching the antenna with the hand or body will reduce signal pickup by "loading" the tuned circuit and reducing (Continued on page 157)

Fig. 3. Close-up view—layout may be varied to conform to builder's requirements.

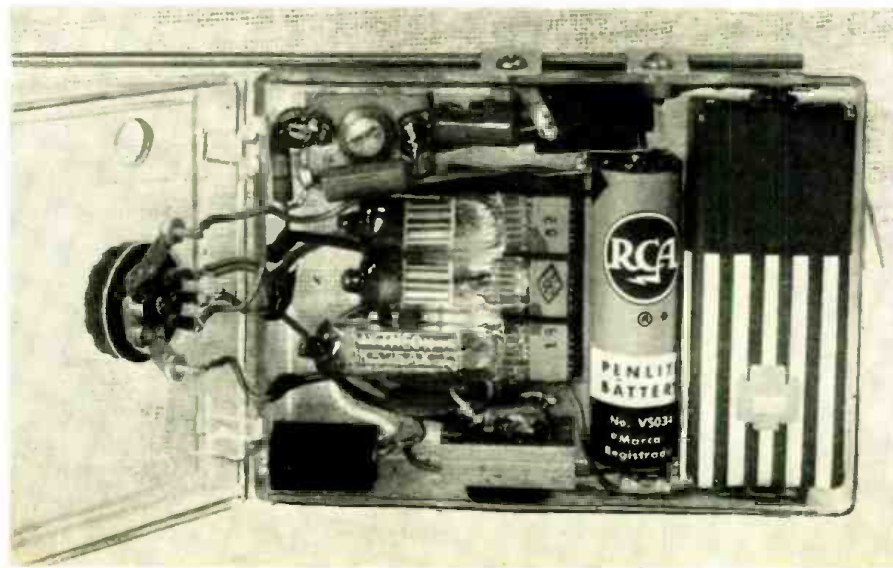

SINGLE-CHANNEL REMOTE BROADCAST AMPLIFIER

By LEON A. WORTMAN

IN THE operation of a 250-watt standard broadcast station there are the usual problems of equipment costs, maintenance, and operation. The cost of equipment for a 250 watt is the same as for a 50 kilowatt, per unit. However, because of lower rate cards and comparatively smaller, though not inadequate staffs, the methods of attacking these problems differ from those of higher powered stations serving larger areas and commercial listening audiences. One such station is KRUX in Phoenix, Arizona. KRUX operates as the "News, Music, and Sports Station" of this southwestern area, and as such finds itself with a heavy schedule of remote broadcasts. These range from church services, public service features, to the entire gamut of sports events, local and national.

Commercially-manufactured remote amplifier "boxes" are expensive; understandably so because of the design and development costs and the comparatively limited demand. An operation such as that at KRUX requires more than the usual number of remote amplifiers. Public service remotes tie up equipment and the engineer's time, and because of sequential remotes

some economical solution had to be found. So, it was decided to "roll our own." Since there are undoubtedly other stations and engineers with the same problem, the following design, description, photographs, and general information are offered as an "assist."

The unit shown in the photographs was constructed to solve the problem of maintaining standard broadcast quality, when carrying the full schedule of the Phoenix Senator's baseball games. This schedule includes approximately 125 broadcasts, exclusive of numerous commercial and public service remotes, during the months from March to September. That meant that about 500 engineer-hours would be required for setting up, riding gain, and tearing down the equipment during the season.

If it could be arranged so that the

Top and underchassis views of the amplifier. It is constructed on a standard 7" x 5" x 2" chassis. Spare parts were used throughout. The power supply is built on a separate chassis of the same dimensions.

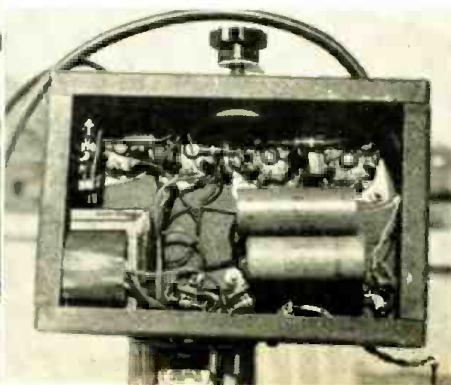
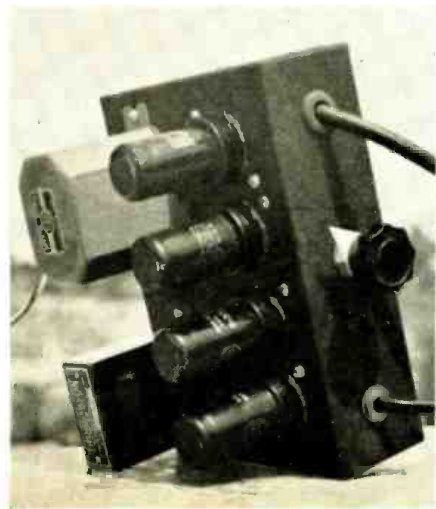

Single-channel remote b.c. amplifier shown mounted under table at ball park. Power supply and amplifier are spaced at least 1½ feet apart to reduce hum pickup.

An inexpensive unit for the small station which can be built from spare parts and needs no tricky adjustments.

equipment remained permanently installed at the ball park, the engineer's time could be cut and his services utilized for other duties. Since it was decided that one microphone was to be used for the broadcast, requiring no mixing, the engineer on duty at the main studio console could do all of the "gain riding" and "zero peaking" necessary for the full modulation of the transmitter. Thus engineering time could again be saved and utilized elsewhere. The final problem of equipment costs was eliminated by constructing a single-channel remote amplifier using existing station facilities.

The equipment had to be small enough to be mounted unobtrusively and without causing any additional crowding in the radio-press box. The amplifier and power supply, as seen in the photographs, are mounted on separate 7" x 5" x 2" chassis. Not one of the components is custom or specially built. All were and can be bought from the local supply houses or ham parts distributors. Many of the components are to be found in the spare parts cabinet, as were most of the ones used in this unit, of any standard broadcast station. Only two different types of tubes are used in order to keep the spare requirements at a minimum.

In the design and construction of any high-gain audio frequency amplifier several precautions must be taken. This type of amplifier is subject to the bugaboos of hum, distortion, and high-frequency thermal noises. A unique method for eliminating such high-frequency thermal agitation noises was the use of standard p.a. transformers instead of flat-response,

MAC'S RADIO SERVICE SHOP

By JOHN T. FRYE

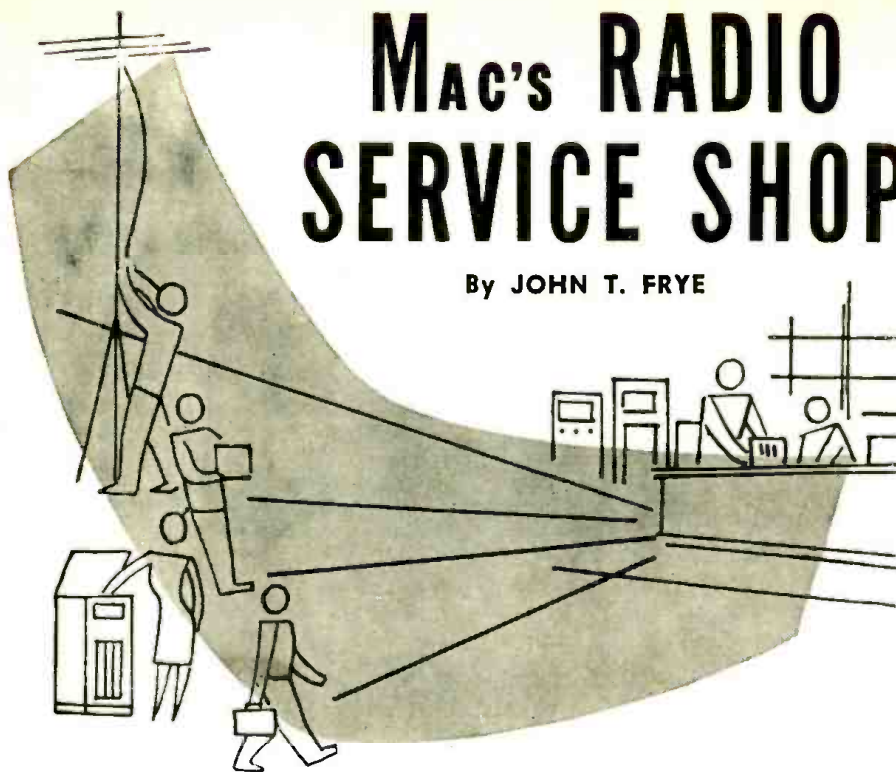

SERVICING WITH THE GDO

ORDINARILY Barney was not eager to get to work, but on this particular morning he was glad to step out of the howling February snowstorm into the warm sanctuary of the service shop.

"Whew!" he exclaimed as he beat the snow from his sock cap and wiped the water from his freckled face. "Tain't fit for man nor beast out there today; and I keep remembering that last fall, when old Indian Summer hung on and on, I was the one who told everyone we weren't going to have any winter weather this year. Hey, Mac, what's the gadget you've got there? Something new?"

"Yes," his boss answered as he fondly cradled the little gray, crackle-finished instrument in the palm of his hand. "Let me introduce you: Barney, this is Mister Grid Dip Oscillator, familiarly known as GDO; Mister GDO, this is Barney, familiarly known as Red, Sorrel Top, or Scarlet O'Gal-

lager. I want the two of you to become better acquainted."

"How do you do?" Barney inquired politely of the instrument. "I've heard a lot about you on the ham bands."

"And from here on in, unless I miss my guess, you're going to hear a lot about him from technicians," Mac stated. "I'm confident the GDO is about to join the parade of instruments from the laboratory to the service bench that began with the cathode-ray oscilloscope and the vacuum tube voltmeter. Engineers and amateurs have long known how useful this rather simple little instrument is; but it was not until the last few months, when several manufacturers brought out grid dip oscillators in both kit and assembled forms at down-to-earth prices, that technicians felt they could afford to buy one of the units just to see what could be done with it in service work. Now that they have found out, the things are selling like

bottle-openers at a bartenders' picnic."

"How does it work?"

"Here's a diagram (Fig. 1) of this particular instrument, the *Heathkit* Model GD-1." Mac said as he slid a paper across the bench. "You can see that it is essentially a high-frequency triode connected as a Colpitts oscillator with plug-in inductances. A 500 microampere meter is connected in the grid return circuit and reads rectified grid current. There is also provision for plugging earphones into this grid-return lead.

"Now watch what happens when I bring the inductance of the GDO close to this coil-and-condenser circuit and tune the grid dip oscillator through the resonant frequency of the combination. See that meter pointer dip downward as I pass through resonance?"

"How come?" Barney demanded.

"The tuned circuit at its resonant frequency absorbs energy from the oscillator and lowers the amplitude of the oscillation, which, in turn, makes the rectified grid current go down. All I have to do is note on this calibrated dial of the tuning condenser of the GDO the frequency at which this dip occurs, and I know the resonant frequency of that tuned circuit."

"What does the variable resistor, R_1 , do in the circuit?"

"That's a sensitivity control. You can see that the negative rectified grid voltage appears at the bottom of this resistor and a positive potential fed through R_2 appears at the top. The resultant of these two opposing voltages causes a current to flow through the meter to ground. If the slider is clear to the top, the positive voltage is grounded and only the grid current registers on the meter. As the slider is moved down, more and more positive voltage is allowed to buck this developed grid voltage."

"But why?"

"The object is to keep the 500 microampere meter on scale for various values of grid current. Different coils and different settings of the tuning condenser will produce different values of grid current. A meter to read this wide range of current without going off scale would have to be one with a relatively high current range; and that would mean a small, hard-to-detect dip with the loose coupling to a tuned circuit required for best accuracy. By using a variable positive bucking voltage, the pointer can be kept on scale for all values of grid current, yet the greater dip-indicating sensitivity of the 500 microampere movement can be retained."

"Is that all it will do: indicate the resonant frequency of tuned circuits?"

"By no means. Watch the screen of the TV set over there on the other bench."

As he said this, Mac plugged another inductance that looked like a fat, king-sized hairpin into the GDO and moved the tuning dial with his thumb. Suddenly the picture was re-

(Continued on page 111)

Fig. 1. Circuit diagram of a commercially-available grid dip oscillator kit.

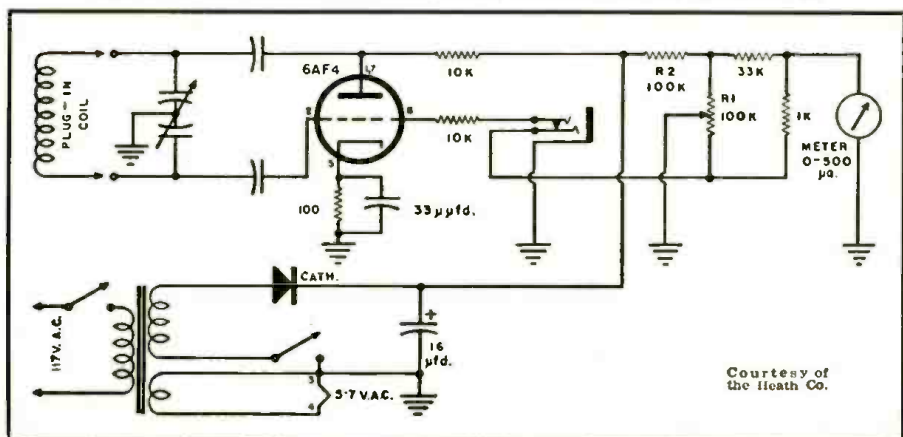



International SHORT-WAVE

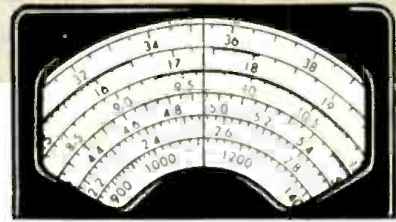

Compiled by KENNETH R. BOORD

IT IS A privilege this month to dedicate the *ISW DEPARTMENT* to radio broadcasting in the Republic of Korea. Thanks goes to Hahn Ki Syun, chief of the engineering section, Radio Korea, Office of Public Information, Pusan, Republic of Korea, for this data:

"Due to the war, we have lost almost all of our broadcasting equipment, but our engineers have been trying to rebuild our facilities one by one. We have constructed a 10 kw. broadcasting (medium-wave) at Taegu, a part of our *Radio Korea Network*, and a similar station was completed at Taejon in November. We expect to build up the 1 kw. short-wave station at Seoul and the 400 w. short-wave station at Taejon within a few weeks. And within a few weeks more, short-wave listeners should be able to listen to our 'Voice of Freedom' on a 10 kw. short-wave outlet from Seoul; a further 10 kw. medium-wave station will follow at Seoul. We have had much difficulty through shortages of equipment, materials, and even engineering books."

Mr. Hahn gives this picture of current broadcasting in Korea:

Seoul, HLKA, 970 kc., 5 kw., and 9.555, 300 w. Pusan, HLKA, 800 kc., 5 kw.; 2.510, 1 kw., and 7.935, 1 kw.; former HLKB, 650 kc., 500 w., is now a 1 kw. "spare" medium-wave outlet. Iri, HLKF, 570 kc., 500 w.; Taegu, HLKG, 710 kc., 10 kw.; Kwangju, HLKH, 780 kc., 500 w.; Taejon, HLKI, 880 kc., 10 kw.; Namwon, HLKL, 1030 kc., 500 w.; Chunchon, HLKM, 1230 kc., 300 w.; Mokpo, HLKN, 650 kc., 500 w.; Masan, HLKO, 600 kc., 50 w.; Chungju, HLKQ, 600 kc., 500 w.; Kangneung, HLKR, 1080 kc., 500 w., and Cheju, HLKS, 1080 kc., 500 w. These stations make up the *Radio Korea Network* which is currently scheduled 1600-1830, 2130-0030, 0500-0900. Various Asiatic languages are used, and at least the short-wave outlets occasionally identify in *English*. By the time you read this, the new short-wave outlet at Taejon and the further short-wave outlet at Seoul (10 kw.) may be on the air.

Best wishes go to the *Radio Korea Network* and its personnel in the further resumption of radio broadcasting in the Republic of Korea.

Club Notes

England—The World Friendship Society of Radio Amateurs, 35, Bell-

wood Road, Waverley Park, Peckham Rye, London, S.E. 15, England, now has a *new* bulletin especially for its Junior Section members; it is called "Wave-Guide" and is edited by D. F. Shaw and J. I. Meardon.

New Zealand—The New Zealand Radio DX League has named Frank W. Wilson as president to succeed Arthur T. Cushen who had headed the group for the past two years.

USA—The Newark News Radio Club, Newark, New Jersey, recently passed its 25th milestone. And the Universal Radio DX Club, located at Hayward, California, recently observed its 19th anniversary. Congratulations to both!

This Month's Schedules

Albania—*Radio Tirana* is reported now using 6.560, 7.850A at 2300-0100, 1000-1130, 1215-1700. Chatfield, N. Y. notes the 7.850A channel at fair level 1500-1600. Levy, N. Y., notes it with news 2345.

Algeria—*Radio Algeria*, 6.160, noted signing off Arabic session with "La Marseillaise" 1745; had news headlines in Arabic just before closing; the 9.570 outlet, used for French sessions,

(Note: Unless otherwise indicated, all time is expressed in American EST; add 5 hours for GCT. "News" refers to newscasts in the English language. In order to avoid confusion, the 24 hour clock has been used in designating the times of broadcasts. The hours from midnight until noon are shown as 0000 to 1200 while from 1 p.m. to midnight are shown as 1300 to 2400.) The symbol "V" following a listed frequency indicates "varying." The station may operate either above or below the frequency given. "A" means frequency is approximate.

The antenna for the 10 kw. transmitter at Taegu, a "Radio Korea" network affiliate.



noted closing 1800 with "La Marseillaise," after news in French 1751. (Pearce, England)

Anglo-Egyptian Sudan—*Radio Omdurman*, 9.737A, is occasionally audible to fair in its 2315-2345 all-Arabic session. (Niblack, Ind., others)

Angola—*Radio Clube de Angola*, 11.862A, Luanda, has been fading in lately as early as 1340. (Niblack, Ind.) *Radio Clube de Huila*, 10.048A, Sa da Bandeira, more recently has been running to 1600 closedown (formerly closed 1500). (Pearce, England; Ridgeway, South Africa) *Radio Diamang*, CR6RG, Dundo, recently moved from 6.870, is now using 7.065 parallel with 9.344 at 1300-1430 daily; CR6RD, Nova Lisboa, has been heard on Saturday opening 0930, Sundays and weekdays 1230, using 9.705, 9.7096 to 1530 closedown. (Ridgeway, South Africa)

Argentina—LRN, 9.66, Buenos Aires, *Radio El Mundo*, noted at strong level around 2045. (Stein, Calif.) SIRA announces *English* for 17.720 at 1700-1930; 11.880 at 1300-1400; 15.290 at 2300-0100. (Villela, Md.) *Radio Belgrano*, 9.755A, has hourly national and world news in Spanish at 55 minutes past the hour, according to Villela; at 1825 ("las 20:25, hora que Eva Peron entro en la eternidad"—"at 2025, the hour that Eva Peron entered Eternity") has a 5-minute official news bulletin in Spanish.

Belgium—ORU, 17.865A, Brussels, noted in French and Dutch 0500. (Pearce, England) The 6.065 outlet noted with dance music 2240, signing off North American transmission 2400. (Lieberman, N. Y.) *English* for North America is currently carried over ORU, 6.065, beamed to North America, and 9.745 beamed to Belgian Congo, and relayed by OTC, 9.655, Leopoldville, at 2100-2400. Kelting, N.Y., notes ORU, 9.745, with French program 2045-2130, then *English*.

Belgian Congo—OTM1, 6.295, appears to have replaced 11.720A, audible around 1500 parallel with OTM2, 9.380, in the *Radio Congo Belge* transmission to 1600 closedown. (Kary, Pa.) OTH, 9.210, is heard in Sweden 1245-1330. (*Nattugglan*, Sweden) *Radio Elizabethville*, OQ2AB, 11.90, has been noted recently on Tue. as well as Sun. with the 0930-1100 session. *Radio Leo*, OQ2AA, 11.717, on Sun. only has a session 0300-0430 which is all-French; OTM4, 11.72A, now opens 0300 with French and Flemish programs to 0730 (Continued on page 127)

3-ELEMENT 14_{MC}. ROTARY BEAM ANTENNA

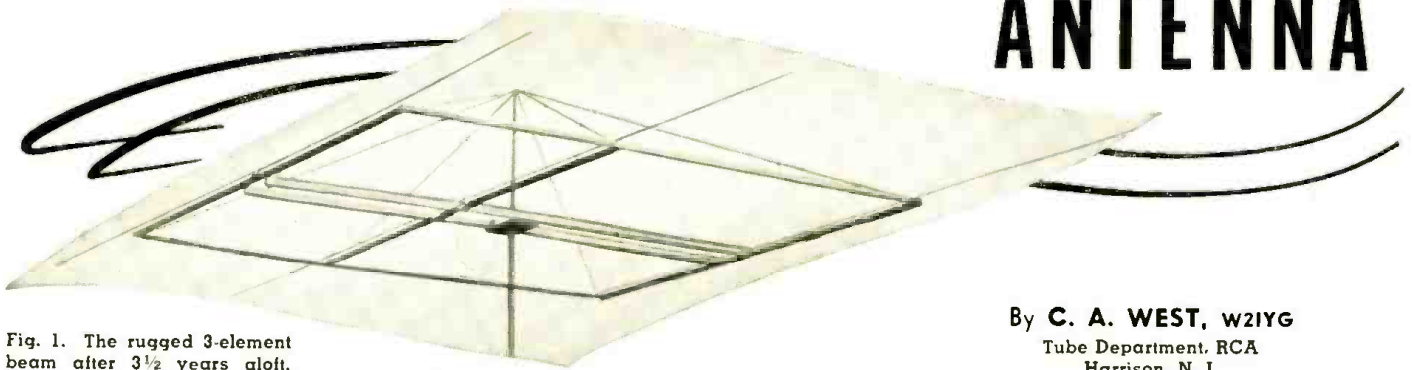

Fig. 1. The rugged 3-element beam after 3½ years aloft.

By **C. A. WEST, W2IYG**
Tube Department, RCA
Harrison, N. J.

High front-to-back ratio, good forward gain, and a beam that stays up in the wind are the result of careful design. Simplified construction and adjustment are also featured.

ONE sure aid in working DX is the use of a rotary-beam antenna. This article describes the construction of a 3-element, 14-megacycle rotary beam which was built by the author. The antenna, which has been in use for more than three and a half years, remains in excellent condition in spite of several of the worst wind and ice storms ever experienced in New Jersey.

There can be very little doubt that sound mechanical planning is of the utmost importance when the construction of an array of this sort is contemplated. Some of the questions which should be answered before actual planning gets under way are:

Is the cost within reason?
Is the array simple to construct?
Can it be assembled easily at its final location?

Is maintenance relatively light?
Will it stay up?

For the beam antenna described in this article, the answer to all of these questions is "yes." The entire cost of the array was about \$75.00. No special tools were required for the construction; anyone familiar with saw, hammer, screwdrivers, and pliers could do the job. The final assembly of the beam on a rooftop was completed by three people in about one and a half hours. The only maintenance required so far was the replacement of the guy wires, a two-hour, one-man job which would have been unnecessary if rust-proof cable had been used initially. Fig. 1 is a photograph of the antenna taken more than three and a half years after its construction.

Preliminary Considerations

It was decided to mount the beam on the roof of the house to avoid the added work and expense of constructing a tower. Mounting the antenna on

the roof also provides for the housing of the motor, gear box, direction-indicating equipment, slip rings, transformer and relay, and associated wiring in the attic, thus providing for their protection against the elements and making maintenance work much easier.

Roof mounting also solves the problem of mounting the parasitic array itself. When a tower or pole is used to support the array, it is usually necessary to assemble the array before it is finally placed atop the tower or the pole. Needless to say, a 3-element, 14-megacycle array, 34 feet long and 17 feet wide, is a rather cumbersome assembly to raise to the top of any tower or pole. Roof mounting, however, provides for assembly at the final location.

Another advantage of mounting the

Fig. 2. A pipe shaft runs up through the roof inside a larger pipe bushing, steadied by pipe straps. At the top are two 2 x 6 roof supports. Note the BX cables.



beam on the roof is that provision is made for short feedlines and other wires and cables for carrying power to the rotator, and to the electric-indicating system, if one is used.

Whether the antenna is to be supported by a roof, a tower, or a pole, many of the ideas presented in this article should prove quite useful. It is recommended that a lot of thought be put into the planning of the beam. Many arrays have been completely destroyed by wind and sleet storms due to poor mechanical construction.

Main Supports

It was estimated that the entire array plus the rotator (propeller-pitch type) would weigh about 150 to 200 pounds. The supports in the attic would have to hold this weight safely and would also have to have enough strength to provide for bending and twisting torque created by the wind striking the array. For this reason, two pieces of 2" x 8" lumber were used to support the platform on which the shaft of the array and the rotator were mounted, as shown in Fig. 2. These 2" x 8" pieces were bolted securely to two of the 2" x 8" rafters in such position that about two-thirds of the shaft supporting the array was below the roof top. It is important that this length of the array be below the roof to provide for bending torque on the shaft, and to reduce the hazard of damage to the roof if strong winds strike the array broadside. Two 2" x 4" pieces of lumber were also bolted to the main supports as shown in Fig. 2 to provide for torque at right angles to the main supports and to give added strength.

After the main supports had been bolted into place, the rotator platform was prepared. Two pieces of 2" x 12" lumber were cut to the width of the main supports, allowing a little overhang for later centering of the shaft of the array on the rotator flange. A hole large enough to pass the array shaft was cut in the center of the joined 2" x 12" pieces and, with the rotator mounting plate used as a template, holes were drilled for fixing

the rotator in place. The mounting plate is used on top of the wood rotator platform for added strength.

At this point, consideration was given to the shaft and its bushing. A 2-inch pipe was used for the bushing and a 1½-inch pipe for the shaft. The two slipped together very easily with a fraction of an inch play, but there was no problem with rattling. When the 2-inch pipe used for the bushing was cut with a pipe cutter, a small edge protruded at the inner circumference; this edge was filed until the 1½-inch pipe shaft fit snugly into the bushing.

It is preferable to install the shaft bushing before the initial assembly of the array. When the proper point was located on the roof, a hole was made in the roof to hold the bushing, as shown in Fig. 4. The roof was re-inforced by means of two pieces of 2" x 6" lumber, and a plumb line was dropped through the bushing so that the bushing could be brought into a vertical position. The steel straps were then fastened in place, as shown in Figs. 2 and 4. The bushing must be sealed at the point where it comes through the roof to prevent rain coming into the attic.

Rotator Preparation

There are several difficulties involved if the rotator (propeller-pitch type) is used "as is," chief of which is slow rotation speed. Another difficulty is the burning of brushes and commutator when a.c. is used to energize the d.c. motor. In addition, a considerable amount of electrical noise is generated, which wreaks havoc in the receiver when the array is rotated to peak a signal.

All these difficulties can be avoided by making the last set of planetary gears inoperative. These gears may be disabled quite simply by removing the upper spline from the gear box assembly and fastening the shaft pipe flange right on top of the planetary gear housing, as shown in Fig. 4. This operation makes possible a much greater shaft rotation speed for a given voltage applied to the rotator motor. Before the spline was removed, about 25 volts a.c. was required to obtain a shaft rotation of 1 rpm. With the spline removed, only about 15 volts a.c. was required for one rpm. Two other improvements are also obtained: (1) electrical noise is cut to a much lower value; (2) burning of the brushes and commutator is prevented and heating of the motor is reduced.

While the rotator is being modified, it is a good idea to remove the motor from the gear box and disassemble it for inspection. If the commutator has a ridge burned in it, the armature should be removed and the commutator turned down. The insulating surfaces between the commutator faces should be cleaned with a sharp pointed tool to remove any small metal particles which accumulate during the commutator turn-down. The entire motor may be cleaned in kerosene with the

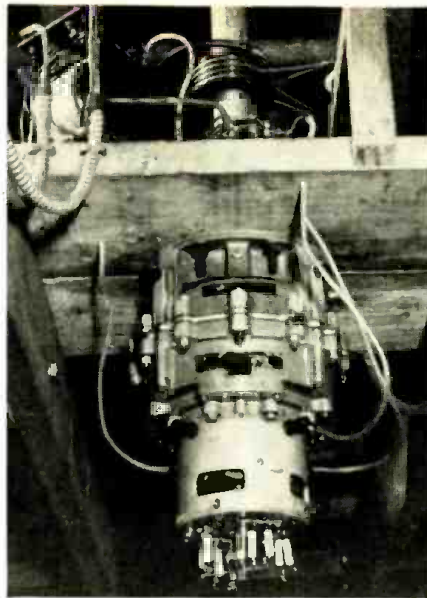

Fig. 3. The motor and gear box are mounted below the platform. The motor housing is removed to show the bypass condensers for the brushes. At top, brass rod brushes bear against slip rings on the shaft.

aid of a brush, then wiped dry and re-assembled.

Electrical noise generated by brush sparking may be reduced by connecting a 0.01 μ f.d. condenser between each brush lead and the case of the motor, as shown in Fig. 3. The reduction in noise on 20 meters is sufficient to allow rotation of the array without drowning out weak signals, even when there is no noise limiter on the receiver.

Array Design

There are two general classifications of array construction, self-supporting and frame with guy-wire supports. The author discarded the self-supporting type almost immediately because of the lack of strength exhibited by several of these beams in his neighborhood. The design shown in Fig. 5 was chosen for several reasons: 1. economy and availability of

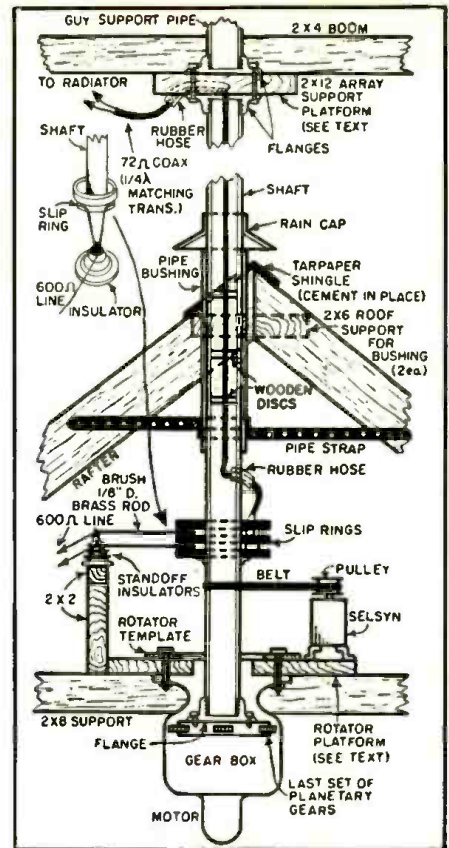

Fig. 4. Detail drawings of the rotator and beam support. One of the two slip ring and brush assemblies is shown at upper left.

materials, 2. strength, 3. ease of construction and assembly, 4. ease of tuning.

Basically, a parasitic array requires at least two elements, a radiator and either a reflector or a director. If greater gain or front-to-back ratio is desired, additional directors and reflectors may be added. The 3-element array was chosen to provide maximum front-to-back ratio. Although a 3-element array may be tuned for either maximum forward gain or maximum front-to-back ratio, the latter was chosen for two reasons: (1) it was

Fig. 5. Construction details of the beam and tuning stubs. The guy wires are broken into non-resonant lengths by the insulators. Aluminum should be used for the tuning stubs, if possible, as copper-to-aluminum contacts may corrode. The wooden braces keep elements from whipping in the wind, changing beam characteristics.

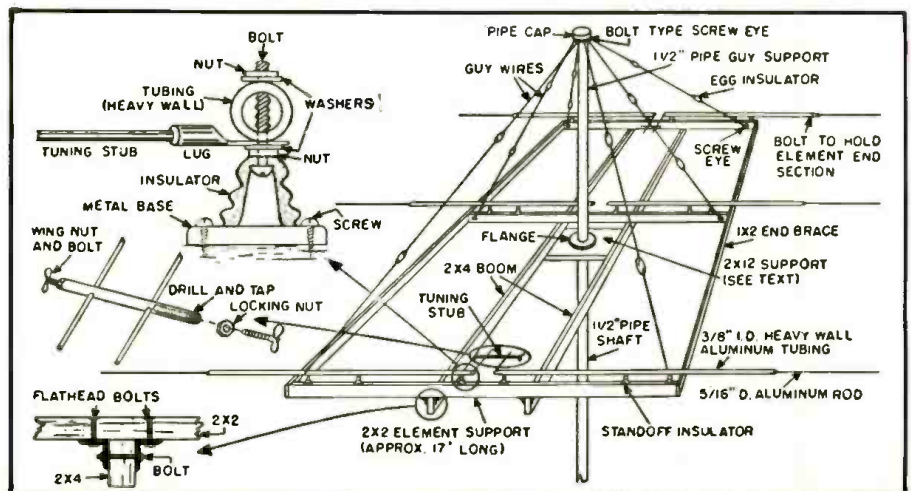



Fig. 6. The "on-off" switch, fuse, and pilot lamp are mounted at the beam-indicator map. The control switch is at the operator's desk. A selsyn drives the arrow.

highly desirable to be able to reduce to a minimum the strength of all signals not coming from the direction of the desired signal; (2) the comparative difference in forward gain between the two systems of tuning is negligible.

When maximum front-to-back ratio is desired, the satisfaction gained by tuning a parasitic array is well worth the small amount of additional effort involved. There are two popular methods of tuning the director and reflector. One is to lengthen or shorten the outer ends of the elements, and the other is to lengthen or shorten the center section of the elements by means of adjustable stubs.

The latter method was chosen for two reasons: (1) the r.f. potential at the center of each element is close to zero, thus preventing r.f. burns when the energized array is being adjusted; (2) correct adjustment is assured because element symmetry is maintained by one adjustment which can be made from a single position on the roof. If the first method of adjustment were used, it would be necessary to move back and forth from the end of each element continually, making an adjustment, testing, and repeating the procedure until the correct element length was obtained. With the second method, it is necessary only to slide the shorting bar back and forth until tuning is correct and then lock the bar in place. The method of making this adjustment will be described later.

Copper-to-aluminum contacts should be avoided in the stubs because they may cause galvanic action, with resultant deterioration of the aluminum. Small copper parts such as lugs, washers, etc., should be carefully tinned, and the final joints covered with a good varnish. It would be a good idea to varnish all the elements when the beam is completed.

Because the author was interested

primarily in best performance in the phone section of the 20-meter band, the design frequency chosen was 14.25 megacycles, the center of the American phone band. The length in feet of the radiator, director, and reflector were determined from the following relations, in which the decrease of 4 per-cent in director length and the increase of 5 per-cent in reflector length, as compared with the length of the radiator, were taken into consideration:

$$\begin{aligned} \text{Length (radiator)} &= \frac{468}{f(\text{mc.})} = \frac{468}{14.25} = 32' 11'' \\ \text{Length (director)} &= \frac{450}{f(\text{mc.})} = \frac{450}{14.25} = 31' 7'' \\ \text{Length (reflector)} &= \frac{492}{f(\text{mc.})} = \frac{492}{14.25} = 34' 6'' \end{aligned}$$

The length of the two tuning stubs and the shorting bar must be taken into consideration, as shown in Fig. 7. For example, the length of each half of the director is 15 feet, 2 inches; thus, the length of the whole director is 30 feet, 4 inches. The length of each tuning stub is 12 inches, but the shorting bar is set initially at 6 inches; thus, the total effective length of the stubs is 1 foot. The shorting bar itself is 3 inches. Therefore, the total length of the director is 31 feet, 7 inches, the desired calculated length. Because the director should be about 4 per-cent shorter in length than the radiator, as mentioned previously, the 12-inch stubs allow for a variation of from 1 per-cent to 7 per-cent, with the mean at about 4 per-cent.

Tests have shown that maximum gain is obtained with a director-radiator spacing of 0.1 wavelength and a reflector-radiator spacing of 0.15 wavelength. The following equations may be used to determine the length in feet between the director and the ra-

diator, L_d , and the length between the reflector and the radiator, L_r .

$$\begin{aligned} L_d &= \frac{0.1K}{f} = \frac{98.4}{14.25} = 6' 11'' \\ L_r &= \frac{0.15K}{f} = \frac{147.5}{14.25} = 10' 4'' \end{aligned}$$

where: K = one wavelength = 984 feet.
 f = frequency in megacycles.

The construction of the array, as shown in Fig. 5, is relatively simple. Because the entire array is supported by six guy wires, pieces of 2" x 4" lumber were used for the boom. The length of the boom is determined by the distance between the director and the reflector. Three pieces of 2" x 2" lumber used to support the elements were bolted to the boom by means of 90-degree angles. After the entire array had been assembled on the ground to determine the "center-of-gravity" point, a piece of 2" x 12" lumber the width of the boom was fastened to the boom at this point. The use of these pieces prevents bending torque on the shaft and balances the entire array on the shaft.

One advantage of the frame construction is that elements of small diameter may be used. About half of the length of each element is supported by the 2" x 2" pieces of lumber, which are approximately 17 feet long. The array shown in Fig. 5 used two 12-foot lengths of heavy-wall aluminum tubing having an inside diameter of $\frac{3}{8}$ -inch, with a length of solid aluminum rod having a $\frac{5}{16}$ -inch diameter inserted into the tubing at the outer end to provide the proper length. Two pieces of 1" x 2" lumber were screwed to the ends of the element supports, as shown in Fig. 5, to prevent the element supports from whipping in the wind and thus changing the spacing between elements.

The main strength of the entire array lies in the six guy wires and their arrangement. A molded steel pipe flange was used to support a five-foot length of 1½ inch pipe, the top of which is used as the focal point for the six guy wires. Two egg insulators break each guy wire into three equal sections and prevent any resonant effect from the guy wires. Rustproof wire or cable should be used for the guy wires to prevent rusting and snapping. If steel wires are used, they should be coated with some rust-inhibiting material, such as aluminum paint. The use of rustproof and rust-inhibiting materials throughout the array will save considerable maintenance time and effort later on. Wooden members should be undercoated and painted with good enamel, with a top coat of spar varnish.

Feeding the Array

There are several methods for feeding a parasitic array, such as the "T" match, delta match, and quarter-wave transformer match. The quarter-wave transformer match was chosen for reasons of cost, simplicity, and ease of adjustment. (Continued on page 142)

Fig. 7. Dimensions of the beam proper. The elements are aluminum tubing. The radiator is fed through a ¼-wave coaxial matching transformer via slip rings.

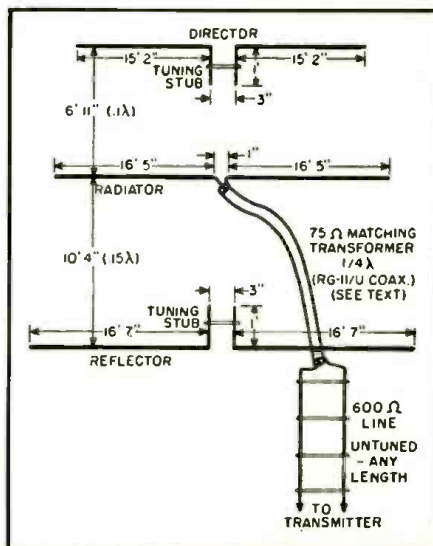

For opportunities within your reach

See what the RCA TV Servicing Course offers you



Good-pay jobs. A business of your own.

OPPORTUNITIES FOR GOOD-PAY JOBS in Television are within your reach when you study TV Servicing by the RCA Institutes Home Study Method. Or perhaps you would like to start a TV Service business of your own.

If you are not satisfied with the way your future now stacks up, see how easily

you can change the course of your career. RCA Institutes Home Study Course in TV Servicing is helping thousands of other people to better jobs. It can help you. Right now thousands of opportunities are going begging. There is a critical shortage of trained TV servicemen. This is *your* big opportunity.

Easy-to-understand, illustrated lessons



The entire course is divided into ten units of several individual lessons. You study them at home in your spare time.

Lesson-by-lesson you learn the theory and step-by-step procedures of installing TV antennas, of servicing and trouble-shooting TV receivers. Hundreds of pictures and diagrams help you understand the how-it-works information and the how-to-do-it techniques. You will be amazed how easily you absorb the knowledge of each lesson, how quickly you train yourself to become an experienced technician.

Experienced engineers and faculty prepared the course, grade your lessons



The RCA Institutes course was written and planned by instructors with years of specialized experience in training men by home-study and resident-school methods. The course embodies RCA's background of television experience plus knowledge gained in training several thousand technicians. A study of the course parallels an apprentice's training. Your lessons are carefully examined and accurately graded by friendly teachers who are interested in helping you to succeed.

One of the leading and oldest Radio-Television training schools



Founded in 1909, RCA Institutes, Inc. has been in continuous operation for the past 44 years. Its

wide experience and extensive educational facilities give students, just like you, unsurpassed technical training in the highly specialized field of radio-television-electronics.

RCA Institutes is licensed by the University of the State of New York . . . an affiliate member of the American Society for Engineering Education . . . approved by the Veterans Administration . . . approved by leading Radio-Television Service Organizations.

It costs so little to gain so much

RCA Institutes makes it easy for you to take advantage of the big opportunities in TV Servicing. The cost of the TV Servicing Home Study Course has been cut to a minimum. You pay for the course on a pay-as-you-learn unit lesson basis. No other home study course in TV Servicing offers so much for so little cost to you.

RCA Institutes conducts a resident school in New York City offering day and evening courses in Radio and TV Servicing, Radio Code and Radio Operating, Radio Broadcasting, Advanced Technology. Write for free catalog on resident courses.

SEND FOR FREE BOOKLET—Mail the coupon—today. Get complete information on the RCA INSTITUTES Home Study Course in Television Servicing. Booklet gives you a general outline of the course by units. See how this practical home study course trains you quickly, easily. Mail coupon in envelope or paste on postal card.



MAIL COUPON NOW!

RCA INSTITUTES, INC., Home Study Dept. RN253
350 West Fourth Street, New York 14, N.Y.

Without obligation on my part, please send me copy of booklet "RCA INSTITUTES Home Study Course in TELEVISION SERVICING." (No salesman will call.)

Name _____ (please print)
Address _____
City _____ Zone _____ State _____



RCA INSTITUTES, INC.
A SERVICE OF RADIO CORPORATION of AMERICA
350 WEST FOURTH STREET, NEW YORK 14, N.Y.

Thousands depend on PHOTOFACT! THEY TELL YOU WHY

Unsolicited letters tell what the world's finest TV and Radio Data means to Service Technicians



Alexander Cuomo
193 Columbia St.
Brooklyn, N. Y.

"Just to let you know that your PHOTOFACT diagrams are a lifesaver to me and many other Radio and TV men. I congratulate you and your entire staff that worked hard to make it possible for us to read your diagrams in a simple manner. Thank you."



C. S. Pruett
Pruett's Radio Shop
450 N. 7th St.
Dade City, Fla.

"I have all of your PHOTOFACT Folders, and I think they are the most useful thing in my shop. They really save time and money."



Fred Hale
719 E. 10th St.
Brooklyn, N. Y.

"Let me say that I like the way you put out PHOTOFACT Folders. It is worth \$1.50 for one circuit alone because you do a thorough job."

NOW! GET THE PROOF FOR YOURSELF!

FREE

We'll send you a Free Photofact Folder on any receiver listed in "PF Index & Technical Digest."

Learn for yourself—at our expense—how PHOTOFACT pays for itself by earning bigger repair profits for you! Select any Folder from the PF Index (if you haven't an index, get a copy from your distributor). When you write us for your Free Folder, be sure to state Photofact Set and Folder Number as shown in the Index. Get your Free Folder now. Examine, use, compare—see why you can't afford to be without PHOTOFACT!

HOWARD W. SAMS & CO., INC.
2203 E. 46th St., Indianapolis 5, Ind.

HOWARD W. SAMS & CO., INC.

NEW TV GRANTS SINCE FREEZE LIFT

Partial listing of construction permits granted by the FCC since lifting of freeze. Additional stations will be listed next month.

STATE	CITY	CALL**	CHANNEL	FREQUENCY (mc.)	POWER (Video)*
Alabama	Gadsden	WTVS	21	512-518	22
"	Mobile	WALA	10	192-198	316
"	Mobile	WKAB-TV	48	674-680	22.5
"	Montgomery	WCOV-TV	20	506-512	88
Arizona	Tucson	KVOA-TV	4	66-72	11
"	Tucson	KOPO-TV	13	210-216	316
Arkansas	Fort Smith	KFSA-TV	22	518-524	265
"	Little Rock	KETV	23	524-530	17.5
"	Little Rock	KRTV	17	488-494	22
California	Santa Barbara	KEYT	3	60-66	50
"	San Bernardino	KITO-TV	18	494-500	87
"	Fresno	KMJ-TV	24	530-536	105
Colorado	Colorado Springs	KDRO-TV	13	210-216	11.5
"	Denver	KIRV	20	506-512	89
"	Denver	KFEL-TV	2	54-60	56
"	Denver	KBTV	9	186-192	240
"	Denver	KDEN	26	542-548	105
"	Pueblo	KCSJ-TV	5	76-82	12
"	Pueblo	KDZA-TV	3	60-66	10.5
Connecticut	Bridgeport	WSJL	49	680-686	99
"	Bridgeport	WICC-TV	43	644-650	81
"	New Britain	WKNB-TV	30	566-572	180
"	Waterbury	WATR-TV	53	704-710	245
Florida	Ft. Lauderdale	WITV	17	488-494	18.8
"	Ft. Lauderdale	WFTL-TV	23	524-530	100
"	Pensacola		15	476-482	20
"	St. Petersburg	WSUN-TV	38	614-620	83
Illinois	Belleville	WTVI	54	710-716	115
"	Decatur	WTVP	17	488-494	18
"	Peoria	WEEK-TV	43	644-650	175
"	Rockford	WTVO	39	620-626	15.5
Indiana	Muncie	WLBC-TV	49	680-686	16
"	South Bend	WSBT-TV	34	590-596	170
Iowa	Sioux City	KVTV	9	186-192	29
"	Sioux City	KWTV	36	602-608	18.5
Kentucky	Ashland	WPTV	59	740-746	250
"	Henderson	WEHT	50	686-692	26
"	Louisville	WKLO-TV	21	512-518	200
Louisiana	Baton Rouge	WAFB-TV	28	554-560	225
Maryland	Frederick	WFMD-TV	62	758-764	105
Massachusetts	Fall River	WSEE-TV	46	662-668	19.5
"	Holyoke	WHYN-TV	55	716-722	65
"	New Bedford	WNBH-TV	28	554-560	200
"	Springfield	WWLP	61	752-758	115
Michigan	Ann Arbor	WPAG-TV	20	506-512	1.75
"	Battle Creek	WBCK-TV	58	734-740	18.5
"	Battle Creek	WBKZ-TV	64	770-776	24.5
"	Flint	WCTV	28	554-560	17.5
"	Flint	WTAC-TV	16	482-488	59
"	Jackson	WIBM-TV	48	674-680	225
"	Kalamazoo	WKMI-TV	36	602-608	83
"	Saginaw	WKNX-TV	57	728-734	17.5
Minnesota	Duluth	WFTV	38	614-620	17
Mississippi	Jackson	WJTV	25	536-542	180
Missouri	St. Joseph	KFEQ-TV	2	54-60	52
"	Springfield	KTTS-TV	10	192-198	12.5
Nebraska	Lincoln	KOLN-TV	12	204-210	21.5
"	Lincoln	KFOR-TV	10	192-198	56
New Jersey	Asbury Park	WCEE	58	734-740	100
"	Atlantic City	WFPG-TV	46	662-668	18
New York	Elmira	WTVE	24	530-536	58
"	Poughkeepsie	WEOK-TV	21	512-518	105
North Carolina	Asheville	WISE-TV	62	758-764	23
"	Greensboro	WCOG-TV	57	728-734	115
"	Raleigh	WETV	28	554-560	280
Ohio	Akron	WAKR-TV	49	680-686	145
"	Dayton	WONE-TV	22	518-524	210
"	Lima	WLOK-TV	73	824-830	20
"	Massillon	WMAC	23	524-530	99
"	Youngstown	WUTV	21	512-518	170
"	Warren	WHHH-TV	67	788-794	80
"	Youngstown	WFMJ-TV	73	824-830	175
"	Youngstown	WKBN-TV	27	548-554	200
Oregon	Portland	KPTV	27	548-554	91

*ERP = (effective radiated power). **Call letters without TV suffix from application files and subject to change; except where included in calls such as KBTV.

.. = Call letters to be announced.

Check these ADVANTAGES FOUND Only in HEATHKITS

1

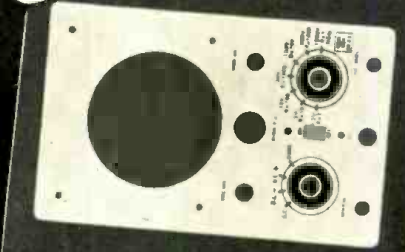

2



3



4



5



6

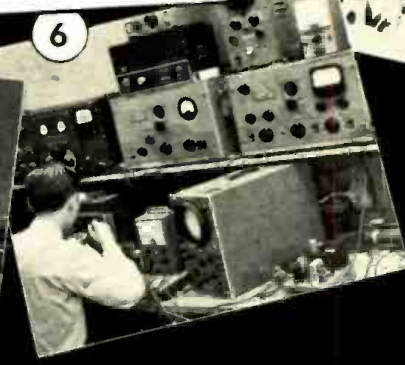

9



8



7



- ✓ **1. Baked Enamel Lifetime Finish Panels** — Oven baked finishes for maximum durability and freedom from mars, scratches and discoloration. Panels that can really take service shop and laboratory abuse.
- ✓ **2. Save Money** — You save all expensive factory wiring costs when you build your own. And, direct factory to customer sales eliminate all middle man profits. You can have a complete Heathkit laboratory or service shop for what one or two pieces of ready built equipment cost.
- ✓ **3. Modern Styling** — New "fitted panels" and formed cabinets with rounded corners present a smart, professional appearance. Dignified appearance for prestige.
- ✓ **4. Quality Components Used Throughout** — Heathkits use well known, time and quality tested components such as Simpson, Chicago Transformer, Wilkor, Allen-Bradley, Altec-Lansing, Centralab, Cinch, Oak, Grigsby-Allison, Mallory and many others.
- ✓ **5. Extensive Factory Facilities** — Shearing, punching, forming, spot welding, etc. is done right in our own plant — controlled production for highest quality and less cost to you.
- ✓ **6. Extensive and careful engineering** — A staff of engineers working in a modern, well equipped laboratory carefully develop Heathkits according to highest engineering practices. Your assurance of accurate, up to the minute instruments.
- ✓ **7. Complete Kits** — All the parts are right in the kit — you get all tubes, controls, transformers, meters — everything — no other components to buy. And no cutting, punching, or painting necessary — it's all done for you. Heathkits go together easily and smoothly.
- ✓ **8. Only Complete Line** — Over 30 kits available — Heathkits form the only complete line of kit-form test equipment on the market. Kits for hams, engineers, service men, schools and audio enthusiasts.
- ✓ **9. Detailed, Complete Instruction Manuals** — Comprehensive manuals tell you exactly how to build your Heathkit. Manuals contain easy-to-follow instructions, clear, large pictorials, schematic, detail drawings, etc. They make construction easy, fun, and educational.

Nine New Heathkits This Year!

EXPORT AGENT
ROCKE INTERNATIONAL CORP.
33 E. 40th ST.
NEW YORK CITY (10)
CABLE: RRKRN Y

The **HEATH COMPANY**

... BENTON HARBOR 15, MICHIGAN

NEW Heathkit "Q" METER KIT

• A HIGH QUALITY Q METER AT LOW COST.

MODEL QM-1

SHIPPING
WT. 12 LBS.

\$39⁵⁰

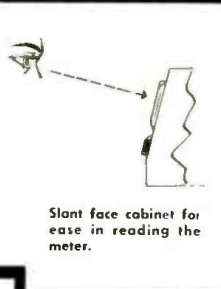
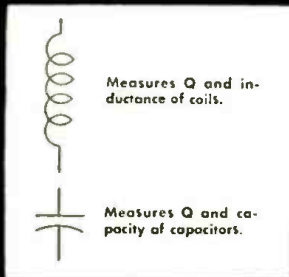

- First Q METER within the price range of all.
- Read Q's of 0-500 directly on calibrated scale.
- Stable oscillator supplies R.F. frequencies of 150 kc to 18 megacycles.
- Calibrated capacitor with range of 40 mmf to 450 mmf with vernier of ± 3 mmf.
- Simple, easy operation.
- Can be used to measure small inductances or capacitors.
- Measures Q of condensers, RF resistance and distributed capacity of coils.
- Measures capacity by substitution, capacity by resonance, inductance by resonance.
- Slanted panel for convenient operation.

Another outstanding example of progressive HEATHKIT engineering. Now a highly desirable Q METER within the price range of all laboratories, schools and experimenters. No longer is it necessary to deny yourself the many measurement advantages offered by this instrument.

Use the new HEATHKIT Q METER for the following simple basic measurements: capacity by substitution, capacity by resonance, inductance by resonance and Q at the OPERATING frequency all can be read on the calibrated scales. The method used to obtain information regarding the Q of condensers, RF resistance, distributed capacity in coils, etc., is only slightly more involved. In the HEATHKIT Q METER, the generated RF signal is coupled through a cathode follower and injected across a low impedance condenser which is included in the resonant circuit under test. Large $4\frac{1}{2}$ " 50 microampere Simpson meter reads Q directly. The resonating condenser and vernier condenser are calibrated in mmf for substitution method capacity tests. The resonating condenser is also calibrated in effective capacity for resonance tests. The inductance calibration serves for rapid determination of the approximate inductance of a coil. The HEATHKIT Q METER has a generator frequency range of 150 kc to 18 megacycles. Vernier capacity covers ± 3 mmf and the resonating condenser is calibrated from 40 mmf to 450 mmf actual capacity or 40 mmf to 350 mmf effective capacity. Meter reads Q directly up to 250. Higher and lower full scale readings can be obtained by varying the injection voltage levels.

The entire kit consists of 12AT7, 6AL5, 6C4, OD3 and 6X5 tubes, 50 microampere Simpson meter, power transformer, cabinet and all other parts necessary for construction as well as instructions for assembling, testing and operation of the completed instrument.

Heathkit DECADE RESISTANCE KIT

The HEATHKIT DECADE RESISTANCE KIT is widely used by schools, experimenters and laboratories because of the extremely wide resistance range offered and the useful, dependable service provided. The DECADE consists of 5 rotary 2 deck ceramic wafer switches with silver plated contacts and twenty 1% precision resistors in a circuit which provides the resistance range of 1 ohm to 99,999 ohms in 1 ohm steps. The HEATHKIT DECADE RESISTANCE KIT is simple to construct and is housed in a beautiful polished birch cabinet with an attractive panel. The DECADE will furnish years of accurate trouble-free service.

Individual decade sections of above can be purchased separately for special applications.



MODEL DR-1
SHIPPING
WT. 4 LBS.

\$19.50

NEW Heathkit DECADE CONDENSER KIT

Extremely useful in all experimental and design work such as determination of condenser values for: compensating networks, filters, bridge impedances, tuned circuits, etc. Uses all precision silver mica condensers within $\pm 1\%$ accuracy. Values run in three decades from 100 MMFD to 0.111 MFD in steps of 100 MMFD. Smooth acting, positive detent, highest quality ceramic wafer switches make all capacitor values easy to set up and keep losses to a minimum. Low loss dielectric terminal board mounts on outside of panel for easy cleaning. Heathkit binding posts accommodate a wide variety of test leads. Comes complete with all parts, including polished birch cabinet.

Individual decade sections of above can be purchased separately.

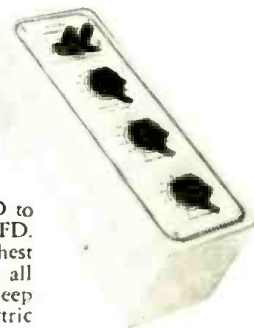

MODEL DC-1
SHIPPING
WT. 4 LBS.

\$16⁵⁰

EXPORT AGENT
ROCKE INTERNATIONAL CORP.
13 E. 40th ST.
NEW YORK CITY (10)
CABLE: RRHAK NYL

The HEATH COMPANY

... BENTON HARBOR 15, MICHIGAN

NEW *Heathkit* OSCILLOSCOPE KIT

• NEW WIDE BAND VERTICAL AMPLIFIER ± 2 DB 10 CYCLES TO 1 MC.



Direct plate connections for modulation tests.



Displays TV sync pulses correctly.



Useful to 5 mc.



Good square wave response at 100 kc.

MODEL O-8

SHIPPING
WT. 29 LBS.

\$43.50

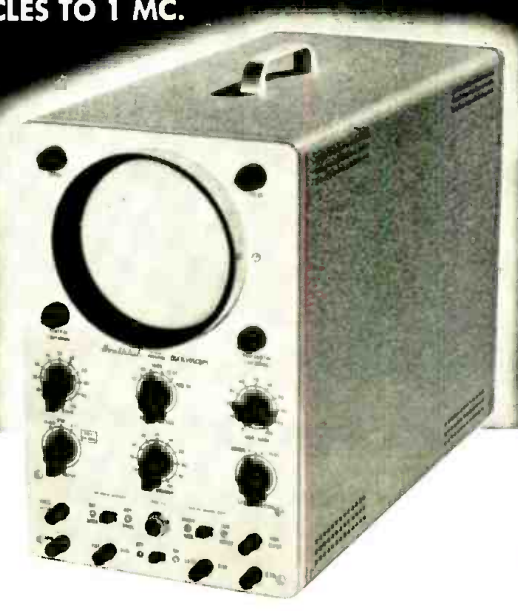

- New wider band vertical amplifier ± 2 db from 10 cycles to 1 megacycle useful to over 5 megacycles.

- High sensitivity in vertical amplifier. .025 volts RMS per inch deflection.

- New 3 step input attenuator input ranges X1, X10, X100.

- New 5CP1 intensifier type tube for greater brilliance.

- Terminal board and rear cabinet opening provisions for direct connections to deflecting plates.

- Newly styled formed and ventilated aluminum cabinet.

- Wide band sweep generator, 15 cycles to over 100 kc. Will synchronize with 5 megacycle signal.

- 10 tube circuit featuring push pull operation of vertical and horizontal amplifiers.

- Internal synchronization on either positive or negative peaks.

- Reproduces faithfully the front and back porches of TV sync pulses. Excellent square wave reproduction to over 100 kc.

- Optional Intensifier kit available for 2200 volt operation.

Proudly announcing the new 1953 HEATHKIT Model O-8 OSCILLOSCOPE featuring the finest performance ever offered in this extremely popular kit instrument. Improved wider band vertical amplifier featuring a new 3-step input attenuator affording smooth control of the excellent .025 volts per inch vertical sensitivity. Possibility of overloading the vertical input circuit is minimized. Greater band width in the vertical channel is a decided advantage to TV service men. Permits clear observation of all TV sync pulse detail and excellent square wave reproduction over 100 kc. 5CP1 intensifier type CR tube provides a brilliant trace with normal accelerating voltages. A handsome, ventilated cabinet with smooth rounded corners and a snug fitting drawn panel adds to the smartly styled professional appearance. Longer life is assured through cooler instrument operation. Push pull output stages in both vertical and horizontal amplifiers for balanced deflection of the spot. All of the many fine features of the previous model have been retained. Rear cabinet access to terminal board for direct connection to CR plates. The entire kit of all 10 tubes, parts, cabinet and panel as well as detailed construction manual for assembly and operation of the instrument included.

INTENSIFIER KIT: For extreme trace brilliance in special applications such as photography, group demonstrations or operation in brightly lighted areas an optional Intensifier kit providing 2200 volt operation of the CR tube is available. Kit includes high voltage filter condenser, high voltage selenium rectifier, etc. \$7.50.

Heathkit SCOPE DEMODULATOR PROBE KIT



Trouble shooting or aligning TV, RF, IF and video stages requires demodulation of high frequency signals before Oscilloscope observation. The HEATHKIT SCOPE DEMODULATOR PROBE KIT was specifically developed for this application. Kit consists of a probe housing, crystal diode detector circuit, shielded cable and spade lugs. Assembly is simple and the probe will quickly prove its usefulness as an Oscilloscope accessory.

No. 337
SHIP. WT. 1 LB.
\$4.50

NEW *Heathkit* VOLTAGE CALIBRATOR KIT

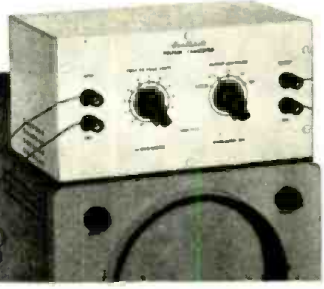

MODEL VC-1
SHIPPING
WT. 5 LBS. **\$9.50**

Use the Heathkit Voltage Calibrator with your oscilloscope to measure peak-to-peak TV complex waveshapes. TV manufacturer's specifications indicate correct peak-to-peak voltages and this kit will permit making these important measurements.

A big help to engineers in circuit work. Makes peak-to-peak voltage measurements of complex waveshapes of all kinds. Flat topped semi-square wave output of calibrator assures fast and easy measurement of any voltage between .01 and 100V peak-to-peak.

The Voltage Calibrator can remain connected to your oscilloscope at all times for instant use. "Signal" position connects signal under study directly through calibrator and into scope input circuit for direct observation. Eliminates transferring leads from calibrator. *A wonderful scope accessory.*

Heathkit ELECTRONIC SWITCH KIT

A few dollars spent for this accessory will increase the usefulness of a scope immeasurably. An electronic switch will open up a whole new field of scope applications for you. The S-2 allows TWO SIGNALS to be observed at the SAME TIME — this important feature allows you to immediately spot phase shift, clipping, distortion, etc. The two signals under observation can be superimposed or separated for individual study. Each signal input has an individual gain control for properly adjusting scope trace patterns. Has both coarse and fine frequency controls for adjusting switching time. Multivibrator switching frequency is from less than 10 cps to over 2000 cps in three overlapping ranges. Kit comes complete including 5 tubes, power transformer, all controls, instruction manual, etc. *Every scope owner should have one!*



MODEL S-2
SHIPPING
WT. 11 LBS.

\$19.50

ROCKE INTERNATIONAL CORP.
13 E. 40th ST.
NEW YORK CITY (16)
CABLE: ARKAD N.Y.

The HEATH COMPANY

... BENTON HARBOR 15, MICHIGAN

Heathkit
VACUUM TUBE

VOLTMETER KIT

• NEW 1½ VOLT RANGE ON 1953 VTVM

MODEL V-6

SHIPPING
WT., 7 LBS.

\$24.50

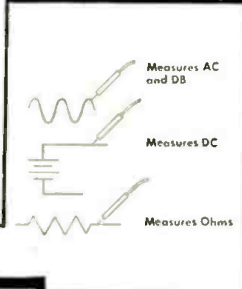
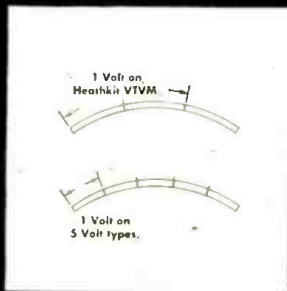
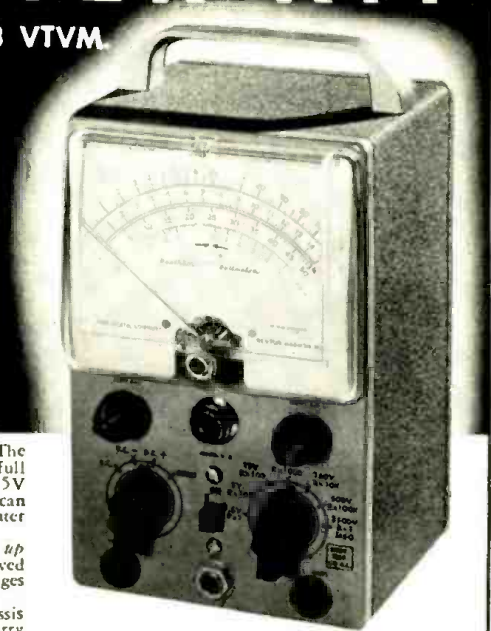

- New 1½ volt low range gives over 2" of scale per volt instead of less than ¾" found on 5 volt range type.
- Increased accuracy due to expanded scales.
- New 1500 volt DC high range gives 50% greater coverage.
- Seven ranges in all. 1½, 5, 15, 50, 150, 500 and 1500 volts DC (1000 volts maximum AC only).
- Provides proper service ranges 150 volts for AC DC work and 500 volts for AC type service.
- High input impedance, 11 megohms minimizes circuit loading.
- Variety of accessory probe kits available.
- 1% precision resistors in multiplier circuits.
- 200 microampere Simpson meter.
- Center scale zero adjust.
- Transformer operated.
- Test leads included.
- New cabinet styling.
- Large, clearly marked meter scales indicate ohms, AC volts, DC volts and DB.

The 1953 Heathkit V-6 VTVM has improved ranges! The lowest range has been moved way down to 1.5V full scale. This gives 3½" of actual scale length for the 1.5V covered—that's 2½ inches per volt!! Now you can make your low level measurements faster and with greater accuracy.

And the upper range has been moved up. Readings up to 1500V DC can be readily made with new, improved VTVM—plus readings up to 1000V on AC. Higher ranges for extended use.

New vertical chassis mounting gives added chassis space for really easy wiring—no tight corners to worry about. Uses only highest quality components throughout. Simpson 200 microampere meter movement combined with 1% precision resistors in multiplier circuit insure highly accurate and dependable readings.

AC and DC voltage ranges are 0-1.5V-5V-15V-50V-150V-500V-1500V. (1000V max. reading on AC) — a total of seven ranges for convenient, accurate readings. Instrument also measures resistance from .1 ohm to over 1 billion ohms in seven handy ranges of RX1, X10, X100, X1000, X10K, X1 Meg., — all convenient multiples of 10 with no skips. Has Db scale in red for easy identification.

New panel has tough baked on enamel finish for freedom from scratches and maximum durability. Modern styled, formed, compact cabinet with rounded edges and crackle finish is truly handsome.

Comprehensive, detailed instruction manual with step-by-step instructions, figures, pictorials, etc. makes assembly a cinch.

Be sure and look over the special accessory VTVM probes below — for added usefulness.

<p><i>Heathkit</i> R. F. PROBE KIT SHIP. WT. 1 LBS. \$5.50 No. 309 Extends RF range of HEATHKIT 11 megohm VTVM to 250 megacycles ± 10%.</p> 	<p><i>Heathkit</i> 30,000 V. D.C. PROBE KIT SHIP. WT. 2 LBS. \$5.50 No. 336 Provides DC multiplication factor of 100 for any 11 megohm VTVM.</p> 	<p><i>Heathkit</i> PEAK TO PEAK VOLTAGE PROBE KIT SHIP. WT. 2 LBS. \$6.50 No. 338 Reads on DC scale of any 11 megohm VTVM 5 kc to 5 megacycle range.</p> 
--	---	---

NEW *Heathkit* BATTERY TESTER KIT

The new Heathkit Battery Tester measures all types of dry batteries between 1½ volts and 150 volts under actual load conditions. Readings are made directly on a three-color GOOD-WEAK-REPLACE scale that your customers can readily understand. Operation is extremely simple and merely requires that the leads be connected to the battery under test. Only one control to adjust in addition to a panel switch for A or B battery types.

The Heathkit Battery Tester features compact assembly. An accurate meter movement and wire wound control mount in the portable, rugged plastic case.

Use the BT-1 to check portable radio batteries, hearing aid batteries, lantern batteries and photo flash gun batteries.

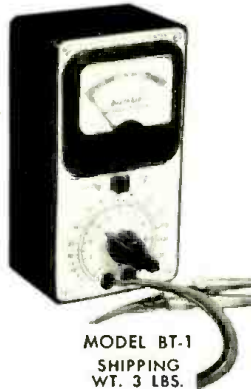

MODEL BT-1
SHIPPING
WT. 3 LBS.

\$7.50

Heathkit AC VACUUM TUBE VOLTMETER KIT

A new AC VTVM that makes possible those sensitive AC measurements required by laboratories, audio enthusiasts and experimenters. Ten full scale ranges of .01, .03, .1, .3, 1, 3, 10, 30, 100 and 300 volts RMS. 10 DB ranges from -52 to +52 DB. Frequency response within 1 DB from 20 cycles to 50 kc. Simpson 200 microampere meter with large plainly marked meter scales. Precision multiplier resistors. Two amplifier stages using miniature tubes. A unique bridge rectifier meter circuit and a clean layout of parts. Order the AV-2 today and become acquainted with the interesting possibilities offered by this instrument.

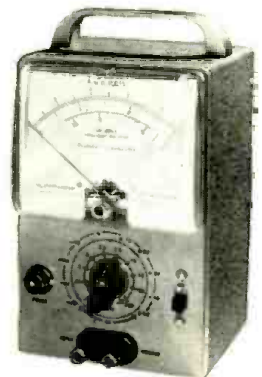

MODEL AV-2
SHIPPING
WT. 5 LBS.

\$29.50

SOLE AGENT
ROCKE INTERNATIONAL CORP.
12 E. 40th ST.
NEW YORK CITY (16)
CABLE: ARELAD NY

The **HEATH COMPANY**

... BENTON HARBOR 15, MICHIGAN

NEW *Heathkit* GRID DIP METER KIT

• CONVENIENT ONE HAND OPERATION.

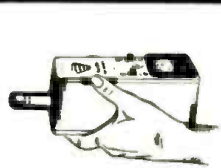
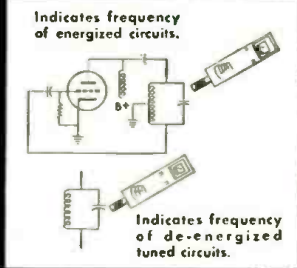

Complete unit easily held and operated with one hand.

MODEL GD-1

SHIPPING
WT. 4 LBS.

\$19⁵⁰



- New GRID DIP METER with assembled calibrated coils.
- Uses quality Simpson 500 microampere meter.
- One hand operation, extremely compact, Only 2½" wide by 3" high by 7" long.
- Variable meter sensitivity control.
- Uses newest type 6AF4 high frequency triode in a Colpitts oscillator circuit.
- Continuous coverage from 2 megacycles to over 250 megacycles in 6 ranges.
- Head phone monitoring jack.
- AC power transformer operated for maximum safety.

Here is the GRID DIP METER KIT you have been asking for. This new HEATHKIT instrument is compact, highly sensitive and easy to use. Housed in a handsome formed aluminum cabinet—rounded corners—durable oven baked finish on panel and cabinet. The entire instrument can be easily held and operated in one hand, tuning accomplished with the thumb wheel drive. This excellent design feature leaves the other hand entirely free for making circuit adjustments. The instrument with many applications—with oscillator energized, use it for finding the resonant frequency of tuned circuits, locating parasitics, determining characteristics of filter circuits, roughly tuning transmitter stages with power off, and neutralizing transmitters. Useful in TV and radio repair work for alignment of traps, filters, IF stages, peaking and compensation networks within the 2 to 250 megacycle range. With the oscillator not energized, the instrument acts as an absorption wave meter and indicates the frequency of radiating power sources. Locates spurious oscillations, as a relative indication of power in various transmitter stages, etc. (Head phones not included). Complete kit includes plug-in coils, tube, all necessary parts and detailed assembly and instruction manual.

Heathkit IMPEDANCE BRIDGE KIT



MODEL IB-1B
SHIPPING
WT. 15 LBS.

\$69⁵⁰

The HEATHKIT IMPEDANCE BRIDGE is especially useful in educational training programs, industrial laboratories and for experimental work. Use it for measuring AC and DC resistance value of resistors,

determination of condenser capacitance and dissipation factor, finding coil inductance and storage factor, electrical measurements work, etc. Quality components: GR 1000 cycle hummer, GR main control, Mallory ceramic wafer silver plated contact switches, ½% precision resistors, etc. The basic circuit is a self powered, 4 arm bridge. Choice of Wheatstone, Capacitance comparison, Maxwell or Hay bridge circuits. Resistance from 10 milliohm to 10 megohm. Capacitance 10 mmf to 100 mfd. Inductance 10 microhenry to 100 henries. Dissipation factor .002 to 1. Storage factor (Q) 1 to 1000. The IMPEDANCE BRIDGE has provisions for external generator use for measurement at other than the 1000 cycle level. Take the guess work out of electrical measurements. The HEATHKIT IMPEDANCE BRIDGE mounted in a beautiful polished birch cabinet with large easy reading panel calibrations will furnish years of accurate, trouble free measurement service.

Heathkit HANDITESTER KIT



MODEL M-1
SHIPPING
WT. 3 LBS.

\$13⁵⁰

The HEATHKIT Model M-1 HANDITESTER fulfills requirements for a portable volt ohm milliammeter. This kit features precision 1% resistors, 3 deck switch for trouble free mounting of parts, specially designed battery bracket, smooth acting ohms adjust control, beautiful molded bakelite case and a 400 microampere meter movement. 5 convenient AC and DC voltage ranges as follows: 10 - 30 - 300 - 1000 - 5000 volts. Ohms ranges 0 - 3000 and 0 - 300,000. DC milliamperage ranges 0 - 10 milliamperes and 0 - 100 milliamperes. The instrument is easily assembled from complete instructions and pictorial diagrams. Test leads are included. Carry the HEATHKIT M-1 HANDITESTER in your tool box at all times for those simple jobs and eliminate that extra trip for additional testing equipment.

SOLE AGENT
ROCKE INTERNATIONAL CORP.
13 E. 40th ST.
NEW YORK CITY (16)
CABLE: 8248 N Y

The **HEATH COMPANY**

... BENTON HARBOR 15, MICHIGAN

NEW
Heathkit

AUDIO GENERATOR KIT

• RANGE EXTENDED TO 1 MEGACYCLE

MODEL AG-8

SHIPPING
WT. 16 LBS.

\$29.50

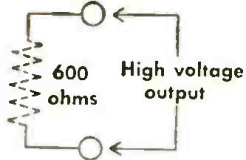

Low impedance output
High voltage output



Sine wave output
from 20 cycles to 1
megacycle.

- Improved design — new low price.
- Frequency coverage in five ranges from 20 cycles per second to 1 megacycle.
- Response flat 1 DB from 20 cycles to 400 kilocycles. Down 3 DB at 600 kilocycles. Down only 8 DB at 1 megacycle.
- Five calibrated output voltage ranges, continuously variable 1 mv, 10 mv, 100 mv, 1 v, 10 v.
- Low impedance output circuit. 600 ohms.
- Distortion less than .4 of 1% from 100 cycles per second through the audible range.
- New HEATHKIT universal type binding posts.
- Durable infra-red baked enamel panel.
- Transformer operated for safe operation.
- Sturdy, ventilated steel cabinet.

A new Audio Generator with features heretofore found in only the most expensive generators. Such features as complete coverage from 20 cycles to 1 Mc — response flat ± 1 db from 20 cycles to 400 Kc, down 3 db at 600 Kc and down only 8 db at 1 Mc.

And it has calibrated output . . . Calibrated continuously variable and step attenuator output controls allow you to easily set calibrated output voltage. Moreover, distortion is less than .4 of 1% from 100 cps through the audible range.

Oscillator section consists of a two stage resistance coupled amplifier (6SJ7 and 6AK6) utilizing both positive and negative feedback for oscillator operation and reduction of distortion. Oscillator section drives a cathode follower output power amplifier (6AK6) which isolates the oscillator from variations in load and presents a low impedance output (600 Ohms). Power supply is transformer operated and utilizes 6X5 rectifier with 2 sections of RC filtering.

An unbeatable dollar value — for here is an audio generator with wide frequency coverage, excellent frequency response, stepped and continuously variable calibrated output, high signal level, low impedance output, and low inherent distortion.

Heathkit AUDIO FREQUENCY METER KIT

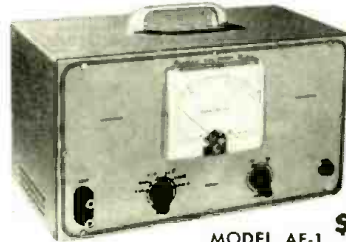

SHIPPING
WT. 15 LBS.

MODEL AF-1 **\$34.50**

The HEATHKIT AUDIO FREQUENCY METER provides a simple and easy way to check unknown audio frequencies from 10 cycles to 100 kc between 3 and 300 volts RMS. The instrument features 7 ranges for accuracy and wide coverage. The meter itself has a quality 200 microampere Simpson movement and large clearly marked scales. The AUDIO FREQUENCY METER is transformer operated and features a voltage regulator tube to maintain constant plate voltage on the second stage. Kit supplied complete with all necessary construction material and a detailed construction manual.

NEW *Heathkit* AUDIO OSCILLATOR KIT



MODEL AO-1
SHIPPING
WT. 14 LBS.

\$24.50

A new Audio Oscillator with both sine and square wave coverage from 20 to 20,000 cycles . . . An instrument designed to completely fulfill the needs of the audio engineer and enthusiast — Has numerous advantages such as high level output (up to 10V obtainable across the entire range), distortion less than .6%, and low impedance output.

Special design features include the use of a thermistor in the second amplifier stage for keeping the output essentially flat across the entire range.

A cathode coupled clipper circuit produces good, clean, square waves with rise time of only 2 microseconds. Oscillator section uses 1% precision resistors in range multiplier circuit for greatest accuracy.

You'll like the operation of this fine new kit.

Heathkit SQUARE WAVE GENERATOR KIT

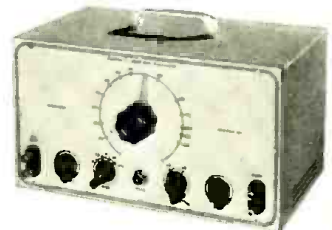

MODEL SQ-1
SHIPPING
WT. 14 LBS.

\$29.50

The HEATHKIT SQUARE WAVE GENERATOR is an excellent square wave frequency source with wide range coverage from 10 cycles to 100 kc continuously variable. This feature makes it useful for TV and wide band amplifier work as well as audio experimentation. The output voltage is continuously variable between 0 and 20 volts. The circuitry consists of a multivibrator stage, a clipping and squaring stage and a cathode follower low impedance output stage. The power supply is transformer operated and utilizes a full wave rectifier circuit with two sections of filtering. Another excellent HEATHKIT value at this remarkable low price. Kit includes all necessary construction material as well as complete instruction manual for assembly and operation.

EXPORT AGENT
ROCKE INTERNATIONAL CORP.
13 E. 40th ST.
NEW YORK CITY (16)
CABLE AREA N.Y.

The **HEATH COMPANY**

... BENTON HARBOR 15, MICHIGAN

NEW *Heathkit* VISUAL-AURAL

SIGNAL TRACER KIT

• NEW NOISE LOCATOR AND WATTMETER CIRCUITS.

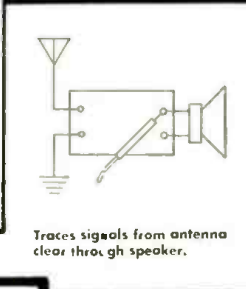
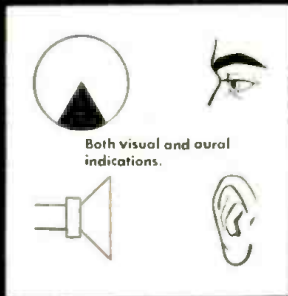

MODEL T-3

SHIPPING
WT. 8 LBS.

\$22.50



- Permits visual signal observation as well as aural operation.
- Two separate input channels.
- Tremendous RF channel sensitivity. Adequate for actual signal detection at receiver input.
- Separate high gain RF and low gain audio channels.
- A unique and useful noise locator circuit.
- Built-in calibrated wattmeter.
- Two separate shielded probes for RF and audio application.
- Additional test leads supplied.
- Substitution test speaker and output transformer eliminates necessity for speaker removal in service work.
- Utility amplifier. Check record changers, tuners, microphones, instrument pickups, etc.
- VTVM and Scope panel terminals.
- 5 tube transformer operated circuit.

The new HEATHKIT VISUAL AURAL SIGNAL TRACER represents one of the most convenient and useful instruments the service man can use in AM, FM and TV service work. The electron ray beam indicator constantly monitors both input channels for visual observation of the signal. Now, see and hear the signal level for easier estimation of signal strength and gain per stage in a receiver circuit. Separate high gain channel and special shielded demodulator probe for RF circuit work. Low gain channel for audio circuit investigation and for use as a noise locator. In this feature, approximately 200 volts DC is applied to a suspected circuit component and the action of the voltage in the component can be seen and heard to determine satisfactory operation. This feature alone will prove tremendously helpful in locating the source of objectionable noises in coils, transformers, resistors, condensers, cold solder joints, controls, etc. A convenient wattmeter permits rapid preliminary check for voltage distribution circuit breakdown as well as transformer failures. Use the T-3 as a universal test speaker and substitution transformer and save service time by eliminating the necessity for speaker removal on every service call. Additional service uses are: as a utility amplifier for checking the output of record changers, tuners, microphones, instrument pickups, etc. Separate panel terminals permit utilization of other shop equipment such as your Oscilloscope or VTVM. Entire kit supplied complete with 5 tubes, all necessary construction material along with a detailed step by step instruction manual for the assembly and operation of the instrument.

NEW *Heathkit* CONDENSER CHECKER KIT

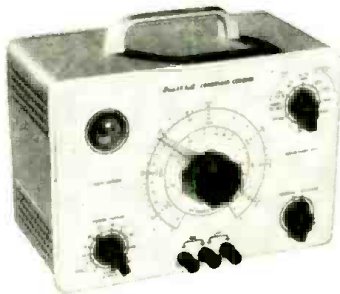

MODEL C-3
SHIPPING
WT. 7 LBS.

\$19.50

Announcing the new improved Model C-3 HEATHKIT CONDENSER housed in a new smartly styled professional appearing cabinet featuring rounded corners and snug fitting drawn panel. Adequate provisions for ventilation insures longer instrument life through cooler operation. Use the C-3 to accurately measure those unknown condenser and resistor values. All readings of condensers and resistors are read directly on the calibrated scales. Range of condenser measurements is from .00001 mfd to 1000 mfd. Calibrated resistance measurements can be made from 100 ohms to 5 megohms. A leakage test with a choice of 5 DC polarizing voltages will quickly indicate condenser operating quality under actual voltage load conditions. The spring return leakage test switch automatically discharges the condenser under test and eliminates shock hazard. An electron ray beam indicator tube is used in a new leakage test circuit for added sensitivity. The instrument is transformer operated for safety and will prove an extremely welcome addition to your shop equipment. The kit is furnished complete with all necessary parts, test leads and includes a step by step detailed construction manual for assembly and operation.

Heathkit TV ALIGNMENT GENERATOR KIT

MODEL TS-2
SHIPPING
WT. 20 LBS.

\$39.50



Here is an excellent TV ALIGNMENT GENERATOR designed to do TV service work quickly, easily and properly. The Model TS-2 when used in conjunction with an Oscilloscope provides a means of correctly aligning TV receivers. The instrument furnishes a frequency modulated signal covering in 2 bands the range of 10 to 90 megacycles and 150 to 230 megacycles. An absorption type frequency marker covers from 20 to 75 megacycles in 2 ranges; therefore you have a simple, convenient means of checking IF's independent of oscillator calibration. Sweep width is variable from 0 to 12 megacycles. Other excellent features are horizontal sweep voltage controlled with a phasing control — both step and continuously variable attenuation for setting the output signal to the desired level — a convenient stand by switch — and blanking for establishing a single trace with a base reference level. Make your work easier, save time and repair with confidence. Order your HEATHKIT TV ALIGNMENT GENERATOR now.

EXPORT AGENT
ROCKE INTERNATIONAL CORP.
13 E. 40th ST.
NEW YORK CITY (16)
CABLE: ARLAB-N.Y.

The HEATH COMPANY

... BENTON HARBOR 15, MICHIGAN

Heathkit TUBE CHECKER KIT

MODEL TC-1

SHIPPING
WT. 12 LBS.

\$29⁵⁰

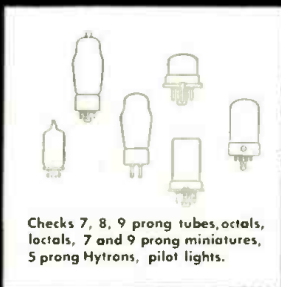
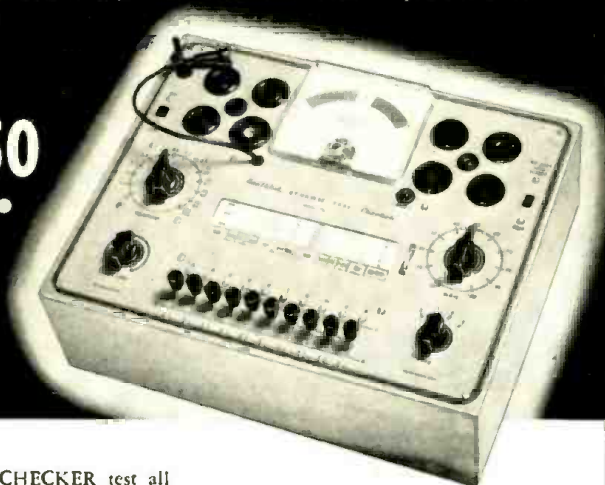

Checks 7, 8, 9 prong tubes, octals, locals, 7 and 9 prong miniatures, 5 prong Hytrons, pilot lights.

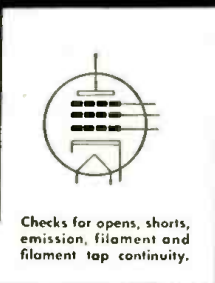

Checks for opens, shorts, emission, filament and filament tap continuity.

- Beautiful counter type birch cabinet.
- 4½" Simpson 3 color meter.
- Simplified setup procedure.
- Built-in gear driven roll chart.
- Checks emission, shorted elements, open elements and continuity.
- Complete protection against obsolescence.
- Sockets for every modern tube.
- Blank for new types.
- Individual element switches.
- Contact type pilot light test socket.
- Line adjust control.

PORTABLE TUBE CHECKER KIT MODEL TC-1P

Same as TC-1 except supplied with polished birch cabinet (with removable lid) instead of counter type cabinet. Shipping weight 14 lbs. **\$34.50**

No. 365 Polished Birch Tube Checker Cabinet only. Shipping Weight 7 lbs. **\$7.50**

With the HEATHKIT TC-1 TUBE CHECKER test all types of tubes commonly encountered in AM-FM and TV receiver circuits. Test setup procedure is simplified, rapid and flexible. Tube quality is read directly on a beautiful 4½" Simpson three color BAD - ? - GOOD scale that your customers can readily understand. Panel sockets accommodate 4, 5, 6 and 7 prong tubes, octals, locals, 7 and 9 prong miniatures, 5 prong Hytrons, a blank socket for new tubes and a contact type socket for quick checking of pilot lights. Built-in gear driven roll chart for instant reference. Neon short indicator, individual three position lever switch for each tube element, spring return test switch, line set control to compensate for supply voltage variations. At this low price, no service man need be without the advantages offered by the HEATHKIT TUBE CHECKER.

Heathkit TV PICTURE TUBE TEST ADAPTER

Use your HEATHKIT TUBE CHECKER with this new TV TEST ADAPTER to determine picture tube quality. Check for emission and shorts, independent of TV power supply. Consists of standard 12 pin TV tube socket, 4 feet of cable, ocal socket connector and data sheet. Quickly prove TV picture tube condition to yourself and your customer.



No. 355
Ship. Wt. **\$4⁵⁰**
1 lb.

Heathkit RESISTANCE SUBSTITUTION BOX KIT



MODEL RS-1
SHIPPING
WT. 3 LBS.

\$5⁵⁰

NEW HEATHKIT RESISTANCE SUBSTITUTION BOX KIT provides switch selection of any single one of 36 RTMA 1 watt 10% standard value resistors, ranging from 15 ohms to 10 megohms. This coverage available in 2 ranges in decades of 15, 22, 33, 47, 68 and 100. Housed in rugged plastic cabinet featuring new HEATHKIT universal type binding posts. The entire kit priced less than the retail value of the resistors alone.

Heathkit BATTERY ELIMINATOR KIT

A clean 6 volt d-c supply source is definitely required for successful automobile radio servicing. Has a continuously variable d-c output from 0 to 8 volts. It can be safely operated at a steady 10 ampere level and will deliver up to 15 amperes for intermittent periods. The voltage output terminals are completely isolated from the chassis to accommodate additional service applications such as supplying bias voltages or d-c substitution voltages for battery operated tube filament circuits.

The output of the Battery Eliminator is constantly monitored by a d-c voltmeter and a d-c ammeter. The circuit features an automatic overload relay of self resetting type. For additional protection, a panel mounting fuse is provided. Build this kit in a few hours and pocket a substantial savings.



MODEL BE-3
SHIPPING
WT. 20 LBS.

\$24⁵⁰

Heathkit VIBRATOR TESTER KIT

Repair time is valuable, and the Heathkit Vibrator Tester will save you hours of work. Instantly tells the condition of the vibrator under test—and the check is thorough and complete. Checks vibrator for proper starting, and the easy-to-read meter indicates the quality of output on large BAD-GOOD scales. Tests both interrupter and selfrectifier types of vibrators. Five different sockets for checking hundreds of vibrators.

Operates from any battery eliminator capable of delivering continuously variable voltage from 4-6V at 4 amps. The Heathkit BE-3 Battery Eliminator is ideal for operating this kit.

Faulty vibrators can be spotted within seconds and you're free to go on to other service jobs.

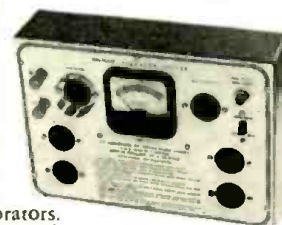

MODEL VT-1
SHIPPING
WT. 7 LBS.

\$14⁵⁰

EXPORT AGENT
ROCKE INTERNATIONAL CORP.
13 E. 40th ST.
NEW YORK CITY (16)
CABLE: ARLENY

The HEATH COMPANY

... BENTON HARBOR 15, MICHIGAN

Heathkit SIGNAL GENERATOR KIT

MODEL SG-7

SHIPPING
WT. 7 LBS.

\$19⁵⁰



Modulated or unmodulated RF output.



400 cycle sine wave output.

- Step attenuated RF output.
- 6 to 1 vernier dial ratio.
- Turret mounted coil sub-assembly.
- Pre-calibrated and adjusted coils.
- Hartley RF oscillator circuit.
- Colpitts oscillator 400 cycle sine wave output.
- Modulated or unmodulated RF output.
- Frequency coverage on fundamentals 160 kc to 50 megacycles in five ranges. 51 megacycles to 150 megacycles on calibrated harmonics.
- RF output in excess of 100,000 microvolts.
- Audio output 1/2 to 2 volts.
- AC transformer operated.
- Professionally styled cabinet.
- Infra red baked enamel panel.

The new HEATHKIT Model SG-7 SIGNAL GENERATOR easily fulfills requirements for a controllable, modulated or unmodulated source of variable frequency. A convenient 400 cycle sine wave output is available for audio work. All RF oscillator coils are precision wound and adjusted to calibration before shipment thereby assuring maximum accuracy. The coils, band switch and tuning condenser all mount as a turret assembly so as to offer the advantage of short wiring leads and easy mounting of parts. The RF output circuit is of the low impedance type obtained by the use of cathode coupling to the output jacks. The level of RF output is varied by means of the RF step and RF output control. Use the HEATHKIT SG-7 as an RF signal source modulated or unmodulated for radio repair, laboratory work, experimental testing, 400 cycle sine wave audio testing, checking RF stages, alignment of both AM and FM IF stages, marker generator for TV alignment, etc. The kit is transformer operated and utilizes miniature tubes for ease in handling high frequency. Panel jacks and a convenient switching system permit either external or internal modulation. The entire kit is supplied complete with tubes and all necessary material as well as a detailed step by step instruction manual for the assembly and operation of the instrument.

Heathkit INTERMODULATION ANALYZER KIT



MODEL IM-1
SHIPPING WT.
18 LBS.

\$39⁵⁰

The HEATHKIT MODEL IM-1 is an extremely versatile instrument specifically designed for measuring the degree of interaction between two

signals caused by a specific piece of apparatus, or a chain of equipment. It is primarily intended for tests of audio equipment but may be used in other applications such as making tests of microphones, records, recording equipment, phonograph pickups and loud speakers. Use it for checking tape or disc recordings, as a sensitive AC voltmeter, as a high pass noise meter for adjusting tape bias, cutting needle pitch or other applications. High and low test frequency source, intermodulation section, power supply and AC voltmeter all in one complete unit. Percent intermodulation is directly read on three calibrated ranges, 30%, 10% and 3% full scale. Both 4 to 1 and 1 to 1 ratios of low to high frequencies easily set up. At this low kit price YOU can enjoy the benefits of Intermodulation analysis for accurate audio interpretations.

Heathkit LABORATORY REGULATED POWER SUPPLY KIT



MODEL PS-2
SHIPPING
WT. 20 LBS.

\$29⁵⁰

New HEATHKIT LABORATORY POWER SUPPLY provides continuously variable regulated DC voltage output

from 160 volts to 400 volts depending on load. Panel terminals supply separate 6.3 V. AC supply at 4 amperes for filament circuits. A 3 1/2" plastic cased panel mounted meter provides accurate metered output for either voltage or current measurements. Exceptionally low ripple content of .012% admirably qualifies the HEATHKIT LABORATORY POWER SUPPLY for high gain audio applications. Ideal for laboratory work requiring a reference voltage for meter calibration or for plotting tube characteristics. In service work, it can be used as a separate variable voltage supply to determine the desirable operating voltage in a specific circuit. Use it as a DC substitution voltage in trouble shooting TV circuits exhibiting symptoms of extraneous undesirable components in plate supply circuits. Entire kit, including all 5 tubes now available at this low price.

EXPORT AGENT
ROCKE INTERNATIONAL CORP.
23 E. 40th ST.
NEW YORK CITY (16)
CABLE 68288 N.Y.

The HEATH COMPANY

... BENTON HARBOR 15, MICHIGAN

Heathkit WILLIAMSON TYPE AMPLIFIER KIT

The new HEATHKIT WILLIAMSON TYPE AMPLIFIER incorporates the latest improvements described in Audio Engineering's "Gilding the Lily." 5881 output tubes and a new Peerless output transformer with additional primary taps afford peak power output of well over 20 watts. Frequency response ± 1 db from 10 cycles to 100 kc. allows reproduction of highs and lows with equal crispness and clarity. Harmonic and intermodulation distortion have been reduced to less than $\frac{1}{2}$ of 1% at 5 watts. This eliminates the harsh unpleasant qualities which contribute to listening fatigue. Make this amplifier the heart of your radio system to achieve the fine reproduction that is the goal of all music lovers.

The HEATHKIT PREAMPLIFIER (available separately or in combination with the amplifier kit) features inputs for magnetic or low level cartridges, crystal pickups and tuners, turnover control for LP or 78 type records, individual bass and treble tone controls each providing up to 15 DB of boost or attenuation. Special notched shafts on preamplifier controls and switches adaptable to custom installation. The preamplifier can be mounted in any position and a liberal length of connecting cable is supplied. No radio experience is required to construct this amplifier. All punching, forming, or drilling has already been done. The complete kit includes all necessary parts as well as a detailed step by step construction manual with pictorial diagrams to greatly simplify the construction.

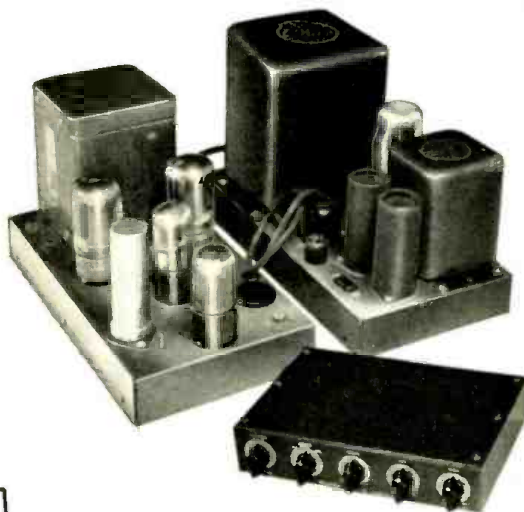

ACROSOUND TRANSFORMER OPTION. If desired, the output transformer with the kit will be the Acrosound output transformer, type TO-300. The use of this transformer permits ultra-linear operation as described in Audio Engineering's "Ultra-Linear Operation of the Williamson Amplifier."

Heathkit FM TUNER KIT

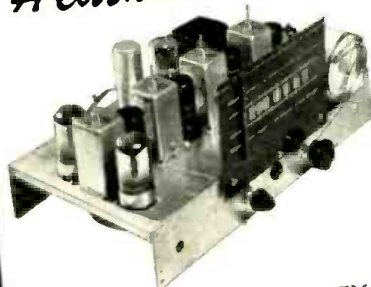

MODEL FM-2
SHIPPING
WT. 9 LBS.

\$22⁵⁰

The HEATHKIT MODEL FM-2 TUNER specifically designed for simplified kit construction features a preassembled and adjusted tuning unit. Three double tuned IF transformers and a discriminator transformer are used in an 8 tube circuit. Smooth tuning is obtained through a 9 to 1 ratio vernier drive using a calibrated six inch slide rule type dial. The usual frequency coverage of 88 to 108 megacycles is provided. Experience the thrill of building your own FM tuner. Operate it through your amplifier or radio and enjoy all the advantages of true FM reception. Transformer operated power supply to simplify connections to all types of audio systems. The kit is supplied complete with all 8 tubes and a necessary material required for construction. A complete instruction manual simplifies assembly and operation.

PRICES OF VARIOUS COMBINATIONS

- W-2 Amplifier Kit** (Incl. Main Amplifier with Peerless Output Transformer, Power Supply and WA-P1 Preamplifier Kit) Shipping Weight 39 lbs. **\$69⁵⁰**
- W-2M Amplifier Kit** (Incl. Main Amplifier with Peerless Output Transformer and Power Supply) Shipping Weight 29 lbs. Shipped express only **\$49⁷⁵**
- W-3 Amplifier Kit** (Incl. Main Amplifier with Acrosound Output Transformer, Power Supply, and WA-P1 Preamplifier Kit) Shipping Weight 39 lbs. Shipped express only **\$69⁵⁰**
- W-3M Amplifier Kit** (Incl. Main Amplifier with Acrosound Output Transformer and Power Supply) Shipping Weight 29 lbs. Shipped express only **\$49⁷⁵**
- WA-P1 Preamplifier Kit only.** Shipping Weight 7 lbs. Shipped express or parcel post. **\$19⁷⁵**

Heathkit ECONOMY 6 WATT AMPLIFIER KIT



MODEL A-7
SHIPPING
WT. 10 LBS.

\$14⁵⁰

THE MODEL A7A amplifier incorporates a preamplifier stage with special compensated network to provide the necessary voltage gain for operation with variable reluctance or low output level phono cartridges. Excellent gain for microphone operation in a moderate powered sound system. **\$16.50**

The HEATHKIT Model A-7 amplifier features beam power, push pull output with frequency response flat $\pm 1\frac{1}{2}$ DB from 20 to 20,000 cycles. Separate volume, bass and treble controls. Two input circuits, output impedances of 4, 8, and 15 ohms. Peak power output rated at full 6 watts. High quality components, simplified layout, attractive gray finished chassis, break off type adjustable length control shafts and attractive lettered control panel.

Heathkit HIGH FIDELITY 20 WATT AMPLIFIER KIT

The HEATHKIT MODEL A-8 amplifier kit was designed to deliver high fidelity performance with adequate power output at moderate cost. The frequency response is within ± 1 DB from 20 to 20,000 cycles. Distortion at 3 DB below maximum power output at 1000 cycles is only .8%. The amplifier features a Chicago power transformer in a drawn steel case and a Peerless output transformer with output impedances of 4, 8, and 16 ohms available. Separate bass and treble tone controls permit wide range of tonal adjustment to meet the requirements of the most discerning listener. The amplifier uses a 6SJ7 voltage amplifier, a 6SN7 amplifier and phase splitter and two 6L6's in push pull output and a 5U4G rectifier. Two input jacks for either crystal or tuner operation. The kit includes all necessary material as well as a detailed step by step construction manual.

MODEL A8-A features an added 6SJ7 stage (preamplifier) for operating from a variable reluctance cartridge or other low output level phono pickups. Can also be used with a microphone. A 3 position panel switch affords the desired input service. **\$35.50**



MODEL A-8
SHIPPING WT. 19 LBS.

\$33⁵⁰

EXPORT AGENT
ROCKE INTERNATIONAL CORP.
13 E. 40th ST.
NEW YORK CITY (16)
CABLE ARLUS N.Y.

The **HEATH COMPANY**

... BENTON HARBOR 15, MICHIGAN

Heathkit SUPERHETERODYNE RECEIVER KITS

- High gain dual iron core tuned type IF transformers
- AC transformer operation for safety
- Continuously variable tone control
- Sturdy punched and plated steel chassis
- Ideal for custom installation
- Full AVC action
- Inverse feedback for improved frequency response
- Kit supplied with all necessary construction material except speaker and cabinet. (Available separately if desired).

6 tube all wave circuit.
3 ranges, continuous coverage 550 kc to over 20 megacycles, shipping wt. 11 lbs.

Model AR-1
\$23.50



5 tube broadcast band
550 to 1600 kc coverage,
shipping wt. 11 lbs.

Model BR-1
\$19.50

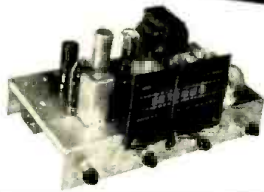

Two excellent radio receiver kits featuring clean design and open layout for simplified construction. Satisfy that urge to build your own radio receiver and select the model which meets your requirements. Both receivers feature continuously variable tone control, a radio phono switch and phono input and an AC receptacle for the phono motor. A six inch calibrated slide rule type dial with a 9 to 1 ratio vernier dial drive insures easy tuning.

SHIPPING INFORMATION

ON PARCEL POST ORDERS include postage for weight shown and insurance. (We insure all shipments.) Don't worry about sending more than the correct amount — if you send us too much, every extra cent will be promptly returned.

ON EXPRESS ORDERS do not include transportation charges. They will be collected by Express Agency on delivery.

ORDERS FROM CANADA must include full remittance for merchandise.

Orders processed on the same day received. Customers notified of unavoidable delay.

U. S. postal or express money orders, bank drafts or checks are acceptable. Do not send loose coins or stamps.

ALL PRICES SUBJECT TO CHANGE WITHOUT NOTICE

ROCKEFELLER AGENTS
ROCKE INTERNATIONAL CORP.
13 E. 40th ST.
NEW YORK CITY (16)
CABLE: ARKAD-NY

The HEATH COMPANY

... BENTON HARBOR 15, MICHIGAN

ORDER BLANK



From _____

SHIP VIA

- Parcel Post
 Express
 Freight
 Best Way

(PLEASE PRINT)

QUANTITY	ITEM	PRICE	QUANTITY	ITEM	PRICE
	Heathkit Oscilloscope Kit—Model O-8 (29 lbs.)	\$43.50		Heathkit Square Wave Gen. Kit—Model SQ-1 (14 lbs.)	\$29.50
	Heathkit Intensifier Kit (O-8 only) No. 339 (1 lb.)	7.50		Heathkit AC VTVM Kit—Model AV-2 (5 lbs.)	29.50
	Heathkit Voltage Calibrator Kit—Model VC-1 (5 lbs.)	9.50		Heathkit Intermodulation Analyzer Kit—Model IM-1 (18 lbs.)	39.50
	Heathkit Electronic Switch Kit—Model S-2 (11 lbs.)	19.50		Heathkit Regulated Power Supply Kit—Model PS-2 (20 lbs.)	29.50
	Heathkit Scope Demodulator Probe Kit No. 337 (1 lb.)	4.50		Heathkit Handitester Kit—Model M-1 (3 lbs.)	13.50
	Heathkit T.V. Alignment Generator Kit—Model TS-2 (20 lbs.)	39.50		Heathkit Decade Resistance Kit—Model DR-1 (4 lbs.)	19.50
	Heathkit Q Meter Kit—Model QM-1 (12 lbs.)	39.50		Heathkit Decade Condenser Kit—Model DC-1 (4 lbs.)	16.50
	Heathkit Grid Dip Meter Kit—Model GD-1 (4 lbs.)	19.50		Heathkit Impedance Bridge Kit—Model IB-1B (15 lbs.)	69.50
	Heathkit VTVM Kit—Model V-6 (7 lbs.)	24.50		Heathkit Battery Tester Kit—Model BT-1 (3 lbs.)	7.50
	Heathkit RF Probe Kit No. 309 (1 lb.)	5.50		Heathkit Resistance Substitution Box Kit—Model RS-1 (3 lbs.)	5.50
	Heathkit MV Probe Kit No. 336 (2 lbs.)	5.50		Heathkit F.M. Tuner Kit—Model FM-2 (9 lbs.)	22.50
	Heathkit Peak-to-Peak Volt. Probe Kit No. 338 (2 lbs.)	6.50		Heathkit Broadcast Receiver Kit—Model BR-1 (11 lbs.)	19.50
	Heathkit Visual-Aural Signal Tracer Kit—Model T-3 (8 lbs.)	22.50		Heathkit Three Band Receiver Kit—Model AR-1 (11 lbs.)	23.50
	Heathkit Condenser Checker Kit—Model C-3 (7 lbs.)	19.50		Heathkit Amplifier Kit—Model A-7 (10 lbs.)	14.50
	Heathkit RF Signal Generator Kit—Model SG-7 (7 lbs.)	19.50		Heathkit Amplifier Kit—Model A-7A (10 lbs.)	16.50
	Heathkit Tube Checker Kit—Model TC-1 (12 lbs.)	29.50		Heathkit Amplifier Kit—Model A-8 (19 lbs.)	33.50
	Heathkit T.V. Tube Adapter No. 355 (1 lb.)	4.50		Heathkit Amplifier Kit—Model A-8A (19 lbs.)	35.50
	Heathkit Battery Eliminator Kit—Model BE-3 (20 lbs.)	24.50		Williamson Type Amplifier Kit (Type Shipped express only)	
	Heathkit Vibrator Tester Kit—Model VT-1 (7 lbs.)	14.50		WA-P1 Pre-amplifier Kit (7 lbs.) (Shipped exp. or p.p.)	19.75
	Heathkit Audio Generator Kit—Model AG-8 (16 lbs.)	29.50			
	Heathkit Audio Oscillator Kit—Model AO-1 (14 lbs.)	24.50			
	Heathkit Audio Frequency Meter Kit—Model AF-1 (15 lbs.)	34.50			

*Please ship C.O.D. Postage enclosed for _____ lbs.

Enclosed find Check Money Order for _____

ELIMINATING OSCILLATOR HUM IN FM RECEIVERS

BY HERBERT MICHELS

AN OFTEN troublesome problem, especially in high fidelity systems, is the elimination of 60-cycle hum originating in the local oscillator of an FM receiver. This hum, noticeable only when a station is tuned in, is the result of the a.c. heater voltage applied to the oscillator tube causing frequency variations in the local oscillator's output at a 60-cycle rate.

The discriminator circuit, responding to modulation of the local oscillator as well as the incoming station, will feed this 60-cycle component on to the audio system.

Oscillator hum is most apparent in circuits in which the cathode is not at r.f. ground potential; however, it also can be troublesome in other types of oscillator circuits. Fig. 1A illustrates the most common circuit wherein the 60-cycle potential between the cathode and the heater of the tube will result in frequency modulation of the oscillator.

There are various methods of eliminating the hum—the easiest, but perhaps least practical, is the careful selection of tubes. However, this can be rather expensive if it means buying extra tubes for the purpose. Fig. 1B shows another, and far more practical, method of hum elimination.

In the circuit as shown in Fig. 1B one side of the heater is connected to the cathode which is connected to ground through the coil. This places the heater at an above ground potential as far as r.f. is concerned. Therefore, it is necessary to place an r.f. choke (20 turns of #12 wire on a 1/2 inch form closewound) in series with the other heater lead. This often brings satisfactory results; however, it also changes the resonant frequency of the tuning circuit. A front-end realignment of the receiver is necessary to assure proper tracking.

A third method as shown in Fig. 1C often brings successful results without

the necessity of realignment. This method is to place a high d.c. potential on the heater system. This potential must not be higher than the maximum allowable heater-cathode potential for the tube being used. It may be necessary to use a tapped bleeder across the "B+" supply to secure the proper potential.

Since a heater circuit in which one side of the heater supply (or transformer center tap) is grounded would result in a shorted plate voltage supply, it is necessary to first remove any ground connections from the heater circuit before connecting the "B+" to the heaters.

One is fortunate if the total current drawn from the d.c. supply in the receiver closely approximates the required heater current of the oscillator tube. If so, this permits the use of the circuit as illustrated in Fig. 1D; a superior method of hum elimination.

The rated values of plate current as listed in a tube manual, or more accurately an actual meter measurement, will determine the current in the d.c. supply. The heater should be connected in the power transformer center tap ground return circuit—this eliminates the possibility of damaging the filter condensers in the event of a tube failure.

One final note: hum in an FM receiver may originate from many sources. This could be due to improper d.c. supply filtering, poor circuit design, insufficient shielding, etc. Determine if the local oscillator is the cause of the hum before proceeding to take corrective measures. To do this, disconnect the heater supply voltage from the oscillator tube heater pins. Then connect a battery of the required voltage to light the tube. If the hum disappears when the battery is substituted for the a.c. heater supply it is an indication that the oscillator is the cause of the hum.

-30-

Fig. 1. (A) Typical FM receiver oscillator circuit. (B) Heater circuit modified for hum reduction. (C) Heater at high d.c. potential. (D) A d.c. heater supply.

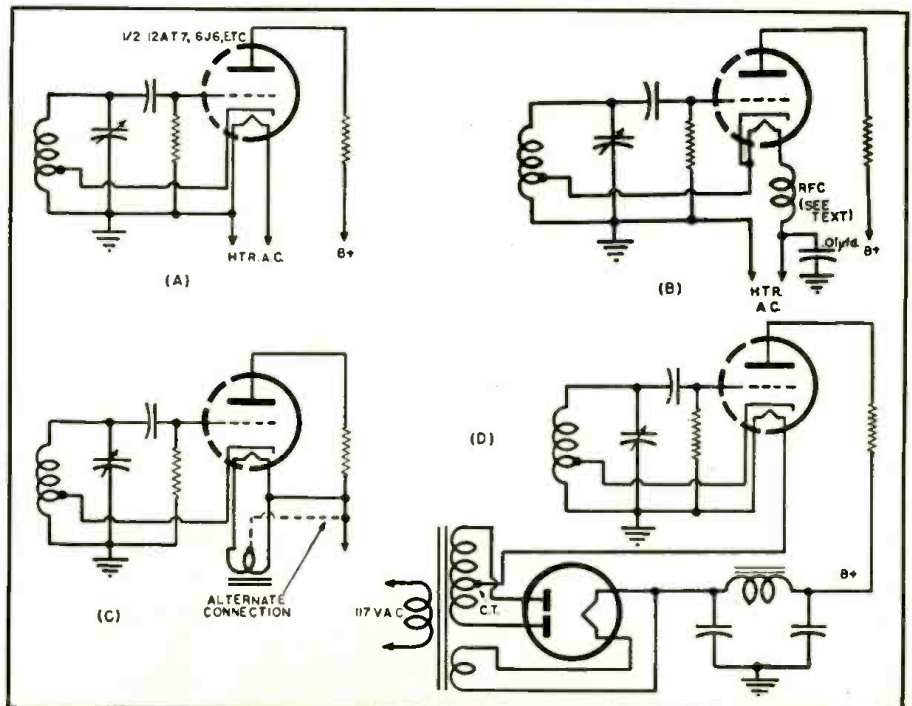

ATR

For
AC CURRENT ANYWHERE



STANDARD AND HEAVY DUTY INVERTERS

For Inverting D. C. to A. C.
Specially Designed for operating A. C. Radios, Television Sets, Amplifiers, Address Systems, and Radio Test Equipment from D. C. Voltages in Vehicles, Ships, Trains, Planes and in D.C. Districts.

ATR ✓ NEW MODELS
✓ NEW DESIGNS
✓ NEW LITERATURE

"A" Battery, Eliminators, DC-AC Inverters, Auto Radio Vibrators

See your jobber or write factory

AMERICAN TELEVISION & RADIO CO.
Quality Products Since 1931
SAINT PAUL 1, MINNESOTA-U. S. A.

J. E. SMITH
President
National Radio
Institute
Washington, D. C.



I Will Train You at Home

For Good Pay Jobs, Success in

RADIO-TELEVISION



YOU LEARN SERVICING

by practicing with equipment I furnish

You build valuable Multitester (at left) as part of my Servicing Course. You use it to make many tests, get practical experience, make EXTRA money fixing neighbors' radios in spare time. Many of my students earn \$5, \$10 a week extra while learning. I send you many other kits too. You build a modern Radio. You build many circuits common to Radio and Television. All equipment is yours to keep. Read about and see other equipment in my free book. Mail card below.



YOU LEARN COMMUNICATIONS

by practicing with equipment I furnish

As part of my Communications Course I send you kits of parts to build the low power broadcasting transmitter shown at right and many other circuits common to Radio and Television. You use this equipment to get practical experience putting a station "on air," performing procedures demanded of Broadcast Station operators. I train you for FCC Commercial Operator's License. Mail Card for Sample Lesson and 64-Page Book. FREE!



TELEVISION is Today's Good Job Maker

In 1951 over 15,000,000 homes had Television sets, more are being sold every day. 108 TV stations are already operating, over 1800 are now authorized and many hundreds are expected to be on the air in 1953. This means new jobs, more jobs and better pay for trained men. The time to act is NOW! Start learning Radio-Television servicing or communications. Want to get ahead? America's fast growing industry offers good pay, a bright future and security. Cut out and mail card now. J. E. Smith, President, National Radio Institute, Washington, D.C.

There are Good Jobs, Good Pay, Success in Radio-TV! SEE OTHER SIDE

CUT OUT AND MAIL THIS CARD NOW

Sample Lesson & 64-Page Book Both FREE

This card entitles you to Actual Lesson on Servicing, shows how you learn Radio-Television at home. You'll also receive my 64-Page Book, "How to Be a Success in Radio-Television." Mail card now!

NO STAMP NEEDED! WE PAY POSTAGE

Mr. J. E. SMITH, President,
National Radio Institute, Washington 9, D.C.

Mail me Lesson and Book, "How to Be a Success in Radio-Television." (No Salesman will call. Please write plainly.)

NAME AGE

ADDRESS

CITY ZONE STATE

A B C D E F G

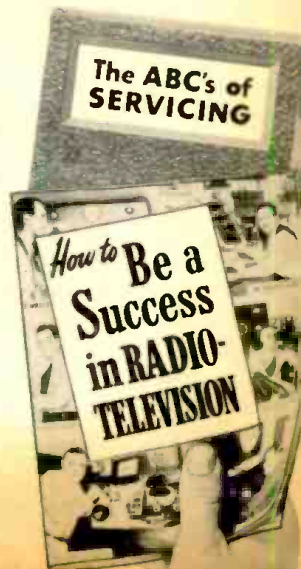

Train at Home to Jump Your Pay as a RADIO-TV Technician



J. E. Smith, President
National Radio Institute

The men whose letters are published below were not born successful. At one time they were doing exactly as you are doing now . . . reading my ad! But they acted. They decided they would know more . . . so they could earn more! They acted! Mail the card now for my 2 books FREE.

There's a Bright Future for You in America's Fast Growing Industry

Do you want good pay, a job with a bright future, security? Would you like to have a profitable business of your own? If so, find out how you can realize your ambition in the fast growing RADIO-TELEVISION industry. Even without Television, the industry is bigger than ever before. 105 million home and auto radios, 2900 Radio Broadcasting Stations, 108 TV Stations with 1800 more now authorized. Expanding use of Aviation and Police Radio, Micro-Wave Relay, Two-Way

Radio for buses, taxis, etc., are making opportunities for Servicing and Communications Technicians and FCC Licensed Operators.

You Learn by Practicing with Kits I Furnish

With both my Servicing Course and my NEW Communications Course I send you many Valuable Kits of Parts. They "bring to life" theory you learn in my illustrated texts. Mail card for my big 64-page book. It shows photos of equipment you build from kits I send.

My Training Includes Television

Both my Servicing and Communications Courses include lessons on TV principles. You get practical experience by working on circuits common to both Radio and Television. My graduates are filling jobs, making good money in both Radio and Television. Remember, the way to a successful career in Television is through experience in Radio.

Send NOW for 2 Books FREE

Mail the Postage-Free Card NOW!

What will YOU be doing one year from today . . . will you be on your way toward a good job of your own in a Radio and Television service shop or business? Decide now that you are going to know more and earn more! ACT NOW! Take the important first step to a career and security. Send the postage-free card now for my FREE DOUBLE OFFER. You get Actual Servicing Lesson. Also my 64-page book, "How to Be a Success in Radio-Television." Read what my graduates are doing, earning; see equipment you practice with at home. Mail card now. J. E. SMITH, President, National Radio Institute, Washington 9, D.C. Our 39th year.

I TRAINED THESE MEN



Handicapped but Successful

"I am now Chief Engineer at WHAW. My left hand is off at the wrist. A man can do . . . If he wants to." R. J. Bailey, Weston, W. Va.



\$10 a Week In Spare Time

"Before finishing, I earned as much as \$10 a week in Radio servicing in my spare time. I recommend NRI." S. J. Petrucci, Miami, Fla.



Control Operator, Station WEAN

"I received my license and worked on ships. Now with WEAN as control operator, NRI course is complete." R. Arnold, Rumford, R. I.



Trained Men Make Money In TV

"I am now servicing Television. Your course enabled me to repair TV receivers without any trouble." R. Currier, Fair Haven, Vt.



Has Growing Business

"Am becoming expert Technician as well as Radiotelephonist. Without your course this would be impossible." P. Brogan, Louisville, Ky.



Got First Job Thru NRI

"My first job was with KDLR. Now Chief Engr. of Radio Equipment for Police and Fire Dept." T. Norton, Hamilton, Ohio.

NRI Training Can Lead to Jobs Like These in RADIO-TELEVISION

BROADCASTING
Chief Technician
Chief Operator
Power Monitor
Recording Operator
Remote Control Operator

GOVERNMENT RADIO
Operator in Army,
Navy, Marine Corps,
Coast Guard
Forestry Service
Dispatcher
Airways Radio Operator

SERVICING
Home and Auto Radios
P.A. Systems
Television Receivers
Electronic Controls
FM Radios

AVIATION RADIO
Plane Radio Operator
Transmitter Technician
Receiver Technician
Airport Transmitter Operator

IN RADIO PLANTS
Design Assistant
Transmitter Design Technician
Service Manager
Tester
Serviceman
Research Assistant

TELEVISION
Pick-up Operator
Voice Transmitter Operator
Television Technician
Remote Control Operator
Service and Maintenance Technician

SHIP AND HARBOR RADIO
Chief Operator
Assistant Operator
Radiotelephone Operator

POLICE RADIO
Transmitter Operator
Receiver Serviceman

Find Out What RADIO-TV Offers You



SAMPLE LESSON and 64-PAGE BOOK Both FREE

Cut out and mail postage-free card today!

FIRST CLASS
Permit No. 20-R
(Sec. 34.9, P.L. & R.)
Washington, D.C.

BUSINESS REPLY CARD

No Postage Stamp Necessary If Mailed In The United States

4c POSTAGE WILL BE PAID BY
NATIONAL RADIO INSTITUTE

16th and U Sts., N.W.

Washington 9, D. C.

Make Extra Money While Learning

Keep your job while training. Many NRI students make \$5, \$10 and more a week extra fixing neighbors' Radios in spare time while learning. I start sending you special booklets that show you how to service sets the day you enroll. Multi-tester you build with parts I furnish helps discover and correct Radio troubles.



Want Your Own Business?

Many N.R.I. trained men start their own business with capital earned in spare time. Let me show you how you can be your own boss . . . Robert Dohmen, New Prague, Minn., (whose store is shown at right) says, "Am now tied in with two television outfits and do warranty work for dealers. Often fall back to N.R.I. textbooks for information on installing Television sets."



WHAT'S

New in Radio

For additional information on any of the items described herein, readers are asked to write direct to the manufacturer. By mentioning RADIO & TELEVISION NEWS, the page and the issue number, delay will be avoided.

NEW "PILOTUNER"

An FM-AM radio tuner for use as the central control head of a hi-fi music system is now available from Pilot Radio Corporation, Long Island City, N.Y.

The Model AF-821 is a 9-tube unit with a two-stage preamp with adjust-



able equalization for various makes of reluctance cartridges, separate input connections for phono and TV operation, extended range bass and treble controls, temperature compensated oscillator for drift-free FM reception, a.f.c., built-in antennas, and full shielding.

G-E CARTRIDGES

General Electric Company has added three wide-range variable reluctance phonograph cartridges to its line.

The RPX 053 dual and the RPX 061 and RPX 063 single are 15,000 cycle units and all feature diamond styli. The new cartridges feature 6 to 8 grams tracking pressure for all types of records, uniform velocity scratch and needle talk. The stylus is retractable.

"STEREOPHONIC RECORDER"

Ampex Electric Corp., Redwood City, Calif. is marketing a stereophonic recorder which employs a dual-track head assembly that records or plays back two separate channels simultaneously.

Material recorded by two properly placed microphones may be played back through two similarly spaced speakers to give a directional effect. The Model 403-2 incorporates separate



electronic assemblies for each track. These assemblies are identical except that the second sound track has a bias

buffer amplifier rather than the bias oscillator of the first assembly. This is done to provide the same bias frequency to each record head.

The new model will operate at either 7 1/2 or 15 inches-per-sec. tape speeds. Frequency response is to 15,000 cycles at the 7 1/2" tape speed and signal-to-noise ratio is over 55 db.

CABINET SPEAKER

White Sound, Inc., 105 W. Madison St., Chicago, Ill. is marketing a new line of cabinet speakers based upon development of an exponential horn, folded within an enclosure.

There are four of these horn-loaded units available at the present time. The company will provide complete specifications on request.

PLUG-IN AMPLIFIERS

Four basic plug-in audio amplifiers are now available from Gates Radio Co., Quincy, Ill.

The Model PRE-1 preamp, Model PGM-1 program amplifier, Model MON-1 monitoring amplifier, and Model PWR-3 regulated power supply can be combined in any assembly. All units are identical in size except the

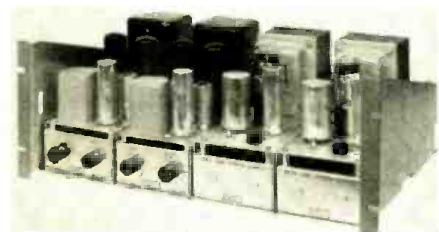

PRE-1 which is half-size. Four program amplifiers can be used in the space formerly occupied by a single unit.

RADIO CONTROL UNITS

Vernon C. MacNabb Co., 909 Westfield Blvd., Indianapolis 20, Ind. is offering a 27,255 kc. Citizens band receiver and transmitter for radio control operations.

The receiver, which weighs 4 ounces and measures 2 1/2" x 1 3/4" x 2 1/4", gives a 5:1 plate current change to operate the Sigma 4F adjustable relay.

The hand-held transmitter, weighing 4 pounds and measuring 3" x 4" x 9", uses two 3V4 tubes. A three-section plug-in antenna is employed.

BASIC AMPLIFIER

A basic amplifier for the average home system is being marketed by Precision Electronics, 9101 King Ave., Franklin Park, Ill. as its Model 100 BA.

Power output is 10 watts with 20

RCP is FIRST again with this . . .

"DO-ALL"

TV Set and Tube Tester

(Includes VT Voltmeter and Reactivator)

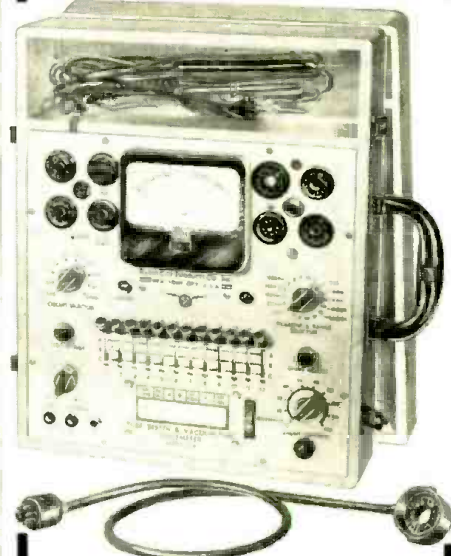

Model 808

ALL IN ONE UNIT!

- **A TUBE TESTER:** All the features of the famous 323 Dynoptimum free point tube tester—protected against obsolescence—tests all modern standard, miniature, novel base and subminiature tubes. Easily read on 4 1/2" meter.
- **A CATHODE RAY TUBE TESTER:** Will check all magnetic deflection type Television picture tubes. Locates and isolates all shorts or leaks.
- **A REACTIVATOR:** Revives and Reactivates many otherwise Dim or Bad Television Picture tubes. Can also be used on other tubes.
- **A VT VOLTMETER (AC-DC):** This really outstanding 17 Range instrument is a VT Voltmeter for AC as well as DC. Balanced bridge type push-pull circuit. Draws negligible current due to high impedance of 25 megohms. Accuracy $\pm 3\%$ DC, $\pm 5\%$ AC. Discriminator alignment scale with zero center. AC & DC volts 0 to 5-25-100-250-1000; db-20 to 16.-6 to 30, 6 to 42, 14 to 50, 26 to 62.
- **AN OHMMETER:** Reads all Resistances 0.2 ohms to 1000 megohms on 5 ranges. Use this instrument also to check condensers for leakage and shorts.

Housed in handsome hand-rubbed oak carrying case with test leads, isolation probe, batteries, etc. Size 12 1/2" x 12 3/4" x 4 3/4"; weight 12 1/2 lbs.

MODEL 808—complete, \$99.95 NET

ready to operate. High Voltage Multiplier Probe for Model 808. Extends Range of VTVM to 30,000 volts.

MODEL No. HVMP-1 \$8.95 NET

For the "GREATEST VALUE PER DOLLAR IN TV-RADIO TEST EQUIPMENT" send for the new, colorful, fully illustrated 1953 RCP catalog. Complete details on Model 808 and other instruments in this top-quality line are shown.

MAIL COUPON NOW FOR

FREE CATALOG

RADIO CITY PRODUCTS CO., Inc. Dept. RN-2, 152 West 25th St., N. Y. 1, N. Y.

Please send me a copy of your new 1953 colorful, fully illustrated catalog featuring the top-quality RCP instrument line.

NAME

ADDRESS

CITY STATE

STOP COSTLY SHUT-DOWNS!

Write for Catalog

WELLS SALES INC. 833 W. Chicago Ave., Chicago 22, Ill.

PHONE WELLS FOR ANY ELECTRONIC COMPONENTS
IMMEDIATE DELIVERY

FROM WORLD'S LARGEST STOCK... Seeley 8-4143

watts peak. Distortion at 10 watts is 1% harmonic and 2% intermodulation. Frequency response at 3 watts is $\pm .5$ db, 20 to 50,000 cps. Frequency response at 10 watts ± 1 db, 30 to 20,000 cps.

POWER AMPLIFIER

Brociner Electronics Lab., 1546 Second Ave., N.Y. 28, N.Y. has developed the Model UL-1 power amplifier which is an "ultra-linear" modification of the Williamson circuit.

Frequency response is from 10 to 200,000 cycles within 1 db. Power output is 20 watts from 30 to 20,000 cycles and 12 watts from 15 to 50,000 cycles. A power take-off socket sup-



plies filtered plate voltage and heater power for use with preamps. The distortion is 2% intermodulation at 20 watts and less than .1% at 1 watt. Hum and noise level is 80 db below 20 watts. The amplifier uses two 12AU7's, two 6BG6G's, and one 5V4G tube.

FOUR-WATT RESISTOR

International Resistance Co., 401 N. Broad St., Philadelphia 8, has added a new power resistor, type PW4, rated at four watts, to its line.

The new type is available in resistances from 1 to 8200 ohms in $\pm 5\%$ and $\pm 10\%$ tolerances. It is $1\frac{3}{4}$ " long by $21/64$ " dia. It can be used in television circuits requiring 2 to 3 watts actual dissipation at high ambient temperature since the unit is completely insulated with an inorganic core material molded in a high temperature plastic which will not support combustion.

TRANSISTORS AVAILABLE

Raytheon Mfg. Co., 55 Chapel, Newton 58, Mass. now has two *p-n-p* ger-

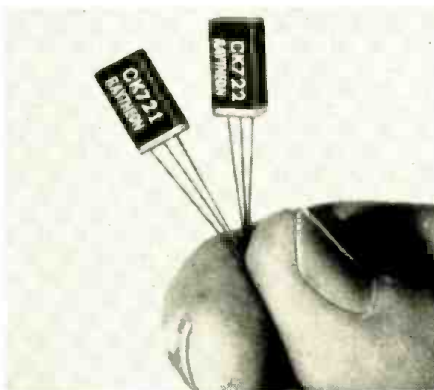

manium junction transistors available—the types CK721 and CK722.

The CK722 is available in production quantities but the CK721 will be

limited in quantity until April. Both units have a 22 db noise factor at 1000 cycles. Power gain of the CK721 is 38 and the CK722 is 30 db. Leads may be soldered or welded or cut for insertion in subminiature sockets.

Technical specifications are available from the Technical Information Service of the company or the company's sales offices in N.Y., Chicago, and Los Angeles.

ALKALINE DRY BATTERY

A new alkaline "B" radio battery has been developed by *RCA* which is 25 per-cent smaller than present comparable types yet offers double the playing capacity.

Designed specifically for use in "personal portables" the 67½ volt battery (VS216) utilizes the alkaline-cell principle formerly incorporated only in wet-type batteries.

The company has redesigned its "A" battery to provide balanced life operation with the new "B" battery. The new "A" unit (VS236) is twice the length of the standard cells but has a life capacity nearly four times greater. Two of these batteries will balance the life of the new alkaline "B" battery in "personal portable" applications.

UNIQUE BATTERY CAP

Industrial Research Inc., 4016 N.W. 29th St., Miami 42, Fla. is producing a new storage battery cap which preserves the water in batteries, prevents corrosion, and warns of overcharge or impending battery failure.

The "Hydrocap" contains a catalyst



which converts the battery's escaping hydrogen and oxygen gases back into water. Full details on these new units are available on request.

BINAURAL ARM

Livingston Electronic Corp. of Livingston, N.J. has developed a binaural transcription arm which plays either conventional or binaural recordings, uses conventional cartridges, costs less than two separate arms, and is especially designed for easy adjustment.

The unit provides independent action for each cartridge and has negligible tracking error.

CITIZENS RADIO GEAR

Motorola, Inc. of Chicago has received FCC approval on its Model T44A mobile receiver and L44A base station equipment for operation in the 460-470 mc. Citizens band.

The receiver circuit includes the
(Continued on page 124)

BUY TEST EQUIPMENT ON THIS RADICALLY NEW TIME PAYMENT PLAN

NO INTEREST!! - NO CARRYING CHARGES!!

USE CONVENIENT TIME PAYMENT ORDER BLANK BELOW

Superior's New

JUNIOR SUPER-METER

MOST COMPLETE AND COMPACT MULTI-SERVICE INSTRUMENT EVER DESIGNED



Handsome round cornered molded bakelite case 3 1/4" x 5 7/8" x 2 1/4" complete with all test leads and instructions

\$2140
NET

Measures: * Voltage * Decibels
* Capacity * Resistance
* Current * Inductance
* Reactance

Specifications: D.C. Volts: 0-7.5/75/150/750/1500 Volts. A.C. Volts: 0.15/150/300/1500/3000 Volts. Resistance: 0-10-100/100,000 ohms. 0-10 Megohms. D.C. Current: 0-7.5/75 Ma. 0-7.5 amps. Capacity: .001 Mfd.—.2 Mfd.—1 Mfd.—20 Mfd. Electrolytic Leakage: Reads quality of electrolytics at 150 Volt test potential. Decibels: —10 Db to +18 Db. + 10 Db. to + 38 Db. + 38 Db. to + 58 Db. Reactance: 15 ohms—25 K ohms 15 K ohms—2.5 Megohms. Inductance: .5 Henry—50 Henries 30 Henries—10 K Henries. Plus Good-Bad scale for checking the quality of electrolytic condensers.

Superior's New
Model TV-11

TUBE TESTER

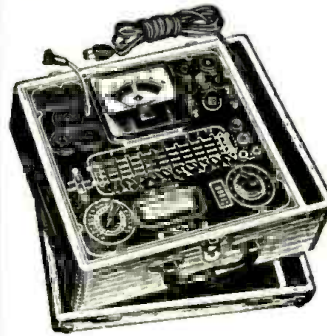

• Uses the new self-cleaning Lever Action Switches for individual element testing. Because all elements are numbered according to pin number in the RMA base numbering system, the user can instantly identify which element is under test. Tubes having tapped filaments and tubes with filaments terminating in more than one pin are truly tested with the Model TV-11 as any of the pins may be placed in the neutral position when necessary. • Uses no combination type sockets. Instead individual sockets are used for each type of tube. Thus it is impossible to damage a tube by inserting it in the wrong socket. • Free-moving built-in roll chart provides complete data for all tubes. • Phono jack on front panel for plugging in either phono or external amplifier detects microphonic tubes or noise due to faulty elements and loose external connections.

Operates on 105-130 Volt 60 Cycles A.C. Hand-rubbed oak cabinet complete with portable cover

\$4750
NET

Superior's New
Model 670-A

SUPER-METER

A COMBINATION VOLT-OHM MILLIAMMETER PLUS CAPACITY REACTANCE INDUCTANCE AND DECIBEL MEASUREMENTS

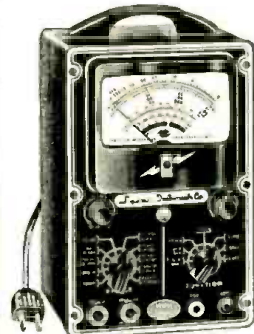

The Model 670-A comes housed in a rugged, crackle-finished steel cabinet complete with test leads and operating instructions. Size 6 1/4" x 9 1/2" x 4 1/2"

\$2840

SPECIFICATIONS:
D.C. VOLTS: 0 to 7.5/15 75/150/750/1500/7500 Volts
A.C. VOLTS: 0 to 15/30 150/300/1500/3000 Volts
OUTPUT VOLTS: 0 to 15/30 150/300/1500/3000 Volts
D.C. CURRENT: 0 to 1.5/15/150/ Ma. 0 to 1.5/15 Amperes
RESISTANCE: 0 to 1,000/100,000 Ohms 0 to 10 Megohms
CAPACITY: .001 to 1 Mfd. 1 to 50 Mfd. (Quality test for electrolytics)
REACTANCE: 50 to 2,500 Ohms. 2,500 Ohms to 2.5 Megohms
INDUCTANCE: .15 to 7 Henries 7 to 7,000 Henries
DECIBELS: —6 to +18 +14 +38+34 to +58

ADDED FEATURE:
The Model 670-A includes a special GOOD-BAD scale for checking the quality of electrolytic condensers of a test potential of 150 Volts.

Superior's New

TV BAR GENERATOR

THROWS AN ACTUAL BAR PATTERN ON ANY TV RECEIVER SCREEN!!



Connects direct to antenna post. No connection inside receiver.

Features.—Can be used when no stations are on the air. • Provides linear patterns to adjust vertical and horizontal linearity • Provides vertical and horizontal sweep signals • Provides signal for testing video amplifiers.

TV Bar Generator comes complete with shielded leads and detailed operating instructions. Only NET

\$3995
NET

Superior's Model 660-A—A NEW A.C. OPERATED

SIGNAL GENERATOR



• Tubes used: 1-6BE6 as R. F. Oscillator, mixer and amplifier. 1-6BE6 as Power Rectifier.
The Model 660-A comes complete with coaxial cable test lead and instructions. NET

\$4295

Provides Complete Coverage for A.M.—F.M. and TV Alignment

• Generates Radio Frequencies from 100 Kilocycles to 60 Megacycles on fundamentals and from 60 Megacycles to 220 Megacycles on powerful harmonics. • Accuracy and stability are assured by the use of permeability trimmed III-Q coils. • R. F. available separately or modulated by the internal audio oscillator. • Built in 400 cycle sine wave audio oscillator used to modulate the R. F. signal also available separately for audio testing of receivers, amplifiers, hard of hearing aids, etc. • R. F. Oscillator Circuit: A high transconductance heptode is used as an R. F. oscillator, mixer and amplifier. Modulation is effected by electron coupling in the mixer section thus isolating the oscillator from load changes and affording high stability. • A. F. Oscillator Circuit: A high transconductance heptode connected as a high- μ triode is used as an audio oscillator in a high-C Colpitts Circuit. The output (over 1 Volt) is nearly pure sine wave. • Attenuator: A 5 step ladder type of attenuator is used.

NEW TIME PAYMENT PLAN ORDER BLANK

MOSS ELECTRONIC DISTRIBUTING CO., INC.
Dept. B-49, 38 Murray Street, New York 7, N. Y.

Please send me the units checked below. I am enclosing the down payment with order and agree to pay the monthly balance as shown. It is understood there will be no carrying, interest or any other charges, provided I send my monthly payments when due. It is further understood that should I fail to make payment when due, the full unpaid balance shall become immediately due and payable.

- JUNIOR SUPER METER Total Price \$21.40
\$5.40 down payment. Balance \$4.00 monthly for 4 months.
- MODEL TV-11 Total Price \$17.50
\$11.50 down payment. Balance \$6.00 monthly for 6 months.
- MODEL 670-A Total Price \$28.40
\$7.40 down payment. Balance \$3.50 monthly for 6 months.
- TELEVISION BAR GENERATOR Total Price \$39.95
\$9.95 down payment. Balance \$5.00 monthly for 6 months.
- MODEL 660-A Total Price \$42.95
\$12.95 down payment. Balance \$5.00 monthly for 6 months.
- I enclose \$..... as down payment.
- Ship C.O.D. for the down payment.

Signature.....

Name.....

Address.....

City..... Zone..... State.....

OLSON'S PENNY PROFIT POLICY MEANS GREATER BARGAINS

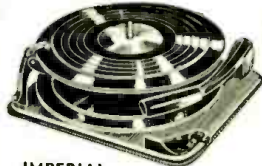

**IMPERIAL
DELUXE MODEL**
STOCK NO. RA-69

Equipped with single needle, with precision metal long-lasting tip. Plays all speed records. 33 1/3, 45 and 78 RPM. Regular retail price \$47.50. Shpg. wt. 5 lbs.

Single, each \$19.99
In lots of 3, each, only \$18.99

HI-FI DELUXE MODEL
STOCK NO. RA-113

Equipped with "Turnover" cartridge and dual needle. One side for 33 1/3 and 45 RPM discs and other side for 78 RPM discs. Both sides equipped with precision metal long-lasting tip. Regular retail price \$52.50. Shpg. wt. 15 lbs.

Single, each \$22.99
In lots of 3, each, only \$21.99

GIANT 3-SPEED RECORD CHANGER SALE!

3-SPEED GENERAL INSTRUMENT AUTOMATIC RECORD CHANGER

Automatically Changes All Sizes—
7", 10" and 12"

All Speeds—33 1/3, 45 and 78 RPM

All the finest features are incorporated in these General Instrument Record Changers. Records Slide Gently down the center spindle. There is no wobble, no scrape, no slip. No chance of damaging your records. The newly-designed controls are so simple, they explain themselves. No instructions needed. All moving parts in every General Instrument Changer are factory adjusted thus insuring years of trouble-free performance.

These Changers are precision-built by craftsmen who have had years of experience. Every Changer is brand new—in original factory-sealed cartons—and guaranteed 100% by Olson and the manufacturer. Here is one of Olson's most sensational bargains. Believe us—you can't go wrong.

Changer can be connected to any radio or amplifier. Equipped with clever "touch-plate"—a slight press and you can reject or skip a disc and go on to the next one. Has perfect cast parts. Here's a Changer you'll be proud to demonstrate to your friends. You can sell plenty of them too. Operates on 115 Volts AC, 60 cycle. Base size 12"x12 1/2"x3 1/2". Above plate and 3 1/2" below. Take your choice of either model.

COMPLETE 3-SPEED RECORD CHANGER AMPLIFIER KIT

Easily Assemble Your Own
Automatic Record Player

Stock No. AS-71
FOR ONLY \$29.99

SEE WHAT YOU SAVE
Complete Kit Regular List Price

3-Speed Changer	\$47.50
Amplifier (Wired)	7.50
Set of 3 Tubes	4.55
5" Heavy Duty Speaker	4.00
Output transformer	8.50
Mounting Base (Pre-Drilled)	8.50
Mounting Hardware	.55
Total List Price	\$74.35

Here's an outfit that normally retails at \$74.35. Save yourself a pile of money and have fun assembling your own 3-Speed Automatic Record Player. It's easy—can be assembled by anyone in just 30 minutes. All notes are drilled and all mounting hardware is provided. The Amplifier is completely wired. All you have to do is attach the Changer and Speaker wires. Shpg. wt. 20 lbs.

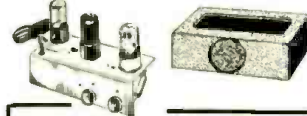

You Get Everything You Need to Easily Assemble Your Own 3-Speed Automatic Record Player. Kit Includes:

GENERAL INSTRUMENT IMPERIAL DELUXE CHANGER (Model RA-69—as described to left).

5" PM HEAVY-DUTY SPEAKER AND OUTPUT TRANSFORMER.
3-TUBE AMPLIFIER COMPLETE WITH TUBES
MOUNTING BASE—WITH HARDWARE & INSTRUCTIONS

HIGH GAIN STANDARD COIL TV BOOSTER

★ Latest Model ★ Brand New
★ Reg. List Price \$30.00
★ While they last. Model No. B-51.

\$10.95
Ea.

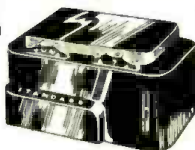

Just connect one of these Standard TV Boosters to your receiver and get brighter, snappier pictures and less "snow" and interference. Easy to install. Works on all TV sets. An amazing deal—you can cash in—save money—Order Today. Tunes all 12 channels. Uses a 6AK5 tube and a selenium rectifier. Complete. Operates on 115 V. AC. Shpg. wt. 6 lbs.

12" Magnavox Speaker and Baffle Close-Out



Stock No. AS-66
Get both for only \$7.95

You get Magnavox's fine 12" PM speaker with Alnico 5 magnet. (Same as you'll find in those expensive Magnavox Super-Radio-Phono Combinations.) Power output 8 watts. Voice coil fully dustproofed. Impedance 6-8 ohms. In addition you get a walnut Speaker Baffle to bring out the full rich, rounded tones of the Magnavox Speaker. Baffle may be mounted on a wall or it will stand on a table. Here's the ideal combination for extension speakers for porches or other rooms. Can be connected to any radio or amplifier. Order 4 or more sets and install them in restaurants, auditoriums, halls.

In lots of 4 sets.
One set for \$8.95.
Shpg. wt. 12 lbs.



**DELUXE
COUNTER**

\$1.69

Stock No. X-298
Shpg. wt. 1 lb.

BIG INSULATED RESISTOR KIT

OLSON SPECIAL PRICE
Contains a carefully selected assortment of 100 insulated resistors. Standard RMA color code. Included are 70—1/2 watt, 20—1 watt and 10—2 watt resistors. Insulation packed in a durable pilonin bag. Regular List Price \$2.99
Stock No. AS-32



SLOTTED SUPER SPACE LINE



LOWER LOSS 300 OHM

STOCK NO. W-115
500 Ft. Spool
Single \$7.95
Lots of 2 Spools

\$7.75
EACH

This slotted 300 ohm TV line is made to standard specifications in such a manner as to provide maximum air spacing while maintaining the dielectric strength and durability of the usual 300 ohm twin line. Color: Brown, with 22 stranded copper, pure polyethylene 55 mil. wall. Never offered before at such a low price. ORDER EARLY—while supply lasts. Shpg. wt. 7 lbs.

DON'T THROW AWAY OLD PICTURE TUBES



BOOST BRILLIANCE
WITH THIS TV
TUBE BOOSTER

\$2.95
Stock No. T-100

Completely automatic. Easy to install—no tools needed. Just plug into old picture tube that is starting to dim and watch the big change. Works on any Tube—10" to 30"—in all AC parallel circuits. Adds months and months of service to those old tubes. Reg. \$5.95. Shpg. wt. 1 lb.

OLSON ELECTRIFYING BARGAIN!

THE NEW WONDER OF ELECTRONIC CONTROL CAN BE YOURS FOR PRACTICALLY NOTHING THYRATRON REMOTE CONTROL



You get the complete outfit, including cabinet, 3 tubes 6SL7, 6SN7 and 6L50021 and wiring diagram.

STOCK NO. RA-111
Single, \$5.99
Lots of 3, each \$4.99

SERVICEMEN—HOBBYISTS—HAMS
EXPERIMENTERS—RADIO SCHOOLS

Here's the chance of a lifetime to own a genuine Thyratron Electronic Remote Control of your own at a fraction of its regular price! This mighty handy unit offers a miracle control can be made to perform hundreds of practical, fascinating feats of remote control. A complete schematic showing the circuit is included with each unit, what you get: Valuable parts and tubes galore that you can so easily use in any other radio, amplifier, etc.—or for experimenting.

LOOK AT ALL THE PARTS YOU GET

- 6SL7 and 6SN7
- GL-5662 Tube
- 16 Mfd. @ 150 Volts
- 1 Mfd. @ 200 Volts
- .02 Mfd. @ 200 Volts
- 1 Mfd. @ 200 Volts
- 1 Mfd. @ 200 Volts
- Control Relay
- Switch-SPST
- Pilot Lamp, Type 44
- 100 Ohm—1/2 Watt Wirewound
- 8000 Ohm—10 Watt Wirewound
- 3000 Ohm—1/2 Watt Wirewound
- 1 Megohm—1/2 Watt Carbon
- 240,000 Ohm—1/2 Watt Carbon
- 2 Ohm—1/2 Watt Wirewound
- 1 Megohm—1/2 Watt Wirewound
- 24 Ohm—2 Watt Wirewound
- 33 Ohm—1/2 Watt Wirewound
- 15,000 Ohm—1/2 Watt Carbon
- 500 Ohm—1/2 Watt Carbon

How can you lose? These parts are certainly worth THREE TIMES this amazing low cost. The General Electric Thyratron Type GL-5662 tube alone costs \$3.30 wholesale. Consider the price sensitive relay, filament transformer, tubes, condensers, resistors (many of them 1% precision). No matter how you cut it, here's a great, great Olson Bargain. Operates on 115 V. AC. Shpg. wt. 5 lbs.



COMBINATION DEAL!

10 WATT HI-FI PUSH-PULL AMPLIFIER

COMPLETE WITH

12" CO-AXIAL SPEAKER

BOTH FOR ONLY \$39.95
WITH TUBES COMPLETELY WIRED NOT A KIT

STOCK NO. AS-67

Order this matched outfit today. You get the 10-Watt Hi-Fi Amplifier PLUS the 12" Co-Axial Speaker both as described below. Can be built into any cabinet or hood—bringing you a complete Amplifier System of which you can be proud. Shpg. wt. 25 lbs.

Amplifier is completely assembled and ready to play. Built-in PRE-AMP for G.E. and similar types of magnetic pickups. 4 Input selector switch. 4 Input selector switch. 1 radio, 1 mike, 4 Controls, 1 Bass, 1 Treble, 1 Volume, 1 Phono-radio Switch. Output Impedances: 4, 8, 16 ohms. Peak power output 17 watts. Order this amplifier today and see what brilliant, realistic tone it will deliver. Supply is limited. Every one in factory-sealed cartons. You couldn't buy the parts alone for this price. Remember this is a full size amplifier, transformer operated, not an AC-DC job. Frequency response 20 to 20,000 cps. at less than 1% of 1% distortion. 3 Tubes, 1-6SL7, 1-6SN7, 2-6AV6, 1-6Y3. Complete with tubes. Size 12" x 6 1/2" x 3 1/2".

Speaker is our new 1953 Co-Axial Model. Guaranteed to outperform any speaker in its price class. Features two "high concentration" Alnico 3 magnets and a high frequency diffuser. The 12" section delivers the bass while the inner, 6" tweeter speaker section delivers the treble tones. Together they give you living tone. This speaker is unconditionally guaranteed to satisfy even the most critical user or Olson promises to refund your money. Only two wires to connect to amplifier. Voice coil impedance 8 ohms. Frequency response 30 to 17,000 cps. Shpg. wt. 25 lbs.

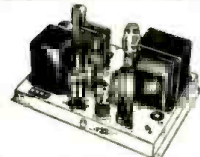

TECH-MASTER

New Williamson-Type Amplifier Kit

Stock No. AMP-12
COMPLETE WITH TUBES \$48.95

Full 15 Watts—Ultra Linear • Includes Altec Lansing Peerless Audio Transformer
Complete Kit of exact transformers, condensers, resistors, sockets, tubes, hardware, punched chassis—every part you need—as well as a full detailed wiring diagram. Utilizes the famous WILLIAMSON circuit for high fidelity reproduction. Only top quality parts are included—specially wound ALTEC LANSING Peerless Transformers, for instance, are employed. Easy to assemble.

SPECIFICATIONS: Output Impedance—4-8-16 ohms; Input Impedance—High for crystal pickups, turners, pre-amps, etc.; Response—8 cps to 80,000 cps; 1 Mfd. @ 2 Tubes, 2-12SN7-28A, 1-6Y3-40; 105-125V. 50-60 cycles 120 W. Size—9"x12"x 6 1/2". Shpg. wt. 27 lbs.

TECH-MASTER

4 CHANNEL PRE-AMPLIFIER KIT

For Use with Williamson Amplifier



Stock No. AMP-13

3 input channels and selector switch for: Pk-AM or TV, Tuner, crystal and reluctance pick-ups, tape or wire recorder, etc. 3 position equalizer switch permits selection of turnover and roll-off. 2 continuous controls for full bass and treble boost and attenuation. Powered from main amplifier. AC outlet permits main amplifier, etc. to be controlled by master switch. Complete with pre-printed punched chassis, all components, tubes, cabinet and detailed instructions. Easy to assemble.

SPECIFICATIONS: 4 Input channels—1 Low frequency gain, 3 Hi-Impedance. Tube Complement (1-12AX7, 1-12AU7). Size—10 1/2"x4"x4". Shpg. wt. 4 lbs.

\$19.55
with Tubes

USE HANDY ORDER BLANK ON NEXT PAGE ►



OLSON RADIO WAREHOUSE

275 E. Market St., Akron 8, Ohio

RADIO & TELEVISION NEWS

SELENIUM RECTIFIERS

Full-Wave Bridge Types

Current (Continuous)	18/14 Volts	36/28 Volts	54/42 Volts	130/100 Volts
1 Amp.	51.25	52.10	53.60	57.50
2 Amps.	2.20	3.60	6.50	10.50
3 Amps.			7.50	15.00
4 Amps.	3.75	6.75	8.75	
5 Amps.	4.95	7.95	12.95	27.00
6 Amps.	6.50	9.00	14.00	33.00
10 Amps.	6.75	12.00	20.00	40.00
12 Amps.	8.50	16.00	25.50	50.00
20 Amps.	13.25	24.00	36.00	90.00
24 Amps.	16.00	31.00	39.50	98.00
30 Amps.	18.50	36.00		
36 Amps.	25.50	45.00		

FLEXIBLE SHAFTS

MC 215

(ALL LENGTHS IN INCHES)

34	163	260
135	186	

MC 124

(ALL LENGTHS SHOWN IN INCHES)

23	61	120	175
29	65	140	205
39	103	161	241
52	114	166	348

PRICE MC 124 or MC 215 **2c Per In.**

CIRCUIT BREAKERS

AM 1614-80—28VDC, 80Amp. \$1.59
 AM 1614-100—28VDC, 100 Amp. \$1.69
 KJ-600V, 15 Amps., up to 300% overload ratings. Trip adj. 10 min.—inst. **\$21.95**

FILTER CHOKES

Stock	Description	Price
CH-533	13.5H, 1A, 13.5KV Test.	539.95
CH-366	20H/3A	6.95
CH-322	35H/50 MA—10 Ohms DCR	2.75
CH-141	Dual 7H/75 MA, 11H/60 MA 5KV DC Test.	4.69
CH-119	8.5H/125 MA	2.79
CH-69-1	Dual; 120H/17 MA	2.35
CH-8-28	2 x .5H/380 MA, 75 Ohms	1.79
CH-776	1.28H/130 MA, 75 Ohms	2.25
CH-344	1.5H/145 MA/1200V Test.	2.35
CH-43A	10H/15 MA—800 ohms DCR	1.75
CH-366	20H/300 MA	6.95
CH-999	15H/15 MA—400 ohms DCR	1.95
CH-511	6H/30 MA—310 ohms DCR	2.45
CH-501	2.5H/400 MA	2.79
CH-188M	5H/200 MA	1.79
CH-303	300H/.02A, 2500V Test	1.69
CH-982	SWING 9-60H/.4-.05A 10KV	7.95

POWER TRANSFORMERS

Comb. Transformers—115V50-60 cps	Input	
CTJ5-2-600VCT/.2A, 5V/6A	5.95	
CT-15A 580VCT .085A 6.3V/.6A, 6.3V/1.8A	2.85	
CT-164 4200V.002V/.12KV Test, 5VCT/3A/12KV Test, 6.3V/0.6A/5400V Test.	12.95	
CT-341 1050 10 MA.—625V @ 5 MA, 26V @ 4.5A 2x2.5V/3A, 6.3V @ 3A	16.95	
CR 825 360VCT .340A 6.3VCT/3.6	3.95	
CT-626 1500V .160A 2.5/12.30/100 9.95		
CT-071 110V .200A 33/.200. 5V/10. 2.5/10	4.95	
CT-367 580VCT .050A 5VCT/3A	2.25	
CT-99A 2x110VCT.010 A 6.3/1A, 2.5VCT/7A	3.25	
CT-403 350VCT .026 A 5V/3A	2.75	
CT-931 585VCT .086A 5V/3A, 6.3V/6A	4.25	
CT-456 390VCT .30MA 6.3V/1.3A, 5V/3A	3.45	
CT-931 585VCT 86 MA 5V/3A, 6.3V/6A	4.95	
CT-442 525VCT 75 MA 5V/2A, 10VCT/2A, 50V/200 MA	3.85	
CT-720 550-0-550/250 MA, 6.3V/1.8A	8.95	
CT-43A 600-0-600V/.12KV Test, 5VCT/6A, 6.3VCT/1A	6.49	
CT-501 650VCT/200 MA, 6.3V/8A, 6.3V/5A	6.49	
CT-444 230-0-230V/.085A, 5V/3A, 6V/2.5A	3.49	
Filament Transformers—115V50-60 cps	Input	
Item Rating Each		
FT-674 8.1V 1.5A	5 1.10	
FT-157 4V-16A, 2.5V 1.75A	2.95	
FT-101 6V/2.5A	7.75	
FT-924 5.25V/21A, 2x7.75V/6.5A	14.95	
FT-824 2x26V 2.5A, 16V 1A, 7.2V 7A, 6.4V 10A, 6.4V 2A	8.95	
FT-463 6.3VCT 1A, 5VCT 3A, 5VCT 3A	5.49	
FT-55-2 7.2V/21.5A, 6.5V/6.85A, 5V/6A, 5V/3A	8.95	
FT-986 16V @ 4.5A or 12V @ 4.5A	3.75	
FT-38A 6.3 2.5A, 2x2.5V 7A	4.19	
FT-A27 2.5V 2.5A, 7V 7A, TAP 2.5V/2.5A, 16KV TEST	18.95	
FT-608 6.3V 3A 750V Test	1.75	
FT-873 4.5V 5A, 7V 7A	2.15	
FT-899 2x5V A 5A, 2x9KV Test	24.50	
Plate Trans.—115V, 60 cps	Rating	Price
PT-699 300/150V .05A, 300/150V.05A	5	2.79
PT-362 120-0-120V 350 MA	4	4.69
PT-108 17.600V/144 MA	120	60
PT-671 62V/3.5A	7	7.95

Send M.O. or Check, Shipping Chgs. C. O. D.

COMMUNICATIONS EQUIPMENT CO.

131 Liberty St. Dept. H-2, New York City 7, N. Y.

Within the Industry

(Continued from page 26)

ALLEN H. CENTER, formerly public relations director for the *Parker Pen Company*, has joined the staff of *Motomola, Inc.* as public relations director . . . **EUGENE M. KEYS** has been elected to the post of executive vice-president, director of sales, and to the board of directors of the *Edwin I. Gutham & Co., Inc.* . . . **EDWARD M. SHERIDAN** has joined *I.D.E.A., Inc.* as industrial sales manager. He was formerly associated with *RCA Victor Engineering Products Division* for 10 years and was manager of the Product Analysis Section of the New Products Division prior to taking his new post . . . **CLARK KELLEY** is the new assistant service manager of *Sparton Radio-Television* of Jackson, Michigan . . . **R. J. McCLUSKER** has been named assistant sales manager of the *Westinghouse Television-Radio Division*. He succeeds **J. W. HITCHCOCK** who resigned recently . . . *Hycon Mfg. Company* has appointed **RAYMOND F. CRISP** to the post of manager of technical services. He was formerly chief electronics engineer for the firm . . . **ROLAND J. SHERWOOD**, vice-president in charge of sales for the *Hullcrafters Company*, has resigned his post to organize his own business in an unrelated field . . . **LEONARD F. CRAMER**, assistant general manager of the *Crosley Division*, has been elected a vice-president of *Arco*. In his new post he will be in complete charge of *Crosley's TV* and radio activities . . . *Raytheon Television and Radio Corporation* has promoted **JAMES R. BUTLER** to the post of merchandising manager for the firm. He was formerly sales promotion manager . . . **WILLIS E. CLEAVES** has been named general sales manager of the *Bendix Radio Communications Division* of *Bendix Aviation Corporation*. He succeeds **ARNOLD ROSENBERG** who has resigned . . . **GAIUS WIKI** is the new general sales manager of *Utah Radio Products Co., Inc.* of Huntington, Indiana. He succeeds **FRED TOWER** who has been promoted to division manager and vice-president of the *Caswell-Rumyan Division* of the firm . . . **T. J. NEWCOMB**, who has been with *Westinghouse* for more than 20 years, has been appointed manager of the company's Television-Radio Division with headquarters at Sunbury, Pa. . . The promotion of **HARRISON JOHNSTON** to the position of general sales manager has been announced by the *Ampex Electric Corporation* of Redwood City, California . . . **EDWARD P. ROBINSON** has been named plant manager for the *Espey Manufacturing Co., Inc.* of New York. He has been with the firm since 1947 . . . **R. K. GILBERT** has been appointed operation manager of the Chicago plants of *Standard Coil Products Co., Inc.* He was formerly associated with *Philco Corporation* for 16 years, serving in several important production capacities . . . **MORT LESLIE**, a veteran in the

radio and television broadcasting sales fields, has been appointed assistant sales manager for *JFD Manufacturing Company, Inc.* . . . **MIKE MEYERS** is the new chief field engineer for *Radio Merchandise Sales, Inc.*

JOHN B. OTTMAN, former advertising manager of *Stewart-Warner's Electric Division*, has been appointed television-radio sales promotion manager for *Admiral Corporation*.



A native of New York City, Mr. Ottman is a graduate of Yale and the Harvard Graduate School of Business Administration. He served in the U.S. Air Force for three and a half years and joined *Stewart-Warner* in 1947.

NEDA will hold its 1953 convention and conference September 14, 15, and 16 at the Chase Hotel in St. Louis, Missouri, according to word received from the association's headquarters.

A departure from past meetings, this year's convention will eliminate booths for conference purposes and provide instead three large rooms on the first floor of the hotel for conferences. Each manufacturer will be allotted a table and several chairs for use in greeting and talking to distributors.

There will be no business or social functions of any kind during conference hours. Entertainment for each of the three evenings will be provided by each of the three groups attending; "The Reps," participating manufacturers, and **NEDA**.

Educational programs are scheduled for 10:00 to 11:30 a.m. each morning of the convention. Conference hours will be 1 p. m. to 6 p. m.

A.T. & T.'s Long Lines Department has announced the recent completion of two new links in its expanding telephone-television network.

The company has now connected **Roanoke, Virginia** into the nationwide television network.

The company also opened a new radio-relay link between **Kansas City** and **Dallas**. The new facility will provide 96 television circuits as well as one **Kansas City-Dallas TV** channel.

Network service is now available to 112 television stations in 69 cities in the U.S., as of December 15, 1952.

CAPT. HENRY J. ROUND, 1952 Armstrong Medal winner, recently received his award from the hands of **John Bose**, president of the **Radio Club of America** at the club's 43rd annual banquet.

The award was made in recognition of **Capt. Round's** pioneering work in radio, especially in the fields of radio direction and position finding and the high amplification of short-wave signals. **Capt. Round** is a native of England,

Let me send you FREE
the entire story

Just fill out the coupon and mail it. I will send you, free of charge, a copy of "How to Pass FCC License Exams," plus a sample FCC-type Exam, and the amazing new booklet, "Money-Making FCC License Information."



EDW. H. GUILFORD
Vice President

I can train you to pass your FCC License Exams in a minimum of time if you've had any practical radio experience — amateur, Army, Navy, radio servicing, or other. My time-proved plan can help put you, too, on the road to success.

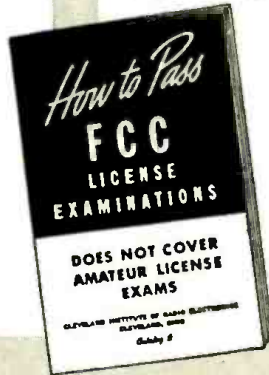

How to Pass FCC COMMERCIAL Radio Operator License Exams

FREE

Tells where to apply and take FCC examinations, location of examining office, scope of knowledge required, approved way to prepare for FCC examinations, positive method of checking your knowledge before taking the examination.

GET YOUR FCC TICKET IN A MINIMUM OF TIME

Get this Amazing Booklet FREE



TELLS HOW

HERE IS YOUR GUARANTEE

If you fail to pass your Commercial License exam after completing our course, we guarantee to continue your training without additional cost of any kind, until you successfully obtain your Commercial license, provided you first sit for this examination within 90 days after completing our course.

WE GUARANTEE TO TRAIN AND COACH YOU AT HOME IN SPARE TIME UNTIL YOU GET

YOUR FCC LICENSE

If you have had any practical experience—Amateur, Army, Navy, radio repair, or experimenting

Employers make

TELLS HOW

JOB OFFERS Like These to Our Graduates Every Month

Letter from Chief Engineer, Broadcast Station, North Carolina. "Need men with radio-telephone 1st class licenses, no experience necessary. Will learn more than at average station for we are equipped with Diesel Electric power, transmitting and studio equipment."

Telegram from Chief Engineer, Broadcast Station, Wyoming. "Please send latest list available first class operators. Have November 10th opening for two combo men."

These are just a few examples of the job offers that come to our office periodically. Some licensed radiomen filled each of these jobs . . . it might have been you!

HERE'S PROOF FCC LICENSES Are OFTEN SECURED IN A FEW HOURS OF STUDY WITH OUR COACHING at HOME in SPARE TIME

Name and Address	License	Lessons
Lee Worthy 2210 1/2 Wishire St., Bakersfield, Calif.	2nd Phone	16
Clifford E. Voot Box 1016, Dania, Fla.	1st Phone	20
Francis X. Foersch 38 Beucler Pl., Bergenfield, N. J.	1st Phone	38
S/Sgt. Ben H. Davis 317 North Roosevelt, Lebanon, Ill.	1st Phone	28
Albert Schoell 110 West 11th St., Escondido, Calif.	2nd Phone	23

TELLS HOW

TV ENGINEERING INCLUDED IN OUR TRAINING & COACHING

Our Amazingly Effective JOB-FINDING SERVICE

Helps GIRE Students Get Better Jobs

Here are a few recent examples of Job-Finding results

GETS FIVE JOB-OFFERS FROM BROADCAST STATIONS
"Your 'Chief Engineer's Bulletin' is a grand way of obtaining employment for our graduates who have obtained their 1st class license. Since my name has been on the list I have received calls or letters from five stations in the southern states, and am now employed as Transmitting Engineer at WMMT."
Elmer Powell, Box 274, Sparta, Tenn.

GETS CIVIL SERVICE JOB
"I have obtained a position at Wright-Patterson Air Force Base, Dayton, Ohio, as Junior Electronic Equipment Repairman. The Employment Application you prepared for me had a lot to do with my landing this desirable position."
Charles E. Loomis, 4516 Genessee Ave., Dayton 6, Ohio.

OURS IS THE ONLY HOME STUDY COURSE WHICH SUPPLIES FCC-TYPE EXAMINATIONS WITH ALL LESSONS AND FINAL TESTS.

GETS JOB WITH CAA
"I have had half a dozen or so offers since I mailed some fifty of the two hundred employment applications your school forwarded me. I accepted a position with the Civil Aeronautics Administration as Maintenance Technician. Thank you very much for the fine cooperation and help your organization has given me in finding a job in the radio field."
Dale E. Young, 122 Robbins St., Dwosso, Mich.

Your FCC Ticket is recognized in all radio fields as proof of your technical ability.



Get All 3 FREE

MAIL COUPON NOW

CLEVELAND INSTITUTE OF RADIO ELECTRONICS

Desk RN-49
4900 Euclid Bldg., Cleveland 3, Ohio
(Address to Desk No. to avoid delay)

I want to know how I can get my FCC ticket in a minimum of time. Send me your FREE booklet, "How to Pass FCC License Examinations" (does not cover exams for Amateur license), as well as a Sample FCC-type exam and the amazing new booklet, "Money-Making FCC License Information."

Tell me how I can get a TV Engineering Course without additional charge.

NAME

ADDRESS

CITY..... ZONE..... STATE.....

Paste on 2-cent post card or send air mail

CLEVELAND INSTITUTE OF RADIO ELECTRONICS

CARL E. SMITH, E. E., Consulting Engineer, President
Desk RN-49 — 4900 Euclid Bldg., Cleveland 3, Ohio

New master of the



THE **NEPCO** LINE

National Electric Products

Radio and Television Department

Pittsburgh, Pa.

RADIO & TELEVISION NEWS

elements



The NEPCO Line—television's new "Master of the Elements"—now meets the pressing demand for better electronic equipment. This complete line of quality TV Antennas, Mounting Accessories and Wire represents more built-in ruggedness than any now known—proves that *only the best meets the test of time!*

See the Nepeco Line today. Examine its radically new design and construction. Prove to yourself that there's nothing finer on the market today—that it's the best by far at any price. Backed by the world's largest producer of electrical "rough-in" materials, the Nepeco Line carries National Electric's guarantee of quality, engineering and research. You can specify and install it with complete confidence of long-life installations and customer satisfaction. Write for details now.

THE **NEPCO** LINE

HARRISON HAS IT!

Famous

Aerosound ★

**ULTRA LINEAR
OUTPUT TRANSFORMERS**

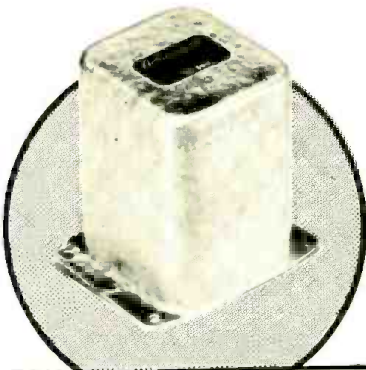

Using a Williamson?

**Double Your Power Output
...Reduce Distortion by 50%!**

ACRO TO-300

One of the world's finest transformers! Specifically designed to obtain maximum performance from ultra linear circuits.

- Undistorted Power: 40 watts, 30 to 20,000 cps
- Frequency Response: ±1 db, 10 to 100,000 cps
- Unequaled Square Wave Performance
- Resonance-Free Response
- Low Phase Shift
- Output Impedances: 4, 8, 16 ohms
- Fully potted steel case: 3 5/8 x 3 1/4 x 1 1/4" H.

\$24⁷⁵

TO-305. Same as TO-300, PLUS 125 and 500 ohm output impedances\$30.75

TO-310. Same as TO-300 except 20 watts. For converting popular 10-watt 6v6 amplifiers to Ultra Linear operation \$18.75
TO-290. 20 watts. For original Williamson using 807, 5881 or KT66 as triodes \$15.75

FREE! 12-page brochure on ultra linear output transformers, amplifier circuits and specs.

If COD, send 25% Deposit.

Mail Your Order TODAY!
Immediate Shipment

HARRISON
RADIO CORPORATION

225 Greenwich St. • N. Y. 7, N. Y.
Please send me the following transformers as checked below (include postage; weight approximately 25 lbs. each):

- TO-300 TO-305 TO-310
 TO-290 Free Data Sheets

Amount Enclosed \$ _____

NAME _____

ADDRESS _____

TV Sound System
(Continued from page 55)

output transformer secondary. The volume control on the receiver can be used to vary the output of the amplifier. This method of connecting the receiver to the amplifier has many advantages over simply running a line to the high impedance input of an amplifier from, say, the hot side of the receiver's volume control. For one thing, there is little chance of hum pickup due to long high impedance lines, also there is no attenuation of the higher frequencies due to long runs of shielded wire which bypass the higher frequencies to ground.

For high impedance inputs, the grid of the 6SN7 is connected to an internal volume control and the cathode resistor R_2 is bypassed with a 25 μ fd. condenser, C_1 . The high impedance input is useful when it is desired to connect a record player attachment with a crystal pickup.

The speaker system used with this amplifier is shown in Fig. 3. It consists of an 8-inch, wide-range speaker mounted in a bass reflex enclosure. An 8-inch speaker was found to be a good compromise between the larger speakers, which require large enclosures, and smaller speakers which are not capable of adequate bass reproduction. A wide range 8-inch speaker, when properly baffled, is cap-

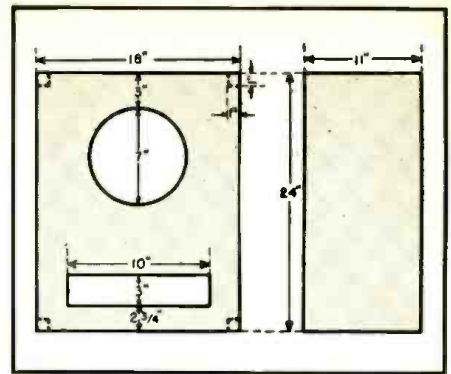

Fig. 3. Construction details for building the associated speaker enclosure. Cabinet should be constructed of 5/8" plywood with corners braced with 1" x 1" blocks of wood.

able of excellent bass response, and the cone is small and rigid enough to reproduce the higher frequencies. The speaker system used by the writer showed remarkably smooth response throughout the audio range. Fig. 3 shows the dimensions of the bass reflex enclosure. The back, one side, and the top of the enclosure should be lined with suitable insulating material such as Celotex or rock wool. It should be rigidly constructed, the joints should be screwed and glued, and the back cover should be very tightly secured to the enclosure.

It is the writer's belief that anyone who constructs this amplifier-speaker combination will find it as useful and enjoyable as he did.

ELIMINATING BARKHAUSEN EFFECT

FROM the Service Department of Scott Radio Labs, Inc. of Chicago comes some useful tips on the causes and remedies of Barkhausen lines in the picture.

"Barkhausen lines are vertical black lines which run the full length of the screen. The lines usually are most prominent and occur more often in the left half of the CR tube screen when facing the front of the receiver. The lines shift and differ in intensity with each channel.

"Barkhausen can occur in any receiver using a 6BQ6, 6CD6, 6BC6, or other similar horizontal output tubes used in modern television receivers. In such tubes an r.f. oscillation is set up between the screen and the plate due to rapid plate potential changes and emanates from the horizontal output tube as an r.f. signal. Physical characteristics of the tube determine the frequency of this oscillation to some degree. Some of the frequencies generated in the horizontal output tube fall within the TV spectrum and if allowed to enter the r.f. section of the receiver, they will appear visually as outlined above.

"The built-in antenna will pick up this radiated signal, and whether or not the built-in antenna is used, it can feed or radiate the signal to the r.f. unit. In receivers where the built-in antenna is not used, it would be best to remove the antenna from the cabinet. The aquadag coating on the outside of the picture tube will also act as a radiator of this r.f. signal if not properly grounded.

"In many receivers, the power cord terminates near the high voltage power box, and the power cord can pick up this signal and transmit it to the antenna leads, particularly where the antenna leads come from an outside antenna and then are allowed to be coiled on the floor in close association with the power lead. Often rearranging of the receiver line cord with reference to the incoming antenna leads will eliminate Barkhausen oscillation.

"Within the receiver, moving of the piece of twin-lead from the tuner to the termination point at the rear of the chassis will often eliminate Barkhausen lines. Since horizontal output tubes radiate at different frequencies, the change of the horizontal output tube may either remove Barkhausen lines entirely or transfer them to a channel which is not in use. Also it would be advisable to try different damper tubes. In extremely difficult cases it may be necessary to attach a magnet to the horizontal output tube. Quite often an ion trap is slipped over the top of the horizontal output tube to eliminate Barkhausen radiation. Another possibility for the elimination of Barkhausen is slight readjustment of the horizontal drive control. Check all tube shields on the tuner to make certain that they are properly grounded.

"Problems of Barkhausen elimination are normally problems of installation and each set will show different characteristics and on each receiver lines will appear on different channels and in a different position on the CR screen."



TUBES

ALL TUBES are guaranteed for one year... individually boxed. Very BEST BRANDS available for immediate delivery!

FREE OFFER!

5 lbs. of good usable radio service parts with every 100 tubes ordered; a kit of assorted radio repair hardware free with every 50 tubes ordered!

0Z4	59c	2B7	.89	6AT6	.59	6CD6G	1.49	6SG7	69c	7B7	79c	12AV7	.89	1B3GT	ea. \$.95	6BK7	ea. \$.98	7H7	ea. \$.69
0Z4G	.65	2C34	.60	6AS5	.90	6D6 7B	1.10	6SH7	.69	7B8	1.30	12A6W	.95	1X2A	.89	6BL7	.79	12AT7	.89
1A5GT	.65	2E5	.89	6AU6T	.89	6D8C	1.15	6SH7GT	.69	7C4	.69	12A4	.69	5U4G	.59	6B06GT	.85	12AU7	.65
1A7	.69	2X2 879	.74	6AUE	.59	6E5	.69	6S17	.59c	7C5	.59	12A7	.69	6A84	.69	6B07	1.19	12A74	.69
1B3GT	.95	3L4	1.19	6AV5GT	.89	6F5GT	.59c	6S17GT	.59c	7C6	.59	12B6	.59	6AU6	.59	6B27	1.29	70L7GT	.89
1B5	.69	3Q4	.69	6AV6	.59	6F6GT	.59	6S17GT	.69	7C7	.69	12B6G	.69	6AV5GT	.69	6C6DG	1.49	715B	7.75
1C7G	.29c	3Q5GT	.89	6AX4	.69	6F8C	1.15	6S17GT	.69	7E6	.69	12B6F	.59c	6AX4	.69	6U8	.89	807	1.55
1E7	.354	3S4	.69	6AX6	.69	6G6G	.95	6SN7GT	.69	7E7	.89	12B7	.69	6B6CG	1.49	6V3	1.29	866A 1616	1.49
1H5GT	.59	3V4	1.40	6B4C	1.44	6H6GT	.59	6S07	.59c	7F7	1.47	12B8	.69	14C5	1.07	3525	.55	75	69c
1J6GT	.69	5T4	.69	6B5	.79	6J5GT	.59	6S07GT	.59	7F8	.79	12C8	.69	14C7	.98	3526G	.95	78	1.10
1L4	.69	5U4G	.87	6B6G	1.15	6J7G	.69	6SR7GT	.59	7G7	.79	12F5GT	.69	14F7	.89	35 51	.79	78 606	.69
1LA4	1.19	5V4G	.87	6B8GT	.59	6J8G	1.15	6S57	.72	7H7	1.07	12H6	.69	14F8	1.30	36	1.06	80	.69
1LA6	.69	5W4GT	.59c	6B8A	.69	6J8GT	.69	6T8	.89	7I7	.79	12J5GT	.69	19B6G	1.49	37	.72	83	1.45
1LC5	.69	5Y3GT	.45	6B8B	.69c	6K5GT	.59	6T8	.89	7K7	.79	12K7GT	.69	19T8	.89	38	.85	84 624	.72
1LDC	.19	5Y4G	.54	6B8C	.69	6K6GT	.59	6U5	.69	7L7	.79	12Q7GT	.69	20	1.40	39 44	.88c	85	.79
1LE5	.19	5X4G	.81c	6B8D5GT	.89	6K8GT	.69	6UGGT	.69	7N7	.79	12SA7GT	.69	24A	.69	41	.72	117A7	1.40
1LH4	.19	5Z3	.69	6B8E	.59	6L5G	.95	6U6GT	.69	7Q7	.79	12S7	.69	24ACSGT	1.04	42	.66	117B7	.89
1LLN5	.19	6A3	1.15	6B8F5	.69	6L6G	.95c	6V3	1.29	7R7	.89	12S7F9GT	.69	25BQ6GT	1.15	43	.72c	117C7	1.40
1L5GT	.69	6A7	1.21	6B8G	.69	6L6GA	.69	6V3	.89	7S7	1.07	12S7P7	.69	25L6GT	.59	45	.59	117D7	.59
1P5GT	.69c	6A8GT	.69	6B8GG	1.49	6L7	.69	6V4GT	.59	7V7	.79	12S7GT	.69	25W4GT	.69	45Z5	.69	117E6	.69
1Q5GT	.69c	6A8A	.69	6B8H	.69c	6M6G	1.40	6W6	.69	7X6	.89	12S17GT	.69	25Z5	1.04	46	.89c	715B	7.75
1R5	.59	6A8B7	1.15	6B8J	.69c	6N7GT	.69	6X4	.59c	7X7	.89	12S17GT	.69	25Z6GT	.69	47	.807	155	1.55
1S5	.69c	6AC5GT	.89	6B8K7	.38	6P5GT	.69c	6X5GT	.69	7Y4	.89	12S17GT	.69	32L7GT	.69	50A5	.89	813	10.95
1T4	.89	6AC7	.99	6B8L7	.79	6Q7GT	.59	6Y6G	.69	7Z4	.79	12S27GT	.69	32L7GT	.69	50B5	.69c	866A 1616	1.49
1U4	.89	6AC5	.69	6B8M	.39	6R7GT	.69	6Z4 84	.72	12A7	1.15	12S27GT	.69c	35A5	.99	50C6G	1.04	1295	.29c
1U5	.59	6AG7	1.49	6B8Q6GT	.85	6S4	.59	7A4	.79	12A8	.69	12S07	.69	35B5	.99	50L6	.69	1619	.45
1V	.88	6AH6	1.49	6B8Q7	1.19	6S7GT	1.15	7A5	.89	12A87	1.45	12S07GT	.69	35C5	.69	50X6	.79	1629	.29
1X2A	.89	6AK5	.89	6B8Z	1.29	6S8GT	.69	7A6	.69	12A15	.54	12Z3	.95	35L6	.69	50Y6	.69	2050	2.00
2A3	1.15	6AK6	1.08	6C4	.59	6SA7GT	.69	7A7	.79	12A16	.59	14A7	.89	35W4	45	70L7	.89c	2051	1.15
2A5	.79	6AL5	.69	6C5GT	.69c	6SC7	.69	7A8	.89	12A17	.89	14A7	.89	35Y4	.93	70L7GT	.89c	7153	.87
2A6	.89c	6AQ5	.69	6C6	.69	6SD7GT	.99	7B4	.69	12A16G	.69	14A7	.89	35Z3	.59	71A	.87	VT51	.29c
2A7	.89c	6AQ6	.51	6C8G	1.15	6SF5	.59	7B5	.59	12A17G	.65	14B6	.69	35Z4	.59	71A	.87	VT52	.87
2B3	.89	6ARS	.74	6C8B	.69	6SF5GT	.59	7B6	.59	12A16G	.59	14B8	.89c	35Z4	.59	71A	.87	VT52	.87

TUBES and PARTS

TUBE SPECIALS!

1B3GT	ea. \$.95	6BK7	ea. \$.98	7H7	ea. \$.69
1X2A	.89	6BL7	.79	12AT7	.89
5U4G	.59	6B06GT	.85	12AU7	.65
6A84	.69	6B07	1.19	12A74	.69
6AU6	.59	6B27	1.29	70L7GT	.89
6AV5GT	.69	6C6DG	1.49	715B	7.75
6AX4	.69	6U8	.89	807	1.55
6B6CG	1.49	6V3	1.29	866A 1616	1.49
14C5	1.07	3525	.55	75	69c
14C7	.98	3526G	.95	78	1.10
14F7	.89	35 51	.79	78 606	.69
14F8	1.30	36	1.06	80	.69
19B6G	1.49	37	.72	83	1.45
19T8	.89	38	.85	84 624	.72
20	1.40	39 44	.88c	85	.79
24A	.69	41	.72	117A7	1.40
24ACSGT	1.04	42	.66	117B7	.89
25BQ6GT	1.15	43	.72c	117C7	1.40
25L6GT	.59	45	.59	117D7	.59
25W4GT	.69	45Z5	.69	117E6	.69
25Z5	1.04	46	.89c	715B	7.75
25Z6GT	.69	47	.807	155	1.55
32L7GT	.69	50A5	.89	813	10.95
32L7GT	.69	50B5	.69c	866A 1616	1.49
35A5	.99	50C6G	1.04	1295	.29c
35B5	.99	50L6	.69	1619	.45
35C5	.69	50X6	.79	1629	.29
35L6	.69	50Y6	.69	2050	2.00
35W4	45	70L7	.89c	2051	1.15
35Y4	.93	70L7GT	.89c	7153	.87
35Z3	.59	71A	.87	VT51	.29c
35Z4	.59	71A	.87	VT52	.87

TUBE KITS

BEST BRANDS AT BEST PRICES



3Q4, 1T4, 1R5, 1S5.	List Value \$8.00. Tube Kit only.	\$1.98
3S4, 1T4, 1S5, 1R5.	List Value \$7.80. 4 Tube Kit.	\$1.98
1U4, 3S4, 1S5, 1R5.	List Value \$7.80. All for 3V4, 1R5, 1S5, 1T4.	\$1.98
117Z3, 1U5, 3V4, 1R5, 1T4.	AC-DC Portable Kit. All for 12A76, 12BA6, 12BE6, 35W4, 50B5.	\$2.49
5 Tubes for 50L6GT, 35Z5GT, 12SQ7GT, 12SK7G, 12SA7G.	3 Tubes for.	\$3.22

PICTURE TUBES

PICTURE TUBES

Send us your duds COLLECT — up to 70 lbs. via Railway Express. Send dud shipments over 70 lbs. by truck. ONE FULL YEAR GUARANTEE—All Types

SIZE	PRICE	PLUS YOUR DUD	SIZE	PRICE	PLUS YOUR DUD
10-Inch	\$10.95	16.95	17-Inch	\$17.95	21.95
12-Inch	13.95		19-Inch	19.95	
14-Inch	14.95		20-Inch	20.95	
7-Inch			21-Inch	21.95	
15-Inch			24-Inch	39.95	
16-Inch					

MISCELLANEOUS BUYS

I. F. TRANSFORMER—456 Kc	19c
PILOT LIGHTS, Type No. 47	10 for 39c
VOLUME CONTROLS with switch, 2" shaft 1 meg, 1/2 meg, 1/4 meg	ea. 15c
SINGLE ION TRAPS	ea. 15c
OUTPUT TRANSFORMER—for 50L6 29c for 6V6 39c	
UNIVERSAL OUTPUT TRANSFORMER, 12 watt	79c
CHIMNEY MOUNT for TV ant.	.98c
3 SPEED G. I. CHANGER	\$24.95
6 foot LINE CORD UL	10 for \$1.95
TV INTERLOCK CORDS	ea. 49c

21" TV CONVERSION KIT

Consisting of rectangular tube, 70 DEGREE YOKE, Beautiful Mask and FLYBACK TRANSFORMER \$31.95 complete

20" TV CONVERSION KIT, as above, \$28.95 complete

17" TV Conversion Kit, as \$23.95 above, complete

300 OHM TWIN LEAD

55 Mil	1,000 ft.	\$10.95
100 ft.		\$1.49
20 GAUGE,	1000 ft.	\$16.95
80 MIL WEB	100 ft.	1.89

TV SET SPECIALS!

"FAMOUS NAME TELEVISION SETS!"

- Automatic Gain Control
- Saw Tooth AFC
- Standard Coil Tuner—adaptable to UHF
- All the exclusive features of most expensive sets
- Meet all Standard RTMA requirements
- Finished in luxurious mahogany
- Manufacturer Licensed under RCA Patents.
- 17" Table Model now only \$149.00
- 21" Table Model now only 179.00
- Console Sets \$20.00 additional.
- Lined Oak Finish \$12.50 extra



NEW DAVIS SUPER-VISION TV ANTENNA

Unbeatable for fringe area and DX—The only television antenna with a money-back guarantee. With the new Electronic Dipole Separators, \$20.55 less mast

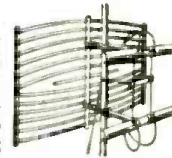

Outdoor TV Antenna Special!

Famous Make Folded Dipole Inline Antenna — no assembly necessary—elements snap in place with guaranteed positive lock. At this low price, we cannot mention manufacturer's name ONLY \$4.95

TV ANTENNA KIT

High Gain, Best Pictures Possible... complete with 300 ohm line, insulators, guy wire, hardware, full size antenna with double length 9 ft. mast. \$6.95 Complete

P. M. SPEAKERS

12" COAXIAL PM SPEAKERS	\$12.95
High Fidelity with high pass filter attached. 20 watt; 40-17500 cps. response; 8 ohm VC.	
Very best quality—NATIONAL BRANDS. Individually Packed.	
3" ea. \$1.39	8" ea. \$3.23
4" ea. 1.59	10" ea. 5.10
5" ea. 1.59	12" ea. 5.95
6" SPECIAL PRICE	ea. \$1.79

RESISTOR KITS

Insulated 1/2, 1 and 2 watt assortment of most used values, I.R.C. Ohmite, Stockpole, Speer, etc. 100 for \$2.95

WELLER SOLDERING GUN

For All Types of Soldering	
Model Watts	
WS-100 150	\$8.77
Single heat	
WS-200 275	\$9.75
Single heat	
WD-135 150-200	\$10.73
Dual Heat	
WD-250 275-350	\$11.71
Dual heat	

Finest TV CHASSIS

Complete with all tubes, including 17" RECTANGULAR PICTURE TUBE and SPEAKER. \$129.50

Complete with all tubes, including 20" rectangular picture tube and speaker. \$149.50

Complete with all tubes including 21" rectangular picture tube and speaker. \$159.50

- INCLUDES: Nationally Known
- manufacturer licensed under RCA patents
- permanent magnet speaker
- all tubes aligned perfectly
- ideal for fringe areas... works better than other receivers and where others can't
- ultra-sensitive fringe area tuner
- standard 90-day guarantee on all tubes and parts
- full band reception and output
- gated AGC—finest automatic gain control
- COMPLETE... READY TO OPERATE

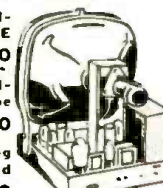

PREMIER T.V. RADIO SUPPLY

Division of Continental Corp. 3237 W. North Ave. • Chicago 47, Ill. Armitage 6-5550

NEW ADDRESS!

CUSTOMERS! We have moved to much larger quarters. FREE ball point pen imprinted with our new address is available... write for yours today!

TERMS 20% DEPOSIT with order, balance C.O.D. All shipments F.O.B. Chicago. Orders Less Than \$5.0

DEALERS-SERVICEMEN-MAKE MORE MONEY-GET ACQUAINTED with McGEE

28 WATT \$150⁰⁰ LIST PORTABLE P. A. ON SALE \$69⁹⁵



**3-SPEED PHONO TOP—TWO 12-INCH SPEAKERS
7-TUBES PUSH PULL 6L6'S HEAVY LEATHERETTE
COVERED PLYWOOD PORTABLE CASES
CRYSTAL MIKE \$8.95 EXTRA**

STOCK No. AP-28X. Portable 28 watt public address system. You get a 7-tube heavy duty push-pull 6L6 amplifier with inputs for 2 mikes either crystal or dynamic with separate mixing volume controls. One phono input. Fully variable tone control high fidelity, wide range frequency response. The heavy duty output transformer has taps for 8, 16, 125, 250 and 500 ohm speaker connections. Two heavy duty 12 inch alnico V P.M. speakers, each with 25 feet of speaker cable. Each speaker is mounted in separate carrying cases. Each case has a snap lock and is large enough to give good speaker baffling. Each case is 21 x 10 x 13 inches. One is used to carry the amplifier. A 3-speed phono motor and pick-up is mounted in the top of the amplifier to play 33 1/3, 45 and 78 RPM records. This portable PA system with push pull 20 watts all day long and 28 to 30 watts peak audio. McGEE offers you this \$150.00 list portable PA system at a terrific saving.

STOCK No. AP-28X complete portable PA system with 3-speed phono and speakers as pictured (loss mike) ship. wt. 71 lbs. \$69.95.

Electro Voice Mike \$10.00 or **Crystal Mike with 20 feet of cable and desk stand \$8.95 extra.**

Floor type mike stand instead of desk stand \$4.95 extra.

OFFERING TO THE RIGHT FOR WALL SPEAKERS INSTEAD OF THE PORTABLE SPEAKERS.)

The AP-28X P.A. system is offered with two of the 25 watt weatherproof trumpet and drivers No. MA-33 shown below. In place of the two portable speakers with baffles. Specify that you want MA-33 trumpets with your amplifier and add \$35.00 to the cost. Stock No. MA-28XX. Net price \$104.95.

**28-WATT AMPLIFIER
WITH 12-INCH WALL
SPEAKERS**

The 28 watt amplifier shown to the left is also offered with two 12 inch wall speakers. In their place we will ship two Sealing Walnut wall baffles with two heavy duty 12 inch alnico V magnet PM Speakers and 500 ohm line matching transformer. Stock No. SS-28X. 28 watt amplifier with 3 speed phono top with two 12 inch wall speakers. \$69.95. Extra 12 inch wall speakers \$11.95. Model 914 Electro Voice mike \$8.95 extra. Floor stand \$4.95 extra.

3 STATION INTERCOM MASTER \$16.95 SUB STATION \$3.95

3-station intercom master housed in chrome plated metal cabinet 7 1/2" x 8 1/2" x 3" deep. Full 3-tube amplifier for 110 volt AC-DC operation. Press-to-talk circuit in on top of cabinet and volume control with off-on switch and station selector switch are on either side. May be used with from one to 3 sub-stations. (See matching cabinet chrome plated sub-station No. PM-A5). Master is quiet at all times except when press-to-talk switch is pressed at the master or call-back switch is pressed at the sub. Uses 3-wire intercom cable. 3-station intercom master PM-A5, shipping weight 10 lbs. Sale price \$16.95 each. Sub-stations extra. 3-wire plastic intercom cable, 100 ft. for \$1.95, 500 ft. for \$8.95.

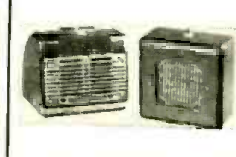
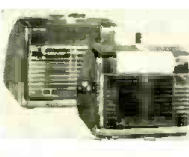

INTERCOM SUB STATIONS \$3.95

Chrome plated, with call back switch for a 3-wire intercom master. Size 7 1/2" x 8 1/2" x 3" deep. 5" Alnico V PM speaker. Intercom dealers buy at less than present production cost. Limited quantity. Stock No. PM-A5, ship. weight 8 lbs. Sale price \$3.95 each or 3 for \$10.00. Special 3-wire plastic intercom cable, 100 ft. for \$1.95, 500 ft. for \$8.95.

BRUSH CRYSTAL EAR PHONE With Control \$5.49

Simply clip on to the speaker voice coil of any radio or TV set or to an amplifier. No soldering necessary. Listen in privacy to your favorite programs. The tiny Brush crystal ear phone fits your ear just like a regular hearing aid ear piece. A small remote control box enables using 20 ft. from the radio or TV set. Has its own separate volume control and small matching transformer built-in to operate the crystal from any speaker voice coil. Ideal for hospitals, homes, hundreds of other uses. 1 1/2" x 1 1/2" x 1 1/2" deep. Includes conventional earphones. Stock No. BR-50 includes Brush crystal ear piece, remote control box, 20 ft. of cable and instructions. Sale price, \$5.49. Complete with metal earphone with 36" cord. Stock No. BR-51. \$2.95. (You connect it like any crystal earphone, diagram furnished.) Accessory kit includes volume control with switch plus coupling circuitry and instructions. 99c extra.



5-TUBE RADIO \$21.95

Top quality 5-tube model radio with Brush Crystal earphone for private listening as well as the regular heavy duty 5" speaker. Beautiful cabinet available in ivory or walnut is constructed so that it has no open back. Using the same finished appearance from either the front or back. Complete with 12SA7, 12SK7, 50L6 and 3Z5Z rectifier tube. Illuminated slide rule dial. Brush crystal earphone has 20 feet of cable and separate control box so that the volume can be regulated to suit the individual. Tiny earphone fits in your ear just like a hearing aid. Makes music programs even more enjoyable. Ideal for hospital and home use and hundreds of other places where you want to listen in privacy with no chance of disturbing others. Complete 5-tube superhet radio with Brush crystal earphone. Stock No. 14-B1A, shipping weight 8 lbs. Sale price \$21.95. Limited finish. See extra for ivory cabinet.

CROSLY RADIO WITH 45 OHM CHANG- ER \$29.95

5 tube superhet radio (450 to 1500 kc Broadcast) using 12SA7, 12SK7, 50L6 and 3Z5Z tubes! Automatic changer for up to 8 45 RPM records (6 7/8" only). Brand new in original factory cartons. Only 100 to sell at the terrific low price of \$29.95. Shipped Express only. Shipping weight 23 lbs. Mahogany cabinet 17" x 16" x 8 1/2" high. Lid covers 45 RPM changer (will not play 78 or 33 1/2 RPM records). Ideal for children and grandparents alike. Model No. 10-145A. \$29.95.

OUTDOOR SPEAKERS — WALL BAFFLES — 50-WATT BOOSTER AMPLIFIER



**25-Watt
Weather-
Proof
Out-Door
Speaker**

25-Watt Horn \$28.95

**8" PM AND LEATHER-
ETTE BAFFLE, \$4.95
LOTS OF 10, \$4.75**

The finest Leatherette Baffle we have ever offered. New, self-supporting, plastic grill material, baffle is covered tan with matching grill. Offered with a good heavy duty 8" alnico V P.M. speaker with 52 ohm voice coil. Stock No. 818. Speaker and Baffle, \$4.95 ea.; lots of 10, \$4.75. 8" Baffle only. Stock No. NV-8. \$2.29 ea.; 10 for \$19.95.



**50-WATT
BOOSTER AMP. \$39.95**

2-Mike Pre-Amp \$12.95 Extra. Not a Kit, but a Manufactured Amp.

50-WATT BOOSTER A sensational 50 watt booster amplifier with push-pull parallel 6L6 output tubes, with the PR-2X Pre-amp to add the use of 2 mikes and one low level input. The booster amplifier has one input jack and with 1 volt input gives 50 watts of audio. Booster has a 6 dB. ported case high fidelity output transformer, 450 ohm speaker with 4-8 1/2 ohm voice coil, also 40 ohm and 200 ohm line. Booster has a 225 mill power supply with 50A rectifier. Price includes tubes: 4 6L6, 7N7 and 5U4. The 50 watt variable controls are for master volume control and bass boost tone control. Size 8 x 6 1/2 x 14 1/2. Stock No. PA-50N. Shipping weight 26 lbs. Sale price \$39.95 ea.

ORDER FOR USE WITH ANY P.A. SYSTEM OFFERED ON MCGEE'S 2 PAGES OF ADVERTISING

25-WATT HORN 25-Watt driver and driver you see the most. Drivers are 100% weatherproof, horn is spun aluminum, offered to you at a considerable savings. Stock No. MA-33. Shipping weight 20 lbs. Net price \$28.95.

2-MIKE PRE-AMP. Pre-amplifier plugs in directly to the PA-55N booster amplifier. It enables use of 2, Crystal or Dynamic Mikes plus one low level input. Furnished with 4 remote control buttons for use with 50 Watt Booster Amplifier. Small chassis size 5 x 3 1/4 x 4". Stock No. PR-2X, with tubes 7N7 and 7N7. Net price \$12.95 ea.

IT'S MCGEE FOR COAXIAL SPEAKERS—3-SPEED CHANGERS—FM-AM CHASSIS

McGEE'S \$62.50 LIST 15" COAXIAL SPEAKER, \$21.95

21 OZ. ALNICO V MAGNET—5" TWEETER

This is the finest 15" coaxial PM speaker value that we have ever offered. New 1952 production, of a famous manufacturer of fine speakers. The 15" speaker has a 2 1/2 oz. Alnico V magnet, equal to 68 oz. of the Alnico 3 type magnet. The cone is free floating, of one piece construction. Will reproduce low frequencies down to 20 cps. The 5" tweeter is coaxially suspended and has a ridged cone to reproduce only the high frequencies. It will respond up to 17,500 cps. The high-pass filter is concealed under the pot cover, leaving only two wires to connect both the tweeter and woofer to any 8 ohm output transformer of a radio, or high fidelity music lover's amplifier. Stock No. P15-CU, shipping weight 13 lbs. Net price \$21.95.



12" COAXIAL SPEAKER, \$12.95

McGee offers the new 1952 model 12" coaxial PM speaker. Quality you would put in your finest sets if you were a manufacturer. 12" woofer has 6.8 oz. Alnico V magnet. Tweeter is coaxially suspended and has a metal diffuser. High pass filter is under the pot cover. Only two wires to connect to your radio or audio amplifier. 8 ohm with 18 watt peak and 10 watt average. Shipping weight 8 lbs. Response from 30 to 17,500 cps. Sale price \$12.95 each; 2 for \$25.00.

12" JENSEN PM, \$15.95

Another McGee Scamp Jensen Concert 12" 1 1/2 oz. Alnico V magnet 12" speaker. 8 ohm voice coil. Will take 25 watt audio. You save dollars on this speaker. Just 100 to sell. Shipping weight 8 lbs. Stock No. P-12P. Sale price \$15.95; 2 for \$30.00.

G.I. 3-SPEED CHANGER WITH G.E. \$22.95
VARIABLE RELUCTANCE TURN-ABOUT CARTRIDGE

Another tremendous McGee Scamp! Brand new General Instrument 3-speed automatic record changers. Complete with RPX-050 G.E. variable reluctance cartridge with turn-about stylus. Plays all 3 speeds automatically. 10" or 12" records. Has reject button. Repeats last record. Base size, 2 1/2" x 1 1/2". Shipping weight 14 lbs. Stock No. 710-GE. Scamp price, \$22.95.

ESPEY 12-TUBE FM-AM CHASSIS, \$59.95

- ★ BUILT-IN PRE-AMP FOR G.E. VARIABLE RELUCTANCE PICK-UP
- ★ WIDE RANGE AUDIO
- ★ WHY NOT ORDER WITH A COAXIAL SPEAKER AND A RECORD CHANGER? SEE OUR SPECIAL OFFERING

McGee's new 1953 model 12-tube FM-AM chassis. Latest design with phono inputs for all types of record players, crystal or G.E. variable reluctance. Receives standard broadcast 550 to 700 kc and FM 88 to 108 mc. Wide range audio response (push-pull 6V6 output) and bass boost tone control. Loop antenna for broadcast and 310 ohm line type FM antenna may be stapled in cabinet. Attractive lighted slide rule dial. Chassis size, 13 1/2" x 9" high and 9" deep. Complete with tubes: 6BE6, 6BA6, 6BM6, 12AT7, 6BM7, 6AL5, 6XQ7, 6SQ7, 12AT7, 2-6V6GT and 3Y3GT rectifier. Shipping weight 20 lbs. Stock No. 7C-X Espey 12-tube FM-AM chassis. Sale price, \$59.95, less speaker. Output matches voice coil of our 12" or 15" coaxial speakers.

ESPEY DEAL (1), \$99.95
Espey 7-C chassis complete with 12" coaxial PM speaker CU-14Y and V1-950 G.E. 3-speed changer equipped with a G.E. turnabout variable reluctance cartridge. A better home music system than ordinarily available. E.g. e.y Deal #1. Sale price \$95.95. With 15" coaxial PM speaker P15-CU instead of CU-14Y. \$10.00 extra.

ESPEY DEAL (2), \$118.95
Espey 7-C chassis complete with 12" coaxial PM speaker CU-14Y and the English Garrard 3-speed changer equipped with a G.E. variable reluctance turnabout cartridge. Our best home music system. E.g. Deal #2. Sale price \$118.95. With 15" coaxial PM speaker P15-CU instead of CU-14Y. \$10.00 extra.

ESPEY DEAL (3) \$138.95
Espey 7-C chassis complete with THREE 12" coaxial PM speakers CU-14Y (these three 12" coaxial speakers give a cone area equal to an 18" speaker) and a Garrard 3-speed changer with G.E. variable reluctance turnabout cartridge. Espey Deal #3. Sale price \$138.95.

McGEE RADIO COMPANY Prices F.O.B. K.C. Send 25% Deposit with Order, Balance Sent C.O.D. With Parcel Post Orders, Include Postage. **TELEPHONE VICTOR 9045. WRITE FOR FLYER 1422 GRAND AVE., KANSAS CITY, MISSOURI**

LOOK TO MCGEE FOR ALL RADIO AND TELEVISION MATERIAL

GENUINE STANDARD COIL T.V. BOOSTER \$11.95

Not Surplus, But Right From The Factory

Latest Model B-51 Standard Coil Television Booster. McGee makes another lucky purchase and as usual, passes the saving on to you. The famous Model B-51, 12 Channel Standard Coil TV booster, which lists for \$35.00, is offered to you for only \$11.95 each, brand new, factory cartoned and fully guaranteed by McGee. This top quality single stage booster utilizes channels. Uses 6AK5 tube. Average gain, 6 to 7 volts on low channels and 5 or 6 on high channels. No distorting of picture or sound. Has extremely fine channel selector control switch for low noise factor. Continuous one-knob tuning and channel selector control switch for on-off and bypassing 300 ohm lead-in to set. Modern design, dark brown plastic cabinet, net. 8"x4 1/2"x4 1/2". Made for 110 volt, 60 cycle AC operation. Shipping weight 5 lbs. Model B-51. Sale price, \$11.95 each, or buy 2 for only \$22.00.



McMURDO SILVER BOOSTER \$10.95

Sensational value. Continuously variable inductance type tuner. from channel 2, including the FM band, through channel 13. This booster is self powered for 110 volts AC operation. It incorporates a 6AG5 tube. Input for 300 ohm TV line and 300 ohm output to the TV set. Single knob tuning. Attractive plastic case. McGee's Silver Super Sales TV-FM booster. Stock No. C-11-47. Shipping weight 5 lbs. McGee's terrific sale price, \$10.95 each, two for \$20.00.



DB-520 REGENCY \$19.10

New Regency DB-520 TV booster with exclusive circuit stabilizer and newly designed cabinet only 4 1/2 x 6 x 4 1/2". Improved circuit with push-pull 610 is equal to the best cascade circuits and has higher gain. Matches 72 or 300 ohm. Net price \$19.10.

CASCO ASTATIC \$19.10

New Astatic "Scanfar" TV booster with improvements to match the newer model TV receivers. Minimum noise with maximum gain. Balanced cascaded circuit with 610 and 12AT7. Input and output for both 72 and 300 ohm. Mahogany finished metal cabinet 6 1/2 x 7 x 4 1/2" high. Model C-11. Net price \$19.10.

20 INCH CONVERSION KIT \$29.95

YOU GET—
20HP4—20" PICTURE TUBE
20-INCH PLASTIC MASK
14 K.V. FLYBACK AND 70° YOKE

Our 20" conversion kit includes a 6-month guaranteed 20HP4, 20" rectangular blackface picture tube, plus a 14,000 volt G.E. built high voltage flyback transformer, plus a matched 70° cosine yoke, plus a 20" rectangular gold trimmed mask and suggested diagram. The picture tube is the latest electro-static focus type that requires no focus coil. Shipped via express or truck only. Slight weight, 40 lbs. Stock No. 20-TP, net price, \$29.95.

14-INCH CONVERSION KIT \$19.95

Our 14" conversion kit includes an RCA 14CP4, 14" rectangular blackface tube, plus a 14,000 volt G.E. built flyback, plus a 70° cosine yoke, plus a 14" plexiglas gold trimmed mask. Offered at the very low price of only \$19.95. Suggested diagram furnished. Ship. weight, 20 lbs. via express or truck only. Stock No. 14-TP, net price, \$19.95.

17-INCH CONVERSION KIT \$24.95

Our 17" conversion kit includes a 6-month guaranteed 17HP4 blackface rectangular picture tube, plus a G.E. built 14,000 volt flyback, plus a matched 70° cosine yoke, plus a gold trimmed 17" plexiglas mask, and suggested diagram. The 17HP4 is the latest electro-static focus tube that requires no focus coil. Shipped via express or truck only. Stock No. 17-TP4. Net price, \$24.95.

T.V.-RADIO NEWS SPECIAL \$9.95

3 Flybacks and 3 Deflection Yokes for \$9.95. You get 3 deflection yokes, 2-70° yokes, and 1-25° yoke, and 3 horizontal flyback and 2 General Electric 14,000 volt ceramic core 70°, and 1 early model Philco. The G.E. flyback cost regularly more than our price for the complete deal. Stock No. 33YR, ship. weight, 5 lbs. Radio News Special, only \$9.95.

4 General Electric Diodes for \$1.95

Reg. \$7.20 Net

You receive 2-1N48, 1-1N52, 1-1N63, 4 genuine General Electric Germanium crystal diodes. The total dealers net is \$7.20. A special purchase enables a saving of over \$5.00 to you on this kit of 4 diodes. G.E. Germanium crystals are growing in popularity every day. Every radio and TV service department will do well to have a few of these kits on hand. Stock No. 61D-4, kit of 4 diodes, (2-1N48, 1-1N52 and 1-1N63) only \$1.95 or 2 kits for \$3.75.

T.V. COMPONENT DEAL #CGE \$12.95

Here is a terrific TV parts deal for those who repair TV or the builder and experimenter. You get a Meissner 12-channel TV tuner, a horizontal output transformer, plus a standard 4-wire vertical output transformer, plus a 70° cosine deflection yoke (no tubes included). It's worth \$20.00. Our special price only \$12.95.

RCA 201E1 T.V. TUNER \$7.95

Terrific buy on this RCA tuner. We have a limited quantity of the famous original 201E1, 13 channel completely wired and tested TV front end tuners. Ready to connect to your TV video I.F. strip. Offered at a sacrifice. Price was \$41.00. Now only \$7.95 each, with tubes. Each tuner in good condition but has been repaired. Stock No. RCA-13P, TV front end tuner. Converter coil type for separate sound as used in the famous 630 chassis. Complete with 3-636 tubes. \$7.95. Specify shaft length desired, either 2" or 4".

Same as pictured above only new—with tubes. Stock No. 2201. Sale Price, \$11.95.

3-TUBE SARKES-TARZIAN T.V. TUNER \$9.95

This popular Sarkes-Tarzian Type 3 tuner is widely used, 13 channel rotary type switch with individually tuned coils. Price is complete with diagram and three tubes: 6C4 osc., 6AH6 R.F. and 6AG5 mixer. Regular factory cost is twice our price. Each tuner is wired ready to hook up to video and sound I.F. strip. May be used with either inter-carrier or separate sound I.F. circuits. Has built-in converter coil, built in fine frequency control. Same as Sarkes-Tarzian tuner, with 3 tubes. Net price, \$9.95 each. Specify shaft length, either 2 1/2" or 3 1/2".

RCA PRINTED CIRCUIT T.V. TUNER \$14.95

RCA Printed Circuit T.V. Tuner with 610 and 6CH6 tubes. Similar mechanically to the standard coil (same knob etc.). Snap-in chassis wgs. transformers. Has 6 1/2" shaft. Used on late Hallcrafters T.V. sets. Stock No. 1C-A12, 12 Channel Tuner with Tubes. Net. \$14.95. Knobs, 59c.

T.V. TUNER FOR EMERSON \$12.95

STOCK NO. SC-947E
For Emerson 660D ETC. Has 2 1/4" insulated shaft and tubes 6BC3—filaments in series—shunted to .6 amps. Stock No. SC-947E. Sale Price, \$12.95. Knobs, 59c.

T.V.-RADIO NEWS SPECIAL \$9.95

3 Flybacks and 3 Deflection Yokes for \$9.95. You get 3 deflection yokes, 2-70° yokes, and 1-25° yoke, and 3 horizontal flyback and 2 General Electric 14,000 volt ceramic core 70°, and 1 early model Philco. The G.E. flyback cost regularly more than our price for the complete deal. Stock No. 33YR, ship. weight, 5 lbs. Radio News Special, only \$9.95.

T.V. COMPONENT DEAL #CGE \$12.95

Here is a terrific TV parts deal for those who repair TV or for the builder and experimenter. You get a Meissner 12-channel TV tuner, Crosley 4-tube video I.F. strip, a 14 K.V. G.E. horizontal output transformer, plus a standard 4-wire vertical output transformer, plus a 70° cosine deflection yoke (no tubes included). It's worth \$20.00. Our sale price, only \$12.95.

TERRIFIC COMBINATION CABINET SALE

Originally intended for an Admiral 14" TV combination. Made of walnut veneer, 32" wide, 35 1/2" high and 20" deep. Offered at less than the factory price. Upper left door is made to swing down, opening record changer compartment. 14 1/2" x 20" x 20" deep. Upper right door swings open for the TV set. Note: The TV chassis area is only 14 1/2" wide and 15 1/2" high, 20" deep, limiting the size of TV chassis to a 14" x 12" set. Panel is cut for the 14" Admiral. 12" speaker may be mounted in the lower right section. Lower left section has hinged door and is for record storage. Brass hardware and matching grill cloth. Shipping weight 60 lbs. Stock No. A-130X mahogany TV combination cabinet. Special Price, \$33.90. Blank panel overlay for cut-out TV panel is furnished.

CAPEHART CABINET FOR 1000 SET—ONLY \$99.95

EITHER WALNUT OR MAHOGANY

Beautiful, finest quality walnut combination radio-phonograph cabinet, 32" wide, 35 1/2" high. Made for Capehart's finest combination, selling for \$100 and up. Cabinet cost manufacturer over \$200.00. Has high polished mahogany walnut panels. Made of 3/4" material. Top 1 1/2" solid stock. This cabinet weighs approximately 175 lbs. The changer radio and speaker grill all have hinged doors. Radio compartment on right hand side is 14" high and 11 1/2" wide. Made to mount chassis vertically. Changer compartment is 14" high by 20" wide. Large enough to hold any record changer or recorder mechanism. Front 10" top over the changer compartment is hinged to fold back for easy access to the changer. Both radio and changer compartments come with uncut blank panels. Speaker is cut for a 12" speaker and the speaker compartment is 12" wide. Shipping weight, 275 lbs. Stock No. K-275 Capehart combination cabinet. Net price \$99.95. SPECIFY when ordering, whether you want Walnut or Mahogany.

COMPLETE RADIO, TELEVISION AND AMPLIFIER KITS AT MCGEE

3-WAY PORTABLE KIT \$15.95

A NEW '52 MODEL

New 1952 Model 3-way personal portable radio kit. Operates on 110 AC-DC or 67 1/2 V. plus 1 1/2 volt self-contained batteries. Leatherette covered case size, 3 1/2 x 5 1/2 x 8 1/2. Receives broadcast 570 to 1650 KC. A conventional 2-band superhet circuit with 456 KC iron core I.F.s. Incorporates the new super gain loop antenna. All plated chassis. Lab. approved circuit—matched parts. Price includes all parts, tubes, diagram, Alnico V PM speaker. A factory quality kit. Stock No. PN-AT, shipping weight 7 lbs. The complete kit, less batteries, \$15.95. 67 1/2 V. Kit \$1.95. 1 1/2 V. A. 39c extra.

Build Your Own Phono-Mike Broadcaster \$19.95

Kit Model DE-6R. With this simple kit, you can build a 3-tube phono oscillator that also has a mike input. Will broadcast over any radio within your home, (about 35 feet) from 1000 to 1500 kc. Inputs for crystal mike or crystal phono pickup. Fader control fades from mike to record. Ideal for a home P.A. system, baby's cradle and home entertainment. A complete kit of parts including tubes. Kit Model DE-6R. Net price, \$7.95. DE-6R, RT, wired and tested. Net price, \$9.95. Crystal mike and desk stand, \$4.95 extra. Concealed microphone unit, only 1" in diameter and 1/2" thick. Suggests hidden mike when ordering. Stock No. T-1001. Net, \$3.95 extra.

8-Tube Hi-Fi Amplifier Kit \$29.95

A complete kit, including tubes, 2-12AX7, 2-12AX7, 2-triode plus rectifier diagram and photos. Inputs for radio tuner and any kind of phono or picture crystal or G.E. variable reactance) and either crystal or dynamic mike. Output matches 8 ohm voice coil. Twin electronic bass and treble tone controls with range selector switch for either juke box quality with heavy bass response or brilliant symphonic range. Response 18 to 20,000 cps. 8 tube all triode amplifier kit, complete with tubes. Shipping weight 25 lbs. Model 7X3. Net \$29.95.

10-Watt Hi-Fi Amplifier Kit \$14.95

A complete kit of parts including tubes, 2-12AX7, 2-12AX7, 2-12AX7, plus rectifier, diagram and instructions to build a Hi-Fi fidelity 10 W. I.F. tone control audio amplifier with bass and treble boost. Inputs for radio tuner, crystal mike and crystal phono pickup. Output matches 8 ohms. Response from 50 to 15,000 cps. Chassis ready punched. Ventilated cover. Straight forward circuit with twin triode gain stages and 2-50L6 tubes in push-pull. Size, 5 1/2" x 10" x 5 1/2". Net \$14.95. 10W, ship. wt. 8 lbs. Sale price, \$14.95.

10-TUBE RADIO KIT \$29.95

10 tube broadcast radio chassis, 12 1/2" x 10" x 8 1/2" high. Complete with tubes, 2-6X87, 2-6BN7, 1-6A17, 2-6V6 plus 5Y3 rectifier, diagram and instructions. 3 gang superhet with 8" slide rule dial. Chassis size, 12 1/2" x 10" x 8 1/2" high. Features push-pull 6V6 high fidelity audio. Output matches 8 to 8 ohm voice coil speakers. Inputs for G.E. variable reactance or crystal phono pickup and crystal mike. Heavy duty power transformer. Model 1K-R10 kit less speaker, shipping weight 18 lbs. Net \$29.95.

17, 20" T.V. Kit \$59.95 Less Tubes

A complete kit of parts to build an AC transformer operated television chassis for use with a 17" or 20" tube. The 12 channel Sarkes-Tarzian tuner is ready wired, as is the 4 tube video I.F. strip. Circuit is of the conventional design. Do not buy this unless you understand television. It is illustrated with a user schematic. Kit model WH-20. Ship. wt. 40 lbs. less all tubes. Net \$59.95. 17" 17BP4A, \$19.95. 20HP4, \$25.00.

6-TUBE 2-BAND KIT \$14.95

Popular with schools and colleges for training. 6 tube AC-DC 2 band radio kit with plastic cabinet. Receives broadcast and 6 to 18 mc shortwave. Full 2 gang superhet with 5" speaker and a slide rule dial. A complete kit with tubes: 12SK7, 12SK8, 12SK7, 12SK7, 50L6 and 5Z5Z, diagram and instructions. Factory quality. Cabinet size 17" x 8 1/2" x 8 1/2". Shipping weight 12 lbs. Model M60-2. Net \$14.95.

5-TUBE AC-DC KIT \$12.95

Model RS-5. A 5 tube AC-DC straight broadcast kit, housed in the same cabinet as #2 above. Complete with tubes. Shipping weight 10 lbs. Net \$12.95.

AC POWERED BROADCAST TUNER KIT \$12.95

A self-powered, 3-gang superhet tuner kit with R.F. stage. This complete kit is furnished with a diagram, photos and tubes. 6BA6 R.F., 6BE6 oscillator, R.F., 6BA6 I.F. detector, 6AL5 diode, AVC, plus rectifier. Connect to any audio amplifier. Ideal for use with our S-2020 or 7X3 amplifier kits. Chassis size, 9 1/2" x 4 1/2" high. Shipping weight, 7 lbs. Broadcast tuner kit Model BT-38X. Net price, \$12.95.

McGEE RADIO COMPANY Prices F.O.B. K.C. Send 25% Deposit with Order, Balance Sent C.O.D. With Parcel Post Orders, Include Postage **TELEPHONE VICTOR 9045. WRITE FOR FLYER 1422 GRAND AVE., KANSAS CITY, MISSOURI**

PRICES SLASHED! SAVE BIG MONEY ON CRT-TV TUBES

All tubes in Penn Tube Cartons. Code dated of current date.

Standard R.M.A. Guarantee.

1X2	\$.65
5U449
5V486
5Y340
6AL550
6AG572
6A5569
6AU649
6AQ566
6BA663
6BC566
6BG6	1.44
6CB669
6CQ6	1.04
6CD6	2.18
6C450
6J675
6K655
6S455
6SN773
6V660
6W455
6T863
12AU775
12AT795
12SN775
12BH785
19BG6	1.98
25L670
25W466
1B365
50L6GT57

ALL OTHER TYPES AVAILABLE

70° DEFLECT. YOKES \$195

U.H.F. CORNER REFLECTOR ANTENNA \$995

CATHODE RAY TUBES

10 INCH (EXCHG. PRICE)	\$ 9.95
12 INCH (EXCHG. PRICE)	10.95
14 INCH (EXCHG. PRICE)	11.95
16 INCH (EXCHG. PRICE)	15.95
17 INCH (EXCHG. PRICE)	16.95
19 INCH (EXCHG. PRICE)	18.95
20 INCH (EXCHG. PRICE)	19.95
21 INCH (EXCHG. PRICE)	20.95

ONE YEAR GUARANTEE

\$ TURN YOUR DUDS INTO CASH. WRITE US. \$

WE WILL BUY YOUR OLD PICTURE TUBES

Mail orders promptly filled. All prices F.O.B. Chicago. Shipping sent C.O.D. Send M. O. or check only. 20% deposit required on all orders. All merchandise subject to prior sale.

PHONE: IN 3-8006

PENN TUBE COMPANY

Radio and Television Tubes
3547 MONTROSE
CHICAGO 18, ILLINOIS

"Ultra-Linear" Amplifier (Continued from page 45)

20 cps to 20 kc. within much less than .1 db. Maximum phase shift over this band is about 3 degrees.

The very wide frequency band and low phase shift permit excellent transient response as attested by the square wave oscillograms of Fig. 7. The slight ringing visible on the high frequency square waves could be removed by introducing roll-off in the circuit above 100 kc. This expedient, however, would lessen the steep rise and round the upper left-hand corner. The designer always has to compromise between damping of the square wave and loss of high frequency response. In this circuit, the Williamson principle of maximum bandpass was preserved, and the resulting square wave is still better damped than that of most other high quality equipment.

Those who have actually tested amplifiers with square waves on scopes capable of showing details of the performance without distortion, will appreciate the extremely short rise time and rectangular corners of these oscillograms.

The transient response of the circuit undoubtedly makes a substantial contribution to its listening quality.

Listening Tests

Many AB listening tests have been made comparing the "ultra-linear" Williamson with the triode Williamson and with other circuits. A variety of speakers and speaker systems have been utilized in these tests, and many different program sources have been included. Results were almost invariably the same—the "ultra-linear" circuit was accepted as the most realistic. On bass passages, drum rolls, and musical climaxes, the ability of the circuit to handle large power without transient instability shows up to advantage.

At the high-frequency end of the spectrum, the low phase shift maintains the correct harmonic structure of complex transients; and the percussive sounds of triangles, cymbals, tambourines, and other instruments come through with a naturalness and crystal clarity which is audibly evident to the untrained ear. String instruments have the natural "gutty" quality; and with a high grade speaker, it is possible to differentiate between the metal "E" string of the violin and the gut "A" string even

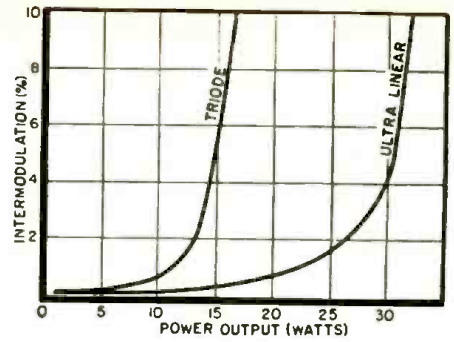

Fig. 4. Intermodulation distortion for triode and "ultra-linear" operation at 40 and 2000 cps mixed in a 4 to 1 ratio.

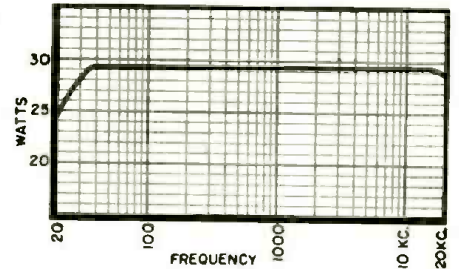

Fig. 5. Undistorted power vs. frequency.

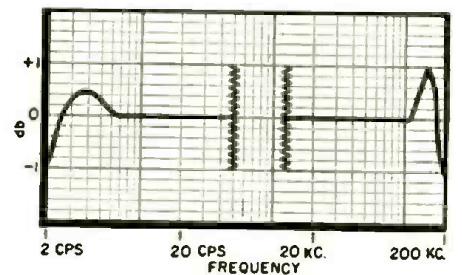

Fig. 6. Frequency response of the amplifier.

though a tone of the same frequency may be played on either.

The scratch of phonograph records is less noticeable and less irritating on the "ultra-linear" Williamson than on other amplifiers. Scratch and noise have a high transient energy content and tend to intermodulate with high frequency signals if the amplifier cannot handle considerable power at the high-frequency end of the musical spectrum.

The low intermodulation content of the amplifier is evident in the crisp definition of the music. There is no blurring, no shrieking. The slip of the violin bow against the bridge, the breathing of the singer, the cough in the audience; all are audible while the music plays. The various instruments are distinguishable individually rather than as a conglomeration of sound.

The increased power handling ca-

Fig. 7. Square-wave performance at (A) 20 cps, (B) 20 kc., and (C) 50 kc.

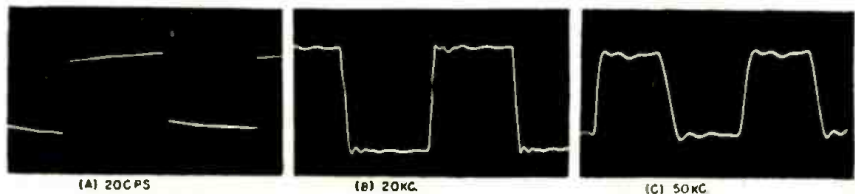

(A) 20 CPS

(B) 20 KC

(C) 50 KC

Long Life—Low Maintenance
No Comebacks with the

New **300 OHM
TRANSMISSION CABLE**
by **BELDEN**

FOR 50 YEARS
*Wiremaker for
Industry*

To You,
Belden's Golden Anniversary
Means

—product performance that
can come only from a "know-
how" that has grown through
actual service since the
inception of Radio.

—an ability to co-oper-
ate in pioneering new
wires to meet or antici-
pate industry's grow-
ing needs.

In the years that
follow

This Belden
Program Is—

— TO BE
CONTINUED



No. 8230



**COPPER-
SHEATHED
20-GAUGE
STRANDED STEEL WIRE**

Brown Polyethylene—Resists Weather and Oxidation

The new Belden Weldohm, 300-ohm Transmission Cable is the greatest advancement in television installation since television began.

Reducing TV lead-in conductor breakage to a minimum is easy. The new Belden Weldohm Cable has overcome the breakage point by 162%, that's 1½ times the strength of pure copper wire.

In actual test, Belden Weldohm Cable will withstand 254% more whipping or severe flexing than the average installation of 300-ohm copper lead-in wire.

There is no difference in the electrical characteristics between an all-copper conductor and the Belden Weldohm copper-coated steel wire. The web is 72 mils of 100% virgin polyethylene.

NEW
FOR U. H. F. INSTALLATION
BELDEN ULTRA - WELDOHM — 8235

BELDEN MANUFACTURING CO., 4681 W. Van Buren St., Chicago 44, Illinois

Belden
Radio **WIRE**

Great, New 1953 Model 630-DX CHASSIS

terrific savings-immediate delivery

Includes newest developments—Cascode Tuner—30 Tubes—for 16" to 24" Picture Tube—Wonderful Saving! Adaptable for color and UHF!

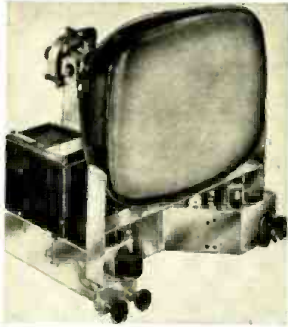

The great 630 with all the up-to-date improvements! Wonderful reception on long range up to 200 miles without a booster is yours today at this low-low price. Gives 3-times normal reception. Special super high-gain standard coil tuner gives greater sensitivity, top performance on any channel. Aligned and tested for 5 hours, molded condensers, 4 microvolts sensitivity, FM sound system, horizontal and linear lock and is directly adaptable for color and UHF.

Model 630 DX-1; RMA Guaranteed—Factory Wired, ready to play. Complete with 12" speaker, hardware and knobs.

149.50
(less CRT)

FREE: New Trouble Shooting book with any chassis!

Giant Savings

TV PICTURE TUBES

Full Year's Guarantee—
Brand New—Black Face—
Standard Brands.

10BP4	\$19.95	20CP4A	\$35.95
12LP4A	22.95	21EP4A	38.50
17BP4A	24.95	27EP4	92.95

All other sizes in stock
—equally low priced!



Save \$50 on this Decorator TV Cabinet

For 17", 20" & 21" Picture Tubes—
630 or other Chassis.

Every beautiful cabinet is richly finished of hand rubbed mahogany and made by our own cabinet makers. They are custom styled, guaranteed new and perfect. Includes mask and mounting brackets. Cabinets are also available with blank control panel to fit any chassis.

Model 200: Original list \$99.95

\$49.50

Blonde finish, add \$10 Now
Also Deluxe Cabinets, write for catalog

WRITE FOR NEW, 1953 CATALOG
MIN. ORDER: \$5.00. 25% with order, balance C.O.D. Include postage with order. All merchandise subject to prior sale. Prices subject to change without notice. F.O.B., New York City.

THE ROSE COMPANY

102 Park Place, Dept. R-2, New York 7, N. Y., COrtlandt 7-6195

SCOOP!

AM Radio Tuner made especially for any 630 of 630 DX Chassis. Complete, ready to install. Fits into well of TV chassis.

ROSE Special **\$14.95** ea.

SUPER 630 DX-2 TV CHASSIS

Includes the same features as the 630 DX-1 chassis PLUS the following:

- ★ Keyed AGC level control
- ★ Cornell-Dubilier plastic molded condensers
- ★ 4.5 Megacycle wave trap to eliminate interference
- ★ Photo input & switch which cuts out high voltage supply
- ★ RCA matched 70° cosine voke & III-Voltage transformer
- ★ Four (4) 6CR6 tubes in video IF strip
- ★ RCA 12" Speaker

Net price **\$159.50** (less Complete CRT)

Universal Mounting Brackets \$5.95

ability of the "ultra-linear" Williamson shows up to audible advantage. The newest LP records, tape, and live FM cover very broad dynamic ranges, and it takes power to do them justice. The ten-watt amplifier cannot reproduce the climaxes of today's program sources, as is evidenced by comparison with a higher power unit such as the "ultra-linear" Williamson. New developments in program sources are forcing new ideas in amplifiers.

For some applications, even higher powers may be required. Just as can be done with the triode Williamson, the "ultra-linear" circuit can be operated in push-pull parallel, and the performance specifications can be maintained within a 60-watt rating. Experimental work is also being carried out with high power transmitting tubes to investigate the feasibility of using the same circuit arrangement in amplifiers of more than 100-watt capacity.

Thus the "ultra-linear" Williamson circuit offers a distinct improvement over the original. It also offers the possibility of still further extension into the higher power ranges.

Many articles have appeared which describe amplifiers in terms of "best we ever heard." Such descriptions do not furnish a basis for the reader to judge the quality of the circuit. In this article the authors have attempted to provide the theoretical justification for an improved amplifier circuit. Theory and specifications cannot substitute for the listening tests which, in the end, are the only ones which count. The dubious reader, therefore, will wait until he hears it before accepting the "ultra-linear" Williamson as the best around. However, when he does hear it, he will find that, to coin a phrase, "hearing is believing."

REFERENCES

1. Keroes, Herbert I.: "Building the Williamson Amplifier." Radio & Television News, December 1950
2. Hafer, David & Keroes, Herbert I.: "An Ultra Linear Amplifier." Audio Engineering, November 1951
3. Cooper, George Fletcher: "Audio Feedback Design." Radio Electronics, December 1950
4. Miller, Edward S.: "A High Quality Audio Amplifier." Radio & Television News, February 1952
5. Keroes, Herbert I.: "Considerations in the Design of Feedback Amplifiers." Audio Engineering, May and June 1950

-30-

AUDIO FAIR

THE Audio Fair-Los Angeles will be held Feb. 5, 6, and 7 at the Alexandria Hotel in Los Angeles with approximately 100 exhibitors demonstrating their products to audio enthusiasts.

Open to the public without charge, the Fair will feature custom high-fidelity equipment, television gear, binational demonstrations, etc.

The Audio Engineering Society, sponsor of the Fair, will conduct technical sessions and present engineering papers on the latest developments in the audio world.

Inquiries regarding this event should be addressed to the Fair Manager, 4245 Normal Avenue, Los Angeles 29. -30-

TRAIN At Home FOR OPPORTUNITIES IN



UHF-TV SERVICING

Set Your Own Pace with This Practical Program!

Get in on the ground floor of this fast-growing field. Train now to cash in on the opportunities that are yours in UHF-TV SERVICING with proven, practical T.C.I. training. Here is non-mathematical training that's complete down-to-cases... up-to-the-minute. Here is training you take in your spare time, without leaving your present job! Think of it—in your own home you learn TV set conversion, master antenna installation, the latest in UHF-TV, money-making short cuts and much more. You learn to trouble-shoot, test and repair TV sets the only practical way—by actually doing this work yourself!

HERE'S HOW YOU LEARN BY DOING!

You get the experience you need by working on a large screen, modern TV receiver that's given to you with the course and is yours to keep. As an optional feature you get two weeks of field experience on service calls and on the repair bench with one of Chicago's largest independent TV servicing organizations. You profit from the experience and know-how of men in the field. Not through books alone but by actually doing the work yourself, you get the knowledge you need to qualify for opportunities in UHF-TV SERVICING! Age is no barrier. Many T.C.I. students are over 40! Mail Coupon for full facts. FREE Catalog and SAMPLE LESSON. Act NOW!

VETERANS discharged since June 27, 1950 are eligible for G.I. benefits. Check coupon.

THESE MEN LIKE YOURSELF SAY T. C. I. TRAINS YOU BEST!

"I've almost completed your course now, but I have been servicing TV sets since almost the beginning of the course." E.R.M., Rhode Island.

"Thanks to your course, jobs that used to take me several hours now take but a few minutes to complete." W.L.K., Wash.

"I like the easy way your lessons are presented. I'm very pleased with your course and have recommended it to a friend." L.R.S., Texas.

TELEVISION COMMUNICATIONS INST. 205 W. Wacker Dr., Dept. 1-AG, Chicago 6, Ill. YES! Rush full facts on UHF-TV training. Include FREE Catalog and Sample Lesson. I am not obligated. Salesman will not call.

Name Veterans Check here

Address

City Zone State

BEGINNERS: Check here for information on Pre-TV Radio Course.

TELEVISION
Communications Institute
205 W. Wacker Dr.,
Dept. 1-AG, Chicago 6, Ill.

MAIL NOW FOR FREE BOOKLET

**Extra profits
for service-
men!**

NOW you can add UHF to the thousands of VHF Super Fans presently installed in your area, with Channel Master's exclusive new Ultra-Dapter, Model No. 414. In 5 minutes you can convert any Super Fan into an all-channel VHF-UHF antenna. See your distributor for details.

VHF *and* UHF

Now! Get all 82 channels
with the
new

CHANNEL MASTER ULTRA FAN

Single Bay
model no. 413

Stacked
model no. 4132

Write for literature on Channel Master's new complete line of UHF antennas including such models as these:



Ultra Bow
Model No. 401

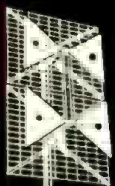

Ultra Bow with
screen reflector
Model No. 403



Ultra Vee
Model No. 404



Today's most sensitive
ALL-VU* antennas!

*All VHF, All UHF

Featuring:

- 1. **2 great antennas in 1** —
A genuine, high gain Super Fan on VHF, and an all-channel Triangular Dipole and reflector for peak UHF reception.
- 2. **Electronic inter-action filter** —
Automatically isolates VHF and UHF bands, eliminates inter-action. Ultra Fan operates with only a *single* transmission line to TV set.
- 3. **"Free space" terminals** —
Channel Master's exclusive UHF "free space" terminals prevent accumulation of dirt and moisture which gradually reduce picture quality in ordinary UHF installations.
- 4. **Famous Channel Master engineering** —
The Ultra Fan is an *integrated* VHF-UHF antenna that give uniformly high gain over all TV channels, from 2 through 83.

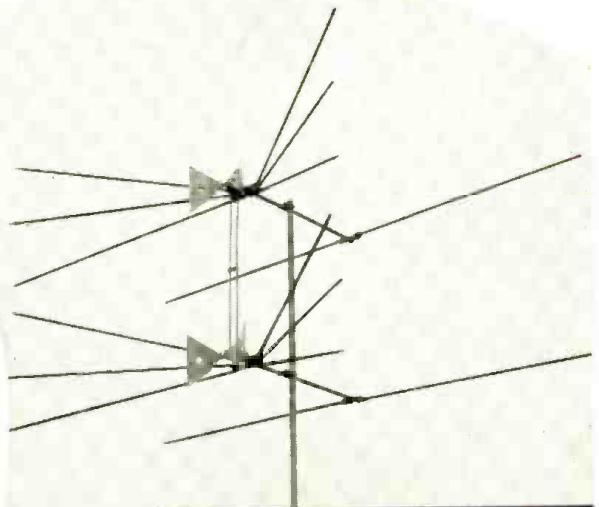

HORIZONTAL POLAR PATTERNS
(Relative Voltage)



Channel 2

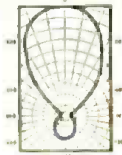

Channel 10

VHF



Channel 60

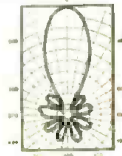

Channel 77

UHF

GAIN CURVES

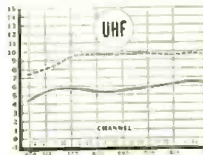
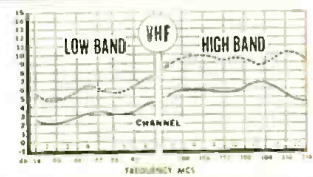

— Single Bay
- - - Stacked

MEMBER



CHANNEL MASTER CORP. ELLENVILLE, N. Y.

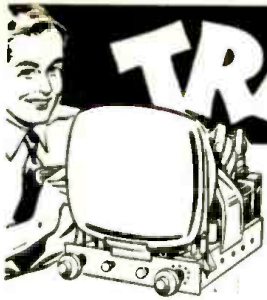

TRAIN AT HOME FOR

REPAIR ANY RADIO OR TELEVISION SET!

The two new Ghirardi service books described below offer you the most complete, up-to-date and easy to understand service training course on the market today—at only a small fraction of the price you might expect to pay!

Takes headaches out of tough jobs! Ghirardi's COMPLETE GUIDE to RADIO-TV CIRCUITS

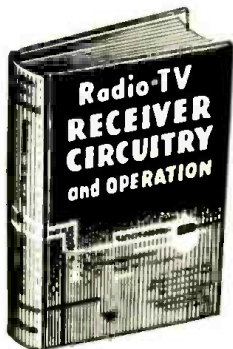

**Radio & TV Receiver
CIRCUITRY & OPERATION**
by Ghirardi & Johnson
688 pages, 417 illus.
Price \$6.00

Naturally, as a radio man, you recognize the importance of a good book on circuits. And wait until you read this one! It can teach you to work faster and better. You can learn service shortcuts you may never dream existed. And you'll get a training in basic circuitry of the type that can fit you for the big money jobs in many phases of electronics!

Actually, there are only a few basic circuits in modern radio and television receivers—but each of these has dozens of variations. Learn these from A to Z and watch service headaches disappear!

**SAVE TIME ON JOBS—
MAKE MORE MONEY!**

This big RADIO & TV RECEIVER CIRCUITRY AND OPERATION book shows exactly how one circuit differs from another; how the different circuits are related; and the troubleshooting difficulties and peculiarities of each. You learn to locate troubles in a small fraction of the usual time—then repair them faster and lots more efficiently.

Receiver stages are studied in their logical order. Over 400 diagrams, charts and photos make every step remarkably clear. Review questions with every chapter help you learn fast and right! Answers are given to odd-numbered questions in back of book.

Use coupon on opposite page to order RADIO & TV RECEIVER CIRCUITRY AND OPERATION today! If not more than satisfied that this big new book will be your "Open Sesame!" to better, more profitable servicing, return it in 10 days and every cent of the purchase price will cheerfully be refunded!



A. A. Ghirardi Radio-TV training books are more widely used than any others of their kind.

Work better, faster, more profitably with Ghirardi's COMPLETE GUIDE to MODERN SERVICE METHODS!

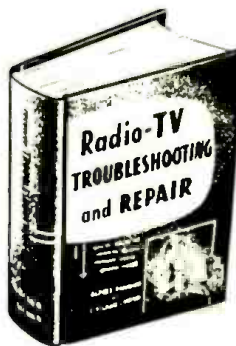

**Radio & TV Receiver
TROUBLESHOOTING
& REPAIR**

by Ghirardi & Johnson
820 pages, 419 illus.
Price \$6.75

**It pays to learn to
work by time-sav-
ing professional
methods!**

Completely modern, profusely illustrated, and written so you can easily understand every word, Ghirardi & Johnson's new RADIO & TV RECEIVER TROUBLESHOOTING & REPAIR book is a complete course in servicing by up-to-date professional methods. Backed with this training, you can quickly prepare for fast accurate and profitable service on any radio or television receiver!

First, RADIO & TV RECEIVER TROUBLESHOOTING & REPAIR teaches you all about modern troubleshooting and test methods. You learn how to locate common troubles in the quickest, easiest ways. You learn all about trouble sources in components. You learn to make simple "static" tests—then progress rapidly to dynamic signal tracing and signal injection techniques.

**HOW-TO-DO-IT CHARTS HELP
YOU LEARN FASTER**

Special problems in hard-to-fix sets are clearly explained. Step-by-step charts show every detail of modern service procedure in jig time. Receiver alignment, tuning problems, speaker troubles, intermittents and dozens of other tough jobs are made so clear you cannot fail to understand them.

Most important of all, this big new book brings you the latest television service procedures and methods in addition to complete coverage on radio problems.

To the beginner, it is a complete service training course. To the established serviceman, it is a guide to every detail of profitable modern methods and also serves as on-the-job reference in giving you quick solutions to puzzling service problems.

Read RADIO & TV RECEIVER TROUBLESHOOTING AND REPAIR for 10 days at our risk. Use coupon on opposite page!

MONEY-SAVING OFFER

On Ghirardi's new 2-vol. service training course!

Get both of the above new Ghirardi service training books at a special combination price! Have the service data you need—when you need it! Sold separately, Radio & TV Circuitry and Operation and Radio & TV Receiver Troubleshooting and Repair would cost you \$12.75. Bought as a combination you get both books for only \$12.00—with the same privilege of returning them in 10 days if you don't like them.

Check SPECIAL COMBINATION OFFER in coupon on opposite page. Mail today!

Ghirardi's COMPLETE BASIC TRAINING for beginners



More people now in Radio-TV got their basic training from this famous book than any other book or course of its type!

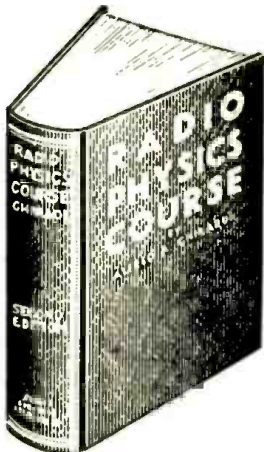

36 COURSES IN ONE

**Ghirardi's
RADIO PHYSICS COURSE**

972 pages, 508 illus.
856 self-test review questions.
Price only \$5.00—the biggest buy in basic training on the market!

"The most complete training course in radio fundamentals ever offered!"—that's what experts say about Ghirardi's world-famous RADIO PHYSICS COURSE. More widely used by Signal Corps, Navy, etc. in World War II than any other basic radio training text. Everything is explained so clearly that you can understand every word without previous radio training of any kind.

Ghirardi's RADIO PHYSICS COURSE starts with Basic Electricity. Then it takes you step by step through the entire field of Radio-Electronics from simple circuits showing the basic functions of resistors, condensers, coils,

transformers, etc., to the final applications of these circuits in home, auto, and aircraft radios, public address systems, etc. Subjects covered include Sound, Speech, Music, Electron Theory, Electric Circuits, Current, Resistance, Capacitance, Inductance, Transformers, Filters, Radio Waves, Vacuum Tubes, Radio Circuits, Loudspeakers and dozens of others. You get the kind of training you need—at a price you can afford to pay. If broken into "course" form and sent as monthly lessons, you'd regard it as a bargain at \$5.00 or more. Instead you buy it for only \$5.00—and you progress as fast as spare reading time permits.

Let these great books GIVE YOUR EARNING POWER A BOOST!

HIGHER PAY in 1953!

Send no money!

Read any of the 7 famous books* described on these pages for 10 days FREE. Use coupon below for examination privilege!

*Except PIX-O-FIX TV Troubleshooter's Guide which is sold for cash only.

Only \$1. HANDLE UP TO 90% OF TV TROUBLESHOOTING by easy picture analysis!



**Ghirardi & Middleton's
PIX-O-FIX
TV TROUBLE FINDER
GUIDE**

Price \$1.00
(Outside U. S. A. \$1.25)
Cash only—
no free examination

This short cut way of handling television troubleshooting and repair can save you hundreds of dollars worth of time! You spot TV trouble symptoms at a glance—repair them lots faster!

Just "dial" PIX-O-FIX until the TV screen photo appearing in its "window" matches the screen picture on the set being repaired. PIX-O-FIX then indicates all possible causes of this particular trouble and the receiver section where they may occur. Step-by-step repair instructions follow.

PIX-O-FIX covers 24 common troubles; 190 possible trouble causes and 253 definite, easily-understood remedies. A truly professional service device—not a "fix-it-yourself" gadget for consumers. Priced at only \$1.00.

**It pays to know how to
USE ELECTRONIC TEST
INSTRUMENTS
more effectively!**

BASIC ELECTRONIC TEST INSTRUMENTS teaches you to use familiar instruments more fully; how to choose the right instrument for each job; how to operate and maintain them properly; and how to evaluate their readings and put them to practical use. You learn dozens of short-cuts in using instruments on hundreds of jobs. Best of all, BASIC ELECTRONIC TEST INSTRUMENTS saves money by helping you avoid buying unnecessary instruments—and it helps you handle even the complicated jobs with fewer instruments. In addition to the older instruments, the book covers all the newer types from grid-dip oscillators, to TV sweep and marker generators, distortion meters and many more. Read it for 10 days at our risk!

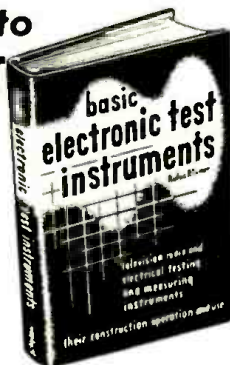

**JUST OUT!
BASIC ELECTRONIC
TEST INSTRUMENTS**

255 pages, 171 illus.
Price \$4.00

**MODERN
OSCILLOSCOPES
AND THEIR USES**

by
Jacob H. Ruiter, Jr.
326 pages.
370 illus.
Price \$6.00

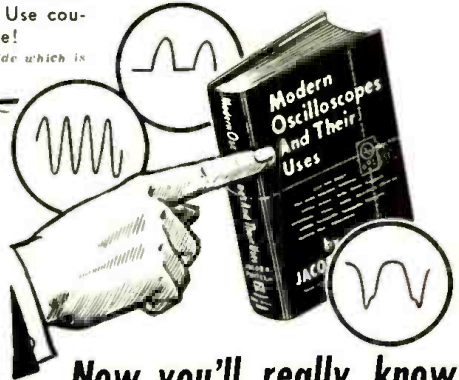

**Now you'll really know
HOW TO USE OSCILLOSCOPES!**

Learn to use the oscilloscope fully on all types of AM, FM and television service work—and watch your efficiency and earnings soar!

MODERN OSCILLOSCOPES AND THEIR USES, a fact-jammed 326-page book by Jacob H. Ruiter, Jr. of the Allen B. DuMont Laboratories contains exactly the help you need—and written in a way that makes these remarkable instruments perfectly understandable. It shows how to use your scope

for faster, more accurate work on all types of jobs from troubleshooting to re-aligning. You learn how to make connections; how to set controls, and, above all, how to analyze patterns. 370 illustrations including dozens of pattern photos make things doubly clear.

No other type of specific service training stands to mean so much to you in terms of being able to do better, faster and more profitable work!

**Let this "Automatic Teacher" show how to
REPAIR OVER 4,800 RADIO MODELS**



Whether you repair radios for a living or work with them occasionally, Ghirardi's manual-size, 744-page RADIO TROUBLESHOOTER'S HANDBOOK can save you time and money on a big percentage of jobs—especially on older sets where data is so often lacking. Eliminates useless testing!

Actually, this giant book contains specific trouble symptoms and their remedies for common troubles found in more than 4800 older sets of leading manufacturers. Just look up the case history notes on the set you want to fix. RADIO TROUBLESHOOTER'S HANDBOOK tells what the trouble is—what causes it—and exactly how to repair it. Hundreds of additional pages contain valuable data on old tubes, parts and equipment, plus graphs, diagrams and money-making service hints. Price only \$5.00, 10-day free examination.

**A QUICK GUIDE TO
TELEVISION SERVICE**

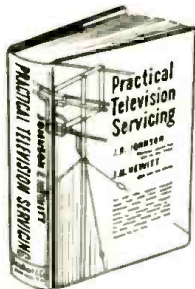

**PRACTICAL
TELEVISION
SERVICING**

by Johnson & Newitt
Price only \$4.00

For those who already know radio, this is the book to help you make the jump to more profitable TV receiver servicing in the least time—at the lowest possible cost!

PRACTICAL TELEVISION SERVICING with its 334 pages and 253 clear illustrations is a complete training course written so you can really understand it. First you learn how TV work differs from radio—how to set up shop—what equipment to get—what mistakes to avoid. Then you learn every detail of TV servicing from quick diagnoses of simple troubles to complicated instrument troubleshooting. Actual TV servicing case histories are worth their weight in gold and make tough jobs easier to understand. Read this big book for 10 days at our risk. Send coupon today!

Mail Order—10 DAY EXAMINATION OFFER

Dept. RN-23, RINEHART BOOKS, INC., Technical Division
232 Madison Ave., New York 16, N. Y.

Send the books checked below for 10-day FREE examination. In 10 days after receiving the books, I will either remit the price indicated or return the books to you postpaid and owe you nothing.

COMBINATION OFFER: Ghirardi's Radio & TV Receiver CIRCUITRY & OPERATION and RADIO & TV RECEIVER TROUBLESHOOTING AND REPAIR (both books) only \$12.00 for the two. (Outside U. S. A. \$13.00.)

Single Books

- Ghirardi's RADIO & TV RECEIVER CIRCUITRY & OPERATION, Price \$6.00.
- Ghirardi's RADIO & TV RECEIVER TROUBLESHOOTING & REPAIR, Price \$6.75.
- Ghirardi's RADIO PHYSICS COURSE, Price \$5.00.
- ELECTRONIC TEST INSTRUMENTS, Price \$4.00.

- PRACTICAL TELEVISION SERVICING, Price \$4.00.
- MODERN OSCILLOSCOPES AND THEIR USES, Price \$6.00.
- RADIO TROUBLESHOOTER'S HANDBOOK, Price \$5.00.
- PIX-O-FIX TV TROUBLEFINDER'S GUIDE, Price \$1.00, CASH ONLY. No free examination. (Outside U. S. A. \$1.25.)

TO ORDER BOOKS OUTSIDE U. S. A., add 50c to price of each book for handling through customs, etc. Cash only. Same 10-day return privilege with money refunded.

Name
Address
City, Zone, State
Employer's Address

TUNG-SOL[®]

for
Uniformity
and
Dependability



REPLACEMENT:

Tung-Sol tubes keep service standards up to set manufacturers' specifications.

INITIAL EQUIPMENT:

Tung-Sol tubes meet the highest performance requirements of set manufacturers.

TUNG-SOL

RADIO, TV TUBES, DIAL LAMPS

TUNG-SOL ELECTRIC INC., NEWARK 4, N. J.
Sales Offices: Atlanta • Chicago • Dallas • Denver
Detroit • Los Angeles • Newark

ALSO AUTO LAMPS, ALL-GLASS SEALED
BEAM LAMPS AND SIGNAL FLASHERS

RADIO-TV Service Industry News

AS REPORTED BY THE
TELEVISION TECHNICIANS LECTURE BUREAU

PRODUCTION for the defense program is supposed to reach its plateau, or peak, in the electronics industry during the months just ahead. It is expected, with the slackening of the demand for critical materials for military needs, expanding supplies of raw materials available for normal channels will rapidly stimulate the development and production of products for civilian use. The allocation and procurement of supplies for the defense program has preceded production by many months so it can be assumed that the flow of material into normal channels of trade will be noticeable even while production for defense stays at a high level.

An Expanding Industry

The electronics industry has been straining at the leash for a long time and the slackening of the pressure for war goods will be followed immediately by the rapid expansion of the industry in several directions. The applications of electronic devices to new tasks mean more complex circuitry with the result that maintenance is demanding a higher degree of training and competence on the part of personnel employed in that phase of the work. It is well worth careful study of what lies in the immediate future to appraise what the up-coming developments may mean to independent service as a business activity.

When television first burst upon the scene in 1947 it found the independent service forces of that day poorly prepared to cope with the new problems it presented. Almost every radio service operator in business at that time jumped into the "bonanza" of contract service for installing and servicing TV receivers. Most of the men who had had good radio service business expanded their activities to handle the sale of TV sets. In the intervening years many of these men have built substantial radio and appliance retail businesses with TV installation and service as a profit producing department.

Very few of the former radio service operators survived as TV service contractors. During the summer of 1951 alone the mortality rate in in-

dependent TV service businesses was close to 20%. In other words, about one out of every five independent service businesses ceased to exist during the six-month period in 1951 when the business of TV servicing hit rock bottom. We have heard of only a few TV service businesses that did not operate at a loss during the two summer months of that year.

Facts of Service Business Operation

The TV service business has been experiencing a small scale "boom" that started with the national political conventions last July. However, only a very small percentage of the independent service businesses have been able, during this period, to build up adequate cash reserves to tide them over the slack periods that are sure to come. This factor will bring about another period of high mortality when the cycle dips again to low business levels for a few months.

In traveling about the country on lecture tours your editors talk to many parts distributors about the caliber of service businesses they have in their trade areas. One of the most common remarks we hear is crystallized in this statement:

"Bill Jones (a neutral name we have selected) could have the leading and most profitable business in this area. He is a good technician; he gets along well with his customers and he tries to maintain a good credit standing.

"But the trouble with Bill is his business is under-capitalized. The result is he hasn't been able to expand enough to handle the volume of business necessary during good times to build adequate reserves to tide him over bad times. So when business gets bad Bill goes into debt to keep going. When business improves it takes him months to pull himself out of debt. He isn't building a business. He merely has a job working for himself in which he is not building any future security for himself or his family."

Then they will point to some other service business in which the owner is not an especially good technician but he is a good enough business man to keep a large enough volume of business coming in so that he can

hire competent men to handle the technical end of his business. He is able to give his attention to sales promotions that keep a steady volume of business coming in, to a regular and careful study of costs, and the planning of work routines and all of the other elements that are involved in running the business so it will produce a profit as well as a good income for the owner. That is the kind of business, they say, that will survive the long pull.

Classifications of Service Work

The many millions of AM radios that are either in use or sitting inoperative in closets, constitute a pretty good market for service in themselves. In TV areas, AM radio servicing has been taken over pretty much by TV service companies and the small shops that handle some minor TV service. As a rule, very little service sales attention is being given to the large number of AM radios that are in need of service. The AM radio repair jobs that come into shops are usually "emergency" jobs. The one that gets repaired is probably the last of several AM radios to finally quit working in that home. Chances are if the service operator who got the repair job would make the effort he could get two or three other AM radios to repair out of the home where the "emergency" job came from.

Recently we mentioned this to a parts distributor who immediately cited what a service operator had told him the day before. This service operator delivered a TV set which he had repaired to the customer's home. As the customer paid him she said, "Will you take our four regular radios to your shop and repair them, too?" These "four regular radios" were a console and three table models—all inoperative.

There has been very little aggressive effort on the part of the service industry to get some of the available business on automatic changer replacements and on record player repairs. In many TV areas set owners are taking a new interest in recorded music. Lots of people who still have single-speed changers in their AM console cabinets that they like as furniture pieces, do not know that they can buy 3-speed changers that would fit into their console cabinets. While it would take some "personal selling" to do it, any radio or TV service operator who needs to increase his volume of business could do it with a campaign on replacing single-speed changers with 3-speed units.

The phono crystal cartridge and needle replacements have been sorely neglected, too. Perhaps it is because technically trained people think only in terms of technical proficiency required of an electronic device and not about how to *sell* their services to the people who own those devices.

The average person is prone to procrastinate in having things repaired.

WALSCO

UHF



FIRST
antenna to be
tested and
accepted in
Portland

PROVEN
America's Finest
all-channel
UHF
antenna

GUARANTEED
everywhere,
anywhere
for one
full year

AVAILABLE NOW!

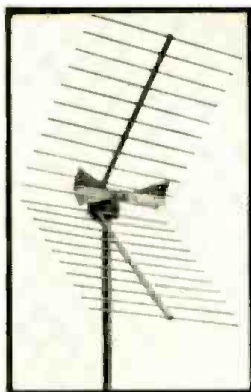

Corner Reflector Model 4450



Reflecto-Fan Model 4400

Freq. MC	Gain in db.*		
	Mod. 4400	Mod. 4402	Mod. 4450
500	6.1	8.4	7.8
600	7.6	10.6	8.9
700	8.9	11.9	11.0
800	7.9	11.3	12.9
900	7.0	9.0	11.8

*Measured gain over tuned folded dipole

List Price

Model 4400 (Single Bay)..... \$ 6.75

Model 4402 (Dual Stack)..... 14.25

Model 4450 (Single Bay)..... 14.50

WALSCO

Walter L. Schott Company

3225 Exposition Place

Los Angeles 18, California

Overseas Representative: Ad Aurlima, Inc. 89 Broad St., New York 4, N. Y.

**RESCO ULTRA-LINEAR
Williamson
Amplifier Kit**
featuring the
ACRO TO-300

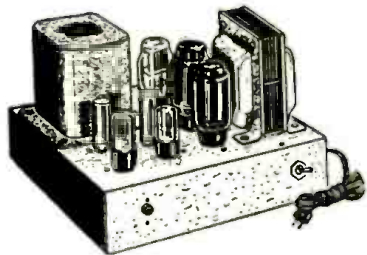

Build the finest amplifier ever developed. Complete with all components, punched chassis, and easy-to-follow instructions. Get the full benefits of Acrosound TO-300 performance as shown by specifications listed below.

Now Available for Immediate Delivery! **\$74⁵⁰**

**ULTRA-LINEAR
WILLIAMSON ACRO TO-300**



The World's Finest Audio Output Transformer

Only a few resistors and condensers are involved in converting to ultra-linear operation — layout remains the same. Get more out of your Williamson by giving it the specifications listed below.

SPECIFICATIONS

- Response — 1 db. 2 cps. to 200 kc.
- 30 watts of clean power within 1 db. 20 cps. to 30 kc.
- Less than 1% IM at 20 watts.
- Square wave transmission to 50 kc.

ACRO TO-300 net \$24.75

ACRO TO-310 net \$18.75

(TO-310 used to change over 6V6 amplifier to ultra-linear operation)

FREE

Write for ACRO Catalog showing amplifier schematics and conversion information.

- TO-300 TO-300 (Shipping wt.—7 lbs.)
- Amplifier Kit (Shipping wt.—25 lbs.)
- Check or M.O. enclosed. I include postage.

Name _____
Address _____
City _____ Zone _____ State _____

Radio Electric
SERVICE CO. OF PENNA., INC.

7th & Arch Streets, Phila. 6, Pa.

Vacuum cleaners stand idle in closets because the housewife puts off getting a new bag to replace the one worn out. Faucets drip because the old man forgets to get new washers until the old ones finally give way completely and the water pours out in a steady stream. Automatic record players gather cobwebs because the needle is worn out or the tripping mechanism gets out of whack.

One case in particular that recently came to our attention is typical of user indolence in having equipment repaired. This family had four AM radios; one in the kitchen, a console in the living room, and table models in each of two bedrooms. When the kitchen radio went out the housewife set it aside with a firm resolve to have it fixed right away and, in the meantime, she put one of the bedroom radios in the kitchen. The bedroom radio went on the fritz so it was set aside to be repaired, the family depending on the radios in the kitchen and living room for their radio listening. Then the substitute set in the kitchen went out, so they relied on the living room radio. Finally the last of their radios started to "act up" so the husband resurrected the first kitchen radio, took it to a radio shop and had it repaired. At last report they were doing all of their radio listening over the repaired kitchen radio. The radio service operator who repaired this set could have had three others to repair if he had been either curious or alert when he dealt with this customer.

The TV service technicians who have called at this home to service the television set have never inquired about their AM radios, record changers, or battery radios. Yet an itinerant grinder picks up about ten dollars each year on his regular annual calls at this home, for sharpening all of the knives and scissors on the place.

TV Servicing

The tremendous dollar volume of business that will continue to flow from TV service and replacements eventually will result in the development of basic types of business operations to handle it economically and profitably. Most TV service businesses are haphazard operations as businesses that are hopelessly swamped when business is good and desolate when it is bad. The TV service contract was so badly abused by some customers' impossible demands for service and by the misguided, mishandling of funds by many service businesses that its usefulness as a medium to level off service revenue to insure year-round operation was destroyed.

Right now the TV service business generally is very good. Yet many service operators are badly under-pricing their labor. Many service operators who are handling a lot of money from their service activities are confusing the volume of dollars they are handling as "earnings". They are not



ACORN

**CARTER Type B-420
SUPER DYNAMOTOR**

A tremendous value at this price! 12 volt input at 12 amps; 400 volt output at 200 ma, continuous. All brand new.

SPECIAL \$23.95



**C-D PHOTOFLASH
CONDENSERS**

400 mfd @ 450 volts, equivalent to 400 watt seconds. All brand new, but removed from original equipment, never used. Limited quantity at this special price. **SPECIAL... \$5.95**

**4 1/2" SQ. 0-200 MICROAMP
MULTI-METER**

Famous make, with multi tester scale. Made specifically for VTVM use. Scales 0-1000 ohms; volts d.c. 0-3, 0-10; volts a.c. 0-3, 0-10. **SPECIAL... \$9.95**



**POWER
TRANSFORMERS**

WESTINGHOUSE Pri. 115v 50-60 cy. Sec. 650v c.t. @ 250 mls; 12.6v c.t. @ 5 amps; 6.3v @ 5 amps; 6.3v @ 5 amps; 5v @ 3 amps. Electrostatically shielded. Brand new. Shpg. wt. 13 lbs. \$4.49



PHILCO Pri. 115v. 50-60 cy. Sec. 650v c.t. @ 150 mls. 6.3v @ 4.5 amps; 6.3v @ .3 amps; 5v @ 3 amps. Half-shell mg. Shpg. wt. 9 lbs. \$3.69

RCA Pri. 115v. 50-60 cy. Sec. 730v c.t. @ 225 mls; 6.3v @ 8 amps; 6.3v @ 1.2 amps; 5v @ 3 amps. Half-shell mg. Shpg. wt. 13 lbs. \$5.99

SPEAKER SPECIALS

RCA 12" SPEAKER

Ideal for replacement or new set use. 6-8 ohm voice coil. **\$3.85**
SPECIAL... \$11.00
3 For



ROLA 8" SPEAKER

Genuine Rola electro-dynamic 8" speaker with 750 ohm field coil. Complete with output transformer. **\$1.95**
SPECIAL... \$18.50
10 For

ROLA 5" SPEAKER

5" electro-dynamic speaker with 750 ohm field coil. Complete with output transformer. **\$1.19**
SPECIAL... \$11.00
10 For

10 MFD-600V OIL CONDENSERS

Sprague and C-D. Diam.: 2 3/8", height 3 3/8". Rated at 220V a.c. Each... **99c**
Brackets for above, each... **15c**
Complete with brackets... **\$2.95**
3 For



SLEEPER SPECIALS!

4-Gang AM-FM tuning condensers. Steatite insulation. (\$12 regular.) Each... \$1.39
4 For

4-Gang FM tuning condensers. 5-40 mmfd. Steatite insulation. (\$11 regular.) Each... \$1.10
5 For

UTC 0-4 Ounce. Plate to Grid Transformer. (\$11 List.) Special... 2.95

**630 SUPER DE LUXE
31-TUBE TV KIT**

Build yourself the finest television with this complete kit. Every late development, including voltage doubler, keyed AGC, etc. For use with all kines from 16" to 24". Complete with all tubes (less kine), easy-to-follow instructions, etc. **\$119.44**
SUPER-SPECIAL...

KIT OF 100 RESISTORS

Consists of popular 1/2 and 1 watt resistor values. Made by leading manufacturers. All Standard Brands, all useful values. **\$2.99**

TERMS: 20% cash with order, balance C.O.D. unless rated. Prices F.O.B. our warehouse in N. Y. C. Minimum order \$3. NOTE: Due to conditions beyond our control, prices are subject to change.

Phone **WOrth 4-3270**

ACORN ELECTRONICS CORP.
76 Vesey St., Dept. N-2, New York 7, N. Y.

amortizing their test equipment, trucks, or any of the capital equipment that is wearing out. Most of them have no system of books whatsoever. Some of them insist they are making a lot of money on service at three dollars per call!

The "TSA News" (Detroit) recently carried an article by C. T. Wycoff which included an interesting breakdown of the cost of a service call:

"Many people think of television service calls at \$5.00 per call for half an hour or less, robbery, not realizing the costs involved.

"Let's break down the cost of a call. In a large city the maximum calls that a technician can complete in one day is seven calls in eight hours; the average mileage required per call is eight miles. 7 calls in 8 hours is one and 1/8 hours per call.

1 and 1/8 hours at \$2.00 per hour (low for professional labor)	\$2.25
8 miles at 9 cents per mile (replacement costs of car)72
Supervision and management (someone has to run the business)83
Clerical and bookkeeping83
Overhead, rent, light, heat, & miscellaneous41

Total cost \$4.64

"These figures are those of a typical service organization and do not figure in the costs of social security, workman compensation, call backs, or jobs guaranteed, etc."

Many service technicians believe that city or state licensing would answer the problems of independent service business operation. Actually, any form of licensing will eventually drive the small operator out of business. Where reports, inspections, and the payment of fees to political elements become a requirement for a man to operate a business, the red tape that develops demands so much time and attention that it becomes impossible to operate in a small way. Larger business units take over and through their volume of business they are able to afford the specialized help necessary to look after the non-productive phases of the business.

In most areas where licensing bills have been proposed the excuse is that "gyp" service technicians are gouging the public and giving inferior service. Yet in those same areas you will find successful TV service businesses that are being operated at a profit and have a high rate of customer satisfaction with the services they are charging and the prices they are charging. These businesses do not sell cheap service. They sell quality service. They are managed by men who realize that TV owners cannot truly appraise the value of good service. It is the responsibility and obligation of the servicing company to tell them about good service and what it rightfully costs. So they carry on regular customer relations programs as a part of every service call.

February, 1953

No "CANNED" Effect!

WEATHERS

FREQUENCY MODULATION PHONOGRAPH PICKUP SYSTEM

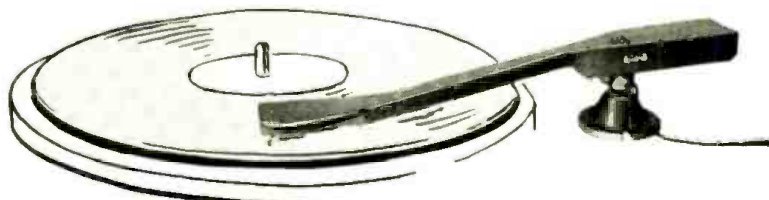

REALISM without "NOISE"



W-2 FM Capacitance Pickup Cartridge

- Greatly Reduced Stylus Pressure
- Extended Record and Stylus Life
- Negligible Distortion
- Negligible Needle Talk
- No Undamped Resonances
- No Hum From Motor Field
- Triple Play Single Stylus Model Plays ALL Records

NEW! Weathers Reproducer Arm for the W-2 FM Capacitance Pickup



(For Standard W-2 Cartridge Only)

W-216 Arm and W-202 Cartridge Set for any 16" transcription turntable

Protect your investment in new records with the one gram stylus pressure of the Weathers cartridge and arm. You will be amazed at the reduction in stylus wear. A new standard in record reproduction which must be heard to be fully appreciated. The low mass of the Weathers stylus follows every groove undulation perfectly without distorting the groove wall.

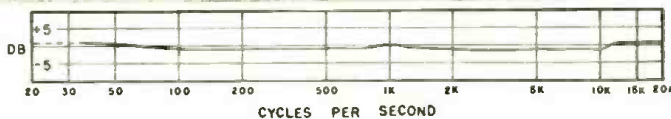

Typical frequency response curve produced with Cook Series 10 Test Record. (Response over 500 cycles compensated to obtain constant velocity characteristic.) Terminals provide compensation based on AES Standard Playback Curve or constant-amplitude response, as preferred.

SIMPLE INSTALLATION COMPONENTS

Each cartridge, or cartridge and arm set, includes a Weathers oscillator with pickup cable receptacle and power cable for one 6AT6 tube. Power cable may be connected to user's amplifier (receptacle supplied) or to Weathers W-22 Power Supply, sold separately. The new W-21A oscillator is factory-adjusted with the cartridge and pickup cable in each set and does not ordinarily require further adjustment, even after tube replacement.



Oscillator

Power Supply

CARTRIDGE FOR STANDARD RECORD PLAYERS

The W-202-C Universal Cartridge Set is available for installation in modern record players, manual and automatic, and in standard makes of transcription arms. Stylus pressure may be adjusted to 3 grams or less when installed in a Webster automatic changer or RCA-45 record player. W-202-C Universal Cartridge Set is electrically identical with the W-202 and W-212 Standard Set (used only with the Weathers arm), but the stylus compliance is slightly reduced.

WEATHERS INDUSTRIES

BOX 531

66 E. GLOUCESTER PIKE, BARRINGTON, NEW JERSEY

See your distributor or write for literature

Gerrold Announces New
MODEL 704
 Direct Reading
FIELD STRENGTH METER

for TV and FM
 it will
 actually
 read
 microvolts!

*Accurate for the Laboratory
 ... Rugged for the Field*



Model 704 offers the answer to field signal measurement!

DIRECT READING . . .
 Microvolts and db meter scales
 5 microvolts to 3.0 volts

ACCURACY . . .
 ±0.8 db

FREQUENCY RANGE . . .
 Continuous Tuning 50-220 M C

INPUT IMPEDANCE . . .
 72 or 300 ohms
 Separates and measures video, audio and adjacent Channel carriers. Locates RF interference.

6 Volt Vibrator Pack available for battery operation.

MODEL 704-6V
Price \$24.75
 (includes cable)

\$275.

MODEL 704
 with AC power supply

JERROLD

ELECTRONICS CORP.

1451 South 26th St. • Philadelphia 46, Pa.

Become an ELECTRICAL ENGINEER in 36 MONTHS
 Bachelor of Science Degree — Major in Electronics or Power

It is estimated by 1955 there will be at least two positions for every engineering and technician graduate. This college offers a tested plan that permits you to enter these vast employment opportunities at an early date. Save a valuable year through optional year-round study. Receive advanced credit for prior training gained in the armed forces, other schools or field experience.

ENTER BOTH RADIO AND TELEVISION 12 months or one-third of the B. S. degree course (Electronics major) — also brings you the Radio Technician's certificate. An added 6-month course qualifies you for the Radio-TV Technician's certificate. Recent developments open unlimited opportunities for TV technicians and engineers.

THE PROVEN "UNIT CHASSIS SYSTEM" of teaching was developed here. It "breaks down" the TV set by stages. You learn every component of all types and makes — and are prepared for future design changes, including the advent of color.

6 to 12-MONTH TELEVISION SERVICE COURSE... trains for good servicing jobs and shop ownership in the shortest practical time under expert instructors.

Terms open April, July, October, January. Over 48,000 former students from all states and 23 overseas countries. Faculty of trained specialists. Modern laboratories and equipment.

Write for free 110-page catalog, 48-page pictorial booklet "Your Career" and "Occupational Guidance Bulletins."

MILWAUKEE SCHOOL OF ENGINEERING

APPROVED FOR VETERANS • NONPROFIT • FOUNDED IN 1903



Milwaukee School of Engineering
 Dept. RN-253, 1025 North Milwaukee
 Milwaukee 1, Wisconsin

Without obligation send Catalog for Electrical Engineering, B. S. Degree, major in Electronics; Power; "Your Career"; Occupational Guidance Bulletin on: Radio-TV; Electrical Power; Welding; Heating, Refrigeration, Air Conditioning; Mechanical Engineering, B. S. Degree; Preparatory; Television Service.

Name.....Age.....

Address.....

City.....Zone.....State.....

If veteran, indicate date of discharge.....

Any service technician who feels that licensing would answer any of his problems would do well to talk to any one-store drug store owner. Just ask him to tell you how many licenses he must carry and what they entail in record keeping alone. It will provide part of the answer why large drug chains are gradually pushing the small, one-man drug store out of business.

Cheap Service or Good Service?

Recently in looking over a community newspaper we noticed the classified section carried three ads offering TV service. One ad listed TV service calls at \$3.00 and gave only the phone number; the second ad listed TV service calls at \$4.00 and gave only the phone number; the third ad offered TV service calls at \$4.50, included the name and address of the advertiser and a brief, professionally-phrased statement about the technical qualifications of the business.

After considerable checking we found the \$3.00 service calls were offered by a man who worked in a factory and handled TV service calls nights and on week-ends; the second was a radio technician who was trying to get some TV service business; and the third was a highly competent TV service company with an almost perfect record of customer satisfaction. The first two were equipped to handle only the simplest forms of TV service work, such as the replacement of receiving type tubes. The TV service company was equipped and manned to handle any type of installation or service.

On the basis of the information we were able to gather, the third company, advertising calls at \$4.50 with company identity included in the ad, is getting about three times as many calls from its ad as the first two combined. It again bears out the statement that TV set owners want to feel that they get full value for the money they pay out for TV service but they do not want cheap service. They want competent, reliable service.

Industrial Electronics

Most electronic devices for industrial applications are either custom-built for the particular operation they perform or are adapted to suit the individual requirements of an installation. Because of those factors the sale of industrial electronics equipment is usually made on the basis of recommendations and specs developed from an engineering study of the function the equipment is to accomplish. Since most of this equipment has been going into large plants, they usually set up their own maintenance departments to install and service it.

However, the easing of the defense program will probably be closely followed by an expansion of the development of electronic control devices for use in smaller plants. This will open a new market for competent independent service.

Make Your Dollar Go Farther!

The father of our country made a dollar go a long way, but your dollar will go a longer way when you get a Walter Ashe "Surprise" Trade-In.

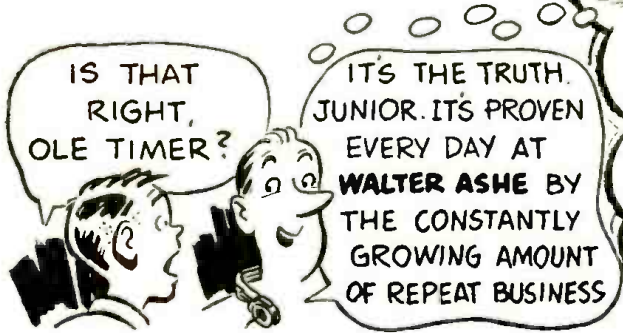

JOHNSON VIKING II TRANSMITTER KIT. Complete with tubes. Shpg. wt. 85 lbs. Only \$279.50
JOHNSON VIKING II Wired and tested. Only \$336.50

There's no doubt about it—you're money ahead when you take advantage of the one and only "Surprise" Trade-In Allowance on your used (factory-built) test and communication equipment. For fast action, use the convenient coupon to tell us what you have to trade and to indicate your choice in new equipment. Get your trade-in deal working today!



NEW COLLINS 75A-3 RECEIVER. Complete with tubes and 3 kc Mechanical Filter. Less speaker. Only \$530.00.

NATIONAL HRO-60T
 Less spkr. Shpg. wt. 90 lbs.
 Only \$483.50



All prices f. o. b. St. Louis



HALLICRAFTERS SX-71
 Less speaker.
 Shpg. wt. 51 lbs.
 Only \$224.50

HAMMARLUND HQ-129X
 Less speaker.
 Shpg. wt. 74 lbs.
 Only \$239.50



Phone Chestnut 1125

Walter Ashe
RADIO CO.
 1125 PINE ST. • ST. LOUIS 1, MO.

-----FREE CATALOG!----- RN-53-2

WALTER ASHE RADIO COMPANY
 1125 Pine Street, St. Louis 1, Missouri

Rush "Surprise" Trade-in-offer on my _____
 for _____
(show make and model No. of new equipment desired)

Send new 1953 Catalog.

Name _____
 Address _____
 City _____ Zone _____ State _____

**Send
 for
 your
 copy
 today**

Trav-Electric

\$15⁹⁵
LIST

Model 6-1160

MIGHTY MIDGET CONVERTER

*Just plug into
Cigar Lighter on Dash*

Converts 6 volts D.C. to 110
volts A.C. 60 cycles 40 watts.

Ideal for phono-
graphs and turntables
at beach, or picnic.



PORTABLE PHONOGRAPH

Radios, short wave
or broadcast bands
in car, truck and
cabin, etc.



IN THE CAR—IN THE TRUCK

Small dictating ma-
chines . . . ideal for
salesmen, business
or professional men.



Dictating Machine

Electric shaver works
beautifully when it
is plugged into Trav-
Electric. A great time
saver.



ELECTRIC SHAVES

Boats—the 110 volts
A.C. operates radios,
lights, etc.



IN BOATS

Ideal for outdoor
musical entertain-
ment from table ra-
dio to phonographs,
including most wire
and disc recorders.



AT PICNICS—OUTINGS

Fully Guaranteed
THOUSANDS IN USE

See your Electronic Dealer or
Jobber, or write direct



Model 6-1160

Size
2 1/2" x 2 1/2" x 3 1/2"

TERADO Company

Manufacturers of Precision Equipment
1068 Raymond Ave. St. Paul 14, Minn.

In Canada, write: Atlas Radio Corp., Ltd., 560 King
Street West, Toronto 28, Ontario

EXPORT SALES DIVISION, Scheel International, Inc.
4237 N. Lincoln Avenue, Chicago 18, Illinois, U.S.A.
Cable Address—Harscheel

Manufacturers of electronics equip-
ment for industrial and commercial
applications have indicated they would
prefer to deal with a single organiza-
tion that could insure adequate main-
tenance and servicing facilities in all
parts of the country rather than to
have to ferret out competent organi-
zations on an individual basis.

In order to provide these manufactur-
ers with a national servicing "pack-
age" of independent servicing com-
panies a group of major service busi-
nesses recently formed the National
Industrial Electronics Service Affili-
ates, as incorporated organization
whose aim it is to tie together in a
cooperative program the leading serv-
ice companies in every town, city, and
hamlet across the nation.

It is the objective of NIESA to
provide manufacturers with a service
that will include the preparation of
the necessary operating, installation,
maintenance, and servicing informa-
tion that its affiliates will need to
efficiently handle the manufacturer's
products.

Major service companies who are in-
terested in receiving detailed informa-
tion on NIESA may write to the
Service News Editor, RADIO & TELE-
VISION NEWS, 366 Madison Ave., New
York 17, N. Y.

Industrial Television

While u.h.f. TV and the new v.h.f.
stations that are building in areas not
previously served by local or nearby
televasting stations will bring an in-
creased volume of business to many
service shops in those areas, the next
big "national" boost the independent
service industry will get will come
from industrial or "closed circuit"
television.

The needed elements to get wired
television underway on a large scale
are now available. There is a com-
paratively low-priced camera tube
built into a compact, easy-to-use
camera. Such cameras are now in
production. Extensive advertising and
sales promotion campaigns will soon
be "breaking" that will create a
widening interest in this newest phase
of TV.

The *Dage* TV camera, now in pro-

duction, is a compact, completely self-
contained unit about the size of a
large brief case. It develops a 525-line
picture with interlaced scanning so it
will work into any standard television
receiver. It is simple to adjust and
operate. An installation consists of
running a cable from the camera to
the receiver or receivers to be used.

The *Dage* camera is to be sold
through regular parts distributing
channels and it is planned to leave the
installation and servicing in the hands
of competent independent servicing
companies. It is presumed, of course,
that progressive TV service companies
will arrange for some of their techni-
cal personnel to study TV camera cir-
cuitry.

Many service technicians are now
studying TV camera circuitry through
a ten-lesson course prepared by the
Television Technicians Lecture Bu-
reau. The pulse generator, constructed
as a part of the course for use with
the TTLB camera, is a very useful
servicing tool in itself.

The TTLB course includes complete
construction details for a camera. All
parts for this inexpensive unit are
available from parts distributor. Infor-
mation on the TTLB course may be
obtained by writing to the Service
News Editor, RADIO & TELEVISION
NEWS, 366 Madison Ave., New York
17, N. Y.

WESTERN SHOW DATES

THE Board of Directors of the Western
Electronic Show and Convention
(WESCON) has set the 1953 conclave for
August 19 through 21 at San Francisco's
Municipal Auditorium.

In 1952, a total of 15,092 individuals
attended WESCON in Long Beach, Cal-
ifornia and plans for 1953 envision a
substantial increase, not only in gen-
eral attendance, but also in the 1952
figure of 2692 persons who registered for
the technical sessions and the 199 ex-
hibitors who displayed products and
services in 224 booths.

WESCON, as an operating organiza-
tion, is jointly sponsored by the West
Coast Electronic Manufacturer's Assn.
and the Seventh Region of the Institute
of Radio Engineers, NEDA and the
California Chapter of "The Representa-
tives" have pledged their cooperation.

Allied Radio Corporation, one of the leading national distributors of electronic
parts and equipment, is building a new \$2,000,000 home at Washington Blvd. and
Western Avenue in Chicago. The new location will give the firm 150,000 square
feet of floor area in which to handle an anticipated 25,000 items. A system of con-
veyor belts, chutes, and electronic controls will move orders and merchandise quick-
ly from one section to another. The building is expected to be ready by summer.



versed from a positive to a negative. He moved the dial a little farther, and the picture returned to normal but the sound was blotted out.

"As you can see," Mac continued, "the grid-dip oscillator is a powerful little signal generator that covers, with the coils that come with it, a range of 2 to 250 megacycles. I have wound additional coils that allow me to go down to 350 kilocycles for use in radio servicing. The one I am plugging in now covers most of the broadcast band. Note when I flip this little switch on the back of the instrument the grid current falls to zero, for I am cutting off the plate voltage; but also notice when I bring the inductance close to the oscillator coil of this little a.c.-d.c. set and tune the instrument to the frequency at which the set oscillator is working, I get a reading on the meter. The grid of the 6AF4 is now acting as the plate of a diode and is rectifying the voltage induced into the plug-in inductance. That gives a means of determining the frequency of any oscillator or other circuit handling a substantial amount of r.f. power. Furthermore, by noting the amount of coupling and the reading of the meter, I can get a rough idea of the amount of r.f. energy present in the circuit being investigated.

"And now," Mac continued as he plugged a pair of phones into the jack of the GDO and switched its plate power back on, "there remains but one more basic function of the grid-dipper to demonstrate. Listen in here while I tune the signal generator across the frequency at which the oscillator is working. Hear that heterodyne? Now we are using the instrument as an oscillating detector, and it provides us with still another method of determining the frequency of an unknown signal when that signal is too weak to give a reading on the rectifying-diode set up."

"These coils you wound have three connections on them. Why?"

"The Colpitts circuit employing a split-stator tuning condenser as the sole 'capacity-voltage-divider' for providing feedback does not work well at low frequencies, especially when the tuning condenser approaches the all-out position. I simply wound my coils in two equal portions and brought out the center tap and grounded it through an extra pin-jack on the frame of the tuning condenser. In effect, this changes the oscillator from a Colpitts to a Hartley; and then the low-frequency, home-made coils work just as well as the ones that come with the instrument. Now that technicians are buying the grid-dippers, I am sure that soon low frequency coils will be sold with them as standard equipment."

Barney picked up a little air-wound coil with a pair of alligator clips fas-

UHF-VHF Signal Testing is QUICK, EASY with...

THE NEW HEAVY DUTY

Alprodco EREC-TOWER

TEST SIGNALS UP TO 80 FT. ▶

EREC-TOWER—and only EREC-TOWER—goes up a full 80 feet. You test signal strength anywhere along the way up... determine just exactly how high the permanent antenna must be!

ERECT PERMANENT TV TOWERS ▶

Use the EREC-TOWER as a gin pole to raise permanent antenna towers. With an EREC-TOWER, for example, two men can erect a 100-foot Alprodco Tower in less than two hours. You save time, money, labor on every job!

DEMONSTRATE TV SETS ▶

EREC-TOWER helps you demonstrate sets quickly, anywhere. Here's the ideal way to show razor-sharp pictures to your fringe area prospects... right in their own homes. EREC-TOWER is a real sales closer!

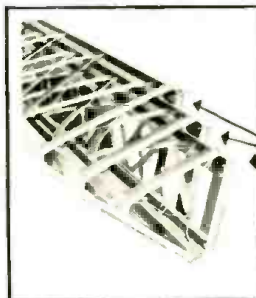

BETTER BUILT

EREC-TOWER is constructed of lifetime aircraft aluminum. Each leg and track (see opposite illustration) is extruded in one solid 24-foot length... will not buckle, crack, stick or rust.

HEAVY EXTRUDED ONE-PIECE ALUMINUM TRACKS

FREE! WRITE TODAY for full information and literature on the Alprodco EREC-TOWER as well as Alprodco Aluminum TV-FM-AM Towers.

Alprodco, Inc.

302 E. MAIN ST., KEMPTON, INDIANA
MINERAL WELLS, TEXAS • DUBLIN, GEORGIA

Dealer
Net Price
(For Tower)
\$233.50

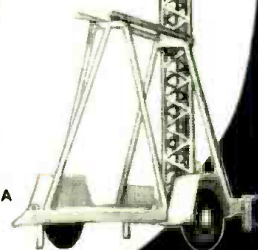

NEW! 2ND EDITION of the only complete reference on AUDIO!

"The Recording & Reproduction of SOUND"

by OLIVER READ

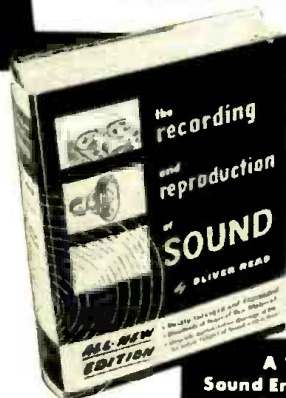

Completely revised and vastly enlarged new edition

OVER
800
PAGES

A "Must" for
Sound Engineers, Hi-Fi
Enthusiasts, P. A.
Men, Broadcasting
Stations, Recording
Studios, Students

largest selling
book in its field

CONTENTS:

A Partial List of Authoritative Chapters:

Behavior of Sound Waves; Basic Recording Methods; Lateral Disc Recording; Microgroove Recording; The Decibel; Phono Reproducers; Styli; Microphones; Loudspeakers and Enclosures; Dividing Networks and Filters; Attenuators and Mixers; Home Music Systems; P.A. Systems; Amplifiers; AM and FM Tuners—PLUS HUNDREDS OF OTHER SUBJECTS

Now you can have all the *right* answers to any subject in the field of Audio. Learn how to select and get the most out of recording equipment. Tells you how to select the proper amplifier for given applications, how to test amplifier performance, how to eliminate hum. Explains microphone, speaker and pickup principles and selection factors. Shows how to utilize inverse feed-back, expanders and compressors. Covers hundreds of subjects—a vast wealth of reliable information found in no other single volume. If you work in the field of Audio, this book belongs in your library. Order your copy today!

6" x 9" **ONLY \$7.95**
Hard Covers
800 pages 700 illustrations

**ORDER
TODAY**

Order from your Parts
Jobber, or write direct to
HOWARD W. SAMS & CO., INC.
2203 E. 46th St., Indianapolis 5, Ind.

My (check) (money order) for \$.....
is enclosed.

Send copy(ies) of *The Recording &
Reproduction of Sound (RR-2)*. \$7.95 per copy.

Name.....

Address.....

City..... State.....

tened to the ends. "Did this come with it?" he asked.

"No, that is a *Barker & Williamson* #3006 'Miniductor' with the ends un-wound until they both take off from the same supporting bar, leaving a full sixteen turns between those ends. I use it to determine the capacity of unknown mica or ceramic condensers. When any condenser of from 2 or 3 $\mu\text{fd.}$ to .005 $\mu\text{fd.}$ is clipped across that coil, the resonant frequency falls within the range of the five lowest-frequency inductances furnished with the instrument. I simply find this frequency with the dipper and then refer to this graph I made in which resonant frequency is plotted against capacity, and I know the value of the condenser. This is the old mustard for identifying condensers when you are not sure of the color code or when one of the colored dots cannot be identified."

"This is rather funny-looking graph paper."

"It is double logarithmic paper with two vertical cycles and four horizontal cycles. The vertical cycles from the bottom up read 1 to 10 and 10 to 100 megacycles. The horizontal cycles from left to right indicate 1 to 10, 10 to 100, 100 to 1000, and 1000 to 10,000 $\mu\text{fd.}$ The resonant frequency of the coil and a small-tolerance 100 $\mu\text{fd.}$ silver mica condenser was carefully measured with the grid-dipper and plotted on the graph. I know that as long as I use the same inductance and vary the capacity, the resonant frequency doubles every time I divide the capacity by four and is halved every time I multiply the capacity by four; so this gives me any number of other points on the graph. On this kind of paper, these points all lie in a straight line; so all you have to do is determine a couple of points a goodly distance apart and draw a straight line through them. Were our coil a pure inductance, this line would be accurate throughout its length; but because of the distributed capacity of the coil, there is a small error at the low-capacity end. To correct this I measured several *Ceramicons* of low capacity and high accuracy and curved the upper left-hand end of my line to pass through these plotted points. There are many other ways of determining capacity with a GDO, some producing greater accuracy; but this method is the easiest and most practical for the needs of the technician."

"Can you measure inductance with the gadget?"

"Why not? All you have to do is place a known condenser across the coil you're measuring and find the resonant frequency with the dipper. Then you refer to a resonance chart to learn what inductance will produce resonance at that frequency with that capacity."

While he was talking Mac clipped a twenty-ohm resistor in series with the coil and condenser lying on the bench. Then he placed a clip across the resistor so that it was shorted out.

"See how sharp the dip is with the

RADIO Surplus Buys



CRYSTALS

... in FT 241-A Holders— $\frac{1}{2}$ " Pin SPC. Marked 54th OR 72nd Harmonic MC Freq. Listed below by fundamental frequency with fractions omitted.

500 KC Crystals ea. **\$1.95**
1000 KC Crystals ea. **\$3.95**

370	407	444	476	509
372	408	445	477	511
374	409	446	479	512
375	411	447	480	513
376	412	448	481	514
377	413	450	483	515
379	414	451	484	516
380	415	452	485	518
381	416	453	486	519
383	418	454	487	520
384	419	455	488	522
385	420	456	490	523
386	422	457	491	525
387	423	458	492	526
388	424	459	493	527
390	425	461	494	529
391	426	462	495	530
392	427	463	496	531
393	429	464	497	533
394	430	465	498	534
395	431	466	501	536
396	433	468	502	537
397	434	469	503	538
398	435	470	504	540
400	436	472	505	
401	437	473	506	
402	438	474	507	
403	440	475	508	
404	441			
405	442			
406	443			

\$1.00 EACH

10 for \$8.00, Postpaid

FOLLOWING CRYSTALS AVAILABLE IN FT 243 HOLDERS $\frac{1}{2}$ " PIN SPACING

3500	5035	7350
3590	5127.5	7450
4165	5285	7750
4280	5587	7875
4335	5660	8006.7
4350	5730	8025
4370	6073.3	8200
4440	6075	
4445	6140	
4540	6150	
4580	6350	
4620	6525	
4635	6700	
4710	6875	
4880	6975	
4980	7075	
4995	7150	

\$1.00 EACH

11 for \$10.00, Postpaid

PLEASE ENCLOSE FULL AMOUNT WITH ORDER
QUANTITIES AVAILABLE
WRITE FOR YOUR REQUIREMENTS

C & H SALES CO.

BOX 356-FT EAST PASADENA STA. • PASADENA 8, CALIF.

Please Mention
RADIO & TELEVISION NEWS
When Answering $\frac{1}{2}$ " Advertisements



**more
dough
from Generous Joe!**

JOE POSSNER Needs Your Equipment for New Operation. Your MONEY rushed by return mail! No Red Tape!
Just write one letter. List items. EXACT condition, price You want!

ALL QUERIES ANSWERED IMMEDIATELY
You Get More Because We Have No Stock.
We Will Swap - Tell Us What You Want.
Equipment - Relays - Switches
Condensers

POSSNER ELECTRONICS
(Formerly Electronics Sales Co.)

DEPT. R-1
5279 West Pico Blvd. • Los Angeles 19, Calif.

resistor out of the circuit," he said to Barney. "Then notice how it broadens out when I cut the resistance in. This difference in dipping action is really an indication of the 'Q' of the tuned circuit. A sharp dip means a high 'Q'; a weak dip, a low 'Q'. Since high resistance or shorted turns in a coil lower the 'Q' of a circuit in which it is used, the dipper can often be used to detect such a coil defect. The manual that comes with the meter tells you how to find the numerical value of 'Q'; but for our purposes, the rough indication of the sharpness of dip is sufficient."

"It's too bad," Barney sighed, "you can't use it to spot intermittents."

"But you can!" Mac exclaimed. "Look on page 108 of the August, 1952, issue of RADIO & TELEVISION NEWS, and you will find an article by Lewis Hughes explaining how the GDO can be used to spot intermittent condensers without removing them from the circuit or turning off the set."

"That thing's got more uses than chlorophyll," Barney muttered.

"Let's talk about using it in everyday radio service," Mac suggested. "Take the case of a receiver in which the r.f. stage will not track with the oscillator. The GDO can be used to check the tuning range of both the r.f. and oscillator circuits and will immediately reveal which one is not covering the span it should. In the same way, without ever plugging the set in, we can trim the turns of a new 'universal' loop antenna until it and the tuning condenser track perfectly with the dial markings. 'Loopstick' antennas can be adjusted just as easily and quickly.

"The instrument also makes an excellent portable signal generator that can be carried in the shopcoat pocket. With it tuned to the proper frequencies, you can quickly tell if a signal will pass through a set from the antenna, the grid of the mixer, or the grid of an i.f. stage. All you have to do is hold the inductance close to the point where you want to insert the signal. This makes for very speedy troubleshooting. We have already shown how the diode-rectifying action of the GDO can be used to determine if the oscillator is working.

"Remember that set we had a while back that gave us such a hard time because of parasitic oscillations? If we had had the dipper, we could have used the oscillating detector to locate the frequency of the parasitic, and then we could have switched off the receiver and used the instrument as a grid-dip oscillator to locate the circuit components yielding resonance at that frequency. Incidentally, as an oscillating detector, the dipper can trace a signal through the i.f. stages, too; and in an emergency, you can even use it as a signal generator to align those i.f.'s"

"The frequency settings could not be too accurate with plug-in coils and that small dial," Barney objected.



HERE ARE JUST A FEW OF THE
BIG VALUES
IN THE LATEST 148 PAGE
B-A CATALOG
WRITE US IF YOU HAVE NOT RECEIVED IT

BURSTEIN-APPLEBEE CO.

1012-14 McGee St., Kansas City 6, Mo.

Send Free B-A Catalog No. 531.

My order is attached for items from below.

\$..... enclosed.

Name.....

Address.....

City.....

State.....

35 MA.—130 VOLT
SELENIUM RECTIFIER

EACH
35c

Very compact 3/4"x1/2" dia. in tubular fibre sleeve, sealed with high temp. wax—easy to mount anywhere with the self supporting 2" tinned wire leads. An exact replacement for Standard B51 and many other TV boosters and ideal for countless other rectifier needs.

No. 15A1172 35c 10 Lots 29c
Spec. Ea.

MIDGET
POWER TRANSFORMER

EACH
89c

117 V., 60 cycle AC primary, 110 V. @ 20 MA H.V. Secondary 6.3 V. @ .3 amp for Filament. Fully enclosed, compact size 1 1/2"x1 1/2"—mtg. ctr. 2 1/8". Color coded leads. An exact replacement for many popular TV Boosters as well as for use in construction of phono pre-amps, bias supplies, phono oscillators, etc. No. 19C714.

Special Each 89c 10 Lots, 79c
As above: 110 V. @ 40 MA H.V. Secondary, 6.3 V. @ 1 amp. for Filament. Size 1 1/2" x 1 3/4" x 1 5/8" — 2 3/8" ctrs.

No. 19C731 \$1.29 10 Lots, \$1.19
Special Each

SWITCH ASSORTMENT

10 FOR
\$1.19

10 Assorted—toggle, push-button and slide type switches. The use of only 9 cents will pay for the lot.

No. 18A935. Per Assmt. Only... \$1.19

A HEAP OF PARTS
ONLY
29c

Assembly consists of 140 mmf midget variable coil socket, dual crystal socket, RF coil socket, 10 contact terminal strip, resistors, etc., neatly assembled on metal chassis with fibre bottom plate 4" x 1 1/4" x 1 1/8" high. Easy to dis-assemble.

No. 18B1044.
Per Assembly Only..... 29c
10 Lots Each..... 25c

16MFD.—150 WKG. V.—225 P.V.
TUBULAR ELECTROLYTIC

EACH
15c

Top make, hermetically sealed in aluminum tube with kraftboard insulating jacket and 3" tinned wire leads. Compact only 1 3/4"x3/8". Fresh stock—fully guaranteed, a widely used capacity at a crazy Low Price.

No. 14B995 15c 10 Lots 13c
Spec. Ea.

6AK5 TUBES

6 FOR
\$4.79

Made by Sylvania and bears the name "Standard" because they were originally intended for use in Standard Boosters—otherwise the identical 6AK5 you would get if buying tubes bearing the Sylvania name and for which you pay up to \$2.06 Net Each (List Price \$3.90 Ea.). Here you get 6 for little more than the regular price of 2 and believe us—they are perfect—new—fully guaranteed—a popular type widely used in Radio, TV, Boosters, etc.

No. 70A98. Pkg. of Six 6AK5 Sylvania Made Tubes ONLY..... \$4.79

PAPER & MICA CONDENSERS

99c

25 assorted useable capacities paper tubular, paper molded and mica condensers. Regular values up to 25c each.

No. 18B203. A Wonderful Value... 99c

TRIMMER CONDENSERS

ONLY
39c

25 Assorted ceramic base mica trimmer condensers popular capacities. Regular cost up to 20c each. You can afford to have several assortments, even if the use is only occasional.

No. 18A156.
PER ASSMT. ONLY..... 39c

36 MOLDED PLASTIC
TUBULAR
CONDENSERS

\$11.70 List Value

\$3.88

Compact, yet with the rugged construction needed to withstand the high temperature in TV, Auto and AC-DC sets. Top quality. Fully guaranteed by the maker as well as B-A. Kit of 36 all 600 Volt: 4 each .001, .002, .005 and 6 each .01, .02, .05, .1.

No. 18A263..... \$3.88
Your Cost.....

Kit of 36 Paper Tubulars at 600 volt assorted as above. \$10.50 List Value.

No. 15A389..... \$2.39
Kit of 36.....

ROTARY SWITCHES

99c

Assortment of TEN—any one of which is worth more than the price of the lot. Anyone experimenting or building will find good use for all.

No. 18A436.
Per Assmt. of TEN..... 99c

INSULATED RESISTORS

ASSTD.
\$1.49

Do not confuse with non-insulated, foreign makes etc. offered by others.

50 Assorted top quality 1/2 watt insulated resistors in most popular capacities.

17A871. Per Assmt. of 50..... \$1.49

ASSORTMENT OF 100
Consists of 75-1/2 watt and 25-1 watt insulated top quality resistors

No. 19B936
Per Assortment of 100..... \$2.49

6 FT. BROWN AC CORDS

10 FOR
\$1.69

All are of U/L approved size 18-2 conductor zip aprand cord and top quality plugs.

No. 19B911
Per Bundle of 10..... \$1.69

FLEXIBLE
MICROPHONE CABLE

Special silver stranding gives extreme flexibility plus unusual tensile strength. Top quality filler, shielding and overall rubber covering. Only 3/8" dia

No. 28132. 100 Ft. \$2.95
Per 25' Coil 95c Ft.

INCLUDE ALLOWANCE FOR POSTAGE—ALL OVERPAYMENTS WILL BE REFUNDED

B-A BURSTEIN-APPLEBEE CO. 1012-14 MCGEE ST. KANSAS CITY, MO.

THE AUDIO PERFORMANCE OF

New **BROOK** ALL TRIODE HIGH QUALITY AUDIO AMPLIFIERS
IS BEYOND DESCRIPTION
Let your Ears Pass Judgment



- Nine distinct positions for record playback provide complete bass and treble equalization for best-known recordings.
- Bass effective to 15 cycles results in improved transient response that makes all bass tones sound more natural.

Write for complete technical data, and be sure to listen to the new **BROOK** at your local dealer's Sound Department.

BROOK ELECTRONICS, INC.
34 DeHART PLACE, ELIZABETH 2, N.J.

Dept. RB-3

"You're right; a GDO is not intended to be a precision frequency instrument in itself. However, by letting a harmonic fall on a known broadcast station, or other known signal, such as WWV's transmissions, you can set the grid dip oscillator very closely. Ordinarily, though, the markings on the dial of the GDO are plenty accurate for most purposes.

"But now let's talk about how the instrument can be used in TV service. You have already seen how it can produce a signal on either the sound or picture frequency of any TV channel, but it will also produce any frequency found in the i.f. channels of either separate sound and picture sets or those of the intercarrier type. I don't need to tell you how such a compact little signal generator as this can be used to isolate trouble in a TV set by simply injecting the proper signal at different parts of the circuit. All you have to do is just hold the inductance of the GDO close to the point where you want to introduce the signal. For example, in the case of a dead oscillator, if the GDO is tuned to the proper oscillator frequency and held close to the mixer tube, a picture can be obtained.

"A very important function of the grid dip meter is to check the frequency of traps and stagger-tuned transformers before any attempt at alignment is made. This can be done in a matter of seconds before the set is turned on and will often save much useless work. It is important that the transformers be set to approximately their correct frequency before alignment with a scope is started—especially if there is reason to believe the original settings may have been changed. Otherwise it is often possible to produce a curve similar to the correct one with the individual transformers set away off their specified frequencies, but the curve will not have the proper amplitude because the mistuned transformers will not have the 'Q' for which they were designed.

"Still another important use for the GDO," Mac went on, "is as an auxiliary 'exploring' marker to be used to determine characteristics of a curve while the regular marker is left fixed at an important point. By positioning the GDO just right with regard to the set, a marker of the desired size can be obtained. If you want a precision marker, a crystal can be plugged into the coil socket, using an adapter, and the oscillator will function at the fundamental frequency of the crystal and produce strong harmonics. The tuning condenser setting serves as a broad control of the amplitude of oscillation and permits the frequency to be varied over a few cycles. I have used ham crystals for the 160, 80, 40, and 20 meter bands in this fashion and all oscillate strongly. A surplus tank-transmitter crystal with a fundamental of about 510 kc. would not work, however.

"But we can't cover all the possible

**EARN MORE MONEY—
BE A PROFESSIONAL
TELEVISION
SERVICE
TECHNICIAN**

**STEP INTO THE TOP PAY
\$5,000—\$10,000 A YEAR
CLASS. YOU CAN WITH
WTI SHOP TRAINING.**

If you want to reach your goal as a Successful Service Technician you will need plenty of "KNOW HOW" to qualify for the better servicing jobs or profitable shop ownership.

**SEND FOR
FREE
BOOK TODAY!**

WESTERN TV offers real experience on live equipment in our **BIG SHOPS AND LABORATORIES** in the shortest practical time under expert instructors. Graduates are in big demand because they have the "field experience" necessary for immediate "bench" or supervisory positions. You learn every phase of Radio and TV servicing (AM, FM, VHF, UHF). WTI men win fast promotion... can demand better pay... develop highly profitable businesses of their own with the latest and most **PRACTICAL PERSONALIZED TRAINING BEHIND THEM.** You concentrate all your time on being a **PROFESSIONAL TV SERVICE TECHNICIAN**—non-essential math and engineering theory omitted. **YOU CAN EARN WHILE YOU LEARN.** Special Finance Plan. **APPROVED FOR VETERANS.** Find out how you can get into the **TOP PAY GROUP**—Send for this fact-packed book NOW!

**WESTERN
TELEVISION
INSTITUTE**

America's Leading
Television
Servicing School

Western Television Institute Dept. R-23
341 W. 18th St., Los Angeles 15, Calif.
Without obligation, please send FREE fully illustrated booklet. (No salesman will call.)

NAME _____
ADDRESS _____
CITY _____ ZONE _____ STATE _____

South River
★ ★ NEWS ★ ★

**EAVE MOUNT
MODEL EM-1**

Heavy steel of a novel, bridge-type, truss construction, hot dip galvanized. Upper bracket provides 4" clearance from eave; lower bracket, generous 48" spread. Complete with hardware.

South River Antenna Mounting Accessories are carried by every leading TV Parts Jobber from coast to coast.

Write for your copy of our new 1953 catalog.

**SOUTH RIVER METAL
PRODUCTS CO., INC.**
SOUTH RIVER, N. J.

PIONEER AND OUTSTANDING PRODUCER
OF FINEST LINE OF ANTENNA MOUNTS

uses of such a versatile gadget now," Mac broke off; "but I'll tell you what I'm gonna do: for every new use for the GDO you come up with, I'll give you a couple of bucks. Said use, however, must be one in which the dipper does a job quicker or better than an instrument normally used for the purpose, or it must be one in which the portability of the grid dip meter is an important item. How does that sound?"

"Like money in the bank!" Barney said enthusiastically. "Come with Papa, Mister Grid Dip Oscillator; we're going to bankrupt this tight-fisted Scotchman!"

-30-

C.W. TRANSMITTER

By GLENN W. DYE

THIS true pocket portable can be built up from scratch or from one of the surplus BC-746B tuning units, some of which are sold with one 80-meter crystal. The basic unit supplies the chassis, tuning condenser, a usable crystal socket, and tie lugs. A 7-pin miniature socket and the small parts listed in the circuit diagram must be added, along with a small coil form and coil form socket, though a fixed-mounted coil can be used.

A home-made, U-shaped chassis about 4"x1 1/4"x1" can be bent from a strip of scrap metal 1 1/4" wide. The tuning condenser can be the familiar APC type or anything similar.

The best above-chassis parts lineup, for simplest and most efficient below-chassis wiring, is crystal-tube-condenser-coil. If a BC-746B is used, its crystal socket should be moved to the end of the chassis and the tube socket installed in its place.

With a 67-volt supply, the plate-screen current of the 3S4 tube will be 12 to 15 ma. in the operating condition. A flashlight cell can power the filament. Keying is done in the "B—" lead from the battery. The antenna (about 135 feet of small magnet wire will do) can be connected to the plate pin of the coil socket (see diagram) and the ground to "B—", or the optional link coil may be used.

Even a beginner can build this tiny rig and have it on the air in the course of an afternoon.

-30-

Circuit of the ultra-midget transmitter.

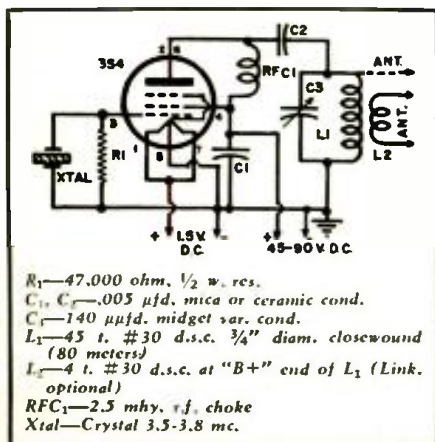

to the
**ELECTRICAL
ENGINEER**

or
PHYSICIST

with experience in

RADAR
or
ELECTRONICS

Hughes Research and Development Laboratories, one of the nation's leading electronics organizations, are now creating a number of new openings in an important phase of their operations.

Here is what one of these positions offers you:

THE COMPANY

Hughes Research and Development Laboratories, located in Southern California, are presently engaged in the development and production of advanced radar systems, electronic computers and guided missiles.

THE NEW OPENINGS

The positions are for men who will serve as technical advisors to government agencies and companies purchasing Hughes equipment—also as technical consultants with engineers of other companies working on associated equipment. Your specific job would be essentially to help insure successful operation of Hughes equipment in the field.

THE TRAINING

On joining our organization, you will work in the Laboratories for several months to become thoroughly familiar with the equipment which you will later help users to understand and properly employ. If you have already had radar or electronics experience, you will find this knowledge helpful in your new work.

WHERE YOU WORK

After your period of training—at full pay—you may (1) remain with the Laboratories in Southern California in an instructive or administrative capacity, (2) become the Hughes representative at a company where our equipment is being installed, or (3) be the

Hughes representative at a military base in this country or overseas (single men only). Compensation is made for traveling and moving household effects, and married men keep their families with them at all times.

YOUR FUTURE

In one of these positions you will gain all-around experience that will increase your value to our organization as it further expands in the field of electronics. The next few years are certain to see large-scale commercial employment of electronic systems. Your training in and familiarity with the most advanced electronic techniques now will qualify you for even more important future positions.

How to apply:

HUGHES
RESEARCH AND
DEVELOPMENT LABORATORIES

Engineering Personnel Department
Culver City,
Los Angeles County, California

If you are under thirty-five years of age, and if you have an E.E. or Physics degree, write to the Laboratories, giving resumé of your experience.

Assurance is required that relocation of the applicant will not cause disruption of an urgent military project.

GIANT BARGAINS BECAUSE WE'RE

SPECIALISTS in TV ANTENNAS ACCESSORIES, EQUIPMENT FOR ALL LOCATIONS



Amazing New Motorless TV ANTENNA

All Channel TV RECEPTION IN ALL DIRECTIONS

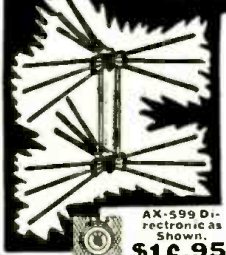

Rocket DIRECTRONIC MOTORLESS TV ANTENNA
360° Electrically Switched Beam

AX-599 Directronics Shown
\$16.95

No Motors
No Roof Orientation
No Electric Power
No Ghosts
Flick of Switch Clears Picture Instantly

Beam Selector

Provides same clear pictures as rotating aerials costing 4 times as much. Electrically beams in all directions with full 360° rotation. You select direction with Directronic Beam Selector located at set. Model AX-509 stacked array includes 18 hi-tensile aluminum elements, 1 set connecting studs, Universal U-Clamps for mast, Directronic Beam Switch, and 75 feet of TH-1 lead-in.

Model AX-59 Directronic 9-element Single **\$10.35**

Rocket ALL CHANNEL CONICALS



This sturdy, all-aluminum constructed TV antenna is designed for broad-band reception on all TV channels. Plus FM. High Gain, 4 to 1 front to back ratio. All channels 2-13. Uni-directional. Maximum signal to noise ratio. For use with 72-150-300 ohm lines. Low inception angle. Complete with all hardware—less mast.

Single Bay Array **\$ 3.95**
2 Bay Array with Tie Rods **8.65**
Fringe Area 4 Bay Array including 4 Bay Stacking Bars **18.95**

With any order of \$10 or more you will receive our Rocket 7 Ft. Intersect Line Cord. Permits adjustment, testing, repair of set while operating with back removed when ordering, state that you want this gift. Don't delay as quantities are limited. Only one given to a customer.

FREE
OF EXTRA COST
CATALOG AVAILABLE ON REQUEST



EVERY RADIOMAN

Can Use These

SERVICE HINTS!

Valuable Manual Yours—FREE!

Every page of "How to Simplify Radio Repairs" is packed with on-the-bench, practical ideas. Contains photos, charts, diagrams—no fluff—no vague theory. In plain every-day language it gives you priceless suggestions—new servicing ideas. You'll use and benefit from the experience of experts. Partial list of contents: How to Localize Trouble; How to Service Amplifiers; How to Test for Distortion; How to Test Audio Circuits; How to Test Speakers; How to Find Faults in Oscillators; How to Test Radio Parts—and It's all yours—FREE! No obligation.



SEND COUPON OR GOVERNMENT POSTCARD FOR YOUR FREE COPY TODAY!

FEILER ENGINEERING CO., Dept. 2-M-3
8026 N. Monticello Ave., Skokie, Ill.
(Suburb of Chicago)

Please RUSH my FREE copy of "How to Simplify Radio Repairs."

Name

Address

City

Zone

State

ROCKET 5 ELEMENT YAGI

Excellent Pictures in Fringe Areas

Designed for high gain with minimum interference from ghosts and noise due to directive pattern. Produces clear sharp pictures. 5 heavy aluminum elements include one folded dipole, one reflector, three directors. Strong molded insulator. Non-slip mast clamp. Completely pre-assembled, less mast.

Channels 7 through 13... **\$3.95**
Channels 5 or 6... **\$6.95**
Channels 2, 3, or 4... **\$7.95**

When ordering, specify exact channel number desired.

Rocket 35-foot Mast Kit

Economy mast kit contains 3-10' seamless duralumin 1 1/2" OD masts, one 5' mast, 300 feet of 6/20 galvanized steel guy wire, and everything else needed including guy rings, mast connectors, insulators, cable clamps, guy hooks, and swivel mounting base.

35-Foot \$15.95 Mast Kit **25-Foot \$11.95 Mast Kit**

LOWEST PRICES ON ANTENNA ACCESSORIES

Mast Steel (Dualcoated 5' crimped) 1 1/2" O.D.	\$1.05
Mast Steel (Dualcoated 10') 1 1/2" O.D.	1.95
Mast Connectors for 1 1/2" O.D. mast	.59
Chimney Mount Complete with Straps	1.19
Peak Roof Saddle (will take up to 1 1/2" O.D.)	1.59
Lightning Arrester-TV	.69
Galvanized Steel Guy Wire—8/20	3/4¢ ft.
Galvanized Steel Guy Wire—11/20	1 1/2¢ ft.
Rocket Twin-Lead—7/28 stranded	2¢ ft.
UTP-type Tubular 300 ohm Twin-Lead	4.95
100' coil	20.95
Rocket Open Line Twin-Lead 500' reel	1.10
Mast Stand-off Insulators—3"	.03
Stand-off Screw Insulators—3"	1.49
Wall Bracket—6" clearance	2.49
Wall Bracket—12" clearance	2.49

ALL PRICES F.O.B. CLEVELAND, OHIO
Do not remit more than complete purchase price. Pay shipping charges on receipt of goods. 25% deposit on C.O.D. orders, please. Money-back guarantee.
Prices Subject to Change Without Notice

National Electronics OF CLEVELAND THE HOUSE OF TV VALUES

102 Delco Bldg. Cleveland 3, Ohio

ROUND, SQUARE, KEY and "D" OPENINGS QUICKLY MADE with Greenlee Radio Chassis Punches



Save hours of hard, tedious work... cut accurate holes in chassis for sockets, plugs, controls, meters, panel lights, etc. with GREENLEE Punches. In 1-1/2 minutes or less make a smooth hole in metal, bakelite or hard rubber up to 1/16" thick. Easy to operate... simply turn with ordinary wrench. Wide range of sizes. Write for details. Greenlee Tool Co., 1882 Columbia Avenue, Rockford, Ill.



Manufacturers' Literature

Readers are asked to write directly to the manufacturer for the literature. By mentioning RADIO & TELEVISION NEWS, the issue and page, and enclosing the proper amount, when indicated, delay will be prevented.

PARTS BULLETIN

Greylock Electronics Supply Co., 115 Liberty Street, New York 6, New York has released an 8-page television and radio technician's bulletin which lists a number of timely buys in television and radio tubes and parts.

The company is also accepting requests for its 1953 catalogue which will be available shortly. The complete catalogue will contain 68 pages of offerings.

PARTS DIRECTORY

The Tube Department, RCA Victor Division, Radio Corporation of America has recently issued a comprehensive, 142-page "Service Parts Directory" containing schematic diagrams, parts lists, and top and bottom chassis views for the seventy-one 1950 and 1951 RCA Victor television receivers.

Designed for the convenience of television service dealers and technicians, the directory speeds and facilitates the selection of service parts.

The directory's pages are 11 x 17 inches in size and so arranged that the parts lists and top and bottom chassis views for a particular model face the corresponding schematic diagram. Service parts are listed by symbol number. This arrangement facilitates the location of the stock number of any part shown on the schematic.

The TV receivers in the directory are indexed by model name, model number, and chassis number. The r.f. tuner chassis number appears on each schematic. The model name, and model and chassis numbers are listed on the right-hand page margins to help locate information quickly.

The directory (SP-1014) is now available from RCA tube and parts distributors.

FACILITIES BROCHURE

The products of Raytheon Manufacturing Company, Waltham, Massachusetts, are shown in the illustrated, three-color catalogue recently published by the electronics firm.

A brief history of the company and a photo layout of its various plants are followed by detailed descriptions of the products of each of the company's four divisions: receiving tube, power tube, equipment, and radio-television. A page is devoted to an outline of the concern's research activities.

—THE BEST IN ELECTRONIC SURPLUS—

12 V. DC HEAVY BEAM MOTOR



Rated at 1/12 horsepower at 1725 rpm, but actually with built-on reducing gears develops many, many times more power. Worm gear at end of reducer is 43 rpm. As is, can be used for hoisting, electric platforms, portable electric trucks, conveyors, etc. Operates from 12 volts DC (two 6 volt storage batteries). Additional 7 inch heavy brass worm gear available to reduce rotation to 2 1/2 rpm, for antenna rotator. NEW, unused surplus.

PRICE, EACH MOTOR \$15.95

7-inch Brass Worm Gear, for 2 1/2 rpm. \$1.50

Hi-QUALITY COMPASS AND ADJ. TRIPOD



For orienting beam antennas, boat owners, hikers and many other useful applications where a real hi-quality compass is required. Compass is deluxe with ball and socket mount adapter, jewel mounts, built-in levels, a zero set, a screw for locking needle when not in use, two vertical sights—folding type, 4 inch pointer on 5 inch compass. 0-360 azimuth calibration (counter-clock-wise). Tripod is exceedingly well made, telescoping from 20 inches to 47 inches, and can be adapted for camera work. PRICE, Complete, as above, NEW unused surplus.

EACH \$14.95

VARIABLE AUDIO OSCILLATOR



For service test bench, code practice (by keying), tone modulation of ham or commercial transmitters, or with oscilloscope for audio amplifier testing. Has 5-point switch to provide 5 different audio tones. Uses a 12A6

pentode to give plenty of audio power. Additional 12A6 in spare socket, for spare. No. 1S4 spare as shown. With diagram. PRICE, EACH **\$5.95**

SCR-283 X'MTTING-RCVG. EQUIPMENT, COMPLETE

Excellent Condition material. R'cvng range: 200 to 400 KC and 4,150 to 7700 KC; X'mting range 2,500 to 7,700 KC. Uses plug-in coils for band changing both transmit and receive. Receiver is superhet, transmitter uses VFO and has power output of 4 watts CW, 3.3 W. on phone. COMPLETE with tubes, all coils, 24 V. DC Dynamotor, Radio Control Box, Antenna Sw. Relay, cables, etc.

A REAL BUY AT . . . PER SET \$34.50

CONDENSER MICROPHONE With 2-Stage Pre-Amp.

Real. Precision quality construction, double Helmholtz Resonator type, with combination microphone and amplifier built-in cylindrical brass case 16 x 6 ins. Uses types 30 and 32 tubes in amplifier. Employs acoustical low-pass filter plugs (removable) for 5-25 cycle response; removing plugs (threaded) and venting cylinder case will result in high-quality, wide-range studio-type microphone. As is, excellent for vibration testing, percussion noises, shock sounds, oil exploration work. Original use—Sound (Artillery) Ranging Eqt. NEW UNITS.

EACH \$34.95

INDUSTRIAL CAPACITORS

G. E. TYPE 18F75
Synco—Capacitor



50-50-50 mfd., Pyranol filled, Delta connected, 90 V. AC, 60 cps. All NEW, packaged capacitors. For power-factor correction on 115 V. 3 phase AC, etc. Large quantity available.

EACH \$6.95

G. E. VOLTAGE REGULATOR AND POWER SUPPLY

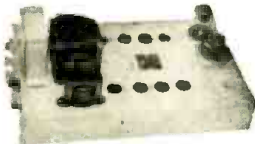

MODEL
3GVD14B3

Output 750 volts at 10 ma; complete power supply using 8 tubes; with selector switch for regulating or non-regulating. Operates from 110 V., 60 cycles AC. NEW units, less tubes, with operational data and diagram.

EACH \$15.95

32 VDC-110V AC CONVERTER

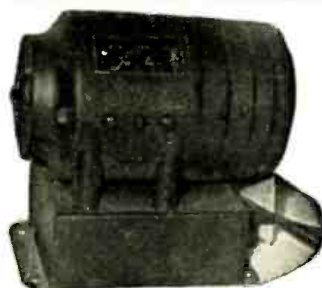

Mfd. by Kato Engineering, for marine or farm installation. Rotary type, compact and ruggedly built for continuous duty. Rubber shock mounting on filter case, with complete input and output filtering. Output 110 volts, 60 cycles AC, .225 KVA, but will operate efficiently on loads up to 300 watts. New units only.

PRICE, EACH \$39.95

INFRA-RED IMAGE "SNOOPERSCOPE" TUBE Extra-Special!!

We've sold thousands of them to Labs, experimenters, Industrials, studios, etc. By using Infra-Red rays, this tube enables you to see in the dark. No scanning, no amplifiers, just a high-voltage power supply is all you need with this tube. Shows image in greenish-white on 1 1/2" screen. For night photography, signaling, snooper or sniper scopes, underwater detectors, etc. British mfr. SOLD IN LOTS OF 6 ONLY! Literature and diagrams furnished with each sale.

6 for \$15.00

FRONT-END LENS, for Infra-Red Tube. Bausch & Lomb. Ea. \$10.00
Plain, Mounted Type. Ea. 7.00

ATTENTION, Please!

To N. Y., N. J., Conn., and other nearby Hams and Experimenters, we invite you to visit our Retail Dept. and Bargain Counters, at this address. We have a terrific quantity of transformers (all types), capacitors of all types, relays, receivers, transmitters, electronic devices that will intrigue you, etc.—all at sensationally low prices. We're in the heart of Coney Island, so visit the Beach, the Amusement area, and our Retail Display. No Parking Problem here! Please, do not write for catalogues or listing of this material.

All Above Material Subject to Prior Sale. 25% Minimum Deposit with All C.O.D.'s. All Prices F.O.B. Our Address.

—TELEMARINE— COMMUNICATIONS CO.

3040 W. 21st Street, Brooklyn 24, N. Y.
Phone: ES 2-4300

20-40 MC FIELD STRENGTH AND WAVEMETER

Uses a 0-100 Micro-ammeter with a 1S4 Pentode, to receive signals in the 20-40 mc range. 1.5 volts battery required. Tuning dial has lock, for fixing position, and telescopic Antenna permits adjusting for strong or weak signals. Calibration chart in the base. With instruction sheet and diagram. NEW, unused eapt. Dim: 6 1/4" x 4 1/4" x 5 1/2". With antenna.



PRICE, Each \$14.95

50-60 W. SPEAKER UNIT



Western Electric Speaker units, for horn or baffleboard mtg. Shock and blast proof diaphragm, will handle up to 60 watts. Response to 7,000 cps, favoring high freq. Impedance 13 ohms. Dim: 6" x 6" x 4 1/2" deep. Throat opening—1 1/2" dia. Anico 5 slug wt. 6

lbs. SPECIAL, PRICE EACH **\$18.75**

BC-221 FREQUENCY METER

Precise Signal Generator and Heterodyne Meter, with crystal calibrator for check points every 1,000 KC. Range .125 to 20.0 MC. Complete with tubes, crystal. Excellent Condition units. BUT NON-MATCHING Calibration Books. Follow the Instruction Manual for "Adjustments," and you can make the instrument and calibration book jibe. We could do it and charge you \$95.00 per unit, but we think you would prefer to do it yourself and save \$30.00.

BC-221 Freq. Meter, \$65.00
as Described. EACH

MISCELLANEOUS SPECIALS

The following items are for Exporters, Governmental Agencies, and Industrial Companies. Wholesale Only! All material is in stock and available for immediate delivery. Descriptive literature and prices available upon request.

MARINE

TCS X'mtr-Receiver for Ship or Shore.
TAJ 500 Watts Output, 175-550 KC. New Equipment, with Spares, Motor Generator (AC and DC available) Starter, Tubes, Complete.
TBK HF 500W. Transmitter with MG, Starter, and Spares.
GO-9 100/125 W. 1F/HF Ship or Aircraft Transmitter, A1 or A2 Emission. All New with Spares.
150-AY Mackay 1F Ship X'mtrs.
8707 RMCA Ship Radio Compass.

MISCELLANEOUS

DZ-2 Direction Finders.
GP-7 Aircraft Transmitters.
ZB-3 ILS Eqt.
SCR-283 RCVG and X'mting Eqt. Complete.
RT-3/ARN-1 Altimeter.
RADIOSONDES AN/AMQ-1A to D. New.

SCR-610 Crystals, in sets (120 channels) or individually. TESTED. Write for PRICES.

EXTRA!

PE-104 POWER SUPPLIES for Receiver of SCR-284, NEW, with Spare Vibrator, Export-Packed. Large Quantity Available. WRITE FOR PRICES.

GROUND AND AIR COMMUNICATIONS

TDQ VHF 100-156 MC 50W. AM X'mtr for 110 V. 50/60 C. AC.
BC-797 VHF 110-126 MC. 50W. AM Output or 110 V. 50/60 C. AC.
SCR-284 Ground Portable AM, Trans-Reer Eqt. for Field Communications.
SCR-522 VHF, 4-Channel, 100-156 MC Trans-Rer Eqt. for Plane or Ground Communications.
SCR-511, Walky-Talky, 3-6 MC. Crystal Controlled Trans-Reer, with Plug-In Units for Freq. Changing.
96-200A, 2 KW Wilcox X'mtr, 125-525 KC, 3 Cabinets: RF Unit, Modulator, Rectifier; A1, A2 and A3 Emission.
10 KW GE FM RF AMPLIFIERS, Type BF-3-A, 88-108 MC. Complete with RF Power Supply (separate unit). New Eqt. For increasing power FM and Television stations. Write for descriptive sheets and prices.

NEW!

2 GREAT BOOKS

By Milton S. Kiver

IF YOU SERVICE TV —YOU NEED THEM!

"TV Servicing Short-Cuts Based on Actual Case Histories"



shows you how to solve commonly recurring troubles

the book that really teaches fast, expert service techniques

This book describes a series of actual TV service case histories, each presenting a specific problem about a specific receiver.

The symptoms of a trouble are described and then followed by a step-by-step explanation of how the service technician localized and tracked down the defect. Finally, there is a detailed discussion of how this particular trouble can be tracked down and solved in any TV set. The discussions which follow each case history are invaluable—they explain how to apply the proper time-saving servicing techniques to any TV receiver. Here, in one volume, is the successful experience of experts—to make your service work easier, quicker, more profitable. Over 100 pages, 5 1/2 x 8 1/2", illustrated. Pays for itself on a single service job.

ORDER TK-1. Only \$1.50

"HOW TO UNDERSTAND AND USE TV TEST INSTRUMENTS"



shows you how to get the most from your test instruments

Provides basic explanations of how each test instrument operates; describes functions of each control and shows their proper adjustment to place the instrument

in operation. Covers: Vacuum Tube Voltmeters, AM Signal Generators, Sweep Signal Generators, Oscilloscopes, Video Signal Generators, Field Intensity Meters, Voltage Calibrators. Describes each in detail; explains functions; tells proper use in actual servicing; shows how to avoid improper indications. Because this book gives you a clear, complete understanding of your test instruments, you get more out of them, save time, and add to your earning power. Over 175 pages, 8 1/2 x 11", illustrated.

ORDER TN-1. Only \$3.00

HOWARD W. SAMS & CO., INC.

Order from your Parts Jobber today, or write direct to Howard W. Sams & Co., Inc. 2203 East 46th Street, Indianapolis 5, Ind.

My (check) (money order) for \$..... enclosed. Send the following books:

TK-1 (\$1.50) TN-1 (\$3.00)

Name.....

Address.....

City..... Zone..... State.....

The catalogue also lists the addresses of the principal sales offices of the company throughout the United States.

INTERCOM DISPLAY

Vocaline Company of America, Inc., 300 Vocaline Building, Old Saybrook, Conn., has released a new counter display featuring its portable intercom.

In the form of an eye-catching arrow, the display "points" to a "Vocatron" intercom on which it stands. In this way the display takes no more counter space than the compact intercom itself.

The sales message is concise and "quick reading" and urges passers-by to "ask for a no-obligation demonstration".

The company will provide complete details on how the new display may be obtained.

PHONO NEEDLE CHART

Jensen Industries, Inc., 329 South Wood Street, Chicago 12, Illinois, has issued a new replacement phonograph needle wall chart which incorporates several exclusive features.

Designed to simplify the work of the record dealer and the service technician, this guide also aids retailer inventory control and shows authorized needle substitutions.

A total of 78 different replacement needles are silhouetted on the chart, each with its Jensen "Durosium" or sapphire equivalent. Representing the requirements of the 16 leading cartridge manufacturers, it shows all the existing cartridge numbers in quick, easy-to-read style.

The chart also features a "best seller list" which indicates the relative turnover of each needle and, in effect, tells the dealer which of the many needles in the line he should stock heavily.

Copies of this 8" x 22" chart, which is printed in two colors, are now available from the company's distributors or by writing the company direct.

DU MONT SCOPE

Allen B. Du Mont Laboratories, Inc., 1500 Main Avenue, Clifton, New Jersey, has recently issued a 12-page catalogue covering its Type 304-A oscilloscope.

The publication outlines the features of the new instrument, instructions on calibrating the unit, data on the various controls, specifications, and other pertinent information.

The catalogue is lavishly illustrated with actual photographs of the unit and scope patterns obtained at specified settings of the controls.

CENTRALAB PRODUCTS

Centralab, A Division of Globe-Union Inc., 900 East Keefe Avenue, Milwaukee 1, Wisconsin, lists 470 new items in its new industrial and distributor stock catalogue, No. 28.

The book has been expanded from 28 to 32 pages and covers the company's five product divisions: variable resistors, ceramic condensers, rotary

and lever switches, printed electronic circuits, and steatite insulators.

The fully-illustrated and indexed catalogue is available free of charge from any Centralab distributor or by writing the company direct.

NEWARK'S 1953 CATALOGUE

Newark Electric Co., 223 W. Madison St., Chicago 6, Ill., has issued its 1953 catalogue, No. 55.

This 194-page listing covers components, equipment, manuals, etc. for industry, laboratory use, high-fidelity applications, and for radio and TV. This complete manual carries a comprehensive index for ready reference.

HUDSON CATALOGUE

Hudson Radio & Television Corp., 48 W. 48th St., N.Y.C. has just issued its catalogue H-53 comprising 194 pages of parts and equipment listings.

Of particular interest to purchasing agents is the inclusion of the latest JAN cross-reference guide. The catalogue is fully indexed to facilitate locating specific parts.

AUDIO CATALOGUE

Terminal Radio Corp., 85 Cortlandt St., New York 7, N. Y. has just published a 132-page audio equipment catalogue which contains fifty pages devoted to high-fidelity home music system components and seventy-six pages covering p.a. institutional, recording and broadcasting equipment as well as audio test instruments and similar specialized equipment.

The new catalogue is available without charge to interested persons or firms on request.

1953 POCKET BOOK

The Tube Dept. of RCA has completely revised and expanded the 1953 edition of its yearly pocket reference and calendar notebook to provide even more technical data on its kinescopes, receiving and transmitting tubes, electronic components, test equipment, radio and industrial batteries, and miniature lamps, than before.

A section on troubleshooting hints, prepared by John Meagher, is included along with 16 pages of full color maps, a 58-page diary, and a memo, address, and telephone number section.

THORDARSON CATALOGUES

Thordarson-Meissner, Mt. Carmel, Ill. has issued three new catalogues of interest to the industry.

The #400-K catalogue lists replacements types of power, filament, and audio transformers for the service industry as well as standard types. A special section is devoted to TV replacement transformers. The second catalogue is a TV replacement guide for the service industry. It provides complete information on over 2500 TV models. Manufacturers parts numbers and the company's replacement types are listed for power and filament transformers, filter chokes, audio, vertical, and horizontal output transformers, focus coils, booster transformers, and deflection yokes.

The #53-A general catalogue gives specifications on the *Meissner* line of AM-FM tuners, receivers, and amplifiers and includes a section on receiver and amplifier kits. The company's new novice transmitter kit and hi-fidelity 10 watt amplifier are listed for the first time.

TV REPLACEMENT GUIDE

Standard Transformer Corp., 3580 Elston Ave., Chicago 18, Ill. has issued a simplified television transformer catalogue and replacement guide which lists replacement information on over 4400 TV models and chassis.

All the technician has to do is look up the manufacturer's part number, listed in numerical order by type of transformer, then the *Stancor* replacement will be found listed next to it.

U.H.F. ANTENNA DATA

The LaPointe-Plascomold Corp., Rockville, Conn. is now offering an 8-page catalogue, entitled "UHF Antenna Systems—How, What and Where for Every UHF Area", to interested persons.

The brochure includes valuable u.h.f. data of interest to the installation technician. It is now available at all "Vee-D-X" jobbers on request.

PRINTED CIRCUITS

Erie Resistor Corp. of Erie, Pa. has issued a new bulletin on its complete line of five types of electronic printed circuits, each in a range of capacities: diode filters, triode plate couplers, vertical integrators, pentode plate couplers, and audio output circuits.

MERIT CATALOGUES

Merit Coil & Transformer Corp., 4425 N. Clark St., Chicago 40, Ill. has issued two replacement guides, one a 36-page book covering practical recommendations for replacements in over 6000 TV models and chassis and the other an 8-page catalogue covering transformers, i.f. and r.f. coils for auto radios.

The auto radio guide is available from jobbers as Form No. 3 while the TV handbook is designated as No. 405. The company will also furnish copies on request.

TAPE RECORDER DATA

The Pentron Corporation, 221 E. Cullerton Street, Chicago 16, Illinois, now has available several brochures describing its line of magnetic tape recorders and recorder accessories.

The first pamphlet is a six-page folder which describes the company's multi-speed portable tape recorder unit. The booklet points out applications for the unit and gives concise data on performance and operation.

The second booklet covers accessories for tape recording, including tape player-amplifier, mike mixer, radio tuner, foot pedal, phonograph, tape player-preamp, speaker in baffle, recording tape, telephone pickup, waterproof cover, accessory cords, and a tape carrying case.



AN/APS-4
Airborne radar. New. Complete P.U.R.

AN/APS-6
Airborne radar set. New. Complete P.U.R.

AN/APR-4
RECEIVER & TUNING UNIT P.U.R.

AN/APS-3
AIRBORNE RADAR SET. Now Complete.... P.U.R.



POWER UNIT PU-41/G
Power Unit PU-41/G (Kohler Model 1M21A) is an electric generating set consisting of a 4-cylinder, 4-cycle valve-in-head, liquid cooled, manual starting (crank) gasoline engine directly converted to an a-c generator of the revolving armature type. Engine is rated 4.25 horsepower at 1,200 r.p.m. and consumes approx. 0.45 gallon of fuel per hour at rated load. Generator is rated at 1.5 kilowatts, 60 cycles, single phase, 110 V., 13.6 amperes at 100% power factor. Length: 45"; width: 16"; height: 36". Weight (crated) 880 lbs. New in original box with spare parts.....\$475.00

Monthly Specials!
RT-34/APS-13 420 MC. TRANSMITTER with 5 stages of 30 MC. IF amplifier strik. Less tubes & R.F. section. With dynatron..... **\$9.95**
2 TRANSMITTERS
BC-457 (4-5.3 MC) and BC-458 (5-3.7 MC). Constant transmitters. Substnmt just in. Limited quantity. Less tubes and xtals. Good cond. EACH \$1.95 PER SET..... **\$9.50**

AN/ARC-5
R-28/ARC-5 RECEIVER 100-156 MC. With tubes. Like New..... **\$49.50**
T-23/ARC-5 TRANSMITTER 100-156 MC. With tubes. Like New..... \$17.50
BOTH UNITS FOR ONLY..... **\$92.50**

SCR-625 FAMOUS MINE DETECTOR
For prospectors, miners, oil companies, plumbers, etc. New..... **\$59.50**
WHILE THEY LAST!

COMMAND EQUIPMENT (SCR-274N)

	Used	New		Used	New
BC-442 ANTENNA RELAY. Less cond.	\$1.95		BC-453 With tubes	\$19.95	
With cond.		3.95	Less tubes	14.95	
BC-451 TRANSMITTER CONTROL BOX		1.50	MC-211 90° ANGLE COUPLING UNIT.		\$0.95
BC-450 3-RECEIVER REMOTE CONTROL BOX		2.95	FT-234 MOUNTING RACK for single transmitter	2.95	3.50
MC-215 MECHANICAL DRIVE SHAFT. Per length		2.95	FT-226 MOUNTING RACK for 2 Command Xmitters.		3.95
BC-496 2-POSITION RECEIVER CONTROL BOX		2.95	FT-221 MOUNTING PLATE for FT-220		1.50
BC-459 Less tubes	12.95		FT-220 MOUNTING RACK for 3 Receivers		2.25
BC-455 6-8 MC RECEIVER. With tubes	9.95	14.95	FT-225 MOUNTING PLATE for BC-456		2.25
Less tubes	7.95		BC-456 MODULATOR. For SCR-274.		4.50
BC-454 (3-8 MC) With tubes	9.95		Complete set of 4 tubes for transmitter		1.95
Less tubes	6.95				

RADAR TEST EQUIPMENT
TS-3, TS-12, TS-13, TS-15, TS-33, TS-31, TS-35, TS-36, TS-45A/MB.

TUBES! NEW! ORIGINAL BOXES!
Limited Quantities Available
250TL..... Ea. \$11.50 250TH..... Ea. \$14.50

ARC-4 TRANSCEIVER
140-144 Mc. Complete with control box, tubes, 12/24 VDC dynamotor with schematic. This is a special reduction for this month only. **\$32.50**
Like new..... \$31.50
MT-101 ARC-4. New..... \$1.50

234-258 MC RECEIVER
11-tube UHF tunable receiver with schematic. New..... **\$17.95**
Rack \$3.50
Control Box 1.50

Miscellaneous Specials!
HS-1R HEADSET. 8,000 ohms. New..... \$2.45
HS-23 HEADSET. High Imp. New..... 4.95
HS-30 HEADSET. Featherweight type. Low Imp. New..... \$2.49 USED..... 1.49
HS-33 HEADSET. Low Imp. New..... 6.95
HS-38 HEADSET. USED, excel. cond..... 1.49
NEW..... 3.50
T-26 CHEST TYPE MIKE. New..... 2.75
T-32 DESK STAND MIKE. Good, used cond..... 2.75
LIP MIKE. Navy type. New..... .98

SURPRISE PACKAGE!
20 lbs. of good, useable radio parts..... **\$2.95**

TUBES!	TUBES!	TUBES!	TUBES!	TUBES!
10J14 \$19.95	304TH \$8.95	6CP1 \$4.95	5E7 \$2.25	5E7 \$2.25
12A14 24.95	304TL 8.95	3BP4 4.95	3AP10 1.49	6D689
16D14 19.95	830-B 2.75	5E7 2.25	211C69	6D699

BC-709 INTERPHONE AMPLIFIER. With tubes. Less tubes. With manual. NEW..... 3.95
PE-101 DYNAMOTOR. Used. ONLY FEW LEFT!..... 1.95
CD-307 EXTENSION CORD. For HS-23-33. NEW..... 4.95
RS-38 MIKE. NEW..... 1.75
Used.....
BC-605 INTERPHONE AMPLIFIER. With dual mike input circuit. NEW..... 5.95
RM-13 COMPLETE REMOTE CONTROL BOX. For 3 separate transceivers. With TS-13 handset. detach. output meter and EP-8 finger unit. 110 V. AC operated. Excel. cond..... 29.50
FL-8 RANGE FILTER..... 1.95

INDUSTRIAL CORPORATIONS
We carry one of the most complete stocks in U. S. of Military Electronic Equipment, Test Equipment, and Aircraft Electronics. Call or write for free catalogue.

MP-22 MOBILE ANTENNA. MOUNTING RACK. Complete with hardware. New..... \$ 3.95
TU-17 TUNING UNIT. (2-3 MC.) For BC-223. New..... 2.95
TU-17.5 TUNING METER. NEW..... 2.50
WOBULATOR. See B. 43 Dec. 71 RADIO NEWS
BC-1023 75 MC. MARKER BEACON RECEIVER. Complete with tubes, etc. NEW..... 10.95
TU-25 TUNING UNIT. (3.5-5.2 MC.) For BC-223. Xmit. Used..... 2.95

COMBO
BC-624 VHF RECEIVER. Freq. range 100-156 MC. Less tubes & crystals. with conversion dope. Used, good cond..... **\$19.95**
BC-625 VHF TRANSMITTER. Freq. range 100-156 MC. Less tubes & crystals. with conversion dope. Used, good condition..... **\$12.95**
BOTH TRANSMITTER & RECEIVER. Per Set..... **\$29.95**

\$5.00 MINIMUM ORDER ACCEPTED. All items subject to prior sale. All shipments F.O.B. warehouse. Calif. residents add tax with remittance. 20% deposit required. Please specify shipping instructions with order. EQUIPMENT WANTED! Highest prices paid for all types of Electronic Gear!

ARROW SALES, INC.
Cable Address: ARROWSALES PO Box 5-1210
Mailing Address: P. O. Box 3878-R, N. Hollywood, Calif.
Office-Warehouse: 7460 Varma Ave., N. Hollywood, Calif.



What Do You Want to Trade In on a New hallicrafters?

I have a complete stock of Hallicrafters receivers and transmitters. We will give you the best doggone trade-in in the world because we need used receivers badly for our trade. What do you have? Write me about it. I give you prompt delivery, 90-day FREE service and the world's lowest credit terms. Write, wire, phone, or visit either store today for the best deal. Export orders solicited.

Bob Henry
WPARA



Popular Double-IF Model SX-71

A double superheterodyne circuit receiver at modest cost. Built-in narrow band FM reception. Temperature compensated, voltage regulated. 5 position band selector for 538-1650 kc, 1600-4800 kc, 4.6-13.5 mc, 12.5-35 mc, 46-56 mc. 11 tubes plus voltage regulator and rectifier. Only \$199.50



All-Wave Receiver Model SX-62

Covers 540 kc to 109 mc—including AM, FM, and SW broadcasts. Six bands: 540-1620 kc, 1620 kc-4.9mc, 4.9 mc-15 mc, 15-32 mc, 27-56 mc (AM-FM), 54-109 mc (AM-FM). Only \$289.50. Other popular Hallicrafters models: S-76, \$169.50; S-40B, \$99.95; S-72, \$109.95; S-72L, \$119.95; S-81, \$49.50; S-82, \$49.50.

Butler 2, Missouri

HENRY RADIO STORES

11240 Olympic Blvd.
LOS ANGELES 25
CALIF.

WORLD'S LARGEST DISTRIBUTORS OF SHORT WAVE RECEIVERS

THE ORIGINAL ULTRA-LINEAR WILLIAMSON AMPLIFIER

by Brociner

with the famous ACRO-SOUND TO-300 Transformer



Model UL-1 Power Amplifier,

20 watts, Ultra-Linear Williamson-type Circuit.

AVAILABLE SEPARATELY

Completely independent, self-powered, remote control unit. Incorporates the famous Model A-100 Phonograph Preamplifier-Equalizer and the Model CA-2 Control Amplifier.



Producer of the widely acclaimed

BROCINER CORNER REPRODUCERS

BROCINER

ELECTRONICS LABORATORY
1546 SECOND AVENUE • NEW YORK 28, N. Y.

TV Receiver Sensitivity Measurements made Simple with

The New "SensiMeter" *
... a "must" in fringe areas



Net \$129.50
*Pat. Applied For

Approved by leading television manufacturers!

Consult your Jobber or write for further information

- * Takes the guesswork out of TV service
- * Checks receiver from antenna terminals to picture tube
- * Microvolt scale is divided into 3 sections as a guide for the servicemen
- * Sensitivity testing is accepted by servicemen as the best method of determining the cause of bad pictures

SI SERVICE INSTRUMENTS COMPANY
422 South Dearborn Street, Chicago 5, Illinois

The third brochure is a small folder briefly describing the portable tape recorder and its accessories and is designed as an envelope stuffer or mailing piece.

Details on any or all of these brochures are available from the company.

-30-

U.H.F. Antennas (Continued from page 58)

again provide a 300-ohm termination at (L-L).

The close positioning of B-B, D-D, and E-E form an array possessing a very low "Q". This low "Q", in effect, represents a dipole of a large electrical diameter which, in turn, accounts for the broad (all v.h.f. channel) frequency characteristics of the entire array.

So much for the v.h.f. sections of the composite array of Fig. 9. To this is added the tilted dipole in front of rod F-F for reception of signals over the u.h.f. band. F-F, as we have said, acts as its reflector.

Now, to prevent interaction between v.h.f. and u.h.f. sections, another printed circuit filter is added to the array. The low-frequency electrical equivalent of this filter is shown in Fig. 8A, while its physical appearance is indicated in Fig. 8B. The transmission line to the set is connected across points P-P. The u.h.f. antenna is then connected to one end of this filter and the v.h.f. section to the other. The various resonant circuits comprising this filter are shown, together with their resonant frequencies. Isolation, now, is achieved in the following manner. The u.h.f. signals leaving the u.h.f. array see short circuits in the 195 mc. and 70 mc. resonant circuits because the u.h.f. signals can pass through the condensers of these sections. On the other hand, u.h.f. signals see high impedances in the 680 mc. tuned circuits. Therefore, there is no tendency for any u.h.f. signal picked up by the v.h.f. antenna to reach points P-P. Any u.h.f. voltages reaching the transmission line must thus come from the u.h.f. antenna.

Considering v.h.f. signals, those coming from the v.h.f. section will encounter little opposition from the 680 mc. resonant filters and therefore v.h.f. signals will reach points P-P undiminished. However, v.h.f. signals picked up by the u.h.f. array will be largely lost across either the 70 mc. tuned circuits (for low v.h.f. band signals) or the 195 mc. filters (for high v.h.f. band signals). Very few of the v.h.f. signals from this source will reach points P-P.

The antenna is designed to operate with any 300-ohm balanced line and at present this means either the 300-ohm flat twin-lead or the 300-ohm tubular. There are, however, other low-loss lines being developed to provide better u.h.f. operation than the lines now available.

(To be continued)

Signal Distribution (Continued from page 47)

plifier can overcome some of the difficult problems of signal levels on the system. With individual channel amplifiers it is possible to adjust the level of each station in relation to a uniform signal distribution amplitude and establish an optimum signal-to-noise ratio for each station. In a difficult local-fringe reception area the strong signals can be held down to a level that will just prevent overload by high amplitude levels. Fringe signals are amplified as much as possible to bring them near what is considered to be the desirable distribution amplitude.

Possible combinations of these basic units in practical distribution systems are illustrated in the block diagrams of Fig. 3. The first shows a simple system that can be used for a small apartment building or a store demonstration arrangement in a strong signal area. In this basic arrangement the amplifiers are for matching and isolation. Some losses occur, so it is really only satisfactory with strong signals and a limited number of outlets. Notice that the larger distribution outlet amplifier can feed individual receiver groups as well as a line running to smaller distribution amplifiers.

A fringe or weak signal installation would require the addition of a wide-band amplifier or a channel-strip amplifier group to bring up the signal levels. Such an arrangement can also be used in a strong signal area for supplying the signal to a larger group of receivers. When the signal level declines to a specified minimum level another amplifier is inserted to re-establish signal distribution levels for continuance of the line. Each amplifier point recovers the losses encountered in the previous section of the distribution system so signal division can be continued.

Still another distribution plan is shown in Fig. 3 and can be used to supply hotels and apartment houses or groups of dwellings. Line lengths must be evaluated (db loss-per-hundred-feet) and made no longer than is required so signals can be amplified to the prescribed level of 10,000 microvolts by the next amplifier of the chain.

Distribution Problems

In a difficult multi-outlet area such as that north and east of Philadelphia, a distribution mixer with individual channel amplifiers is a necessity if New York and Philadelphia reception is desired. In this area there are very strong local signals and weak fringe signals (some 60-80 miles to New York). There are many stations to be received (10 stations maximum) and strong adjacent channel interference must be overcome. Practically all reception difficulties exist that would tax

SEE THESE GREAT BUYS TODAY AT PLATT'S NEW BRANCH STORE

Branch Store: 159 GREENWICH ST., N. Y. C.
(Off Cortlandt Street)

Main Store: 489 BROOME ST., N. Y. C.
(Send All Mail Orders Here)

PLATT BREAKS ALL PRICES! TEST EQUIPMENT SALE

AT NEW BRANCH STORE

No doubt about it, you haven't seen buys like these in many a month! Why don't you check them yourself? All merchandise is on display at PLATT'S New Branch Bargain Store. And you'll find many more items not listed here. First come, first served! (Send Mail Orders to Main Store.)

NATIONALLY FAMOUS VTVM

4 1/2" meter with adjustable pointer to zero center for TV & FM discriminator alignment. AC range: 0-5/10/100/500/1000 V. Resistance Ranges: 2 ohms-1000 megs. dB scale for audio and S meter measurements. Completely wired & tested—ready for use—SPECIAL WHILE THEY LAST! **\$34.95**



TOP BRAND SIGNAL GENERATOR Model 320

Freq. Coverage on fundamentals: 160 KC to 1200 KC. 1.3 harmonics. Completely wired & tested—ready for operation. SPECIAL! **\$24.95**

Radio City Products Model 449

VOLTOHMMETER

AC-DC output: 1000 V. ohmage up to 2 megs. In metal case with zero adjusting knob on front panel. Ready for use. ONLY A LIMITED NUMBER. RUSH! **\$14.95**



APPROVED Model A-200 SIGNAL GENERATOR

Freq. Range: 100 KC to 75 megs in 8 signal bands. AC operated. Excellent for TV & FM alignment. This special buy cannot last long—so please hurry so that you aren't disappointed. **\$21.95**

BRAND NEW SPEAKER SALE!

4" P.M. . . . \$1.39 8" P.M. . . . \$2.95
5" P.M. . . . \$1.49 12" P.M. . . . \$4.95

A full line of Recording Tape, Crystals, Pickups, Phono Motors, and the New G.E. Resistance Cartridge are available at Platt's Branch Store. It will pay you to come in and browse around a bit!

BC-221 Frequency Meter

Real Value! QUANTITY IS LIMITED—so hurry, come, first come, first served. They are just like new, with original calibration charts. Range 125-20,000 KC with crystal check points in all ranges. Complete with crystal and tubes. **\$129.50**
MODULATED TYPE WITH AC Power Supply \$189.50
These Frequency Meters are factory tested, checked for frequency alignment and GUARANTEED.

MN-26 INSTALLATION

MN-26 RECEIVER—Remote control commercial type navigational. Indicates direction of any desired transmitting station. 3 bands—frequency range 150KC to 15.0MC. has 2-BV type tubes. Brand New. **\$39.95**
Original Cost \$600.00

ARMY TEST UNIT I-236

Meter is contained in a metal box 5 1/2" long x 3 3/4" wide x 3 1/4" deep. Comes complete with test leads and instruction book. Can be used for testing between AC and DC measuring resistances of circuits, checking fuses and testing capacitors. SPECIAL **\$4.19**

MINIMUM ORDER \$2.00
Immediate Delivery—Send 25% deposit on C.D. orders. All shipments F.D.B., N.Y.C. (N.Y.C. residents add sales tax to your remittance.)

TUBES	BRAND	NEW!	TUBES
	JAN!	BOXED!	
1B22 69c	100R 49c	841 19c	
1B23 \$3.75	114B 29c	951 13c	
2B22 49c	215A 9c	110 49c	
2C21 9c	221 29c	1025 29c	
2C26A 09c	304TH \$5.95	1020 19c	
3B22 \$1.19	310A 29c	1021 22c	
3C24 98c	385A 59c	7193 19c	
3D6 39c	471A \$1.19	0002 69c	
7C4 39c	512A \$1.19	0006 19c	
10Y 19c	522A 95c	E1148 49c	
12K8V 39c	801A 19c	1K148 99c	
15H 39c	826 29c	VR92 14c	
30/44 29c	843 17c	VT127 15c	

ELECTRIC MEGAPHONE SYSTEM

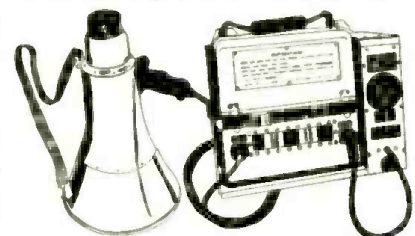

For Rural Areas, Hotels, Commercial Steamers, Ball Parks, Etc.

U. S. NAVY Type PA-1 Electric Metal-Phone equipment is designed for voice reinforcement in much the same manner as, but to a greater degree than, the familiar acoustic megaphone. Consists of Megaphone Unit (which contains a microphone and reproducer in a single assembly), Portable Amplifier which electrically amplifies the output signal of the microphone section of the megaphone and feeds this amplified signal to the reproducer section. Charging Rack for recharging the self-contained storage battery of the portable amplifier. 10 AMP NEW-A TRIMMABLE VARI-DEMO DEMONSTRATION GIVEN AT EITHER OF **\$149.50**
PLATT'S STORES

SCR-274N COMMAND and ARC-5 EQUIPMENT

EXCELLENT

RECEIVERS	USED	NEW
BC-453—190 to 550 KC	\$29.95	\$49.95
BC-454—3 to 6 MC		24.95
BC-455—6 to 9 MC	\$13.95	19.95

TRANSMITTERS

Model	Price	Price
A-958—2.1 to 3 MC		29.95
BC-458—5.3 to 7 MC	7.95	17.95
ARC5-T-19—3 to 4 MC	24.95	34.95
BC-459—7 to 9 MC		24.95
T-15 ARC 5—500 to 800 KC		29.95

ADDITIONAL EQUIPMENT

Model	Price	Price	Price
BC-456 Modulator	2.49	2.95	5.95
BC-450 Control Box (3 Receiver)	1.49	1.95	2.75
BC-451 Control Box (Transmitter)	1.29	1.79	2.39
BC-442 Relay Unit (ANT)			3.69
Plugs: PL-147, 148, 151, 152, 153, 154, 156—EACH		1.25	
Flexible Shafting with gear to fit receivers			2.69
3 Receiver Rack	1.79	2.29	2.98
2 Transmitter Rack	1.69	2.39	3.97
Single Transmitter Rack			3.97
DM-32 Dynamotor for Command Set		3.95	5.95
DM-33 Dynamotor for Command Set		2.95	3.95
Mounts for 2 Trans. Rack, 3 Rec. Rack, Modulator, & Antenna Relay Unit		1.95	

HEADSETS

HS-33 low impedance with cord and plug, used, fine condition	\$2.79
HS-23 high impedance, BRAND NEW with ear pads.	5.95
HS-13 low impedance, BRAND NEW with ear pads, cord and PL-34 plug	55.39
HS-21 BRAND NEW—Western Electric	5.95
CD-307A Cords, 6 ft. NEW	.89
H-16/U high impedance. Includes two receiving units	3.95
HS-16 high impedance—used	2.49

20 POUNDS OF ASSORTED RADIO PARTS

A TERRIFIC BUY
AT ONLY **\$2.79**

TURBO AMPLIFIER

4 tube Amplifier used by U. S. Air Force. 115 V. Input at 400 cycles. WITHOUT TUBES—BRAND NEW **\$119**
SPECIAL

PLATT ELECTRONICS CORP.
DEPT. A, 489 BROOME ST., NEW YORK 13, N. Y.
PHONES: WO 4-0827 and WO 4-0828

UHF—CONCORD HAS IT—UHF
VEE-D-X All-Channel UHF-VHF Antennas

The VEE-D-X "V"
 All channel primary aza. Excellent broad-band characteristics. Supplied as a straight UHF antenna. List \$1.62
 \$2.75. Your net cost.

VR-MM30
 Vee-D-X "V" as listed above, supplied with Vee-D-X Mighty Match for use in combination with VHF antenna using single transmission line. List \$3.97
 \$6.75. Your Net Cost.

VEE-D-X MIGHTY MATCH
 Model MM-30. Provides best method of combining UHF-VHF antenna systems with single transmission line. Automatic action. Printed circuit filters. List \$2.35
 List \$1.00. Your Net Cost.

UHF ADAPTING BRACKET
 Permits addition of UHF antenna to existing VHF installation. Mounts three different ways to most of antenna boom. List \$1.50.
 Your Net Cost. **88c**

VEE-D-X "Ultra Q-Tree"
 Combines both UHF and VHF into single antenna using single transmission line. Designed for primary areas, will receive a 11 channels 2-83. List Price Single \$14.25.
 Your Net Cost. **\$8.38**

ULTRA-Q-TREE Stacked, High gain 2-bay array, similar to above. List \$24.55.
 Your Net Cost. **\$17.58**

"Smartest Booster Buy of Them All!"

SUTTON UHF

BOOSTER CONVERTER

ONLY
\$34.95



More than a Booster—It's a Booster AND CONVERTER—at the SAME PRICE! Converts any TV set to UHF reception, and boosts all VHF and UHF channels. Very easy to install. 7"x5"x6". Wt. 6 lbs.

GET ON OUR SPECIAL BARGAIN BULLETIN MAILING LIST!

For our Special Bulletins, listing Red Hot Limited Quantity Buys,—write your name and address on postal card, and send it TODAY—to Dept. N-2.

RECEIVING TUBES

BRAND NEW
 BOXED
60% OFF LIST PRICE!
 GUARANTEED



Type	Net	Type	Net	Type	Net
1B3GT	\$1.02 6BF5	.88 6V6G	1.00		
1H5GT	.68 6BG6G	1.92 7N7	.88		
1L4	.84 6BE6	.84 12AT6	.62		
1L6	1.06 6BJ6	.84 12AT7	1.16		
1N5GT	.84 6BK6	.60 12AU6	.72		
1R5	.84 6BQ6GT	1.36 12AU7	.96		
1S5	.76 6C4	.68 12AV6	.62		
1T4	.84 6CB6	.84 12AV7	1.16		
1T5GT	1.04 6D6	.88 12AX7	1.00		
1X2A	1.06 6F6	.84 12BA6	.76		
3Q5GT	1.00 6F6GT	.66 12BA7	1.00		
3V4	.80 6F8G	1.34 12BE6	.76		
3V4	.80 6M6	.66 12SA7GT	.74		
5V4G	.60 6H6GT	.74 12SK7GT	.74		
5V4G	.98 6J5	.60 12SL7GT	1.00		
5Y3G	.54 6J5GT	.60 12SN7GT	.92		
5Y3GT	.44 6J6	1.00 12SQ7GT	.64		
6AR4	.80 6K6GT	.64 12SG6G	2.40		
6AG5	.90 6L6G	1.25 19CR	1.28		
6AK5	1.66 6L6GA	1.42 25BQ6GT	1.36		
6AK6	.94 6A4	.68 25L6GT	.68		
6AL5	.72 6A7GT	.74 25Z5	.66		
6AQ5	.80 6S7	.66 25Z6G	.54		
6AQ6	.76 6K7	.66 35A5	.72		
6AR5	.66 6SK7GT	.66 35L6GT	.68		
6A55	.84 6SL7GT	.98 35L6GT	.68		
6AT6	1.28 6W6GT	.88 35W4	.80		
6AU6	.62 6V6GT	.60 35Z5GT	.50		
6AU7	.88 6T8	1.16 50B5	.50		
6AV6	.62 6V6GT	.80 50C5	.80		
6B4G	1.28 6W6GT	.74 50L6GT	.68		
6BA7	.76 6W6GT	.88 11L7	1.56		
6BA7	1.00 6X4	.62 11Z23	.62		
6BC5	.80 6X5GT	.62 11Z6GT	1.00		
6BE6	.76				

Concord Radio

55 Vesey Street. Phone
 New York 7, N. Y. Dlgy 9-1132

the performance of a multi-outlet installation. Consequently, we can consider this as an ideal testing area.

In this section the individual channel amplifier and mixer combination affords greater versatility. Individual amplifiers tune to specific channels and amplify only those signals that require amplification. Strong signals are not amplified (and for some installations must be attenuated) and, therefore, are not permitted to reach overload levels. Here is a definite aid in overcoming adjacent channel interference. A wide-band amplifier would only accent adjacent channel spill-over and intermodulation because of over-amplification of strong local signals.

In a typical installation, Fig. 1, a *Blonder-Tongue* MA4-1-M was used. This unit will accommodate four individual channel amplifiers. The most consistent New York channels are 2, 4, and 5 and individual amplifiers were used for these channels. A Channel 10 amplifier occupied the fourth position because it is the weakest local channel.

Two antenna arrangements were employed, each performing satisfactorily. In the first plan, Fig. 4A, a compromise low-band yagi was used to receive New York Channels 2, 4, and 5 and a separate conical type for local channels. The yagi was applied to the Channel 2, 4, and 5 amplifiers; the conical to the Channel 10 amplifier and the wide-band antenna input of the mixer. The strong local Channels 3 and 6 signals entered the mixer at this point and consequent attenuation reduces their levels to safe interference limits. The mixer output feeds the distribution system. Weak signals have been strengthened; strong ones, retarded. Thus, from this point conventional wide-band amplifiers can be used to maintain distribution signal levels. In areas where there are fewer stations, a separate and peaked antenna could be used for each weak station and, it is apparent, the individual channel amplifiers afford maximum antenna versatility.

The same plan can be used for a two-receiver home installation. Just a single "Directronic" antenna was used to supply the signal to the four channel amplifier (2, 4, 5, and 10), Fig. 4B. The wide-band antenna input of the mixer was not used. Instead, by properly connecting a jumper on the mixer, the wide-band antenna input circuit can be used as a second output and two receivers in the house were supplied with all signals and no interaction. It is important to realize that the Channel 3 and 6 signals entered the mixer at a useful level via the Channel 2, 4, and 5 amplifiers.

The advantages of the second plan insofar as a dwelling is concerned are single simple antenna installation and two-receiver feed without any additional equipment. Disadvantages are that "Directronic" switching is required as the switch must be set properly for either New York or Philadel-

Columbia
GEM OF THE SURPLUS

WALKIE TALKIE
 Long range, 9 tube s, portable transceiver. Crystal control. Freq. 3,000-6,500 kc. Metal carrying case. Complete, ready to operate with collapsible antenna. 5 PM mike-speaker, all tubes and batteries. New.
PER PAIR \$125.00

DYNAMOTORS 6 & 12 V.
PE-73: 24 V. in. 1,000 V. out. @ 350 ma. Used, good cond. \$ 5.95
PE-101: 12 or 24 V. in. 400 V. @ 130 ma output. See Dec. '52 CQ for conv. to 6 VOLTS. New boxed. 4.95
BD-77: 12 V. in.; 1,000 V. out. @ 350 ma. 14.95
COMMAND RECEIVER DYNAMOTOR: 12 V. used 7.95

WET CELL BATTERIES
 24 V. EXIDE AIRCRAFT. New, orig. box. \$15.95
 12 V. 27 amp @ 8-hr. rate. NEW 12.95
 6 V. 13 amp @ 10-hour rate. New 6.95
 4 V. For TBY Transceiver. NEW. HOT! 4.95

ADJUSTABLE 2-METER TANK COIL: Can also be used for parallel lines. Silverplated. Approx. freq. range 100-200 MC. Will handle a full kw. Excel. cond. SPECIAL \$4.95

TUBES! NEW! GUARANTEED!
 832-A .. \$8.50 6L6M .. \$1.50 3AP1 .. \$7.95
 829-B .. 7.95 2AP1 .. 7.95 807 .. 1.35

APN-1 TRANSCEIVER
 For 420-440 A-1 band for ham or citizens' band. With tubes & schematic. Excel. cond. **\$17.95**

STOP! Make extra dough NOW by rushing us your new and used radio gear. We buy it fast at peak-high prices. WRITE TODAY! We will meet and beat any bid!

ARC-5 OR 274-N TRANSMITTERS
 2-1-3 mcs. \$19.95
 4-5-3 mcs. Used, good cond. 24.50
 5-5-7 mcs. 5.50
 7-9-1 12.50

ARC-5 OR 274-N RECEIVERS
 19-55 kc. Excel. cond. \$14.95
 1-5-3 mcs. Brand new 24.50
 4-6 mcs. Less tubes 8.95
 3-4 mcs. With tubes 9.95
 0-9-1 mcs. Excel. cond. with tubes 14.95
 0-9-1 mcs. Used, Less tubes 8.95

MD-7 ARC-5 PLATE MODULATOR. Excel. cond. 14.95
RACK FOR DUAL TRANSMITTER (274-N) 2.95
RACK FOR DUAL TRANSMITTER ARC-5 3.95
TRIPLE RECEIVER RACK 5.00
DUAL RECEIVER CONTROL BOX, BC-106. New 2.95
BC-442-A ANTENNA RELAY with 50 mcs. cond. Excel. cond. 3.95
COMMAND RECEIVER FLEX CABLE. 0-1-2 mcs. 2.95
12 V. COMMAND RECEIVER DYNAMOTOR, NEW 12.95

BC-625 TRANSMITTER: Part of SCR-522. Freq. 100-150 MC. Less tubes. A **\$13.95**
HOT BUY!
BC-624 RECEIVER: Part of SCR-522. Freq. range 100-150 MC. Less tubes. **\$19.75**
TELETRIC THE PAIR ONLY \$29.95

ARC-4 VHF TRANSCEIVER: For police, 2-meter, Ct. or CAP. All tubes. Excellent cond. SPECIAL. **\$32.50**
 All orders F.O.B. Los Angeles. 25% deposit required. All items subject to prior sale.

COLUMBIA ELECTRONIC SALES
 522 South San Pedro St. Los Angeles 13, Calif.

TELEPHONE EQUIPMENT & PARTS

New TW handsets with Flip switch in handle. Each **57.00**
 New W.E. FIW handsets with cord & P1-47 plug. Each **7.00**
 Reconditioned TR9 handsets with 3 Cond. Cord. Each **4.95**
 C-191 repeat coils. Each **3.50**
 New HM29A remote control units export packed. Each **16.00**
 Desk telephones with dial & ringer box. Complete **9.00**
 ERB field telephones reconditioned in stained leather bags & tested. Each **20.00**
 New transmitter and receiver units, like & interchangeable with WICO HA1 & P1. Each **1.25**
 Reconditioned Sound power Army field telephones. Each **25.00**
 Corus 2 cond. w/Alligator clips 6 Ft. Each **.60**
 New C-158 holding coils. Each **.50**
 New Kellogg R2A induction coils. Each **.75**
 New 4 1/2 foot rubber cords W/P1-47 plug. (Rubber jackets) Each **.75**
 Keys, Lock, make and break positions, each strip contains 10 complete. Each **7.00**
 WECO 20 line Jack strips 275-217A mtg. 60-70 per strip. Each **9.00**
 Reconditioned operators' head & chest sets. H.S. 10. Each **5.50**

Terms: Check with order—F.O.B. Brooklyn 5, N. Y.
EASTERN TELEPHONE CO.
 323 Vanderbilt Avenue Brooklyn 5, N. Y.

phia reception. Also, New York signals do not receive the benefit of the full antenna gain obtained with a yagi-type antenna.

To amplify more than four channels, a second mixer amplifier can be connected in series with the first mixer, Fig. 4C. For this area it was expedient to insert Channel 7, 9, 11, and 13 amplifiers into the second mixer. These are the most inconsistent stations because of erratic signal levels which vary widely due to weather conditions. Daytime reception is not possible in most of the area. Evening signals vary from very poor to quite good. However the second mixer furnishes fairly good reception of these stations in the evening.

For a single dwelling installation two antennas are advisable in order to make full use of the high-band signals when levels rise—a "Directronic" can be used for Mixer #1 (as discussed previously) and a modified stacked yagi for the New York high-band channels to be introduced via the second mixer. In a multi-outlet system serving a number of families, the most practical plan is to use a low-band yagi for Channels 2, 4, and 5; a stacked high-band yagi for Channels 7, 9, 11, and 13; and a conventional conical for local reception.

In summary, the examples given demonstrate the versatility of the channel amplifier-mixer combination in reducing the problem of distribution in areas where there are numerous stations with great variations in signal level.

CODE PRACTICE

By DR. T. H. LIPSCOMB, W4RTJ

WSC and WSL send out nightly (at 2318 WEST) weather, baseball scores, political information, and human interest news at a rate of approximately twenty-five words-per-minute.

I have recently recorded some of this material at seven and one-half inches-per-second on tape and play it back at just half this speed. This gives twelve and one-half words-per-minute of straight matter at a speed which is ideal for code practice required for the "Amateur Conditional" and "General Class" licenses.

This same material could equally well be recorded at 78 rpm on discs and played back at 33 1/3 or 45 rpm.

The table below lists the times, calls, and frequency of broadcasts which are suitable for obtaining this code practice material.

Stations transmitting code signals.

TIME (EST)	CALL	FREQ. (kc.)	ORIGIN	SPEED
11:18 p.m.	WSC	125	N.J.	25
		6350		
		8430		
		11,175		
11:18 p.m.	WSL	5555	N.Y.	25
		11,115		
		6270		
1:05 a.m.	KFS	12,550	Calif.	25
3:10 a.m.	KPH	126	Calif.	25
		6370		
		8440		
		12,735		
12:00 noon	DZM	8670	Manila	25 ¹

¹ "Learning the Radiotelegraph Code," ARRL

THE PLUS VALUE ANTENNA

for perfect ULTRA VISION TV!

Rytel

DOUBLE "O" UHF ANTENNA



UHF stations are springing up all across the country. Demand is terrific. Start right with a performance antenna that can't give you "customer headaches."

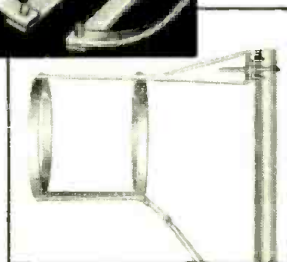

SIMPLICITY . . . NO ELECTRICAL OR MECHANICAL BREAKDOWNS

The facts: high signal-to-noise ratio. Here is why. The Double-O antenna has high directivity along horizontal planes, acts like a wall in blocking noise from vertical sources and cancels out at the feed point all noise and multipath reflections. In addition, 2-circle antennas fed 90° out of phase with a gain of 3.8 db, plus 1 db gain over a single dipole in each of two circles, give an overall gain in forward direction of 5.8 db. Result . . . low noise, high gain . . . Perfect Vision.

PLUS ECONOMY . . . simple, tough aluminum construction means low price, no maintenance, long life.

PLUS RUGGED CONSTRUCTION . . . simplicity of design avoids fragile, expensive insulators, no chance of electrical or mechanical breakdown. Supported at current node (ground potential).

PLUS APPEARANCE . . . no more monstrosities on the roof . . . just simple, attractive . . . perfect Double-O.

PLUS INSTALLATION . . . no more "servicemen's nightmares" . . . Double-O is a serviceman's dream . . . comes completely assembled, just a "U" clamp to tighten, no "adjustments."

It's the DOUBLE-O for PERFECT ULTRA VISION . . . ACT NOW AND BE READY WITH A UHF ANTENNA THAT NEEDS TO BE SOLD JUST ONCE.

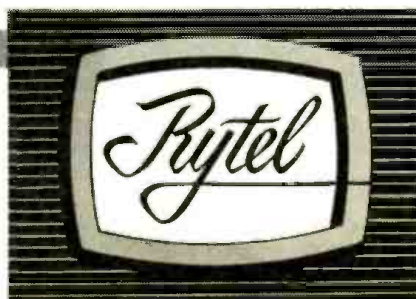

RYTEL ELECTRONICS MFG. CO.
9820 Irwin Avenue • Inglewood, California

Also connector clips, impedance matches, tube reactivators, tube-pullers, etc. Over 800 Rytel distributors in the United States. Write for further information.

"For those who can hear the difference"
Listen

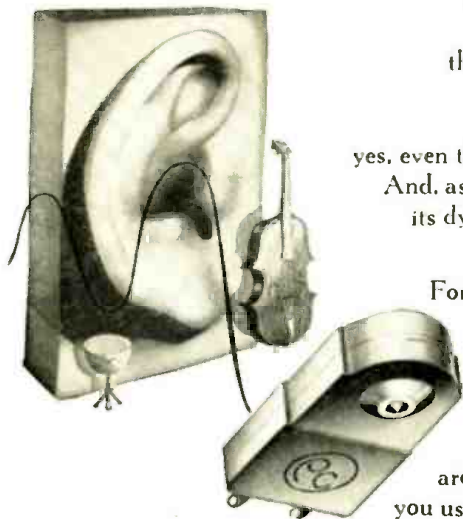

it comes to you
 in the subtle shading of a piano . . .
 in the clean brilliance of violins,
 the purity of a flute. Your ear detects
 the sweet mellowness of cellos,
 the roundness of a clarinet . . .
 yes, even the iridescence of clashing cymbals.
 And, as the symphony swells to crescendo,
 its dynamic energy adds a flood of color
 to your musical canvas.

For those who can hear the difference,
 these are the elusive pleasures
 that often remain hidden
 in the grooves of fine recordings.

These are the thrilling
 new listening experiences that
 are released for your enjoyment when
 you use quality components by Pickering.

PICKERING and company, incorporated

Pickering High Fidelity Components are available through leading Radio Parts distributors everywhere; detailed literature sent upon request. Address Department C-1

Oceanside, L. I., New York



INSURANCE
 against KICKBACKS
 because of
NOISY
CONTROLS

Your guarantee for quieting noisy television and radio controls, switches and other moving parts is QUIETROLE . . . the original, quality lubricant-cleaner. There is no substitute for "real insurance" to satisfy your customers.

In 3 sizes
 2 oz., 4 oz., 8 oz.

Carried by recognized jobbers . . . everywhere.

manufactured by



QUIETROLE
COMPANY
 Spartanburg, South Carolina

COMPETITORS*

Team Up to Bring You One
 Great Electronics Firm
 Geared for Greater Values!

LOOK AT THESE BUYS!

- PROP-PITCH MOTORS, new, original boxes \$17.95
- MICRO SWITCHES, new 29c ea. 4 for 1.00
- RC-42 ANTENNA MOTOR & REEL, 24 V., DC, new 5.95
- DM-53AZ DYNAMOTORS, 12 V. Input (for RC-733D) 9.95

Special Value Combination!
954 ACORN TUBES & SOCKETS
 Brand New **29c** per set or buy **4** sets **\$1**

- METER SPECIAL O-1 MA METER, 2" round, new, boxed \$3.95
- ARC-4 complete with tubes, less dynamotor. Excellent condition 29.50
- LIP MICROPHONES, MC-419, brand new98
- TUNING KNOBS, slotted postpaid59 ea.
- TELEPHONE HANDSET HANGERS, postpaid 1.98

POWER TRANSFORMERS
 110 V., 60 cy. primary.
 150 V., 30 MA secondary. **79c** ea.
 6.3-1 Amp. Fil.
 PB for grid dip kits, test equipment, etc.

New Partnership Will Pay More Cash for Your Equipment!

Get what you want for your radio equipment without red tape or haggling! Fast action—and no kick-backs! Write today!

HARJO SALES CO.

* Formerly CANDEE-AIRCO combined with ALVARADIO SALES CO.
 4109 BURBANK BLVD.,
 P.O. Box 1187 Magnolia Park Station
 BURBANK, CALIFORNIA
 Phone: RÖckwell 9-1070

What's New in Radio
 (Continued from page 86)

company's "Sensicon" circuit with "Permakay" filter and employs 21 tubes (only 5 types, however, for economy in maintenance). The transmitter, which has a nominal power output of 20 watts, uses 9 tubes.

HIGH RATIO CONDENSER

Johanson Mfg. Corp., Boonton, N.J. is marketing a new concentric high-ratio condenser with a range of 1 μ fd. to 35 μ fd.

Designed for low minimum capacity, high "Q", applications, it has been used successfully in ten-channel transceivers. A friction spring locks the rotor to insure stability. Constructed of silver-plated brass and Pyrex glass, it operates well at the higher frequencies.

OVAL RESISTORS

Milwaukee Resistor Co., 700 W. Virginia, Milwaukee 4, Wis. is producing a new line of oval-type wirewound resistors to provide higher wattage ratings in small areas.

The resistors are currently available in 10 watt ($\frac{3}{8}$ " x $\frac{3}{4}$ ") and 15 watt



($\frac{3}{8}$ " x 1") sizes. Spacers attached to ends of aluminum mounting strips permit easy stacking and better heat conduction.

HIGH-SPEED CONDENSER

A butterfly-type variable condenser capable of continuous operation at speeds as high as 3200 rpm is available from Hammarlund Mfg. Co., Inc., 460 W. 34th St., New York 1, N.Y.

Units are available with series effective capacity values ranging from 5.4 to 17 μ fd. nominal. Air gap between plates is .030" nominal. Outside dimensions of each silicone-treated steatite base are 1 $\frac{3}{8}$ " x 1 $\frac{3}{8}$ ".

PORTABLE TAPE RECORDER

A battery-powered portable tape recorder with spring-wound motor, the "Broadcaster Model 610-SD", is now available from Amplifier Corp. of America, 398 Broadway, N.Y. 13, N.Y. Measuring only 11 $\frac{1}{2}$ " x 10" x 7 $\frac{1}{2}$ ", the unit weighs 15 lbs. with batteries. It operates at 7 $\frac{1}{2}$ inches-per-sec., furnishing 15 minutes of playing time on

a 5" diameter, 600-foot reel of tape. A single-track head with double-gap is used. Recordings may be played back on any a.c.-operated studio unit at equivalent speed.

ENGINE FOR MODELS

Production is underway at the Herkimer Tool and Model Works, Inc., Herkimer, N. Y. on a new class A

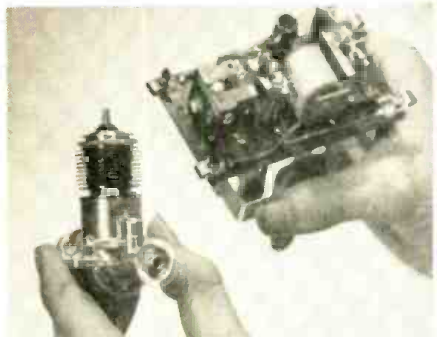

engine designed for radio-controlled model plane operation.

The "OK Cub .14" weighs only 2 3/4 ounces but will carry sturdy radio equipment even in bumpy air. The company points out that the FCC now allows any model fan to fly his ship by radio control on the Citizens band (27.522 or 465 mc.) with approved equipment by just filing a registration form with the Commission.

"META-GUN"

A volt-ohmmeter in gun form has been introduced by Jersey City Technical Lab., 880 Bergen Ave., Jersey City 6, N.J. for radio and TV service work.

It has a built-in light, a flexible probe for reaching test points, and a trigger range selector. All work can be performed with one hand. The Model



3A has 1000 ohms/volt sensitivity and the Model 3B 20,000 ohms/volt sensitivity. The gun measures 5 1/2" x 8" x 3", operates on four self-contained pen-light cells, and weighs just 2 lbs.

MOBILE CONVERTERS

Radio Manufacturing Engineers, Peoria, Ill., a division of Electro-Voice has release three new mobile converters for hams.

The MC-55 is a five-band model covering the 10-11, 15, 20, 40, and 75 meter bands. The Model MC-53 is a three-band converter for 2, 6, and 10-11 meters. The Model MC-57 is a three-

ORDER BY MAIL FROM WHOLESALE RADIO

Low Prices • Complete Stocks • Fast Shipments

All Directional TV AERIAL

Same Clear Pix as Motor Rotating Aerial Systems Costing Triple! **\$18.95**

FOR FRINGE AREA

COMPLETE with three 3 1/2 ft. masts, 75 ft. 3 cond. cable, beam selector sw., guy rings and mounting base. Electronically beams complete 360° rotation to give clear pix on all elements. You choose direction with electronic selector sw. installed on or near TV set. Complete double stacked array with 18 hi-tensil double alloy aluminum elements. AX-599 same as TX-599 less masts, guy ring & mtg. base. **\$16.95**

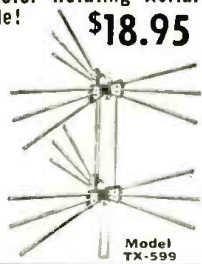

Model TX-599

New! Sensational, Sound AMPLIFIER

COMPLETE WITH TUBES & SPEAKER. **\$9.50**

Nearly everyone has a use for this sensational new amplifier. Use with all speed record players and eliminate special wiring and hookups to radio or TV. Use with FM tuner. Use a pair with microphones as intercom. Use for parties, meetings, baby minder, etc. Full range volume control with on-off switch. 5" Alnico 5 PM speaker. Input jack for phone or mike. Attractive cabinet covered in simulated alligator leather. 7 1/2" x 6 1/2" x 6" d. Complete with tubes: 6X250T, 6AU6GT, 12SQ7, AC or DC 105-120 V., 25-60 cycles. Wt. 2 1/2 lbs. Order Model S-311.

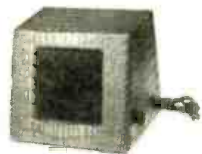

TV ANTENNA ACCESSORIES

- STEEL EXTENSION POLES. Weather treated.
 - 10 ft. long, 1 1/2" d. Straight ends. **\$1.95**
 - 5 ft. long, 1 1/2" d. Crimped ends. **1.39**
- CHIMNEY MOUNT BRACKETS.
 - CM-100 Complete with strap. Pr. **1.59**
- ANTENNA SWIVEL BASE. Aluminum.
 - 2 1/2" O.D. mast section. **.39**
- GUY WIRE. 0 stranded #20.
 - 50 Feet. **.39**
 - 21 Impregnated 50 ft. reels. 1200 ft. **6.00**
- 300 OHM TWIN LEAD.
 - Per ft. 21 g. 100 ft. **\$1.95** 1000 ft. **17.50**
- DOUBLE POLE DOUBLE THROW KNIFE SWITCH. **.45**
- RMS LIGHTNING ARRESTOR. Model LA-3.
 - Standard or open 300 ohm line. UL approved. **.59**
- ANTENNA WALL MOUNTS.
 - PAM-1 for poles 1 1/2" d. 0" from mast to wall **1.15**
 - PAM-4 for poles 1 1/2" d. Up to 12 1/2" from wall **1.89**
 - PAM-B for poles 3/4" d. 1 1/2" d. Adj. 1" to 10" from wall **3.45**

Address Orders to Dept. RN-2

WHOLESALE RADIO PARTS CO., Inc.

311 W. BALTIMORE ST., BALTIMORE 1, MD.

Immediate Shipment!

UHF YAGI TV ANTENNAS

Hi-tensil aluminum elements. **\$4.95**
For all UHF channels

We Have Complete Line!
EICO KITS!

5" SCOPE! PUSH-PULL DEFLECTION
High sensitivity and response for precise servicing of TV, FM and AM receivers. Push-Pull amplified vertical and horizontal amplifiers. Boosted sensitivity. .05 to .1 rms volts/inch. Useful to 2.5 mc TV type multivibrator sweep circuit. 15 cps-7.5 kc. 2-axis intensity modulation feature. Dual positioning controls move trace anywhere on screen. Complete with tubes including CRT. 3-color etched rub-proof panel; rugged steel case. 1 1/2 x 8 1/2 cycle **\$44.95**
8 1/2 x 17 1/2 x 17 1/2 Model 425K Model 425K
Model 425 Factory wired—**\$79.95**



OTHER FAMOUS EICO KITS!

	KIT	WIRE
RF Probe Kit for 'Scope	P76K	\$ 3.75 P-70 — \$ 5.95
Tube Tester	425K	24.95 P-25 — 49.95
VTVM	214K	25.95 P-21 — 49.95
VTVM with 7 1/2" meter	214K	34.95 P-24 — 54.95
RF probe for VTVM	753K	3.75 P-75 — 5.95
RV probe	RVPL	6.95
RC Bridge & RCL Com-		
parator	950A-K	19.95 P-90A — 29.95
20,000 Ohms/volt Multi-		
timer	565K	24.95 P-65 — 29.95
As above with 1 1/2" pre-		
cision resistors	555K	29.95 P-55 — 34.95
1000 Ohms/volt multi-		
timer	566K	14.90 P-66 — 18.95
Same as above with 1 1/2"		
precision resistors	556K	16.90 P-56 — 23.50
1000 Ohms/volt multi-		
timer. Ranges 0-1V up to		
0-200V	536K	12.90 P-56 — 14.90
As above with 1 1/2" pre-		
cision resistors	536K	13.90 P-56 — 16.90
Voice ohm meter	511K	14.95 P-11 — 17.95
RF Signal Generator	320K	19.95 P-20 — 29.95
RF Signal Generator	322K	23.95 P-22 — 34.95
Deluxe RF Sig. Generator	315K	39.95 P-15 — 59.95
TV-FM Sweep Generator	360K	34.95 P-60 — 49.95
Sine & Square Wave		
Audio Generator	377K	31.95 P-77 — 49.95
Multi-Signal Tracer	145K	19.95 P-45 — 28.95

GE REPLACEMENT STYLI

	Single Speed	
RP1-001 Sapphire, .0025		\$ 2.10
RP1-002 Diamond, .0025		16.50
RP1-003 Diamond, .003		16.50
RP1-004 Diamond, .001		2.10
RP1-005 Sapphire, .001		2.10
RP1-006 Sapphire, .0025		2.10
Assemblies for Triple Play		
RP1-007 Sapphire, .001 & .0025 comb.		\$ 3.57
RP1-010 Sapphire, .001 & .003 comb.		3.57
RP1-011 Diamond, .001 & .0025 comb.		29.97
RP1-012 Diamond, .001 & .003 comb.		29.97
RP1-013 Diamond, .001, Sapphire, .003.		18.60

Write for Free FYI Bulletin

THE MARCH ISSUE

of
RADIO & TELEVISION NEWS
Will Be on Sale Feb. 24
Be Sure to Reserve Your Copy
Now!

New Electronic Headquarters—
VAN SICKLE RADIO SUPPLY CO.
1320 So. Calhoun St. Phone E-4136
FORT WAYNE 2, IND.
Please note new address. Eugene Van Sickle, Owner

EASY TO LEARN CODE

It is easy to learn or increase speed with an Instructograph Code Teacher. Affords the quickest and most practical method yet developed. For beginners or advanced students. Available tapes from beginner's alphabet to typical messages on all subjects. Speed range 5 to 40 WPM. Always ready—no QRM.

ENDORSED BY THOUSANDS!

The Instructograph Code Teacher literally takes the place of an operator. Instructs and enables anyone to learn and master code without further assistance. Thousands of successful operators have "acquired the code" with the Instructograph System. Write today for convenient rental and purchase plans.

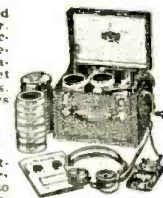

INSTRUCTOGRAPH COMPANY

4711 SHERIDAN ROAD, CHICAGO 40, ILLINOIS

STAN-BURN SPARKS

ANTENNAE SPECIALS

DOUBLE V 3/8"	1-11	12 or more
DOUBLE V 1/2" Dowel	52.98	52.20
DOUBLE V 1/2" Dowel	3.45	2.45
10 Element Conical 3/8"	3.95	2.95
10 Element Conical 3/8"	3.55	2.55
Folded Hi Straight Low Quick Rig		
4/8 elements	4.25	3.25
WINDOW CONICALS	4.95	3.75
5 FOOT SWEGGED MASTS		
10 FOOT PLAIN	.79	.69
TV WIRE	1.39	1.29
42 Mil.		\$ 9.95 M Ft.
55 Mil. 300 OHM		14.95 M Ft.
72 OHM COAXIAL		45.00 M Ft.

CATHODE RAY TUBE SPECIALS

Standard Brands—Unconditionally Guaranteed			
G. E.			
5TP4	\$43.55	21EP4A	\$37.35
7JP4	18.15	24AP4A	73.20
SHELDON			
10BP4A	18.35	10BP4A	14.30
10FP4A	24.40	12LP4A	17.80
12KP4A	27.50	14BP4A	20.35
12LP4A	21.40	15DP4	22.55
12UP4B	27.10	16FP4	24.85
14CP4	22.60	16EP4A	24.85
14EP4	18.45	16DP/HP4A	24.85
16AP4A	29.10	16JP4A	24.85
16DP4A	26.65	16LP4A	24.85
16GP4	27.85	16KP4A	24.85
16KP4 16RP4	25.25	17BP4	26.05
17BP4	23.90	19DP4	28.50
17CP4	23.90	19AP4	30.80
19AP4A	34.80	20CP4	30.80
20CP4	35.45	21EP4	32.45
20LP4	36.95	16EP4A Rauland	42.00

CHASSIS 630 REGAL with Cascode Tuner. \$149.50
OPEN FACE CABINET 42.00

SPECIALS

4 Prong Vibrators, each	\$ 1.29
Lots of 12 or more	1.19
12" Heavy Slug Speaker	Special 4.98
Audio Devices, Discs and Scotch Tape in Stock	
Audio Plastic Food Oxidize Plastic tape—	
Half-hour special	\$2.30
One-hour special	\$3.30
WIRE RECORDERS IN STOCK	
WILCOX GAY—Model 2210	\$ 89.97
PENTRON—Model 9T3C—2-speed Tape Re-	
order	Net 134.50
RADIO CRAFTSMAN	
Model RC2—HiFi Amplifier	Net 42.89
Model RC10—AM-PM Tuner	Net 130.84
Model CS—Williams Amplifier	Net 99.45

AUTHORIZED DISTRIBUTORS for General Electric, Kenrad, Tung-Sol, National Union, De Wald, Reuland, Automatic and General Motors.

We carry a Complete line of HI-FIDELITY and sound equipment. Send us your requests. We also carry a complete line of popular makes of Radio and TV tubes at 50% discount. Also many other special purpose and transmitting types, and all electronic parts and equipment at lowest prices. Send us a list of your requirements for prompt quotations. Terms: 20% with order. Balance COD. All prices FOB. NEW YORK Warehouse. Minimum order \$5.00. Write for our latest price list to Dept. RN-2

STAN-BURN RADIO and ELECTRONICS CO.
(C.B.S. THEATRE BLDG.)
1697 BROADWAY • NEW YORK 19, N.Y.

band unit covering 10-11, 20, and 75 meter bands.

All models have edge-lighted dials, side-knob tuning through a 25:1 worm gear drive, individual slug-type coils for each band, three-gang tuning, four tuned i.f. circuits, and an output frequency of 1550 kc.

Bulletin #169 covering all of the company's converters is available on request.

PENCIL SOLDERING IRON

A pencil-type soldering iron for precision applications has been introduced by *The Lenk Mfg. Co.*, 30-38 Cummington St., Boston 15, Mass.

Available in either 25 or 40 watt sizes, the new tool weighs 2 ounces, measures 7 1/2" over-all, and comes equipped with a 1/8" dia. tip. The handle is of plastic.

meter range is selected, and test switch pressed. The "Good-Bad" dial shows the condition of the rectifier and indicates life expectancy.

TRANSISTOR SOCKETS

Transistor sockets are now available in limited quantity from *Mycalex*



Tube Socket Corp., 60 Clifton Blvd., Clifton, N.J.

Contacts can be supplied in brass or beryllium copper. The sockets, the "Mycalex 410", are readily solderable and will not warp or crack when subjected to high soldering temperatures.

NEW ELECTROLYTICS

Aerovox Corp. of New Bedford, Mass. has introduced a new series of twist-prong base electrolytics for filtering in selenium rectifier circuits.

The Type AFHS series has been especially designed for this service with provision being made for handling the high ripple currents found in selenium rectifier circuits.

CONNECTOR KIT

Elco Sales Co. is now offering a "Varicon" miniature connector kit through its jobber outlets.

The new kit contains all parts needed to assemble the company's miniature connectors. Detailed instructions accompany each kit of components.

RECTIFIER TESTER

Jackson Electrical Instrument Co., 18-46 S. Patterson Blvd., Dayton 2, Ohio has developed an instrument for testing all radio and television selenium rectifiers rated from 20 to 650 ma.

The Model 710 operates on 110 to 125 volts a.c. and has a variable indicated voltage range of 25 to 300 volts a.c. Use of the instrument is simple. After the load and voltage indicators are set and the line voltage adjusted, the test lead clips are placed on the rectifier terminals, the correct

Regency

LARGEST SELLING BOOSTER

at any price!

International Short-Wave
(Continued from page 65)

closedown. (Ridgeway, South Africa)

Brazil—The new *Radio Cultura* outlet, ZYR57, 9.745, Sao Paulo, can be heard best on Mon. when HCJB, Quito, Ecuador, is absent from that channel; noted with identification 2300. (Niblack, Ind.) Wants reports to Av. S. Joao 1285, Sao Paulo, Brazil. (Villela, Md.) The Brazilian which tested some time ago on 11.855 was an experimental transmitter, PRB4, *Radio Club de Santos*, Rua Jose Cabalero 60, Sao Paulo, Brazil. ZYR63, *Radio Emissora de Piratininga*, Praca do Patriarca 26, Sao Paulo, Brazil, operates on 6.025, 50 kw., 0400-2300. (Serrano, Brazil, via Radio Sweden)

Radio Nacional, Rio de Janeiro, is scheduled in Portuguese 0345-1500, 1800-2310 on 9.720; 1703-1937 on 15.295; Spanish at 1400-1420; by this time should also have a service in *English*. (WRH) ZYK3, 9.565, noted 1705 in Portuguese. (Tonsi, Wisc.) ZYR59, Sao Paulo, *A Voz de Sertas*, is noted on 3.338 at good level 1830-2100. (Ridgeway, South Africa) PRLA, 9.770, Rio de Janeiro, noted with *English* session 1700-1800 recently. (Sutton, Ohio)

British Honduras—*Radio Belize* on announced 4.950 can be heard occasionally in USA with weak to fair signal, much CWQRM and aircraft phone QRM, around 1830-1904A sign-off. Uses *English*. (West, Va., others)

Bulgaria—*Radio Sofia*, 7.671, announces *English* for Europe now 1345-1400, 1600-1630 on this channel parallel with 6.070; for North America 2000-2030, 2300-2315 on 9.700 (is slightly lower). (Pearce, England) Noted on 9.700A with good level in the 2000-2030 period. (Lund, Iowa)

Canada—VE9AI, 9.540, Edmonton, Alba., noted at fair level 1845; at 1900 announces for medium-wave CJCA. (Brown, N.Y.) Calgary, 6.030, Alberta, has good signal around 1400; announces "The Voice of the Prairies"; power is listed 100 w. (Gaylord, Washington State) CBNX, 5.970, St. John's, Newfoundland, noted to 2235 sign-off; is in the clear after 2230 when H14T signs off. (Machajewski, N.Y.)

Cape Verde Islands—CR4RA, 7.112, Praia, noted 1515 with call in Portuguese. (Pearce, England) And signing off 1700. (Saylor, Va.)

Ceylon—*Radio Ceylon* sent these current schedules—*Commercial Service*—2045-0230, 15.120, 100 kw., *English* to India, Pakistan; 0730-0830, 15.120, 100 kw., Urdu, Hindi (VOA relay) to India, Pakistan; 0844-1145, 11.975, 100 kw., *English* to India, Pakistan; 2045-0230, 7.190, 7.5 kw., *English* to India, Pakistan; 0630-1145, 7.190, 7.5 kw., Hindi (0630-0830), *English* (0830-1145) to India, Pakistan; 0015-0130, 17.820, 7.5 kw., *English* to Africa; 0415-0615, 17.820, 7.5 kw., *English* to Southeast Asia; 0630-0845, 11.975, 7.5 kw., Hindi to

SEE LEO FIRST FOR . . .

hallicrafters

I can SAVE you money . . . Liberal Trade-ins



LEO I. MEYERSON
WØGFO

SPECIAL NOTICE—NEW SX-73 NOW AVAILABLE AND IN STOCK — \$975.00



\$179.50

S-76 RECEIVER

Extra selectivity with double superheterodyne circuit. One RF, two conversion and 3 IF stages. Range 550-1550 Kc, 1.7-34 Mc in four bands. 8 tubes plus voltage regulator and rectifier. Complete with tubes, less speaker.



\$224.50

SX-71 RECEIVER

Double Conversion sharp selectivity, plus built-in NBFM at moderate cost. 11 tubes plus voltage regulator and rectifier. Low down payment.

NAME YOUR TERMS • LOW DOWN PAYMENTS • PERSONALIZED SERVICE

HALLICRAFTERS RECEIVERS AVAILABLE FOR IMMEDIATE SHIPMENT

S-81	\$49.50	S-40B	\$119.95	ST-83	\$129.95
S-82	\$49.50	S-53A	\$ 89.95	S-78A	\$ 89.50
A-84	\$99.50	S-72L	\$119.95	SX-62	\$299.50
S-38C	\$49.50	S-77A	\$119.95	S-72 Portable	\$109.95
R-46 Speaker	\$19.95	HT-20 XMTR	\$449.50		

Famous WRL RADIO REFERENCE MAP 25c



CU on 10-20 & 75 Meters

NEW LOG BOOK 25c

For mobile or fixed station. Spiral binding. Full column log listing all FCC required info. Will accommodate 1,325 stations. "Q" signals, phonetic alphabet, amateur international prefixes.

PHONE 7795

WRITE—WIRE



IT'S NEW! IT'S FREE!
WRL 1953 CATALOG

Send for your copy today. Contains everything new in radio and television. Jam-packed with bargains. Leo I. Meyerson, WØGFO



Send For FREE Copy

WORLD RADIO LABORATORIES
744 West Broadway
Council Bluffs, Iowa

R-2

Please send me:

- Radio Map
- New Catalog
- Used Equipment List
- SX-71 Info
- S-76 Info
- New Log Book

Name

Address

City..... State.....



- 1220 pages
- 80,000 items
- 8,000 illustrations
- 8" x 11" — 5 lbs.

publisher's price \$6.50—your price through your regular parts distributor **\$1.95**

The right part when you need it for service

This permanent, hard cover Official Buying Guide of the electronic-TV parts and equipment industry with its comprehensive detailed index, eliminates the need for maintaining files of small catalogs and manufacturers' literature. RADIO'S MASTER catalogs 90% of TV and electronic equipment. Not merely part number listings—complete descriptions, specifications and illustrations written and compiled by each manufacturer. Enables you to make comparisons or substitutions right now!



UNITED CATALOG PUBLISHERS, INC.
110 Lafayette St., New York 13

Sensational Performance!

MATTISON

SILVER ROCKET 630 CHASSIS

• with **TUNEABLE** •

**BUILT-IN BOOSTER
for Better DX Reception**

*Featuring **NEW CASCODE TUNER** made for UHF interchangeable tuning strips and 70° **COSINE YOKE**

Tube Complement:
28 tubes
3 rectifiers
1 CRT

32



All Channel Booster

• Broad band single knob control pre-amplifier built in to eliminate long leads which may cause regeneration and attenuation of signal.

• **ONLY THE MATTISON 630 CHASSIS HAS AN ALL CHANNEL TUNEABLE BUILT-IN BOOSTER THAT INCREASES SIGNAL STRENGTH UP TO 10 TIMES. THE SILVER ROCKET WILL OUT-PERFORM ANY CHASSIS MADE AND IS PRICED RIGHT TO SELL FAST WITH**

AN EXTRAORDINARY MARGIN OF PROFIT FOR YOU. WRITE FOR CONFIDENTIAL PRICE SCHEDULE.

• Mattison features a complete line of cabinets MADE IN MATTISON'S OWN CABINET FACTORY. 36 breathtaking designs that blend perfectly in any setting, traditional or modern.

**ALL
CABINETS
MADE IN
MATTISON'S
OWN
CABINET
FACTORY!**



The AMBASSADOR 17" and 21"

Best Looking . . . Best Value, Too!
Full size console for eye level television. Available in genuine mahogany or blond mahogany. Featuring removable safety glass. Dimensions height 42 inches, width 26 inches, depth 23 inches.

DEALERS! SERVICE DEALERS! Here is your opportunity to become the "important" TV Dealer in your area for the **FINEST CUSTOM-BUILT LINE OF TV RECEIVERS. FREE!** Write for Mattison's merchandising portfolio explaining the "UNASSEMBLED PLAN" and "\$1,000,000 FLOOR PLAN."



Manufactured with integrity

When you buy from Mattison you need only one source of supply! You can buy a Mattison Chassis, a Mattison Cabinet or a complete Mattison TV Set!

Mattison Television & Radio Corp.

10 West 181st St., Dept. RN, N.Y. 53, N.Y.

India, Pakistan; 2100-1145, 6.006, 7.5 kw., *English* (2100-0630), Oriental (0630-0830), *English* (0830-1145), relaying Home Service (Sun. opening is at 2045 Sat. *EST*). *Home Service (Western)*—2000-0330. 0530-1130, 6.075, 250 w., *English*; 2000-0330, 0530-1130, 3.395, 250 w. *Home Service (Oriental)*—2000-0300, 0600-1200, 4.900, 250 w., Sinhalese, Tamil. *Schools Service*—2315-0215, 0315-0500, 6.075, 250 w., 4.900, 250 w., *English*, Sinhalese, Tamil. (Scheiner, N.J.)

Chile—CE920. 9.200A, Punta Arenas, has been at fair level recently to 2200A sign-off; slogan is "Radio Militar Austral." CE960, 9.593A, noted around 2000 at good level; announces "Radio La Americana." (Niblack, Ind.) Closes 0030. (Kary, Pa.)

CE1175. 11.73A, noted with powerful signal 2303. (Bellington, N.Y.) CE622, 6.220, Santiago, heard with news in Spanish 2130, then music. (Levy, N.Y.)

China—*Radio Peking's* 11.69AV channel has been noted with *English* 1730-1800 again lately. (Niblack, Ind., others) Noted in Britain with strong signal on 15.060AV with *English* session 0400; announced *English* broadcasts as 1730 on 6.100, 7.500, 9.040, 10.260, 15.060, 15.170, 0400 on 6.100, 10.260, 11.690, 15.060, and 0830 on 11.690, 15.060. (Pearce, England) Noted on 7.500 early mornings (*EST*) and evenings to around 2000. (Chatfield, N.Y.)

Schedule received by Scheiner, N.J., from *Radio Peking*, listed these Peking outlets for use in relay of Home Service—6.100, 7.500, 9.040, 10.260, 15.170 at 1800-1830, 2100-2150, 2255-0145, 0425-0845, 0900-1300; listed Mukden, Manchuria, on 7.660; Shanghai on 5.985, 6.812; Wuhan on 6.645; Chungking on 6.154, 11.000; Sian on 6.400, 9.480. Rosenauer, Calif., notes slow-speed Chinese 1000 on 6.100, 7.500, 9.035A, 9.435 outlets.

Another Chinese channel noted is 6.05 heard lately after 0400 and as late as 1030 in parallel with 6.105A Peking; 15.060AV and 15.130A are heard in parallel often after 2000. (Balbi, Calif.) *Radio Sian*, 9.480, is heard at good strength opening 0600. (N.Z. *DX Times*)

Costa Rica—TIDCR. 9.62, has news in Spanish daily 2350-2400 sign-off. (Bellington, N.Y.)

Cuba—Tests in *English* around 0030-0130 (at least Sun., Mon., perhaps other days) to learn how well the medium-wave transmitter on 590 kc. is heard in USA, have been carried also on the 11.727A and 6.450 short-wave channels of COCY. (Guentzler, Ohio, others) Asks for reports to CMCY, P. O. Box 770, Havana, Cuba. (Levy, N.Y.)

Cyprus—ZJM6, 6.790, logged 1100-1130 with Arabic music; time signal 1115. (Wada, Japan) Noted parallel recently on 6.12A and 6.168A around 2345 in Arabic. (Bellington, N.Y.)

Dominican Republic—HI2A, Santiago, *La Voz de la Reeleccion*, opens 0700 with Dominican National An-

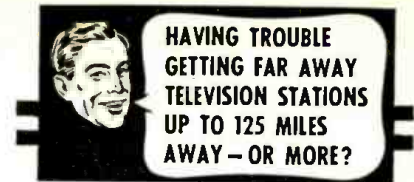

**HAVING TROUBLE
GETTING FAR AWAY
TELEVISION STATIONS
UP TO 125 MILES
AWAY—OR MORE?**

WHAT'S YOUR ANSWER TO THIS QUESTION?

If you're in FRINGE area — not right next door or fairly close to the television stations you want to get, you need the DAVIS VHF SUPER-VISION ALL-CHANNEL ANTENNA. For ALL CHANNELS.

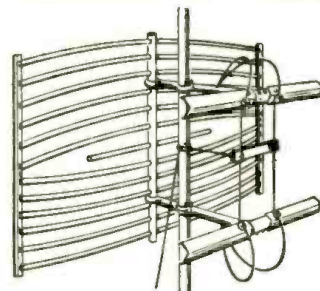

DAVIS SUPER-VISION FOR FRINGE AREA & DX

"The Original Antenna Sold With A Money-Back Guarantee"

Built By America's Fastest Growing Antenna Manufacturer

The DAVIS SUPER-VISION is one of the three basic elements necessary for FINE RECEPTION. It's actually as important as the finest television receiving set. So, when you buy, BUY RIGHT — all the way through: Set, Antenna and Leadline. And the services of a competent television technician to make the installation. If you miss an one, you'll miss what you're really buying: AMERICA'S FINEST TELEVISION RECEPTION.

The DAVIS STORY is a BIG STORY—in performance. Get all the facts. Aside from distance and DX reception, know about the "other ten" important features.

PRICED RIGHT for such fine reception. List only \$34.95. Worth every cent of its cost with "the price forgotten long after fine reception remains."

AT YOUR JOBBERS, or MAIL COUPON TO:

DAVIS ELECTRONICS	1-25
4313 West Magnolia Blvd., Burbank, California	
SIRS: RUSH INFORMATION TO ME AS CHECKED BELOW:	
<input type="checkbox"/>	Send Free Technical Data on new SUPER-VISION ANTENNA.
<input type="checkbox"/>	Send Name and Address of NEAREST JOBBER.
Name	_____
Street	_____
City	_____ State _____

SPEAKER RECONING

Complete line Cones, Spiders, Rings and Voice Coils. Custom Built Voice Coils. Low prices. Write for Parts List and Reconing information.

WESTERN ELECTRONICS CO.

3164 West Colfax Denver 4, Colo.

ON-THE-SPOT BATTERY RECORDER

WALKIE-RECORDALL 8 lb. miniature BATTERY RECORDER-PLAYBACK. Continuous, permanent, accurate, indexed recording at only 5c per hr. Instantaneous, permanent playback. Picks up sound up to 60 ft. Records conferences, lectures, dictation, 2-way phone & sales talks while walking, riding or dining. Records in closed briefcase with "hidden mike"! Write for Detailed Literature.

MILES REPRODUCER CO., INC.

812 BROADWAY Dep't RN-2, NEW YORK 3, N. Y.

RADIO & TELEVISION NEWS

them; is readable to 0745 when begins to fade out; during hours of darkness is usually snowed under by strong QRM. (Kary, Pa.) H18Z, 5.023A, is sometimes intelligible around 2000, but has bad CWQRM, Kary says.

Ecuador—HC1AC, 6.210A, noted with call 2216; nice level; announced "La Voz de La Democracia." (Nblack, Ind.) Excellent opening 0600 with news in Spanish. (Kary, Pa.) HC2BK, listed 4.710 but nearer 4.700A, *Radio El Mundo*, Guayaquil, is best after 2200 to 2300A sign-off; programs then are entirely musical, with many commercials in Spanish; HC4AS, 4.202, Bahia de Caraquez, is fair to poor daily, with bad CWQRM; has news in Spanish 1945-2000A; mentions "La Voz de las Caras." (Kary, Pa.) HCJB, 11.915, noted at good level 0015-0130. (Lieberman, N.Y.) And to 0300 at good level in Ill. (Gustafson)

Egypt—SUX, 7.866A, sometimes has strong signal 1400-1700; all-Arabic. (Chatfield, N.Y.) At least some days runs to 1800. (Brown, N.Y.)

El Salvador—YSAXA, 11.950, San Salvador. *La Voz Panamericana*, was audible recently from interception 0945 to past 1200, had sporting event. (Kary, Pa.) YSUA, now on 6.190A, noted to after 2030; should sign-off around 2400. (Stark, Texas)

Ethiopia—ETAA, *Radio Addis Ababa*, 15.017AV, noted recently 1320-1420 with *English* recordings of popular music and *English* announcements; poor level, heavy CWQRM. (Saylor, Va., others) Is heard often in Britain now from 1030A sign-on; some days has religious (missionary) programs in *English* around 1030-1100; has *English* news some days 1110A; format is irregular. (Pearce, England)

Finland—Helsinki, 15.190, noted with news 0700, parallel 9.555, 17.800. (Pearce, England) *English* should be repeated on these channels around 2200.

France—*English* from Paris is daily 0245, 6.145, 7.240; 1445, 11.970; Sundays only 0800-0900, 7.240. (ISWC, London) Noted on 6.200 at 0200-0300 with musical session, strong level; on 6.145 signing on 0300 with program in French weak. (Chatfield, N.Y.)

French Cameroons—Douala sends on 7.287 at 1230-1500 (Sun. also 0500-0800) according to "Malmo DX-aren", Sweden. Not confirmed.

French Morocco—*Radio Maroc*, 15 Avenue du Congo, Rabat, sent schedule for CNR3, 6.006, 1 kw., as 0200-0330, 0600-1000, 1200-1800 (Sun. 0200-1800). (Kary, Pa.)

French West Africa—*Radio Dakar*, 9.560, noted opening with French march 0200. (Pearce, England) Current schedule is 11.896A weekdays 0130-0300, 0700-0900, 1400-1810, Sun. 0200-0900, 1300-1810; 9.562A, weekdays 0145-0315, 0730-0845, 1200-1730, Sun. 0430-0845, 1330-1730; news in French on 11.896A at 0230, 0800, 1500, 1800; on 9.562A at 0800, 1700. (WRH) Sometimes opens on 9.560A as early as 0130. (Radio Sweden)

Germany—By this time, the German

NOW...AT LOWEST PRICES!

BROADCAST BAND & AERO



MM-26-C Remote Controlled Navigational Direction Finder and communications receiver. Manual DF in any one of three freq. bands, 150 to 1500 KC., 24 V. Self contained dynamometer supply. Complete installation, including receiver, control box, loop, minimum control, left-right indicator, plugs, drop transmission line and flex shafts. **LIKE NEW \$69.50**

MM-26-Y 150 to 325 KC. 325 to 695 KC. 3.4 to 7 megacycles, comp. Installation \$69.50
Receiver alone (less tubes) 39.50
MM-26-C alone, like new 39.50
MM-26-C or MM-26-Y as is less tubes 13.95
with tubes, Used Road 24.95
MM-20-E Loop, Brand New 6.95
MM-52 Crank drive, New 2.50

SCR-274N COMMAND and ARC-5 EQUIPMENT

RECEIVERS	AS IS	EXC. USED	NEW
BC-458-190 in 550 KC	\$10.95		
BC-451-3 to 6 MC.	4.95	\$11.95	
BC-453-8 to 9 MC.	4.95	11.95	
TRANSMITTERS			
BC-457, 4 to 5.3 MC.	4.95	9.95	
BC-458, 5.3 to 7 MC.	4.95	9.95	
BC-459, 7 to 9.1 MC.	5.95		
BC-458 Modulator	2.95	4.95	
ADDITIONAL EQUIPMENT			
BC-450 Control Box (3 Receiver)		1.95	3.95
BC-451 Control Box (Transmitter)		1.95	3.95
BC-452 Relay Unit ANT With Condenser		3.95	
Without Condenser		1.29	2.95
Flexible Shielding w/ 1 h Gear to fit receivers		2.29	2.45
3 Receiver Rack		2.39	3.97
2 Transmitter Rack		2.25	2.95
Single Transmitter Rack		2.25	2.95
DM-12 dynamotor for Command Set		3.25	7.95
DM-33 dynamotor for Command Set		2.95	3.95
Shock Mtg. for 3 Receiver Rack, 2 Trans. Rack, Modulator or Ant. Relay Unit		1.95	2.45

MONTHLY SPECIAL!

16P4 only \$9.95 16DP4 \$9.95
WHILE THEY LAST... only 40 left of each...
90-day guarantee!

TUBES.....10 for \$3.50

12SR7	6SL7	Your choice of these nationally advertised tubes.
1613(6F6)	6V6GT	
9006	6Ns	
6Z7G	1626	
211	954	
6AG6	12M6	

TUBES

9002	50.59	6AJ5	\$1.59
9003	.98	4AP10	.95

RT/34 AP5 13 Transceiver used as a tall warning radar on 415 MC. Containing a 30MC IF Strip and various other parts, these units have been stripped of RF sections and all tubes, but are an excellent buy if only for parts and IF Strip. Used \$ 4.95
BC-624 receiver (SCR 522), less tubes. Used 19.95
100 A 158. 12525. Used 9.95
BC 625 transmitter (SCR 522) less tubes. Used 9.95
SCR 522 transceiver, complete in case with top bracket, less tubes. 29.95
Transceiver-110-144 mc. 2 meter, used, excellent condition, less dynamotor, with tubes. only 24.95

WANTED!

All TS, APR, AP5, ARC, ARN, ART, SCR, R89 and BC equipment. Write today!
Quote lowest prices in your first letter

MIKES and HEADSETS

H5-33 Low Impedance Headset, exc. \$2.95 new \$4.95
H5-23 Headset used \$2.95 new \$4.95
CD-307 Ext. cord for HS 23-33
Throat Mike-T 30 like new .79
Lip Mike-Navy Type New .98
Extension Cord and Switch Assembly for Lip and throat Mikes New .98
CW 40505 High Impedance headset complete with leather headband and rubber cushions. **08c**
T-17, Microphone Used exc. 53.75
H5-38 Used exc. \$1.95 new 2.29
H5-30, miniature headset, used 1.49 new 2.49



DYNAMOTORS

The best dynamotor for conversion to 6v. Multiple windings! After conversion you get choice of 190 or 350 v. at 60 MA or 250 v. at 100 MA. Complete dope sheet furnished. **\$9.95**
BRAND NEW (See "CQ" Aug. Issue)

PE 103	used exc.	\$19.95
DM 53A	new \$7.95; used	2.95
BD 83	used exc.	8.30
DM 34	used exc.	9.95
DM 28	new	5.95
PE 94	new \$7.95; used	4.95
DY 22	used exc.	14.95
DM 21	used exc.	7.95

WOBULATOR

BUILD TV-FM-AM SWEEP GENERATOR

You can build "Versatile Sweep Frequency Generator" with APN-1 magnetic units. \$5.95

RT7/APN1 TRANSCEIVER UNIT—Used as an altimeter. It may be converted for signaling control circuits, etc. Complete with 14 tubes and dynamotor they are in good used condition at the amazingly low price of \$17.95. Used, less tubes, with wobulator. 9.95

MISCELLANEOUS EQUIPMENT

FL 8 used, exc. \$1.19 BC 347 each, used 95c
BC 906 each. 9.95

SELSYN TRANSMITTER

Loop Motor and Autosyn Transmitter Assembly for matching to I-R2 indicator. Used, excellent condition. ONLY \$5.95. Complete with Indicator. \$14.95

SCR 625 FAMOUS ARMY MINE-DETECTOR

For Prospectors, Miners, Oil Companies, Plumbers, etc. This unit is being offered now at a considerable reduction in price. Recently advertised at \$79.50 it is now available in the same brand new wrappings in suitcase style carrylign case (less batteries) at

\$59.50 WHILE THEY Used, like
LAST! new, \$39.50

RL-42 Reversible Motor with antenna reel and clutch, used \$ 2.95
BC-433 RADIO COMPASS RECEIVER, 200 to 1700 KC, used, excellent condition, with tubes, exc., less tubes. 39.95
Used, as is, less tubes and cover, exc. for parts 24.95 8.95

PLUGS for 274N.....\$1.25 each

ARMY SURPLUS PORTABLE TELEPHONE

Complete with TS 13 handset. \$14.95 ea.
2 for \$27.50

Shipments F.O.B. warehouse. 20% Deposit on orders. Minimum order \$5.00. Illinois residents, add regular sales tax to remittance.
Prices subject to change without notice.

R W ELECTRONICS

Dept. N, 1712-14 S. Michigan Ave., Chicago 16, Ill.

PHONE: HARRISON 7-9374

STRIP-IT A New Precision Tool

For Removing Insulation from Wire and Cable
Designed for the Electronic Industry



- Fits in Tight Spots
- Cuts as Well as Strips
- Speedy, Efficient, Rugged
- Tool Steel Blades for Long Life
- INSTANT Adjustment to All Wire Sizes



The simple design and fool-proof operation of STRIP-IT makes this a tool that will become indispensable for electronic technicians and assemblers. Held in the palm of the hand, the operation is merely to bite into the insulation, twist, pull, and the wire is ready for the terminal connection. The sliding adjustment bar is set with a touch of the finger. STRIP-IT is engineered for thousands of operations, using only one set of blades.



THE **CM** SEE YOUR LOCAL DISTRIBUTOR, OR WRITE
MANUFACTURING COMPANY

Norman R. Mac Innis, 1430 Mass. Ave., Cambridge, Mass., National Sales Representative



Economically Priced
\$1.95 net

YOU SAVE AT POLY-TECH

GOING MOBILE? CO-AXIAL 6 VDC RELAY. SPDT, WILL HANDLE UP TO 75 W. RF. uses standard co-ax connectors. Send your order in today 'b'cauz they'll go like hot cakes. PP USA..... **\$6.75**

MOBILE VHF ANTENNA MFD. BY G. E. 152-162 MC, complete with 12 ft. RG58U Coax cable, removable antenna rod, mount, 831SP (PL-259) Coax connector, installation hardware and instructions. Special, only..... **\$2.45**

NOVICE 115V, 60 CY PWR SUPPLY KITS
A 600 VCT 95 MA, 6.3V 3A, 5V 2A; 8 HY 100 MA chokes (2 ea.); 8 x 8 MFD 600 VDC oil capacitors..... **\$6.50**

B Plate transformer 740VCT 305 MA; 5V 6A x 6.3V 6A dual fil. transformer; 4.6 HY 310 MA chokes (2 ea.); 8 x 8 MFD 600 VDC oil capacitors..... **\$12.50**

C **IDEAL KIT FOR NOVICE X-MITTER.** Transformer 880 VCT @ 125 MA, 2.5V 3A, 5V 3A, 6.3VCT 3A, 7 HY 125 MA choke (2 ea.), Dual 8 MFD 600 VDC oil cap. Chassis, 5U4G, jewel, Tog. Sw., Line cord, Fuse post, Bleeder. Hook up wire and Schematic..... **\$15.95**

D 750 VDC @ 225 MA Pwr Supply, ideal for powering from one source ARC-5 X-Mitters, or any 150 Watt rig. Transf. 750-600-0-600-750 VDC @ 225 MA, 6 HY 250 MA choke (2 ea.), 6.3V 4A x 6.3V 4A Fil. Transf., 2 MF 1.5 KVDC and 3 MF 1 KVDC oil cap. 5V 4A Fil. Transf. chassis, 5R41GV, Bleeder, jewels, Tog. Sws., line cord, Schematic, etc. Only..... **\$29.50**

* Free Telegram Key on request when ordering C & D kits.

CHOKES

200 HY 0 MA, cased	\$1.95
9 HY 95 MA, cased	1.15
15 HY 100 MA, cased	0.90
10 HY 200 MA, cased	2.75
15 HY 250 MA, cased	3.75
3 HY 250 MA 15 ohm, cased	.95
5 HY 300 MA 70 ohms	2.99
8 HY 300 MA 110 ohms, cased	5.59
6 HY 300 MA 35 ohms, cased	7.25
.05 HY 3A 1 ohm	2.95
.02 HY 5A .5 ohm, cased	4.95

1N34 DIODES LIMITED QUANTITY
10 for only..... **\$3.95**

ZA GLIDE PATH RECEIVER BLACK CRACKLE ALUMINUM CASE 6"x7"x12" complete with shock mount, 130 6CG tubes, resistors, capacitors, etc. Used, excellent condition. Limited Quantity..... **\$2.95**

OHMITE DUMMY ANTENNA LOAD
TYE D-250 250W, 600 or 75 ohm non-induct. Resist., ea..... **\$6.95**

OIL CAPACITORS
5 MF 236VAC 50.95
10 MF 330VAC 2.95
14 MF 275VAC 3.49
4 MF 1000VDC 6.95
8 MF 1000VDC 2.95
35 MF 1000VDC 7.50
2 MF 1500VDC 1.85
16 MF 1500VDC 6.95
2 MF 2000VDC 2.25
4 MF 2000VDC 4.50
8 MF 2000VDC 5.50
2 MF 3000VDC 3.95

SENSITIVE PLATE RELAY

Sigma 5 Prong Plug In Relay Polarized Coil 3000 ohms DC, operates on 2-4 MA. SPDT contacts. Limited Supply..... **\$3.25**

STRUTHERS-DUN

115 VAC 40-60CY. Relay, SPST, No. 1 Amp 115VAC Contacts Quantity Ltd..... **\$1.95**

Mailroy Inductancor, 3 Section..... **\$3.95**

TELECHRON

3.0 RPM Synchronous 115v 60CY Mo- Kors. Special..... **\$1.95**

Isolation or Bias Transformer, Prim. 117V, Sec 135V TAP, 6.3V 35W..... **\$1.95**

115V FILAMENT TRANSFORMERS 60 CY
2.5 VCT 10A, 10 KV Insulation..... \$4.50
5V 4A 2.5 KV Insulation..... 3.95
5.0 V 6A, 6.3 V 6A..... 3.95
5.0 V 12A, 2.5 KV Insulation..... 5.95
5.0 VCT 20A, 2.5 KV Insulation..... 6.85
6.3 VCT 3A, 2.5 KV Insulation..... 2.25
6.3 VCT 6A, 2.5 KV Insulation..... 3.15
6.3 V 10A..... 3.95
10 VCT 10A, 2.5 KV Insulation, cased..... 6.00
Dual 25V 1 Amp..... 1.95
3-4-1V 1A..... 1.49

115V POWER TRANSFORMERS 60 CY
68 to 83 V Half Wave, 1.5A..... \$ 1.25
300 V Half Wave .02..... .75
435 VCT 145 MA 6.3V 3A, 5V 3A..... 2.95
700 VCT 100 MA, 5V 3A, 2.5V 10A..... 2.25
740 VCT 185 MA, 6.3V 4A, 5V 3A..... 5.95
800 VCT 200 MA, 5V 2A..... 3.95
680 VCT 225 MA..... 2.95
750-680-0-600-750 VDC 225 MA..... 11.50
3600 VCT 350 MA..... 29.50

POLY TECH

Dept. B-3, 919 Dawson St., New York 59, N. Y.
Send for Bulletin Murray Hill 6-2650

Short-Wave Overseas Service should be on the air. I hope to have details shortly.

Baden-Baden, 6.320, was noted fair a recent Sat. at 1830 with popular recordings; this extended schedule may be Sat. only. (Kary, Pa.)

Gold Coast—Accra, 4.915, tuned 1230 when had music; 1245 Gold Coast news, followed by weather forecast, then dance music to 1300 closedown with "God Save the Queen." (Pearce, England)

Greece—Radio Athens is now using 9.607 to North America on winter schedule of 2000-2100; English news around 2035. (Bellington, N.Y.) Noted on 7.300 with news in Greek 0215; on 15.345 with light music 0800; heard on 9.607 with news 1430, then news in French 1445. Larissa, 6.745, noted with call 1530, now signs off 1600 (formerly 1500). "Radio Amateur", London, reports a Greek Forces Station at Kozani operating around 7.940-7.950, heard at good level 1300.

Greenland—OXI, 9.310A, Godthaab, on a recent Sun. had extended schedule to 2012 sign-off. (Stark, Texas) Normal sign-off is around 1850. (Niblack, Ind.; Kary, Pa.)

Guadeloupe—Basse-Terre, 7.445A, noted at fair level some days shortly before 0600 in French. (Kary, Pa.) May sign on 0530.

Guatemala—TG2, 6.620, logged 2015 in Spanish. (Tonsi, Wisc.) TGZA, 6.675AV, Zacapa, Radio Oriental, is audible to 0805A mornings and to 2210A sign-off evenings; has had QRM. (Kary, Pa.)

Haiti—The "wandering" 4 V R W, Radio Haiti, has been varying lately around 10.070-10.092A. (Niblack, Ind., others) A badly distorted signal has been noted from a Haiti outlet on 6.230A to 2015 sign-off. (Stark, Texas) 4VEH, 9.685AV, Cap-Haitien, heard signing on 0630. (Chatfield, N.Y.) A letter from Radio Citadelle indicates that power of 4VWA, 6.235, is 150 w. (to be increased to 1 kw.); slogan is "Ici Radio Citadelle. Cap-Haitien, capitale touristique de la Republique d'Haiti." (Kary, Pa.) Is heard to after 0800 and past 1815; may sign off around 2015. (Stark, Texas) 4VPL, 5.902, Petionville, is audible from as early as 1830 to past 2000 with varied musical programs. (Kary, Pa.)

Honduras—HRP1, 6.35, El Eco de Honduras, San Pedro Sula, noted 1715-1730 at fair level in Spanish. (French, Mass.) Good level 2246-2323. (Patterson, Ga.) HRXW, Radio Comoyaguella, noted moved to 6.105 from 8.985A and 6.110; is best after 2200; signs off around 2300. (Stark, Texas, others) At times, HIROW, Radio Monserrat, uses both 6.675 and 6.660; noted parallel one night recently past 2015. (Stark, Texas) Signs off around 2130. (Dexter, Iowa) IRLP, 6.410, Tegucigalpa, Radio America, is best prior to 1900 with recorded music and commercials in Spanish; after 1930, signal weakens rapidly. (Kary, Pa.)

Hong-Kong—ZBW3, 9.525, Victoria, noted at good level 0530. (Ballou,

What to look for in a record changer...

INTERCHANGEABLE SPINDLES...

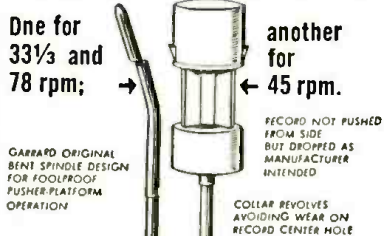

For greater convenience and longer record life; Eliminates "spiders" One of many features which make

GARRARD

The World's Finest 3 Speed Record Changer

Fully automatic with automatic stop

Can be used with your present set.



MODEL RC 80

Garrard Sales Corp., Dept. R-164 Duane St., N. Y. 13, N. Y.
Send GARRARD Fact Sheet.

Name.....
Address.....
City..... Zone..... State.....

\$42.30 net less cartridges

CHECK JSC for COMPLETE 300 Ohm TV Lead-In Wire Needs!

22 Gauge Copper	20 Gauge Copper
40 mil	40 mil
55 mil	55 mil
70 mil	70 mil
80 mil	80 mil
100 mil	100 mil

4-Conductor Rotor Wire Perforated 300 Ohm Open Wire JSC has highest quality wire at lowest possible prices. Lithographic pools of Orange and Blue individually poked 1000 feet to the metal spool.



See your nearest JSC distributor who proudly displays the Blue and Orange disc of quality.

ELECTRONIC'S LATEST TROUBLE-SHOOTER

A compact—complete—circuit analyzer



ONLY \$24.95

THE AMAZING TV SERVISSET

Model E-C
(Pat. Pending)

A precision engineered professional quality electronic test instrument. Ideal for field or bench servicing of Radio, Television, Radar, Communications gear, etc.

Now—Quickly—Conveniently—At Low Cost

CHECKS: sync, sweep, video, audio circuits, TV high voltage supplies (DC, RF, or Pulse), low voltage supplies, coils, condensers, resistors, tubes, transformers, speakers, etc. Will localize trouble to a particular stage, determine defective component and can actually be clamped in circuit to restore circuit operation temporarily in 80% of component or tube defects. Ideal for locating and confirming intermittents.

SPECIFICATIONS:

RF & AF Signal Tracer, RF & AF Signal Injector, AC & DC Voltage Indicator 0/60/950/20,000, DC Polarity Indicator 50/50/20,000 volts, Lo ohms 0-5, Hi ohms 0-500k-20 megohms, Tests Condensers .00023-12 mfd., Tests Resistors 2 ohms-20 megohms, 2 Capacitance Sub ranges 51-1 & 4-40 mfd., 3 Resistance Sub ranges 50-500 ohms, 5k-25k, 100k-1 meg.

Will complement your existing equipment and will outperform other testers costing many times more.

A MUST FOR THE MODERN TV AND ELECTRONICS SERVICE ENGINEER.

Comes in handy cloth pouch, complete with all accessories including ALNICO phone, TV high voltage adapter, phone extension cord, test lead, Klipzon adapter and complete detailed instruction Manual, disclosing latest TV trouble-shooting techniques.

Be sure to ask for and see **SERVISSET** at your distributor or send today for complete information and name of your local distributor.

LEE ELECTRONIC LABS., INC.

233 Dudley Street Boston 19, Mass.

Calif.) Has been closing lately 1030; has BBC's Radio Newsreel (probably recorded) at 1000 now. (Ridgeway, South Africa)

Hungary—Budapest. 9.833, noted with *English* to North America 1700-1730, 1930-2000. (Lubell, N.Y.) Should be parallel on 7.222A and 6.240A.

India—AIR, 11.790, noted signing on 2030 with *English* identification; the 15.160 outlet noted closing down 0730 with *English* announcement. (Niblack, Ind.) Noted with European Service 1445-1545 now over 11.780, 9.565A, 7.120; asks for reports; heard signing on 1445 on 7.125 with French session, also audible over 5.960; with Indonesian program 1745-1800 on 7.125, 5.960A; with news 0300 on 17.705, 15.160, closing 0330. Bombay, 4.840, noted 1200 with native program, signed off 1230; Delhi, 4.910, strong in native 1200, closed 1330 at end of Persian session. Madras, 4.920, noted with news relay from Delhi 1030. (Pearce, England) Is strong level opening 0830 with news on 11.780. (Brown, N.Y.) Noted with news 0730 on 17.760. (Gillett, Australia)

Indo-China—Radio France-Asie, 9.754A, Saigon, still noted with *English* session to Europe 1734A-1800; announces next *English* for 1830 on 7.230; noted on 15.430 with news 0500, and closing with "Knightsbridge March" 0513. (Pearce, England) Heard on 11.935 with bilingual (*English-French*) sessions from 0900. (Ridge-

(Continued on page 132)

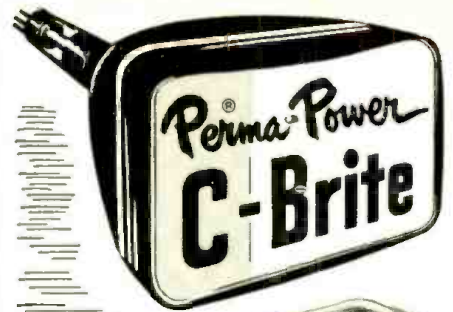

to add increased brilliance to any TV PICTURE TUBE

manufactured by

Perma-Power COMPANY

Chicago 25, Illinois

Manufacturers of Electronic Equipment Since 1928

New RADIO COURSE only \$2.50



MADE MONEY FIRST WEEK

"You should get more money for your course. The first week I studied it, I made \$10.00 repairing sets. I built my own test outfit from details given in this course. I have repaired 100 radios to date."

Signed: Robert C. Hammel, 120 W. 13th, Davenport, Iowa.



COMPLETED IN 8 WEEKS

"I am very satisfied with the course. When I was at the twelfth lesson I started repairing radios. It took me two months to master your course." From a letter written by Roger Langlois, 1679 Pompadour St., Montreal, Canada.



MODERN, UP-TO-DATE

"Your course is modern and up-to-date. There is not one page in the whole course which anyone can afford to miss. Your course started me on the road to a well paid job and has repaid me many times." Charles Alpaech, 433 Elm St., Reading, Pa.

AMAZING BARGAIN OFFER

Here is a practical home-study course that will teach you how to repair all radio sets faster and better. These newly reprinted 22 lessons cover all topics just like other correspondence courses selling for over \$150.00. Our amazing offer permits you to obtain the course complete for only \$2.50, nothing else to pay. Easy-to-follow, well illustrated sections on test equipment, circuit tracing, alignment, F.M., use of oscilloscope, amplifiers, and every other topic needed to be an expert in radio repairing. Trouble-shooting hints, circuits, short cuts, service suggestions, new developments. Send coupon today, and use the complete course at our risk. Satisfaction guaranteed. All 22 lessons, in large manual form, + self-testing questions, \$2.50 complete, your cost only.....

INTRODUCTION TO TELEVISION

These 22 practical lessons making up this course-book are easy to follow and apply to actual radio jobs. Use this training to get ahead in radio and as an introduction to television. Radio facts that puzzled you will be quickly cleared up. You will find yourself doing radio repairs in minutes instead of hours—instantly finding faults or making needed adjustments. Every new radio development of importance and thousands of time-saving radio facts are packed into this complete course-manual. For example, there is a large lesson on servicing F.M. sets and another full lesson on audio amplifiers. Use coupon below to order Course for 10-day examination in your own home. Look over the material, read a few lessons, apply some of the hints. Then decide to keep the lessons at the bargain price of \$2.50 (full price), or return the material and get a cash refund.



Supreme Radio & TV Manuals

Your complete source of all needed RADIO and TV diagrams and service data. Most amazing values. Still sold at pre-Korean prices. Only \$2 for most volumes. Every Radio manual contains large schematics, all needed alignment facts, parts lists, voltage values, trimmers, dial stringing, and service hints. Each TV manual is a practical treatise on servicing the year's sets, with giant blueprints, patterns, waveforms, hints, charts, suggested changes. See coupon at right for a complete list of these low-priced manuals.

NO-RISK TRIAL ORDER COUPON

SUPREME PUBLICATIONS, 3727 W. 13th St., Chicago 23, ILL.

Radio Diagram Manuals

- Year 1952 Manual. \$2.50
- 1951 Radio } EACH
- 1950 Manual } \$2.50
- 1949 Radio
- 1948
- 1947
- 1946
- 1942
- 1941
- 1940
- 1939
- 1926-1938 Manual. \$2.50

PRICED AT ONLY \$2 EACH

Send Radio and TV manuals checked at left and below. Satisfaction guaranteed or money back.

- Complete RADIO COURSE, all 22 lessons... \$2.50
- 1952 Television Manual. \$3. 1951 TV. \$3.
- 1950 Television Manual. \$3. 1949 TV. \$3.
- 1948 TV. \$3. 1947 TV & FM. only \$2.

- I am enclosing \$..... Send postpaid.
- Send C.O.D. I am enclosing \$..... deposit.

Name:
Address:

Supreme Publications

Sold by All Leading Radio Jobbers

HARVEY

The House
of Audio



THE ORIGINAL WILLIAMSON HR-15 AMPLIFIER KIT

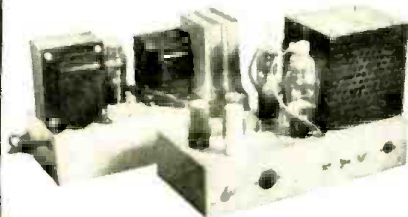

The famous, original Williamson HR-15... still acclaimed the leader... in kit form, with the Partridge Output Transformer specified by Williamson in his original design. Assemble this kit, and in 3 hours or less, enjoy the finest sound you ever heard. Operates from a tuner, phono-preamp, crystal pick-up, or other signal source. Absolute gain is 70.8 db with 20db of feedback. Frequency response: $\pm .5$ db, from 10 to 100,000 cps. Output impedances to match all speakers from 1.7 to 109 ohms. Kit is complete with 5 tubes (1-5V4, 2-6SN7, and 2-5881 (or 807 if requested), 2-Punched Chassis, 2-Resistor Mounting Strips, Sockets, Partridge WWFB Output Transformer, Assembly Instructions, and All Other Necessary Parts for Amplifier and Power Supply. **\$76.50**

PARTRIDGE OUTPUT TRANSFORMERS

Available Separately. WWFB **\$26.00**

NOTE: HR-15 may be had with British KT-66 Output tubes for \$3.00 additional.

WESTERN ELECTRIC 755-A
High Quality 8" PM Speaker
Special **\$24.60**

The MAGNECORDette



A truly professional tape recorder for the discriminating listener... designed for home use.

- Quickly interchangeable speeds: 7½ or 15 inches/sec.
- Rewinds 1200 feet in 40 seconds.
- Frequency response: ± 2 db, 50 to 15,000 cps. at 15 inches/sec. and 50 to 7000 cps. at 7½ inches/sec.
- Dual AC motors for operation and rewind.
- Maximum flutter 0.3%.
- Housed in an attractive cabinet, natural or walnut.

\$395.00



**10½ INCH
REEL ADAPTER
MECHANISM**

Attaches simply and easily to all MAGNECORD and MAGNECORDette Tape Recorders. Permits playback, rewind, and high speed forward with 10½-inch reels. In stock for immediate delivery.

\$35.00

NOTE: All prices are Net, F.O.B., N. Y. C., subject to change without notice.



Harvey

RADIO COMPANY, INC.

103 W. 43rd St., N. Y. 36, N. Y. • LU 2-1300

way, South Africa) *Radio Hue* can be heard in Japan very well but with some hum around 0500-0800 on 7.205; closes 0800 with identification in French. *Radio Dalat* is at fair strength, sometimes QRM'd by *Radio Moscow*, on 7.265, closes 0630 daily except Sat. when runs to 0700; has French on Sat. 0630-0700. (Wada, Japanese Short-Wave Club)

Iraq—Radio Baghdad, 11.724A. noted 1145 with Arabic music; at 1200 clock chimes the hour, call, then news in Arabic. (Pearce, England) Should have *English* 1415-1500A closedown.

Italy—Rome, 9.575A, noted with news to North America 1930, good level. (Nblack, Ind.) Noted on 6.010 in Russian 2215-2245. (Lubell, N.Y.)

Jamaica—Due to requests of listeners. *Radio Jamaica* has announced it no longer changes from 4.950 to 3.360 at 1515 but remains on 4.950 to 2300 closedown; opens 0600. (Levy, N.Y., others) Station officials list this one as 5 kw., using omnidirectional antenna. (Baitzel, N.J.)

Japan—AFRS, Tokyo, noted parallel over JKL, 9.605, and JKI, 11.825, at 0100. (Stein, Calif.) Good signal over JKL, 4.860, at 0825, moderate fading. (Ballou, Calif.)

Mexico—A Mexican has been noted on 9.575 identifying as "La Hora" (Continued on page 137)

Transistor Receiver (Continued from page 37)

grounded base circuit. The value of R_2 should be chosen so that the collector current is about 1 milliamper. The collector current of the detector/amplifier transistor will depend on the strength of the received signal but will average about 200 microamperes with a strong signal.

Battery life with only one transistor will probably equal the shelf life of the battery. With two transistors, the

life will depend on average hourly use but should be at least 100 hours for two penlight type cells.

If magnetic phones are used, they may be connected directly in the collector of either transistor. Low impedance phones or a speaker will require the use of a matching transformer. A load impedance of 2000 ohms in the output stage is correct for the voltage and current indicated.

Alignment is perfectly straightforward but should be done carefully in order to realize maximum sensitivity. Any good service oscillator or signals from broadcast stations may be used to accomplish the alignment. The collector current of the first transistor is a good indication of resonance. The parallel trimmers are used to line the set up on the high frequency end and the slugs on the low frequency end.

The output power of this receiver is about 1.5 milliwatts and is sufficient for adequate earphone volume. An efficient speaker can be connected to the output circuit and adequate volume will be obtained in a quiet location. However, the addition of a class B output stage to drive the loudspeaker is recommended.

The receiver, as originally built and as shown in the photos, included a CK705 germanium rectifier and several parts associated with this rectifier. The junction transistors were used as straight audio amplifiers. Tests proved that the diode was not essential and in fact provided no advantage, so the receiver has been modified to the circuit of Fig. 4.

BIBLIOGRAPHY

Doremus, John A.: "Point-Contact and Junction Transistors," *Radio-Electronic Engineering Edition of RADIO & TELEVISION NEWS*, April 1952.

Reich, Dr. Herbert J.: "Transistors and Transistor Circuits," *Electrical Manufacturing*, November, December 1952.

Proceedings of the IRE, Vol. 40, November 1952.

-50-

Under chassis view of the transistor receiver designed around the CK722 transistor.

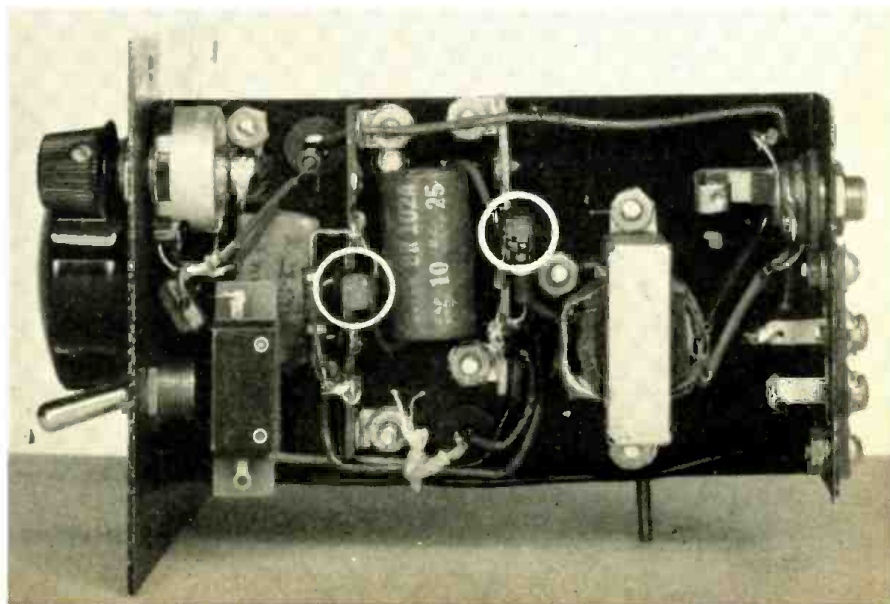

Writing for Profit
(Continued from page 59)

ing time. In addition, there is the real satisfaction of doing creative work.

Articles prepared for the popular technical magazines must still meet reasonable standards of neatness and, to be easily salable, should be prepared with certain basic rules in mind. We will discuss these factors separately.

1. *Choose Your Market:* Before starting a technical article, decide how the article is to be slanted and to which magazine (s) the article is to be submitted. This will determine the style of presentation and, to some extent, the subject matter. Obtain copies of the magazine and *carefully* read the majority of articles published. In this way, you can obtain a better insight into the style preferred by that magazine, the types of articles desired, and the general level of writing.

It is a good idea to send an outline of the proposed article to the editor of the magazine before writing the article. If the editor is interested, the chances of selling the finished article are many times better. However, if the editor is not interested in the suggested article, he will often tell why, and may, at the same time, list the type of articles desired at that time.

Most of the technical magazines can be grouped into five general classifications, as follows:

Semi-Technical Magazines: In this group are the very popular "home mechanic" magazines. Articles for these magazines must be extremely simple, should include detailed sketches and photographs, and must be fairly short. Preferred are construction articles on phonographs, radios, amplifiers, "gadgets," and electronic toys.

Technical Magazines: In this group fall the majority of radio, television, and electronic magazines. Articles may range from semi-engineering in nature to simple construction. All phases of the electronic field are covered. However, construction articles, in general, are the most popular. Articles written for these magazines should not be over-simplified, but extensive theory and complex mathematical expressions should be avoided.

Specialized Technical Magazines: In this group fall a number of magazines designed to appeal to a specific group in the electronic field. There are *audio* magazines for the audio and high fidelity enthusiasts, *service* magazines for the radio-TV technician and service-dealer, and *amateur* magazines for the amateur radio operators or "hams."

Engineering Magazines: Magazines in this group are designed to appeal to practical engineers and, to some extent, to engineering executives. Preferred articles include descriptions of new circuits and specialized electronic equipment, production and management methods, practical design techniques, and new laboratory techniques.

**NEW 1953
630 FA-2***

**ONLY AT AIREX...THE MOST
POWERFUL FRINGE AREA
TV CHASSIS MADE**

Tube Mfg. Brackets \$6.50

The CHASSIS That Television Engineers and Servicemen Are Buying for Themselves . . .

This amazingly advanced 31-tube TV chassis is years ahead in engineering and gives you the ultimate in TV viewing and listening pleasure. To assure you trouble free TV our engineering staff has incorporated into the "630 FA-2" design the experiences of hundreds of TV servicemen and engineers. Receiving range includes stations up to 200 miles away. Nothing has been spared to bring you the finest of TV chassis. Only the best and most expensive parts are used. There is no other chassis that compares with the "630 FA" * for fringe area reception.

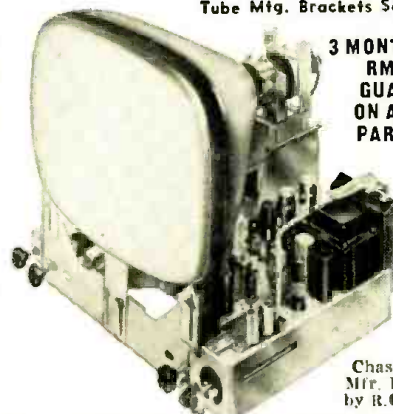

**3 MONTHS
RMA
GUAR.
ON ALL
PARTS**

Chassis
Mfr. Lic.
by R. C. A.

**THE ONLY CHASSIS WITH
PUSH-PULL AUDIO OUTPUT AT**

\$169⁹⁵

Less C.R. Tube
and Brackets

Complete with 12" ROLA Hi-Fi Speaker
(Fed. Tax Incl.)
Complete Service Manual & Schematic—\$1

✓ CHECK THESE EXCLUSIVE FEATURES ✓

- 10 WATT push-pull audio output. Frequency range from 40 to 12,000 cycles • Link coupled Standard Coil Cascade Tuner prevents radiation
- Retrace Blanking Circuit allows you to raise the brightness without the annoying vertical retrace lines • Heavy duty front focus control • Automatic gain control potentiometer allows you to adjust the threshold sensitivity as low as 4 microvolts & still keep the full 4MC band width
- Improved sync amplifier • Improved automatic brightness control • Set aligned for 40 MC. New Ham band will not interfere • Improved fused high voltage power supply gives full 14.5 KV under load • Will handle all picture tubes up to 24 inch with full sweep • Improved video amplifier has a gain of 40 • All moulded plastic condensers give long life & trouble-free operation • Easily adapted to new

UHF stations in 2 minutes by just changing a strip in the tuner • Extra heavy duty power transformer with large safety factor • 6CB6 tubes in Video IF to give full gain • Extra filtering in power supply for hum & ripple free operation • Color connection on chassis which is adaptable to the cathode follower circuit of color converter • Phono Connection & switch on chassis allows you to play your phonograph or tuner through the built-in 10 watt hi-fidelity amplifier • Extra heavy duty focus coil, which runs cool • Full focus cosine yoke.

SUPER 630 DX
30 Tube Chassis
Standard Coil Cascade
Tuner, 12" RCA Hi-Fi
Speaker, Fed. tax incl.
\$154.95

Complete Service
Manual For "630FA"
or Super 630DX—\$1

**OVER 100 BARGAIN-PRICED
CABINETS, TV & AUDIO IN-
STALLATIONS . . .** Send for
FREE folder and price list. Full
line table models, consoles, con-
solettes and TV-Radio Phono
combinations. Many styles. Ma-
hogany, blonde, etc.

**SEND FOR FREE NEW TV
PARTS & HI-FIDELITY
EQUIP. CATALOG**

**TV TUBE EXTRA
STANDARD BRANDS
FACTORY NEW**

1ST QUALITY—GUAR. 1 YEAR

17BP4 \$27.95	21" TV tube \$39.95
20" TV tube 34.95	24" TV tube 64.95
Ring & Sleeve for 24" Tube \$7.50	
TV Gold Plastic Masks	
16" and 17" \$4.95	24" \$14.95
20" and 21" \$7.95	

All merchandise is brand new, factory fresh & fully guaranteed. Mail & phone orders filled upon receipt of certified check or money order for \$25 as deposit on TV chassis, 20% on other items. Balance C.O.D., F.O.B. N. Y. Prices & specifications subject to change without notice. No Fed. Taxes to pay. Prices lower than OPS Regs.

AIREX RADIO CORP.

171 Washington St., N. Y. C. 7, N. Y.
Phone WOrth 2-4029

BC 453

. . . 190—550 KC. Receiver, complete with DM32 28V. Dynamotor; 1 RF and 2 IF Stages, BFO and AVC; 12A6 Audio Output; LIMITED NUMBER in A1 Shape. ORDER IMMEDIATELY. **\$19.95**

OUTSTANDING "BUYS"
from



ASSOCIATED INDUSTRIES, Inc.

AN/ARC-4

Terrific crystal-controlled, 4-channel, 100 to 150 Mcs. receiver-transmitter, 12 or 28V. power input, originally used plane-to-ground and plane-to-plane. Receiver has 1 RF and 3 IF stages. Cost U.S. GOVT. HUNDREDS. Excellent shape, like new. (Less dynamotor) **\$27.50**

SEMLER BUYS & SELLS
Semler Pays TOP Buck
for electronic equipment.

PHONE COLLECT if you have TS 12, TS 13, TS 25, TS 35, TS 45, TS 62, TS 117, TS 120, TS 146, TS 147, TS 148, TS 155, TS 174, TS 175, TS 239, TS 251, TS 268, TS 375; WRITE on other items.

20% Deposit required on purchases; balance C. O. D.

NC 100



Like new 5-band communications receiver; 1 band 200-400 KC.; 4 continuous bands from 1300 KC to 31 Mcs. Power input: 110V-60 Cycles. BFO & Noise limiter. S meter. Separate RF & AF Gain controls; 1 RF and 2 IF Stages. A HONEY of a set, at LESS than the **\$69.50** cost of the tubes!

6855 Tujunga Ave., North Hollywood, Calif.
Phone: STANley 7-5458

SMASH SALE!

SUPREME TEST EQUIPMENT

MODEL 600 TUBE & SET TESTER

SUPREME'S Time Tested Emission Tube Tester with all Multi-meter functions—Battery Tester (including the 47.5 volt. Sockets for all tubes (including nine pin) and a spare. **METER**—7 "Clear Plastic. Over 6" of calibrated scale plus mirror for accurate readings. **FLEXIBLE**—SUPREME'S Patented Filament Return selector switch insures only one socket for each type tube. **ROLL CHART**—Illuminated—double width—ample room for all tube ratings. Plus one year free tube setting service. **MULTI-METER RANGES**—Operate at the touch of a button. **CASE**—Metal in beautiful Hammer-rod finish with removable cover, new type leather carrying strap. **DC VOLTS**—7 ranges of 0.5/1.0/5.0/25.0/50.0/100.0/250.0 volts. Lowest reading of .1 volts. All ranges 1000 ohms per volt. **AC VOLTS**—4 ranges of 0/10/50/250/500/1000/2500 volts. Rectifier guaranteed as any other part. Double bridge circuit affords maximum of scale linearity and rectifier protection. **DC CURRENT**—7 ranges: 0/100 microamperes 1/5 10/50/250 and 1000 milliamperes and 1/10 ampere. Lowest reading 1 microampere. All shunts wire wound. **OUTPUT VOLTS**—4 ranges of 0/5/10/50/250/500/1000 volts. Ideal for receiver alignment. No ext. transformer. **OHMMETER**—5 ranges of 0/200/20,000/200,000 ohms and 2-20 megohms. Center scale of low range 3.5 ohms. Lowest reading 0.1 ohms. Ideal for checking low resistance coils such as voice coils and oscillator coils. **BATTERY TESTS**—Provides proper loads for most commonly used A and B portable batteries. **POWER SUPPLY**—100-130 volts—30/60 cycles. Special voltages and frequencies on request. Note: Test leads furnished with this instrument. Size—11" x 15" x 6 1/2". Shipping Weight—20 pounds. Regular Net Price \$117.50. **SPECIAL ONLY \$89.50**

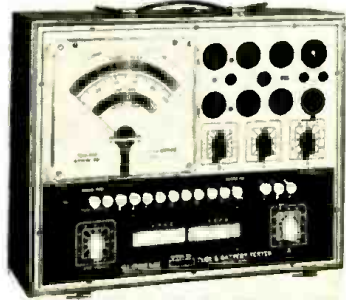

In Canada order from: CANADIAN RADIO SUPPLY, 262 Queen St. W. Toronto, Ontario.

MODEL 616 TUBE & BATTERY TESTER

CHECKS AM FM TV RECEIVING TUBES AND PORTABLE RADIO BATTERIES. The Supreme Model 616 cannot be beat for EFFICIENT bench or counter tube testing. Minimized obsolescence by use of Supreme patented element selector system. Socket facilities for all AM, FM and TV receiving tubes. **ILLUMINATED ROLL CHART** with hundreds of types listed. **TUBE SETTING DATA** on future tubes supplied by Supreme as they come into use. Quality test conditions for both tubes and batteries on "Menther-rod" scales of beautiful BIG SEVEN INCH FULL VISION METER. Non-breakable window. Also checks portable Universal PHONO LOGAN. Tests batteries with rated voltages of 1.5, 1.2, 0.45, and .90 volts. Hammer-rod finished metal case with detachable cover. Approx. dimensions 11 x 15 x 6 1/2 inches. Shipping weight 20 pounds. Regular Net Price \$87.50. **SPECIAL ONLY \$69.50**

OLYMPIC ELECTRONICS SUPPLY

DISTRIBUTORS

1440 W. OLYMPIC BLVD. • LOS ANGELES 15, CALIF.

EXPERIMENTERS SPECIALS

1 RPM MOTOR
115 volts, 60 cycles. Synchron model 600. Use for timing devices models, displays, gadgets, etc.
Stock No. R-5
Price **\$2.95** each

FILTERED OUTPUT DYNAMOTOR AND SPARES
Model EN-2. 12 volts DC input @ 2.2 Amps. Filtered outputs of 150 v. DC at 0.040 Amps and 3.0 v. DC at 4 Amps. 10 ft. cable with battery clamps. Spare capacitors and chokes, etc.
BRAND NEW.
Stock No. R-111

A bargain @ **\$17.50** each

AMPERE DEMAND METER
Stewart Warner-748A. Indicates up to 20 Amperes long time average current drain. High time lag—follows heating effect of supply transformers. Use to check motor and line overload as well as peak average demand. Indicating average and average peak recorder pointers.
Stock No. R-119
Special @ **\$3.95** each

Tachometers—Stewart Warner—0-2000 rpm \$5.95 each.
Tachometers—Stewart Warner—0-4000 rpm. \$6.95 each.
Mercury Switch—711 to actual 1/2 Amp. 4 for \$2.00.
CIB Thyatrons—1 Ampere rating Special. \$4.25 each.
Plastic Box—12 compartments—10 1/2" x 1 1/2" \$1.49 ea.
Plastic Box—18 compartments—10 1/2" x 1 1/2" \$1.49 ea.
Plastic Box—18 compartments—8 1/2" x 1 1/2" \$0.66 ea.
Write for free catalogue of Electronic, Aircraft, Hydraulic, and other equipment. See January Radio and Television News for our Motor Adapter Special.
Minimum order \$2.00. F.O.B. Paterson, N. J.

Electro Devices

INCORPORATED

247 BROADWAY PATERSON, N.J.

New TUBES

Guaranteed	Standard Brands
0A2 \$1.00	6AJ5 \$1.95
0A3 VR75 1.10	6AKSW 1.50
0B2 1.40	6ALSW 2.00
0B3 VR90 1.50	6AN5 3.95
0C3 VR105 1.00	6AN6 2.75
0D3 VR150 1.00	6AR6 2.25
1A2 1.25	801 11.95
1B22 2.25	808 2.75
1B23 8.95	813A 34.95
1B28 West 16.50	813 4.45
1B27 14.50	817 1.45
1B32 2.10	845 8.50
1N21B 1.25	852 19.95
1N22 1.25	861 3.75
1N23A 1.25	861 19.95
1N23B 3.50	868 53.90
1N28 1.50	6F4 4.50
1N40 8.50	6J4 6.95
1N55 2.75	6K4 3.95
1N58A 1.50	15E 1.25
1N63 2.39	15R .69
175GT 9.95	250R 8.95
2C40 25.00	250TH 20.00
2C43 15.00	304TH 7.95
2C44 4.95	307A 4.25
2C52 4.95	350A 5.95
2D21W 2.49	350B 5.95
2K22 39.50	388A 1.49
2K23 39.50	393A 8.95
2K24 32.00	394A 8.95
2K28 32.00	417A 8.50
2K29 23.95	423A 4.50
2K41 110.00	434A 19.95
2K45 110.00	446A 1.19
2K48 Write	450TH 3.50
2X2 9.95	464A 10.95
3A4 .65	60CX 5.95
3A5 .85	701A Write
3B23 4.95	702A 2.75
3B24 4.95	703A 4.95
3B24W 7.50	707B 14.95
3BP1 3.50	715R 8.95
3C22 8.50	717A 8.95
3C24 24G 1.50	721A 2.95
3C27 2.75	722A 1.95
3C33 9.50	724R 2.75
3C45 14.95	730A 25.00
3DP1 3.95	750TL 3.25
3E29 1.95	802 3.95
3FP7 1.95	804 10.95
3GP1 3.95	807 1.59
3P7 3.95	807W 9.95
4B24 6.95	809 5.95
4-125A 25.00	810 10.95
4K150A 22.50	811 2.90
4X500A 100.00	812 2.90
5B1 4.25	812 6.026
5B11 4.25	812 2.25
5C22 35.00	812 4.95
5E29 19.95	812 1.95
5FP7 1.95	50-15 55.95
5GP1 4.50	50-20 10.00
5R4CY 1.50	50-32 12.00
6G6 1.10	7-30 9003
6AC7W 2.75	12-20 9004
	12-32 9004
	100-20 9006
	100-20 9006
	666 12.50

YOUR SURPLUS WANTED
We pay Highest Prices!

Vacuum Capacitors

Thousands of other receiving and transmitting types in our stock. If you don't see it listed, ask for it. Send cash with order and save C.O.D. charges.

J. S. H. SALES CO.

Dept. R-18, 7552 Melrose Ave., Los Angeles 46, Calif.

A reasonable amount of math may be included, but it must be remembered that the articles are slanted towards practical men, many of whom don't have time to "wade through" page after page of advanced mathematics.

Professional Journals: Articles or "papers" written for these magazines must be on a high academic level. Considerable math is permitted and often desired. Articles are generally concerned with new developments in fundamental research and, more specifically, with the derivation of new circuits and design methods.

2. **Pick Your Subject:** The prospective writer should pick a subject he knows well, but also one that will carry appeal to the readers of the chosen magazine. In general, commonplace subjects are to be avoided. While a top-notch author may be able to write and sell an article on "A Three-Tube Phonograph Amplifier," for example, the beginner will stand a better chance if he chooses a less common subject.

Above all, take care not to "borrow" from previously published material. To do so is not only poor taste, but may also be a criminal offense.

It is possible to write a number of articles on the same, or similar subjects, of course, but deliberate copying may cause legal action against the writer.

Timely subjects are especially good, but care must be taken that the material will not become "dated" in a few months. Often, an article may not be published until several months after acceptance. If the material cannot stand a few months' delay in publication without detracting from its interest, there is a good chance the article will not be accepted regardless of the quality or interest of the writing.

When writing for the general technical magazines, avoid subjects appealing only to very limited groups. To use an analogy, don't write articles appealing only to "one-armed paper-hangers with red hair."

3. **Preparing the Article:** Once the possible market (magazine) and the subject have been chosen, the article itself may be written. Here, again, there are certain basic rules to follow. Some authors work from an outline, preparing first a "rough draft," then second and third drafts and the final copy. Others prepare only a rough draft, followed by the final copy, thus permitting the first writing to serve both as outline and rough draft. The author generally prepares final copy directly, working from a preliminary outline.

However, until experience is gained in writing, it is suggested that both an outline and rough draft be prepared before starting the final article.

Avoid superfluous words. While some magazines pay on a "per word" basis, and others on a "space" basis, there is an increasing tendency to pay on the relative merits of the article

itself, regardless of length. Thus, a well-written 2500 word article on an interesting subject may result in a larger check than a longer and more wordy article on the same subject.

Articles must be typewritten and should be written on plain white 16 lb. or 20 lb. paper. Double-spacing and good margins are mandatory.

While an occasional error and correction in the body of the finished manuscript is permissible, if there are an excessive number of errors, the manuscript should be retyped.

When writing an article, good grammar is important, but letter-perfect grammar is not as important as an interesting and clear presentation of the written material. Thus, a stiff, cold, and very formally written article may stand less chance of acceptance than an easy-to-read and "straight-from-the-shoulder" style, even with an occasional minor grammatical error.

4. *Illustrations:* When writing an article, remember that the final published material should "look good" if the reader's interest is to be held. Page after page of the printed word may become boring.

Illustrations are especially important in the case of construction articles, where both sketches (schematic diagrams) and actual equipment photographs must be included.

In most cases, the magazines prefer to have any final drawings prepared by their own art staff in order to maintain a consistent style and quality. Therefore, schematic diagrams and other drawings may be submitted as pencil sketches. However, care should be taken in preparing the sketches so that the magazine artist or draftsman will have no difficulty in interpreting and redrawing the illustrations.

It is perfectly all right to use a straight-edge and compass to prepare the pencil sketches. An example of an acceptable diagram is given in Fig. 2.

Photographs must be suitable for direct reproduction. Small snapshots are definitely not acceptable to most magazines. Preferred are 7" x 9" or 8" x 10" glossy prints with good contrast. If possible, the photographs should be made by a commercial photographer and prints prepared "for reproduction."

Fig. 1 (right) shows a poor photograph of a small laboratory meter. It lacks contrast, is slightly out-of-focus, and is improperly lighted. Another shot, from the same angle and of the same instrument, is shown in Fig. 1 (left). Notice the superiority of the second photograph.

Avoid writing on or marking the photograph itself in any way. If it is necessary to identify parts or objects in the photograph, do so on a piece of tracing paper laid over the photo and secured to its back with rubber cement or Scotch tape.

5. *Submitting The Article:* Once the article is finished and "ready-to-go,"

at Last!



Once you make contact with a jobber or distributor who handles the complete line of Sangamo Type PL "Twist-Tab" electrolytics, you will never again have to "shop around" for odd sizes or capacities. Why? ... because the Sangamo line is the most complete in the industry.

Used by all leading manufacturers of TV sets, Sangamo Type PL "Twist-Tab" electrolytics are exact replacements. They assure long life and dependable performance at 85° C and under conditions of high surge voltages and extreme ripple currents often found in TV applications.



Ask your distributor for a copy of the Sangamo TV Replacement Catalog. It's easy to use and helps you choose the right replacement every time.

Deal with your Sangamo "Headquarters."

Those who know... choose Sangamo.



SANGAMO ELECTRIC CO. MARION ILLINOIS

3 easy STEPS TO BETTER TV INSTALLATIONS

with MOSLEY FLUSH SOCKETS



1. Get the PK Package (right)—contains everything needed to complete installation!

2. No outlet box needed. Mounting brackets fit any type wall—easily, quickly installed!

3. Here's a neat, efficient installation. TV owners like the convenience of plug-in connection to lead-in!

Available at Radio Parts Jobbers

MOSLEY Electronics

2125 Lackland Rd.
Overland, Missouri

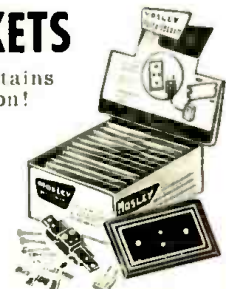

SUPER SENSITIVE RELAY BK-7-B

Single pole, double throw. Coil 4000 ohms. Sensitivity accurately adjustable. At 5 milliwatts (1 milliwatt, 2 volts) and from 5 to 40 on scale the sensitivity decreases linearly to 1.5 ma (9 milliwatts, 6 volts). Thousands of uses: telemetering, voice-operated or capacity operated or thermocouple operated circuits, relay circuits, etc. Fully enclosed. 1 1/2" x 1 3/4" x 1 1/2" deep. Weight, only 1.75 oz. With contact inspection door and screwdriver adjustable stationary contacts.

BRAND NEW, only \$1.95 each (plus 15c mailing charge anywhere in U.S.)
10 for \$17.50, postpaid

A SENSITIVE RELAY!

Closes at 4 to 5 ma. (Extra set of SPST contacts for additional sequences, close at 6.5 ma.) Coil 6000 ohms. Sensitivity easily altered by bonding limit arm or changing spring. Only 1 1/2" x 2 1/4" x 1 3/4" overall. Dozens of applications, and offered at a "stock up" price. Removed from clean equipment.

ONLY 98c each, 3 for \$2.75
Boxed, reconditioned, like new... \$1.69

12 CHANNEL T-V TUNER

Complete front end, famous make "Silver Circle." Furnished with original factory instructions, less tubes, dozens of tubes; receivers, converters, etc. The TV bargain of the year for holidayers, amateurs, students. These are factory selected for minor damage. TUBE & TUBE SHIELD kit for this tuner, ONLY 98c, 3 for \$2.50

RF AMMETER, 0-4 amps, 2" round, thermocouple type, has 1" scale spread between 1 and 3 amps. NEW \$3.95

NOVICE 80 METER CW XMTR

This is the 4-5.3 MC Command xmtr which may be easily converted to Novice operation. We furnish complete instructions, including keyed photos and before-and-after schematics.

EXCELLENT, with tubes... \$8.95
5.3 to 7 Command Xmtr, with tubes, converters, etc. The best requires two more conversion steps... \$7.95

6-9.1 MC Command Receiver, EXCELLENT, with tubes... \$6.95

274N PLUG, 7-prong male plug to fit back of command rxvrs. and xmtrs. This is the same plug as used in the racks. NEW, each 21c five for \$1.00
Local Control Adjuster Parts for 274N or AIC-5 rxvr. Exact pot. switch, knobs, etched plate, and instruction data. Ready to mount... \$1.29
SPRING TUNING KNOB... \$1.75

12 VOLT COMMAND DYNAMOTOR

For receivers SCR-274N, AIA, AIC-5. Plugs onto rear end. 250 V, 60 ma. Guaranteed good condition. Less plug-in base... \$7.95
5.95

A VIBRATOR BUY, 6 or 12 volts, self-rectifying, hermetically sealed. Can take high overloads. With socket and schematic. Specify volts. ONLY 89c

ANTENNA MAST SECTIONS, NS-49, 50, 51, 52. 39c each. New, original packing.

PHASE SPLITTER, or low-level mixer, or hybrid, or push-pull unit. Built-in winding, and excellent 1:1 to any other; essentially flat 100-15,000 CPS. BRAND NEW, ONLY... 69c

VINYLLITE SPAGHETTI, clear, 0.166 ID, three 2 1/2" lengths for only... 96c

BUILD TV-FM-AM SWEEP GENERATOR

(See Dec. 1951 Radio & TV News)
Now you can build a "VERSATILE" SWEEP FREQUENCY GENERATOR! We've got a few more of those vital APN-1 magnetic units. With reprint of the article... \$6.95

PRECISION CALIBRATED TUNER

Build a Q-meter or an audio oscillator, a signal generator, a VFO, an ultra-stable receiver, or you name it! Lab-standard accuracy and stability. 3-gang condenser assembly with 4" precision dial etched 1.5-12 mc in 3 bands plus a reference scale. Triangular plastic hairline indicator; 40:1 ratio drive assembly, all gears spring-loaded double-section. Has tuning lock. Plates are two single speed 250 uf, and one double-speed 250 uf section. Use double section to eliminate drift. ONLY \$4.95

BROADCAST BAND & AERO

MN-26-C Remote Controlled navigational direction finder and communications receiver. Manual DF in any one of three freq. bands, 150 to 1500 KC. 24 V. Self-contained dynamotor supply. Complete installation, including receiver, control box, loop, azimuth control, Left-Right Indicator, plugs, loop transmission line, and flex. shafts. BRAND NEW, ORIG. PACK... \$69.50

SUPER HI-FI HEADSET BUY!

Uses annular-grooved plastic fibre cones with voice coils as in speakers, and a special circuit to obtain spacing for correct acoustical load. Gives finest music reproduction, flat far beyond upper and lower limits of auditory perception. Pair in series has measured impedance of 600 ohms at 1000 cycles, obtained with built-in high quality transformers. However, severe mismatching makes no apparent difference. Far superior to crystal phones. Manufacturer's net price is \$45.00 per pair! (Each unit can also be used as high quality dynamic mike with 300 ohm output impedance.) They came to you checked out with freshly laundered chamolais pads in cellophane bag. ONLY \$7.95

PORTABLE POWER KITS

1. Includes 2 volt, 20 AH wet cell, lightweight transparent plastic, flurite separators, 3 ball hydrometer, 4" x 3" x 3 1/2" high shippable dry cell, 2 volt charger, chronus vibrator, no tube needed, also 2 volt charger, 115 v 50/60 cy in. This high quality unit uses step-down transformer and dry disc rectifier, with pilot lamp in output to indicate and regulate charging rate. With eyedropper type battery filler and instructions. ALL 4 ITEMS, BRAND NEW... \$4.95
2. Six volt vibrator kit. Vibrator plus non-sens transformer with two outputs: 345 v, 145 ma for plates, 15 v for bias. With schematic. BRAND NEW \$2.75

OUTPUT TRANSFORMER, 5000 ohms input to TWO outputs, 300 ohms or 3.5 ohms. Use as output for 12A6, 6V6, etc. or to match speaker or headset. NEW, potted, shielded... 79c

EASY MONEY!

We're still buying surplus gear. Tell us what you've got, its condition, and your price. If we like it you'll get our check quick.

G. L. ELECTRONICS

905 S. Vermont Ave., Los Angeles 6, Calif.
All Prices F.O.B. Los Angeles. Calif. Buyers Add Sales Tax
SEND FOR OUR LATEST FLYER.

determine the number of words in the article, and give this information along with the number of illustrations and photographs and the author's full name and address on the title page (even if a pen name is used). Some magazines also like the author's name and the title of the article repeated on each succeeding page.

Mail the article in a manuscript type envelope—don't fold the article and send in a conventional envelope, even if the article is short. Articles should *always* be mailed flat. If photographs are included, chipboard or corrugated board stiffening should be included to minimize bending or folding.

If the material is a construction article, be sure to include a complete parts list. Any "special" parts should be indicated, along with the manufacturer's name and type number.

A self-addressed and stamped envelope should be included for the return of the manuscript should it not prove acceptable for use. If this is not done, the article may not be returned to the author if rejected.

If the article is rejected, don't be discouraged. It may only indicate that the magazine already has an article on hand covering the same subject. The article may still be submitted to other magazines and may be sold on the second try. Try and try again!

However, don't submit the same article to more than one magazine at the same time. Both publishers may accept the article, resulting in undue embarrassment all around.

Often, the editor of the magazine will send a letter of general criticism on the article. In such cases, a revision of the article may turn otherwise wasted work into a salable effort. Accept the criticism in the same good spirit in which it is offered, and profit by the greater experience of the editor.

Good Luck! Probably every technician and engineer in the nation has, at one time or another, completed a piece of work which would be a suitable subject for a technical article. Use that subject, follow the general hints given, and write that technical article!

You will find two thrills awaiting you, and it's difficult to tell which is the greater—receiving that first check in the mail, or seeing *your* article in print.

Like many states on this side of the border, the Province of Quebec, Canada, recognizes the emergency value of amateur radio and issues special call-letter automobile registration plates to amateurs.



Special Get-Acquainted Offer!
TUBES AND ACCESSORIES
60% - 70% OFF TOP STANDARD BRANDS ONLY. 100% GUARANTEED BUY NOW AND SAVE!

024	\$0.59	6AUG	.69	12K7	.79
1B3	.93	6BE6	.69	12SA7	.66
1Y4	.79	6BG6	1.92	12SK7	.66
1X2	1.16	6BJ6	.64	12SQ7	.53
5Y3GT	.39	6K6	.64	35Z5	.68
5V4G	.49	6SN7	.69	50L6	.68
6AG5	.89	6W4	.63	7C4	.39

CONDENSER SPECIALS

20-20 MFO, 150V	29c	50 MFO, 150V	500
40-40 MFD, 150V	.39c	MFD, 5V (2 in one unit)	.49c
50-30-20 MFO, 150V	.49c	6000 MFD, 15V	.99c
150V	.49c	Mallory	.99c

60" DEFLECTION YOKE... 50c ea.
70" DEFLECTION YOKE... complete with made & all necessary resistors & condensers wired in... \$2.95 ea.
RCA FLYBACK TRANSFORMER No. 75585 1.49 ea.
UNIVERSAL TYPE FLYBACK (Regular \$1.50) SPECIAL 2.50 ea.
CRT TUBE REJUVENATOR... 1.95 ea.

SPEAKERS

2 1/2" P.M.	50.69	5" P.M.	\$1.39
4" P.M.	1.19	6" P.M.	1.79

5" 62 OHM TV Speaker... 99c
WINDOW ANTENNAS: Flying V Antenna 2.85
Conical B63... 3.75
Conical B61... 4.75
Folded B61... 5.75
ROOF ANTENNAS: 3 1/2" Wall Bracket .29
100 Ft. 300 Ohm Lead TV Wire, Best Grade 1.89

FREE CHEATER CORD WITH EVERY ORDER!
Write today for FREE CATALOG & MONTHLY SPECIALS on tubes, accessories and equipment.
20% deposit with order, balance C.O.D. All merchandise subject to prior sale. F.O.B. N.Y. Prices subject to change without notice.

ADAMSON ELECTRONICS CO.
589 East Tremont Ave., N.Y. 57, N.Y. Phone: CY9-0979

YOUR OWN ELECTRONIC MUSIC
How to build and play my latest model electronic organ without a knowledge of music.
Send stamp for details
JIM KIRK, W6DEG,
1552 Church St., San Francisco 14, Cal.

ADAMSON'S T.V. RADIO SERVICE LIBRARY

HERE IS LATE INFORMATION IN A HANDY FORM FOR RADIO & TELEVISION REPAIRMEN, SERVICEMEN & STUDENTS



2 VOL. \$6 COMPLETE \$1.00 PAY ONLY 1 MO.
IT PAYS TO KNOW!

AUDELS T.V.-RADIO SERVICE LIBRARY presents the important subjects of Modern Radio, Television, Industrial Electronics, F.M. Public Address Systems, Auto, Marine & Aircraft Radio, Phonograph Pick-Ups, etc. Covers Basic Principles—Construction—Installation—Operation—Repairs—Trouble Shooting. Shows How to get Sharp, Clear T.V. Pictures, Install Aerials—How to Test. Explains Color Systems & Methods of Conversion. 1001 Facts—Over 1260 Pages—625 Illustrations—Parts & Diagrams—Valuable for Quick Ready Reference & Home Study. Tells How to Solve T.V. & Radio Troubles—Answers T.V. & Radio Questions.

Get this information for Yourself.
7 DAY TEST—ASK TO SEE IT!

MAIL ORDER

AUDEL Publishers, 49 W. 23 St., N.Y. 10
Mail AUDELS T.V. Radio Service Library 2 Vols. \$6 on 7 days free trial. If O.K. I will remit \$1 in 7 days and \$1 monthly until \$6 is paid. Otherwise I will return them.

Name _____
Address _____
Occupation _____
Employed by _____

International Short-Wave
(Continued from page 132)

Nacional;" heard from interception 0745 past 0900. (Kary, Pa.) XESC, 15.205, noted 1700 with call in Spanish. (Baitzel, N.J.) XEBT, 9.625, noted around 1300-2100 in Spanish only. (Simpson, Kans.)

Monaco—Radio Monte Carlo noted on the new 7.350 channel (replacing 9.785) in parallel with 6.035 at 0200, strong level in French, commercials interspersed with music. (Pearce, England, others)

Mozambique—The Portuguese Service from Lourenco Marques is noted on 15.285A some days as early as 1515, good level; noted closing 1515 with "A Portuguesa." (Niblack, Ind.) Heard in Britain on this channel from 1045A opening. (Pearce) Lourenco Marques was noted on a channel of 4.825 recently at 1345; was found another day near 4.865 with news in Portuguese 1300, says Pearce.

Lourenco Marques is now on "summer" schedule in English 2300-0200, 11.742, 4.916; 0200-0800, 11.742, 9.766, 7.262; 0800-1200, 11.742, 4.916; 1200-1500, 9.766, 4.916, 3.490; still announces 11.761 but has been measured 11.742; Portuguese Service is 0000-0100, 9.804AV, 4.830; 0430-0630, 9.804AV, 8.005, 7.216; 1100-1500, 4.830, 15.285 (Ridgeway, South Africa)

Nicaragua—Granada, 7.850A, heard 1800 with strong signal in Spanish. (Chatfield, N.Y.) YNBH, 6.015. Radio Panamericana, was heard recently around 2215 with news in broken English, interspersed with short musical interludes and short Spanish announcements. (Stark, Texas)

North Korea—In answer to a query by your short-wave editor, Hahn Ki Syun of Radio Korea, Republic of Korea, says the Communist radio at Pyongyang, North Korea, is using frequencies of 970 kc., 1080 kc., 4.440, and 6.230 (varies). Rosenauer, Calif., says the latter channel now appears to be 6.275A, heard 0950 with speech in Korean, good level.

Northern Rhodesia—Lusaka, 4.826, noted 1300 with BBC news relay, signing off 1400 with "God Save the Queen." (Pearce, England)

Norway—Oslo, 11.735, noted signing on to South America 1800. (Pearce, England) Heard on 15.175 in Norwegian at 1100. (Hoffman, N.Y.)

Pakistan—Radio Pakistan, 17.715A, noted with news 0330; to Indonesia on 15.270 and 17.835, 0630-0715. (Pearce, England) Latter transmission noted in New York. (Mast) Dacca, 4.807, heard in Britain 1110 with native program, fair level, CWQRM. (Catch) Noted on 9.647A from tuning 0750 to close-down 0815; no English; good signal. (Ferguson, N.C.)

Panama—HOJA, 9.645, Chitre, Radio Provincias, is fair from 0600 past 0700. (Kary, Pa.) HO50, 5.995.5, noted 0558 signing on with S7 signal. (Oskay, N.J.) HOLA, 9.505, Colon, on Satur-

SPEED UP YOUR SERVICING WITH "STANCOR TRIOS"



(Groups-of-three most frequently used Stancor TV Replacement Components listed below)

Don't Waste valuable time waiting for a replacement—carry it in stock!

STANCOR CHOKES	C-2325 C-2326 C-2327	COVER 70% of your TV REPLACEMENTS*
STANCOR DEFLECTION YOKES	DY-1 DY-8 DY-9	COVER 70% of your TV REPLACEMENTS*
HORIZONTAL DEFLECTION OUTPUTS	A-8127 A-8128 A-8130	COVER 45% of your TV REPLACEMENTS*
VERTICAL DEFLECTION OUTPUTS	A-8112 A-8115 A-8123	COVER 70% of your TV REPLACEMENTS*
VERTICAL BLOCKING OSCILLATORS	A-8111 A-8121 A-8122	COVER 65% of your TV REPLACEMENTS*

* Based on a statistical analysis of all replacement recommendations in the Stancor TV Replacement Guide.

Stancor Transformers are listed in HOWARD W. SAMS' Photofact Folders and JOHN RIDER'S Tek-Files.

FREE!

Stancor's new 24-page catalog listing over 475 transformers and related components for all types of electronic applications. Includes over 100 TV units. Get your free copy from your Stancor distributor or write Stancor direct!



STANDARD TRANSFORMER CORPORATION

3584 ELSTON AVENUE, CHICAGO 18, ILLINOIS



RCA INSTITUTES, INC.
A Service of Radio Corporation of America, 350 West 4th St., New York 14, N. Y.

OFFERS COURSES IN ALL TECHNICAL PHASES OF RADIO, TELEVISION, ELECTRONICS
Approved for Veterans
Write Dept. RN-53 for Catalog



SOUND POWERED PHONES RCA-MI-2454

Complete with 24' of Rubber Covered Wire. **NEW EXPORT PACKED** Shipping weight 6 lbs.

\$9.95 per set 2 for \$19.50

EACH SET GUARANTEED Brand New. Gov't Cost \$42.00

RCA MI-2475 SOUND

POWERED PHONES

complete with 22' rubber covered cable press to talk switch are light weight, the mic is on a swivel boom that can be moved to any position in front of face. Cost \$62 ea.

BRAND NEW Price **\$14.95** Ea. Include postage with order.

McCONNELL'S 3834 Germantown Ave. Phila., Penna. RA 5-6033

ARKAY
world's finest radio kits
Write for free Brochure
RADIO KITS, INC., 120 Cedar St., N. Y. 6

Superior's Model 660-A NEW A. C. OPERATED SIGNAL GENERATOR

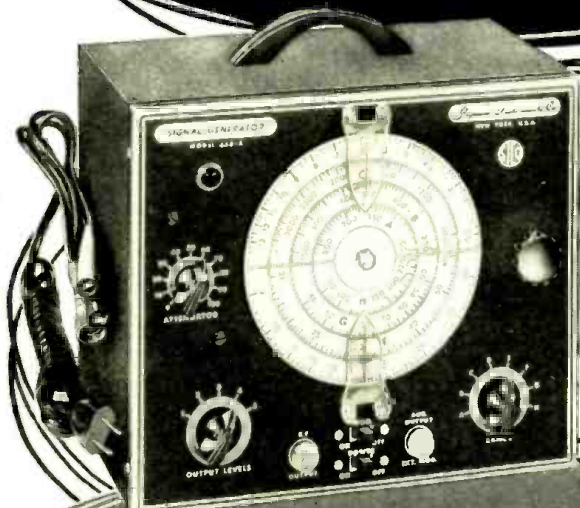

PROVIDES
COMPLETE COVERAGE
FOR A.M.-F.M.
and TV ALIGNMENT

\$42⁹⁵

DEALERS NET PRICE

Write Dept. RN-2 for
catalog of complete
line.

**AT YOUR
RADIO
PARTS
JOBBER**



Manufactured and Guaranteed by
SUPERIOR INSTRUMENTS CO.
227 Fulton Street, New York 7, New York

AC-DC MUSIC AMPLIFIER

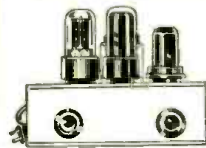

Volume and tone control.
1.5 w. output.
See your jobber.

MICHEL MFG. CO.
227 N. Water St.
Milwaukee 2, Wis.

LEARN TELEVISION

ELECTRONICS and RADIO
Engineering Laboratory and Classroom
Training. Day and Evening Classes.
Write for illustrated Catalog

ELECTRONICS INSTITUTE, Inc.
21 HENRY, DETROIT 1, MICH.



Standard Brands

Individually
Boxed

TUBES

PRICES SLASHED

Brand New—Standard Warranty

0Z4S .54	5Y3GS .39	6BA6S .54	6F6GTS .54	6W4GTS .54	12SQ7GTS .63
1B3GT87	6AB461	6BA776	6H657	6W6GT65	198G6G . 1.75
1L445	6AC798	6BC565	6J5GT54	6X449	19T887
1R565	6AC564	6BE657	6J676	6X5GT43	25AV5GT 1.05
1S476	6AG71.05	6BF569	6K6GT54	12AT647	25BQ6GT 1.08
1S564	6AH61.05	6BG6G1.69	6L6GA1.05	12AT776	25L6GT . . .54
1T464	6AK594	6BH672	6SA7GT61	12AU765	25Z6GT . . .49
1U469	6AL554	6BJ661	6SC776	12AV788	35B561
1U561	6AO554	6BL798	6SH758	12BA654	35C561
1X2A79	6AO649	6BN672	6SH758	12BE658	35L6GT . . .61
30Q475	6AR554	6BO71.08	6S1764	12BH782	35W441
30Q5GT72	6AS562	6C449	6SN7GT73	12S47GT62	35Z5GT . . .39
35465	6AT646	6C557	6S7GT49	12S7GT61	50B561
3V465	6AU654	6CD665	6T887	12SH749	50C561
5T41.31	6AV5GT1.05	6CD6G1.82	6V6GT57	12SK7GT63	50L6GT . . .59
5U4G54	6AV646	6E576		12SN7GT73	117Z354
5V4G98	6B4G98				

Many other types equally low priced—include all your tube needs with your order.

One of the largest stocks in the country!

Min. Order \$25.00. Terms: 25% with order, balance C.O.D.

All prices subject to change without notice, F.O.B. New York City. Mail order division.

TeleVision Materials Corp.

125 Cedar St., New York 6, N. Y. • COrlandt 7-4307

days has "late dance music" to 0200 (Sun.) (Vilella, Md.)

Paraguay—The outlet on 6.270A is best before 2100. (Stark, Texas) Is ZPA1, Asuncion.

Peru—*Radio America*, OAX4W, 9.405A, was noted a recent Sun. at 2150 with American recordings and announcements in *English*; mentioned this as a request program; may be weekly feature. (Niblack, Ind.) Heard signing off 0050. (Sutton, Ohio) *Radio Nacional del Peru* is now using OAX4T, 9.550A, to 1800, then changes to OAX4Z, 6.082A. (Vilella, Md.) Latter channel heard closing down 0030 with announcements in *both Spanish, English*. (Saylor, Va.)

Philippines—*Radio Free Asia* relay, 6.110, Manila, noted at good level with news 0920. (Balbi, Calif.) Far Eastern Broadcasting Co., 17.805A, Manila, a new channel, noted 0430 with identification in *English*, wiped out by Rome coming on air 0445; on 11.855 at 1030 with *English* identification, then "Bringing Christ to the Nations" in native dialects. (Pearce, England) DZH7, 9.73, noted 0750 at excellent level. DZH2, 9.64, Manila, heard at weak level 0452. (Ballou, Calif.) DZI4, 6.110, Manila, noted with weak signal 0613. (Oskey, N.J.)

Portugal—Lisbon, 6.374, noted 1900-2005. (Patterson, Ga.) CSA32, 11.995A, opens 1230 in Portuguese. (Baitzel, N.J.) *Radio Sweden* says a new transmitter at Coimbra is testing daily 1300-1500 on 7.020A.

Portuguese India—*Radio Goa* is scheduled 2100-1230 on 6.025, 9.610; has *experimental* transmissions on 3.425. (WRH) Heard on 9.610 in Hindi 0930; Portuguese 1000; *English* 1030; has guitar interval signal; closes 1230; good level in South Africa.

Reunion—St. Denis, 7.168, broadcasts 0900-1200 (Wed. to 1330, Sat. to 1400). (ISWC, London)

Sao Tome—CR5SB, 17.683A, is noted Sun. with strong signal 0700-0800, musical session with Portuguese announcements. (Ridgeway, South Africa)

Sarawak—Scheiner, N.J., has received this information direct from the Information Officer, Sarawak Information Service, Kuching, Sarawak: "The broadcasting station here does not yet exist. Our plans are made, our money voted, and the chief members of our staff engaged, but the station will not be completed and in operation before the end of 1953. In the beginning, it will be operated as a department of this office." Promised further information on developments.

Saudi Arabia—Djeddah, 7.245, noted signing on around 2249 with 8-note signature tone, march, then Arabic music; signal is sometimes S8. (Brown, N.Y.) Noted parallel on 6.102A. (Stark, Texas; Bellington, N.Y.)

South Africa—SABC, 9.870, noted 1400-1500 with *English* program, fair level; QRM at times. (Chatfield, N.Y.) The African Service is radiated from a 5 kw. post office transmitter of the

radio telegraph station at Roberts Heights, 15 miles south of Pretoria; is beamed northerly 0330-0715 weekdays, 0330-0845 Sat. and Sun. on 15.230; 0900-1130 daily on 11.937, and 1145-1505 over 9.870; *English* on Tue., Thur., Sat.; Afrikaans, Sun., Mon., Wed., Fri. (Ridgeway, South Africa) Johannesburg is using 9.680 now for its *new* South-west African transmission 2345-0130, 0315-0715, 0900-1405 (Sun. opens 0055). (*N.Z. DX Times*)

South Korea—Wada, Japan, confirms that Seoul's HLKA is using 9.555 in parallel with Pusan's HLKA on 9.735. The latter outlet is noted from as early as 0340 with Western classical music; commentary in Korean 0345, fair signal in Calif., reports Rosenauer. Measured recently 7.9342 by Ballou, Calif. Heard by Balbi, Calif., from around 0450; cannot hear the Seoul 9.555 channel, however.

Spain—*Radio Mediterraneo*, 6.995A, Valencia, noted strong 1315 tune-in. *Radio S.E.U.*, 7.088, Madrid, strong with call 1930, then popular music; *La Voz de Falange, Madrid*, noted on 7.380A at 1435, still on the air 1535. (Pearce, England) Malaga appears to vary in frequency, is now about 6.960, possibly slightly higher; some days becomes audible as early as 1445. (Kary, Pa.)

Sweden—*Radio Sweden*, 11.880, noted to North America with *English* 0700-0715, then in Swedish; heard with *English* on 9.535 at 2300. (Niblack, Ind.) Heard on 6.065 closing period to North America with *English* announcement 2000. (French, Mass.)

Switzerland—International Red Cross, 7.210, Geneva, recently was heard with test broadcasts in various languages, including *English*, at 0130-0230, 1630-1730. (Kary, Pa.; Pearce, England, others) Wants reports.

HER5, 11.865, noted 0945 with music, good level in N. Y. (Hoffman) Heard opening 1015A to Western North America on 9.535 at excellent level, parallel with (announced) 6.165, 7.21, 9.665, 11.865. (Bishop, Ohio)

Syria—Damascus, 11.913A, noted with news, in clear, 1720-1730 sign-off. (Black, Pa.)

Taiwan—BED7, 7.130A, noted at good level 0435 and again 0630. BED29, 6.095, is fair signal around 0630. (Ballou, Calif.) Taipeh is noted on 11.735 in Chinese dialects from around 0830 to 1145 when has had QRM from *Radio Nederland*; from 0930, BED7, 7.130A, is in parallel. Is good level in *English* on 15.235 at 2300-2400 when goes into Chinese. (Ridgeway, South Africa) BEC32, 9.778V, noted 0500 with *English* program, children's session; BED26, 10.080, heard 0830 with Western music, then Chinese news. (Sanderson, Australia)

Tangier—*Radio Africa* has returned to 7.126 after a brief move to 7.193A; noted with call 1515. (Pearce, England, others) VOA, 7.215A, noted 0830-0922; news in Arabic 0900; had announcements in *English*. (Maynard, Ky.)

Thailand—Bangkok, 7.105, strong 0914. (Ballou, Calif.) Strong signal on 6.24 and 15.625 from 0915 to closedown 1030 when gives call in *English*, then Thai. (Ridgeway, South Africa) Noted on 11.910A with chimes 0615, then news. (Sanderson, Australia)

Trans-Jordan—Ramallah has ceased broadcasts on short-wave. (WRH)

Trinidad—*Radio Trinidad* has news 0700 on 9.625. (West, Va.) Sent this schedule—on 9.625, 0430-1515; on 3.275, 1500-2200. (Levy, N. Y.)

Turkey—TAT, 9.515, heard with powerful signal to North America in *English* 1815-1900. (Machajewski, N. Y.)

Uganda—The station projected for Uganda will use 7.5 kw., to give complete coverage to this Central African colony; will operate in vicinity of 4.000; will not be completed for about a year yet. (Radio Amateur, London)

Uruguay—CXA10, 11.90A, seems to have settled down on 11.895A right atop *Radio Dakar*. (Bellington, N. Y.) Noted with strong signal 1850. (Gerran, N. Y.) CXA3 heard on *measured* 6.0755 at 2125; signed off 2201; announced "CXA3, Integrante de la Radiodifusoras Ariel." (Rastorfer, N. Y.)

USI (Indonesia)—In response to an inquiry, officials of *Radio Republik Indonesia*, Djakarta, explained—Ambon does not operate on 11.089 or in that vicinity as reported by listeners some months ago, but transmits *only* on 4.865. A new transmitter of 50 kw. has been put into service with test transmissions on 9.868A (is heard on *meas-*

BUILD 15 RADIOS

AT HOME ONLY

With the New Improved 1953 Progressive Radio "EDU-KIT" **\$19⁹⁵**

NOW INCLUDES

SIGNAL TRACER
and
CODE OSCILLATOR

- FREE TOOLS WITH KIT
- ABSOLUTELY NO KNOWLEDGE OF RADIO NECESSARY
- NO ADDITIONAL PARTS NEEDED
- EXCELLENT BACKGROUND FOR TELEVISION
- 10 DAY MONEY-BACK GUARANTEE



WHAT THE PROGRESSIVE RADIO "EDU-KIT" OFFERS YOU

The Progressive Radio "Edu-Kit" offers you a home study course at a rock bottom price. Our Kit is designed to train Radio Technicians, with the basic facts of Radio Theory and Construction Practices expressed simply and clearly. You will gain a knowledge of basic Radio Principles involved in Radio Reception, Radio Transmission and Audio Amplification.

You will learn how to identify Radio Symbols and Diagrams; how to build radios, using regular radio circuit schematics; how to mount various radio parts; how to wire and solder in a professional manner. You will learn how to operate Receivers, Transmitters, and Audio Amplifiers. You will learn how to service and trouble-shoot radios.

You will learn code. You will receive training for F.C.C. license. In brief, you will receive a basic education in Radio exactly like the kind you would expect to receive in a Radio Course costing several hundreds of dollars.

THE KIT FOR EVERYONE

The Progressive Radio "Edu-Kit" was specifically prepared for any person who has a desire to learn Radio. The Kit has been used successfully by young and old in all parts of the world. It is not necessary that you have even the slightest background in science or radio.

The Progressive Radio "Edu-Kit" is used by many Radio Schools and Clubs in this country and abroad. It is used by the Veterans Administration for Vocational Guidance and Training.

The Progressive Radio "Edu-Kit" requires no instructor. All instructions are included. All parts are individually boxed, and identified by name, photograph and diagram. Every step involved in building these sets is carefully explained. You cannot make a mistake.

PROGRESSIVE TEACHING METHOD

The Progressive Radio "Edu-Kit" comes complete with instructions. These instructions are arranged in a clear, simple and progressive manner. The theory of Radio Transmission, Radio Reception, Audio Amplification and servicing by Signal Tracing is clearly explained. Every part is identified by photograph and diagram. You will learn the function and theory of every part used.

The Progressive Radio "Edu-Kit" uses the principle of "Learn by Doing." Therefore you will build radios to illustrate the principles which you learn. These radios are designed in a modern manner, according to the best principles of present-day educational practice. You begin by building a simple radio. The next set that you build is slightly more advanced. Gradually, in a progressive manner, you will find yourself constructing still more advanced radio sets, and doing work like a professional Radio Technician. Altogether you will build fifteen radios, including Receivers, Transmitters, Amplifiers, Code Oscillator and Signal Tracer.

The Progressive Radio "EDU-KIT" Is Complete

You will receive every part necessary to build 15 different radio sets. Our kits contain tubes, tube sockets, chassis, variable condensers, mica condensers, paper condensers, resistors, line cords, selenium rectifiers, tie strips, coils, hardware, tubing, hook-up wires, solder, etc.

Every Part that you need is included. These parts are individually packaged, so that you can easily identify every item. Tools are included, as well as an Electrical and Radio Tester. Complete, easy-to-follow instructions are provided. In addition, the "Edu-Kit" now contains lessons for servicing with the Progressive Signal Tracer, F.C.C. instructions, quizzes. The "Edu-Kit" is a complete radio course, down to the smallest detail.

TROUBLE-SHOOTING LESSONS

Trouble-shooting and servicing are included. You will be taught to recognize and repair troubles. You will build and learn to operate a professional Signal Tracer. You receive an Electrical and Radio Tester, and learn to use it for radio repairs. While you are learning in this practical way, you will be able to do many a repair job for your neighbors and friends, and charge fees which will far exceed the cost of the "Edu-Kit." Here is your opportunity to learn Radio quickly and easily, and have others pay for it. Our Consultation Service will help you with any technical problems which you may have.

FREE EXTRAS IN 1953

- ELECTRICAL AND RADIO TESTER
- ELECTRIC SOLDERING IRON
- BOOK ON TELEVISION
- RADIO TROUBLE-SHOOTING GUIDE
- MEMBERSHIP IN RADIO-TELEVISION CLUB
- CONSULTATION SERVICE • QUIZZES
- TRAINING FOR F.C.C. LICENSE

The Progressive Radio "Edu-Kit" is sold with a 10-day money-back guarantee. Order your Progressive Radio "EDU-KIT" Today, or send for further information.

We pay shipping charges all over the world, if you send check or money order for \$19.95 with your order. On C.O.D. orders, you pay cost of delivery.

PROGRESSIVE ELECTRONICS CO.

497 UNION AVE., RN-15, Brooklyn 11, N. Y.

TOP TV SERVICE

REQUIRES

TOP Quality

COMPONENTS

and for
TOP QUALITY
ask for

Elmenco Paper Tubulars



That white, ceramic-cased paper tubular is appearing in more and more TV circuits as new models roll off the lines... your assurance that this unit excels those which preceded it.

Follow the lead of these manufacturers by offering your customers complete satisfaction with components which will require no further replacement during the life of their sets...

**Air-Tight,
Water-Tight,
Yet
Reasonably
Priced**

Just
Wire In
and
Forget.



And you can keep a stock of Elmenco Capacitors on hand without worry of deterioration on the shelf. They have unlimited shelf life.

Contact your local jobber for full information and ask him about our handy paper tubular kits.

STANDARD PAPER KIT

5 Each
of 25
Capacities

.001 to .1—600V; .25—400V & .5—200V
List Price \$37.50

1000 Volt Paper Kit 5 Each of 17 Capacities
.001 to .05 MFD
List Price \$35.00

ARCO ELECTRONICS INC.
103 LAFAYETTE ST., N. Y. 13, N. Y.

ured 9.866 at 0430-1030 in parallel with 6.045, according to Balbi, Rosenauer, Calif., others). A service is planned for the whole of USA but when it will be inaugurated is yet unknown. PLB9 and PLQ2, reported heard some months ago, are not stations of *Radio Republic Indonesia*; officials said these might be amateur stations or stations used by the Post-Telegraph and Telephone Service as transmitters for telephone communications. (Scheiner, N.J.)

YDF6, 9.580. Djakarta, has been heard with "Voice of Indonesia" program in *English* for Europe 1400-1500, evidently replacing YDF7, 11.770. (Fairs, England, via URDXC) However, may be using both 9.580 and 11.770 at 1400 since Pearce, England, more recently heard this broadcast on the 11.770 outlet; announced three daily broadcasts in *English*—for 0600, 0930, 1400; announced use of 11.77, 15.15. Radio Sweden says Djakarta has been heard with an *English test* program on 11.935 at 0630-0725 sign-off. Gillett, Australia, notes an Indonesian on 3.960A at 0600 with good level.

Vatican—HVJ, 11.685, noted recently with *English* 1315-1330. (Niblack, Ind.) Heard signing off on 9.55 at 1615 after 15-minute period in Russian. (Baitzel, N. J.) Noted on this channel with news 1000. (Balbi, Calif.)

Venezuela—Radio Barquisimeto verified reception of 9.510, call YVXJ, by hectograph form letter in Spanish; QRA is Avenida 20 No. 491 (or Apartado Postal 76); listed YVMQ, 4.940, 4 kw., and YVMR, 1490 kc., 3 kw. YVKT, 3.350. Caracas, has newscast in Spanish 1830-1900; one night recently had news in Italian 1900-1915, then news in Portuguese to 1930.

Western Samoa—From 2AP, Box 23, Apia, Western Samoa, Scheiner, N. J., has received word that this (medium-wave) station has two short-wave fre-

quencies, one of which, 6.040, will test soon, but no date could be fixed; 2AP operates on 1420 kc.

Press Time Flashes

Radio Free Europe can be heard at excellent strength 1900 on 9.695 in foreign language. (Niblack, Ind.) Madrid, 15.625, noted with news in Spanish 1146, signing off 1155A. (Pearce, England) Leon, Spain, more recently has been heard on 7.590A concluding relay from Madrid 1625. (Kary, Pa.) A station heard in Arabic on 5.000 around 1340-1403 close (with short band ant- them), is probably Al Kuwait, Kuwait, in the Persian Gulf. (Pearce, England)

Pearce, England, says he has been unable to log EA8AB, Canary Islands, for some weeks now, although WRH reports it is currently operating on 7.295. Kary, Pa., recently noted this one on 7.305A with bad QRM to 1800 closedown; news in Spanish 1705. The *Voice of America*, New York 19, New York, has informed Kary, Pa., it is now set up to verify reports on reception of the relay base outlets overseas.

The station manager of medium-wave ZNS, Bahamas, has thanked Kary, Pa., for a report on reception of ZNS on 7.308A, but did not indicate if this is a fundamental operation or a spurious frequency. This one has been heard with weak signal here in West Virginia with BBC relay 1800, then local program from 1815 when gives the time in EST.

Radio Athens, 7.300, more recently has had news 0000. (Bellington, N. Y.)

Emisora Nuevo Mundo, 6.000, Bogota, Colombia, verified with attractive QSL card; listed HJKC, 830 kc., 10 kw.; HJKD, 6.100, 10 kw., and HJKF, 9.520, 10 kw. (Kary, Pa.) A station heard on 7.126A around 0830-0900 with native music is probably Hargeisa, British Somaliland. (Stark, Texas) Is scheduled 0815-0930 according to QSL

The transmitter room of Station KPTV, Portland, Oregon, the first u.h.f. station to go into operation in the country. The transmitter is the same as that used by RCA-NBC at its experimental station in Stratford, near Bridgeport, Conn. At the control desk is Russ Olsen, station's chief engineer. Looking on is Bill McAllister, NBC engineer who helped install the transmitter. Working at the panel in the far corner is Victor Bary, another National Broadcasting Co. engineer.

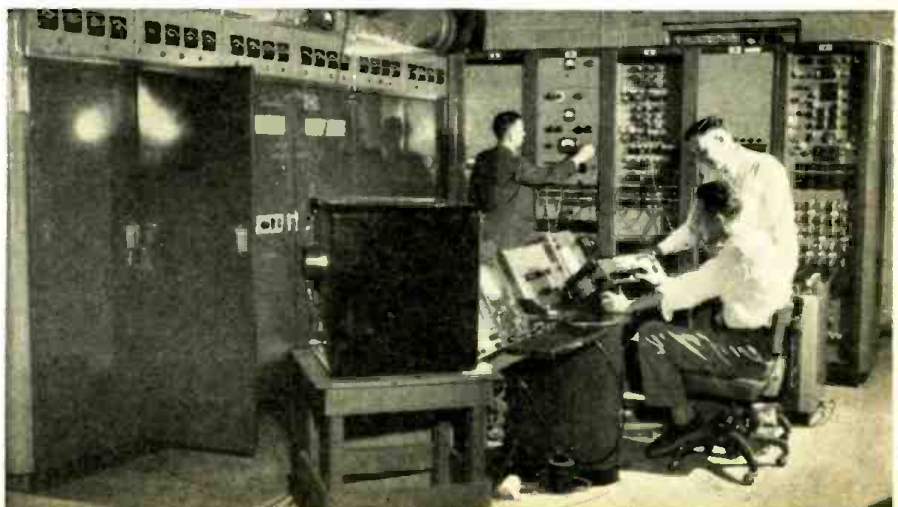

received. (Radio Sweden) At press time, *Radio Jamaica* appeared back on 3.360 from 4.950 to 2300 sign-off. (Saylor, Va.) *Radio Brazzaville*, 11.970. French Equatorial Africa, takes relay from Paris 1445 of *English* lesson ("The French Have a Word For It"); good strength in Britain. (O'Sullivan) *Radio Journal do Commercio*, Recife, Pernambuco, Brazil, sent schedule of 15.145, 455-1300; 11.825, 1100-2120; 9.565, 0455-1105, 1300-2120. (Boggs, Mo.) Zurich sunspot prediction for March is 21; for April, 20. (Ferguson, N. C.)

Radio Juventud de Sabadel is on a new channel of 7.312, audible from around 1400. (Buettner, Germany) Direct from Taipei, Taiwan, comes this current schedule of "Voice of Free China"—2300-2400, 15.235, 11.735, *English* to USA 0530-1230, 7.130, 11.735, 6.095 (latter 1100-1230 only), to Japan, Korea, Malaya, Chinese Mainland; 1400-1600, BED4, 11.800 (reported "heard," however, on 11.920—K.R.B.) to Europe and the Near East with *English* 1420-1445. (Kary, Pa.)

The Ecuador station on measured 6.7873 announces as *Radiodifusora Costa Azul*, Portoviejo, Province of Manabi; noted 2026-0041; the measured 6.8298 outlet announces "Radio Equinoccial," Ibarra, Province of Imbabura. (Rastorfer, N. Y.)

Here is the complete schedule of *Radio Pakistan* as received by Scheiner, N. J. Service for East and West Pakistan—Karachi, 2125-2300, 5.980; 0210-0230, 15.270; 0230-0430, 9.645; 0730-0810, 7.096.6; 0915-1045, 5.990; 0815-0900, 7.096.6; 2115-2300, 15.335; 0210-0230, 17.710; 0230-0430, 17.710; 0730-0750, 17.835; 0915-1045, 6.945, 9.630.

Zonal Service—Lahore, 2115-2330, 3.915; 0230-0310, 6.138; 0730-0930, 3.469; 0930-1300, 3.469. Dacca, 2000-2200, 4.807; 0100-0130, 7.150; 0600-0800, 4.807; 0815-1130, 3.325. *External Services*—Karachi, 1430-1515, 6.235, 7.010 in Turkish Service; 1515-1600, 6.235, 7.010, to United Kingdom; 2015-2100, 11.885, 15.335 to Southeast Asia; 2315-2400, 17.750, 15.335 to East and South Africa; 0445-0530, 9.645, 15.335 to South Asia; 0630-0715, 15.270, 17.835, Indonesian to Indonesia; 0830-0915, 9.630, 9.645 Burmese to Burma; 1100-1200, 6.235, 7.010. Afghan-Perisian program; 1210-1230, 6.235, 7.010. *General Overseas Service* (slow-speed news in *English*); 1230-1315, 6.235, 7.010, Iranian Service; 1315-1415, 6.235, 7.010, Arabic program; power for Karachi was listed 50 kw., for Lahore, 300 w., for Dacca, 7.5 kw. To East and West Pakistan uses *English*, Urdu, Bengali, Sindhi, Kashmiri, Baluchi, Gurati, Pushto; Lahore uses *English*, Urdu, Punjabi; Dacca uses *English*, Urdu, Bengali.

Acknowledgment

Thanks for the fine reports. Just keep them coming to Kenneth R. Board, 948 Stewartstown Road, Morgantown, West Virginia, USA. Good listening! K.R.B.

February, 1953

Smaller than a desk pen — just as convenient

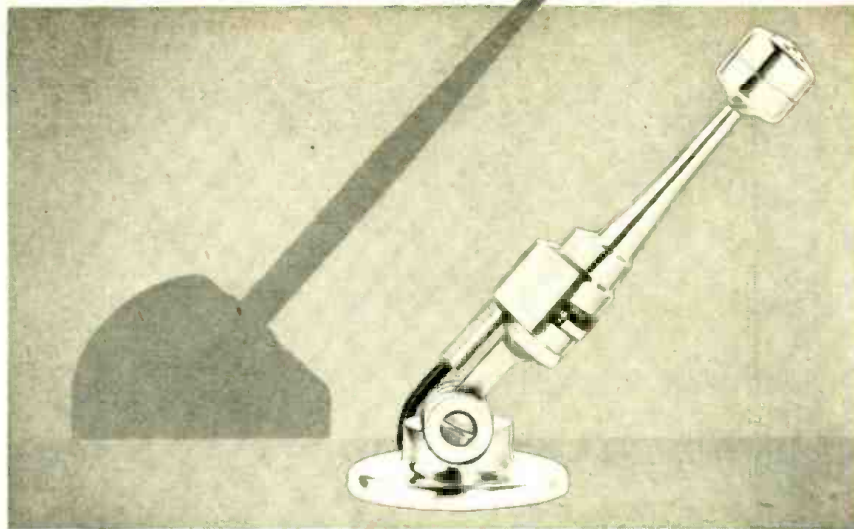

The NEW Turner C-4 Stand for Model 80 Microphone

The new C-4 stand gives complete maneuverability and convenience with the Model 80. It pivots the microphone in a 135° arc for any operational angle — swings parallel to base needing little more packing space than two packs of cigarettes.

The microphone is held firmly by the unique, positive-action hinge, yet moves smoothly and easily to any desired position without adjustment. Microphone quickly and easily removed.

This new, matching stand is solidly built of die-cast zinc overlaid with beautiful satin chrome plate. It is heavy enough to prevent tipping — it will not slide with the weight of the cord. The C-4 stand complements the graceful shape of the Model 80; the combined unit is an attractive but inconspicuous addition to a speakers' table. Ideal for use with wire recorders, public address systems, pulpits, office and factory call systems, amateur operators and other similar uses.

Model C-4 matching stand, 3/8" — 27 thread. List Price.....\$ 5.75
Model 80 Microphone. List Price.....\$15.95



THE TURNER COMPANY

900 17th St., N. E. Cedar Rapids, Iowa

In Canada: Canadian Marconi Company, Toronto, Ont., and Branches
Export: Ad Auriema, Inc., 89 Brood Street, New York 4, N. Y.

SCHEMATICS—CONVERSIONS FOR SURPLUS GEAR

NEW LIST! MANY ADDITIONS!

Send stamped, self addressed envelope for List B. Add 25c for chart explaining AN nomenclature.

R. E. BOX 1220
GOODHEART BEVERLY HILLS, CAL.

FREE

Write today for "How to Service T. V. Receivers" with the HICKOK VIDEO GENERATOR.

The Hickok Electrical Instrument Co.
10824 Dupont Ave., Cleveland, Ohio

GET INTO ELECTRONICS



You can enter this unovercrowded, interesting field. Defense expansion, new developments demand trained specialists. Study all phases radio & electronics theory and practice: TV; FM; broadcasting; servicing; aviation, marine, police radio. 18-month course. Graduates in demand by major companies. U.S. or equivalent required. Begin Jan., March, June, Sept. Campus life. Write for catalog.

VALPARAISO TECHNICAL INSTITUTE
Dept. RD Valparaiso, Indiana



Special Offer On This Complete RADIO ENGINEERING LIBRARY

New, Up-To-Date Edition of Famous Library Covers Whole Field of Radio Engineering. Places Latest Facts, Standards, Data, Practice, and Theory At Your Fingertips.

The five big volumes of the new edition of the Radio Engineering Library now include the very latest facts, standards, data, and practice. This Library will help solve hundreds of problems for designers, researchers, engineers, and students in any field based on radio.

Written by leading radio engineers, these books cover circuit phenomena, networks, tube theory, vacuum tubes, amplification, measurements, etc.—give specialized treatment of all fields of practical design and application. They provide you with a complete and dependable encyclopedia of facts.

- 5 Volumes, 3872 Pages, 2770 Illustrations.
- Eastman's FUNDAMENTALS OF VACUUM TUBES, 3rd Edition.
- Terman's RADIO ENGINEERING, 3rd Edition.
- Everitt's COMMUNICATION ENGINEERING, 2nd Edition.
- Hund's HIGH FREQUENCY MEASUREMENTS, 2nd Edition.
- Henney's RADIO ENGINEERING HANDBOOK, 4th Edition.

SEND NO MONEY

Special Low Price—Easy Terms

On this special offer you get this Library for \$37.50, instead of \$43.50. You save \$6.00 and may pay on easy terms. Mail coupon below to examine the Library FREE for 10 days. No obligation. These books are recognized as standard works; you are bound to need them. So take advantage of this special money-saving offer. *Mail coupon at once!*

McGraw-Hill Book Co., Dept. RTN-2-53
327 West 41st St., New York 36, N. Y.

Send for 10 days' FREE trial, the RADIO ENGINEERING LIBRARY. If not satisfied I will return books. Otherwise I will send \$7.50, plus delivery charges, then; and \$6 a month for 5 months. (Reg. price \$43.50; you save \$6.)

Name.....
Home Address..... RTN-2-53
City & State.....
Employed by.....
 We'll Pay Delivery Charges if you enclose \$7.50 first payment WITH coupon. Same return privilege.

14 mc. Rotary Beam

(Continued from page 68)

A matching device between the transmission line and the driven element is necessary because transmission lines on the order of 5 to 15 ohms are not obtainable. Depending somewhat on the height above the ground, the impedance of the driven element of a three-element array is usually about 10 ohms. A 600-ohm open-wire untuned line, which can be any length, was used for the transmission line. In order to match this 600 ohms to the 10-ohm impedance of the radiator, a 75-ohm coaxial cable (RG-11U) ¼ wavelength (electrical) was used. For a given transmission-line impedance, Z_L , and radiator impedance, Z_R , the impedance of the quarter-wave transformer, Z_T , is determined by the following relation:

$$Z_T = \sqrt{Z_L \times Z_R}$$

For example, if a 300-ohm transmission line were used with the 3-element array, then

$$Z_T = \sqrt{300 \times 10} = 54.8 \text{ ohms.}$$

In this case, 52-ohm coaxial cable could be used.

The actual physical length of the quarter-wave transformer is not ¼ wavelength, but is somewhat shorter due to the "velocity factor" of the particular cable used. Most manufacturers give this "velocity factor" in the data for their cable. Using this figure, the following equation may be used to calculate the actual physical length required for the transformer:

$$L = \frac{KV}{f}$$

where: L = length in feet of the transformer,

K = a constant, 246,

V = velocity factor of cable used for transformer.

f = resonant frequency of the array in megacycles.

The RG-11U cable used has a velocity factor of 0.65; the length of the transformer, therefore, was:

$$L = \frac{246 (0.65)}{14.25} = 11.2 \text{ feet}$$

A further improvement may be made by using a shielded cable such as "Twinax" for the transformer. With such a cable, a capacitive unbalance to ground does not occur when the transformer is run up inside the metal pipe shaft. The cable length within the shaft of the array should be kept to a minimum if conventional coaxial cable is used.

The standing-wave ratio of the transmission line is about 4:1. This is negligible for the 600-ohm line, but it must be remembered that the power carried by the quarter-wave transformer would then be quadrupled. It is important to select coaxial cable

POLYSTYRENE					
ROD — 12" or 48" lengths					
Dia.	12"	48"	12"	48"	
1/8"	\$.03	\$.12	3/4"	.80	3.20
3/16"	.06	.24	1"	1.55	6.20
1/4"	.10	.40	1-1/8"	2.00	8.00
5/16"	.16	.64	1-1/4"	2.30	9.20
3/8"	.21	.84	1-3/8"	3.00	12.00
7/16"	.30	1.20	1-1/2"	3.30	13.20
1/2"	.40	1.60	1-3/4"	4.50	18.00
5/8"	.57	2.28	2"	5.90	23.60

SHEET-masking paper both sides.

Thickness	Size	Price
1/16"	12" x 12"	\$2.50
3/32"	12" x 12"	2.75
1/8"	12" x 12"	3.00
3/16"	12" x 12"	3.75
1/4"	12" x 12"	4.60
1/16"	12" x 24"	4.90
3/32"	12" x 24"	5.25
1/8"	12" x 24"	5.90
3/16"	12" x 24"	7.25
1/4"	12" x 24"	8.25
1/32"	20" x 20"	7.75
1/16"	24" x 24"	9.50
3/32"	24" x 24"	10.25
1/8"	24" x 24"	11.75
3/16"	24" x 24"	14.00
1/4"	24" x 24"	16.00
5/16"	20" x 20"	14.50
3/8"	20" x 20"	16.00
3/8"	24" x 24"	23.75
1/2"	20" x 20"	21.50
1/2"	24" x 24"	31.88
5/8"	20" x 20"	34.50
3/4"	20" x 20"	41.00
1"	20" x 20"	55.50

TUBING — 12" or 48" lengths.

O.D.	I.D.	12" lgth.	48" lgth.
1/4"	1/8"	\$.07	\$.28
5/16"	3/16"	.10	.40
3/8"	1/4"	.13	.52
1/2"	3/8"	.18	.72
5/8"	1/2"	.23	.92
3/4"	5/8"	.29	1.16
1"	7/8"	.38	1.52
1-1/2"	1-1/4"	1.13	4.52
2"	1-3/4"	1.50	6.00

All prices F.O.B. our warehouse New York

LEEDS RADIO CO.

75 Vesey St. Dept. A New York City 7

Amateur and CD

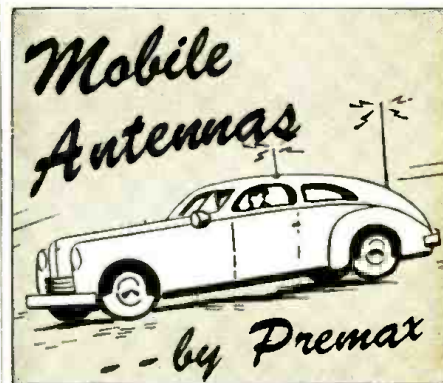

From 2 to 75 Meters

Tested and proven Antennas for the 1¼, 2, 6, 10, 11, up to 75-meter mobile installations—designed to increase the signal strength and yet offer low-cost equipment for amateurs and Civil Defense Corps.

Send for special Bulletin and prices.

PREMAX PRODUCTS

DIVISION CHISHOLM-RYDER CO., INC.

5304 Highland Ave. Niagara Falls, N. Y.

RADIO & TELEVISION NEWS

for the transformer which will carry the power required. The approximate power in the cable may be determined by assuming a final class C amplifier efficiency of about 75 per-cent. In the array described, therefore, the power would be 600 x 0.75, or 450 watts. With a standing-wave ratio of 4:1, however, there would be 1800 watts of power being carried by the coaxial cable, as well as by the 600-ohm line.

The fundamental reason for a mismatch which creates standing waves is that the transmission line is not terminated in a pure resistance. Mismatch may be caused by a radiator cut to the incorrect length, by nonsymmetrical transmission lines, by unbalance to ground along the line, or by an incorrectly tuned quarter wavelength transformer. If the radiator is cut accurately according to the equation given previously, and if the transmission line is mounted symmetrically and kept at least a few feet away from metallic objects, this loss due to mismatch may be neglected for all practical purposes.

The 600-ohm transmission line was connected to the 75-ohm, quarter-wave matching transformer by means of slip rings. A set of slip rings was mounted on the shaft of the array with brass brushes (1/8" diam. rod stock) connected to the 600-ohm line making contact with the rings. The 75-ohm coaxial cable which runs up the center of the shaft connects to the inner surface of the rings, thus making possible continuous rotation in either direction.

Electrical Controls

As mentioned previously, a propeller-pitch control unit is used to rotate the described 20-meter array. These rotator units come complete

Fig. 8. Wiring diagram of 14-mc. beam rotator and selsyn-indicator systems.

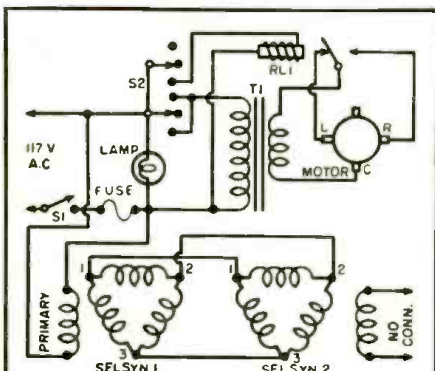

S_1 —S.p.s.t., 125 volt, 10 amp. switch
 S_2 —D.p.d.t., 125 volt, 3 amp. switch ("center off")
 T_1 —Trans. 117 v. primary, 50-60 cycles, 10-20 v. sec. @ 10-15 amps.
 RL_1 —S.p.d.t. relay, normally closed, 15 amp. contacts, 117 v. a.c. coil.
 Lamp—117 v. pilot lamp (see text)
 Motor—Propeller-pitch type motor (see text)
 Fuse—125 v., 5 amp. "Slo-Blo" type
 Selsyns (2)—117 v., 60-cycle type. Lower-voltage surplus types can be used (see text).
 *Note: The motor will have four connection terminals. Consult the instruction sheet supplied with the motor to determine which three of the terminals to use for this application.

RADIO SHACK BUYS OUT APPROVED HI-FI FM-AM TUNER INVENTORY!



Biggest Buy in Hi-Fi History!

Reg. \$63.25

12 MIN. TUBES
 DOUBLE LIMITER
 DISCRIMINATOR
 TUNED RF (AM)
 TUNED RF (FM)
 10 uv @ 92 MC
 12 uv @ 106 MC

Another exclusive Radio Shack value. The nationally cataloged *Approved Electronics* Model A-710 hi-fi genuine Armstrong circuit PM-AM tuner at a price more than 45% below regular dealer net! With 12 miniature tubes, escutcheon, knobs, schematic and full guarantee. Compact 8 1/4 x 5 3/4 x 8" deep chassis. Less power supply: requires 170V DC @ 20 mls and/or 150V DC @ 40 mls, and 6.3V AC @ 4 amps — see A-620 supply below. Tuner: Ord. No. 36-206, \$34.50.

ORDER BY MAIL

MORE APPROVED ELECTRONICS BUYS!

\$37.50

APPROVED PREAMP-EQUALIZER!



\$19.95

Model A-800, almost half off! Preamp for magnetic pickups, 6 pos. equalizer for G-E and Pick. Separate tone controls and all remote features. Take power off Williamson and other amps. Ord. No. 33-246, \$19.95.

APPROVED'S A-610 SUPPLY ONLY \$12.05



For A-710 Tuner, scores of other uses. 6.3V AC @ 4 amps, 150V DC @ 40 ma, 170V DC @ 20 ma. Ord. No. 36-207, \$12.05.

TECHMASTER WILLIAMSON Amplifier KIT



Williamson type kit, complete to the last component, can be wired by anyone. Includes power supply, 9 x 12 x 6 1/2". Ship wt. 27 lbs. Order No. RN33-340 \$49.95

FREE! 224-PAGE 1953 CATALOG — WRITE TODAY!



MAIL ORDER FACTS:

Include estimated postage, we refund any overpayment. Min. 20% deposit on COD's. Write for time-pay form!

RADIO SHACK CORPORATION

167 Washington St., Boston 8, Mass.

BEFORE YOU SELL, LET US BID ON YOUR ART-13's

Also need CFI units for above—and will pay top \$5 for BC-788, 1-152, and BC-348 receivers.
 For Top Prices, Write
BOB SANETT
 5404 1/2 Packard St. Los Angeles, Calif.
 Phone: WEBster 1-7414

BARGAIN HUNTING? RADIO SERVICEMEN!
 Write for SENSATIONAL CATALOG
HENSHAW RADIO SUPPLY
 3619 TROOST KANSAS CITY, MO.



REG. \$8.20
DUAL PICKUP ONLY \$5.70



The most famous make variable reluctance cartridge (requires preamp) and a Radio Shack exclusive. Separate sapphire styli for 78 and 33-45. Same as reg. stock except for packaging which is mfg's bulk. Ord. No. 15-092, \$5.70, 3/\$16, 6/\$30.

EQUALIZER FOR GE CART.



Also for Audox, and another Radio Shack exclusive. 6 position switch for all domestic and foreign 78 and LP records, including noise eliminator. No wiring: plug tone arm lead into equalizer, plug equalizer lead into preamp; mounts on any panel. Ord. No. 15-568, \$11.95. Special, with above cartridge, \$16.95.

AUDIOPHILES! COOK LABS. 10" LP HI-FI DISCS, \$4 EACH



#1025 *Kills On Parade* (bagpipes). #1070 *Rail Dynamics* (RR sounds). #1035 *Great Barrelhouse Piano* (hi-fi on the nickelodeon). #1030 *Harp solo*. #1050 *Pipe Organ Vol. 1*. #1051 *Pipe Organ Vol. 2*. Also Cook test records \$4.80 each: Series 10 (78 rpm); Series 10A (10" LP). Both have 35-20,000 cycle tones accurately calibrated. Add 50c per ship't for packing and mailing.

ACROSOUND TO-300 XFMR. FOR ULTRA-LINEAR "WILLIAMSON" AMPLIFIERS

Half the size of competitive units. Freq. response ± 1 db, 10 cps to 100 kc. 24 watts @ 3% intermodulation with only 3/4 volt input. Gray Hammerstone case. Order No. R14-343. \$24.75

LOOK! KLIPZON FREES BOTH HANDS!



UNIQUE SELF-HOLDING POINTS bring new convenience and timesaving to service work.

- V.H.F. CRYSTAL PROBES
 - ADAPTORS
 - STREAMLINED TEST PRODS
 - CONNECTORS
 - LOW LOSS — LOW CAPACITY LEADS
- See KLIPZONS at your distributor. Send for FREE folder #36.

UNITED TECHNICAL LABORATORIES
 Engineers • MORRISTOWN, N. J. • Manufacturers



PREAMPLIFIER-EQUALIZER • MODEL 50-C

THE HIT of the
AUDIO FAIR!

The Fisher Master Audio Control

MODEL 50-C

■ This is the equipment (50-C and 50-A) used to reproduce WQXR's binaural broadcast to the AES Annual Banquet. You can pay considerably more but you cannot buy finer! THE FISHER Master Audio Control can be used with any amplifier. Intermodulation distortion is virtually unmeasurable; complete, professional phonograph equalization settings and tone controls; genuine F-M loudness control; 5 inputs and 5 independent input level controls; cathode follower outputs. Finest preamplifier. Self-powered.

As shown, 50-C: \$97.50
Chassis only, 50-CH: \$89.50

The Fisher All-Triode Amplifier

MODEL 50-A

■ THE FISHER Laboratory Standard Amplifier is, beyond a shadow of a doubt, the world's finest all-triode amplifier—and yet moderately priced! FEATURES: High output—less than .3% harmonic distortion at 40 watts (.08% at 10 watts.) Intermodulation distortion below .8% at 40 watts. Uniform response within .1 db, 20-20,000 cycles; 1 db, 5 to 100,000 cycles. Hum and noise better than 98 db below full output. Quality components used throughout. Beautiful workmanship. \$159.50

Write for illustrated brochure

FISHER RADIO CORPORATION
39 EAST 47th STREET • NEW YORK
ALL-TRIODE AMPLIFIER • MODEL 50-A

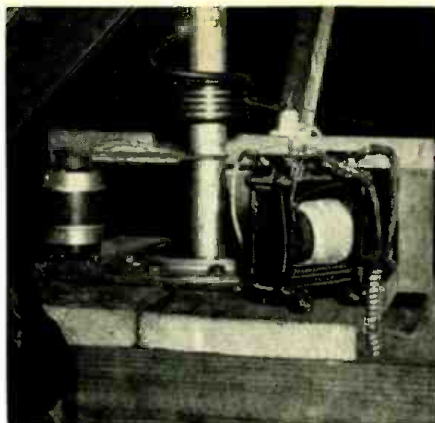
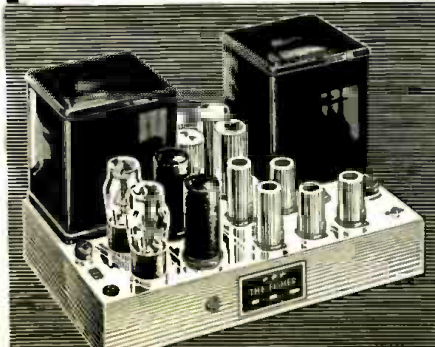

Fig. 9. Side view of the rotator mechanism, showing the indicator selsyn, the motor transformer, and the coaxial matching section entering the pipe shaft.

with motor and gear box and are ideal for this purpose. They are presently selling for about \$15.00 and are well worth it.

The simple electrical system employed with the rotator, as shown in Fig. 8, consists of a d.p.d.t. switch, normally open in the center position, a 10-to-20-volt, 15-ampere transformer, and a s.p.s.t. 110-volt a.c.-operated relay, normally closed, with contact points capable of making and breaking a 15-ampere circuit. BX cable was used for all the wiring shown in Fig. 8.

The transformer and relay were mounted as close to the motor as possible to provide for short leads in the motor circuit. The switch, S_1 , fuse, and lamp were mounted together near the beam-heading indicator shown in Fig. 6. The lamp is used to light the beam-heading indicator, which can be a compass card or great-circle map, so the lamp can be of any convenient size and brilliance. The switch S_2 was mounted at the operating position for convenience.

Selsyn #2 was mounted upright near the shaft of the array and coupled to the shaft by means of a rubber belt, as shown in Figs. 2 and 9. The pulley for the selsyn is a 1-inch length cut from the pipe shaft, thus providing a 1:1 ratio. Gears may be used to couple the shaft of the array to the selsyn, but this method is much more expensive and is not necessary. Although some error may be introduced due to slight differences in the circumferences of the shaft and the pulley and to slippage, this error can be kept to a minimum by rotating the beam backwards to return it to its final position of rest. To keep the array properly oriented, the beam-direction indicator should be marked with a small arrow to indicate the position of rest.

You will notice that the primary of only one of the two selsyns was connected to the a.c. line. The other was left "floating." Both primaries could have been connected, but it was unnecessary since no appreciable power was needed to drive the arrow on the indicator map or compass card. If both are connected some fussing with phas-

MID WINTER SALE PRICES SLASHED

T.V. TUBES—ROCK BOTTOM PRICES

In lots of 6 each No. only
6BG6 89c 6CB6 39c 6AQ5 38c
19BG6 89c 6AK5 69c 6CD6 \$1.09
12AX7 47c 6BQ6 57c 654 49c

Tube Special—Broken Keys—Electrically Perfect
12SK7 8 for \$2.00 12SK8 4 for \$1.00
6L6 69c; 4 for 2.25 12K8 49c; 7 for 3.00
Tube Sale—2A7-35-27-85-31-50-57, No Mixed Ass'n.
6 of Any Type \$2.25

Heavy Duty Shielded P.P. Input Trans. \$1.00
Signal Corps Transmitting Keys 49c
Bat Handle S.P.S.T. or D.P.S.T. Toggle Switch, 25c
In Lots of 12, each 23c

2 Gang Var. Cond. 456 K.C. with Osc. Section. 49c
2 3/4 in. Pulley on 3/8" Shaft. 49c

2 Gang S.W. Var. Cond. 50 MMFD per Sec. Double Spaced, 10-20 Meters with Tank Coil 1/2 in. Shaft 39c

Westinghouse Kuprox Rectifier 0.64 Amp. 28 Volts. Reg. \$11.00 ea. Special. \$1.95

BRAND NEW 10" PHONO RECORDS—ASST. Jazz—Popular, Rhythm—Blues. Please specify. 12 for \$1.79 or 24 for \$3.00

Single Pole—10 Pos. 2 Gang Switch 29c

2 piece, 5 pole Male and Female separable Amphenol plugs, Both with Flex. shielded cables, Approx. 5 ft. long, 35c pair 3 pr. for \$1.00

Grid your own Crystals. Pure Brazilian Quartz. Various sizes and thicknesses. 1/2 lb. blk. \$1.00

4 Tube Drilled Chassis. 4 1/2" x 6 1/2" x 1 1/2". 29c each

5 in. 450 ohm Dynamic Speaker \$1.35

Signal Corps Phones—2 M. Ohms (8 M. Ohms Imp.) \$1.25

2 Ft. Ext. Cord (and Plug) 40c

TOBE TUBULAR ELECTROLYTICS

20-20 MFD. 150 V. 49c 30-30 MFD. 150 V. 57c

40-40 MFD. 150 V. 39c

Low-Loss Short Wave Lock Type Air Trimmer Variable Condensers

5 Pl.—20Mmfd. 14c

7 Pl.—25-30 Mmfd. 15c

8 Pl.—30-35 Mmfd. 16c

14 Pl.—56 Mmfd. 24c

3 GANG T.R.F. VARIABLE CONDENSERS

D.P.D.T. SLIDE TOGGLE SWITCH 15c

1,000 OHM WIRE WOUND POTENTIOMETER. 13c

30 MV-FILTER CHOKE SHIELDED 3 for \$1.25

PIZZO CRYSTAL HOLDERS. 12 for \$1.00—\$8.00 per C

RCA band switches—

3 Gang, 3 pos. 3 band, 30c 6 gang, 4 pos. 4-5 band, 40c

Trimmer-Padder Ass't—all isolantite—singles, dual, triples—100 ass't. \$2.25

ATTENTION: Prospectors. Explorers for Hidden Treasures! Construct a U.S. Army Type of Metallic Mine Detector Amplifier. Amplifier unit only (less tubes and batteries) with cables, headphone cord, and jack. Army wiring diagram. Type AN/PRS-1. \$1.95

MINIMUM ORDER \$3.00—NO C.O.D.

SHIPMENTS—PLEASE INCLUDE POSTAGE

NEWARK SURPLUS MATERIALS CO.

324 Plane Street Dept. FE NEWARK 1, N. J.

Handy, New Pfan-Tone PICK-UP KIT!



Discover the hidden music in your records—untapped by standard phonograph pickup equipment. Let amazing new Strain-Sensitive PFAN-TONE Pickup bring out the best in your records—old and new.

- ✓ Exclusive New Principle Modulates current from preamplifier—reproduces faithful electrical image.
- ✓ Free From Hummmmm—No coils to pick up induced current from turntable motor.
- ✓ Easy to Install—Now in handy KIT form. No soldering necessary.

Ask your radio supply man or write today for FREE INFORMATION. If you use a single play, professional turntable, ask about the new functional PFAN-WOOD TONEARM.

Pfanstiehl

CHEMICAL COMPANY

100 Lake View Avenue Waukegan Illinois

RADIO & TELEVISION NEWS

ing may be required, although this amounts to reversing one set of primary leads. It does not matter which selsyn has its primary energized. It was convenient in this case to connect selsyn #1, at the indicator position, to the 117 v. line, as a handy outlet was already there.

The selsyns used in this system have 117-volt primaries. The low-voltage selsyns being sold on the surplus market may be substituted by using a suitable voltage-dropping arrangement, preferably a transformer.

Final Assembly

When the rotator was in place, and all the electrical wiring had been completed and tested, the final assembly of the beam was made. The array had previously been assembled on the ground, balanced, and then disassembled. The following method was used to transfer the array to the rooftop and re-assemble it:

1. The 1½-inch pipe shaft was placed in the roof bushing, and the rotator platform was shifted until the threaded end of the shaft could be screwed into the flange at the rotator. The rotator platform was then fastened into position with wood screws.

2. The coaxial-cable matching transformer was inserted into the shaft, as shown in Fig. 4.

3. The slip rings and selsyn belt were attached to the shaft from inside the attic, and the shaft was screwed into the rotator flange.

4. The boom was transferred from the ground to the roof peak by means of ropes, and was temporarily held in position.

5. The 1½-inch pipe guy-wire support with all six guy wires attached was transferred to the roof, and the guy-wire pipe flange and boom were fastened in place on the shaft flange by means of four bolts, as shown in Fig. 4.

6. The radiator assembly, director assembly, and reflector assembly were transferred to the roof peak and bolted in their proper positions along with the 1" x 2" side pieces.

7. The guy wires were connected as shown in Fig. 5, and were adjusted until the entire array was parallel and squared away.

8. The entire array was rotated by hand until the threaded end of the shaft began to tighten at the rotator flange; the shaft was then pulled up with a large pipe wrench from the attic.

9. The array was synchronized with the indicator needle. When a great circle map is used, it should be remembered that north is geographic north, and not magnetic. When the array had been adjusted for true north, the needle of the indicator was set to north by slipping the belt on the shaft of the array.

10. The array was rotated continuously in both directions several revolutions from the operating position to make sure that everything was positioned correctly.



Sheath-Leed the all-weather lead line for finest TV reception

SHEATH-LEED—the DON GOOD super-fine leadline is built for use wherever tough weather conditions prevail. It's especially recommended for use in coastal areas where salt spray encrusts the regular leadline and devitalizes it. And also in hot humid areas, where much alternate rainfall and strong sunlight prevails, and where leadlines are subjected to frost, snow and icy conditions.

- PURE POLYETHYLENE TUBING—ENCASING GOODLINE AIRLEAD
- TWO COLORS—STANDARD BROWN or SILVER-GRAY TUBING
- RECOMMENDED FOR FINEST VHF or UHF RECEPTION
- GIVES MAXIMUM LONG-LIFE SERVICE VS WEEKS OF SERVICE WHERE A REGULAR TYPE LEADLINE IS USED

Goodline Airlead—Nationally Accepted as the Basis of Finest Television Reception

- 80% OF LOSS PRODUCING DIELECTRIC WEB IS REMOVED
- CORRECT IMPEDANCE FOR SHARP, CLEAN, "SNOW-FREE" PICTURES
- PACKAGED: 100'—250'—500'—1000'—2500'

GIVE TELEVISION SETS A CHANCE TO GIVE YOU FINEST RECEPTION
INSIST ON SHEATH-LEED or GOODLINE AIRLEAD

Don Good, INC.

SOLD BY LEADING
JOBBER & DEALERS

Send coupon NOW for complete information. Get samples "in your hands"—you'll realize why Goodline Products give the finest possible in television reception.

DON GOOD, INC. I-1
1014 Fair Oaks Ave., So. Pasadena, Calif.
Please rush Samples and Complete Information covering Sheath-Leed and Goodline Airlead.

Name _____
Street _____
City _____ State _____

SUPER SURPLUS VALUES

VARIAC GENERAL RADIO CO. 200C 5 to 7½ AMP 115VAC in 0-150VAC \$13.95
out from new equip. 4.95

AC-METER 0-150VAC Weston or West. 2" B. \$3.95

MOTOR 4 pole shaded pole induction 1700 RPM G.I. 1.70 HP running torque 12 oz. inches list \$12.00 F type wire or disc recording \$3.50

HEADSET TELEX monoset Mod. 2570 reg. 14.00 4.95

MICROPHONE SHURE 707A & 814B desk stand. 4.95

RECTIFIERS Fed. Sel. 403B2787 150 MH 130V75

CIRCUIT BREAKERS Homemann Cal. 0711 5 amp 115VAC curve D \$1.25 30 Amp 115VAC 1.65

POWER TRANS. Thordarson 70R32 350-350 145 mil 5V 3 Amp 6.3V 4.5 Amp from used equip. 2.95

OUTPUT TRANS. RCA pair 616 class AB 10 watt sec. 4-8-15-250 ohms a real buy new. 1.50

CHOKE THORD. 11C10 8 H. 170 MH 200 ohm. 1.25

CHOKE CHICAGO trans. Co. 6 H 80 mil 50 ohm75

1000 MFD 15 VDC Sprague C81A Condenser.95

3500 X 3500 MFD 25VDC Solar D2P 3 pin can. 1.50

XTALS 2 meters 144-10 MC 103 holder. 1.50

XTALS 300 KC standards C11-2U U special. 1.50

Include postage with order. Min. order \$3.00

McCONNELL'S 3834 Germantown Ave. Phila., Penna. RA 5-6033

Unlimited Opportunities in
RADIO ENGINEERING

DEGREE IN 27 MONTHS

Complete Radio Engineering course, including Telev., U.H.F. and E.M. Bachelor of Science Degree also in Mech., Civil, Elect., Chem., and Aero. Eng.; Bus. Adm., Acct., Extensive campus, modern buildings, well equipped labs. Low cost. Prep courses. Personalized, practical instruction. Founded 1884. Placement service. Growing shortage of engineers. Prepare now for unlimited opportunities ahead. Approved for Korean vets. Enter March, June, September, January. Write for catalog.

TRI-STATE COLLEGE

1623 College Avenue, ANGOLA, INDIANA

TV Technicians—

Show your Skill

Let your customers SEE that GOOD service is your business. Your skill is your most precious asset. Dress it up with the right tools to make sure its appreciated.



\$14.95*

Carries TOOLS and TUBES, Saves TIME, MONEY

PAYS for ITSELF

Technicians who carry the Tube Caddy make the right impression. Handy top tray for tools, soldering gun, or meter. Regimented drawers give tube inventory at a glance. Slip-apart hinges on cover, with clips inside for price list or mirror.

Its efficiency saves time, its neatness inspires confidence—builds business. Can pay for itself in three weeks time. Size 18 x 14 1/2 x 9 1/4 in. Ask your Parts Jobber or write.

*Net to Dealer. Higher on West Coast. Other Models \$13.50 and \$7.75.

Craftsmanship in Cabinets
Argos
 PRODUCTS COMPANY
 310 MAIN STREET • GENOA, ILLINOIS

The array may be tuned with the aid of a field strength meter or a receiver with an "S" meter. When the field strength meter was used, it was placed several wavelengths from the array and turned so that the back of the array was facing the meter. The transmitter was connected to the array, and its frequency was tuned to the frequency of the array. With as small an input to the transmitter as possible, the field strength meter was tuned to the operating frequency. The shorting bars of the director and the reflector were adjusted to the position corresponding to the minimum reading at the field strength meter. The director adjustment is more critical than the reflector adjustment, and should be made carefully. This method of adjustment tunes the beam for maximum front-to-back ratio. If maximum forward gain is desired, the array is pointed toward the field strength meter and the stubs are adjusted for maximum field strength.

The pattern for the array, shown in Fig. 10, was obtained with the aid of W2GMN. Fred C. Read. With full input to the transmitter on phone, the array was pointed toward Fred's receiver, located two blocks away. The receiver "S" meter was set to S9, and the reading was recorded. Readings were taken at every 10-degree rotation point, and were transmitted back to the author by means of 40-meter c.w. The entire procedure was repeated several times to check the readings.

Conclusion

As stated at the beginning of the article, the main purpose of building the rotary-beam antenna was to be able to work DX; this antenna has certainly accomplished this goal. To present a clearer picture of the improvement that resulted, it might be worthwhile to look at the record. During the years 1949, 1950, and 1951, 860 DX calls were made and 413 replies were received. The percentage of replies, therefore, was 48. During a previous two-year period, a 66-foot "zepp" antenna showed a reply percentage of 25, while a 33-foot "zepp" showed a reply percentage of 18. The two "zepp" antennas were at the same location as the beam antenna, were

Fig. 10. Field pattern of the 3-element beam, showing high front-to-back ratio.

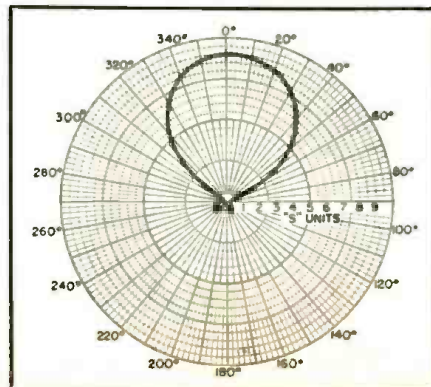

BIG VALUE at a Low Price



Model M-G 18

You'll look long and hard before you'll find an 18-watt amplifier with mike and phono inputs, bass and treble controls, output impedances from 4 to 500 ohms, and two speaker outlet sockets, that will outperform this M-G unit. You'll pay much more for one of equal performance.

Compare its value . . . or that of any of the six other M-G models . . . with amplifiers of other makes. You'll say it's the biggest value on the market for the money.

FREE Catalog



Catalog 200 shows the entire line of M-G Sound Equipment. Get your copy today!



DON McGOHAN, INC.

3700 W. ROOSEVELT RD., CHICAGO 24, ILL.

SURPLUS VALUES

MOBILE DYNAMOTORS

- (SMALL SIZE—BRAND NEW)
- * 8 volts input, 425 volts @ 375 MA **\$27.95 ea.**
- * 12 volts input, 425 volts @ 375 MA **\$19.95 ea.**
- * Each supplied with Mounting Brackets and Brush Filters

G.E. RELAY CONTROL

- (Ideal for Model Controls, Etc.)
- * Contains a sigma midjet 8,000 ohm. relay, (trips at less than 2 MA), high impedance choke, bi-metal strip, neon pilot and many useful parts.
- * The sensitive relay alone worth much more than the total low **\$1.25 each, 10 for \$9.90**

WESTINGHOUSE OIL CONDENSER

- * 10 M.F.D.—1000 VDC (Marked 440 VAC) **\$1.95 ea.**
- * —A terrific bargain at . . .

FILTER CONDENSER BARGAIN

- * 8x8 M.F.D. 600 vdc oil compound filled. **.95 each**
- * NEW, but scratched. ONLY . . .

BAKELITE CASED MICAS

MFD	VDC	Price	MFD	VDC	Price	MFD	VDC	Price
*.001	600	5.18	.002	1200	35.005	2500		.55
*.002	600	.24	.024	1500	.65	.002	2500	.45
*.01	600	.26	.033	1500	.75	.044	2500	.50
*.02	600	.26	.02	2 KV	.90	.0001	5 KV	.70
*.01	1 KV	.45						

PANEL METERS

Panel Meters	Price	OIL CONDENSERS	Price
* 0-10 MA AC	2.95	50 mfd 600 vdc	\$4.95
* 0-4 AMP RF	2.95	3.75 mfd 660 vac	2.45
* 0-200 Microamp	6.95	15 mfd 1000 vdc	4.95
* 0-500 Microamp	5.95	1 mfd 1500 vdc	.89
* 0-2 MA	4.95	1 mfd 2500 vdc	1.75
* 0-100 VDC (1MA)	5.95	1 mfd 3600 vdc	1.95
* 0-150 VDC (1MA)	5.95	.1 mfd 7500 vdc	1.95
* 0-250 VDC (1MA)	5.95		
* 0-15 KVDC (500 UA) with multi-plier	9.95	H.D. FILTER CHOKES	
* 0-4 METERS	8.95	6 My 50 ma	5.75
* 0-200 UA	8.95	6 My 500 ma	4.95
* 0-50 UA	12.95	4 My 1 Amp, 10KV insulation	22.50

WIRE WOUND RESISTORS

- * 5 watt ohms: 25-50-84-200-2500 \$0.09 ea.
- * 10 watt ohms: 25-40-1325-2K-4K15 ea.
- * 20 watt ohms: 150-300-750-1K-1.5K,20 ea.
- * 2.5K-2.7K-10K-20K20 ea.
- * 30 watt ohms: 100-2500-5300-18K22 ea.

N. Y. ADDRESS
PEAK ELECTRONICS CO.
 66 West Broadway, New York 7, N. Y.
 Phone WOrth 2-5439

of the same height, and were fed by the same 600-watt transmitter. A further comparison shows that about 75 per-cent of the DX calls made with the "zepp" antennas were Canadian and Central- and South-American stations within about 2000 miles, whereas the calls made with the beam antenna included stations from all over the globe.

Spot Radio News

(Continued from page 18)

areas. In Ceylon, batteries are also charged at central stations and are often transported to different sites by motor vans and laborers. Access to most of the sites is often through thick jungles, an arduous task involving up to four days of travel just to replace a single battery. And at this time, this antiquated method of providing radio reception is still in use.

ON A 210-acre site directly south of Boulder, Colorado, near the campus of the University of Colorado, the Bureau of Standards has begun construction of a \$4,500,000 lab, to conduct research on the propagation of radio waves and on the expanded utilization of the spectrum for FM, television, facsimile, and radar.

The building will house a staff of about 500, including scientific and clerical personnel, whose efforts will not only be directed to specific problems of research, but to key problems posed by the Defense and State Departments as well as the FCC, for the benefit of the nation and Mr. and Mrs. America.

TRANSISTOR TRANSMITTER

GEORGE M. ROSE, K2AII, an RCA development engineer, was the principal in an "historic ham first" when he built and successfully transmitted v.h.f. signals over a transmitter based on a single RCA point-contact transistor.

Mr. Rose's equipment was used to contact three ham stations in New Jersey, one 25 miles away.

Over-all view of the home-built transistor transmitter constructed by George M. Rose.



ARB NAVY RECEIVER

105 to 9050 KC. Four Bands. Calibrated Dial, LF-Ship-BC-80 & 40 Meter—Complete with Tubes and Dynamotor. For 24 Volt operation; easily converted to 110 V—12 or 6 Volt. Size: 8 1/4" x 7 1/4" x 1 1/2". Price: \$29.95

COMMAND TRANSMITTERS Complete with Tubes & Crystals

BC-457 Transmitter—4 to 5.3 MC.—Used.....\$ 8.95
 BC-458 Transmitter—5.3 to 7 MC.—Used..... 7.95
 BC-459 Transmitter—7 to 9 MC.—NEW..... 22.95
 BC-456 Modulator—NEW: \$5.95—Used..... 2.95
 Transmitter Rack—Single: \$1.50—Dual..... 2.00
 Rec. Rack—Dual: \$1.50 Modulator—Mtg..... 1.50
 Rec. Dyn.—Used: \$2.95, Trans. Dyn.—Used..... 2.95

TRANS.—REC.—AMPLIFIERS

TA-12B TRANSMITTER with Tubes—Used.....\$39.95
 RI ARR-1 Receiver—easily converted to 220 MC. (See R.N. Jan. '49) Complete w Tubes. NEW.....\$4.95
 BC-1206—200-400 KC. Delco. w Tubes..... 9.95
 BC-216 Amplifier—2 Tubes—6F7, 39/41..... 1.95
 BC-367 Amplifier—w Tubes, less Dyn & Case..... 4.95
 BC-605—With Tubes. Used..... 3.95
 BC-709—W Tubes—New: \$4.95—Used: 3.95
 BC-347—Less Tubes—New: \$2.95—Used: 1.95

AIRCRAFT CONTROL CABLE

3 32"—7x7 Strand, Weatherproofed, Galvanized, Preformed, 920 lb. test. Ideal for Television Guying and many other uses. Prices:
 1/2" per Ft.—1000 Ft. or more @ 4c Per Ft.

BLOWERS—115 VAC 60 CYCLE

SINGLE TYPE: (Illustrated at left) 100 CFM. 2 1/2" intake; 2" outlet. Complete size: 5" x 6". Order No. IC939.....\$8.95
 DUAL TYPE: 100 CFM. 4" intake; 2" Dis. Each Side. Complete Size: 8" x 6". Order No. IC880.....\$13.95
 COMPACT TYPE: 108 CFM. Motor built inside squirrel cage. 3 1/2" intake; 3 3/4" x 3" Dis. Complete size: 4 1/4" W x 8 3/4" H x 8 3/4" D. Order No. 2C067.....\$11.50
 FLANGE TYPE: 140 CFM. 3 1/2" intake; 2 1/2" Dis. Complete size: 7 1/2" W x 7 1/4" H x 6 3/4" D. Order No. IC807.....\$13.95
 FLANGE TWIN: 275 CFM. 4 1/2" intake; 3 1/4" x 3" Dis. Complete size: 11 1/4" W x 8 3/4" H x 8 1/16" D. Order No. 2C069.....\$21.95

DYNAMOTORS

DYNAMOTOR and BLOWER: 9 Volts DC input; output 450 Volts 60 MA. 4500 RPM. At 6 Volts DC input; output 260 Volts 65 MA. 3000 RPM. \$4.95
 Price

PE-101C DYNAMOTOR.....NEW \$4.95

INPUT:	OUTPUT:	STOCK No.:	PRICE:
14 V. DC	600 V. 300 MA.	BD-86	\$9.95
12 V. DC	220 V. 70 MA.	DM-24	6.95
12 V. DC	220 V. 100 MA.	DM-18	4.95
14 V. DC	375 V. 150 MA.	DM-375	8.95
14 V. DC	330 V. 135 MA.	DM-330	7.95
14 V. DC	500 V. 500 MA.	PE-59	14.95
12 or 24 V. DC	275 V. 110 MA.	USA 0516	3.95
12 V. DC	250 V. 50 MA.	DM-25	8.95
12 or 24 V. DC	500 V. 50 MA.	USA 0515	3.95
12 or 24 V. DC	440 V. 200 MA.		
	225 V. 100 MA.	D-104	14.95
28 V. DC	250 V. 60 MA.	PE-86	5.95

Address Dept. RN • Minimum Order \$5.00 • Prices F.O.B., Lima, O. • 25% Deposit on C.O.D. Orders

FAIR RADIO SALES 132 SOUTH MAIN ST. LIMA, OHIO

VACUUM CONDX.: 40, 50, 150, 200 and 300 Mf. 20-500 V. Special: Only \$6.40 ea.
 TOBE DUAL 8 MFD. 600 V. OIL COND. 2.50 ea.
 ASSORTED RUBBER GROMMETS: Box of 10......59
 OHMITE 15 OHM 50 W. RESISTORS: New 6 for 1.00
 4 to 25 MMF. AIR TRIMMERS: New 8 for 1.00
 4200 KC. COMMAND I.F. X-FMRS: 1 set. Interchange-out. Also BFG. Coil set of 4. Only..... 1.39
 DUAL ERIE 4-30 MMF. CERAMIC TRIMMERS 3 for 1.00
 CENTRALAB T.V. HI-VOLT CONDX. 500 1.00
 SIMPLI-12 (1200V) VIK. 12 for 1.00
 TRANSFORMER 113 V. pri. Sec. 125 V. 1 1/2 ma. 1/2 wave and 6.3 V @ 6 amp. Write for small converter or preamp. New only..... 1.39
 Send remittance with order and we pay postage.
K. & L. RADIO PARTS CO.
 1406 Venice Blvd. Los Angeles 6, Calif.

ANTENNA EQUIPMENT

MAST BASES—INSULATED:
 MP-132 BASE—Illustrated at left—1" heavy coil spring, 2" insulator. Overall length: 11 1/2". Weight: 2 1/2 lbs. Price.....\$3.95
 MAST BASE—Insulated type with heavy coil spring and 5" dia. insulator. Requires 1" hole for mounting. Weight: 9 lbs. Price.....\$5.95
MAST SECTIONS FOR ABOVE BASES
 Tubular steel, copper coated, painted, in 3 ft. sections, screw-in type. MS-53 can be used to make any length with MS-52-51-50-49 for taper. Any section.....\$1.50 Each
 Larger Diameter Sections: MS-55-54.....\$1.25 Each

CORDS—CABLES

CD-501 Cord f GN-45 Generator.....\$2.50
 CD-318 Cord w PL-68 & SW-141 & JK-48F......89
 CD-307 Cord—6.5 Ft. w/PL-55 & JK-26......89
 CD-604 Cord w/C-410 Trans. & PL-54 Plug......89
 CD-365 Cord for LP-21 Loop..... 1.50
 MC-215 Tuning Shaft for 274N..... 2.00

POWER SUPPLIES

PE-157 POWER SUPPLY—2 Volt Vibrator Supply, operates from BB-54 2 Volt Battery mounted in Case. Output voltage 1.4 V. 1/2 Amp. 125 V. 50 MA. Less Battery, Speaker, & External Power Cord—with Vibrator.....Used \$4.95
 BB-54 2 Volt Dry Battery..... 2.95
 MP-28 BA Power Supply & Modulator f/TA-12—New..... 24.95
 Power Supply No. 3 f/Mark II No. 19 Radio Set 12 or 24 V. Two PM Dynamotors: 500 V. 50 MA: 275 V. 110 MA—New..... 12.95
 PE-104 Vibrator Unit f/BC-654.....Used 10.95
 550C Vibrator f/PE-104—New..... 1.95
 VB-16 Vibrator f/PE-237—SCR-694—New..... 4.95

TRANSFORMERS AND CHOKES

TRANSFORMERS—110 V. 60 CYCLE PRIMARIES:
 5 Volt CT-25A—10,000 V. Ins. OPEN FRAME—6" x 5" x 4 1/2".....\$7.95
 6.3 V. 1 Amp.....1.25 24 V. 1 Amp..... 1.95
 24 V. 1/2 Amp.....1.50 24 V. 6.5 Amp..... 5.95
 6—24—or 30 Volt 8 Amp..... 5.95
 Two 12 V. 4 A. windings, gives 12 V. 8 A. or 24 V. 4 A..... 5.95
 325-0-325 V. 50 MA—6.3 V. 2.5 A; 6.3 V. 6 A (Reel, 6x5) Half Shell—2 1/2"x3 1/2"x3"—No. T-23-28..... 2.75
 440 VCT 70 MA—5 V. 2 A.—6.3 V. 4 A..... 3.95
 490 VCT 60 MA—5 V. 2A.; 6.3 V. 4 A.; 6.3 V. 2A 3.25
 460 VCT 90 MA—5 V. 3 A.; 6.3 V. 4 A..... 3.75
 175-0-175 V. 40 MA—6.3 V. @ 2-4 A; 6.3 V @ .6 A; Halfshell 2 1/2"x2 1/2"x3"—No. T-23-30..... 1.75
 350-0-350 V. 90 MA—6.3 V. @ 3 A; 5 V. @ 3 A; Upright—3 1/2"x3 1/2"x3 1/2".....3.25

CHOKES

15 Henries—165 MA. 125 ohms.....\$2.95
 5 Henries—150 MA. 85 ohms OC—Res. Cased..... 1.95
 8 Henries—150 MA. 200 ohms..... 1.95
 5-20 Henries—300 MA. 110 ohms. 1000 V. Ins..... 3.95

AERIAL WIRE—Phosphorus Bronze #16 Stranded, 200 lb. test. Weatherproof. 150 Ft. on Reel. RL-3 w Clips.....\$1.50
 Telephone Wire—3 Cond. copper & steel, 525 Ft. 4.75

TRAIN FOR A SUPERVISORY POSITION IN ELECTRONICS

Thorough 2-year course covers electrical circuits and machinery, basic electronics and industrial electronics. Franklin Technical Institute graduates are in demand as junior engineers for research and test work, sales engineering, supervisory work on production lines and drafting room design work. Other engineering and technical courses. Coed. Day, evening, 44th year. Write for catalog.
FRANKLIN TECHNICAL INSTITUTE
 46 Berkeley Street Boston 16, Mass.

GET YOUR COPY OF THE NEW ZIFF-DAVIS PUBLICATION SEA STORIES Thrilling Tales of the Deep! NOW ON SALE

20-20 PLUS!

S-226-Q Output Transformer

±1 db 10—100,000 cycles
20 watts 30—40,000 cycles

5 watts at 10 cycles
10 watts at 15 cycles

Insertion loss
0.5 db

Primary impedances
6,600 CT & 1,650 CT

Connected between halved impedances, frequency response is extended at each end; between doubled impedances, ±1 db 15—45,000 cycles.



Write today for the new 1953 Peerless Catalog

Dimensions:
4 1/8" x 3 3/8" x 3 3/8"

PEERLESS
Electrical Products

A DIVISION OF



9356 Santa Monica Blvd., Beverly Hills, Calif.
161 Sixth Avenue, New York 13, New York

Current TV Topics (Continued from page 51)

tube receives the video signal and the cathode is at a d.c. potential determined by the brightness control. Therefore a positive pulse must be applied to the cathode and this pulse can be obtained either from the plate of the vertical output tube or from the low side of the deflection yoke. R_1 is used to reduce the amplitude of the pulse to avoid interference with either the sound or synchronizing sections. The leads from the vertical section should be short and kept far away from either the sound or synchronizing circuits.

Where the cathode receives the video signal, the circuit of Fig. 4B is suggested. In many sets this circuit is not possible because instead of a regular output transformer an autotransformer is used. This means that only positive polarity pulses are available at the output section which cannot be applied to the picture-tube grid. An alternate scheme is shown in Fig. 4C, where the negative pulse is obtained from the output of the vertical oscillator. The pulse amplitude usually is no more than about 50 volts peak and it is therefore possible to tap down on the oscillator plate resistor R_1 by substituting a 330,000 ohm and 680,000 ohm (R_A and R_B) for the original 1 megohm value. This avoids loading down the oscillator and keeps the signal on the output tube substantially unchanged. In Fig. 4, the coupling condenser, C_1 , is given as .01 μ fd. because this is a good value for most cases. In order to get sufficient blanking in some sets it may be necessary to increase this condenser to .02, .05, or even .1 μ fd. On the other hand it may be necessary to reduce the blanking pulse if the top or bot-

tom of the picture appears darkened. Reducing either the condenser to .005 μ fd. or connecting a 10,000 to 100,000 ohm resistor in series with it usually achieves good, even blanking.

Foldover

Until the latest TV models came out, quite a few sets were plagued with horizontal foldover. The technician will by now be quite familiar with the complaint: part of the picture appears folded back on itself at either edge. Adjustment of the various horizontal controls sometimes reduced this trouble, sometimes it was removed by extending the picture beyond the edge of the mask and occasionally, incorrect centering hid it. It was soon recognized that in most cases the trouble could not be corrected by the technician but was due to the circuits and components used. The main drawback of the new high-efficiency flyback transformers was their excessive retrace time which caused most foldover. Fig. 5A shows the relation between the horizontal sweep, the retrace of this sweep, and the horizontal blanking pulse which is part of the video signal. As shown, the foldover will appear at the righthand edge of the picture. In reality, the length of the line is much greater than shown in the diagram and the duration of the retrace period proportionally much smaller, but for illustrating the idea this relation was chosen. From Fig. 5A, we see that the retrace period of the sweep is longer than the picture tube blanking. To reduce the retrace time of the sweep would often require a complete redesign of the horizontal deflection section. As a matter of fact most late model receivers use autotype flyback transformers in which retrace periods are much shorter and foldover does not occur.

For the technician faced with the

Fig. 4. Three basic circuits for blanking vertical retrace lines. (A) Circuit in which the grid of the picture tubes receives the video control and the cathode is at d.c. potential as determined by the brightness control. (B) The circuit to be used where the cathode receives the video signal. (C) Alternate circuit for use when the negative pulse is obtained from the output of the vertical oscillator.

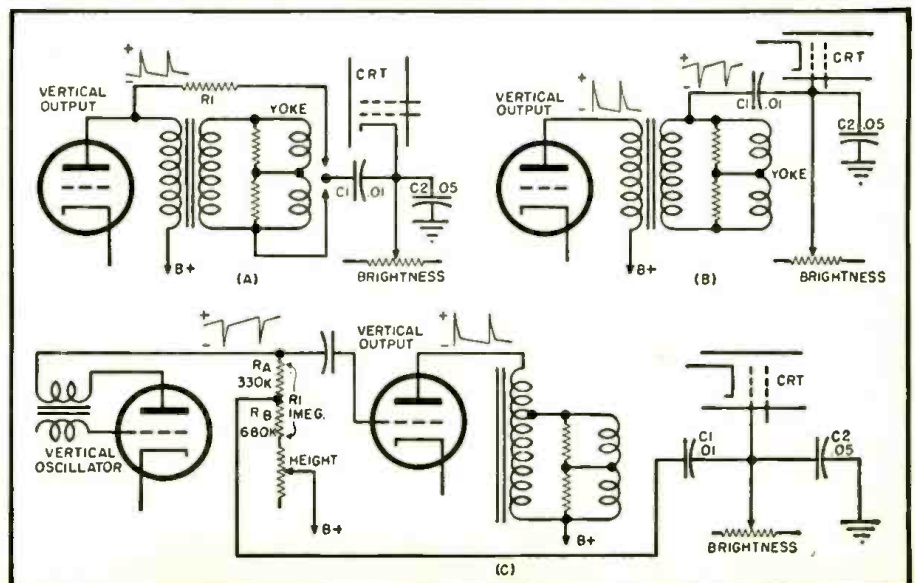

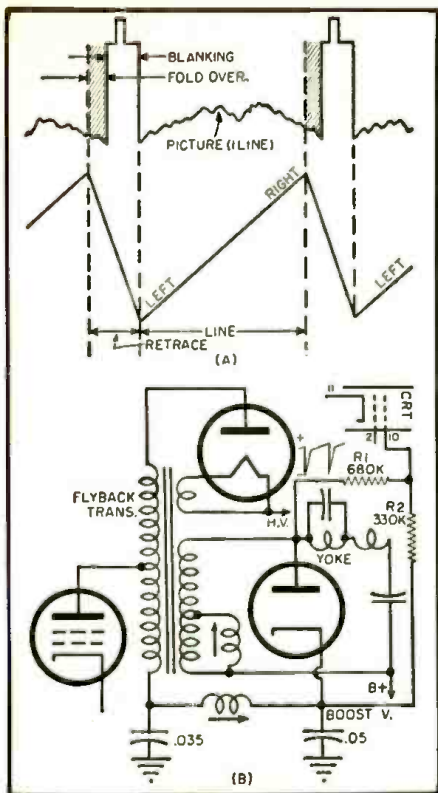

Fig. 5. (A) Relation between the horizontal sweep, the retrace of this sweep, and the horizontal blanking pulse. (B) A simple scheme for extending the blanking period slightly so as to cut off the picture tube during the entire retrace period.

problem of foldover due either to a flyback replacement, big screen conversion, or any other reason, it is only necessary that the blanking period be extended slightly so that the picture tube is cut off during the entire retrace period. Fig. 5B shows a fairly simple and popular scheme for accomplishing this. To get a blanking pulse of the same length as the retrace time, the actual flyback pulse from the flyback circuit is used. To avoid interference with other circuits this pulse is applied to a normally passive picture tube element, the first anode or accelerator grid. This anode is usually at the highest available "B plus" value, the boost voltage from the flyback circuit. A strong negative pulse makes the first anode less positive and thereby cuts off the tube. Such a pulse, ranging up to 2000 volts, is present at the deflection yoke-transformer junction. A portion of this pulse is applied to the first anode through the voltage divider R_1 and R_2 . The values shown for these two resistors were found to work in many cases, but are not absolutely the best in all sets. If the foldover does not completely disappear, R_2 should be increased. If either side of the screen appears darker than the rest, R_1 should be increased. A combination of resistor and condensers could also be used, but this introduces additional problems such as wave-shape voltage rating, etc.

Installation of U.H.F. Strips

With the opening of the first few

"CONICAL-V-BEAMS"

*REGISTERED TRADE MARK

It's *Telrex* across the nation
-FOR UHF AND VHF!
-TESTED, TRIED, AND PROVEN FOR EVERY RECEPTION AREA...NEAR OR FAR!

Now you can depend on Telrex for all antenna needs, both UHF and VHF. The same sterling quality featured in VHF models, combined with reliable factory ratings, assure antenna satisfaction on every UHF installation. There's a Telrex UHF and VHF antenna for every area — city, suburban or remote-from-transmitter.



MODEL BW-1

Bat Wing Model

FOR UHF AND VHF RANGE — FROM 5 TO 10 MILES

FOR UHF AND VHF RANGE — FROM 10 TO 50 MILES

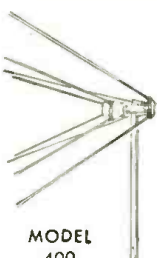

MODEL 400

Clover-V-Beam

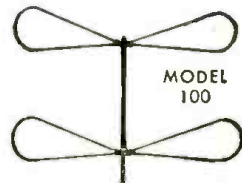

MODEL 100

FOR UHF AND VHF RANGE — FROM 10 TO 20 MILES



telrex INC.
CONICAL-V-BEAMS

AMERICA'S OUTSTANDING TELEVISION BEAM

ASBURY PARK 7, N. J.

Be sure it's a "CONICAL-V-BEAM" look for the *telrex* TRADEMARK

WILL PAY UP TO \$300 FOR ART-13's

Also desperate for CFI units for above—plus BC-788, 1-152 and BC-348 receivers. Also interested in other airborne electronics. Top dollar paid. Inquiries answered promptly.

V & H Radio & Electronic Supply Co.
 2033 W. Venice Blvd. Los Angeles 6, Calif.
 Phone: REpublic 3-1127

PEN-OSCIL-LITE

Extremely convenient test oscillator for all radio servicing; alignment • Small as a pen • Self powered • Range from 700 cycles audio to over 600 megacycles u.h.f. • Output from zero to 125 v. • Low in cost • Used by Signal Corps • Write for information.

GENERAL TEST EQUIPMENT
 38 Argyle Buffalo 22, N. Y.

RADIO ENGINEERING DEGREE IN 27 MONTHS

Radio engineering is a big field. There's room for you in it—if you're good. Get first-class training at Indiana Tech. Intensive specialized course. Including strong basis in mathematics and electrical engineering, advanced radio theory and design, television, electronics, Modern laboratories. Low rate. Also B.S. DEGREE IN 27 MONTHS in Aeronautical, Chemical, Civil, Electrical and Mechanical Engineering. G.I. Government approved. Enter December, March, June, September. You can earn part of your expenses right here in Fort Wayne while you are studying.

INDIANA TECHNICAL COLLEGE
 923 E. Washington Blvd., Fort Wayne 2, Indiana

Please send me free information on B.S. Engineering Degree in 27 months as checked.

Radio-Television Aeronautical
 Civil Mechanical Electrical

Name

Address

IT'S **NEWARK**

For the Best Buys in Audio

NEWARK'S FM-AM RECEIVER

Hi-fi FM-AM chassis featuring push-pull audio output. FM circuit is drift-compensated. Has full range bass-treble tone control and phono jack with built-in preamp for magnetic pickups. Chassis is complete with 12" PM speaker, built-in AM and FM antennas, 12 tubes (including rectifier), all hardware, and escutcheon. Size, 13 1/2 x 9 x 9". Wt., 20 lbs.

946034. SPECIAL PRICE..... **69.50**

SAVE ON THE FAMOUS BRUSH MICROPHONE

It's another sensational Newark value—the famous Brush BA-116 microphone which originally sold for \$8.61—now selling, while quantities last, at the very low price of \$5.95! This rugged microphone is ideal for tape recording, PA, or Amateur use. Response, 50 to 6,000 cycles. Output level, -53 db. High impedance. Shock-mounted crystal cartridge. Has 3/8"-27 thread. Brown finish. Wt., 1 1/2 lbs.

54F350. SPECIAL PRICE **5.95**

Send for

NEWARK'S NEW CATALOG No. 55

196 Pages of the Latest Releases in Radio, T.V., High Fidelity and Industrial Electronics

WRITE TO DEPARTMENT R-23



FREE!

The New Electronics Reference Book

223 W. MADISON ST.

NEWARK
ELECTRIC COMPANY

CHICAGO 6, ILLINOIS

Editors and Engineers PUBLICATIONS



RADIO HANDBOOK, GIANT 13TH EDITION. A one-volume library of radio information with extensive, simplified theory. Detailed how-to-build-it data on dozens of items of practical radio equipment. Book No. E&E-RH13... \$6.00*

BETTER TV RECEPTION (in fringe and low-signal areas). **NEW SECOND EDITION.** The standard guide for installation technicians. A popular text for TV enthusiasts. Book No. E&E-TR2..... \$2.50*

RADIOTELEPHONE LICENSE MANUAL. Typical study questions with concise answers for any commercial U.S.A. radiotelephone operators license. Book No. E&E-RL1..... \$3.75*

ANTENNA MANUAL. A practical, comprehensive book on antennas, for everyone interested in transmission and reception. Over 300 pages. Book No. E&E-AM1..... \$3.50*

RADIO HANDBOOK, 12TH EDITION. Selected constructional items only. English edition. Book No. E&E-RH12..... \$3.00*

Spanish edition. Book No. E&E-RHSP12... \$4.00*

WORLD'S RADIO TUBES (BRANS' VADE MECUM). NEW 9TH EDITION. Lists over 15,000 tubes from every tube making country. Printed in 16 languages. Book No. E&E-VM9... \$5.00*

SURPLUS RADIO CONVERSION MANUAL, VOL. 1. Practical conversions. Write for list of contents. Book No. E&E-SM1..... \$2.50*

SURPLUS RADIO CONVERSION MANUAL, VOL. 2. Companion to Volume 1. Book No. E&E-SM2..... \$2.50*

*Plus any tax.

BUY FROM YOUR DISTRIBUTOR

ADD 10% ON DIRECT MAIL ORDERS TO EDITORS AND ENGINEERS, Ltd. OX 689A, SANTA BARBARA, CALIF. Bookstore order from BAKER & TAYLOR, Milliner, N. J.

STAR-SPECIALS

NEWEST ITEMS! LOWEST PRICES!



PERMOFLUX REAR DECK SPEAKER KITS

Easy to install; provides greater radio enjoyment in your car. Requires only connection to speaker terminals in auto radio. 3-way wired switch permits speakers to operate separately or together. Complete with metal grille and protective speaker screen, hardware, template, Instructions, etc.

RS16A 4" x 6" Speaker Kit..... **\$7.94**
RS96J 6" x 9" Speaker Kit..... **\$10.29**

NOVICE TRANSMITTER KIT

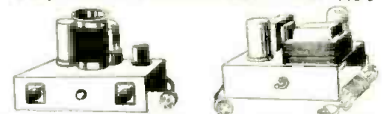

Ideal for beginning amateur or for use as a stand-by rig. Operates on 80 and 11 meters. Big pictorial and schematic diagrams for easy assembly by anyone. Complete with two punched chassis, coil forms and wire, tuning indicator, and all other assembly parts plus standard telegraph key and tubes (6V6, 6L6 and 5Y3GT). Less crystal and small amount of hookup wire and solder required. Novice Transmitter Kit..... **\$32.58**

BARGAIN LOW PRICE FLYBACK TRANSFORMER

(Similar to GE 77J1)
Regular \$11.00 list price high voltage transformer similar to General Electric 77J1. Used for general replacement in many sets up to 14KV and with up to 19" tubes. Not available elsewhere at our low price! A-1827 Flyback Transformer..... **\$2.49**

COMPLETE STOCKS Just off the press
All Standard Brands **BIG BARGAIN BULLETIN**

STAR ELECTRONIC DISTRIBUTORS, INC.
Dept. RN-2—7736 S. Halsted, Chicago 20, Ill.

u.h.f. stations many technicians are confronted with the problem of converting existing v.h.f. sets to receive the u.h.f. channels. In the June and July 1952 issues of RADIO & TELEVISION NEWS various u.h.f. conversion methods were shown. Since then some of these units have been installed and a certain number of difficulties were encountered. The major problem lies in the double superheterodyning used by most u.h.f. tuners. This requires that the u.h.f. station signal beat with the local u.h.f. oscillator to produce a first i.f. corresponding to one of the v.h.f. channels. The regular v.h.f. tuner contains another oscillator which beats with this first i.f. to produce a second i.f. signal, usually in the 22 to 26 mc. range. In intercarrier receivers a third i.f. signal is obtained at the second detector when the sound and picture carrier beat to produce the 4.5 mc. FM sound signal. It becomes apparent that with two oscillators and three i.f. signals the chances for unwanted beats are quite great and indeed this has been one of the major drawbacks of the double superheterodyne system.

Another source of trouble is from v.h.f. stations adjacent to the v.h.f. channel which now carries the first i.f. signal from the u.h.f. transmission. A good example is the case where Channel 8 is used as the first i.f. to receive the beat from a u.h.f. station and the local u.h.f. oscillator. Assume now that a strong local station exists on Channel 7. Under normal conditions the sound from Channel 7 might come through on Channel 8, but since no station is located there, this does not matter. Now, however, the sound from Channel 7 can interfere with the u.h.f. station if it reaches the v.h.f. tuner.

There are a large variety of frequency combinations where such troubles can be expected. To complicate matters, many v.h.f. tuners can be modified by means of added u.h.f. strips. Such strips were described in detail in the June issue. Fig. 3 shows one set of strips for the *Standard Coil* tuner. In this system the local v.h.f. oscillator is tuned to a predetermined v.h.f. frequency, its output passed through a crystal which generates harmonics and either the second or third harmonic is then used to beat the u.h.f. station signal down to a v.h.f. channel. Basically the same scheme is used by *Zenith* and other manufacturers who supply tuning strips to adapt the v.h.f. tuner for u.h.f. By adding these strips no provision is made to exclude unwanted v.h.f. signals which could readily interfere with the u.h.f. station. Thus the chance for v.h.f. interference is considerable in such installations. Most u.h.f. converters use a special hi-pass filter preceding the tuner to prevent v.h.f. interference.

The best method found to date for dealing with such v.h.f. interference is the use of either a suitable wave trap or else a shorted half-wave or open quarter-wave transmission line tuned to the offending channel. In

each individual case it will be necessary to adjust and experiment somewhat before an acceptable solution is found. In order to remove unwanted beats, the offending signal must first be located and this is best done by substituting a generator for either of the two oscillators or else by using a wavemeter to determine the frequency of the beat signal. The cure is to shift the frequency of either of the two oscillators and in this connection it might be suggested that the u.h.f. oscillator be left alone. Where the strip type of conversion is used the frequency of the basic oscillator can be varied by means of the fine tuning control. A 1-mc. variation of the fine tuning control may mean a 2- or 3-mc. variation of the u.h.f. harmonics, shifting the entire beat sufficiently. The only drawback to shifting oscillator frequency at any time is that it also affects the r.f. passband and, more important, the i.f. section. It is often possible to shift the entire i.f. section by 1 or 2 mc. without substantially changing its characteristics.

Many more u.h.f. conversion troubles are bound to occur and solutions to each of them will, in due time, be found. New u.h.f. techniques, new u.h.f.-v.h.f. tuners and completely new i.f. systems will be developed, but at present the TV technician in a u.h.f. area will have his hands full. A knowledge of the various stations, u.h.f. oscillator, v.h.f. oscillator, v.h.f.-r.f. and i.f. frequencies and their possible beats will be a great help in correcting this type of interference.

In preparing a chart showing such frequencies it should be kept in mind that each time two different frequencies are mixed, four different frequencies are obtained, the two original ones and the sum of both and the difference of both. Local oscillators in the v.h.f. band are usually operated above the incoming signal, but for u.h.f. they are often set below the u.h.f. station signal. When all these possibilities are noted and the frequencies of local v.h.f. stations considered, most of the likely beats and interferences can be anticipated.

HAM CONTACTS

THE FCC has recently warned that American amateurs are forbidden, in accordance with international agreement, to contact foreign stations whose governments prohibit their amateurs from working stations outside their country. Governments currently making this prohibition are Austria, Cambodia, Indonesia, Iran, Viet Nam, Laos, and Thailand.

U. S. hams are also required to comply, when working VK (Australian) DX, with an Australian regulation restricting Aussie hams to sending and receiving only experimental data and remarks of a purely personal nature.

The Commission stresses that this list is not to be confused with one published last Spring of countries which permit outside contacts but forbid their hams to handle international third-party traffic.



70% to 90% off list! TOP TUBE BUYS

All Tubes Individually Boxed! Same Day Service!
Check this list for Fully 90-Day Guaranteed Tubes

Type	Price	Type	Price	Type	Price	Type	Price	Type	Price
0B3/VR90	.75	5U4G	.45	6BF5	.41	6AU6	.60	14W7	.40
1A5GT	.46	5V4	.73	6BF6	.37	6U5	.44	19BG6G	.95
1A6G	.59	5W4	.50	6BG6G	1.25	6U6	.63	19C8	.70
1A7GT	.47	5X4	.40	6BM6	.46	6U8	.61	19T8	.79
1A85	.59	5Y3G	.32	6BJ6	.39	6V6GT	.39	19V8	.89
1B3	.65	5Y3GT	.32	6BK7	.59	6W4GT	.44	24A	.63
1B5	.59	5Y4G	.35	6BL7	.59	6W6GT	.44	25AV5	.83
1B7GT	.59	5Z3	.46	6BQ6GT	.59	6X4	.37	25B06GT	.62
1C5GT	.43	6A3	.59	6C4	.37	6X5GT	.37	25L6GT	.39
1E7	.29	6A7	.59	6C5GT	.39	6Y6G	.48	25Z5	.40
1H4G	.48	6A8	.62	6C6	.58	7A4	.47	25Z6GT	.37
1H5GT	.40	6A8A	.44	6C8B	.44	7A7	.53	25W4	.56
1G6	.60	6AC5	.43	6CD6G	1.11	7B4	.44	26	.45
1L4	.46	6AJ5	.90	6D6	.45	7C6	.40	27	.39
1LCS	.51	6AK5	.75	6E5	.48	7E6	.49	32L7	.89
1N5	.46	6AL5	.38	6F5GT	.39	7X7	.70	35B5	.40
1P5	.57	6A05	.39	6F6	.37	12AL5	.37	35C5	.39
1Q5	.58	6A06	.37	6G6G	.52	12AT6	.37	35L6GT	.41
1R5	.45	6AR5	.37	6H6GT	.41	12AT7	.56	35W4	.37
1S5	.39	6AS5	.50	6J5GT	.37	12A06	.38	35Z4	.39
1T4	.45	6AT6	.37	6J6	.52	12AU7	.43	35Z5GT	.37
1T5	.53	6AUG	.38	6J7G	.43	12AV6	.39	36	.60
1U4	.45	6AV5	.83	6J8	.69	12AV7	.59	41	.42
1U5	.39	6AV6	.37	6K5	.47	12AX4	.48	42	.42
1X2	.63	6AX4	.53	6K6GT	.37	12AX7	.48	43	.55
2A3	.70	6B4G	.64	6K7	.44	12A27	.69	45	.55
2X2	1.50	6B5	.64	6L6	.64	12BA6	.38	50B5	.39
3A4	.45	6BA6	.39	6M7	.45	12BD6	.45	50C5	.39
3E5	.46	6BA7	.57	6S4	.38	12BE6	.39	50C6	.59
3Q4	.48	6BC5	.44	6S8	.53	12BF6	.39	50L6GT	.41
3Q5GT	.49	6BD5GT	.59	6SA7GT	.43	12BH7	.63	50Y7	.50
3S4	.46	6BD6	.45	6SD7GT	.41	12J5GT	.42	70L7GT	1.09
3V4	.47	6BE6	.38	6SF5GT	.46	12Q7G	.39	75	.41
				6SG7GT	.41	12S8	.70	76	.44
				6SH7	.73	12SA7GT	.44	77	.57
				6SJ7GT	.41	12SG7GT	.52	78	.47
				6SK7GT	.41	12SJ7	.44	80	.35
				6SL7GT	.48	12SK7GT	.48	83	.68
				6SN7GT	.52	12SL7GT	.47	85	.59
				6SQ7GT	.37	12SN7GT	.52	117L7	.99
				6SR7GT	.45	12SQ7	.44	117Z3	.37
				6S57	.42	12SR7	.49	807	.99
				6T8	.56	14J7	.60	2050	1.85

Rad Tel TUBE CO.

"Integrity Is Our Chief Asset"

Phone: Essex 5-2947

TERMS: A 25% deposit must accompany all orders—balance C.O.D. All shipments F.O.B. Irvington warehouse. Orders under \$10—\$1.00 Handling Charge. Subject to prior sale.

Don't Delay . . . Order Today!

**115 COIT STREET
DEPT. RN-253
IRVINGTON 11, N. J.**

THE NEW

Regency

VB-1 Voltage Booster*

Get peak performance from your TV set or any electrical device drawing 350 watts or less. This manually operated autotransformer maintains full 117 volt power supply. Insures full size TV picture when low line voltage shrinks picture size.

THE VB-1, \$19.95 LIST

*by the makers of the Regency VHF TV booster and UHF TV converter

Ask any radio parts jobber for further information or write:
I.D.E.A., INC., REGENCY DIVISION
7900 Pendleton Pike, Indianapolis 16
Cherry 2466



If you're in television

THESE BOOKS CAN BE IMPORTANT TO YOU

Movies for TV

By John Battison. The practical information you need for making the most effective use of movies on TV programs. Explains why some types of pictures are better than others; how to make titles and special effects; what types of lighting to use; various ways to present commercials; causes of technical flaws and how to avoid them, and a wealth of other information on principles, techniques, and equipment. \$5.00

Painting with Light

By John Alton. A leading Hollywood Director of Photography, winner of the 1951 "Oscar" for photography, explains his professional lighting techniques—what equipment to use and how to place it for a particular mood or effect, indoors or out; how, for instance, to get candlelight or a moving train at night, what lighting to use for rain, for close-ups, and hundreds of other special scenes—information as vital for good TV pictures as for movies. \$6.75

Mandl's Television Servicing

By Matthew Mandl. Detailed, illustrated instructions for locating and correcting every flaw or failure you're likely to encounter, including those hard-to-find troubles. Simple signal tracing procedures, trade tricks in diagnosing troubles in minimum time, essentials of VHF and UHF servicing, complete master trouble chart. Fully and clearly explains each stage in today's receivers, showing what faults may occur in each and why. \$5.50

Television for Radiomen

By E. M. Noll. Very clear, non-mathematical explanations of the function and operating principles of every element and circuit in TV reception, together with practical instruction on the installation, alignment, adjustment and troubleshooting of modern receivers. Provides the THOROUGH UNDERSTANDING of TV needed for effective servicing. \$7.75

Television and FM Antenna Guide

By E. M. Noll & Matthew Mandl. Are interference, fringe reception, ghost reception your problems? This book tells you how to overcome them—how to improve gain, minimize noise from the transmission line, get the MOST out of the antenna system at any location. A brief clear course in antenna theory is followed by instructions for determining the right type of antenna for the site, the best position for it, the right installation, with full, tested data on all types of antennas including those for UHF and VHF locations. \$6.25

See these most helpful books at your book store, or write for on-approval copies to

THE MACMILLAN COMPANY
60 Fifth Avenue, New York 11, N.Y.

V.F.O. Multiplier (Continued from page 53)

gang may be used for S_{1c} . The underside of the first gang is located just about right for S_{1b} . S_{1a} can be the top half of the first gang (looking at it from the underside of the chassis).

After all wiring has been completed, the unit can be connected to a suitable power supply for initial testing and adjustment. The first step is to check all voltages at the tube sockets. If these are correct, the v.f.o. trimmer can be adjusted so the v.f.o. will cover the proper range. It should tune over the entire amateur 80-75 meter band with some extra room at each end. A communications receiver makes an excellent monitor to check output from the v.f.o.-multiplier unit. The v.f.o. tank coil slug was left all the way in on the original model. After the v.f.o. tuning range has been set, a little preliminary adjustment of the broadband couplers should result in settings which show resonance at the lower end of the 80-75 meter bands, as indicated by a small neon light touched to the "hot" side of each trimmer. The keying lead is grounded for all these preliminary adjustments.

The next step is to check for parasitics, and the keying lead should be left unconnected for this. No spurious oscillations from the v.f.o.-multiplier unit should be heard over the entire range of a communications receiver that tunes from 540 kilocycles to 30 megacycles or more. A check should be made with the bandswitch in each of the five positions. The only parasitic oscillation found in the original model was removed by inserting the 500-ohm resistor, R_6 , in the grid lead of the second multiplier tube. If other parasitics are found they should be traced to their source and eliminated before proceeding any further.

Some check should be made on the frequency stability of the unit. Frequency drift due to changing temperatures can be minimized by the use of a proper value of negative-temperature-coefficient condenser in parallel with the v.f.o. tank coil and tuning condenser together.

The third step in adjusting the multiplier unit requires the use of an experimental grid circuit exactly like the one into which the multiplier will work. Plate and screen voltages need not be applied to the experimental stage, but some means must be devised whereby the rectified grid current in that stage can be read with the tube heater lighted. This may be a low range d.c. milliammeter in series with the grid choke, or it may be a 0-200 volt d.c. voltmeter connected across a 50,000 ohm resistor which has been placed in series with the grid choke. The output of the multiplier is connected to the grid of this experimental stage through a 50 μ fd. mica trimmer. The trimmer is set for maximum capacity.

"SPECIAL!!" ALL-CHROME CRYSTAL BULLET MIKE (Famous Make) . . . 30-10,000 cycle response. . . \$2.00. Swivel head. (L.P. \$27.35.)

NOW ONLY \$8.95

50W POWERED PHONE UNITS for all types of intercom work. 2" O.D. ea. \$1.95; 2 1/2" ea. \$1.95. 4W NEON GLOW LAMP (NE-18) ea. 29¢; 10" 2.49 D.C. BAYONET SOCKET. Flush mtg. for NE-18. 23

LEOTONE

"JUMBO RADIO PARTS"
LBS. of COILS, SWITCHES, CONDENSERS, SOCKETS, RESISTORS, CONN. SERS, WIRE, AND MUCH, MUCH MORE! (Ship. wt. 50 lbs.)
\$3.95

RADIO HARDWARE TREASURE FULL CAN of Nuts, Screws, Lug, Washers, etc. . . . 89¢

5" C.R. TUBE FRONT BEZEL . . . blk. crackle . . . 50.89
5" SCOPE VISOR . . . flexible vinylite 89
5" SCOPE GRID radial calibrated 89
5 1/2" ROUND CONVEX LENS . . . clear glass . . . ea. 39¢
16" TV MASK-ESCUTCHEON (round silver) moulded of crystal clear Lucite. Sliver gray masking ground-structure. Ship. wt. 2 lbs. 1.69
ARMY GAS MASK (fully adjust. Protects against fumes, dust, spray, etc. Less CAN. 39¢

"TUBE CLEARANCE SALE!!" . . . 90-DAY GUARANTEE Standard brands; unsealed cartons
= 24, 26, 27, 34, 41, 42, 55, 56, 55, 59 or 6K7 ea. 29¢
= 1H4, 1H6, 1J6, 6BT, 6P5, 6G5, 6S17, 6SH7, 6U7 or 7A ea. 39¢
= 35, 45, 71, 77, 1L4, 5Y3, 5Y4, 5U3, 6F8, 6J5, 6K8, 6S47, 6SK7, 6C5, 6U7, 7A4, 7H9 or 7G7 ea. 59¢
= 1A7, 1L6, 1LH4, 2A5, 2A6, 6A3, 6AB, 6H8, 6SC7, 6SN7, 7A7, 7AG7, 7C6, 7C7, 7Y4, 12SN7, 47, 50 or 57 ea. 69¢

TUBE CARTONS plain white. Prices per 100
Min (1 1/2" x 2 1/2" x 3 1/2") . . . \$1.20; GT (1 1/2" x 2 1/2" x 3 1/2") . . . \$1.45; Med (1 1/2" x 3 1/2" x 4 1/2") . . . \$1.65; Large (2" x 3 1/2" x 4 1/2") \$1.98

CONNECTOR SPECIALS!! . . . Jones 33 Contact (-33) . . . Cable female; panel male. Off cable set \$1.29; 5 . . . \$5.00
PL-54 JK-26 CONNECTORS . . . ea. set \$3.00; 10 . . . 3.49
PL-291 JK-48 MIDGET CONNECTORS set 39¢
CABINET DRAW SLIDES (client ball-bearing)
pr. \$2.25; 10" (12" ext.) . . . pr. \$2.10; 12" (14" ext.) . . . pr. \$2.39; 14" (16" ext.) . . . pr. \$2.59; 16" (18" ext.) . . . pr. \$3.25
Hvy. duty all steel 10 1/2" pr. \$3.25

"KINKLESS" SUPER-FLEXIBLE BRAID WIRE (32 #10) . . . WITHSTANDS CONTINUOUS BENDING as in Relays, Slewcoils, etc. Cotton core; outside silk.
20 ft. /98¢ 100 ft. /\$3.75 1000 ft. /\$32.50

"DIRECT FACTORY SPEAKER REPAIRS SINCE 1927" Min. order \$3.00. 20% deposit req. on all C.O.D.'s. Full remittance with foreign orders. Please add sufficient postage—access refunded.

LEOTONE RADIO CORP.
67 Dey Street
New York 7, N.Y.

STAY ON THE AIR WHEN POWER FAILS...with an ONAN Electric Plant



AUTOMATIC START & STOP

Model 10EL, 10KW A.C.

When storms, floods, or fires interrupt electricity and force you off the air, you lose listeners and income. Guard against loss, assure vital public service during emergencies by installing an Onan Electric Plant. Onan Standby Electric plants serve many network and private stations. Automatic models to 35,000 watts.

PORTABLE ELECTRIC PLANTS FOR MOBILE RADIO USES
Supply A.C. power for broadcasting at scene of events. Light in weight. Can be carried by hand or in trunk of car. A.C. models: 400 to 3,000 watts.

Write for **FREE Folder**

D. W. ONAN & SONS INC.
7894 University Avenue
Minneapolis 14, Minnesota

Set the bandswitch in the fifth position, and tune the v.f.o. so a signal is heard on a communications receiver with its dial set at 14 megacycles. Then adjust C_{12} and C_{15} for maximum grid current. Then set the v.f.o. so a signal is heard at 15 megacycles. Adjust C_{15} and C_{22} for maximum grid current at this setting. Again set the v.f.o. so a signal is heard at 14 megacycles and repeat the adjustment of C_{12} and C_{15} . Then follow the same procedure as before with C_{15} and C_{22} . By adjusting the broadband couplers in this way it should be possible to find settings at which the grid current in the following stage runs from 1½ to 2 milliamperes at the 14 and 15 megacycle settings of the v.f.o., and slightly less in between. The final output curve should be two-humped, with peaks on or just outside the edges of the range from 14 to 15 megacycles, and a slight dip in the middle. If this kind of a response curve cannot be obtained by adjusting the four trimmers in the order given previously, reverse the frequencies at which each trimmer is peaked, using the 14 megacycle setting for C_{15} and C_{22} , and the 15 megacycle setting for C_{12} and C_{15} . If difficulty is still experienced, adjust C_{12} and C_{22} at one frequency and C_{15} and C_{15} at the other. If C_{22} seems to have too much capacity to allow proper adjustment, reduce the capacity of C_{22} .

After these adjustments have been made, set the bandswitch to position four and check the output over the range from 7 megacycles to about 7.2 megacycles. The same two-humped curve should be noted. If it is not, find settings of C_{12} and C_{15} which will improve output in the 7 megacycle range without materially affecting the output in the 14 to 15 megacycle range with the switch in position five. No adjustments are necessary with the bandswitch in positions one and two because the broadly resonant 80-75 meter coil is in the plate circuit of the first multiplier-buffer tube. Output should be between 1½ and 2 milliamperes over the entire 80-75 meter range.

Minor re-adjustment will probably be necessary after the unit is permanently mounted in the equipment with which it is to be used. The output over the necessary range on each setting of the bandswitch should be checked and the broadband coupler trimmers adjusted for proper response curves.

The unit can be mounted on top of a regular chassis, with ¼" holes drilled to give access to the broadband trimmers. It will be necessary to mount the v.f.o. multiplier unit to the panel first, so the panel bearing on the bandswitch and the four mounting screws of the National SCN dial assembly can be tightened. Care should be taken to mount the unit in such a way that none of the coils or chokes is in a magnetic field from a nearby power or filament transformer. This is particularly true of the v.f.o. tank

KESTER

Since the most important single step in Radio-Television Servicing is soldering... it's just plain good sense to use the best — KESTER SOLDER... Key Name in Solder for More Than 50 Years.

KESTER SOLDER COMPANY
4235 Wrightwood Avenue • Chicago 39, Illinois
Newark 5, New Jersey • Brantford, Canada

SOLDER

WE MADE A TERRIFIC TUBE PURCHASE!

STEVE-EL'S large purchasing power enabled us to buy the entire stock of a leading manufacturer. Every tube carries the STEVE-EL name which is your guarantee of complete satisfaction or money back. All tubes individually boxed.

SEE FOR YOURSELF

1B3GT \$0.63	6BE648	6SQ742	12BA647	25BQ677
1U448	6BG6 1.21	6T874	12SA752	25W448
1U548	6BH662	6U657	12SK749	25L648
1S548	6BJ653	6U878	12SL757	25Z642
1X263	6BK786	6V6GT46	12SN754	35L648
5U438	6BQ676	6V883	12SQ742	35Z533
5W4GT46	6BQ786	6W445	14AF759	50L648
5Y3GT29	6CB648	6W652	19T878	8038
6A762	6F649	6X434		
6A851	6J679	7C642		
6AG562	6L6G89	7X762		
6AK5 1.14	6SA752	12A7648		
6AL541	6SG749	12AU648		
6AU643	6SK749	12AU756		
6BC558	6SL752	12AV652		
6BC786	6SN754	12AZ794		

SPECIAL DISCOUNTS 50 Asst. { 5% 100 Asst. { 10%

Write Dept. RN-2 for FREE Catalog.

SPECIALS

- Web-Cor Tape Recorder #210-1B \$146.50
- Pentron Tape Recorder #9T3C 117.50
- Tape Master #PT 125 89.50
- Tape Master #SA 13 69.50
- Wen 250 Watt Soldering Gun 9.71

STEVE-EL ELECTRONICS CORP. VISIT OUR NEW STORE

61 Reade St., New York 7, N. Y. COrtlandt 7-0086

Neither

~~TRIODES~~

Nor

~~Tetrodes~~

permit the low distortion and high efficiency of the

Acrosound

ULTRA-LINEAR Amplifier Circuit

This circuit and the Acrosound TO-300* output transformer are designed to work together for the highest quality sound obtainable. The combination provides optimum performance resulting in the most linear output stage which can be made with conventional tubes.

The heart of this new circuit development is the transformer whose specifications and proven performance make it the world's finest.

ACROSOUND TO-300*



\$2475 net

At Leading Distributors

- ✓ response ± 1 db 10 cps to 100 kc
- ✓ 20 watts undistorted 20 cps to 30 kc
- ✓ 40 watts undistorted 30 cps to 20 kc
- ✓ Unequalled square wave performance
- ✓ Resonance free response
- ✓ Uniformity of characteristics
- ✓ Compact, rugged construction

Complete data and characteristics of Ultra-Linear Circuits and Acrosound Output Transformers on request.

* Patents Pending

ACRO PRODUCTS CO.
369 Shurs Lane, Phila. 28, Pa.

coil. Frequency modulation at the a.c. frequency of the power or filament transformer will result if the v.f.o. tank is in any stray magnetic field. The unit should be located so that it is protected from drafts. It is better to let it reach a certain temperature and stay there rather than to try to keep it cool. A good source of screen voltage for the v.f.o. is a 30,000 ohm wire-wound potentiometer connected across the regulated supply to the v.f.o. plate. This potentiometer can then be adjusted for most satisfactory operation of the v.f.o. multiplier over its entire frequency range and for best keying characteristics. A VR75 tube in series with a VR105 makes a good combination for delivering regulated voltage to the v.f.o. and to the multiplier screens. The plate and screen power supply should be capable of delivering around 70 milliamperes at the required voltages.

-30-

Remote B.C. Amplifier
(Continued from page 63)

equipment. The all-important radio line is permanently installed. The engineer on duty at the main studio feeds program down the line right up to air time. The sports announcer listens with his earphones and starts his program on a pre-determined broadcast cue. This is usually a time announcement or a direct cue such as "We take you now to Phoenix Municipal Stadium and your sportscaster..." The engineer at the main studio opens the gain control on the remote channel of his console and the program is on the air. After the broadcast the announcer reverses his operation, pulling the a.c. plug, his mike, and earphones.

It's as simple and economical as that.

-30-

NEW LICENSE FORMS

NEW forms and a radically different procedure have been adopted by the FCC for new or modified station licenses in the Public Safety, Industrial, and Land Transportation services.

FCC Forms 400 and 400-A will be available at all Field Offices during February and will replace FCC Forms 401, 401-B, 403, 702, and 703, some or all of which have been necessary for various applications. Form 400 is for new licenses and 400-A for modifications.

A "List of Equipments Acceptable for Licensing" will be released at the same time as the forms and retained at all FCC Field Offices, where they may be inspected or reproduced by interested parties. An applicant may use any equipment on the list that fulfills the requirements of his service. Non-listed equipment can still be authorized, however, provided the proper technical data accompanies the application.

A feature of Form 400-A is the simple manner in which authority can be obtained to add mobile units to an existing system.

-30-

PHOTOCON SALES

417 N. Foothill Blvd. SY camore 2-4131
Pasadena 8, Calif. RY an 1-6751

FREE 24 PAGE WINTER SURPLUS SALES CATALOG

WANTED new or clean used electronic surplus. Please state exact description of the condition and details of modification. Include lowest price in first letter.

LM & BC-221 Frequency Meter with cal. book, crystal, and tubes.....	Exc.	\$ 99.50
TS-352/U Weston Test Set.....	Exc.	150.00
TS-148/CP.....	New Mfg.	PUR*
Signal Generator 10GA.....	Like new	PUR*
Million Signalyzer Radio & TV.....	Like new	PUR*
Dumont 208 Scope.....	Exc.	PUR*
TS-146/EP X-Band Signal Generator.....	Exc.	PUR*
TS-34/A1 Portable Oscilloscope.....	Exc.	350.00
TS-12 Test Set for X-Band Box 1 & 2 complete.....	Exc.	PUR*
TS-323 Frequency Meter 20-480 mc.....	Exc.	PUR*
Hewlett-Packard 410A VTVM. Like New	Exc.	185.00
Signal Generator Mod. 804 8-330 mc. Exc.	Exc.	PUR*
Simpson Genescope, New.....	Exc.	275.00
305B Floor model Oscilloscope 7" tube	Exc.	PUR*
RCA mfg.....	Exc.	PUR*
APR 4 Search Receiver.....	Exc.	PUR*
Tuning Unit for APR-4 Receiver.....	Exc.	PUR*
BC-348, BC-312, BC-342 Receivers.....	Exc.	PUR*
APS-3.....	Exc.	PUR*
SCR-284 Fields Sets.....	Exc.	PUR*
APN4A or B.....	Exc.	PUR*
API-5A.....	Exc.	PUR*
SCR-545 Radar Trailer.....	Exc.	PUR*
Type 120A Test Set 130-210 mc.	Exc.	PUR*
Donnan Radio Corp.....	Exc.	17.50
Antenna AT 104/APN9.....	New	
Automatic Pilot Inverter		
Type DA Input 28VDC, @ 12 amps.		
Output 115V., 3 phase, 400 cps.		
115VA.....	Exc.	80.00
T-17 Hand Microphone with cord and PL-68.....	Exc.	4.50
HS-23 8000 ohm. Used \$2.95.....	New	5.95
HS-18 8000 ohm. Used 1.75.....	New	2.25
HS-33 600 ohm. Used 3.50.....	New	6.95
HS-38 600 ohm. Used 1.75.....	New	2.25

* PUR - PRICE upon request.

NOTE: One of the largest and most complete electronic surplus stocks in the country. We have thousands of tubes, capacitors, plugs, accessories, transmitters-receivers, test equipment, etc. Send us your requirements.

TERMS: Prices F.O.B. Pasadena, California. 25% on all C.O.D. orders. Californians add 3% Sales Tax. Prices subject to change without notice.

SUPER VALUE!



0-1 MA DC
4" SCALE

Only \$5.95 ea.

2 FOR ONLY \$11.00

Greatest meter value ever offered! Sensitive 1 MA DC basic movement may be used for any type of current or voltage meter. Big 4" scale calibrated 0-1 for easy fractional readings. Rectangular bakelite case with corner mounting holes mounts flush on panel, projects 2" forward. Nothing behind panel except meter terminals. Meter case measures 4 1/2" high, 5 3/8" wide. These meters are slightly used but have been thoroughly checked and reconditioned. We guarantee them for absolutely top performance. Don't delay; order now! No more available after present supply is sold!

25% with order—

balance C.O.D., F.O.B. Chicago

NATION WIDE RADIO

572 W. Randolph Street Chicago 6, Ill.

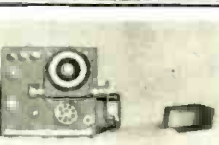

RU-18 RECEIVER

Navy 6-tube aircraft receiver with DF loop and antenna input; complete coverage from 190 KC to 13.9 mc.; in 8-coil sets; less tubes; brand new with any 5-coil sets; you name the frequency you desire; F.O.B. shipping wt., 25 lbs. \$19.95

McCONNELL'S

3834 Germantown Ave. Phila., Penna. RA 5-6033

ATTENTION

Distributors in Chan. ± 12 Territory

We are in production on 5, 10 & 12-Element—most efficient YAGI ever designed. MANY TERRITORIES STILL OPEN. We Welcome your Inquiries. ALSO COMPLETE LINE OF THE ANTENNAS.

FRENCHY RADIO MFG. CO.

164 W. Parker St.

Scranton 8, Pa.

Technical BOOKS

"ESSENTIALS OF MICROWAVES" by Robert B. Muchmore. Published by John Wiley & Sons, Inc., New York. 232 pages. Price \$4.50.

With more and more services moving into the microwave region as the spectrum becomes more and more congested, interest in the subject has been stimulated to the point where there was a real need for a basic and not-too-technical work covering microwave principles.

Mr. Muchmore has met this need by writing a clear and logical explanation of the phenomena governing the action of microwaves. His style is lucid and straight forward which should prove to be a boon to the student or layman.

The book is divided into fifteen chapters which cover: introductory material, the electromagnetic laws of Maxwell, characteristic waves and wave guides, cavity resonators and filters, characteristic waves and antennas, typical microwave antennas, waves and electron streams—grid-control tubes, klystrons, traveling-wave and multiple-stream tubes, magnetrons, electrical noise, microwave radio systems—relays, radar, applications of microwaves in physical research, and microwave measurements.

A glance at these chapter headings indicates the scope of the text and those interested in microwaves should find plenty of food for thought in this volume.

* * *

"ELECTRICAL FUNDAMENTALS OF COMMUNICATION" by Arthur L. Albert. Published by McGraw-Hill Book Company, New York. 522 pages. Price \$7.00. Second Edition.

In the ten years since the first edition of this work appeared radio communications, which constitutes a third of the subject matter, have made great strides. Because of these advancements the author has reworked large portions of the original text to bring the reader up-to-date with the state of the art.

The text covers the three divisions of communications, telegraphy, telephony, and radio with its allied branches. Additional emphasis has been placed on radio fundamentals in this edition, along with its allied art—television.

Since this book is designed specifically for beginning students, the explanatory material has been made as simple as possible. One interesting technique which the author has employed is to use illustrative material from the field of communications rather than resort to electrical power analogies or non-related scientific branches.

The sixteen chapters which comprise this book cover such subjects as the fundamentals of electronics; direct voltages and currents; conductors,

Don't Gamble.... ON ULTRA HIGH FREQUENCY

"RECEPTION"



..you can count on the....

MI-TEE RAY

UHF ANTENNA

- designed and engineered exclusively for UHF
- all aluminum sturdy construction
- minimum space requirements
- matchless reception
- nationally advertised

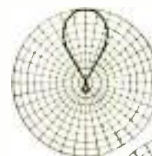
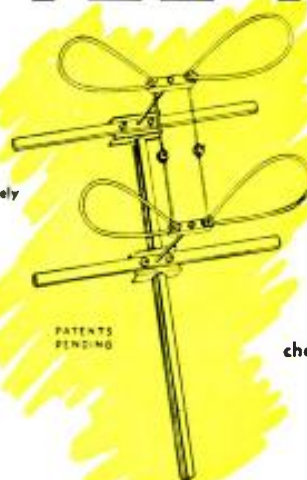

channel 14



channel 83



INCORPORATED
Pittsburgh 19, Pennsylvania

WANTED!

• RADCOM pays highest prices for surplus equipment, parts and tubes

- TCS-7 and up • SCR-274N, SCR-300 • ARC-1, ARC-3, ART-13
- SCR-399 Equipment JB-70, JB-60, BC-939A, BC-610-E, RA-63, EE8, BC-614-E, PE95, PE197, Trailer K-52, Gords, LS-3
- SCR-508 . . . BC-604, BC-603, FT-237. Crystal Sets
- SCR-506 . . . BC-653-A, BC-652-A, DM-40-A, FT-253-A, BC-658-A
- BC312, 342, 348, BC-1000 Receivers
- SCR522 Equipment, RA-34 Rectifiers
- Transmitters BC-696, R89/ARN-5A, MN-62, Test Equipment SCR-211, 1-208
- Selsyns—All kinds . . . Magnetrons
- Generators—GN-45—All kinds
- 5-KW Gas Generators, PE-75, PE-95, PE-197
- Plugs and Connectors
- Tubes—Special Purpose, Lots
- Technical Manuals Especially for ARC-5

Bigelow 2-6666

Always Right With Earl White

RADCOM Engineering Co. 8 Livingston St. Newark 3, N. J.

MOTOROLA-DETROIT CO.

one of the country's largest distributors of television sets and appliances

SAYS

KRYLON

100% ACRYLIC

IS A PROFITABLE ITEM TO STOCK FOR 2 REASONS

1. TV SERVICEMEN BUY IT



"Our customers use Krylon and plenty of it," reports Motorola-Detroit parts manager, Paul Wallace. "The spray nozzle makes it easy to insulate the complete chassis in a matter of minutes." Because of its high dielectric strength, Krylon helps prevent corona.

2. WE USE IT OURSELVES



Indoor service chief, John Workman, reports, "We use Krylon clear plastic coating to spray the bell part of metal picture tubes. Krylon stops dust from adhering to the tube and prevents arcing. We find Krylon is a must in television service operations."

ALSO

"Our appliance division uses White Krylon to touch up any white goods that become chipped. We're sold on White Krylon for one big reason—it won't turn yellow."

Schedule J Wapoff
Service Manager
Motorola-Detroit Co.

In U.S.A. and CANADA
SEE YOUR JOBBER
Or Write For Information
Department 2702

KRYLON, Inc.
2601 N. Broad St., Philadelphia 32



resistors, and insulators; direct current electric power and energy; alternating voltages and currents; the magnetic field and inductance; the electric field and capacitance; electric measuring instruments; alternating current circuits; algebraic representation of vectors; electric networks; bridge circuits; the transmission of electromagnetic waves; fundamental principles of electron tubes; electron tubes as circuit elements; and electro acoustics. A table of natural trigonometric functions has also been included.

"HIGH FIDELITY SIMPLIFIED" by Harold D. Weiler. Published by John F. Rider Publisher, Inc., New York. 208 pages. Price \$2.50. Paper bound.

This compact handbook has been prepared for the benefit of the audio enthusiast who knows and appreciates good music but is not cognizant of the technical "why's and wherefore's".

The author's easy and conversational style helps tremendously in putting the subject matter across to the layman. He opens the book by discussing the meaning of high-fidelity reproduction, how it may be obtained, and a brief resumé of the type of equipment that is available.

The balance of the book is taken up with a discussion of the individual components which go to make up a high-fidelity music system, i.e., speakers, amplifiers, record players, tuners, and tape recorders.

The text material is lavishly illustrated with actual photographs of commercially-available equipment. A list of high-fidelity component manufacturers is appended for ready reference.

Those planning high-fidelity music systems for their homes will save themselves time, money, and trouble by reading this book first then making their purchases.

"DATA AND CIRCUITS OF MODERN RECEIVING AND AMPLIFYING VALVES" compiled and edited by N. S. Markus & J. Otte. Published by Philips Technical Library, Eindhoven, Holland. Available in the U. S. from Elsevier Press Inc., 402 Lovett Boulevard, Houston 6, Texas. 487 pages. Price \$6.25. Book IIIA, Second Supplement.

This is the third in the Philips series covering receiving and amplifying tubes. The previous volumes covered the years 1933-1939 and 1940-1941. With this book the authors have dealt with tubes brought out by Philips in the postwar years 1945-1950.

Of special interest to engineers is the company's "Rimlock" series of tubes, and the new noval types which include the EQ 80, a specially-designed component for FM and AM-FM receiver applications.

Like the previous volumes of this series, the authors have devoted a generous amount of space to practical applications for the various new tubes. Technical details and performance data are lavishly provided, along with

Profit Building Replacement Yoke RCA-Type 74952



only
349
LIST 10.30

Used in RCA TV Models

6T53	6T65	6T75
6T54	6T71	6T76
6T64	6T74	Etc.

Servicemen, dealers—here's a terrific profit builder for you. This direct drive yoke (also known as Drawing No. 970669-1) is used in most popular RCA TV models. Fully guaranteed. Complete, ready for use, with network and octal plug. ORDER NOW!

Send for FREE catalog of other bargains.
GREEN TELE-RADIO
DISTRIBUTORS, INC.
Dept. R-2, 472 Sutter Ave., Brooklyn, N. Y.

DON'T PASS THIS BUY

GOOD VALUE MARINE BAND RADIO RECEIVERS AT LOW COST—UNITS REMOVED FROM POLICE RADIO CARS, used but in good working condition, fixed tunable in 2-3mc band. Complete with 5 tubes, speaker & 6 volt input power supply. Also suitable CD. AUXILIARY POLICE-FIRE SERVICE. As is w/money-back guarantee. Wt. 28 lbs. \$14.95

ARMY SURPLUS SECTIONAL STEEL WHIP ANTENNAS—12 1/2 ft. \$1.85; 18 1/2 ft. \$2.50; 24 1/2 ft. \$3.25

IDEAL 30-40 meter vertical assy. 2 1/2 ft. 4.65

HINGED TYPE INSUL. WTC BASE, IDEAL/low bridge lowering of nut. Used W/insul. units. 7.95

BRAND NEW MFD 6 V. BATTERY CHARGERS, keep your battery in good cond. during winter 7.95

COMPACT ELTRON VIBRATOR PACK, 6V in. 20V/30 ma will operate on 4 D cells. 2 1/2 dia. x 2 1/2 in. 3.95

6 VOLT DYNAMOTOR, 250V/100 ma. brand new 11.95

W. E. MARINE RADIO-TELEPHONE, brand new 4 channels, w/12 volt power supply. 149.50

YOUR NEW RADIO CONTROL PARTS HEADQUARTERS CRYSTALS, 27.255mc. .04 tol. (PCO) atomk 3rd harmonic oscil. newly mfd to our specs. 54.25

XFG-1, that hard-to-get English tube. 3.35

SIGMA 4F relay, 10,000 ohm .04 watt sensat. 2.45

SIGMA 5P relay, 150 ohm dual coils. 2.95

SIGMA 5P relay, 5000 ohm super-sensitive, 4 1/2 the ideal relay for your receiver, special. 6.95

MILLER RECEIVER PARTS PACKAGE, complete tube & SIGMA 4F relay, wonderful buy. 11.95

ESSCO SUPER, a new 2 tube reliable receiver at price of one tube, complete kit. 15.95

RECEIVER PARTS PACKAGE, for AIR TRAILS PLAN R-101, with XFG-1 & SIGMA 4F relay 12.95

TRANSMITTER PARTS PACKAGE, w/tube, crystal, antenna & meter, for AIR TRAILS PLAN R-101 circuit, all first class materials 14.95

3 SIGNNY BACK GUARANTEE ON ALL ITEMS Save G.O.D. Fees, Incl. Postage Extra Refunded Minimum Order—\$3.00. Please

Special Bonus: 1 lb Hookup Wire Kit Free '55 Order

ELECTRONIC SPECIALTY SUPPLY CO.
58 WALKER STREET, NYC 13, N. Y. WALKER 5-8187

WATCH FOR THE NEW ZIFF-DAVIS

PUBLICATION

SEA STORIES

Thrilling Tales of the Deep!
NOW ON SALE!



TWO DOTS
MAKE THE
LETTER



GET in on the fun of operating your own licensed transmitter. I guarantee you will memorize the International Morse Code alphabet within two hours by my simple picture method, or return method within five days and I will refund your money.

COMPLETE COURSE ONLY \$1
NOTHING ELSE TO BUY!
OTTO LUTHER, NEW PRESTON, CONN.

RADIO & TELEVISION NEWS

graphical representation of the tube's characteristics.

A separate section in the back of the book provides data on the company's latest measuring and auxiliary equipment line. Each piece of test gear is illustrated, classified, and accompanied by a detailed technical explanation of its performance, etc.

Those who are familiar with the previous volumes in the *Philips* series will find that the same high standard prevails in this newest publication. Those who are not acquainted with these particular works will find the approach stimulating and informative.

"THERMIONIC VACUUM TUBES AND THEIR APPLICATIONS" by W. H. Aldous & Sir Edward Appleton, Published by *John Wiley & Sons, Inc.*, New York. 156 pages. Price \$2.00.

This pocket-size book packs a wealth of practical information into its comparatively few pages. Although written for the student of general physics rather than the radio specialist, nonetheless the engineer or advanced ham will find much of interest.

Thirteen chapters divide the text material and cover an introduction, the construction of thermionic tubes, the internal action of the two-electrode tube or diode, the internal action of the three-electrode tube or triode, the internal action of multi-electrode tubes, the use of tubes as amplifiers, limits to amplification, the use of tubes as rectifiers, the use of vacuum tubes as frequency changers, the use of tubes as oscillation generators, miscellaneous uses of feedback, the use of space charge control tubes at u.h.f., and transit time tubes.

While some knowledge of simple mathematical procedures is requisite for a thorough understanding of the text material, the student should experience no difficulty in handling the subject matter.

Vest-Pocket Receiver (Continued from page 61)

ing "Q". Detuning also takes place, requiring readjustment of the tuning condenser.

Once the assembly and wiring have been completed, and the unit checked for operation, a small screwdriver or alignment tool may be used to tune in the builder's favorite local station. The tuning condenser (C₂) may then be left fixed in position permanently.

If the builder does not wish to leave the receiver tuned to a single station, a small extension might be soldered in place on the trimmer adjustment screw, and a "tuning" knob provided alongside of the "On-Off" switch and volume control.

However, irrespective of the minor modifications undertaken by the individual builder to suit his own requirements, the completed "Vest-Pocket Receiver" should give many hours of pleasure.

This **TECHNICAL INDEX** is one reason you need this 28-page volume!



Not just a catalog!

Includes both technical and product data in factual, concise form with dozens of helpful explanatory photographs, charts and tables. Features much engineering information available NO-WHERE ELSE!

IT'S THE *University* **TECHNIOLOG**

The new 1952 compilation of valuable information that explains and simplifies the application of loudspeakers. A real time and money saver for dealers, contractors, service men and installation designers. The most authoritative, single piece of literature ever published on loudspeakers. It's yours FREE.

TECHNICAL INDEX

SELECTING THE PROPER LOUDSPEAKER SYSTEM	Page 4
METHODS OF CONNECTING SPEAKERS TO THE AMPLIFIER	Page 8
IMPEDANCE MATCHING	Page 9
CONSTANT VOLTAGE DISTRIBUTION SYSTEM	Page 12
IMPEDANCE MATCHING TRANSFORMERS	Page 16
EFFECTS OF MISMATCH UPON POWER TRANSFER	Page 16
CONTROLLING LOUDSPEAKER VOLUME	Page 20
OVERLOAD PROTECTION OF LOUDSPEAKERS	Page 22
PHASING LOUDSPEAKERS	Page 23
REVERBERATION	Page 23
BAFFLING A CONE SPEAKER	Page 26

ADDRESS REQUESTS TO YOUR DISTRIBUTOR



UNIVERSITY LOUDSPEAKERS • INC
80 SO. KENSICO AVE., WHITE PLAINS, NEW YORK



Mr. FED says **HAPPY NEW YEAR**

with these **Federated MONEY SAVING SPECIALS**

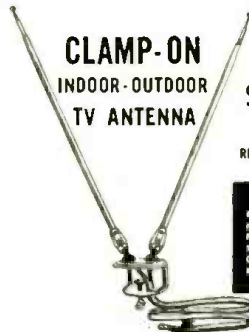

**CLAMP-ON
INDOOR-OUTDOOR
TV ANTENNA**

Model #1N852

\$1.39

REGULAR LIST PRICE \$4.25

EXTRA:

Mention this ad at your nearest FEDERATED SUPPLY CENTER TO OBTAIN 3-SECTION DI-POLES FOR \$12.50. Cash in on this money-saving offer now!

Brush Microphone

MODEL BA-116.

\$5.95.

List Price \$14.75.



Rugged, dependable. Uniform frequency response. Smart brown hammered metallic finish. Ideal for hand or desk use — requires no stand.

COMPARE THESE EXCLUSIVE FEATURES

- Special clamp for easy installation on rear of TV set, wall, or outside of window.
- Felt-lined bracket to protect cabinet finish.
- 3-section di-poles telescope to desired length for all-channel reception.
- Plated-brass construction.
- Ball socket plus swivel joint for quick extension in any direction.
- Easy-to-attach lead-in wire with lugs.

- Frequency Response 50 to 6,000 cps.
- Output level 53 db below 1 volt/dyne/cm².
- 8' cable.
- High impedance equivalent to approximately .002 mfd. (1.8 megohms at 1,000 cycles.)
- Shock Mounted.
- Metalseal crystal cartridge insures longer life.

Act and Save Now... They're Moving Fast!

Hams! Servicemen! Experimenters! Save... Visit your nearest Federated center!

Federated Purchaser

Nation's Only Coast-To-Coast Electronics Distributor

- New York City 7, N. Y., 66 Dey St.
- Newark, N. J., 114 Hudson St.
- Allentown, Pa., 1115 Hamilton St.
- Easton, Pa., 925 Northampton St.
- Los Angeles 15, Cal., 911 So. Grand Ave.



L. Veltri, busy service-dealer of Westchester, N. Y., reports:

I SAVED \$940*
by making a \$59 INVESTMENT
in a Transvision
FIELD STRENGTH METER

* Says Mr. Veltri: "... The way I figure, in the last 6 months I saved that much money in installation time alone ..."



FIELD STRENGTH METER
Saves 50% of Installation Cost
Pays for itself on 3 or 4 jobs

NO TV SET NEEDED

Works from antenna . . . Measures actual picture signal strength directly from antenna. Shows antenna orientation maxima. Compares gain of antenna systems. Measures TVI on all channels. Checks receiver re-radiation (local oscillator). Permits one man antenna installation.



Eliminate variables, insure accuracy with direct meter readings on the FSM.



Don't lug sets. The Transvision FSM makes installation easy.

PREVENT WASTE OF SERVICING TIME! By checking antenna performance with the Field Strength Meter, the serviceman can determine whether the TV set or antenna, or both, are the source of trouble. Call backs are eliminated.

Wide range: Measures field strength from 10-50,000 microvolts. Has Fringe Area Switch for weak signal areas. 13 channel selector. Individually calibrated on every channel.

ADAPTABLE for UHF

Model FSM-2, for 110V AC only. Complete with tubes. Wt. 13 lbs. net \$59.

Model FSM-3B, for 110V AC and Battery Operation (all batteries and cables included). Wt. 22 lbs. net \$79.

Order direct from factory:

TRANSVISION INC., NEW ROCHELLE, N. Y.

FREE: Sample copy of "TV and Electronics Notes". Or send 50¢ for year's subscription.



10 DAY TRIAL
Buy and try this fine instrument for 10 DAYS. Then, if you wish, you may return it. Your purchase price less 10% (our cost of handling and re-packaging) will be promptly refunded.

TRANSVISION, INC.
DEPT. RN-23F NEW ROCHELLE, N. Y.

() Send me _____ Model FSM-2; _____ FSM-3B
() Enclosed find \$ _____ deposit. Balance C.O.D.
() Enclosed find \$ _____ in full. Send prepaid.
I accept your 10 Day Trial terms.

Name _____
Address _____
City _____ State _____

NEW TV PRODUCTS on the Market

PORTABLE TV CAMERA

A portable, self-contained television camera is now available from Dage Electronics Corp., Beech Grove, Ind.

Designed for closed-circuit TV, the new camera measures 14" long, 9 3/4"



high, and 4 3/4" wide. It can be used with any standard television receiver, permitting an unlimited range of screen sizes. No alterations are necessary to the receiver. Daylight or normal room light is sufficient for clear transmission and reception in most cases.

U.H.F. LINE

A closer-spaced, open-wire transmission line for u.h.f. has been released by Gonset Company, 80 S. Main St., Burbank, Calif.

The No. 18 gauge solid copper wire is spaced at 1/2" by means of polystyrene spacers. The closer spacing restricts the field and minimizes dissipation losses and reflection "bumps". Surge impedance is 375 ohms. Attenuation is approximately 2 db per 100 feet at the low end of the u.h.f. band and approximately 3 db at the high end (dry). The u.h.f. attenuation increases moderately when the line is wet.

U.H.F. ANTENNA OFFERINGS

Fretco Inc., 1041 Forbes St., Pittsburgh has introduced the "Mi-Tee Ray" antenna which has been designed exclusively for u.h.f. reception. This all-aluminum unit measures 9 1/2" x 10 1/2" x 16 1/2". It is pre-assembled for easy installation.

JFD Mfg. Co., Inc. of 6101 16th Ave., Brooklyn 4, N. Y. has added a bow-tie antenna with screen reflector to its u.h.f. line. Delivering between 4 and 6 db in a single array, with gain increasing as frequency increases, the antenna is especially suited for suburban installations.

LaPointe-Plascomold Corp., Rockville, Conn. is marketing the "Ultra Q-Tee Suburban" which is similar to the company's present Channel 2-83 "Ultra" model except that the u.h.f. "V" portion of the antenna is replaced by an 8-element u.h.f. yagi. It is de-

signed for fringe area u.h.f. reception as well as reception in all multi-channel v.h.f. areas.

Telrex, Inc., Asbury Park, N. J. has added the Model #300 "Duplex" yagi to its u.h.f. line. The new antenna is a multi-element beam, small in size, light in weight, and readily installable above existing v.h.f. antenna systems.

Walter L. Schott Company, 3225 Exposition Place, Los Angeles 18, Calif. has two new all-channel u.h.f. antennas available for the trade. The "Reflecto-Fan" includes a screen reflector to give directivity in the horizontal and vertical plane. It is constructed of heat-treated alloy with insulators of special polystyrene compound. The reflector is designed for low wind resistance. The second antenna is a "Corner Reflector."

U.H.F. TUNERS

General Electric Company is now in production on u.h.f. tuners for its TV receivers. Two variations of the tuner will be available; both can be installed by field technicians without removing the chassis from the cabinet.

One type, for use in G-E sets made since January, 1949, provides control of the unit from a selector knob on the front panel. For sets made before January, 1949, the u.h.f. control is designed to be installed on the side of the cabinet.

TV TEST PROBE

General Cement Mfg. Co., Rockford, Ill. has introduced a tester for checking high-voltage TV circuits. Measuring about 7" in length, the unit glows when in contact with high voltage.

It can be used for checking high-voltage rectifier tubes, output and transmitter tubes, and high-voltage transformers. The probe is merely brought in contact with the component to be checked. For testing high-voltage filter resistors, the tester is



moved along the body of the resistor with an open or cracked resistor making the tester glow at the trouble point.

TV ANTENNA TOWERS

Alprodco, Inc., Kempton, Ind. is offering three aluminum towers for TV antenna installation applications.

**FL-8 FILTER
AND
"FILTER FACTS"
BOOKLET**

BRAND NEW!
Both for
\$1.25

CONDENSER TESTER

One of our best sellers! Useful, versatile laboratory item, in kit form. Simple, and easy to build in less than an hour. Checks condenser leakage and continuity up to 8 megs. Will test any paper, electrolytic, mica or oil capacitor from 50 mmf. to 50 mfd. Self-contained power supply and neon bulb indicator with socket and bezel. Drilled metal cabinet. Complete instructions and diagrams included with each kit. Only \$5.00.



U-V LIGHT SOURCE

8 watt ultra-violet light source. In kit form including Schumann black light tube, for U-V light in the 3660 Angstrom unit region) ballast, starter, mounting panel, reflector, line cord/plug, hardware, instructions. An invaluable device for schools, labs, service shops, home workshop, etc. Here is a genuine value. Complete kit, (less outer housing) . . . only \$4.95

FONE PATCH!

Now available, the superior new O-R, # 6008 phone patch. Provides you with exactly what you need to patch your phone into transmitter or receiver. Featuring a bi-impedance input suitable for x1 mike. Both hi and lo impedance outputs to insure proper match to your particular receiver. Unit is complete—"sure-fire" ready to go to work for you. Only \$4.95 ea.



NOVICE TRANSMITTER KIT

A two tube, crystal controlled transmitter covering 3700 to 3750 kcs . . . can be used later for all bands, 20 to 160. Has pi coupler output to match most antennas. Uses 6V6 and 6BE. 35 watts input. Less coils, tubes and crystals . . . \$9.90
Matching Power Supply Kit . . . \$9.90
One coil, (specify band) . . . 1.05
Tube kit, (3 tubes) . . . 3.95
Crystals, (Specify frequency band) . . . 2.75

SENSITIVE RELAY

Miniature type (1) - overall SP-ST contacts. Coil resistance 6500 ohms. (2 ma). An excellent relay for voice control or model applications. \$2.50 ea. Manufacturers write for quantity prices.

**SPLINED TUNING KNOB
FOR 274N RECEIVERS**

An exclusive O-R item manufactured for us. Fits BC-453, BC-454 and other 274N receivers. This is a really hard-to-obtain item. Only . . . 89c ea.



TRANSFORMERS-CHOKES:

325-0-325 @ 225 ma. 6.3 @ 5A. 5V @ 3A. Pri. 110V. 60 cy AC. Size, 4 1/8" x 4 1/8" x 3 1/2". Only . . . \$6.95 ea.

Isolation transformer. Useful for AC-DC supplies. Pri. 117V. Sec. 120V, AC. at 25 ma. Also 6.3V at 1/2 amp. Only . . . \$1.80 ea.

Isolation transformer. Pri. 117V AC. Sec. 120V, AC. at 50 ma. Also 6.3V at 2 amps. . . . \$2.79

020-0-020 or 740-0-740 AC @ 200 ma. Pri. 115V, 60 cycle. AC. Upright shielded case. Excellent for 807's. . . . Only \$10.80 ea.

5V. 25A. Pri. 115V. 60 cy. AC. A real rugged job excellent for 301TL—4.250A etc. Limited quantity. Only \$4.50 ea.

2.5V @ 10A AC. 10,000V insulation. Pri. 115V AC only \$3.39 ea.

350-0-350 @ 300 ma. 6.3 @ 4A. 6.3 @ 8A. 5V @ 3A. Pri. 115V, 60 cy. AC. . . . only \$7.95 ea.

450-0-450 @ 200 ma. Pri. 115V, 60 cy. AC. 5V @ 3A. 6.3 @ 5 amp. 1a shielded case. Only \$8.90 ea.

350-0-350 @ 350 ma. 6.3 @ 10A. 5V @ 6A. Pri. 115V, 60 cycle. Only . . . \$8.95 ea.

**110V, AC POWER SUPPLY
FOR ANY 274-N RECEIVER**

Just plug it into the rear of your 274-N RECEIVER . . . any model. Complete kit and black metal case, with ALL parts and diagrams. Simple and easy to build in a jiffy. Delivers 24 volts plus B voltage. No wiring changes to be made. Designed especially for the 274-N receiver. Only \$8.95.

Filament trans. for 274N receivers. Pri. 110V, 60 cy. AC. Sec. 24V @ .6A. An excellent buy at . . . \$1.95 ea.

Minimum order \$2.00. All items subject to prior sale. All prices subject to change without notice. 20% deposit must accompany all orders. balance C.O.D.

OFFENBACH-REIMUS
1564 MARKET STREET
SAN FRANCISCO, CALIF.

The Type AT-6W standard unit will carry a static top load of 300 pounds at a recommended height of 120 feet. The Type AT-6C commercial tower will carry 400 pounds at a height of 150 feet while the Type AT-6E economy model is designed to handle 125 pounds at 48 feet. The first two units are self-supporting to 18 feet and 24 feet respectively. The economy model must be guyed every 18 feet.

All of the towers come knocked down in easy-to-handle sections. A data sheet covering the company's entire line is available on request.

"DETECTO" PROBE

Kapner Hardware, Inc., 2248 Second Ave., New York 29, N. Y. is offering an inexpensive testing tool which permits instant tracing of high-voltage TV troubles.

The "Detecto" probe is equipped with a built-in lamp which lights when



high voltage is present. It will check operation of the horizontal amplifier and high voltage transformer by indicating the presence or absence of high voltages. Complete instructions are included with each probe.

U.H.F.-V.H.F. ANTENNA

Channel Master Corp., Ellenville, N. Y. is featuring an all-v.h.f.-u.h.f. antenna, the "Ultra Fan, Model 413."

The u.h.f. section features "free-space" terminals, two stamped holes to minimize wind resistance, and single transmission line operation. The v.h.f. and u.h.f. bands are electronically isolated by a 2-stage filter which automatically eliminates all interaction. No switching is necessary in tuning from one band to the other.

FOCUS COIL

Heppner Manufacturing Company of Round Lake, Illinois, has redesigned its "P.M. Focomag" unit to fit 21" and 27" magnetically focused tubes

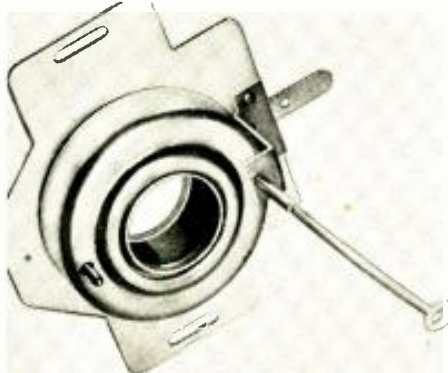

as well as small sized picture tubes. The efficiency of the ring magnet is said to be such that only 4 ounces of Alnico are required. Another new fea-

BIG PROFITS:
Repair
CRTs
this
Easy Way

EVERY SERVICE SHOP CAN MAKE BIG MONEY with these PATENTED INSTRUMENTS for

1. TESTING picture tubes accurately.
2. REACTIVATING dim or worn out tubes.
3. SPARKING OUT electrical leakage.

CRT TESTER—REACTIVATOR—SPARKER

3 Instruments in 1, making a complete CRT testing and repair unit . . . It's a combination of the Transvision Tester-Reactivator and a Sparker in one handy unit. It TESTS picture tubes—measures Cathode emission, locates shorts between elements, locates high resistance shorts or leakage as high as 3 meg-ohms. REACTIVATES dim tubes. SPARKS OUT electrical leakage.



\$34.95 net

CRT TESTER—REACTIVATOR

2 Instruments in 1 . . . As a REACTIVATOR it renews brightness and detail of dim CR Tubes, without removal of tube from set. It's also an accurate TESTER same as the above. 110V-60 cycles; wt. 3 lbs.

only \$19.95 net

CRT TESTER—SPARKER

2 Instruments in 1 . . . As a SPARKER, it sparks out electrical leakage between



elements. Saves many picture tubes and small tubes which would usually be discarded. Cathode-grid leakage is an especially common occurrence. The Sparker also gives a rapid check of gas condition of the tube.

As a TESTER it provides a variable 8,000-14,000 V D.C. supply—useful for analyzing hard-to-solve deflection problems . . . \$25.95 net



Order direct from factory:
TRANSVISION INC., NEW ROCHELLE, N. Y.
FREE: Sample copy of "TV and Electronics Notes". Or send 50c for year's subscription.

10 DAY TRIAL: Buy and try these fine instruments for 10 DAYS. Then, if you wish, you may return them. Your purchase price less 10% (our cost of handling and re-packaging) will be promptly refunded.

DEPT. RN-23R NEW ROCHELLE, N. Y.

() Send me _____

() Enclosed find \$_____ deposit. Balance C.O.D.

() Enclosed find \$_____ in full. Send prepaid.

I accept your 10 Day Trial terms.

Name _____

Address _____

City _____ State _____

L. A. HAM SHACK SELLS FOR LESS



METERS—WESTON • SANGAMO
ALL NEW • ALL D. C. • 2" SQUARE

0-5 Ma \$3.29
0-15 Ma } EACH
0-50 Ma } 3 for \$9.00
0-100 Ma }
0-200 Ma }
0-300 Ma }
0-500 Ma }
0-2 Ma \$3.95

Mfg's inquiries: lots over 100
Voltmeter, 2" sq.—0 to 20 Volts.....\$3.29
DC Voltmeter, 2" sq.—0 to 300 Volts w/Ext. resistance. Complete \$3.95.....3 for \$9.95
RF Ampmeter, 2" sq.—0 to .5 Amp.....\$3.95
Ampmeter, 2" rd.—0 to 50 Amps.....\$3.29
Ampmeter, 2" sq.—0 to 50 Amps.....\$3.29

3" Round Meters, DC, All New, 0-15, 0-30, 0-300 Mills. \$4.95 Each.....3 for \$11.95
Milliampmeters, 2 1/2" rd. 0-30 Mills. Each \$3.95
Milliampmeters, 2" rd. 0-50 Ma. 0 to 5 Ma. movement. Each \$3.29.....3 for \$9.00
Thermocouple, 2" rd. 350 Milliamp. HF.....\$3.29



"S" METER. Illuminated face. Full scale reading of 5 ma. A standard value for most "S" Meter Circuits. 2 3/8" Black face. New \$2.49
New Amp Meter, No. 60-0-60.....\$1.29

COMMAND AND/OR ARCS
TRANSMITTERS and RECEIVERS
3-6 MC Receiver.....Used \$6.95—New \$17.95
6-9.1 Receiver.....Used 7.95—New 12.95
Triple Receiver Rock.....1.95
V.H.F. ARC5 Transmitter or Receiver.....Used 24.95
Complete w/tubes.....New

4-5.3 MC Transmitter with tubes \$ 8.95
5.3-7 MC Transmitter with tubes 6.95
7-9.1 MC Transmitter with tubes 9.95 \$19.95
3-4 MC Transmitter with tubes 18.95
28V Receiver Command Dynamos.....1.95

Cash with order. Prices subject to change without notice. California orders please include 3 1/2% Sales Tax. Please include approximate postage—Excess will be refunded. What Have You Surplus? Submit

L. A. HAM SHACK 1306 BOND STREET, at PICO LOS ANGELES 15, CALIFORNIA

MODULATORS Used New
BC-456 with Tubes, less dyn... 2.95
MD-7 Modulator Dynamotor, 28V 3.95
BC-433 Receiver—with tubes... 24.95
MN-26C Compass Receiver... 24.95 \$39.50
MN-26Y Compass Receiver... 24.95 39.50
BC-357 Marker Beacon Rec. W.O. Tube 5.95

CIVIL AIR DEFENSE or 2 METERS
522 Trans-Receiver, W/tubes, Good, used 69.50
Modulation Transformer, BC-375, New 2.49
BC-306 Antenna Loading.....New 1.95
FL8 Filters—A's, B's, C's.....New 1.95
FL5 Filters.....New .95
Hand Keys—J-38.....New 1.19
Heineman Circuit 115 V., 20 amp. 1.39
Breakers 115 V., 5 amp. .97

TRANSFORMERS
12V 24V 20m 110V primary.....\$2.95
Code Tapes for TG-10 15 rolls. New.....7.95

DYNAMOTORS
PE-101C.....New \$ 4.95
PE-103 New Case.....29.95
PE-73 29V @ 20 amps. output 1000V @ .350 amps.....New 9.95
PE-77 14V @ 40 amps output 1000V @ .350 amps.....New 24.95
RL-428 Antenna Reel Ass. Less wire.....New 9.95

OIL CONDENSERS
Standard Makes—New
2 mfd 600V \$0.49
4 mfd 600V 1.39
1 mfd 1000V .69
3 mfd 4000V 7.95
.5 mfd 2500V 1.49
10 mfd 600V 2.95
2 mfd 2500V 3.95
2 mfd 5000V \$8.95 2 mfd 7500V 29.59

HEAD SETS
HS-30.....New \$1.95
HS-23.....Used \$2.95
Matching Transformer for HS-30 .69
MIKE CHEST SET "F-1" button.....New 2.95

ture is a specially designed, break-proof flexible nylon adjusting shaft which replaces the rigid shafts formerly employed. The flexibility of the new shafts eliminates accidental breakage during installation.

A built-in picture positioning lever is used to center the picture. Mounting arrangements are according to the user's specifications. Contact the company for full information on the new "Focomag."

TUNING SLUG RETRIEVER
R. N. Hunter Sales Co., 3499 East 14th Street, Los Angeles 23, California, is now marketing a new tool which has been designed to retrieve

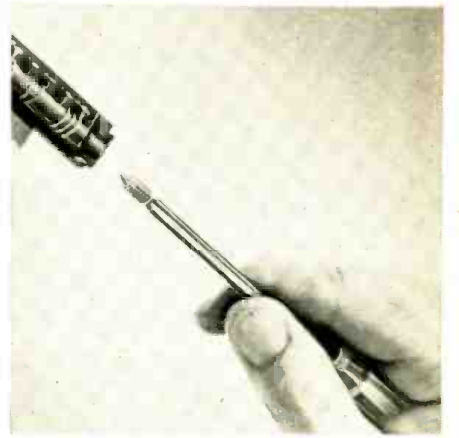

the tuning slugs in standard coil tuning units, such as those used in RCA, Admiral, Hoffman, and many other television receivers.

The slug-retrieving screwdriver incorporates a unique non-magnetized holding mechanism which enables the technician to retrieve the slug without removing the chassis.

The method employed is simple. The specially-designed blade of the retriever is slipped into the tuning unit opening until it engages the slot on the head of the slug. When contact is made, a forward pressure on the handle of the tool firmly seats the patented locking pin and the slug is then withdrawn and placed in its proper tuning position.

CONDENSER-RESISTOR TESTER
Sprague Products Company, 51 Marshall St., North Adams, Mass. has developed a condenser-resistor analyzer to help speed TV servicing.

The Model TO-4 "Tel-Ohmike" has push-button range selection, extended capacitance ranges from 1 μfd. to 20,000 μfd., direct reading of insulation resistance to 20,000 megohms, direct leakage current reading of electrolytics at rated d.c. working voltage, and a three-range power factor measurement of electrolytics. All condensers are automatically discharged for safety after test by releasing the push-buttons.

Resistance measurement range of the unit is from 2 1/2 ohms to 25 megohms at line frequency. A 16-page technical instruction manual accompanies each instrument. A descriptive

CODE SENDING RECEIVING SPEED

HIGH SPEED WITHOUT NERVOUS TENSION

REVEALING BOOK shows how "crack" operators develop high speed and proficiency. Learn code for Amateur or Commercial Radiotelegraph License, or improve your sending and receiving.

with the Candler System which develops radio-telegraph experts and code champions.

CANDLER SYSTEM FREE BOOK

Box 928, Dept. 2-B, Denver, Colo.

BENDIX 4-CHANNEL E.C.O.

Channel 1 1050-1700 KC Channel 2 2000-3400 KC Channel 3 3000-4800 KC Channel 4 4370-7000 KC

Unit is front end of TA-12B transmitter by adding an 807 driver and a pair of 807's for a final you have a 50 watt trans. each osc. section is completely shielded and mounted on an aluminum chassis with var. cond. shafts extended ready to odd voltage. GOVT. COST OVER \$150.00 NEW WHILE THEY LAST For That New Ham Band 3700 KC. \$5.95

3834 Germantown Ave. Phila., Penna. RA 5-6033

McCONNELL'S

PAY LESS FOR TUBES

INDIVIDUALLY BOXED • FULLY TESTED • EACH TUBE GUARANTEED FOR SIX MONTHS

Type	Price	Type	Price	Type	Price	Type	Price
1B3GT	\$.69	6AT6	\$.38	6K6GT	\$.41	12AZ7	\$.70
1H5GT	.46	6AU6	.43	6L6G	.80	12BA6	.45
1L4	.57	6AV6	.38	6L6GA	.80	12BE6	.47
1L6	.58	6BA6	.96	6S4	.46	12BH7	.63
1NSGT	.57	6BA6	.45	6SA7GT	.52	12BZ7	.75
1R5	.56	6BA7	.60	6S7GT	.47	12SA7GT	.52
1S5	.47	6BC5	.53	6SK7GT	.50	12SK7GT	.50
1T4	.56	6BD5GT	.89	6SL7GT	.62	12SL7GT	.61
1T5GT	.71	6BE6	.47	6SN7GT	.54	12SN7GT	.54
1X2	.67	6BF5	.60	6SQ7GT	.42	12SQ7GT	.44
3Q5GT	.65	6BG6	1.34	6T8	.78	19BG6	1.39
35A	.55	6BH6	.57	6U8	.85	19C8	.94
3V4	.56	6BG6	.48	6V6GT	.46	19T8	.79
5U4G	.43	6BK7	.85	6W4GT	.45	25B06	.89
5V4G	.73	6BL7	.83	6W6GT	.57	25L6GT	.48
5Y3G	.34	6B06	.89	6X4	.34	25Z6GT	.42
5Y3GT	.30	6B07	.85	6XSCT	.33	35A5	.48
6AB4	.46	6B27	.95	6Y6G	.59	35B5	.47
6AG5	.54	6C4	.34	7N7	.52	35C5	.47
6AK5	.95	6CB6	.53	12AT6	.38	35L6GT	.47
6AK6	.63	6CD6	1.85	12AT7	.68	35W4	.31
6AL5	.40	6F6GT	.45	12AU6	.43	35Z5GT	.30
6AQ5	.46	6F8C	.93	12AU7	.53	50B5	.47
6AQ6	.42	6HG6T	.49	12AV6	.38	50C5	.47
6ARS	.38	6J5GT	.40	12AV7	.80	50L6	.47
6AS5	.50	6J6	.62	12AX7	.61	117Z3	.39
						117Z6	.68

Motorola Ballast Tube #17A485459.....30

Each tube is performance-proven. 25% deposit must accompany all orders. Balance C.O.D. All Prices F.O.B., N.Y.C. If remittance is made with order, you can deduct 2%. \$1.00 handling charge for orders under \$10.00. Subject to Prior Sale.

PHILLIPS TUBE COMPANY 2610 E. 16th Street Brooklyn 35, N. Y.

bulletin, M-499, is available on request.

BAR GENERATOR

RMS, 2016 Bronxdale Ave., New York 60, N. Y. is making a low-cost portable bar generator, the Model BAR-1.

The unit transmits a modulated carrier on Channels 4, 5 or 6 as predetermined by the technician, producing both vertical and horizontal bars on the screen. A control is provided for adjusting the number of bars on the screen. The instrument is moderately priced.

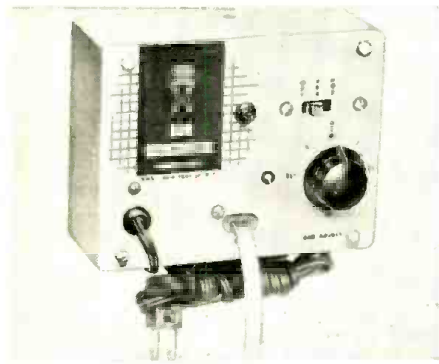

mined by the technician, producing both vertical and horizontal bars on the screen. A control is provided for adjusting the number of bars on the screen. The instrument is moderately priced.

PHOTO CREDITS

Page	Credit
35, 37, 40, 132	Raytheon Manufacturing Company
41, 147	Radio Corporation of America
42, 58 (Figs. 8 & 9)	LaPointe-Plascomold Corp.
43, 45	Acro Products Company
46	Blonder-Tongue Laboratories
50, 51 (bottom)	Standard Coil Products Co.
56 (Fig. 1), 57 (Fig. 5)	JFD Manufacturing Co.
56 (Figs. 2 & 3), 57 (Fig. 4)	Ward Products Company
57 (Fig. 6)	RMS
58 (Fig. 10)	Technical Appliance Corporation
65	Radio Korea
110	Allied Radio Corporation
136	Province of Quebec
140	Station KPTV, Portland

ERRATA

When using the RADIO & TELEVISION NEWS Preamplifier (November, 1952, issue) with an Audak pickup, change resistor R₁ (Fig. 3) from 22,000 ohms to 100,000 ohms. For optimum results the Audak requires a load of 47,000 ohms. R₁ in parallel with R₂ will provide 50,000 ohms which is satisfactory.

In the article "A Novel Capacitance Relay" appearing in the December, 1952, issue, the circuit diagram shows "117 volts a.c. or d.c.". The unit will not operate on d.c. and this statement should read "117 volts a.c."

In "Spot Radio News," December issue, a misstatement occurred. Station KPTV in Portland was the first u.h.f. television station in the country and in the northwest but station KING-TV, Seattle, was actually the first TV station in the Pacific Northwest. Our apologies to KING-TV for this slip-up.

In the article "A Low-Cost Audio Oscillator" appearing in the January, 1953, issue, the values of condensers C₁-C₃ (Fig. 3) are not clearly indicated. They should be as follows: C₁, C₂—1.2 μfd. (20-200 cps); C₃, C₄—12 μfd. (200-2000 cps); C₅, C₆—.012 μfd. (2000-20,000 cps); C₇, C₈—0.012 μfd. (20-200 kc.).

FREE Equipto CATALOG!
Especially Designed for the ELECTRONICS Industry

BENCHES **DRAWER UNITS**
CHASSIS STANDS **TEST STANDS**
SALES COUNTERS **STORAGE BINS**
SHELVING **WARM UP RACKS**
SERVICE COUNTERS **TRUCKS**

Steel is Finished in Polymerized Shock-Proof Insulating Enamel.

Equipto's especially designed Electronics Equipment is used by thousands of the country's largest radio, television and electrical service shops and stores. Combining strongest possible construction with moderate prices, even the small budget shop can take full advantage of Equipto's complete line of storage and work shop equipment.

Merchandise displayed on Equipto's well-styled units always boosts sales. These units give better than **ONE-THIRD** more display and storage space for items now occupying the same area.

Have you a storage or display problem?
We'll be glad to help you.

40TH YEAR **Equipto** Division of Aurora Equipment Co.
800 Prairie, Aurora, Illinois Phone: Aurora 9231

WRITE FOR FREE CATALOG

NEED TUBES?

Make Barry your source for FAST-DELIVERY on all types. We carry all the standard brands. All tubes individually cartoned and carry Standard RMA Guarantee.

Tube Orders Over \$8.00 with full remittance Prepaid To You in U.S.A.

Prior to shipment, all tubes INDIVIDUALLY retested (not just spot-checked) on our Hickok Mutual-Conductance Tube-Tester to insure you the perfect merchandise. For your maximum money's worth, buy in full confidence from TUBE-SPECIALISTS. Here is only a partial listing of our large stocks. You may order types not listed at approx. same savings.

0A2	.98 6F6-M	.69 274-A	2.95
0B2	1.10 6F8-G	.89 274-B	2.95
0C3/VR105	1.19 6G6-G	.95 275-A(WE)	3.00
0D3/VR105	.95 6J4	6.75 276F & G	15.00
0Z4	.59 6J5	.49 304-TH	7.00
1A7GT	.89 6J6	.59 304-TL	8.75
1AE4	.90 6J7	.75 310A (WE)	5.95
1B3GT	.85 6K6GT	.59 311A (WE)	6.50
1B22	2.00 6K7-M	.70 328-A (WE)	5.00
1B23	8.00 6L5-G	.49 337A (WE)	3.04
1B27	14.98 6L6-G	1.19 349A (WE)	1.35
1L4	.60 6L7	.98 350-B (WE)	3.95
1L21 (GE)	4.00 6N7-M	.95 359-A (WE)	4.00
1LA6	.90 6Q7GT	.80 371-B	.85
1N21-B	2.95 6S7-M	.98 373-A (WE)	4.00
1N23-A	2.25 6S07	.79 374-A (WE)	3.50
1N23-B	3.49 6S67	.88 387-A (WE)	2.50
1N34	.64 6S87	.64 400-A (WE)	2.50
1N34-A	.75 6S9	.69 401-B (WE)	3.50
1N44/400B	1.21 6SK7GT	.62 403-B (WE)	2.50
1N45/400C	1.39 6SL7GT	.60 407-A (WE)	5.00
1N48	.55 6SN7GT	.70 408-A (WE)	2.75
1N54	.89 6U3-GT	.65 421-A (WE)	3.50
2B7	.75 6V6GT	.60 GL-559	1.00
2C43(GE)	15.95 6X5GT	.52 KU-676	25.00
2C52	5.50 7A6	.65 710-C	20.00
2D21	1.37 7A8	.75 717-A	.98
2E24	2.75 7C6	.80 803	3.25
2E30	2.19 7C30	85.00 805	2.50
2J22	6.50 7F7	.74 807	1.59
2J34	27.25 7H7	.80 811	2.75
2J48	24.25 12A6	.65 811-A	3.50
2I49	3.40 12A7	.75 817	2.75
3A4	.59 12A7U	.69 812-A	3.50
3AP1	9.00 12AV6	.55 816	1.07
3B28	7.50 12AX7	.99 832-A	8.50
3B29	12.00 12BA6	.69 837	1.45
3BP1	5.75 12BA7	.90 860	3.95
3BP11	9.50 12BD6	1.25 861	22.50
3C22	85.00 12BE6	4.866-A	1.35
3C23 (GE)	10.50 12C8	.79 872-A (GE)	3.50
3C27	7.50 12M6	.75 1280	.80
3C33	9.95 12SA7	.75 1613	.75
3D6/1299	.50 12SF5	.70 1614	2.25
3Q5GT/G	.99 12SG7	.87 1616	.74
3S4	80 12SW7	.95 1622 (6L6M)	1.95
4C35	26.50 12S17	.69 1625	.40
4X-150A	33.50 12SK7	.75 1629	3.00
5F7P	1.95 12SL7	.75 1631	1.50
5R4GY	1.29 12SN7GT	.84 1632	.70
5U4G	.55 12SR7-M	.75 2050	1.48
5X4G	.85 14F7	.80 2051	1.19
5Y3GT	.45 25AV5	1.25 5514	4.50
6AB7	.98 25B06GT	.79 5516	6.95
6AC7	.94 25L6GT	.64 5528 C6L	15.00
6AG5	.65 25Z6	.67 5608-A	3.95
6AG7	1.25 35B5	.40 5654	2.00
6AH6	1.00 35C5	.69 CK-5702	3.25
6AJ5	1.75 35L6	.49 CK-5744	2.25
6AK5	.79 35Z6GT	.65 CK-5886	3.00
6AN5	2.25 42	.50 5814	4.50
6AU6	.65 50C5	.55 5910	.75
6AV6	.65 50L6GT	.55 5912	.98
6B8	.85 117Z6	1.00 8020	.35
6BD6	.86 FG-105	19.50 9004	.85
6BE6	.45 F-123-A	6.95 9002	.85
6C4	.45 211	.75 9004	.39
6CB6	.45 250-TH	18.75 9006	.39

SELENIUM RECTIFIERS FULL-WAVE BRIDGE TYPES

Current (Continuous)	18/14 Volts	36/28 Volts	54/42 Volts	130/100 Volts
1 Amp.	\$1.35	\$2.15	\$3.70	\$7.50
2 Amps.	2.20	3.60	5.40	10.50
2 1/2 Amps.			8.00	13.00
4 Amps.	3.75	6.75	10.25	
5 Amps.	4.25	7.95	12.95	25.25
6 Amps.	4.75	9.00	13.50	33.00
10 Amps.	6.75	12.75	20.00	40.00
12 Amps.	8.50	16.25	25.50	45.00
20 Amps.	13.25	25.50	39.00	79.50
24 Amps.	16.25	32.50	45.00	90.00
30 Amps.	20.00	38.50		
36 Amps.	25.00	48.50		

New Selenium Rectifier Transformers

- PRI: 115 V. 60 cycles in. } 4 Amps. \$ 8.75
- SEC: 9, 12, 18, 24, and 36 } 12 Amps. \$29.50
- volts. } 24 Amps. \$37.75
- 115V. PRI.-36V. 50 amp second XFMR. \$39.95
- 115V. PRI.-5V. 190 Amp. SEC. \$59.95
- 115 230V. 60 cy. PRI. SEC.: 1.5, 30.5, 33.5, and 36.5V. @ 4 AMPS. Herm. sealed. \$6.50
- New Selenium Rectifier Chokes
- 4 Amps.-.07 hy.-6 ohm. \$17.95
- 12 Amps.-.01 hy.-1 ohm. \$14.95
- 24 Amps.-.004 hy.-.025 ohm. \$29.95

We can manufacture other Selenium Rectifiers, Selenium Rectifier Supplies, XFMRs., & Chokes.

- Biiley-Type SMC100-- Crystal Standards.
- New-100 KC and 1,000 KC BAR. \$8.50

SOLA HEAVY-DUTY PLATE TRANSFORMER.

- PRI: 200, 220, 240 volts-00 cy.
- SEC: 7000-700 @ conservative 200 MA. 5"x8"x6 1/2"-NEW-WT. 15 lbs. Special @ \$17.50
- CARTER DYNAMOTORS 6 V DC Input-500 VDC Output @ 150 MA. Only 7"x4"x3". \$28.00
- In Orig. Mfr's Cartons. Only.
- AR-11-SUPERHET PCVR. & 50 WATT XMTR w/built-in 110 vac pwr. supply. Unit 12"x9"x5" for 20, 40, & 80 meters. Brand New. \$99.50
- A complete station for only.



136 Liberty Street, N. Y. 6, N. Y. REctor 2-2562. Terms: 25% with order, balance C.O.D. - Send a few cents for postage - All merchandise guaranteed. F.O.B. N.Y.C. Remember, you may order tubes not listed!

INDEX OF Advertisers

FEB. 1953

While every precaution is taken to insure accuracy, we cannot guarantee against the possibility of an occasional change or omission in the preparation of this index.

ADVERTISER	PAGE	ADVERTISER	PAGE
Aern Electronics Corporation	106	Mattison Television Company	128
Acro Products Company	151	Michel Mfg. Company	138
Adams Electronics	126	Miles Reproducer Company	128
Airex Radio Corporation	133	Milwaukee School of Engineering	108
Allied Radio Corporation	9	Mosley Electronics	135
Alproden Inc.	111	Moss Electronics	87
Alice Lansing Corporation	148	National Electric Products	92, 93
American Phenolic Corporation	22	National Electronics of Cleveland	116
American Television & Radio Company	82	National Radio Institute	83, 81
Arco Electronics, Inc.	140	National Schools	13
Argos Products Company, Inc.	140	Nation Wide Radio	151
Arkay Radio Kits, Inc.	137	Newark Electric Company	150
Arrow Sales, Inc.	119	Newark Surplus Materials	141
Ash Radio Company, Walter	400	Newcomb Audio Products Company	18
Audel & Company, The	136	Offenbach & Reims Company	159
Barr Electronics	162	Ohmite Mfg. Company	26
Bell Telephone Company	32	Olson Radio Warehouse	88, 89
Belden Mfg. Company	99	Olympic Electronics Supply	131
Brocner Electronics Laboratory	120	Onan & Sons, D. W.	152
Brock Electronics, Inc.	114	Peak Electronics	146
Burstein-Applebee Company	113	Penn Tube Company	98
C & H Sales Company	112	Perma Power	131
Candler System Company	160	Pfanstiel Chemical Company	144
Capital Radio Engineering Institute	27	Phillips Tube Company	160
Centralab, Inc.	3	Photocon Sales	151
Channel Master Corporation	101	Pickering & Company	121
Cleveland Institute of Radio Electronics	91	Plant Electronics	121
Collins Audio Products	31	Polys-Tech Company	130
Columbia Electronic Sales	122	Posner Electronics	112
Communication Equipment Company	90	Premax Products Company	142
Concord Radio Corporation	122	Premier Radio Tube Company	95
Coyne Electrical School	163	Progressive Electronics Company	139
Davis Electronics	128	Pyramid Electric Company	34
DeForest's Training	5	Quietrole Company	124
Eastern Telephone Company	122	RCA Institutes	69, 137
Editors & Engineers	150	R W Electronics	129
Electro Devices	131	Rulecon Engineering Company	155
Electronics Institute	138	Radiart Corporation	12
Electronic Instrument Company - 3rd cover		Radio City Products, Inc.	85
Electronic Specialty Supply Co.	156	Radio Corporation of America	2nd cover
Electro-Voice	8	Radio Craftsmen, Inc.	145
Equipto	161	Radio Electric Service Company	110
Fair Radio Sales	147	Radio Shack of Boston	113
Federated Purchaser, Inc.	157	Radio-Television Training Ass'n	25
Feiler Engineering Company	116	Rud-Tel Tube Company	151
Fisher Radio	144	Ruhland Corporation	20
Franklin Technical Institute	136	Ruthcon Mfg. Company	19
Frenchy Radio Mfg. Company	151	Regency	126, 151
Fretco Television Company	155	Rinchart Books	102, 103
G. L. Electronics	136	Rose Company, The	100
Garrard Sales Corporation	130	Rytel Company	123
General Cement Manufacturing	21, 28	Sams & Company, Howard W.	70, 112, 118
General Electric Company	145	Sanett, Bob	113
General Test Equipment	141	Sangamo Electric Company	135
Good Inc., Dun	141	Schott Company, Walter L.	105
Goodheart, R. E.	141	Semler Associated Industries	133
Greenlee Tool Company	116	Service Instruments Company	120
Green Tele Radio, Inc.	156	South River Metal Products Company	114
Halliercrafters Company	7	St-Air-55 of California	163
Harjo Sales	121	Sprague Products Company	17
Harrison Radio	91	Sprayberry Academy of Radio	15
Harvey Radio Company	132	Stan Burn Radio & Electronics	126
Heath Company	71 thru 81	Standard Transformer	137
Henry Radio Stores	120	Star Electronics Distr. Inc.	150
Henshaw Radio Supply	143	Steve-El Electronics Corporation	153
Hickok Electrical Instrument Company	141	Stevens Wadden, Inc.	24
Hughes Research Labs.	143	Super Instrument	138
Hyton Radio & Electronics Company	23	Supreme Publications	131
Indiana Technical College	149	Sylvania Electric Products	29
Instructograph Company	125	TAB	161
JFD Mfg. Company	11	Tech-Master Products Company	163
J. S. H. Sales Company	131	Technical Appliance Corporation	161
Jerrold Electronics	108	Tele-Marine Corporation	117
Jersey Specialty Company	130	Television Communications Institute	100
K & L Radio Parts Company	147	Telex, Inc.	149
Kester Solder Company	153	Teraco Company	106
Kirk, Jim	136	Transvision, Inc.	158, 159
Krylon, Inc.	156	Trio Mfg. Company	30
L A Ham Shack	160	Tri-State College	115
LaPointe Plastics Mold Corporation	33	Triplet Electrical Instrument Company	10
Lee Electronic Labs., Inc.	131	Tung-Sol Electrical Company	101
Leeds Radio Company	142	Turner Company	141
Leotone Radio Company	152	United Catalogue Publishers, Inc.	127
Luther, Otto	156	United Technical Laboratories	143
McCormell's	137, 145, 151, 160	University Loudspeakers, Inc.	157
McGee Radio Company	96, 97	V & H Radio & Electronics	149
McGohun, Don	146	Valparaiso Technical Institute	141
McGrath Hill Book Company	142	Van Sickle Radio Supply Company	125
MacInnes, Norman R.	129	Weathers Industries	107
MacMillen Company	152	Western Electronics	128
Mallory, P. R.	11th cover	Western Radio & Television Institute	114
		Westinghouse Electric Corporation	14
		Wholesale Radio Parts	125
		World Radio Laboratories, Inc.	127

Classified

Rate 50c per word. Minimum 10 words

RADIO ENGINEERING

COMPLETE radio, electronics theory & practice; television; broadcasting; servicing; aviation, marine, police radio. 12 or 18 months. Catalog. Valparaiso Technical Institute, Dept. N, Valparaiso, Ind.

SALE

TAPE Recorders, Tapes, Accessories. Unusual Values. Dressner, 621-R East 20th St., N.Y.C. 9.

ALL types of Antennas for Amateur and TV. Aluminum Tubing. Willard Radcliff, Postoria, Ohio.

DIAGRAMS Radio, Record Changers, Recorders, 75c; Television with Service Data, \$1.25 up. State manufacturer and model number. Kramer's Radio Service, Dept. F53, 36 Columbus Ave., New York 23, N. Y.

BROWNING (R J-14) AM-FM Tuner. Excellent Condition: only \$65.00. B. K. Balch, 514 Jefferson Ave., Rahway, N. J.

TV-FM antennas. All types including UHF. Mounts, accessories. Lowest prices. Wholesale Supply Co., Dept. H, Lunenburg, Mass.

TUBES and equipment bought, sold, and exchanged. For action and a fair deal, write B. N. Gensler, W2LNI, 136 Liberty, N. Y. 6, N. Y.

FOR low cost DX Television, reconditioned receivers, 10", \$50; 12", \$60, up. Spltz, 1120 South Randolph, Arlington, Virginia.

FOR Sale: Tubes at 70% off list. Write for listing. Williams Electronics Co., 168 Washington St., New York 6, N. Y.

COLOR code chart. Every resistor and capacitor code ever used (total 17), 50c. No stamps. N. S. Brown Associates, 5522 Merrimac, Dallas, Texas.

WANTED

ELECTRONIC components and equipment needed, send details for offer. Bargain Literature, "Electronic Outlet," Box 72, Lawrence, Mass.

WANTED: Federal type 101B voice-frequency ringers Signal Corps type TA-3/FT. Box 529, % Radio & Television News, 185 N. Wabash Ave., Chicago 1, Ill.

WANTED: Western Electric gray-finished equipment cabinets for 19" panels. Heights of 2'6", 3'6", 7'0" and 7'6". Box 530, % Radio & Television News, 185 N. Wabash Ave., Chicago 1, Ill.

WANTED: Top prices paid. Navy Selsyns 1DG, 1F, 1CT, 5CT, 5D, 5DG, 5G, 6G, 7G, etc., and RC-318, RC-221, AN/ART-13, AN/ARC-1, AN/ARC-3, RTA-1B, AN/APR-4. Electronic Research, 719 Arch St., Philadelphia.

WANTED: Variometer. Vario-coupler. Crystal Set or other equipment made in early 1920's by Columbian Radio Corporation of Chicago. Good price paid. Write J. W. Rubin, Allied Radio Corp., 833 W. Jackson Blvd., Chicago 7, Ill.

CORRESPONDENCE COURSE

ELECTRONIC Draftsmen—Many needed immediately by Defense Agencies and Contractors. Excellent pay. Pioneer Radio Engineer offers an original and exceptionally high class correspondence course to qualified ambitious young men and women. Details free. C. Roland Leutz, P. O. Box 368, Silver Spring, Maryland.

USED correspondence courses and educational books bought, sold, rented. Catalog free. Educational Exchange, Summerville, Ga.

MISCELLANEOUS

500 QSL Cards printed two colors, \$8. On U. S. Postals. \$15. Iannone, 2227 Camino del Reposo, La Jolla, Calif.

RUY Wholesale—25,000 items—Catalog 25c. Matthews, 1472-R5 Broadway, N. Y. C. 36.

Leading ENGINEERS and TECHNICIANS Recommend...

TECH-MASTER CUSTOM-BUILT TV CHASSIS

GOLD MEDAL SERIES Deluxe TV Chassis

World's Most Sensitive, Most Reliable TV Receiver—Truly custom-designed and custom-built to provide the ultimate in sight, sound, and value. Employs most advanced engineering methods, finest components, and most rigid alignment and test standards. Tech-Master improved 630-type chassis • Advanced Cascode Standard turret tuner, adaptable to UHF without tools • Full 4 Mc. bandwidth • Quick action keyed AGC circuit • New, Hi-sweep auto-transformer system • 5 microvolt sensitivity • For all picture tubes from 16" to 24".

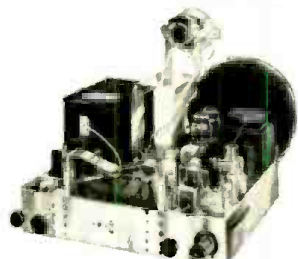

Chassis plated, gleaming nickel finish... completely wired, aligned and tested, ready for installation.

MODEL 2430: with quality PM speaker, all tubes less picture tube, universal picture tube m't'g. brackets, phono-input jack. Equipped with audio take-off to feed sound thru external amplifier, if desired \$189.50
MODEL 2431P: Same as 2430, (less sound take-off), but with true fidelity Push-Pull Audio Amplifier \$199.95

BLUE RIBBON Custom-built TV Chassis



Tech-Master design features for high quality image and sound.

Retains the outstanding characteristics of the RCA-630 circuitry, namely the 4-stage, full bandwidth picture IF strip, and the 3-stage FM sound section • Latest innovations in synch and sweep circuits • Advanced Cascode turret tuner adaptable to UHF without tools • 5 microvolt sensitivity • Permanent magnetic focalizer • A.G.C. level control • 29 tubes (including 4 rectifiers). For all picture tubes from 16" to 24".

MODEL C-30: With quality PM speaker, and all tubes (less picture tube), completely wired, aligned and tested \$149.50

Sold by all leading Radio Parts Distributors.

Write for detailed literature



TECH-MASTER PRODUCTS CO. 443-445 BROADWAY, NEW YORK 13, N. Y.

FIELD TRANSMITTER SET



COMPLETE WITH KEY, HEADPHONES, CARRYING CASE & SHOULDER STRAP

\$795

Two for \$15.00

Here's the famous Fullerphone C.W. Field Telegraph Transmitter at a sensationally low price. Ideal for hams, scouts, rangers, etc. Removable from case for permanent station operation. Makes fine code practice unit; has extra jack for additional set of phones. Get two for complete point-to-point communication system. Wt. 20 lbs. Batteries not supplied.
FULLERPHONE TRANSMITTER, Each \$7.95
Two for \$15.00



HS-33 HEADPHONE SET
The lowest price ever on these fine, low impedance headsets. Brand new, complete with light weight, comfortable rubber ear pads, and PL-354 plug. HS-33 HEADPHONE SET \$4.49



T-17B TYPE HAND MIKE
You'll never get a chance to repeat this buy! Famous press-to-talk T-17B type hand microphone. New. Complete with 6 ft. cord and connector.
HAND MIKE SPECIAL \$1.29

SP-AIR-ES, INC. OF CALIFORNIA
3108 Valhalla Drive Dept. R-2
Burbank, California

GET INTO ONE OF THESE GREATER OPPORTUNITY FIELDS

Electricity or Radio-Television

TRAIN IN THE GREAT SHOPS OF COYNE

OLDEST, BEST EQUIPPED SCHOOL OF ITS KIND IN U. S.
Come to the Great shops of Coyne in Chicago. Get practical training in TELEVISION—RADIO—ELECTRICITY—ELECTRONICS—vital in Defense Program. Prepare now for a better job in Industry or higher rating in Armed Forces.

Approved for Veterans—finance plan—enroll now, pay most of tuition later. Part time employment service while training if needed. Special tuition plan for men of Draft Age.

FREE BOOK Clip coupon for Big Free Illustrated Book. No obligation. No salesman will call. Act NOW.

B. W. Cooke, President
A TECHNICAL TRADE INSTITUTE CHARTERED NOT FOR PROFIT Established 1899 500 S. Paulina, Chicago
COYNE SCHOOL
ELECTRICITY ★ TELEVISION
RADIO ★ REFRIGERATION ★ ELECTRONICS

B. W. COOKE, Pres.
COYNE School
500 S. Paulina St., Chicago 12, Ill. Dept. 23-85H
Send FREE BOOK and details on:

RADIO-TELEVISION ELECTRICITY

NAME

ADDRESS

CITY.....STATE.....

"HO" RAILPACK



0 to 12 VDC 2 Amp. Variable DC supply, unregulated, completely built-in 15V/600mA. Suitable for battery charging, model railroad, includes voltage or speed control and motor cut reverser. Ideal for two "HO" locomotives. **"TAB" SPECIAL... \$10.95; 2 for \$20.00**

SELENIUM RECTIFIERS

We specialize in Rectifiers and Power supplies to your immediate delivery!

Current	18/14	36/28	54/40	150/100
(Volts)	Volts	Volts	Volts	Volts
1AMP	1.35	2.70	4.05	12.15
2AMP	2.20	3.60	5.40	10.50
4AMP	3.75	7.95	10.25	25.25
5AMP	4.25	8.50	12.95	30.00
10AMP	8.50	17.25	25.50	45.00
12AMP	8.50	16.25	25.50	40.00
20AMP	13.25	25.50	39.00	79.50
24AMP	16.25	32.50	45.00	90.00
30AMP	20.00	38.50		
36AMP	25.00	48.50		

Full-Wave Silicon Rect. Trans. In Kit Form. All 115V/60 cycle inputs up to 14VDC at 12 amps... \$18.98
up to 28VDC at 12 amps... 20.98
up to 28VDC at 48 amps... 117.00
up to 28VDC at 6 amps... 12.98

RECTIFIER XFMRs

18-8-12-20-24-21.4Volts	12 Amp	\$10.98	
31-32-34-36 Volts	12 Amp	2 Kvs	19.98
12-12-9-CT-9-12-18V	40mA	7	8.50
18-12-9-CT-9-12-18V	12AMP		16.75
36VCT-24V-18V	24 AMP		35.75
18V 2A 52.75	18V 2A		3.35

RECTIFIER CHOKES

4AMP	.07	MY	.6	OHM	\$7.95
12AMP	.01	MY	.1	OHM	14.95
24AMP	.004	MY	.025	OHM	29.95

BATTERY CHARGER RECTIFIER

10-0-10V (CT) 120 Amp., fan cooled. Replace your old inefficient silicon diode with new selenium type. **SPECIAL... \$13.75**

RELAY SPECIALS

SPST Min. size, 115V, 300V, 3A, CTS 98¢; 3 for \$2.75
SPDT Min. size, 115V, 60V, 3A CTS \$1.39; 3 for \$3.75
SPDT 24VDC/5A CTS. 98¢; 6 for \$5.00
DIP-16 SPNO 12 V DC 100 Connects. **"TAB" SPECIAL... \$2.98; 4 for \$10.00**

INFRARED SNOOPSCOPE

Immerse-Converter Tube HiSensitivity simplified design 2" dia. Williams screen—Resistivity up to 450 Ohm—Resistivity data & tube, etc. \$4.98; 2 for \$9.49
SNOOPSCOPE PWR SUPPLY
1800VDC 35MA, Using Double Cr. Transformer, Rectifiers, Sockets, Resistors, Capacitors and Diagram. \$6.98

TEST CORDS

Precision Feeder Cable, 1.1 ft. Ideal for Test and Relay Work
Removable Gauges: 0127, 018, 025, 018, 037, 035" .98¢; 6 for \$5.00
15 Foot Extension Cord 115V 100V Rubber Covered Insulation \$1.00
6 Foot Line Cord W/Plug Rubber Cover .55¢; 2 for \$1.00
4 Foot Test Cord, Plug & Indicator (Cable Attached, Special 59¢; 2 for 98¢)
4 Foot Instrument Test Leads, High Quality, Red & Black 59¢; 2 for 98¢

TOGGLE SWITCHES

SPST GR 1/4 250V .25¢; 5 for \$1.00
SPDT AHH 3A 250V .35¢; 4 for \$1.00
SHP Momentary 5A/125V 89¢; 3 for \$2.50
DPST CH 250V 1/2 125V .65¢; 5 for \$2.95
DPST 20A/230V .1125¢; 3 for \$3.25

PHOTOFLASH CAPACITORS

100MFD/500VDC C. Dabiller	\$2.89
200MFD 500VDC C. Dabiller	2.89
300MFD 450VDC C. Dabiller	2.89
15MFD 330VAC 1500VDC Intermitt.	\$3.98
25MFD 330VAC 1500VDC Intermitt.	6.49
16MFD 600VAC 2800VDC Intermitt.	6.49
16MFD 600VAC 2800VDC Intermitt.	7.95
32MFD 1.2KVDC 23V, Sec.	7.49
27MFD 1.2KVDC 23VDC Int. 54W Sec.	8.99
5MFD 650VAC 300VDC Int. 29W Sec.	20.00
26MFD 330VAC 1.5KVDC Int. 29W Sec.	\$11.95

TAB "SUN-FLASH" LAMPS

No.	Replaces	Max.	W-sec.
U2W	GE FT105	100	\$5.98
U10	GE FT114	100	7.25
23A	1 AMGL05804X	100	10.98
23ST	GE FT 210	200	9.98
33GT	GE FT 330	200	9.98
VA	SYLV. 4330	200	9.98
23MT	PT 214	250	9.98
22ST	PT 110	200	9.98
33GTQ	FT 303	5000	49.98
V4X4	N400	200	10.98

Write for Complete "THREELITE" Data Booklets, Ext. Hex. Units for Flood Plane Shutters and Accessories. We Buy, Sell & Swap Radio & Camera Equip.

HIV PHOTOFLASH KIT

Includes V4X4 Flash Lamp, Flashed 200 Watt Seconds, Flash Lamp Holder, 2 Reflector & Cable, 115V/100W Imp. Power Transformer & 50 W Sec. Mini. Section Capacitor Bank. All Resistors, Capacitors, Rectifiers & Sockets. **SPECIAL... \$24.98**

LO-VOLT PHOTOFLASH KIT

Includes DLX15 Flash Lamp, Flashed 200 Watt Sec. Flash Lamp Holder & Reflector & Cable, Power Transformer & 50 Watt Sec. Mini. Section Capacitors, (2) 200 Mfd Each W Output of 100 Watt Sec. All Resistors, Capacitors, Rectifiers & Sockets. **SPECIAL... \$29.98**
Extra Flash Lamp Holders W/8" Reflector & Cord \$3.98; W/ V4X4 or DLX \$12.98

AUDIO COMPONENTS

GE RELUCTANCE CART-
RIDGE MP5041 \$4.98
VAR-RELUCTANCE CART-
TONE MP5041 \$4.98
5" PM SPEAKER Model 820P, Good Hi-Freq. Response, Excellent Tone Reproduction. Priced at \$1.98
12" PM SPEAKER Model R120P, Same Mgr as above, Good Low Tone Reproduction. The above combination of 5" & 12" speakers is "Tab's" Answer for a low cost, high fidelity loud speaker system. Combination Special... 6.49

"TAB"

THAT'S A BUY

TEST EQUIPMENT

MODEL 103 AC/DC 24 ranges VOM: AC & DC 10 ranges to 3000V, 10-5 mA to 0-44D. AC currents 3 mA to 600 mA, DC current 4 mA to 60 mA, ohms 2 mA to 1 meg. ohm. Std. mfg. "TAB" GTD display models. **SPECIAL Post Paid... \$17.49**

MODEL 102 Pocket timer features AC & DC 10 ranges to 3000V, AC current 3 mA to 600 mA, DC current 4 mA to 1.2 amp, ohms 2 mA to 1 meg. ohm. Compact, accurate & durable construction. Std. mfg. "TAB" GTD display Model. **SPECIAL Post Paid... \$13.98**

MODEL 106 Vacuum tube volt meter features include: AC & DC 10 ranges to 1000V, ohms 2 mA to 1000 meg. ohms, 5 1/2 ranges AC Range freq. response 25 to 100,000 cycles, designed for field alignment of TV & Radio sets. Std. mfg. "TAB" GTD display Model. **SPECIAL Post Paid... \$33.49**

MODEL 106 VTRM in kit form... \$22.98

MODEL HVP 30,000 volt probe for Model 100. Display Model. Post Paid... \$8.25

MODEL 206P Real Mutual Inductance Tube Tester. Tests all latest tubes, Industrial, radio & TV types. Checks all elements for gas, shorts, opens, & leakage. Meter 4 1/2 inch scale, 5000 scale, 1000 scale, & good Ruler chart. GTD includes factory warranty & new test data as available. Postpaid... \$80.00 Write for Test Equip Pamphlet

Infrared Snoopscope

Immerse-Converter Tube HiSensitivity simplified design 2" dia. Williams screen—Resistivity up to 450 Ohm—Resistivity data & tube, etc. \$4.98; 2 for \$9.49
SNOOPSCOPE PWR SUPPLY
1800VDC 35MA, Using Double Cr. Transformer, Rectifiers, Sockets, Resistors, Capacitors and Diagram. \$6.98

CIRCULAR SLIDE RULE

Easily to use, fully 6" Radius, LAMINATED—Incl. 2 Scales, Grad. 1/100, 1/1000, CUBES & ROOTS, Log, Decimal Equiv., 98¢

TABOGRAM

WRITE FOR IT

WE STOCK LARGE VARIETY OF COMPONENTS. TELL US YOUR NEEDS. **SELL US YOUR TUBES & EQUIPMENT.**

TUBES

0A2 VR75 .50 3D6 1299 .69 6507GT .80
0B2 1.37 3D22 13.95 65F7 .73
0B3 VR90 1.09 3D23 4.90 65F7 .73
0C3 VR105 .90 4-125A 29.95 65J7 .70
103 R016 .41 4-250A 40.95 65K7GT .69
103 471A 1.25 4-100A 10.95 65L7GT .68
1822 2.20 AC35 27.25 65N7GT .69
1823 9.90 EL58HD 16.98 65N7WGT .65
1824 9.45 AC35 27.25 65N7GT .69
1826 2.45 SC22 49.95 65R7 .69
1827 12.75 SC30 CSB 3.95 65S7 .98
1828 532.3 3.90 SC23 36.50 65V7GT .26
1837 16.98 5J29 1.92 65VGT .19
1840 4.95 5R4GY 1.39 64WGT .57
1841 4.95 5R4CYW 1.75 12A47GT 1.45
1842 1.80 5R4CY 1.39 12A47GT 1.45
1846 1.98 6AG7 1.99 12A5W 2.98
1853 4.95 6AG5 1.49 12A5L 5.75
1854 38.50 6AG5 1.49 12A5L 5.75
1858 1.75 6A15 1.40 12A7T .81
1860 6.90 6AK5 2.74 12A7U 6.75
1863A 75.00 6AK6 1.05 12A7V 1.98
2036 27.00 6AL5 1.54 12A7V 1.98
2037 21.00 6AL5 1.98 12A7V 1.98
2040 1.75 6AN5 2.90 12A46GT 1.20
2043 7.49 6AQ5 3.55 12A7T .79
2044 464A 6AQ5W 3.55 12A7T .79
2044 1.40 6AQ6 .81 12A7T 1.49
2051 1.65 6AQ7GT 1.32 12B8A 5.59
2052 1.45 6AR6 2.98 12B8C 1.23
2056 1.49 6AS6 2.43 12B8E .59
2057 1.49 6AS7 4.14 12B8T 1.29
2062 1.49 6A5GT 1.10 12B7T .69
2063 27.00 6A5GT .59 12S27GT .69
2064 37.00 6AV6 1.49 12S27GT .69
2065 37.00 6AV6 1.49 12S27GT .69
2066 34.00 6AV6 1.29 12S27GT .69
2067 108.00 6BA6 1.63 12S27GT .69
2068 187.00 6BA6 1.63 12S27GT .69
2069 117.50 6BA7 1.27 12S27GT .69
2070 44.00 6BA7 1.27 12S27GT .69
2071 187.00 6BA7 1.27 12S27GT .69
2072 44.00 6BA7 1.27 12S27GT .69
2073 34.00 6BA7 1.27 12S27GT .69
2074 34.00 6BA7 1.27 12S27GT .69
2075 34.00 6BA7 1.27 12S27GT .69
2076 34.00 6BA7 1.27 12S27GT .69
2077 34.00 6BA7 1.27 12S27GT .69
2078 34.00 6BA7 1.27 12S27GT .69
2079 34.00 6BA7 1.27 12S27GT .69
2080 34.00 6BA7 1.27 12S27GT .69
2081 34.00 6BA7 1.27 12S27GT .69
2082 34.00 6BA7 1.27 12S27GT .69
2083 34.00 6BA7 1.27 12S27GT .69
2084 34.00 6BA7 1.27 12S27GT .69
2085 34.00 6BA7 1.27 12S27GT .69
2086 34.00 6BA7 1.27 12S27GT .69
2087 34.00 6BA7 1.27 12S27GT .69
2088 34.00 6BA7 1.27 12S27GT .69
2089 34.00 6BA7 1.27 12S27GT .69
2090 34.00 6BA7 1.27 12S27GT .69
2091 34.00 6BA7 1.27 12S27GT .69
2092 34.00 6BA7 1.27 12S27GT .69
2093 34.00 6BA7 1.27 12S27GT .69
2094 34.00 6BA7 1.27 12S27GT .69
2095 34.00 6BA7 1.27 12S27GT .69
2096 34.00 6BA7 1.27 12S27GT .69
2097 34.00 6BA7 1.27 12S27GT .69
2098 34.00 6BA7 1.27 12S27GT .69
2099 34.00 6BA7 1.27 12S27GT .69
2100 34.00 6BA7 1.27 12S27GT .69
2101 34.00 6BA7 1.27 12S27GT .69
2102 34.00 6BA7 1.27 12S27GT .69
2103 34.00 6BA7 1.27 12S27GT .69
2104 34.00 6BA7 1.27 12S27GT .69
2105 34.00 6BA7 1.27 12S27GT .69
2106 34.00 6BA7 1.27 12S27GT .69
2107 34.00 6BA7 1.27 12S27GT .69
2108 34.00 6BA7 1.27 12S27GT .69
2109 34.00 6BA7 1.27 12S27GT .69
2110 34.00 6BA7 1.27 12S27GT .69
2111 34.00 6BA7 1.27 12S27GT .69
2112 34.00 6BA7 1.27 12S27GT .69
2113 34.00 6BA7 1.27 12S27GT .69
2114 34.00 6BA7 1.27 12S27GT .69
2115 34.00 6BA7 1.27 12S27GT .69
2116 34.00 6BA7 1.27 12S27GT .69
2117 34.00 6BA7 1.27 12S27GT .69
2118 34.00 6BA7 1.27 12S27GT .69
2119 34.00 6BA7 1.27 12S27GT .69
2120 34.00 6BA7 1.27 12S27GT .69
2121 34.00 6BA7 1.27 12S27GT .69
2122 34.00 6BA7 1.27 12S27GT .69
2123 34.00 6BA7 1.27 12S27GT .69
2124 34.00 6BA7 1.27 12S27GT .69
2125 34.00 6BA7 1.27 12S27GT .69
2126 34.00 6BA7 1.27 12S27GT .69
2127 34.00 6BA7 1.27 12S27GT .69
2128 34.00 6BA7 1.27 12S27GT .69
2129 34.00 6BA7 1.27 12S27GT .69
2130 34.00 6BA7 1.27 12S27GT .69
2131 34.00 6BA7 1.27 12S27GT .69
2132 34.00 6BA7 1.27 12S27GT .69
2133 34.00 6BA7 1.27 12S27GT .69
2134 34.00 6BA7 1.27 12S27GT .69
2135 34.00 6BA7 1.27 12S27GT .69
2136 34.00 6BA7 1.27 12S27GT .69
2137 34.00 6BA7 1.27 12S27GT .69
2138 34.00 6BA7 1.27 12S27GT .69
2139 34.00 6BA7 1.27 12S27GT .69
2140 34.00 6BA7 1.27 12S27GT .69
2141 34.00 6BA7 1.27 12S27GT .69
2142 34.00 6BA7 1.27 12S27GT .69
2143 34.00 6BA7 1.27 12S27GT .69
2144 34.00 6BA7 1.27 12S27GT .69
2145 34.00 6BA7 1.27 12S27GT .69
2146 34.00 6BA7 1.27 12S27GT .69
2147 34.00 6BA7 1.27 12S27GT .69
2148 34.00 6BA7 1.27 12S27GT .69
2149 34.00 6BA7 1.27 12S27GT .69
2150 34.00 6BA7 1.27 12S27GT .69
2151 34.00 6BA7 1.27 12S27GT .69
2152 34.00 6BA7 1.27 12S27GT .69
2153 34.00 6BA7 1.27 12S27GT .69
2154 34.00 6BA7 1.27 12S27GT .69
2155 34.00 6BA7 1.27 12S27GT .69
2156 34.00 6BA7 1.27 12S27GT .69
2157 34.00 6BA7 1.27 12S27GT .69
2158 34.00 6BA7 1.27 12S27GT .69
2159 34.00 6BA7 1.27 12S27GT .69
2160 34.00 6BA7 1.27 12S27GT .69
2161 34.00 6BA7 1.27 12S27GT .69
2162 34.00 6BA7 1.27 12S27GT .69
2163 34.00 6BA7 1.27 12S27GT .69
2164 34.00 6BA7 1.27 12S27GT .69
2165 34.00 6BA7 1.27 12S27GT .69
2166 34.00 6BA7 1.27 12S27GT .69
2167 34.00 6BA7 1.27 12S27GT .69
2168 34.00 6BA7 1.27 12S27GT .69
2169 34.00 6BA7 1.27 12S27GT .69
2170 34.00 6BA7 1.27 12S27GT .69
2171 34.00 6BA7 1.27 12S27GT .69
2172 34.00 6BA7 1.27 12S27GT .69
2173 34.00 6BA7 1.27 12S27GT .69
2174 34.00 6BA7 1.27 12S27GT .69
2175 34.00 6BA7 1.27 12S27GT .69
2176 34.00 6BA7 1.27 12S27GT .69
2177 34.00 6BA7 1.27 12S27GT .69
2178 34.00 6BA7 1.27 12S27GT .69
2179 34.00 6BA7 1.27 12S27GT .69
2180 34.00 6BA7 1.27 12S27GT .69
2181 34.00 6BA7 1.27 12S27GT .69
2182 34.00 6BA7 1.27 12S27GT .69
2183 34.00 6BA7 1.27 12S27GT .69
2184 34.00 6BA7 1.27 12S27GT .69
2185 34.00 6BA7 1.27 12S27GT .69
2186 34.00 6BA7 1.27 12S27GT .69
2187 34.00 6BA7 1.27 12S27GT .69
2188 34.00 6BA7 1.27 12S27GT .69
2189 34.00 6BA7 1.27 12S27GT .69
2190 34.00 6BA7 1.27 12S27GT .69
2191 34.00 6BA7 1.27 12S27GT .69
2192 34.00 6BA7 1.27 12S27GT .69
2193 34.00 6BA7 1.27 12S27GT .69
2194 34.00 6BA7 1.27 12S27GT .69
2195 34.00 6BA7 1.27 12S27GT .69
2196 34.00 6BA7 1.27 12S27GT .69
2197 34.00 6BA7 1.27 12S27GT .69
2198 34.00 6BA7 1.27 12S27GT .69
2199 34.00 6BA7 1.27 12S27GT .69
2200 34.00 6BA7 1.27 12S27GT .69
2201 34.00 6BA7 1.27 12S27GT .69
2202 34.00 6BA7 1.27 12S27GT .69
2203 34.00 6BA7 1.27 12S27GT .69
2204 34.00 6BA7 1.27 12S27GT .69
2205 34.00 6BA7 1.27 12S27GT .69
2206 34.00 6BA7 1.27 12S27GT .69
2207 34.00 6BA7 1.27 12S27GT .69
2208 34.00 6BA7 1.27 12S27GT .69
2209 34.00 6BA7 1.27 12S27GT .69
2210 34.00 6BA7 1.27 12S27GT .69
2211 34.00 6BA7 1.27 12S27GT .69
2212 34.00 6BA7 1.27 12S27GT .69
2213 34.00 6BA7 1.27 12S27GT .69
2214 34.00 6BA7 1.27 12S27GT .69
2215 34.00 6BA7 1.27 12S27GT .69
2216 34.00 6BA7 1.27 12S27GT .69
2217 34.00 6BA7 1.27 12S27GT .69
2218 34.00 6BA7 1.27 12S27GT .69
2219 34.00 6BA7 1.27 12S27GT .69
2220 34.00 6BA7 1.27 12S27GT .69
2221 34.00 6BA7 1.27 12S27GT .69
2222 34.00 6BA7 1.27 12S27GT .69
2223 34.00 6BA7 1.27 12S27GT .69
2224 34.00 6BA7 1.27 12S27GT .69
2225 34.00 6BA7 1.27 12S27GT .69
2226 34.00 6BA7 1.27 12S27GT .69
2227 34.00 6BA7 1.27 12S27GT .69
2228 34.00 6BA7 1.27 12S27GT .69
2229 34.00 6BA7 1.27 12S27GT .69
2230 34.00 6BA7 1.27 12S27GT .69
2231 34.00 6BA7 1.27 12S27GT .69
2232 34.00 6BA7 1.27 12S27GT .69
2233 34.00 6BA7 1.27 12S27GT .69
2234 34.00 6BA7 1.27 12S27GT .69
2235 34.00 6BA7 1.27 12S27GT .69
2236 34.00 6BA7 1.27 12S27GT .69
2237 34.00 6BA7 1.27 12S27GT .69
2238 34.00 6BA7 1.27 12S27GT .69
2239 34.00 6BA7 1.27 12S27GT .69
2240 34.00 6BA7 1.27 12S27GT .69
2241 34.00 6BA7 1.27 12S27GT .69
2242 34.00 6BA7 1.27 12S27GT .69
2243 34.00 6BA7 1.27 12S27GT .69
2244 34.00 6BA7 1.27 12S27GT .69
2245 34.00 6BA7 1.27 12S27GT .69
2246 34.00 6BA7 1.27 12S27GT .69
2247 34.00 6BA7 1.27 12S27GT .69
2248 34.00 6BA7 1.27 12S27GT .69
2249 34.00 6BA7 1.27 12S27GT .69
2250 34.00 6BA7 1.27 12S27GT .69
2251 34.00 6BA7 1.27 12S27GT .69
2252 34.00 6BA7 1.27 12S27GT .69
2253 34.00 6BA7 1.27 12S27GT .69
2254 34.00 6BA7 1.27 12S27GT .69
2255 34.00 6BA7 1.27 12S27GT .69
2256 34.00 6BA7 1.27 12S27GT .69
2257 34.00 6BA7 1.27 12S27GT .69
2258 34.00 6BA7 1.27 12S27GT .69
2259 34.00 6BA7 1.27 12S27GT .69
2260 34.00 6BA7 1.27 12S27GT .69
22



320K SIG. GEN. KIT \$19.95 WIRED \$29.95



145K SIG. TRACER KIT \$19.95 WIRED \$28.95



950K R-C BRIDGE & R-C-L COMP. KIT \$19.95 WIRED \$29.95



360K SWEEP GEN. KIT \$34.95 WIRED \$49.95



New 214K VTVM KIT \$34.95 WIRED \$54.95 7 1/2" METER



New 377K SINE & SQUARE WAVE AUDIO GEN. KIT \$31.95 WIRED \$49.95



1040K BATTERY ELIM. KIT \$25.95 WIRED \$34.95



OVER 1/4 MILLION

EICO INSTRUMENTS

in use the world over!



New 536K MULTIMETER KIT \$12.90 WIRED \$14.90 1,000Ω/v; 31 ranges

EICO new modern facilities for research, development and production—your greater assurance of . . .

LABORATORY PRECISION AT LOWEST COST



1171K RES. DECADE BOX KIT \$19.95 WIRED \$24.95



625K TUBE TESTER KIT \$34.95 WIRED \$49.95



CRA PIX TUBE ADAPTOR for Tube Tester \$4.50



New 365K MULTIMETER KIT \$24.95 WIRED \$29.95 20,000Ω/v; 31 ranges



315K DELUXE SIG. GEN. KIT \$39.95 WIRED \$59.95



HIGH VOLTAGE PROBE \$6.95



221K VTVM \$25.95 WIRED \$49.95



425K 5" PUSH-PULL SCOPE KIT \$44.95 WIRED \$79.95

NEW AUDIO GENERATOR

- Accuracy: $\pm 3\%$
 - Sine Wave Range: 20-200,000 cps in 4 bands
 - Square Wave Range: 60-30,000 cps
 - Freq. Response: ± 1.5 db, 60 cps-150 kc.
 - Output Voltage: 10 volts across 1000 ohms (rated load); 14 volts across 10,000 ohms; 8 volts across 500 ohms
 - Distortion: less than 1% at rated output (100 mw)
 - Hum: less than 0.4% of rated output
- Clear, three-dimensional drawings and simplified construction information. 15-page Instruction Book describes circuitry, applications and maintenance.



377K KIT \$31.95 WIRED \$49.95

You Build EICO Kits in One Evening, but . . . They last a Lifetime! and You SAVE OVER 50%

YOU be the judge. See the famous EICO line TODAY — in stock at your local jobber — and SAVE!

Write NOW for FREE newest Catalog 1-CA.

America's greatest instrument values bear the name—



ELECTRONIC INSTRUMENT CO., Inc., 84 Withers Street, Brooklyn 11, N. Y.

EVERYBODY'S TALKING ABOUT NEWCOMB'S "AUDI-BALANCE"

PATENT APPLIED FOR

"The greatest amplifier improvement in recent years" . . . A godsend to both owner and service man." . . . "It used to take me hours to do what Audi-balance does in seconds." . . . "Does even better than I've been able to do with meters, this balances tubes dynamically." . . . "The problem has plagued us for years, it is now possible to keep perfect balance in output tubes consistently for lowest distortion." . . . "Audi-balance is the perfect solution."

Just one of the features that make the brand new Classic amplifiers by Newcomb so exciting. Write for catalog of 8 completely new home music amplifiers priced from \$39.50 to \$269.50 audiophile net.

The Classic 25

For the sound thrill of a lifetime this superb new 25 watt custom amplifier has every practical operational feature electronic engineering can offer you. Even more important is the incomparable listening pleasure it provides.



The Classic 15

This outstanding 15 watt amplifier is unique in luxury features and technical perfection at a surprisingly moderate cost. Its smartly designed remote control unit is a superlative piece of engineering, beautifully finished in brushed brass.

Substantial Installation Savings

Savings of as much as, or more than, the entire cost of these fine amplifiers are being reported by enthusiastic purchasers. This is due to their unique design which removes the usual necessity of a remote control being near the amplifier, tuner and changer. These items can now be installed in a hall closet or any similar out of the way location leaving only the beautiful remote control and

the speaker, with no messy confusion of wires, in the living room. No accessories connect directly to the remote control. All inputs connect only to the main amplifier. The savings in cabinetry and of installation labor are obvious and very real to those who take advantage of this new complete remote control design.

Write for Catalog

NEWCOMB

DEPT. F 6824 LEXINGTON AVENUE, HOLLYWOOD 38, CALIF.

15 years of quality leadership



Ernest Lawrence, who has developed a simplified tri-color tube, which will soon be demonstrated in New York again; the original model was shown a year ago. According to Resnick, Paramount has invested well over a half-million dollars in this color tube, and \$300,000 in another TV development, a subscription system, which employs a coin box to unscramble scrambled pictures as they are received over a wire or otherwise.

As this column is being prepared, the merger issue is still deadlocked and appears to be a long way from settlement.

LONG DISTANCE overseas transmission is not only a project of our Voice of America, but many European countries, too. In Belgium, two 100-kilowatt transmitters are used for French and Flemish transmissions.

Several types of antennas are used; curtains directed toward the Belgian Congo and rhombics also directed to this zone and to this country, too. A reversible rhombic is also used to beam signals to Scandinavia.

TV is attracting the attention of many new European countries, reports from the continent indicate. In Norway, a substantial sum of money has been appropriated for experimental tests on a 7-megacycle and 625-line system. It is expected that the tests will last about two years.

Extensive tests are also being conducted in Spain over the Chamartin de la Rosa station. Under consideration are the erection of TV stations at Barcelona and Bilbao.

France will expand its TV activities, and by 1958 will probably have a nationwide service featuring their 819-line system.

A NOVEL LISTENING plan is in use in Northern Rhodesia, according to EBU. About ninety community receivers are hooked up for group listening in the Lusaka area.

In the early summer of '52 a 15-kilowatt short-wave transmitter was placed in service in Rhodesia. In addition, a mobile recording unit was sent out and covered over sixteen-thousand miles, making over 1300 discs of tribal choirs and other native music.

Community listening has also been reported to be very popular in Ceylon. By the end of September of 1950, 825 receivers had been installed at different community centers, rural development society offices, preaching halls, schools, temples, cooperative stores, etc.

Community broadcasting has also been used in Bombay, Madras, and Delhi. Today there are over 4000 receivers in operation all over the country.

Most receivers are operated from batteries and thus maintenance is a problem. To provide battery power, a network of battery-charging centers is used. In Madras, there are 67 such
(Continued on page 147)

RADIO & TELEVISION NEWS



Here's The New

Model TO-4 **TEL-OHMIKE**[®] CAPACITOR-RESISTOR ANALYZER

- You'll be proud to have this completely new instrument on your service bench!
- The result of a nationwide survey of radio and television technicians makes the new TO-4 Tel-Ohmike meet your capacitor test needs to a capital "T". Trim and trustworthy, it has instant push-button range selection, magic-eye bridge balancing, safety discharge feature, direct meter readings of leakage current and insulation resistance, and a continuously adjustable test voltage for checking electrolytics at exact rated voltages.
- Two especially valuable features are the provision of a special low capacitance circuit for checking small ceramics and "gimmick" capacitors down to 1 mmf (in addition to a top capacitance range of 2000 mf) and the simplified insulation resistance circuit with a top reading of 20,000 megohms.
- See a demonstration of this new instrument at your distributor without delay!
- And the price of this new improved Tel-Ohmike is still the same Only **\$73.50** NET.



Write for full descriptive bulletin today

SPRAGUE PRODUCTS COMPANY

(Distributors' Division of Sprague Electric Co.)

51 MARSHALL STREET, NORTH ADAMS, MASS.

ANOTHER NEW DEVELOPMENT BY THE WORLD'S LARGEST CAPACITOR MANUFACTURER



**We rest our case
on evidence
you can hear**



Words can't prove the performance of this superb High Fidelity Tuner. Neither can witnesses. When it's time for a decision, your judgement of the CRAFTSMEN 10 is based on one thing: evidence you hear with your own ears. Listen—and the conclusive evidence of incomparable sensitivity and flexibility will turn your trial into a lifetime of distinctly better listening.

the
craftsmen 10
high fidelity
FM-AM tuner

- Two cathode followers furnish both audio output and detector output for remote installations.
- Built-in pre-amplifier, compensated for variable reluctance pick-ups.
- Automatic Frequency Control entirely eliminates drift, simplifies tuning.
- 5 microvolts sensitivity on both FM and AM.
- 10 kc filter on AM eliminates inter-station squeal.
- Bass and treble tone controls for boost, cut, or 20-20,000 cycle flat response.

JUDGE
THE C-500 TOO!
Williamson all-
triode circuit—
99.99% distor-
tion-free!



high fidelity by craftsmen
means distinctly better listening

For information, write to:
The radio CRAFTSMEN, Inc.
Dept. R-2, 4401 N. Ravenswood Ave.,
Chicago 40, Ill.

Spot Radio News

* Presenting latest information on the Radio Industry.

By RADIO & TELEVISION NEWS'
WASHINGTON EDITOR

THE PROJECTED TV SPAN across the nation, with stations in practically all of the states, often enthusiastically described by many in Washington and industry, seemed to be well on its way to becoming a firm reality, as the closing days of '52 appeared. With nearly 140 grants already issued to new TV operators in four-fifths of the states, and sincere promises from the Commission that hundreds more in all states would soon receive building permits, the prospects for the robust growth of TV looked bright indeed to everyone.

Whereas, only a few months ago, a few states seemed to be favored in the allocation race, nearly all were now receiving a share of the rich prize. The interesting expansion is illustrated in the partial listing of grants issued, at this writing, in the table on page 70.

In studying the table it will be noted that some existing TV areas, with v.h.f. stations, have received new stations which will be operated on the higher bands. One such market is Philadelphia, which now has three stations, and will soon have a u.h.f. station operated by WIP on Channel 29. Other cities in the new and old role are Greensboro, North Carolina and Johnstown, Pennsylvania. Here, Channels 57 and 56, respectively, will compete with the present very-high installations. The Channel 29 grant to the "City of Brotherly Love" was the first u.h.f. authorization to a major metropolitan center and represented an important trend in approvals from the processing staff. It had been felt that grants of this type would be delayed and perhaps not issued until '53. The earlier issuance was described as a major change in philosophy toward large city high-low band operation which would serve to spark sales of TV sets in areas believed riding close to a saturation point among viewers. In Philadelphia, dealers and distributors beamed when the high channel announcement appeared in the local papers. Notwithstanding the fact that the new station will not be placed in operation for some time, interest soared and sales jumped.

THEATER TV, which had a very brief airing during the late winter months of '52, became steeped in gloom as the official hearings began in '53. Many in

the theater industry felt very doubtful about the ultimate success of allocations of channels for theater circuits.

According to the general counsel for motion picture exhibitors, the Commission has shown little enthusiasm for the assignment of channels to the theater. He indicated that most of the questions asked by the Commission during the hearing seemed to indicate that the legislators were not too keen about the proposed system. It was hoped, he said, that the facts presented during the lengthier hearings will convince the Commission that the theaters should have the requested channels, and as soon as possible.

THE ROARING DEBATE in the hearing offices of the Commission concerning the merger of ABC and Paramount, which it was generally felt would taper off with the release of Hearing Examiner Leo Resnick's approval of the merger, flared up with the objections filed by the broadcast bureau of the Commission.

The Resnick report was an extremely interesting document, covering every phase of the case and revealing some intriguing data on Paramount's role in the television industry. It was noted that the motion picture producer began to study the possibilities of TV as early as 1937, when it invested in *Du Mont*. They then applied for experimental television licenses in both Los Angeles and Chicago from which developed the present stations KTLA and WBKB. The transmitters for these stations were said to be among the first built, and the antenna and transmitter at Mount Wilson near Los Angeles was noted as being the first to be established at that focal point.

The report also indicated that the flicker maker has been instrumental in the development of video recording and large-screen TV, too. They have developed a camera and projector which can record TV images almost instantaneously, after they are received, on film said to be suitable for almost immediate projection on large screens used in theaters. In addition to these activities in TV, it was said, the company has become interested in color TV, through participation in the company formed by Dr.



TRAIN **FASTER**—TRAIN **BETTER**—TRAIN **EASIER**
 IN 10 MONTHS—OR LESS—FOR
RADIO-TELEVISION
 Our 21st Year Training Men for Greater Incomes and Security in Radio-Television

I SEND YOU 18 BIG KITS

of Radio Television parts and equipment. Much of your training will be actual construction and experimentation . . . the kind of truly PRACTICAL instruction that prepares you for your Radio-Television career.



Frank L. Sprayberry
 President
 Sprayberry Academy
 of Radio

NEW! NO OBLIGATION PLAN

You Have No Monthly Payment Contract to Sign
 Pay For Your Training as You Earn and Learn

You can get into Radio-Television, today's fastest growing big money opportunity field, in months instead of years! My completely new "package unit" training plan prepares you in as little as 10 months or even less! *No monthly payment contract to sign—thus NO RISK to you!* This is America's finest, most complete, practical training—gets you ready to handle any practical job in the booming Radio-Television industry. Start your own profitable Radio-Television shop . . . or accept a good paying job. I have trained hundreds of successful Radio-Television technicians during the past 21 years—and stand ready to train you, even if you have no previous experience! Mail coupon and get all the facts—FREE!



Valuable Equipment Included With Training

The new Sprayberry "package" plan includes many big kits of genuine, professional Radio-Television equipment. You perform over 300 demonstrations, experiments and construction projects. You build a powerful 6-tube 2-band radio set, multi-range test meter, signal generator, signal tracer, many other projects. All equipment and lessons are yours to keep . . . you have practically everything you need to set up your own profitable Radio-Television service shop.

Earn Extra Money While You Learn!

All your 10 months of training is IN YOUR HOME in spare hours. Keep on with your present job and income while learning. With each training "package" unit, you receive extra plans and "Business Builder" ideas for spare time Radio-Television jobs. New television stations everywhere, open vast new opportunities for trained Radio-Television Technicians—and those in training. If you expect to be in the armed forces later, there is no better preparation than practical Sprayberry Radio-Television training.

YOU BUILD the Television set and the powerful superhet radio receiver shown above. IN ADDITION to the other test units shown here (many are not shown because of lack of space). All equipment I send you is **YOURS TO KEEP.**

SPRAYBERRY ACADEMY OF RADIO 111 NORTH CANAL ST. Dept. 25-S, Chicago 6, Ill.

MAIL COUPON TODAY! NO OBLIGATION

SPRAYBERRY ACADEMY OF RADIO, Dept. 25-T

111 North Canal St., Chicago 6, Ill.
 Please rush to me all information on your 10-MONTH Radio-Television Training Plan. I understand this does not obligate me and that no salesman will call upon me. Be sure to include 3 books FREE.

Name..... Age.....
 Address.....
 City..... Zone..... State.....

I invite you to get all the facts—
FREE TO 3 BIG RADIO-TELEVISION BOOKS

I want you to have ALL the facts about my new 10-MONTH Radio-Television Training—without cost! Rush coupon for my three big Radio-Television books: "How to Make Money in Radio-Television." PLUS my new illustrated Television Bulletin PLUS an actual sample Sprayberry Lesson—ALL FREE. No obligation and no salesman will call. Mail coupon NOW!



DEALERS GETTING WESTINGHOUSE TUBES PROFIT FROM HEAVY LOCAL ADVERTISING AT NO COST

Service dealers are getting powerful local advertising support from new Westinghouse RELIATRON™ Tube Distributors. In cities now served by Westinghouse Distributors, dealers get local newspaper advertising, a complete kit of store display and imprinted mailing material.

All of it—local ads and kits—are designed to build TV-radio service business in the dealer's local area.

Best of all, none of it costs the dealer a penny!

You can get your store listed in two local newspaper ads at no charge, and get a kit to boot. If Westinghouse Tubes are now sold in your area, see your Westinghouse Distributor and take advantage of this \$900-worth-of-advertising-at-no-cost offer.

NEWSPAPER ADS

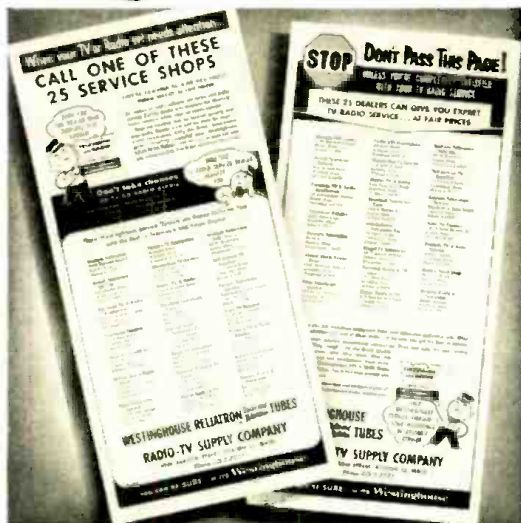

MAILERS

STICKERS

COMING YOUR WAY

If Westinghouse Tubes are not yet distributed in your area, be patient. Distributors are being established in all market areas as fast as product availability and good service permit.

You'll soon have the chance to buy RELIATRON Tubes. Keep this tremendous opportunity in mind: you'll get newspaper advertising at no cost! Imprinted material for mailings! Imprinted signs for your window!

All of it is local advertising which sells your service in your own area where it counts.

For the name of your Westinghouse Distributor, or the approximate date when Westinghouse Tubes will be available in your area, drop a postal card to Dept. G-202 or have your regular distributor contact Dept. G-202 for information on how he can better serve you.

**YOU CAN BE SURE...IF IT'S
Westinghouse**

RELIATRON TUBES
TM

WESTINGHOUSE ELECTRIC CORPORATION, ELECTRONIC TUBE DIVISION, ELMIRA, N. Y.

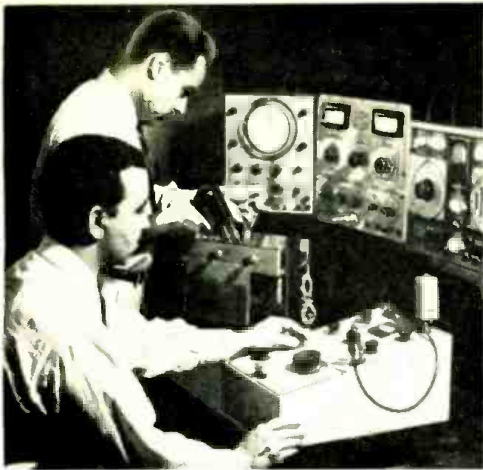

EARN MORE MONEY AS AN EXPERT

Get Shop-Method
Training at Home in

RADIO TELEVISION ELECTRONICS

One Master Course - One Low Tuition
LEARN ALL PHASES - EARN WHILE YOU LEARN

AS A NATIONAL SCHOOLS GRADUATE THERE'S A PLACE FOR YOU IN THIS EXPANDING INDUSTRY...*Never before* such a demand for *you!* For *never before* such a *growing* industry as today's Television, Radio and other Electronic fields. This industry needs *you*... TODAY... and it needs you as a *trained* man... the kind of man you will be as a National Schools graduate. So don't wait. Start your National Schools training NOW...and enjoy big money, job security, SUCCESS!

LEARN from EXPERTS! BE A SUCCESSFUL MAN YOURSELF! You learn from men who are themselves successful Radio, Television and Electronics technicians. You learn the *practical* way... by *doing*... with equipment we send you. And you *advance* quickly, step by step. Get ALL the facts from FREE book and sample lesson. Mail coupon below NOW. Absolutely no obligation.



All yours at
no extra cost!

You can qualify **FAST** for these big-pay jobs...plus many more

Radio Station Technician • Your own Sales and Service Shop • District Service Manager • Inspector Technician • Aircraft Radio Inspector • Special Govt. Positions • Service Specialist • Sound Truck Operator • and many others!

ONLY NATIONAL SCHOOLS GIVES YOU THIS PROFESSIONAL MULTI-TESTER



Ready to use. Easy to operate. Light enough to carry on service calls.

DRAFT AGE? National Schools training helps you get into special service classifications—get higher grades, better pay!

GET YOUR TRAINING FROM THE RADIO-TV CAPITAL OF THE WORLD

Let National Schools—a *resident* technical trade school for nearly 50 years—train you at home for today's unlimited opportunities in Radio-TV.



FREE!

Radio-TV Book & Sample Lesson JUST MAIL COUPON!

NATIONAL SCHOOLS GRADUATES IN BIG DEMAND. You'll find National Schools graduates in good jobs everywhere. For these are the jobs National Schools *trains* you for. Such complete, shop-method home training can be *your* ticket to success...your key to the job happiness you've always wanted. It's up to you. Mail coupon NOW!

FRIENDLY GUIDANCE AS STUDENT AND GRADUATE. Our special Welfare Department is constantly at your service. Helps you with your technical and personal problems. Gives you the benefit of its wide industry contacts and experience in helping you after graduation. **BOTH RESIDENT AND HOME STUDY COURSES OFFERED.**

NATIONAL SCHOOLS APPROVED FOR G. I. TRAINING

Los Angeles, Calif. • Est. 1905 • In Canada: 193 Hastings St., Vancouver, B.C.

YOU GET ALL THE PARTS INCLUDING TUBES for this superheterodyne receiver... and lots of other equipment...to keep!

NATIONAL SCHOOLS, Dept. RH-23
4000 South Figueroa Street
Los Angeles 37, California

Mail in envelope or paste on postal card

Send me FREE book "My Future in Radio-Television and Electronics." Also a FREE sample lesson. I understand no salesman will call on me and that there is no obligation.

NAME _____ AGE _____

ADDRESS _____

CITY _____ ZONE _____ STATE _____

VETS! Check here if you are a veteran.

ACT NOW

Don't put it off! Mail coupon NOW!

In a Class
by Itself



the
C·D·R Rotor



Speedy Installation ... the servicemen's dream come true! No loose parts to assemble ... no kits with loose washers, nuts and bolts ... quick mounting antenna mast collet plus four wire cable hookups!

Dependable ... experience has proven that once a CDR ROTOR is up ... it's THERE TO STAY! No costly call-backs! Completely weather-sealed and streamlined ... it's the outstanding value in the field!

Powerful ... sturdy in design to support and TURN ANY TV ANTENNA array ... never a worry about the CDR rotor working! Locking instantly it will not drift! Instantly reversible ... makes a complete revolution in 45 seconds!

MODEL TR-12 A special combination value consisting of complete rotor including thrust bearing ... handsome modern design plastic cabinet with meter control dial, only **\$47.95**

MODEL TA-6 Thrust bearing accessory, separately **\$4.95**

MODEL TR-11 Same as TR-12 without thrust bearing.. **\$44.95**

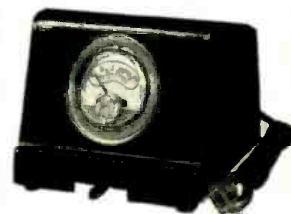

SUBSIDIARY OF



THE **RADIART** CORPORATION
CLEVELAND 13, OHIO

CORNELL-DUBILIER
SOUTH PLAINFIELD, NEW JERSEY
RADIO & TELEVISION NEWS

N 3

THE ONLY COMPLETE CATALOG FOR
EVERYTHING IN TV, RADIO AND
INDUSTRIAL ELECTRONICS

get your 1953 **FREE**

ALLIED

236-PAGE CATALOG

it's complete
it's value-packed

THE WORLD'S LARGEST STOCKS

- TV and Radio Parts
- Test Instruments
- Hi-Fi and P.A. Equipment
- Custom TV Chassis
- AM, FM Tuners & Radios
- Recorders and Supplies
- Amateur Station Gear
- Builders Supplies
- Equipment for Industry

**QUICK
EXPERT
SERVICE**



Send for it today!

Here's the *one* authoritative, complete Buying Guide to *Everything in Electronics*—packed with the world's largest selections of quality equipment at lowest money-saving prices. See the latest in TV custom chassis, TV antennas and accessories; AM and FM tuners and radios; High-Fidelity Custom Sound components; latest P.A. Systems and accessories; recorders; Amateur receivers, transmitters and station gear; specialized industrial electronic equipment; test instruments; builders' kits; huge listings of parts, tubes, tools, books—your choice of the world's *most complete stocks* of quality equipment.

ALLIED gives you every buying advantage; speedy delivery, expert personal help, lowest prices, liberal time payment terms, assured satisfaction. Get the latest 1953 ALLIED Catalog. Keep it handy—and save time and money. Send for your **FREE** copy today!

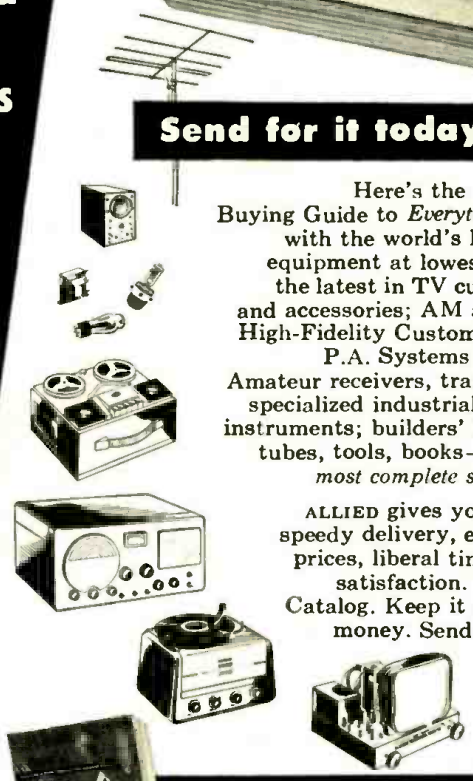

**EVERYTHING IN
ELECTRONICS**

**SEND TODAY FOR RADIO'S
LEADING BUYING GUIDE**

free

ALLIED RADIO

World's Largest Electronic Supply House

EASY-PAY TERMS

Take advantage of ALLIED's liberal Easy Payment Plan—Radio's best terms—only 10% down, 12 months to pay—no interest if you pay in 60 days. Available on Hi-Fi and P. A. units, recorders, TV chassis, test instruments, Amateur gear, etc.

TV & HI-FI SPECIALISTS

To keep up with developments in TV and High-Fidelity, look to ALLIED! Count on us for *all* the latest releases and largest stocks of equipment in these important fields. If it's *anything* in Television or High-Fidelity equipment—we have it in stock!

ALLIED RADIO CORP., Dept. 1-B-3
833 W. Jackson Blvd., Chicago 7, Illinois

Send **FREE** 236-Page 1953 ALLIED Catalog.

Name

Address

City Zone State

E-V

**for PA
LIKE ON TV**

**636
Slimair
DYNAMIC
MICROPHONE**

Gives you features similar to those in the famous E-V Slim-Trim TV Microphones. That's why it is so outstanding for Public Address, Recording and other general-purpose use.
List Price \$70

SMOOTH RESPONSE
60-13,000 CPS
HIGH OUTPUT
OMNIDIRECTIONAL
ACQUSTALLOY
DIAPHRAGM
BUILT-IN
BLAST FILTER

Can be used
in the hand,
on a stand,
or overhead

SEND FOR BULLETIN

Electro-Voice

410 CARROLL ST. • BUCHANAN, MICH.
Export: 13 E. 40th St., N. Y. 16, U.S.A.

For the RECORD.

BY THE EDITOR

THE TELEVISION SERVICE OPERATOR

MANY letters coming to our desk are from technical trainees attending classes in our trade schools and colleges. These students, generally, state that they are learning radio or television theory and practice as preparation for a career in the servicing business. Typical questions asked include: "What do I need to start a service shop?", "Should I specialize in television service exclusively or should I consider both radio and television?" and "What test equipment will I need for television servicing?"

It is a well established fact that television installation and service requires considerably more test instruments and other equipment than does radio. Such equipment can be very costly and, in the case of the independent service technician, almost prohibitive in areas of limited clientele. TV test equipment must be sensitive and accurate. In many cases it is too massive or heavy for home servicing and belongs on the test bench where it can be conveniently and effectively used. A well-equipped shop is a prerequisite for television servicing.

The service shop, however well equipped, is but one link in the chain of equipment required by the progressive service operator. Successful TV service contractors have learned that to cope with the many problems that arise in TV areas they must not only have a well trained staff of technicians but that their men must be properly equipped with the tools of the trade.

Paul Forte of the *Television Contractors Association* recently named several important components that are required to render good service. They include a panel truck or specially fitted car. In it must be carried a supply of tools, equipment, and spare parts that are in most common need. When a television set can't be repaired with these facilities, the car or truck must be suited so that a chassis and/or cabinet can be brought back to the shop for bench work. Such vehicles cost money and represent another investment on the part of the service contractor.

Since there are, roughly, about eighty different makes of television sets and thousands of models, the effectively operating contractor must have a complete library of diagrams, schematics, and service notes. These cost money, and taking care of them, adding to them, and using them costs time and money. Without them no man can claim that he is ready to service television.

A service operator cannot properly

function unless he has records of all service calls. These are not things he keeps in his wallet. He's got to have files and forms and he's got to have somebody work on them to keep them up-to-date. That means he has to have an office and someone in it to handle service requests and dispatch them promptly. These things cost money, a cost that can't be borne by the independent technician. If he does bear them, then he isn't an independent technician any longer; he's either a contractor or a service operator.

He must have special equipment and facilities for installations which include the erection of antennas. This, definitely, requires a truck. He can contract the antenna installation to someone else but that is hardly a good method of conducting a business. Trucks, too, cost money and are an integral part of the investment that must be put into a television service operation, as well as into the cost of service.

Since he's dealing with expensive television equipment in the customer's home, he has to carry Public Liability and Property Damage Insurance. He has to carry other insurance on his vehicles, test equipment, parts stock, and other facilities. It costs more money! It's all part of the investment that goes into a properly handled service business.

If the so-called independent technician says he doesn't need these things in order to maintain himself in the television service business, he is kidding himself. Certainly he won't kid the public, upon whom he depends for business.

There is little time, if any, for the aggressive technician to relax and sit back with a hope that he can keep pace with the fastest growing industry in our time. Instead, he must constantly keep abreast of new developments, in addition to performing his routine tasks as each day passes. He must continually study new circuits, new products, new applications, and new techniques.

He must learn all that he can about u.h.f. behavior, circuitry, antenna theory, and troubleshooting. He must employ common sense in his relationship with the public he serves. He must conduct himself as a successful business man and be ethical.

If he trains himself NOW and if he builds a firm foundation based on the experience of other technicians—the television service operator can certainly look to a future of interesting opportunities in this industry we choose to call electronics O.R.

**Accepted and praised by
the most critical expert in the world**

...the American Amateur Radio Operator



hallicrafters



A Ham's Dream—The SX-71—Planned with you, the advanced amateur, in mind. Communications Receiver SX-71 is a double conversion set, built-in NBFM limiter stage. 538 kc to 34 mc. In 5 bands. Plus A 46 to 55 mc band. Temperature comp.; voltage regulator. 1 r-f, 2 converters, 3 i-f stages. Xtal. filter, 3-position selectivity. 115 V AC, 11 tubes, regulator, rectifier **\$224.50**



Precise Selectivity—The S-76—Amazingly selective! Crisp station separation. Double conversion with 50 kc 2nd i-f. Giant 4-in. "S" meter. 540-1580 kc, 1.72-32 mc in 4 bands. 1 r-f, 2 converters, 2 i-f stages. 5 position selectivity. Phono input jack, 3 watt output. 115 V AC, 9 tubes, regulator, rectifier **\$179.50**



Low Price—High Performance!—S-40B—540 kc to 43 mc in 4 bands. Electrical band spread. Temperature compensated. 1 r-f, 2 i-f. 3 watt output. Built-in speaker. 115 V AC only, 7 tubes, plus rectifier. (S-77—same as S-40B, for 115 V AC or DC) **\$119.95**

The first Hallicrafters radio was built *specifically* for the ham operator more than twenty years ago. Today, Hallicrafters sell more communications sets to the armed forces, professionals and hams, than *all other manufacturers combined*. Yet today, these Hallicrafters sets are still designed *specifically* for the most critical expert in the world—the American amateur operator. There is no higher standard.

hallicrafters

"The Radio Man's Radio"

World's Leading Manufacturer of Precision Radio and Television • Chicago 24, Illinois

The Finest Buy in SW 1—The S-38C—Best performance per dollar you'll find, the S-38C is the outstanding low priced set on the market. 540 kc to 32 mc in 4 bands. Maximum sensitivity per tube—far outperforms ordinary broadcast sets. Built-in speaker. 115 V AC or DC. 4 tubes plus rectifier **\$49.50**



G-C HAS MADE... 125 MILLION STAND-OFFS FOR THE TELEVISION INDUSTRY

125 MILLION STAND-OFFS! Yes, G-C recently completed the manufacture of its 125,000,000th Stand-Off... made possible by the fact that the entire radio-TV service industry recognizes the value, the top quality built into every G-C Stand-Off—available from your jobber in 24 popular styles.







All G-C Stand-Offs are supplied with genuine Polyethylene insulators like this... featuring the exclusive G-C reinforcing rib that keeps the insulator from collapsing.

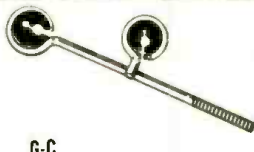

G-C KANT-STRIP MAST STAND-OFFS

Exclusive, improved mast stand-offs with strip-proof extruded threads. Extra strong; no flimsy light metal used; no loose nuts to fall out. Galvanized strap has round end for easier threading. Genuine Polyethylene insulator, unique G-C design.

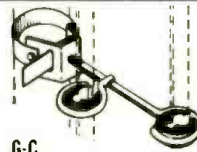
No.	Size
8253	3 1/2" Single
8257	7 1/2" Single

 <p>G-C UNIVERSAL STAND-OFFS (Machine Screw Type)</p> <table border="0"> <tr> <th>No.</th> <th>Length</th> </tr> <tr> <td>8031</td> <td>3 1/2"</td> </tr> <tr> <td>8032</td> <td>5 1/2"</td> </tr> <tr> <td>8035</td> <td>7 1/2"</td> </tr> </table>	No.	Length	8031	3 1/2"	8032	5 1/2"	8035	7 1/2"	 <p>G-C UNIVERSAL STAND-OFFS (Wood Screw Type)</p> <table border="0"> <tr> <th>No.</th> <th>Length</th> </tr> <tr> <td>8027</td> <td>3 1/2"</td> </tr> <tr> <td>8028</td> <td>5 1/2"</td> </tr> <tr> <td>8029</td> <td>7 1/2"</td> </tr> <tr> <td>8030</td> <td>12"</td> </tr> </table>	No.	Length	8027	3 1/2"	8028	5 1/2"	8029	7 1/2"	8030	12"	 <p>G-C NAIL-IN STAND-OFFS</p> <p>New, speed-type nail-in stand-offs save installation time, labor and cost on each job. Easy to use. Genuine Polyethylene insulators.</p> <table border="0"> <tr> <th>No.</th> <th>Length</th> </tr> <tr> <td>8343</td> <td>3 1/2"</td> </tr> </table>	No.	Length	8343	3 1/2"	 <p>G-C DUPLIX IN-LINE STAND-OFFS</p> <p>Two styles, wood screw and machine screw types. Heavily zinc plated to prevent rust.</p> <table border="0"> <tr> <th>No.</th> <th>Size and Type</th> </tr> <tr> <td>8225</td> <td>7 1/2" Wood Screw</td> </tr> <tr> <td>8226</td> <td>7 1/2" Machine Screw</td> </tr> </table>	No.	Size and Type	8225	7 1/2" Wood Screw	8226	7 1/2" Machine Screw
No.	Length																														
8031	3 1/2"																														
8032	5 1/2"																														
8035	7 1/2"																														
No.	Length																														
8027	3 1/2"																														
8028	5 1/2"																														
8029	7 1/2"																														
8030	12"																														
No.	Length																														
8343	3 1/2"																														
No.	Size and Type																														
8225	7 1/2" Wood Screw																														
8226	7 1/2" Machine Screw																														
 <p>G-C SNAP-ON STAND-OFFS</p> <p>NEW, improved snap-on that is easier to install, then stays on. Snap... and it's on; that's all there is to it! Two standard sizes. Feature exclusive G-C reinforced insulators.</p> <table border="0"> <tr> <th>No.</th> <th>Size</th> </tr> <tr> <td>8797</td> <td>For 1" Masts</td> </tr> <tr> <td>8798</td> <td>For 1 1/4" Masts</td> </tr> </table>	No.	Size	8797	For 1" Masts	8798	For 1 1/4" Masts	 <p>G-C "WIRE-GRIP" GUY WIRE STAND-OFFS</p> <p>TV lead-ins and rotator wires can be brought down long guy wires. Fasten permanently; easy to use. Genuine Polyethylene insulators.</p> <table border="0"> <tr> <th>No.</th> <th>Size and Type</th> </tr> <tr> <td>8255</td> <td>3 1/2" Single</td> </tr> <tr> <td>8256</td> <td>Double Type</td> </tr> </table>	No.	Size and Type	8255	3 1/2" Single	8256	Double Type	 <p>G-C DUPLIX KANT-STRIP MAST STAND-OFFS</p> <p>Heavy steel stand-off with strip-proof extruded threads. A deluxe stand-off at a really low price. Galvanized strapping. For both 300-ohm and coaxial lines.</p> <table border="0"> <tr> <th>No.</th> <th>Type</th> </tr> <tr> <td>8258</td> <td>Double</td> </tr> </table>	No.	Type	8258	Double	 <p>G-C EAVE TYPE CLAMP-ON STAND-OFFS</p> <p>New type, clamp-type stand-off that quickly fastens to eaves. Easy to install. Genuine Polyethylene insulators.</p> <table border="0"> <tr> <th>No.</th> <th>Type</th> </tr> <tr> <td>8811</td> <td>Single</td> </tr> <tr> <td>8812</td> <td>Double</td> </tr> </table>	No.	Type	8811	Single	8812	Double						
No.	Size																														
8797	For 1" Masts																														
8798	For 1 1/4" Masts																														
No.	Size and Type																														
8255	3 1/2" Single																														
8256	Double Type																														
No.	Type																														
8258	Double																														
No.	Type																														
8811	Single																														
8812	Double																														



**G-C
TEE-TYPE STAND-OFFS**

Heavy zinc plated for permanent installation. Two types, wood screw and machine screw. For both 300-ohm and coaxial lines.

No.	Size and Type
8809	7 1/2" Wood Screw
8810	7 1/2" Machine Screw

FREE G-C's big, illustrated Catalog, chock-full of hundreds and hundreds of radio-TV service aids. Send a postcard for your copy today!



GENERAL CEMENT MANUFACTURING Co.
904 TAYLOR AVENUE ROCKFORD, ILLINOIS

Prepare Now... in spare time at Home ... for a New,

PROFITABLE, INTERESTING FUTURE

TELEVISION
RADIO - ELECTRONICS

RADIO CHIEF OF ILE DE FRANCE
FRENCH LUXURY LINER PRAISES D. T. I.

Radio Chief—Jean Desmas Says:

"DeForest's Training, Inc., of Chicago, is known not only throughout Europe, but also in many parts of the world as one of America's finest Television, Radio and Electronics training centers."



JACK DEMPSEY
Former World's Heavyweight Champion
TELLS WHY HE'S PROUD
TO BE WITH **D.T. I.**

- I have been greatly impressed with D.T.I.'s wonderful spirit of friendliness and sincere determination to help its students make good in Television-Radio-Electronics.
- I admire its remarkable 20 year record of helping men build brighter futures.
- I also admire the business policy of its management and the thoroughness of its large faculty of instructors.
- Never have I heard young men praise a school as enthusiastically as do the students and graduates of D.T.I. They are its best boosters.



Prepare At Home Or In Our Chicago Laboratory!

See for yourself how readily you may prepare at home, or in our modern Chicago laboratories, for a better job or business of your own in one of America's fastest-growing fields—TELEVISION-RADIO-ELECTRONICS.

If you train at home you get (1) the use of a 16-mm. movie projector and 16 reels of animated movies to help you learn important points faster . . . easier, (2) modern lessons and (3) sixteen shipments of electronic parts enabling you to get valuable practical experience from over 300 projects—including building and keeping the electronic equipment shown below. And upon completing training, you have the optional privilege of building and keeping a big 17-INCH TV set at moderate added cost. Get the full story. Mail coupon today!

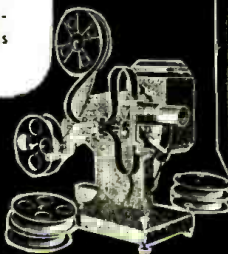

HOME MOVIES



MULTIMETER

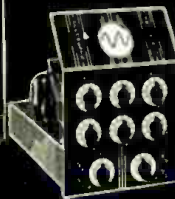

OSCILLOSCOPE



6-TUBE RADIO

R-F SIGNAL GENERATOR



LAUD D. T. I.'s HOME MOVIES IN CONGRESS

D. T. I.'s remarkable home training benefit of visual training MOVIES has been praised from the floor of the House of Representatives in Washington, D. C. and recorded in The Congressional Record.

MILITARY SERVICE!

If subject to military service, the information we have for you should prove very helpful. Mail coupon today.



De FOREST'S TRAINING, INC.
AFFILIATED WITH
De VRY Technical INSTITUTE
CHICAGO 14, ILLINOIS



MAIL COUPON TODAY!

Dept. RN-2-J
DE FOREST'S TRAINING, INC.
2533 N. Ashland Ave., Chicago 14, Ill.

I would like your Opportunity News Bulletin showing "89 Ways to Earn Money in Television-Radio-Electronics"; also, the folder showing how I may prepare to get started in this thrilling field.

Name _____ Age _____
Address _____ Apt. _____
City _____ Zone _____ State _____

Editor
OLIVER READ, D.Sc., WIETI

Managing Editor
WM. A. STOCKLIN, B.S.

Technical Editor
H. S. RENNE, M.S.

Service Editor
CHARLES TEPPER

Amateur Radio Editor
NICHOLAS ROSA, W1NOA

Assistant Editors
P. B. HOEFER
M. C. MAGNA

Television Consultant
WALTER H. BUCHSBAUM

Short-Wave Editor
KENNETH R. BOORD

Staff Artist
FRANK SAYLES

Draftsman
A. A. GANS, W2TSP

Advertising Manager
L. L. OSTEN

Midwest Adv. Manager
JOHN A. RONAN, JR.

Western Adv. Manager
JOHN E. PAYNE



COVER PHOTO: Every new antenna that reaches the market represents hours of engineering time and exhaustive testing like this new "Vee-D-X" unit by LaPointe-Plascomold Corp. (Ektachrome by James Pickands)

Chairman of the Board and Publisher
WILLIAM B. ZIFF

President
B. G. DAVIS

Secretary-Treasurer
G. E. CARNEY

Vice-Presidents
H. J. MORGANROTH
Production Director

LYNN PHILLIPS, JR.
Advertising Director

H. G. STRONG
Circulation Director

BRANCH OFFICES
 CHICAGO (1)
 185 N. Wabash, AN 3-5200
 LOS ANGELES (14)

Staller Center, 900 Wilshire Blvd., Mich. 0850

First in
radio-television-electronics
 Average Paid Circulation over 220,000

RADIO & TELEVISION NEWS

Reg. U.S. Pat. Off.

Radio News Trademark Reg. U. S. Pat. Office • Television News Trademark Reg. U. S. Pat. Office.

CONTENTS

FEBRUARY, 1953

Build this Transistor Receiver.....Robert K. Dixon 35

Oil-Cooled Load Wattmeter.....Robert M. See, W9OCL/5 38

Care of Transistors.....Rufus P. Turner, K6AI 40

V.H.F.-U.H.F. Antenna Design.....L. F. B. Carini 42

Improving the Williamson Amplifier.....David Hafler & Herbert I. Keroes 43

TV Signal Distribution Methods.....Edward M. Noll 46

An Improved Corner Horn Speaker System.....George L. Augspurger 48

Current TV Topics.....Walter H. Buchsbaum 50

A Compact Bandswitching V.F.O. Multiplier.....Earl Snader, W0ZFO 52

Sound System for Your TV Set.....John Potter Shields 54

U.H.F. Antennas (Part 3).....Milton S. Kiver 56

Writing for Profit and Prestige.....Louis E. Garner, Jr. 59

A Vest-Pocket Receiver.....E. G. Louis 60

Single-Channel Remote Broadcast Amplifier.....Leon A. Wortman 62

Mac's Radio Service Shop.....John T. Frye 64

3-Element 14 mc. Rotary Beam Antenna.....C. A. West, W2IYG 66

New TV Grants Since Freeze Lift.....70

Eliminating Oscillator Hum in FM Receivers.....Herbert Michels 82

Radio-TV Service Industry News.....104

DEPARTMENTS

For the Record.....The Editor	8	What's New in Radio.....	85
Spot Radio News.....	16	Manufacturers' Literature.....	116
Within the Industry.....	24	Technical Books.....	155
Short-Wave.....K. R. Boord	65	New TV Products.....	158



COPYRIGHT 1953
ZIFF-DAVIS PUBLISHING COMPANY
 Editorial and Executive Offices
 366 Madison Ave., New York 17, N. Y.
 VOLUME 49 • NUMBER 2



Member
 Audit Bureau of
 Circulations

SUBSCRIPTION SERVICE: All communications concerning subscriptions should be addressed to Circulation Dept., 64 E. Lake St., Chicago 1, Ill. Subscribers should allow at least two weeks for change of address.

CONTRIBUTIONS: Contributors are advised to retain a copy of their manuscripts and illustrations. Contributions should be mailed to the New York Editorial Office and must be accompanied by return postage. Contributions will be handled with reasonable care, but this magazine assumes no responsibility for their safety. Any copy accepted is subject to whatever adaptations and revisions are necessary to meet the requirements of this publication. Payment covers all author's, contributor's, and contestant's rights, title, and interest in and to the material accepted and will be made at our current rates upon acceptance. All photos and drawings will be considered as part of the material purchased.

RADIO & TELEVISION NEWS

Thirteen NEW CRL Printed Electronic Circuits for replacement service!

Brand new Centralab PEC units that cover over two million radio and TV sets now in use. Get your supply for easy servicing. The new PEC Guide No. 2 covers all replacements.

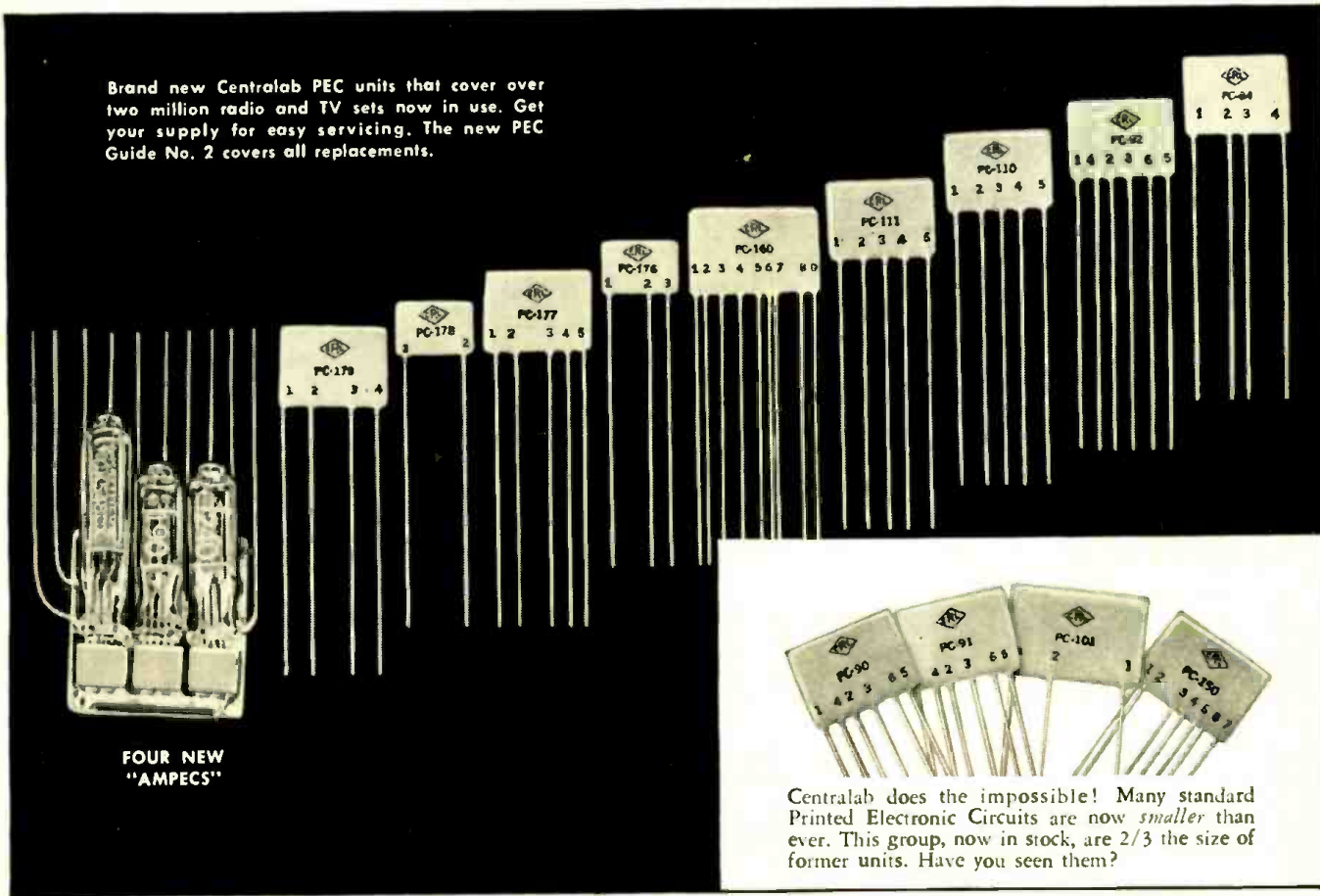

FOUR NEW "AMPECS"

Centralab does the impossible! Many standard Printed Electronic Circuits are now smaller than ever. This group, now in stock, are 2/3 the size of former units. Have you seen them?

Now Available from your Centralab Distributor

THESE thirteen new Printed Electronic Circuits are now in use in thousands of radio and TV sets. You should have a complete stock on hand for shop work and service calls. Centralab Circuits are safest and easiest for servicing. In most cases, the replacement PC number is the same as shown on the original part.

These new PEC units replace whole Pentode Coupling, TV I. F., Triode Coupling, or Pentode Detector networks. Four new plates, too, to replace *special* manufacturer's parts. Together with the other CRL stock Printed Electronic Circuits, these parts will cover 95% of all PEC replacements. Over 15 million circuits are now in use . . . are you ready to service them?

Don't overlook the new smaller sizes in older PEC units. Small size is not enough . . . Centralab makes Printed Electronic Circuits even smaller! For complete information on parts, replacements, and test data, see the *new* Printed Electronic Circuit Guide No. 2. Ask your distributor for a copy, or use the coupon.

Make your Centralab distributor headquarters for exact electronic replacements

Centralab

A Division of Globe-Union Inc.

Milwaukee 1, Wisconsin

In Canada, 635 Queen Street East, Toronto, Ontario

Centralab Printed Electronic Circuits are among the more than 470 *new* items listed in Centralab's new Catalog 28. Get your copy of this 32-page index to the latest developments in the fast-changing electronic field, plus the 20 page Printed Electronic Circuit Guide No. 2. See your distributor or use coupon.



CENTRALAB, A Division of Globe-Union Inc.
910 E. Keefe Avenue, Milwaukee 1, Wisconsin

Please send me my copy of:

P.E.C. Guide No. 2 Centralab Catalog 28

Name..... Position.....

Company.....

Address.....

City..... State.....

RADIO & TELEVISION NEWS is published monthly by the Ziff-Davis Publishing Company at 185 N. Wabash Ave., Chicago 1, Ill. Entered as second-class matter, July 21, 1948, at the Post Office, Chicago, Ill., under the act of March 3, 1879. Authorized by Post Office Department, Ottawa, Canada, as second-class matter. SUBSCRIPTION RATES: Radio & Television News—one Year, U. S. and Possessions, Pan-American countries, and Canada \$4.00; all other foreign countries \$5.00; Radio-Electronic Engineering Edition—one year, U. S. and Possessions, Pan-American countries, and Canada \$6.00; all other foreign countries, \$7.00. Postmaster—Please return undelivered copies under form 3589 to 64 E. Lake St., Chicago 1, Ill.

The gun that looked 100% "perfect" ... yet never "fired a shot"

RCA RADIO CORPORATION of AMERICA
ELECTRON TUBES

How we **SPOT** "shady characters" before they can damage your business

RCA RADIO CORPORATION of AMERICA
ELECTRON TUBES

The guinea pig that "runs a fever" to bring you better picture tubes

RCA RADIO CORPORATION of AMERICA
ELECTRON TUBES

99.9% pure phosphor... yet we throw it away

RCA RADIO CORPORATION of AMERICA
ELECTRON TUBES

The evidence is clear...

RCA safeguards your reputation... with tubes of unequalled quality

In RCA Tubes and Kinescopes the difference is top-quality control



RADIO CORPORATION of AMERICA
ELECTRON TUBES

HARRISON, N. J.

TMK. ®

A **DOUBLE-TAKE** to safeguard your reputation

RCA RADIO CORPORATION of AMERICA
ELECTRON TUBES

The **Torture Chamber** that tests the strength of RCA Picture Tubes

RCA RADIO CORPORATION of AMERICA
ELECTRON TUBES

How we get **NOZZLE** that's just right for RCA picture-tube screens

RCA RADIO CORPORATION of AMERICA
ELECTRON TUBES

Quality control by feedback... the secret of RCA tube performance

RCA RADIO CORPORATION of AMERICA
ELECTRON TUBES

The **Million-Dollar Test Equipment** that pays off in better picture tubes

RCA RADIO CORPORATION of AMERICA
ELECTRON TUBES

Take a look at **quality** being born

RCA RADIO CORPORATION of AMERICA
ELECTRON TUBES