

RADIO & TELEVISION NEWS

ANC

OCTOBER

1952

35¢

In Canada 40¢

IN THIS ISSUE

MIDGET

RADIO-CONTROLLED AUTO

RADIO & TELEVISION NEWS

TEST BENCH

("Data-Print" No. 6)

ELIMINATING 21 MC.

INTERFERENCE

5-WATT NOVICE TRANSMITTER

REMOTE-CONTROL TUNER

PICTURE-TUBE REJUVENATORS

THE YAGI

TRANSISTOR DEVELOPMENTS

UNIVERSAL DESIGN CURVES

SELENIUM RECTIFIERS

(See Page 66)



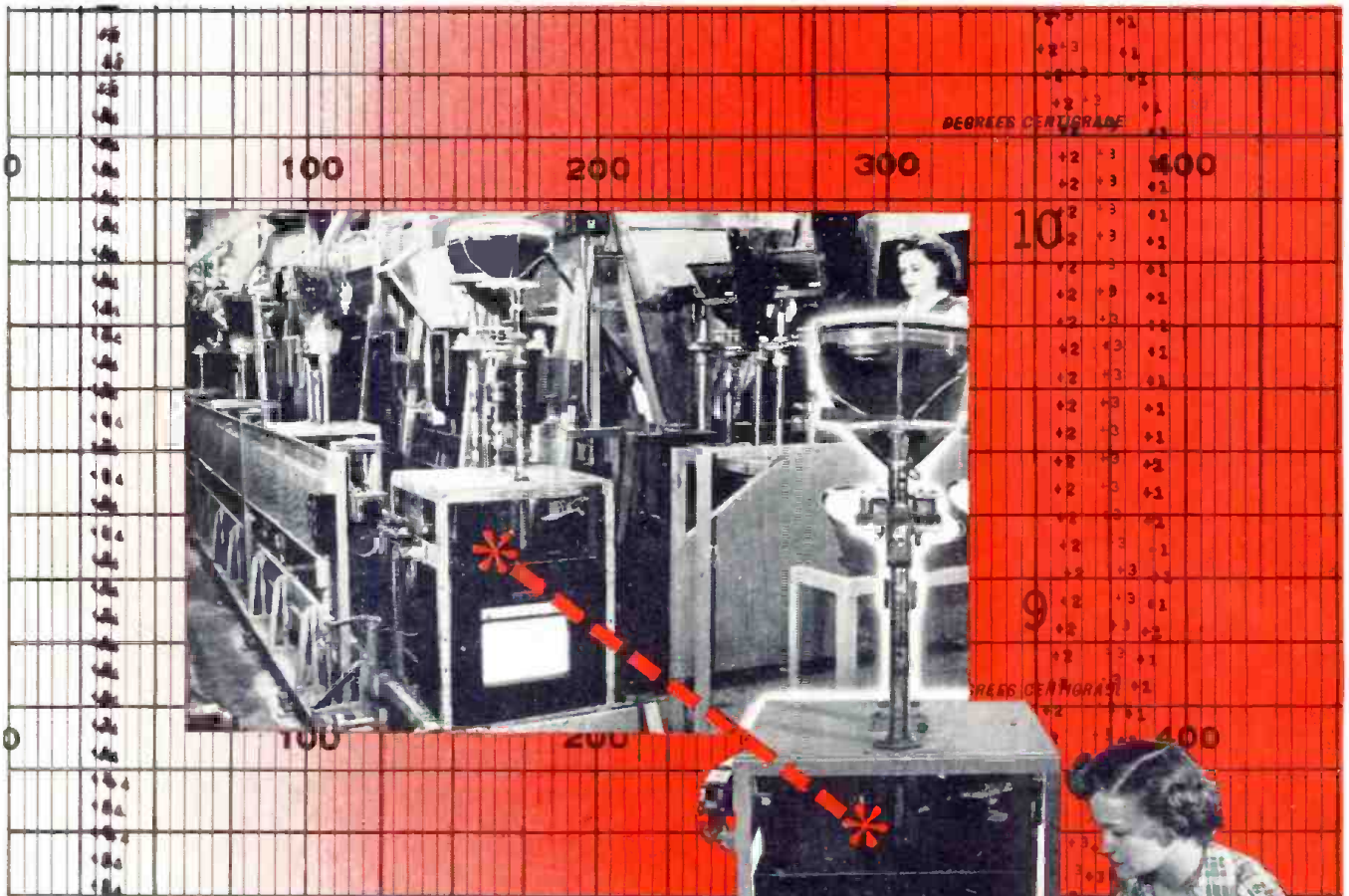

The guinea pig that "runs a fever"

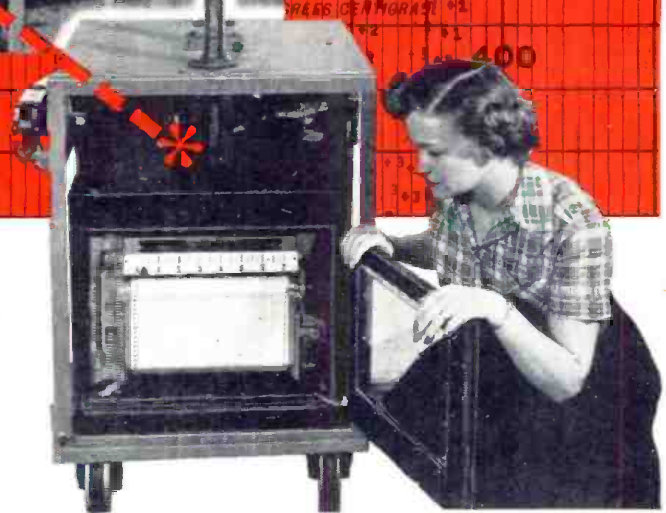

to bring you better picture tubes

IN THE straight-line exhaust systems used at RCA picture-tube plants, each picture tube rides through a long oven on its own "exhaust cart." As the tube passes through this oven, the envelope is freed of gas by baking it at high temperatures.

These high temperatures must be carefully controlled for each picture tube type, and held to rigidly prescribed limits, in order to avoid setting up harmful strains in the glass, especially at the faceplate and wall of the tube.

Here is where the "electric guinea pig" comes in. The "guinea pig" actually consists of a sample tube, with five thermocouples attached to its outside surfaces. These thermocouples are connected to an instrument known as a recording pyrometer. At intervals during the day, this "guinea pig" travels through the oven, and emerges with a complete and accurate "fever chart" for the particular tube type in production. In this manner, temperature deviations are quickly spotted . . . and promptly corrected.

This is another example of the care exercised in the manufacture of RCA picture tubes. Through constant vigilance, RCA closely guards its own reputation for quality . . . and yours as well.

With RCA Receiving Tubes, as well as RCA Kinescopes, TOP-QUALITY CONTROL makes the difference.



RADIO CORPORATION of AMERICA
ELECTRON TUBES

TMKS. ®

HARRISON, N. J.

YOU PRACTICE COMMUNICATIONS with Kits I Send You

YOU PRACTICE SERVICING with Kits I Send You

Build This Transmitter

As part of my Communications Course I send you parts to build the low power Broadcasting Transmitter shown at the right. Use it to get practical experience putting a station "on the air," perform procedures required of Broadcast Station operators. You build many other pieces of equipment with kits I send. I train you for your FCC Commercial Operator's License.

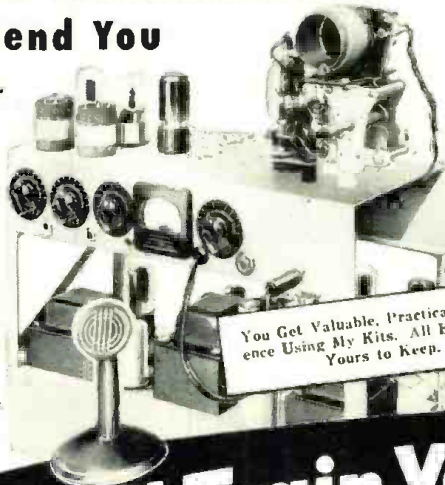

You Get Valuable, Practical Experience Using My Kits. All Equipment Yours to Keep.



Build This Tester

You build this Multitester from parts I send, use it to earn extra money in your spare time fixing neighbors' Radios. I also send you speaker, tubes, chassis, transformer, loop antenna, everything you need to build a modern Radio and other equipment. You get practical experience working with circuits common to both Radio and Television. All equipment is yours to keep. See and read about it in my FREE 64-page book. Just cut out and mail coupon below!



J. E. Smith has trained more men for Radio-TV than any other man.

I Will Train You at Home to be a RADIO-TELEVISION Technician

TELEVISION

Today's Good Job Maker



TV now reaches from coast-to-coast. Over 15 million TV sets are now in use; 108 TV stations are operating and 1800 new TV stations have been authorized. This means more jobs, good pay jobs with bright futures. Now is the time to get ready for success in TV. Find out what Radio-Television offers you. Mail coupon now for my 2 Books FREE!

America's Fast Growing Industry Offers You Good Pay, Success

Do you want a good pay job, a bright future, security? Then get into the fast growing RADIO-TELEVISION industry. Hundreds I've trained are successful RADIO-TELEVISION TECHNICIANS. Most had no previous experience, many no more than grammar school education. Keep your job while training at home. Learn RADIO-TELEVISION principles from easy-to-understand lessons. Get practical experience on actual equipment you build with parts I send you.

Make Extra Money in Spare Time While Training

The day you enroll I start sending you SPECIAL BOOKLETS that show you how to service neighbors' Radios in spare time while training. Use MULTITESTER you build to help service sets, get practical experience working on circuits common to both Radio and Television. Find out how you can realize your ambition to be successful in the prosperous RADIO-TELEVISION industry. Even without Television, the industry is bigger than ever before. 105 million home and auto Radios, over 2900 Radio Stations, expanding Aviation and Police Radio. Micro-Wave Relay, FM and Television are making opportunities for Servicing and Communications Technicians.

Mail Coupon — Find Out What Radio-TV Offers You

Send for my FREE DOUBLE OFFER. Cut out and mail coupon below. Send in envelope or paste on postal. You will get actual Servicing Lesson to prove it's practical to learn at home. You'll also receive my 64-page Book, "How to Be a Success in Radio-Television." Read what my graduates are doing, earning, see photos of equipment you practice with at home. J. E. Smith, President. Dept. 2KE National Radio Institute, Washington 9, D. C.

Good for Both—FREE

- MR. J. E. SMITH, President, Dept. 2KE National Radio Institute, Washington 9, D. C.
- Mail me Sample Lesson and 64-page Book.
- "How to Be a Success in Radio-Television."
- Both FREE. (No salesman will call. Please write plainly.)

Name..... Age.....
Address.....
City..... Zone..... State.....

Approved Under G. I. Bill

The ABC's of SERVICING

How to Be a Success in RADIO-TELEVISION

NRI Training Leads to Good Jobs Like These



Broadcasting: Chief Technician, Chief Operator, Power Monitor, Recording Operator, Remote Control Operator. Servicing: Home and Auto Radios, P.A. Systems, Television Receivers, Electronic Controls, FM Radios. In Radio Plants: Design Assistant, Transmitter Design Technician, Tester, Serviceman, Service Manager. Ship and Harbor Radio: Chief Operator, Assistant Operator, Radiotelephone Operator. Government Radio: Operator in Army, Navy, Marine Corps, Coast Guard; Forestry Service Dispatcher, Airways Radio Operator. Aviation Radio: Transmitter Technician, Receiver Technician, Airport Transmitter Operator. Television: Pick-up Operator, Voice Transmitter Operator, Television Technician, Remote Control Operator, Service and Maintenance Technician.

Tested Way to Better Pay

I TRAINED THESE MEN



Has Growing Business
"I am becoming an expert Teletician as well as Radiotrician. Without your practical course I feel this would have been impossible. My business continues to grow."—Philip G. Brogan, Louisville, Ky.

Good Job with Station

"I am Broadcast Engineer at WLP. Another technician and I have opened a Radio-TV service shop in our spare time. Big TV sales here. As a result we have more work than we can handle."—J. H. Bangley, Jr., Suffolk, Va.

Praises NRI as Best Course

"I was a high school student when I enrolled. My friends began to bring their Radios to me. I realized a profit of \$300 by the time I completed the course."—John Hopper, Nitro, West Va.

Gets First Job Thru NRI

"My first job was operator with KDLR, obtained for me by your Graduate Service Dept. I am now Chief Engineer in charge of Radio Equipment for Police and Fire Department."—T. S. Norton, Hamilton, Ohio.

RADIO & TELEVISION NEWS is published monthly by the Ziff-Davis Publishing Company at 185 N. Wabash Ave., Chicago 1, Ill. Entered as second-class matter, July 21, 1948, at the Post Office, Chicago, Ill., under the act of March 3, 1879. Authorized by Post Office Department, Ottawa, Canada, as second-class matter. SUBSCRIPTION RATES: Radio & Television News—one year, U. S. and Possessions, Pan-American countries, and Canada \$4.00; all other foreign countries \$5.00; Radio-Electronic Engineering Edition—one year, U. S. and Possessions, Pan-American countries, and Canada \$6.00; all other foreign countries, \$7.00. Postmaster—Please return undelivered copies under form 3589 to 64 E. Lake St., Chicago 1, Ill.

Editor
OLIVER READ, D.Sc.

Managing Editor
WM. A. STOCKLIN, B.S.

Technical Editor
H. S. RENNE, M.S.

Associate Editor
HAROLD BECKER

Service Editor
CHARLES TEPFER

Assistant Editors
P. R. HOEFER
M. C. MAGNA

Television Consultant
WALTER H. BUCHSBAUM

Short-Wave Editor
KENNETH R. BOORD

Staff Artist
FRANK SAYLES

Draftsman
A. A. GANS, W2TSP
J. A. GOLANEK

Advertising Manager
L. L. OSTEN

Midwest Adv. Manager
JOHN A. RONAN, JR.

Western Adv. Manager
JOHN E. PATNE

Color Art Editor
HERMAN R. BOLLIN



COVER PHOTO: Color-coding selenium rectifiers to indicate correct polarity is one step in the manufacture of these units at the Bloomington, Ind. plant of Sarnes Tarzian, Inc. (Ektachrome by Argyle Wampler)

Chairman of the Board and Publisher
WILLIAM B. ZIFF

President
B. G. DAVIS

Secretary-Treasurer
G. E. CARNEY

Vice-Presidents
H. J. MORGANROTH
Production Director
LYNN PHILLIPS, JR.
Advertising Director

H. G. STRONG
Circulation Director

BRANCH OFFICES
CHICAGO (1)
185 N. Wabash, AN 3-5200
LOS ANGELES (14)
Sutler Center, 900 Wilshire Blvd., Mich. 9856

First in
radio-television-electronics
Average Paid Circulation over 220,000

RADIO & TELEVISION NEWS

Reg. U.S. Pat. Off.

Radio News Trademark Reg. U. S. Pat. Office • Television News Trademark Reg. U. S. Pat. Office.

CONTENTS

OCTOBER, 1952

Midget Radio-Controlled Auto.....	William H. Minor	35
Subminiature 75-Meter Mobile Converter.....	Samuel J. Lanzalotti, W2DVX, and Harry French, W2KQJ	39
Packaged Radar.....	William Wagner	42
Mobile Radio (Part 2).....	Leo G. Sands	43
Universal Design Curves for Tone-Control Circuits (Part 4).....	M. B. Knight	46
Eliminating 21 mc. Interference.....	Walter H. Buchsbaum	48
Radio & Television News Test Bench—Data-Print No. 6 (Insert).....		51
Reactance Chart.....		54
A 35-Watt Novice Transmitter.....	Everett G. Taylor, W8NAF	55
A Remote-Control Tuner.....	Glen Southworth	56
Add an Astigmatism Control to Your CRO.....	Louis E. Garner, Jr.	58
The Yagi.....	M. G. O'Leary	59
Cathode-Ray Tube Rejuvenators.....	Albert J. Eisenberg	62
Survey of Transistor Development (Part 2).....	B. N. Slade	64
Selenium Rectifiers.....	S. Niciejewski	66
Mac's Radio Service Shop.....	John T. Frye	68
A High-Quality Speaker System.....	Lt. Harold W. Ballew	69
A Superregenerative TVI Checker.....	Hartland B. Smith, W8VVD	70
Test Instrument for Checking Flyback Transformers.....	Phil Weiss	90
Radio-TV Service Industry News.....		146

DEPARTMENTS

For the Record.....	The Editor	8	Manufacturers' Literature	124
Spot Radio News.....		16	Technical Books	132
Withing the Industry.....		26	What's New in Radio.....	154
Short-Wave.....	K. R. Boord	72	Reel Review	160



VOLUME 48 • NUMBER 4



Member
Audit Bureau of
Circulations

Editorial and Executive Offices, 366 Madison Ave., New York 17, N. Y.

SUBSCRIPTION SERVICE: All communications concerning subscriptions should be addressed to Circulation Dept., 64 E. Lake St., Chicago 1, Ill. Subscribers should allow at least two weeks for change of address.

CONTRIBUTIONS: Contributors are advised to retain a copy of their manuscripts and illustrations. Contributions should be mailed to the New York Editorial Office and must be accompanied by return postage. Contributions will be handled with reasonable care, but this magazine assumes no responsibility for their safety. Any copy accepted is subject to whatever adaptations and revisions are necessary to meet the requirements of this publication. Payment covers all author's, contributor's, and contestant's rights, title, and interest in and to the material accepted and will be made at our current rates upon acceptance. All photos and drawings will be considered as part of the material purchased.

Copyright 1952 by Ziff-Davis Publishing Company. All rights reserved.

RADIO & TELEVISION NEWS

Prepare Now... in spare time at Home ... for a New,

PROFITABLE, INTERESTING FUTURE

in
TELEVISION
RADIO - ELECTRONICS

RADIO CHIEF OF ILE DE FRANCE
FRENCH LUXURY LINER PRAISES D. T. I.

Radio Chief—Jean Desmas Says:

"DeForest's Training, Inc., of Chicago, is known not only throughout Europe, but also in many parts of the world as one of America's finest Television, Radio and Electronics training centers."



JACK DEMPSEY

Former World's Heavyweight Champion
TELLS WHY HE'S PROUD
TO BE WITH **D.T. I.**

- I have been greatly impressed with D.T.I.'s wonderful spirit of friendliness and sincere determination to help its students make good in Television-Radio-Electronics.
- I admire its remarkable 20 year record of helping men build brighter futures.
- I also admire the business policy of its management and the thoroughness of its large faculty of instructors.
- Never have I heard young men praise a school as enthusiastically as do the students and graduates of D.T.I. They are its best boosters.



Prepare At Home Or In Our Chicago Laboratory!

See for yourself how readily you may prepare at home, or in our modern Chicago laboratories, for a better job or business of your own in one of America's fastest-growing fields—TELEVISION-RADIO-ELECTRONICS.

If you train at home you get (1) the use of a 16-mm. movie projector and 16 reels of animated movies to help you learn important points faster... easier, (2) modern lessons and (3) sixteen shipments of electronic parts enabling you to get valuable practical experience from over 300 projects—including building and keeping the electronic equipment shown below. And upon completing training, you have the optional privilege of building and keeping a big 17-INCH TV set at moderate added cost. Get the full story. Mail coupon today!



LAUD D. T. I.'s HOME MOVIES IN CONGRESS

D.T.I.'s remarkable home training benefit of visual training MOVIES has been praised from the floor of the House of Representatives in Washington, D. C. and recorded in The Congressional Record.



If subject to military service, the information we have for you should prove very helpful. Mail coupon today.



De FOREST'S TRAINING, INC.
AFFILIATED WITH
De VRY Technical INSTITUTE
CHICAGO 14, ILLINOIS



MAIL COUPON TODAY!

Dept. RN-10-1
DE FOREST'S TRAINING, INC.
2533 N. Ashland Ave., Chicago 14, Ill.

I would like your Opportunity News Bulletin showing "89 Ways to Earn Money in Television-Radio-Electronics"; also, the folder showing how I may prepare to get started in this thrilling field.

Name _____ Age _____
Address _____ Apt. _____
City _____ Zone _____ State _____

G.E. TELLS YOUR CUSTOMERS!

National advertising sponsored by General Electric gives public the facts about the important service rendered by a skilled, highly-trained industry.

This ad, now running in LIFE and COLLIER'S, will help 35,000,000 readers to understand and respect the television serviceman and his work.

As a manufacturer of high-quality tubes and parts, General Electric has an important stake in your business, and is anxious to see a greater appreciation of your experience and abilities.

For extra copies of this LIFE-COLLIER'S ad write General Electric Company, Tube Department, Schenectady 5, New York.

AMERICA'S NEWEST "PROFESSION" KEEPS 18 MILLION TV SETS HEALTHY!

EIGHTEEN MILLION new "patients" is a tremendous responsibility for the television service industry—an industry that had only 2,000 sets to take care of just five short years ago. The phenomenal growth of TV has challenged every resource of service shop and individual technician. Television itself embodies new electronic principles which had to be learned by over 51,000 servicemen, most of whom were radio specialists. Manufacturers did everything they could to make it easy for these men to become the highly-qualified TV experts they are today. Schools and courses were established . . . new test equipment was developed . . . replacement tubes and parts were distributed to every TV area. But the real responsibility for acquiring

TV know-how rests with the serviceman. As a group, these technicians have done an unprecedented job of meeting the service needs of the "TV epidemic". They have built for themselves an important new industry based on one ideal: to safeguard a billion-dollar owner investment in TV. Your TV serviceman deserves your full respect and confidence. He has invested over \$3,000 in special test and other equipment. He spends an average 12 hours a day in servicing sets. He is technically trained . . . experienced . . . familiar, by constant study, with latest television improvements. Call your favorite TV serviceman whenever you want your set put in top working order. He will always do his best to serve you promptly and at a fair, reasonable cost!

This advertisement is published as a tribute to the television servicemen of America by the Tube Department of the General Electric Company, Schenectady, N. Y.

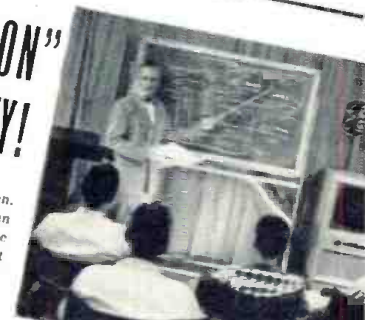

LONG, TOUGH TRAINING—FOR EVERY TV SERVICEMAN. Months of study, and intensive practical experience, are only the start of your serviceman's training. He must know intimately the circuit of every make of TV. He must keep posted on all design changes. No professional man in a field is obliged to read and study more continuously.

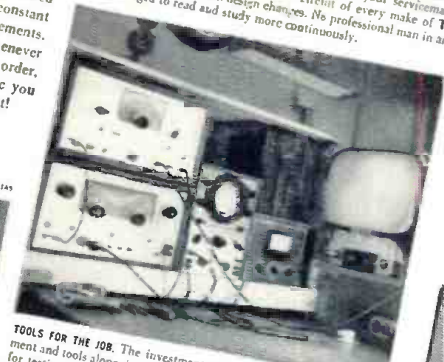

TOOLS FOR THE JOB. The investment of your TV technician in equipment and tools alone, is seldom less than \$3,000. Precision instruments for testing . . . special hand-tools . . . bench equipment for major TV shop repairs . . . these are pluses he must add to the customary businessman's investment in shop and trucking facilities.



OPERATION TELEVISION—RIGHT IN THE HOME. When your TV serviceman removes your TV chassis from its cabinet, ask him to show you the "myriad tubes, coils, and other parts, inter-connected by an "orderly maze" of wiring! Only highly-skilled hands can safely probe for faults, make repairs—usually on the spot—that restore the picture and sound to normal. His tools and equipment are as complete for their purpose as the contents of a doctor's kit. Aided by his specialized training, your serviceman diagnoses TV troubles, and restores your set to "health", in the least time and at the least cost to you.



ON CALL RIGHT THROUGH THE DAY. Morning, afternoon, or evening, a phone call finds your TV serviceman ready to respond. Serving a community that relies on him, he makes every possible effort to live up to this responsibility. His charges—which reflect the actual time he spends serving you plus any necessary tubes and replacement parts—are your best investment in television satisfaction.

★ THIS ADVERTISEMENT IS PUBLISHED AS A TRIBUTE TO THE TELEVISION SERVICEMEN OF AMERICA BY THE TUBE DEPARTMENT OF THE GENERAL ELECTRIC COMPANY
RADIO & TELEVISION NEWS

**Accepted and praised by
the most critical expert in the world**

...the American Amateur Radio Operator



hallicrafters



A Ham's Dream—The SX-71—Planned with you, the advanced amateur, in mind, Communications Receiver SX-71 is a double conversion set, built-in NBFM limiter stage. 538 kc to 34 mc. in 5 bands. Plus A 46 to 55 mc band. Temperature comp.; voltage regulator. 1 r-f, 2 converters, 3 i-f stages. Xtal. filter, 3-position selectivity. 115 V AC, 11 tubes, regulator, rectifier **\$199.50**



Precise Selectivity—The S-76—Amazingly selective! Crisp station separation. Double conversion with 50 kc 2nd i-f. Giant 4-in. "S" meter. 540-1580 kc, 1.72-32 mc in 4 bands. 1 r-f, 2 converters, 2 i-f stages. 5 position selectivity. Phono input jack, 3 watt output. 115 V AC, 9 tubes, regulator, rectifier **\$169.50**



Low Price—High Performance!—S-40B—540 kc to 43 mc in 4 bands. Electrical band spread. Temperature compensated. 1 r-f, 2 i-f. 3 watt output. Built-in speaker. 115 V AC only, 7 tubes, plus rectifier. (S-77—same as S-40B, for 115 V AC or DC) **\$99.95**

The first Hallicrafters radio was built *specifically* for the ham operator more than twenty years ago. Today, Hallicrafters sell more communications sets to the armed forces, professionals and hams, than *all other manufacturers combined*. Yet today, these Hallicrafters sets are still designed *specifically* for the most critical expert in the world—the American amateur operator. There is no higher standard.

hallicrafters

"The Radio Man's Radio"

*World's Leading Manufacturer of Precision
Radio and Television • Chicago 24, Illinois*

The Finest Buy in SW!—The S-38C—Best performance per dollar you'll find, the S-38C is the outstanding low priced set on the market. 540 kc to 32 mc in 4 bands. Maximum sensitivity per tube—far outperforms ordinary broadcast sets. Built-in speaker. 115 V AC or DC. 4 tubes plus rectifier **\$49.50**



THE
Original
WRENCH
WITH THE
SCREWDRIVER ACTION!



SPINTITE
REG. U. S. PAT. OFFICE

120 STYLES and SIZES

for

- ASSEMBLY WORK
- REPAIR WORK
- RADIO
- TELEVISION
- INDUSTRIAL
- AIRCRAFT



STEVENS WALDEN, Inc.
WORCESTER 4, MASS.

For the **RECORD.**
BY THE EDITOR

COMMUNITY TELEVISION SYSTEMS

TOO OFTEN the remark has been made that the pioneering spirit which made our country great has been dissipated. The limitless horizons of yesterday have, to many, appeared limited. However, we must transcend geography when we consider the spirit and courage of the pioneer. True, no longer are there uncharted lands and rivers; no longer is there the need for traveling the breadth of our country for adventure and riches. Yet each day brings with it a new approach, a new method—particularly in the field of technical accomplishment.

Many of you remember our detailed report on America's first community TV antenna system (March, 1951) titled "How TV Came To Panther Valley." This article graphically revealed how five men with courage, initiative, and a new approach brought television to what was once an isolated area.

These five men set the pattern for community TV systems throughout the country. Their endeavors have been well emulated so that today there are 96 such systems in operation, 35 of which have banded together to form a *National Community TV Association*.

We should also give proper recognition to those manufacturers who pioneered the equipment and successfully nurtured its development. The early work of both *Jerrold Electronics* and *RCA* provided the necessary know-how and the will to see the job through. Since then further equipment refinements have been made by many other companies, such as *Blonder-Tongue*, *Technical Appliance Corp.*, *Philco*, *L. S. Brach*, and *Spencer-Kennedy*. Indications are that other manufacturers will enter the business, particularly in the production of wide-band amplifiers and low-loss cable.

The TV industry has come of age, bringing with it the problems and responsibilities of growth. In the early stages the legal lights of local and state governments paid no heed to the upstart. But now, as the tree flourishes, everyone wishes to pluck its fruit. The federal government has levied an 8% "wire and equipment" excise tax. State governments are contemplating various actions, many of them tending to treat the operator as a public utility. As to what some of the local townships contemplate, your guess is as good as ours.

The second question, that only time will fully answer, concerns itself with the effect of new station growth. One can be sure that although greater cov-

erage will result from increased power assignments and new station grants, many valley towns will never be served adequately. Furthermore, subscribers who have had the choice of programming emanating from three stations are not going to settle for one TV outlet. Probably of even greater importance in the future will be the attitude of the Federal Communications Commission. Since the incoming signal often crosses state boundaries, they maintain their usual regulatory function. To date, the Commission has kept clear of any rulings affecting community systems, a detachment which has been undoubtedly due to their presently overloaded schedule and the lack of complaints against any community operator. However, it is very possible that the future will see the Commission become more interested in community operations.

In considering the high rate charge, it must be remembered that the initial equipment outlay can run as high as \$300,000. There also exists an unusually high rate of equipment depreciation. Let us not forget that since the cost of pioneering is always high, the related cost of its service must be high.

As the community TV business stands today, one can only look at the future with the utmost optimism. The 96 systems presently in operation have a potential market of 200,000 subscribers. Practically all of them have gone into the black after their first year of operation. Considering the many and varied valleys throughout the country we expect to see new pioneers hoisting antennas up nearby hills. Lest we think that the community TV antenna systems are limited to small towns, it should be mentioned that one of the more recent projects is in Wilkes-Barre, Pa. Prospects are that community TV will cover one to two million subscribers.

As we see it, a challenge has been met. Thousands of families deprived of seeing television have been given the opportunity of enjoying its varied pleasures. There are many of you who are engaged in the radio-TV business in areas receiving no TV signal or a weak signal. The continuing advances that have been made in community antenna systems point the way towards breaking down no-signal areas. As a member of a growing industry, each of us has a responsibility to broaden the base of its growth. There's business in those valleys. But even more, we should make every effort to place television before the eyes of everyone, whether he be hill-dweller or valley-settler O.R.

**THE ONLY COMPLETE CATALOG FOR EVERYTHING IN
TELEVISION, RADIO AND INDUSTRIAL ELECTRONICS**

your 1953

ALLIED free!

236-PAGE CATALOG
complete...value-packed

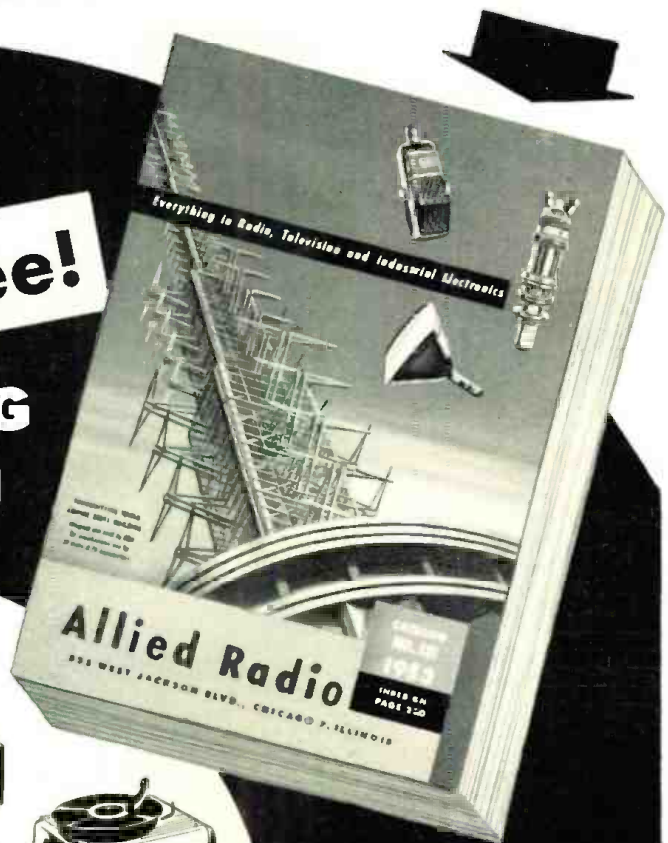

Send for it Today!



Here's the *one* authoritative, complete Buying Guide to *Everything in Electronics*—packed with the world's largest selections of quality equipment at lowest, money-saving prices. See the latest in TV, AM and FM receivers; High-Fidelity Custom Sound components; latest P.A. Systems and accessories; recorders; Amateur receivers, transmitters and station gear; specialized industrial electronic equipment; test instruments; builders' kits; huge listings of parts, tubes, tools, books—the world's *most complete stocks* of quality equipment.

ALLIED gives you every buying advantage: speedy delivery, expert personal help, lowest prices, liberal time payment terms, assured satisfaction. Get the latest 1953 ALLIED Catalog. Keep it handy—and save time and money. Send for your FREE copy today!

the world's largest stocks

- TV and Radio Parts
- Test Instruments
- Hi-Fi and P.A. Equipment
- Television & Home Radios
- Recorders and Supplies
- Amateur Station Gear
- Builders' Supplies
- Equipment for Industry

quick, expert service

EVERYTHING IN ELECTRONICS

ALLIED RADIO
World's Largest Radio Supply House

free

Send Today for Radio's
Leading Buying Guide

EASY-PAY TERMS

Take advantage of ALLIED'S liberal Easy Payment Plan—Radio's best terms—only 10% down, 12 months to pay—no interest if you pay in 60 days. Available on Hi-Fi and P.A. units, recorders, TV chassis, test instruments, Amateur gear, etc.

TV & HI-FI SPECIALISTS

To keep up with developments in TV and High-Fidelity, look to ALLIED! Count on us for all the latest releases and largest stocks of equipment in these important fields. If it's anything in Television or High-Fidelity equipment—we have it in stock!

ALLIED RADIO CORP., Dept. 1-K-2
833 W. Jackson Blvd., Chicago 7, Illinois

Send FREE 236-Page 1953 ALLIED Catalog

Name _____

Address _____

City _____ Zone _____ State _____

the greatest Yagi of them all

JFD 10-ELEMENT "Baline" YAGI

***12 db** (gain of stacked JFD BALINE over a tuned folded dipole)

***9½ db** (gain of single JFD BALINE over a tuned folded dipole)

*These figures have been verified by the Hazeltine Corporation, world famous research laboratory. All JFD gain figures are based on a reference tuned folded dipole. Beware of exorbitant gain figures which are not based on any reference level.

ACTUAL FIELD TESTS PROVE IT

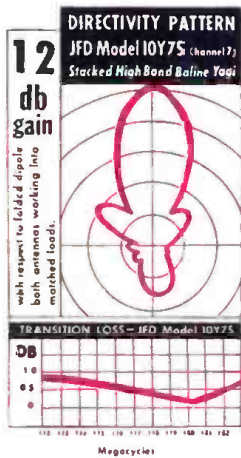
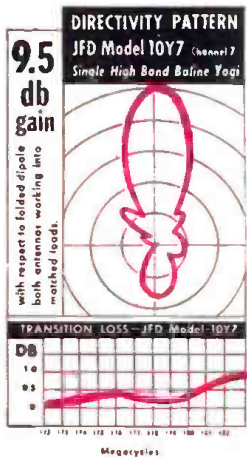

Single JFD High Band BALINE Yagis

Channels	Models	List Price
7-13	10Y7-10Y13	\$13.85

Stacked JFD BALINE Yagis

Channels	Models	List Price
2	10Y2S	\$63.70
3	10Y3S	63.70
4	10Y4S	56.90
4-5	10Y45S	67.80
5	10Y5S	56.90
6	10Y6S	51.40
7-13	10Y7S-10Y13S	27.70

Include JFD Baline matching transformers at no extra charge

Single JFD Low Band BALINE Yagis

Channels	Models	List Price
2	10Y2	\$31.85
3	10Y3	31.85
4	10Y4	28.45
4-5	10Y45	33.90
5	10Y5	28.45
6	10Y6	25.70

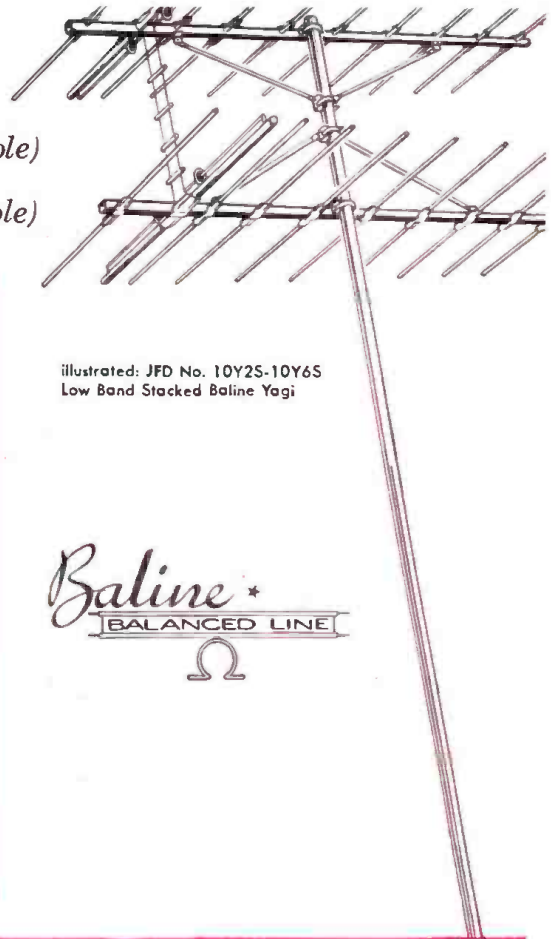

illustrated: JFD No. 10Y2S-10Y6S Low Band Stacked Baline Yagi



The antenna sensations of the Nation!

JETENNA... the conical with jet-action assembly
...no other fan conical assembles so fast, performs so well!



1. Pre-assembled JFD JeTenna as packaged. Note its compactness of construction and craftsmanship of design.

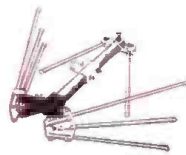

2. As the JeTenna swings open, dipole elements fan instantly into exact position by riding along unique fulcrum indices.

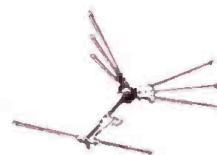

3. JeTenna elements lock into position effecting 35° forward inception angle and 40° dipole angulation for greater signal pickup. Reflectors snap into place for quick tightening by wing nuts.

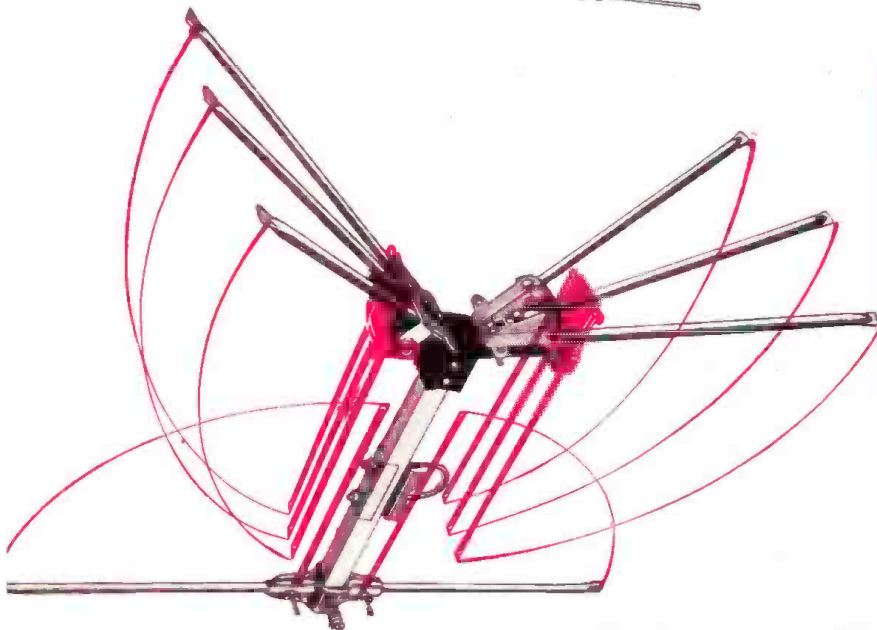

Series with 1" seamless aluminum square crossarm and seamless aluminum elements reinforced with Fibreglas dowels.

No. JET160	Single Bay	Up to 8.8 db*	\$12.50 list
No. JET161	2 Bay	Up to 12.5 db*	\$26.40 list
No. JET164	4 Bay	Up to 15.5 db*	\$56.80 list

Series with 1" seamless square aluminum crossarm and wood-doweled butt-seam aluminum elements.

No. JET660	Single Bay	Up to 8.8 db*	\$ 9.75 list
No. JET661	2 Bay	Up to 12.5 db*	\$20.70 list
No. JET664	4 Bay	Up to 15.5 db*	\$45.40 list

*Performance tested and figures verified by the Hazeltine Corporation, Little Neck, N.Y. World Famous Research Laboratory.

JFD MFG. CO.
BROOKLYN 4, N. Y.
BENSONHURST 6-9200



World's Largest Manufacturer of TV Antennas and Accessories

www.americanradiohistory.com

TRAIN

for Security! Good-Paying Jobs!

MAKE THE MONEY YOU'VE ALWAYS DREAMED OF!



LEARN RADIO -TELEVISION

AND ELECTRONICS BY EASY SHOP METHOD TRAINING AT HOME!

**You get
all the parts—even tubes!—**
for this modern Superheterodyne Receiver. You learn to build it step by step. And you keep it! Get all the facts. Mail coupon now.

Let **NATIONAL SCHOOLS**—a resident-training school for nearly 50 years—train you at home for today's unlimited opportunities in Radio-Television-Electronics. National Schools is one of the largest schools of its kind. It is located in Los Angeles—the center of Radio and TV world! It has four large buildings of modern shops and labs. Its faculty is considered tops in the business.



You learn from lessons prepared by experienced instructors and engineers. Men who are successful Radio and Television technicians. Men who have trained 1000's of men like YOU!



FREE BOOK TELLS YOU HOW!

Page after page—in color—tells you everything you want to know. Mail the coupon. Get this valuable book today. And if you hurry—**YOU GET A FREE SAMPLE LESSON.** TOO! Shows how easy National Schools Home Training is. Mail the coupon today.

You Train At Home—In Your Spare Time

National Schools Shop Method Home Training gives you basic and advanced instruction in all phases of Radio-TV-Electronics. And remember—your training is based on resident school training principles. You learn fast from hundreds of diagrams and pictures. All instructions are written by experienced technicians who work in Radio and TV every day. All instructions have been developed and tested in National Schools' own labs and studios, which are equipped with the latest RCA equipment. No wonder this National Schools course is so up-to-date, practical, interesting. And so easy to learn! And no wonder it is held in such high regard by leaders of American industry! Approved for eligible Veterans.

We Teach You How To Make Welcome Extra Money—While You Learn!

Many National Schools students—men like you—make plenty of extra dollars each week in spare time! Fixing neighbors' radios, appliances—and other ways we teach you. You start learning and earning from the day you enroll. From the very first lesson!

**WE SEND YOU LOTS OF PARTS
LIKE THIS!**



With National Schools Shop Method Home Training, you get basic principles and plenty of practical training. You learn by doing. No wonder you learn so fast! We send you many parts—all of professional, modern quality. You do lots of practical experiments. You advance day by day, step by step. Until you can even build the modern Superheterodyne Receiver you see above—plus other important testing units. The free book tells you all about it. The free sample lesson shows how easy the training is. Use the coupon. Send today—without fail!



Only National Schools Gives You This Professional Multi-Tester!

You get this amazing, new testing instrument—factory-made and tested—complete—ready to use! Simple to operate. Accurate and dependable. An instrument every Radio-TV man needs. Light enough to carry around—so you can use it at home or on service calls. You'll be proud to own this valuable equipment.

Here are only a few of the Good-Paying Jobs You Can Choose

Radio Station Engineer, District Service Manager, Aircraft Radio Inspector, Own Your Own Repair Shop, Inspector Technician, Service Specialist, Special Government Jobs, Complete TV Service, Sound Truck Operator. Many more! National Schools graduates have secure, good-paying jobs like these! So don't wait—mail the coupon today. Now—while you're thinking about it!

Attention! Men Going into Service Soon!

National Schools' course quickly prepares you for many important jobs in the Armed Services. With National Schools Training you have an opportunity to get into special service classifications—with higher pay and grade—immediately!

FREE SERVICE FOR GRADUATES

National Schools uses its great influence and prestige to help you find your place in the field of your choice. Don't put it off! Start yourself toward a skilled trade! Get the big pay you've always wanted!

NATIONAL SCHOOLS

LOS ANGELES 37, CALIFORNIA • ESTABLISHED 1905
In Canada: 193 Hastings St., Vancouver 4, B.C.

Today's Shortage of Trained Technicians Creates Chance of a Lifetime For You!

Think of it! With guided missiles, radar, and other electronic devices so important to national defense! With big, new developments in TV. With over 90,000,000 home and auto radios, over 12,000,000 TV sets. With more than 3100 radio stations...over 100 TV stations—and more building every day...yes, imagine the great opportunity you have today!

YOU are wanted in Radio-Television-Electronics! America's fastest-growing field. High-pay jobs—the kind you've always wanted—are waiting for YOU!

Job Security! Big Money! For YOU! in Today's Expanding Industries!

Trained Radio and Television technicians really make important money these days. Thousands of National Schools graduates—men just like you—are earning good money all over the country. Why not you? And—National Schools graduates get the personal satisfaction of being highly-skilled technicians. Men people respect. Men who enjoy their work—rather than having to drag along in just any old job.

National Schools Has Trained 1000's of Successful Men! Why Not YOU?

In almost every state—and many foreign countries—National Schools graduates are filling big jobs with famous companies. Or running their own successful businesses. What are YOU waiting for? National Schools training is complete training. So when you graduate you can take advantage of today's big opportunities in Radio-Television-Electronics—fast.

**DON'T PUT
IT OFF!
GET THE
BIG SALARY
YOU HAVE
ALWAYS
WANTED!**

MAIL THIS COUPON TODAY—WITHOUT FAIL!

NATIONAL SCHOOLS, Dept. RH-102
4000 South Figueroa Street
Los Angeles 37, California

Mail in envelope
or paste on
penny post card.

Mail me FREE the book mentioned in this ad. Also a free sample lesson. I understand no salesman will call on me.

NAME _____ AGE _____

ADDRESS _____

CITY _____ ZONE _____ STATE _____

Check here if you were released from the Service less than 4 years ago.

POWER

your TV
PICTURE
with a
VEE-D-X
antenna

ALL
CHANNEL
VHF-UHF

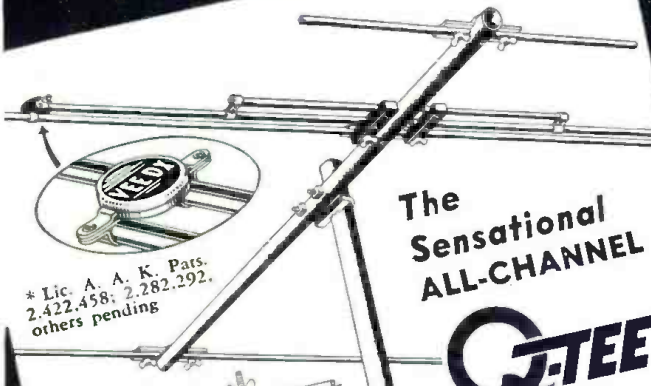

* Lic. A. A. K. Pats.
2,422,458; 2,282,292,
others pending

The
Sensational
ALL-CHANNEL



with patented - printed
circuit channel
separators

NEW RUGGEDIZED
CONSTRUCTION

For positive element support
the Q-Tee is now supplied
with special reinforcing brack-
ets, at no extra cost.

Brilliant all-channel performance in all multi-channel areas.
The first antenna ever to employ printed circuit channel
separators. The Q-Tee provides higher average gain than
other broad band antennas and has higher uniform gain
over all channels. Excellent front-to-back ratio - perfect
300 ohm match and lower standing wave ratio. Easily
installed and has excellent rooftop appearance. Small and
light in weight, yet features "ruggedized" construction.
Available in three series - Q-Tee Single Bay for primary
areas; Q-Tee Double for near-fringe areas; Q-Tee Quad
for fringe areas.



The New
ULTRA Q-TEE
2-83

THE FIRST ALL-CHANNEL VHF-UHF ANTENNA
Install the Ultra Q-Tee now for VHF -
and it's ready for UHF. It gives brilliant
reception on every TV channel from 2
to 83 using one transmission line, elim-
inating the need for two or more anten-
nas with multiple lead-ins and switches.

the sensational NEW
LONG LONG JOHN

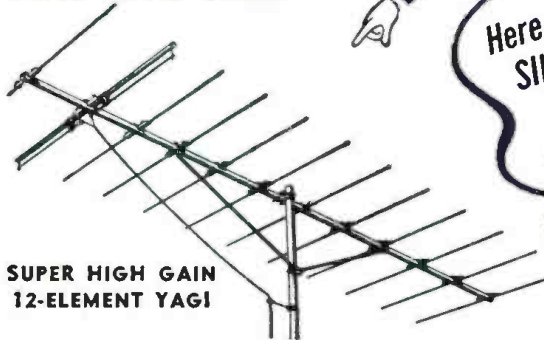

SUPER HIGH GAIN
12-ELEMENT YAGI

Here are the finest
SINGLE CHANNEL
ANTENNAS
ever perfected!

Here is the highest gain single-channel antenna
ever developed. Provides grand slam power for
fringe areas. Guaranteed to outperform all others.
New "rigidized" boom bracing gives extra
strength. Pre-assembled for fast, easy installation.
Can be stacked for extra gain.

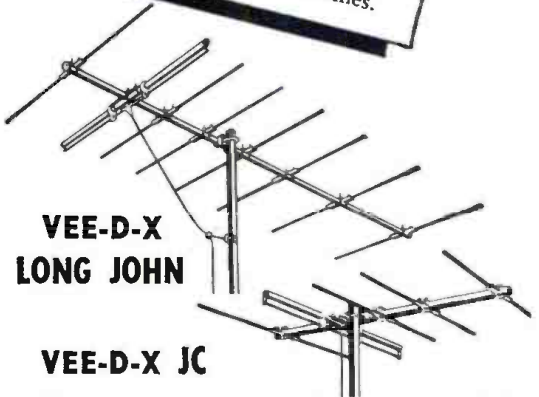

VEE-D-X
LONG JOHN

VEE-D-X JC

The original 8-element Long John and the
famous 5-element JC outperform and outsell all
others. There is a Vee-D-X Yagi for every in-
stallation requirement in all single-channel areas.



FREE
CATALOG

THE LaPOINTE-PLASCOMOLD CORP.
ROCKVILLE, CONNECTICUT N 10

Send full details on the following:

- All-channel Q-Tee
- Ultra Q-Tee
- Long John
- Long Long John
- JC Yagi
- New Catalog

NAME

ADDRESS

CITY..... ZONE..... STATE.....

Sylvania now presents . . .

A Brighter Picture-Tube Screen

for **BRIGHTER BUSINESS**

*GOOD NEWS
FOR YOUR
CUSTOMERS
GOOD BUSINESS
FOR YOU!*

*IT'S
BETTER
3 WAYS*



- 1.** Gives a brighter picture
- 2.** Color fast throughout entire tube life
- 3.** Brings greater viewing comfort

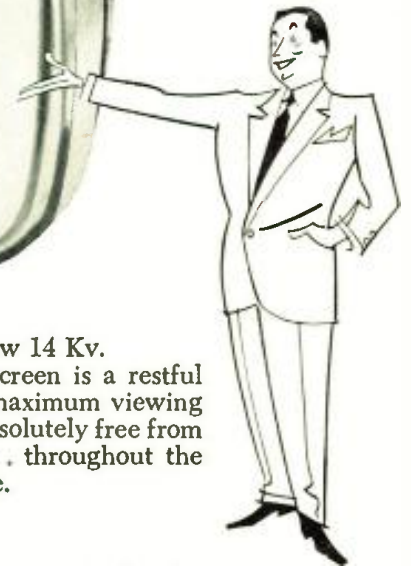

Now Sylvania announces a greatly improved picture-tube screen...the result of years of phosphor research.

This new screen gives an increased light output over former screens . . . particularly when the tubes are oper-

ated at voltages below 14 Kv.

The face of this screen is a restful blue-gray color for maximum viewing comfort. And, it is absolutely free from any discoloration . . . throughout the entire life of the tube.

This new screen is standard in all Sylvania Picture Tubes. So, when it's a question of new TV picture tubes, be sure to answer with Sylvania.

For prices and complete information mail the attached coupon NOW!

**FULL YEAR GUARANTEE ON
ALL SYLVANIA PICTURE TUBES**

Sylvania now guarantees all its Picture Tubes for one entire year from date of installation. This is your positive assurance of trouble-free performance and satisfied customers.



SYLVANIA

RADIO TUBES; TELEVISION PICTURE TUBES; ELECTRONIC PRODUCTS; ELECTRONIC TEST EQUIPMENT; FLUORESCENT TUBES, FIXTURES, SIGN TUBING, WIRING DEVICES; LIGHT BULBS; PHOTOLAMPS; TELEVISION SETS

Sylvania Electric Products Inc.
Dept. R-2310, 1100 Main Street
Buffalo 9, N. Y.

Please send me full information about the improved screen on Sylvania Picture Tubes.

Name _____

Street _____

City _____

Zone _____ State _____

TRIPLET
650 VTVM

There's Nothing finer for

Television



This combination of features explains why

- Complete frequency coverage with one probe, 20 cps to over 110-mc. Insulated and shielded RF tube probe, found usually only with laboratory instruments, is included.
- Peak to Peak ACV and RF with one probe.
- One volt full scale reading on AC & DC.
- One main selector switch, all ranges.
- ACrms—Peak to Peak
- 32 Ranges
- Zero center mark for FM discriminator alignment plus any other galvanometer measurements.
- High input impedance 11 megohms on DC.

Suggested U.S.A. Dealer Net \$6950 • Prices subject to change without notice.

TRIPLET ELECTRICAL INSTRUMENT CO., BLUFFTON, OHIO



RADIO & TELEVISION NEWS



TRAIN **FASTER**—TRAIN **BETTER**—TRAIN **EASIER**
 IN 10 MONTHS—OR LESS—FOR
RADIO-TELEVISION

Our 21st Year Training Men for Greater Incomes and Security in Radio-Television

**I SEND YOU
 18 BIG KITS**

of Radio-Television parts and equipment. Much of your training will be actual construction and experimentation... the kind of truly PRACTICAL instruction that prepares you for your Radio-Television career.



Frank J. Sprayberry
 President
 Sprayberry Academy
 of Radio

NEW! NO OBLIGATION PLAN

**You Have No Monthly Payment Contract to Sign
 Pay For Your Training as You Earn and Learn**

You can get into Radio-Television, today's fastest growing big money opportunity field, in *months* instead of years! My completely new "package unit" training plan prepares you in as little as 10 months or even less! *No monthly payment contract to sign—thus NO RISK to you!*

This is America's finest, most complete, practical training—gets you ready to handle any practical job in the booming Radio-Television industry. Start your own profitable Radio-Television shop... or accept a good paying job. I have trained hundreds of successful Radio-Television technicians during the past 21 years—and stand ready to train you, even if you have no previous experience! Mail coupon and get all the facts—FREE!

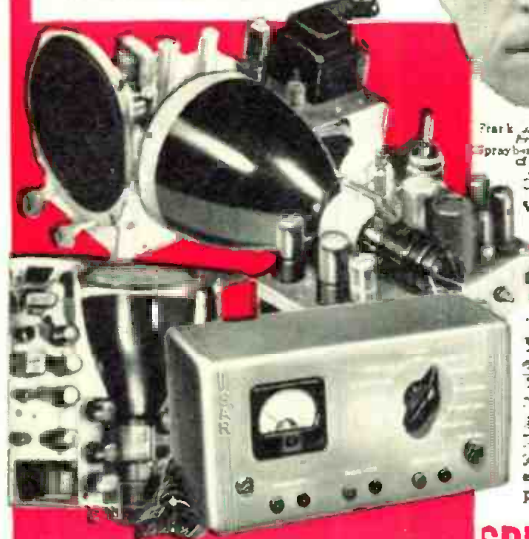

**Valuable Equipment Included
 With Training**

The new Sprayberry "package" plan includes many big kits of genuine, professional Radio-Television equipment. You perform over 300 demonstrations, experiments and construction projects. You build a powerful 6-tube 2-band radio set, multi-range test meter, signal generator, signal tracer, many other projects. All equipment and lessons are yours to keep... you have practically everything you need to set up your own profitable Radio-Television service shop.

Earn Extra Money While You Learn!

All your 10 months of training is IN YOUR HOME in spare hours. Keep on with your present job and income while learning. With each training "package" unit, you receive extra plans and "Business Builder" ideas for spare time Radio-Television jobs. New television stations everywhere, open vast new opportunities for trained Radio-Television Technicians—and those in training. If you expect to be in the armed forces later, there is no better preparation than practical Sprayberry Radio-Television training.

YOU BUILD the Television set and the powerful superhet radio receiver shown above. **IN ADDITION** to the other test units shown here (many are not shown because of lack of space). All equipment I send you is **YOURS TO KEEP.**

Approved for Veterans under the G. I. Bill

**SPRAYBERRY ACADEMY OF RADIO 111 NORTH CANAL ST.
 Dept. 250-N, Chicago 6, Ill.**

**MAIL COUPON
 TODAY!
 NO OBLIGATION**

I invite you to get all the facts—

**FREE TO YOU 3 BIG
 RADIO-TELEVISION BOOKS**

I want you to have ALL the facts about my new 10-MONTH Radio-Television Training—without cost! Rush coupon for my three big Radio-Television books: "How to Make Money in Radio-Television," PLUS my new illustrated Television Bulletin PLUS an actual sample Sprayberry Lesson—ALL FREE. No obligation and no salesman will call. Mail coupon NOW!

SPRAYBERRY ACADEMY OF RADIO, Dept. 250-N

111 North Canal St., Chicago 6, Ill.

Please rush to me all information on your 10-MONTH Radio-Television Training Plan. I understand this does not obligate me and that no salesman will call upon me. Be sure to include 3 books FREE.

Name..... Age.....

Address.....

City..... Zone..... State.....



Available from stock
at TRIAD
jobbers!

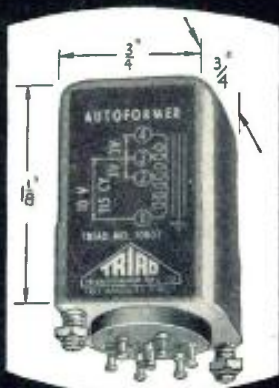

"The World's Smallest Hermetically Sealed Transformer"

Miniaturization has become increasingly important in the design of all types of electronic equipment. Use of improved core materials and better winding techniques in our JAF series permits these great reductions in size and weight of low level audio transformers. TRIAD JAF Transformers, as listed below, are "the world's smallest hermetically sealed transformers." All have 45 db. shielding and are available in MIL standard AF case as shown above. Carried as stock items at all Triad jobbers.

Type No.	Impedance		Req. Resp.	List Price
	Primary	Secondary		
JAF-1	600/250/50	50000	100-10000	\$14.50
JAF-2	600/250/50	250000	300-3000	15.30
JAF-3	600/250/50	60000 C.T.	100-10000	15.30
JAF-11	15000	50000	100-10000	13.60
JAF-12	15000	60000 C.T.	100-10000	14.50
JAF-13	15000	95000 C.T.	350-5000	15.30
JAF-21	15000	600/250/50	100-10000	14.50
JAF-22	15000	600/250/50	350-5000	14.50
JAF-23	20000 C.T.	600/250/50	100-10000	15.30
JAF-31	600/250/50	600/250/50	100-10000	14.50
JAF-101	50 h - 1 Ma.			11.60

Maximum level +10 dbm. *DC in primary, except JAF-1, 2 and 3 (0 dbm.)

Write for Catalog TR-52A



Spot Radio News

* Presenting latest information on the Radio Industry.

By RADIO & TELEVISION NEWS'
WASHINGTON EDITOR

FCC's master plan for TV's future, which received a rousing reception in over a dozen communities who were fortunate enough to win channels for new stations (22 have been approved at this writing), also found itself strongly buffeted by a spreading audience of dissenters immediately after the rich allocation awards were made. Soon after the assignment report appeared, protests claiming injustice and inequities had begun trickling in, and it was felt in some quarters that the anticipated storm of briefs asking relief might not appear after all. However, aided and abetted by the stinging blasts of Commissioner Jones, the storm of complaints did appear and in a howling fashion. As a result, the Commissioners began reconsidering and probing their blueprint, and interesting modifications have come into existence.

Five permanent alterations in the table have already been approved: Baltimore has been given Channel 60 in place of 30; Harrisburg now has Channel 55 as a substitute for 33; Reading received 33 in place of 55; Youngstown lost 33 and was given 21, which was removed from the Warren (Ohio) roster and replaced by Channel 67.

A strong petition, submitted by *Chesapeake Television Broadcasting*, prompted the Commission to shuffle the Baltimore, Harrisburg, and Reading channels. The brief stated that Baltimore and Harrisburg assigned Channels 18 and 33, respectively, were separated by a distance of only 68 miles, and Baltimore and Lebanon, which had been assigned Channels 30 and 15, were separated by a distance of only 72 miles, whereas under the rules, separations of 75 miles were necessary to avoid picture image interference. The Commission agreed that the broadcaster was correct in its analysis and ordered the changes made. Other dissenting briefs have prompted the Commission to propose the shifting of channels in nine cities: Wilmington (Del.), Channel 83 to replace 53; Elberton (Ga.), Channel 24 as a substitute for 16; Fort Wayne (Ind.), 69 to take the place of 21; Lexington (Ky), 64 replacing 33; Fall River (Mass.), 68 to replace Channel 40; North Adams (Mass.), 74 replacing Channel 15; Lima (Ohio), 73 as a substitute for 41; Allentown (Pa.), 67 to take the place of 45; and Newberry (S.C.), Channel 70

in place of 37. In view of these proposed changes, the Commission reported that it will not be possible to process applications at the present time in the following cities: Allentown, Channel 39; Greenville (S.C.), Channel 23; Lima, Channel 35; Winchester (Ky.), Channel 37; Cincinnati, Channel 48; New London (Conn.), Channel 26; New Britain (Conn.), Channel 30; Fort Wayne, Channel 27; Wilmington, Channel 59; and Greenville, Channel 23. The delay has won plaudits and jeers, too, particularly from those in New Britain, among the first to receive a construction permit, and now obliged to shelve their immediate plans.

To permit a systematic judgment of the questioned allocations, the Commission has prepared a comprehensive list of the cities scheduled to have new TV stations, and arranged them in order of priority for hearings. Three cities have fallen in the first golden lot, and pro and con sessions will begin in the early Fall. The choice of the cities (*Denver, Canton* (Ohio), and *Portland*) disturbed Commissioners Hennock and Bartley. In a partial dissent, Bartley declared that the Commission should make grants where the greatest need exists. In his opinion, such a need does not exist in Denver, which has already received three grants. That city, he continued, stands . . . "to end up with possibly six grants before we can schedule hearings looking toward a second grant for St. Louis, a city twice the size of Denver, and eight other single station cities larger than Denver." The Commissioner declared that he felt that it would be more in line with the responsibilities of the body . . . "if we employed our extremely limited resources on the basis of the facts existing at the time examiners become available."

According to the second issue of priority listings, twenty-five other cities have been included in the current processing line: Tampa-St. Petersburg (Fla.); Youngstown (O.); Wichita (Kan.); Flint (Mich.); Spokane (Wash.); Beaumont-Port Arthur (Tex.); Duluth (Minn.)-Superior (Wis.); Sacramento (Cal.); Fort Wayne; Austin (Tex.); Chattanooga (Tenn.); El Paso (Tex.); Mobile (Ala.); Evansville (Ind.); Bridgeport (Conn.); Fall River (Mass.); Reading (Pa.); New Bedford (Mass.); Allentown (Pa.); Waterbury (Conn.); Harrisburg (Pa.); Jackson

HERE'S PROOF!

Glass used
in second hand
tubes is
20% DIMMER
than NEW
GLASS used in



PICTURE TUBES

THE unretouched picture above demonstrates why you risk your reputation as a competent service dealer every time you sell your customers a second hand tube.

A standard Raytheon Tube was put on life test equipment and adjusted so that the raster did not cover the entire face of the tube. The tube was given the equivalent of 1000 hours of operation in a consumer set. The tube neck was then cut, the gun removed, the tube renecked and the screen washed out. The bulb was re-washed and rescreened and as you can see, the portion of the bulb that was scanned is about 20% darker than the unscanned area. In short,

scanning darkens glass and any used bulb that is rescreened will be 20% darker than a new bulb. The only way you can get new tube-brightness out of a second hand tube, is to increase the beam current. And since beam current comes from the cathode, increasing the beam current shortens tube life. For this reason, when you replace with second hand tubes your customer loses, and in the long run so do you!

It's good business to always replace with *new* tubes. And, of course, if you want the finest new tubes that money can buy...



... use RAYTHEON TELEVISION PICTURE TUBES
They're Right for Sight ... and Right for You ... and Always New!

Excellence in Electronics

RAYTHEON MANUFACTURING COMPANY

Receiving Tube Division

Newton, Mass., Chicago, Ill., Atlanta, Ga., Los Angeles, Calif.

RAYTHEON MAKES ALL THESE

RECEIVING AND PICTURE TUBES • RELIABLE SUBMINIATURE AND MINIATURE TUBES • GERMANIUM DIODES AND TRANSISTORS • NUCLEONIC TUBES • MICROWAVE TUBES



ANNOUNCING THE SENSATIONAL

FISHER

All-Triode Amplifier

AND

Master Audio Control

■ THE FISHER Laboratory Standard Amplifier is, beyond a shadow of a doubt, *the world's finest all-triode amplifier* — and yet moderately priced. **FEATURES IN BRIEF:** High output — less than ½% harmonic distortion at 40 watts (.08% at 10 watts). Intermodulation distortion below 3/10% at 30 watts. Uniform response within .1 db, 20-20,000 cycles; 1 db, 5 to 100,000 cycles. Hum and noise better than 92 db below full output. Quality components, beautiful workmanship. ■ THE FISHER Master Audio Control can be used with *any* amplifier. Intermodulation distortion is virtually unmeasurable; complete, professional phonograph equalization settings and tone controls; genuine F-M loudness control; 5 inputs and 5 independent input level controls; cathode follower outputs. Self-powered.

Write for illustrated brochure and full specifications.

FISHER RADIO CORPORATION • 39 E. 47th ST., N.Y.

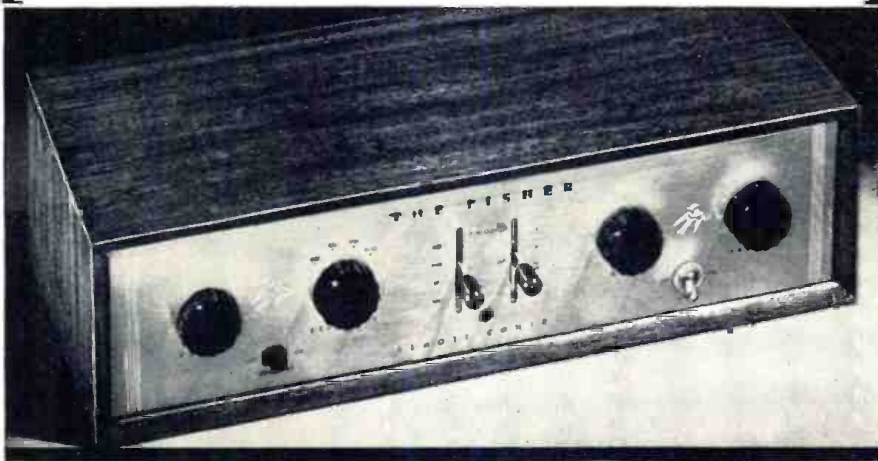

(Mich.); New Castle (Pa.); Battle Creek (Mich.); and High Point (N.C.).

With hundreds and hundreds more primed for appearance in the priority lineup and attorneys all geared for battle, the hearing rooms should be quite a lively area during the Fall and Winter months.

IN A CONCERTED EFFORT to convince everyone that the allocation timetable, as approved, offered the only plausible solution to the webby problem, several Commissioners have been conducting a forceful speaking campaign. Thus far, Commissioners Walker, Sterling, and Webster have hammered away at the practical virtues of the official plan. During the early Summer, veteran Rosel Hyde joined the crusade and delivered a blistering attack at the critics before the Virginia Association of Broadcasters, meeting at Fort Monroe.

Swinging away at the fault-finders, the Commissioner declared that if the vague allocation plans proposed were adopted, true confusion would now be rampant. To illustrate, he selected a hypothetical example of an applicant for Channel 9 in Pittsburgh. In the first place, he said, this applicant would be involved in hearings with every other applicant on the same channel, within . . . "signal-interference distance from Pittsburgh." In addition, it was noted, the applicant would also be involved in the same hearing with every applicant for Channels 10 and 8 who would be . . . "within an adjacent-channel signal-interference distance from Pittsburgh." Also drawn into the snarl would be all those other applicants involved in interference problems with the applicants for Channel 9, who might be within interference range of Pittsburgh. Other applicants for Channels 8 and 10, who might be involved in interference problems with those applicants who were brought into the hearing because of adjacent-channel interference to Pittsburgh, would also be required to appear. And this new group of applicants, continued the Commissioner, would also by . . . "chain reaction bring in additional interference problems and more applicants." Accordingly, he opined, we have a situation where until the breaking point between channels was reached, or between 7 and 6 where we have an 86-megacycle separation and between 13 and 14 where there's a 254-megacycle separation . . . "you would have thrown into one hearing virtually every applicant for Channels 7 to 13 in a section of the United States bounded roughly on the south by South Carolina and on the west by Nebraska."

Asking his listeners to envision the possibility of having scores of applicants in this single hearing for Channels 7 to 13, and a cross-examination by an applicant for a channel in Bangor, Maine, of an applicant three channels removed in Newport News, Virginia, the Commissioner declared that such a mammoth hearing would

(Continued on page 142)

RADIO & TELEVISION NEWS



*Are These Your
Selenium
Rectifiers?*



ANGLE WAMPLER ADVERTISING

All of us here at the Rectifier Division are rather proud of the parts we play in the production of Sarkes Tarzian "Centre-Kooled" Selenium Rectifiers. Barbara, shown here color-coding, is no exception. • If you are not familiar with the wide variety of applications of Sarkes Tarzian Rectifiers, your inquiry is invited. Our staff of engineers is ready to assist you with your power conversion problems. • A most complete Selenium Rectifier Handbook is available at 50c. Write us or see your dealer.

*Where
⚡⚡'s
are used—
Specify*

Sarkes Tarzian, Inc.

Sarkes
Tarzian

RECTIFIER DIVISION
Dept. R-7, 415 North College Ave., Bloomington, Indiana

BUY DIRECT
AND SAVE

COLLINS OFFERS FOR YOUR

COLLINS "PRE-FAB" TUNERS and RECEIVERS

4 ALL NEW Complete Kits
for Every High-Fidelity Need

ASSEMBLE YOURSELF AND SAVE

*Unsurpassed COLLINS workmanship makes this astounding
announcement possible—A mighty proud FIRST FOR COLLINS!*

The Famous COLLINS FM-11 NOW IN KIT FORM FM TUNER KIT

IF Amplifier mounted and
wired right in Chassis.

\$55



A terrific value in an FM tuner! 11 tubes. Formerly sold for \$87.50. Nothing has been changed. The tuner is available in kit form with the IF Amplifier mounted in the chassis and wired and tested by us. You mount the RF Tuning Unit, power supply and after some simple wiring, it's all set to operate. If you had a million dollars, you couldn't buy a finer tuner than this COLLINS unit. It's the best at a really fair price! Buy direct and save! Tube lineup: 6J6 RF amp, 6AG5 converter, 6C4 oscillator, 6BA6 1st IF, (2) 6AU6 2nd and 3rd IF, (2) 6AU6 limiters, 6AL5 discriminator, 6AL7-GT double tuning eye, 5Y3-GT rectifier. Sensitivity 6 to 10 microvolts, less than 1/2% distortion, 20 to 20,000 cycle response with 2DB variation. Chassis dimensions: 12 1/2" wide, 8" deep, 7" high. Shipping weight 10 lbs.

The New 1953 Model Redesigned Smaller Chassis

FM-AM TUNER KIT \$77⁵⁰



The original 15 tube deluxe FM/AM pre-fab kit redesigned on a smaller chassis. The tuner now measures 14" wide by 12" deep by 7 1/2" high. This attractive, new front and dial assembly opens up new applications where space is at a premium. Kit includes everything necessary to put it into operation—punched chassis, tubes, wired and aligned components, power supply, hardware, etc. Kit comprises FMF-3 tuning unit, IF-6 amplifier, AM-4 AM tuning unit, magic eye assembly and complete instructions. All tubes included. Shipping weight 17 lbs.

A New Addition To The Pre-fabs! FM RECEIVER KIT

Tuning Eye and ALL Tubes Included

\$78⁵⁰

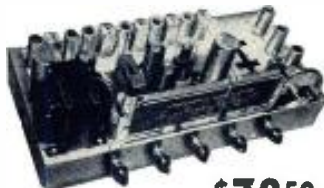

New! A complete 15 tube pre-fab Receiver Kit requiring only an antenna and speaker for operation. Where space is at a premium, the COLLINS Custom FM Receiver Kit can be conveniently mounted in a book shelf or end table with a remote speaker. Highly sensitive and selective, the COLLINS FM receiver will pull in those distant FM stations with clarity and fidelity. Kit includes all necessary parts for assembly and operation: punched chassis, dial assembly, power supply, tuning eye, wired and aligned components, all tubes and complete instructions. 6 to 10 microvolt sensitivity, IF band width 200 KC, 20 to 20,000 cycle response, low distortion, 6 watts output. Bass and treble tone controls, phonograph input. Tubes: 6J6 RF amp., 6AG5 converter, 6C4 oscillator, 6BA6 1st IF, (2) 6AU6 2nd and 3rd IF, (2) 6AU6 limiters, 6AL5 discriminator, 12AU7 1st audio, 6SN7-GT 2nd Audio, (2) 6K6-GT push-pull power output. Order today for the best FM package you'll ever find! Shipping weight 20 lbs.

Another New Star in the Pre-Fab Galaxy

FM-AM RECEIVER KIT \$89⁵⁰



New! Another COLLINS FIRST. A complete FM/AM receiver kit on one chassis, with power amplifier capable of delivering 6 watts of high fidelity audio into a loud speaker. Tops in quality, easily recognizable in the fine workmanship and first grade materials. Kit includes all necessary parts for assembly and operation: punched chassis, dial assembly, power supply, tuning eye, wired and aligned components, all tubes and complete instructions. 20 microvolt sensitivity on FM, 10 on AM. Shipping weight 20 lbs.

COLLINS AUDIO PRODUCTS CO. is in
no way affiliated with Collins Radio Co.

WHEN YOU THINK OF TUNERS —

A COMPLETE LINE LISTENING PLEASURE . . .

**BUY DIRECT
AND SAVE**

Selected Basic Components For Those With Special Applications

Coupled with tremendous popular demand for COLLINS Complete Pre-Fab Tuner and Receiver Kits, we have also supplied many users with many of the individual components shown below. These units, as well as being parts of the kits shown on the opposite page, are also available separately to builders and those who experiment and who wish to use their own chassis or special layouts. Each assembly is completely wired, tested and aligned ready for immediate use. In buying these COLLINS custom components direct from our factory, you save many dollars and are assured of the highest manufacturing standards. All prices include tubes. Diagrams and instructions furnished with each unit. Operating voltages are all that are necessary to place these units in operation!



FM IF AMPLIFIER

FM 10.7 MC, IF-6 Amplifier. **\$19⁷⁵**

A remarkable value! 6 tubes are used in the IF amplifier: 6BA6 1st IF, (2) 6AU6 2nd and 3rd IF's, (2) 6AU6 limiters and 6AL5 discriminator. High gain, wide-band response for highest fidelity. 20 to 20,000 cycles. Distortion less than 1/2 of 1%. Chassis plate dimensions: 11 3/8" x 2 1/2". Shipping weight: 3 lbs.

FM TUNING UNIT SPECIAL



. . . at a
NEW
LOW
PRICE
\$10

A precision FM tuning unit for a ten dollar bill! Permeability-tuned, 88 MC to 108 MC, stable and drift-free. Two tubes: 6AG5 converter, 6C4 oscillator. Sensitivity 20 microvolts. Used with 10.7 MC IF amplifier such as our model IF-6. Compact, small, light in weight, and adaptable to many, many FM applications. Chassis plate measures 4 1/2" x 4 1/2". Aligned, tested and calibrated—ready to operate. Tubes included as well as schematic and instructions. Shipping weight FMF-2: 2 lbs. Dial: 2 lbs.

Slide Rule Tuning
Dial Assembly \$3.85

COMPLETE FM TUNER CHASSIS (RD-1C and Slide Rule Dial) **\$28⁵⁰**



Only Power Supply and Amp. Required.

The COLLINS RD-1C FM tuner chassis is unique in the field. A whole, compact FM tuner that fits in the palm of your hand. Convert AM sets to FM/AM receivers for only a few dollars! Unlimited applications where space is at a premium. So compact that you can get two in a cigar box! Use in conjunction with your phonograph amplifier. Full frequency response to 20,000 cycles. Sensitivity 20 microvolts, Permeability tuned. Tuning unit and IF amplifier on the same chassis plate. Tubes: 6AG5 converter, 6C4 oscillator, (2) 6AU6 IF amplifiers, 6AL5 in new ratio detector circuit. Shipping weight 2 1/2 lbs. Dial: 2 lbs.

FM TUNING UNIT FMF-3 FM Tuning Unit **\$15²⁵**



Slide Rule Tuning
Dial Assembly \$3.85

The best for FM. The most sensitive and most selective type of "front-end" on the market. 6 to 10 microvolts sensitivity. Image ratio 500 to 1. 6J6 tuned RF stage, 6AG5 converter, 6C4 oscillator. Permeability tuned, stable and drift-free. Chassis plate measures 7" x 4 1/2". In combination with the IF-6 amplifier, the highest order of sensitivity on FM can be attained. Tubes included as well as schematic and instructions. Shipping weight FMF-3: 2 1/2 lbs. Dial: 2 lbs.

AM TUNING UNIT

Tubes Included **\$24⁵⁰**



Tops in AM superhet performance! A 3-gang tuning condenser gives 3 tuned stages and consequently higher sensitivity and selectivity. Assembly is completely wired, tested and aligned ready for immediate use. Frequency coverage 540 KC to 1650 KC at a sensitivity of 5 microvolts. Tubes: 6BA6 RF amplifier; 6BE6 converter and oscillator; 6BA6 IF amplifier and 6AT6 detector. Mounts on a chassis plate measuring 4" x 7 3/8". Shipping weight 2 1/2 lbs. Dial: 2 lbs.

**MAIL
COUPON
TODAY**

To: Collins Audio Products Co. Inc.
P.O. Box 368, Westfield, N.J.
Tel. Westfield 2-4390

FROM:

- | | | |
|--|---|---|
| <input type="checkbox"/> FM Tuner Kit | <input type="checkbox"/> FM/AM Receiver Kit | <input type="checkbox"/> IF-6 Amplifier |
| <input type="checkbox"/> FM/AM Tuner Kit | <input type="checkbox"/> FMF-2 Tuning Unit | <input type="checkbox"/> RD-1C Tuner & Dial |
| <input type="checkbox"/> FM Receiver Kit | <input type="checkbox"/> FMF-3 Tuning Unit | <input type="checkbox"/> AM-4 Tuning Unit |

NAME _____
ADDRESS _____
CITY _____ STATE _____

Amount for Kit \$ _____ See weights, add shipping cost \$ _____ Total amount enclosed \$ _____ Check Money Order

— THINK OF COLLINS AUDIO

CHANNEL MASTER

proudly introduces

the world's first Broad Band Yagi

the

f.u.t.u.r.a.m.i.c

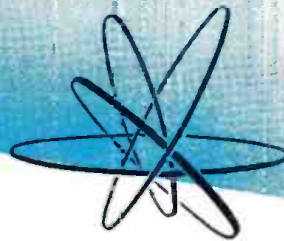

**A great new type of antenna
that combines:**

-  **Broad Band coverage** *with the*
-  **high gain and directivity of the Yagi**

Spectacular high gain! Razor-sharp directivity! In fact, all the brilliant performance that only a Yagi can deliver, is now yours with the FUTJRAMIC — not on just one channel, but CLEAR ACROSS THE BAND!

For the first time in television history, here is an antenna that not only solves today's installation problems — but also provides for the new VHF channels of the future. This is the antenna you have been waiting for — the 10 Element FUTJRAMIC is a true Broad Band Yagi!

for today and tomorrow!

The same **FUTURAMIC** that
 ✨ Solves **today's**
 reception problems
 ✨ Will also receive
tomorrow's new VHF channels

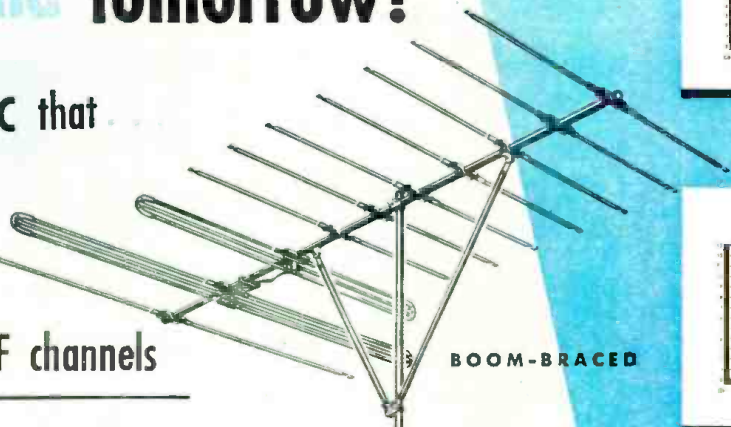

BOOM-BRACED

GAIN CURVES

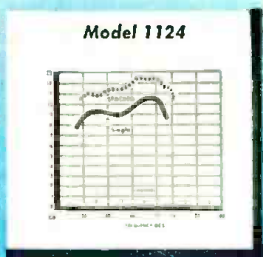

Covers Ch. 2, 3, 4

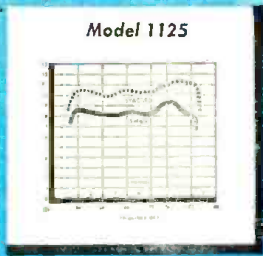

Covers Ch. 2, 3, 4, 5

Horizontal Polar Pattern

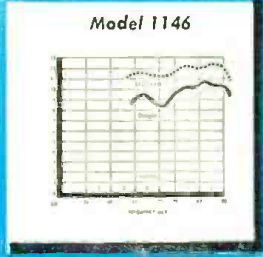
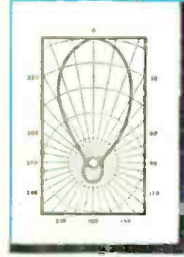

Covers Ch. 4, 5, 6

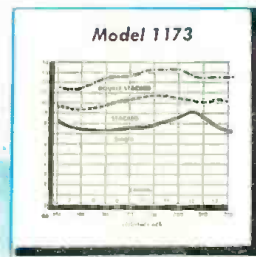

Covers Ch. 7, 8, 9, 10, 11, 12, 13

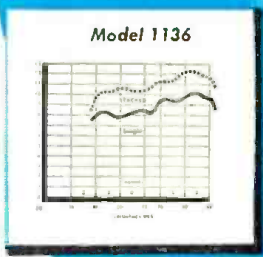

Covers Ch. 3, 4, 5, 6

THE FUTURAMIC MEANS BIG BUSINESS FOR YOU IF YOU SERVE ANY OF THESE 3 BOOMING VHF MARKETS!

1. Areas in which the FCC has ordered VHF stations to change channels (on the same band).

When a channel-shift takes place, the thousands of single-channel Yagis in use will become obsolete overnight. The set owner will face a dilemma: If he changes his antenna before the channel-shift, he will be without reception until the shift occurs. If he waits until the station changes channels, he will be without reception until his new antenna is installed. You can install the Futuramic now — before the rush starts! It will provide better reception than conventional Yagis on the present channels—and when the shift occurs, this superior reception will continue on the new channel without interruption!

2. Areas in which a new VHF station is being added to the present one.

The hundreds of thousands of single-channel Yagis now in use will not bring in the new channel. This means that an additional Yagi will have to be installed and tied into the present installation with a separate lead, through an annoying switching system. However, one Futuramic will do the job of both antennas — at lower cost — with better results on both channels. Install the Futuramic now to improve your present picture. And at the same time be ready for future channels on the same band.

3. Areas served at present by two or more VHF stations (on the same band).

In such areas, the installation man must choose between conventional broad band antennas and separate Yagis for each channel. Each approach has important advantages. Only the Futuramic will give you the advantages of BOTH, combining highest gain, and sharpest directivity on each channel with simple, economical installation.

ALL THIS AND Z-MATCH TOO!

The Futuramic uses Channel Master's famous Z-Match system which eliminates mismatch, gives maximum stacking gain, and provides stacking bars at no extra cost.



SHATTERS all performance records!

- Channel for channel, the Broad Band Futuramic will outperform any conventional SINGLE-CHANNEL Yagi!
- On each of its specified channels, one single Low Band Futuramic will outperform any 4-bay conical or fan array!
- A single High Band Futuramic will outperform any 2-bay conical or fan array on every channel from 7 to 13!
- A high-low Futuramic combination is the most sensitive array ever devised for all-channel VHF reception!

Model No.	Channels Covered	List Price
1173	7, 8, 9, 10, 11, 12, and 13	\$20 ⁸³
1124	2, 3, and 4	\$40 ⁹⁷
1125	2, 3, 4, and 5	
1136	3, 4, 5, and 6	
1146	4, 5, and 6	

Write for complete technical literature.



CHANNEL MASTER CORP. ELLENVILLE, N.Y.



Same wires— many more voices

Connecting new multi-voice system to open-wire lines, near Albany, Georgia. With new system, 150,000 miles of short open-wire telephone lines can be made to carry up to 16 simultaneous messages economically.



MUCH of your Long Distance telephone system works through cable but open-wire lines are still the most economical in many places. Thousands of these circuits are so short that little would be saved by using elaborate carrier telephone systems which are better suited for long-haul routes. But a new carrier system . . . the Type O designed especially for short hauls . . . is changing the picture. It is economical on lines as short as 15 miles. With Type O thousands of lines will carry as many as 16 conversations apiece.

Type O is a happy combination of many elements, some new, some used in new ways. As a result, terminal equipment takes up one-eighth as much space as before. Little service work is required on location; entire apparatus units can be removed and replaced as easily as vacuum tubes.

Moreover, the new carrier system saves copper by multiplying the usefulness of existing lines. For telephone users it means more service . . . while the cost stays low.



Repeater equipment is mounted at base of pole in cabinet at right, in easy-to-service position. Left-hand cabinet houses emergency power supply. System employs twin-channel technique, transmitting two channels on a single carrier by using upper and lower sidebands. A single oscillator serves two channels.

BELL TELEPHONE LABORATORIES

Improving telephone service for America provides careers for creative men in scientific and technical fields





**MEET
THE NEW
● PYRAMID
imp**

**MOLDED TUBULAR
PAPER CAPACITORS**

important!

"IMPS" are molded
in rugged thermo-
setting plastic!



important!

"IMPS" are
IMPervious to
moisture!



important!

"IMP" leads are
securely anchored!



important!

"IMPS" will withstand
temperature of 100°C.
(212°F.) — the boiling
point of water!



"imps" are now available to the service trade in all popular ratings, in 200, 400 and 600 volt ranges.

Write now for complete literature— and your free sample!

**MAIL THIS COUPON FOR
FREE SAMPLE**

YOUR NAME _____
 COMPANY NAME _____
 ADDRESS _____
 CITY, ZONE, STATE _____



PYRAMID ELECTRIC COMPANY
 1445 Hudson Blvd., North Bergen, N. J., U. S. A.

Complete control of materials and manufacturing procedures

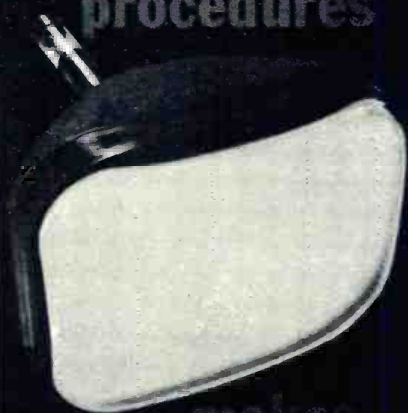

makes Tung-Sol Tubes dependable!

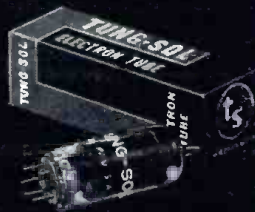

You can build a reputation on Tung-Sol Quality

TUNG-SOL

RADIO, TV TUBES, DIAL LAMPS

TUNG-SOL ELECTRIC INC., Newark 4, N. J.
Sales Offices: Atlanta • Chicago • Culver City
Dallas • Denver • Detroit • Newark

Tung-Sol makes All-Glass Sealed Beam Lamps, Miniature Lamps, Signal Flashers, Picture Tubes, Radio, TV and Special Purpose Electron Tubes.

Within the INDUSTRY

ROBERT B. MOON has joined the *Hammarlund Manufacturing Company, Inc.* of New York as general sales manager.



Previously manager of governmental sales for the *General Instrument Corporation*, he was formerly associated with *Bendix Radio* where he was responsible for all commercial sales.

In his new position Mr. Moon will be responsible for the sales of communications receivers, variable condensers, remote supervisory equipment, as well as all other products manufactured by the company.

* * *

RICHARD A. GRAVER, vice-president-electronics of *Admiral Corporation*, has resigned that post to join *Capehart-Farnsworth Corporation* of Fort Wayne, Indiana . . . **CARL D. VOLPE** has been promoted to the post of plant manager for the *Starrett Television Corporation*. He was formerly director of quality control. **LEO BERNSTEIN**, former industrial engineer of the plant, is now the assistant plant manager . . .

EARL STEIKER is the new general manager for the Rectifier Division of *Galvanic Products Corporation* of New York. He will make his headquarters at the company's Valley Stream, Long Island plant . . . *The La Pointe-Plascomold Corporation* has made two appointments of interest to the industry. **GRAHAM R. TREADWAY**, former president of *Horton-Bristol Manufacturing Company*, has been named assistant to the president while **CHARLES D. TOWNSEND** is the new director of manufacturing for the Rockville, Connecticut antenna maker . . .

The Tube Department of *RCA Victor* has created separate kinescope and receiving tube sales functions within its renewal sales organizations. **K. B. SHAFFER** has been appointed manager of kinescope renewal sales, **D. M. BRANIGAN** will continue as manager of receiving tube renewal sales, while **A. G. PETRASEK** has been appointed manager of electronic component renewal sales . . . **BOB AB-BOTT**, advertising manager and assistant sales manager of *Littelfuse, Inc.* for 8 years, has joined the staff of *Burton Browne Advertising*. He will continue to handle the advertising and merchandising of *Littelfuse* as account executive and will be coordinator of the *Burton Browne* creative departments . . . **STANLEY M. ABRAMS**, director of sales for *Emerson Radio and Phonograph Corporation*, has resigned his post to become a distributor of *Emerson* products in Nassau and Suffolk Counties. Long Island . . .

John F. Rider, Publisher, Inc. has appointed **STANLEY B. SCHIFFMAN** to the post of manager of the firm's field liaison division. He will contact service managers of radio and television receiver manufacturers . . . **CARL H. CUMMINGS**, formerly sales manager, has been appointed general manager of the *Haydon Manufacturing Company* of Torrington, Conn. He succeeds **ARNOLD J. WILSON, JR.** who has resigned to enter an unannounced new field . . . **R. G. SCOTT** has been named manager of sales engineering of the Cathode-Ray Tube Division of *Allen B. Du Mont Laboratories, Inc.* . . . **DONALD H. KRESGE** has been appointed business manager for the *Certified Television and Electronics Association of Maryland*. He will make his headquarters at the association's Baltimore office . . . **W. E. BENOIT** has been named manager of the Electronics Division of the *Westinghouse Electric Corporation* . . . **DAVID J. HOPKINS** is the new director of sales and advertising for the *Emerson Radio and Phonograph Corporation* . . . *Roanwell Corporation*, Brooklyn manufacturer of communications terminal equipment, has appointed **H. E. MARROWS** to the post of product engineer in its sales division . . . **LEO BEISER** has been advanced to the post of assistant chief television engineer for *CBS-Columbia, Inc.*, the electronic manufacturing subsidiary of *The Columbia Broadcasting System*. He formerly was engaged in the design and development of television receivers.

* * *

JOHN D. McLELLAN has been named plant manager of the *Marion Electrical Instrument Company* of Manchester, New Hampshire. He will be in charge of all the company's manufacturing operations.



As former vice-president and general manager of *J. H. Bunnell & Co.*, he brings to his new position broad experience in electrical engineering and manufacturing. He is an engineering graduate of the University of Toronto. His experience includes work with *Canadian Telegraphs* and the *Self-Winding Clock Company*. He is a member of the AIEE and SAM.

* * *

THE AUDIO FAIR, the annual exhibit held in connection with the yearly convention of the Audio Engineering Society, will run for four days this year instead of the customary three.

Slated to open October 29 at the

RADIO & TELEVISION NEWS

Here's your Opportunity



to prepare for a good job or a business of your own in TV SERVICING

There are today more good jobs open in TV Servicing than there are trained and experienced men to fill them. Yes, thousands of opportunities exist now for good-pay jobs offering employment security for years and years to come. Thousands of TV Servicing jobs are going begging. Do you want one of them?

Experts agree, that because of the critical shortage of trained and experienced TV Servicemen, and the tremendous future growth of the industry, no vocational field today offers more opportunities than TV Servicing.

The Big New Industry with a Great Future

Television is just in the beginning stages of its big industrial boom. Look at these amazing facts:

- Lifting the freeze on new TV stations will open many new TV areas and will improve the coverage of existing areas. The result will be an enormous demand for TV receivers.
- Within a few years over 1000 TV stations will be telecasting compared with 108 TV stations now on the air.
- Nearly one-half of all families living within the present TV areas do not yet own TV receivers.
- The new trans-continental video network plus better and more interesting programs plus larger viewing screens and color TV will increase the installation of new receivers, will induce present owners of 12-inch and smaller size viewing screens to buy newer model receivers.
- The power increases of many existing stations and improved reception range of current receivers will result in receivers being installed and serviced in the fringe areas of present stations.
- Under the FCC proposal, over 70 per cent of all communities will be served by UHF channels exclusively. This means TV servicemen must know UHF receivers before the new UHF stations in their area are opened.
- No one yet knows how great the industrial TV market will be.

RCA Institutes Home Study Course prepares you for a Career in TV Servicing

The addition of the RCA Institutes TV Service Training to your present radio-electronics experience will qualify you to step out and grasp the golden opportunities that now exist in television—America's fastest growing industry.

Learn at home—in your spare time—while you study the practical *how-to-do-it* techniques with *how-it-works* information. Easy-to-read and easy-to-understand lessons under the supervision of RCA engineers and experienced instructors quickly train you to qualify for the many good jobs now waiting for trained TV servicemen. Don't pass up this lifetime opportunity for financial security and a bright future in TV. Learn TV Servicing from RCA—pioneers and leaders in radio, television and electronic developments.

RCA Institutes conducts a resident school in New York City offering day and evening courses in Radio and TV Servicing, Radio Code and Radio Operating, Radio Broadcasting, Advanced Technology. Write for free catalog on resident courses.

Send for FREE BOOKLET

Mail the coupon—today. Get complete information on the RCA INSTITUTES Home Study Course in Television Servicing. Booklet gives you a general outline of the course by units. See how this practical home study course trains you quickly, easily. Mail coupon in envelope or paste on postal card.



MAIL COUPON NOW!

RCA INSTITUTES, INC., Home Study Department RN-1052
350 West Fourth Street, New York 14, N. Y.

Without obligation on my part, please send me copy of booklet "RCA INSTITUTES Home Study Course in TELEVISION SERVICING." (No salesman will call.)

Name _____ (please print)
Address _____
City _____ Zone _____ State _____



RCA INSTITUTES, INC.
A SERVICE OF RADIO CORPORATION of AMERICA
350 WEST FOURTH STREET, NEW YORK 14, N. Y.

3 MICROPHONES DESIGNED FOR YOU...

BA-109... Flat frequency response from 40 to 10,000 cps. Nondirectional in the horizontal plane... output of 54 db below 1 volt/dyne/cm². Fits standard stand. List... \$22.50.



BA-106... Essentially flat frequency response from 40 to 6,000 cps. Output level - 50 db below 1 volt/dyne/cm². List... \$19.75.



BA-116... Hand or desk model. Can be used with standard stand if desired... uniform response from 50 to 6,000 cps. Finest of the low priced microphones. List... \$14.75.



No matter how good your ham rig, your P.A. system or your tape recorder, you can only get out of it what your mike puts into it. You want a sensitive, wide range mike with flat response, yet you want a mike that is sturdy and trouble-free.

Brush had you in mind when they designed their line of microphones. Each Brush mike is engineered to do an outstanding job in its class. All use the exclusive Metalseal Crystal* which assures protection from both high and low humidity.

The 3 Brush microphones illustrated as well as the Brush Vibromike* and the Brush Lapel microphone are available from your local radio parts jobber.

Brush headphones—for the first time combine all the most wanted headphone features. See them at your dealer.

*T. M. Reg.

THE **Brush**
DEVELOPMENT COMPANY



Piezoelectric Crystals and Ceramics
Magnetic Recording Equipment
Acoustic Devices
Ultrasonics
Industrial & Research Instruments

3405 Perkins Avenue • Cleveland 14, Ohio

Hotel New Yorker in New York City, the Fair will close on November 1st. This year's exhibit is expected to draw the greatest number of manufacturers of high-fidelity sound equipment ever to participate in a single exhibit.

The Audio Fair is open to the public and admission is free to all persons with an interest in the reproduction of sound, hobbyists and professionals alike.

* * *

RUDOLPH SACHS has been named manager of the new *CBS-Hytron* division for semi-conductor products.



A graduate of the University of Alabama and the holder of an MS degree from Columbia University, Mr. Sachs was employed at *Western Electric Co.* from 1943 to 1951. He served as a product engineer specializing in all phases of the manufacture of quartz crystal oscillator plates and later devoted his time to engineering problems involving the manufacture and testing of germanium and silicon diodes and transistors.

At *CBS-Hytron*, he will coordinate all activities connected with semiconductor research, development, and production.

* * *

WILLIAM J. LARKIN, vice-president in charge of engineering and production for the *National Company, Inc.*, of Malden, Massachusetts, passed away recently, according to word received from the company.

A well-known figure in the industry, Mr. Larkin's death comes as a shock to his many friends and business associates.

* * *

AMBROSE C. MILLER, has joined *The William Brand & Co., Inc.*, in the post of product engineer.



He joins the Willimantic, Connecticut firm after being associated with the *Philco Corporation* for 25 years. At *Philco* he worked as a general engineer, set designer, and a component designer. He also served as the company's contact man with the *Underwriters' Laboratories*.

In his new post he will employ his production "know-how" in stepping up the output of the company's electrical insulating materials, varnished tubing, saturated sleeving, mica and mica products, etc.

* * *

MARK ELECTRONICS, 23 West 60th Street, New York 23, New York has entered the distribution field and will specialize in the sale of test equipment to the industry... **ROLAND RADIO CORPORATION** has been set up as a separate company to manufacture radio receivers. The parent company is **STEELMAN PHONOGRAPH AND RADIO**

(Continued on page 102)

RADIO & TELEVISION NEWS



Service Clinic!

Engineering information to help you better service Raytheon

STABILIZING "SYNC" SEPARATION

Stabilized Sync. Separation prevents interference noise peaks, that appear in the composite video sync., from disturbing the proper sync. separation clipping level. Without stabilization, noise bursts will cause horizontal bending (illustrated) or excessive vertical rolling.

The Gated Sync. Separator functions as a normal sync. separating amplifier, but has utilized a tube with an additional control grid to gate off tube conduction during noise peaks. The noise selective gating action is accomplished by decoupling the negative video signal to grid G_1 through resistor R_1 . The resistor R_1 , combined with adjustable positive voltage from adjustment R_5 , will grid current damp normal video and sync. signals from affecting tube conduction. However, strong negative noise peaks that overcome the

grid current damping will stop tube conduction.

This gating action stabilizes sync. in two ways:

- (a) The self-bias of grid G_2 derived from the positive sync. signal does not build up during noise bursts, since grid G_1 will not allow grid G_2 to conduct.
- (b) The negative noise at grid G_1 , when positive noise is at grid G_2 , will prevent noise peaks from entering the sync. output.

Improved circuitry such as this is one of the many reasons why you can feel free to recommend Raytheon TV to a friend or customer.

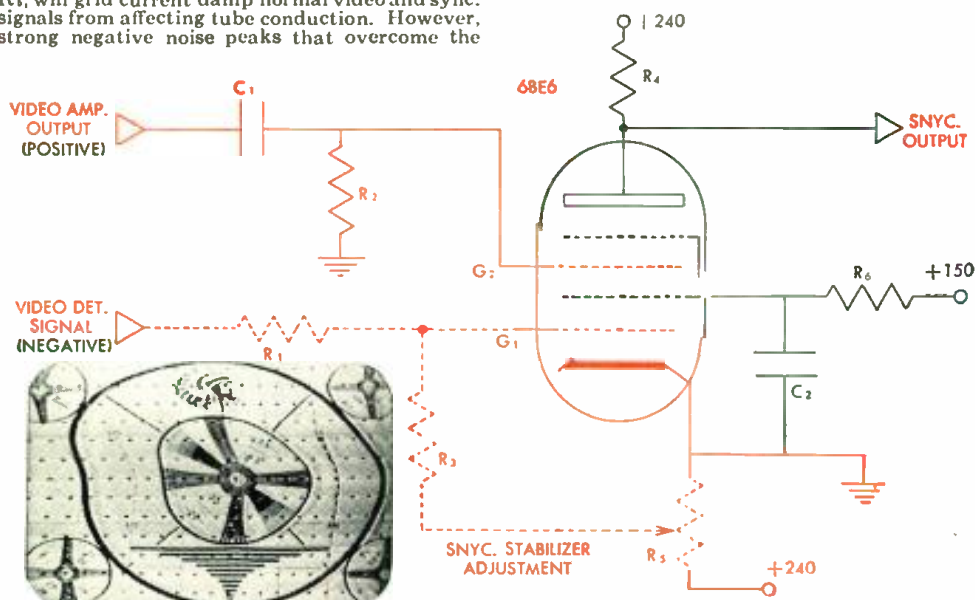

This circuit will prevent noise from displacing the picture.

© BELMONT RADIO CORP.



RAYTHEON TELEVISION & RADIO CORPORATION
5921 West Dickens Avenue, Chicago 39, Illinois

October, 1952



Dependably Built for Dependable Performance



THE "CONTINENTAL" BERMUDA
Model C-2113

NOW-

Centralab's new miniature a lot more switch

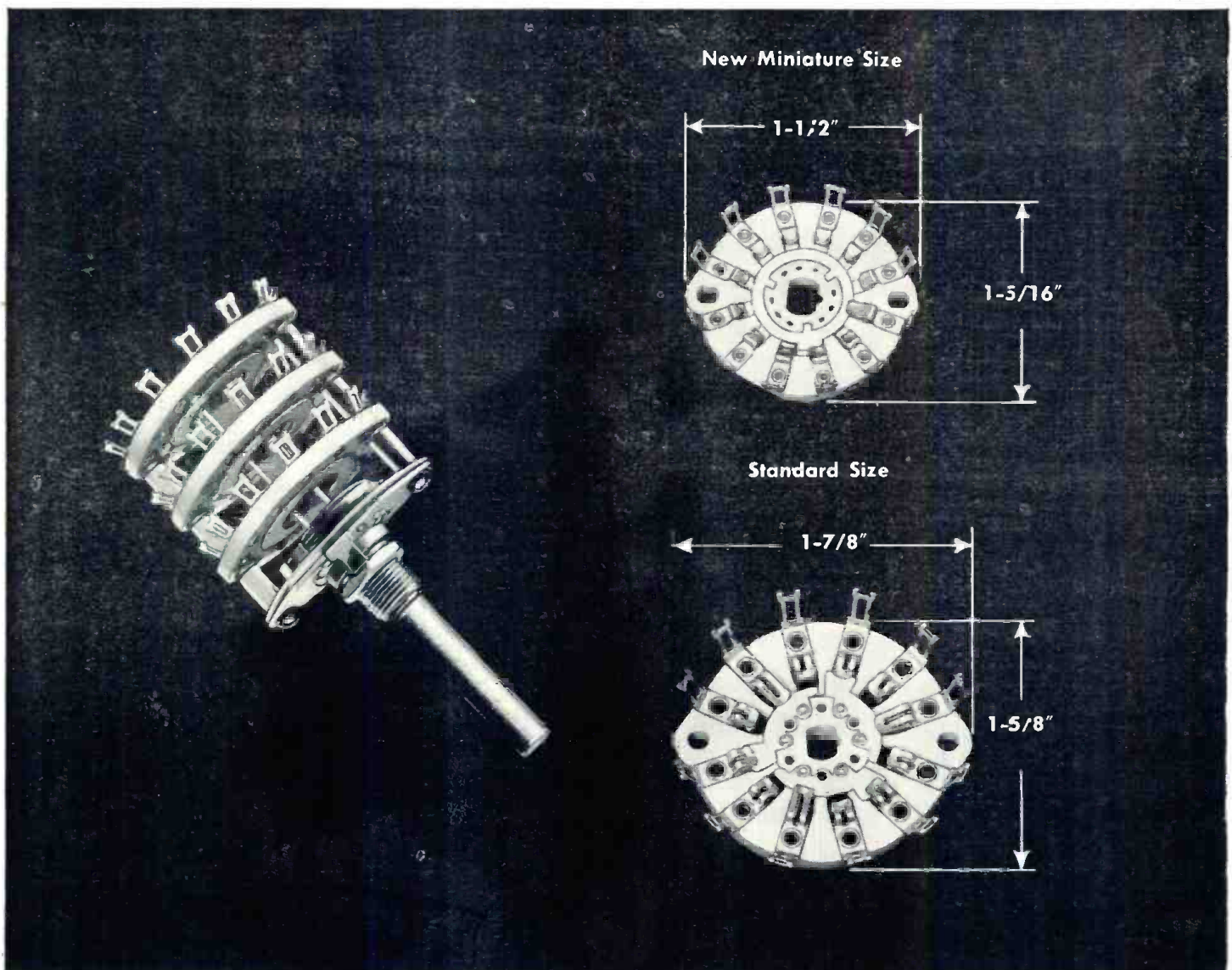

COMPARE the size of the new Centralab miniature switch with conventional standard size models

The new, miniature switch is a full $\frac{3}{8}$ " smaller in diameter than standard switches! More important, they allow more positions per pole, even with miniaturization. For example:

- 1 pole — 12 active positions per section
(former 1-pole switch had only 11 positions).
- 2 poles — 6 active positions per section
(former 2-pole switch had only 5 positions).

- in stock!

switch line offers you in a lot smaller package

THESE new series PA-2000 miniature switches give you more flexibility. And expert designing retains maximum protection.

Centralab miniature switches feature one-piece shaft construction, permitting more accurate indexing. They are available with one to six sections per shaft, one to 18 poles per switch. Sections are Steatite and can be had in shorting and non-shorting arrangements. Adjustable stop allows selection of positions or continuous rotation. *More, these switches are guaranteed to withstand a minimum of 50 hours of salt-spray tests.* No other units on the market as stock

items will do as well. Separate Steatite sections, index assemblies, hardware and accessories also available.

These features make it possible for you to use these Centralab switches for AM, FM or TV repair, intercom installations, mobile equipment, public address systems or any medium power application.

You save time and money when you insist on Centralab switches. That's because the complete Centralab line offers you the exact switch you want, when you need it, always available from one source. *And they're offered at attractive low prices!*

CHECK THESE NEW SMALLER DIMENSIONS!

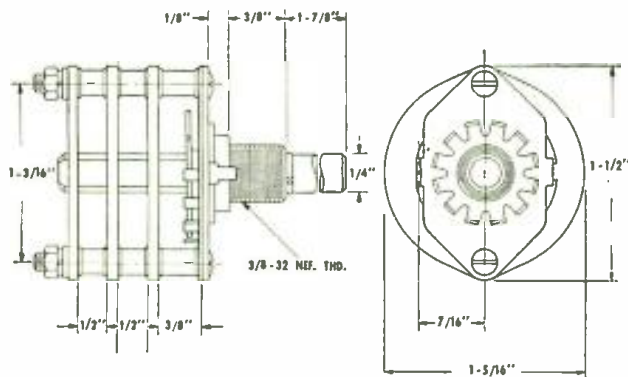

Total Number Poles	Total Positions	Number Sections	Poles Per Section	Cat. No. Shorting	Cat. No. Non-Shorting
1	2-12	1	1	PA-2000	PA-2001
2	2-6	1	2	PA-2002	PA-2003
2	2-12	2	1	PA-2004	PA-2005
3	2-5	1	3	PA-2006	PA-2007
3	2-12	3	1	PA-2008	PA-2009
4	2-6	2	2	PA-2010	PA-2011
4	2-12	4	1	PA-2012	PA-2013
5	2-3	1	5	PA-2014	PA-2015
5	2-12	5	1	PA-2016	PA-2017
6	2	1	6	PA-2018	PA-2019
6	2-5	2	3	PA-2020	PA-2021
6	2-6	3	2	PA-2022	PA-2023
6	2-12	6	1	PA-2024	PA-2025
8	2-6	4	2	PA-2026	PA-2027
9	2-5	3	3	PA-2028	PA-2029
10	2-3	2	5	PA-2030	PA-2031
10	2-6	5	2	PA-2032	PA-2033
12	2	2	6	PA-2034	PA-2035
12	2-6	6	2	PA-2036	PA-2037
15	2-3	3	5	PA-2038	PA-2039
18	2	3	6	PA-2040	PA-2041

SPECIAL

1	2-10	1	1	PA-2042
---	------	---	---	---------	-------

MINIATURE SWITCHES WITH 60° INDEXING

1	2-6	1	1	PA-2043
2	2-6	2	1	PA-2045

(1 1/2" spacing between sections)



The Centralab miniature switch line is only one of the more than 470 *new* items listed in Centralab's new Catalog 28. Get your copy of this 32-page index to the latest developments in the fast-changing electronics field. See your distributor or write direct.

Centralab

A Division of GLOBE-UNION INC.

910 E. Keefe Avenue • Milwaukee 1, Wisconsin

In Canada, 635 Queen Street East, Toronto, Ontario



Unquestionably the greatest
new contribution in years
to reproduced music enjoyment

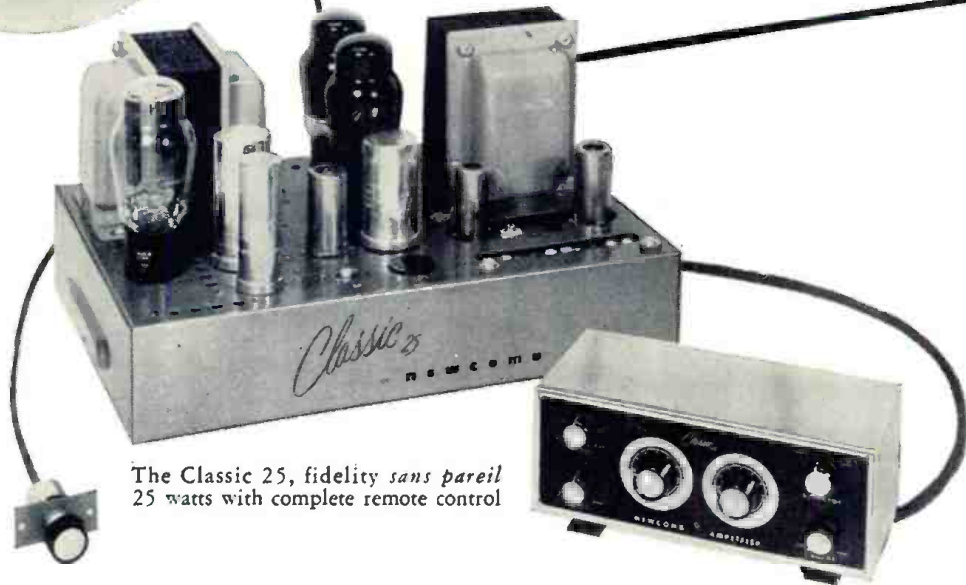

The Classic 25, fidelity sans pareil
25 watts with complete remote control

modern Classics in sound by newcomb

Designed exclusively for the connoisseur of music who wants to hear *all* of it, just as it was recorded . . . eight completely new custom home music amplifiers that not only sound better but are easier to install.

There is nothing, short of live music itself, to compare with the brilliant, clear, full-bodied tones of the Classic 25, the star of this amazing new series of fine amplifiers. Its galaxy of features include a remote control beautifully finished in rich, brushed brass, a dramatic accent to even the most tastefully appointed interiors. Distortion is reduced to the lowest limits of measurement, yet reserve power has not been sacrificed. Frequency response extends from below 10 to over 100,000 cycles. New

"Audi-balance" achieves perfect balance of output tubes in seconds. Exclusive "Adjust-a-panel" extends control shafts instantly for cabinet mounting. Six inputs are provided for radio, TV, tape recorder, crystal and magnetic (2) pickups. "Fletcher-Munson" compensated volume control maintains perfect aural balance. A cross-over selector simplifies attainment of correct playback response, includes foreign and domestic frequencies and the new A.E.S. standard.

Send for our catalog describing all
8 completely new amplifiers priced from \$39.50 to \$269.50 audiophile net.



Classic 15 A-15 A-104R A-104 AM-10R AM-10 A-10

Newcomb
15 years of quality leadership
6824 LEXINGTON AVENUE, HOLLYWOOD 38, CALIFORNIA



Write Dept. F for catalog C-20M

RADIO & TELEVISION NEWS

Rauland Tubes give you a prettier profit picture



Rauland picture tubes are first choice of an ever growing number of service dealers and men. First, because of the completeness of the Rauland replacement line.

Second, because you get the benefit of acknowledged leadership in picture tube engineering. Rauland research has developed more picture tube improvements since

the war than any other company.

You get quality you can count on, too. Rauland production employs machines unique in the industry—many of them designed by Rauland engineers and built in Rauland's own plant.

And finally, you get assurance of customer satisfaction beyond

what any other line can give you. Installation and adjustment of Rauland tubes is faster and better. The Indicator Ion Trap gives you the surest known protection against ion burn and shortened tube life.

Specify Rauland—deliver Rauland—and assure yourself of pleased picture tube customers.

THE RAULAND CORPORATION



Perfection Through Research

4245 N. KNOX AVENUE • CHICAGO 41, ILLINOIS



Model
1203D



HIGH-FIDELITY REPRODUCTION AT ONE-TENTH THE COST!

Model
1201D



Compared with speakers ten times more expensive—many listeners actually prefer G-E Model 1201D

IN recent tests, many un-biased listeners actually preferred the G-E 1201D for its exceptionally fine reproduction! Side by side comparisons at a given volume level were made to try and determine the difference between these G-E speakers and others costing ten times as much.

These General Electric speakers are designed to meet and surpass the exacting standards of performance so essential to high fidelity. Their wide acceptance spells out the answer—for dependability, durability, and all-round superb performance.

Remember, there's a General Electric speaker for every application—27 speaker models in 8 different sizes!

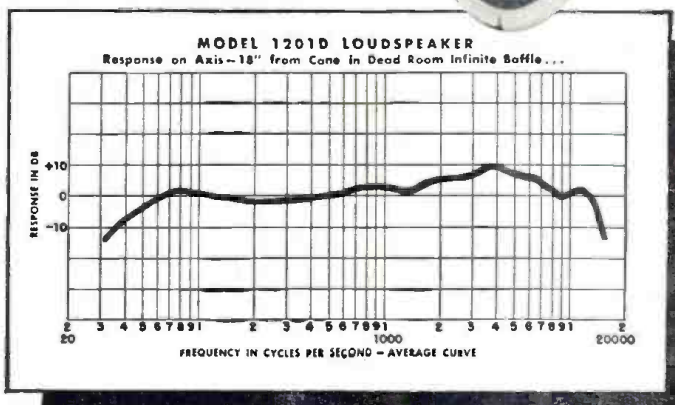

OUTSTANDING FEATURES:

- **ECONOMY**—Compare their cost, and you'll find it lower by far than any speaker of comparable quality on the market.
- **EXCEPTIONALLY WIDE FREQUENCY RANGE**—50 to 13,000 cycles.
- **FAMOUS G-E ALUMINUM BASE VOICE COIL**—Unaffected by moisture and temperature variations.
- **G-E ALNICO 5 MAGNET**—for both maximum efficiency and sensitivity.

GENERAL ELECTRIC

**GET THIS
CATALOG
FREE!**



General Electric Company, Section 9102
Electronics Park, Syracuse, New York

Please send me your G-E Loudspeaker Catalog.

NAME _____

ADDRESS _____

CITY _____ STATE _____

MIDGET

RADIO-CONTROLLED

AUTO

By WILLIAM H. MINOR



The midget car and its control transmitter. The "on-off" switch can be seen at the base of the right door. A license is required to operate this equipment.

Complete construction details on a control unit which will operate various types of small models or children's toys.

IF, LIKE the author, you have a boy age 6, building a radio-controlled model automobile for him is an interesting project.

Most radio-controlled models are, at best, difficult to build and often complicated to operate or keep in working order. The model illustrated above affords excellent control, yet it is simple enough for a child to operate after a few moments' instruction. It is not difficult to build and can be made using readily available parts and ordinary hand tools.

Three commands can be given the car: "move forward," "stop," and "move backward." By a judicious choice of the original model car, the problem of turning was met by the fact that the car will travel forward in a straight line but backward in a circle. Thus, the car can be maneuvered like a larger car using only these simple commands.

An attractive feature of the car is its physical size. The model is ten inches long and stands three inches at its highest point. There can be no doubt, on examining the photographs, that all available space is fully utilized for the control components.

The transmitter described operates with A2 emission. This is defined in the regulations as tone-modulated

telegraphy. A2 emission is permitted on the following frequency bands.

26.96	—	27.23	mc.
50	—	54	mc.
144	—	148	mc.
220	—	225	mc.
235	—	240	mc.
420	—	450	mc.

Coil specifications are given for 144-148 and 220-225 mc., but the higher band is recommended for two very good reasons. Of course, holders of currently valid Amateur Operators Licenses will immediately recognize which bands they can and cannot use.

Since 220 mc. is above the highest v.h.f. television channel, this is recommended to eliminate possible interference with other services.

The second reason deals with the aspect of licensing. Operation of transmitting equipment is limited to those who are licensed by the government. New regulations recognize the value of experimentation by those who are interested in radio for just such purposes as described. For this reason the Technician Class License is available to anyone who demonstrates an interest and a small knowledge of technical radio. The examination is quite simple and well worth the effort. This license permits the use of all frequencies above 220 mc. which are set aside for amateur uses.

Invariably two other points in question arise. The first is that of "limited radiation." Under the law, no license would be required if the transmitter output were sufficiently low. Actually, the radiation could not exceed 50 microvolts per meter at a distance of $\lambda/2\pi$ from the transmitter. While it might be possible to construct a transmitter which would not exceed the legal radiation limit yet would operate the car over a very short range, it probably would require far better test equipment to insure legal operation than is ordinarily available to the experimenter. Operation, then, without a license is most certainly ill advised.

The second point concerns the often discussed Citizens Band at 460 mc. The advantage would be in the ease with which an operator's permit can be obtained. The catch is that the FCC has some rather rigid specifications on the transmitting equipment that can be used. It would be extremely difficult for the average constructor to design, build, and secure approval for the necessary transmitter. This rules out the use of the Citizens Band, for this project at least.

A little investigation will prove that the Technicians Class License can be obtained after only a short period of study. For this reason it is rapidly becoming a very popular license.

The Car

The builder might wish to start from scratch and assemble the entire model to his own specifications, but modification of an existing toy is no less interesting and time is saved in the over-all process.

There are, on the toy market, several small automobiles that are of the "wired-control" type, that is, they contain a small 3-volt electric motor and a pair of wires that lead to a battery case designed to be held in the operator's hand. Some of these cars have pneumatic steering control, some have no control at all. This particular model was chosen for two distinct reasons. Although it was small, it was not so tiny that it was necessary to revert to

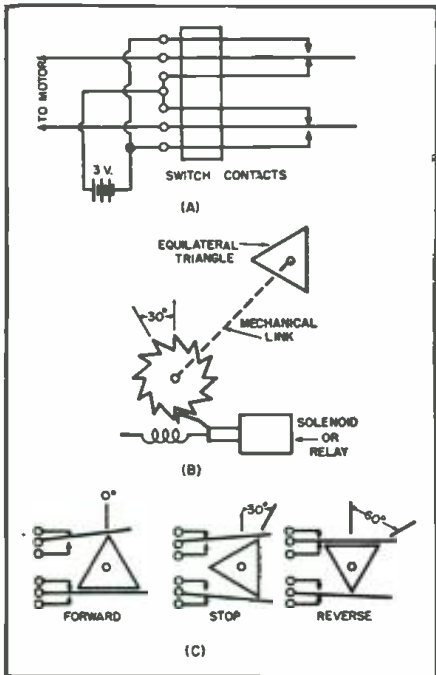

Fig. 1. Construction details on the "decoder." A double-pole, double-throw switch is activated by a triangular piece of plastic rotated between the switch arms.

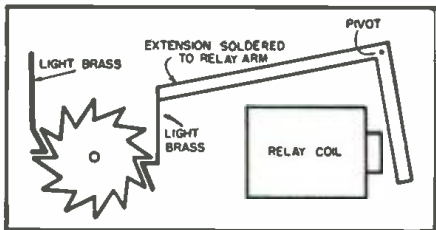

Fig. 2. Details of reversing switch relay.

subminiaturization. The unique method of steering fits into the plans for keeping the controls simple.

This car has the drive motor installed on the front wheel mount and

View of model car looking toward rear axle and showing the locations of (A) the equilateral triangle, (B) the decoder switch, and (C) the decoder relay unit.

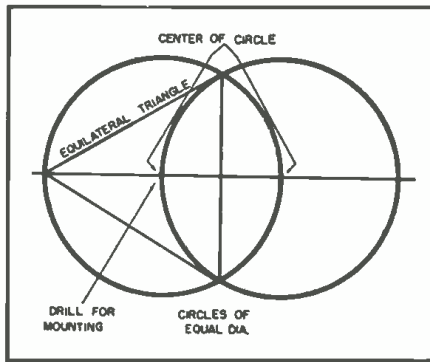
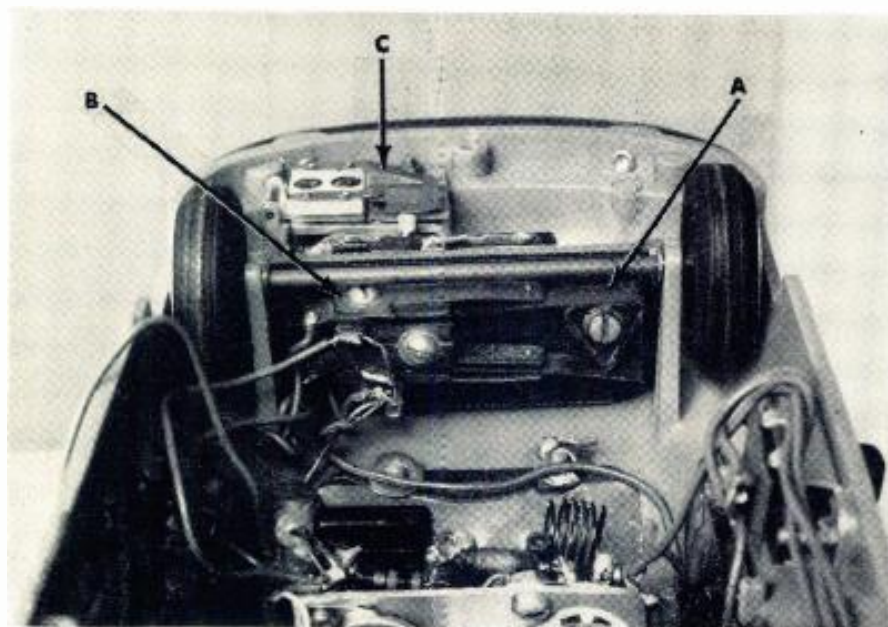

Fig. 3. How an equilateral triangle is obtained using a compass and a straightedge.

is free to turn left and right with the wheels. The rear wheels are not in line with the axis of the car. As the car is driven forward the torque of the motor is canceled by the offset back wheels. As the car is driven backward the offset causes the car to turn.¹

The Decoder

The heart of the car was, in its "wired-model" form, a reversing switch which was located in a battery case held in the hand. For radio control, this switch had to be located in the car and some arrangement made for it to assume the position desired by the operator. The mechanism which performs this task is called the "decoder." There are several methods of accomplishing decoding. The one to be described is about the simplest possible.

Examine Fig. 1. This shows the construction of a double-pole, double-throw switch activated by a triangle which rotates between the moving arms of the switch.

Using relay contacts, a set is constructed exactly as shown in the drawing of Fig. 1. No dimensions are given, as the builder may have to construct it from whatever parts are available. For simplicity, the constructor may de-

sire to buy a kit of relay contacts such as those manufactured by *Guardian*. These kits are reasonably priced and simple to assemble in any manner desired. A kit contains sufficient parts for two switches. In the event the Series E-200 contacts are used, be careful in the over-all construction of the decoder, for the space in the car is limited and these contacts are a snug fit in the "trunk compartment" over the rear axle. See the photograph below showing location of components.

After the switch has been constructed, measure the distance between the two moving arms. Measure the distance one of the moving arms must travel to make contact with the outer stationary arm. Now add the distance the arm must travel to one-half the distance between the moving arms. Draw a circle on a piece of stiff non-conducting material using this figure as the radius of the circle. Inscribe within the circle an equilateral triangle and after marking the center, cut out the triangle. The material from which this triangle is made may be a piece of plastic about $\frac{1}{8}$ inch thick. Fig. 3 shows how an equilateral triangle may be inscribed in a circle using a compass and a straightedge.

This equilateral triangle may be used only if the proper ratchet gear is in combination with it. The ratchet must have *twelve teeth* so the triangle will turn through 30 degrees each time the solenoid is activated.

This twelve-tooth ratchet gear was taken from a broken alarm clock. Spring-variety clocks contain two of these gears, one on the main spring and another on the alarm spring. It is wise to inspect the gears before tearing up the wife's favorite kitchen clock, for some may not have the proper number of teeth. (The gear, that is; it is assumed the wife has the correct number.) Larger clocks have gears with a shaft about $\frac{3}{16}$ inch in diameter. This shaft can be cut off to just the correct length to pass through a small mounting panel then drilled and tapped for a No. 4 or 5 screw. The triangle can be bolted to the shaft on the side of the panel opposite the ratchet.

The diagram Fig. 2 shows the gear being activated by a reconstructed relay which is available on the junk counters of many of the surplus stores. It originally had a 300-ohm winding for use in 28-volt d.c. systems. The winding was removed and replaced with enough #28 wire (approximately 92.46 feet) to have a resistance of 6 ohms. An easy method of winding this is to clamp the core form in the chuck of a hand drill and turn the drill as the wire is fed evenly in by hand. Six ohms of #28 wire just fills the spool of this particular relay core.

After winding the new coil, replace the core and set the relay for a stroke that pulls easily yet firmly. Add an extension to the relay arm so that the tip will move through a distance equal

¹Manufactured by the Vibro-Roll Products, Inc., Pittsburgh 23, Pa. This particular model is their "Sedan" and is available in some of the larger toy departments.

to or very slightly greater than the distance between teeth on the twelve-tooth ratchet. Fig. 2 is a drawing of the physical additions that were made to the relay to operate the reversing switch shown in the photographs.

Although only one switch was needed, two of them were constructed and are offered as alternate designs. The second switch, the same size physically as the one just described, was activated by a solenoid. The mechanical connection is shown in Fig. 1B.

Using a small piece of aluminum tubing through which a soft iron nail will slide easily, wind 6 to 8 ohms of #28 wire (approximately 93 to 123.2 feet) in a coil about one inch long. Insulate the winding by wrapping on a thin layer of tape. Cut a strip of metal from a tin can—the width equal to the length of the coil. Wrap the coil in the metal and solder it. Build the ends of the same metal, allowing the aluminum tubing to protrude a little. Make a plunger of the soft iron nail with a catch on it as pictured in Fig. 1. An iron screw should be run into the opposite end of the solenoid to provide a stop for the plunger and to afford a greater attraction for it during the time a current is in the coil. This solenoid is mounted on the switch panel in such a way that one stroke of the plunger will cause the switch ratchet to move through 30 degrees or one tooth.

Fig. 1C shows three consecutive positions of the triangle and switch arms as the relay or solenoid is activated. Follow the electrical wiring as shown in Fig. 1A. This is not the only arrangement which would result in a reversal of current through the motor, but is the method which will insure that the battery will not be shorted during the movement of the ratchet and triangle or in the "off" positions.

The only time current is drawn by the decoder is during the actual pulsing of the relay. This time can and should be made very short by transmitting only short pulses. This eases the strain on the batteries within the car.

The Receiver

In order that the car will operate with a minimum of adjustments at the receiver, a circuit which is sensitive yet stable is highly desirable. A one-tube receiver could be constructed that would occupy less space than the one shown, but this type of receiver requires adjustments quite frequently. The circuit of Fig. 4 is not at all "fussy" as to adjustments or deterioration of "B" batteries. In fact, after this particular receiver was constructed no adjustments were required before actual installation in the car. It worked properly the first time it was turned on.

A superregenerative detector is followed by two stages of audio amplification. The last stage has a grid resistor returned to "B+" allowing the tube to draw sufficient current to operate the sensitive relay in its plate circuit.

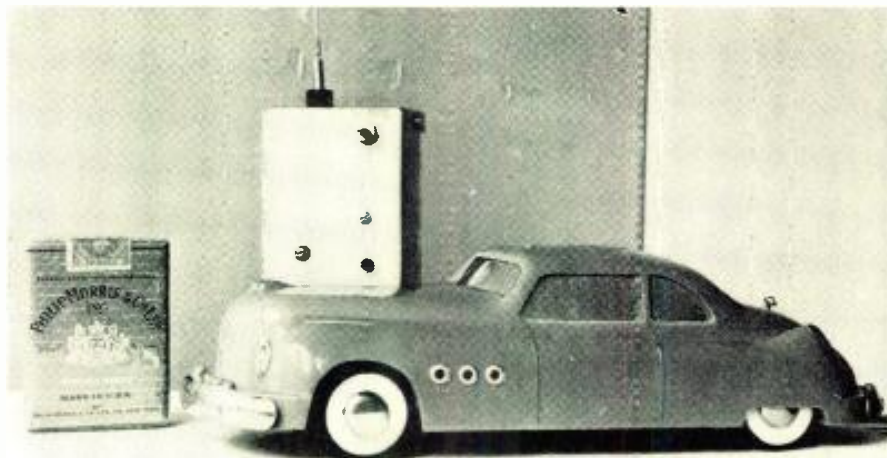

The model car and its transmitter shown beside pack of cigarettes to indicate size.

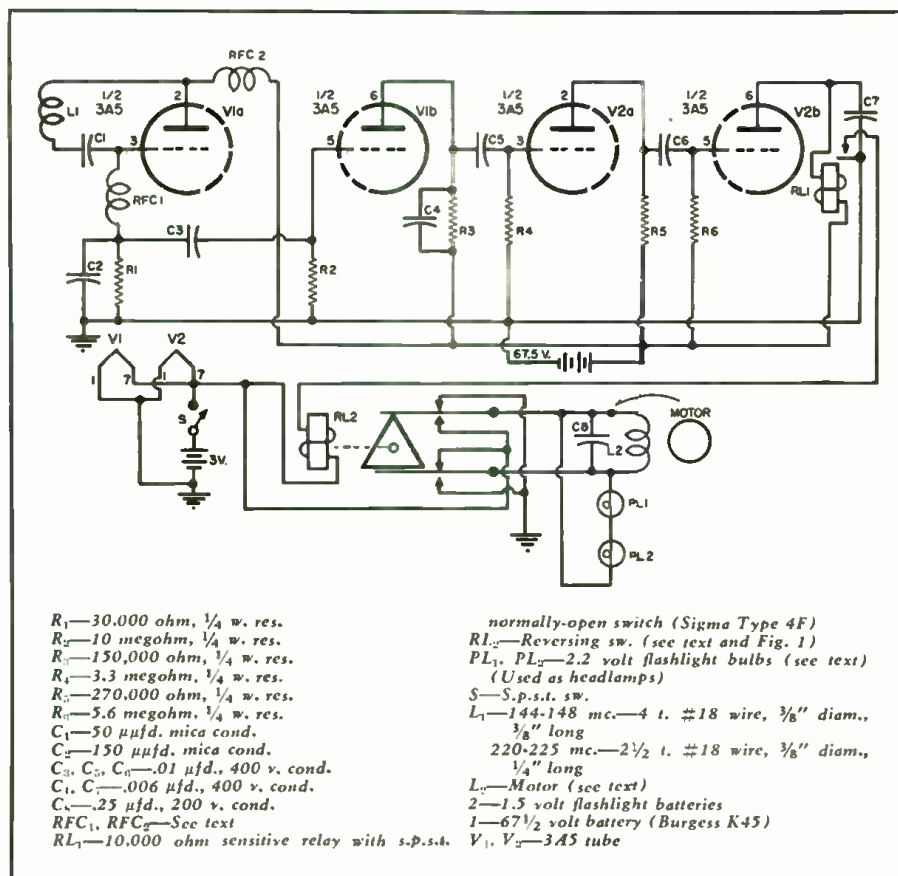
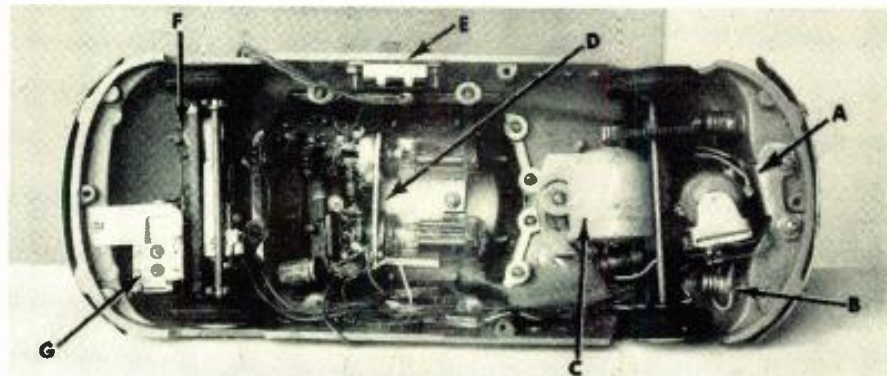
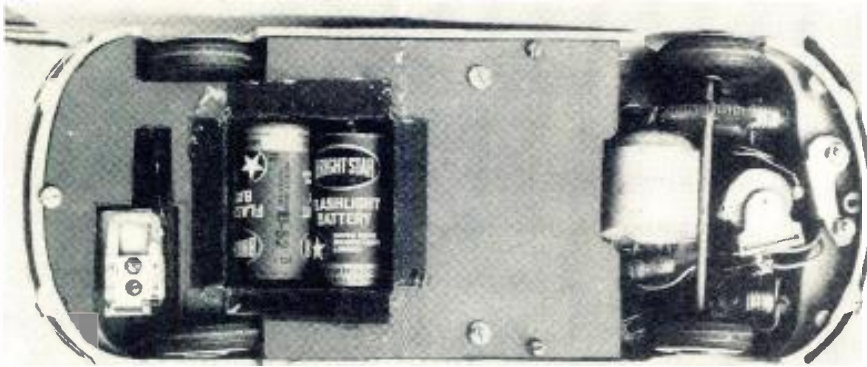

Fig. 4. Complete schematic of the receiver which is installed in the model car.

Bottom view of car with base plate removed. Components visible include: (A) sensitive relay, (B) head lamp, (C) drive motor, (D) receiver, (E) "on-off" switch, (F) decoder mechanism, and (G) the decoder relay. See text for complete details.





Bottom view of the model automobile with the base plate in its correct position.

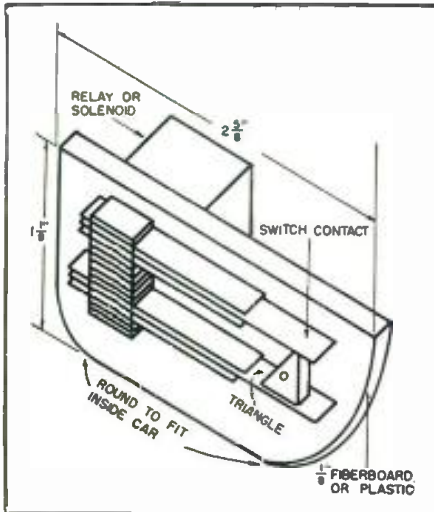

Fig. 5. Decoder switch mounting procedure.

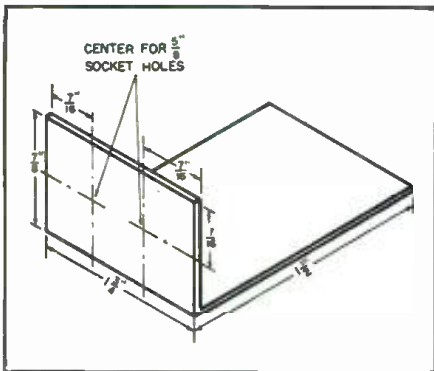
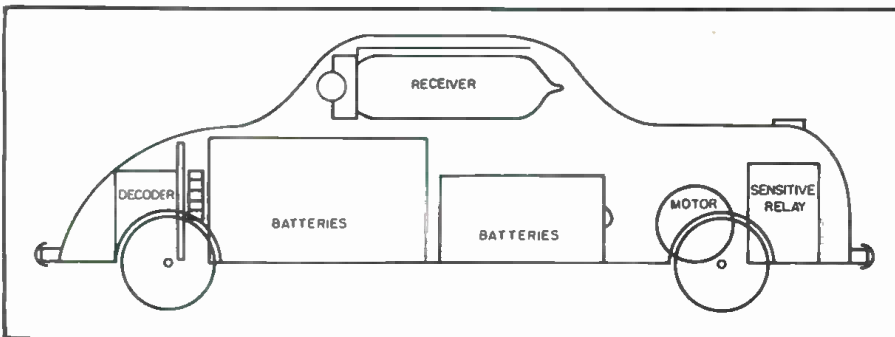

Fig. 6. Receiver chassis dimensional data. The chassis measures 1½ inches by 1¼ inches and has a ⅛-inch flange. It may be constructed of any lightweight metal.

Fig. 7. Outline drawing of the car showing how the various components are placed.



little ¼ watt units would make construction a little easier. Be sure to use mica or equivalent condensers in the r.f. circuit.

Space can be saved by making your own r.f. choke, about 35 or 40 turns of #36 wire on the body of a 15 megohm, ¼ watt resistor. A neat method of doing this is to clamp the resistor by one of its pigtail leads in the chuck of a hand drill, holding the drill in a vise. The wire can then be wound in the same way as was suggested for the relay coil.

As soon as the receiver is complete, connect the batteries. Use a pair of headphones in series with a .006 µfd. condenser and place this across the sensitive relay. A hiss should be heard in the headphones. If no hiss is heard either the amplifiers are not working or the detector is not superregenerating. Remove the headphones. The sensitive relay should be closed with power turned on. Touch the finger of one hand to the grid of the first amplifier stage and put the other hand on or near the 117 volt wire of the soldering iron. The relay should open and a 60-cycle buzzing noise should be heard.

If this buzzing is not heard, the amplifiers are not working. Recheck the circuit. Assuming that the amplifiers are OK and the hiss has been heard in the headphones another trouble might be that the relay will not close. This could happen because the audio fed into the amplifier by the detector does not allow sufficient current to flow in the final stage. Two things can be done to correct this. There should be sufficient shunt capacitance in the circuit to bypass the squelch frequency, but if there is not, the condenser *C_i* across the plate load resistor of the first stage of audio can be increased. Care should be taken not to increase it so much that the audio from the received signal will not open the relay. Another thing that may be done is to lower the voltage to the detector by placing a resistor in series with the "B+." Be certain, if this is done, that the tube is still in superregeneration as indicated by the hiss heard in the headphones.

When the set is operating properly the relay should close after the power is turned on and remain closed until a signal is received from the transmitter. A received signal should hold the relay open as long as it is being received.

This receiver, using the component values given in the parts list, should draw a total of 4 milliamperes with no signal being received. This will decrease when a signal is received.

Location of Components

Fig. 7 shows an idea of the correct location of the component parts of the control system. There is no spare room. Care must be taken that the parts do not occupy more space than has been allocated for them.

The receiver is mounted flush against the top of the car by a single 4-40 machine screw. The decoder is mounted beneath the rear axle with the relay

(Continued on page 106)

SUBMINIATURE 75-METER MOBILE CONVERTER

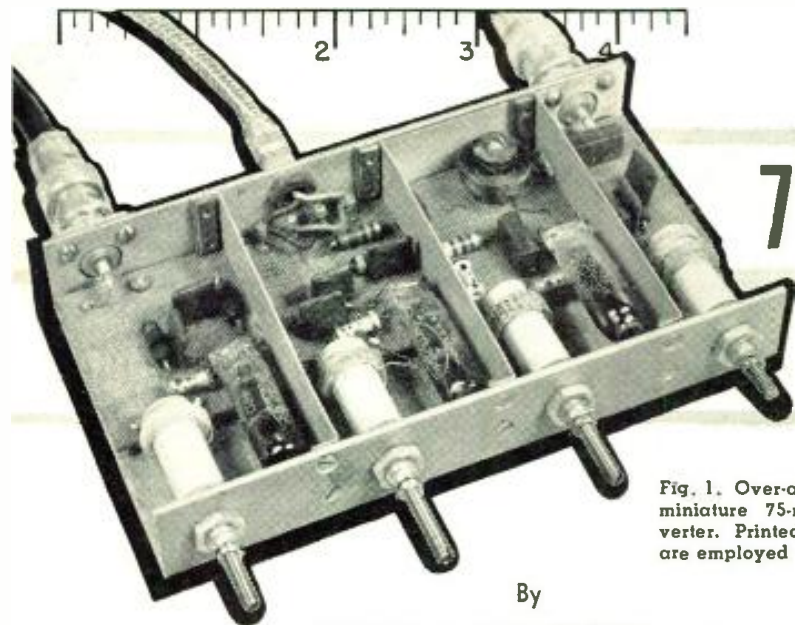

Fig. 1. Over-all view of the subminiature 75-meter mobile converter. Printed circuit techniques are employed in this construction.

By
SAMUEL J. LANZALOTTI, W2DVX
and
HARRY FRENCH, W2KQJ
Signal Corps Engineering Laboratories

Using Signal Corps miniaturization techniques, the authors have developed an extremely compact unit.

COULD you use a top-notch mobile converter about the size of a cigarette flat which can fit about anywhere in your car? If so, you can readily build it yourself.

After much experience in the design of new Army units, turning out first-rate performance in a few inches of space, we decided to apply identical techniques to a 75-meter mobile unit and see if our amateur model would perform like its military predecessors. It worked every bit as well and the finished product appears in Fig. 1.

Its intended use was primarily for civil defense needs where the compactness of the latest miniature circuit assembly and single-package techniques are major assets. The finished broadband converter passes the entire 75-meter band without appreciable loss even at its edges, and any frequency is selected within the band merely by tuning your auto radio (now the i.f. amplifier) from 1300 to 1600 kc. Couldn't be simpler.

The converter uses three subminiature *Raytheon* tubes with flying leads.

Two CK-605-AX's (CK-5702), one functioning as the mixer and one as the r.f. stage, are the subminiature equivalents of the popular 6AK5. A CK-608-AX (CK-5703) triode is used as the oscillator. Pin connections are shown in Fig. 2. The circuit shown in Fig. 4 was chosen for its simplicity. The r.f. and mixer stages were broadened to produce a response substantially flat over the entire band with sensitivity dropping off below 3800 kc. and above 4000 kc. The required band-pass is supplied through the design of the r.f. and mixer coils. To further simplify the circuit, no r.f. gain control was used, instead, the a.v.c. action and audio gain control of the broadcast receiver serve to control the weak and exceptionally strong signals. The r.f. stage is left wide open, operating at maximum gain. The only precaution necessary to prevent oscillations in the r.f. or the mixer stages was to use shields between stages. Tests were conducted to determine whether oscillations would occur when the screen was bypassed to the cathode or direct-

ly to ground without antenna loading. Since the stages did not oscillate, it was decided that bypassing of the screens should go directly to ground and grid 3 should be connected to the cathode.

No provision was made for regulating the oscillator plate voltage since simulated tests (using 3.9 mc. as reference) showed that the oscillator frequency fluctuation due to voltage variation, usually encountered in mobile operation, was insignificant. If desired, a crystal-controlled oscillator may be substituted for the variable frequency type. The variable frequency oscillator permits shifting of the i.f. (output frequency) to provide tuning of the 3800 to 4000 kc. band on the broadcast receiver anywhere between 1300 to 1600 kc.

Details of the coils are given in Fig. 5. All coils are pi-wound on *Cambridge Thermionic* slug-tuned ceramic forms, type LS-5. Spacing between the

Fig. 2. Pin connections for CK-605-AX, 608-AX.

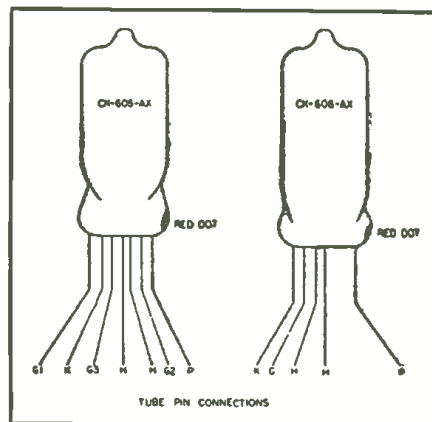
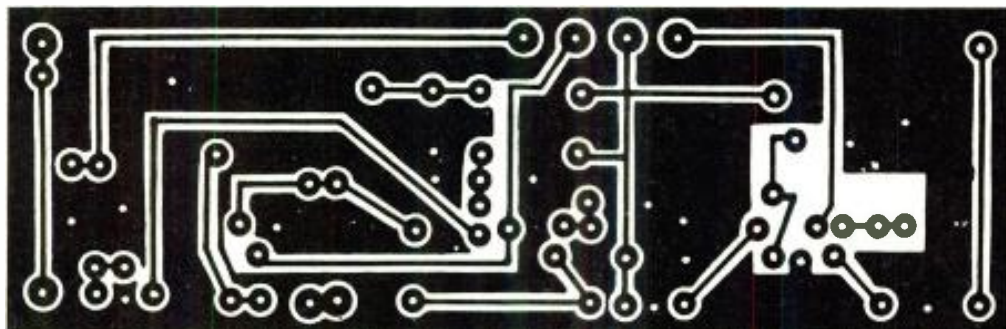

Fig. 3. Reproduction of template used by the authors. It is printed full-size in order to provide an exact copy for those who wish to make their own printed circuits. The blackened areas represent the copper circuit and the white areas represent the insulated or non-conducting areas. If every detail of this template is reproduced accurately, the builder should experience no difficulty in duplicating the subminiature converter described.



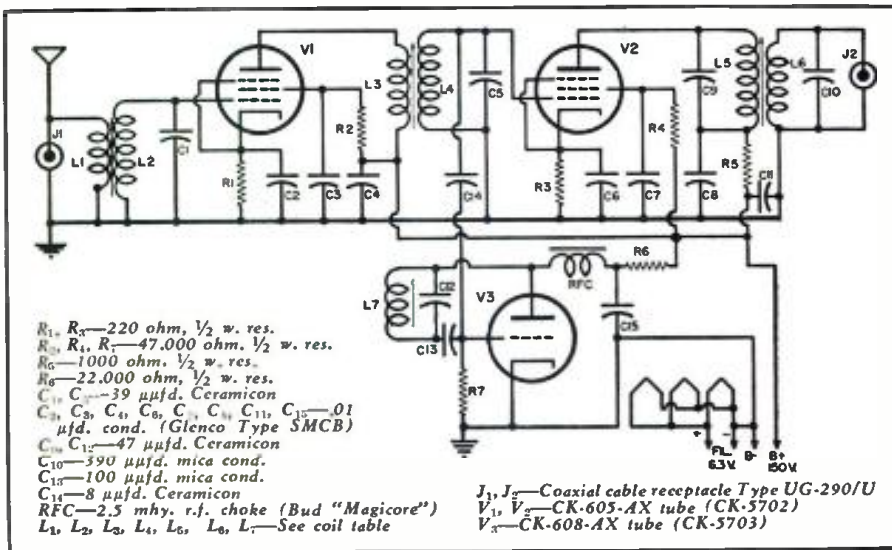

Fig. 4. Complete circuit diagram and parts list covering the subminiature converter.

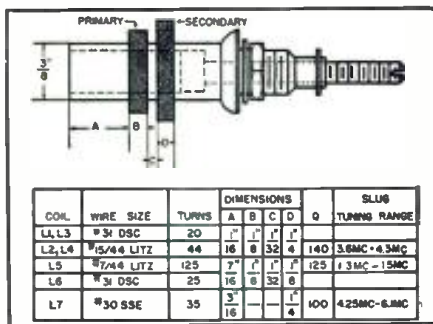

Fig. 5. Coil winding data. All coils are pi-wound on Cambridge Thermionic Type LS-5 coil forms, using a universal coil winder. All coils are tuned with Henry L. Crowley powdered iron slugs. Type D-1 (#C-3165).

primary and secondary coils is important since the amount of coupling will determine the over-all frequency response. For the lack of a universal coil winder, the coils may be layer wound using polystyrene coil dope

between layers to facilitate winding.

Pre-Fabricated Wiring

All wiring in the converter is replaced by a pre-fabricated circuit formed (etched) from copper foil bonded to a plastic laminate. Here's how any amateur can process the etched copper foil circuit:

The converter makes use of a pre-fabricated circuit formed from an etched copper foil-clad plastic laminate. These laminates are available from many of the plastic laminators, for example the *Formica Co.*, Cincinnati, Ohio; *Synthane Corp.*, Oaks, Pa.; *St. Regis Paper Co.*, Trenton, N. J.; *Richardson Co.*, Chicago, Ill.; etc. The laminate used in the converter consists of .00135" copper foil bonded to 1/16" thick XXXP phenolic (bakelite) base material. Price of this material is around \$2.00 for a sheet measuring 18" x 18".

The pattern of Fig. 3 (drawn to ac-

tual size) shows the complete etched wiring of the converter. Blackened areas represent the copper circuit and the white areas represent insulated or non-conducting areas. This pattern should be used as a template to fabricate an exact replica on the copper-clad phenolic laminate.

Many commercial etching concerns are currently supplying the electronic industry with metal foil patterns completely etched on various types of plastic base materials including phenolic, melamine, polystyrene, silicone, teflon, etc. The only requirement is that the etching concern be supplied with a pattern similar to that shown in Fig. 3, and specification as to the type of plastic base material and copper thickness desired. The commercial concerns employ mass production techniques involving offset flat-bed printing presses, silk screens, and the photo resist process similar to that used by photo engravers, to fabricate these patterns.

In the absence of elaborate equipment, the amateur or experimenter may fabricate similar patterns by preparing a silk screen stencil and squeegeeing silk screen enamel (the acid resist) onto the copper surfaced laminate. After drying, the laminate is etched in a bath of ferric chloride.

Another method for delineating (laying down) an acid resist pattern would be through the use of a draftsman's ruling pen and compass. Ordinary four-hour enamel thinned down to a proper consistency for use with a ruling pen may be used as the resist. Any color paint may be used. After drawing the circuit on the copper surface with paint, the panel is set aside and allowed to dry. When the paint is dry, the panel is placed, pattern side up, in a nonmetallic tray containing a sufficient amount of 50% solution of ferric chloride to cover the top of the panel. (It may be added, that *Dykem* steel blue ink has been found to work very well as a resist when used with a ruling pen, compass, or a fine paint brush.) Etching of the exposed copper is accomplished by rocking the tray; the etchant (ferric chloride) will flow from side to side, washing over the pattern. In about two to three minutes the exposed copper should be completely etched away. The pattern should be examined closely for short and open circuits. The etchant is composed of one part of ferric chloride by volume and one part of water by volume. Ferric chloride may be purchased from a photographic supply house. One pound costing less than thirty cents should be more than ample. The paint resist may be removed by a suitable solvent (cleaning fluid is satisfactory).

A simpler method that may appeal to the amateur is that of hand-cutting the copper foil. Trace the pattern, Fig. 3, on carbon paper placed over the copper side of the laminate to form pattern guide lines. By cutting along the carbon lines through the copper foil with a sharp pointed instrument or knife and then lifting and stripping

Fig. 6. Dimensional data for constructing aluminum case and the drilling template.

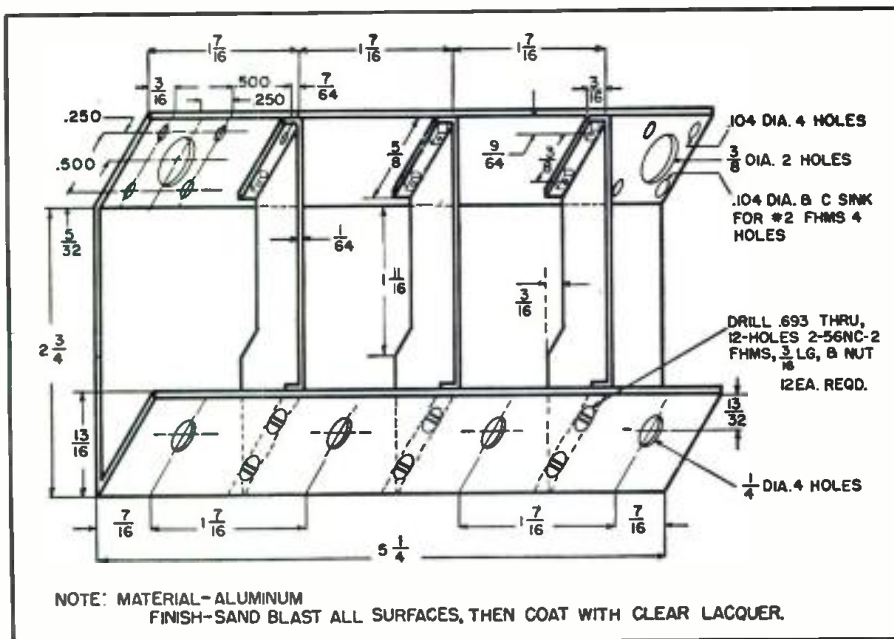

the unwanted copper (white areas) the complete circuit can be formed.

The panel is now ready for drilling of mounting holes and component terminations as indicated in Fig. 8. Holes are drilled with a #66 drill. This pattern may be used as a guide for locating the holes. Holes should be drilled with a #66 drill to permit a snug fit for the component leads. The components, including the tubes, are mounted on the top side of the panel (pattern side down) with their pigtail leads extending down through the holes in the panel, see Fig. 8. Solder the leads to the copper pattern (a 25-watt pencil type soldering iron should be used, and care should be taken not to apply too much heat), and cut off all the excess component leads as close to the pattern as possible. (In mass production similar assemblies are fabricated by automatic assembly techniques whereby the panel loaded with components is fluxed and lowered onto the surface of a molten solder bath—pattern side down—dip soldering the component leads and pattern in one operation.) In the final operation, the patterned side of the panel is coated with polystyrene coil dope for moisture protection. The panel is then ready for mounting in the aluminum case. The completed panel with components mounted and soldered is shown in Fig. 9. The panel should be spaced approximately $\frac{1}{8}$ " above the bottom portion of the case so that the copper circuitry does not short circuit to the case. The large copper ground portion of the pattern should make good electrical contact to the aluminum case through the use of metal spacers and screws. The coils and power leads are soldered to the proper eyeleted terminations on the panel. Small brass eyelets are used to assure a firm anchor for the coils and power leads. Complete constructional details of the aluminum case are shown in Fig. 6. Miniature "Hi-K" ceramic condensers are used for bypassing throughout the converter. These condensers are commercially available from the *Gulton Manufacturing Co.*, Metuchen, New Jersey. Similar units are available from *Erie Resistor Co.* and *Sprague Electric Co.*

The power requirements for the converter are 150 volts d.c. at 22 ma. and 6.3 volts at .6 ampere. Tuning and adjustments are accomplished in the conventional manner. The oscillator slug should be set to cover the desired range of 5 to 5.5 mc. for a tuning range of 3.8 to 4.0 mc. with an i.f. between 1300 to 1500 kc. The i.f. slug may then be adjusted to peak at 1400 kc. The required bandwidth will be sufficiently broad for reception of all signals in the 3.8 to 4.0 mc. band without loss of gain if the coils are wound as shown in Fig. 5. The choice of the i.f. to be used will be determined by the tuning range of the receiver with which the converter is to be used. Your unit will really work.

-30-

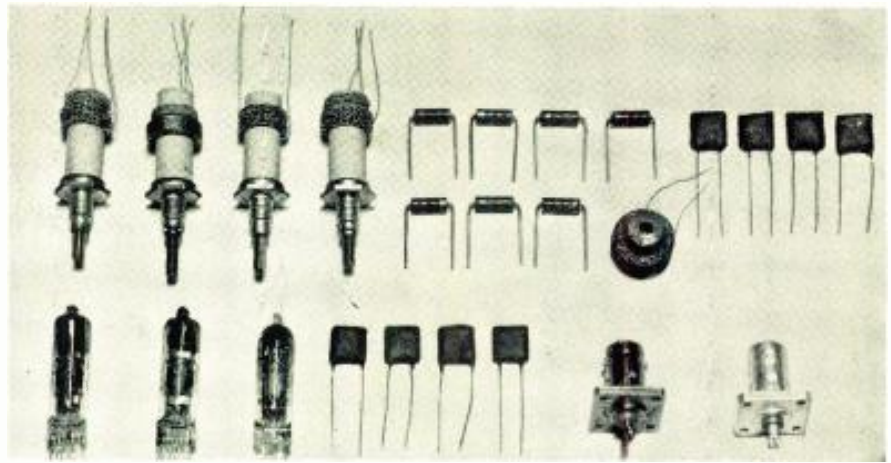

Fig. 7. Components for subminiature converter. All of the coils, resistors, inductor tubes, coax cable receptacle, etc., needed in construction are pictured.

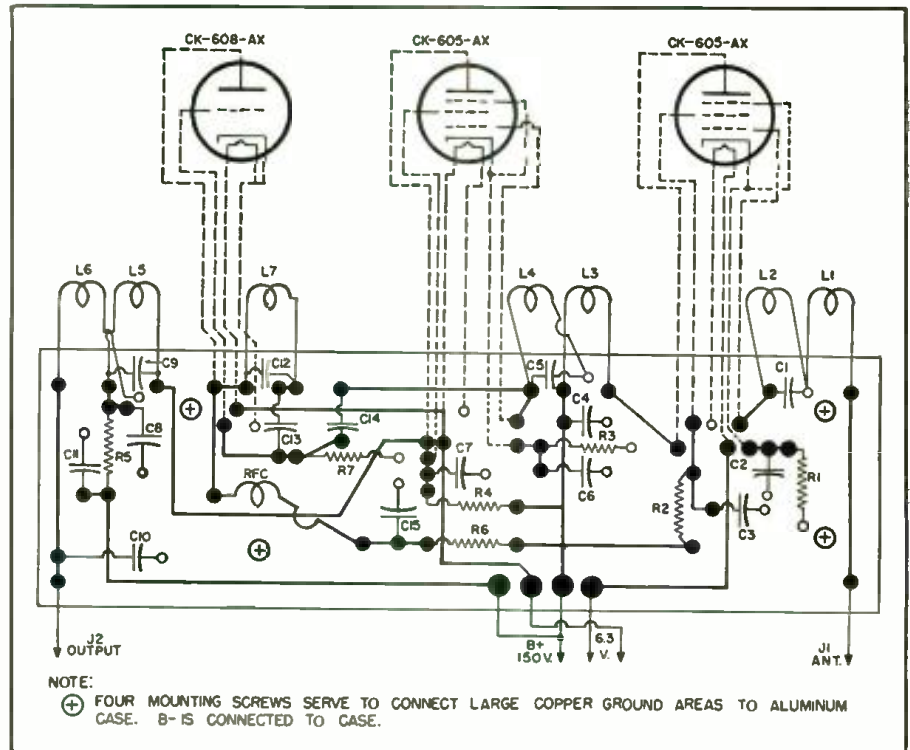
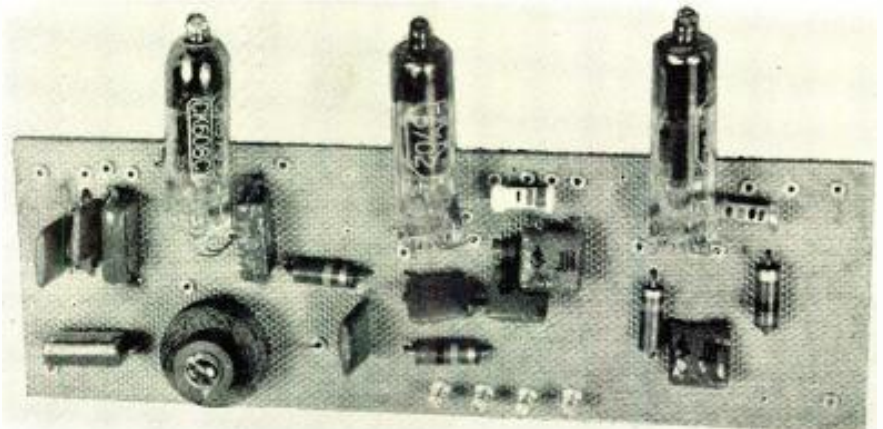
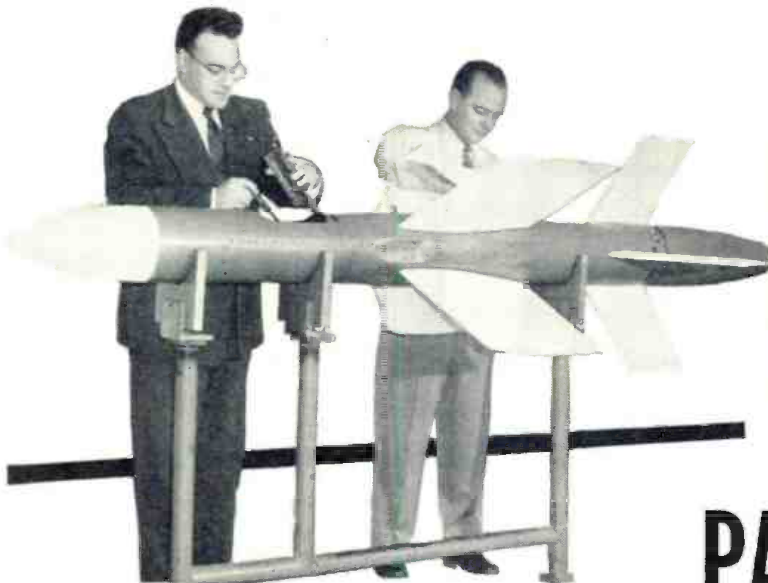

Fig. 8. Composite drawing (pattern down) showing placement of components with circuit wiring. The heavy solid lines indicate the printed circuit and, in the final form, appear on the rear portion of the panel shown. All components are mounted on the top of this panel, that is, on the opposite side of the printed circuit. All connecting leads are fed through eyelets to complete the circuit.

Fig. 9. Tubes and other components are mounted on reverse of printed circuit.





An application in which the ultimate in telescoped radar installations has been achieved. This is the Ryan "Firebird"—a first air-to-air guided missile.



Using a jeweler's tool and magnifying glass, this Ryan electronics engineer wires a packaged subminiature circuit used in the radar equipment developed by Ryan.

PACKAGED RADAR

By **WILLIAM WAGNER**
Ryan Aeronautical Company

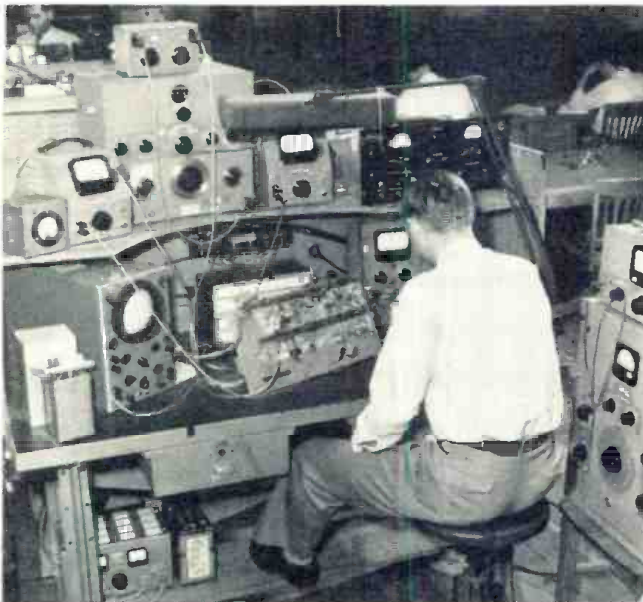

Surrounded by a maze of intricate electronic test equipment, this Ryan engineer checks an experimental circuit.

Radar, one of the greatest technical advancements of World War II, utilizes huge parabolic scanners to transmit signals and receive echoes from enemy aircraft in flight.



FLYING radar stations for use in extremely advanced-type aircraft are being built experimentally at *Ryan Aeronautical Company* in "packages" so small they could almost fit into a briefcase or handbag.

The flying radar station consists of an "intelligence" head, electronic circuitry, and a power supply which provides the various voltages required. Tubes, resistors, and coils no larger than a fingernail, a paper clip, or a key are packaged amidst an intricate maze of wiring, some strands of which are as small as 3/1000th of an inch. The cylinder housing the brain is likely to be less than a foot in diameter and perhaps two feet long.

The "brain" contains the transmitter and receiver. The information reflected back to the unit is received by a midget equivalent of the "dish" style antenna of larger radar installations. The information thus received is channeled to two locations—the "brain" to determine the navigation required, and the aircraft controls for making the necessary flight adjustments.

The problems involved in producing such equipment include not only all of the problems inherent in miniaturization but also problems encountered because of the extremes of temperature at which the equipment is to operate and those which arise because of the vibration and shock to which the gear is subjected.

The time-consuming and painstaking procedures necessary to develop this equipment have been worked out satisfactorily and "packaged radar" is now a reality. —30—

(Left) No larger than a package of cigarettes, this 5-tube miniature radar amplifier has been compressed into unbelievably small proportions. (Right) Viewed with a thumb tack and paper clip for comparison, this miniature diode indicates the scale on which radar units are being built.



MOBILE RADIO

By

LEO G. SANDS

Bogue Railway Equipment Division

THE radio spectrum, or the ether, for want of a more appropriate description, belongs to the people. It is an asset not to be bartered or sold. However, as is the case with most of our actions, its use must be regulated. Otherwise there would be such chaos that few would really benefit.

In the very early years of radio, the ether could be used by anyone as he chose. As the art of radio communication progressed, it became apparent that the use of radio had to be regulated.

The authority to assign radio frequencies and to issue licenses was vested in the United States Department of Commerce. As Secretary of Commerce, Herbert Hoover was the top regulating officer over radio communications.

When radio outgrew its original regulatory body, Congress passed an act setting up the Federal Radio Commission which was later superseded by the present Federal Communications Commission.

The Federal Communications Commission issues licenses, assigns frequencies, and enforces the laws, rules, and regulations governing the use of radio. The Commission governs communications with the consent of the governed. The rules and regulations of the FCC are usually drafted after extensive hearings have been conducted to determine how the public can best be served.

Radio communications are employed by many industries for a multiplicity of purposes. The users of radio are classified into services such as the Maritime Radio Services, Land Transportation Services, Industrial Radio Services, etc. Mobile radio is a general definition of radio services wherein radio communications are conducted between moving vehicles and land-based radio stations or from one vehicle to another.

Because the radio spectrum can be divided into only so many channels, it is necessary to control the use of radio communications so the public interest is best served. Exclusive of broadcasting stations or communications common-carriers, radio is not used directly for profit making purposes. However, the use of radio does provide indirect profits or direct operating economies for many services and industries.

In general, the basic policy is to

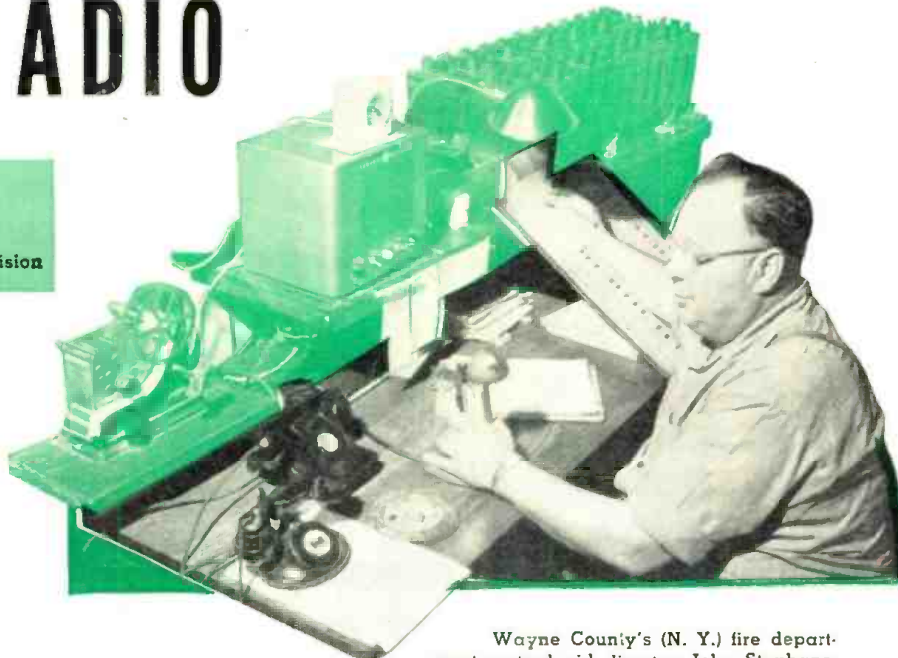

Wayne County's (N. Y.) fire department mutual aid director, John Stephans, speeds calls with G-E two-way radio equipment.

Part 2. How to obtain a mobile station license, FCC rules and regulations, correct application forms to use, etc.

issue licenses to those applicants whose use of radio communications will be in the public interest, necessity, or convenience. Where adequate facilities are available through common carriers at reasonable cost, authority to use radio might not justifiably be granted.

A portion of the radio spectrum has been set aside for use by individuals and organizations not eligible for licensing in any of the regularly established or developmental radio services. This band, called the Citizens Radio Band, may be used by any citizen such as the housewife or a business organization specifically excluded from using other radio services.

The prime requisite for obtaining a radio license is that the applicant, if an individual, must be a citizen of the United States. Likewise, corporations and associations must be owned and controlled by American citizens.

A potential user of two-way radio communications should first determine into which service his proposed communications system falls. This can be determined by a study of the rules and regulations of the Federal Communications Commission, copies of which may be obtained from the Government Printing Office.

When it has been determined in which service the potential user of two-way radio is eligible, application should be made for radio station construction permits. A separate permit is required for each base station whereas a single permit may cover any number of mobile or hand-carried portable stations.

After construction permits have been granted, the applicant may install and

test the equipment covered by the permits in accordance with the terms of the grant and the applicable rules. Upon completion of the installation and tests, application may be made for licenses which will permit operation of the radio stations for a specific period unless authorization is revoked before the license expiration date.

A radio communications system, except in the Citizens Radio Service, can be operated only under the jurisdiction of a licensed operator. In most mobile services, a third class or restricted radio-telephone operator's permit is adequate. This type of license can be obtained by a United States citizen who certifies familiarity with the applicable laws, is able to transmit and receive messages in spoken English, and can read and write English or a language in common use, that is readily translatable into it.

Only a person holding or working directly under the supervision of another person holding either a first or second class radio telephone or telegraph operator's license is permitted to make adjustments on a radio transmitter. Such a license requires considerable technical knowledge as well as familiarity with applicable laws.

Radio operator and station licenses are issued by the FCC to qualified applicants without charge. Restricted radio-telephone operator permits may be secured by mail but operator licenses of higher classification require that the applicant pass written examinations which are given at certain places designated by the Commission.

FCC form 401 is generally used for making application for radio station construction permits in the mobile

FORM NUMBER	PURPOSE
401	Application for radio station construction permit
401-A	Description of proposed antenna structure
401-B	Application for police, fire, or forestry radio station construction permit
403	Application for radio station license
405	Application for renewal of radio station license
405-A-1	Application for renewal of radio station license (short form)
408	Application for experimental or special temporary authority
425	Informal application for special temporary authority
456	Notification of completion of radio station construction
505	Application for Citizens Radio station construction permit and license
701	Application for additional time to construct radio station
702	Application for consent to assignment of radio station
703	Application for consent to transfer of control of corporation holding construction permit or station license
756	Application for Radio Operator license or permit
756-B	To be submitted with form 736

Table 1. The correct FCC application forms for different phases of mobile service.

radio services. A special simplified form, 401-B, may be used by the police, fire, or forestry-conservation radio services. Form 401-A, sometimes required with applications, concerns antenna installations which might constitute an air-navigation hazard.

An application for a radio station construction permit for a mobile radio system consists of a letter of transmittal, two copies of form 401 for the base station (or 401-B if applicable), two copies of form 401 for the mobile stations, and, when required, four copies of form 401-A. In addition, exhibits such as financial statements and

supplemental statements, when required, should be included in duplicate.

The letter of transmittal should be addressed to Mr. T. J. Slowie, Secretary, Federal Communications Commission, Washington 25, D. C. This letter should list the documents included in the application, a statement as to why authorization to use radio should be granted, and any pertinent facts, particularly regarding any special conditions. The letter should be signed by the same person signing the application forms.

Form 401 is not difficult to complete if the applicant or his agent reads the

application form carefully and checks the applicable rules and regulations. The formal name and address of the applicant should be printed or typed in at the appropriate spaces at the top right of page one of form 401.

The first section of item #1 of form 401 requires identification of the applicant as an individual, partnership, association, or corporation. If an individual, the blank spaces of item #1 require information on the citizenship of the applicant. If the applicant is not an individual, all of the blank spaces of item #1 may be marked "not applicable."

Item #2 requires a "yes" or "no" answer of all applicants as to whether the applicant is a representative of an alien or foreign government.

Item #3 should be filled in completely if the applicant is a corporation. If not a corporation, all of the blanks may be marked "not applicable."

Item #4 (a) should note the class of station such as "base station" or "mobile station," whichever is applicable. Item #4 (b) should designate the nature of service such as "Railroad Radio Service," "Petroleum Radio Service," "Low Power Industrial Radio Service," etc. Item #4 (c) should be checked to denote that the application is for a new station. If not for a new station, items #4 (d) or #4 (e) should be filled in with the required information, in which case the boxes below will require checking.

The next space, still item #4, requires a statement describing the applicant's principal business, e.g., "Railroad Common Carrier," "General Contractor," "Petroleum Refiner," "Common Carrier Pipe Line Operator," etc.

Item #5 should be filled in if the applicant is a corporation controlled directly or indirectly by another corporation. If this is not the case, all of the blanks may be marked "not applicable."

Item #6 should be filled in if applicant is an unincorporated association; if not, these spaces may be marked "not applicable."

Item #7 requires information on the applicant's interest in other radio stations. If the answer is "yes," detailed information may be given on a separate sheet if necessary and the blank space should be marked, "see exhibit A or B," as the case may be. This information applies to amateur radio station operators too.

If the applicant is to be the owner of the proposed radio station, item #8 should be filled in "owner" in the top box and "not applicable" in the middle box. If the equipment is to be loaned or leased, the top box should designate the relationship of the applicant to the station and a copy of the lease or other agreement with the owner should be attached. The top box should also state "see exhibit B or C," as the case may be and the middle box should list the name of the owner. The lower box requires a "yes" or "no" answer and if "no," a copy of the

Table 2. The sections of the FCC regulations that apply to various mobile services.

TYPE OF BUSINESS	NATURE OF SERVICE	COVERED BY FCC RULES & REGULATIONS
Ambulance	Special Emergency Radio Service	Part 10
Auto Towing Service	Automobile Emergency Radio Service	Part 16
Automobile Owners Clubs	Automobile Emergency Radio Service	Part 16
Beach Patrols	Special Emergency Radio Service	Part 10
Coal Mine	Special Industrial Radio Service	Part 11
Delivery Service (urban)	Citizens Radio Service	Part 19
Department Store	Citizens Radio Service	Part 19
Diaper Service	Citizens Radio Service	Part 19
Electric Utility	Power Radio Service	Part 11
Fire	Fire Radio Service	Part 10
Fishing Boats	Citizens Radio Service	Part 19
Forestry Conservation	Forestry-Conservation Radio Service	Part 10
General Contractor	Special Industrial Radio Service	Part 11
Highway Maintenance Crews	Highway Maintenance Radio Service	Part 10
Highway Trucking	Highway Truck Radio Service	Part 16
Housewife	Citizens Radio Service	Part 19
Industrial Plant (Large)	Special Industrial	Part 11
Intercity Bus Lines	Intercity Bus Radio Service	Part 11
Logging Camp	Forest Products Radio Service	Part 11
Manufacturers	Low Power Industrial Radio Service	Part 11
Motion Picture Producer	Motion Picture Radio Service	Part 11
Movie Location Crews	Motion Picture Radio Services	Part 11
Natural Gas Distributor	Power Radio Service	Part 11
Natural Gas Pipe Line Transportation	Petroleum Radio Service	Part 11
Newspaper	Relay Press Radio Service	Part 11
Newspaper Reporter	Relay Press Radio Service	Part 11
Petroleum Pipe Line	Petroleum Radio Service	Part 11
Physicians	Special Emergency Radio Service	Part 10
Police	Police Radio Service	Part 10
Press Association	Relay Press Radio Service	Part 11
Radio & Television Service	Citizens Radio Service	Part 19
Railroad (captive)	Special Industrial Radio Service	Part 11
Railroad (common carrier)	Railroad Radio Service	Part 16
School Bus	Special Emergency Radio Service	Part 10
Sheriff	Police Radio Service	Part 10
Taxicabs	Taxicab Radio Service	Part 16
Tree Farmer	Forest Products Radio Service	Part 11
Urban Bus Lines	Urban Transit Radio Service	Part 16
Yachts	Citizens Radio Service	Part 19

contract or document which affects applicant's absolute control of the station should be attached, again calling attention to the attachment by referring to "exhibit so and so."

Item #9 may be filled in with a statement to the effect that ample funds are available to cover cost of construction and operation of this station. A copy of the applicant's financial statement may be attached in which case reference to the exhibit should be made in the box.

Item #10 requires a "yes" or "no" answer and item #11, if "no," may also include the statement "not a communications common carrier."

Item #12 is divided into seven columns. Column (1) requires a list of all of the transmitting frequencies which the applicant desires to use. They should be noted in kilocycles. Generally, only one frequency is required. The frequency to be requested should be cleared with the industry organization which allocates channels in the applicant's particular industry, e.g., the Petroleum Industry Electrical Association, Association of American Railroads, etc. Where only one frequency in any one band is listed in the rules for the applicant's particular service and application, this frequency may be requested without consultation of the coordinating agency.

Column (2) requires information on the hours the applicant proposes to operate on this specific frequency. In most cases in the mobile services, "unlimited" is noted in this space.

At column (3), alongside each requested frequency, the power input in watts to the final radio frequency stage or the power output in watts fed to the antenna should be noted. Indicate whether this is input or output. This information may be secured from the manufacturer of the transmitter to be used.

Information for column (4) again may be obtained from the manufacturer. Usually this is filled in as "F-3" designating frequency-modulated radio telephony or "A-3" for amplitude-modulated systems.

At column (5) the highest modulating frequency should be noted, usually 3000 cycles for voice transmitters. Column (6) is filled in as "not applicable" if the application concerns radio telephony.

If the application is for a base station, the seventh column, "points of communication," should be filled in "associated mobile units in general vicinity of this station. See accompanying application."

On the other hand, the application form covering mobile units should specify "associated base station. see accompanying application." If communication between mobile units is contemplated, it may be so stated in this column.

At item #13 the quantity, make, and type or model number of transmitters to be operated should be noted. At the bottom of page 2 are several spaces requiring information on the



Foreman W. J. Lynch of the Colorado Interstate Gas Company uses his General Electric two-way radio equipment to talk to the company's headquarters 15 miles away.

tube complement of the transmitters. Generally, this information has been filed with the FCC by the manufacturer and if this is so, the applicant may write across this section: "data on file with FCC." This also applies to the continuation of item #13 on page 3 and item #14.

At item #15 (a) it may be stated that the station frequency will be checked at regular intervals. If the transmitter frequencies are to be checked by a service organization, its name and address should be noted at #15 (b) and items #15 (c), #15 (d), #15 (e) and #15 (f) may be marked "not applicable."

However, if the applicant plans to do his own frequency checking item

#15 (b) should be marked "not applicable" and the other sections of item #15 should be filled in with the desired data.

Item #16 (a) should note the estimated cost of the transmitter, antenna system, receiver, any special power equipment, installation labor, etc. At item #16 (b) the answer is "not applicable" unless the applicant is a communications common carrier which provides communications service for a fee.

Applications for a base station require no answer at the top line of item #17 but do require accurate answers on location. The exact latitude and longitude of the base station must

(Continued on page 163)

A compact and effective two-way radio installation using Motorola's equipment.

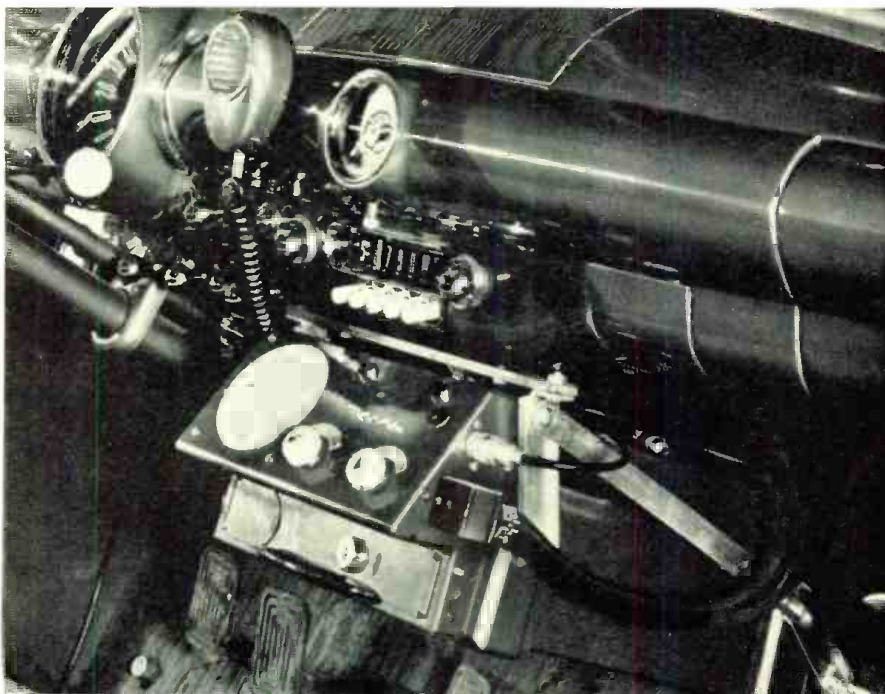

UNIVERSAL DESIGN CURVES

FOR TONE-CONTROL CIRCUITS

By M. B. KNIGHT
RCA Victor Division, Harrison, N. J.

Part 4. The final article in this series covers a circuit for variable treble boost and attenuation.

THIS is the final article in the current series on practical RC tone-control circuits. These articles describe simple circuit arrangements suitable for particular types of tone control and include frequency-response curves obtained with each circuit. The curves permit rapid evaluation of the ability of a circuit to fulfill specific design requirements. They also indicate the preferred potentiometer taper and facilitate the choice of component values.

The three preceding articles and the author's article in the November, 1951,

issue gave universal design curves for six different tone-control circuits. Part 4 presents a seventh circuit. This circuit is adjustable for treble boost or attenuation with a single control.

Treble Boost and Attenuation

The circuit selected as most practical for either attenuating or boosting the treble with a single control is shown in Fig. 1. If the equivalent source impedance of the tube V_1 , and its plate load resistor (which is the effective parallel value of the plate load resistor, R_p , and the plate resistance, r_p , of the tube) is small compared to resistor R , the constant-voltage equivalent circuit of Fig. 3 may be used. If the source impedance is not small compared to R , the available boost will be reduced, some gain will be wasted, and the high-frequency response may be degraded.

The frequent appearance of the constant a in the component values should be explained. This circuit, in the generalized form, has too many variables for the type of analysis we are making, which is a common difficulty with more complex circuits. The number of variables can be reduced, however, by assigning certain relationships between the components. The particular relationships chosen were dictated by practical con-

siderations. In order to make it possible to adjust the control for flat frequency response it is necessary for the ratio of the condensers to be the inverse of the ratio of the resistors in the voltage divider. The choice of the value for the potentiometer is not quite so direct. One consideration in the determination of this value is that if it were too small, condensers C and C/a in series would shunt the output of the tube V_1 , and degrade the high-frequency response. If we assume the source impedance of the tube to be $1/10 R$ or less, the potentiometer should be at least as large as aR to avoid any adverse effect on high-frequency response. The lowest value of source impedance of practical voltage amplifiers having a gain of 10 or more is on the order of 10,000 ohms. Resistor R should be at least 10 times that value, or about 100,000 ohms. If the design requirements for the circuit are for 20 db of boost, the value of a must be 10, which makes aR one megohm. This minimum value also approaches the practical maximum dictated by the values available in inexpensive pots. It was considered a practical compromise, therefore, to assign this value aR to the pot.; particularly in view of the fact that our calculations were considerably simplified by that choice.

Three universal design curves for this circuit are presented in Figs. 2, 4, and 5. One disadvantage of this circuit is that the boost and attenuation are not symmetrical, that is, they do not occur at quite the same frequency. The symmetry of the boost and attenuation characteristic can be improved by making the value of the potentiometer larger than that assigned, but the practical limitations may be rather severe, as explained previously. The curves are approximately correct, however, if it is practical to use a larger value potentiometer and the curves can be used as a guide to determine the condenser values. The boost and attenuation curves become less symmetrical if a smaller value potentiometer is used.

It may be noticed that the frequency-response curves for this circuit, and for others given in previous articles, cross the zero axis. Although the amount of crossover (one or two db) is so small as to be insignificant to the human ear, the form of the curve represents a departure from what might be expected from a simple physical concept of the circuit behavior. Frankly, when such effects appeared, it was suspected that some error had been committed in the calculations. However, more thorough study revealed that these effects are characteristic of the circuits. The use of a larger value

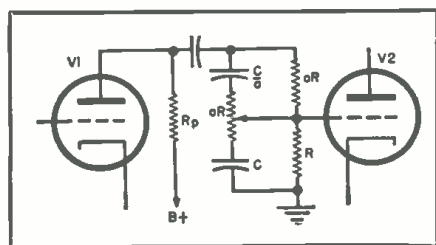

Fig. 1. Circuit which provides variable treble boost and treble attenuation.

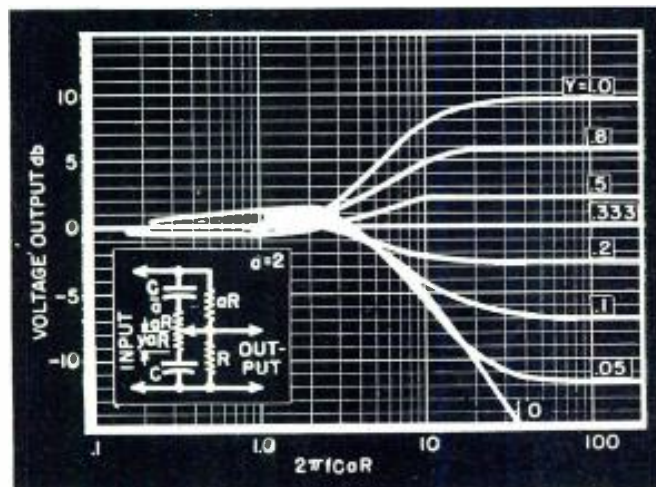

Fig. 2. Design curves for Figs. 1 and 3 with " α " equal to 2.

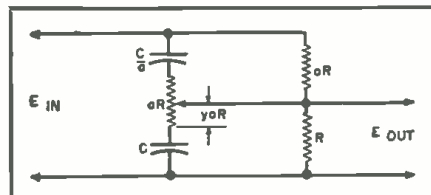

Fig. 3. Equivalent circuit for Fig. 1.

for the potentiometer in Fig. 3 increases the amount of crossover.

As an example of the application of the design curves, it might be well to consider a circuit which requires some interpolation in the use of the curves. Let us set up a requirement for a treble tone control that can provide 12 db of boost. (There is no limit to the attenuation capabilities with this circuit, of course.) A further requirement of the circuit for this example will be that, with the control set for maximum boost ($y = 1^*$), 3 db of boost should occur at 2000 cycles. The maximum boost from this circuit in db is equal to $20 \log(a + 1)$. Setting this expression equal to 12 db and solving for a , we find that a should be 3.0 (rounded off to two significant figures). If we select a 1-megohm potentiometer, aR is one megohm and R is 330,000 ohms. The equivalent source impedance of the tube V_1 should be 33,000 ohms or less. The maximum boost curve with a equal to 2.0 (Fig. 2) has an abscissa value of 3.7 for 3 db of boost. The abscissa value for the same conditions taken from Fig. 4 (a equals 5.0) is 6.5. Interpolation for a value of 3.0 for a gives an abscissa value of 4.6. It may be noted that the difference between the values used in the interpolation is so small that the interpolation is of little significance from a practical standpoint. The expression containing frequency with which all the curves of these articles were plotted was chosen deliberately to minimize the need for interpolation between curves. Having the interpolated value, however, we may solve for C .

$$2\pi fCaR = 4.6$$

$$C = \frac{4.6}{2\pi faR} = \frac{4.6}{2\pi (2000) (10^{-6})}$$

$$C = 3.66 \times 10^{-10}$$

$$C = 366 \text{ micromicrofarads}$$

The two condensers, C and C/a , would be 330 micromicrofarads and one-third of that value or 100 micromicrofarads (rounded off to RTMA

(Continued on page 74)

* y denotes the setting of the tone control and is defined to mean the fraction of the total resistance of aR included between the wiper of the pot. and the junction of C with the pot.

Fig. 4. Design curves for Figs. 1 and 3 when "a" is equal to 5.

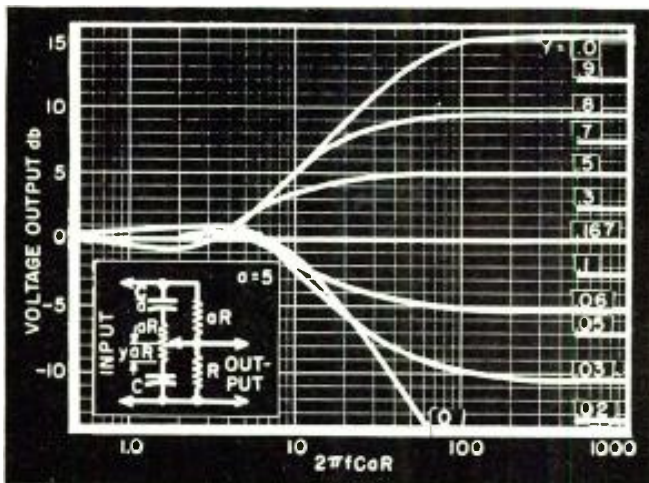

Fig. 5. Design curves for Figs. 1 and 3 when "a" is equal to 10.

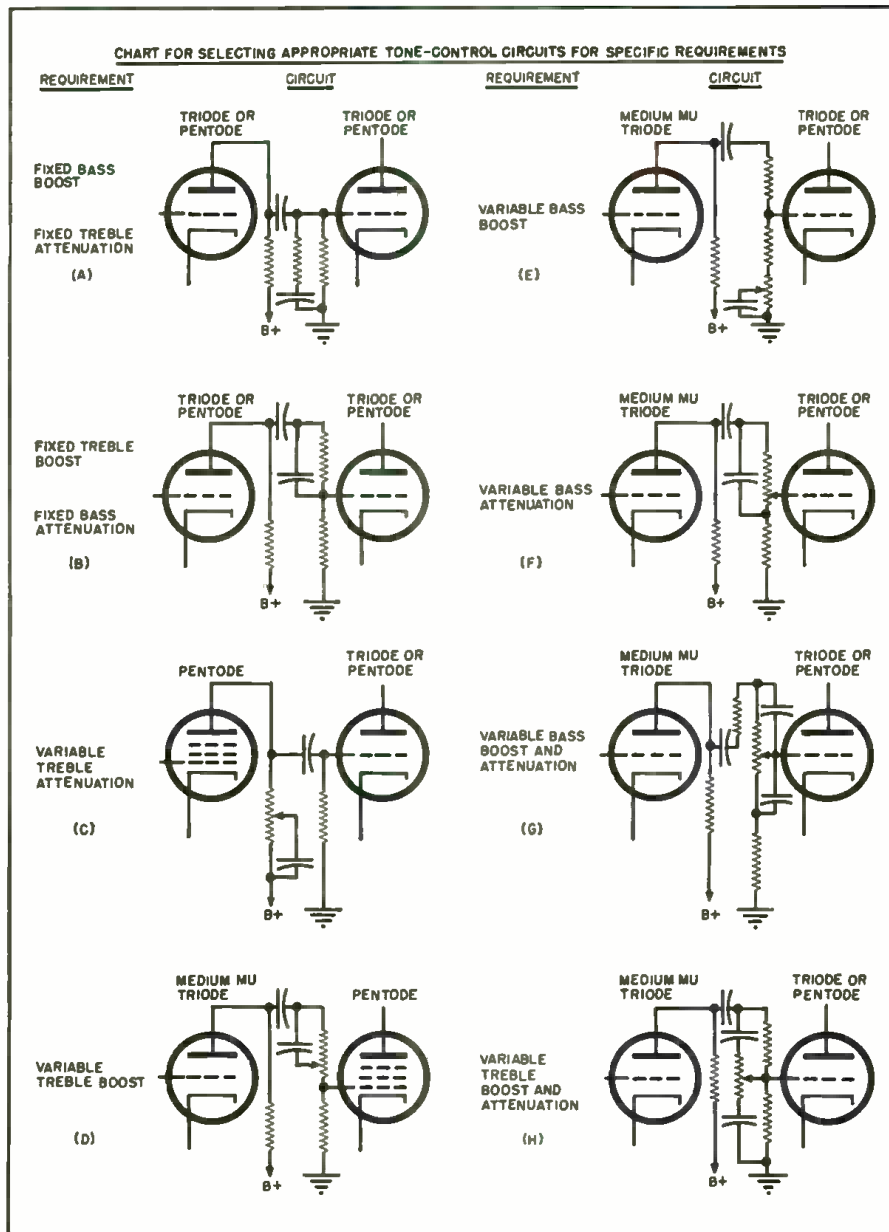
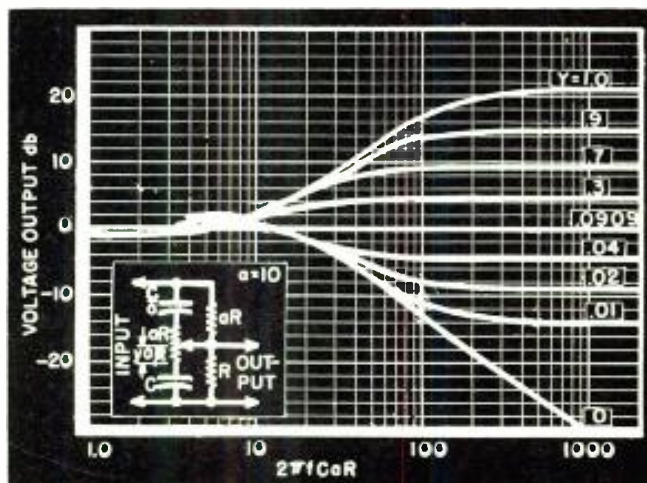
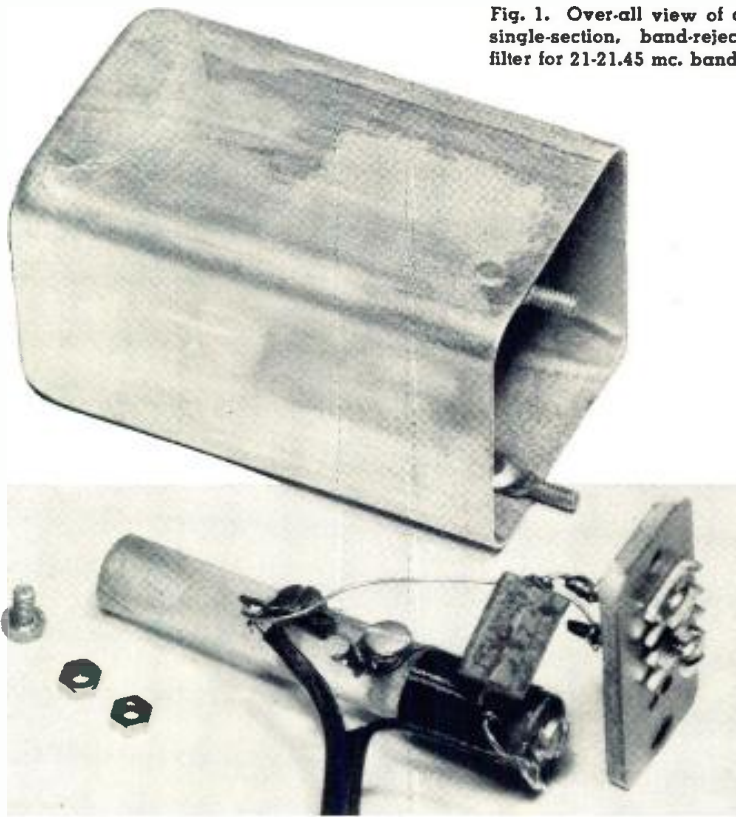

Chart for selecting tone control circuits for specific requirements. For more detailed information refer to the original discussions on these circuits as follows: (A) Fig. 1, Nov., 1951 issue. (B) Fig. 2, Nov., 1951 issue; Fig. 8, Part 2; and Fig. 5, Part 3. (C) Fig. 4, Part 1. (D) Fig. 2, Nov., 1951 issue. (E) Fig. 2, Part 2. (F) Fig. 8, Part 2. (G) Fig. 6, Part 3. (H) Fig. 3, Part 4. Part 1 appeared in the July, 1952 issue. Part 2 in the August, 1952 issue. Part 3 in the September issue. This article is Part 4.

Fig. 1. Over-all view of a single-section, band-reject filter for 21-21.45 mc. band.



A complete resumé of the servicing techniques to be employed in eliminating 21 mc. amateur interference.

AS MORE and more amateurs begin operation in their *legally-assigned* band from 21 to 21.45 mc., the greater will be the demand on technicians to handle the interference arising from such operations.

Since more than half of all the television sets now in use feature a separate sound i.f. channel, usually tuned to 21.25 mc., these receivers often require adjustment when amateur interference is encountered.

Intercarrier-type receivers often feature traps tuned to 21.25 mc. and the actual sound i.f. is 4.5 mc. Unless a very strong interfering signal is present, a ham transmitter will have no effect. Misalignment of the i.f. section can cause some interference in the picture, but the remedy for that is simple. A few TV receivers using a separate sound i.f. have this section tuned to 21.6 or 21.9 mc., reducing the chance of interference somewhat, but in most cases the sound i.f. channel is sufficiently wide to pick up even a 21.25 mc. signal.

Ham interference is fairly easy to recognize because of two important characteristics. It is present only during certain hours, the operating time of the ham, and it appears only for short periods, usually no more than ten minutes at a time. This is due to the fact that the transmitter is on the air only while a message is being sent and is off during the time the reply is being received. The 21 mc. interference is usually noticeable only

in the sound section unless the set is misaligned or the interference is extremely strong. On strong signals the sound may disappear entirely and be supplanted by a squeal, gurgle, or even the operator's voice. The picture may tear, show striped and herringbone patterns, and generally become unusable. Medium strength interference may show up only lightly on the screen as a weaving set of stripes and will result in distorted TV sound, squeals, and gurgles. Light interference is apparent only in weak and distorted sound with the weaving patterns visible only when the fine tuning control is tuned through the band.

Before attempting to eliminate this type of interference we must know where and how it enters the TV receiver. There are three main points of vulnerability and the interference can enter by any or all of them. The

Fig. 2. Curve showing result when the sound i.f. is shifted from 21.25 mc. to 21.6 mc.

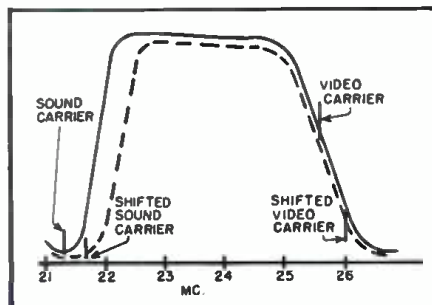

ELIMINATING 21 mc. INTERFERENCE

By
WALTER H. BUCHSBAUM
Television Consultant
RADIO & TELEVISION NEWS

most frequent source is through the antenna and transmission line, even though these sections are tuned to a much higher frequency. It is also possible for the 21 mc. signal to come into the TV set through the a.c. power line or, finally, it can be picked up directly by certain components in the TV receiver. To locate the source of the interference is not too difficult if the process of elimination is used. Disconnecting the lead-in at the receiver and shorting the antenna terminals will eliminate the interference if it was picked up by that section. Bypassing, filtering, and just squeezing the a.c. power line will have an effect only if that is the source. Pulling tubes in the chassis itself will spot the particular circuit responsible for the interference.

Detuning the I.F.

One obvious remedy for 21 mc. interference appears to be a shift in the sound i.f. to a higher frequency. Since most of the split-sound type receivers use 21.25 mc. as the i.f. a shift to 21.6 mc. may not appear too difficult. This would bring the sound section out of the 21-21.45 mc. range and thus eliminate interference. Unfortunately things are not this simple. There are a number of important considerations which make such a shift in frequency a complicated and time consuming job even for the well-equipped, thoroughly-experienced technician.

The sound i.f. must be 4.5 mc. lower than the picture carrier. The curve of Fig. 2 shows what happens when the sound i.f. is shifted from 21.25 to 21.6 mc. As illustrated, the picture carrier slides down on the slope with a resultant loss of such low frequency components as the vertical and horizontal synchronizing pulses. When the 21.25 mc. sound traps are tuned to 21.6 mc. they are unable to keep the sound out of the picture and sound bars will appear. To complicate mat-

ters, the 21.25 mc. discriminator transformer is designed to present a linear response only with 21.25 mc. as center frequency. When that is shifted, the discriminator response is often lopsided and this produces distorted sound. The bandwidth of the sound i.f. is at least 50 kc. so that a 21.45 mc. signal will easily pass through a 21.6 mc. i.f. This means that in most cases a shift to 21.6 mc. will be of no help at all. To shift the frequency still higher aggravates the effect on the picture. It is feasible, in many cases, to shift the sound i.f. to 21.9 mc. and out of the reach of some interference without wrecking the picture. To accomplish this an accurate signal generator, sweep generator, and oscilloscope are required. First the sound i.f. is aligned to the new frequency, the discriminator response being checked either on the scope or by plotting a curve. Then the sound traps in the picture i.f. are aligned and finally the entire picture i.f. section is re-aligned with the individual frequency of each coil being shifted by the same amount as the sound i.f. shift. It is necessary to check the curve on the scope to make sure that each tuned circuit still contributes the correct response and that the overall i.f. curve is correct. As a final step the local oscillator in the front-end tuner must be re-touched for each channel.

Because of the complexity of this procedure and the likelihood of errors and a poorer picture we do not recommend i.f. detuning as an efficient means of eliminating 21 mc. interference.

Antenna Interference

Whether interference is picked up primarily by the antenna or by the transmission line will decide some of the steps to be taken to remedy the trouble. If disconnecting the transmission line at the antenna removes the interference, the antenna itself is picking it up. If this procedure has no effect on the interference, the transmission line is the culprit. In many cases both the line and antenna contribute some interference pick-up in which case only filters will help.

Where it appears that the antenna is the major contributor to the interference, simple remedies are available. If the offending ham antenna is visible, check to see if it is in the same direction as a TV station. Rotating the antenna or installing reflectors will help when the TV station lies in a different direction. It is often feasible to relocate the TV antenna so that a taller building, chimney, or other structure is between it and the ham antenna. In some instances a copper screen can be placed between the two antennas but if this is done be sure to keep the screen at least 10 feet from the TV antenna. If the ham is located in the same direction as the TV station or none of the other measures help, a filter at the receiver may do the trick.

Interference picked up by the trans-

mission line can often be reduced if, in the case of 300-ohm twin-lead, the ribbon is twisted. This has the effect of cancelling out any pick-up on the line. Using coaxial or shielded 300-ohm line also helps, as does relocating the line so that it does not face the ham transmitter directly. The last method of interference elimination consists of filtering out the interference before it can reach the r.f. amplifiers.

Filter networks consist of coils and condensers so arranged that at certain frequencies they will prevent the signal from passing through. There are three basic types of such filters and rather than give a long dissertation on their theory we here present one example of each type, with practical values for easy construction by the service technician. Many commercial filters are on the market, but since a large number of our readers often prefer to build their own, complete construction data is provided.

The first filter is a single-section, band-rejection type which will attenuate any signal between 21 and 21.45 mc. The photograph, Fig. 1, shows its physical appearance when removed from the can. The coil form for L_1 is a 470,000 ohm, 1 watt *Ohmite* resistor while the series coil L_2 , is wound on a polystyrene rod. Complete winding data, the circuit, and a performance graph are given in Fig. 3. It should be pointed out here that this filter is not of the balanced type and should preferably be used with coaxial cable transmission lines. The theory of operation of this filter lies in the high impedance of the parallel resonant circuit L_1-C_1 , which is tuned to 21 mc. and the low impedance of the series resonant circuit L_2-C_2 , which is tuned to 21.45 mc. Thus at one end of the interference band L_1-C_1 acts as a high resistance, keeping the signal away from the receiver, while at the other end L_2-C_2 acts as a virtual short circuit for interfering signals.

The second filter network is of the single-frequency, balanced type. A series resonant circuit effectively shunts the undesired signal to ground. The two coupling condensers C_1 and C_2 have more impedance to lower frequencies, such as the 21 mc. interference, than to the TV signals starting at 54 mc. As the photograph of Fig.

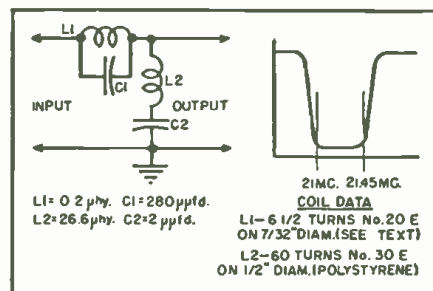

Fig. 3. Design data for a single-section, band-reject filter for 21 mc. ham band.

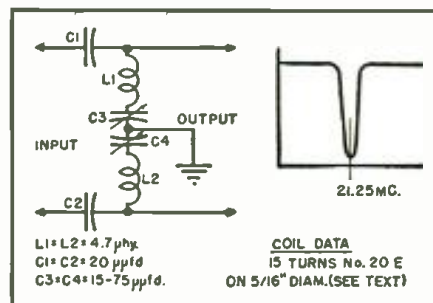

Fig. 4. Circuit diagram of a balanced, single-frequency (21.25 mc.) TV filter.

5 indicates, the two trimmer condensers C_3 and C_4 were salvaged from an old broadcast i.f. transformer. Making use again of materials at hand, we used a 470,000 ohm, 2 watt *Ohmite* resistor as a coil form for L_1 and L_2 . The complete circuit with coil winding data and a performance graph is shown in Fig. 4. This type of filter is recommended when the interference is not too strong and is not picked up by any section other than the antenna and transmission line. The filter can be mounted directly at the antenna terminals of the receiver with the bus bar from the two trimmers going to a convenient point on the TV chassis. This ground connection should be soldered if possible.

When the interference is noticeable each trimmer is tuned in turn to give minimum interference effect. The theory of operation is that the two series-resonant circuits present a virtual short to ground to the interfering signal.

The third type of filter is the one most commonly used in commercial TV interference units. It is called a balanced high-pass filter and is de-

Fig. 5. Over-all view of a single-frequency, balanced-filter for 21-21.45 mc. band.

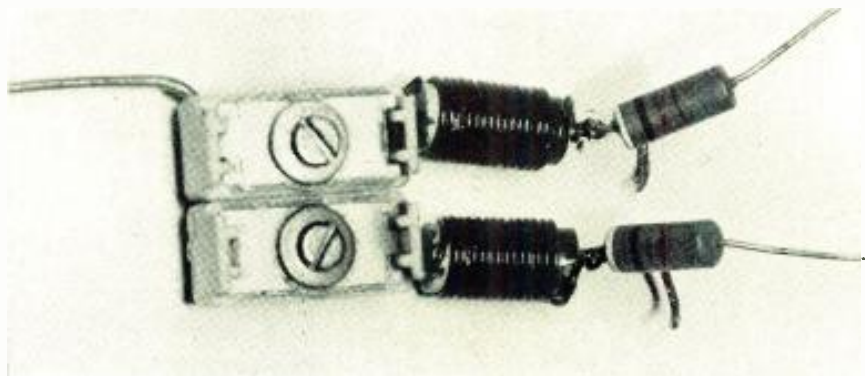

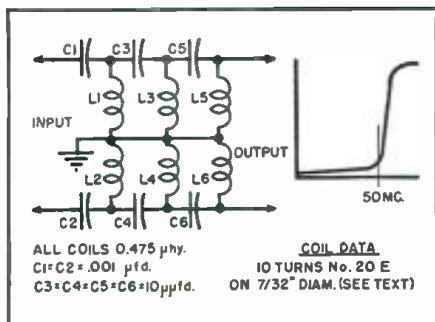

Fig. 6. Design details on a three-section, high-pass television interference filter.

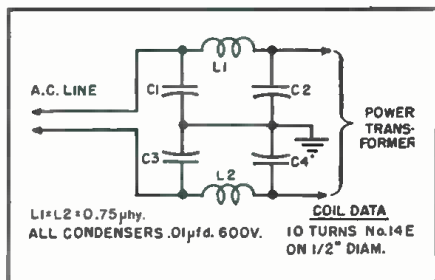
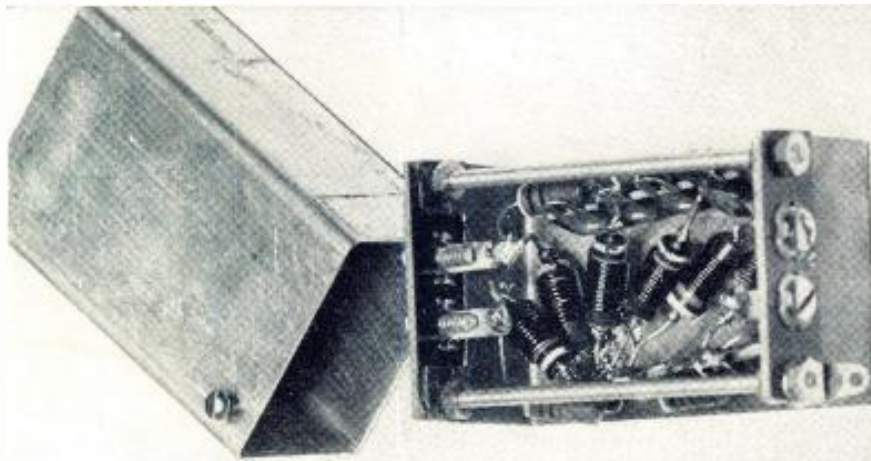

Fig. 7. A pi-type line voltage filter unit.

signed to attenuate any signal below 50 mc. In Fig. 8, it is shown withdrawn from its shield can, again an old i.f. can with the top cut away. Fig. 6 shows its actual circuit. Consisting of three sections, the theory of operation here is that at low frequencies the coupling condensers present a much larger impedance than the coils going to ground, while for higher frequencies the reverse is true. By using three sections more attenuation is achieved and enclosing it in a can eliminates any possible pick-up due to a resonance effect of the filter elements. The 300-ohm impedance of this filter and the fact that it is balanced makes it ideal for installations using 300-ohm twin-lead. Since the cut-off frequency of this filter is set at 50 mc., there is no need for tuning it exactly to any interfering ham signal and once installed it will need no further attention. Mounting it as close as possible to the r.f. tuner will prevent any interference pick-up between the filter and the tuner.

Fig. 8. A high-pass, 300-ohm, three-section balanced filter with cut-off below 50 mc.



A ground lug is provided next to the output terminals to permit grounding of the filter case to the chassis. Since the output is grounded for d.c. through L_5 and L_6 it may be necessary to connect a .1 μ fd. condenser between the TV chassis and the filter can to avoid shock in case the chassis is connected to the power line. All components used are standard items found on any service bench and their actual values are not too critical since it will not matter too much if the cut-off point is 48 or 52 mc. instead of the design center of 50 mc. For the coil forms 470,000 ohm, 1 watt *Ohmite* resistors were used. In either event, the TV signals will not be attenuated while the interfering 21 to 21.45 mc. ham signals will be greatly reduced.

There is a great variety of possible filters and combinations which can be used but we have only presented three as tried and proven examples of what can be done to reduce interference from the antenna and line.

Power Line Interference

Although the 50- or 60-cycle power lines would hardly appear suitable for transmitting 21 mc. signals, it frequently happens that they are a source of trouble. The large leakage capacity of most power transformers, standing waves, resonant line effects, and similar phenomena often cause the power line to transmit sufficient signals to cause interference in TV receivers. In addition, the a.c. line cord often acts as an antenna for the 21 mc. signal and introduces it into the receiver from that source. Fortunately this is not too difficult to overcome and a few simple procedures will completely eliminate the power line as a source of interference.

Commercially-made line filters are available from any radio supply house. These filters are designed to remove any r.f. from the line voltage and to smooth out sudden voltage variations. In general such a device will be satisfactory in the case of 21 mc. interference, but occasionally the interfering signal is strong enough to ride through the line filter. Where the interference is due to pick-up on the

line cord, the plug-in type of line filter will be unsatisfactory. Hanking the line cord to the shortest usable length and connecting the filter as close to the TV set as possible may help somewhat.

The most effective place for an a.c. line filter is right inside the TV chassis since this scheme eliminates not only signals from the line but also pick-up from the line cord. Many TV sets use one or two condensers, usually .01 μ fd. units, from the a.c. line to the chassis. These condensers help only slightly unless they are used in conjunction with an inductance. A typical pi-type line voltage filter which can be mounted right inside the TV receiver is shown in Fig. 7. The two coils L_1 and L_2 are made of #14 wire since they carry a relatively high current. In this circuit the actual inductance of the coils is not too important as long as it represents a high impedance to the 21 mc. interfering signal. Although 400-volt condensers could be used in this circuit, we recommend the 600-volt type since they will be less likely to fail and a short in the a.c. line would be a serious defect.

Direct Pick-up Interference

Only where the ham signal is exceedingly strong will direct pick-up be encountered. In such instances elimination of this interference will prove both difficult and costly. To make certain that direct pick-up is taking place, disconnect the antenna and short out the antenna terminals. Connect an a.c. line filter through an extension cord right to the TV set with the set's line cord wrapped tightly and placed close to the chassis. If interference is still present, direct pick-up is responsible.

Occasionally it is feasible to relocate the TV set in the room so that it is shielded by a concrete wall, chimney, sheet metal ornamentation, etc. This may help reduce the direct pick-up. Failing this, the simplest method would be to put the entire receiver in a shielded cage with proper filters at the antenna terminals and a.c. input. Since this is expensive and often impractical we shall try to find the spots where the interference pick-up originates and attack it there. The most likely culprits are unshielded sound traps located on top of the chassis. In 630-type receivers the large coil on the tuner and the cathode trap near the center of the chassis are the worst offenders. The remedy consists of placing a shield can over these coils. After the can is installed it will be necessary to realign the coils. Other likely sources are sound i.f. tubes operating without a tube shield, grid or plate wires located away from the chassis, and some tuned circuits underneath the chassis. To eliminate direct pick-up from the underside of the chassis it is convenient to use an aluminum or copper bottom plate instead of individual shields.

Sometimes the interference is so
(Continued on page 171)

REACTANCE CHART

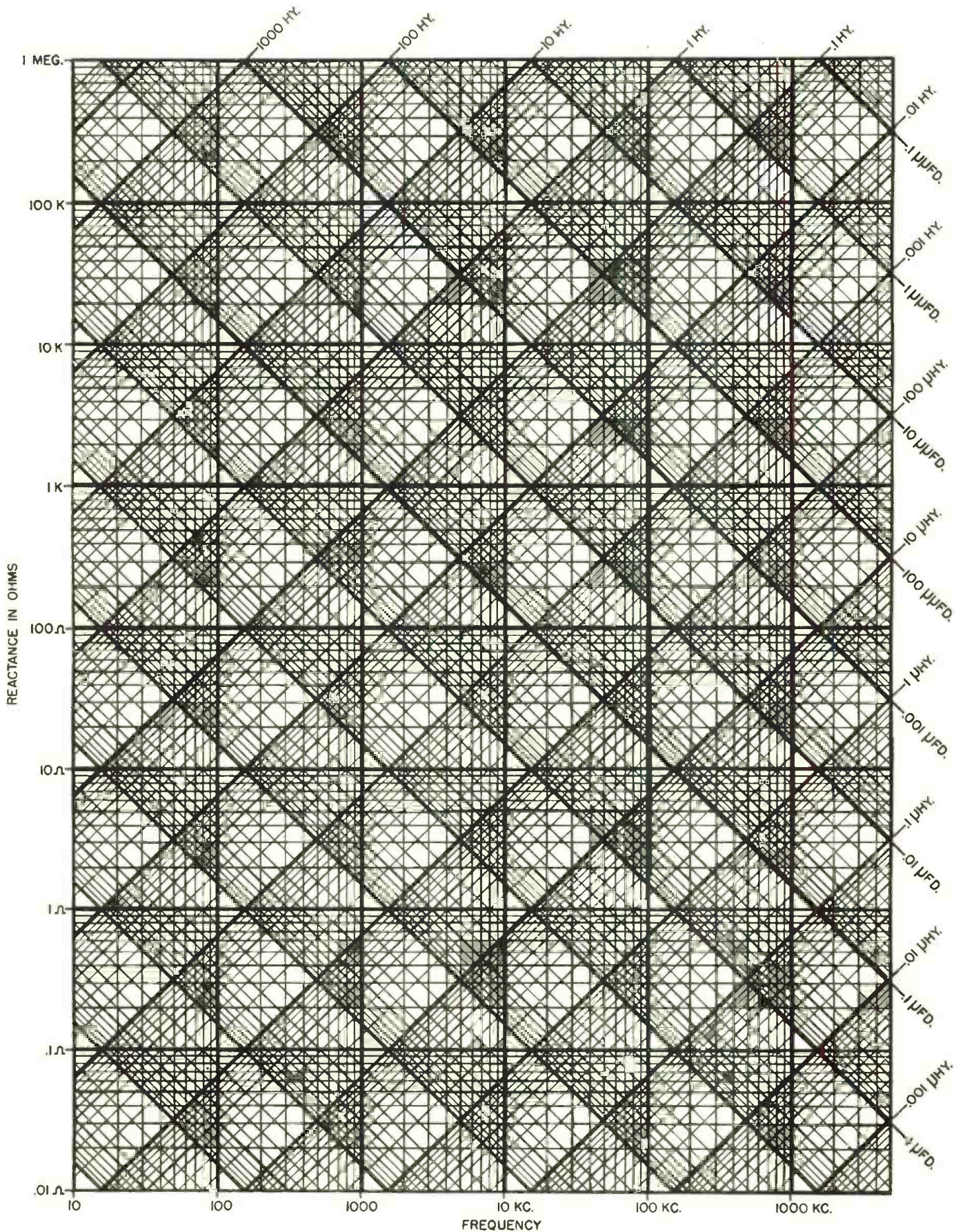

RADIO & TELEVISION

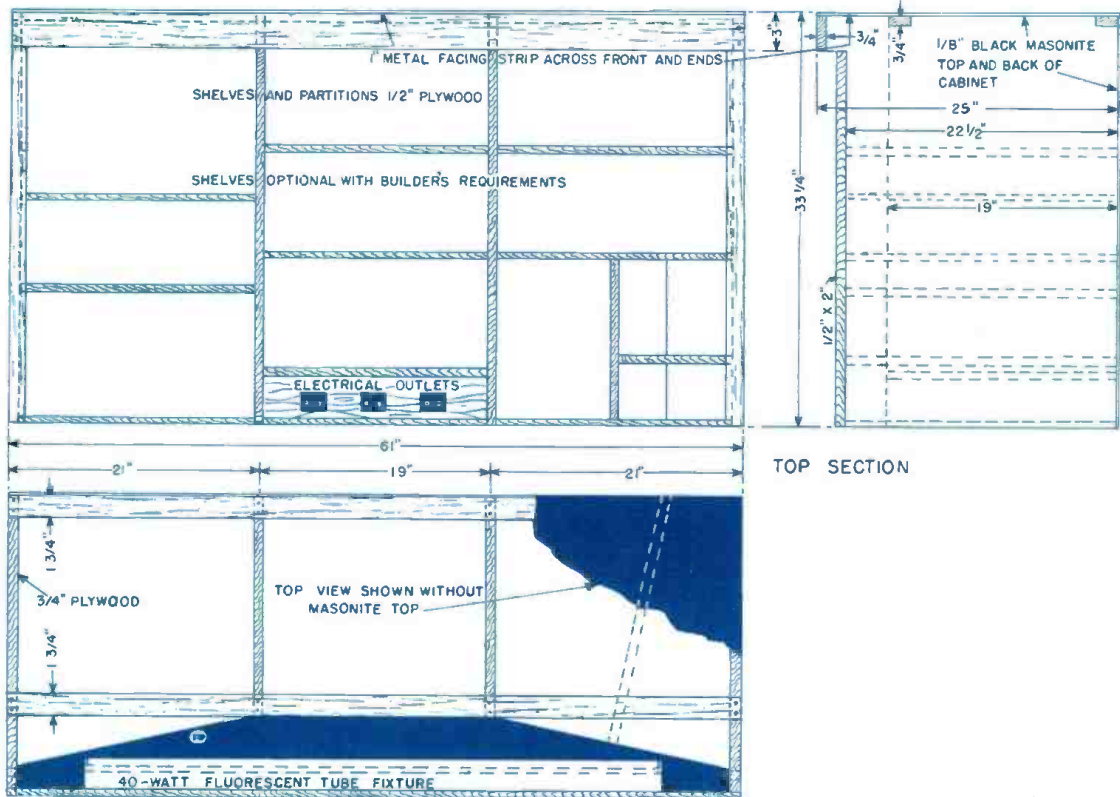

TOP SECTION

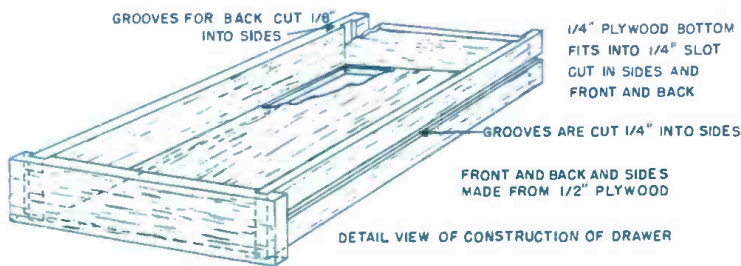

DETAIL VIEW OF CONSTRUCTION OF DRAWER

In response to an ever-recurring demand for an all-round service test bench, the editors of RADIO & TELEVISION NEWS are presenting herewith their conception of an all-purpose unit. Obviously no single design could provide all of the features desired by all segments of the industry. The professional service technician, engineer, hobbyist, etc. each has his own specific requirements. Because of this wide divergence of interests, this bench is, of necessity, a compromise incorporating those features which provide maximum utility, neat appearance, and low cost. This design is flexible to the extent that any individual, whether a hobbyist or service technician, could, without detracting in any way from its appearance, alter the arrangement to obtain maximum efficiency for his particular needs. The construction of this bench is relatively simple—the materials are comparatively inexpensive. All dimensions shown are merely suggestions—they can be altered to meet the builder's requirements. Reference to specific types of test equipment has been purposely avoided since each group will wish to incorporate the units germane to his field.

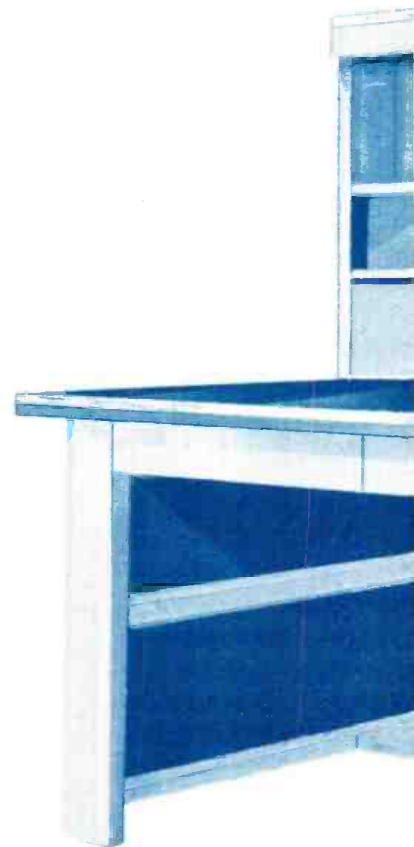

There was no attempt made to show the bench incorporates a 40-watt fluorescent tube fixture. In addition to those shown it is suggested that a 40-watt fluorescent tube fixture be included. The number and position of outlets should be indicated. Some may desire to have the test instrument mounted on a shelf permitting easy removal of the instrument. It would be convenient to have an outlet for the test instrument.

NEWS TEST BENCH

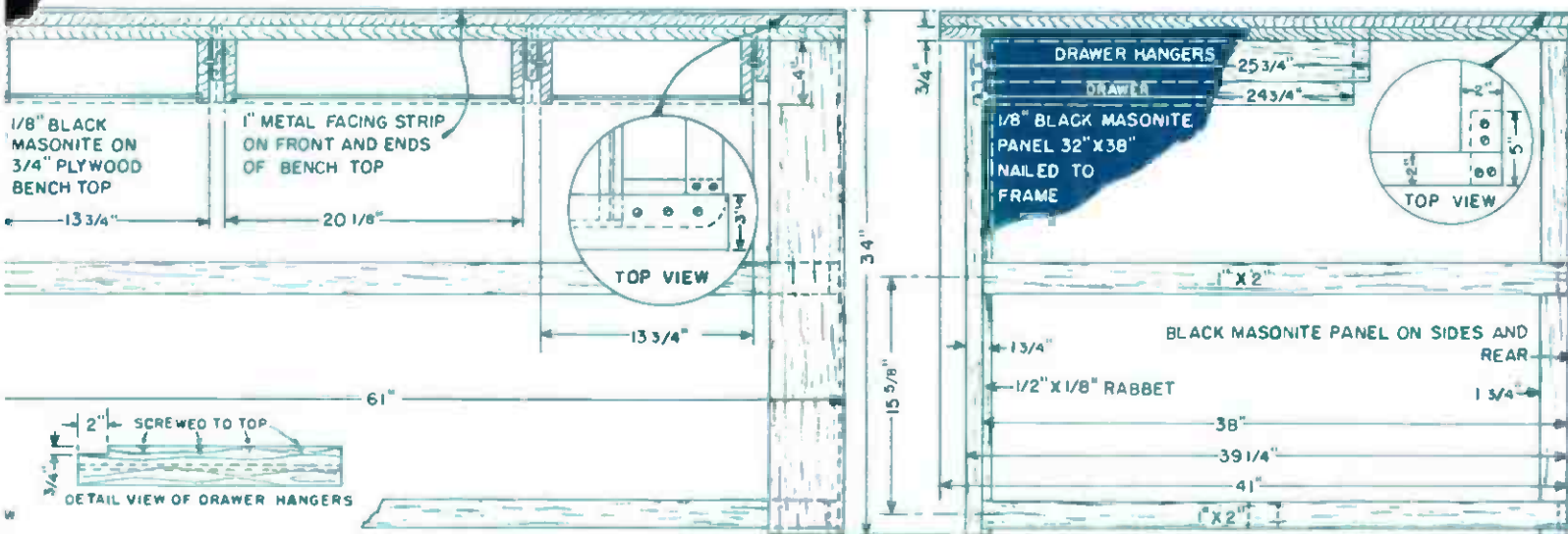

BENCH

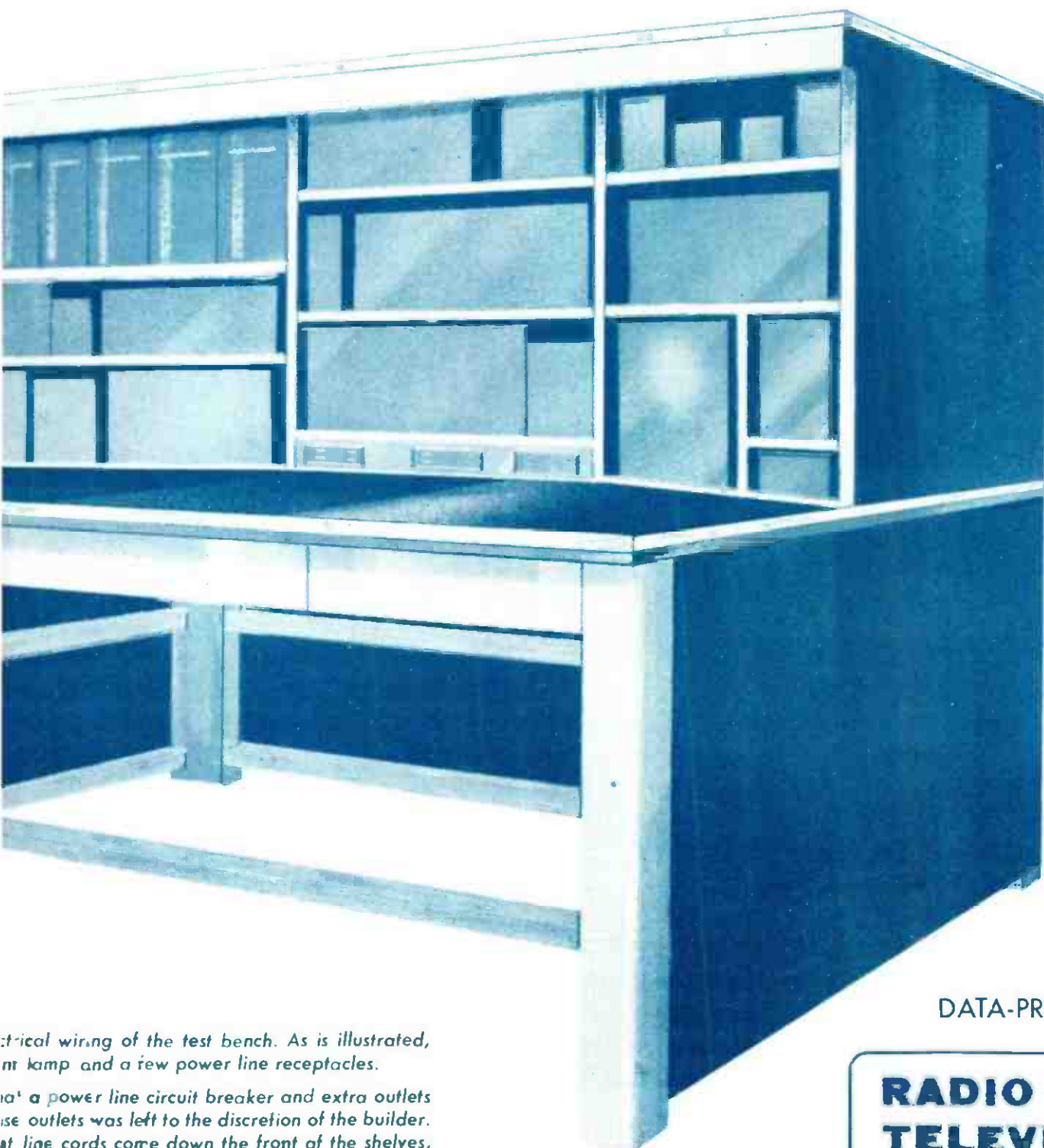

DATA-PRINT #6

**RADIO &
TELEVISION
NEWS**

(Copyright 1952)

MOST USEFUL TV INSTRUMENT YET DEVELOPED

HICKOK Model 650 VIDEO GENERATOR



MODEL 650

Read What Typical Users Say

My Hickok Model 650 Television Video Generator is the most time saving instrument I have ever used. Television Service companies who don't have this instrument should get one, and they could turn out three times as much work.

- F. W. Gibbons

F. W. GIBBONS
TELEVISION RADIO AND REFRIGERATION SERVICE
600 SOUTH LEXINGTON STREET
COLUMBUS, OHIO

CAPEHART-FARRNSWORTH CORPORATION

THE LIVELY TECHNICAL SCHOOL
Corner Duval Street and Park Avenue
TALLAHASSEE, FLORIDA

COMMONWEALTH TELEVISION
INSTALLATION & SERVICE COMPANY
186 CONCORD AVENUE
CAMBRIDGE 38, MASS.

I am very much impressed with the Hickok Model 650 Video Generator. I feel that you have made a great contribution to the servicing trade by producing this fine instrument within the reach of all. In my opinion, no self-respecting TV service organization should be without one. Hickok has again pioneered with a quality piece of equipment at a price anyone can afford.

- Donald T. Birch
Radio-TV Instructor

Your Hickok Model 650 Video Generator is the most practical single piece of television test equipment offered to the TV serviceman. I like every feature about it, and believe me, I have seen it used in every way possible.

Jack P. Moore,
Service Manager

The Hickok Model 650 is, without a doubt, one of the most useful instruments yet developed for the Television Servicing Technician.

- Ray S. Guichard,
Mgr. Service Training

This \$1.00 Book FREE

LIMITED TIME OFFER TO TV TECHNICIANS

THE HICKOK ELECTRICAL INSTRUMENT COMPANY

10524 Dupont Avenue

Cleveland 8, Ohio

Gentlemen:

Kindly send me a free copy of your new one-dollar, 32 page illustrated book showing detailed description of the latest methods of television servicing with the Hickok Model 650 Video Generator.

Name _____

Street _____

City _____ Zone _____ State _____



Front view of 35-watt transmitter.

A 35-WATT NOVICE TRANSMITTER

By EVERETT G. TAYLOR, W8NAF

EVER since the FCC has been issuing Novice class tickets, we have been listening in on the 3700-3750 kc. portion of the 80 meter band with a great deal of interest. In eavesdropping on the Novices, we find that a lot of them are running around 30-40 watts.

With this information under our belt, we took off on the construction of a simple transmitter which would be easy for the Novice to build and get on the air.

We chose the modified Pierce oscillator which is rather easy on crystals and will also permit doubling to 40 with an 80-meter crystal when the Novice is advised by the FCC that he can drop the "N" from his call.

The parts for the oscillator and power supply are mounted on a 7 x 9 x 2 inch steel chassis. An aluminum chassis may be used, of course, but the one we used "just happened to be around." An aluminum chassis is much easier to drill and work than a steel one and is, therefore, to be preferred.

Having obtained several 6BG6G television tubes at a bargain price we decided to use one of them. We are not sorry that we chose this tube as it can be loaded up to 100 ma. at 400 volts very easily. This tube is rather husky and is similar to the Type 807 transmitting tube.

A 5R4GY tube is used as the rectifier to supply the high voltage to the oscillator tube. The choice of this tube was another case of using what we had on hand. Other tubes may be substituted for the 5R4GY—such as the 5U4G or the 5X4G if the correct pin connections are taken into consideration.

The power transformer is a *Stancor* Type P-6012, which is rated at 700 volts—center-tapped—at 90 milliamperes. By eliminating the usual filter choke and using a higher-than-usual-capacity filter condenser, which in this case is a 40 μ fd., 450 volt unit, nearly 400 volts is obtained on the 6BG6G with the key down.

Perhaps some of the readers are wondering about the c.w. note without the choke. We QSO'ed about twenty fellows on this rig during the course of

Construction details on an easily-built, compact rig which uses two tubes and a minimum of parts.

a single evening and received T9-X reports from all of them.

The *Stancor* transformer has center-tapped filament connections and these were cut short, the enamel removed, and the wires then soldered together. Regular transformer tape was placed over the exposed wires and then given a coat of *Duco* cement.

One side of the 6.3 volt filament winding for the 6BG6G is grounded at the tube socket while the other lead goes to the appropriate filament connection on the tube socket. A .005 μ fd. disc-type condenser is used to bypass the screen of the oscillator tube. Voltage for the screen is supplied through a 25,000 ohm, 2 watt resistor.

The r.f. choke (in series with the cathode and key), the 35 μ fd. *Erie* "Ceramicon" condenser, and the 100 μ fd. mica condenser form the feedback portion of the oscillator which permits doubling to the higher frequency bands. A .005 μ fd. disc-type condenser is used across the key. A 50,000 ohm resistor is used from the grid of the 6BG6G tube to ground.

A s.p.d.t. toggle switch is mounted

Complete schematic of two-tube Novice rig.

- R₁—50,000 ohm, 1 w. res.
- R₂—50 ohm, 1 w. carbon res. (used as coil form for L₁)
- R₃—25,000 ohm, 2 w. res.
- C₁—40 μ fd., 450 v. elec. cond.
- C₂—35 μ fd. Ceramicon cond. (*Erie*)
- C₃—100 μ fd. mica cond.
- C₄—0.005 μ fd. disc-type cond.
- C₅—0.01 μ fd., 1250 v. cond.
- C₆—50 μ fd. var. cond. (*National* Type TMK)
- C₇—25 μ fd., 7500 v. cond. (*Centralab* 8505)
- RFC₁, RFC₂—1 mhy. r.f. choke (*National* Type R-300U)
- L₁—14 t. #24 en. wound on R₂
- L₂, L₃—End link (*Barker & Williamson* 80 BEL)
- T₁—Power trans. 350-0-350 @ 90 ma.; 5 v. @ 3 amps.; 6.3 v. @ 3.5 amps. (*Stancor* P-6012 or equiv.)
- J₁—Open circuit jack
- S₁—S.p.s.t. toggle sw.
- S₂—S.p.d.t. toggle sw.
- V₁—5R4GY tube
- V₂—6BG6G tube
- 2—Crystals (See text)

on the front drop of the chassis to permit the choice of two crystal operating frequencies within the Novice band. The crystals are mounted in an octal socket since it is more economical than purchasing two crystal holders.

The builder can construct this unit using a single crystal, however, if he wishes to have a choice of two operating frequencies, he can incorporate two crystals as shown in the diagram. The crystals operate on their fundamental frequencies and therefore should be 3700-3750 kc. units.

Just as a word of caution, it is advisable to stay away from the edge of the band and thus, in choosing your crystals, it would be well to stay within the range 3710 and 3740 kc.

Parallel feed is used to the plate of the oscillator tube, thus removing the positive potential from the tuning con-

(Continued on page 153)

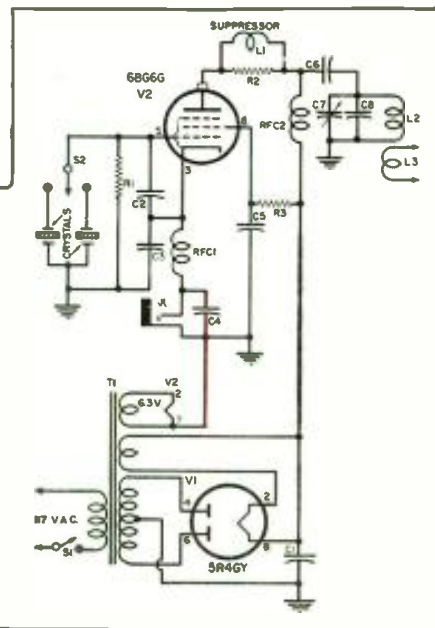

A REMOTE-CONTROL TUNER

By

GLEN SOUTHWORTH

REMOTE control is a subject which has been attracting increasing interest in the planning of home installations of sound equipment. Already several manufacturers are offering compact preamplifier-equalizer control units for use with phonograph equipment. It is an accepted fact that many listeners prefer to enjoy musical reproduction at an appreciable distance from the loudspeaker system and for maximum convenience the essential controls should be located close at hand.

In many cases an increase in listening enjoyment may be obtained by applying remote control techniques to conventional radio reception as, to some ears, even a lecture will sound appreciably better when reproduced over high quality equipment, and subtleties in comedy or dramatic entertainment are easier to detect. Essentially, a control unit should be compact, require a minimum number of connecting wires, and be capable of operating any place in the house, in conjunction with a remote loudspeaker, in order that the fullest use of a high quality amplifying system may be obtained.

The unit shown in the accompanying photograph and in the diagram appears to fulfill these requirements with a minimum of circuit complexity. Essentially, it is a miniature AM tuner with an unusual power supply and a cathode follower output stage to feed the audio signal to the main power amplifier. Only four conductors are required to connect the tuner to the rest of the equipment. Provision is made to turn the main a.c. power supply on or off from the remote location by means of relay operation. In addition, the tuner is designed so that it may be plugged into an appropriate four-prong receptacle in any location in the house and as only low voltages are carried by the connecting conductors, wiring installation may be greatly simplified.

Shown in its original form, the tuner uses three tubes, a 6SA7 as an r.f. and mixer stage, a 6SK7 as the i.f. amplifier, and a 6SL7 as the cathode follower output stage. The power supply consists of a 6.3 volt filament transformer connected backwards, a 50 milliamperes selenium rectifier, and a three-section 150 volt electrolytic condenser mounted in a plug-in socket. The entire tuner is assembled on a standard 5 x 7 x 2 inch chassis which is light and readily portable. If desired,

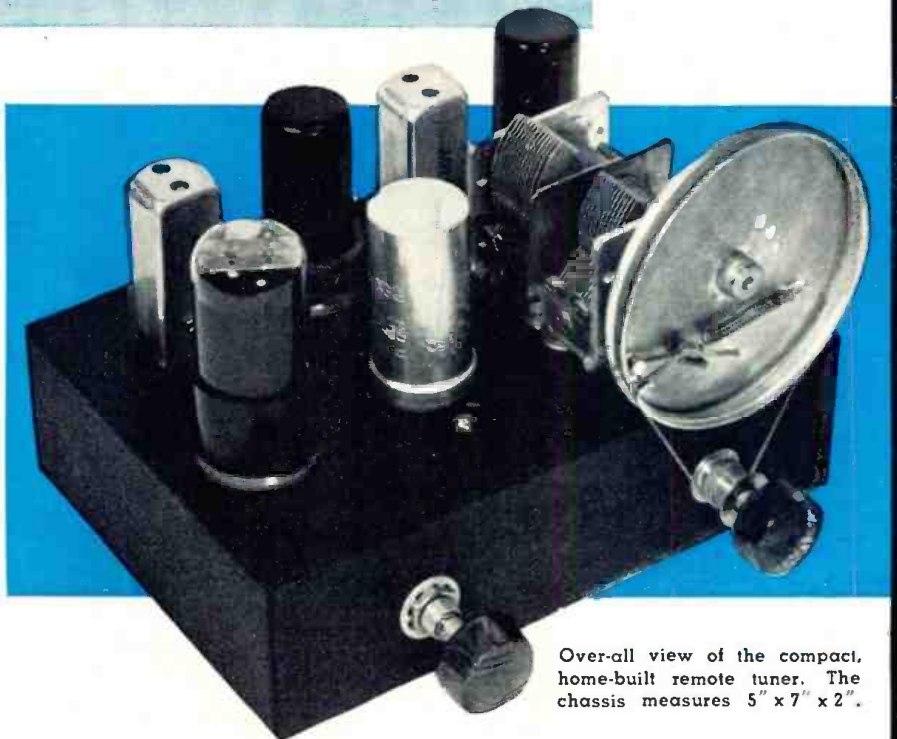

Over-all view of the compact, home-built remote tuner. The chassis measures 5" x 7" x 2".

Construction details on a unit which features a unique power supply and cathode-follower output.

miniature tubes could be substituted for their octal counterparts, thus making an even more compact unit possible. As the basic design elements consist of the type of power supply used and the relay control, the ingenious constructor may easily introduce modifications in construction or circuitry to fit his personal requirements. For example, an extra r.f. stage might be added, or a t.r.f. circuit used throughout. The design shown, however, was considered most likely to have the widest application.

Although it was originally planned to use one half of the 6SL7 as a diode second detector, it was found preferable, from the standpoint of low distortion, to use a germanium diode such as the Raytheon CK705. The reason for this is that thermal emission from the tube cathode tended to produce an undesirable potential that caused severe distortion on weak signals—oscilloscope patterns showing fifty per-cent distortion or more. The amount of distortion produced by an effect of this kind is closely related to the signal strength at the second detector, with very weak signals being almost completely attenuated and strong signals having only a small percentage of distortion due to this effect.

The antenna system used with the tuner will also influence the total amount of distortion in the audio output. In the case of reception from

weak stations, it is desirable to have as strong a signal as possible at the r.f. grid of the 6SA7 mixer stage in order that tube noise and hiss may be masked and that undue distortion does not occur in the conversion process. This indicates the desirability of some form of outside antenna system or the addition of a tuned r.f. stage before the mixer. On the other hand, in most instances the tuner will be used for reception from local stations and in this case, it will be necessary to guard against overloading. Although an r.f. gain control or a carefully designed a.v.c. system might be used, a simpler method is to use the tuner with a small loop antenna. In this way, the tuner may be oriented for maximum signal strength in the case of weak stations, and for minimum signal strength in the case of strong locals. In addition, the well-known benefits of a loop in reducing noise or interference are frequently desirable, as such signals are often as objectionable as harmonic distortion.

The tuner circuit shown uses miniature, high gain, i.f. coils and has excellent selectivity when the coils are peaked at the same frequency. Broader band response and a corresponding improvement in audio response at high frequencies may be obtained by stagger tuning the i.f. coils or shunting the coils with 100,000 ohm to one megohm resistances. Both of these methods re-

duce the sensitivity of the tuner and increase stability, but if excessive distortion occurs in the audio chain or tuner it may lead to a paradoxical condition in which the ten kilocycle interstation heterodyne whistle may be unbearably loud, but the listener is unable to perceive anything resembling "highs" in the program that he is hearing. This is usually due to the fact that the highs suffer such severe intermodulation that they are not reproduced in recognizable form, while the ten kilocycle heterodyne, being much stronger, actually tends to mask highs that are properly reproduced. As a result, in some AM reception, the listener may actually perceive a wider frequency range on a system which has poorer electrical fidelity as far as high frequency response is concerned. A good aural check of the over-all system quality is the ability to distinguish between different program sources with respect to such characteristics as apparent frequency response, tonal coloration, distortion, and acoustics. A poor system will tend to have a uniform "tonelessness" no matter what the station or program source.

Turning to the constructional features of the tuner, the power supply includes a Cinch plug-in socket for the three-section electrolytic condenser. As a result of this type of construction the filter may be as easily checked and replaced as the tubes. The only connection to the tuner is made through a conventional four-prong socket

mounted on the rear of the chassis. Two leads carry the 6.3-volt current from the main power amplifier which supplies both the filament and plate power for the tuner. The other two leads carry the audio signal from the tuner back to the main amplifier. The relay connection for turning the main a.c. supply on and off is connected between the ground side of the audio line and one side of the 6.3-volt filament supply. However, in this case it is important that the filament supply not be grounded elsewhere and some constructors may find it simpler to run a separate line for the relay connection.

Two methods of energizing the a.c. contacting relay are shown. The first uses a miniature 45 volt "B" battery which is connected to the relay circuit long enough for the rectifier tube in the main amplifier to heat and provide hold-down voltage for the relay. To turn the equipment off, the relay coil is merely shorted from the remote location and the contacts open. In the case of an amplifier with large filter condensers, it may be necessary to short the relay coil for several seconds in order to prevent the charge that remains on the condensers from again closing the coil.

The second method of relay operation involves the use of a small, low drain power supply which is left in continuous operation and serves as exciting power for the relay coil through a conventional a.c. switch on the tuner volume control. In either case the

amount of voltage required for relay operation will depend upon the sensitivity and resistance of the relay coil. For example, a one-mil relay with a 2000-ohm coil would require only two volts, while a five-mil relay with a 5000-ohm coil would require twenty-five volts for consistent operation. The constructor may suit his convenience as to which type of relay operation he desires, but in either case the amount of a.c. ripple carried by the ground lead of the audio line should be small or hum will result.

The low impedance output of the cathode follower means that it is often unnecessary to use shielded cable for short connections, however, if distances of more than ten feet are to be covered, shielded wire is recommended. In the case of an elaborate installation, connecting wires may be pulled through the walls, attic, or basement and four-prong receptacles mounted permanently at convenient locations throughout the house. The inclusion of additional speakers with individual "L" pads in various rooms is also frequently desired by listeners.

To further enhance the value of the tuner, bass and treble controls may be added to the circuit and the other half of the 6SL7 used as an audio amplifier stage to make up for any loss in gain. In any event, the constructor should find that the versatility and convenience of this unit adds greatly to the enjoyment of a high quality amplifying system.

Remote tuner and amplifier connections. An alternate circuit for the remote control of the "On-Off" function is shown in the box.

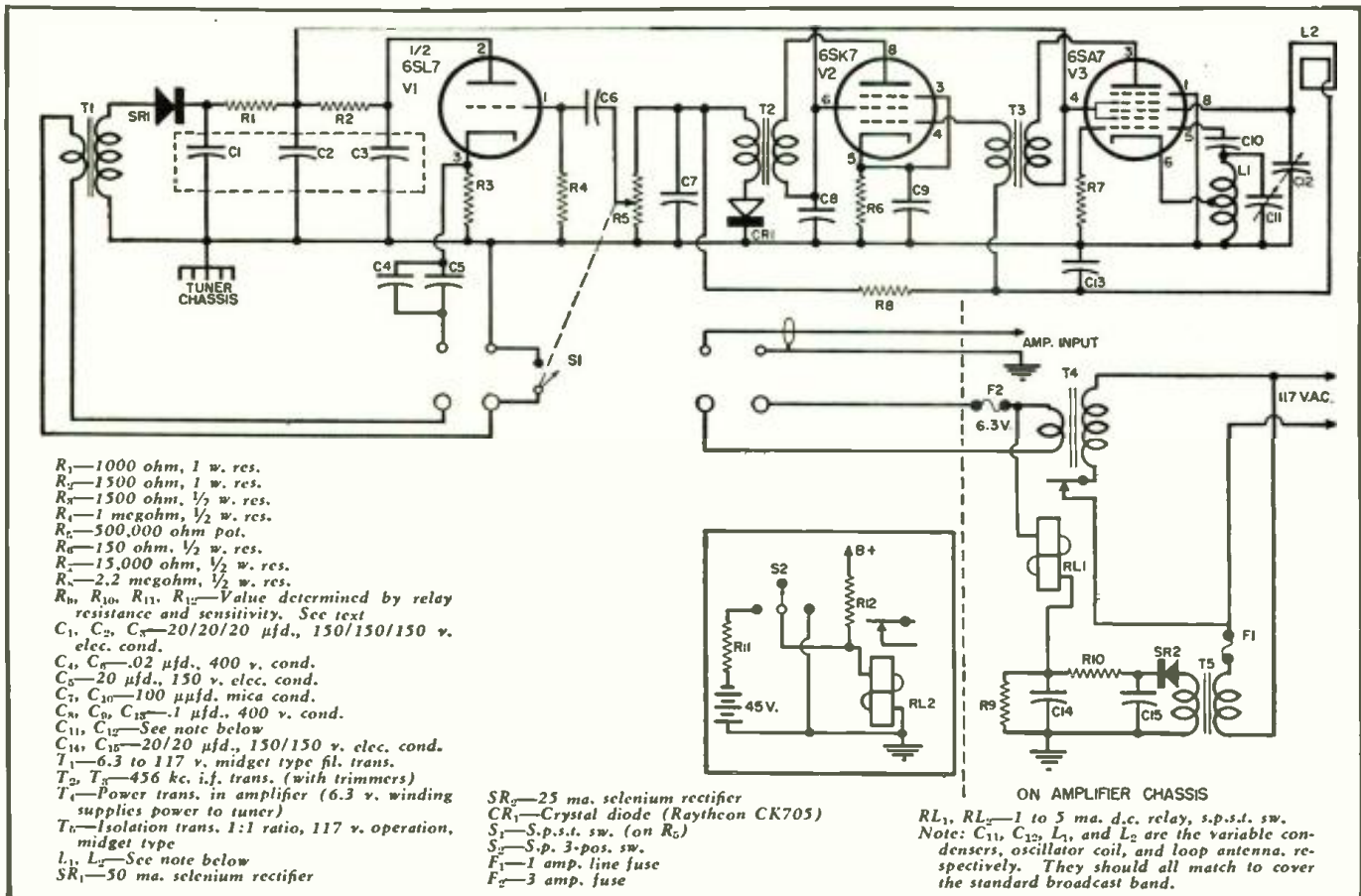

ADD AN ASTIGMATISM CONTROL TO YOUR CRO

By
LOUIS E. GARNER, JR.

A simple circuit which can be added to any scope will increase both its usefulness and performance

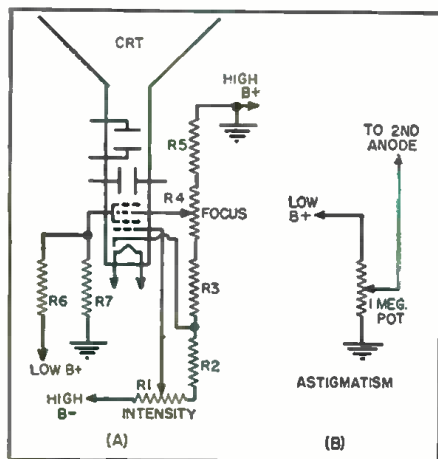

Fig. 1. (A) High voltage divider circuit of a conventional CRO. (B) Circuit changes required to add "Astigmatism" control feature.

ONE control often found on the better grade laboratory-type cathode-ray oscilloscopes, yet almost always lacking on the less expensive instruments, is the "Astigmatism" or "Spot Shape" control. To add this type control to the average scope is quite an easy job, hardly requiring more than an hour's time for the skilled technician. The cost, too, is low, since only an inexpensive carbon potentiometer, a knob, and a little wire and solder are all that are required.

Before discussing the technique of adding this control to a CRO, let us see why such a control is necessary or desirable.

Fig. 1A is the schematic diagram of a typical CRO high voltage divider as used to supply d.c. operating voltages to the cathode-ray tube (CRT). For the purpose of our discussion,

parts values are not important and, therefore, are not given (these will vary from scope to scope, in any case). For the same reason, connections to the deflection plates are not shown on the diagram.

The sharpness of the spot obtained on the screen of the CRT is controlled by the voltage relationship of the focusing and accelerating electrodes. In less expensive scopes, the voltage on the accelerating electrode is generally fixed, while the voltage on the focusing electrode is varied as a focus adjustment.

In Fig. 1A, the focusing electrode is connected to R_4 , which serves as the "Focus" control, while the accelerating electrode is connected to the junction of R_6 and R_7 .

Although the sharpness of the spot depends on the relationship of the focus and accelerating electrode voltages, the spot shape depends not only upon this factor, but upon the relationship between the voltage of the accelerating electrode and other electrodes in the CRT.

The "ideal" is a sharp, perfectly round spot, as shown in Fig. 2A. With such a spot, the image trace will be sharp and clean as in Fig. 2D. Even small irregularities in the waveform which is being checked can be quickly spotted and analyzed.

Too often, however, the spot, though sharp, will be somewhat elliptical or oblong, as shown in Figs. 2B and 2C. When the spot is oblong vertically, the waveform obtained will appear blurred with the trace line quite thick at the top and bottom of the image, as shown in Fig. 2E. All horizontal portions of the trace will appear thicker than the vertical portions.

If the spot is oblong horizontally, on the other hand, vertical portions of the trace will appear thick and blurred compared to horizontal portions. Thus, a spot shape as shown in Fig. 2C may cause a sine-wave trace to appear as in Fig. 2F.

With a spot shape as shown in either Figs. 2B or 2C, small irregularities or distortions of the image may be masked and thus overlooked. For accurate work, such a condition is intolerable. (Incidentally, for purposes of illustration, the distortion of the spot image has been deliberately ex-

(Continued on page 86)

Fig. 2. Test patterns before and after control is added. See text for explanation.

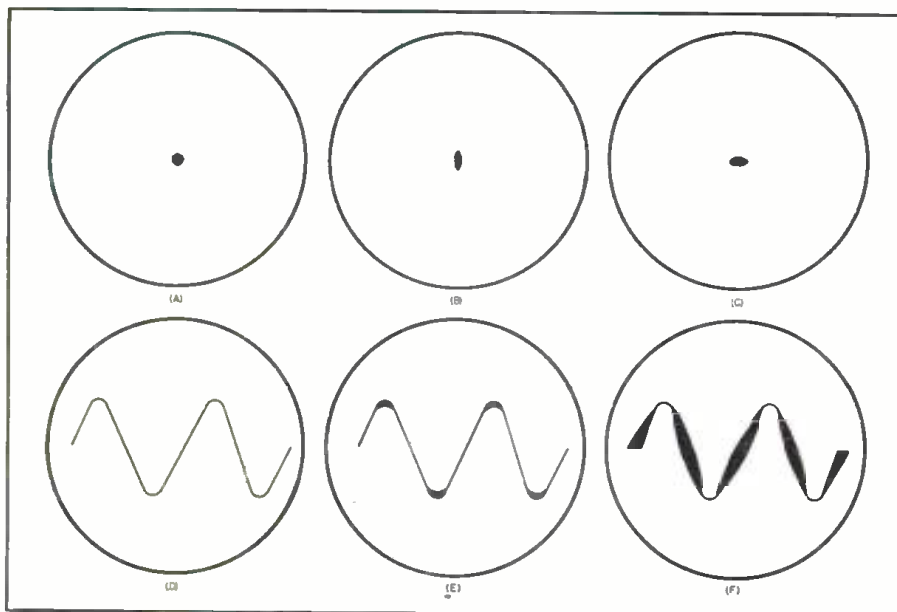

THE YAGI

By
M. G. O'LEARY

KINGSTON, Ontario is 75 miles north of Syracuse, N. Y. With a booster and high-gain antenna, reasonably good pictures can be obtained from WSYR, Channel 5, and WIEN, Channel 8, even during the poor winter months. However, good antenna installations are costly; mounted on a 20 ft. roof-top mast, one single-channel yagi costs about \$60.00, while two, one for each channel, run at \$90.00. Home-made installations can be completed for from \$10.00 to \$15.00.

It was the author's chore to design a Channel 5 antenna for a friend who intended to construct it himself. The results of our joint efforts were highly successful from the performance as well as the constructional point of view. The pictures obtained are equal to, and in some cases better than, those obtained from several commercial installations. The finished product weathered a recent bad sleet storm intact, while many other antennas in the vicinity were badly damaged. Readers living in fringe areas who intend to build their own yagis should be able to benefit from some or all the ideas that were worked out for this design.

Deciding on the type of antenna to be used was the first problem. Lack of space ruled out the highly desirable rhombic design.¹ A horn type² was mighty attractive, especially because of the very high gain on Channel 8 as well as the adequate gain on Channel 5, but the structure was to be mounted on a small bungalow and, from the purely aesthetic point of view, its size precluded its use. Five-element yagis and stacked conicals with reflectors have proven themselves in this area, and our choice boiled down to either one of these types. The yagi was finally selected—for two reasons: robust construction is much more easily achieved, and the experience of others suggested that this type picked up less noise.

The design of the yagi turned out to be a very complex matter. Two ready-made designs were available, one for single channels, the other for reception of both Channels 4 and 5.^{3,4} We were looking for something more robust than the former, and a previously-constructed model of the latter had been found to set up substantial amounts of standing waves in the feedline when Channel 5 was being received—probably due to a lack of preciseness in the wiring of the rather critical feed arrangement. A third article was consulted but constructional details were lacking.⁵ The "Radio Amateurs' Handbook" contained much helpful infor-

Fig. 1. Over-all view of the author's home-built yagi antenna designed for the fringe area reception of Channel 5, Syracuse. Director tuning stubs are clearly visible.

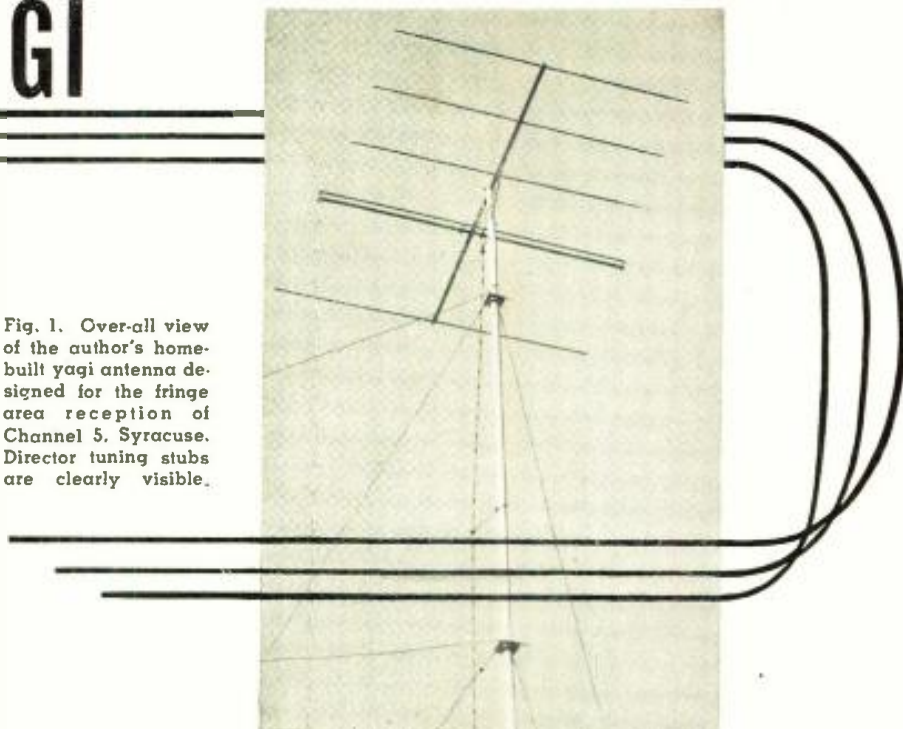

Construction details for building your own fringe area antenna. Although designed for Channel 5, data is included to cover any of the v.h.f. TV channels.

mation but did not delve too deeply into the problem of the five-element yagi.

At this point we were somewhat discouraged by something we could not then comprehend. There was a seemingly serious discrepancy from article to article on the feed point resistance of the yagi antenna. The "Handbook" stressed that the resistance of the dipole was substantially reduced by the addition of parasitic elements. Yet some of the other articles were claiming figures of 200 to 300 ohms for five-element folded dipole arrays. Luckily, an issue of "QST" was at hand with two excellent articles on yagi design.^{6,7} From these it was learned that reflector and director spacings and lengths had significant effects on the antenna feedpoint resistance, bandwidth, front-to-back ratio, "Q," and dipole resonant frequency. While the information given covered only two- and three-element arrays, it was decided to use it as the basis for a five-element design.

However, it was apparent that there were many pitfalls in designing a multi-element antenna without laboratory test equipment. Thus we decided that our antenna would be one that could be easily adjusted to peak performance. Reference (6) used graphs to show how director lengths and director-dipole spacings (with a director-reflector spacing constant at 0.3 wavelength) affect bandwidth, feedpoint resistance, and "Q" of a

three-element yagi. If these graphs are studied, it is apparent that an adjustable director length can only vary all these values over wide limits if the director-dipole spacing is fixed at 0.1 wavelength. (The dipole-reflector spacing is then 0.2 wavelength.) For our purposes we assumed—guessed may be a better description—that two additional directors would have the same effect, to a lesser extent, as the one director. At any rate we fixed our director-dipole and reflector-dipole spacings at 0.1 and approximately 0.2 wavelength respectively and estimated that if all director lengths were adjustable, we would have adequate control. Reference (7) shows by graphs how varying the director or reflector lengths will change the dipole resonant frequency and it thus seemed desirable to incorporate a length adjustment in the dipole.

The design finally worked out called for the following:

1. A three-conductor folded dipole to raise the feedpoint resistance sufficiently so that it could be adjusted to around 300 ohms, thus properly matching 300-ohm lead-in ribbon.
2. A dipole of variable length.
3. A 0.53 wavelength long reflector spaced approximately 0.2 wavelength from the dipole.
4. Three directors, all spaced 0.1 wavelength, and all adjustable in length.
5. An easily adjusted open quarter-wave matching stub at the dipole feed-

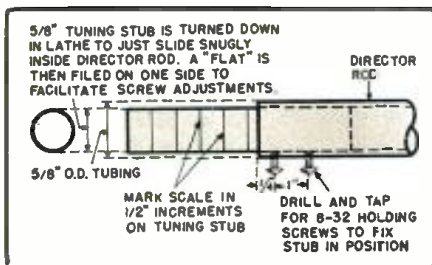

Fig. 2. Construction details on the tuning stubs shown in over-all diagram (Fig. 4).

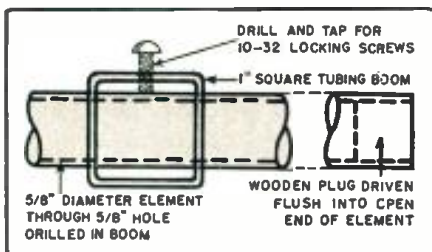
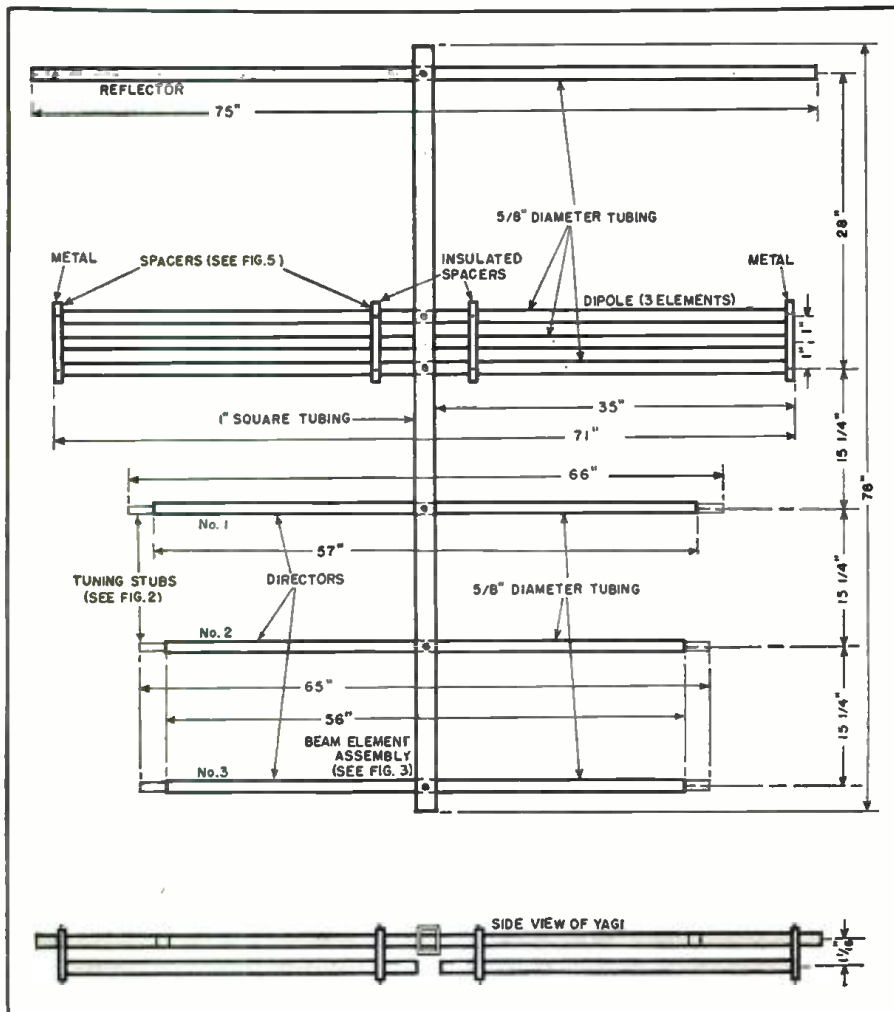

Fig. 3. Method of fastening antenna elements to 1" square #61ST alloy tubing.

point. This will be discussed later. For ruggedness, 5/8" dia. 24ST tubing was used throughout. 61ST alloy should be a satisfactory substitute, but it is recommended that such alloys as 24SO, 61SW, 61SO, 2S, and 3S be

Fig. 4. Dimensions for the Channel 5 yagi. Figures are given for the element lengths with and without matching and tuning stubs. See Table 1 for other channel dimensions.



avoided unless the wall thicknesses are very heavy. The boom was made from 61ST 1" square tubing. Round tubing can certainly be used for the boom, but the "squaring-up" will be much more difficult.

Fig. 4 is a diagram giving all Channel 5 dimensions. These dimensions were computed using the formula

$$0.5 \text{ wavelength} = \frac{492 \times K}{\text{frequency (mc.)}}$$

K is obtained from the "Handbook." Fig. 10-44 of my 1948 edition graphically shows the effect of antenna diameter on half-wave resonant length. To find K for 5/8" tubing in Channel 5 design we first compute

$$\frac{\text{free space half-wavelength}}{\text{conductor diameter}} = \frac{492 \times 12}{77.25 \text{ mc.}} \times \frac{8}{5} = 122$$

For this 122 ratio K is taken from the graph to be 0.93. This value is used in determining the physical length of the 0.53 wavelength reflector. K for the dipole is less than 0.93 due to the three closely-spaced conductors, but the actual value is difficult to obtain. Since, for tuning, it is desirable to have the dipole slightly on the long side, 0.93 was used for K in the length calculations. Spacings between the various elements are found with K = 1.

Since this antenna was built and found to be an excellent one, two additional books have been consulted: "TV and Other Receiving Antennas" and the 1952 edition of the "Radio Amateurs' Handbook." The value of K for 5/8" tubing at 77.25 mc. has been checked in each: in the former it turned out to be 0.90; in the latter, 0.965. This demonstrates just how opinion varies on this matter. Our value of 0.93 is at least a very good average—and it works. Again, this disagreement is another excellent argument for the tunable antenna.

The directors should be adjustable from 0.4 to 0.48 wavelength (for 5/8" tubing). They were, accordingly, made to the dimensions shown—which will allow plenty of leeway in adjusting the 8" long stubs. Fig. 2 details these stubs. They should be calibrated in half-inches along their length for precise balancing of the director lengths on each side of the center boom.

All elements are mounted on the boom through 5/8" holes drilled through the 1" square tubing. After each element is centered exactly, it is fixed by tightening the holding screws as shown in Fig. 3. Wooden plugs are fitted into the ends of all the open tubes to lessen wind resistance.

Fig. 5 illustrates the spacing device for the dipole conductors. The outer ones are made of aluminum alloy and are used for adjusting the effective length of the dipole. The inner ones can be made from lucite, bakelite, or red fiber, and are locked into position very near to the center feedpoint.

Fig. 6 shows the center connections of the dipole. A word of explanation here may be appropriate. Ideally, the feedpoint resistance of the antenna should equal the surge impedance of the feedline: 300 ohms for 300-ohm line. For many antenna designs the feedpoint resistance is lower than the line impedance. This mismatch can be remedied by a commonly recommended device, a quarter-wave, open-end matching stub. This can be made up of a quarter-wavelength of 300-ohm line attached to the antenna feedpoint. The 300-ohm line is then attached to the point along the length of this stub that gives the best match (or best picture). Such a matching stub was desired on our antenna in case the tuning adjustments for the best picture lowered the resistance appreciably below 300 ohms. If one tries to picture oneself adjusting a matching stub of 300-ohm ribbon twin-lead, while experimenting with dipole and director length adjustments, it will soon be realized that some much more simple arrangement is desirable. Fig. 10-14 in the 1948 "Handbook" shows that 1/4" dia. tubing spaced 1 1/2" apart has a line impedance of 300 ohms. Accordingly, the 300-ohm matching stub was made of 1/4" tubing spaced with bakelite or lucite spacers. For Channel 5 each piece was 35 3/4" long. The length factor K must again be used and, for 1/4" tubing at 77.25 mc., the 1948 "Handbook" gives this value as 0.945. Bat-

tery clips attached to the feedline can now be adjusted quickly up and down the stub for optimum positioning.

Fig. 1 shows the completed and adjusted antenna mounted on a 2" diameter mast 20 feet high. The 1" square boom was mounted in a 1" slot cut into the top of the pole. It was fastened with a 1/4" carriage bolt and then squared up with two aluminum shelf brackets of the common variety. The matching stub is not visible as it was found, after optimum adjustments had been completed, that the best position of the feedline was the extreme lower end of the stub. This indicated that the antenna matched the 300-ohm line very closely and thus the stub was not necessary.

A very laborious tuning procedure can be worked out including all the possible combinations of adjustments if one desires to get the very last ounce of picture out of this antenna. However, experience has taught that the owners of new television sets insist on watching the pictures and thus, a shorter and less precise procedure was, of necessity, followed. Yet, sufficient experimentation was carried out to insure that almost optimum, if not optimum, results were obtained. Most of the adjustments were made with the antenna temporarily mounted on the 20-foot mast and the mast resting on the front lawn leaning against a verandah column. We were able to get a picture with the array set up in the bungalow's living room and some of the preliminary adjustments were made there. For each set of director length adjustments, the dipole length was varied by sliding the outer spacers in and out. Then the battery clips were adjusted along the length of the matching stub for best results. Observations were based on picture clarity, contrast (lack of snow in this fringe area during February), and quality of the audio. The best settings were finally rechecked before a final setting was made.

After final adjustment, several sets were tried out. It was interesting to watch the surprised looks of some of the installation technicians when they found they could not change the picture quality by grasping the lead-in line. We received many compliments on the installation. Just back of the house is a main thoroughfare, but buses, transports, etc. do not disturb the picture or the sound. The antenna bandwidth is good. The test pattern comes through perfectly to the screen with absolute clarity on all the vertical stripes.

Incidentally, for those who wish to make a Channel 5 antenna without tuning attachments, the final dipole length was 71", and the lengths of the directors 66", 65", 65" in respective order of distance from the dipole. These Channel 5 dimensions have been transposed for the other channels in Table 1. 5/8" dia. tubing is used for all channels, but the change in K factor due to changes in the wavelength-diameter ratio is taken into considera-

CHANNEL	DIPOLE LENGTH	REFLECTOR LENGTH	SPACINGS				
			DIRECTORS 1	DIRECTORS 2	DIRECTORS 3	REFLECTOR TO DIPOLE	DIRECTORS
2	101 1/2"	106"	93 1/4"	92"	92"	39 1/4"	21 1/4"
3	90 3/4"	95 1/4"	83 3/4"	82 1/2"	82 1/2"	35 1/4"	19 1/4"
4	82"	86 1/4"	75 3/4"	74 3/4"	74 3/4"	32 1/4"	17 1/2"
5	71"	75"	66"	65"	65"	28"	15 1/4"
6	65 1/8"	69"	60 3/8"	59 3/4"	59 3/4"	26"	14 1/8"
7	29 1/2"	31 1/4"	27 1/2"	27 1/8"	27 1/8"	12 3/8"	6 3/4"
8	28 1/2"	30 1/4"	26 5/8"	26 1/4"	26 1/4"	12"	6 1/2"
9	27 5/8"	29 1/4"	25 3/4"	25 3/8"	25 3/8"	11 5/8"	6 1/4"
10	26 3/4"	28 3/8"	25"	24 3/8"	24 3/8"	11 1/4"	6 1/8"
11	25 7/8"	27 1/2"	24 1/2"	23 3/4"	23 3/4"	10 7/8"	5 7/8"
12	25 1/4"	26 5/8"	23 1/2"	23 1/8"	23 1/8"	10 1/2"	5 3/4"
13	24 1/2"	25 7/8"	22 3/4"	22 1/2"	22 1/2"	10 1/4"	5 5/8"

Table 1. Antenna element dimensions computed for all of the v.h.f. television channels.

tion in the figures. The 1948 "Handbook" does not give values of K for 5/8" tubing at high-band frequencies. Since we are dealing with relative values at the different frequencies, we did not worry too much about which of the other two sources of K values we used. All values for the transposing calculations were taken from "TV and Other Receiving Antennas."

However, for those who really desire superior results, it is suggested that the small extra effort put into a tunable antenna is well worthwhile.

REFERENCES

1. Smith, Woodrow; "Rhombic Antennas for Television," *Radio & Television News*, October, 1949.
2. Morgan, Dean O.; "How Antennas for Television," *Electronics*, October, 1951.
3. Greculce, Lyman E.; "High-Gain Directional Array for Marginal TV Reception," *Radio & Television News*, August, 1949.
4. Carmichael, G. N.; "Two-Channel TV Yagi Design," *Radio & Television News*, October, 1950.
5. Harris, Harold; "The Yagi Antenna," *Radio & Television News*, October, 1951.
6. Shanklin, J. P.; "Bandwidth of Two

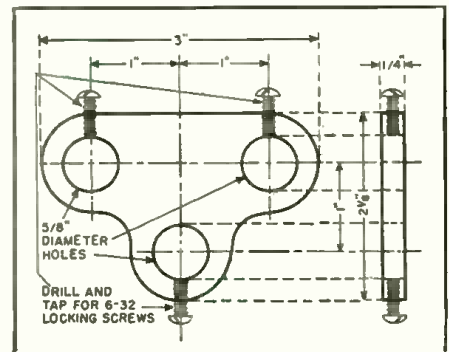

Fig. 5. Details of the dipole spacer units. Four of these units are required—two of aluminum and two of either lucite, fiber, or bakelite. See Fig. 4 for positioning.

and Three-Element Yagi Antennas," *QST*, October, 1950.

7. Dukat, F. M.; "Driven Element Length," *QST*, October, 1950.

8. Bailey, Arnold B.; "TV and Other Receiving Antennas," John F. Rider Publisher Inc., pages 318, 319.

—30—

Fig. 6. How the matching stubs are attached to the dipole of the author's antenna.

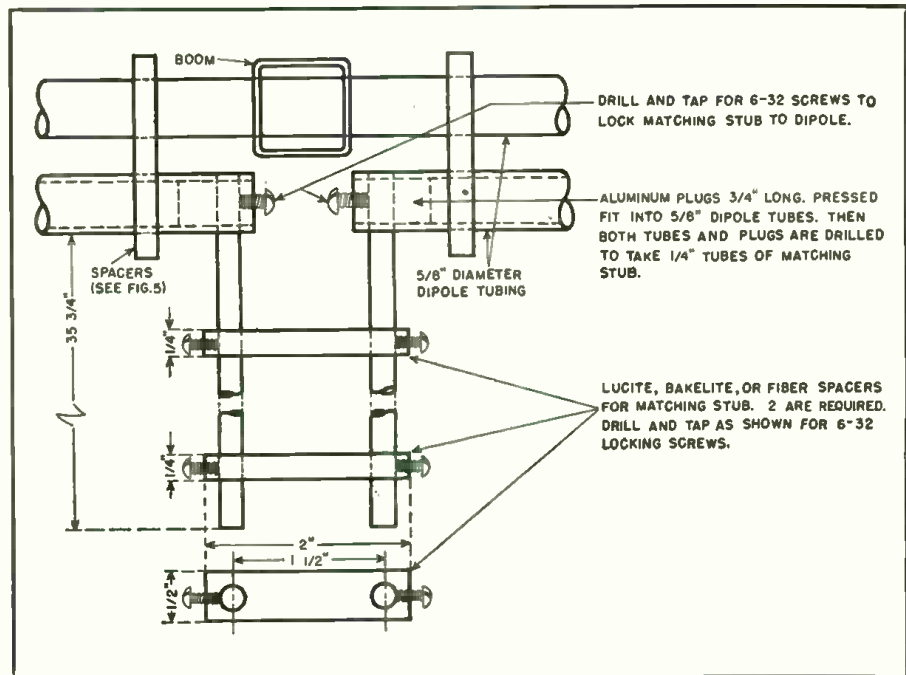



The "Kine-Lite" manufactured by Vidair Television Company, Lynbrook, N. Y.

Crest Laboratories' version of a permanently-installed type of cathode-ray rejuvenator unit.

The Model CR-54 picture-tube booster manufactured by Telematic Industries.

The "EbcO" rejuvenator as manufactured by Electronic Beam Corporation.

"TV Tube Britener" made by Perma-Power Company of Chicago, Illinois.

The "Stay-Brite TV Tube Saver" marketed by Television Communications Institute.

CATHODE-RAY TUBE REJUVENATORS

By **ALBERT J. EISENBERG**
Crest Laboratories, Inc.

A survey of currently-available units for prolonging the life of TV picture tubes.

THIS YEAR it is estimated that approximately three million picture tubes will fail in service at an average cost of \$45.00 per tube. This means a loss of over \$135,000,000. It has been found that over 85% of these defective cathode-ray tubes have failed because of low emission. Newly developed rejuvenators restore the emission to a satisfactory level by raising the cathode temperature. As the use of rejuvenators effects a restoration of brightness in over 80% of weak tubes, a resultant saving of almost \$100,000,000 could be realized, eliminating the expense of purchasing new cathode-ray tubes and taking substantial risk and expense from parts warranties.

The idea of rejuvenating vacuum tubes is not a new one. Patents have been issued as far back as 1926 on rejuvenating principles. As a matter of fact, during the initial manufacture of cathode-ray tubes, many tube manufacturers apply considerably greater-than-normal heater voltage in curing the cathode emitting surface and thereby improve emission characteristics.

The heating of the cathode of the picture tube increases the kinetic energy of the cathode surface electrons to the point where electron emission occurs.

Pure barium oxide requires a minimum of heat energy to cause electron emission from the cathode and, consequently, is most often used as a cathode coating. In low emission tubes, the oxide coating has combined with, or has been contaminated by, the occluded gases in the tube. This usually happens when the surface layer of barium oxide is not replaced as fast as it evaporates. By using a cathode-ray tube rejuvenator, cathode temperature is raised permanently so that the kinetic energy of the electrons is sufficiently increased to permit easier escape. In addition, some reformation of the cathode surface and the reduction of the impure molecular barium oxide layer reduces the work function or energy required of an electron to escape from the cathode.

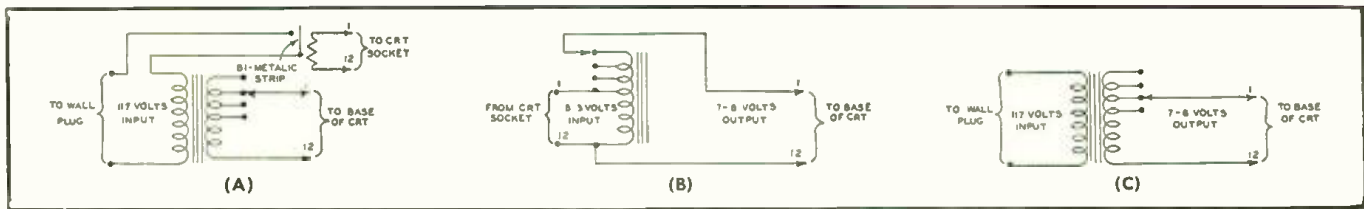

Fig. 1. (A) Transformer type rejuvenerator with automatic "on-off." (B) auto-transformer type, (C) transformer type rejuvenerator.

The reactivation of cathode-ray tubes may be accomplished by one of two methods, which we shall call "flashing" and "rejuvenating."

In the "flashing" method, one and one-half times the normal heater voltage is applied to the picture tube for about one minute. Then the picture tube is run at ten per-cent over normal voltage for one to two hours. Doing this returns the contaminated barium carbonates or the barium oxides to the pure barium metal state.

In the "rejuvenating" method, 25% additional voltage is permanently applied to the heater. The increased heat enables more electrons to be continually emitted. One might assume that this continual over-voltage would cause premature heater failure. However, cathode-ray tube heaters are designed to withstand a 100% overload for a considerable period of time to enable the cathode-ray tube manufacturers to cure the cathode surfaces during initial manufacture.

The "flashing" method of reactivating picture tubes usually effects a 60% to 75% cure. However, this cure may not be a permanent one; after several months, the tube may once again decrease in efficiency. The "rejuvenator" method of permanently applying high temperatures to the cathode effects a 70% to 85% cure. This writer has seen rejuvenators that have been installed in television receivers and have been in service well over a year without customer complaints.

The reactivation method only corrects for low emission in cathode-ray tubes. Picture trouble caused by mechanical defects cannot be corrected. However, higher operating temperatures in the cathode-ray tube, as created by the use of the rejuvenator, sometimes expand the internal structure of the cathode-ray tube and may open up inter-element short circuits. Some rejuvenators use an isolated heater transformer, rather than an auto-transformer, to eliminate the effects of a cathode-to-heater short. However, the isolated type of transformer must be plugged into the wall for its source of power and requires additional circuits for switching. On the other hand, the auto-transformer type of rejuvenator will work from the normal power of the set, without such additional switching. In addition, the auto-transformer type of booster is considerably less expensive.

The rejuvenator leads should be made as short as possible to prevent loss of detail and detuning of video traps caused by excess capacity on the grid of the cathode-ray tube. Consequently, many rejuvenator manufacturers run the grid leads separately instead of cabling them.

Fig. 1 shows the modified schematic diagrams of the various types of rejuvenators in use. Fig. 1A is an isolation-type rejuvenator with an automatic "on-off" switch. The bi-metallic-heater strip is gradually seated by the resistor fed from the filament pins of the old CRT socket. This strip closes the primary circuit of the transformer when it is sufficiently seated. Fig. 1B is an auto-transformer-type rejuvenator requiring no external source of power. Fig. 1C is a simple transformer-type rejuvenator. All three show the various taps available to increase or decrease the filament voltage as required. *Crest Laboratories, Inc.*; *Telematic*; *TCI*; *Vidaire*, and *Ebco* manufacture the auto-transformer-type rejuvenator.

Perma-Power manufacture an automatically-operated transformer rejuvenator that can be used with series- and parallel-heater receivers. Suitable for flashing as well as rejuvenating is the unit marketed by *Rytel*.

All schematic diagrams shown in Fig. 1 are of units designed for a.c. operation on standard picture tubes, using 6.3 volt, 0.6 ampere heaters.

Crest Laboratories, Incorporated

2117 Mott Avenue, Far Rockaway, New York

Electronic Beam Corporation

923 Old Nepperham Avenue, Yonkers 3, New York

Perma-Power Company

41-21 N. Damen Avenue, Chicago 25 Illinois

Rytel Electronic Manufacturing Company

11138 Hawthorne Bldg., Inglewood California

Telematic Industries, Incorporated

1 Joralemon Street, Brooklyn, New York

Television Communications Institute

205 W. Wacker Drive, Chicago 6, Illinois

Vidaire Television Company

576 W. Merrick Road, Lynbrook, New York

Companies which manufacture rejuvenators and reactivators.

It would appear, at first glance, that the use of rejuvenators might decrease the sales volume of both the service agency and the cathode-ray tube manufacturer. However, the effect of its use has been quite the contrary. By installing a rejuvenator in a set that has a low-emission picture tube, the customer can immediately see picture brightness return, and thus be convinced that it was his picture tube that was defective. Since the rejuvenator is not actually applied until useful tube life is exhausted, any time added is something gained. Should the rejuvenator maintain tube life for only a relatively short period of time, consistent good-will still would have been maintained. Of course the rejuvenator may be used over and over again for the life of the television receiver.

The picture-tube rejuvenator is many times sold on a three-month brightness guarantee basis. Should the revived picture tube go bad during that time, full credit for the cost of the rejuvenator is applied toward the purchase of a new tube. In this manner, the use of the picture-tube rejuvenator is actually a stimulant rather than a deterrent to picture-tube sales. As the installation is simply a matter of only a minute or so by non-technical personnel, the service call profit picture is rather lucrative. Thus, to summarize, as all cathode-ray tubes eventually go bad sometime, the use of the rejuvenator simply postpones the day when a new tube must be purchased. —30—



Two versions of the "reactivator-type" CR brightener: (Left) The Ebco Model 10 and (Right) the Rytel unit.

SURVEY OF TRANSISTOR DEVELOPMENT

By

B. N. SLADE

Tube Dept., Radio Corporation of America
Harrison, New Jersey

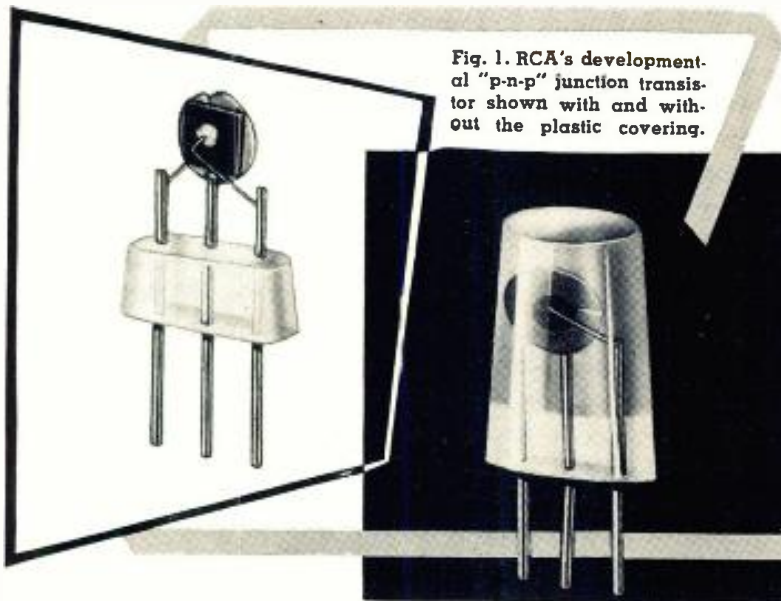

Fig. 1. RCA's developmental "p-n-p" junction transistor shown with and without the plastic covering.

Part 2. A resumé of point-contact characteristics, its frequency response, and power considerations.

IN THE first article of this series the preparation of germanium crystals, the conductivity of germanium, the fabrication of the point-contact transistor, point-contact rectification, and the operation of the point-contact transistor were covered. This article will consider the characteristics of a point-contact transistor, transistor frequency response, and power considerations of this unit.

Characteristic Curves

The electrical characteristics of the point-contact transistor may be described by static characteristic curves having slopes equal to the open-circuit resistances. For example, the input characteristic, illustrated by the curves in Fig. 2, is defined as the emitter voltage vs the emitter current for several values of constant collector current. The slope of the curve taken at any point is defined as the open-circuit input resistance because the output circuit is an open circuit for a.c. currents.

The feedback characteristic is illus-

trated in Fig. 3. The slope of this curve is the internal feedback resistance which is mutual to both input and output circuits. This resistance is a measure of the effect of collector current upon the voltage drop at the emitter point. It acts as a positive feedback element, and, if it becomes too large, the transistor may become unstable.

The output characteristic curve is given in Fig. 5. The slope of this curve is the open-circuit output resistance. This resistance is approximately equal to the collector resistance, or the a.c. impedance which exists at the collector contact. The current amplification factor which is a measure of the effect of the emitter current upon the collector current, may also be measured from the output characteristic. Along a line of constant collector voltage, a change in collector current for an increment of emitter current may be measured. The current amplification factor is equal to the change in collector current divided by the change

in emitter current. The output characteristic curve is similar to the curves of the plate family of the electron tube except that the voltages are plotted as a function of the currents for the transistor while the currents are plotted as functions of the voltages for the vacuum tube. An oscillogram of the output characteristic of a typical point-contact transistor is shown in Fig. 4.

Because a transistor may have a negative input resistance, it is possible to obtain two sets of currents for one set of voltages. This effect is shown in the curve of emitter voltage vs emitter current for a constant collector voltage, in Fig. 7. As the emitter and collector currents increase, the voltage across the internal feedback resistance becomes larger. Since this voltage is negative with respect to the base and is in series with the applied emitter voltage, a point is reached where the total emitter voltage decreases with increasing emitter current, resulting in a negative input resistance. For an emitter voltage of 0.26 volt and a collector voltage of -20 volts there are two values of emitter current which may be selected from the curve shown in Fig. 7: 0.6 milliamperere and 2.2 milliamperes. There will also be different collector currents for these values of emitter current (2.0 and 5.0 milliamperes, respectively). Because there is only one set of voltages for a given set of currents, it is desirable to plot the voltages as a function of currents. It is also highly important that constant-current rather than constant-voltage sources be used. If fixed voltages were applied directly to the emitter and collector, any slight increase in collector current would tend to increase the emitter current due to the effects of feedback. This increase would, in turn, increase the collector current and considerable instability would result. In junction transistors, which will be discussed later, neither the negative input resistance nor the positive feedback exist. Therefore, constant voltage supplies may be used with no possibility of instability.

The transfer resistance is defined as

Fig. 2. Input characteristic of the RCA developmental point-contact transistor.

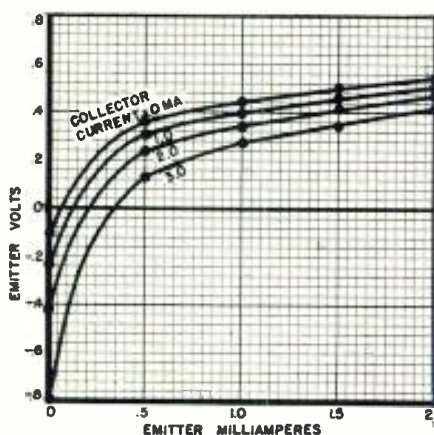
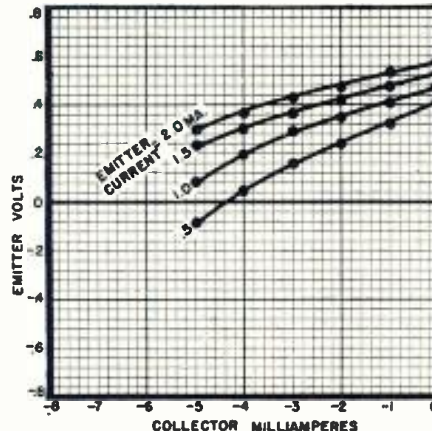

Fig. 3. Feedback characteristic of the RCA developmental point-contact unit.



the slope of the transfer characteristic curve which is illustrated in Fig. 6. This resistance is also equal to the product of the current amplification factor and the output resistance.

Some typical values of open-circuit resistances for a point-contact transistor are: input resistance, 300 ohms; output resistance, 20,000 ohms; feedback resistance, 120 ohms; and transfer resistance, 40,000 ohms.

Because of feedback effects, the optimum input and output impedances for maximum gain in an amplifier circuit using this transistor are slightly less than the open-circuit resistance values. However, an input impedance of 200 to 500 ohms and an output load impedance of 10,000 to 20,000 ohms would result in a power gain of approximately 20 db which is close to the maximum available gain.

The power gain of the transistor depends upon three major factors. First, the gain varies almost directly with the ratio of output impedance to input impedance. This ratio may be on the order of 100 to 200 to 1 in point-contact transistors; in junction transistors the ratio may be on the order of 10,000 to 1. Secondly, the power gain varies as the square of the current amplification factor, which may be on the order of 2 or 3 for point-contact transistors and slightly less than one in junction transistors. Thirdly, the positive feedback of the transistor accounts for several decibels in power gain. The amount of the gain due to feedback depends upon the magnitude of the internal feedback resistance and the current amplification.

Transistor Frequency Response

The frequency response of the point-contact transistor is limited by the transit time of the holes or electrons; transit time is the time it takes the holes or electrons to travel from the emitter to the collector. The transit time in seconds may be calculated approximately through use of the expression $S^2/\rho\mu I_e$, where S is the contact spacing or the distance between the emitter and collector in centimeters, ρ is the resistivity of the germanium in ohm-centimeters, μ is the mobility of the holes or electrons in centimeters squared per volt-second, and I_e is the emitter current in amperes. Since an improved frequency response results from a small transit time, it can be seen from this expression that the response can be improved by using germanium of high resistivity and small contact spacings. The mobility of the holes or electrons is the velocity with which they move through the germanium when an electric field is applied. In the case of "n"-type germanium, holes travel from the emitter to the collector; in the case of "p"-type germanium, electrons travel from the emitter to the collector. The mobility of electrons is greater than that of holes and, consequently, the frequency response of "p"-type germanium is slightly better than that of "n"-type germanium, pro-

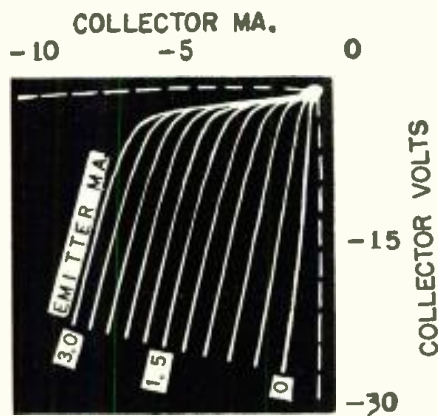

Fig. 4. Oscilloscope of output characteristics of RCA developmental transistor.

vided that the contact spacings and resistivities are comparable.

The frequency response may be defined as the measure of the change in current amplification with increasing frequency. The current amplification factor of certain types of close-spaced point-contact transistors drops approximately 3 db. at 10 mc. A 3-db. drop in gain has been chosen to define the cut-off frequency. This method of measuring frequency response, however, defines only one parameter as a function of frequency. If the power gain of the device is measured as a function of frequency in an amplifier with a high-impedance load, the response of the transistor deteriorates more rapidly. A transistor having a 3-decibel drop in the current amplification factor at 10 megacycles may have a cut-off of voltage or power gain at 4 megacycles or less.

Wide-Spaced Transistors

The frequency of operation of point-contact transistors decreases fairly rapidly with increased point spacings. Since the transit time of the electrons or holes increases as the point spacing increases, in theory the frequency response of the transistor varies inversely as the cube of the spacing. However, some interesting studies have been made of "n"-type transistors having wide spacings between

(Continued on page 112)

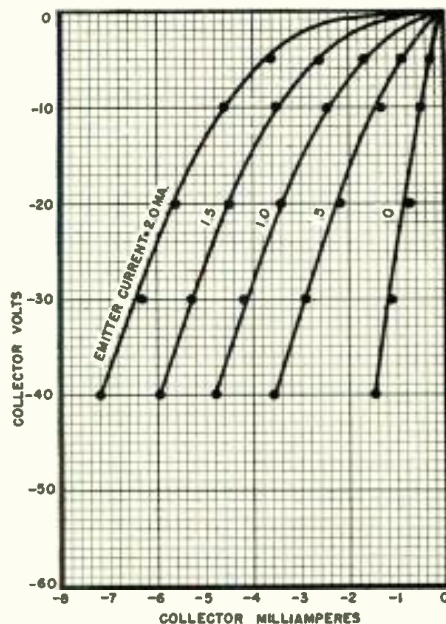

Fig. 5. Output characteristics of the RCA developmental point-contact transistor.

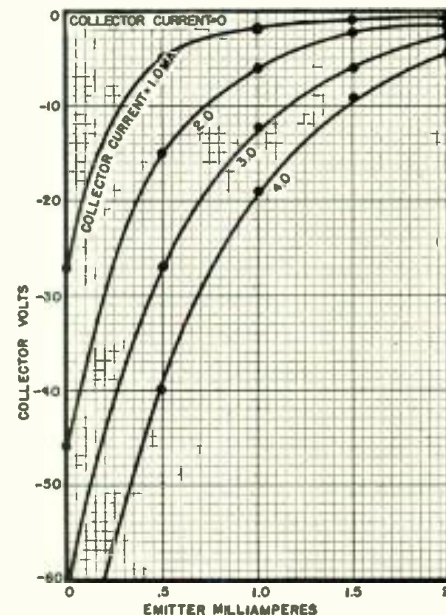
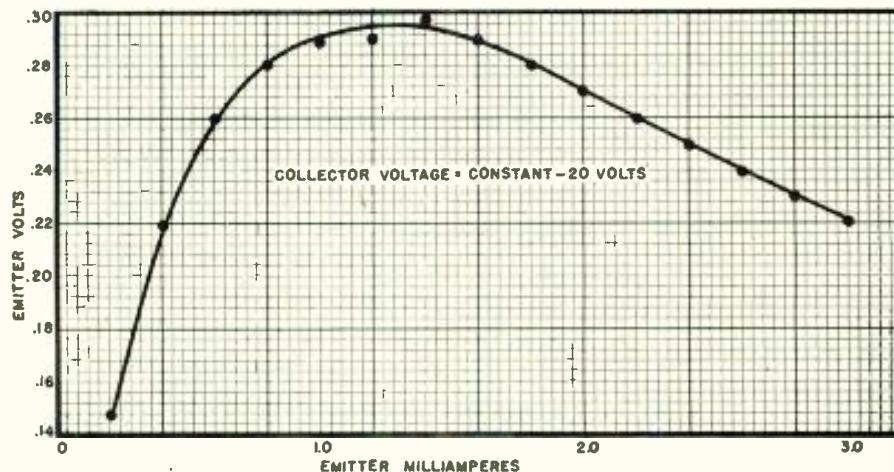
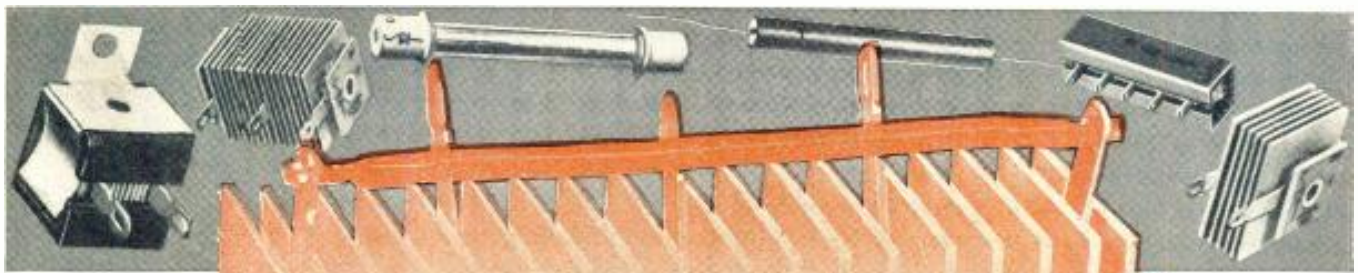

Fig. 6. The transfer characteristic of RCA's developmental point-contact transistor.

Fig. 7. Negative input-resistance characteristics of the point-contact transistor.





SELENIUM RECTIFIERS

By **S. NICIEJEWSKI**, Sales Manager
Rectifier Division, Sarkes Tarzian, Inc.

The production of these units is carefully controlled from the selection of raw materials to final testing.

IN APPEARANCE, selenium rectifiers are relatively simple devices; however, the process and quality control under which rectifiers are produced are exacting and critical. A one per-cent change in nucleation temperature or an additional few parts per million of impurity in raw materials may disturb the balance enough to produce poor results.

The basic materials required are few: selenium, aluminum, and a low melting point alloy; however, the proper application and treatment of these is important. The aluminum is a special alloy that will chemically etch and nickel plate properly in an established process, and the selenium is very nearly 100 per-cent pure; impurities are measured in parts-per-million and the difference between 7 and 10 parts-per-million may result in a poor selenium rectifier. The eutectic alloy used in the counterelectrode is a combination of pure metals that consistently melts at the same temperature.

The first step in the process of manufacturing selenium rectifiers is to prepare aluminum base plates by chemical etching and electroplating with a very thin "flash" coat of nickel. The undercut etch serves as a mechanical means of bonding the selenium layer to the base plate during the subsequent pressing operation. The nickel plating governs crystal growth and orientation in the selenium layer.

High purity selenium is sprinkled over the nickel plated base plate in fine powder form and is then subjected to high temperature and pressure in hydraulic presses with electrically heated platens. The pressing operation not only causes the selenium to adhere to the base plate but actually starts crystal nucleation in the selenium which is amorphous when

applied. This process is very critical and important since poor adhesion of selenium to base plate will have adverse effects on useful life.

After the powder-press operation, selenium rectifier cells are placed in long conveyor ovens for heat treatment that completes the crystallization process. Here the selenium is completely converted to "metallic" form and the crystals are arranged to cause rectification. During this heat process the temperature is exceedingly critical; a one per-cent deviation could cause poor crystallization and consequently, a poor rectifier cell. This heat treatment also forms a very thin "barrier layer" on the selenium and it is believed that rectification is accomplished in this layer.

To produce cells with high inverse voltage ratings it is necessary to expand, artificially, the barrier layer formed during heat treatment. This is accomplished by applying a thin layer of organic lacquer especially developed for this purpose. Under magnification, the artificial barrier layer forms a sponge-like surface, microns

thick, that increases the initial reverse or blocking resistance of the rectifier and allows it to be increased even more during later operations.

To form a positive contact and current pick-up a low melting-point alloy is sprayed over the barrier layer. The alloys used vary between manufacturers; however, those in common use are alloys that range in melting temperature from 100° C to 175° C.

When the alloy is applied the rectifier cell is virtually complete and will efficiently rectify low voltages, approximately 10 volts r.m.s. per cell. However, since most applications require relatively high voltages, the reverse or blocking resistance of the rectifier must be increased substantially to be practical and this is accomplished by subjecting rectifier cells to voltages that cause current to flow in the reverse direction. This process, known as "electroforming," varies slightly, depending on cell size, and usually requires approximately six hours to produce stable cells with acceptable conductive and blocking characteristics.

After electroforming, cells are carefully checked for acceptability and placed in stock for assembly into rectifier stacks. For rectifiers normally used in radio and television receivers, stacks are immediately assembled and stocked because some standardization has been reached; however, for commercial power-type rectifiers, stacks are not assembled until orders are received, since most requirements are custom designed and a very large number of combinations is possible.

Quality control plays a very important part in the production of selenium rectifiers. Inspection stations are located at every step of the process and numerous tests are made daily. Any indication of inferior qual-

Fig. 1. How the nonlinear characteristics of selenium rectifiers contribute to high efficiencies even at large overload factors.

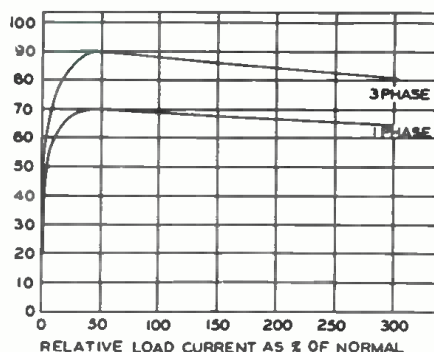

ity causes an immediate shutdown of the process line. Also, on completed rectifier stacks, life tests under adverse conditions are continually in progress to determine quality, useful life expectancy, and aging characteristics.

Extreme care and control are applied during the manufacture of selenium rectifiers and units shipped into the field are of the highest quality possible to attain; however, in spite of wide application, there are still reports from the field of incorrect application where the rectifier is either caused to fail or is not producing optimum results. It is well at this time to consider a few factors governing the application of selenium rectifiers.

Application Notes

During the past five years, selenium rectifiers have found application in virtually every phase of electronic and electrical equipment production. Typical applications include radio and television receivers, communications equipment, business machines, battery chargers, electroplating equipment, electrolysis equipment, cathodic protection equipment, guided missiles, magnetic amplifiers, radar and sonar equipment, as well as many special applications. Wherever d.c. power is either required or desirable, selenium rectifiers will provide an economical and efficient method of conversion.

In spite of widespread use, the selenium rectifier is still somewhat of a mystery and enigma to the average engineer and technician.

Selenium rectifiers are thermally as well as electrically rated devices; therefore, special precautions must be taken to insure long useful life under adverse conditions. The rectifier stack should be mounted with the cells in a vertical plane so that the convection of air is unimpeded. The stack should be mounted at the coolest location on the chassis, away from heat dissipating equipment such as resistors, tubes, transformers, ballasts, or any heat radiating element. If the ambient or surrounding temperature is higher than 50° centigrade, stacks should be properly derated to insure long, trouble-free life; however, derating is not as severe when relatively short life (1000 hours minimum) is required. Since temperature presents a very complex problem, particular applications should be referred to the manufacturer of selenium rectifiers for individual consideration and recommendation. Following this procedure will always result in the most economical design compatible with life and duty requirements. Table 1 shows general derating factors; however, individual requirements may often require deviation from the listed values.

To conserve space and decrease weight, many design engineers take advantage of forced air cooling. A sufficient volume of air to limit operating temperatures allows a 250 per-cent increase in d.c. load current.

For example, a rectifier that is rated at 10 amperes with normal convection cooling can be operated at 25 amperes if sufficient air is passed between the cells. Also, to decrease the effects of very high ambient temperatures, forced air is often used to allow higher percentages of normal rating. In all cases, the recommendations of the manufacturer should be followed.

The efficiency of conversion in selenium rectifiers is relatively high, usually on the order of 90 per-cent in three-phase, full-wave circuits and 70 per-cent in single-phase, full-wave circuits. The nonlinear characteristics of selenium rectifiers contribute to high efficiencies even at large overload factors. For example, in Fig. 1, it is evident that there is only a 10 per-cent decrease in the efficiency of a three-phase, full-wave circuit as the load is varied from 50 per-cent to 300 per-cent of normal, and only 7 per-cent under the same conditions in a single-phase, full-wave circuit. This information is important to the design engineer who plans to use overload factors with forced air cooling.

By the very nature of its construction (two metals separated by a semiconductor) selenium rectifiers have a considerable amount of inherent capacity. This capacity, approximately .1 to .15 microfarad-per-square-inch of rectifying area, limits the frequency at which rectifiers can be used. The practical frequency limit varies between 1000 and 15,000 cycles-per-second, depending on cell size and electrical requirements. In general, in applications that require small values of d.c. current, the maximum practical frequency is 15,000 cycles-per-second; and 1000 cycles-per-second in applications where relatively large d.c. load currents are required. Operation of the rectifier at frequencies

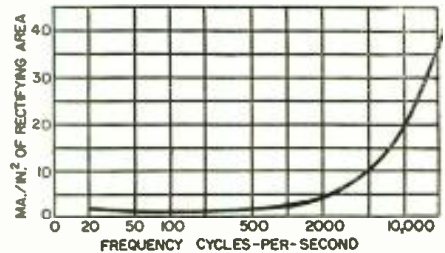

Fig. 2. How reverse current increases as frequency is varied from 20 to 15,000 cps.

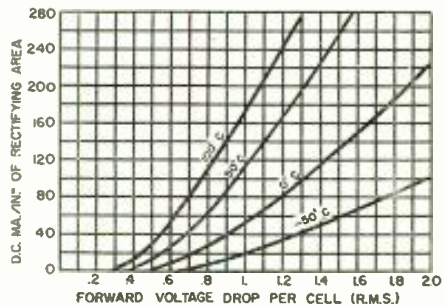

Fig. 3. Graph of typical isothermal characteristics of selenium rectifiers and threshold voltages at various temperatures.

AMBIENT TEMPERATURE	% E	% I
45° C.	100	100
60° C.	100	80
65° C.	80	100
70° C.	100	65
75° C.	80	80
80° C.	80	45
85° C.	60	50
90° C.	50	30
95° C.	50	45
100° C.	40	40

Table 1. Derating factors on selenium rectifiers. Note that these factors are based on long life requirements of the units.

above the practical limit results in sharp reduction of the rectification (Continued on page 118)

Fig. 4. Six common circuits in which selenium rectifiers are used, together with approximate wave shapes under resistive load, ripple percentage and approximate a.c.-d.c. ratio. (A) Half-wave, single-phase, (B) bridge, single-phase, (C) center-tap, single-phase, (D) half-wave, three-phase, (E) bridge, three-phase, and (F) center-tap, three-phase.

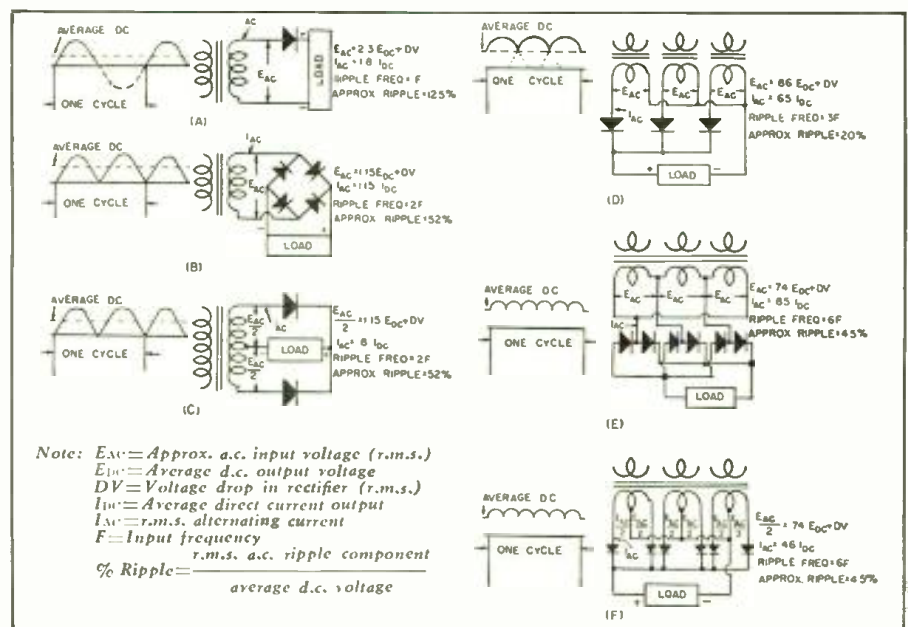

Mac's RADIO SERVICE SHOP

By JOHN T. FRYE



A.C.-D.C. BREAD AND BUTTER

BARNEY, returning from picking up the mail at the post office, was so intent upon looking at the small object he was holding up toward the sky that he walked straight into the screen door of the service shop. The squeaking protest of the stretched wire made Mac look up from the chassis on which he was working.

"Could it be that you need glasses—or maybe a whole new head?" he inquired solicitously.

"Neither," Barney promptly retorted. "I was merely trying to look at these transparencies that just came back. They are all shots of the fall leaves that Margie and I took on our trip to the southern part of the state a few days ago."

Mac picked up the box of slides and held some of them toward the light. "Say!" he exclaimed, "you've got some beauties here. I really get wound up about the show Old Mother Nature puts on in October in this part of the country, and these color shots of yours really do justice to the autumn foliage."

"Why all these kind words?" Barney asked suspiciously as he looked around. "Oh I get it now," he said as his eye lighted on a great stack of small a.c.-d.c. sets piled on the receiving bench. "You're trying to butter me into wading through that bunch of cigar-boxes."

"My boy," Mac said solemnly, "sit yourself down and let me tell you some of the facts of life. Those 'cigar boxes' as you disparagingly call them are quite likely to be a major part of your bread and butter for some time to come. Have you noticed that while the number of consoles we get is less and less since TV started in this fringe area, the number of these

a.c.-d.c. sets seems to be on the increase?"

"Now that you mention it, I have," Barney assented. "How come?"

"The television receiver has almost entirely thrust the console radio out of the place of honor in the living room," Mac explained; "but the little radio is still holding its own in the kitchen, basement, bedroom, or any other location in the house where a person may want to listen to music, news, soap opera, or what-have-you while going ahead with work, reading, or other similar activity. That is why it looks as though the small set will be the last to go under before the onslaught of television—if it ever goes under. I've been glancing back through our records, and I find that we are actually getting more of these little fellows to service now than we did before TV started. Since a very high percentage of the radio work we do is going to be on these sets, I thought it might be a good idea if we sort of overhauled our a.c.-d.c. service procedure and made sure our technique in handling these sets is the best possible."

"I know all there is to know about working on those sets," Barney stated flatly.

"I'm sure that you do," Mac said meekly. "If there is one kind of set that the technician should know like the back of his hand, it is the five or six tube a.c.-d.c. receiver; but I am getting kind of old and in my dotage and do not remember things as well as you young fellows do; so if you don't mind, we'll just run over a few points about working on them for my benefit. After being in this game for a quarter of a century, the one thing I am sure of is that you never know so much about

service work but that you can learn something new—present company excepted, of course."

A quick flush spread over Barney's freckled face. "Okay," he mumbled. "I had that coming—and I got it!"

"I have noticed," Mac went ahead quickly, "that when a set comes in that quite likely has a burned out tube, you try to locate the tube and replace it without removing the set from the cabinet. In the future, I want the set removed in every case. Doing so usually will actually save time. Trying to remove the tubes with the set still in the cabinet often results in breaking loose the leads of the dangling loop antenna. When you try to remove the tubes in the cramped and awkward quarters inside the cabinet, often a tube will suddenly come loose and slip from your fingers like a pinched watermelon seed and sail halfway across the shop. If it is not ruined on the spot, the jarring will likely cause it to go out in the not very distant future.

"Another reason for taking the set out of the cabinet is that it gives you a chance to look it over for other trouble and to clean the dial glass—a small item that looms surprisingly large in the eyes of the ladies. With the chassis out in the open, a single glance is all that is needed to spot a frayed dial cord that needs replacing or a slack tension spring that is getting ready to cause trouble. The same quick look will reveal cracks in the speaker cone that require cementing. Then you can flip the chassis over and take a look for charred resistors, especially in the vicinity of the rectifier socket. While you are at it, notice if a lightning surge may have blown apart the line bypass condenser. Look at the dial lamp. If the filament is open, replace the lamp before turning on the set; and in that case a good first guess on the tube with an open filament is the rectifier."

"I know that you mean that quite likely the portion of the rectifier filament that the dial lamp bridges has gone out and let the full current pass through the dial lamp and burn it out," Barney interrupted; "but I do not see why it is important to replace the dial lamp right away."

"In the first place, I never like to subject that tapped portion of the rectifier filament to an overload, even for a short while; and that is what it will get if the dial lamp is not replaced. Secondly, a seasoned technician always watches that dial lamp while the set is warming up. Since the rectified plate current as well as the filament current flows through it, the brilliance of the lamp gives you a rough but useful indication of any excessive current drawn from the rectifier. Many a time I have seen a dial lamp blooming in time to snap off the set and save a rectifier.

"After the set has warmed up for a few minutes, align it. You can improve the alignment in almost every
(Continued on page 96)



A HIGH-QUALITY SPEAKER SYSTEM

By

LT. HAROLD W. BALLEW

Details on a cabinet which uses two tweeters and a coaxial speaker to provide "natural" reproduction. Its construction requires no special equipment.

Fig. 1. Over-all view of speaker housing.

ONE OF the most often overlooked requirements in building or purchasing high fidelity systems has been the "naturalness" of the system, or how closely it reproduces the original sound. In all systems, the continuous goal is to have the reproduction sound as if the listener were sitting in his seat in the music hall or opera house. Therefore, rather than frequency range, the term "high fidelity" has evolved to refer to the "naturalness" or "presence" of reproduction systems.

The naturalness of any given system will depend primarily upon three factors: 1. The frequency range of the system; 2. The amount of distortion in the system; and 3. The amount of diffusion of the sound from an essentially point source such as a loudspeaker.

Insofar as frequency range and distortion are concerned, while they are major problems, they have been partially solved by the better grades of amplifiers, preamplifiers, tuners, and pickups. The results that can be obtained with a small outlay of cash are very good. The better grades of speakers, coaxial and otherwise, while they fall far short of perfection, are still good enough to satisfy most listeners.

It is the purpose of this article to describe an inexpensive and easy-to-construct speaker cabinet which offers very good sound diffusion. This cabinet provides what appears to be lacking in most high-fidelity systems, that is, the proper diffusion of the sound.

This cabinet is of the labyrinth type with the back loading exhaust into the corner of a room, as shown in Fig. 1. It was built for a medium priced coaxial speaker (Electro-Voice SP-12) with a base cone resonance of about

45 cycles. The construction is of solid 1" oak, 1/2" and 3/4" fir plywood as shown in Figs. 2A, B, and D. All pieces are joined together with a good grade of glue and enough screws to insure that when a good strong bass note comes through the system, the component parts will not vibrate. Of course, the cabinet can be constructed of almost any material provided the material has about the same flexile strength as 3/4" plywood. The use of hardwoods for the top and front gives a professional appearance, however.

It will be noted that the insert has a rounded bottom. This is done to in-

sure that no one frequency will be favored in the feedback radiation from the back of the cone to the front of the cone. This insert is shown in Figs. 2A, B, and D.

Due to the narrow cone of dispersion common to high notes put out by cone-type "tweeters," two small 4" speakers are mounted in the sides of the cabinet as shown in Fig. 2B. In this manner, the treble notes are dispersed throughout the room. No similar provision needs to be made for the bass notes since they are reflected off the walls of the room, because of

(Continued on page 170)

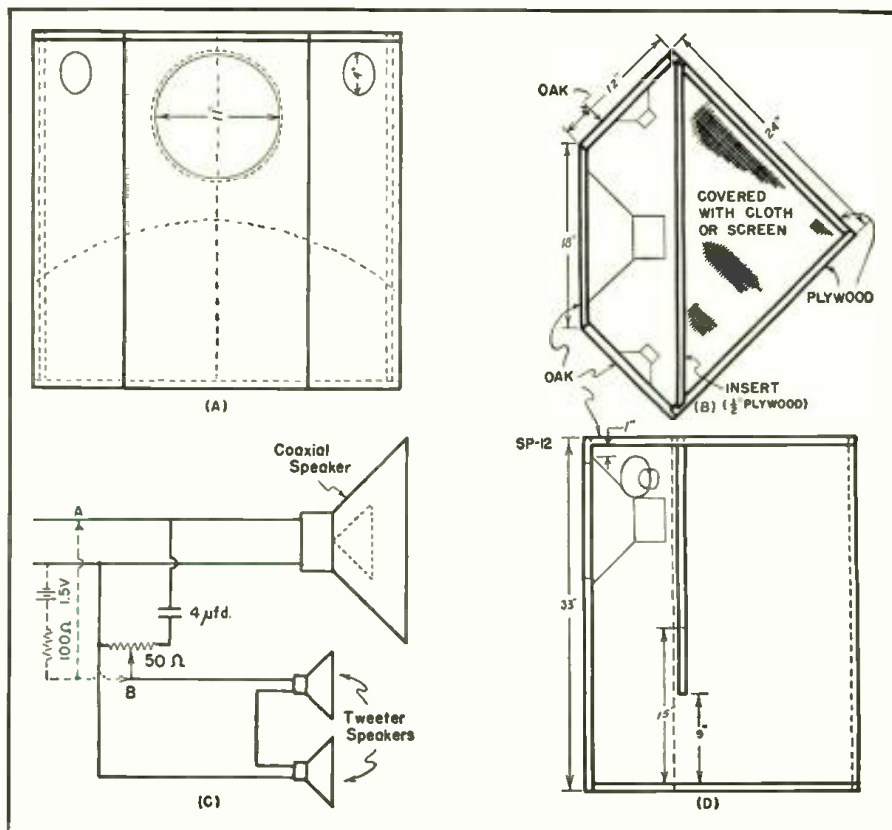

Fig. 2. (A) Front view of cabinet which contains one Electro-Voice SP-12 speaker and two 4" tweeters. (B) Top view, looking into cabinet, shows how speakers are mounted. (C) Method of connecting the speakers. See text for details on phasing. (D) Side view.

A SUPERREGENERATIVE TVI CHECKER

By HARTLAND B. SMITH, W8VVD

A useful gadget for hams. TV technicians can also use this unit as a field strength meter to measure relative signal levels.

A GREAT many U. S. hams are still plagued with TVI. Although it is fairly easy to wipe out all signs of interference on receivers located more than 150 feet from the transmitting antenna, it often proves quite difficult to eliminate interference on the next door neighbor's set. A TV receiver in your own home poses an even more difficult problem.

The situation may, at first, appear almost hopeless, but many a seemingly incurable case can be cleared up with the aid of proper test equipment. Absorption wavemeters and grid dip oscillators are far too insensitive for tracking down weak but dangerous harmonics. If you wish to prove once and for all that your rig is free from spurious emissions, you must employ a field strength meter sensitive enough to pick up the TV stations subject to interference.

A commercially-built meter will cost between \$60 and \$100. While some hams probably can afford to make such an investment to effect a TVI cure, most fellows are rightfully shy when it comes to spending this amount. Many amateurs have overlooked the possibilities inherent in the lowly superregenerative. As a matter of fact, the superregen has a decided edge on the average superhet when it comes to checking TVI. A superhet, overloaded with fundamentals from your transmitter, will often give out with all kinds of spurious signals. A superregenerative device, on the other hand, is a one-frequency device. It doesn't produce beats, images, etc., that might unwittingly be blamed on your rig.

Sensitivity of the superregenerative meter to be described is such that with only a 6 inch antenna, TV stations 20 miles away are received with good strength. When the meter's antenna is placed close to the twin-lead coming from a TV receiving aerial, the unit will detect any signal which is strong enough to produce useful audio or video in the TV set.

Fig. 1. Front panel view of the compact, home-built superregenerative field strength meter.



This particular field strength meter has one characteristic common to all superregenerative detectors. It radiates a good deal of r.f. energy. Thus, it may cause some interference when operated within 50 feet or so of a TV receiver. However, since the meter will only be used while locating TVI, there should be little cause for complaint on this score.

Since you can't do an effective job of harmonic hunting when tied to an a.c. line cord, battery operation is a "must." A triode-connected 1S4 performs very satisfactorily as a superregenerative detector and so it was chosen for this unit. "B" voltage is provided by a 67½ volt "personal portable" battery, while one size D flashlight cell furnishes filament power. Adequate space inside the case is provided for the batteries behind meter *M*, and the phone jack.

It will be noted from examination of Fig. 2 that the plate circuit of the detector is shunt fed. *C*₂, a .01 μfd. condenser, supplies audio to a pair of crystal headphones while preventing the passage of d.c. Since this form of plate feed keeps the 67½ volt "B" potential inside the case its use is suggested, even if a pair of magnetic phones are to be employed with the device.

*M*₁, the 0-1 millimeter indicator, reads full scale with no signal and drops at least .1 ma. as soon as a carrier of any consequence is tuned in. A strong signal will lower it as much as .2 ma. While this variation may seem rather small, it is actually 1/5 full scale and is sufficient to show whether or not a particular transmitter change has had an effect on harmonic output. Use of an indicating

meter with greater sensitivity is not recommended because of the abuse to which it would be subjected in a circuit of this nature. Different settings of the regeneration control and variations in antenna coupling will have a pronounced effect on the 1S4's plate current. There is certainly no use bending a needle or burning out a movement unnecessarily.

Since the amount of rush heard in the headphones varies with received signal strength, in a pinch, the plate meter may be dispensed with altogether. After a little practice you will be able to get a fair idea of signal level merely by noting to what extent the superregenerative hiss drops down as a TV station or transmitter harmonic is tuned in.

*L*₁ can be practically any small filter choke or inductor that happens to be handy. I used one winding of an "Ouncer" audio transformer.

The values of *L*₂ and *C*₁ shown in Fig. 2 cover a tuning range from the video carrier of Channel 2 to the sound carrier of Channel 5. Channels 3 to 6 may be covered by slightly reducing the inductance of *L*₂. If you wish to tune all the low-band channels, use a variable condenser with a somewhat greater capacity range.

No provision has been included for tuning the high-band TV channels. In most cases, if TVI is eliminated completely on Channels 2 to 6, there is little likelihood that much difficulty will be experienced on high-band stations, at least when your ham rig operates below 30 mc. There is no reason why a superregenerative meter cannot be made to work on Channels 7 to 13. However, it might be necessary to use another tube in place of the 1S4. A

957 acorn type would undoubtedly be a better choice.

The case was constructed from aluminum of rather light gauge. While the unit can easily be built into a standard 4" x 5" x 6" box, dimensions are given in Fig. 5 for those who prefer to do their own fabricating. The top, sides, and front panel are fastened together by means of 6-32 machine screws, while the back is held in place with small self-tapping sheet metal screws. All parts except the antenna and antenna coupling coil, L_1 , are mounted on the front panel, or on the small aluminum chassis which is fastened to both the front and rear panels.

It will be noted in Fig. 3 that the tuning knob is isolated from the condenser by means of a section of insulated shaft. This precaution was taken in order to reduce the possibility of unwanted hand-capacity effects. The 1S4 socket is held in place by soldering the lug of pin 2 directly to one of the stator connections on C_1 . A short length of No. 14 wire is then run from the lug of pin 5 to one of the ground points on S_1 . Since the 1S4 is light in weight, this rather unorthodox method of socket mounting has proven highly satisfactory.

The antenna is approximately 6 inches long and was originally from a CW1/ARR1 test oscillator, a surplus item often referred to as the "gold plated special." One end of coil L_1 is soldered to the center lug of the antenna socket while the other end is fastened to a solder lug held by one of

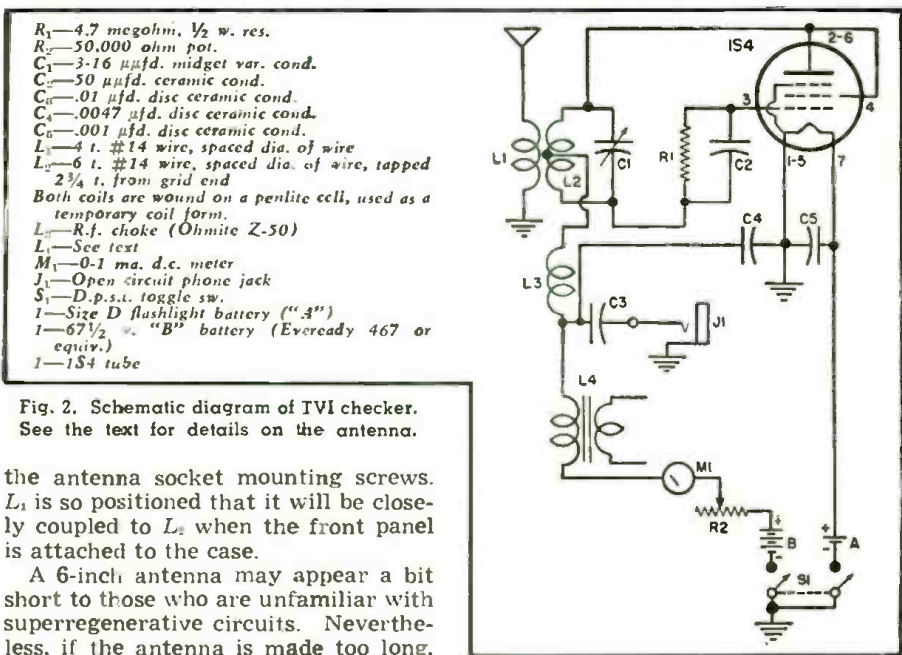

Fig. 2. Schematic diagram of TVI checker. See the text for details on the antenna.

the antenna socket mounting screws. L_1 is so positioned that it will be closely coupled to L_2 when the front panel is attached to the case.

A 6-inch antenna may appear a bit short to those who are unfamiliar with superregenerative circuits. Nevertheless, if the antenna is made too long, there is a good chance that it will resonate and load the grid circuit so heavily that the detector will go out of oscillation, thus causing a dead spot at some point on the dial. Besides obviating this situation, the short antenna also helps to keep the unit from becoming awkward to handle.

After wiring the device, a preliminary check should be made before placing it in its case. S_1 should be turned on and the resistance of R_2 decreased until a loud rushing sound is heard in

the phones. C_1 should then be tuned through its range. If you are within 20 or 30 miles of a low-band TV station, you will be able to pick out both the diathermy-like sound of the video carrier and, 4.5 mc. above it, the audio carrier.

The detector is most sensitive when R_2 has just a little less resistance than that which stops the hiss. When R_2 is so set, M_1 should read approximately
 (Continued on page 152)

Fig. 3. Top chassis view of the unit. The tuning knob is isolated from condenser by means of an insulated shaft section.

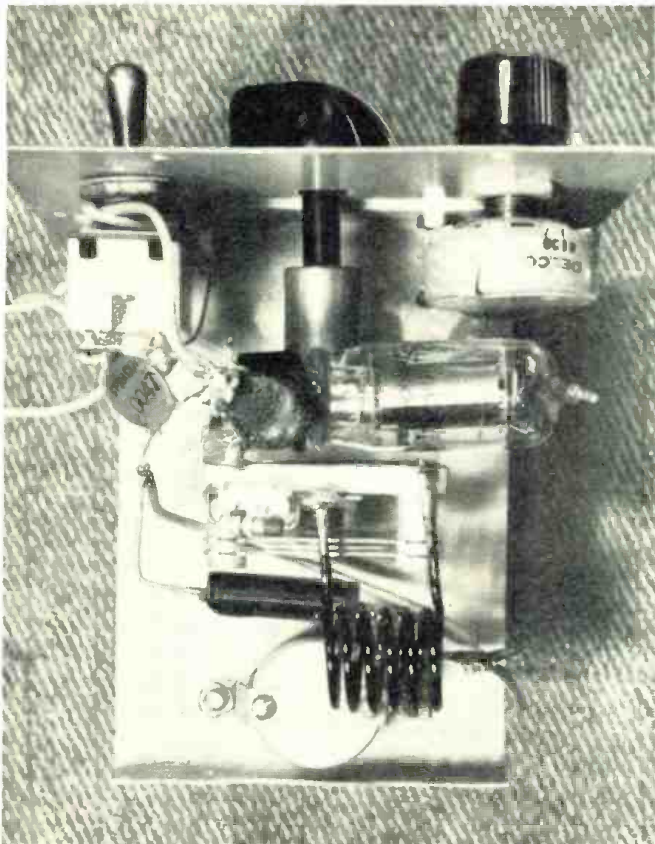
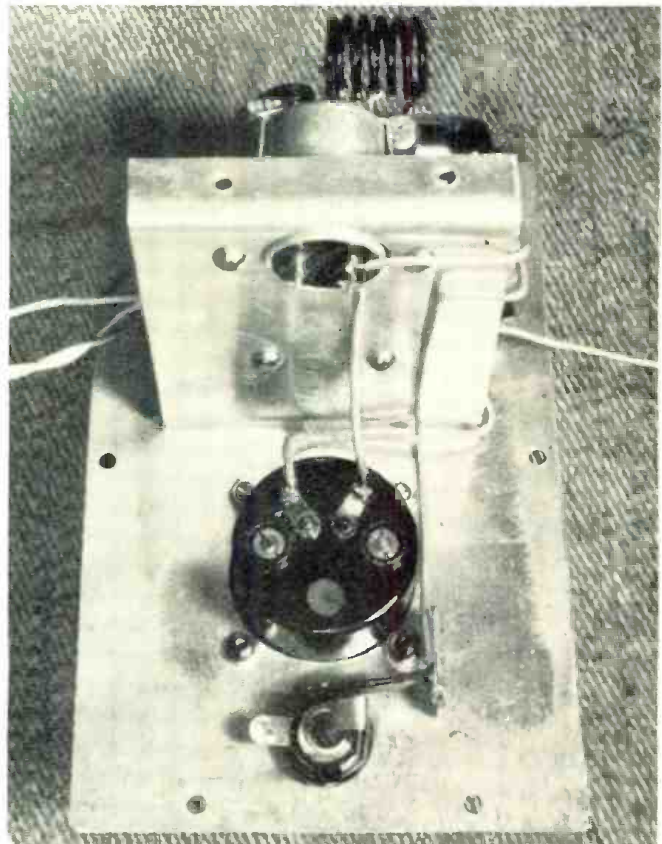

Fig. 4. Under chassis view of TVI checker. The entire unit can be built into 4"x5"x6" box or into housing shown in Fig. 5.





International

SHORT-WAVE

Compiled by **KENNETH R. BOORD**

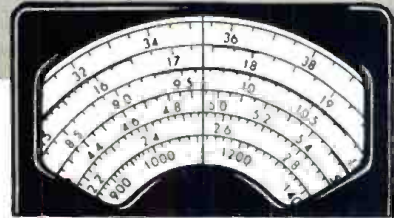

THE pleasing chimes of the Westminster clock, the stroke of the great hour bell, Big Ben, and then—"This is London Calling"—these familiar sounds have long been radiated from the seat of the British Empire to every corner of the world. And so it is a great pleasure to dedicate this month's *ISW DEPARTMENT* to the British Broadcasting Corporation. We are grateful to J. R. T. Hopper, Overseas Press Officer of the BBC, London, for this data:

The British Broadcasting Corporation, whose news bulletins and programs are known throughout the world, is in no sense a department of the British Government. It is not a ministry. Nor, on the other hand, is it a commercial concern. The BBC has been granted a Royal Charter by the British Government on three successive occasions, by the terms of which it acts as Great Britain's national broadcasting service. One of the most important aspects of this charter is that the BBC has no politics. It is specifically instructed to give its listeners news that is objective and without political bias, and to see that over the

whole range of its programs, political comment is fair and impartial. While the BBC is not beyond the criticism of press and public in Great Britain, its value both as a cultural force and a provider of popular entertainment is acknowledged, and the impartiality of its news is trusted by its listeners, and is carefully watched by the press and Parliament.

The first BBC was the British Broadcasting Company, Limited, formed in 1922 by the principal manufacturers of wireless apparatus. It operated under a short-term license from the Postmaster-General, derived its revenue partly from royalties charged on the sale of "wireless" receiving sets, and partly from receipts for the issue of receiving licenses, and had to provide a service to the Postmaster-General's "reasonable satisfaction".

(Note: Unless otherwise indicated, all time is expressed in American EST; add 5 hours for GCT. "News" refers to newscasts in the English language. In order to avoid confusion, the 24 hour clock has been used in designating the times of broadcasts. The hours from midnight until noon are shown as 0000 to 1200 while from 1 P.M. to midnight are shown as 1300 to 2400.)
The symbol "v" following a listed frequency indicates "varying." The station may operate either above or below the frequency given. "A" means frequency is approximate.

When the first BBC came to an end in December 1926, the number of licenses had grown from 35,000 at the end of 1922 to well above the million mark.

In 1926, the Crawford Committee recommended that broadcasting should be conducted by a public corporation to be known as the British Broadcasting Corporation, acting as Trustee for the national interest. The present BBC—the British Broadcasting Corporation—was created by Royal Charter on January 1, 1927. The Charter provided that the Corporation should be controlled by a number of Governors appointed by the King in Council with a chief executive officer to be known as the Director-General. The General Manager, Sir John Reith (later created Lord Reith), became the first Director-General of the Corporation. The Charter declared that "broadcasting had shown itself of great value as a means of education and entertainment" and it called upon the Corporation to develop these qualities "to the best advantage and in the national interest." The Charter expired at the end of 1936, but following the report of the Ullswater Committee, Parliament renewed it for another ten years with few changes. The new Charter expressly charged the BBC with the duty of carrying on the Empire Service, created in 1932, and the Television Service, created in 1936.

In 1946, the British Government announced its intention of renewing the Charter for five years, from January 1, 1947, with a public inquiry into the broadcasting service to be held during that period. As this was compiled, a new Charter for the continuance of the BBC for the next ten years was due to be signed shortly.

The BBC operates under license from the Postmaster-General, who is the ultimate authority for wireless telegraphy in Great Britain. As of April 30, 1952, the license figures stood at 11,159,000 for sound, and 1,487,000 for television.

The revenue of the BBC is drawn from a license fee paid by listeners in Great Britain. The ordinary "sound" license is 1 pound per year; the license fee for sound and television is 2 pounds per year. The Overseas Services of the BBC are paid for by a Treasury grant-in-aid, but the content of the programs remains entirely the responsibility of the BBC.

The present Director-General, Sir
(Continued on page 134)

British Broadcasting Corporation's "home," Broadcasting House in London, England.

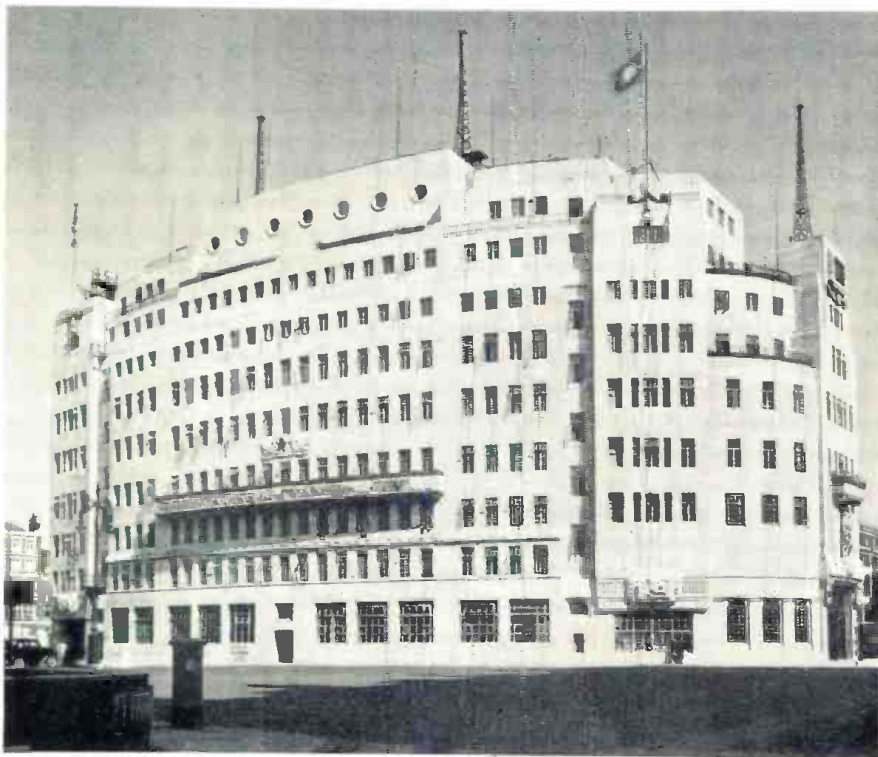

The "Fittingest" thing you ever saw . . .



MALLORY MIDGETROL®

Dual Concentric Volume Controls

FIT 'EM FAST . . . FIT 'EM EASY

- In just five steps that take less than five minutes, you assemble a dual control that gives you the precise resistance values you need.
- Directions are short, easy to follow and you need no special tools . . . no soldering.
- Front and rear sections are factory-assembled and inspected.
- Instant AC switch attachment without control disassembly.

MAKE YOUR CUSTOMERS HAPPY

- Longer lasting resistance elements even in extremes of temperature and humidity.
- Better and more accurate taper curves resulting from precision processing methods.
- No pigtail connections to break—thanks to Mallory's exclusive sliding contact that gives EXTRA quiet operation.
- Minimum wobble with Mallory exclusive two-point shaft suspension.

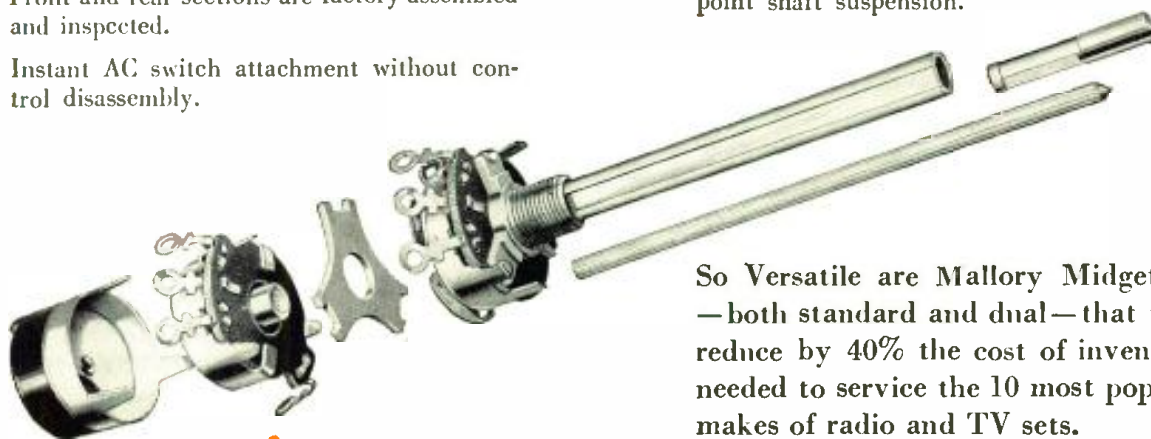

So Versatile are Mallory Midgetrols—both standard and dual—that they reduce by 40% the cost of inventory needed to service the 10 most popular makes of radio and TV sets.

**Make Sure!
Make it Mallory!**

You can build more than 10,000 different combinations with Mallory Midgetrols and do it fast . . . easily. Each dual control you build duplicates exactly the control it replaces. The Mallory Midgetrol Line, in addition to dual concentrics, includes round shaft, standard controls with the advantages of stable, two-point shaft suspension, instant AC switch attachment. Ready adaptability to split-knurl and flatted type knobs.

P. R. MALLORY & CO. Inc.
MALLORY

CAPACITORS • CONTROLS • VIBRATORS • SWITCHES • RESISTORS
• RECTIFIERS • VIBRAPACK* POWER SUPPLIES • FILTERS
*Reg. U.S. Pat. Off.

APPROVED PRECISION PRODUCTS

P. R. MALLORY & CO., Inc., INDIANAPOLIS 6, INDIANA

PHOTOFACT USERS TELL THE EXPERT WAY TO TACKLE ANY TV-RADIO SERVICE JOB

here's what you do:

1

Determine the make and model number of the set on your bench. Use your PF INDEX to find the applicable PHOTOFACT Folder—takes just 60 seconds.



2

Reach into your PHOTOFACT library for the proper Folder. You're ready for time-saving, work-saving, expert service action.



3

YOU HAVE YOUR HANDS ON THE ONE TOOL YOU'LL USE ON EVERY JOB

Here's what you find in PHOTOFACT Folders: A uniform, consistent presentation of complete service data, accurate because it's based on actual analysis of the production receiver. And here are the exclusive features—Standard Notation Schematics with voltages and wave forms right on the diagrams; chassis view photos, top and bottom, with all parts and relationships shown, all alignment points given, all parts identified; tube placement diagrams, top and bottom, all tubes and functions indicated, even socket pin locations shown, including fuse location guide and rating; tube check chart showing common troubles and tubes responsible; complete alignment instructions, including oscilloscope patterns; resistance measurements taken at every tube socket; separate photos of TV tuner, showing all parts locations and alignment points; photos of cabinet showing service controls; complete disassembly instructions; complete parts lists, each part identified by circuit symbol and keyed to schematics and photos—showing ratings, manufacturer's original part number and proper replacements available from 29 leading components manufacturers—plus—dial cord stringing instructions; special service instructions (such as horizontal sweep circuit adjustments, etc.)—everything you have a right to expect in the world's finest TV-Radio service data . . .

4

NOW HERE'S HOW YOU SAVE TIME AND EARN MORE

You're ready to tackle the job—any job—because you have all the answers instantly at your finger tips in PHOTOFACT. Here are the practical ways it works for you: Suspect a tube? Diagnose and replace the defective tube in seconds—the tube location chart shows you which one and where. Operating voltages correct? The exact answers are right on the schematic—available at a glance. Need fuse replacement? The answer's right on the tube location guide. Defective component? There's the right replacement in the parts list. For these and a hundred other problems, PHOTOFACT provides the instant, correct solution. That's why the experts use PHOTOFACT—the practical way to save time and earn more.



Yes, your PHOTOFACT Service Data is the ONE TOOL YOU'LL USE ON EVERY SERVICE JOB



if you're not using the Expert Way—we'll prove you'll save time and earn more with PHOTOFACT service data

FREE SERVICE TECHNICIANS HERE'S OUR OFFER:

We'll send you any Photofact Folder listed in the "PF INDEX and Technical Digest." If you haven't an Index, get a Free copy from your local Photofact distributor or write us for it today. To obtain Free Folder, be sure to state Photofact Set and Folder Number exactly as shown in the index.

NOW—learn for yourself how PHOTOFACT makes your TV and Radio repair work quicker, easier, more profitable. We want you to get and use an actual PHOTOFACT Folder. We want you to know why over 35,000 expert service technicians count on this invaluable data daily—count on it for successful, profitable business. Get your FREE Folder now. Examine, compare. Then try the Expert Way on your very next job. You'll discover why you can't afford to be without PHOTOFACT!

NOTE: Our FREE Folder offer is limited to Service Technicians only. Attach coupon to your letterhead or business card, and mention your jobber's name. Experimenters and others may obtain the Photofact Folder by remitting amount shown below.

HOWARD W. SAMS & CO., INC.

HOWARD W. SAMS & CO., INC.
2203 E. 46th St., Indianapolis 5, Ind.

I am a Service Technician. Send me Free Folder No. which appears in Photofact Set No. (as listed in the PF Index).

I am an Experimenter. Enclosed \$ Send Folder No. which appears in Photofact Set No. (TV—\$1.00. AM/FM—50c. Record Changer or Communications Receiver—75c).

Name

Address

City Zone State

EASY PAY PLAN!

PAY AS YOU EARN! Ask your distributor about this desirable plan. Only \$18.39 puts the entire profit-boosting Photofact library in your shop now!

Design Curves (Continued from page 47)

standard values). These component values are shown in the complete circuit of Fig. 6.

These articles have presented universal design curves for a group of circuits which fulfill the normal requirements of tone control and compensation. Circuit variables have been restricted to resistive and capacitive elements because specific inductance

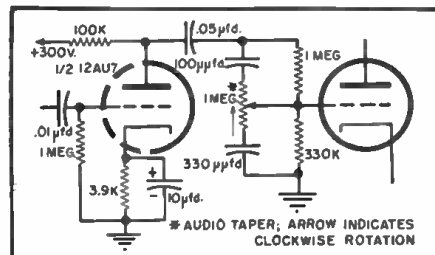

Fig. 6. Circuit for variable treble boost and attenuation which is capable of providing 3 db boost at 2000 cycles and approximately 12 db boost at 20,000 cycles.

values are usually difficult for the experimenter to obtain. Circuits using feedback have also been excluded because they are not so readily adaptable to universal design curves, because they are often more difficult to design, and because they seldom offer any significant advantage to the experimenter. The design curves indicate the level of performance which may be expected from the circuits shown. If the requirements of a particular application are not fulfilled by any of these circuits, the designer may find a study of all the circuits and design curves helpful in suggesting the proper approach to his problem.

MIKE CONNECTOR

By ARTHUR TRAUFFER

BY SAWING OFF the end of a 5/8"-27 threaded cap and chain you will have a threaded collar that will convert a male connector into a female connector, will join two male connectors together, or will allow a male connector to be connected to a chassis unit. Simply screw the cap onto the male connector, clamp the male connector in a vise, and saw the cap where the top meets the sides of the cap.

The photo shows two male connectors joined together with the threaded collar. The remains of the cap and chain are in the left foreground, and a complete cap and chain is in the right foreground.

This handy mike-connector is easy to make.

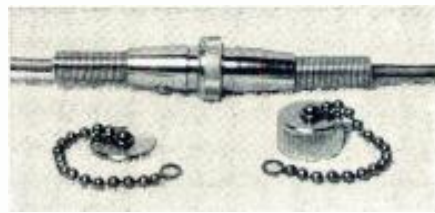

RADIO & TELEVISION NEWS

Check these ADVANTAGES FOUND Only in HEATHKITS

1

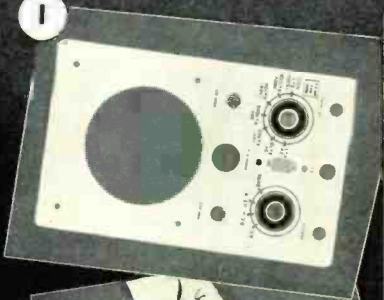

2



3



4



5



6



9



8



7

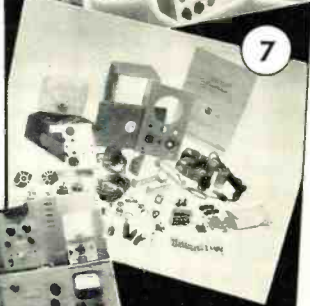

- ✓ 1. **Baked Enamel Lifetime Finish Panels** — Oven baked finishes for maximum durability and freedom from marks, scratches and discoloration. Panels that can really take service shop and laboratory abuse.
- ✓ 2. **Save Money** — You save all expensive factory wiring costs when you build your own. And, direct factory to customer sales eliminate all middle man profits. You can have a complete Heathkit laboratory or service shop for what one or two pieces of ready built equipment cost.
- ✓ 3. **Modern Styling** — New "fitted panels" and formed cabinets with rounded corners present a smart, professional appearance. Dignified appearance for prestige.
- ✓ 4. **Quality Components Used Throughout** — Heathkits use well known, time and quality tested components such as Simpson, Chicago Transformer, Wilkor, Allen-Bradley, Altec-Lansing, Centralab, Cinch, Oak, Grigsby-Allison, Mallory and many others.
- ✓ 5. **Extensive Factory Facilities** — Shearing, punching, forming, spot welding, etc. is done right in our own plant — controlled production for highest quality and less cost to you.
- ✓ 6. **Extensive and careful engineering** — A staff of engineers working in a modern, well equipped laboratory carefully develop Heathkits according to highest engineering practices. Your assurance of accurate, up to the minute instruments.
- ✓ 7. **Complete Kits** — All the parts are right in the kit — you get all tubes, controls, transformers, meters — everything — no other components to buy. And no cutting, punching, or painting necessary — it's all done for you. Heathkits go together easily and smoothly.
- ✓ 8. **Only Complete Line** — Over 30 kits available — Heathkits form the only complete line of kit-form test equipment on the market. Kits for hams, engineers, service men, schools and audio enthusiasts.
- ✓ 9. **Detailed, Complete Instruction Manuals** — Comprehensive manuals tell you exactly how to build your Heathkit. Manuals contain easy-to-follow instructions, clear, large pictorials, schematic, detail drawings, etc. They make construction easy, fun, and educational.

Nine New Heathkits This Year!

EXPORT AGENTS
ROCKE INTERNATIONAL CORP.
122 W. 40th ST.
NEW YORK CITY (16)
CABLE APLA:NY

The **HEATH COMPANY**

... BENTON HARBOR 15, MICHIGAN

October, 1952

NEW Heathkit "Q" METER KIT

• A HIGH QUALITY Q METER AT LOW COST.

MODEL QM-1

SHIPPING
WT. 12 LBS.

\$39⁵⁰



Measures Q and inductance of coils.



Measures Q and capacity of capacitors.

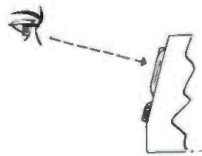

Slant face cabinet for ease in reading the meter.



• First Q METER within the price range of a l.

• Read Q's of 0-500 directly on calibrated scale.

• Stable oscillator supplies R.F. frequencies of 150 kc to 18 megacycles.

• Calibrated capacitor with range of 40 mmf to 450 mmf with vernier of ± 3 mmf.

• Simple, easy operation.

• Can be used to measure small inductances or capacitors.

• Measures Q of condensers, RF resistance and distributed capacity of coils.

• Measures capacity by substitution, capacity by resonance, inductance by resonance.

• Slanted panel for convenient operation.

Another outstanding example of progressive HEATHKIT engineering. Now a highly desirable Q METER within the price range of all laboratories, schools and experimenters. No longer is it necessary to deny yourself the many measurement advantages offered by this instrument.

Use the new HEATHKIT Q METER for the following simple basic measurements: capacity by substitution, capacity by resonance, inductance by resonance and Q at the OPERATING frequency all can be read on the calibrated scales. The method used to obtain information regarding the Q of condensers, RF resistance, distributed capacity in coils, etc., is only slightly more involved. In the HEATHKIT Q METER, the generated RF signal is coupled through a cathode follower and injected across a low impedance condenser which is included in the resonant circuit under test. Large $4\frac{1}{2}$ " 50 microampere Simpson meter reads Q directly. The resonating condenser and vernier condenser are calibrated in mmf for substitution method capacity tests. The resonating condenser is also calibrated in effective capacity for resonance tests. The inductance calibration serves for rapid determination of the approximate inductance of a coil. The HEATHKIT Q METER has a generator frequency range of 150 kc to 18 megacycles. Vernier capacity covers ± 3 mmf and the resonating condenser is calibrated from 40 mmf to 450 mmf actual capacity or 40 mmf to 350 mmf effective capacity. Meter reads Q directly up to 250. Higher and lower full scale readings can be obtained by varying the injection voltage levels.

The entire kit consists of 12AT7, 6AL5, 6C4, OD3 and 6X5 tubes. 50 microampere Simpson meter, power transformer, cabinet and all other parts necessary for construction as well as instructions for assembling, testing and operation of the completed instrument.

Heathkit DECADE RESISTANCE KIT

The HEATHKIT DECADE RESISTANCE KIT is widely used by schools, experimenters and laboratories because of the extremely wide resistance range offered and the useful, dependable service provided. The DECADE consists of 5 rotary 2 deck ceramic wafer switches with silver plated contacts and twenty 1% precision resistors in a circuit which provides the resistance range of 1 ohm to 99,999 ohms in 1 ohm steps. The HEATHKIT DECADE RESISTANCE KIT is simple to construct and is housed in a beautiful polished birch cabinet with an attractive panel. The DECADE will furnish years of accurate trouble-free service.

Individual decade sections of above can be purchased separately for special applications.



MODEL DR-1
SHIPPING
WT. 4 LBS.

\$19.50

NEW Heathkit DECADE CONDENSER KIT

Extremely useful in all experimental and design work such as determination of condenser values for: compensating networks, filters, bridge impedances, tuned circuits, etc. Uses all precision silver mica condensers within $\pm 1\%$ accuracy. Values tun in three decades from 100 MMFD to 0.111 MFD in steps of 100 MMFD. Smooth acting, positive detent, highest quality ceramic wafer switches make all capacitor values easy to set up and keep losses to a minimum. Low loss dielectric terminal board mounts on outside of panel for easy cleaning. Heathkit binding posts accommodate a wide variety of test leads. Comes complete with all parts, including polished birch cabinet.

Individual decade sections of above can be purchased separately.



MODEL DC-1
SHIPPING
WT. 4 LBS.

\$16⁵⁰

EXPORT AGENT
ROCKE INTERNATIONAL CORP.
13 E. 40th ST.
NEW YORK CITY (16)
CABLE: ARKAB, N.Y.

The **HEATH COMPANY**

... BENTON HARBOR 15, MICHIGAN

NEW *Heathkit* OSCILLOSCOPE KIT

• NEW WIDE BAND VERTICAL AMPLIFIER ± 2 DB 10 CYCLES TO 1 MC.

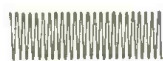
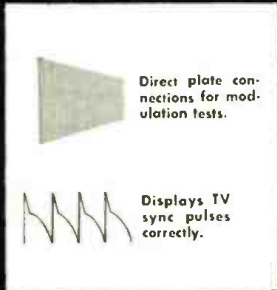

MODEL O-8

SHIPPING
WT. 29 LBS.

\$43.50



- New wider band vertical amplifier ± 2 db from 10 cycles to 1 megacycle useful to over 5 megacycles.
- High sensitivity in vertical amplifier. .025 volts RMS per inch deflection.
- New 3 step input attenuator input ranges X1, X10, X100.
- New 5CP1 intensifier type tube for greater brilliance.
- Terminal board and rear cabinet opening provisions for direct connections to deflecting plates.
- Newly styled formed and ventilated aluminum cabinet.
- Wide band sweep generator, 15 cycles to over 100 kc. Will synchronize with 5 megacycle signal.
- 10 tube circuit featuring push pull operation of vertical and horizontal amplifiers.
- Internal synchronization on either positive or negative peaks.
- Reproduces faithfully the front and back porches of TV sync pulses. Excellent square wave reproduction to over 100 kc.
- Optional Intensifier kit available for 2200 volt operation.

Proudly announcing the new 1953 HEATHKIT Model O-8 OSCILLOSCOPE featuring the finest performance ever offered in this extremely popular kit instrument. Improved wider band vertical amplifier featuring a new 3-step input attenuator affording smooth control of the excellent .025 volts per inch vertical sensitivity. Possibility of overloading the vertical input circuit is minimized. Greater band width in the vertical channel is a decided advantage to TV service men. Permits clear observation of all TV sync pulse detail and excellent square wave reproduction over 100 kc. 5CP1 intensifier type CR tube provides a brilliant trace with normal accelerating voltages. A handsome, ventilated cabinet with smooth rounded corners and a snug fitting drawn panel adds to the smartly styled professional appearance. Longer life is assured through cooler instrument operation. Push pull output stages in both vertical and horizontal amplifiers for balanced deflection of the spot. All of the many fine features of the previous model have been retained. Rear cabinet access to terminal board for direct connection to CR plates. The entire kit of all 10 tubes, parts, cabinet and panel as well as detailed construction manual for assembly and operation of the instrument included.

INTENSIFIER KIT: For extreme trace brilliance in special applications such as photography, group demonstrations or operation in brightly lighted areas an optional Intensifier kit providing 2200 volt operation of the CR tube is available. Kit includes high voltage filter condenser, high voltage selenium rectifier, etc. \$7.50.



Heathkit SCOPE DEMODULATOR PROBE KIT

Trouble shooting or aligning TV, RF, IF and video stages requires demodulation of high frequency signals before Oscilloscope observation. The HEATHKIT SCOPE DEMODULATOR PROBE KIT was specifically developed for this application. Kit consists of a probe housing, crystal diode detector circuit, shielded cable and spade lugs. Assembly is simple and the probe will quickly prove its usefulness as an Oscilloscope accessory.

No. 337
SHIP WT. 1 LB.
\$4.50

NEW *Heathkit* VOLTAGE CALIBRATOR KIT



MODEL VC-1
SHIPPING
WT. 5 LBS. **\$9.50**

Use the Heathkit Voltage Calibrator with your oscilloscope to measure peak-to-peak TV complex waveshapes. TV manufacturer's specifications indicate correct peak-to-peak voltages and this kit will permit making these important measurements.

A big help to engineers in circuit work. Makes peak-to-peak voltage measurements of complex waveshapes of all kinds. Flat topped semi-square wave output of calibrator assures fast and easy measurement of any voltage between .01 and 100V peak-to-peak.

The Voltage Calibrator can remain connected to your oscilloscope at all times for instant use. "Signal" position connects signal under study directly through calibrator and into scope input circuit for direct observation. Eliminates transferring leads from calibrator. *A wonderful scope accessory.*

Heathkit ELECTRONIC SWITCH KIT



MODEL S-2
SHIPPING
WT. 11 LBS.

A few dollars spent for this accessory will increase the usefulness of a scope immeasurably. An electronic switch will open up a whole new field of scope applications for you. The S-2 allows TWO SIGNALS to be observed at the SAME TIME — this important feature allows you to immediately spot phase shift, clipping, distortion, etc. The two signals under observation can be superimposed or separated for individual study. Each signal input has an individual gain control for properly adjusting scope trace patterns. Has both coarse and fine frequency controls for adjusting switching time. Multivibrator switching frequency is from less than 10 cps to over 2000 cps in three overlapping ranges. Kit comes complete including 5 tubes, power transformer, all controls, instruction manual, etc. *Every scope owner should have one!*

\$19.50

EXPORT AGENT
ROCKE INTERNATIONAL CORP.
131 E. 40th ST.
NEW YORK CITY (16)
CABLE APRA-NT

The **HEATHKIT COMPANY**

... BENTON HARBOR 15, MICHIGAN

Heathkit VACUUM TUBE VOLT METER KIT

• NEW 1½ VOLT RANGE ON 1953 VTVM.

MODEL V-6

SHIPPING
WT., 7 LBS.

\$24.50

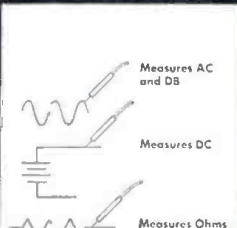
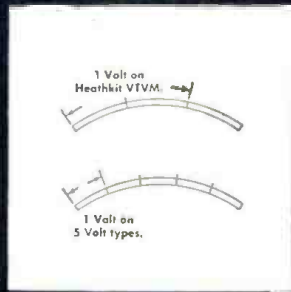

- New 1½ volt low range gives over 2" of scale per volt instead of less than ¾" found on 5 volt range type.
- Increased accuracy due to expanded scales.
- New 1500 volt DC high range gives 50% greater coverage.
- Seven ranges in all. 1½, 5, 15, 50, 150, 500 and 1500 volts DC (1000 volts maximum AC only).
- Provides proper service ranges 150 volts for AC DC work and 500 volts for AC type service.
- High input impedance, 11 megohms minimizes circuit loading.
- Variety of accessory probe kits available.
- 1% precision resistors in multiplier circuits.
- 200 microampere Simpson meter.
- Center scale zero adjust.
- Transformer operated.
- Test leads included.
- New cabinet styling.
- Large, clearly marked meter scales indicate ohms, AC volts, DC volts and DB.

The 1953 Heathkit V-6 VTVM has improved ranges! The lowest range has been moved way down to 1.5V full scale. This gives 3½" of actual scale length for the 1.5V covered—that's 2⅓ inches per volt!! Now you can make your low level measurements faster and with greater accuracy.

And the upper range has been moved up. Readings up to 1500V DC can be readily made with new, improved VTVM—plus readings up to 1000V on AC. Higher ranges for extended use.

New vertical chassis mounting gives added chassis space for really easy wiring—no tight corners to worry about. Uses only highest quality components throughout. Simpson 200 microampere meter movement combined with 1% precision resistors in multiplier circuit insure highly accurate and dependable readings.

AC and DC voltage ranges are 0-1.5V-5V-15V-50V-150V-500V-1500V. (1000V max. reading on AC)—a total of seven ranges for convenient, accurate readings. Instrument also measures resistance from .1 ohm to over 1 billion ohms in seven handy ranges of RX1, X10, X100, X1000, X10K, X1 Meg.—all convenient multiples of 10 with no skips. Has Db scale in red for easy identification.

New panel has tough baked on enamel finish for freedom from scratches and maximum durability. Modern styled, formed, compact cabinet with rounded edges and crackle finish is truly handsome.

Comprehensive, detailed instruction manual with step-by-step instructions, figures, pictorials, etc. makes assembly a cinch.

Be sure and look over the special accessory VTVM probes below — for added usefulness.

<p>Heathkit R. F. PROBE KIT SHIP. WT. 1 LBS. \$5.50 No. 309 Extends RF range of HEATHKIT 11 megohm VTVM to 250 megacycles ± 10%.</p>	<p>Heathkit 30,000 V. D.C. PROBE KIT SHIP. WT. 2 LBS. \$5.50 No. 336 Provides DC multiplication factor of 100 for any 11 megohm VTVM.</p>	<p>Heathkit PEAK TO PEAK VOLTAGE PROBE KIT SHIP. WT. 2 LBS. \$6.50 No. 338 Reads on DC scale of any 11 megohm VTVM 5 kc to 5 megacycle range.</p>
--	---	---

NEW Heathkit BATTERY TESTER KIT

The new Heathkit Battery Tester measures all types of dry batteries between 1½ volts and 150 volts under actual load conditions. Readings are made directly on a three-color GOOD-WEAK-REPLACE scale that your customers can readily understand. Operation is extremely simple and merely requires that the leads be connected to the battery under test. Only one control to adjust in addition to a panel switch for A or B battery types.

The Heathkit Battery Tester features compact assembly. An accurate meter movement and wire wound control mount in the portable, rugged plastic case.

Use the BT-1 to check portable radio batteries, hearing aid batteries, lantern batteries and photo flash gun batteries.



MODEL BT-1
SHIPPING
WT. 3 LBS.

\$7.50

Heathkit AC VACUUM TUBE VOLT METER KIT

A new AC VTVM that makes possible those sensitive AC measurements required by laboratories, audio enthusiasts and experimenters. Ten full scale ranges of .01, .03, .1, .3, 1, 3, 10, 30, 100 and 300 volts RMS. 10 DB ranges from -52 to +52 DB. Frequency response within 1 DB from 20 cycles to 50 kc. Simpson 200 microampere meter with large plainly marked meter scales. Precision multiplier resistors. Two amplifier stages using miniature tubes. A unique bridge rectifier meter circuit and a clean layout of parts. Order the AV-2 today and become acquainted with the interesting possibilities offered by this instrument.

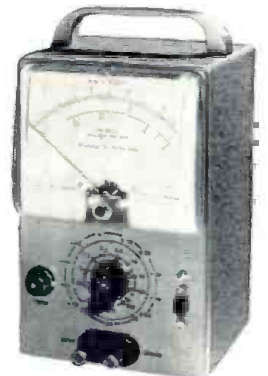

MODEL AV-2
SHIPPING
WT. 5 LBS.

\$29.50

REPORT AGENT
ROCKE INTERNATIONAL CORP.
13 E. 40th ST.
NEW YORK CITY (16)
CABLE 67148-N-Y

The **HEATH COMPANY**

... BENTON HARBOR 15, MICHIGAN

NEW *Heathkit* GRID DIP METER KIT

• CONVENIENT ONE HAND OPERATION.

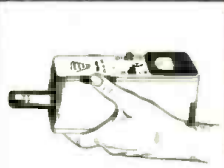
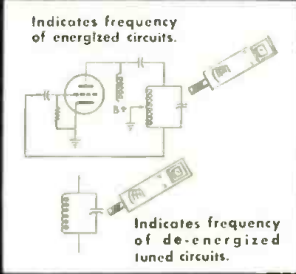

Complete unit easily held and operated with one hand.

MODEL GD-1

SHIPPING WT. 4 LBS.

\$19⁵⁰



- New GRID DIP METER with assembled calibrated coils.
- Uses quality Simpson 500 microampere meter.
- One hand operation, extremely compact. Only 2½" wide by 3" high by 7" long.
- Variable meter sensitivity control.
- Uses newest type 6AF4 high frequency triode in a Colpitts oscillator circuit.
- Continuous coverage from 2 megacycles to over 250 megacycles in 6 ranges.
- Head phone monitoring jack.
- AC power transformer operated for maximum safety.

Here is the GRID DIP METER KIT you have been asking for. This new HEATHKIT instrument is compact, highly sensitive and easy to use. Housed in a handsome formed aluminum cabinet—rounded corners—durable oven baked finish on panel and cabinet. The entire instrument can be easily held and operated in one hand, tuning accomplished with the thumb wheel drive. This excellent design feature leaves the other hand entirely free for making circuit adjustments. The instrument with many applications — with oscillator energized, use it for finding the resonant frequency of tuned circuits, locating parasitics, determining characteristics of filter circuits, roughly tuning transmitter stages with power off, and neutralizing transmitters. Useful in TV and radio repair work for alignment of traps, filters, 1F stages, peaking and compensation networks within the 2 to 250 megacycle range. With the oscillator not energized, the instrument acts as an absorption wave meter and indicates the frequency of radiating power sources. Locates spurious oscillations, as a relative indication of power in various transmitter stages, etc. Phone jack permits monitoring of AM transmitter for determination of radiated hum, audio quality, etc. (Head phones not included). Complete kit includes plug-in coils, tube, all necessary parts and detailed assembly and instruction manual.

Heathkit IMPEDANCE BRIDGE KIT



MODEL IB-1B
SHIPPING WT. 15 LBS.

\$69⁵⁰

The HEATHKIT IMPEDANCE BRIDGE is especially useful in educational training programs, industrial laboratories and for experimental work. Use it for measuring AC and DC resistance value of resistors,

determination of condenser capacitance and dissipation factor, finding coil inductance and storage factor, electrical measurements work, etc. Quality components: GR 1000 cycle hummer, GR main control, Mallory ceramic wafer silver plated contact switches, ½% precision resistors, etc. The basic circuit is a self powered, 4 arm bridge. Choice of Wheatstone, Capacitance comparison, Maxwell or Hay bridge circuits: Resistance from 10 milliohm to 10 megohm. Capacitance 10 mmf to 100 mfd. Inductance 10 microhenry to 100 henries. Dissipation factor .002 to 1. Storage factor (Q) 1 to 1000. The IMPEDANCE BRIDGE has provisions for external generator use for measurement at other than the 1000 cycle level. Take the guess work out of electrical measurements. The HEATHKIT IMPEDANCE BRIDGE mounted in a beautiful polished birch cabinet with large easy reading panel calibrations will furnish years of accurate, trouble free measurement service.

Heathkit HANDITESTER KIT

The HEATHKIT Model M-1 HANDITESTER fulfills requirements for a portable volt ohm milliammeter. This kit features precision 1% resistors, 3 deck switch for trouble free mounting of parts, specially designed battery bracket, smooth acting ohms adjust control, beautiful molded bakelite case and a 400 microampere meter movement. 5 convenient AC and DC voltage ranges as follows: 10 - 30 - 300 - 1000 - 5000 volts. Ohms ranges 0 - 3000 and 0 - 300,000. DC milliamperes ranges 0 - 10 milliamperes and 0 - 100 milliamperes. The instrument is easily assembled from complete instructions and pictorial diagrams. Test leads are included. Carry the HEATHKIT M-1 HANDITESTER in your tool box at all times for those simple jobs and eliminate that extra trip for additional testing equipment.



MODEL M-1
SHIPPING WT. 3 LBS.

\$13⁵⁰

ROCKE INTERNATIONAL CORP.
13 E. 40th ST.
NEW YORK CITY (16)
CALL APLA 4-1

The **HEATH COMPANY**

... BENTON HARBOR 15, MICHIGAN

NEW
Heathkit

AUDIO GENERATOR KIT

• RANGE EXTENDED TO 1 MEGACYCLE

MODEL AG-8

SHIPPING
WT. 16 LBS.

\$29.50

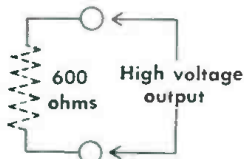

Low impedance output
High voltage output



Sine wave output
from 20 cycles to 1
megacycle.

- Improved design — new low price.
- Frequency coverage in five ranges from 20 cycles per second to 1 megacycle.
- Response flat 1 DB from 20 cycles to 400 kilocycles. Down 3 DB at 600 kilocycles. Down only 8 DB at 1 megacycle.
- Five calibrated output voltage ranges, continuously variable 1 mv, 10 mv, 100 mv, 1 v, 10 v.
- Low impedance output circuit. 600 ohms.
- Distortion less than .4 of 1% from 100 cycles per second through the audible range.
- New HEATHKIT universal type binding posts.
- Durable infra-red baked enamel panel.
- Transformer operated for safe operation.
- Sturdy, ventilated steel cabinet.

A new Audio Generator with features heretofore found in only the most expensive generators. Such features as complete coverage from 20 cycles to 1 Mc— response flat ± 1 db from 20 cycles to 400 Kc, down 3 db at 600 Kc and down only 8 db at 1 Mc.

And it has calibrated output . . . Calibrated continuously variable and step attenuator output controls allow you to easily set calibrated output voltage. Moreover, distortion is less than .4 of 1% from 100 cps through the audible range.

Oscillator section consists of a two stage resistance coupled amplifier (6SJ7 and 6AK6) utilizing both positive and negative feedback for oscillator operation and reduction of distortion. Oscillator section drives a cathode follower output power amplifier (6AK6) which isolates the oscillator from variations in load and presents a low impedance output (600 Ohms). Power supply is transformer operated and utilizes 6X5 rectifier with 2 sections of RC filtering.

An unbeatable dollar value — for here is an audio generator with wide frequency coverage, excellent frequency response, stepped and continuously variable calibrated output, high signal level, low impedance output, and low inherent distortion.

Heathkit AUDIO FREQUENCY METER KIT

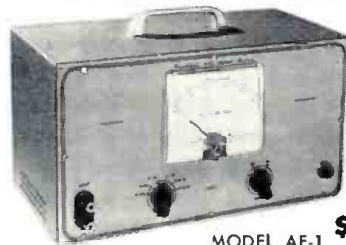

SHIPPING
WT. 15 LBS.

MODEL AF-1 **\$34.50**

The HEATHKIT AUDIO FREQUENCY METER provides a simple and easy way to check unknown audio frequencies from 10 cycles to 100 kc between 3 and 300 volts RMS. The instrument features 7 ranges for accuracy and wide coverage. The meter itself has a quality 200 microampere Simpson movement and large clearly marked scales. The AUDIO FREQUENCY METER is transformer operated and features a voltage regulator tube to maintain constant plate voltage on the second stage. Kit supplied complete with all necessary construction material and a detailed construction manual.

NEW *Heathkit* AUDIO OSCILLATOR KIT



MODEL AO-1
SHIPPING
WT. 14 LBS.

\$24.50

A new Audio Oscillator with both sine and square wave coverage from 20 to 20,000 cycles . . . An instrument designed to completely fulfill the needs of the audio engineer and enthusiast — Has numerous advantages such as high level output (up to 10V obtainable across the entire range), distortion less than .6%, and low impedance output.

Special design features include the use of a thermistor in the second amplifier stage for keeping the output essentially flat across the entire range.

A cathode coupled clipper circuit produces good, clean, square waves with rise time of only 2 microseconds. Oscillator section uses 1% precision resistors in range multiplier circuit for greatest accuracy.

You'll like the operation of this fine new kit.

Heathkit SQUARE WAVE GENERATOR KIT



MODEL SQ-1
SHIPPING
WT. 14 LBS.

\$29.50

The HEATHKIT SQUARE WAVE GENERATOR is an excellent square wave frequency source with wide range coverage from 10 cycles to 100 kc continuously variable. This feature makes it useful for TV and wide band amplifier work as well as audio experimentation. The output voltage is continuously variable between 0 and 20 volts. The circuitry consists of a multivibrator stage, a clipping and squaring stage and a cathode follower low impedance output stage. The power supply is transformer operated and utilizes a full wave rectifier circuit with two sections of filtering. Another excellent HEATHKIT value at this remarkable low price. Kit includes all necessary construction material as well as complete instruction manual for assembly and operation.

EXPORT AGENT
ROCKE INTERNATIONAL CORP.
13 E. 40th ST.
NEW YORK CITY (16)
CABLE: RPLAS:NY

The **HEATH COMPANY**

... BENTON HARBOR 15, MICHIGAN

NEW *Heathkit* SIGNAL TRACER KIT

• NEW NOISE LOCATOR AND WATTMETER CIRCUITS.

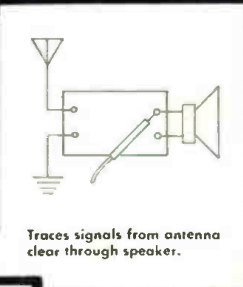
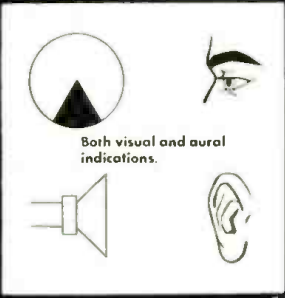

MODEL T-3

SHIPPING WT. 8 LBS.

\$22.50



- Permits visual signal observation as well as aural operation.
- Two separate input channels.
- Tremendous RF channel sensitivity. Adequate for actual signal detection at receiver input.
- Separate high gain RF and low gain audio channels.
- A unique and useful noise locator circuit.
- Built-in calibrated wattmeter.
- Two separate shielded probes for RF and audio application.
- Additional test leads supplied.
- Substitution test speaker and output transformer eliminates necessity for speaker removal in service work.
- Utility amplifier. Check record changers, tuners, microphones, instrument pickups, etc.
- VTVM and Scope panel terminals.
- 5 tube transformer operated circuit.

The new HEATHKIT VISUAL AURAL SIGNAL TRACER represents one of the most convenient and useful instruments the service man can use in AM, FM and TV service work. The electron ray beam indicator constantly monitors both input channels for visual observation of the signal. Now, see and hear the signal level for easier estimation of signal strength and gain per stage in a receiver circuit. Separate high gain channel and special shielded demodulator probe for RF circuit work. Low gain channel for audio circuit investigation and for use as a noise locator. In this feature, approximately 200 volts DC is applied to a suspected circuit component and the action of the voltage in the component can be seen and heard to determine satisfactory operation. This feature alone will prove tremendously helpful in locating the source of objectionable noises in coils, transformers, resistors, condensers, cold solder joints, controls, etc. A convenient wattmeter permits rapid preliminary check for voltage distribution circuit breakdown as well as transformer failures. Use the T-3 as a universal test speaker and substitution transformer and save service time by eliminating the necessity for speaker removal on every service call. Additional service uses are: as a utility amplifier for checking the output of record changers, tuners, microphones, instrument pickups, etc. Separate panel terminals permit utilization of other shop equipment such as your Oscilloscope or VTVM. Entire kit supplied complete with 5 tubes, all necessary construction material along with a detailed step by step instruction manual for the assembly and operation of the instrument.

NEW *Heathkit* CONDENSER CHECKER KIT



MODEL C-3
SHIPPING
WT. 7 LBS.

\$19.50

Announcing the new improved Model C-3 HEATHKIT CONDENSER housed in a new smartly styled professional appearing cabinet featuring rounded corners and snug fitting drawn panel. Adequate provisions for ventilation insures longer instrument life through cooler operation. Use the C-3 to accurately measure those unknown condenser and resistor values. All readings of condensers and resistors are read directly on the calibrated scales. Range of condenser measurements is from .00001 mfd to 1000 mfd. Calibrated resistance measurements can be made from 100 ohms to 5 megohms. A leakage test with a choice of 5 DC polarizing voltages will quickly indicate condenser operating quality under actual voltage load conditions. The spring return leakage test switch automatically discharges the condenser under test and eliminates shock hazard. An electron ray beam indicator tube is used in a new leakage test circuit for added sensitivity. The instrument is transformer operated for safety and will prove an extremely welcome addition to your shop equipment. The kit is furnished complete with all necessary parts, test leads and includes a step by step detailed construction manual for assembly and operation.

Heathkit TV ALIGNMENT GENERATOR KIT

MODEL TS-2
SHIPPING
WT. 20 LBS.

\$39.50



Here is an excellent TV ALIGNMENT GENERATOR designed to do TV service work quickly, easily and properly. The Model TS-2 when used in conjunction with an Oscilloscope provides a means of correctly aligning TV receivers. The instrument furnishes a frequency modulated signal covering in 2 bands the range of 10 to 90 megacycles and 150 to 230 megacycles. An absorption type frequency marker covers from 20 to 75 megacycles in 2 ranges; therefore you have a simple, convenient means of checking IF's independent of oscillator calibration. Sweep width is variable from 0 to 12 megacycles. Other excellent features are horizontal sweep voltage controlled with a phasing control — both step and continuously variable attenuation for setting the output signal to the desired level — a convenient stand by switch — and blanking for establishing a single trace with a base reference level. Make your work easier, save time and repair with confidence. Order your HEATHKIT TV ALIGNMENT GENERATOR now.

EXPORT AGENT
ROCKE INTERNATIONAL CORP.
131 W 40th ST.
NEW YORK CITY (16)
CABLE: ARLAD-N.Y.

The **HEATH COMPANY**

... BENTON HARBOR 15, MICHIGAN

Heathkit TUBE CHECKER KIT

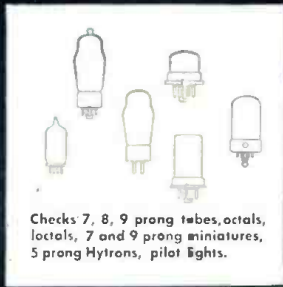

Checks 7, 8, 9 prong tubes, octals, loctals, 7 and 9 prong miniatures, 5 prong Hytrons, pilot lights.

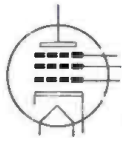

Checks for opens, shorts, emission, filament and filament tap continuity.

MODEL TC-1
SHIPPING
WT. 12 LBS.

\$29.50

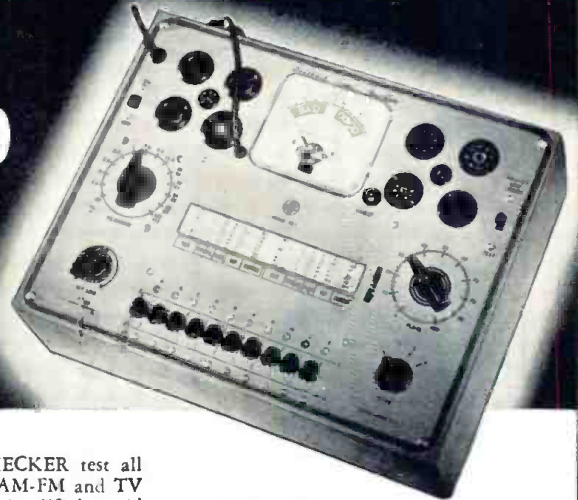

- Beautiful counter type birch cabinet.
- 4½" Simpson 3 color meter.
- Simplified setup procedure.
- Built-in gear driven roll chart.
- Checks emission, shorted elements, open elements and continuity.
- Complete protection against obsolescence.
- Sockets for every modern tube.
- Blank for new types.
- Individual element switches.
- Contact type pilot light test socket.
- Line adjust control.

With the HEATHKIT TC-1 TUBE CHECKER test all types of tubes commonly encountered in AM-FM and TV receiver circuits. Test setup procedure is simplified, rapid and flexible. Tube quality is read directly on a beautiful 4½" Simpson three color BAD - ? - GOOD scale that your customers can readily understand. Panel sockets accommodate 4, 5, 6 and 7 prong tubes, octals, loctals, 7 and 9 prong miniatures, 5 prong Hytrons, a blank socket for new tubes and a contact type socket for quick checking of pilot lights. Built-in gear driven roll chart for instant reference. Neon short indicator, individual three position lever switch for each tube element, spring return test switch, line set control to compensate for supply voltage variations. At this low price, no service man need be without the advantages offered by the HEATHKIT TUBE CHECKER.

Heathkit TV PICTURE TUBE TEST ADAPTER

Use your HEATHKIT TUBE CHECKER with this new TV TEST ADAPTER to determine picture tube quality. Check for emission and shorts, independent of TV power supply. Consists of standard 12 pin TV tube socket, 4 feet of cable, octal socket connector and data sheet. Quickly prove TV picture tube condition to yourself and your customer.



No. 355
Ship. Wt. 1 lb. **\$4.50**

Heathkit RESISTANCE SUBSTITUTION BOX KIT



MODEL RS-1
SHIPPING
WT. 3 LBS.

\$5.00

NEW HEATHKIT RESISTANCE SUBSTITUTION BOX KIT provides switch selection of any single one of 36 RTMA 1 watt 10% standard value resistors, ranging from 15 ohms to 10 megohms. This coverage available in 2 ranges in decades of 15, 22, 33, 47, 68 and 100. Housed in rugged plastic cabinet featuring new HEATHKIT universal type binding posts. The entire kit priced less than the retail value of the resistors alone.

Heathkit BATTERY ELIMINATOR KIT

A clean 6 volt d-c supply source is definitely required for successful automobile radio servicing. Has a continuously variable d-c output from 0 to 8 volts. It can be safely operated at a steady 10 ampere level and will deliver up to 15 amperes for intermittent periods. The voltage output terminals are completely isolated from the chassis to accommodate additional service applications such as supplying bias voltages or d-c substitution voltages for battery operated tube filament circuits.

The output of the Battery Eliminator is constantly monitored by a d-c voltmeter and a d-c ammeter. The circuit features an automatic overload relay of self resetting type. For additional protection, a panel mounting fuse is provided. Build this kit in a few hours and pocket a substantial savings.

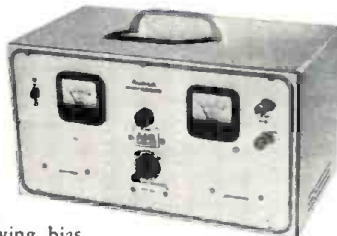

MODEL BE-3
SHIPPING
WT. 20 LBS.

\$24.50

Heathkit VIBRATOR TESTER KIT

Repair time is valuable, and the Heathkit Vibrator Tester will save you hours of work. Instantly tells the condition of the vibrator under test — and the check is thorough and complete. Checks vibrator for proper starting, and the easy-to-read meter indicates the quality of output on large BAD-GOOD scales. Tests both interrupter and selfrectifier types of vibrators. Five different sockets for checking hundreds of vibrators.

Operates from any battery eliminator capable of delivering continuously variable voltage from 4-6V at 4 amps. The Heathkit BE-3 Battery Eliminator is ideal for operating this kit.

Faulty vibrators can be spotted within seconds and you're free to go on to other service jobs.



MODEL VT-1
SHIPPING
WT. 7 LBS.

\$14.50

EXPORT AGENT
ROCKE INTERNATIONAL CORP.
175 E. 40th ST.
NEW YORK CITY (16)
CABLE APLAD-NY

The **HEATH COMPANY**

... BENTON HARBOR 15, MICHIGAN

Heathkit SIGNAL GENERATOR KIT

MODEL SG-7

SHIPPING
WT 7 LBS.

\$19⁵⁰



Modulated or unmodulated RF output.



400 cycle sine wave output.

- Step attenuated RF output.
- 6 to 1 vernier dial ratio.
- Turret mounted coil sub-assembly.
- Pre-calibrated and adjusted coils.
- Hartley RF oscillator circuit.
- Colpitts oscillator 400 cycle sine wave output.
- Modulated or unmodulated RF output.
- Frequency coverage on fundamentals 160 kc to 50 megacycles in five ranges. 51 megacycles to 150 megacycles on calibrated harmonics.
- RF output in excess of 100,000 microvolts.
- Audio output 1 1/2 to 2 volts.
- AC transformer operated.
- Professionally styled cabinet.
- Infra red baked enamel panel.

The new HEATHKIT Model SG-7 SIGNAL GENERATOR easily fulfills requirements for a controllable, modulated or unmodulated source of variable frequency. A convenient 400 cycle sine wave output is available for audio work. All RF oscillator coils are precision wound and adjusted to calibration before shipment thereby assuring maximum accuracy. The coils, band switch and tuning condenser all mount as a turret assembly so as to offer the advantage of short wiring leads and easy mounting of parts. The RF output circuit is of the low impedance type obtained by the use of cathode coupling to the output jacks. The level of RF output is varied by means of the RF step and RF output control. Use the HEATHKIT SG-7 as an RF signal source modulated or unmodulated for radio repair, laboratory work, experimental testing, 400 cycle sine wave audio testing, checking RF stages, alignment of both AM and FM IF stages, marker generator for TV alignment, etc. The kit is transformer operated and utilizes miniature tubes for ease in handling high frequency. Panel jacks and a convenient switching system permit either external or internal modulation. The entire kit is supplied complete with tubes and all necessary material as well as a detailed step by step instruction manual for the assembly and operation of the instrument.

Heathkit INTERMODULATION ANALYZER KIT



MODEL IM-1
SHIPPING WT. 18 LBS.

\$39⁵⁰

The HEATHKIT MODEL IM-1 is an extremely versatile instrument specifically designed for measuring the degree of interaction between two

signals caused by a specific piece of apparatus, or a chain of equipment. It is primarily intended for tests of audio equipment but may be used in other applications such as making tests of microphones, records, recording equipment, phonograph pickups and loud speakers. Use it for checking tape or disc recordings, as a sensitive AC voltmeter, as a high pass noise meter for adjusting tape bias, cutting needle pitch or other applications. High and low test frequency source, intermodulation section, power supply and AC voltmeter all in one complete unit. Percent intermodulation is directly read on three calibrated ranges, 30%, 10% and 3% full scale. Both 4 to 1 and 1 to 1 ratios of low to high frequencies easily set up. At this low kit price YOU can enjoy the benefits of Intermodulation analysis for accurate audio interpretations.

Heathkit LABORATORY REGULATED POWER SUPPLY KIT



MODEL PS-2
SHIPPING WT. 20 LBS.

\$29⁵⁰

New HEATHKIT LABORATORY POWER SUPPLY provides continuously variable regulated DC voltage output

from 160 volts to 400 volts depending on load. Panel terminals supply separate 6.3 V. AC supply at 4 amperes for filament circuits. A 3 1/2" plastic cased panel mounted meter provides accurate metered output for either voltage or current measurements. Exceptionally low ripple content of .012% admirably qualifies the HEATHKIT LABORATORY POWER SUPPLY for high gain audio applications. Ideal for laboratory work requiring a reference voltage for meter calibration or for plotting tube characteristics. In service work, it can be used as a separate variable voltage supply to determine the desirable operating voltage in a specific circuit. Use it as a DC substitution voltage in trouble shooting TV circuits exhibiting symptoms of extraneous undesirable components in plate supply circuits. Entire kit, including all 5 tubes now available at this low price.

ROCKE INTERNATIONAL CORP.
13 E. 40th ST.
NEW YORK CITY (16)
CABLE AREA 7

The HEATH COMPANY

... BENTON HARBOR 15, MICHIGAN

Heathkit WILLIAMSON TYPE AMPLIFIER KIT

The HEATHKIT WILLIAMSON TYPE AMPLIFIER performance has been verified on the basis of critical listening tests and laboratory measurements by both music lovers and audio experts. Use this outstanding amplifier as the heart of your audio system for the fine musical reproduction that is the goal of every audio enthusiast. A new Peerless output transformer with additional primary taps permits ultra linear type circuitry, affording a peak power output of well over 20 watts. Quality of reproduction is instantly apparent and measurements actually bear out the superb performance. Frequency response ± 1 DB from 10 cycles to 100 kc allows reproduction of the highs and lows with equal crispness and clarity. Harmonic and intermodulation distortion both less than $\frac{1}{2}$ of 1% at 5 watts eliminate the harsh unpleasant qualities which contribute to listening fatigue.

The HEATHKIT PREAMPLIFIER (available separately or in combination with the amplifier kit) features inputs for magnetic or low level cartridges, crystal pickups and tuners, turnover control for LP or 78 type records, individual bass and treble tone controls each providing up to 15 DB of boost or attenuation. Special notched shafts on preamplifier controls and switches adaptable to custom installation. The preamplifier can be mounted in any position and a liberal length of connecting cable is supplied. No radio experience is required to construct this amplifier. All punching, forming or drilling has already been done. The complete kit includes all necessary parts as well as a detailed step by step construction manual with pictorial diagrams to greatly simplify the construction.



Heathkit FM TUNER KIT



MODEL FM-2
SHIPPING
WT. 9 LBS.

\$22.50

The HEATHKIT MODEL FM-2 TUNER specifically designed for simplified kit construction features a preassembled and adjusted tuning unit. Three double tuned IF transformers and a discriminator transformer are used in an 8 tube circuit. Smooth tuning is obtained through a 9 to 1 ratio vernier drive using a calibrated six inch slide rule type dial. The usual frequency coverage of 88 to 108 megacycles is provided. Experience the thrill of building your own FM tuner. Operate it through your amplifier or radio and enjoy all the advantages of true FM reception. Transformer operated power supply to simplify connections to all types of audio systems. The kit is supplied complete with all 8 tubes and a necessary material required for construction. A complete instruction manual simplifies assembly and operation.

PRICES OF VARIOUS COMBINATIONS

WA-A1 Amplifier kit—Combination 1—(Main amplifier and Power Supply) complete with WA-P1 Preamplifier kit.

Total Shipping Weight 39 lbs. (Shipped Express only) **\$69.50**

WA-A1 Amplifier kit only—Combination 4—(Main Amplifier and Power Supply). Less WA-P1 Preamplifier.

Total Shipping Weight 29 lbs. (Shipped Express only) Price **\$49.75**

WA-P1 Preamplifier kit only. (less power supply) Tubes included.

Total Shipping Weight 7 lbs. (Shipped Exp. or P.P.) Price **\$19.75**

PLEASE BE SURE TO STATE COMBINATION NUMBER WHEN ORDERING.

Heathkit ECONOMY 6 WATT AMPLIFIER KIT



MODEL A-7
SHIPPING
WT. 10 LBS.

\$14.50

The HEATHKIT Model A-7 amplifier features beam power, push pull output with frequency response flat $\pm 1\frac{1}{2}$ DB from 20 to 20,000 cycles. Separate volume, bass and treble controls. Two input circuits, output impedances of 4, 8, and 15 ohms. Peak power output rated at full 6 watts. High quality components, simplified layout, attractive gray finished chassis, break off type adjustable length control shafts and attractive lettered control panel.

THE MODEL A7A amplifier incorporates a preamplifier stage with special compensated network to provide the necessary voltage gain for operation with variable reluctance or low output level phono cartridges. Excellent gain for microphone operation in a moderate powered sound system. **\$16.50**

Heathkit HIGH FIDELITY 20 WATT AMPLIFIER KIT

The HEATHKIT MODEL A-8 amplifier kit was designed to deliver high fidelity performance with adequate power output at moderate cost. The frequency response is within ± 1 DB from 20 to 20,000 cycles. Distortion at 3 DB below maximum power output at 1000 cycles is only .8%. The amplifier features a Chicago power transformer in a drawn steel case and a Peerless output transformer with output impedances of 4, 8, and 16 ohms available. Separate bass and treble tone controls permit wide range of tonal adjustment to meet the requirements of the most discerning listener. The amplifier uses a 6SJ7 voltage amplifier, a 6SN7 amplifier and phase splitter and two 6L6's in push pull output and a 5U4G rectifier. Two input jacks for either crystal or tuner operation. The kit includes all necessary material as well as a detailed step by step construction manual.



MODEL A-8
SHIPPING WT. 19 LBS.

\$33.50

MODEL A8-A features an added 6SJ7 stage (preamplifier) for operating from a variable reluctance cartridge or other low output level phono pickups. Can also be used with a microphone. A 3 position panel switch affords the desired input service. **\$35.50**

EXPORT AGENT
ROCKE INTERNATIONAL CORP.
121 E. 40th ST.
NEW YORK CITY (10)
CABLE AREA 8 N.Y.

The HEATH COMPANY

. . . BENTON HARBOR 15, MICHIGAN

Heathkit SUPERHETERODYNE RECEIVER KITS

- High gain dual iron core tuned type IF transformers
- AC transformer operation for safety
- Continuously variable tone control
- Sturdy punched and plated steel chassis
- Ideal for custom installation
- Full AVC action
- Inverse feedback for improved frequency response
- Kit supplied with all necessary construction material except speaker and cabinet. (Available separately if desired).

6 tube all wave circuit.
3 ranges, continuous coverage 550 kc to over 20 megacycles, shipping wt. 11 lbs.

Model AR-1
\$23.50

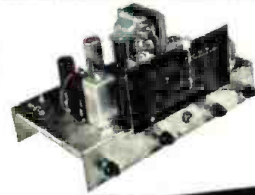

5 tube broadcast band
550 to 1600 kc coverage,
shipping wt. 11 lbs.

Model BR-1
\$19.50

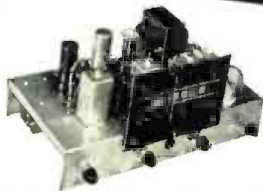

Two excellent radio receiver kits featuring clean design and open layout for simplified construction. Satisfy that urge to build your own radio receiver and select the model which meets your requirements. Both receivers feature continuously variable tone control, a radio phono switch and phono input and an AC receptacle for the phono motor. A six inch calibrated slide rule type dial with a 9 to 1 ratio vernier dial drive insures easy tuning.

SHIPPING INFORMATION

ON PARCEL POST ORDERS include postage for weight shown and insurance. (We insure all shipments.) Don't worry about sending more than the correct amount — if you send us too much, every extra cent will be promptly returned.

ON EXPRESS ORDERS do not include transportation charges. They will be collected by Express Agency on delivery.

ORDERS FROM CANADA must include full remittance for merchandise.

Orders processed on the same day received. Customers notified of unavoidable delay.

U. S. postal or express money orders, bank drafts or checks are acceptable. Do not send loose coins or stamps.

ALL PRICES SUBJECT TO CHANGE WITHOUT NOTICE

EXPORT AGENT
ROCKE INTERNATIONAL CORP.
13 E. 40th ST.
NEW YORK CITY (16)
CABLE: ARLAB N.Y.

The HEATH COMPANY

... BENTON HARBOR 15, MICHIGAN

ORDER BLANK



From _____

SHIP VIA

- Parcel Post
- Express
- Freight
- Best Way

(PLEASE PRINT)

QUANTITY	ITEM	PRICE	QUANTITY	ITEM	PRICE
	Heathkit Oscilloscope Kit—Model O-8 (29 lbs.)	\$43.50		Heathkit Square Wave Gen. Kit—Model SQ-1 (14 lbs.)	\$29.50
	Heathkit Intensifier Kit (O-8 only) No. 339 (1 lb.)	7.50		Heathkit AC VTVM Kit—Model AV-2 (5 lbs.)	29.50
	Heathkit Voltage Calibrator Kit—Model VC-1 (5 lbs.)	9.50		Heathkit Intermodulation Analyzer Kit—Model IM-1 (18 lbs.)	39.50
	Heathkit Electronic Switch Kit—Model S-2 (11 lbs.)	19.50		Heathkit Regulated Power Supply Kit—Model PS-2 (20 lbs.)	29.50
	Heathkit Scope Demodulator Probe Kit No. 337 (1 lb.)	4.50		Heathkit Handitester Kit—Model M-1 (3 lbs.)	13.50
	Heathkit T.V. Alignment Generator Kit—Model TS-2 (20 lbs.)	39.50		Heathkit Decade Resistance Kit—Model DR-1 (4 lbs.)	19.50
	Heathkit Q Meter Kit—Model QM-1 (12 lbs.)	39.50		Heathkit Decade Condenser Kit—Model DC-1 (4 lbs.)	16.50
	Heathkit Grid Dip Meter Kit—Model GO-1 (4 lbs.)	19.50		Heathkit Impedance Bridge Kit—Model IB-1B (15 lbs.)	69.50
	Heathkit VTVM Kit—Model V-6 (7 lbs.)	24.50		Heathkit Battery Tester Kit—Model BT-1 (3 lbs.)	7.50
	Heathkit RF Probe Kit No. 309 (1 lb.)	5.50		Heathkit Resistance Substitution Box Kit—Model RS-1 (3 lbs.)	5.50
	Heathkit HV Probe Kit No. 336 (2 lbs.)	5.50		Heathkit F.M. Tuner Kit—Model FM-2 (9 lbs.)	22.50
	Heathkit Peak-to-Peak Volt. Probe Kit No. 338 (2 lbs.)	6.50		Heathkit Broadcast Receiver Kit—Model BR-1 (11 lbs.)	19.50
	Heathkit Visual-Aural Signal Tracer Kit—Model T-3 (8 lbs.)	22.50		Heathkit Three Band Receiver Kit—Model AR-1 (11 lbs.)	23.50
	Heathkit Condenser Checker Kit—Model C-3 (7 lbs.)	19.50		Heathkit Amplifier Kit—Model A-7 (10 lbs.)	14.50
	Heathkit RF Signal Generator Kit—Model SG-7 (7 lbs.)	19.50		Heathkit Amplifier Kit—Model A-7A (10 lbs.)	16.50
	Heathkit Tube Checker Kit—Model TC-1 (12 lbs.)	29.50		Heathkit Amplifier Kit—Model A-8 (19 lbs.)	33.50
	Heathkit T.V. Tube Adapter No. 355 (1 lb.)	4.50		Heathkit Amplifier Kit—Model A-8A (19 lbs.)	35.50
	Heathkit Battery Eliminator Kit—Model BE-3 (20 lbs.)	24.50		WA-A1 Amplifier Kit—Comb. 1 (Incl. main amplifier, power supply and WA-P1 preamplifier) (39 lbs.) Shipped express only	69.50
	Heathkit Vibrator Tester Kit—Model VT-1 (7 lbs.)	14.50		WA-A1 Amplifier Kit—Comb. 4 (Main amp. and power supply) (29 lbs.) Shipped express only.	49.75
	Heathkit Audio Generator Kit—Model AG-8 (16 lbs.)	29.50		WA-P1 Preamplifier Kit (7 lbs.) (Shipped exp. or p.p.)	19.75
	Heathkit Audio Oscillator Kit—Model AO-1 (14 lbs.)	24.50			
	Heathkit Audio Frequency Meter Kit—Model AF-1 (15 lbs.)	34.50			

*Please ship C.O.D. Postage enclosed for _____ lbs.

Enclosed find Check Money Order for _____

NOW—Get this expert SELF-TRAINING in RADIO SERVICING

by ABRAHAM MARCUS



co-author of famous "Elements of Radio" which has sold over 800,000 copies! Here is every detail you need to know about radio repair, replacement, and re-adjustment. Easy-to-understand, step-by-step self-training handbook shows you how to locate and remedy defects quickly.

Covers: TRF Receivers; Superheterodyne Receivers; Short-Wave Receivers and Converters; Multiband Receivers; Portable Receivers; Automobile Receivers; Communication Receivers; F-M Receivers; Power Supplies operated from AC, DC, Batteries, Motor-Generators, etc. Tells you the HOW and WHY of: Electron Tubes (Diode, Triode, Pentode, Beam Power, Thyatron, Phototube, Cathode Ray, etc.); Rectifier Circuits (Half-wave, Full-wave, Bridge, Voltage-Doubler, etc.); Detector Circuits (Diode, Triode, Regenerative, Superregenerative, Infinite-impedance, etc.); Amplifier Circuits (Audio, Radio, I-F, Video, D-C, etc.); Oscillator Circuits (Hartley, Colpitts, Crystal, Transitron, Multivibrator, Sweep-circuit etc.); Control Circuits (Volume, AVC, DAVC, Tone, Noise-Suppression, Automatic Tuning, Automatic Frequency Control, etc.).

All in one big volume — easy to read. 16 Big Chapters, 121 Sections, 400 "Show-How" Diagrams, 775 pages of practical radio instruction.

Explains how to use testing instruments such as: meter, vacuum-tube voltmeters, ohmmeters, bridges, multimeters, signal generators, tube checkers, cathode-ray oscilloscopes, etc. Over 100 pages and 69 illustrations in this section alone!

Get this authoritative radio repair handbook today! Coupon below brings you "Radio Servicing" on FREE trial for 10 days. Mail it NOW.

PRENTICE-HALL, Inc., Dept. M-RN-1052
70 Fifth Ave., New York 11, N. Y.

Send me, for 10 DAYS' FREE TRIAL, "Radio Servicing," by Abraham Marcus. I will return it in ten days and pay nothing—or keep it and send \$1.95 down (plus postage) and \$2 monthly for 2 months.

Name

Address

City State

() SAVE! Send \$5.95 WITH COUPON—we pay postage.

★ STAR SPECIALS

NEWEST ITEMS! LOWEST PRICES!

BARGAIN LOW PRICE

FLYBACK TRANSFORMER

(Similar to GE 77J 1)

Regular \$11.00 list price high voltage transformer similar to General Electric 77J1. Used for general replacement in many sets up to 14KV and with up to 19" tubes. Not available elsewhere at our low price!

A-1827 Flyback Transformer **\$2.49**



Simpson Model 381 CAPACITY BRIDGE

Direct-reading in micro-microfarads and microfarads; no multiplying factors or intricate switching. Three ranges to read 20-5000 mmf, 0.005-2.0 mfd, and 1.0-500 mfd. Compact bakelite case measures only 3 3/4" x 5 1/2" x 2 3/8"; etched aluminum panel. For 115-volt 50-60 cycles. **\$27.93**



Price Slashed!
65 MA

SELENIUM RECTIFIERS

Brand new, famous make 65 ma. selenium rectifiers used by servicemen and builders. Standard replacement for many AC-DC sets and other transformerless power supplies. Stock up now at our low price!

A-1598 65 ma. Selenium Rectifier **65c** ea.
10 for only \$5.90! 100 for only \$54.00!

COMPLETE STOCKS All Standard Brands Just off the press
BIG BARGAIN BULLETIN

STAR ELECTRONIC DISTRIBUTORS, INC.
Dept. RN 10—7736 S. Halsted, Chicago 20, Ill.

Astigmatism Control

(Continued from page 58)

aggerated. Although the actual distortion will usually be less in practice, it is enough to cause considerable difficulty when making careful waveform checks or analyses.) With a spot as shown in Fig. 2C, it may become impossible to distinguish between the rise and fall traces of sharp pulses.

To correct the conditions described, it is only necessary to make a change in the CRT supply circuits so that the accelerating electrode voltage can be made variable. With the circuit shown in Fig. 1A, R_6 and R_7 are replaced by a 1 megohm potentiometer, as shown in Fig. 1B. A linear taper pot. may be used.

In CRO's using a different arrangement of resistors in the high voltage supply circuit, simply identify the connection to the accelerating electrode and place a potentiometer at this point, connected so that the electrode voltage is variable. The size of the pot. is not critical and in most applications any value from 500,000 ohms to 2 megohms will be all right.

With the circuit shown in Fig. 1A the accelerating electrode does not have too high a potential with respect to ground, and hence the pot. may be mounted directly on the front panel of the CRO. In some scopes, the accelerating electrode may be above ground by almost the full voltage of the high voltage power supply. In such cases, the "Astigmatism" control pot. should be mounted with insulating washers, and an insulating bushing used between the control shaft and the control knob on the front panel.

For greatest ease of operation, the "Astigmatism" control should be mounted reasonably close to the "Focus" control on the front panel of the CRO. Where this is impossible, the control may be placed elsewhere, but should be clearly labeled, using either decals, a nameplate, or any other suitable method. A small knob may be used on the control, for once the optimum position is found, the adjustment may generally be left in this position for reasonably long periods of time.

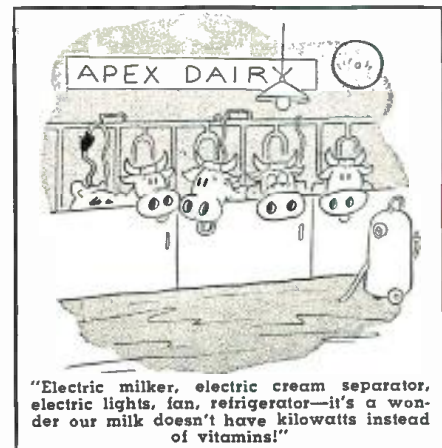

More Leading ENGINEERS and TECHNICIANS Choose

TECH-MASTER TV KITS

C. G. McPrud, Editor of AUDIO Engineering, writes, "... I was amazed with the speed and simplicity ... friends marvelled at the picture quality ..."

TECH-MASTER Advanced 630-Type Circuit

World's Finest TV Kit — For all tubes from 16" to 24" • Advanced standard TURRET TUNER, adaptable to U.H.F. without tools • Cascade R.F. amplifier stage • Keyed AGC circuit • Full 4 Mc band width • "Hi-Sweep" voltage multiplier system • 3-stage synchronized amplifier • 3-stage video amplifier. Model 630D24-Deluxe, (all principal components mounted) \$159.50
Model 630S24-Standard, (unassembled) \$154.50
Complete with all components, picture tube mounting brackets, speaker and a 1 tubes (less Kine, wire and solder).

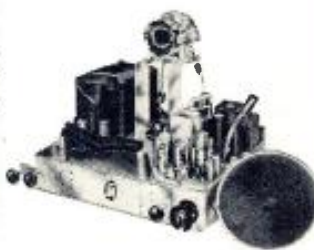

TECH-MASTER Universal AC/DC KIT

High quality TV now within reach of all. Advanced 12-channel TURRET TUNER adaptable to U.H.F. without tools • Latest type hi-gain stagger-tuned IF system • New AGC system • Maximum signal amplification, even in fringe areas • For 14" and 17" rectangular picture tubes. Model 5116: Complete with set of 16 circuit tested tubes, hardware, instructions and picture tube mounting brackets, (less Kine, wire and solder) \$99.95



Sold by all leading Radio Parts Distributors.



Write for literature.

TECH-MASTER PRODUCTS COMPANY

443-445 BROADWAY, NEW YORK 13, N. Y.

Fill your parts requirements from a single dependable source

**Delco
Radio**

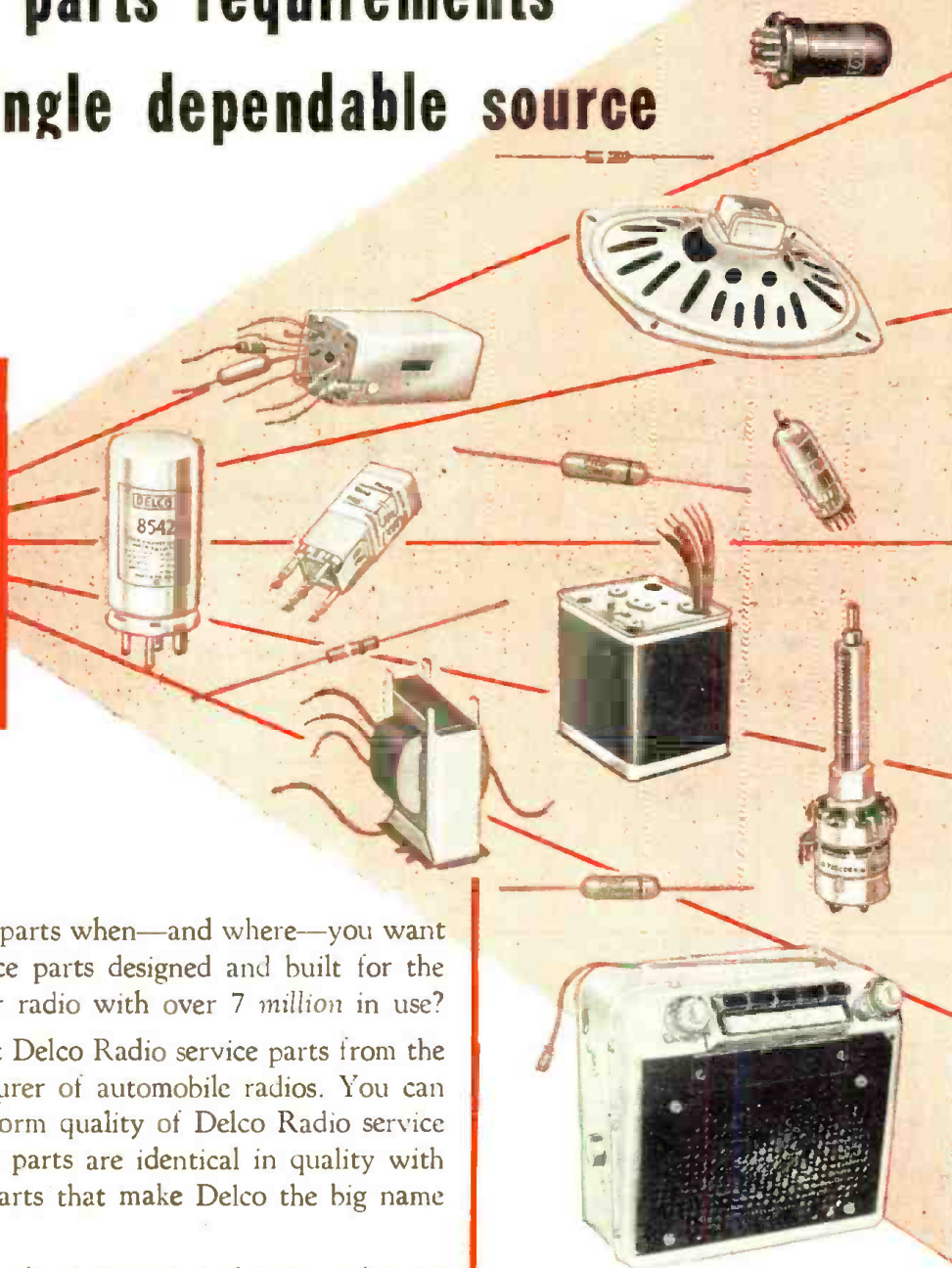

Want *good* radio service parts when—and where—you want them? Want radio service parts designed and built for the world's most popular car radio with over 7 million in use?

If you do . . . you want Delco Radio service parts from the world's largest manufacturer of automobile radios. You can depend on the high, uniform quality of Delco Radio service parts. These replacement parts are identical in quality with the original equipment parts that make Delco the big name in car radios.

Both Delco Radio original equipment and universal service parts are available promptly through United Motors wholesalers.

DELCO RADIO PARTS

A GENERAL MOTORS PRODUCT  A UNITED MOTORS LINE 

DISTRIBUTED BY WHOLESALERS EVERYWHERE

DELCO RADIO

DIVISION OF GENERAL MOTORS CORPORATION
KOKOMO, INDIANA

THINGS TO REMEMBER ABOUT DELCO RADIO SERVICE PARTS

- 1** Offer largest market for original-equipment replacement parts.
- 2** Backed by world's largest factory devoted exclusively to automobile radios.
- 3** Designed by one of the largest and most forward-looking engineering groups devoted exclusively to automotive radio.

TRIO ANNOUNCES SENSATIONAL NEW **ZIG-ZAG** ANTENNA

Patent Pending

- ★ **Higher Gain than any Yagi!**
- Plus
- ★ **All-Channel VHF Performance!**

Here's the greatest advance in TV antennas since TRIO'S introduction of the dual channel yagi! The sensational new TRIO ZIG-ZAG antenna is basically a multiple element yagi type antenna on each channel, yet one 2-bay antenna — and in some models a single bay antenna — covers all VHF channels!

This sensational antenna has sharper directivity and higher front-to-back ratio. It provides snow-free pictures, and fade-free sound even in the most remote fringe areas.

Tremendous forward gain is accomplished without long, bulky, arrays that operate on only one channel. With the new fringe area model ZIG-ZAG antenna, one bay provides tremendous gain on all low channels, 2 thru 6, and the other bay provides similar high gain on channels 7 thru 13.

HOW THIS AMAZING ANTENNA WORKS
 Trio ZIG-ZAG antennas utilize a new principle whereby an array is composed of a series of elements, one or more of which is resonant on any one channel while the remaining elements, which are non-resonant on that channel, provide parasitic voltages having the proper phase relative to the direct voltage. These act as very efficient directors and reflectors. All elements are directly connected to the feed-line.

The various models, listed below, are designed to provide a simple installation for all areas, from metropolitan to extreme fringe. Two bay models, like the single bay models, are operated with a single 300 ohm lead-in to the set, with less than a 3:1 standing wave ratio.

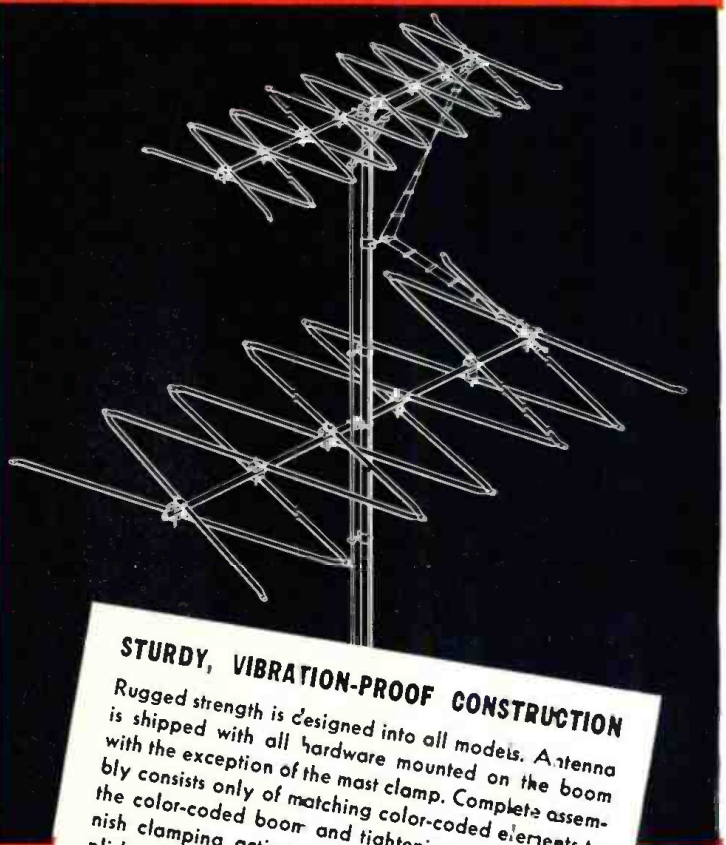

STURDY, VIBRATION-PROOF CONSTRUCTION
 Rugged strength is designed into all models. Antenna is shipped with all hardware mounted on the boom with the exception of the mast clamp. Complete assembly consists only of matching color-coded elements to the color-coded boom and tightening nuts which furnish clamping action. Complete assembly is accomplished in minutes.

8 MODELS FROM WHICH TO CHOOSE:



ZZ12L

ZZ16H

FOR EXTREME FRINGE RECEPTION — ZZ16H provides over 14 DB voltage gain as compared with a resonant reference dipole on Channels 7 thru 13; and ZZ12L provides gain of 12 to 14 DB on Channels 2 thru 6. Gain of the ZZ12L is 12 DB on Channels 2 and 3 and is 14 on Channels 4, 5 and 6. These models have narrowest forward lobe and highest front-to-back ratio and should be used in areas where co-channel interference is a problem.



ZZ8L

ZZ8H

FOR NORMAL FRINGE RECEPTION — Where maximum gain is not necessary, these models are ideal. The ZZ8H for Channels 7 thru 13 and the ZZ8L for Channels 2 thru 6. Voltage gain is 9 DB on Channels 2 and 3 and 11 DB on Channels 4 thru 13. These models have pattern comparable to a well designed multi-element single channel yagi.



WRITE FOR CATALOG

ZZ6L

ZZ6H

FOR NEAR FRINGE RECEPTION — These models provide a voltage gain of 8 to 9 DB on Channels 2 thru 13. These models have pattern and gain comparable to a cut-to-channel yagi. ZZ6L covers Channels 2 thru 6. ZZ6H covers Channels 7 thru 13.

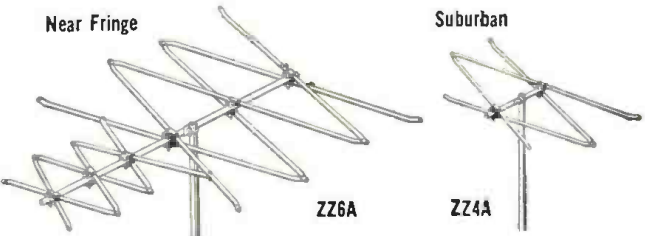

Near Fringe

Suburban

ZZ6A

ZZ4A

SINGLE BAY ALL-CHANNEL RECEPTION — Model ZZ4A is a single bay antenna providing adequate gain and directivity on all channels, 2 thru 13, in suburban areas. Model ZZ6A is also an all-channel single bay antenna providing greater gain for near fringe use.



TRIO MANUFACTURING COMPANY • GRIGGSVILLE, ILLINOIS

The TRIO ROTATOR



Easy to Sell!

It's easy to sell a product with as many plus features to talk about as the TRIO ROTATOR. In design, in construction, appearance; it is by far the outstanding TV antenna rotator in the market today!

Stays Sold!

In addition to providing a powerful sales story, the features listed below are your assurance of complete customer satisfaction: Assurance that the TRIO ROTATOR will give dependable performance year in and year out — in all kinds of weather!

- ✓ Two powerful 24 volt motors used — one for each direction of rotation. Each motor under load only fraction of time — will not burn out!
- ✓ Corrosion resisting, weatherproof housing of die-cast aluminum for greater strength, lighter weight, perfect alignment of parts!
- ✓ Positive electrical stops at ends of 360° rotation prevent damaging or twisting of leads!
- ✓ Will support heavy TV arrays — even in 80 MPH winds!
- ✓ Permanently lubricated with special grease that functions perfectly in high and low temperature extremes!
- ✓ Ball-bearing end thrusts on all shafts, including motor! Main shaft vertical load carried on large oversized "Oilite" self-lubricating bearing!
- ✓ All motors, shafts and gears mounted on a rugged, one-piece casting for true alignment and longer life!
- ✓ 1 1/16" diameter tool steel main shaft and mast holder will withstand 4500 inch pounds bending moment!
- ✓ Rotator and mast holder fits any pipe size up to 2" OD.
- ✓ Precision built to extremely close tolerances!



Smartly Styled

DIRECTION INDICATOR

The TRIO Direction Indicator is housed in a sturdy plastic cabinet of graceful lines. It is a beautiful instrument that will blend harmoniously with any furniture style.

Utmost ease in selecting the desired antenna direction is provided by a new "finger tip" control that operates at a light touch and the easy-to-read dial face that clearly and instantly indicates the exact antenna position.



**FULLY TESTED
BEFORE
SHIPMENT**

Each TRIO ROTATOR is thoroughly factory tested to the equivalent of 3 months of constant operation. This, plus an additional torque test guarantees each unit to be perfect in every detail of assembly.

The TRIO ROTATOR's sound design and construction has been proven by three years of extensive field testing under every extreme of weather.



TRIO Manufacturing Company
GRIGGSVILLE, ILLINOIS

ATR

Makes it easy to DEMONSTRATE AND TEST D.C. APPARATUS FROM A.C. LINES



"A" BATTERY ELIMINATORS
For DEMONSTRATING AND TESTING AUTO RADIOS

New Models . . . Designed for testing D.C. Electrical Apparatus on Regular A.C. Lines. Equipped with Full-Wave Dry Disc Type Rectifier, Assuring Noise-less, Interference-Free Operation and Extreme Long Life and Reliability.

ATR ✓ NEW MODELS ✓ NEW DESIGNS ✓ NEW LITERATURE

"A" Battery Eliminators, DC-AC Inverters, Auto Radio Vibrators

See your jobber or write factory

AMERICAN TELEVISION & RADIO CO.
Quality Products Since 1931
SAINT PAUL 1, MINNESOTA-U.S.A.

TEST INSTRUMENT FOR CHECKING FLYBACK TRANSFORMERS

By PHIL WEISS

Construction details on an easily-built test unit which can speed service work and conserve parts.

EVERY television technician has been faced with the problem of whether or not to replace a flyback transformer which is not delivering the required high voltage. Usually the transformer is replaced only as a last resort, after all other components have been checked. Even so, there is always an anxious moment when the new transformer is turned on.

Fig. 1 shows a typical high voltage sweep circuit. A 6SN7 oscillator generates a 15,750 cycle saw-tooth wave at the grid of a 6BQ6 driver. Each sharp interruption of the 6BQ6 current induces a high voltage pulse in the transformer, *T*, which is rectified by the 1B3 to provide 14,000 volts to the kinescope. The transformer also drives the horizontal deflection coils. The 6W4 damper helps to preserve the proper saw-tooth waveshape in the deflection coils, and incidentally builds up the supply voltage from an original 225 volts to 460 volts.

An internal short in the flyback transformer would result in:

1. Greatly reduced output to the 1B3 and to the deflection coils
2. Little or no voltage build-up across the 6W4.

However these same conditions could also be caused by a defect—either short or open—in any one of the components marked "A" in Fig. 1. Evidently it would be very useful to have a direct means of testing the transformer apart from the rest of the circuit.

Since different TV sets use a variety of input and output impedances, and many different methods of coupling to the deflection coils and damper tube, it would be hopeless to try to test each transformer in the circuit for which it was designed. It would be useful if all transformers could be tested in the same circuit.

The common principle of all flyback transformers is that a large current is drawn through the primary and just as this current reaches a peak, it is sharply cut off. Fig. 2 shows a circuit which performs this function. The transformer is connected at three points: the supply voltage—in this case 117 volts at 60 cycles; the 6BQ6 plate; and the 1B3 plate, through a 500 μ fd., 20,000 volt condenser.

Fig. 2 shows a circuit which performs this function. The transformer is connected at three points: the supply voltage—in this case 117 volts at 60 cycles; the 6BQ6 plate; and the 1B3 plate, through a 500 μ fd., 20,000 volt condenser.

Fig. 1. Conventional high-voltage sweep circuit as found in modern TV receivers.

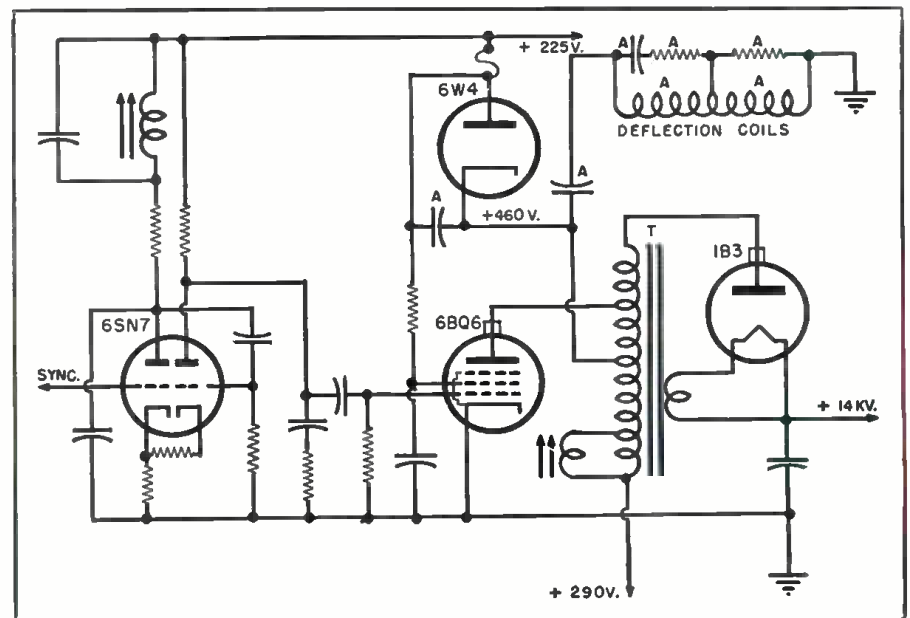

ACTUAL SIZE

New CBS-HYTRON

Germanium Diodes

Guaranteed Moisture-Proof!

GENERAL PURPOSE TYPES

1N48

1N51

1N52

1N63

1N64

1N65

1N69*

1N70*

1N75

1N81*

*JAN TYPES

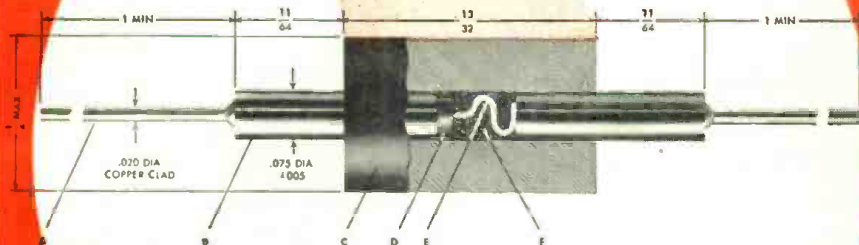

Mechanical Specifications

- A. .020" copper-clad wire
- B. Nickel-silver "clip-in" pin
- C. Glass-filled plastic case
- D. Germanium crystal soldered directly to base
- E. .005" tungsten cat whisker
- F. Moisture-resistant impregnating wax

WHY CBS-HYTRON GERMANIUM DIODES ARE BETTER RECTIFIERS

1. **MOISTURE-PROOF** . . . eliminates humidity and contamination problems
2. **SELF-HEALING** . . . self-recuperating from temporary overloads
3. **SUBMINIATURIZED** . . . only 1/2 inch long, 1/4 inch in diameter
4. **SOLDERED WAFER** . . . omission of plating eliminates flaking
5. **LOW SHUNT CAPACITY** . . . 0.8 μmfd average
6. **SELF-INSULATING CASE** . . . mounts as easily as a resistor
7. **EXCEPTIONAL LIFE** . . . 10,000 hours minimum under rated conditions
8. **NO FILAMENTS** . . . low drain, no hum

Vital germanium wafer in a CBS-Hytron diode is *guaranteed moisture-proof*. Sealed against deadly moisture . . . fumes . . . and contamination, a CBS-Hytron diode keeps moisture where it belongs . . . out! First, by a chemically and electrically inert impregnating wax. Second, by a glass-filled phenolic case. With *moisture-proof* CBS-Hytron germanium diodes, you can be sure of maximum trouble-free life.

Superior techniques also permit CBS-Hytron to omit plating of the germanium wafer. Soldering is directly to the base. Thus flaking is eliminated and quality improved. Universal design of CBS-Hytron diodes follows Joint Army-Navy specifications. "Clip-in" feature gives you versatility, ruggedness, and electrical stability. Flexible pigtails of copper-clad steel welded into sturdy nickel pins also insure you against damage by soldering heat.

Check the eight important-to-you reasons why CBS-Hytron *moisture-proof* germanium diodes are better rectifiers. Send today for complete data and interchangeability sheets. Specify CBS-Hytron *guaranteed moisture-proof* diodes for superior, trouble-free operation.

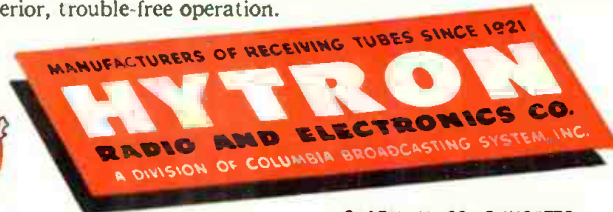

SALEM, MASSACHUSETTS

"I like Loopsticks...!"

GRAYBURNE
that is "

say hundreds of Servicemen all over the country

Grayburne Loopsticks are the most sensitive small radio antennas ever produced! Substitute them for the old type loops in every radio you repair. You'll improve set performance so amazingly, your customers will call you an electronics wizard!



FERRI-LOOPSTICK
(fig. A): Market-proved. Recommended for economical installations. Just set and forget. List 75¢.

VARI-LOOPSTICK
(fig. B): Same features as Ferris-Loopstick plus added advantages of Micrometer adjustment and one-hole mounting. List \$1.00.

Newest Advance in RF CHOKE MINIMIZATION

Grayburne is first to open new design and application possibilities with the smallest, most efficient chokes ever made! They have higher "Q", lower DC resistance, lower distributed capacity, less weight... require less copper, are easier to handle... and employ the new Ferricore Ferrite cores.



FERRI-CHOKES
(fig. C): available in 4 stock types: 2½, 5 and 10 mh @ 125 ma; 2½ mh @ 300 ma.

VARI-CHOKES
(fig. D): available in 2 stock types. Model V-6: 0.65-6.00 mh; Model V-25: 5.0-43.0 mh.

Grayburne Chokes can be supplied in a wide variety of inductances and windings on quantity requirements.

Experimenter's Ferrite Core Kit

For purposes of development and research, Grayburne has assembled a kit of 27 various-sized Ferrite cores well adapted for experimentation in IF and RF coils, chokes, linearity, width and other controls—and in many electro-mechanical applications. Type FCK, net \$2.25.

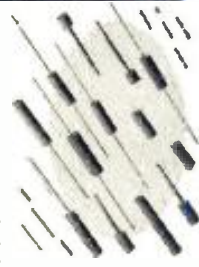

For complete Grayburne Catalog, advance information on new products to come, and name of your nearest distributor, write NOW to Dept. Z



GRAYBURNE CORP., 103 Lafayette St., N. Y. 13

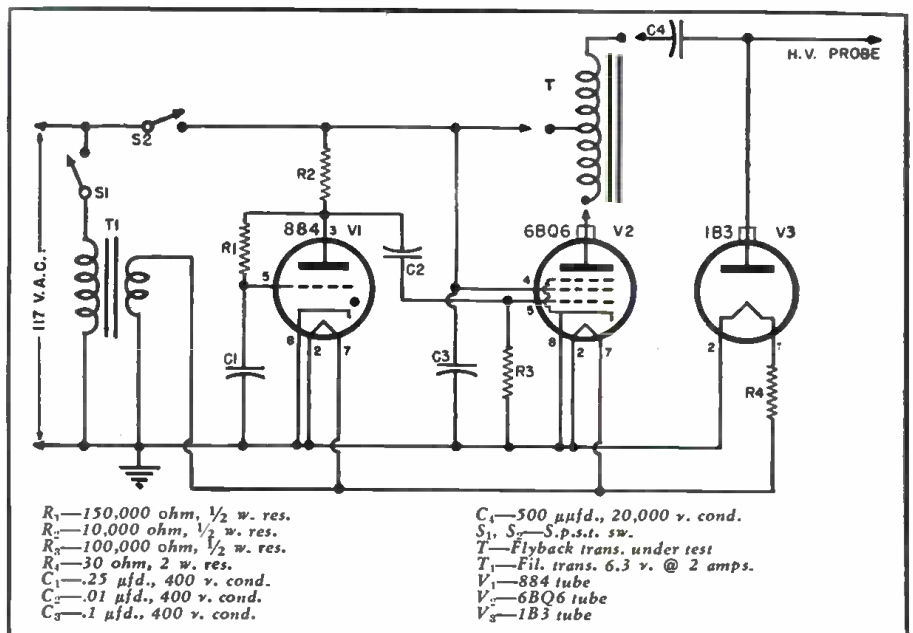

R₁—150,000 ohm, ½ w. res.
R₂—10,000 ohm, ½ w. res.
R₃—100,000 ohm, ½ w. res.
R₄—30 ohm, 2 w. res.
C₁—25 μfd., 400 v. cond.
C₂—0.1 μfd., 400 v. cond.
C₃—1 μfd., 400 v. cond.

C₄—500 μfd., 20,000 v. cond.
S₁, S₂—S.p.s.t. sw.
T—Flyback trans. under test
T₁—Fil. trans. 6.3 v. @ 2 amps.
V₁—884 tube
V₂—6BQ6 tube
V₃—1B3 tube

Fig. 2. Circuit diagram of the simple unit for testing flyback transformers.

All other connection points on the same winding are left open. Separate windings, if any, should be grounded to detect any short between windings.

The 6BQ6 plate current is sharply cut off at maximum by the 884 thyatron. The 884 grid is controlled by choosing R₁ and C₁ so that the tube fires at maximum supply voltage. It is interesting to note that the average 884 plate voltage is negative and can therefore be used for grid bias.

R₂ and C₂ are chosen so that the 6BQ6 remains cut off for the remainder of the cycle, but not long enough to interfere with the next cycle.

The result is a series of sharp single pulses in the transformer, 1/60 second apart, which is a long enough interval to avoid any resonant effects. Resonance in the transformer and coupled circuits, especially the deflection coils, is quite important at the normal frequency of 15,750 cycles and can be confusing when the transformer is operated out of its normal circuit.

The series of pulses is rectified (Fig. 2) and the result can be measured with

a high-voltage probe across the 1B3. The voltage reading obtained is not a true indication of the pulse height, since the duty cycle is so short that even the slight current drawn by the probe has a considerable loading effect. A better indication is obtained by using a 1000 to 1 capacity voltage divider and a calibrated oscilloscope to observe the pulses. Such a capacity voltage divider can easily be constructed using a 1000 μfd. condenser and a burned-out 1B3. The 1B3 serves as a 1 μfd. condenser capable of withstanding the high voltage pulses. Caution—the 1B3 should not be gassy, or it will conduct even though the filament is cold. However such refinements are unnecessary in ordinary shop work.

A number of transformers were tested, including six different types, from widely different circuits. On all the good transformers the instrument read between 7000 and 8000 volts. Transformers with shorted or open windings showed up immediately by a low voltage reading.

—30—

INTERCHANGE OF HAM LICENSE PRIVILEGES

UNDER the terms of a treaty with Canada which became effective on May 13, 1952, certain mobile and amateur radio stations licensed by that government or the U.S. may be authorized to operate across the border in each other's territory.

Those licensees desiring to avail themselves of this privilege are required to apply for and receive a permit in advance of operations. A form for the purpose has been provided by both countries. Canadian licensees should send the application (FCC Form 410) to the Secretary, Federal Communications Commission, Washington 25, D.C., while U.S. licensees should mail the Canadian application form to the Controller of Telecommunications, Department of Transport, Ottawa, Canada. Application forms of both countries may be obtained at either of the offices listed.

The types of licensed radio equipment covered by the treaty may be summarized as follows:

1. Mobile radio units installed in vehicles employed in: (a) police, fire, and other public safety services; (b) the operation or maintenance of pipe line or other industrial facility extending across the border; (c) the public carriage of persons or goods between the two countries.

2. Mobile radio units which are limited to communications through common carrier radiocommunication companies or agencies.

3. The equipment of visiting amateur radio licensees.

Radio stations of one country when operated within the borders of the other country are subject to the radio regulations of the country in which operations take place.

—30—

OLSON'S PENNY PROFIT POLICY MEANS GREATER BARGAINS



FREE! OLSON'S BIG BARGAIN CATALOG

Get Olson's LOWER-than-wholesale prices from this famous book. STANDARD BRANDS—FRESH STOCK. IMMEDIATE DELIVERY. Catalog is two colors—40 full pages of unbelievable bargains. A new catalog mailed Bi-Monthly—with new low bargains each mailing. Simply note on order blank or write today for your free copy from: OLSON RADIO WAREHOUSE, 275 E. MARKET ST., AKRON 8, OHIO.

12" Magnavox Speaker and Baffle Close-Out



Stock No. AS-66
Get both for only **\$795**

You get Magnavox's fine 12" PM speaker with Alnico 5 magnet. (Same as you'll find in those expensive Magnavox Super-Radio-Phono Combinations.) Power output 8 watts. Voice coil fully dustproofed. Impedance 6-8 ohms. In addition you get a walnut Speaker Baffle to bring out the full rich, rounded tones of the Magnavox Speaker. Baffle may be mounted on a wall or it will stand on a table. Here's the ideal combination for extension speakers for porches or other rooms. Can be connected to any radio or amplifier. Order 3 or more sets and install them in restaurants, auditoriums, halls, etc.

BUILD YOUR OWN RECORD PLAYER DELUXE 3-SPEED MODEL



Stock No. AS-53
\$1195

This fine kit contains a 3-speed phono rim drive motor to play all 33 1/2, 45 and 78 RPM discs. Velvet finish turntable, crystal pickup arm, all-purpose needle, 4" PM speaker, matching output transformer, 2-tube AC-DC amplifier and a set of tubes (35W4 and 50B5). Shpg. wt. 8 lbs.

TWO-TUBE PHONO AMPLIFIER



\$250

Only 1000 amplifiers to be sold by Olson during this sale at this remarkable low price. Efficient 2-tube amplifier. Input for crystal mike. Can be used with any PM speaker from 4" to 12". Delivers 3 watts of audio with excellent fidelity. Equipped with both volume control and tone control. Less tubes.

Shpg. wt. 3 lbs. Kit of 2 tubes (35W4 and 50B5) for above amplifier. Both for **\$1.28**

AND FOR **1c** With every Amplifier you order you can get an output transformer—retail value \$1.75—your cost only 1 cent.

PHONO PRE-AMPLIFIER



\$895

For use with G.E. and other low level magnetic pickups. Can be attached to any radio or amplifier. Built on aluminum chassis. finest workmanship throughout. Ample bass boost provided. Operates on 115 volt AC. Size 4 1/4" x 2 1/4" x 3 1/2". Complete with 12AX7 tube. Shpg. wt. 2 lbs.

RECORDING WIRE—BELOW JOBBER'S COST!



15-MINUTE SPOOL 1800 FEET
Reg. list price \$1.85. Stock No. W-113. Single, each 99c. Lots of 10, each... **79c**

30-MINUTE SPOOL 3600 FEET
Reg. list price \$2.75. Stock No. W-114. Single, each \$1.49. Lots of 10, each... **\$1.29**

Order from Olson and get the Rock-bottom price on this fine Recording Wire. Every spool comes equipped with 2 leaders, one plastic and one nylon. Individually packed in handy telescoping box. Wire is the finest magnetic stainless steel. Moves through any recorder easily and quietly. Get your supply now. No more when our stock is gone.

RECORDING TAPE—FAMOUS MFR'S. CLOSE OUT!



Get the buy of your life. Save up to 64% on high quality RECORDING TAPE. A large manufacturer had to sell his inventory and he unloaded the whole deal. Olson now offers you this high grade recording tape at prices which defy competition. Standard 1/2" wide, 1200 ft. long. Frequency response 50 to 8,000 cps. Plastic Reel included with each.

PAPER BASE 1200 ft. Stock No. X-248
Single each \$1.69
Lots of 10, each **\$1.49**

PLASTIC BASE 1200 ft. Stock No. X-249
Single, each \$2.19
Lots of 10, each **\$1.99**

PRICES SLASHED ON EMPTY PLASTIC REELS

Finest clear plastic—will not warp. 5" Diameter—600' Size No. X-250 Single, ea. 39c. LOTS OF TEN, EA. . . . **29c**

7" Diameter—1200' Size No. X-251 Single, ea. 49c. LOTS OF TEN, EA. . . . **39c**

WANTED!

\$500,000.00

WORTH OF

RADIO AND TV PARTS, SPEAKERS, TRANSFORMERS, TUBES, PICTURE TUBES, CONDENSERS, RESISTORS, SWITCHES, WIRE, ETC.

ALSO

PARTIALLY ASSEMBLED OR COMPLETE RADIO AND TV CHASSIS.

ALSO

TEST EQUIPMENT, RECORD PLAYERS, AUTOMATIC CHANGERS, MOTORS, MICROPHONES, TONE ARMS.

MANUFACTURERS and WHOLESALERS

Here's your chance to dispose of your inventory for cash.

WRITE: **OLSON RADIO WAREHOUSE**
PHONE: **ATT'N. I. J. OLSON**
WIRE: **275 E. MARKET ST., AKRON 8, OHIO**
PHONE: **JEfferson 9191**

CRYSTAL MIKES

Astatic high output crystal mike for PA systems and recorders. Equipped with handle base and 7' shielded cable. Shpg. wt. 3 lbs. M-67, each... **\$5.95**

M-66, same but with on-off switch built into handle... **\$6.95**

12" PM SPEAKER

A full size 12" PM speaker worth much more. Olson made a good deal and you can cash in. Cone is designed to bring out full rounded tones. You can stock up on these fine speakers if you act fast. In all our history we never had a speaker with such fine features at a price to compare with this. Voice coil impedance 8 ohms. Shpg. wt. 6 lbs. Stock No. S-167 **\$395** Each
Lots of 3 Single, Each **\$4.95**



TELEPHONE PICKUP

Stock No. M-80 **\$450**

Record or amplify both sides of a telephone conversation. No connection to telephone necessary. Just tap pickup under any cradle type phone and connect lead to hi-impedance input of any disc, wire or tape recorder or any amplifier. Operates by induction.

12" CO-AXIAL SPEAKER

Our new 1952 Model. Guaranteed to outperform any speaker in its price class. Equipped with two "high concentration" Alnico 5 magnets and a high frequency diffuser. The 12" section delivers the bass while the inner 3" tweeter speaker section delivers the treble tones. Together they give you "living tone." This speaker is unconditionally guaranteed to satisfy even the most critical user or Olson promises to refund your money. Only two wires to connect to any radio or amplifier. Voice coil impedance 8 ohms. Frequency response 50 to 17,500 cps. Shpg. wt. 10 lbs.



FAMOUS 3-SPEED AUTOMATIC RECORD CHANGER

Completely automatic—one of the most famous brands in changers. Every one in original factory packing. 100% guaranteed to please or money back. It's one of Olson's most sensational bargains. The changer has a reject lever and a control for selecting 33 1/3, 45 or 78 RPM speeds. Plays 7", 10" and 12" records. Equipped with a crystal cartridge and a long-life needle. Records drop gently and smoothly—just like velvet. Operates on 115 volts, 60 cycles AC. Base 12x 12 1/2". 5 1/4" above plate and 3 1/2" below. Shpg. wt. 15 lbs. Limited quantity. When these are gone—no more.

Stock No. RA-69 **\$19.99**

USE HANDY ORDER BLANK—2nd PAGE TO RIGHT ▶



OLSON RADIO WAREHOUSE • 275 E. Market St., Akron 8, Ohio

OLSON TV BARGAINS

STANDARD COIL TV BOOSTER

★ Latest Model ★ Brand New
★ Reg. List Price \$30.00
★ While they last. Model B-51

\$10.95 Ea.

Just connect one of these Standard TV Boosters to your receiver and get brighter, snappier pictures and less "snow" and interference. Easy to attach. Works on all TV sets. An amazing coil—you can cash in—save money—Own Today. Tunes all 12 channels. Uses a 6AK5 tube and a selenium rectifier. Complete. Operates on 115 V. A.C. Shpg. wt. 6 lbs.



Stock No. B-51

14,000 VOLT FLYBACK AND 70° YOKE

OLSON COMBINATION DEAL!

Now change over small picture TV sets to large kinescopes for very little money. Here Olson offers you the two main parts for less than you normally pay for one. You get a high efficiency 14,000 volt Ferrite horizontal flyback transformer like the General Electric RTO-085 (77J1) and you get one 70° yoke. This combination can be used to convert sets to use picture tubes up to 19" and larger. Buy several of these kits now. No more when these are gone. Shpg. wt. 3 lbs.

Stock No. X-273

\$4.88 BOTH FOR



COMPLETE TV ANTENNA

Stock No. AU-23

\$9.99 Complete Set

A complete snacked array. Made by a famous manufacturer whose name and name is on every factory sealed carton. Look what you get: 3 Six-element conical rays, 1 pair "Q" bars, 2 Five-foot mast sections, 50 ft. 300 ohm twin line, 5 Standoff insulators, 1 mounting base, 1 size ring, clamp, hardware. Elements are highest quality aluminum. Reg. list price is \$31.00. Shpg. wt. 15 lbs. Express only.



NEW JFD INDOOR ANTENNA

This antenna is one of Olson's real buys. Ideal for city dwellers, apartment residents and those living within 25 miles of stations. Adjustable 3-section dipoles, telescope out. COMPLETELY TIP-PROOF! Solid weighted base insures no-tipping, no matter how dipoles are oriented or spread. Felt bottom keeps furniture unscratched. In perfect condition. Mahogany finish blends with all interior designs. Priced by Olson for you. Shpg. wt. 4 lbs.

Stock No. TA-158

\$1.49



OPEN WIRE TV LINE ★ Use in Place of 300 Ohm Line

Ideal for fringe area installations. Not affected by moisture or sun. Made of 2 18 copperweld wire with genuine polystyrene insulators spaced 8" apart. Tensile strength 400 lbs.

Stock No. W-78

100 ft. coll. **\$4.66**
Shpg. wt. 4 lbs.

Stock No. W-79

250 ft. coll. **\$10.95**
Shpg. wt. 9 lbs.



STOP IGNITION NOISE WITH THIS TV FILTER!

Did you miss the punch line or the important action on your favorite TV program because of interference? Get rid of bus, truck, auto, etc. ignition interference which cause picture streaks and distracting noise. Simply connect filter across antenna lead-in terminals at back of any set. Noise and streaks vanish like magic. Shpg. wt. 1 lb.

Stock No. X-267

\$1.20



300 OHM TWIN LINE LEAD-IN with FREE INSULATORS

AVAILABLE IN 3 LENGTHS

100 Ft. SPOOL	500 Ft. SPOOL	1000 Ft. SPOOL
Lots of 10... \$1.99 EACH	Lots of 2... \$6.75 EACH	Lots of 2... \$12.50 EACH
Single, ea. \$5.99	Single, ea. \$6.95	Single, ea. \$12.95
Stock No. W-73	Stock No. W-102	Stock No. W-99
Shpg. wt. ea. 2 lbs.	Shpg. wt. ea. 6 lbs.	Shpg. wt. ea. 12 lbs.

With new TV stations near completion and more in the offing since the lifting of the ban on TV construction—now is the time to stock up on lead-in wire. Our purchase price was low and we're passing the savings on to you. This genuine low-loss polyethylene twin line is the heavy type with stranded copper conductors. Weather-resistant for all TV sets. AND YOU GET FREE—WITHOUT CHARGE—a box of 50 JFD 3" screw-eye insulators for 300 ohm line with every 500 ft. you order. Get 2 boxes with 1000 ft. etc. Regular retail price is \$9.00 per 100 insulators.



QUALITY

SERVICE

HOW MANY OF THESE BARGAINS DO YOU NEED?

FAIRCHILD GRINDER

Stock No. FL-3

\$9.98

Every service shop needs one of these handy tools made by Fairchild, a famous manufacturer of precision electric grinders. Regular nationally advertised price is \$19.75. The set consists of 1-115 volt high speed, air cooled grinder, 6 assorted grinding wheels, 1 circular saw blade, 1 hardened steel reamer, 1 buffing brush, 1 abrasion stone and a natural finish wood case size 10"x5"x3" to house the grinder. Shipped in original factory sealed cartons.



GIANT CONDENSER KIT

— 69 PIECES — 4-DRAWER CHEST

FREE OF EXTRA COST

Olson's Price **\$16.95**

You get \$51.60 list worth of "Akkrad" Condensers Plus the 4 drawer steel cabinet FREE. size 10 1/2" x 11 1/2". Shpg. wt. 11 lbs.

Also 27 "AKRAD" Electrolytic Condensers

Qty.	Cap.	Volts	List ea.	Total
2	.001	600	\$25	\$50
2	.002	600	25	50
2	.005	600	25	50
5	.01	600	30	150
5	.02	600	30	150
10	.05	600	40	400
10	.1	600	45	450
2	.005	1600	55	110
2	.008	1600	55	110
2	.01	1600	60	120

69 Value..... \$51.60



CONVERT 6V DC to 110V AC

Now you can have all the advantages of a 110V AC power supply IN YOUR OWN CAR! Converts 6V DC to 110V AC 60 cycle with capacity to 43-50 watts. Fully filtered. Just plug in cigar lighter and operate portable phonos, radios, dictating machines, lights, electric shavers, etc. Only slightly larger than cigarette pack! Ideal for picnics, camping, summer traveling pleasure. Shpg. wt. 3 lbs.

Stock No. RA-104

\$10.93



LOOP KIT

KIT OF 6 LOOPS

Stock No. AS-56

\$1.00

Get this big assortment of 6 loops for just \$1.00. Any one loop is worth the price you pay for the whole kit. Shpg. wt. 2 lbs.



42 "AKRAD" By-Pass Condensers

Qty.	Cap.	Volts	List ea.	Total
2	.001	600	\$25	\$50
2	.002	600	25	50
2	.005	600	25	50
5	.01	600	30	150
5	.02	600	30	150
10	.05	600	40	400
10	.1	600	45	450
2	.005	1600	55	110
2	.008	1600	55	110
2	.01	1600	60	120

Also 27 "AKRAD" Electrolytic Condensers

Qty.	Cap.	Volts	List ea.	Total
2	10	25	\$1.00	\$2.00
2	25	25	1.00	2.00
5	20	150	1.20	6.00
5	40	150	1.35	6.75
4	20	150	1.65	6.60
5	8	450	25	6.25
4	16	450	1.40	5.60

69 Value..... \$51.60

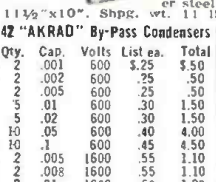

INSULATED RESISTOR KIT

Olson's Special Price

Stock No. AS-32

\$2.99

Contains a carefully selected assortment of 100 insulated resistors. Standard RMA color code. Included are 70-1/2 watt, 20-1 watt and 10-2 watt resistors. Handsomely packed in a durable pillbox bag. Regular list price \$15.80. Shpg. wt. 3 lbs.



BUILD A VIBRATOR POWER SUPPLY

Stock No. X-272

\$1.49

Get 150 volts DC from any 6 volt storage battery. Use it to furnish "B" power for portable radios, aircraft and marine receivers. No tube needed. In this kit you get: 1 Mallory Type 45 Sine Vibrator, 1 Power Transformer, The Mallory vibrator has a standard 5 prong socket and the can measures 1 1/2" x 3 1/2". This is the same as Mallory number 245, 1 1/2" x 3 1/2". The transformer is fully shielded and measures 1 1/4" x 1 1/4" x 2". The genuine Mallory vibrator alone lists at \$7.70 and the transformer at \$3.00. Shpg. wt. 3 lbs.

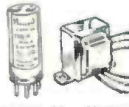

6 x 9" HEAVY DUTY PM SPEAKER

GENUINE OXFORD

Super Alnico 5 Magnet (6.64 oz.), the same size as you'll find in 12" Speakers. Delivers terrific volume. For all Auto sets. Extension Speakers. Public Address, etc. Police Coil 3.2 ohms. Shpg. wt. 6 lbs.

Stock No. S-170

WHILE THEY LAST

\$2.99

Single, Ea. \$3.39

Lots of 10, Ea.



SCREW-EYE INSULATORS

This is a real buy. You won't find better quality or a lower price anywhere. We cannot continue this offer much longer—so stock up now—before jobber's cost. Insulators are JFD Quality. Polyethylene insert for 300 ohm line. Shpg. wt. 4 lbs.

Stock No. X-285

Box of 50.

\$1.19 ONLY



807 TUBES

A chance to stock up. Popular Power Tube. Stock No. X-288. each \$1.49

USE HANDY ORDER BLANK ON NEXT PAGE →

OLSON RADIO WAREHOUSE • 275 E. Market St., Akron 8, Ohio

GET YOUR MONEY'S WORTH from OLSON RADIO WAREHOUSE

FAMOUS MAKE CUSTOM-MADE AUTO RADIOS

CHECK THESE FEATURES

- ✓ Priced Low—They sell Fast.
- ✓ Every set is 6 tubes—3 gang.
- ✓ No cables, no brackets, no holes to drill. Installs in 3 to 4 minutes.
- ✓ Custom-Built, especially designed for the individual Auto.

\$41.97
CHOICE OF ANY MODEL

OUTSTANDING BARGAIN

ORDER AUTO SETS FROM THIS LIST

Stk. No.	Make of Car	Year Model	Price
RA-300	Chevrolet	1949-1950	\$41.97
RA-351	Chevrolet	1951-52	41.97
RA-200	Dodge	1949-1950	41.97
RA-251	Dodge	1951-52	41.97
RA-100	Ford	1949-1950	41.97
RA-151	Ford	1951	41.97
RA-152	Ford	1952	41.97
RA-451	Hudson	'48-49-50-51-52	41.97
RA-751	Henry J.	1951-52	41.97
RA-200	Plymouth	1949-1950	41.97
RA-651	Plymouth	1951-52	41.97
RA-551	Studebaker	1950-1951-1952	41.97

Superhetrodyne. Six tubes including rectifier. Six volt storage battery operation. Two dual purpose tubes. Eight tube performance. Simple one or two unit construction depending upon the car. Three gang tuning condenser and tuned R.F. stage for extreme sensitivity. Automatic volume control. Permanent magnet, dynamic speaker with powerful Alnico 5 magnet. Easy vision slide-rule dial. Low battery drain. Beautiful hammer-tone finish. Shpg. wt. 12 lbs.

FREE! Famous manufacturer's triple-chrome-plated auto antenna given **FREE OF CHARGE** with each auto set ordered during this special sale.

MANUFACTURER'S CLOSEOUT! MAJESTIC 8 TUBE AM-FM RADIO CHASSIS

DIV. OF WILCOX-GAY
1952 MODEL Complete: Tubes, Loop Antenna, Escutcheon, Knobs, etc.

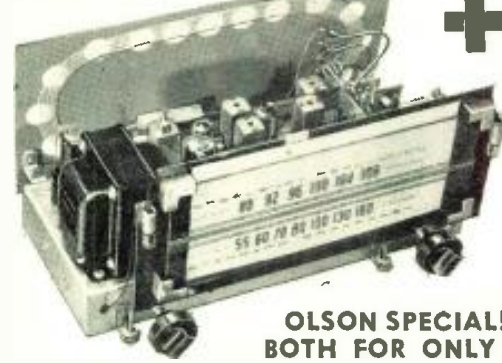

REG. \$110.00
COMPLETE WITH 12" CO-AXIAL SPEAKER

OLSON SPECIAL! BOTH FOR ONLY

\$49.95

STOCK NO. RA-5268

This is one of the biggest deals we've ever offered. So big most buyers couldn't come up with the cash. Olson completed the deal and is passing this terrific bargain on to you. Naturally when our present stock is gone, we can't duplicate this offer. Olson never gave you a greater value. Order your outfit today. Speaker is guaranteed to outperform any speaker in its price class. Equipped with two "High Concentration" Alnico 5 magnets and a high frequency diffuser. 12" section delivers bass, inner 3" tweeter section delivers treble tones, giving you "living tone." 8 ohm impedance. Radio is not a kit or a tuner. It's a real high-powered AM-FM Radio Chassis that will pull in distant stations with amazing volume and brilliance of tone. Makes a perfect custom installation in existing cabinets, book-cases, walls, etc. Servicemen and Experimenters: Make money installing these for friends and customers. The circuit is modern and employs 8 tubes (12AT7, 6BE6, 2-6BA5, 6AL5, 6AV6, 6V6 and 5Y3). The entire R. F. assembly and the 4-section tuning condenser are rubber mounted. Tuned R. F. stage plus two I. F. stages give this set terrific FM sensitivity. Separate FM oscillator tube for extreme stability, and triode R. F. and mixer circuits plus radio detector assure noise free, high fidelity FM reception. Two modern dual knobs control on-off, volume and tone plus AM-FM, phone switch. Equipped with two panel lamps and edge lit dial. Phone input socket and AC receptacle at rear of chassis. Chassis size 13" wide, 7 1/2" deep, 7 1/4" high. Cut out in cabinet requires 8x3 1/4". Output impedance 8 ohms operates on 110-125v AC, 60 cycles. Shpg. wt. 20 lbs. In factory sealed cartons.

COMBINATION DEAL!

10 WATT HI-FI PUSH-PULL AMPLIFIER COMPLETE WITH 12" CO-AXIAL SPEAKER



BOTH FOR ONLY \$39.95 COMPLETELY WIRED NOT A KIT WITH TUBES

STOCK NO. AS-67

Order this matched outfit today. You get the 10-Watt Hi-Fi Amplifier PLUS the 12" Co-Axial Speaker both as described below. Can be built into any cabinet or bookcase—giving you a complete Amplifier System of which you can be proud. Shpg. wt. 25 lbs.

Amplifier is completely assembled and ready to play. Built-in PRE-AMP for G.F. and similar types of magnetic pickups. 3 inputs: 1 crystal phono, 1 magnetic phono, 1 radio. 1 mike. 3 Controls: 1 Bass, 1 Treble, 1 Volume, 1 Phone-radio Switch. Output impedances: 4, 8, 16 ohms. Peak power output 17 watts. Order this amplifier today and see what brilliant, realistic tone it will deliver. Supply is limited. Every one in factory-sealed cartons. You couldn't buy the parts alone for this price. Remember this is a full size amplifier, transformer operated, not an AC-DC job. Frequency response 20 to 20,000 cps at less than 1% of 1% distortion. 5 Tubes: 1-6SL7, 1-6X7, 2-6V6, 1-5Y3. Complete with tubes. Size 12" x 6 1/2" x 5 1/2".

Speaker in our new 1952 Co-axial Model. Guaranteed to outperform any speaker in its price class. Equipped with two "high concentration" Alnico 5 magnets and a high frequency diffuser. The 12" section delivers the bass while the inner 3" tweeter speaker section delivers the treble tones. Together they give you "living tone." This speaker is unconditionally guaranteed to satisfy even the most critical user or Olson promises to refund your money. Only two wires to connect to amplifier. Voice coil impedance 8 ohms. Frequency response 30 to 17,500 cps.

HOWARD W. SAMS PHOTOFAC TV COURSE

FREE! Thousands sold at \$3.00. Olson gives you a copy free of charge. Bound in book form. 215 big pages 8 1/2" x 11", crammed with valuable data and diagrams. Gives a complete understanding of TV operation and principles. Look at some of these chapter titles: Deflection Systems, Power Supplies, Inter-carrier Systems, Video Amplifiers, 18 Chapters in all.

HOW TO GET COURSE FREE. Just make out an order totaling \$20 or more from these Olson Ads using Order Blank below. We'll ship your order instantly and include the Big TV Course Book FREE OF CHARGE. One Book to a customer.

IT'S EASY TO ORDER FROM OLSON'S

How to order: Order directly from this ad. For convenience use this order blank. Fill in columns below with quantity desired, stock number, description and price. You may send remittance with order (include enough for postage or parcel post shipment), or if you prefer SEND NO MONEY. Olson will ship C.O.D. and you may pay mail or expressman for merchandise and postage.

MONEY BACK GUARANTEE:
Everything you order from Olson is guaranteed as advertised. If you are not more than satisfied, you may return merchandise for cash refund.

MAIL TO: OLSON RADIO WAREHOUSE
WE SHIP SAME DAY WE GET YOUR ORDER

Please Minimum Order \$3.00

MICROPHONE CABLE

50' COIL Stock No. W-74 \$2.95
100' COIL Stock No. W-105 \$4.50

Single tinned stranded conductor. Low loss insulation. Braided copper shield covered with smooth plastic. For all types of mikes.

GRILLE CLOTH

Stock No. X-286 69c Size 27x18"
X-287 99c Size 27x36"

The most beautiful grille cloth you ever saw. Rich brown with interwoven gold thread. Made for Magnavox's finest sales. Available in 2 sizes from Olson at a fraction of the regular price.

BUILD A RECEIVER SET OF BASIC COMPONENTS

Stock No. AS-38 \$1.89 Kit of 5 Parts
You get this kit of 5 basic parts to build an AC-DC set or portable:
Parts Reg. List Price
Loop Oscillator Coil .50
R. F. Coil .10
I.F. Transformer .10
450 KC Input .10
Output .50
Oscillator Coil .75
List Price of Set 6.00
Use any 305 mfd variable for tuning. Covers 535-1625 KC.

CLEVELAND, OHIO

2020 Euclid Ave.
If you live in or near Cleveland visit our store, get these and many more bargains.

CHICAGO, ILLINOIS

623 W. Randolph Street
If you live in or near Chicago visit our store, get these and many more bargains.

OLSON HAS OVER 150,000 SATISFIED CUSTOMERS

OLSON RADIO WAREHOUSE • 275 E. Market St., Akron 8, Ohio

COMMAND TRANSMITTERS Complete with Tubes & Crystals

BC-457 Transmitter—4 to 5.3 MC.—Used	8.95
BC-458 Transmitter—5.3 to 7 MC.—Used	7.95
BC-459 Transmitter—7 to 9 MC.—NEW	22.95
T-20/AIC-5 Transmitter—4 to 5.3 MC. NEW	12.95
BC-456 Modulator. NEW	5.95
Transmitter Rack—Single	5.15
Rec. Rack—Dual	5.15
Rec. Dyn.—Used	5.25

POWER SUPPLIES:

VIBRATOR TYPE—6 Volt DC input; output 230 Volt DC 50 MA.—not filtered—w/Tube. Ideal for Command Receiver operation as receiver is filtered internally. Size: 4 1/2" x 4 1/2" x 3 1/2"	5.45
PE-157 POWER SUPPLY—2 Volt Vibrator Supply. Operates from BB-54 2 Volt Battery mounted in Case. Output voltage 1.4 V. 1/2 Amp 125 V. 50 MA. Less Battery, Speaker, & External Power Cord—with Vibrator	5.45
BB-54 2 Volt Dry Battery	2.95

JUST WHAT YOU NEED . . .

Standard Test Leads, 4"x1 1/2" Prods. Pair	39c
Phone Plug—Nickel Plated. Screw Terminals	39c
Instrument Knobs—Bar. Octagon. Round. Set Screw. Skirts. Ass't.	10¢
Line Cord—Bro. Rubber 7 ft. Molded Rubber Plug	29c
Line Cord—Black Rubber 6 ft. Angle Molded Plug	39c

TRANSFORMERS AND CHOKES

TRANSFORMERS—110 V. 60 CYCLE PRIMARIES:	
600-0-600 V. 200 MA.—6.3 V. 3 A.; 6.3 V. 4 A.; 5 V. 3 A.—3 1/2" x 4 1/2" Stancor. No. P-6170	56.95
325-0-325 V. 50 MA.—6.3 V. 2.5 A.; 6.3 V. 6 A (Rect. 6x3) Half Shell—2 1/2" x 3 3/4" x 3"—No. T-23-28	2.75
6.3 V. 1 Amp.	1.25
24 V. 1/2 Amp.	1.50
24 V. 6.5 Amp.	5.95
6—24—or 30 Volt 8 Amp.	5.95
Two 12 V. 4 A. windings, gives 12 V. 8 A. or 24 V. 4 A.	5.95
6.3 Volt 6 Amp.—6.3 Volt 4 Amp.	2.25
440 VCT/70 MA.—5 V. 2 A.—6.3 V. 4 A.	3.35
700 VCT/200 MA.—6.3 V. 4 A.—6.3 V. 4 A.—5 V. 3 A.	4.95
700 VCT/120 MA.—5 V. 3 A.; 6.3 V. 4 A.; 32 V. 2 A.	4.75
490 VCT/60 MA.—5 V. 2 A.; 6.3 V. 4 A.; 6.3 V. 2 A.	3.25
460 VCT/90 MA.—5 V. 3 A.; 6.3 V. 4 A.	3.75

CHOKES:

5 Henries—150 MA., 85 ohms DC—Res. Cased	5.95
8 Henries—40 MA., 80 ohms, 5000 V. Ins.	8.95
7.5 Henries—400 MA., 60 ohms, 5000 V. Ins.	6.95
6.2 Henries—300 MA., 82 ohms, 5000 V. Ins.	4.95
15 Henries—300 MA., 260 ohms	4.75
5-20 Henries—300 MA., 110 ohms, 1000 V. Ins.	3.95

DYNAMOTORS:

DYNAMOTOR and BLOWER: 9 Volts DC input; output 450 Volts 60 MA. 4500 RPM. At 6 Volts DC input; output 260 Volts 65 MA. 3000 RPM.	5.95
--	------

PE-101C DYNAMOTOR. . . . NEW \$3.95

INPUT:	OUTPUT:	STOCK No.:	PRICE:
14 V. DC	600 V. 300 MA.	BD-86	59.95
12 V. DC	220 V. 70 MA.	DM-24	6.95
12 V. DC	220 V. 100 MA.	DM-18	4.95
14 V. DC	375 V. 150 MA.	DM-375	8.95
14 V. DC	330 V. 135 MA.	DM-330	7.95
14 V. DC	500 V. 500 MA.	PE-50	14.95
12 or 24 V. DC	275 V. 110 MA.	USA/0516	3.95
12 V. DC	250 V. 50 MA.	DM-25	8.95
28 V. DC	250 V. 60 MA.	DM-32	2.95
		(Used)	2.95
12 or 24 V. DC	500 V. 50 MA.	USA/0515	3.95
12 or 24 V. DC	410 V. 200 MA.		
	225 V. 100 MA.	D-104	14.95
28 V. DC	250 V. 60 MA.	PE-86	5.95

Address Dept. RN • Minimum Order \$5.00 • Prices F.O.B., Lima, O. • 25% Deposit on C.O.D. Orders

FAIR RADIO SALES

132 SOUTH MAIN ST.
LIMA, OHIO

PORTER SALES FEATURE

Famous 2" Sq. Weston Sangamo
PANEL METERS



0-20v DC
0-40v DC
0-100 MA (0-300 SCALE)

LARGE QUANTITIES AVAILABLE

\$2.69

Any Type were \$3.95

WRITE TUBE REQUIREMENTS

MONEY BACK GUARANTEE!

PORTER RADIO SALES CO.
132 Nassau Street, New York 38, N. Y.

BLOWERS—115 VAC 60 CYCLE



SINGLE TYPE: (Illustrated at left) 100 CFM. 2 1/2" intake; 2" outlet. Complete size: 5" x 6". Order No. RN-520	\$7.99
DUAL TYPE: 100 CFM. 4" intake; 2" Dis. Each Side. Complete Size: 8" x 6". Order No. RN-800	\$12.95
COMPACT TYPE: 108 CFM. Motor built inside squirrel cage. 4 1/2" intake; 3 3/4" x 3" Dis. Complete size: 4 1/2" W x 8 3/4" H x 8 3/4" D. Order No. RN-860	\$13.50
FLANGE TYPE: 140 CFM. 3 1/2" intake; 2 1/2" Dis. Complete size: 7 1/2" W x 7 1/4" H x 6 3/4" D. Order No. RN-865	\$12.95
FLANGE TWIN: 275 CFM. 4 1/2" intake; 3 1/2" x 3" Dis. Complete size: 11 1/4" W x 8 3/4" H x 8-1/16" D. Order No. RN-134	\$20.95

AIRCRAFT CONTROL CABLE

3/32"—7x14 Strand. Weatherproofed, Galvanized, 920 lb. Test. Ideal for Television Guying and many other uses. Prices: 3¢ per Ft.—1000 Ft. or more @ 3¢ per Ft.

CORDS—CABLES

CD-501 Cord f/GN-45 Generator	\$2.50
CD-318 Cord w/PL-68 & SW-141 & JK-48F	.89
CD-307 Cord—6.5 Ft. w/PL-55 & JK-26	.89
CD-604 Cord w/C-410 Trans. & PL-54 Plug	.89
CD-365 Cord for LP-21 Loop	1.50
MC-215 Tuning Shaft for 274N.	2.00

ANTENNA EQUIPMENT

MAST BASES—INSULATED:



MP-132 BASE—Illustrated at left—1" heavy coil spring, 7" insulator. Overall length: 11 1/2". Weight: 2 3/4 lbs. Price	\$3.95
MP-48 BASE—Insulated type with heavy coil spring. Requires 1 1/2" mounting hole. Weight: 1 1/2 lbs.	\$4.95
MP-57 BASE—Insulated type with heavy coil spring and 5" dia. insulator. Requires 1 1/2" hole for mounting. Weight: 9 lbs. Price	\$5.95

MAST SECTIONS FOR ABOVE BASES

Tubular steel, copper coated, painted, in 3 ft. sections, screw-in type. MS-53 can be used to make any length with MS-52-51-50-49 for taper. Any section 50¢ Each
Larger Diameter Sections: MS-55-54. \$1.25 Each

AERIAL WIRE—Phosphorus Bronze #16 Stranded. 200 lb. test. Weatherproof. 150 Ft. on Beel. RL-3 w/Clips	\$1.50
Telephone Wire—3 Cond. copper & steel. 525 Ft. 4.75	

AMPLIFIERS

BC-367—Uses two 6V6GT Tubes. Carbon Mic. Input. Tapped output. Ideal for intercom. With Tubes & Schematics. Less Dyn. and Case—Used	\$4.95
BC-605—With Tubes. Used	3.95
BC-709—W/Tubes—New	\$4.95
BC-347—Less Tubes—New	\$2.95

BC-223 TRANSMITTER—With Tubes & TU-17 Tuning Unit	Used \$26.50
CABLE—Transmitter to Power Supply	\$2.00
TUNING UNITS—TU-17—2000-3000 KC. TU-25—3500-5250 KC.	\$4.95 EACH
PE-125-AX POWER SUPPLY f/BC-223—12/24 Volt input; output 500 Volt 150 MA.	NEW: \$20.95
OPERATING MANUAL for BC-223AX	2.50
SHOCK MOUNTING for PE-125	1.50
FT-173 MOUNTING for BC-223	2.50

85 KC f/ COIL—7267—for BC-453	\$1.50
BFO—85 KC.—.75¢ 1415 KC.—IF.	1.50 Ea.
TU-7-8-9-10-26 for BC-191/BC-375	Used: 3.95

Mac's Service Shop (Continued from page 68)

case. The transformers used in the i.f. stages are usually not the most expensive, and they are subjected to very high temperatures inside the small cabinets. The alternate heating and cooling tends to change the resonant frequencies of the windings. I kept a record of all the a.c.-d.c. sets serviced for a week one time, and I found that in nine cases out of ten I could effect at least a 20% increase in output measured across the voice coil simply by realigning the i.f.'s. While you are adjusting the transformers, notice how sharply they resonate. Of course, the winding across the diode load will tune broader than the others; but the remaining three should peak up quite sharply and definitely. If they do not, something is wrong. A weak i.f. tube, shorted turns in one of the windings, a high resistance in the winding, or a defective trimmer condenser may be at fault.

"If the set oscillates when you try to bring it into alignment, that is another headache; but never say to yourself 'I guess it was just made that way' and solve the problem by throwing it out of alignment until it stops oscillating. Look for open plate or screen bypasses. See if the output section of the filter condenser—which doubles in brass as a plate bypass in many of the inexpensive sets—has not deteriorated. Change the i.f. tube. Check the a.v.c. bypass condensers. Make sure the plate and grid leads are dressed away from each other. See to it that the metal shell of the i.f. tube is properly grounded through the socket connection. If none of these causes is present, try changing the i.f. transformer. Often the heat causes the top i.f. winding to slide down toward the bottom winding and cause over-coupling."

"Hold up, now! Changing an i.f. is quite a little job just to see if it could be the trouble."

"Not the way I do it. Simply cut loose the leads from the transformer to the plate and to the grid or diode. Then tack the connections from the replacement transformer to these points and also to "B-plus" and to the a.v.c. bus with the soldering iron. Then use a short clipped lead to ground the shield can to the chassis. This outboard transformer can then be brought into alignment, and it can be quickly seen if the trouble is corrected. If so, the transformer can be installed permanently; if not, the leads of the transformer in the set can be reconnected in a matter of seconds."

"Say," Barney broke in, "when you're aligning the front end of a set and you can't make the oscillator track both with the dial and the r.f. stage, which one should you choose?"

"Well, if a choice has to be made, I'd say make it track with the r.f. stage, for that would give you the

PEN-OSCIL-LITE

Extremely convenient test oscillator for all radio servicing; alignment • Small as a pen • Self powered • Range from 700 cycles audio to over 600 megacycles u.h.f. • Output from zero to 125 v. • Low in cost • Used by Signal Corps • Write for information.

GENERAL TEST EQUIPMENT
38 Argyle Buffalo 22, N. Y.

K I T S	RADIOS 1, 2 & 3 band Electric and/or battery	K I T S
	TELEVISION AC/DC Operation	
	TEST INSTRUMENTS Write for FREE Catalog	
	ARKAY—Radio Kits, Inc. 120 Cedar St., New York 6, N. Y.	

AIREX 630FA*

ONLY at AIREX—THE FINEST, MOST POWERFUL TV CHASSIS MADE

TUBE MTG. BRACKETS—\$6.50

THE CHASSIS TELEVISION ENGINEERS AND SERVICEMEN ARE BUYING FOR THEMSELVES

This amazingly advanced 32 tube TV chassis is years ahead in engineering and gives you the ultimate in TV viewing and listening pleasure. To assure you trouble free TV our engineering staff has incorporated into the "630 FA" design the experiences of hundreds of TV servicemen and engineers. Receiving range includes stations up to 200 miles away. Nothing has been spared to bring you the finest of TV chassis. Only the best and most expensive parts are used. There is no other chassis that compares with the "630 FA" * for fringe area reception.

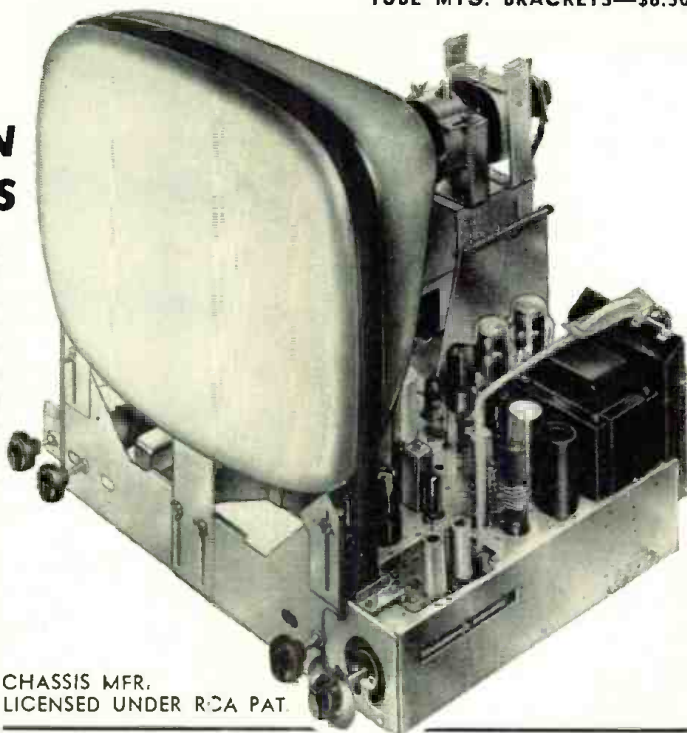

CHASSIS MFR. LICENSED UNDER RCA PAT.

\$164⁹⁵

Less CR Tube

Complete with 12" ROLA Hi-Fi Speaker (Fed. tax incl.)

AND FREE SERVICE MANUAL

✓ CHECK THESE EXCLUSIVE FEATURES ✓

- 10 WATT push-pull audio output. Frequency range from 60 to 12,000 cycles • Link coupled Standard Coil Cascode Tuner prevents radiation • Retrace Blanking Circuit allows you to raise the brightness without the annoying vertical retrace lines
- Heavy duty front focus control • Automatic gain control potentiometer allows you to adjust the threshold sensitivity as low as 4 microvolts & still keep the full 4MC band width • Separate high & low frequency sync amplifiers • Set aligned for 21.75 MC. New Ham band will not interfere • Improved fused high voltage power supply gives full 14.5 KV under load • Will handle all picture tubes up to 24 inch with full sweep • Improved video amplifier has a gain of 32 • All moulded plastic condensers give long life & trouble-free operation • New TIOGA

- tube. Thermal delay allows filaments & parts to warm up before B+ is applied—preventing parts & small tubes from breaking down because of surge voltage. Protects cathode emission of picture tubes & gives longer tube life • Easily adapted to new UHF stations in 2 minutes by just changing a strip in the tuner • Extra heavy duty power transformer with large safety factor • 6CB6 tubes in Video IF to give full gain • Extra filtering in power supply for hum & ripple free operation • Color connection on chassis which is adaptable to the cathode follower circuit of color converter • Phono Connection & switch on chassis allows you to play your phonograph or tuner through the built-in 10 watt hi-fidelity amplifier • Extra heavy duty focus coil, which runs cool • Tuner can be removed up to 25 feet • Full focus cosine yoke.

SUPER 630-DX TV CHASSIS...

30 TUBES
STANDARD COIL
CASCODE TUNER

\$149⁹⁵

Fed. Tax Incl.

INCLUDES 12 INCH RCA HI-FI SPEAKER AND FREE SERVICE MANUAL

SENSATIONAL SPECIAL OFFER OF THE AIREX SUPER DX COMPLETE TV SETS . . . THE FINEST SET VALUE IN ITS PRICE CLASS

These outstanding sets were specially designed to meet our rigid specifications to assure you many pleasant hours of trouble free TV at an unequalled price. The mfr. is licensed by RCA. RMA guarantee. All you have to do is plug in and play.



Complete Service Manual For "630FA" or Super 630DX—S1
SEND FOR FREE NEW TV PARTS & HI-FI AUDIO EQUIPT. CATALOG

Includes These Features

- Has standard coil Cascode tuner that brings in reception up to 200 miles • 20 tubes • Large HI-FI speaker • Hand rubbed, satin finished genuine mahogany cabinet • AGC • Moulded plastic condensers • Black, glareless picture tube, guaranteed for 6 months • Adaptable for UHF and color • Synchronized FM audio system • 5 hour heat run at factory • Factory wired, aligned and tested • Mounted in cabinet.

17"—\$174.95
20"—\$199.95



17"—\$154.95
20"—\$179.95

TV TUBE EXTRA STANDARD BRANDS FACTORY NEW

1ST QUALITY—GUAR. 1 YEAR

10BP4 . . . \$17.95	17BP4 . . . \$27.95
12LP4A . . . 21.95	19AP4B° . . . 34.95
16GP4° . . . 24.95	20" TV Tube 34.95
16JP4° . . . 24.95	21" TV Tube 39.95
16HP4 . . . 24.95	24" TV Tube 64.95

Ring and Sleeve for 24" Tube . . . \$7.50

°Guaranteed for 6 months only

TV GOLD PLASTIC MASKS

16" & 17", \$4.95; 20" & 21", \$7.95; 24", \$14.95

38 BARGAIN-PRICED CABINETS FOR THE "630" & OTHER CHASSIS

Send for FREE folder and price list. Full line table models, consoles, consolettes and TV-Radio Phono combinations. Many styles. Mahogany, blonde, etc.

SEND POSTCARD TO BE PUT ON FREE MAILING LIST

All merchandise is brand new, factory fresh & fully guaranteed. Mail & phone orders filled upon receipt of certified check or money order for \$25 as deposit on TV chassis, 20% on other items. Balance C.O.D., F.O.B. N. Y. Prices subject to change without notice. No Fed. Taxes to pay. Prices lower than O.P.S. tags.

AIREX RADIO CORP. 171 Washington St., N. Y. C. 7, N. Y.
Phone WOrth 2-4029



FOR ELECTRONIC COMPONENTS

We offer immediate delivery from our vast stock of more than 25,000 items—all standard make, carefully inspected and fully guaranteed. Our prices are below market.

Always Check Wells' Stock First!

Quotations and quantities available will be given immediately upon request.

**ADEL CLAMPS
ANTENNAS**

Insulators, Most Sections

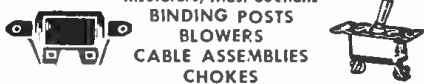

**BINDING POSTS
BLOWERS
CABLE ASSEMBLIES
CHOKES
COILS**

CONDENSERS

Oil Filled, Bathub, Hearing Aid, Transmitting Micas, Silver Micas, Ceramic, Variable, Trimmer

CRYSTALS

DYNAMOTORS & BRUSHES

FILTERS

FUSES & MOUNTINGS

GENERATORS

GROUND RODS

HEADSETS

IF COILS

JACKS

JACK BOXES

KEYS, Telegraph

KNOBS

LAMPS

LORD MOUNTS

LUGS

MOTORS & BRUSHES

PLUGS

RECTIFIERS

Selenium, Copper Oxide, Meter, Diode

RESISTORS—All Types

SELSYNS

SOCKETS

SWITCHES

Aircraft, Micro, Switchettes, Toggle

TIMERS

TUBING—Flexible

TUNING SHAFTS

TRANSFORMERS—All Types

VIBRATORS

WALKIE TALKIES

Available Now!

A complete signal corps stock number listing of items in our stock. Write for listing No. SG-200. (For government agencies and contractors only.)

Manufacturers and distributors—write for Radio-Electronics Catalog No. H 501.

Write, Wire, Phone Your Requirements

all phones: SEeley 8-4143



833 W. Chicago Ave. Dept. R Chicago 22, Ill.

best reception," Mac replied; "but usually you can shift the i.f. or bend the plates of one or the other or both sections of the tuning condenser so as to arrive at a happy condition in which the oscillator will track with both the dial markings and the r.f. stage. Don't be afraid to bend those plates. That's why they are slotted. Use the trimmers to line up the set at the high frequency end of the band and then bend the plates to do the same thing at around 600 kilocycles."

"How about sets that are just low on pep?"

"Try substituting tubes, even though the ones in the set test good. This is especially important with rectifier and mixer tubes, for a tube tester will often mislead you on these. A bad i.f. transformer is often a cause, and the best test is to substitute a new one as I mentioned awhile ago. Reversed antenna leads to a loop antenna will sometimes play hob with the sensitivity, too. Of course, when you are aligning the set, you should note if the gain from the mixer grid to the speaker is normal or not. That helps a lot in knowing where to start looking for the trouble.

"Hum is another common trouble with these little sets. Usually it is caused by weak or open filter condensers, but that is not always the case. Heater-to-cathode leakage will often produce hum, especially in the output tube because the filament at this point is considerably above ground. Changing tubes, of course, corrects it. A hum that is only heard when a station is tuned in and one that is loudest when the received signal is strongest is likely to be caused by an open line bypass condenser. It will go away if this condenser across the a.c. line is bridged with a good unit. On some sets the tuning condenser is isolated from the chassis by rubber grommets around the mounting bolts. If one of these grommets is cut through or slips out of position so that the tuning condenser can short to the chassis, you get an exceptionally loud hum. Recently a receiver of this sort gave me a hard time because it developed a hum only at certain points on the dial. The giveaway clue was the fact that while the tuning condenser was being rotated a scratching sound was heard just before the hum would start. I found the metal pointer on the end of the tuning condenser shaft was shorting to the grounded metal foil on the face of the dial at certain spots. Bending the pointer away from the foil cleared the trouble.

"While looking for strange noises, always jar the tubes lightly with that little rubber tapper we use. These miniature tubes are bad ones for developing internal shorts, and sometimes you can spot one developing by noticing a rattling sound or change in volume when the tube is tapped. Especially notice if the rectifier makes a noise when tapped. 35Z5's, 35Y4's, and the like often become noisy and should

Sensational TV BARGAINS!

AMAZING 360° ALL CHANNEL RECEPTION

with the Famous **Rocket DIRECTRONIC** MOTORLESS TV ANTENNA

- 360° Electronically Switched Beam
- No Motors
- No Roof Orientation
- No Electric Power
- No Ghosts

Flick of Switch Clears Picture Instantly

Provides same clear pictures as rotating aerials costing 4 times as much. Electronically beams in all directions with full 360° rotation. You select direction with Directronic Beam Selector located at set. Model AX-599 stacked array includes 18 hi-tensile aluminum elements. 1 set connecting stubs. Universal U-Clamps for mast. Directronic Beam Switch, and 75-foot of TRI-X lead-in. Model AX-59 Directronic-9-element Single... \$16.95

ROCKET 8 ELEMENT YAGI

Super-Powered Fringe Reception

Designed for clear pictures in ultra fringe and other areas where signal is weak. Highly directional—engineered for maximum reception on each channel. Pre-assembled for quick rig. Eight hi-tensile elements include one folded dipole, 6 directors, and 1 reflector. Less mast.

Channels 7-13	\$7.95
Channels 4, 5, or 6	\$12.95
Channels 2 or 3	\$15.95

ROCKET 5-ELEMENT YAGI

Excellent Pictures in Medium Fringe Areas

Designed for high gain with minimum interference from ghosts and noise due to directive pattern. Produces clear sharp pictures. 5 hi-tensile aluminum elements include one folded dipole, one reflector, three directors. Strong molded insulator. Non-slip mast clamp. Completely pre-assembled. Less mast.

Channels 2 or 3... ea.	\$7.95	Channels 4, 5, or 6...	\$6.95
Channels 7 to 13	\$3.95		

When ordering specify exact channel number desired.

ALL CHANNEL CONICALS

Single Bay (8 elements)..... \$3.65
Stacked array with tie rods (16 elements)..... 7.95

ROCKET 35-FOOT MAST KIT

Economy mast kit containing 3-10' seamless duct-coated 1 1/2" O.D. mast, one 5' mast, 300 feet of 6/20 galvanized steel guy wire, and everything else needed including guy links, mast connectors, insulators, cable clamps, guy hooks, and swivel mounting base. Rocket 35' mast kit..... ONLY \$12.95
Rocket 25' mast kit..... ONLY 9.95

LOWEST PRICES ON ANTENNA ACCESSORIES

Mast Steel (Ductcoated 5' crimped) 1 1/2"	\$ 1.05
O.D.	1.95
Mast Steel (Ductcoated 10' 5/8" O.D.)	1.59
Mast Connectors for 1 1/2" O.D. mast	1.19
Chimney Mount Complete with Straps	1.59
Peak Roof Saddle (will take up to 1 1/2" O.D.)	.69
Lightning Arrestor-TV	3/4c ft.
Galvanized Steel Guy Wire—6 20	1 1/2c ft.
Galvanized Steel Guy Wire—11 20	1 1/2c ft.
Rocket Twin-Lead—7/28 stranded	2c ft.
Rocket Open Line Twin-Lead (500' reel)	19.95
Mast Stand-off Insulators—3"	.11
Stand-off Screw Insulators—3"	.03
Wall Bracket 6" Clearance	1.49
12" Clearance	2.49

FREE of extra cost

With each order of \$10 or more received on or before October 31, you will receive our Rocket 7 Ft. Interlock Line Cord. Permits adjustment, testing, repair of set while operating with back removed. When ordering, state that you want this gift. Don't delay as quantities are limited. Only one given to a customer.

ALL PRICES F.O.B., CLEVELAND, OHIO. Do not remit more than complete purchase price. Pay shipping charges on receipt of goods. 25% deposit on C.O.D. orders, please. Money-back guarantee. Catalog Available upon Request

National Electronics OF CLEVELAND

THE HOUSE OF TV VALUES

110 DELCO BUILDING, CLEVELAND 3, OHIO

be replaced; otherwise, the set will make a scratching noise every time it is jarred, even by a loud sound from the speaker.

"Finally, after the set has been on for some little time, check the bias voltage on the output tube. If it is low, cut the coupling condenser loose from the grid and see if this makes any difference. If it does, the coupling condenser is doubtless leaky, but you can double-check by seeing if the end cut loose does not display a positive voltage. If the grid of the output tube remains positive with respect to ground after the coupling condenser has been disconnected, you probably have a tube afflicted with secondary emission. Try another tube and see if the condition does not disappear. If the bias is developed across a resistor in the cathode circuit, perhaps the resistor has changed value or the electrolytic bypass across it may be partially shorted. The main point is that you should not let the set leave the shop until the bias voltage of the output tube is within ten per-cent of its rated value. A set cannot sound good unless this voltage is correct."

"You know," Barney reflected, "I am beginning to think I may have been a little hasty in saying that I knew all there was to know about a.c.-d.c. sets. Two or three of those points you made kind of brought to mind things I did know once but had forgotten. Of course I *did* know about them."

"Of course," Mac agreed with an enigmatic smile.

-30-

DISTRIBUTING POWER

By D. A. DICKIE, W2VIW

MANY times, finding a suitable connector to tap off voltages from a power supply, radio, or any radio gear has presented the author with many problems.

In many cases, there is only need for three connections, ground ("B-") and one side of filament, the filament (hot with respect to ground), and "B+."

I finally licked this problem using surplus PL-68 jacks and plugs, and two-wire, rubber-covered shielded mike cable. This cable consists of two rubber covered wires which are size 20 AWG. These two wires are covered with a braided shield and a rubber jacket. The diameter of this cable is 1/4 inch. I have used this type of cable and connector with voltages as high as 450 without encountering any difficulties.

Another important factor is they are easily installed, take up very little room, and may be connected and disconnected at will without any trouble.

An example of its usefulness is in the author's mobile rig in his car. A 4-foot cable with two PL-68 plugs and jacks is used to tap the car radio and feed the necessary voltages to the converter.

-30-

Connector for tapping off various voltages.



October, 1952

There's no tower like an

Alprodco

ALUMINUM TOWER

TV • FM • AM
BROADCASTING — RECEIVING

the height of perfection

easy to install

attractive and modern

low cost ...

light weight

strong durable ...

NO PROFITS LIKE THOSE IN AN ALPRODCO TOWER! For fringe areas and other difficult locations, these cant-be-beat antenna towers get the antenna up where the signal is — and keep it up without costly follow-up maintenance for you. Get full details from your local parts distributor now.

WRITE FOR NEW LITERATURE AND OTHER INFORMATION ... ADDRESS DEPT. B.

Alprodco, Inc.

KEMPTON, INDIANA
MINERAL WELLS, TEXAS DUBLIN, GEORGIA



BUY YOUR FM-AM CHASSIS—CHANGERS—SPEAKERS AT MCGEE

ESPEY 12-TUBE FM-AM CHASSIS, \$64.50

- ★ BUILT-IN PRE-AMP FOR G.E. VARIABLE RELUCTANCE PICK-UP
- ★ WIDE RANGE AUDIO
- ★ WHY NOT ORDER WITH A COAXIAL SPEAKER AND A RECORD CHANGER? SEE OUR SPECIAL OFFERING

McGee's new 1952 model 12-tube FM-AM chassis, latest design with phono input for all types of record players, crystal or G.E. variable reluctance. Receives standard broadcast 550 to 17.0 mc and FM 88 to 108 mc. Wide range audio response (push-pull 6V6 output) and bass boost tone control. Loop antenna for broadcast and 300 ohm line type FM antenna may be stapled in cabinet. Attractive lighted slider rule dial. Chassis size, 13 1/2" x 9" high and 9" deep. Complete with tubes: 6BE6, 6BA6, 12AT7, 6SH7, 6AL5, 6SQ7, 6SQ7, 12AT7, 2-6V6GT and 5Y3GT rectifier. Shipping weight 20 lbs. Stock No. 7C-X Espey 12-tube FM-AM chassis. Sale price, \$64.50, less speaker. Output matches voice coil of our 12" or 15" coaxial speakers.

ESPEY DEAL (1), \$104.95
Espey 7-C chassis complete with 12" coaxial PM speaker CU-14Y and VM-05D G.E. 3-speed changer equipped with a G.E. turnabout variable reluctance cartridge. A better home music system than ordinarily available. Sale price \$104.95. With 15" coaxial PM speaker P15-CR instead of CU-14Y. \$10.00 extra.

ESPEY DEAL (2), \$118.95
Espey 7-C chassis complete with 12" coaxial PM speaker CU-14Y and the English Garrard 3-speed changer equipped with a G.E. variable reluctance turnabout cartridge. Our best home music system. Espey Deal #2. Sale price \$118.95. With 15" coaxial PM speaker P15-CR instead of CU-14Y. \$10.00 extra.

ESPEY DEAL (3) \$138.95
Espey 7-C chassis complete with 12" coaxial PM speaker CU-14Y (these three 12" coaxial speakers give a cone area equal to an 18" speaker) and a Garrard 3-speed changer with G.E. variable reluctance turnabout cartridge. Espey Deal #3. Sale price \$138.95.

CAPEHART CABINET, \$79.95

BLANK OR CUT TO FIT ESPEY CHASSIS

Buy this cabinet with Espey chassis and the VM changer listed above and have a fine radio-phono combination for less than the value of the cabinet alone. This beautiful cabinet was intended for Capehart's \$200.00 combination. It is the finest possible furniture quality cabinet workmanship. The cabinet is wide and 21" front to back. Hinged top lifts in two sections. 2 1/2" lid covers the changer compartment and 1 1/2" is the width of the radio compartment. Changer mounting panel is furnished blank. Radio panel is shipped ready cut to fit the 7-C Espey chassis. Baffle is cut to hold 2-12" speakers. Made of top quality walnut veneer. 7 1/2" high. Shipping weight, 160 lbs. Shipped via truck, rail or express only. Shipping wt., 160 lbs. Stock No. C-175, with panel cut to fit Espey 7-C, \$79.95. Stock No. B-175B, with blank changer and radio panel, \$79.95. Buy 12" 3C cut. Alnico FM speakers for use in this cabinet for only \$48.00 (\$7.50 each).

MCGEE'S \$62.50 LIST 15" COAXIAL SPEAKER, \$24.95

21 OZ. ALNICO V MAGNET—5" TWEETER

This is the finest 15" coaxial PM speaker value that we have ever offered. New 1952 production, of a famous manufacturer of fine speakers. The 15" speaker has a 2 1/2 oz. Alnico V magnet; equal to 16 oz. of the Alnico 2 type magnet. The cone is free floating, of one piece construction. Will reproduce low frequencies down to 20 cps. The 5" tweeter is coaxially suspended and has a ridged cone to reproduce only the high frequencies. It will respond up to 17,500 cps. The high pass filter is concealed under the pot cover, leaving only two wires to connect both the tweeter and woofer to any 8 ohm output transformer of a radio, or high impedance amplifier. Stock No. P15-CR, shipping weight 13 lbs. Net price \$24.95; 2 for \$47.95.

12" JENSEN PM, \$15.95

Another McGee Scoop! Jensen Concert 12" 14 1/2 oz. Alnico V magnet PM speaker. 8 ohm voice coil. Will take 25 watt audio. You save dollars on this speaker. Just 100 to sell. Shipping weight 8 lbs. Stock No. P-12P. Sale price \$15.95; 2 for \$30.00.

3-SPEED CHANGERS ON SALE AT MCGEE

WEBSTER CHICAGO MODEL 100-2 ONLY \$26.95

For the first time we offer the world famous Webster-Chicago model 100-2. Features a newly designed spindle, that drops the records flat; air-cushioned to the turntable. Pickup arm sets down automatically after the last record plays. Plays all records automatically. 33 1/3, 78 and 45 rpm. New balanced tone arm with Electro-Voice Tilt-A-Matic cartridge with dual needles. Ordinarily cost over \$37.00. McGee offers them for only \$26.95 each. Base size 12"x12 1/2". Shipping weight 14 lbs.

V.M. 3-SPEED MODEL 406 \$22.95

VM model 406, deluxe 3 speed automatic record changer. Plays them all. Interlocks records of the same speed. Equipped with a flip over crystal pickup with twin needles. Base size, 12 1/2"x13 1/2". Shipping weight 12 lbs. VM-406. Net price \$22.95.

TERRIFIC COMBINATION CABINET SALE

39.95 Modern design walnut combination Radio-Phono cabinet, size 32" wide, 35 1/2" high and 20" deep. Offered to you at less than it cost the large Radio-TV factory that it was made for. Upper left door swings down to open changer compartment. 14 1/2"x13 1/2" high. Changer pull-out hardware is included. Radio compartment 11 1/2"x15" high, has blank panel and hinged door. Record storage compartment is 14 1/2"x14 1/2" high. Baffle will take a 12" speaker. Polished mahogany finish with brass hardware and matching grill cloth. Stock No. A-32B, shipping weight 60 lbs. Net price, \$39.95. 12" coaxial PM speaker, \$12.95, extra, when purchased with cabinet.

CAPEHART CABINET FOR 1000 SET—ONLY \$99.95

99.95 Beautiful walnut combination radio-phono cabinet, 42" high, 42" wide and 22" deep. Made for Capehart's finest combination, selling for \$200.00. Has highly polished matched walnut panels. Made of 3/4" material. Top 1 1/2" solid stock. Cabinet weighs approximately 175 lbs. The changer, radio and speaker grill all have hinged doors. Radio compartment on right hand side is 14" high and 11 1/2" wide. Made to mount chassis vertically. Changer compartment is 14" high by 26 1/2" wide. Large enough to hold any record changer or disc recorder. Front 10" of top over the changer compartment is hinged to fold back for easy access to the changer. Both radio and changer compartments come with uncut blank panels. Speaker baffle is cut for a 12" speaker and the speaker compartment is completely enclosed. Shipping weight, 275 lbs. Stock No. K-275 Capehart combination cabinet. Net price \$99.95. SPECIFY when ordering, whether you want Walnut or Mahogany. Note: This cabinet has a very large record changer compartment. It is suggested that you obtain a selective record changer from a juke box operator and make a selective radio-phono combination.

50-WATT BOOSTER AMPLIFIER—\$39.95



25-Watt Horn \$28.95
50-Watt Booster \$39.95
2-Mike Pre-Amp \$12.95 Extra.
25-Watt Horn A sensational value, 50 watt booster amplifier with push-pull parallel 6L6 output tubes. Connect to your present amplifier as a booster or use with the PR-2X Pre-amp to add the use of 2 mikes and one low level input. The booster amplifier has one input jack and with 1 volt input gives 50 watts of audio. Booster has a 6 lb. potted case high fidelity output transformer, matches speaker with 4-8-16 ohm voice coil, also 60 ohm and 250 ohm line. Booster has a 225 mill power supply with 5U4 rectifier. Price includes tubes: 4 6L6, 7N7 and 704. The two variable controls are for master volume control and base boost tone control. Size 8 x 6 1/2 x 14 1/2. Stock No. PA-35N. Shipping weight 26 lbs. Sale price \$39.95 ea.
2-MIKE PRE-AMP Pre-amplifier plugs in directly to the PA-35N booster amplifier. It enables use of 2, Crystal or Dynamic Mikes plus one low level front cables and plugs for remote control of the 55 watt Booster Amplifier. Small chassis size 5 x 3 1/4 x 4". Stock No. PR-2X, with tubes 7F7 and 7N7. Net price \$12.95 ea.
25-WATT HORN 25-Watt Driver and 3 1/2-foot air column re-entrant Trumpet. The 100% weather-proof, horn is spun aluminum, offered to you at a considerable savings. Stock No. MA-33. Shipping weight 20 lbs. Net price \$28.95.

3-SPEED PORTABLE ELECTRIC PLAYERS

TWO NEW MODELS

\$21.95 \$18.95

\$21.50—LOTS OF 3—\$18.50

PLAYS ALL 3 SPEEDS

ALL 3 SIZES

New 1952 model 7841-X electric portable player has crystal pickup with all-purpose, 3-speed needle and brown reptile grain leatherette cover. Ship. wt. 10 lbs. Sale price, \$18.95 each, lots of 3, \$18.50 each.
Deluxe model 8522-X electric portable player has tone control and flip-over crystal cartridge with two needles for playing LP and standard records. Tan leatherette cover. Ship. wt. 11 lbs. Sale price, \$21.95 each, lots of 3, \$21.50 each.
Both models are housed in sturdy wood cases covered with durable leatherette material. They have powerful 3-tube amplifiers with full-size Alnico V dynamic speakers and volume controls. Plays all 3 speeds, 78, 45 and 33 1/3 RPM and all 3 sizes, 7", 10" and 12" records.

TERRIFIC VALUES IN SPEAKERS AND BAFFLES

8" PM AND LEATHERETTE BAFFLE, \$4.95

LOTS OF 10, \$4.75

The finest Leatherette Baffle we have ever offered. New self-supporting plastic grill material, baffle is covered tan with matching grill. Offered with a good heavy duty 8" Alnico V PM speaker with 3.2 ohm voice coil. Stock No. 818. Speaker and Baffle, lots of 10, \$4.75. Baffle only, 8", \$2.29 ea.; 10 for \$19.95.

12" PM AND WALNUT BAFFLE, \$9.95

LOTS OF 3, \$8.95

The finest built 12" Walnut plywood wall baffle we know of. Factory cost of the famous juke box manufacturer \$14.00. We offer with a 12" PM for little more. You pay only \$9.95 in single lots, or \$8.95 in 3 lots for each a 12" Quam Alnico V PM with 3.2 ohm voice coil and the beautiful wall baffle. 12" Speaker Baffle combination, Stock No. BK-12Q, \$9.95 ea.; lots of 3, \$8.95 ea. 12" Baffle only, #SEG-12C, \$4.95 each.

MIKES AND STANDS

4D-T, high impedance dynamic mike with 12 feet of cable. Sale price, \$10.95. 35" to 64" chrome floor stand for mike, \$5.85.

McGee's Super High Fidelity Best Value in U. S. A.

OUTPUT TRANS. \$7.95

Model A-403 High fidelity output transformer. Why pay \$20 or \$30 for an output, when our A-403 is available at \$7.95? Impedance, 6000 ohms plate to plate for 6L6 or 6V6, 10% feedback winding, 4-8-15-250 and 500 ohm secondary. Housed in a potted case. Net weight 8 lbs. Recommended for all amplifiers up to 34 watts.

3-STATION INTERCOM MASTER, \$14.95

USE UP TO 3-SUB STATIONS, \$4.49 EACH

A red-hot intercom master value. A full 3 tube, 110 volt AC-DC master, with 3 station selector switch and easy accessible volume control. Small compact size, 5" x 6" x 3 1/2" high. Makes an attractive intercom installation. May be used with from one to three of our G-4T substations described below. Intercom master is quiet at all outputs, except when press-to-talk switch is pressed at either the master, or one of the subs. Shipping wt. 5 lbs. Stock No. G-4T intercom station, less tubes, \$14.95. Stock No. G-4T, brown plastic substitution, with Alnico V PM speaker and press-to-talk switch. May be purchased with or without master station. Shipping weight 2 lbs. Net, \$4.49 ea. 3 wire plastic intercom cable, 100 ft. \$1.95; 500 ft. \$8.95.

38-WATT WIDE RANGE AMPLIFIER

WITH PUSH PULL PARALLEL 6L6'S—FOR USE WITH RADIO TUNER OR RECORD CHANGER

★ TWIN TONE CONTROLS FOR REMOTE OPERATION

38 watt amplifier for use with phono pickup or radio tuner. 1 volt input produces full audio output. Features: 4-6L6 tubes push-pull parallel 6L6's, 500 ohm secondary with capacity output transformer with taps at 4-8-16-60 and 250 ohms. Wide range audio response 20 to 15,000 cps. Twin electronic continuously variable bass and treble tone controls and gain control on a remote control with 3-foot cable so that the amplifier can be conveniently located. One half of the dual triode input is left unwired, so that you can add enough gain for a microphone or a G.E. variable reluctance phono pickup if desired. Chassis size 12"x18". Remote control 22 1/2"x7 1/2". Shipping weight, 30 lbs. Model No. RA-538, complete with 4-6L6, 3-6SN7, and 2-6W4GT tubes. Sale price, \$49.95.

G.I. 3-SPEED CHANGER WITH G.E. \$22.95

VARIABLE RELUCTANCE TURN-ABOUT CARTRIDGE

Another tremendous McGee Scoop! Brand new General Instrument 3-speed automatic record changers. Complete with RPX-050 G.E. variable reluctance cartridge with turn-about stylus. Plays all 3 speeds automatically. 7", 10" or 12" records. Has reject button. Repeats last record. Base size, 12"x12 1/2". Shipping weight 14 lbs. Stock No. 700-GE. Scoop price, \$22.95.

G.I. 3-speed changer same as above, but with Webster flip-over twin needle cartridge. Stock No. GI-700. Sale price, \$21.95 each.

MCGEE RADIO COMPANY Prices F.O.B. K.C. Send 25% deposit with Order, Balance Sent C.O.D. With Parcel Post Orders, Include Postage. **TELEPHONE VICTOR 9045. WRITE FOR FLYER 1422 GRAND AVE., KANSAS CITY, MISSOURI**

Let MILTON S. KIVER Help You Prepare For U.H.F.-TV And...

TELEVISION SERVICING

Easy to TRAIN AT HOME This Practical Way!

Men with the right training in Television Servicing are in big demand... pull down big pay. T.C.I. TRAINS YOU RIGHT with easy-to-follow technical training designed by servicemen, for servicemen! You learn practical, professional type Television Servicing without leaving your present job. Included are money-making extras such as set conversion, master antenna installation, U.H.F.-TV and field servicing short cuts. You can start earning Television money after the first few lessons. You learn to test, trouble shoot and repair all types of TV sets the proven, practical way!

HERE'S HOW YOU GET EXPERIENCE!

You train on your own large screen modern television receiver, furnished as part of your course. This set is yours to keep! As an optional feature you can get two weeks of actual field experience out on service jobs and on the repair bench for Chicago's largest independent servicing organization. You learn Television Servicing by actually doing Television Servicing... you get the practical know-how you need to qualify for BIG MONEY in this fast-growing field! Age is no barrier. Many TCI students are over 40!

ACT NOW! Fill out and mail coupon for FREE Catalog and SAMPLE LESSON. Write TODAY!

TELEVISION COMMUNICATIONS INSTITUTE
205 W. Wacker Dr., Dept. I-AB Chicago 6, Ill.

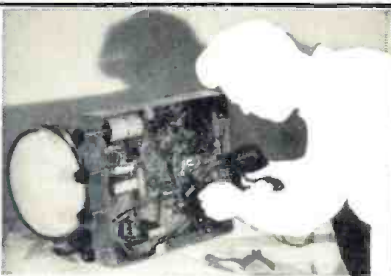

YOU GET and keep modern large screen Television receiver.

YOU DO actual testing, servicing, trouble shooting and repairing

TV BROADCASTING COURSE READY NOW!
Train at home for these big pay studio jobs! Video engineers, cameramen, microwave engineers, etc. Easy non-mathematical training covers all phases. Write!

MAIL NOW FOR FREE BOOKLET

MILTON S. KIVER, President
TELEVISION COMMUNICATIONS INSTITUTE
205 W. Wacker Dr., Dept. I-AB, Chicago 6, Ill.
Rush full facts on the course checked below. I am not obligated. Salesman will not call.

() TV Servicing () TV Broadcasting

Name _____ Age _____

Address _____

City _____ Zone _____ State _____

() BEGINNERS check here for information on Pre-Tel Radio Course.

TWO-IN-ONE

FREQUENCY STANDARDS
CRYSTAL ONLY \$8.95 NET



MODEL DFS
100 KC AND 1000 KC
A Valpey Exclusive!

Build your own frequency standard—portable or fixed—to be used on those tough calls. Save time and money. Two quartz crystals in one holder and entirely independent of each other so that 100 KC or 1000 KC are available separately or together. Calibration accuracy at 28°C is .005%. Crystals are matched so that one trimmer may be used. A complete catalog sheet with parts list and circuit diagram available for the asking.

Write Dept. RN9 for Free Circuit

VALPEY Crystal
HOLLISTON, MASSACHUSETTS

Standard R.M.A. Warranty	TUBES	Price
0A2	50.95 4X150-A	\$35.00 717-A
0B2	1.10 5FP7	1.95 805
1L4	.69 5U4-G	.59 807
1N23-A	2.00 5K4-G	.75 829-B
1N23-B	0.00 6AK5	.75 872-A (GE)
1N34	.62 6AN5	1.95 1616
1N43-A	.75 6C4	.49 1625
1N54	.89 6J6	.59 5516
2C43	15.95 7C30	85.00 5654
2E24	2.85 12A6	69 8020
2E30	2.15 12AU7	69 9001
3E29	10.90 304-TH	1.75 9002
3E34	.90 304-TL	8.00 9004 (RCA)
4D32	22.40 408-A (WE)	2.75 9006

Current (Continuous)	18 Volts	14 Volts	36 28 Volts	54 42 Volts	130 100 Volts
1 Amp.	5 1.25	5 2.10	5 3.60	5 8.00	
2 Amps.	2.20	3.60	6.50	10.50	
2 1/2 Amps.				13.00	
4 Amps.	3.75	6.75	8.75		
5 Amps.	4.95	7.95	12.95	27.00	
6 Amps.	5.50	9.00	14.00	36.00	
10 Amps.	6.75	12.00	20.00	45.00	
12 Amps.	8.50	16.00	25.50	52.50	
20 Amps.	13.25	24.00	36.00	90.00	
24 Amps.	16.00	31.00	39.50	98.00	
30 Amps.	18.50	36.00			
36 Amps.	25.50	45.00			

SELENIUM RECTIFIERS—FULL-WAVE BRIDGE TYPES

• New Selenium Rectifier Transformers

PRI: 115 V., 60 cycles in. } 4 Amps. \$ 8.75
SEC: 0, 12, 18, 24, and 36 } 12 Amps. 16.75
volts. } 24 Amps. 35.75

• 115V. PRI.—36V. 50 amp second XFMR. \$39.95
• 115V. PRI.—5V @ 190 Amp. SEC. \$59.95
• 115/230V. 60 cy. PRI. SEC.: 1.5, 30.5, 33.5, and 36.5V @ 4 AMPS. Herm. sealed. \$6.50

• New Selenium Rectifier Chokes

8 Amps.—.07 hy.—.05 ohm \$ 7.95
12 Amps.—.01 hy.—.1 ohm \$14.95
24 Amps.—.004 hy.—.025 ohm \$29.95

We can manufacture other Sel. Rec., Sel. Rec. Supplies, XFMRs., & Chokes.

• CARTER DYNAMOTORS 6 V DC Input—500 VDC Output @ 150 MA. Only 7" x 4" x 3" \$28.00
In Orig. Mfr's Cartons. Only

• AR-11—SUPERHET RCVR & 50 WATT XMTR w/110 and 220 Volt—60 Cycle. Built-in pow. supply only 12" x 9" x 5" for 20, 40 & 80 meter Brand New. \$99.50
A complete station for only

• ART-1—OE LUXE MOBILE 75 meter AM XMTR w/40 watt supply—only 8" x 6". \$19.95
Close Out

BARRY ELECTRONICS CORP.

136 Liberty Street, N. Y. 6, N. Y. REctor 2-2563
Terms: 25% with order, balance C.O.D.—Send a few cents for postage—All merchandise guaranteed. F.O.B. N.Y.C. Remember, you may order tubes not listed!

Within the Industry
(Continued from page 28)

COMPANY, INC. of Mt. Vernon, New York. Principals of the new corporation will be announced later... **ARROW ELECTRONICS INC.** has set up a new division, **THE AUDIO CENTER**, which will offer specialized facilities for the high-fidelity enthusiast, audio engineers, industrial plant and professional sound equipment users, and designers. The new Center is located at 65 Cortlandt Street, New York... The Cathode-Ray Tube Division of **ALLEN B. DU MONT LABORATORIES, INC.** has set up a replacement sales department which will handle the sale of all television replacement parts and picture tubes, thus centralizing the company's sales to jobbers and distributors... **MERCURY ELECTRONIC COMPANY** has been formed in Red Bank, New Jersey for the design, development, and manufacture of electronic equipment. Andrew Munchak, Jr. is the founder of the new firm... **GENERAL ELECTRIC SUPPLY CORPORATION** has announced a change in its corporate name to **GENERAL ELECTRIC DISTRIBUTING CORPORATION**... **F-R MACHINE WORKS**, a partnership, has been dissolved and all assets have been transferred, set over, and assigned to and all liabilities have been assumed by **F-R MACHINE WORKS, INC.** The successor firm will continue to operate the business from the main office at 44-14 Astoria Boulevard, Long Island City 3, New York.

FREDERICK G. SUFFIELD is the new engineering manager of *Transco Products, Inc.*, manufacturers of coaxial switches, valves, antennas, matching networks, etc.



He has an engineering background of fifteen years, specializing in airborne search radar and related electronic units. Formerly with *Westinghouse* and until recently with the *Houston Corporation* which was acquired by *Radio Corporation of America* in 1950, Mr. Suffield was chief engineer of the electronics division and manager of the engineering section handling design of military search radar systems.

Mr. Suffield will make his headquarters at the company's Los Angeles plant.

PACKARD-BELL COMPANY has broken ground for a new \$300,000 addition to its Los Angeles headquarters. The new building will be used primarily for manufacturing and will include a second floor containing 7500 square feet which will be devoted to engineering facilities. Completion of the building is expected shortly... **TEKTRONIX, INC.** has established a branch office at 313 Nottingham Road in Syracuse,

Only the G-E Dual Regulated Power Supply ST-9A gives you...



1. ELECTRONIC OVERLOAD PROTECTION

2. BUILT-IN MODULATOR

TYPE ST-9A (500 VOLT) Electrical Specifications

Power Requirements	105-125 volts (210-250 volts), 50/60 cycle, 320 watts maximum
Output Voltages	
#1 Regulated	Continuously variable, 0-500 volts, maximum current 100 ma
#2 Regulated	Same as #1
Parallel #1 and #2	Continuously variable, 0-500 volts, maximum current 150 ma
Unregulated	Approximately 650 volts no load, maximum current 200 ma
-75 Volts	VR tube regulation, 0-2 ma
-150 Volts	VR tube regulation, 0-4 ma
Filament Supply Regulation	6.3 volts a-c at 10 amps Better than $\frac{1}{2}\%$ + $\frac{1}{2}$ volt within the cross-hatched area of the graph (below)
Ripple and Noise	Less than 3.5 mv (10 mv peak-to-peak) on all regulated outputs
Instruments	Milliammeter 0-300 ma d-c; voltmeter 0-500 volts d-c; voltage and current can be metered at #1 and #2 Regulated and Unregulated outputs; total current drawn from all outputs can be metered and it should not exceed 200 ma
Overload Protection	3 amp fuse in the a-c line; $\frac{3}{8}$ amp fuse in the d-c line; overload of any degree on the regulated outputs will harm neither the supply itself nor the instruments.
Ambient Temperature	0 to 40°C

FOR general laboratory purposes, no power supply on the market today can match this new General Electric unit. Routine bench casualties are no problem for the ST-9A: the instruments cannot be harmed by short circuits on the regulated outputs. And—for the first time you can observe hum and noise tolerances by actually duplicating them on the equipment. This saves you time by establishing final power supply design specifications quickly.

- Outputs readily available on insulated binding posts
- Output terminal on rear for rack mounting
- Outputs are individually metered and a fourth position is added for metering total current
- *Even when* the unit is cabinet or rack-mounted, drop front panel permits easy accessibility to components (without removing panel lock)
- Regulation specification holds over the full range of 0-500 volts.

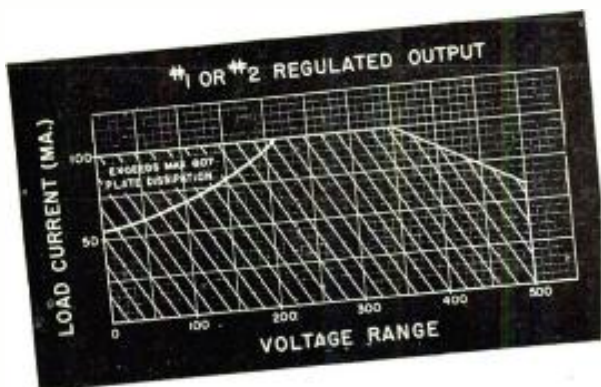

General Electric Company, Section 9102,
Electronics Park, Syracuse, N. Y.

Please send my copy of your new G-E Power Supply Catalog.

NAME _____
 COMPANY _____ TITLE _____
 ADDRESS _____
 CITY _____ STATE _____

GENERAL  ELECTRIC

Sensational TUBE SAVINGS



80% to 90%
off list!

UNBEATABLE! UNPRECEDENTED!

Tried and true performance plus economical service make these low, low priced, high quality, fully guaranteed tubes the sensation of the nation. Every tube rigidly tested, every tube a standout value.

All Tubes Individually Boxed! Same Day Service!

✓ Check this list for Fully 90-Day Guaranteed Tubes

Type	Price	Type	Price	Type	Price	Type	Price	Type	Price
0B3/VR90	.75	5U4G	.40	6BJ6	.39	6V6GT	.39	12SR7	.49
1A5GT	.46	5V4	.73	6BK7	.59	6W4GT	.44	14A7	.44
1A6G	.59	5X4	.40	6BL7	.59	6W6GT	.44	14AF7	.50
1A7GT	.47	5Y3	.32	6BC6GT	.59	6X4	.37	14B6	.40
1AB5	.59	5Y4G	.35	6BQ7GT	.72	6X5GT	.37	14J7	.60
1B3	.49	6A3	.59	6BY5	.65	6Y6G	.48	14W7	.60
1B5	.59	6A7	.59	6B7	.90	7A7	.47	19GGG	.95
1B7GT	.59	6AB4	.44	6C4	.37	7A7	.48	19C8	.70
1CSGT	.43	6AG5	.43	6C5GT	.39	7A8	.43	19T8	.79
1E7	.29	6AJ5	.90	6C8E	.44	7AF7	.53	19V8	.89
1H4G	.48	6AK5	.75	6CD6G	1.11	7B4	.44	25B0GGT	.62
1H5GT	.40	6AL5	.38	6D6	.45	7C5	.40	25L6GT	.39
1G6	.60	6AQ5	.39	6E5	.48	7C6	.40	25Z5	.40
1L3	.46	6A0E	.37	6F3GT	.39	7E6	.49	25Z6GT	.37
1L6	.43	6ARS	.37	6F6	.37	7F7	.59	25W4	.56
1LC5	.51	6A55	.50	6GG6	.52	7N7	.47	26	.45
1N5	.46	6AT6	.37	6H6GT	.41	7X7	.70	27	.39
1P5	.57	6AUG	.38	6J5GT	.37	7Y4	.34	32L7	.85
1Q5	.58	6AV6	.37	6J6	.52	12AL5	.37	35B5	.40
1R5	.45	6AX4	.53	6J7G	.43	12AT6	.37	35C5	.39
1S5	.39	6B4G	.64	6J8	.69	12A7	.56	35L6GT	.41
1T4	.45	6B5	.64	6K5	.47	12AUG	.38	35W4	.37
1T5	.53	6BA6	.39	6K6GT	.37	12AU7	.43	35Z4	.39
1U4	.45	6BA7	.57	6K7	.44	12AV6	.39	35Z5GT	.37
1U5	.39	6BC5	.44	6L6	.64	12AV7	.59	36	.60
1X2	.63	6BC7	.71	6Q7	.45	12AX4	.48	41	.42
2A3	.70	6BD5GT	.59	6S1	.38	12AX7	.48	42	.42
3A4	.45	6BD6	.45	6S8	.53	12A27	.69	43	.55
3E5	.46	6BE6	.39	6SA7GT	.43	12BA6	.38	45	.55
3Q4	.48	6BF5	.41	6SC7	.41	12B87	.46	50B5	.39
3Q5GT	.49	6BF6	.37	6SD7GT	.41	12BD6	.45	50C5	.39
354	.46	6BG6G	.94	6SG7GT	.41	12BE6	.39	50C6	.59
3V4	.47	6BH6	.45	6SM7	.73	12BF6	.39	50L6GT	.41
				6SJ7GT	.41	12BH7	.63	50Y6	.46
				6SK7GT	.41	12K7GT	.46	50Y7	1.09
				6SL7G1	.48	12Q7G	.39	70L7GT	1.09
				6SN7GT	.37	12S8	.70	75	.41
				6SQ7GT	.37	12SA7GT	.44	76	.44
				6SS7	.42	12SJ7	.44	78	.47
				6T8	.56	12SK7GT	.48	80	.35
				6U5	.44	12SL7GT	.47	117L7	.99
				6U8	.61	12SN7GT	.52	117Z3	.37
				6V3	.93	12SQ7	.44	807	.99



TUBECO.

"Integrity Is Our Chief Asset"

Phone: Essex 5-2947

TERMS: A 25% deposit must accompany all orders—balance C.O.D. All shipments F.O.B. Irvington warehouse. Orders under \$10—\$1.00 Handling Charge. Subject to prior sale.

Enlarged Quarters to Serve You Better!

115 COIT STREET
IRVINGTON 11, N. J.

RADIO'S NEWEST CREATION

Privatear Radio
Smallest Real Personal Pocket Radio

- Private-Ear is Electronic Magic!
- A Tiny ear phone of Special Design lets you enjoy your favorite programs in complete privacy
- Large 4-Tube Set Performance with 2 Tubes plus Diode Crystal Detector
- Weighs Less than 8 ozs. including Batteries
- 50 mile Daytime Reception
- Dimensions: 2 1/4" wide, 5 3/4" long, 7/8" thick

Excellent for Premiums and Gifts

PRIVAT-EAR CORPORATION

20 Mechanic St., New Rochelle, N. Y., New Rochelle 3-7210



Write for Dealers—Distributors
Brochure Some Key Territories Available

New York. Byron H. Broms is the sales engineer in charge . . . **MILLER TELEVISION COMPANY** of 2840 N. Naomi Avenue, Burbank, California has embarked on a \$50,000 expansion program which will increase its experimental laboratory facilities for the development of television antennas. Production facilities and assembly lines have also been increased to handle the demand for the company's products . . . **ROBINSON AVIATION, INC.** of Teterboro, New Jersey has established an engineering laboratory in conjunction with its West Coast engineering office in Burbank, California to provide full test facilities for evaluating vibration control equipment used in the air frame and electronics industry . . . **AMPEX ELECTRIC CORPORATION** of Redwood City, California, has opened expanded Midwestern district sales facilities at 111 East Ontario Street in Chicago. Russell J. Tinkham is in charge of the new headquarters . . . **COIL WINDERS, INC.** has recently moved into a new building at Westbury, Long Island, New York. The new location provides 10,000 square feet of manufacturing space . . . **RES-DEL ENGINEERING** has acquired larger quarters at 2351 Riverside Drive in Los Angeles, adjacent to its old facilities, in order to handle production of a wide variety of Signal Corps and Navy contract items . . . **GALVANIC PRODUCTS CORPORATION** has recently completed a new plant at Valley Stream, Long Island for the manufacture of selenium rectifiers, complete rectifier equipment, and allied electronic components.

-30-

HANDY THUMB-NUTS

By ARTHUR TRAUFFER

SAVE those old safety razors that you no longer use; the knurled brass handles on them will make swell thumb-nuts for radio and electrical use. Simply saw up the handles into pieces of the desired length, bore proper size holes through the centers and tap the holes. If you own a metal-turning lathe, bore through the entire handle at one crack and then saw it up and tap it.

The photo shows a couple of these thumb-nuts being used on a voltmeter. Some safety razor handles come chrome plated, or nickel plated, which improves the appearance.

-30-

Old razors are a source of thumb-nuts.

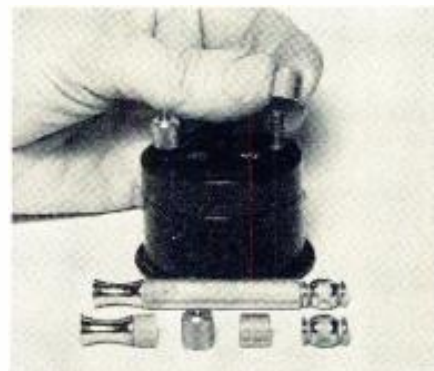

BUY TEST EQUIPMENT ON THIS RADICALLY NEW TIME PAYMENT PLAN

NO INTEREST!! - NO CARRYING CHARGES!!

USE CONVENIENT TIME PAYMENT ORDER BLANK BELOW

Superior's New JUNIOR SUPER-METER



MOST COMPLETE AND COMPACT MULTI-SERVICE INSTRUMENT EVER DESIGNED

Measures: * Voltage * Decibels
* Capacity * Resistance
* Current * Inductance
* Reactance

Specifications: D.C. Volts: 0-7.5/75/150/750/1500 Volts. A.C. Volts: 0.15/150/300/1500/3000 Volts. Resistance: 0-10-000/100,000 ohms. 0-10 Megohms. D.C. Current: 0-7.5/75 Ma. 0-7.5 amps. Capacity: .001 Mfd.-2 Mfd. 1 Mfd.-20 Mfd. Electrolytic Leakage: Reads quality of electrolytics at 150 Volt test potential. Decibels: -10 Db to +18 Db. +10 Db. to +38 Db. +38 Db. to +58 Db. Reactance: 15 ohms-25 K ohms 15 K ohms-2.5 Megohms. Inductance: .5 Henry-50 Henries 30 Henries-10 K Henries. Plus Good-Rad scale for checking the quality of electrolytic condensers.

Handsome round cornered molded bakelite case 3 1/2" x 5 3/4" x 2 1/4" complete with all test leads and instructions

\$21.40
NET

Superior's New Model TV-11 TUBE TESTER

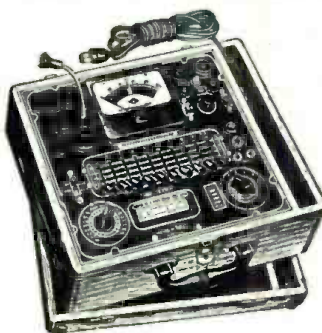

• Uses the new self-cleaning Lever Action Switches for individual element testing. Because all elements are numbered according to pin number in the RMA base numbering system, the user can instantly identify which element is under test. Tubes having tapped filaments and tubes with filaments terminating in more than one pin are truly tested with the Model TV-11 as any of the pins may be placed in the neutral position when necessary. • Uses no combination type sockets. Instead individual sockets are used for each type of tube. Thus it is impossible to damage a tube by inserting it in the wrong socket. • Free-moving built-in roll chart provides complete data for all tubes. • Phone jack on front panel for plugging in either phones or external amplifier detects microphonic tubes or noise due to faulty elements and loose external connections.

Operates on 105-130 Volt 60 Cycles A.C. Hand-rubbed oak cabinet complete with portable cover **\$47.50** NET

Superior's New Model 670-A SUPER-METER

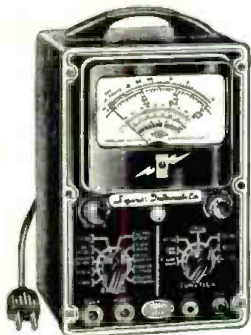

A COMBINATION VOLT-OHM MILLIAMMETER PLUS CAPACITY REACTANCE INDUCTANCE AND DECIBEL MEASUREMENTS

SPECIFICATIONS:

D.C. VOLTS: 0 to 7.5/15/75/150/750/1,500/7,500 Volts.
A.C. VOLTS: 0 to 15/30/150/300/1,500/3,000 Volts.
OUTPUT VOLTS: 0 to 15/30/150/300/1,500/3,000 Volts.
D.C. CURRENT: 0 to 1.5/15/150 Ma. 0 to 1.5/15 Amperes.
RESISTANCE: 0 to 1,000/100,000 Ohms 0 to 10 Megohms
CAPACITY: .001 to 1 Mfd. 1 to 50 Mfd. (Quality test for electrolytics)
REACTANCE: 50 to 2,500 Ohms, 2,500 Ohms to 2.5 Megohms
INDUCTANCE: .15 to 7 Henries 7 to 7,000 Henries
DECIBELS: -6 to +18 +14 +38 +34 to +58

ADDED FEATURE:

The Model 670-A includes a special GOOD-BAD scale for checking the quality of electrolytic condensers at a test potential of 150 Volts.

The Model 670-A comes housed in a rugged, crackle-finished steel cabinet complete with test leads and operating instructions. Size 6 1/4" x 9 1/2" x 4 1/2".

\$28.40

Superior's New TV BAR GENERATOR



Throws an Actual Bar Pattern on Any TV Receiver Screen!!

Two Simple Steps:

1. Connect Bar Generator to Antenna Post of any TV Receiver.

2. Plug Line Cord into A.C. Outlet and Throw Switch.

RESULT: A stable never-shifting vertical or horizontal pattern projected on the screen of the TV receiver under test.

TV Bar Generator comes complete with shielded leads and detailed operating instructions. Only **\$39.95** NET

Power Supply: 105-125 Volt 60 Cycles. Power Consumption: 20 Watts. Channels: 2-5 on panel. 7-13 by harmonic. Horizontal lines: 4 to 12 (Variable). Vertical lines: 12 (Fixed). Vertical sweep output: 80 cycles. Horizontal sweep output: 15,750 Cycles.

New Model 200 AM and FM SIGNAL GENERATOR

Provides complete coverage for A.M.-F.M. and TV alignment



* Tubes used: One 954 as oscillator; one 954 as modulated buffer amplifier; T-2 as modulator; 7193 as rectifier.

The Model 200 comes complete with output cable and operating instructions

\$21.85
NET

NEW TIME PAYMENT PLAN ORDER BLANK

MOSS ELECTRONIC DISTRIBUTING CO., INC.
Dept. B-35, 38 Murray Street, New York 7, N. Y.

Please send me the units checked below. I am enclosing the down payment with order and agree to pay the monthly balance as shown. It is understood there will be no carrying, interest or any other charges, provided I send my monthly payments when due. It is further understood that should I fail to make payment when due, the full unpaid balance shall become immediately due and payable.

- JUNIOR SUPER METER..... Total Price \$21.40
\$5.40 down payment. Balance \$4.00 monthly for 4 months.
- MODEL TV-11..... Total Price \$47.50
\$11.50 down payment. Balance \$6.00 monthly for 6 months.
- MODEL 670-A..... Total Price \$28.40
\$7.40 down payment. Balance \$3.50 monthly for 6 months.
- TELEVISION BAR GENERATOR..... Total Price \$39.95
\$9.95 down payment. Balance \$5.00 monthly for 6 months.
- MODEL 200..... Total Price \$21.85
\$5.85 down payment. Balance \$4.00 monthly for 4 months.
- I enclose \$..... as down payment.
- Ship C.O.D. for the down payment.

Signature.....

Name.....

Address.....

City..... Zone..... State.....

HARVEY

For the **FINEST** in **AUDIO**

THE ORIGINAL WILLIAMSON HR-15 AMPLIFIER KIT

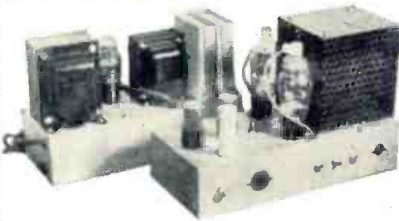

The famous, original Williamson HR-15... still acclaimed the leader... in kit form, with the original Partridge output Transformer. Assemble this kit, and in 3 hours or less, enjoy the finest sound you ever heard. Operates from a tuner, phono-preamp, crystal pick-up, or other signal source. Absolute gain is 70.8 db with 20 db of feedback. Frequency response: $\pm .5$ db, from 10 to 100,000 cps. Output impedances to match all speakers from 1.7 to 109 ohms. Kit is complete with 5 tubes (1-5V4, 2-6SN7, and 2-5881 (or 807 if requested), 2-Punched Chassis, 2-Resistor Mounting Strips, Sockets, Partridge WWFB Output Transformer, Assembly Instructions, and All Other Necessary Parts for Amplifier and Power Supply. **\$76.50**

HR-15, as above, but with Partridge CFB Output Transformer (Hermetically Sealed) **\$90.00**

PARTRIDGE OUTPUT TRANSFORMERS — Available Separately. WWFB.....\$26.00 CFB.....\$40.00

HR-15T WILLIAMSON Kit—Furnished as above, with TRIAD Transformers and Chokes **\$69.50**

NOTE: HR-15 and HR-15T Kits may be had with British KT-66 Output tubes for \$3.00 additional.

HI-FI PICKUP CARTRIDGES

AUDAX POLYPHASE

DL-6 "Chromatic"—.001" Diamond and .003" Sapphire Styli **\$41.70**
L-6 Sapphires, .001" and .003" **20.70**
KL-4 Same as L-6, but higher output (for record changers) **20.70**

G. E. VARIABLE RELUCTANCE

RPX-040 Sapphire .003" **\$5.97**
RPX-041 Sapphire .001" **5.97**
RPX-050 "Triple Play"—.001" & .003" Sapphires **8.37**

PICKERING

S-140S Sapphire .001" **\$15.00**
D-140S Diamond .001" **36.00**
S-120M Sapphire .0027" **9.90**
D-120M Diamond .0025" **24.90**
.001" for 33 $\frac{1}{3}$ & 45 rpm
.003" & .0025" for 78 rpm

NOW READY! **FREE** HARVEY AUDIO CATALOG

A comprehensive, profusely illustrated directory of High Fidelity Sound-Reproducing Equipment. Contains descriptive data and specifications, suggested combinations for home installations, plus enlightening explanatory introductions.

Write to Dept. SR-8

Visit the Harvey **AUDI**orium
See, hear, and compare sound equipment from the largest selection available anywhere.

See you at the Audio Fair

NOTE: Price Net, F.O.B., N.Y.C. and subject to change without notice.

Telephone **hrc** LUxemburg 2-1500

HARVEY
RADIO COMPANY, INC.
103 West 43rd St., New York 36, N. Y.

Midget Auto (Continued from page 38)

or solenoid extending out into the trunk compartment. The sensitive relay is mounted in front of the axle under the hood. Batteries are fastened to the base plate which screws to the under side of the plastic car. Removal of this base plate exposes all operating parts of the car.

Another feature is not at first apparent. The headlamps are the pre-focused 2.2 volt bulbs ordinarily found in the pen-cell flashlights. These are just the proper size to poke through the metal grommets the original car used as headlamps. Two of these bulbs are connected in series (using soldered connections) and are glued into the holes. For more realism, "tilt" lamps may be made. Place the bulbs in a flashlight and note whether the rays come directly along the axis of the flashlight. If they do not, while the bulb is lighted lightly strike the flashlight against some solid object. The filament should shift in the bulb causing the beam to tilt downward. Mark the side of the bulb toward which the beam bends and when it is glued in the car place this mark down. Then when the car runs the lamps will cast two round beams of light like the headlights of a real car.

Receiver Power Supply

The space within the car is quite limited and special care must be taken to provide the necessary power for operation without exceeding the allocated volume.

Base plate showing "B" battery and the box which holds two size "C" dry cells.



The batteries required are one *Burgess* K45 and two size "C," 1 $\frac{1}{2}$ volt flashlight cells. The K45 is a 67 $\frac{1}{2}$ volt battery chosen because of its compact physical size. This battery is slightly smaller than its *Eveready* equivalent which was a trifle too large to mount in the available space.

Originally the car was operated by 3 volts obtained from a series-parallel arrangement of ten pen cells. It was found, however, that the middle size flashlight cell worked equally well, was more economical, and was far easier to change.

The base plate of the car was replaced by a piece of thin composition, cut as shown in the photographs. The original metal dust cover was used as a template. Note that an additional opening was provided for the relay and its arm which protrudes slightly below the level of the axle.

A small box, the correct size to hold the two 1 $\frac{1}{2}$ volt batteries, was made from light cardboard and bound with *Scotch* electrical tape for greater rigidity. This was inserted through a square hole in the base plate and then glued in place. A metal plate was fastened along the inside of one side of the box to contact the battery poles and connect them in series. On the opposite side of the box roundhead screws provide contacts for positive and negative poles of the two batteries. The batteries slip in and out, but are secure enough to stay in place even with the rather rough treatment a small boy gives his playthings.

The "B" battery is held firmly in place by a thin aluminum band anchored at the ends by 6-32 screws and nuts.

Reverse of the base plate showing how dry cells are located for easy replacement.

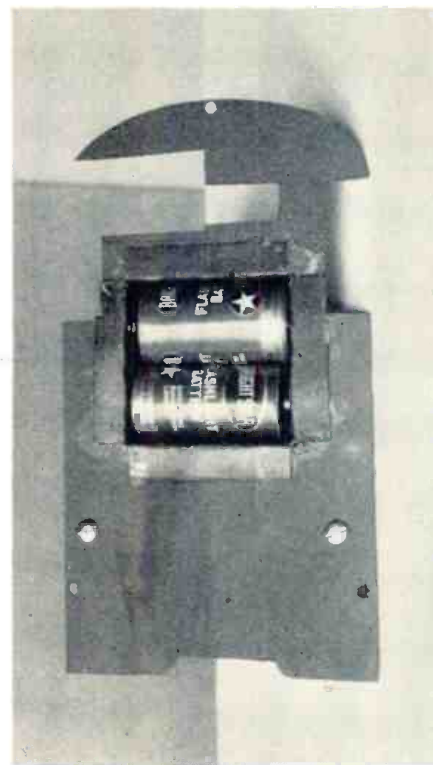

OHMITE®

Little Devil® RESISTOR ASSORTMENTS

FOR RADIO-TV SERVICEMEN



WITH HANDY
PLASTIC CABINET

ALL FOR THE PRICE OF RESISTORS ALONE!

Here's a handy all-plastic resistor cabinet that's a real timesaver for the radio-TV serviceman. This handsome, sturdy cabinet has five drawers, with eight compartments in each drawer. Each compartment is individually labeled—making it easy to locate the right resistor and to maintain visual stock control. The cabinet is extremely compact—only 9" long, 4¾" high, and 5¼" deep. Dovetail joints permit cabinets to be stacked one on top of another.

Factory packed in each cabinet is an assortment of 150 (½-watt) or 125 (1 or 2-watt) carefully selected Ohmite "Little Devil," individually marked, insulated composition resistors, in the 40 values (10 ohms to 10 megohms) most frequently used by servicemen.

These assortments are offered at the price of the resistors alone—the cabinet being furnished without extra cost. Order from your jobber.

OHMITE MANUFACTURING COMPANY

4883 W. Flournoy Street, Chicago 44, Illinois

October, 1952

QUANTITIES AND RESISTANCE VALUES

QUANTITY			OHMS	QUANTITY			OHMS	QUANTITY			OHMS
CAB-10	CAB-2	CAB-3		CAB-10	CAB-2	CAB-3		CAB-10	CAB-2	CAB-3	
1	1	10	5	3	1000	3	1	33,000	10	10	0.47 meg.
1	1	15	1	1	1500	5	5	39,000	1	1	0.68 meg.
1	1	27	1	1	2200	10	10	47,000	10	10	1.0 meg.
1	1	47	3	3	2700	3	1	68,000	1	1	1.5 meg.
5	1	100	10	5	4700	1	1	82,000	1	1	2.2 meg.
1	1	150	1	1	6800	10	10	0.1 meg.	3	1	2.7 meg.
3	1	270	10	10	10,000	5	5	0.15 meg.	1	1	3.9 meg.
1	1	330	3	3	15,000	3	1	0.22 meg.	1	1	4.7 meg.
3	1	470	5	5	22,000	10	10	0.27 meg.	1	1	6.8 meg.
1	1	680	10	10	27,000	3	1	0.33 meg.	1	1	10.0 meg.

Be Right with **OHMITE**

RHEOSTATS • RESISTORS • TAP SWITCHES

COMPLETE TRAINING FOR BETTER RADIO-TV SERVICE JOBS

ONLY \$12

for the complete 2-volume course

3 MONTHS TO PAY

Let these two great new Ghirardi training books teach you to handle all types of AM, FM and TV service jobs by approved professional methods—and watch your efficiency and earnings soar!

Completely modern, profusely illustrated and written so you can easily understand every word, these books pave the way to fast, accurate service on any type of home radio-TV electronic equipment ever made. Each book is brand new. Each contains the latest data on the latest methods and equipment—NOT a re-hash of old, out-of-date material. Each is co-authored by A. A. Ghirardi whose famous RADIO PHYSICS COURSE and MODERN RADIO SERVICE were, for 20 years, more widely used for military, school and home study training than any other books of their type!

THE NEW Ghirardi RADIO-TV SERVICE LIBRARY

Almost 1500 pages and over 800 clear illustrations show step-by-step how to handle every phase of modern troubleshooting and servicing.

1—Radio and Television Receiver TROUBLESHOOTING AND REPAIR

A complete guide to profitable professional methods. For the novice, it is a comprehensive training course. For the experienced serviceman, it is a quick way to "brush up" on specific jobs, to develop improved techniques or to find fast answers to puzzling service problems. Includes invaluable "step-by-step" service charts. 820 pages, 417 illus., price \$8.75 separately.

2—Radio and Television Receiver CIRCUITRY AND OPERATION

This 689-page volume is the ideal guide for servicemen who realize it pays to know what really makes modern radio-TV receivers "tick" and why. Gives a complete understanding of basic circuits and circuit variations; how to recognize them at a glance; how to eliminate guesswork and useless testing in servicing them. 417 illus., price separately \$6.

New low price easy terms

If broken into lesson form and sent to you as a "course," you'd regard these two great books as a bargain at \$50 or more! Together, they form a complete modern servicing library to help you work faster, more efficiently and more profitably. Completely indexed so you can look up needed facts in a jiffy.

Under this new offer, you save 75c on the price of the two books—and have the privilege of paying in easy installments while you use them! No lessons to wait for. You learn fast—and you learn right!

10-DAY EXAMINATION PRIVILEGE

Dept. RN-102, Rinehart Books, Inc., Technical Division, 232 Madison Ave., New York 16, N. Y.

Send me GHIRARDI'S NEW 2-VOL. SERVICE LIBRARY. I enclose \$3 as my first installment and will send you \$3 a month for three months until the total price of only \$12.00, plus a few cents postage, is paid. It is understood I may read the books for 10 days. Then, if not satisfactory, I will return them postage paid and you agree to refund my \$3 and cancel the remaining installments. (Books shipped postpaid for full remittance with order—same return privilege.)

Name

Address

City, Zone, State

Employer's Name & Address

OUTSIDE U.S.A.—\$13.00 cash only. Same 10-day return privilege with money refunded.

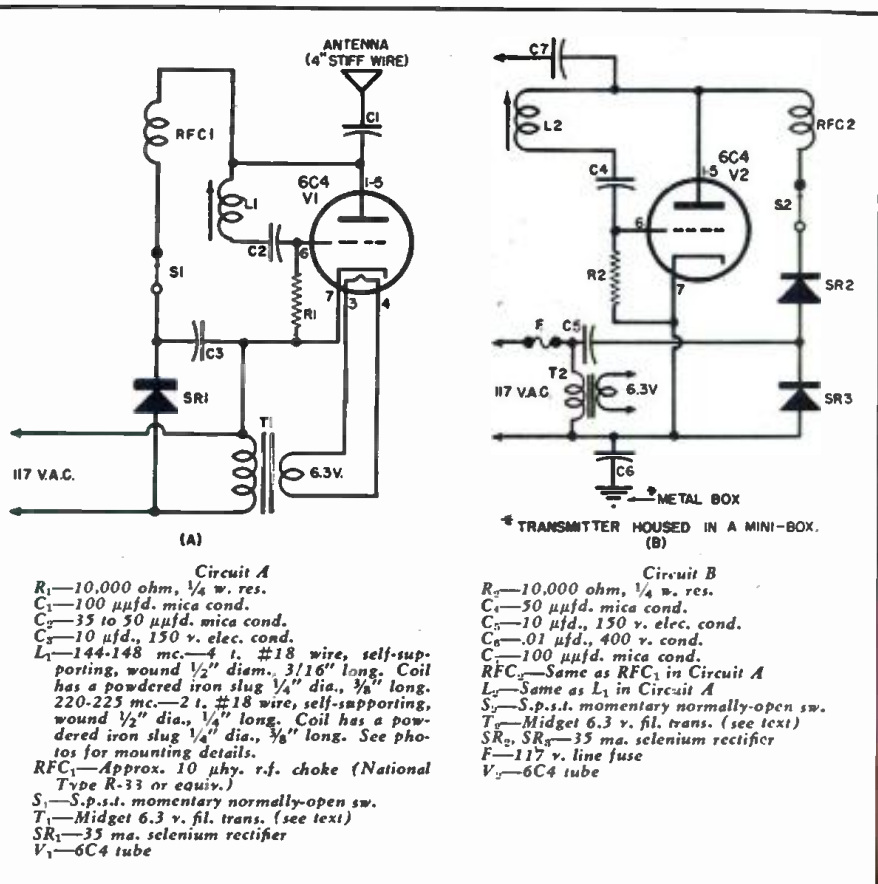

Fig. 8. (A) Original version of the transmitter using an ultraudion oscillator. (B) Improved version which performs better but requires an additional rectifier. The photos of the transmitter appearing in this article are of the "improved" circuit (B).

The Transmitter

The choice of transmitter circuits depends upon the preference of the builder, the frequency at which he desires to operate, and whether it is to be a.c. or d.c. powered. No great amount of power output is demanded of the transmitter, but it is important that the output be modulated.

Two transmitters are described because both were built and found satisfactory. The first of these is pictured in Fig. 8A. A 6C4 tube is used in an ultraudion oscillator circuit having its plate voltage supplied by a half-wave rectifier not fully filtered. The 60-cycle ripple appears in the transmitter output as modulation. The advantage

The transmitter as housed in a Bud "Mini-box." (A) Phone tip jack for the antenna, (B) the transmitter tuning screw, and (C) the transmitter control button.

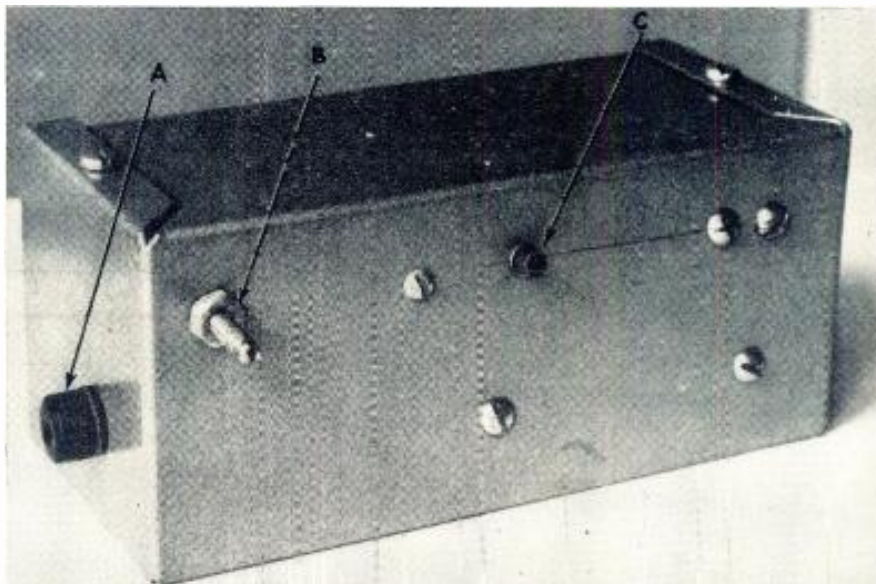

of this circuit is that it can be constructed in the plastic case which was originally the battery case of the model car. Fig. 9 shows the location of the components in the case.

The transmitter of Fig. 8B differs from the other only in the design of the power supply for the plate. It does, however, represent an improvement that makes this superior to the former unit. It has the disadvantage of being slightly larger and requiring an additional rectifier.

The power supply will probably be recognized as one form of a voltage doubler circuit minus the filter. The action of the condenser and rectifier arrangement is to clamp the average voltage at the line voltage and allow the peak to vary from zero to 220 volts at a 60-cycle rate. Since the plate voltage swings as it does, the transmitter is 100% modulated at 60 cycles. The audio component of the transmitted signal is clean and the maximum the carrier can supply without splatter and signal distortion. This is important because it is the audio which operates the sensitive relay in the receiver.

The filament voltage in either unit is supplied by a midjet transformer with a secondary winding that will give the necessary 6.3 volts. This should, if possible, be one of the several midjets which have been designed for this purpose. One such transformer is found in television boosters.

A universal output transformer will also serve the purpose without modification after the voltages have been measured and the correct taps chosen.

The original choice of supplying the transmitter plate with voltage from the a.c. lines was made for the simple reason that it eliminated the necessity for a modulator being built into the set. A battery supply would necessitate an additional tube and transformer as an audio signal generator and a modulator. The use of a.c. is no serious disadvantage since the car is normally operated indoors where the supply is readily available.

Running the Model

By this time the builder is probably quite anxious to get the first run-in on the model. A little experience will show the best way to get the car started. The description of a simple procedure will help.

When the switch in the auto is first turned on and before the tube filaments have had time to light, the decoding relay will operate. This is due to the fact that the sensitive relay is not opened until the receiver current reaches the closing current. Operation of the stepping relay will cause the drive motor to start running. To avoid this, hold the thumb on the armature of the sensitive relay for about a second while the tubes warm up to operating temperature.

Now place the car upside down on the floor and standing several feet away with the transmitter plugged in to the a.c., slowly turn the transmitter tuning slug until the relay in the car



FREE!
1953 CATALOG



12-TUBE FM-AM CHASSIS

Here at a **BIG SAVING** you get a complete celebrated make AM-FM Radio Chassis for modernizing old sets, for new custom installations, built-ins, etc.

Top make latest design, with built-in pre-amp for Phono operation with either reluctance or crystal type pick-up. Tunes standard broadcast 550 to 1700 KC and FM 88 to 108 MC.

Wide range audio response (push-pull 6V6 output) and bass boost tone control. Tubes: 6BE6, 2-6BA6, 2-12AT7, 2-6SQ7, 6SH7, 6AL5, 2-6V6GT and 5Y3GT rectifier. Attractive lighted slide rule dial.

Supplied ready to operate, complete with tubes, antennas, escutcheon and hdwe. for mtg. in a table or console cabinet, built-ins, etc. Chassis size 13 1/2" wide x 9" high x 9" deep. Cutout required for dial escutcheon 7 3/4" x 2 3/4". Operates on 115 V 60 cycle AC. Output impedance 3-4 ohms, for any PM or Co-Axial Speaker. Shpg. wt. 20 lbs. **ONLY \$56.88**
No. 31B18.



1/4-IN. ELECTRIC DRILLS

Light and compact . . . makes it easy to carry in tool kit. Powerful 1/10 HP motor delivers 1200 RPM at chuck, makes it right for the average drill need. Top quality make with sturdy hand-tite 3 jaw chuck, dynamically and statically balanced armature to produce vibrationless operation; die-cast aluminum housing with non-peeling hard finish; dependable instant action switch. Complete with 6 1/2 ft. cord. Operates on 110-120 volts AC-DC. Shpg. wt. 3 lbs.
No. 36B102. **SPECIAL EACH \$8.49**
Drill as above, except with popular saw-grip handle.
No. 37A32. **Special Net Each \$9.97**



G. E. FLANENOL WIRE

Weather, Water, Flame and Abrasion Proof! Parallel size 17 solid tinned copper conductors encased in black Vinyl Plastic jacket which is impervious to water, flame, weather or abrasion. Makes it just the wire for either in or outdoor installations of alarm, intercom, telephone, PA, etc., and even for electric extensions, where a tough durable insulation is desired. 2 Cond. flat O.D. size .150 X .300". Available in continuous lengths 100 ft. and over.
No. 2B17. Per 100 Ft. **\$2.19**

HERE ARE JUST A FEW OF THE
BIG VALUES
IN THE LATEST 148 PAGE
B-A CATALOG
WRITE US IF YOU HAVE NOT RECEIVED IT

BURSTEIN-APPLEBEE CO.

1012-14 McGee St., Kansas City 6, Mo.

Send Free B-A Catalog No. 531.
 My order is attached for items from below.

\$ _____ enclosed.

Name _____

Address _____

City _____

State _____

6AK5 TUBES



Made by Sylvania and bears the name "Standard" because they were originally intended for use in Standard Boosters—otherwise the identical 6AK5 you would obtain if buying tubes bearing the Sylvania name and for which you pay up to \$2.06 Net Each (List Price \$3.90 Ea.). Here you get 6 for little more than the regular price of 2 and believe us—they are perfect—new—fully guaranteed—a popular type widely used in Radio, TV, Boosters, etc.

No. 70A98. Pkg. of SIX 6AK5 Sylvania Made Tubes. Only. **\$4.79**

FANTASTIC VALUE!



LOOK WHAT
YOU GET
FOR ONLY

\$1.39

A Compact Power Transformer for many applications . . . exact replacement for most popular TV Boosters—for replacement or in construction of pre-amps, bias supplies, phono oscillators, etc.

117 V. 60 cycle AC Pri., 120 V., @ 40 MA H.V. Sec., 6.3 V. @ 1.2 amp. Fil. Fully enclosed, size 2 1/4" W. x 2" H. x 2" D. Mtg. ctr. 2 1/2". Shpg. wt. 2 lbs.

No. 19C790 **\$1.39** 10 Lots **\$1.29**
Special Each. Each.

As Above: 110 V. @ 20 MA H.V. Sec., 6.3 V. @ .3 for Fil. Size 1 3/4" x 1 3/4" x 1 3/4". Mtg. ctrs. 2 1/4". Shpg. wt. 1 lb.

No. 19C709 **99c** 10 Lots **89c**
Special Each. Each.

OIL-FILLED CONDENSERS



Known quality brands in hermetically sealed metal cases and insulated terminals. Capacity and voltage exact as per original markings of the maker. Built to rigid AN specs.—every one brand new.

7 Mfd—600 V. DC. 3 1/2" H. x 3 3/4" W. x 1 1/2" x 1 1/4". Shpg. wt. 1 1/2 lbs.

No. 18B1043 **\$1.45** 10 Lots **\$1.35**
Special Each. Each.

7 Mfd—330 V. AC. Equip. to at least 600 V. DC. Size 3 1/2" H. x 3 3/4" W. x 1 1/4". Has removable mtg. brackets. Shpg. wt. 1 1/2 lbs.

No. 18B1042 **\$1.65** 10 Lots **\$1.55**
Special Each. Each.

3.7 Mfd—330 V. AC. (Use as 4 Mfd—600 V. DC.) Size 1 3/4" x 4 1/4" x 1". Wt. 1/2 lb.

No. 18B891 **49c** 10 Lots **45c**
Each. Each.

As above except round can, size 1 3/4" dia. x 2 1/2" high.

No. 18B892. Ea. **39c** 10 Lots **35c**
Each. Each.

5.7 Mfd—240 V. AC (use as 6 Mfd—400 V. DC.) Size 1 3/4" x 5 1/4" x 1 1/4". Wt. 1 lb.

No. 18B893 **65c** 10 Lots **60c**
Each. Each.

INCLUDE ALLOWANCE FOR POSTAGE—
ALL OVER-PAYMENTS REFUNDED.

BURSTEIN-APPLEBEE CO.

1012-14 MCGEE ST. KANSAS CITY, MO.

Trav-Electric

\$15⁹⁵
LIST
Model 6-1160

MIGHTY MIDGET CONVERTER

Just plug into Cigarette Lighter on Dash

Converts 6 volts D.C. to 110 volts A.C. 60 cycles 40 watts.



PORTABLE PHONOGRAPH

Ideal for phonographs and turntables at beach, or picnic.



IN THE CAR-IN THE TRUCK

Radios, short wave or broadcast bands in car, truck and cabin, etc.



DIKTATING MACHINE

Small dictating machines . . . ideal for salesmen, business or professional men.



ELECTRIC SHAVER

Electric shaver works beautifully when it is plugged into Trav-Electric. A great time saver.



IN BOATS

Boats—the 110 volts A.C. operates radios, lights, etc.



AT PICNICS-OUTINGS

Ideal for outdoor musical entertainment from table radio to phonographs, including most wire and disc recorders.

Fully Guaranteed THOUSANDS IN USE
See your Electronic Dealer or Jobber, or write direct



Model 6-1160

Size 2 1/2" x 2 1/2" x 3 1/2"

TERADO Company
Mfrs. of Precision Equipment
1068 Raymond Ave., St. Paul 14, Minn.

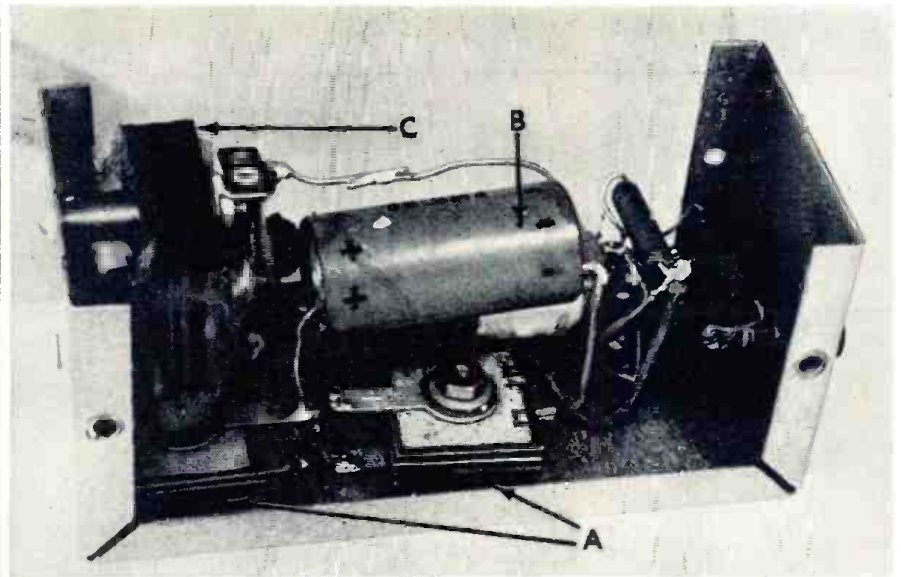

Side view of transmitter with dust cover removed to show: (A) the selenium rectifiers, (B) the clamper condenser, and (C) the midget filament transformer.

operates each time the transmitter switch is depressed. Avoid holding the "transmit" button down while the transmitter is tuned to the receiver frequency, for this allows the stepping relay to be held closed. This is an unnecessary drain on the batteries.

(Editor's Note: To make certain that you are operating within the frequency limits of one of the amateur bands, check the transmitter frequency with a calibrated receiver, wavemeter, or Lecher wire setup. Adjustment of receiver coil L, (Fig. 4) may be necessary to establish the proper operating frequency.)

After the transmitter has been tuned, set the car on its wheels and you are ready for the first run. Quickly push the transmitter button and release it immediately. The relay in the car will operate and the car will move. Pulse the button again and the car will stop. A third pulse will start the car moving in the opposite direction.

Play with it awhile and see how easily the car will obey your command. Now that the car is made, will the

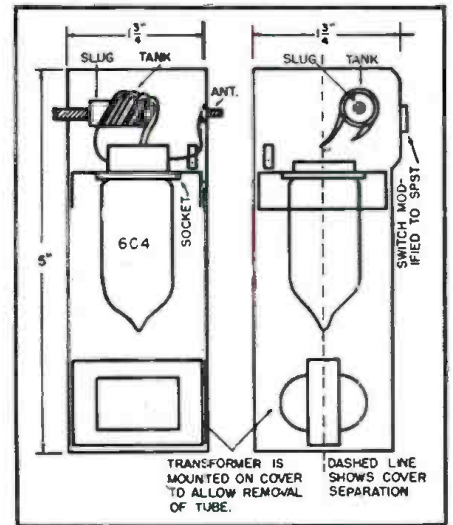
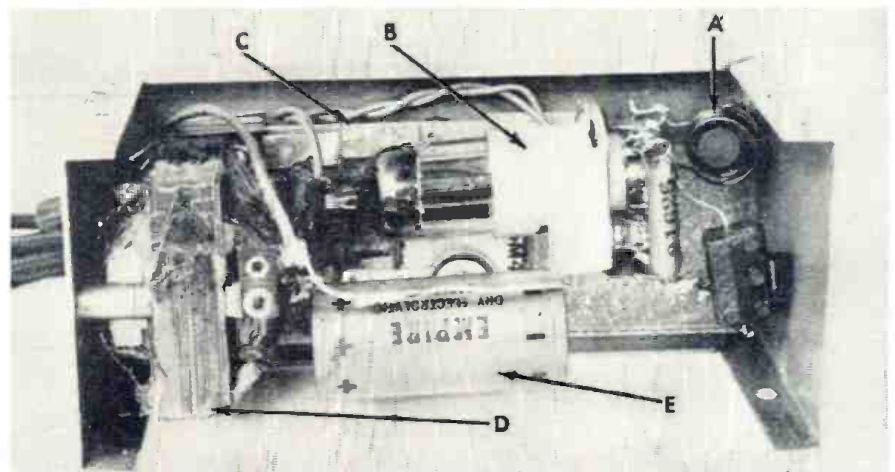

Fig. 9. Top and bottom chassis views showing how the transmitter parts (Fig. 8A) are mounted in the original battery case.

kid you started to make it for get it? He will! How soon? -30-

Top view of transmitter with dust cover removed. (A) Coil and slug, (B) oscillator tube, (C) the switch, (D) the midget transformer, and (E) the clamper condenser.



What you can do now
to speed your

SUCCESS IN RADIO- TELEVISION- ELECTRONICS

Send for this FREE CREI Booklet and see

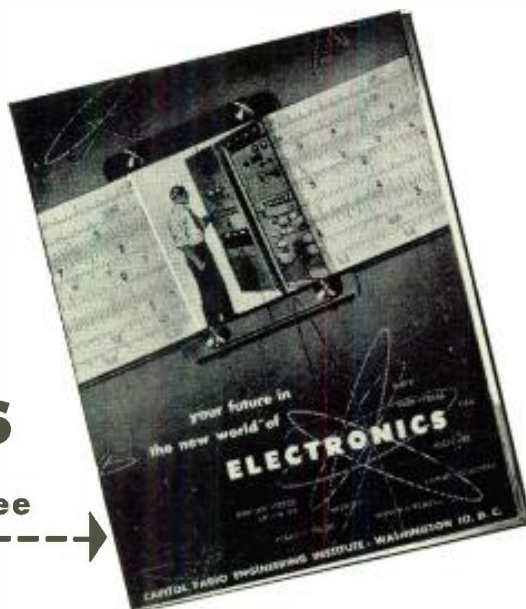

THERE IS A vacancy coming up. It means a boost in pay, prestige and security. Can you fill it? The answer is "No." if you postpone your preparation for success.

The answer is "Yes," if opportunity finds you ready. "Ready" means "TRAINED." And your training must start now, if you expect to be big enough for a bigger job. You ask "What can I do *now*?" You will find many valuable suggestions in a free booklet, "Your Future in the New World of Electronics." Not only does it picture fabulous opportunities . . . it tells you what to do to grow with an industry desperately seeking trained men. Expansion is phenomenal: In the defense build-up alone, many billions in electronics contracts have been awarded. In 1951, the top manufacturers alone sold about \$3 billion in equipment. It is estimated that by 1961 the radio-electronics industry will do no less than \$10 billion per year, excluding defense orders.

Growing civilian markets include radio-equipped police cars, fire-equipment, taxis, planes, ship—in increasing numbers. There are industrial radio network installations, medical applications, and countless others. There are 109 TV stations now on the air, and 2000 more expected now that the FCC freeze is off. Already it is estimated there are over 18,000,000 TV sets and over 100,000,000 radios in operation. How these figures will increase in the next few years, the most daring experts are reluctant to predict. This much is certain: Limitless numbers of positions must be filled—in development, research, design, production, testing, inspection, manufacture, broadcasting, telecasting, and servicing. To fill these posts, trained men are needed—men who somewhere along the line are alert enough to improve their knowledge and skills. "Your Future in the New World of Electronics" shows how CREI Home Study leads to greater earnings, by helping get you ready for the openings described above.

CREI promises no short cuts. In an accredited technical school such as this, *you must study* to transform your ambition and energy into knowledge that pays off. Since its founding in 1927, CREI has provided thousands of professional radio men with technical educations. During

World War II CREI trained thousands more for the Armed Services. Leading firms choose CREI courses for group training in electronics at company expense; among them are United Air Lines, Canadian Broadcasting Corporation, Trans Canada Airlines, Bendix Products Division, All American Cables and Radio, Inc., RCA Victor Division, Mochlett Laboratories, Canadian Marconi and Heppner Mfg. CREI's practical courses are prepared by recognized experts. You get up-to-date material; your work is under the personal supervision of a CREI staff instructor, who knows and teaches you what industry needs. Training is accomplished on your own time, during hours chosen by you. As a graduate, you'll find your CREI diploma the

key to success in Radio, TV and Electronics. At your service is the CREI Placement Bureau, which finds positions for advanced students and graduates. Although CREI does not guarantee jobs, requests for personnel far exceed current supply. CREI alumni hold top positions in America's leading firms.

Now is the time to decide—to act. When opportunity knocks, knowledge must be "at home." You supply the willingness to learn. We supply the technical training. This combination of ambition and knowledge is unbeatable in the new Age of Electronics. Fill out the coupon and mail it now. We'll promptly send you your free copy of "Your Future in the New World of Electronics."

CREI resident instruction (day or night) is offered in Washington, D. C. New classes start once a month. VETERANS: If you were discharged after June 27, 1950—let the new G. I. Bill of Rights help you obtain CREI resident instruction. Check the coupon for full information.

MAIL COUPON FOR FREE BOOKLET

CAPITOL RADIO ENGINEERING INSTITUTE

Dept. 1110D, 3224 16th St., N.W., Washington 10, D. C.

Send booklet "Your Future in the New World of Electronics" and course outline.

CHECK FIELD OF GREATEST INTEREST TV, FM & Advanced AM Servicing Aeronautical Radio Practical Television Engineering Engineering Broadcast Radio Engineering (AM, FM, TV) Practical Radio Engineering

Name

Street

City Zone State

Check Residence School Veteran

Become an ELECTRICAL ENGINEER in 36 MONTHS

Bachelor of Science Degree — Major in Electronics or Power

It is estimated by 1955 there will be at least two positions for every engineering and technician graduate. This college offers a tested plan that permits you to enter these vast employment opportunities at an early date. Save a valuable year through optional year-round study. Receive advanced credit for prior training gained in the armed forces, other schools or field experience.

ENTER BOTH RADIO AND TELEVISION 12 months or one-third of the B. S. degree course (Electronics major) — also brings you the Radio Technician's certificate. An added 6-month course qualifies you for the Radio-TV Technician's certificate. Recent developments open unlimited opportunities for TV technicians and engineers.

MILWAUKEE SCHOOL OF ENGINEERING

NONPROFIT • FOUNDED IN 1903



THE PROVEN "UNIT CHASSIS SYSTEM" of teaching was developed here. It "breaks down" the TV set by stages. You learn every component of all types and makes — and are prepared for future design changes, including the advent of color.

12-MONTH TELEVISION SERVICE COURSE... trains for good servicing jobs and shop ownership in the shortest practical time under expert instructors.

Terms open January, April, July, October. Over 48,000 former students from all states and 23 overseas countries. Faculty of trained specialists. Modern laboratories and equipment.

Write for free 110-page catalog, 48-page pictorial booklet "Your Career" and "Occupational Guidance Bulletins."

Milwaukee School of Engineering
Dept. RN-1052 1025 North Milwaukee
Milwaukee 1, Wisconsin

Without obligation send Catalog for Electrical Engineering, B. S. Degree, major in Electronics; Power; "Your Career"; Occupational Guidance Bulletin on: Radio-TV; Electrical Power; Welding; Heating, Refrigeration, Air Conditioning; Mechanical Engineering, B. S. Degree; Preparatory; Television Service.

Name.....Age.....

Address.....

City.....Zone.....State.....

If veteran, indicate date of discharge.....



Transistor Development

(Continued from page 65)

contacts,¹ and these devices appear to have some useful characteristics. If germanium having high resistivity is used, transistor power gain and current amplification are relatively independent of the separation of the points up to approximately 0.015 inch. As the spacings increase, however, the effect of the collector upon the emitter decreases, that is, the feedback resistance decreases. A transistor having a feedback resistance of 200 ohms at 0.002-inch spacing of the contacts would have only 50 ohms at 0.015-inch spacing. This value of feedback resistance for the wide-spaced transistors is low enough to assure short-circuit stability while values of power gain as high as 23 decibels are maintained. Even though the frequency-response limit varies inversely with the point spacing, the cut-off of the current amplification factor of the wide-spaced transistor is approximately 100 kilocycles because the resistivity of the germanium is higher than that used in narrow-spaced units. The other characteristics, except for the low internal feedback, are similar to those of the close-spaced transistor.

Power Considerations

The power capabilities of point-contact transistors are low and considerably limit the use of these devices. Most point-contact transistors do not withstand a collector power dissipation greater than 200 milliwatts. If the efficiency of operation as a class A amplifier is assumed to be 30 per cent, only 60 milliwatts of power output may be obtained from one stage of a transistor amplifier. A conservative figure for operation would be somewhere between 30 and 40 milliwatts. There are, however, many applications in which some benefit may be obtained from a device which operates at low power dissipations. Consequently, the greatest opportunities for the use of point-contact transistors lie in those applications where power output is of relatively little importance and conservation of power is of primary importance.

The power-handling capacity of the point-contact transistor is limited largely because of thermal effects at the collector point. Considerable heat is generated at this point of contact when a current is passed through it. Germanium is a fair conductor of heat and, consequently, some of the heat is conducted away from the point of contact through the germanium crystal and away from the crystal by the metal support. If too large a value of current is passed, however, the germanium and adjacent parts are unable to carry the heat away rapidly enough.

1. Slade, B. N.; "A High Performance Transistor with Wide Spacing Between Contacts," *RCA Review*, Vol. XI, No. 3, page 517, December, 1950

What is Your Musical Preference?

Classic symphonies
Chamber Music

Red-Hot Jazz Band?

Enjoy... one or all in natural, lifelike reproduction with a

ALL TRIODE **BROOK** HIGH QUALITY
AUDIO AMPLIFIER

Available in 10 or 30 watt models, featuring:

- All triodes.
- Attractive, remote-control pre-amplifier with inputs for tuner, TV and phono; or single-chassis units.
- Exclusive BROOK 3-position stepped bass & treble control circuits.
- BROOK-designed transformers and "transient peak" circuits.
- Harmonic distortion and intermodulation reduced to vanishing point.



Write for technical data, free booklet, "Better Listening" and name of local dealer, Dept. PK-

BROOK ELECTRONICS, INC.
34 DeHART PLACE, ELIZABETH 2, N.J.

REK-O-KUT

Presents the New Model B-16H

THREE SPEED, 16"

Transcription Turntable



For the BROADCAST
and RECORDING STUDIO

The Model B-16H employs entirely new elements of design, with operational features suggested by leading engineers in the field.

Dimensioned as a replacement for your obsolete 2-speed table. Present consoles can, with slight modifications, house this unit. The base is drilled and tapped for mounting Audak, Grey and Pickering arms.

- MOTOR: Hysteresis Synchronous
- TURNTABLE: 16" Cast Aluminum, Lathe turned
- SPEED CHANGE: Instantaneous for all 3 speeds
- 45 RPM ADAPTER: Disappearing type, built into hub of turntable.
- SPEED SHIFT: Mastermatic, self-locking.
- MODEL B-16H.....\$250.00 NET

Write for detailed literature.

REK-O-KUT CO.

38-05 Queens Blvd., Long Island City, N. Y.
EXPORT DIVISION: 458 Broadway, N. Y. C. U.S.A.
Canada: Atlas Radio Corp., Ltd., Toronto 28, Ont.

WANTED! WANTED!

Needed for Government Defense Projects—all types of military electronic gear with the prefix TS, BC, SCR, APR, AFS, etc. Highest prices paid or will exchange for your needs. No offer too small or too large.

WRITE! WIRE! CALL!

EQUIPMENT



TS-34/AP SYNCHROSCOPE AND OSCILLOSCOPE.

Used to test and service airborne and ground radars. Complete in portable carrying case with all probes, cables and accessories. Input 110v 60/2500 cyc.

- TS-3 AP-S-Band Power Frequency Meter
- TS-10/AP-APN-1 Test Set
- TS-12/AP-X-Band V.S.W.R. Test Set
- TS-13/AP-X-Band Signal Generator
- TS-14/AP-S-Band Signal Generator
- TS-15/AP-Flux Meter
- TS-16/AP-APN-1 Test Set
- TS-18 AP-Capacity Divider
- TS-23/APN-SCR-718 Test Set
- TS-33/AP-X-Band Frequency Meter
- TS-35 AP-X-Band Test Set
- TS-36 AP-X-Band Power Meter
- TS-45/APM-3 X-Band Signal Generator
- TS-59 APN-APN-1 Test Set
- TS-61 AP-S-Band Echo Box
- TS-62 AP-X-Band Echo Box
- TS-69/AP-300-1000 MC Frequency Meter
- TS-89/AP-Pulse Voltage Divider
- TS-98/AP-Pulse Voltage Divider
- TS-102/AP-Range Calibrator
- TS-111 AP-S-Band Wavemeter
- TS-118 AP-Power Meter
- TS-125 AP-S-Band Power Meter
- TS-155 UP-S-Band Signal Generator
- TS-164/AP-Frequency Meter
- TS-170/ARN-5-I.L.S. Test Set
- TS-184/AP-Test Set
- TS-226 AP-300-1000 MC Power Meter
- TS-268 UP-Crystal Test Set
- TS-278 AP-APS-13 Test Set
- IE-19-SCR-522 Test Set
- IE-36-SCII-522 Test Set
- BC-221-Frequency Meter
- BC-1277-S-Band Signal Generator
- TBN/3EV-Thermistor Bridge
- CW/60 ABM-S-Band Frequency Meter

FLUXMETER

Portable Gauss Meter with range of 500-4000 Gauss. Used to test Magnatron and other magnets. Probe has a gap of 1/4". Complete. Brand New \$32.50

RECEIVING TUBES

0A2	50.95	GAK5	50.88	6ST7	50.98
0A4G	1.05	GAK6	1.09	6SU7GT	2.75
0B2	1.95	6AL5	.52	6SV7	.98
0Z4	.59	6AQ5	.57	6V6	1.55
1A3	.70	6AQ6	.85	6V6GT	.65
1A7GT	.82	6AR6	1.25	6WA	.74
1B3/801G	.82	6AR6	.65	6X4	.65
1C5GT	.75	6AU5	1.19	6X5GT	.65
1D8GT	.65	6AU6	1.25	6V6G	.65
1G6GT	.65	6AV6	.55	6Y7G	.75
1L4	.67	6B4G	1.25	7A6	.75
1L4A	.85	6B7	.95	7B7	.75
1L6A	.95	6B8G	.75	7C5	.75
1L8A	.98	6B8A	.65	7C7	.75
1L85	.91	6BE6	.65	7N7	.85
1L85G	.75	6BF6	.72	7Y4	.59
1P5GT	.69	6CH6	1.89	12AG	.65
1R4	.69	6BJ6	.95	12A7	.90
1R5	.95	6BQ6	1.25	12AT6	1.19
1S4	.69	6C4	.55	12AT7	1.10
1S5	.65	6C5	.60	12AU6	.75
1T4	.65	6C6	1.59	12AU7	.88
1V4	.67	6CBG	.85	12B6	.69
1V	.65	6D6	.72	12C8	.69
1K2	.96	6D8	.85	12H6	.69
2A3	1.10	6E5	.79	12M8	.92
2X2	1.05	6F6	.85	12SA7GT	.79
2K2A	.65	6G7	.85	12SC7	.85
3A4	.65	6M6	.65	12SC7	.85
3A5	.85	6H6GT	.65	12SJ7GT	.65
3B7/1291	.43	6J5GT	.55	12SL7GT	.75
3D6/1299	.63	6J6	.95	12SN7GT	.85
3Q5GT	.75	6J7	.95	12TGT	.72
354	.74	6J7C	.60	12SR7	.72
3V4	.74	6K6GT	.65	14B6	.75
5R4GY	1.85	6L7	1.15	14H7	.85
5T4	1.32	6M8GT	1.15	25L6GT	.65
5U4G	.69	6L6	2.25	25Z5	.65
5V4G	.95	6SC7	1.50	25Z6GT	.68
5W4	.79	6L6GA	1.50	41	.69
5V3GT	.45	6L7	.85	43	.65
5Y4G	.85	6N7GT	.75	50A5	.89
5Z3	.85	6R7	.79	50A5	.89
5Z4G	.95	6SA7GT	.65	50B5	.75
6A3	.82	6SF7	.95	50C5	.67
6A6	.82	6SF7	.75	50L6GT	.65
6A7	.89	6SC7	.75	50Y6	.72
6B8GT	.95	6SH7	.65	53	.68
6AB7	.98	6SJ7	.75	53	.68
6AC5GT	1.05	6SK7GT	.72	75	.82
6AC7	.95	6SL7GT	.75	80	.65
6AG5	.75	6SN7GT	.75	83	.95
6AG7	1.45	6SQ7	.65	83V	.92
6AH6	.95	6STGT	.80	84/6Z4	.95
6AJ5	1.95	6SS7	.80		

PHONE: DIGBY 9-0347

WRITE FOR QUANTITY PRICES
Prices subject to change without notice. F.O.B., NYC minimum order \$10.00. 20% deposit required. All merchandise guaranteed.



RELIABILITY! HONESTY! SERVICE!
RADAR

- APA-10—Panoramic Adaptor
- APA-17—Automatic Direction Finder 250-1000 MC
- APQ-5—Low Altitude Tracking & Bombing Equip.
- APR-1—Radar Search Receiver 40-3400 MC
- APR-2—Radar Search Receiver 85-1000 MC
- APR-4—Radar Search Receiver 38-4000 MC
- APR-5—Radar Search Receiver 1000-3100 MC
- APR-6—Radar Search Receiver 3000-6000 MC
- APS-2—S-Band Search Radar
- APS-3—X-Band Search Radar
- APS-4—X-Band Search & Homing Radar
- APS-6—X-Band Search & Gun Laying Radar
- APS-15A—X-Band Blind Bombing Radar
- APT-4—Radar Jamming Xmitter 165-780 MC
- APT-5—Radar Jamming Xmitter 350-1400 MC
- SO-13—S-Band Marine Radar, Lightweight
- SO—10 CM Portable Radar
- TPS-1—Portable Search Radar
- TPS-3—L-Band Search Radar
- UPN-1 & 2—S-Band Portable Beacon Battery or 110v AC

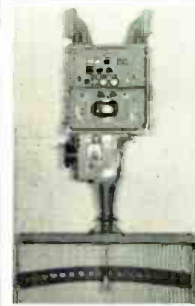

SO 10 CM PORTABLE RADAR

This set is a very compact search radar. Complete installation available. New in carrying cases. Tech. data as follows:
power input: 90-130v cyc.; pulse rate: 800 cyc.; range: 8, 15, 45 miles; pulse width: 1 microsec.; 300 yds. min. range, all ranges; I.F. synch. output available; accuracy ± 5'; power output 1 KW;

beam width: 8° horiz. 15° vert.; presentation: A, B, P.P.1.

MOBILE POWER PLANT (GAS DRIVEN)

Output: 220v—3KW—60 cyc. One phase. Excellent condition, checked out.

- RA-34—Power Supply for BC-375E
- RA-62—Power Supply for NCR-522
- BC-1016—Ink Tape Recorder
- PE-103—Vibrator Power Supply
- PE-104—Vibrator Power Supply
- GN-56—Hand Cranked Generator W/Legs & Seat
- SCR-578—Gibson Girl (Emergency Xmitter)
- CRT-3—Victory Girl Dual Gen. Emergency Xmitter Sound Powered Cheat & Headsets MI-2454-B; Type O, Mfg. KCA.
- AS-32/APX-1—Antenna
- AW CRC-7—V.H.F. Handi-Talkies 112MC Xtal Controlled
- MN/26-Y—Compass Receiver
- BC-733D—Receiver with Tubes
- C-3—Navy Snopescope in Carrying Case
- BC-1284—Lighthouse Tube Preampifier
- BC-99E—Interphone Amplifier
- RL-42—Motor Antenna Reel
- 30 MC—I.F. Strips Using 6AK5
- RD-7/APA-23—Recorder for APR
- AS-27/ARN-5—Antenna
- ARA—Receiver—500-1500 KC
- ID/80/APA-17—Indicator
- R-28/ARC-5—Receiver—100-156 MC
- RM-29—Remote Control
- BC-45E—Receiver—6-9 MC
- BC-45A—Receiver—3-6 MC
- BC-800—Transmitter/Receiver
- BC-950—Transmitter—100-156 MC
- RA-300—FM Exciter (Mfg. Tempco)
- FL-8—Filter
- FL-5—Filter, Less Cables
- 3C-16-D GSAP—Gun Camera Computers with All Accessories in Carrying Case
- AT-2A/APN-2—Antenna

SPARE PARTS AND COMPONENTS AVAILABLE FOR MANY EQUIPMENTS

ALL EQUIPMENT SOLD IS CAREFULLY RECONDITIONED AND CHECKED OUT TO ORIGINAL SPECIFICATIONS IN OUR OWN SHOPS USING FINEST LAB TYPE TEST EQUIPMENT.

THESE COMPLETELY EQUIPPED SHOPS AND OUR EXPERIENCED TECHNICAL STAFF ARE AVAILABLE FOR GOVERNMENT, PRIME OR SUB-CONTRACT WORK OR PRIVATE COMMERCIAL ORDERS ON ANY TYPE OF COMMUNICATIONS OR RADAR APPARATUS.

PANEL METERS

2" SQUARE WESTON—SANGAMO

- 0-20 Volts D.C. \$2.95
- 0-40 Volts D.C. 2.95
- 0-5 Amp. R.F. 2.95
- 0-5 Ma. \$2.95
- 0-500 Microamp. 4.95
- 0-100 Ma (0-300 scale) 2.95

COMMUNICATIONS

AN/ARC-1 TRANS/REC.

Provides Radio-Telephone Communication between Aircraft or Aircraft and Ground. Complete with Shock Mount and Control Box. Input: 28V DC. Excellent condition. Available in either 10 or 20 Crystal Controlled Channels 100-156 MGS.

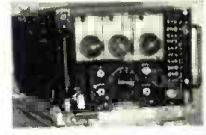

- APA-11—Pulse Analyzer
- APN-1—Airborne Radio Altimeter
- ARC-4—VHF Transceiver 140-150 MC
- ARN-5—Glide Path Receiver
- ARN-7—Airborne Direction Finder
- ARR-2—Homing & Receiving Equipment
- ART-13—Collins Autotune Transmitter
- BC-223—30-Watt Transmitter 2-5.2 MC
- BC-342—Receiver—1.5 to 18 MC 110v AC
- BC-348—Receiver—1.5 to 18 MC 28V DC
- BC-375E—Radio Transmitter
- BC-639—VHF Receiver 100-156 MC
- BC-640—VHF Transmitter 100-156 MC
- BC-1206—Beacon Receiver 200-400 KC
- RC-103—Airborne Localizer Receiver
- SCR-269—Radio Compass
- SCR-274N—Command Equipment
- SCR-284—Field Radio Station
- SCR-291—Semi-Portable Direction Finder
- SCR-300—Field Transmitter and Receiver
- SCR-522—VHF Transmitter and Receiver
- SCR-536—Handi-Talkie
- SCR-555—Semi-Portable Direction Finder
- SCR-694—Portable Field Transceiver
- SCR-625—Mine Detector
- SCR-718A-AM-C—High Altitude Altimeter
- T-50—Radio Telegraph Transmitter
- TCS—Marine Telephone Transceiver

XMITTING TUBES

0A3/VR75	51.04	15R	50.69	866A	51.35
0B3/VR90	1.19	2807	1.95	866JR	1.29
0C3/VR105	1.28	30 Spec.	3.25	872A	2.95
0D3/VR150	9.75	35T	3.25	874	1.19
1B24	9.75	45 Spec.	3.25	874	1.19
1B27	14.95	211	.65	885A	1.39
1B29	2.45	250TH	1.95	902A	9.95
1N21B	2.45	250TH	1.95	918	1.10
1N23	1.25	262B	3.95	922	1.25
1N23A	5.39	274B	2.95	928	1.05
1N28	1.25	104TH	8.75	927	1.05
1N34	.76	304TL	8.95	930	.95
1N34A	10.95	307A/RK75	3.95	931A	4.47
2AP1	7.50	328A	8.95	955	.35
2C40	14.95	350A	6.45	955	.35
2C44	6.45	350B	7.75	959	.39
2C46	7.95	368A5	7.50	958	.49
2D21	6.45	371A	3.95	959	.39
2E22	1.75	393A	7.95	1603	4.95
2E26	4.65	394A	3.95	1613	.79
2E26	4.65	394A	3.95	1616	.69
2K25/723AB	25.75	434A	27.50	1619	.24
2K28	25.75	446A	1.15	1622	2.45
2K33A	310.00	575A	15.75	1624	1.45
3A1	9.95	701A	5.75	1625	.35
3B24W	7.95	705A	1.65	1626	1.18
3B26	2.95	707B	1.95	1629	.25
3B27	2.95	714AY	7.95	1630	.75
3C22	115.00	715A	6.39	1631	.72
3C24/24C	7.75	715B	2.45	1638	.45
3C45	15.95	717A	19.95	1851	1.55
3CP1	1.95	717A	.98	1851	1.55
3CP1S1	4.45	721A	2.45	8011	.90
3DP1	4.45	723A	9.50	8012	2.65
3DP1A	6.95	723A/B	19.95	8013	2.59
3DP1-52A	1.65	724B	2.95	8014	.98
3D21A	3.25	725A	6.75	9001	1.50
3E29	13.95	726A	18.95	9002	.98
3FP7	1.65	730A	29.50	9003	1.65
3GP1	4.99	800	1.75	9004	.35
4-125A	27.50	802	3.95	9005	1.45
4-250A	37.50	803	3.25	9006	.27
4AP10	4.45	804	1.75	C1A	9.95
4C35	27.50	805	3.75	C6A	7.95
4E27	14.95	806	24.95	C6J	6.39
5AP1	3.45	807	1.59	CKD105	.48
5AP4	3.45	808	2.69	F123A	7.75
5BP1	4.45	810	9.50	F127A	27.50
5BP4	4.45	811	2.85	F128A	89.50
5CP1	4.99	812	2.75	FG17	4.89
5DP1	11.75	813	1.75	FG18	4.95
5D21	15.95	814	2.69	FG32A	8.95
5FP7	1.85	815	2.35	FG57	14.95
5GP1	4.95	816	2.35	FG81A	3.49
5JP1	24.45	826	.69	FG105	17.95
5JP2	22.50	828	8.95	FG172	33.50
5LP1	11.75	829	10.25	GL34A	29.95
5NP1	5.50	829B	12.95	GL502A	1.79
6AN5	3.30	830B	2.75	HF100	8.95
6A56	2.50	832A	3.75	HF300	22.45
6A57	4.45	832A	8.50	HY114B	.69
6C21	21.00	836A	3.49	HY115	.69
6J4	6.75	837	1.45	WL101	47.50
7BP7	6.55	836	2.25	REL21	1.95
7DP4	14.50	845W	4.25	RK60/1641	2.25
9L7	4.95	849C	27.50	RK65	26.50
10BP4	17.45	851	47.50	RK72	22.45
10Y	.39	860	.95	VT127A	2.45
12DP7	14.75	861	22.50	WL1616	34.50
15E	1.35	865	.98		

CABLE: HAMSHACK, N. Y.

RADIO HAM SHACK inc.
189 GREENWICH STREET NEW YORK, N.Y.



What Do You Want to Trade In on a New Hallicrafters?

I have a complete stock of Hallicrafters receivers and transmitters. We will give you the best doggone trade-in in the world because we need used receivers badly for our trade. What do you have? Write me about it. I give you prompt delivery, 90-day FREE service and the world's lowest credit terms. Write, wire, phone, or visit either store today for the best deal. Export orders solicited.

Bob Henry
WPARA



Popular Double-IF Model SX-71
A double superheterodyne circuit receiver at modest cost. Built-in narrow band FM reception. Temperature compensated, voltage regulated. 5 position band selector for 538-1650 kc, 1600-4800 kc, 4.6-13.5 mc, 12.5-35 mc, 46-56 mc. 11 tubes plus voltage regulator and rectifier. Only \$199.50



All-Wave Receiver Model SX-62
Covers 540 kc to 109 mc—including AM, FM, and SW broadcasts. Six bands: 540-1620 kc, 1620 kc-4.9mc, 4.9 mc-15 mc, 15-32 mc, 27-56 mc (AM-FM), 54-109 mc (AM-FM). Only \$289.50. Other popular Hallicrafters models: S-76, \$169.50; S-40B, \$99.95; S-72, \$109.95; S-72L, \$119.95; S-81, \$49.50; S-82, \$49.50.

Buffer 2, Missouri

HENRY RADIO STORES

11240 Olympic Blvd.
LOS ANGELES 25
CALIF.

"WORLD'S LARGEST DISTRIBUTORS OF SHORT WAVE RECEIVERS"

LEARN

Television-Radio Electricity

REFRIGERATION-ELECTRONICS

IN THE GREAT SHOPS OF

COYNE

TRAIN QUICKLY! OLDEST, BEST EQUIPPED SCHOOL of ITS KIND in U.S. Draft Age and Older Men..

Come to the Great Shops of Coyne in Chicago. Get practical training in TELEVISION-RADIO or ELECTRICITY—vital in Defense Program. Prepare now for a better job or better service rating.

Approved for veterans—finance plan for non-vets. Non-vets enroll now, pay most of tuition after graduation. If you need part-time work to help out with living expenses while at Coyne, we'll help you get it. Special plan for men of Draft Age.

FREE BOOK Clip coupon for Big Free Illustrated Book. Indicate below, course that interests you. No salesman will call. Act NOW.

B. W. Cooke, President
COYNE A TECHNICAL TRADE INSTITUTE CHARTERED NOT FOR PROFIT Established 1899 500 S. Paulina, Chicago

ELECTRICITY ★ TELEVISION RADIO ★ REFRIGERATION ★ ELECTRONICS

B. W. COOKE, Pres.
COYNE School
500 S. Paulina St., Chicago 12, Ill. Dept. 72-85H

Send FREE BOOK and full details on:

TELEVISION-RADIO ELECTRICITY

NAME.....

ADDRESS.....

CITY..... STATE.....

PHOTOCON SALES

417 N. Foothill Blvd. SY camare 2-4131
Pasadena 8, Calif. RY an 1-6751

FREE 24 PAGE SURPLUS SALES CATALOG

WANTED new or clean used electronic surplus. Please state exact description of the condition and details of modification. Include lowest price in first letter.

Audio Oscillator Hewlett-Packard 200 BR 20-20,000 c.p.s.	Exc.	\$110.00
1M & BC-221 Frequency Meter with cal. book, crystal, and tubes	Exc.	99.50
TS-352/U Weston Test Set	Exc.	150.00
TS-173/UR Frequency Meter 90-450 mc. complete with crystal, cal. book, & 115 VAC. Power Supply	Like new	600.00
TS-148/UP	New Mfg.	PUR*
Signal Generator 1000	Like new	PUR*
Million Signalizer Radio & TV	Like new	PUR*
Dumont 208 Scope	Exc.	PUR*
TS-146/UP X-Band Signal Generator	Exc.	PUR*
TS-12/ALP X-Band Signal Generator	Exc.	PUR*
TS-34/ALP Portable Oscilloscope	Exc.	350.00
TS-12 Test Set for X-Band Box 1 & 2 complete	Exc.	PUR*
Measurements Corp. Model S2 Standard Signal Generator 200x.50mc.	Exc.	PUR*
Hewlett-Packard Model 410A High Frequency V.T.V.M.	Like new	PUR*
Kay Electronic Mega-Sweep 100kc. to 1000 mc.	Exc.	PUR*
APR-4 Search Receiver	Exc.	PUR*
Tuning Units for APR-4 Receiver	Exc.	PUR*
BU-348. BC-312, BC-342 Receivers	Exc.	PUR*
APS-3	Exc.	PUR*
SCR-284 Fields Sets	Exc.	PUR*
A1NA or B	Exc.	PUR*
APR-5A	Exc.	PUR*
SCR 545 Radar Trailer	Exc.	PUR*
Type 120A Test Set 130-210 mc. Bouillon Radio Corp.	New	PUR* 20.00
Antenna AT 104/ATN9	New	
Automatic Pilot Inverter		
Type DA Input 28VDC @ 12 amps. Output 115V., 3 phase, 400 cps. 115VA.	Exc.	80.00
RG-8/U Coaxial Cable		.15/ft.
RG-58/U Coaxial Cable		.06/ft.
T-17 Hand Microphone with cord and PL-68	Exc.	4.50
1H-23 8000 ohm. Used	New	5.95
1H-18 8000 ohm. Used	New	2.25
1H-53 600 ohm. Used	New	6.95
1H-38 600 ohm. Used	New	2.25

*PUR—PRICE upon request.
NOTE: One of the largest and most complete electronic surplus stocks in the country. We have thousands of tubes, capacitors, plugs, accessories, transmitters-receivers, test equipment, etc. Send us your requirements.
TERMS: Prices F.O.B. Pasadena, California, 25% on all C.O.D. orders. Californians add 3% Sales Tax. Prices subject to change without notice.

If the collector point becomes too hot, the collector resistance decreases and a change occurs in the collector bias current and also in the voltage drop across the collector. Some permanent damage may occur if the transistor is operated at too high a dissipation. It is desirable, therefore, that the mechanical construction of the transistor be designed for the best possible heat conductivity away from the crystal. By increasing the size of the crystal support and adding cooling fins, the allowable dissipation of the transistor may be increased to 500 milliwatts or more, thus increasing the power output of the transistor.

The amount of conduction of heat away from the contact area varies inversely with the ambient temperature. As the ambient temperature is increased, the temperature at the point of contact becomes too great and the collector resistance is reduced. Changes in other properties of the transistor, such as the emitter resistance, transfer resistance, and internal feedback resistance, may also occur. The net result of these changes is a loss of power gain, changes in bias conditions, and possible permanent damage to the transistor. For best operation, germanium transistors should be operated at temperatures below 60 degrees centigrade. The maximum dissipation ratings of the device should also be reduced as ambient temperatures are increased above normal room temperature. At ambient temperatures below 25 degrees centigrade the situation is less critical, and if the temperature is low enough higher dissipations may be used without loss of stability.

Life Considerations

The life of the point-contact transistor is largely dependent upon electrical and physical considerations. The most obvious requirement for long life is that the transistor be physically very rugged. The slightest shifting of the point contacts may result in large changes in transistor characteristics. The RCA developmental transistors² which are illustrated here are embedded in a thermosetting plastic or resin. As a result of this embedding process, the transistor may be subjected to severe impacts with no damage to the physical and electrical characteristics of the transistor. Centrifugal forces with accelerations as high as 31,000g, and impact tests with accelerations as high as 1900g, have been applied to these transistors with no effect upon their characteristics, irrespective of the directions of the applied forces.

Experience has indicated that one of the most important causes of slump and failure in transistor operation is the attack of moisture and other chemical agents of the atmosphere upon the point-contact area of the transistor. A transistor which is completely unpro-

2. Slade, B. N.: "A Method of Improving the Electrical and Mechanical Stability of Point-Contact Transistors." RCA Review, Vol. XII, No. 4, pages 651-659, December, 1951

ected may fail in relatively high humidity in a few hours. It has become necessary, therefore, to prevent this moisture attack as much as possible by enclosing the point-contact area in waxes or resins having low moisture-absorption properties. Developmental RCA resin-embedded transistors have been subjected to continuous exposure at 95 per-cent relative humidity and immersion in water for periods of several months with practically no effect on transistor characteristics. Under normal conditions, transistors may be expected to survive with little change in characteristics for a long time. Predictions of point-contact transistor life of more than 70,000 hours either on the shelf or in operation do not seem at all unlikely if the transistors are operated within their ratings.

The resin-embedded transistors also withstand temperatures lower than -70 degrees centigrade and higher than 100 degrees centigrade during storage with no damage. Operation at the low values of temperatures is practical, but operation at high ambient temperatures is not feasible, as was mentioned before. These developmental transistors have also been subjected to temperature cycling between -70 degrees centigrade and 100 degrees centigrade with no change in transistor electrical or physical properties resulting.

Uniformity

If the transistor is to compete with other electron devices, uniformity and reproducibility of its characteristics are essential. The uniformity of transistors may be influenced to a large degree by the proper control of point spacing, point pressures, and the fabricating techniques employed. The uniformity of the germanium itself, however, is probably the most important factor in obtaining reproducible transistor characteristics. The art of germanium-crystal growing is rapidly progressing, and the uniformity of germanium has improved to the point where various transistor characteristics, such as current amplification, power gain, feedback resistance, and input and output resistance, have been controlled to within ± 25 per-cent. Uniformity comparable to that of the electron tube seems entirely possible.

Junction Transistors

Other developmental germanium-crystal devices, known as "p-n" junction transistors, have somewhat different characteristics from those of the point-contact transistor. In comparison with currently produced point-contact types, the junction transistors have lower noise, higher power gain, greater efficiency of operation, and higher power-handling capabilities. These improved characteristics, however, are not obtained without some loss in frequency response. Table 1 compares average values of several characteristics of the two types of transistors.

Two types of junction transistors have been developed. The "n-p-n"

HERE'S YOUR FALL BARGAIN GUIDE

OIL FILLED CONDENSERS

ALL NEW! ALL GUARANTEED! ALL BARGAINS!

1 mfd	600 vdc	C-D T6010	\$.079
2 mfd	600 vdc	C-D T72-6020	.89
2 mfd	330 vac	C-D Aerovox 605	.89
12.75 mfd	330 vac	C-D XX3127A	2.95
10 mfd	1500 vdc	C-D TJU-15100	4.75
15 mfd	2000 vdc	C-D TJU-15150	6.95
6 mfd	2000 vdc	C-D TJU-20050	4.95
6 mfd	2000 vdc	C-D TJU-20060	4.95
10 mfd	2000 vdc	C-D TJU-20100	6.95
4 mfd	2500 vdc	C-D TJU-25100	3.39
10 mfd	2500 vdc	C-D TJU-25100A	7.95
1 mfd	3000 vdc	C-D TJU-30010	1.50
0.1 mfd	4000 vdc	C-D TJU-40001	2.50
0.5 mfd	4000 vdc	C-D TJU-40005	3.45
4 mfd	4000 vdc	C-D TJU-40009	1.65
4 mfd	4000 vdc	C-D TJ-40040GB	11.95
0.02 mfd	5000 vdc	C-D MV-843	1.98
0.1 mfd	6000 vdc	Aerovox 6012	2.75
0.01 mfd	6000 vdc	C-D TJ-600010A	6.95
0.01 mfd	7500 vdc	Aerovox 7512	1.65
0.03 mfd	7500 vdc	Aerovox 7512	1.85
0.1 mfd	7500 vdc	Aerovox 7512	2.95
1 x 1 mfd	7500 vdc	Aerovox 7512	27.50
0.02 mfd	8000 vdc	C-D TJU-8023	1.15
0.65 mfd	2500 vdc	West 2K120065-1	19.50
3 mfd	12500 vdc	West Inerteen 258043	49.50
0.25 mfd	15000 vdc	Aerovox 15020	17.50
0.02 mfd	16000 vdc	GE 14F380	4.95
0.25 mfd	20000 vdc	GE 14F64	27.50
1 mfd	2500 vdc	West Inerteen 1166899	49.50

G-E PYRANOL SUPER SPECIALS

0.5 mfd 5000 vdc	GE 26F405, with mounting brackets, 3 3/4" x 4 1/2" x 2 1/2"	\$ 3.95
1 mfd 5000 vdc	GE 23F49, 3 3/4" x 4 1/2" x 4 1/2"	4.95
1 mfd 10000 vdc	GE 14F104, 7 1/2" x 9 1/2" x 4 1/2"	27.50

12 mfd 1500 vdc	Industrial 155AU1200	\$4.95
0.5 mfd 2000 vdc	C-D Dykanol TJU-20050	\$1.45

THERMADOR

POWER TRANSFORMERS & CHOKES
New Manufacture! Guaranteed One Year!

Type "A", Fully Enclosed POWER TRANSFORMER
5A-1225

PR1: 115 v 50/60 cycles
SEC: 750 v 250 ma CT
3 v, 3 a
6.3 v, 3 a
5.0 v, 3 a
Shipping Wt. 12 lbs.

POWER TRANSFORMER
5A-1225

PR1: 115 v 30/60 cycles
SEC: 600-440-0-440-000 v, 250 ma
3 v, 3 a
6.3 v, 3 a
5.0 v, 3 a
Shipping Wt. 17 lbs.

\$7.95

\$10.80

SMOOTHING CHOKES 7A-1225	SWINGING CHOKES 7A-5250
12 H. 250 ma. \$6.90	5 to 30 H. 250 to 25 ma. \$6.90

HERE'S THAT MIKE!

This is the low-priced hand-mike you boys have been waiting for. Same impedance as high-priced T-177, fits in palm of your hand. Frosted-talk switch on side. With 5' cord and PL-6R. Size: 3 1/2" x 1 1/2" x 3 1/2". Supplied in kit form or completely assembled. \$7.95. Kit with full instructions. \$2.79. Assembled, tested, ready to use. \$3.95

NOVICE 80 METER CW XMTR

Here's a neat and compact surplus item which converts very simply to 3700-3750 KC crystal controlled. Condition: Guaranteed suitable. Instructions? We furnish them! Complete, comprehensive, step-by-step; nothing left to guesswork. This is 5-3-7, the command transmitter which has been such a favorite with bird-timers. ONLY \$7.95

4 USES—4 DOLLARS

The most versatile dynamometer in surplus! The best dynamometer for conversion to 6 v. Multiple windings! After conversion you get choice of 190 or 350 v at 50 MA or 230 v at 100 MA. \$2.95. Excellent shift around, no mechanical work. Or use it as a 2:1 or 1:2 step-up or step-down transformer for DC voltage! Changes 6 to 12, or 12 to 24, or vice versa. Or use it as a GENERATOR! Turn with motor, get 12 v DC at 12.0 A or 24 v DC at 6.3 A, plus high voltage. Includes easily removable self-contained 800:1 scaled-in-oil gear reduction unit. Complete dope sheet furnished. BRAND NEW. \$4.00

COMMAND EQUIPMENT

With free dope sheets and schematics

RECEIVERS

BC-455, 6-0 mc. NEW \$12.95 GOOD USED. \$7.95

TRANSMITTERS

T-19 ARC-5, 3-4 mc. Excellent. \$17.95

BC-457 or T-20/ARC-5, 4-5.3 mc. Like new. 12.95

MOD BC-455, Brand new \$2.95. Excellent unit. \$2.49

As is, for parts. 1.29

274N PLUG, 7-prong male plug to fit back of command revs. and xmtrs. This is a new plug as used in the racks. NEW. each 21c. five for \$1.00

Local Control Adapter Parts for 274N or ARC-5 revs. Exact pot, switch knobs, etched plate and instruction data. Ready to mount. \$1.29

SPLINE TUNING KNOB. 79c

ANTENNA MAST SECTIONS, MS-49, 50, 51, 52. 39c

55. New, original packing. Each

EASY MONEY!

If you don't get our postcards telling the cash we'll pay for that surplus gear you bought when the buying was good, then you're missing OUT ON EASY MONEY! So send us your name and address NOW and GET ON OUR MAILING LIST! Or just tell us what you've got and we'll tell you what it's worth.

PRECISION CALIBRATED TUNER

Build a Q-meter or an audio oscillator, a signal generator, a VFO, an ultra-stable receiver, or you name it! Take standard accuracy and reliability, 3 gang condenser assembly with 4" precision dial etched 1.5-12 mc in 3 bands plus a reference scale. Triangular plastic hairline indicator; 50:1 ratio drive assembly, all gears spring-loaded double-section. Has tuning lock. Plates are two single spaced, 250 uuf, and one double-spaced 200 uuf section. Use double spaced section to eliminate drift. All are ceramic insulated. Neat and compact. Uncle paid a lot of money for this baby! New, clean, orig. pack from bulk spares. Was the VFO tuner for Collins TCS xmtr. We furnish free schematic complete TCS-12 with this. \$4.95 ONLY

BROADCAST BAND & AERO

MN-26-C Remote Controlled navigational direction finder and communications receiver. Manual DF in any one of three freq. bands, 150 to 1500 KC, 24 V. Self-contained dynamotor supply. Complete installation, including receiver control box, loop, azimuth control, Left-Right Indicator, plugs, loop transmission line, and flex. shafts. \$69.50

BRAND NEW, ORIG. PACK. \$39.50

MN-26-C alone, New. 6.95

MN-20-E Loop, Brand new. 6.95

MN-52 Crank drive, New. 2.50

BUILD TV-FM-AM SWEEP GENERATOR

(See Doc. Radio & TV News)

Now you can build that "VERMONT" SWEEP FREQUENCY GENERATOR! We've got a few more of these vital APN-1 magnetic units. With reprint of the article. \$6.95

SUPER HI-FI HEADSET BUY!

Uses annular-grooved plastic fibre cones with voice coils as in speakers, and padded chamois ear muffs to obtain spacing for correct acoustical load. Gives finest music reproduction, flat far beyond upper and lower limits of auditory perception. Pair in series has measured impedance of 600 ohms at 1000 cycles. Obtained with built-in high quality transformers. However, severe mismatching makes no apparent difference. Far superior to crystal phones. Manufacture at net price is \$45.00 each per pair. (Each unit can also be used as high quality dynamic mike with 300 ohm output impedance.) They come to you checked out with freshly laundered chamois pads in cellophane bag. ONLY \$7.95

PORTABLE POWER KITS

1. Includes 2 volt, 20 AH wet cell, lightweight transparent plastic, fibrite separators, 3 ball hydrometer, 4" x 3" x 5 1/2" high, shipped dry; also 2 volt synchronous vibrator, no tube needed; also 2 volt charger, 115 v 50/60 cy in. This high quality unit uses step-down transformer and dry disc rectifier, with pilot lamp in output to indicate and regulate charging rate. With eyepopper type battery filler and instructions. ALL 4 ITEMS, BRAND NEW. \$4.95

2. Six volt Libbrack kit. Vibratory transformer with two outputs; 345 v, 145 ma for plates, 15 v for bias. With schematic. BRAND NEW \$2.95

AUDIO SUPER-SPECIALS

SUPER HI-Q high cut choke, 0.65 H, 55 ohms DC. Tune with .001-.0004 MF. ONLY .98c

LOW CUT, 5 H, 284 ohms. Tune with 1 MF. Or use as 50 ma filter choke. ONLY .98c

OUNCER Transformers, one for mike to push-pull grid, cut 50 to 15,000 CPS; other for push-pull output, tapped sec., turns 1:1:1. In unit with resistors, condensers, etc. BOTH FOR ONLY. \$2.29

PHASE SPLITTER, or low-level amplifier, or push-pull unit. Has 3 windings, each exactly 1:1 to any other; essentially flat 100-15,000 CPS. BRAND NEW ONLY .69c

80 METER RECEIVER

3-6 MC Command, with schematic, excellent electrically, but show work. Satisfaction guaranteed. \$14.95

ANOTHER "G.L." FIRST!
TRANSISTORS

For Non-Priority Users

Triodes—Diodes—Photodiodes—Relays

The experimenter's bargain of the year! Transistors are the greatest advance in electronics since the invention of the vacuum tube. They perform most vacuum tube functions, but use less time and operate at very low plate power input. There are literally thousands of applications; amplifiers, control circuits, tripping circuits, firing circuits, etc., etc., etc., with many more awaiting discovery. You've read the literature on them; you want to get started on your own practical and experimental applications. Order now!

With each order we furnish data sheets on 36 types of transistors which we have available, together with useful dope sheet.

Here is a Popular Example of a Triode

Actual Size DCT-7		Actual Size DCT-7	
Data on Some Typical Triode DCT-7		Data on Some Typical Triode DCT-7	
DCT-4 DCT-5 DCT-6 DCT-7 DCT-8		DCT-4 DCT-5 DCT-6 DCT-7 DCT-8	
Xtal triode HF, max 5mc.	x	x	x
Xtal triode AF	x	x	x
Operating pwr gain (db)	16	17	17
Input impedance (ohms)	75k	250	200k
Output impedance (ohms)	1k	12k	2.5
Max cut-off freq. (MHz)	1.5	1.5	1.5
Max emit sig level DCV	+7	+3	+2
DC emitter cur (ma)	0.5	0.5	0.5
Max DC coil cur (ma)	2	2.5	1.3

\$2.95 EACH

Shipped Postpaid Anywhere in U.S.A.

Plus Free Data Sheets on 35 Other Types

Special Discounts to Mrs. and Parts Jobbers

Order Direct from this Advertisement
Send Check or M.O. NO C.O.D.s, please
Allow 30 to 45 days for initial order
ORDERS WILL BE FILLED IN ROTATION OF RECEIPT

G. L. ELECTRONICS 905 S. VERMONT AVE. LOS ANGELES 6, CALIF.

ALL PRICES F. O. B. LOS ANGELES. CALIF. BUYERS ADD SALES TAX

At your RMS Jobber

CVA-500 end-fired array — excellent reception in the fringe. Rugged — up fast, stays fast.



The little man



SP-6J Triode Tube Boosters . . . new beauty . . . excellent performance in semi-fringe and fringe. U/L approved.

is always there

SP-6 Pentode Tube Booster with external gain control ideal in the extreme fringe. U/L approved.



with everything



HG-450 Hi-Gain open transmission line is Copperweld . . . for stronger!

you need for

LA-3 lightning arrester — static discharge eliminator for twin lead or open line. Mounts flat or to mast. U/L approved.



TV installation



STYLE 8 and 10 element yagis . . . real uniquely steel-braced.

ask him for RMS products
RMS, New York 60, N. Y.

junction transistor³ is composed of alternate n, p, and n layers of germanium grown from a single crystal, as illustrated in Fig. 8. The center layer of "p"-type germanium is very thin; its thickness may be as little as 0.001 inch. Low-resistance contacts to the "n"-areas form the emitter and collector, and a low-resistance connection to the "p"-layer constitutes the base terminal. The principle of operation of the junction transistor is somewhat different from that of the point-contact transistor in that the rectification takes place at the junctions between the p- and n-type layers rather than at point contacts. In the point-contact transistor, holes or electrons drift from the emitter to the collector under the influence of electric fields. In the "n-p-n" junction transistor, electrons diffuse through the p-type layer and are attracted to the collector. The center layer has an excess of holes, but if this layer is thin enough, most of the electrons entering the base region from the emitter will reach the collector region without recombining with the holes. Practically all the electrons leaving the emitter reach the collector, thus resulting in a current amplification of approximately one, but this type of transistor cannot attain current amplifications greater than one unless more complex junctions are introduced. High power gains are obtained as a result of the tremendous impedance step-up between input and output circuits. The emitter junction is biased in the forward direction, and since the forward resistance of the junction is very low, the input impedance of the device is as low as 25 to 100 ohms. The resistance of the collector junction, which is biased in the reverse direction, is very high, on the order of several megohms, thus resulting in a very high output impedance. This tremendous difference in impedances can result in power gains of over 40 decibels.

Another junction device, the "p-n-p" transistor, illustrated in Fig. 1, is formed by diffusing two "p"-type impurity metals on opposite faces of a piece of "n"-type germanium. Atoms diffuse from these impurity metals into the germanium at high temperatures converting a portion of the "n"-type germanium to "p"-type, thus

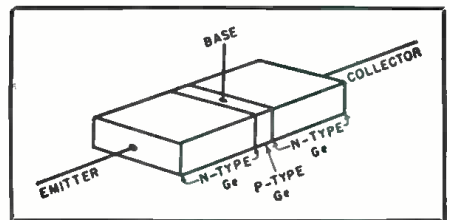

Fig. 8. Arrangement of "n" and "p" layers in an "n-p-n" type junction transistor.

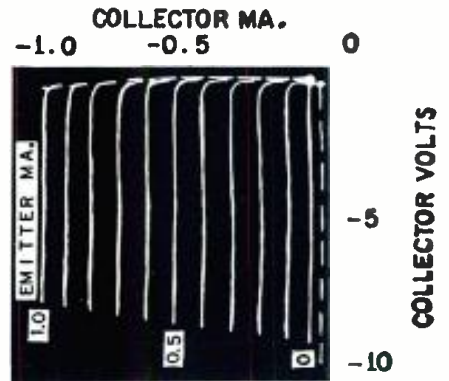

Fig. 9. Oscillogram of output characteristics of RCA's "p-n-p" junction transistor.

forming "p-n" junctions.⁴ In this transistor, the emitter is biased positively with respect to the base, and the collector is biased negatively with respect to the base. Hole carriers are injected by the emitter and arrive at the collector, resulting in a current amplification factor of approximately one, as in the "n-p-n" transistor.

An appreciation of some of the most outstanding qualities of the junction transistor may be obtained from a study of the output characteristics given in Fig. 9. This family of curves indicates that the junction transistor has a constant current amplification factor and output resistance down to very low collector voltages. Operation with power inputs as low as 0.6 microwatt have been reported. This input is about one-ten-thousandth the power dissipation required to operate the point-contact transistor, and less than one-millionth the power required to heat the cathode of most vacuum tubes. The almost ideal static characteristics show that the junction transistor can operate close to 50 per-cent efficiency as a class A amplifier. Although the junction transistors for which these characteristics are plotted can operate at only limited power dissipations, approximately 50 milliwatts, design of these devices for operation at 2 watts or greater is possible.

(To be continued)

- Wallace, R. L., Jr. and Pietenpol, W. J., "Some Circuit Properties and Applications of N-P-N Transistors," *Proceedings of the I.R.E.*, Vol. 39, No. 7, pages 753-767, July, 1951
- Saby, J. S.: "Recent Developments in Transistors and Related Devices," *Tele-Tech*, Vol. 10, No. 12, December, 1951

Table 1. Average values of several characteristics for two types of transistors.

	POINT-CONTACT TYPE	JUNCTION TYPE
Power Gain (Grounded base).....	23 db	40 db
Current Amplification Factor.....	2.5	0.98
Noise Figure (db above thermal at 1000 cycles)...	55 db	10 db
Minimum d.c. dissipation for satisfactory operation.	5 to 15 mw.	0.6 microwatt
Efficiency, Class A operation.....	30%	49%
Frequency Cut-off (3 db down in current amplification factor)	10 mc.	1 mc.

HEADQUARTERS FOR NEW IDEAS

FM, Records, Tape

Looking for ideas in FM tuners, or equipment used in conjunction with records and tape? Or ideas for installing and using them?

All over the Country, amateur enthusiasts and professional designers are working out new and constantly improved hi-fi installations. They range from simple, functional designs to those of strikingly decorative appearance. Some introduce new types of equipment; others represent unusual, special-purpose arrangements. They are reported in elaborately illustrated articles in HIGH-FIDELITY Magazine, described in the "Noted with Interest" columns, and discussed in the "Readers' Forum".

Everyone knows that interest in high fidelity, both as a hobby and a business, is spreading like wildfire, but if you want to find out just how much excitement it's creating, and the amount of new hi-fi equipment being brought out by the manufacturers, you can get the whole picture from the editorial and advertising pages in HIGH-FIDELITY.

Equipment Reports

For factual data on new equipment, the department containing the "Tested-in-the-Home Reports" is particularly valuable. These are not laboratory reports. Instead, they explain special design features, describe experiences with the equipment under conditions of use at home, and point out its suitability to particular applications.

In the opinion of many readers, such information is far more valuable than reports which presume to rate performance, and to compare products of different manufacturers, because an instrument that might be given a low rating will still outperform another of higher rating if the latter is

used improperly, or in an application for which it is not intended. As a matter of fact, we have had a great number of letters from readers who found that the Tested-in-the-Home Reports cleared up essential points about equipment which were not covered in manufacturers' instructions or literature.

Acoustics

There is a great deal of engineering data available on the subject of acoustics, but very little of it can be applied to the practical problems of home installations. A notable exception is the series of articles on speaker systems and room acoustics by G. A. Briggs. Probably the top-ranking authority on this subject in England, Mr. Briggs has the faculty of understanding what members of the hi-fi fraternity want to know. Then he has a way of presenting down-to-earth explanations, copiously illustrated, that are a joy to read because they are so easy to understand. Perhaps you are acquainted with his books on audio subjects. They are: "Amplifiers", "Sound Reproduction", "Loudspeakers", and "Pianos, Pianists, and Sonics". If so, you'll be doubly interested in Mr. Briggs series in HIGH-FIDELITY.

Installations

If you are planning a hi-fi installation for your own home, or if you are in the business of doing custom work for others, you will find an endless supply of ideas in HIGH-FIDELITY's picture sections devoted to various designs ranging from the simplest to the most expensive. In each issue a dozen or more installations are shown in big, detailed illustrations. There are modern music walls, equipment that disappears when not in use, methods for using old furniture pieces, and new

ways to mount speakers. Ideas? Why every issue of HIGH-FIDELITY is filled with them!

Audio Fair

You are particularly invited to visit us at the New York Audio Fair, Hotel New Yorker, October 29 to November 1. The FAS-2 audio system, to be described in HIGH-FIDELITY for November, will be on demonstration in Rooms 552 and 553. If you want to hear some of your own records on the FAS-2, bring them in. We'll be glad to play them for you. That is the best way to compare reproduction from the FAS-2 with your own system. Our editorial staff, now including Associate Editor John Conly, will be on hand to greet you.

High-Fidelity

This Magazine, now published on the first of every other month, not only covers all subjects related to hi-fi reproduction from FM, records, and tape, but includes a 24-page section of LP record reviews by some of the leading music authorities and critics. In each issue there is a complete discography by C. G. Burke, listing and reviewing all LP's of a leading composer. There is also information on discs and tape of interest to those who are particularly concerned with recording techniques.

The November issue, which will be mailed to subscribers on October 20, will be a special New York Audio Fair number.

HIGH-FIDELITY is a large-size magazine, elaborately illustrated, and beautifully printed on fine paper. If you are not already a subscriber, by all means order your subscription without delay. When you receive your first issue, if you are not entirely satisfied, the entire amount of your remittance will be refunded.

High Fidelity

MILTON B. SLEEPER, *Publisher*

"THE MAGAZINE FOR AUDIOPHILES"

Charles Fowler, Editor
HIGH-FIDELITY Magazine
RN-10 Publishing House, Great Barrington, Mass.

Please enter my subscription to HIGH-FIDELITY for which I enclose:

\$5.00 for 1 year (6 issues) SAVE \$1.00
 \$10.00 for 3 years (18 issues) SAVE \$8.00
(Single-copy price \$1.00)

Name.....
Address.....
Foreign postage: Add \$1.00 per year.

**OUTPERFORMS ORDINARY ENCLOSURES
MORE THAN 3 TIMES ITS SIZE!**

New



**MAXIMUM BASS
MINIMUM SPACE!**



USE WITH ANY LOUDSPEAKER FOR FINEST PERFORMANCE

A new trend! R-J enclosures will amaze you, as they did thousands at the Audio Fairs! Three models, each only slightly larger than the 8", 12" or 15" speaker it fits. Yet, you'll hear clean, smooth bass fundamentals, down to low organ pedal notes. Clean, unobstructed "highs", too. No distorting cabinet resonances. Versatile, low in price . . . especially adaptable to normal-size rooms. Mahogany or blonde Korina, fine furniture construction. Available for first time, at leading sound departments.

Send coupon for literature

R-J Audio Products
164 Duane Street, N. Y. 13, Dept. R-10
Gentlemen:
Please send literature and information on
R-J Speaker Enclosures.

Name.....
Address.....
City.....
Town.....State.....

POLYSTYRENE

ROD 12" LENGTHS			
O.D.	Price	O.D.	Price
1/8	\$.03	3/4	\$.80
3/16	.06	7/8	1.15
1/4	.10	1	1.55
5/16	.16	1 1/4	2.30
3/8	.21	1 1/2	3.30
1/2	.40	1 3/4	4.50
5/8	.57	2	5.90

TUBING 12" LENGTHS			
O.D.	I.D.	WALL	PRICE
1/4	1/8	.062	\$.07
5/16	3/16	.062	.10
3/8	1/4	.062	.13
1/2	3/8	.062	.18
5/8	1/2	.062	.23
3/4	5/8	.062	.29
1	7/8	.062	.38
1 1/2	1 1/4	.125	1.13
2	1 3/4	.125	1.50

SHEET-CLEAR MASKED BOTH SIDES

SIZE 12" x 12"		SIZE 12" x 24"	
1/16"	\$2.50	1/16"	\$4.90
3/32"	2.75	3/32"	5.25
1/8"	3.00	1/8"	5.90
3/16"	3.75	3/16"	7.25
1/4"	4.60	1/4"	8.25

Larger Thicknesses Up to 1"
Prices on Request

If not rated 25% with order, balance C.O.D. All prices F.O.B. our warehouse New York. No order under \$2.00. We ship to any part of the globe.

LEEDS RADIO CO.

75 Vesey Street Dept. EN-10
COrtlandt 7-3440 New York City 7

**YOU CAN
BUY**

QUIETROLE
TRADE MARK REG. U. S. PAT. OFF.

**NOW
IN**

3 SIZES



2-oz. 4-oz. 8-oz.

QUIETROLE is the original non-conductive, non-inflammable lubricant and cleaner for quieting noisy controls and switches. Over 15 years research, on the market over 5 years. QUIETROLE costs just a few cents more than cheap imitations. There is no substitute.

BUY AT YOUR DISTRIBUTORS

MFD. BY

QUIETROLE COMPANY

SPARTANBURG SOUTH CAROLINA

Selenium Rectifiers
(Continued from page 67)

ratio (reverse to forward impedance) and efficiency, due to increased reverse current. Fig. 2 shows the increase in reverse current as the frequency is varied from 20 to 15,000 cycles-per-second.

The minimum voltage at which a rectifier will pass measurable amounts of d.c. current in the forward, or conducting, direction is known as the threshold voltage. Depending on temperature, the threshold voltage in a selenium rectifier will vary between approximately .25 volt at high temperatures and .6 volt at low temperatures. This characteristic excludes the use of selenium rectifiers in applications where very low voltages are required; typical of these are measuring instruments and some control circuits. To insure proper operation and stability the r.m.s. voltage should be a minimum of 1 volt. On the other hand, many applications have been developed around this threshold voltage characteristic and selenium rectifiers are being used as filament voltage regulators and as protective shunts across sensitive instruments. Fig. 3 shows typical isothermal characteristics and values of threshold voltages at various temperatures.

When operated, and to a lesser extent when idle, selenium rectifiers will age; that is, with a constant a.c. input voltage, the rectified d.c. output voltage is higher when the rectifier is first installed than it is after a period of operation. The average decrease in output voltage after 10,000 hours of operation under normal conditions is approximately 5 per-cent, most of which occurs during the first few thousand hours. In applications where the d.c. voltage requirements are extremely critical, the transformer used should be provided with "aging" taps that will increase the a.c. input voltage to the rectifier by 5 to 10 per-cent. By this method any aging of the selenium rectifier can be compensated by increased input voltage.

Selenium rectifiers can be overloaded for their current output under momentary or cyclic conditions without serious damage; however, a prolonged overload such as caused by a short circuit will damage the rectifier. Fuses or other protective devices should be used wherever possible and the cause of trouble corrected before power is applied to the rectifier.

Overvoltage conditions are more serious than current overloads. A potential in excess of rating may cause a breakdown across the selenium layer and while a selenium rectifier is "self-healing" to an extent, prolonged overvoltage conditions will cause rectifier failure. If an overvoltage condition occurs and the breakdown across the rectifier is sustained the odor of selenium fumes can be detected and power should be turned off immediate-



Sensational new TV set for multiple-view installation!

MANUFACTURED BY BELMONT RADIO CORP.—
A DIVISION OF RAYTHEON CORP. OF AMERICA!

Trans-Vue

"ENTERTAINER"

MODEL No. 160-L

1 REMOTE TUNER SERVICES UP TO 4 DEFLEC- TION CHASSES!

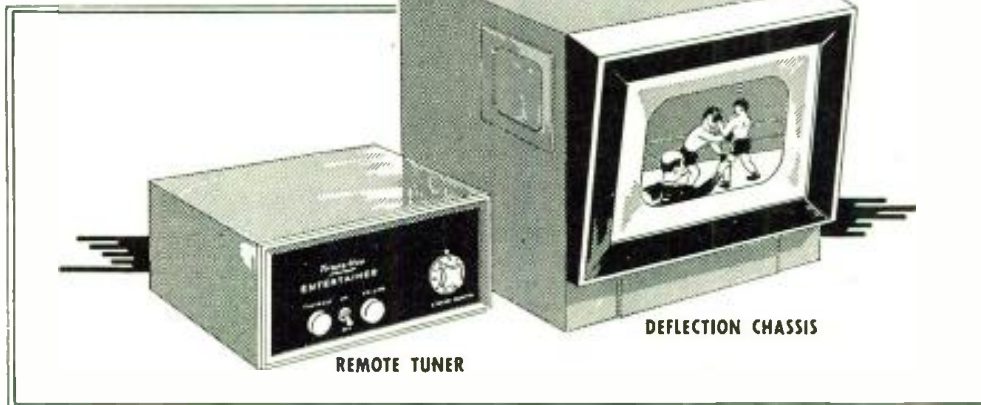

The TRANS-VUE Model 160-L consists of two units—the Remote Tuner and the Deflection Chassis. The antenna installation should be made under the supervision of a qualified serviceman. Use an antenna with a balanced 300 ohm impedance. All controls on the Deflection Chassis have been pre-set at the factory. Both Chassis and Tuner are ready for immediate installation and operation.

The set should be operated from a 105-125 V. source, AC, 50-60 cycles. Deflection chassis gets its AC supply through long cord connecting it to Remote Tuner which has 1 AC outlets. One tuner services up to 1 chassis all of which are regulated simultaneously with on-off switch on remote tuner. DIMENSIONS: Deflection Chassis: height, 23 1/4"; width, 23 1/2"; depth, 26 1/2" (top), 23 1/4" (bottom). Remote Tuner: height, 9"; width, 16 1/4"; depth, 15 1/2".

- 22 Tubes in Chassis
- 12 Tubes in Remote Tuner
- 16AP4 CR Tube
- 8 In. P.M. Speaker
- Cabinets of Highly Polished Mahogany!

SET OF REMOTE TUNER AND DEFLECTION CHASSIS **\$139.50** for Both

Complete with all cables, wire, connectors and full schematic covering installation, operation and maintenance.

EXTRA CHASSIS \$79.50 EACH



JACKSON HI-FIDELITY FM-AM CHASSIS

- Custom Engineered for High Quality at Low Cost
- Ideal for Modernization or New Cabinet Installation
- Advanced Design—Superior Components—Unexcelled Performance

The extra-sensitive superhet circuit, with separate RF amplifier, covers the FM band from 87.5 to 108.5 Mc, and the AM band from 540 to 1620 Kc. Tube complement, 1—12AT7, 1—6BE6, 2—6BA6, 1—6AL5, 1—6AT6, 1—6AQ5, plus a 6X4 rectifier. Phono input with front panel control. An extra heavy duty transformer type power supply is used. The music lover will appreciate its colorful tone on FM, AM and phono, plus the convenience of varied tone control on all. The 3.2 ohm output transformer may be used with any good speaker. A template is furnished to facilitate cutting dial opening and control shaft holes. Chassis comes complete with all tubes, large 3 1/2" slide rule dial with soft-lite rear illumination, escutcheon, knobs, mounting parts and complete instructions. For 115-125 volts 60 cycles AC. Dimensions: 7" high, 12" wide, 6 1/2" deep. Shpg. wgt. 1 1/2 lbs. **\$54.95**

MODEL FABA SPECIAL

ASTATIC CRYSTAL MIKE



WITH ON-OFF SWITCH

\$6.95

HI-VOLTAGE TV CONDENSER

500 MMFD—20,000 V.



500 MMFD ceramic enclosed condensers for TV power supplies and for coupling and high voltage by-pass. 1" diameter. Threaded terminals. 100% guaranteed.

79c EACH

SANGAMO MOLDED BY-PASS CONDENSERS

.01—600V \$0.12	.001—600V \$0.10
.02—600V12	.002—600V10
.05—600V16	.005—600V10
.1—600V19	.008—600V10

C. R. TUBES—

NEW NAME BRAND..... **\$22.50**

16AP4, Each 1 year Guarantee. 14BP4..... **\$19.95**

VIDEO BEAM

INDOOR ANTENNA: 3-section. New low price. Ea. **\$1.49**

3-WAY PHONO PICK-UP L-20 ASTATIC #307..... **\$3.45**

\$22.50

BRUSH CRYSTAL MICROPHONE HEARING AID

Actual size 1" diam. black or natural colors. Use on radio as extra speaker, or as lapel microphone. Also as hearing aid, dictation, telephone communication, or throat mike. Brand new. Limited quantity. **\$1.95** Cord... **\$0.95** Set of both Mike & Cord... **\$2.49**

SENSATIONAL SPEAKER VALUES

Most popular types for replacement and new construction!

1 inch P.M. \$1.39	10 inch P.M. \$2.69
5 " P.M. 1.49	12 " P.M. 3.49
6 " P.M. 1.69	8 " Electro-dynamic 1.49
4x6 " P.M. 1.49	11 " 500 ohm 1.89
6x9 " P.M. 2.49	12 " 1,000 ohm 2.29
8 " P.M. 2.29		

BONUS BOX OF SUPER SPECIALS

MIDGET IF XFMR, 456 Kc. \$0.49
PLASTIC RECORDING TAPE: Red oxide. 1,200 ft. 2.29
WESTINGHOUSE DIAL LIGHTS: 100 to the box. #44, #46, #47; \$5.29; #51. 4.29
PC-81 PRINTED CIRCUIT CENTRALAB.25
DUAL TV VOLUME CONTROL. With switch39
8AS 450 V. CONDENSER UPRIGHT.49

TV DEFLECTION YOKES

Major brand names. Most popular types at LOWEST PRICE! Ea. ONLY **89c**

SUPERSONIC TV BOOSTER \$8.95

RADIANT VIBRATOR

S-1 ea. **\$1.39**

SPECIAL In lots of 25, each only \$1.25

LAMP CORD #18

ZIPS APART 2-CONDUCTOR 250 Ft. Spool **\$4.95**

All orders F.O.B. Los Angeles. All goods subject to prior sale. 25% deposit required with order.

OLYMPIC ELECTRONICS SUPPLY DISTRIBUTORS

1440 W. Olympic Blvd., Los Angeles 15, Calif.

**EDLIE ELECTRONICS
BRINGS YOU
TV RECEPTION
UP TO 200 MILES**

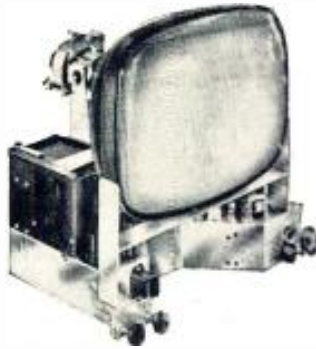

**ON ACTUAL FIELD TESTS WITH
NEW DX630 CHASSIS
USING THE CASCADE TUNER**
will operate in fringe areas or in localities remote from TV broadcast stations up to 200 miles.
HAS 4 MICROVOLT SENSITIVITY—10 times any other TV receiver. Will pick up distant stations without use of booster or special antenna arrays—and with less noise. Will operate any tube including 24", greater brilliance, improved keyed AGC circuit (eliminating flickering and fading). Uses the best materials with a high factor of safety to insure trouble-free operation. **STD. RTMA GUARANTEE** free replacement of defective parts or tubes for 90 days. Completely factory-wired chassis ready to operate with 12" P.M. Speaker.
Price Including Excise tax.....\$144.50

EDLIE ELECTRONICS INC.—154 GREENWICH St., NEW YORK 6, N. Y.



**DRESS UP YOUR HOME
WITH THIS**

Console cabinet of beautiful design made of the finest veneers and good finish. Size 39" high x 24" wide x 22 3/4" deep. Finished in mahogany or walnut. Cut for 630 chassis with 12" speaker; will take either 16, 17, or 20" tube. (Please Specify Size.)

Price including mask and excise tax.....\$43.95
Extra for glass.....\$2.75

TELEVISION PICTURE TUBES

Standard Brands

ONE-YEAR GUARANTEE

12 1/2" (Black) or White)....	\$22.50	Glass 16" Round (Black)	\$22.50
Glass 14" Rectangular (Blk.)	\$23.50	Glass 16" Rectangular (Blk.)	\$22.50
17" Rectangular (Blk.)	\$24.50	19" Round (Blk.)	\$34.50
20" Rectangular (Blk.)	\$34.50	21" Rectangular (Blk.)	\$36.50
21" Rectangular (Blk.)	\$36.50	24" Metal	\$67.25

WRITE FOR COMPLETE CATALOG N-5

ly to minimize the damage. Cause of the overvoltage condition should be determined and corrected before the power is turned on again.

Typical circuits in popular use and a brief explanation of each follows:

Single Phase

Half Wave (Fig. 4A): Half-wave rectification is generally used in applications that require little power. Most popular applications have been in radio and television receivers to deliver "B+" power. The ripple frequency is the same as the supply frequency and the ripple component is large since the rectifier conducts only during one half of the input cycle. Special transformer design is required because of unidirectional flow of d.c. current through the secondary.

Bridge (Fig. 4B): The single-phase bridge rectifier is popular because it offers flexibility of design, full-wave rectification, ripple frequency twice source frequency, high efficiency, and utilization of an economical transformer design. Its fields of application cover every phase of electronic and electrical design.

Center Tap (Fig. 4C): As in the bridge circuit, the ripple frequency and efficiency are high; however, the transformer design is more complicated. The full-wave, centertap circuit is commonly used in low voltage applications (less than 10 volts d.c.) such as laboratory electroplating and battery charging equipment.

Three-Phase

Half Wave (Fig. 4D): The three-phase, half-wave connection is primarily used in low voltage high current applications. The output ripple frequency is three times the source frequency and the load ripple component is approximately 20 per-cent. The three-phase, half-wave rectifier is commonly used in commercial electroplating applications that require thousands of amperes of current.

Bridge (Fig. 4E): The three-phase bridge is the most economical and useful circuit where d.c. power requirements are high and efficiency is an important factor. The ripple frequency is six times the source frequency and the load ripple component is only 4.5 per-cent. In most applications filtering is not required. Popular applications include aircraft motor starters, electrolysis equipment, large power supplies, and arc welding equipment.

Center Tap (Fig. 4F): The three-phase, centertap circuit is used where d.c. voltage requirements do not exceed 15 volts and load current requirements are high. Special transformer design is required to provide a six-phase secondary. This connection is used to some extent in electroplating equipment.

In addition to the popular circuits discussed, selenium rectifiers are used in many special applications that take advantage of characteristics peculiar to selenium rectifiers. Typical of



**Where You Need it!
When You Need It!**

NOW—no more halted work, no more writing to the factory for missing instruction sheets. Tough identifying labels giving complete application and hook-up data are affixed to all Halldorson components. This provides maximum convenience in original installations or reuse at some later date. The same data appears on each box for instant identification.

This is only one of Halldorson's many aids designed to save your valuable time. Look to Halldorson for the biggest variety of transformer components, plus the newest for TV. Ask your distributor for your copy of Halldorson's great new catalog and TV Replacement Guide... today. The Halldorson Transformer Co., 4500 N. Ravenswood Ave., Chicago 40, Ill. Dept. RN13



HALLDORSON
QUALITY Transformers SINCE 1913

EXPORT: Intex Co., Inc., 303 W. 42nd St., New York 36, N.Y. Cable Address: Intexcom, N.Y.

**Why not get the BEST in—
Quality Test Equipment!**

**Famous Professional
TS-3 "Stethoscope"**



The World-Famous instrument that locates all radio faults—intermittents, noisy sets, mis-tracking, low sensitivity, etc., . . . in a jiffy.

Easy to use by beginners or experts. Similar model shipped to U. S. Navy.

TS-3K Easy-to-Build Kit Form.....ONLY \$24.95
TS-3W Factory-built, tested.....ONLY \$37.95

**New Cathode Ray
"Stethoscope" TS-7**

For FM and television . . . finds faults in a hurry . . . best for really tough jobs. Includes a quality 5" oscilloscope plus aural "Stethoscope" and other useful features.



TS-7K Easy-to-Build KIT FORM... ONLY \$49.50
TS-7W Factory-built and tested... ONLY \$98.50

ALSO

TS-9 . . . VACUUM TUBE VOLT-OHM-MILLIAM-METER . . . assembled or in kit form . . . from \$25.45
TS-8 . . . "ELECTROSCOPE" Electric Appliance Tester. Tests all Appliances, circuits, motors, etc. only \$20.75

You owe it to yourself to get the BEST. Get the full story on the complete FEILER line before you buy.

Available at all leading Radio Parts Jobbers . . . Write for FREE folder—"How to Select Your Radio and TV Test Instruments."

Clip this coupon (write your name, address in margin).
FEILER ENGINEERING and MFG. CO.
8026 N. Monticello Ave.
Skokie, Ill.
(Suburb of Chicago)



EDW. H. GUILFORD
Vice President

I can train you to pass your FCC License Exams in a minimum of time if you've had any practical radio experience—amateur, Army, Navy, radio servicing, or other. My time-proved plan can help put you, too, on the road to success.

Let me send you **FREE** the entire story

Just fill out the coupon and mail it. I will send you, free of charge, a copy of "How to Pass FCC License Exams," plus a sample FCC-type Exam, and the amazing new booklet, "Money-Making FCC License Information."

How to Pass FCC License Exams

**Commercial
Radio Operator**



FREE

Tells where to apply and take FCC examinations, location of examining office, scope of knowledge required, approved way to prepare for FCC examinations, positive method of checking your knowledge before taking the examination.

Get Your FCC Ticket in a Minimum of Time

Get this Amazing Booklet **FREE**

TELLS HOW—

WE GUARANTEE
TO TRAIN AND COACH YOU AT HOME
IN SPARE TIME UNTIL YOU GET

YOUR FCC LICENSE

If you have had any practical experience—Amateur, Army, Navy, radio repair, or experimenting

TELLS HOW—

Employers make

JOB OFFERS Like These
to Our Graduates Every Month

Letter from Chief Engineer, Broadcast Station, North Carolina. "Need men with radio-telephone 1st class licenses, no experience necessary. Will learn more than at average station for we are equipped with Diesel Electric power, transmitting and studio equipment."

Telegram from Chief Engineer, Broadcast Station, Wyoming. "Please send latest list available first class operators. Have November 10th opening for two combo men."

These are just a few examples of the job offers that come to our office periodically. Some licensed radiomen filled each of these jobs . . . it might have been you!

HERE'S PROOF FCC LICENSES ARE OFTEN SECURED IN A FEW HOURS OF STUDY WITH OUR COACHING AT HOME IN SPARE TIME

Name and Address	License	Lessons
Lee Worthy 2210 1/2 Wilshire St., Bakersfield, Cal.	2nd Phone	16
Clifford E. Vost Box 1016, Dania, Fla.	1st Phone	20
Francis X. Fogeh 38 Bauler Pl., Bergenfield, N. J.	1st Phone	38
S/Set. Ben H. Davis 317 North Roosevelt, Lebanon, Ill.	1st Phone	28
Albert Schoell 110 West 11th St., Escondido, Cal.	2nd Phone	23

CLEVELAND INSTITUTE OF RADIO ELECTRONICS
Carl E. Smith, E. E., Consulting Engineer, President
Desk RN-45—4900 Euclid Bldg., Cleveland 3, Ohio

TELLS HOW—

Our Amazingly Effective
JOB-FINDING SERVICE

Helps GIRE Students Get Better Jobs

Here are a few recent examples of Job-Finding results

GETS FIVE JOB-OFFERS FROM BROADCAST STATIONS
"Your 'Chief Engineer's Bulletin' is a grand way of obtaining employment for your graduates who have obtained their 1st class license. Since my name has been on the list I have received calls or letters from five stations in the southern states, and am now employed as Transmitting Engineer at WMMT."
Elmer Powell, Box 274, Sparta, Tenn.

GETS CIVIL SERVICE JOB
"I have obtained a position at Wright-Patterson Air Force Base, Dayton, Ohio, as Junior Electronic Equipment Repairman. The Employment Application you prepared for me had a lot to do with my landing this desirable position."
Charles E. Loomis, 4516 Genessee Ave., Dayton 6, Ohio.

GETS JOB WITH CAA
"I have had half a dozen or so offers since I mailed some fifty of the two hundred employment applications your school forwarded me. I accepted a position with the Civil Aeronautics Administration as Maintenance Technician. Thank you very much for the fine cooperation and help your organization has given me in finding a job in the radio field."
Dale E. Young, 122 Robbins St., Owassee, Mich.

Your FCC Ticket is recognized in all radio fields as proof of your technical ability.

Get All 3 FREE
MAIL COUPON NOW

CLEVELAND INSTITUTE OF RADIO ELECTRONICS

Desk RN-45 4900 Euclid Bldg., Cleveland 3, Ohio
(Address to Desk No. to avoid delay)

I want to know how I can get my FCC ticket in a minimum of time. Send me your **FREE** booklet, "How to Pass FCC License Examinations" (does not cover exams for Amateur License), as well as a Sample FCC-type exam and the amazing new booklet, "Money-Making FCC License Information."
 Tell me now I can get a TV Engineering Course without additional charge.

NAME.....
ADDRESS.....
CITY.....ZONE.....STATE.....

Paste on 2-cent post card or send air mail



Big Savings at **NEWARK** on Top Notch Audio Equipment

Save On Every Item

Save More By Buying the Complete System

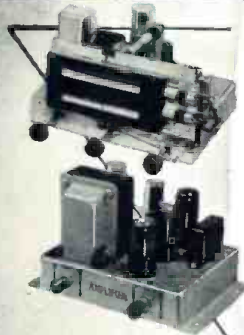

The Complete System
only \$82.50

PILOT HI-FI FM-AM TUNER. Save more than half on this deluxe tuner worth \$89.95. Bandswitch has 4 positions: AM, FM, Phono and TV. Circuit includes 1-stage audio amplifier with response, ± 2 db, 20 to 15,000 cps. Separate 3-gang tuning condensers and tuned RF stages on both FM and AM. FM section has temperature compensated oscillator for minimum drift; AM section has IF wave trap for rejection of signals in the IF passband. Sensitivity: FM, 20 mv for .3 volt output with quieting; AM, 3 mv for .3 volt output. With: 6-6BA6, 1-6BE6, 1-6AL5, 1-6AT6, 1-6X5GT. Self-contained power supply. Has built-in FM and AM antennas, plus provision for external ones. 11 1/2 x 6 x 9". Wt., 8 1/2 lbs. **81F003. Special Price..... 42.95**

NEWARK LOW-COST AMPLIFIER. Compact 8-watt amplifier using 2-6V6 or 6K6 push-pull output tubes. Employs 6SN7 as Audio Driver and Phase Inverter; 5Y3GT is rectifier. Response, 50 to 12,000 cycles. Has continuously variable tone and volume controls. Outlet for AC phono motor plug on back. Output impedance, 8 ohms. Chassis size, 6x8 1/2 x 5 3/8". Wt., 7 lbs. **81F001. Special Price..... 21.50**

The Famous Regency
Model DB-410
Television
Booster
Special Price!
\$14.11

Handsome mahogany
plastic case, 5 1/4 x 4 1/8 x
3 3/8". All brand new, in
original cartons. With
616 tube, 6 lbs.
90F150. Special... 14.11



G.I. 3-SPEED CHANGER. Tone arm uses crystal cartridge with single .002" needle to play both standard and microgroove records. Size: 12 3/4 x 12 x 5-7/16". Requires 4-1/16" above, 3/8" below. Wt., 12 lbs. **81F000. Special Price..... 17.88**

NEWARK 12" SPEAKER. Handles 13 watts of audio power. Has heavy Alnico V magnet. 6-8 ohms voice coil. Wt., 5 lbs. **81F104. Special Price..... 6.95**

ORDER
FROM
DEPT. R-10

COMPLETE FM-AM SYSTEM. Wt., 15 lbs.
81F013. Special Price..... 82.50

FREE! CATALOG No. 51

NEWARK
ELECTRIC COMPANY

223 W. MADISON ST.
CHICAGO 6, ILLINOIS

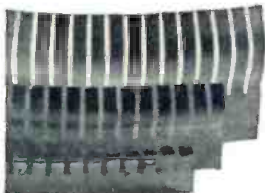

FINGER STOCK

Electrical Weather-Stripping
by Eimac —
Now Available!

Silver-plated, spring alloy, pre-formed finger stock especially suited for electrical "weather-stripping" for TVI-proofing cabinet access doors, etc. Also ideal for making coaxially constructed tube connections and many other uses. Available in 17/32", 31/32", and 1 1/8" widths.

- Write for new Eimac Catalogue Summary showing Eimac tubes and other accessories.

Eimac

EITEL - McCULLOUGH, INC.
San Bruno, California

South River
★ ★ NEWS ★ ★

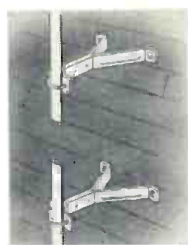

6"
WALL
BRACKET

Model
WB-6

Designed for average wall installation on homes with small eave overhang. Constructed of heavy gauge steel, riveted for extra strength. Has hot-dip galvanized finish which prevents rust-staining of walls. Special "U" bolt fits all size masts up to 1 1/2" O.D. and prevents mast from turning in high winds. With hardware.

South River Antenna Mounting Accessories are carried by every leading TV Parts Jobber from coast to coast.

New catalog mailed to all Dealers and Service Men. Write, if you haven't received yours!

**SOUTH RIVER METAL
PRODUCTS CO., INC.**
SOUTH RIVER, N. J.

PIONEER AND OUTSTANDING PRODUCER
OF FINEST LINE OF ANTENNA MOUNTS

these are voltage regulators, spark quenchers, protective shunts, polarizing circuits, magnetic and capacitive field discharge, and d.c. blocking.

A few precautions which must be taken when using selenium rectifiers include:

1. Do not use an ohmmeter to test rectifiers. The nonlinear resistance inherent in selenium rectifiers will give erroneous results.

2. Do not loosen the rectifier stack assembly.

3. Take care to keep solder and soldering irons from contacting rectifier cells.

4. Do not install selenium rectifiers with open construction in explosive atmospheres.

5. Even though the rectifier is rugged and can stand abuse, do not subject stacks to severe shock or dropping.

6. Do not expose rectifiers to concentrated mercury vapors.

7. Mount rectifiers away from other heat radiating components.

8. Take special precautions at extremely high and low temperatures.

A good policy to establish is to contact a manufacturer of selenium rectifiers whenever there is any question regarding application or design. Competent engineers and modern laboratory facilities are available to solve your problem.

-30-

PURPLE GLOW VHF CLUB TO LAUNCH PG-2 BALLOON

THE Purple Glow VHF Club of Albuquerque, New Mexico will launch another balloon on Saturday, October 25, 1952, airborne by 7:30 p.m. (MST), which will transmit a c.w. signal on 143.99 mc., using the call AF5CA (by courtesy of the Air Force Mars). The balloon is expected to remain aloft approximately 24 hours.

The call AF5CA will be followed by a 3-letter cipher (secret) which will be sent continuously at a slow rate on c.w. All v.h.f. enthusiasts are urged to listen for the PG-2 balloon during its scheduled flight.

-30-

HUDSON DIVISION ARRL

THE Albany Amateur Radio Association will sponsor the Hudson Division ARRL Convention October 3, 4, and 5 in Albany, New York. Meetings will be held at the Ten Eyck Hotel in that city.

A diversified program of interest to all amateurs is being planned. The committee has scheduled demonstrations and talks on single sideband, microwaves, and the transistor as well as special features of interest to the mobile enthusiast and the Novice amateur.

An FCC examiner will be on hand to give examinations for those interested in obtaining their licenses.

A complete program of special activities has been planned for the ladies attending the convention.

Tickets are obtainable from H. L. Schultz, Jr., c/o Box 6073, Albany, N.Y. Tickets are \$6.00 each and since reservations are limited, interested amateurs are asked to send in their orders promptly.

-30-

SAVE ON New HICKOK INSTRUMENTS

WITH A *Walter Ashe Surprise* TRADE-IN ALLOWANCE

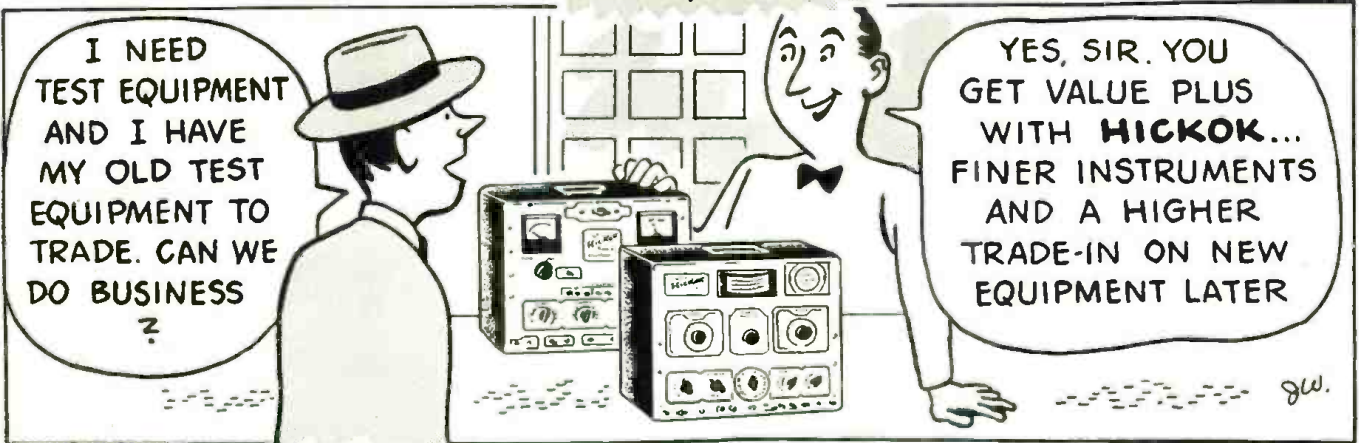

Your HICKOK Is Always Worth More!!..

SEND COUPON TODAY FOR TOP TRADE!



NEW HICKOK MODEL 670 5-INCH OSCILLOGRAPH.

Accurate, stable. High sensitivity with AC and DC amplifiers. Shpg. wt. 35 lbs. Only \$229.00

For sensational savings on the new Hickok test instruments of your choice, get our trade in allowance on your used (factory-built) test or communication equipment. Cash in on the bigger-than-ever allowances offered by Walter Ashe on these test instrument triumphs by Hickok. Wire, write, phone or use the handy coupon today!



HICKOK MODEL 650 TELEVISION VIDEOMETER. Quickly localizes and accurately identifies trouble in any section of a TV receiver. Shpg. wt. 40 lbs. Only \$310.90



HICKOK MODEL 610-A UNIVERSAL TELEVISION ALIGNMENT SIGNAL GENERATOR. Another HICKOK "first" — the first complete instrument of its type. Shpg. wt. 32 lbs. Only \$219.00

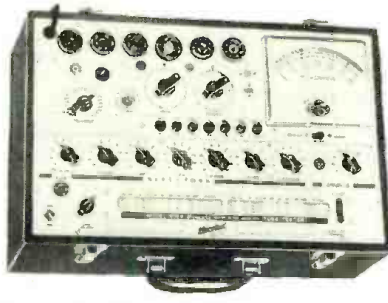

HICKOK MODEL 600-A DYNAMIC MUTUAL CONDUCTANCE TUBE TESTER. Lightweight, portable carrying case with detachable cover. Ideal for on-location or shop bench servicing. Shpg. wt. 25 lbs. Only \$155.00

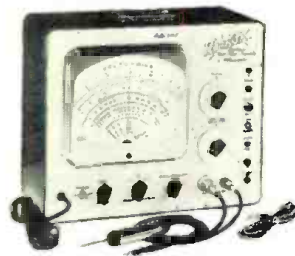

HICKOK 209-A VACUUM TUBE VOLT-OHM-MILLIAMMETER. Laboratory size; features large nine-inch meter with zero center scale. Shpg. wt. 25 lbs. Only \$132.50

Walter Ashe
RADIO CO.
1125 PINE ST. • ST. LOUIS 1, MO.

All prices
f. o. b.
St. Louis
•
Phone
CHestnut
1125

WALTER ASHE RADIO CO. RN-10-52
1125 Pine St., St. Louis 1, Mo.

Rush "Surprise" Trade-in Allowance on _____

(show make and model number of used equipment)

for the following Hickok Test Instruments: _____

Send new 1953 catalog.

Name _____

Address _____

City _____ Zone _____ State _____

THE 3 B's... BEETHOVEN, BRAHMS AND BACH

they're different
they're improved
they're better than ever!

Yes, Bach, Beethoven and Brahms are now better than ever—we don't mean we've improved their music, but we do mean we've improved the reproduction of their recorded music.



It's the new, improved Pickering Cartridges that give credence to this claim. Yes, Pickering Cartridges are different. They're improved. They're better than ever. Pickering patented Cartridges with Dynamic Coupling* are superior in every way, by providing: HIGHER FREQUENCY RESPONSE • NEGLIGIBLE INTERMODULATION DISTORTION • BETTER TRACKING CHARACTERISTICS
*DYNAMIC COUPLING ASSURES constant stylus contact with the record grooves over the entire audio spectrum (20-20,000 cps) • full frequency response • full transient response • no resonances • no mistracking • no grinding of groove walls

PICKERING and company, incorporated



Pickering High Fidelity Components are available through leading Radio Parts distributors everywhere; detailed literature sent upon request. Address Department C



Queenside, L. I., New York

GREYLOCK SLASHES PRICES!
STANDARD BRAND TUBES

INDIVIDUALLY BOXED
RCA—SYLVANIA—KENRAD
and Other Top Tube Manufacturers

6 Month Guarantee excepting only burnouts and breakers. SPECIAL OFFER: Additional 5% Discount on order for 100 or more tubes assorted.

024Q	\$.50	6C5	\$.50	34	\$.50	99
1A5GT	.69	6C5GT	.69	35/51	.75	
1A7GT	.99	6C6	.69	36B5	.75	
1B3/8016	.99	6C6G	2.39	35L6GT	.75	
1E7	.59	6F8	.69	38W4	.49	
1H40	.59	6H6	.69	35Y4	.69	
1N5GT	.69	6J5GT	.59	325GT	.49	
1N5GT	.99	6J5	.99	36	.69	
1Q5GT	.99	6J7GT	.89	37	.69	
1M5	.79	6K6GT	.59	39/44	.69	
1S4	.99	6N7B	.99	47	.99	
1K8	.79	6R7GT	.99	50A5	.69	
1T4	.79	6S4	.69	50C5	.69	
1T8GT	.99	6S47M	.69	50L6GT	.69	
1U4	.79	6S67M	.69	58	.59	
1X2	.99	6S7GT	.69	57	.69	
3D6/1299	.79	6S7GT	.69	58	.59	
3Q4	.89	6S7GT	.69	76	.69	
3Q5GT	.99	6N7GT	.79	77	.69	
3S4	.79	6S7GT	.79	117Z6GT	1.09	
3V4	.79	6S7GT	.59	11A4	.99	
5U4G	.69	6T8	.99	11C5	.99	
5V4G	.99	6V6GT	.69	11G5	.99	
5Y3GT	.99	6W4GT	.69	11E3	1.19	
5Z3	.79	6X5GT	.59	11G5	1.19	
6AB4	.79	6Y6G	.99	11H4	1.19	
6AC7	1.09	12A6	.69	11N5	1.99	
6AG5	.79	12AT6	.69	31F4	1.19	
6AG7	1.29	12A7	.99	7A8	.89	
6AH6	1.29	12AU6	.69	7B7	.89	
6AK5	1.29	12AV7	.89	7C6	.79	
6AL5	.69	12AV6	.69	7E5	.79	
6AQ5	.69	12AV7	1.19	7E5	.79	
6AR5	.69	12B6	.69	7E5	.79	
6AR6	2.49	12BE6	.69	7E5	.79	
6AT6	.59	12BH7	.69	7M7	.79	
6AUS	1.29	12SC7	.69	7F7	.79	
6AU6	.69	12K6GT	.59	7L7	1.09	
6AV6	.59	12SA7GT	.79	7O7	.89	
6AX5GT	.79	12S7GT	.69	724	1.29	
6A3	.99	12SK7GT	.89	14A4	.79	
6A7	.99	12SN7GT	.69	14C5	.99	
6B6	.79	12SN7GT	.69	14C5	.99	
6B8G	.69	19BQ6G	2.39	14F8	1.19	
6BL7GT	.69	25L6GT	.99	14J7	.99	
6BN6	1.29	25L6GT	.99	14J7	.99	
6BQ6GT	1.29	25W4	.79	14H7	.99	

Write TODAY For our Bargain Supplement N10-4, and get your name in line to receive our GREAT NEW 1953 COMPLETE CATALOG, now in preparation. All Prices F.O.B. N.Y.C. Please include postage and insurance with your remittance. 25% deposit required on C.O.D. orders. 50c handling charge on orders under \$5.

GREYLOCK ELECTRONICS Dept. N.10
SUPPLY CO. 115 Liberty Street New York 6, N. Y.

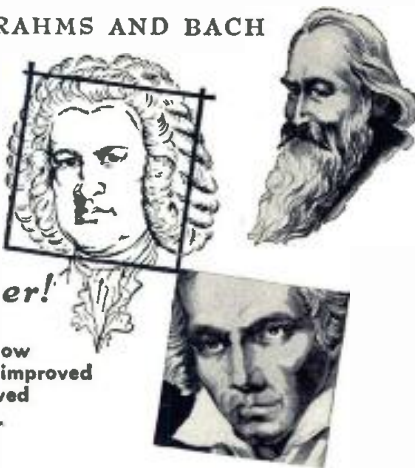

Manufacturers' Literature

Readers are asked to write directly to the manufacturer for the literature. By mentioning RADIO & TELEVISION NEWS, the issue and page, and enclosing the proper amount, when indicated, delay will be prevented.

RADIO-TV PARTS

Radio Surplus Corp., 732 South Sherman Street, Chicago 5, Illinois, has recently issued a 16-page catalogue which lists hundreds of radio and television replacement parts.

Among the items listed and pictured are switches, relays, various types of condensers, sockets, connectors, resistors, volume controls, terminal strips, coaxial cable, transformers, microphones, meters, Signal Corps components, tubes, and hardware.

A copy of this catalogue is available on request.

CONDENSER DATA

Astron Corporation, 255 Grant Avenue, East Newark, New Jersey, has announced the availability of catalogue sheets covering its new line of Type AQ subminiature paper condensers.

The new units will operate at temperatures up to 125 degrees C without derating as a result of the company's newly-developed X-250 high temperature impregnant. The line is available in a variety of case styles and sizes.

For a copy of the data sheet covering these new units, please address your request to the company direct.

TRANSFORMER DATA

Sierra Electronic Corporation, 813 Brittan Avenue, San Carlos, California, is presenting several examples of its new transformer engineering technique in a new folder, Form SA14.

Examples of four typical ferrite core units are shown in the folder along with circuit application data and response curves. Included are a 3-kw. grid driving transformer, a 2½-watt, 3300-volt grid driving unit, a 4-watt push-pull output transformer, and a 500-ohm unbalanced to 500-ohm balanced miniature transformer, all having response curves essentially flat over the 20 kc. to 1 mc. spectrum or more.

Also included in the folder is an application chart showing the areas of frequency and power-handling capacity most advantageously covered by transformers of this design.

A.F. RECORDERS

Audio & Video Products Corporation, 730 Fifth Avenue, New York 19, New York, is currently offering copies of a new brochure describing the

ARC-S P.A. XMYR COIL -7250-79 Mc. \$0.98
3-9 MFD-330 VAC OIL CONDENSERS (Brush Type A) 2.98
CRYSTAL HEADPHONES (Brush Type A) 4.95
50,000-imp. With adjust. band & tipped cord
G.E. PLATE RELAY (CR2791-100P56) 10,000-
coil, 3A. DPST contacts N.O. ea. 98¢ 6/ 5.00
6 VOLT DC MOTOR . . . 1750 RPM. ¼" x 2 ¼" x 3 ¾" shaft, O.D. 2 ¼" x 1 1/7 HP M O T O R . . . 2.49
113V. AC INDUCTION MOTOR . . . 1750 RPM. fract. H.P. 2 1/2" x 3 1/4" x 1 1/2" shaft, O.D. 1 1/2" x 1 1/2" x 1 1/2" . . . 1.39
50W. XMYR SOCKET (G.E. for 511) 59¢
RADIO HARDWARE TREASURE . . . FULL LB. CAN of Nuts, Screws, Locks, Washers, etc. 89¢
BALL BEARINGS (Fafahr) . . . O.D. ¼". I.D. 3/16" 29¢
O.D. ½". I.D. 1/4". 23¢

Leotone
AC-DC BLOWER . . . 5400 RPM. 3" fan. 27V. 1.5A. O.D. 2 1/2" x 5 1/2" . . . \$3.95
Shp. wt. 3 lbs.

AUTO GENERATOR CONDENSERS ea. 35¢
8 POS. PUSH BUTTON ASS'LY (6" x 2 1/2" x 1 1/2") . . . 3 PDT ckt. transfer. 2 1/2" shafts \$0.86
Set of 8 push-button knobs. 49¢
ROTARY SWITCHES . . . 2 deck, ¼" shaft 3 pos. D.P. or 6 pos. S.D. . . . either 39¢; 6/ 1.99

90-DAY GUARANTEE!!
Standard brands, untested cartons. 29¢
24, 26, 27, 34, 39, 41, 42, 46, 55, 56, 85, 89 or 9K7 39¢
21H4, 1H6, 1J6, 6B7, 6F5, 6G5, 6SD7, 6SH7, 6R7 or 7B 59¢
245, 71, 77, 114, 5Y4, 5Y3, 6F6, 6J3, 6K8, 6SA7, 6SK7, 6C5, 6U7, 7A4, 7B8 or 7C7 69¢
1A7, 11C6, 11H4, 2A5, 2A6, 6A3, 6A6, 6B8, 6SC7, 7A7, 7AG7, 7C6, 7C7, 7Y4, 12SN7 or 37 69¢

5" C.R. TUBE FRONT BEZEL . . . black crackle. \$0.89
5" SCOPE VISOR . . . leather; rubber eye-piece . . . 98¢
HIFIDELITY CRYSTAL HAND W/REAR . . . 3.95
Imp.-d. moulded bakelite case, 5 1/2 ft. cable 3.95
CABINET DRAW SLIDES . . . silent ball-bearing 75¢
13" 10" ext. - \$2.10 pr. 15" 11" ext. \$2.25; 16 1/2" (12 1/2") . . . 2.39
Heavy duty all-steel 16 1/2" / 12 1/2" . . . pr. 3.25
12 1/2" FT. WHIP ANTENNA . . . 4 steel screw sects. 1.98
EXPERIMENTAL TUBES . . . for Test, Research, etc. Fill, tested. Kit of 40. 1.98
STOP! LOOK! SAVE! . . . JUMBO RADIO PARTS KIT . . . 17 FULL LBS. OF EVERYTHING FOR THE RADIO MAN: COILS, CONDENSERS, SWITCHES, RESISTORS, CONTROLS, HARDWARE, WIRE plus MUCH, MUCH MORE. Shp. wt. 20 lbs. . . . 3.95
"KINKLESS BRAID WIRE" . . . 4 SUPER FLEXIBLE BRAIDED COPPER (220). Cotton core & outside sleeve. WITHSTANDS CONTINUOUS FLEXING as in Relays. Shp. wt. 20 ft. \$3.75; 1000 ft. - \$32.50
"DIRECT FACTORY SPEAKER REPAIRS SINCE 1927" Min. order \$3.00. 20% deposit req. on all C.O.D.'s. Full remittance with foreign orders. Please add sufficient postage-excess refunded.

LEOTONE RADIO CORP.
67 Day Street
New York 7, N. Y.

FREE OFFER
LIMITED TIME ONLY

TUBES

FREE 5 lbs. of good usable radio service parts with every 100 tubes ordered; a kit of assorted radio repair hardware free with every 50 tubes ordered!

ALL TUBES are guaranteed for one year . . . individually boxed
Very BEST BRANDS available for immediate delivery!

TUBE SPECIALS!

0Z4 49c	6A15 59c	6Q7GT . . . \$.49	7R7 \$.89	25AC5GT . \$1.04
0Z4G65	6AQ581	6R7GT69	7S7 1.07	25BQ6GT . 1.15
1A5GT59	6AQ674	6S449	7V769	25L6GT . . 49
1A759	6AR574	6S7GT . . . 1.15	7W7 1.07	25W4GT . . 59
1B3GT69	6AT649	6S8GT69	7X689	25X5 1.04
1B559	6AS590	6SA7GT . . . 59	7X769	25Z6GT . . 59
1C7G 29c	6AU5GT . . . 69	6SC759	7Y4 73c	32L7GT . 1.15
1E759	6AU6 49c	6SD7GT . . . 99	7Z459	35A5 99
1H5GT49	6AV6 1.44	6SF549	12A7 1.15	35B5 59c
1J5GT69	6B4G79	6SF5GT . . . 49	12A859	35C5 59c
1L459	6B579	6SH759	12AH7 1.45	35L6 59
1LA4 1.19	6B6G 1.15	6SH7GT . . . 59	12AL5 54c	35W4 45
1LA669	6B8GT 1.15	6SJ759	12AT6 49	35Y4 99c
1LC569	6BA649	6SJ7GT . . . 49c	12AT7 89	35Z4 49
1LC6 1.19	6BA769	6SK7GT . . . 49	12A859	35Z5 55
1LD595	6BC559	6SL7GT . . . 69	12AU7 65	35Z6G . . . 95
1LE5 1.19	6BC779	6SN7GT . . . 59	12AV6 49	35Z6G . . . 95
1LH4 1.19	6BD5GT . . . 89	6SQ7 49c	12AV7 89	35Z6G . . . 95
1LN5 1.19	6BE649	6SQ7GT . . . 49c	12AW6 95	41 72
1N5GT59	6BF559	6SR7GT . . . 49	12AX7 69	42 59
1P5GT 69c	6BF659	6SS772	12BA6 49	43 72c
1Q5GT 59c	6BG6G . . . 1.49	6T7G 1.15	12BA7 69	45 72c
1R5 59c	6BH6 59c	6T889	12BE6 49c	45Z5 59
1S5 59c	6BJ6 59c	6U559	12BF6 49c	46 89c
1T4 59c	6BL779	6U6GT . . . 59c	12BH7 69	47 89c
1U4 59c	6BN689	6U7G 59c	12C8 1.15	50A5 89
1U549	6BQ6GT . . . 85	6V6GT 59	12F5GT . . . 59c	50B5 59c
1X2A69	6BQ7 1.49	6W4GT . . . 49c	12H6 65c	50C5 59c
2A3 1.15	6C449	6X4 49c	12J5GT . . . 54	50CG6 . . . 1.04
2A579	6C5GT . . . 59c	6X5GT . . . 49c	12K7GT . . . 59	50L6 69
3LF4 1.19	6C6 59c	6Y6G 69	12Q7GT . . . 59	50X6 79
3Q459	6C8G 1.15	7A459	12SA7GT . . 69	50Y6 59
3Q5GT . . . 1.08	6CB659	7A589	12SC7 59	70L7 89
3S4 59c	6CD6G . . . 1.49	7A673	12SF5GT . . 59c	71A 87
3V4 59c	6D659	7A773	12SF7 59c	75 59c
5T4 1.40	6D8G 1.15	7A873	12SH7GT . . 59	77 1.10
5U4G49	6E559	7B473	16S7GT . . . 49	7869
5V4G87	6F5GT . . . 49c	7B573	12SK7GT . . 69	80 1.45
5W4 49c	6F6GT . . . 49c	7B673	12SL7GT . . 69	83 1.45
5W4GT . . . 49c	6F8G 1.15	7B773	12SN7GT . . 99	8579
5X4G65	6G6G 95	7B873	12SQ7 49	117L7 . . . 1.40
5Y3GT 45	6H6GT . . . 49	7C4 1.30	12S7GT . . . 59	117N7 . . . 89
5Y4G54	6J5GT 49	7C5 73c	12S7GT . . . 59	117P7 . . . 1.40
5X4G 81c	6J6 1.04	7C6 73c	12Z3 95	117Z3 . . . 49
5Z3 81c	6J7G 59	7C759	14A7 89	117Z6 . . . 69
6A3 1.15	6J8G 1.15	7E659	14AF7 93	807 1.55
6A7 1.21	6K5GT . . . 69	7E769	14B6 89c	813 8.95
6A8GT 59	6K6GT . . . 49	7F789	14B8 89c	1294 29c
6AB7 1.15	6K7GT . . . 59	7F8 1.47	14C5 1.07	1299 29c
6AC5GT . . . 89c	6K8GT . . . 69	7G769	14C798	1619 45
6AC7 89c	6LSG 95	7H759	14F789	1629 29
6AG569	6L6G 95c	7J769	14F8 1.30	2050 2.00
6AG789	6L769	7K7 1.07	19BG6G . . 1.49	2051 1.15
6AH6 1.40	6N6G 1.40	7L769	19T889	7193 87
6AK589	6N7GT . . . 69c	7N759	20 1.40	VT51 29c
6AK6 1.08	6P5GT . . . 69c	7Q7 59c	24A59	VT52 29c



C. M. FRY
ATC
United States Naval Reserve

Chief Fry says:

"In Civilian life my business for the past seventeen years has been running a Radio Shop. In that time I have handled over thousands of radio tubes. I have always made it a point to sell the Public on keeping good tubes in their receivers and as a result have always had satisfied customers. About five years ago I went to Chicago and bought my first tubes from Premier, and to tell you the truth I was skeptical that tubes priced so low could meet the rugged test I give each new tube before putting it on the shelves to be sold to the customers. Since that date I have handled over five thousand of Premier's tubes and have always found them satisfactory."

C. M. Fry, Chief USN.

Finest TV CHASSIS

Complete with all tubes, including 12 1/2" picture tube
\$6950

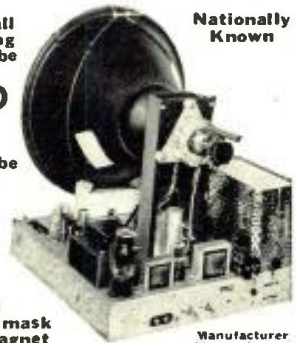

16" picture tube with complete chassis
\$9950

INCLUDES:

- beautiful bronze metal mask
- permanent magnet 12" speaker
- all tubes aligned perfectly
- ideal for fringe areas . . . works better than other receivers and where others can't
- ultra-sensitive fringe area tuner
- standard 90-day guarantee on all tubes and parts
- full band reception and output gated AGC—finest automatic gain control
- COMPLETE . . . READY TO OPERATE

Fringe Area DOUBLE "V" TV ANTENNA KIT

High Gain, Best Pictures Possible . . . complete with 300 ohm line, insulators, guy wire, hardware, full size antenna with double length 9 ft. mast **\$695** Complete

I. F. TRANSFORMER 456 Kc **19c**
PILOT LIGHTS Type No. 47
10 for **39c** 100 for **\$2.95**

VOLUME CONTROLS with switch, 2" shaft 1 meg, 1/2 meg, 1/4 meg **34c** ea.
SINGLE ION TRAPS **15c**
OUTPUT TRANSFORMER for 50L6 **29c**
for 6V6 **39c**

UNIVERSAL OUTPUT TRANSFORMER, 12 watt **79c**
CHIMNEY MOUNT for TV antenna **98c**
WELLER SOLDER GUN **\$8.95**
3 SPEED G. I. CHANGER **24.95**
300 ohm TWIN LEAD 1000 ft. **16.95**
100 ft. **1.89**
6 foot LINE CORD UL 10 for **1.95**
TV INTERLOCK CORDS ea. **49c**



P. M. SPEAKERS
12" Coaxial PM Speakers **\$12.95** ea.
High fidelity with high pass filter attached. 20 watt; 40-17500 cps response; 8 ohm VC.

SPECIAL PRICE
6" P.M. Speaker . . . \$1.29
Standard Replacement **1** ea.

RESISTOR KITS
Insulated 1/2, 1 and 2 watt assortment of most used values, I.R.C. Ohmite, Stackpole, Speer, etc. 100 for **\$2.95**

TV PICTURE TUBES

ONE FULL YEAR GUARANTEE—All Types

SIZE	PRICE	SIZE	PRICE
10-Inch	\$995	16-Inch	\$1795
12-Inch	\$1295	17-Inch	\$1995
14-Inch	\$1595	19-Inch	\$2295
7-Inch	\$1595	20-Inch	\$2395
15-Inch	\$1495	21-Inch	\$2595

TERMS: 20% DEPOSIT with order, balance C. O. D.
All shipments F. O. B. Chicago

PREMIER Radio Tube Division 551 W. Randolph St.
CONTINENTAL CORPORATION Chicago 6, Illinois
ANdover 3-1590

TOP-SELLING TV-RADIO PUBLICATIONS distributed by HOWARD W. SAMS & CO., INC.

COYNE FAMOUS SHOP-TESTED REFERENCE BOOKS

"Latest Testing Instruments for Servicing Radio-TV"

New 1952 edition tells all about modern electronic testing equipment and how to use it most effectively. Packed with money-making short-cuts on trouble-shooting, servicing, construction and other subjects involving use of test instruments. Covers Multipliers, Resistors, Ohmmeters, Oscilloscopes, etc. All data shop-tested for practical application. Profusely illustrated, 350 pages.



ORDER CTB-3. Only \$3.25

"TV Servicing Cyclopedica"—A Best Seller

The fact-packed TV reference book by H. P. Manly. Covers every phase of TV, including latest data on color and UHF. Shows you how TV works, how to service sets. Special sections on picture pattern servicing; testing and measuring; alignment; full treatment of amplifiers, antennas, controls, ion traps, sync. circuits, power supplies, video IF amplifiers, sweep oscillators, adapters, converters—covers everything. 750 pages.



ORDER CTB-1. Only \$5.95

"Television and Radio Handbook"

1952 edition of the famous TV and radio "answer" book. Over 3000 facts packed into a single volume to speed trouble-shooting. Covers solutions to most frequent TV-radio service troubles; offers short-cut time-saving tips; data on TV boosters, latest UHF conversion methods, etc. 375 pages, hundreds of illustrations.

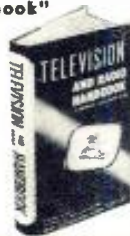

ORDER CTB-5. Only \$2.75

BOYCE AUTHORITY TV & RADIO HANDBOOKS

"Video Handbook"

Covers entire subject of TV; gives expert data on design, construction, production, installation, operation and servicing. Fourteen complete sections cover the field of TV exhaustively. All subjects treated practically and simply for easy understanding. A remarkable handbook widely used by schools, engineers, experimenters, and industrial technicians. 892 pages.



ORDER BB-2. Only \$5.95

"Radio and Electronics Handbook"

Here is the basic knowledge and data of Radio and Electronics digested in 18 sections; complete, easy-to-locate data. Clearly explains radio and electronic theory, and covers all phases of the subject in detail. The most widely used handbook of its kind—absolutely invaluable to anyone interested in radio or electronics. 890 pages; illustrated.



ORDER BB-1. Only \$4.95

HOWARD W. SAMS & CO., INC.

Order from your Parts Jobber today, or write direct to Howard W. Sams & Co., Inc. 2203 East 46th St., Indianapolis 5, Ind.

\$ enclosed. Send the following books:

- CTB-3 CTB-1 CTB-5
 BB-2 BB-1

Name

Address

City Zone State

Ampex Models 402 and 403 audio frequency recorders.

This four-page, two-color booklet describes the equipment in some detail and provides specifications on frequency response, tape speed, signal-to-noise ratio, controls, etc. It also carries details on accessory equipment for these two models.

REPLACEMENT GUIDE

Standard Transformer Corporation, 3580 Elston Avenue, Chicago, Illinois, has revised its catalogue and replacement guide to contain over 500 separate listings of transformers and related components.

This 24-page publication includes a separate television component section, a numerical index and price list, a classified index, and separate sections for high fidelity; input, interstage, output, driver, modulation, and power transformers; filter chokes; filament, plate, and isolation transformers; and autotransformers.

Seventy classifications are indexed in the catalogue. Also included is an output transformer chart, matched power supply charts, and data on the Stancor-Williamson amplifier.

WALDOM CATALOGUES

Waldom Electronics, Inc., 911 N. Larrabee Street, Chicago 10, Illinois, has released two new catalogues of interest to the industry.

The company's replacement speaker cone manual #52 lists over 5000 models of 105 set and speaker manufacturers. Included are the manufacturers' model numbers, speaker size, and the Waldom replacement cone numbers. The manual includes a section showing how to replace speaker cones, and comes complete with an explanation and illustrated procedures.

The second publication lists electronic components and "Croname" products. Catalogue #5C2 contains complete descriptive listings and illustrations of the "Croname" line of knobs, dial plates, title plates, tuners, auxiliary drives, instrument dials, panel kits, etc. Waldom knobs, tube sockets, terminal strips, and TV components are also included.

Either or both of these catalogues will be supplied on request.

MALLORY GUIDE

P. R. Mallory & Co., Inc., Indianapolis 6, Indiana, has recently published a television replacement control guide which lists replacements on the basis of the original part number irrespective of model or year.

The new guide was developed as a result of a comprehensive study of manufacturers' sets in which it was found that manufacturers often used the same parts in several models over a period of years. By thus eliminating duplications, the new guide not only eases and speeds the technician's job of locating the correct replacement part, but also, by listing controls which will be used in subsequent sets, prolongs the useful life of the book.

For inventory simplification and

RADIO & TV TUBES
STANDARD WELL KNOWN BRANDS

Some in thousands, others limited, rush your orders in—first come, first served.

At 39c each — 35Z5, 35W4, 5Y3, 6AL5, 37, 43, 80, 6H6, 6SQ7, 12SJ7.

At 59c each — 1LD5, 0Z4, 3V4, 5U4, 6AT6, 6K6, 6SA7, 6SK7, 12SF7, 117Z3.

At 69c each — 1H5, 1Q5, 1T4, 1T5, 6C4, 6C5, 6AB4, 6AU6, 6BE6, 12SK7, 12SA7, 50L6, 6BA6, 6AG5, 6CB6, 6SN7.

At 72c each — 1LE3, 1S4, 1X2, 3Q4, 3Q5, 3S4, 12AT7, 12AU7, 12BE6, 35Y4.

At 98c each — 1A7, 1B3, 1LB4, 5V4, 6AC7, 6AH6, 6AK5, 6J6, 6SH7, 6SL7, 6SC7, 25A6, 35A5, 50A5, 117Z6.

A PLAN TO SAVE YOU MONEY

PACKAGE DEALS—Each containing an assortment of the most desirable types and sizes, at a cost of only 1/3 than if bought separately! Resistor & cond. code charts FREE with each order!

100	ASSORTED TUBULAR CONDENSERS	\$4.69
100	ASSORTED 1/2 WATT RESISTORS	\$3.97
15	Asst. Radio Electrolytic CONDENSERS	\$4.74
15	Assorted TV Electrolytic CONDENSERS	\$6.88
100	ASSORTED MICA CONDENSERS	\$4.99
100	ASSORTED CERAMIC CONDENSERS	\$4.99
100	ASSORTED 1 WATT RESISTORS	\$5.86
100	ASST. PILOT LIGHTS #44, 46, 47 & 51	\$4.83
100	ASSORTED SOCKETS Octal, Loctal & Miniature	\$3.92
100	ASSORTED KNOBS SCREW & PUSH-ON	\$3.97
10	VOLUME CONTROLS ASSORTED, WITH SWITCH	\$2.94
10	VOLUME CONTROLS ASSORTED, LESS SWITCH	\$1.94

PULSE KEYED AGC KIT

Finest, most accurate and the easiest Kit to install in a #630 or in any other make TV receiver. Improves performance, eliminates airplane flutter and picture jumping and insures a steady picture on all channels.

COMPLETE SET OF PARTS \$4.59
 Including 6AU6 tube & instructions

UNIVERSAL Picture Tube MOUNTING BRACKETS

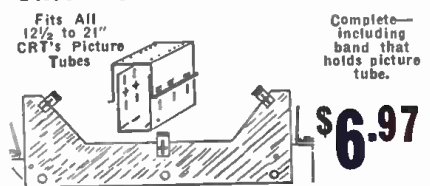

Hints for Better Pictures on your 630TV, 630TV Schematic with Modifications, Illustrated Television Conversion Manual, Pulse Keyed Type AGC Circuit Diagram, RMA Handy Resistor & Mica Code Charts. POSTPAID

\$1.00

Extra 5% discount on orders of \$50 or over!

BROOKS 84 Vesey St., New York 7, N. Y.

FIRST CLASS
Permit No. 37110
Sec. 34.9, P. L. & R.
NEW YORK, N. Y.

BUSINESS REPLY CARD

No Postage Necessary if Mailed in U. S. A.

3c Postage will be Paid by



366 MADISON AVENUE
NEW YORK 17, NEW YORK

FIRST CLASS
Permit No. 37110
Sec. 34.9, P. L. & R.
NEW YORK, N. Y.

BUSINESS REPLY CARD

No Postage Necessary if Mailed in U. S. A.

3c Postage will be Paid by

Radio - Electronic Engineering

EDITION OF RADIO & TELEVISION NEWS

366 MADISON AVENUE
NEW YORK 17, NEW YORK

Enter A Subscription for:

RADIO & TELEVISION NEWS

REGULAR EDITION

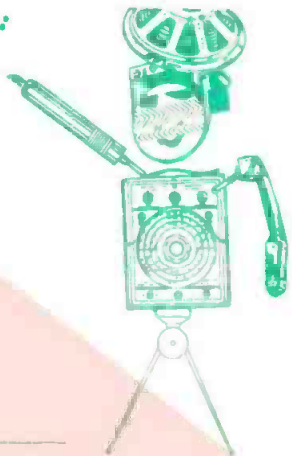

Enter A Subscription for:

RADIO-ELECTRONIC Engineering

EDITION OF RADIO & TELEVISION NEWS



NAME _____

ADDRESS _____

CITY _____ ZONE _____

STATE _____

POSITION _____

COMPANY _____

N-10-52

- Remittance enclosed
- I'll pay when Billed

Canada, Mexico, South America same as U. S. A. For all other countries add \$1.00 for each year.

- 3 years \$9⁰⁰
- 2 years \$7⁰⁰
- 1 year \$4⁰⁰

NAME _____

ADDRESS _____

CITY _____ ZONE _____

STATE _____

POSITION _____

COMPANY _____

N-10-52

- I'll pay when Billed
- Remittance enclosed

Canada, Mexico, South America same as U. S. A. For all other countries add \$1.00 for each year.

- 3 years \$10⁰⁰
- 2 years \$9⁰⁰
- 1 year \$6⁰⁰

Special Audio Issue!



Bigger
Better
Audio Articles
in
November

RADIO & TELEVISION NEWS
on sale October 24

Subscribe Today
at
money-saving
rates

or
reserve your
monthly copies
at
your newsstand!

RADIO & TELEVISION NEWS' PREAMP-EQUALIZER

Complete construction details on a specially designed preamplifier-equalizer, for use with any power amplifier not incorporating signal modification controls. Unit has all major features desirable in an audio control unit for home use!

MULTI-STATION INTERCOM . . . Build this simple battery-operated unit which includes low battery drain and instant heating tubes! Ideally suited for home use!

CABINETRY . . . Profitable custom installation made easy when you understand good design and can recognize quality wood finishes!

NEW PROFESSIONAL TAPE RECORDER . . . Has many innovations, plus a new-type brake and novel means of mounting tape reels to conserve space!

plus **AUDIO AMPLIFIER DESIGNS . . .** other great articles

**RADIO &
TELEVISION
NEWS**

EVERY dynamic issue vital to you!

ZIFF-DAVIS PUBLISHING COMPANY
Publishers also of: RADIO-ELECTRONIC ENGINEERING Edition of RADIO &
TELEVISION NEWS • PHOTOGRAPHY • PHOTOGRAPHY ANNUAL, 1953 Edition
MODERN BRIDE • FLYING • FICTION GROUP • ZIFF-DAVIS COMICS

33 1/3% More Storage Space in Same Area With *Egypto* SHELVING

Especially designed for
the Electronic Industry

- Economical • Light Weight, High Capacity • Shelves Instantly Adjustable.

Don't waste valuable space with useless oversized shelving. The new 8" deep *Egypto* shelving specifically designed for electronics trade can be used as a regular instantly adjustable shelf or inverted to use the turned up shelf edge for extra protection to keep valuable items from falling to floor. The 8" depth is made expressly for the narrow lineup of merchandise necessary in this field. Holds 150 lbs. without reinforcements. Can be reinforced to hold up to 1200 lbs. on each shelf.



TYPICAL ASSEMBLY

Use end to end as shown or back to back for maximum storage in small space. Shelves may be adjusted on any one unit on 1 1/2" centers without adjusting shelves on any other unit.



No. 565-A
Closed Type Shelving 8" x 3' x 7' high. Single or starting unit; equipped with backs and sides. Ideal for dope storage.

No. 893-8
Open Type Shelving 8" x 3' x 7'



Even if items tip over—the risk of falling to floor is greatly reduced when shelves are used with flange turned up. The turned up flange is used as a stop. Also saves 1" of space at shelf flanges.



View of typical 8" deep shelf showing flange down.

The fast, labor saving shelf clip used to make all shelves instantly adjustable on 1 1/2" center.

View of typical 8" deep shelf inverted showing flange up.

Sway Braces available as needed, included in price.

OTHER STYLES AND SIZES AVAILABLE

Egypto Division of Aurora Equipment Co.
300 Prairie • Aurora, Illinois
Phone: Aurora 9231

Write for FREE Catalog **40** YEAR

WALKIE TALKIES \$4.99 Set of 2
POCKET SIZE —ELECTRONIC VOICE POWERED
No tubes, batteries, adjustments, license or permit needed!
Guaranteed to work anywhere up to 1/2 mile with extra wire. Swell for garage to house, etc.: your own private, talk-listen phone. Not war surplus. Brand new. Solid Aluminum Case. Two complete units with wire—READY TO USE! SEND ONLY \$1.00 deposit and pay postman \$3.99 C.O.D. or send \$4.99 for PP delivery. Sold only by mail from: MIDWAY CO., Dept. WRT-10, KEARNEY, NEBRASKA.

\$2.95 EACH OR 2 FOR \$5.00!
Upright Telephone complete with cord in tested and guaranteed condition. For intercomm. or extension. Complete list of telephone parts, switchboards, handsets, magneto and dial telephones, etc. Write for list.
TELEPHONE ENGINEERING CO.
Main Blvd. Simpson, Pa.

4 GOOD REASONS WHY The New MAGNEMITES* Are The Perfect Tape Recorders for Portable Use

- World's Smallest, Lightest Tape Recorders**
Letterhead size, weighing 10 lbs., the Magnemites* offer every desirable feature for field recording, compactly assembled in beautiful, precision recorders.
- Record Without AC Power**
The Magnemites* are powered by inexpensive dry-cell flashlight-type batteries that last 100 operating hours. No wet cells that require daily recharging.
- Playback and Monitoring Facilities Built-In**
An output connection which feeds ear-phones or an auxiliary amplifier and speaker during playback, is also used for monitoring while recording.
- Exceptional Recording Quality**
4 Magnemite* models are available for any recording need. Designed to record music, interviews, or any type of sound effects with lifelike reproduction.

The Magnemite* series consists of 3 dual-track models (1 1/2", 3 3/4", or 7 1/2 in. per sec.) and 1 single-track model (7 1/2 in. per sec.) designed to NAB standards.

Many exclusive features distinguish Magnemites* as the outstanding portable recorders. Write today for complete literature and direct factory prices.

*Trade Mark Reg.

AMPLIFIER CORP. of AMERICA • 398-4 Broadway • New York 13, N. Y.

economy without sacrifice of electrical performance or physical size requirements, control styles have been standardized whenever possible.

In addition to the cross reference by original part number, the replacement control guide gives a cross reference by replacement control part number. Physical and electrical specifications are given for all *Mallory* controls listed in the guide.

SOUND SYSTEMS

A new catalogue listing a complete line of amplifiers and sound systems has been issued by *Don McGohan, Inc.*, 3700 West Roosevelt Road, Chicago 24, Illinois.

Designated as catalogue No. 200, this up-to-date bulletin describes eight amplifiers ranging in power from 7 to 60 watts, a 60-watt amplifier booster, a mobile unit with regular or phono top, seven portable sound systems, a complete line of air-luggage type carrying cases, speaker baffles, sound projectors, microphones, and a three-speed record player and changer.

WARD BOOKLETS

Two new booklets, designed as envelope stuffers, have been issued by *Ward Products Corp.*, Division of *The Gabriel Co.*, 1523 East 45th Street, Cleveland 3, Ohio.

Form 54-187, "Your Road to Better FM," is designed both as a catalogue and an envelope stuffer. It describes the company's line of FM antennas. "All Dressed Up" is the title of the second promotional piece which includes specifications on all of the company's auto aerials. This folder dramatizes the point that a new aerial "dresses up your car."

Both of these booklets are now available through the company's distributors.

FREE SAMPLE COPY

Transvision, Inc. of New Rochelle, New York, is offering a sample copy of its "Television Notes," a magazine devoted to the technical and servicing aspects of television in the field.

The publication includes a review of servicing techniques, the use of service instruments, hints on quick servicing short-cuts, an analysis of TV failures, and other pertinent data.

Address your requests for sample copies to David Gnessin, the editor.

SPRAGUE POSTER

Sprague Products Company, 51 Marshall Street, North Adams, Massachusetts, has prepared a new window display poster for service shop use entitled "Why Doesn't My Set Stay Fixed."

The text material clearly and convincingly answers questions often asked by television set owners. Designed as a public relations service to promote a better understanding between the public and service technicians, the new poster is a follow-up to the now-famous "Are Servicemen Gyps?" message distributed by the company earlier in the year.

BUILD 15 RADIOS WITH THE PROGRESSIVE RADIO "EDU-KIT"

This is a practical home radio course! No radio experience is needed. You start learning a simple radio circuit and advance as quickly as you wish. You build RECEIVERS, TRANSMITTERS, AMPLIFIERS, CODE OSCILLATOR, SIGNAL TRACER. All parts and instructions are included and clearly explained.

ALL PARTS ARE INCLUDED!

The Progressive Radio "Edu-Kit" contains all parts necessary to build 15 different radios including tubes, paper condensers, mica condensers, electrolytic condensers, variable condensers, selenium rectifiers, chassis, hardware, tie strips, tube sockets, solder, wire, soldering iron, tubing, coils, instruction book, radio tester, etc.; in brief, everything you need in a practical radio course. The Progressive Radio "Edu-Kit" requires no instructor. All instructions are included. All parts are individually boxed and identified by name, photograph and diagram. Every step involved in building these sets is carefully explained. You cannot make a mistake.

Nothing extra to buy . . . nothing to return . . . you keep everything! You can quickly pay for kit by repairing radios. Think of it — the signal tracer alone is worth more than the small cost of this kit!

Nothing extra to buy . . . nothing to return . . . you keep everything! You can quickly pay for kit by repairing radios. Think of it — the signal tracer alone is worth more than the small cost of this kit!

WHAT "EDU-KIT" BUYERS SAY!

"I can assure you that it is a wonderful kit and good value" C. J. Benadie, Newton Road, Beaconfield, Kimberley, South Africa; "I am very satisfied with the "Edu-Kit" Dominic Stracuzza, 111 Clarence St., London, Ont. Canada; "I received my Progressive "Edu-Kit" and I want to let you know that I am very pleased with it" F. B. Hartman, 290 Westminster St., Providence, R. I.; "This morning I was showing my Progressive Radio "Edu-Kit" to one of our representatives from our office in Richmond, and, already he wants me to purchase some for his hospitals" Veterans Administration, Physical Medicine Rehabilitation Service, Washington, D. C.; "I received one of your Radio "Edu-Kits" and I am happy to report that my ten-year-old boy, with very little supervision, built a complete three-tube receiver - one that works - in less than three hours" Bill Leonard, C.B.S. Radio, New York, N. Y.

**FREE RADIO TESTER . T. V. BOOK
FREE QUIZZES . SOLDERING IRON
MEMBERSHIP IN RADIO AND T. V. CLUB**

FREE Radio and T.V. Trouble-shooting Guide sent when you ask for complete information OR rush us your order and you get FREE valuable Surprise Gift Package in addition to Radio and T.V. Trouble-shooting Guide. Write today!

Now anyone can

LEARN RADIO

at Home



**NO PREVIOUS
TRAINING**

**NEEDED... EXCELLENT
BACKGROUND FOR T. V.**

Specifically prepared for any person with the desire to learn radio, it has been successfully used by young and old. It is unnecessary to have even the slightest background in science or radio. The Progressive Radio "Edu-Kit" is used by many Radio Schools & Clubs in this country and abroad. It is used by the Veterans Administration for Vocational Guidance and Training.

You risk nothing -
10 DAY MONEY-BACK GUARANTEE

BUILD 15 RADIOS
Only
\$19.95
COMPLETE

*STUDY FOR
A GOOD PAYING
NEW JOB!*



*ENJOY AN
INTERESTING
HOBBY!*



*START YOUR OWN
PROFITABLE
BUSINESS!*



POSTAGE PREPAID ON CASH ORDERS
—C.O.D. ORDERS ACCEPTED IN U.S.A.

PROGRESSIVE ELECTRONICS CO.
497 UNION AVE. :: **RN-10** :: BROOKLYN 11, NEW YORK

SERVICEMEN!

Have You Entered
THE BIG

Jensen
\$5,000.00

Cash Prize Contest?

SEE YOUR *Jensen* NEEDLE DISTRIBUTOR
TODAY FOR DETAILS AND ENTRY BLANKS.

OSCILLOSCOPES

ARE
"GOLD
MINES"!

... if you learn
how to use them fully
on all types of
service jobs!



Learn to handle the oscilloscope fully on all types of AM, FM and TV service work—and watch your efficiency and earnings soar!

MODERN OSCILLOSCOPES AND THEIR USES, a fact-jammed 326-page book by Jacob H. Rutter, Jr., of the Allen B. DuMont Laboratories contains exactly the help you need—written in a way you can clearly understand. It shows you how to use your "scope" for fast accurate work on all types of jobs from troubleshooting to realigning; how to make connections; how to adjust circuit components; how to set controls and how to analyze patterns fast and accurately. 370 helpful illustrations including dozens of pattern photos make things doubly clear.

No other type of specific service training stands to mean so much to you in terms of being able to do better, faster and more profitable work!

- ✓ When, where, why and exactly how to use oscilloscopes
- ✓ How to interpret oscilloscope patterns
- ✓ How to handle tough jobs in less time

MAIL ORDER 10-DAY FREE EXAMINATION

Dept. RN-102, RINEMART BOOKS, Inc.,
Technical Division,
232 Madison Ave., New York 16, N. Y.

Send MODERN OSCILLOSCOPES AND THEIR USES for 10-DAY EXAMINATION. If I decide to keep the book, I will then remit \$6.00 plus a few cents postage in full payment. If not, I will return book postpaid and owe you nothing.

Name

Address

City, Zone, State

Employer's Name & Address

OUTSIDE U.S.A.—Price, \$6.50 cash only. Money back in 10 days if book is returned.

FALL SALE PRICES SLASHED

T.V. TUBES—ROCK BOTTOM PRICES
In lots of 6 each No. only

6BQ6 99c 8BQ6 74c
18 B6B 99c 6AQ5 49c
1A X7 59c 6CD6 \$1.29
6CB6 59c 6F4 49c
6A K5 79c

Westinghouse Kudrox Rectifier .64 Amp. 28
Volts. Reg. \$11.00 ea. Special! \$1.95

15 BRAND NEW 10" PHONO RECORDS—Ass't.
Jazz—Popular, Rhythm—Blues. Please specify. \$1.79

Skogie Pole—10 Pos. 2 Gang Switch 29c

2 piece, 5 pole Male and Female separable Amphenol
plugs. Both with Flex. shielded cables. Approx.
5 ft. long. 35c pair. \$1.00

Getnd your own Crystals. Pure Brazilian Quartz. Vari-
ous sizes and thicknesses. 14 lb. pkg. \$1.00

4 Tube Drilled Chassis. 4 1/2" x 6 1/2" x 1 1/2". 29c each

4 inch P.M. SPEAKER. \$1.50

5 in. 450 ohm Dynamic Speaker. \$1.35

Signal Corps Phones—2 M. Ohms (8 M. Ohms)
Imp. \$1.25

2 Ft. Ext. Cord (and Plug) 40c

TOBE TUBULAR ELECTROLYTICS

20-20 MFD. 150 V. 49c 30-30 MFD. 150 V. 57c

40-40 MFD. 150 V. 59c

Low-Loss Short Wave 3 GANG T.R.F.
Lock Type Air Trimmer VARIABLE CGN.
triples—100 ast. \$2.95
D E N S E R S
000365 Con. 65c

5 Pl.—20Mmfd. 14c

7 Pl.—25-30 Mmfd. 15c

8 Pl.—30-35 Mmfd. 16c

14 Pl.—56 Mmfd. 24c

PIEZO CRYSTAL HOLDERS. 12 for \$1.00—\$6.00 per C

RE A Band Switches—

3 gang, 3 pos. 3 band. 30c 6 gang, 4 pos. 4-5 band. 40c

Trimmer-Padder Ass't.—all Isolantite—singles, dual,
triples—100 ast. \$2.95

Prifco push button Rotary Switch Double Pole. 33c

ATTENTION: Prospectors, Explorers for Hidden Treasures!
Construct a U.S. Army Type of Metallic Mine Detector
Amplifier. Amplifier unit only, dross tubes and bat-
tles (not) with cables, headphone cords, and Jack. Army
wiring diagram. Type AN/PRS-1 \$1.95

8 or 9 Gang Push Button Switch 49c

DRILED CHASSIS FOR 5-6 tubes 5" x 10" x 1 1/2" 23c

P=ONE JACKS—OPEN & CLOSED AUTO. 13c

SALE—PHONO RECORD ALBUMS—12" 3 comp. 15c;
10" 3 comp. 15c; 4 comp. 20c; 12 comp. 63c

VLLCAN HEAVY DUTY 100 WATT SOLDERING IRON.
Built for U.S.N.—Brand New—Equally sells for
\$6.50. OUR PRICE \$2.99

12 SK7 TUBES—Bayonet missing. Perfect condition.
\$ for \$2.00

MINIMUM ORDER \$3.00—NO C.O.D.
SHIPMENTS—PLEASE INCLUDE POSTAGE

NEWARK SURPLUS MATERIALS CO.

324 Plane Street Dept. SE NEWARK 1, N. J.

These large window-size posters with a cartoon at the top are available free from local *Sprague* distributors or direct from the company for 10 cents to cover the cost of handling and mailing.

FREE REPAIR HINTS

The readers of this magazine are being offered a free copy of the bulletin, "How to Use Diagrams for Faster Radio and Television Repairs," by *Supreme Publications*, 3727 West 13th Street, Chicago 23, Illinois.

This handy four-page pamphlet contains many valuable hints on how to derive the most benefit from available servicing information.

MICROWAVE COMPONENTS

Graham Manufacturing Company of East Greenwich, Rhode Island has recently released a new catalogue featuring selected equipment from its line of standard and custom microwave components.

Bulletin 100-A contains information on attenuators, double-slug tuners, pedestals, precision slotted sections, terminations, tube mounts, tunable crystal mounts, tuning plungers, wave guide-to-coaxial adapters, and wave guide clamps.

TRAINING DATA

Progressive Electronics Co., 497 Union Ave., Brooklyn 11, New York, has issued two new booklets which are being offered to our readers without charge.

The first booklet is a two-color brochure which describes in detail the company's new "Radio Edu-Kit." The book also contains useful servicing information in a new, convenient, and handy digest form.

The second book is a TV servicing manual which contains information on troubleshooting procedures for use on television receivers.

Copies of either or both of these books are available to those writing Dept. RN of the company at the above address.

FUSE GUIDE

Littelfuse, Inc., 1865 Miner St., Des Plaines, Ill., is now offering an up-to-date version of its "Official TV Fuse Guide" to service technicians and parts jobbers.

The guide is printed on durable enamel stock, punched at the top so it can be hung on a nail in the repair shop. It lists the brand name, model numbers, and corresponding fuse requirements for all makes and models.

Copies are available either through jobbers or from the company direct on written request.

FACILITIES BROCHURE

General Cement Manufacturing Company, 919 Taylor Ave., Rockford, Ill., is now offering a copy of its 16-page brochure, "The Story of G-C," to interested persons.

The booklet describes the company's facilities for the manufacture of a wide variety of components.

Lafayette Radio

FOR OVER 32 YEARS
HEADQUARTERS FOR SERVICEMEN, SET-BUILDERS, ENGINEERS, EXPERIMENTERS.

Lafayette NEW!!! 1952 TV CHASSIS

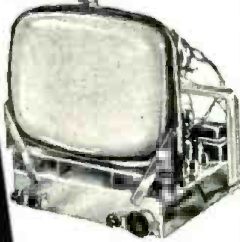

Everything you have ever wanted in a TV receiver is here now in Lafayette's new, precision-engineered circuit. Cascade tuner — a new development to provide the best signal in fringe areas, with double shielding to reduce radiation; low-noise bi-filter system to provide wideband response. Receiver can be modified for U.H.F. reception when available. Automatic Gain Control circuit to provide stabilized picture and reduce adjustments of operating controls. Local-fringe switch. Designed to receive all channels. 8" PM speaker included.

Tubes Used: 6BK7; 6Js; (2) 6CB6; (3) 6AL5; 6AC7; 6AU6; 6AV6; 6V6; (2) 12AU7; 12BH7; 6SN7G; 6BQ6; 1X2A; 6W4; 5U4G; TV Picture Tube.

- *Lafayette Chassis Model 200R with 8" PM Speaker, Complete with Tubes and 17" Picture Tube..... Net 144.50
- *Lafayette Chassis Model 201R with 8" PM Speaker, Complete with Tubes and 20" Picture Tube..... Net 159.50
- Lafayette Model 194R Complete 17" Console Set..... Net 174.50
- Lafayette Model 196R Complete 20" Console Set..... Net 199.50
- Lafayette Model 193R Complete 17" Table Model..... Net 159.50
- Lafayette Model 195R Complete 20" Table Model..... Net 179.50
- *With 12" speaker add \$3.50.

Prices Include Federal Tax and R.M.A. Warranty
 Chassis dimensions: 20" wide, 22" deep and 22" high with 17" tube. 20" wide, 22" deep and 25" high.



FOR CUSTOM INSTALLATION IN YOUR OWN BOOKCASE, WALL OR CABINET.



NATIONAL DISTRIBUTORS FOR RCA, G. E. & SYLVANIA TUBE

Lafayette, one of the outstanding tube distributors in the country for RCA, G.E. and Sylvania, carries complete stocks of tubes. Each guaranteed for six months, is brand-new and in original manufacturer's carton. Order any type at discount of 40%, 10% and 2%. In lots of 100 assorted tubes, additional discount of 10%. Be assured of lowest prices, brand-new tubes in original cartons, six-month guarantee; buy tubes from Lafayette. We handle only brand new tubes—"firsts," not seconds.

LAFAYETTE — KNOWN FOR THE LARGEST STOCK OF T.V. ANTENNAS, ACCESSORIES AND REPLACEMENT PARTS.

5 WATT MICROPHONE AND PHONOGRAPH AMPLIFIER



A compact, 5 watt amplifier with many applications, such as low powered P.A. System, Paging System and Phonograph Amplifier. It is designed to be used with either a microphone and/or phonograph. Separate but its and trim controls are provided for microphone and phonograph. The latest compensated tone control circuit is used and is effective on both inputs. An "on/off" switch incorporated on tone control. In use: 1 microphone, 1 phonograph. Controls: 1 zone, 1 microphone, 1 phonograph. Output impedance: 3.2 ohms. Supplied complete with tubes: 1-6X4, 1-6V6GT and 1-6X5 rectifier. Size 8 1/2 x 5 x 11. For 110 Volts AC operation only. 8 1/2 lbs. approx. 10 lbs. \$21.19

VEE-D-X ULTRA Q-TEE



Solves one of TV's biggest problems by combining both VHF and UHF (all-channels 2-83) into single antenna using single transmission line. Employs eight printed circuit band reject filters that isolate the VHF and UHF portions of antenna.

- Vee-D-X Ultra Q-tee Antenna.....NET 8.38
- Ultra Q-tee Double, a two-boy array for near fringe areas. Increases gain 30%.
- VEE-D-X Ultra Q-tee Double.....NET 17.38
- Ultra Q-tee Quad, a four-boy array for fringe areas. Increases gain 80%.
- Vee-D-X Ultra Q-tee Quad.....NET 36.10

LAFAYETTE LARGEST STOCK.

PLASTIC BASE RECORDING TAPE

Here is a real buy on Recording Tape. Nationally known brand. 1200-foot roll of Plastic Base Recording Tape, facing in or facing out, specify which. Per 1200 foot roll..... \$1.89



E-Z-I LIGHT AND TELEVISION CLOCK



Provides proper amount of background light for televiewing. Accurate, rotating numeral clock. Walnut plastic case. 110 v. 60 cycle AC only. Size 5x5x3. 2 1/2 lbs. NET, incl. tax..... \$7.66

BEST PRICES, FINEST SERVICE

OPEN WIRE TV LINE

Ideal for fringe area installations. Not affected by moisture or sun. Made of #18 copper-wire with genuine polystyrene insulators spaced 6" apart. Tensile strength 100 lbs. 100 ft. coil, Shpr. 250 ft. coil, Shpr. wt. 4 lbs. \$5.32 100 ft. coil, Shpr. wt. 9 lbs. \$13.31

TWIN LINE

High quality, low loss. For all TV and FM installations. Shpg. wt. 2 lbs. 17' coil..... \$1.45

GRAYBURNE MODEL TSB-1 TV SIGNAL BOOSTER



Increases video and sound output over 20%. Consists of complete IF stage which easily plugs into any receiver inside the cabinet, thus eliminating external switches and connections. Has advantages of broad band boosters but without separate tuning for each channel. Ideal for poor signal areas. Grayburne TSB1 \$5.65 less tube

EVERY MAKE OF BOOSTER IN STOCK All Guaranteed

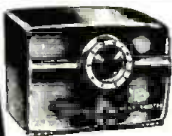

- NEW ReGENCY Model 520 NET 19.11
- NEW Astoria Model CT-1 NET 19.11
- Electro-Voice Model 3000 NET 33.81
- Electro-Voice Model 3002 NET 23.23
- Electro-Voice Model 3010 NET 51.74
- Electro-Voice Model 3100 NET 40.87
- NEW Bogren Model BB1-A NET 19.11
- Manco Sky Chief NET 44.42
- Manco Super Sky Chief NET 44.42
- Anchor ARC-101-100 NET 29.10
- Anchor ARC-101-75 NET 22.05

The new JFD Yagi antennas provide 52% more gain than conventional Yagis. "Ballnet" insures an efficient match between the antenna and 300 ohm lead-in. Elements precision cut to each channel for max. gain with full 6 MC band width. High signal to noise ratio. Factory preassembly makes installation simple. All aluminum with seamless cross-arm. Less mast. Single array 10 lbs., stacked—20 lbs.

SINGLE ARRAYS

Type	Channel	List	NET EACH
10Y2	2		
10Y3	3	\$31.85	18.73
10Y4	4	31.85	18.73
10Y5	5	28.45	16.73
10Y6	6	28.45	16.73
10Y7	7	25.70	15.11
10Y8	8		
10Y9	9		
10Y10	10		
10Y11	11	13.85	8.14
10Y12	12		
10Y13	13		

STACKED ARRAYS

Type	Channel	List	NET EACH
10Y7S	7		
10Y8S	8		
10Y9S	9		
10Y10S	10		
10Y11S	11	27.70	16.29
10Y12S	12		
10Y13S	13		

HEADQUARTERS FOR HIGH-FIDELITY PHONO-EQUIPMENT

GENERAL ELECTRIC PICKERING - AUDAK
 3 SPEED RECORD CHANGERS
 Garrard - VM Triomatic
 Markel-Webster-Chicago

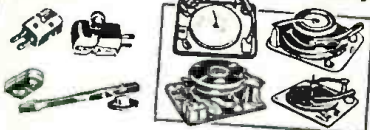

- Webster Model 121-1, with dual needle turnover crystal cartridge..... Net 37.24
- Webster Model 121-270, as above, but with G.E. RPX-060 triple-play magnetic cartridge in standard tone arm. Less pre-amp..... Net 38.81
- V-M Model 951, with turnover crystal cartridge and dual needles..... Net 29.62
- V-M Model 951GE, with G.E. triple-play variable reluctance cartridge and dual needles, less base. Requires pre-amp. Net 32.80
- Garrard Model RC-80 Changer..... Net 41.45
- Markel Model 74 Changer..... Net 63.39

GE Pre-Amplifiers

- Self powered preamp UPX003—NET 10.55
- Eternal powered preamp. SPX001—NET 7.00

- CARTRIDGES AND STYLII**
- G.E. RPX-041 Single-Play Cartridge L.P. 5.85
 - G.E. RPX-040 Single-Play Cartridge Std 5.85
 - G.E. RPX-050 Triple-Play Cartridge..... 8.20
 - G.E. RPJ-010 Sapphire .001" .003" Needle..... 3.50
 - G.E. RPJ-005 Sapphire .001" Needle..... 2.06
 - G.E. RPJ-001 Sapphire .003" Needle..... 2.06
 - NEW: G.E. RPJ-013 Diamond .001" Needle..... 16.17
 - Has .001" Diamond Triple-Play Needle Sapphire Tip..... 18.23
 - NEW: G.E. RPX-052 Triple-Play Cartridge, 1 MIL Diamond and 3 MIL Sapphire Tips..... 22.90

Lafayette Radio

NEW YORK 13 100 SIXTH AVE.
 BRONX 58 542 E. Fordham Rd.
 NEWARK 2 24 Central Ave.
 BOSTON 10 110 Federal St.

Mail Orders Filled
 20% deposit with order please, balance C.O.D. Postage and shipping charges are extra.

PROFIT PICTURE WEAK?

PICTURE TUBE REJUVENATOR

BRIGHTENS PROFITS

HOW IT WORKS: Easy-to-install PICTURE TUBE REJUVENATOR increases cathode emission of weak CRT's by raising cathode temperature — brightens the TV picture.

HOW IT SAVES: Actually assures years of clear-vue TV pictures from weak tubes. Save the difference between a new C.R.T. and only \$2.79 for the REJUVENATOR! Save on SERVICE CONTRACTS and PARTS WARRANTIES. P.T.R. brightens your profit picture!

- ✓ Simple Plug-In Unit — installed in less than 1 minute.
- ✓ No Exposed Wires
- ✓ Permanent Hook-Up
- ✓ Fits all Size Tubes
- ✓ Automatically Operated

Model "C" for standard tubes \$2.79 Dealer Net
Heavy duty Model "B" for electrostatic tubes as well as standard. \$3.40 Dealer Net



CREST

Available at Local Jobbers,
or inquire

LABORATORIES, INC.
WHITEHALL BUILDING
FAR ROCKAWAY, NEW YORK

SAVE UP TO 50%
CABINART FOLDED
HORN ENCLOSURE KITS

MODEL 61
For 12"
Speakers:
32" H, 32" W,
16" D.
Wt. 26 lbs.
\$19⁹⁵
NET



MODEL 63
For 15"
Speakers:
32" H, 36"
W, 17 1/2" D.
Wt. 28 lbs.
\$23⁹⁵
NET

You high fidelity fans can assemble your own acoustically engineered folded horn corner speaker enclosure from a fine Cabinart kit. Save up to 50% and more on the usual complete models by less than two hours of simple assembly. Enjoy a full extra octave of full clean bass never reproduced by the ordinary cabinet.

Kit includes everything you need — 3/4" pre-cut select white gum plywood — pre-cut speaker opening, grille cloth, kimsul acoustic insulation, hardware. Assembly and finishing instructions.

Make Arrow's great, new Audio Center your home base for everything in high fidelity and sound equipment. Audio Center is America's only 5-story building devoted exclusively to Audio — Biggest Stocks, Best Prices, Fastest Service. Check us on your needs — convince yourself.



MONEY-SAVING
GREEN SPECIALS

RCA 14EP4

(regularly \$25 each)

2 for \$25

Take advantage of this terrific buy — while we can still supply! These are all brand new, RCA 14EP4 picture tubes in original factory-sealed cartons. Full one-year guarantee. Shpg. wt. 14 lbs. each. (One for \$13.50.)

630 TV SUPER-CHASSIS

Super-quality, top-flight 630 TV chassis with marvelous, extra-sensitive Cascade Tuner, Keyed AGC, Concert Speaker, Kine Mounting Brackets (up to 21"), Knobs and full complement of tubes. Standard RMA Guarantee.

\$134⁹⁵
SPECIAL..... (Incl. Fed. Tax Less Kine)

Send for FREE catalog of other bargains.

GREEN TELE-RADIO

DISTRIBUTORS, INC.

Dept. R-10, 472 Sutter Ave., Brooklyn, N. Y.
67-15 Fresh Pond Road, Queens, N. Y.

Technical BOOKS

"SOUND RECORDING AND REPRODUCTION" by J. W. Godfrey and S. W. Amos. Published by *Iliffe & Sons, Ltd.*, London. 265 pages. Price \$6.75. Available in the U. S. from *The British Book Centre, Inc.*, 122 E. 55th Street, New York 22, N. Y.

This text is another in the series of engineering training manuals prepared by the *BBC* for its personnel but is equally well suited for the sound engineer or audio hobbyist outside of the broadcast field.

The text material is divided into seven chapters and nine appendices. The first chapter deals with the general principles of sound recording and reproduction while other chapters are devoted to a discussion of the principles of disc recordings, *BBC's* disc recording equipment, reproduction of discs and pressings, the processing of discs, magnetic recording and reproduction, and film recording and reproduction. Although none of the equipment described, with the exception of the American-made "*Presto*" disc recorder, is in widespread use in the United States many of the basic principles involved are the same as those governing the operation of U. S. types of recorder units.

The book is lavishly illustrated with graphs, circuit diagrams, line drawings, and photographs which supplement the lucidly-written text material. We believe that persons interested in all phases of sound reproduction will find this book a worthwhile "source book" and a valuable addition to any audio library.

"VADE-MECUM 1952" compiled by the staff of P. H. Brans. Published by *P. H. Brans, Ltd.*, Antwerp. 416 pages. Price \$5.00. Available in U. S. from *Editors & Engineers, Ltd.*, 1311 Kenwood Road, Santa Barbara, California.

The ninth edition of this well-known reference work is even more comprehensive than its predecessor volumes. It includes data on tubes manufactured by 261 companies throughout the world.

In order to keep this volume from becoming unwieldy the editors have adopted a new technique in presenting the material. Unlike the previous issues all tubes are now classified numerically and alphabetically in a single table. Only receiving and transmitting tubes have been included with special-purpose tubes now being omitted. A number of the obsolete tubes which were listed in all the previous editions have been omitted and the newest types added. The result of this revised listing is that it is possible to find any tube in a matter of seconds.

As was the case in the previous editions, instructions for using this reference work are given in several languages.

FIX ANY RADIO

Amazing New Invention



Find radio faults with a new simplified method. Repair all radios in minutes instead of hours. Revolutionary, different Comparison technique permits you to do expert work almost immediately. Most repairs can be made without any test equipment. Simplified point-to-point, cross-reference, circuit suggestions locate faults quickly and easily.



NO TESTERS NEEDED

This newly developed method tells you how to locate the source of trouble in any radio set without equipment. Make needed tests, measure voltage, trace the signal, by using only a 5¢ resistor, small condenser, and a crystal detector. Inject signals without any signal generator. Test parts by the new Comparison method. Test tubes without equipment. Repair any radio expertly following simplified picture plans. Improve your radio servicing ability. Data on all sets, portables, FM, AC-DC, P.A., inter-coms, clock radios. Send coupon.

CHARTS, BLUE-PRINTS, TESTS

Learn time-saving trouble-shooting short-cuts; find any radio fault with ease. Follow the tests shown on 24 large circuit blueprints. Gives over 1,000 practical repair hints. For all types of radios. Hundreds of simplified tests using only a 5¢ resistor and any filter condenser. Introductory material to help beginners. Several chapters on test equipment. Complete plan in manual form. 61 job-sheets, data on all tubes, 92 large pages, 8½ x 11 inches. Schematics, pictures, charts. Sold on no-risk trial. Price, only \$1.50. Use coupon below.

Supreme Radio & TV Manuals

Your complete source of all needed RADIO and TV diagrams and service data. Most amazing values. Still sold at pre-Korean prices. Only \$2 for most volumes. Every Radio manual contains large schematics, all needed alignment facts, parts lists, voltage values, trimmers, dia. stringing, and service hints. Each TV manual is a practical treatise on servicing the year's sets, with giant blueprints, patterns, waveforms, charts, suggested changes. See coupon at right for a complete list of these low-priced manuals.



NO-RISK TRIAL ORDER COUPON

Supreme Publications, 3727 W. 13th St., Chicago 23, ILL.

Radio Diagram Manuals

- New 1952 Manual, \$2.50
- 1951 Radio EACH
- 1950 Manual EACH
- 1949 Radio EACH
- 1948
- 1947
- 1946
- 1945
- 1944
- 1943
- 1942
- 1941
- 1940
- 1939
- 1926-1938 Manual, \$2.50

PRICED AT ONLY \$2 EACH

Send Radio and TV manuals checked at left and below. Satisfaction guaranteed or money back.

- Simplified Radio Servicing (Fix Any Radio) \$1.50
- 1952 Television Manual, \$3. 1951 TV, \$3.
- 1950 Television Manual, \$3. 1949 TV, \$3.
- 1948 TV, \$3. 1947 TV & FM, only \$2.

I am enclosing \$..... Send postpaid.
 Send C.O.D. I am enclosing \$..... deposit.

Name:
Address:

Supreme Publications
Sold by All Leading Radio Jobbers

MODEL 999

MODEL 912

MODEL 909

MODEL 907

MODEL 635

MODEL 630

save more than 50%

the highest quality instruments in kit form

precise

above all else

Instruments in Kit and Wired form

MODEL 630 RF-AM-TV AND MARRER GENERATOR. The very first hit to reach 150 mc on fundamentals, 330 mc on harmonics. The first kit to offer a complete factory pre-assembled and calibrated RF head.
Model 630A ... \$38.95 (pre-assembled head)
Model 630W ... \$53.95 (Factory wired) Model 630K ... \$33.95

MODEL 635 UNIVERSAL AF SINE, SQUARE & PULSE GENERATOR. Sine waves; square waves, pulses; Wien Bridge Oscillator; variable impedance output; voltage regulation insures a veritably constant output; cathode follower output; square waves and pulses with a minimum overshoot and rounded through 30,000 cycles; sine waves through 200,000 cycles. Factory wired \$52.50. \$33.50

MODEL 999 HIGH VOLTAGE PROBE. Multiple insulation, mechanically shockproof construction. Interchangeable tips; swivel lead connection; interchangeable resistors. Wired Only ... \$6.98

MODEL 909 VACUUM TUBE VOLTMETER. Ceramic precision resistors 1% or better; etched panel; steel cabinet; Amphenol type DC connector; separate 5v. AC scale; special zero alignment scale; burn out proof circuit; RUGGED OVERSIZE 4 1/2" meter. Factory wired \$44.98 RUGGED OVERSIZE 4 1/2" meter ... \$25.98

MODEL 912 R. F. PROBE. Lowest priced, finest factory wired and calibrated R.F. Probe in the industry. Wired Only ... \$4.25

MODEL 907 DELUXE VACUUM TUBE VOLTMETER. Vertical or Horizontal Construction. ELGANTIC 3 1/2" meter movement. Factory wired \$57.98 \$38.98

In stock at all of our convenient branches.

Federated Purchaser
INCORPORATED
THE ONLY COAST TO COAST ELECTRONICS DISTRIBUTOR

New York City 88 Day St. Dicky 9-3050	Los Angeles 910 S. Grand Ave. TRinity 7311	Newark, N. J. 114 Hudson St. WArner 3-9035	Allentown, Pa. 1115 Hamilton St. Phone 3-7441	Easton, Pa. 925 Northampton St. Phone 4259
---	--	--	---	--

Prices slightly higher in the West.
Prices and specifications subject to change without notice.

FREE

Pocket adding machine with operating instructions in English and Spanish given free with every order of \$5.00 or more.

FREE

AMAZING TUBE OFFER

All tubes are new & guaranteed for 90 days. Your money refunded if dissatisfied.

Table listing various vacuum tubes and their prices, including 1A7GT, 1B3GT, 1N5GT, etc.

115V POWER TRANSFORMERS 60 CY

Table listing power transformer specifications and prices, such as 58 V Half Wave, 3A, etc.

CHOKES

Table listing choke specifications and prices, including 9 HY 50 MA, 7 HY 150 MA, etc.

115V FILAMENT TRANSFORMERS 60 CY

Table listing filament transformer specifications and prices, such as 2.5 VCT 10A, 10 KV Insulation, etc.

Table listing receiver coils and their prices, including CW 4705, CW 47105, etc.

SIGMA SENSITIVE 5 Prong Plug in relay, polarized coil 3000 ohms D.C. operates on 2-4 MA SPDT contacts. Ideal for use with electric eye, control of model hobby equipment, etc.

ZA GLIDE PATH RECEIVER, NEW. BLACK CRACKLE ALUMINUM CASE 6"x7"x12", complete with shock mount, (3) 6C6 tubes, resistors, capacitors, etc.

ZA LOCALIZER CONVERTER, NEW. BLACK CRACKLE ALUMINUM CASE 9"x6"x7", complete with shock mount, tubes 6F8-6C8, resistors, capacitors, 60 and 150 CY Band Pass Filters

ZA CROSS POINT LANDING INDICATOR (cay 22316), contains 2 (0-200uA) meter movements, new

ZA BAND PASS FILTERS, 60, 90 or 150 cy. each.

MOBILE VAP ANTENNA MFD. BY G. E. 152-162 MC, complete with 12 ft. RG8U Coax cable, removable antenna rod, mount, 831SP (PL-259) Coax connector, installation hardware and instructions, new \$2.45.

SHY 300 MA CHOKE, 70 OHMS, 225.00 KV insulation, new \$2.99.

115V POWER SUPPLY KITS 60 CY

A 660VCT 95 Ma. 6.3V 3A, 5V 2A; 8 HY 100 MA CHOKES (2 ea.); 8x8 MFD 600 VDC OIL CAPACITORS.

B 740VCT 150 MA. 6.3V 4A, 5V 3A TRANSFORMER; SHY 150 MA CHOKE; 8x8 MFD 600 VDC OIL CAPACITOR.

C PLATE TRANSFORMER 740VCT 305 MA; 5V 6A x 6.3V 6A DUAL FIL. TRANSFORMER; 4.6 HY 310 MA CHOKES (2 ea.); 8x8 MFD 600 VDC OIL CAPACITORS.

D PLATE TRANS. 750-600-0-600-750 VDC 225 MA; 6 HY 250 MA CHOKE (2); 6.3V 4A 6.3V 4A DUAL FIL. TRANSFORMER; 5V 3A FILAMENT TRANSFORMER; 2 MF 1.5 KVDC & 4 MF 1 KVDC OIL CAP.

POLY TECH

Dept. 102, 919 Dawson St., New York 59, N. Y. Send for Bulletin Murray Hill 6-2650

International Short-Wave

(Continued from page 72)

William Haley, K.C.M.G., LL.D., in the 1952 BBC Year Book, makes these interesting observations:

"In 1952, broadcasting enters its fourth decade. Quite apart from the calendar it is for the BBC an exciting and expectant moment. However eventful the past, whatever achievement the last thirty years have brought, there is still great promise ahead. . . . If there is one thing more than any other which makes the future of broadcasting even more attractive an adventure than it was thirty years ago, it is that there is now a body of men and women, experienced, trained, stimulated, and devoted, who know that the service of broadcasting is one of the most rewarding activities of our time. In their entirety they are the BBC. They go into the fourth decade with the joyous knowledge that whatever it may bring it will stretch their faculties to the full."

The many operations and services of the BEC are so complex that only a few details can be cited here. Programs for listeners outside the United Kingdom are broadcast regularly in 46 languages. They are known as the External Services, and are organized in two parts—the European Services in 25 languages on medium- and short-wave, and the Overseas Services, also in 25 languages, on short-wave only. The Transcription and Monitoring Services also form part of the Overseas Division of the BBC. The Services are designed to furnish to as wide an audience as possible an accurate, objective, and comprehensive news service, to present the British point of view on current affairs, and to describe and illustrate the British way of life. An important and regular feature of both the European and the Overseas programs is the series, "English by Radio."

The General Overseas Service, conducted wholly in English, is on the air for 21 hours of the 24, and is the descendant of the prewar Empire Service. It is addressed to all areas of the world in turn, and, while primarily intended for British communities (including the Armed Forces overseas), has a large secondary audience among English-speaking nationals of foreign countries. It offers a comprehensive service of programs, drawing for its material on the Home, Light, and Third Programs as well as on material originated specially for overseas transmission. Special attention is given, of course, to matters of Commonwealth or Colonial interest. The focus of coverage by this Service moves westward through the day, and programs are timed to reach their destinations at the most popular local listening hours. Operating in parallel with the GOS are a number of special services in English and other tongues, each addressed to a particular audience and carried on its own independent frequencies. These services vary from the

Advertisement for Concertone Magnetic Tape Recorders. Features an image of a recorder and text: "just like being there" THE ONLY low cost high fidelity tape recorders delivering professional performance. Professional users' net prices begin at \$34500. Write for Bulletin #102 Manufactured By Berlant Associates 4917 W. Jefferson Boulevard Los Angeles 16, California

Advertisement for TEVCO Single Reflector Conicals. Features diagrams of antenna structures and a list of products with prices: 1259—Single Bay 3/8 elements, 3.19; 1256—Single Bay 1/2 elements, 3.89; 1254—Double Bay 3/8 elements, 6.68; 1258—Double Bay 1/2 elements, 7.89; 1257—Four Bay 3/8 elements, 14.89; 1253—Four Bay 1/2 elements, 17.19. Also lists Five Element Yagi Beams and other antenna models.

Pacific Service, broadcast to Australia, New Zealand, and the Pacific area for 45 minutes each day, to separate services in Spanish and Portuguese for Latin America.

BBC broadcasts to the Continent of Europe was started in 1938, and are now going out in 25 languages.

The BBC Transcription Service supplies overseas broadcasters with a selection of BBC programs in English and other languages in recorded form. By this means, programs from Britain are heard by overseas listeners, on their own home stations, often on medium-wave sets, thus increasing considerably the size of the audience.

The Monitoring Service, based at Caversham, maintains a continuous watch on foreign broadcasting stations. Trained linguists transcribe news items and other material, which is transmitted by teleprinter to the BBC news organization and the Government.

The BBC provides three sound programs for listeners in the United Kingdom—the Home Service, Light Program, and the Third Program. One wavelength in the long-wave band and 12 in the medium-wave band are being used for transmitting these programs in accordance with the Copenhagen Wavelength Plan of 1948.

The BBC's Overseas and European Services are radiated from a total of 39 short-wave transmitters of 50-100 kw. power, designed to operate on any of the 85 frequencies available for use by the Corporation. These include the two high-powered transmitters at Tebrau on the mainland of Johore, near Singapore, Malaya, which are used mainly to relay programs originating in the United Kingdom and addressed to audiences in the Far East and Southeast Asia. These programs are received from London at a specially constructed receiving station in Singa-

pore, whence they are fed to the transmitters at Tebrau.

The total number of studios in use for the sound programs is 190, plus 22 specially constructed rooms for the production of artificial echo. The largest studio is at Maida Vale, London, with a floor area of 7776 square feet. The floor area of all the studios is approximately 133,100 square feet.

As to BBC publications, best known are "Radio Times" (some 8,000,000 copies each week), printed in eight regional editions, as a guide to listeners in Britain; "London Calling," for overseas listeners, with separate editions for the Eastern and Western Hemispheres. Many other specialized publications are issued.

While the BBC does not verify, it does welcome letters from its listeners throughout the world, with comments on the substance and reception of its various broadcasts. Any such letters

**BUY DIRECT
and SAVE!**

STEVE-EL CUSTOM- MADE TV CABINETS



Model 100



Model 200



Model 300



Model 400

Cabinets are designed and built by country's leading craftsmen. Custom-made and designed for standard 630 type chassis with 20" picture tube. All cabinets supplied with mask and mounting brackets. (Hardware appointments subject to change depending on availability.)

- Model 100—Open face console, Mahogany.....\$55.00
- Model 200—Console with doors. Narrow type, mahogany.....\$79.00
- Model 300—Side Mount console with doors, mahogany.....\$80.00
- Model 400—Console with bar, blond only.....\$136.50

**BUY THIS COMBINATION DEAL
AND SAVE STILL MORE!**

Choose cabinet in combination with famous 630 TV chassis and 20" picture tube. Note the additional saving passed on to you!

Cabinet Model	#100	#200	#300	#400
CASCADE Chassis	\$219	\$239	\$249	\$295
DF CASCADE Chassis	\$229	\$249	\$259	\$305

Above includes 20" picture tube.



SUPER DELUXE 630 TV CHASSIS

Finest component parts. Takes all picture tubes from 16" to 24". Complete with 12" speaker. Manufactured under RCA license.

With CASCADE TUNER.....\$138.50

With SUPER DF CASCADE TUNER.....\$151.95

(Specially designed for fringe area reception)

TV PICTURE TUBES

All Brand New STANDARD BRANDS—NO REBUILTS!
ONE FULL YEAR GUARANTEE

- 148P4\$19.95
- 16GP4 26.00
- 16KP4 23.40
- 17BP4 23.40
- 19AP4 23.95
- 20CP4 32.00
- 21EP4 34.40
- 24AP4 59.60

Write Dept. RN-10 for latest catalog and complete list of tubes on special sale.

STANDARD BRAND TUBES				Individually Boxed and Guaranteed
(Manuf. of tubes refuses permission to mention name because tubes are FAR BELOW FAIR TRADE).				
1A789	6AG579	6CB671	6X562	12SQ768
1B389	6AH6 ...1.29	6CD639	7C574	14A784
1H571	6AK5 ...1.29	6I553	7F774	14B694
1N574	6AL568	6J693	7K71.09	25BQ6 ...1.29
1R579	6AQ559	6K666	7N784	25L664
1S579	6AT568	6K774	12AT665	25W478
1T479	6AU669	6SA764	12AT799	25Z667
1U578	6BA669	6SH764	12AU786	35L686
1X2A94	6BC574	6SJ773	12AV7 ...1.19	35W452
3Q489	6BE679	6SK772	12AX799	35Z551
3Q589	6BG6 ...1.76	6SL774	12BA669	50A596
3V473	6BH686	6SN774	12BE669	50B579
5U463	6BK7 ...1.15	6SQ764	12BH799	50C566
5V497	6BQ6 ...1.24	6T899	12SA777	50L664
5Y347	6BQ7 ...1.15	6V6GT64	12SK777	117Z364
6AC794	6C454	6W464	12SN784	

Above partial listing only. Send for complete list.

STEVE-EL ELECTRONICS CORP.
61 Reade St. New York 7, N. Y.
Cortland 7-0086

The New Model 670-A

SUPER-METER

a combination

**VOLT-OHM MILLIAMMETER plus
CAPACITY REACTANCE, INDUCTANCE
and DECIBEL MEASUREMENTS**



SPECIFICATIONS:
D.C. VOLTS: 0 to 7.5/15/75/150/750/1,500/
7,500 Volts
A.C. VOLTS: 0 to 15/30/150/300/1,500/3,000
Volts
OUTPUT VOLTS: 0 to 15/30/150/300/1,500/
3,000 Volts
D.C. CURRENT: 0 to 1.5/15/150 Ma.
0 to 1.5/15 Amperes
RESISTANCE: 0 to 1,000/100,000
Ohms to 10 Megohms
CAPACITY: .001 to 1 Mfd. 1 to 50 Mfd.
(Quality test for electrolytics)
REACTANCE: 50 to 2,500 Ohms 2,500
Ohms to 2.5 Megohms
INDUCTANCE: .15 to 7 Henries 7 to 7,000 Henries
DECIBELS: -6 to +18 +14 to +38 +34 to +58

The Model 670-A comes housed in a rugged crackle-finished steel cabinet complete with test leads and operating instructions. Size 6 1/4" x 9 1/2" x 4 1/2".

\$28⁴⁰ NET

ADDED FEATURE

The Model 670-A includes a special GOOD-BAD scale for checking the quality of electrolytic condensers at a test potential of 150 Volts.

**AT
YOUR
RADIO
PARTS
JOBBER**

Write Dept. RN-10 for complete catalog

Manufactured and Guaranteed by

SUPERIOR INSTRUMENTS CO.
227 Fulton Street • New York 7, N. Y.

**ROUND, SQUARE, KEY and "D"
OPENINGS QUICKLY MADE
with Greenlee
Radio Chassis Punches**



Save hours of hard, tedious work . . . cut accurate holes in chassis for sockets, plugs, controls, meters, panel lights, etc. with GREENLEE Punches. In 1-1/2 minutes or less make a smooth hole in metal, bakelite or hard rubber up to 1/16" thick. Easy to operate . . . simply turn with ordinary wrench. Wide range of sizes. Write for details. Greenlee Tool Co., 1890 Columbia Avenue, Rockford, Ill.



**HIGH
IMPACT
PLASTIC**

CONNECTOR

**NOT A REMODELED
CLOTHESPIN**

HAS PROVISIONS FOR THE NEW
R.C.A. - PHILCO PIN TYPE CONNECTION

Also Mfgs. of

**ANTENNAS • TUBE COVERS
REACTIVATORS • SPEAKER GRILLES
TUBE PULLERS • CLAMPS**



ELECTRONICS MFG. CO.
Inglewood, Calif.

SEE YOUR
LOCAL
DISTR.

—addressed to the BBC, London, W 1, England—will receive the most careful attention, Corporation officials point out.

Our best wishes go to the BBC for success in its future operations!

* * *

Radio Club Notes

England—Bob Kenny, G3AAU, president of *The World Friendship Society of Radio Amateurs*, says that any books or magazines intended for "Bedfast Club" members should go direct to John Gill, 30, Shore Broke View, Leeds, Yorks., England, and that all USA and Canadian inquiries may now go to Cary Ripton, 47 Lake St., Le Roy, New York, the club's American representative; other inquiries should go to Ern Mitchell, 27, Fir Close, Willand, Nr. Cullompton, Devon., England. This club's official organ, "Skywire," is now being printed instead of mimeographed as formerly.

USA—New officers chosen by the *United 49'ers Radio Society* are Edward I. Broome, president; James J. Zaloudek, Sr., first vice-president; Charles E. McCormick, Jr., second vice-president; Mrs. Julia Boice, secretary; James R. Pickering, treasurer; Anson M. Boice, editor; John J. Flanagan, Jr., assistant editor and DX columnist; William McKenna, chaplain. The club plans a membership contest and a DX contest soon, according to President Broome.

* * *

This Month's Schedules

Albania—Radio Tirana, 7.850A, heard with news 1615 to sign-off 1630. (Baetz, Ill.) The 6.560A channel is still used in parallel. (DX-Radio, Sweden)

Algeria—Radio Algerie, 9.570, is heard in Sweden 1600. (Nattugglan, Sweden) Noted signing off with "La Marseillaise" 1757, good level. (Niblack, Ind.)

Andorra—Radio Andorra, 5.980A, noted 1722-1730 with music. woman announcer in Spanish. (Rodger, Scotland)

Anglo-Egyptian Sudan—Radio Omdurman now appears to be on 9.708 for its Arabic transmission 2315-2345; poor level in West Virginia.

Angola—A QSL card received airmail from CR6RG, Radio Diamang, Dundo, gives frequency as 6.870. power 400 watts, schedule of 0530-0700, 1300-1430. (Radio Amateur, London) Luanda, measured 11.865 (listed 11-862), noted signing off 1730 at good level; is CR6RA. Radio Clube de Angola. (Ferguson, N.C., Hord, Ind.) Sunday sign-off is 1530. (Pearce, England) CR6RN, 7.132, was recently noted in parallel with 11.865 from tune-in 1730 to sign-off (both channels) at 1850 on a Saturday. (Kary, Pa.)

CR6RB. Benguela, sent QSL for report on 9.165 with verification in English; listed schedule of 0615-0745, 1230-1500. Heard when tuned 1330 to 1500 closedown with "A Portuguesa." Radio Clube de Huila, 10.050, noted

1345, with call 1400; is CR6RJ, Sa da Bandeira. (Pearce, England)

Argentina—LRU, 15.290, Buenos Aires, noted 2300-0100 in English for Western North America, fair signal; LRX, 9.660, heard 2220 in Spanish, good level. (Scheiner, N.J.) LRA, 17.720, heard with English for Eastern North America 1700-1930, good level in Wisconsin. (Tonsi) LRT, 11.840, Tucuman, noted with strong, fairly clear signal around 1910-1930 in Spanish. (West, Va.) LRY, 9.450A, noted at good level in Spanish evenings (EST). (Lanc, Wyo.)

Latest schedules from SIRA are—LRA, 1000-1200, Portuguese to Brazil, 17.720; 1200-1500 French to France, 17.720; 1505-1700 Spanish to Europe and America, 17.720; 1700-1930 English to USA, 17.720; 2000-0100 Spanish to Caribbean, 9.690. LRU, 0700-0845 Spanish to Hispanic America, 15.290; 1300-1545 Spanish to Hispanic America, 15.290; 2100-2300 Spanish to Hispanic America, 15.290; 2300-0100 English for USA, 15.290. LRS, 11.880, at 0800-1300 Portuguese to Brazil; 1300-1400 English to England; 1400-1500 German to Europe; 1500-1600 Italian to Italy; 1600-1700 Spanish to Europe and America; 1700-2230 Portuguese to Brazil, and 2300-0100 Spanish to America.

Austria—Radio Wien, Vienna, noted on 11.785 and 9.664 when tuned 0115; both had recordings interspersed with time checks but were not parallel; all-German. (Pearce, England)

Brazil—Nattugglan, Sweden, lists Radio Cultura da Bahia, Ltd., Luiz Ribeiro Rocha, Avenida 7 de Setembro 311, Salvador, Bahia, Brazil, on 3.345 at 1600-2000.

PRL9, 6.1467 (measured by Oskay, N.J.), leaves the air around 2130 and immediately re-opens over PRL7, 9.720. (Stark, Texas) PRL7, 9.720, was noted recently in English and Portuguese after 2145. (Scheiner, N.J.) A Brazilian heard on 6.195 to after 2130 is probably Emissora Continental. (Stark, Texas) Radio Jornal do Commercio, Recife, may be heard some mornings on 15.145 around 0730 at good level; plays much Latin American music. (Niblack, Ind.) DX-Radio, Sweden, says PRD4, Radio Cultura, Sao Paulo, is heard 1930-2030 on 2.470.

Radio Record, 9.505, is fair around 2240 but with bad QRM from YEWV. (Lane, Wyo.) This one signs on daily 0455; other Brazilian outlets heard opening 0455 are ZYK3, 9.565, and ZYC8, 9.610; PRL7, 9.720, comes on earlier—probably 0400. (Kary, Pa.) Serrano, Brazil, confirms that Radio Ministerio da Educacao e Saude, Rio de Janeiro, has returned to PRL4, 9.770, from PRL5, 11.950, with schedule unchanged. (WRH)

Bulgaria—Radio Sofia, 7.671, opens 2225 with a 5-note interval, then a march-like tune; is in Bulgarian at sign-on. (Stark, Texas) Noted on this channel at weak level in Pa. 1700, probably with relay of Home Service. (Kary) Still heard on 15.330 with news 2300-2315. (Sanderson, Australia)

CONCORD Presents RCP

RADIO CITY PRODUCTS

"FIRST WITH THE FINEST" IN

TEST EQUIPMENT



At Last! A Complete "Do-All" TV Generator

MODEL 740. One compact, efficient instrument giving the performance of several high-priced TV service instruments.

IT'S A SIGNAL GENERATOR
Modulated or unmodulated carrier signal covering every VHF TV channel. And even FM band—ALL ON FUNDAMENTALS.

A MARKER GENERATOR
1/10th of 1% on 9-11 Mc. Better than 1/2 of 1% overall. Perfect for alignment.

AN AUDIO GENERATOR
Supplies 540 cps signal at the audio output.

A PATTERN GENERATOR
Horizontal or vertical bars or cross-hatch.

RANGE: 9-220 Mc with skips, all on fundamentals.
MODULATION: Both 540 cps and 220.5 Kc provided.
TUNING: Dial continuously calibrated thru 340 Mc. Each TV channel precisely spotted on dial.

Handsome metal cabinet with new rugged construction. Size 10x6x6. Weight 8 lbs. Net

\$69.50

TV - RADIO - CRT TUBE TESTER & VTVM

ALL IN ONE UNIT:

- A Tube Tester
- A CRT Tester
- A CRT Reactivator
- A VTVM (AC & DC)
- AN Ohmmeter

THE TUBE TESTER: All of the features of the famous 323 Dynoptimum free point tube tester. Tests all modern tubes.

THE CRT TESTER: Will check all magnetic deflection type Television Picture tube.

THE REACTIVATOR: Revives and reactivates many otherwise Dim or Bad Television CRTs.

THE VTVM: -17 range balanced bridge type VTVM. Input imp. 25 Megohms. Zero center scale for discriminator alignment. AC DC volts 0-1000 on 5 scales. db, 20 to +62 on 5 scales.

THE OHMMETER: 2 ohms to 1000 Mega on 5 Ranges. Ideal for checking condenser leakage or shorts.

Hand-rubbed oak carrying case with leads, probe, batteries, etc.—12 1/2 x 12 3/4 x 4 3/4"—wt. 12 1/2 lbs. Net \$99.95

MODEL 808—Complete High Voltage probe for above. Extends range to 30,000 V on VTVM. Net \$8.95
MODEL HVPM-1



\$99.95

"Mighty Midget" MIDGETSCOPE MODEL 553M



\$99.50

A truly miniaturized professional oscilloscope for maximum operational convenience.

FEATURES: High sensitivity; wide-band response; light in weight and small in size; all controls on front panel below the screen; operates in horizontal or vertical position; CRT tilted for best angle viewing; shielded CRT with protective bezel and graph screen.

Specifications:
Sensitivity—Vertical: .02 Volts per 1" rms. Horizontal: .06 Volts per 11" rms.
Frequency Response—2 db. from 20 cps. to 150 Kc. Excellent Transient Response.
Push-Pull Deflection—For undistorted response.
Input Impedance—Vertical: .5 Megohms shunted by 50 MMF. Horizontal: 1 Megohm shunted by 70 MMF.
Tubes—12AT7, 12AU7, 6J6, 117Z6, 6MP1 CRT.



VALUES GALORE!
• RADIO
• TELEVISION
• ELECTRONIC BUYER'S GUIDE
CONCORD RADIO

Send TODAY for your

FREE COPY
of our latest Buyer's Guide

CONCORD RADIO
55 VESEY ST. - NEW YORK 7, N.Y.
Phone Dlgby 9-1132

RCP's SERVISHOP

Equal to a Complete Service Shop



- Tube Tester
- Condenser Tester
- Set Tester
- AM Generator
- FM Generator
- AF Generator

MODEL 8773 —
Complete with tubes, batteries and test leads, output leads, etc.—housed in beautiful natural finish oak case. Weight 18 lb. Overall Size 18 1/2 x 12 3/4 x 5 1/4". An outstanding value at

\$99.95 Net

At last! An up-to-date tube tester for testing modern, miniature, novel base and sub-miniature tubes with the new, speedy Rollindex Roll Chart—combined with a complete multimeter measuring AC and DC volts—DC milliamperes and amperes—ohms and megohms, decibels and output volts and also a condenser tester, AM signal generator, FM signal generator and audio oscillator.

CONCORD RADIO Dept. N-10
55 Vesey Street, New York 7

- Please send at once:
- FREE COPY of your latest BUYER'S GUIDE.
 - Model 740 RCP TV Generator.....\$69.50
 - Model 808 RCP CRT Tester & VTVM.....\$99.95
 - Model 553M RCP Midgetscope.....\$99.50
 - Model 8773 RCP Servishop.....\$99.95
- Check in full, or 20% deposit enclosed.

NAME

ADDRESS

CITY STATE

Do You Run a SERVICE SHOP?

... then You'll Surely PROFIT by these Instruments—
LOW IN COST • PAY FOR THEMSELVES QUICKLY

CRT TESTER-REACTIVATOR

2 Instruments in One: It's a Picture Tube Tester: Tests quickly and accurately all picture tubes—in the set or in the carton. It's also a Picture Tube Reactivator: Renews brightness of dim tubes with only a few minutes of application. Almost 75% of low emission tubes—whether practically new or very old—are vastly improved with this famous Transvision Instrument.

\$19⁹⁵ net
Fully
Guaranteed



CRT TESTER-SPARKER: 2 Instruments in One

Ideal for Labs, too
Picture Tube Sparker: Sparks out electrical leakage between elements. Saves many picture tubes and small tubes which would usually be discarded. Cathode-grid leakage is an especially common occurrence. The Sparker corrects this very quickly. The Sparker also gives a rapid check of gas condition of the tube.
TESTER: A variable 8,000-14,000 DC supply, useful for analyzing hard-to-solve deflection problems. Fully Guaranteed.

\$19⁹⁵ net

CRT TESTER-REACTIVATOR-SPARKER: 3 in 1

A combination of the Tester-Reactivator and Tester-Sparker in one handy instrument. It does not have the variable 8,000-14,000 DC supply included in the Tester-Sparker and therefore cannot be used for sweep circuit analysis. However, it performs all the other functions: Tests Picture Tubes; Reactivates Dim Tubes; Sparks out Electrical Leakage in Picture Tubes. A compact, profitable 3-in-1 Service Instrument. Fully Guaranteed.

\$34⁹⁵ net

FIELD STRENGTH METER— A GREAT BUY at NEW LOW PRICE

Improve TV installations; save half the work with the Transvision Field Strength Meter. Especially good for fringe areas—measures field strength as low as 10 microvolts.
Model FSM-1, complete with tubes.

\$59 net



Improve Your Business—Order These Instruments Now—Direct from
TRANSVISION, INC., Dept. RN-10, NEW ROCHELLE, N.Y.

SCHEMATICS—CONVERSIONS FOR SURPLUS GEAR

NEW LIST! MANY ADDITIONS!

Send stamped, self addressed envelope for List B. Add 25c for chart explaining AN nomenclature.

R. E. BOX 1220
GOODHEART BEVERLY HILLS, CAL.

LEARN TELEVISION
ELECTRONICS and RADIO
Engineering Laboratory and Classroom
Training. Day and Evening Classes.
Write for illustrated Catalog
ELECTRONICS INSTITUTE, Inc.
21 HENRY, DETROIT 1, MICH.

WANTED!

•RADCOM pays
•highest prices for surplus
•equipment, parts and tubes

- TCS-7 and up
- SCR 274N, BC 696
- SCR 399 Equipment JB 70, JB 60, BC-939A BC-610-E RA-63, EE8, BC-614-E, PE95, PE197, Tra:ler K-52, Cords, LS-3
- SCR-508 . . . BC-604, BC-603, FT-237, Crystal Sets
- SCR-506 . . . BC-653-A, BC-652-A, DM-40-A, FT-253-A, BC-658-A
- BC312, 342, 348 Receivers
- SCR522 Equipment, RA-34 Rectifiers
- Transmitters BC 696, R89/ARN-5A MN 62
- Test Equipment SCR-211, I-208, BC211
- Selsyns—All kinds
- Generators—GN 45—All kinds
- 5 KW Gas Generators PE 75, PE 95 PE 197
- Plus and Connectors
- Magnetrons 4J-52, 720-AY—Others
- Tubes—Special Purpose, Lots
- Technical Manuals

Bigelow 2-6666

Always Right With Earl White

RADCOM Engineering Co. 8 Livingston St.
Newark 3, N. J.

Canary Islands—Radio Clube de Tenerife, 7.520, Santa Cruz, noted Sundays with bulletin of sports and local news in Spanish 1707-1712. (Kary, Pa.)

Ceylon—The Commercial Service of Radio Ceylon is good level 0930-1000 on 11.975, to India-Pakistan. (Olsen, Calif.) Noted on 15.120 with weak to fair signal 2310 with popular tunes. (Cox, Dela.) Normal sign-on has been 2045 but more recently has been noted coming on air 2030; announces for 7.190, 11.975, 15.120. (Niblack, Ind., Ferguson, N.C., others) Heard on 15.120 ending Hindi session 0130, then continuing in English to 0230 closedown. Logged signing off 1145 on 11.975; noted more recently on this channel 1203 calling Australia with test transmission from 1205 to around 1245. (Pearce, England)

Chile—Santiago, 6.190, noted to past 2130 on Sundays. (Stark, Texas) Radio Sociedad de Minería, Santiago de Chile, sent verification for reception of CE1173, 11.730; verification was on folder card complete with views and printed in English and Spanish. (Pearce, England)

China—Radio Peking, 15.05A, noted 0932 in Chinese by man; weak with slight whistle on carrier. (Cox, Dela.) Heard on 9.040 at 0645 with Chinese music, with news 0400; on 11.690A at 0400 with news. (Sanderson, Australia) Pearce, England, notes the news 0400 on the 15.060A outlet.

Radio Peking noted on 15.13-15.14A with news 0400, when 15.060A, 11.70A, 10.20, and 10.26 are fair; 9.04 and 6.10 are QRM'd at that time. (Balbi, Calif.)

Colombia—Scheiner, N.J., reports HJXC, "La Voz de Colombia," Bogota. on 6.020 at 2145 in Spanish, good level. Reported 0215 by Pelegri, N.Y. And by Sanderson, Australia, at 0130 with good musical program.

The 6.010 Colombian is giving a medium-wave call of HJFM and a short-wave call of HJFC; is "La Voz de Armenia." (Stark, Texas) Excellent level around 2245-2315; uses commercials; all-Spanish. (Niblack, Ind.)

Curacao—PJC2, 5.017, Willemstad. has fair signal with English program on Wednesdays 2000-2030; on its verification listed another channel of 7.250, power 3 kw. (Baetz, Ill.)

Czechoslovakia—Prague has English for Europe 0715-0745 on 11.840 and 1400-1425 on 9.504. (ISWC, London) Confirmed by Pearce, England. Is noted on 11.840 in foreign language and with interval signal 1415, fair level in Indiana, reports Niblack. Mack, N.Y., says Prague, 9.550, continues with good level with English for North America 1930-2000.

Dutch New Guinea—According to the N.Z. DX Times, Radio Hollandia is testing daily on 5.090 at 0430-0700. (ISWC, London) Not heard on 5.090 in Calif., but is still noted on 7.126 around 0500-0700; heard Sundays 0430 with religious service. (Balbi)

Ecuador—HCJB, Quito, noted on its new 11.915 (replacing 12.455) channel 0130, parallel with 9.745, 15.115, beginning 1½-hour program in English for

Australia; opened with "Southern Cross Salute." (Pearce, England) The new 25-m. channel was measured 11.9155 by Oskay, N.J., at 1945.

Egypt—Radio Cairo, 11.815 (announced), noted recently from 1600 tune-in to sign-off 1702; had recorded music to 1640 when announced in French, English, Greek, Italian; said would be back next day 1515. Had severe QRM from Rome, 11.810, after 1630. (Kary, Pa.) Pearce, England, reports the 11.815 outlet tuned 1335 when had news in progress to 1345, then went into a foreign language; heard another day 1325 with French news in progress, then English news 1330.

El Salvador—Stark, Texas, has heard a station on 11.767A around 0900 announcing "Radio Victoria en San Salvador." Gave a call of YSG which may be a medium-wave call. Uses varied recordings, some Spanish, some English. Has been heard before 0800 and as late as after 2300.

Ethiopia—Radio Addis Ababa, ETAA, 15.050A, noted 1300 in Amharic and closing 1304 after short selection of native music; no English heard. (Pearce, England) Sutton, Ohio, says that on a Saturday some weeks ago this one had news 1300-1315, S6, light QRM.

Falkland Islands—Serrano, Brazil, says Port Stanley is operating on 1500 kc. and 3.400, 0.25 kw., to be increased in 1953 to 5 kw., Mondays 1815-2030, Wednesdays 1815-2000, Fridays 1815-2000, Saturdays 1600-1700, Sundays 0600-1700, 1800-1859. (WRH)

Fiji—Dorothy Sanderson, Australia, has received a verification from ZVJ, 17.680, Suva, in reply to her report on reception of special sports (yacht races) broadcasts some time ago; station officials said there were no plans for any special transmissions soon.

France—Paris, 15.350, noted signing on in French 1015. (Cox, Dela.) Heard on 9.680 at 1945 at fair level in New York. (Pelegrini) Noted on 7.105 with call in French 1500 followed by news in that language; heard signing on 1215 on 11.845 with news in French. (Pearce, England) Paris, 7.24, noted signing off 0215 with interval signal. (West, Va.)

French Cameroons—Radio Douala now operates on 7.280—not 9.657—at 1245-1500. (ISWC, London)

French Equatorial Africa—Radio Brazzaville noted recently on 15.595 at 0630-0720 sign-off, had news in French, good level; played classical music. (Saylor, Va.) Radio Chad, Brazzaville, has transmissions in Arabic 0030-0130, 1305-1335 over 15.595; QRA is Radio Chad, P. O. Box 758, Brazzaville, French Equatorial Africa. (ISWC, London)

French Morocco—Radio Maroc, 6.006, Rabat, noted signing on 0200; soon was buried in QRN. (Saylor, Va.)

French West Africa—Radio Dakar, 11.896A, noted with call, news in French 1515; also heard 0203 with program details in French by woman announcer, then symphonic music; 0230 had news in French followed by varied

TV DIRECT TO YOU

FROM THIS GREAT FACTORY

BRINGS YOU

Finest Quality at Lowest Prices



TRANSVISION

TV KITS, WIRED CHASSIS, and SETS
CABINETS, COMPONENTS, INSTRUMENTS, and ACCESSORIES

NEW LOW PRICES

on Top Quality TV Picture Tubes:



- **TRADE-IN ALLOWANCE**
Make from \$2.00 to \$5.00 glass allowance on each "dud."
- **FULL 2 YR. GUARANTEE:**
Only Transvision gives you a Guarantee for 24 months.

FREE BOOKLET: "INSIDE CRT, or What You Should Know About Picture Tubes." Written by CRT experts, illustrated. It will MAKE MONEY FOR YOU. WRITE FOR IT NOW.

FREE CHART: Write for Picture Tube Interchangeability Chart.

COMPARE: Get the full details on the Transvision tube deal today.

New... TRANSVISION Picture Tube PRICES

Tube Type	Cost, WITH GLASS allowance	Cost, WITHOUT GLASS allowance
10BP4	\$11.80	\$13.80
12½" Glass (any type)	13.45	15.75
12½" Metal (any type)	13.95	16.25
14BP4	16.90	18.25
16" Metal (any type)	19.90	22.20
16" Round or Rect. (any type)	18.90	22.25
17BP4	18.90	22.25
19" Metal or Glass (any type)	23.95	28.95
20CP4	26.95	31.95

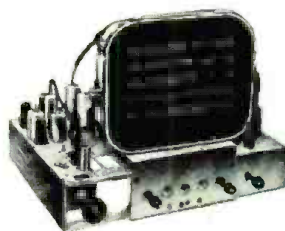

Sensational Offer:

TV \$39

KITS DOWN*

Build World's Finest Chassis—the A4

***BUILD THE FINEST CHASSIS MONEY CAN BUY** with the famous A4 Kit by Transvision. **PAY AS YOU WIRE**—only \$39 for the starting package. Easy to assemble, enjoyable, educational—gets you the most superb TV set imaginable. Easiest to service, too. Don't put it off. With these easy terms you can get started now.

Also **WIRED CHASSIS at LOW COST.** The A4 in completely wired chassis form gives you the world's finest TV set, with latest circuits and extra sensitivity for fringe areas. Gives clearer, brighter picture. Easy to service and keep up to date: built to last for years. Write for amazing low prices.

SIZES: The A4 Kit and Wired Chassis are available in 17" and 20" sizes. Also with **REMOTE CONTROL.**

BEAUTIFUL TV CONSOLES

Ideal for Custom Building or Conversion. Factory prices start from \$49. Send for Cabinet Catalog now.

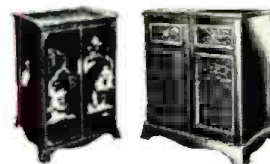

MULTI-SET CONNECTORS

feed up to 5 TV Sets from 1 Antenna
Prices: Multi-Set Conn. for 2 sets... \$4.95 list*
For 3 or 4 sets... 7.95 list*
*Dealers, write for discounts

U. H. F. ADAPTERS

will be available for all Transvision Sets and Kits.

Write for Transvision's Factory Agent Plan and complete literature

FREE: EXTRA INCOME EVERY MONTH from hits in "TV and Electronics Notes." Request sample copy, plate and mailing for FREE subscription. Monthly issues are gold mines of info on New Products, Sales, Service, Conversion, etc. **WRITE DEPT. RN-10 TODAY!**

TRANSVISION, INC. NEW ROCHELLE, N. Y.

LOOK at these BIG VALUES!

AIR TRIMMERS



Capacity	Capacity		Fig.	Shaft Length	Post Length
	Min. μ f	Max. μ f			
2	12		D	5/16"	3/8"
2	27		A	7/16"	3/8"
3	10		D	5/16"	3/8"
2	18		D	5/16"	3/8"
4	25		A	17/32"	3/8"
5	50		A	7/16"	3/8"
5	55		A	7/16"	3/8"
7	23		C	5/16"	3/8"
7	45		D	5/16"	3/8"
8	45		A	17/32"	3/8"

PRICE, EACH.....32c

Fig. A: Round Shaft, Screwdriver Adj. W/Locknut.
Fig. C: Rd. Shaft, Screwdriver Adj. Fig. D: Hex-nut screwdriver Adj.

AUDIO TRANSFORMERS

AT201 50L6 output (4000 ohms) to V.C. (3 ohms) \$4.40
AT 50B Sub tuner, Multitap, 200 ohms to 15 K ohm C.T. and 100 K ohm Grids.....\$6.69
AT731 H.F. Plate (1500 ohm C.T.) to V.C. (1674 ohms) 20-15KC.....\$3.29
AT501 HI-FI Special: PRI: 3000 ohms P-P/Sec. 1/16/12 50,200 ohms 60-10,000 CY.—1 db 50W.....\$3.49
AT182 HI-FI Driver Pri: 10,000 ohms Sec: 40,000 ohms PP Grids 50-15 KC/1 db.....\$1.49
AT062 Output to H.S. or line PRI: 14,200 ohms SEC: 8000 (300 ohms).....\$1.10
AT449 HI-FI Driver (5000 ohms) to P-P output Grids (4,000 ohms) 100-10,000 CY. 10W 6V6 to PP 805'.....\$2.39
AT668 Interon Input: Spkr (4-8 ohms) to grid (250-1000 ohms).....\$1.69
AT415 Plate (12,000 ohms C.T.) to line (125 ohms) 175 W.—500-600 CY.....\$1.85
AT858 Plate (10,000 ohms C.T.) to line (125 ohms) 125130 (ohms) HI-FI—50W.....\$1.95
AT070 Mike-or-Line (250 ohms) to grid (250-1000 ohms C.T.).....\$1.20
AT765 Mike-or-Line (600 ohms to grid (50,000 ohms C.T.).....\$1.69
AT-894 HI-FI Output: 3 Watts, 8500 Ohms P-P to V.C. (15 Ohms) 15-15KC PM 1 db.....\$1.49
AT-8A1: Mike (33 ohms Carbon) to Line 800 ohm 200 ohm.....\$1.19
AT648: Line (300 ohms) to Grid (75K ohms).....\$1.89
AT430: Line (600 ohms) to V.C. (6 ohms) 17 db.....\$1.19
AT631: Mike-or-Line (200 ohms) to Single or P-P Grids (50K Ohms).....\$1.59
AT718 Line (300 ohms) to Line 600/30 Ohm Response 50-20KC P.M. 1 db.....\$4.49

RU/GF GEAR



RU/GF XMTR COIL SETS
2000-2300 KC.....\$1.75
3000-3675 KC.....\$1.75
3675-4525 KC.....\$1.75
6000-7350 KC.....\$1.75
7350-9050 KC.....\$1.75

ACCESSORIES
REMOTE TUNING BOX TYPE.....\$1.75
CW-2301.....\$1.75
XMTR. CONTROL BOX, CW-23097. 1.69
RCVR. SWITCH BOX, CW-23096A 1.75
28V DYNAMOTOR & FILTER BOX FOR RU.....\$8.95

COMPLETE RU/GF SET WITH ALL PLUGS, MOUNTINGS, XMTR., RCVR., TUNING UNITS, DYNAMOTOR, INSTRUCTION BOOK—READY TO GO—ALL BRAND SPARKING NEW.....\$97.50

RU/GF COIL SETS SINGLE BAND RCVR UNITS
BAND..... FREQUENCY
L..... 400-600 KC
C..... 540-830 KC
E..... 1300-2040 KC
F..... 2040-3000 KC
G..... 4525-6000 KC
H..... 6000-7700 KC
M..... 6000-6050 KC
K..... 6050-13,375 KC
PRICE: \$1.50 EACH

RCVR. DUAL BAND COILS
400-600 KC 6000-9050 KC
540-830 KC 5200-7700 KC
1300-2040 KC 400-435 KC
540-830 KC 540-830 KC
PRICE \$2.25 EACH
Schematic of RU/GF Set 35c

RECTIFIER TRANSFORMERS

PRI: 115V. 60 CY. SEC: 28V/3.1A.
26V/8.4A. 7.3V/14A.....\$12.95
PRI: 210/215/220/225/230/235/240V. 60 CY.
1 Phase
SEC: 11/10/7.5/5VCT @ 35A.....\$9.50
PRI: 115V. 60 CY. SEC: 20V @ 10A.....\$3.95
PRI: 115V. 60 CY. SEC: 8.1V @ 1.5A.....\$1.39

UNIVERSAL SUPPLY KIT

Delivers 220V @ 40MA DC. From 110/220VAC. 60 CY. Kit consists of 1 Transformer, 1-5 HY @ 40MA Choke, 2-8MFD @ 450V Filter.....\$3.95
Cond. 1—6X5 Tube. A Great Buy at Only.....

Interphone Transformer Set

Big your own Interphone. Kit consists of 1—Input Transformer (matches 4 or 6 ohm spkr to grid) and 1—Output Transformer (matches 50L6, 35L6, 25L6, etc. to 4 or 6 ohm speaker).....\$1.00
Set of 2 Xfms. Only.....

All Merchandise Gtd. All Prices F.O.B. N.Y.C.
Send M.O. or Check. Shipping Chas. C.O.D.
COMMUNICATIONS EQUIPMENT CO.
131 Liberty St. Dept. N-10 New York City 7, N. Y.

program of recordings; still on air at 0400 tune-out. (Pearce, England)

Germany—The transmissions planned for Germans all over the world will not begin until the end of the year; the transmitter is not yet finished. (ISWC, London) Stuttgart, 6.030, now uses 20 kw. weekdays 2255-2215, Sundays 0000-1900.

Leipzig, 9.728A, heard opening 2227 with interval signal on French horn, anthem 2229, then opening announcements in German 2230 followed by news in German; has QRM from HI2T. Hamburg, 11.795, noted with news in German 2300; setting-up exercises 0005-0010, then with classical music; heard on 7.290 around 1652-1715. (Kary, Pa.)

RIAS, 6.005, Berlin, noted with nice signal recently 0030-0100 when was "killed" by QRN. (Saylor, Va.) Sent verification and said is broadcasting 24 hours daily on this channel. Hamburg, 6.270, is good signal daily in Britain around 0100. Munich sent QSL card for 6.160, 10 kw., scheduled Mon-Sat. 2330-0420, 0515-1900, Sundays 0000-1900; Frankfurt, 6.190, sent QSL card but no schedule. (Pearce)

Greece—Radio Athens is now using 11.717A for its North American daily transmission in Greek-English 1900-2000; usually has English news around 1940-1950. (West, Va., Golden, Mass., others) Heard on 7.300 with Home Service recordings when tuned 0104. (Pearce, England)

Radio Mytilini, Lesbos Island, is a new outlet heard in Britain at good level to 1600 when signals are obliterated by Radio Italiana opening on the same channel of 6.240; Mytilini is scheduled around 1300-1630. (Radio Amateur, London)

Greenland—OXI, Gronlands Radio-foni, sent 2 QSL cards for reception earlier in the year from Godthaab, 7.094; said now on 633 kc. and 5.964. (Pearce, England)

Guam—Radio Free Asia relay, 9.490, is noted some mornings shortly after 0700 opening. (Stark, Texas) Closes 0920.

Guatemala—TGNC, 11.850, noted signing on 1730 with trumpet solo and continuing in Spanish. (Lane, Wyo.) When announces in Spanish uses call TGNC, but during the English session 2200-2230 the only call given is TGNA. (Ferguson, N. C.) Noted over 9.668 at 2200-2230 (Wed. to 2300A) in English, usually at excellent level. (Scheiner, N. J.) TGWB, 6.180, seems to have English irregularly around 2230-2300. (Niblack, Ind.) Usually, TGWA, 9.760, parallels.

Haiti—4VEH, East and West Indies Bible Mission, Box 1, Cap-Haitien, Haiti, has been heard testing on approximately 9.640 around 0700-0800 and more recently around 2200; asks for reports; is seeking a clear channel for its new 10 kw. transmitter. (United 49'ers Radio Society) Announces signing on for 0600. (Stark, Texas) Measured 9.628; noted with organ music when tuned 0620; heard in Spanish 0750, then with English 0800-0830 close-

one model for all tv sets



Pat. App. For

Order the
Engineered Product
— installs
permanently inside
cabinet in minutes
(no wiring or
soldering) — fully
automatic — 3 boost
positions to
select desired
tube brilliance.



- ★ For either Series — or Parallel-wired filaments.
- ★ Increases electron emission, makes dim tubes BRIT E
- ★ Isolates filament, relieves cathode-filament shorts.
- ★ Line power supply, does not disturb any TV Set circuits.
- ★ Made to sell, packaged to sell.

Write for complete, illustrated literature. ORDER TODAY!
SOLD through recognized wholesalers ONLY.

Perma-Power COMPANY
4721 N. Damen Ave., Chicago 25, Ill.
"Manufacturers of electronic equipment since 1928"

down. (Ferguson, N. C.) Oskay, N. J., recently measured this one as 9.6245 at 0800. Was found at 1904 recently by Bellington, N. Y.

Holland—Hilversum, 9.590, noted 2030 with program in Spanish, fair level in New York. (Pelegri) Noted over PHI, 11.730, at 2230 with program to Australia-New Zealand, news. (Sanderson, Australia) PCJ, 9.59, noted 2130 in parallel with PHI, 11.730, good signals. (Hoffman, N. Y.)

Honduras—HRN was noted recently on 5.883A to after 2130. (Stark, Texas) HROW, *Radio Monserrat*, 6.675, Tegucigalpa, noted in Spanish around 2220 and later, excellent signal. (Scheiner, N. J.) This one has a sportscast in Spanish 2120-2130 which is preceded and concluded by the "Washington Post March." (Kary, Pa.)

Hong-Kong—ZBW3, 9.525, noted 0600 with BBC news relay, then music. (Sanderson, Australia)

Hungary—Radio Budapest, 11.910, noted relaying Moscow in English at 1440 tune-in, good level; at 1500 has French. (Alcock, Ky.) Heard signing on 1715 to North America over 7.22, 9.833, 11.910. (Pearce, England)

India—AIR, 11.85, is good signal with news 1930-1940; follows usually with news in Tamil. (Pingitore, Mich.) Heard on 11.78 with music 0955, then announcing for the External Service, fair level in N. C. (Ferguson) Heard on 21.510 at 0230 with news and music in Home Service; on 9.720 at 1830 with Home Service also parallel on 15.290, 11.850. (Sanderson, Australia) Noted opening 1345 for Europe on 11.790, 9.560, and announcing 7.240 and 6.085 (not heard) as in parallel; news 1350. Heard opening 0230 for Southeast Asia on 17.705, 15.160, news 0300; noted opening 0830 for Southeast Asia on 15.190, 11.780, news; noted opening 1000 on 11.790 and announcing 7.125 as parallel, in English. (Pearce, England)

AIR, 11.760, is noted at excellent level 1745-1800 in Indonesian; announces in English 1800 closedown; the 11.85 outlet is often excellent 1830-2000, news 1930. (West, Va.) Fair to good on 15.160 in native transmission 2030-2200 sign-off. (Saylor, Va.)

(Continued on page 166)

ROSE Saves You Up to \$50 on These Brand New Decorator TV Cabinets.

For 17", 19", 20" and 21" Picture Tubes—530 or Other Chassis



Model 100: Original list, \$79.95.
Now only... **\$38.50**

Every beautiful cabinet is richly finished of hand rubbed mahogany and made by our own cabinet makers. They are custom styled, guaranteed new and perfect. Includes safety glass, mask and mounting brackets. Cabinets are also available with blank control panel to fit any chassis.



Model 200: Original list, \$99.95.
Reduced to **\$45.50** →
Blonde finish, add \$10

New Reduced TV PICTURE TUBES

Full Year Guarantee—Non-glare—Black Face—Brand New—Standard Brands—Sealed Cabinets

10BP4 Round Glass	\$19.95	16KP4 Rect. Glass	\$24.95
12LP4 Round Glass	22.95	17BP4 Rect. Glass	23.95
14BP4 Rect. Glass	23.95	19AP4 Round Metal	33.95
16AP4 Round Metal	36.95	20CP4 Rect. Glass	34.95
16CP4 Round Metal	28.95	21EP4 Rect. Cyl. face	36.95
16HP4 Round Glass	32.95	24AP4 Round Metal	53.95

Never Before have we been able to sell these tubes at such low prices—order now!

CONVERT YOUR OLD TV SET

To 17", 20", 21", or 24" PICTURE TUBE

Complete conversion kit to match your set! Wonderful new kit comes complete with all parts and diagrams necessary to easily convert any set to larger tube size. Kit includes:

- 70° Cosine yoke
- Matched hi-voltage transformer
- Width coil
- 20,000 V. condenser
- Kit of resistors
- Diagram & instructions

Dealer Net: **\$9.95**
Complete Kit

Be sure to send us make and model of your set for matching conversion kit.

TODAY! Write for new fall catalog with hundreds of savings—tubes, parts & accessories for TV and radio, also test equipment.

Lowest price ever on new 1953

630-DX CHASSIS

With new Ca-code tuner, 30-tubes, for 16" to 24" picture tube. Adaptable for color and UHF.

FREE Channel Strips for UHF in localities where UHF is transmitted this year.

For extra large range and finest reception up to 200 miles without a booster. Can't be beat for price or quality.

\$139.50 (incl. Fed. Tax, less CRT)

RMA Guaranteed. Factory wired, tested and ready to play. Includes 12" speaker, hardware and knobs. Universal Mounting Brackets... \$5.95 FREE! New trouble shooting book with every chassis!

BY POPULAR DEMAND!



We Proudly Present The New

GONSET "COMMUNICATOR"

A COMPLETE 2 METER TRANSMITTER—RECEIVER POWER SUPPLY IN ONE CABINET



IDEAL FOR AMATEUR—CIVIL DEFENSE—COMMERCIAL ACTIVITIES—FIXED OR MOBILE

2E26 FINAL AMPLIFIER—7 WATTS OUTPUT (not a doubler)

FEATURES

- CRYSTAL CONTROL
- RANGE—over 100 miles
- COMPACT—6" x 8 1/2" x 10 1/2"
- FOOLPROOF TUNING
- 12 WATTS INPUT
- WEIGHT—14 lbs.

Superheterodyne receiver is complete with 6BQ7 Cascode RF stage, 3 stages 1F and employs the famous GONSET NOISE CLIPPER circuit. Receiver has an edge-lit calibrated tuning dial and all transmitter-receiver controls are located on front panel. Transmitter employs 8 MC crystals for stability. No overtone crystals are used. Modulator can be used for P.A. system, for emergency and CD work. Unit operates on either 110 Volts AC or 6 Volts DC and may be plugged into auto cigar lighter. The husky AC vibrator power supply alone weighs 7 pounds. A truly fine communications station complete with 19" whip antenna ready for local operation.

Other frequency models available on special order

GONSET CO. 801 S. MAIN ST. BURBANK, CALIF.

See your Jobber or write direct for information

Only **\$189.50** (less microphone and crystal)



Rose Co.'s ANTENNA KIT

Saves you many dollars! New antenna kits contain everything needed for a complete, satisfactory installation. NOW is the time to replace those old rusty worn out antennas with these brand new aluminum jobs. Be ready for the millions of dollars of TV entertainment scheduled for the fall. Don't miss a single show because of poor reception!

No. K-21 KIT includes:
75 ft. highest quality 300 ohm wire
2-5 ft. 1 1/4" steel mast sections
2 mast stand-off insulators
4 screw-eye standoffs
1 all-angle base mount
1 UL approved lightning arrester

Dealer Net: **\$699** Complete Kit

No. K-22 KIT includes:
Same as K-21 except that it includes 2-8 element conical antennas and 1 set of stacking bars.

Dealer Net: **\$999** Complete Kit

No. K-31 KIT includes:
Same as K-21 (above) except that it includes a new single pre-assembled super-fan conical antenna. Finest conical ever made.

Dealer Net: **\$1099** Complete Kit

No. K-32 KIT includes:
Same as K-31 except that it includes 2 super-fan conical antennas and one set of stacking bars.

Dealer Net: **\$1499** Complete Kit

MIN. ORDER: \$5.00. 25% with order, balance C.O.D. include postage with order. All merchandise subject to prior sale. Prices subject to change without notice. P.O.B. New York City.

We've Cut Prices to the Bone!

Genuine MOLDED CONDENSERS

Fresh Stock! All mineral oil filled—Fully molded—100 Centigrade—Meets Jan. C91 tests—GUARANTEED All 600 Volts

Cap.	per 10	per 100
.001	\$.79	\$6.90
.002	.79	6.90
.005	.79	6.90
.01	.89	7.90
.02	.89	7.90
.05	1.09	9.90
.1	1.25	11.50

May be assorted in 100 lots

5 Tube, AC DC Superhet RADIO



Table model radio of famous make with illuminated dial, glistening plastic cabinet, automatic volume control. Licensed by RCA.

- 5-Tubes, incl. rect.
- AC/DC superhet. circuit
- Alnico V speaker
- 540 to 1650 KC (560 to 182 meters)
- 6 tuned circuits
- Built-in loop antenna

Dealer Net: **\$14.95** ea. Lots of 4:

THE ROSE COMPANY

102 Park Place, Dept. R-10, New York 7, N. Y., COHandt 7-6195

DON'T MISS THESE BARGAINS

G.E. RELAY CONTROL

(Ideal for Model Controls, Etc.)

Contains a sigma midget 8,000 ohm, relay, (trips at less than 2 MA), high impedance choke, bi-metal strip, neon pilot and many useful parts. The sensitive relay alone worth much more than the total low price of **\$1.25 each, 10 for \$9.90**

WESTINGHOUSE OIL CONDENSER

10 M.F.D.—1000 VDC (Marked 440 AC)—A terrific bargain at **\$1.95 each**

HIGH CAPACITY CONDENSER

50 M.F.D. 600 VDC, oil filled, only . . . **\$4.99 each**

MICROAMMETER BARGAIN

Basic 0-200 Microamp (0-10 Scale), Rectifier Type, Reads 0-1 Volt A.C., 2" Round, Removed from equipment. Guaranteed. Ideal for Field Strength Meters, Grid Dip Meters, Wave-Meters, Etc. **SPECIAL \$2.95 each**

FILTER CONDENSER BARGAIN

8x8 M.F.D. 600 vdc oil compound filled. **NEW, but scratched. Only .98 each**

HIGH CURRENT CHOKE

Filter choke, 4 Hy @ 1 Amp, 10,000 Volt insulation, Fully cased, Brand New **\$22.95**

SENSITIVE RELAY

D'Arsonval moving coil type, mounted in meter case. Adj. 700 microamps to 1 ma. Made by Triplet. **\$5.75 ea.**

PANEL METERS

NEW GOVT SURPLUS *Special Sale

2" METERS

0-10 MA, AC. **\$2.95**
0-4 AMP RF **2.95**

3" METERS

0-2 MA **4.50**
0-2.5 AMP RF **5.95**
0-200 MA **4.95**
0-100 VDC (1 MA). **5.95**
0-200 VDC (1 MA). **5.95**
0-250 VDC (1 MA). **5.95**

FILTER CHOKES

6 Hy 90 MA. **\$0.79**
5 Hy 250 MA. **1.95**
6 Hy 500 MA. **4.95**

PIGTAIL MICAS

MMF: 5, 20, 50, 60, 100, 250, 300, 400, 500, 750, 800, 1000, 2000, 3000, 4000, 5000, 6000, 10000. **\$0.09 ea.**

BAKELITE CASED MICAS

MFD	VDC	Price	MFD	VDC	Price
.001	600	\$1.18	.024	1500	\$0.85
.002	600	.24	.033	1500	.75
.01	600	.28	.005	2500	.55
.02	600	.28	.002	2500	.45
.01	1 KV	.45	.004	2500	.50
.002	1200	.35	.0001	5KV	.70

BLEEDER RESISTOR

100,000 ohm
150 watt vitreous enamel resistor.
.59 each

WIRE WOUND RESISTORS

5 watt ohms: 25-50-84-200-2500 **\$0.09 ea.**
10 watt ohms: 25-40-1325-2K-4K **.19 ea.**
20 watt ohms: 150-300-750-1K-1.5K **.20 ea.**
2.5K-2.7K-10K-20K **.20 ea.**
30 watt ohms: 100-2500-5300-18K **.22 ea.**

ADJUSTABLE SLIDER RESISTORS

20 Watt: 1, 5, 300 ohms **\$0.25**
75 Watt: 100, 150, 200 ohms **.39**

PEAK ELECTRONICS CO.

378 Great Neck Rd., Great Neck, New York
Phone Great Neck 2-0082

Spot Radio News (Continued from page 18)

not be out of order, if there were no assignment plan. Even if one of the examiners were . . . "endowed with the wisdom of Solomon . . . and . . . was able to digest the record and . . . present some kind of proposed decision," the Commissioner continued, the proposed decision would only be . . . "an assignment plan for the north-eastern United States for Channels 7 to 13."

Reminding his audience that thus far he had only discussed the ramifications that would obtain on the present bands if the no-assignment plan idea were adopted, Hyde said that the problem really became knotty when the ultra-highs came up for review. Not only does the same chain reaction appear, he said, but it is complicated and aggravated by what . . . "we might call engineering taboos with respect to co-channel and adjacent-channel interference, oscillator-radiation interference, sound and picture-image interference, i.f. beat interference, and intermodulation." All these problems must be considered, the Commissioner added, for 70 channels, not just 13, as in the present bands. Declaring that the Commission studied this maze of potential problems that would have to be considered without a plan, Hyde noted that they came to the conclusion that a plan was absolutely essential. "In my opinion," he said, "avoidance of this administrative morass alone would have been more than ample justification for the adoption of an allocation plan." But this was only a minor consideration, it was pointed out. There were four other extremely important factors that were equally . . . "coherent and equally impelling . . ." the Commissioner added. One was . . . "the inescapable conclusion that the most efficient use of the TV spectrum required an assignment plan." The second was . . . "that the protection of the interests of the smaller communities as far as assignments were concerned, and the ultimate establishment of a nationwide system and coverage of TV, required an assignment plan." The third was . . . "proper distribution and allocation of channels for non-commercial educational stations," and the fourth reason revolved about the . . . "orderly settlement of . . . assignment problems along our borders . . ." an arrangement which could only be worked out with an assignment plan.

Declaring that the plan as finally evolved was not perfect, the Commissioner noted that it was . . . "the best that we could evolve from the record before us." Undoubtedly, if further hearings could have been held during another year or so, Hyde added, further thought might have been given to the refinement of solutions to some of the knottier problems. "But those few rough spots, of necessity," he said,

EASY LOW-COST WAY to own a PROFESSIONAL QUALITY tapeMaster TAPE RECORDER



DUAL SPEED HIGH FIDELITY

PORTABLE MODEL PT-125

Use with Your Own Audio Amplifier, Radio or Radio-Phono Combination, or with new tapeMaster Model SA-13 Power Amplifier and Speaker.

For the first time, a completely flexible professional quality tape recorder like this—at such economical cost! Advanced engineering and customized design make tapeMaster a natural choice of recording enthusiasts everywhere.

Built to RTMA Standards • Dual Track Dual Speed—7.5" and 3.75" sec. • Fast Forward and Rewind • Direct Threading of Tape • Push-Pull Supersonic Bias-Erase Response 50-8000 cps ± 3 db at 7.5 and 50-5000 cps at 3.75 • Inputs for Radio, Phono and Mike • Full Monitoring • Neon Record Level Indicator • For 105-125 V 60 cycle AC (Also available for 110-220 V 50 cycle AC)

Complete with 5" spool of plastic tape and 7" empty take-up spool, in sturdy carrying case covered with waterproof leatherette, less audio amplifier and microphone. Size: 12 1/2" x 12" x 9 1/2" high. **\$99.50** Net Price.

(Slightly Higher West and South)

Tape Transport Mechanism and Matching Pre-Amplifier with Push-Pull Supersonic Bias-Erase Oscillator also available individually for custom installations.

MODEL SA-13 POWER AMPLIFIER AND SPEAKER

Portable companion to the PT-125 tape recorder. Combines a special type speaker, new amplifier design, and effective principle of baffling. Amplifier response ± 1 db 30-15,000 cps. Peak output 8 watts. Has separate bass and treble control. 12" x 9 1/2" x 18 1/2" high. **\$79.50** Net Price.



Send for FREE Bulletin 102-A

tapeMaster inc.

13 W. HUBBARD ST. • CHICAGO 10, ILL.

Export: Scheel International, Inc.
Chicago 18, U.S.A. • Cable: Harscheel

RADIO & TELEVISION NEWS

"will occur in any plan of this magnitude." It was felt that it was more important to have a good plan immediately, viewed the air chief, than a more perfect plan sometime in the indefinite future.

COMMISSIONER HYDE'S earthy opinions also appeared in a dissenting brief, submitted during the first grants for non-commercial stations to the Kansas State College of Agriculture and Applied Science, and to the University of the State of New York. Chiding the Commission for issuing the grants now, particularly to Kansas State, Hyde said: "Examination of the present application indicates that the applicant's own governing board, the State Board of Regents, has not approved construction of the proposed station, although it did authorize applicant to apply. . . . The application gives the estimated cost of construction as \$362,624 and the cost of operation the first year as \$332,800. But it does not appear from the application that any steps whatsoever have been taken toward establishing a budget for the purpose of construction. On the contrary, it appears that funds for construction will require further board approval even before the request is submitted to the legislature. . . . I question whether granting applications under the conditions presented in this case would be consistent with the Commission's own responsibilities. I doubt whether granting applications without a showing of authority, without a firm showing, or intention to construct within the foreseeable future, and without at least some showing as to a financial plan, will encourage actual construction."

Commercial telecasters and applicants applauded the Commissioner's strong stand and viewed the dissent as one which might serve to influence many in government and scholastics to urge setting aside a substantial slice of the education channels for commercial use.

The Kansas State construction permit provides for operation on Channel 8, with an effective radiated power of 52 kilowatts visual and 26 kilowatts aural. An antenna height of 450 feet above average terrain has been assumed.

In New York, three permits were granted for stations in Albany, Buffalo, and Rochester. The Albany station will operate on Channel 17 with an antenna 1410 feet high. In Buffalo, the station will use Channel 23 and a 630-foot antenna, while the Rochester station will operate on Channel 21 with a 700-foot antenna. All stations will have an erp of 205 kilowatts for video. Audio outputs will be 110 kilowatts for Albany, and 105 kilowatts for both Buffalo and Rochester.

SATELLITE AND BOOSTER TV station operation, described by many to be the only practical solution to spotty reception in shadow areas, will soon become an extensive experimental project in

Now the one definitely better television booster

THE SCANAFAR

NEW
MODEL
CT-1

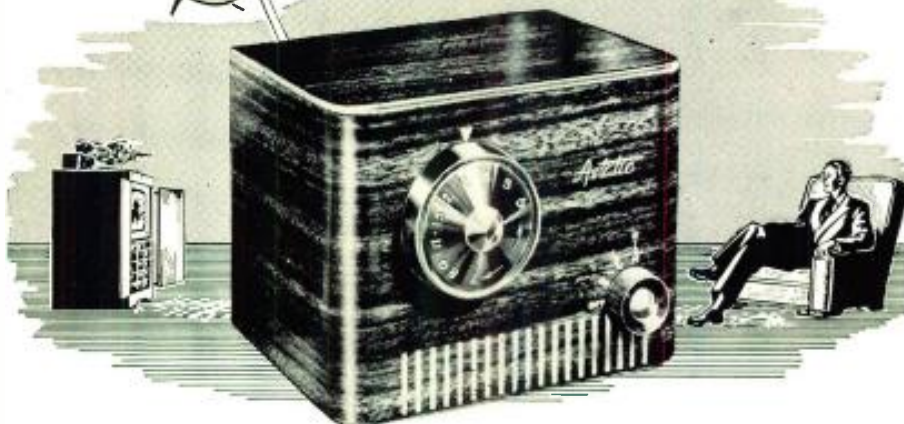

by Astatic Great, major improvements in new television receivers have left ordinary boosters wanting. Where such boosters had been able to effect some slight improvement in the reception obtained with older model sets, the new sets have actually been found to suffer, in picture clarity and definition, when oldstyle boosters are cut into the circuit. That's why Astatic's new Scanafar TV Booster, model CT-1, is causing such a stir in trade circles. Here is a booster of brand-new design that more than meets the tougher requirements of today . . . works to the advantage of the best new receiver front-ends . . . makes fine reception finer and poor reception fine . . . imposes no loss of picture definition nor suppression of sound. The Scanafar is truly the one definitely better TV Booster. Your first trial hook-up will show the real difference.

LIST PRICE \$32.50

FEATURES

The Scanafar employs a balanced, cascaded circuit, with a neutralized 6J6 tube driving a 6BQ7 (the highly touted "quiet tube"). Both tubes are used over the entire TV frequency range. Band width is over seven megacycles on all channels. Provision is made for either 72 ohm or 300 ohm impedance input and output. For other descriptive and technical information, write for illustrated literature.

THE
Astatic
ASTATIC CORPORATION
CONNEAUT, OHIO
IN CANADA: CANADIAN ASTATIC LTD, TORONTO, ONTARIO

EXPORT DEPARTMENT

401 Broadway, New York 13, N. Y. Cable Address: ASTATIC, New York

BATTERY
ELIMINATORS



Convert
Battery Radios to
All-Electric

**PROFIT
NOW!**
put
**THOUSANDS
of
IDLE RADIOS
BACK to
WORK**

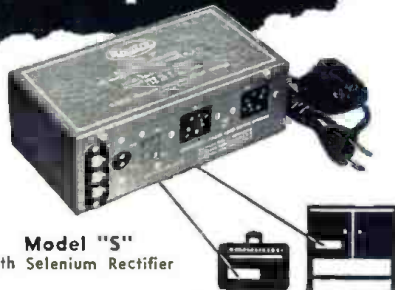

Model "S"
with Selenium Rectifier

Make those battery operated portables "sing" again. No need for high battery replacement costs to shut them up when it's so economical to convert them to permanent AC all-electric operation with an EPL Battery Eliminator. Gives years of hum-free reception. Uses less than 1/4 the power of the cheapest AC radio. Net price..... **\$1110**

Simple as A B C

- A—Slips into battery space.
- B—Insert battery plug or plugs.
- C—Plug into AC outlet.

- Filtering eliminates hum.
- Operates any 1.4 volt 4 to 6 tube radio from 115 volt, 50/60 cycle outlet.
- Guaranteed 3 years.

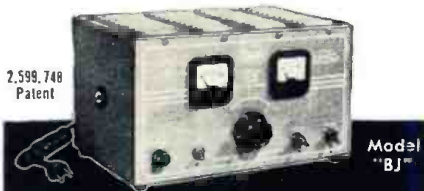

2,599,748
Patent

Model
"BJ"

MAKE MONEY Testing and Servicing Auto Radios

**Low Cost Filtered
DC POWER SUPPLY**

EPL conduction cooling doubles rectifier power rating at lowest cost per ampere output. Dissipates over 3 times the heat. Withstands high overloads. 1—12.5 amps. 6 volts continuous output, instantaneous **\$3750** rating of 25 amps. Net.....

See Your Distributor! Request Folder!

ELECTRO PRODUCTS LABORATORIES
4501-Ns North Ravenswood Ave., Chicago 40, Ill.

In Canada: ATLAS RADIO CORP., LTD.
Toronto, Ontario

Emporium (Pa.) and Lawrenceburg (Tenn.). The Commission has authorized construction of a satellite station by a tube maker in Emporium and released Channel 82 (878-884 megacycles) for the tests; signals from WJAC-TV in Johnstown will be picked up and retelecast by a transmitter having a visual power of 30 watts and aural output of 10 watts, using an antenna about 80-feet high. The Tennessee plan, which will be operated by WSM-TV, Nashville, will provide retransmission of this station's signals on Channel 4 from the Lawrenceburg site. Powers will be 5 and 2½ watts, respectively, for visual and aural output, and a 100-foot antenna will probably be used. In defining the nature of booster and satellite service the Commission said that booster operation is on the same channel as that of the main station, while satellite operation is on a channel other than that of the main station.

Viewers in Emporium will also be able to pick up the WJAC-TV programs on Channel 22 or 518 to 524 megacycles over experimental station KG2XDU, also operated by the tube manufacturer. Permission has also been granted for retransmission of programs from other stations, if and when the signals can be picked up and retelecast.

Another form of booster operation using microwaves for relaying and providing a receiving subscription service, long in the planning stage, has been temporarily shelved by the Commission, who declared in a letter to the applicants from Poplar Bluff in Missouri, that such a system might constitute a common carrier system and thus might be in violation of the Communications Act. In addition, the Commission questioned the effectiveness of program service, no data having been submitted on the continued service that it would be possible to offer. The applicant proposed the erection of stations 30 to 40 miles from Memphis, Tennessee in Mississippi County, Arkansas, and in Kennett, Missouri.

BILL S 658, authored by Senator Ernest W. McFarland, which was introduced three years ago, and blocked, and then reintroduced in a modified version, finally became law a few weeks ago when the President placed his signature on the document. Technically, the bill becomes an amendment to the Communications Act of 1934 and introduces several significant changes in the Act.

Hereafter, the Commission will have full authority to issue cease and desist orders, in addition to its license revocation power. Commissioners who resign to practice before the FCC will now have to wait one full year from date of resignation, before they can appear before the Commission. Each Commissioner will now have a legal and engineering assistant. No staff personnel involved in a case will be allowed to recommend actions to Commissioners. The burden of proof that

EXTRA!
GOOD
Transformer
NEWS!

New 20-20 plus
transformers

New miniature
transformers

New—super
standard audio

New
400 cycle power

All with...
extra quality
extra flexibility
extra performance

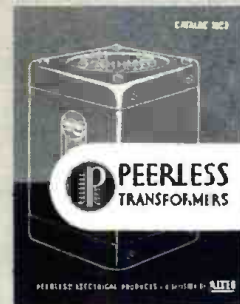

Write
today
for the
new
1953
Peerless
Catalog

It's the best transformer
news in years

PEERLESS
Electrical Products

A DIVISION OF



9356 Santa Monica Blvd., Beverly Hills, Calif.
161 Sixth Avenue, New York 13, New York

a licensee is not qualified for renewal will now rest with the Commission, according to the new law.

THE BIRTHDAY OF HENRI DUNANT, founder of the Red Cross, was celebrated in a novel manner in Geneva recently, with a thirteen-country broadcast under the auspices of the International Committee of the Red Cross, the League of Red Cross Societies, and the European Broadcasting Union. Featuring the use of a multiplex circuit, and feeding to Austria, Australia, Belgium, Canada, France, Greece, Italy, Luxemburg, Morocco, the Principality of Monaco, Switzerland, Western Germany, and Yugoslavia, the broadcast originated in the Geneva studios. The multiplex system was used to provide two-way modulation between all studios. In a report on the plan employed, Felix Dupuis noted in the *EBU* journal that each studio had to be linked with the central studio by two program circuits and a telephone line for technical conversations. Since it was not possible to secure sufficient program circuits, sub-centers were set up in certain amplifying stations to reduce the number of lines which had to be brought right into Geneva. These sub-centers were employed to mix the signals coming from various studios, to provide a single signal for transmission.

The link to Canada was via a pair of radiotelephone channels, one coming from Swiss transmitter Schwarzenburg to a receiving station in Canada, and the other from a Canadian transmitter to a Swiss receiving station at Chatonnaye, each connected with respective studios by a line. The programs from Greece, Australia, and Luxemburg had to be recorded and transmitted from the Geneva studio.

It was noted that the tempo of call and reply between studios was fairly rapid during the broadcast, and thus the microphones had to be kept alive. The problem of oscillation was thus acute and every precaution had to be taken to prevent such feedback.

The broadcast was not only a tribute to the technical skill of the various staffs, but the diplomatic ability of the administrative departments who demonstrated that stouthearted efforts can still produce international cooperation L.W.

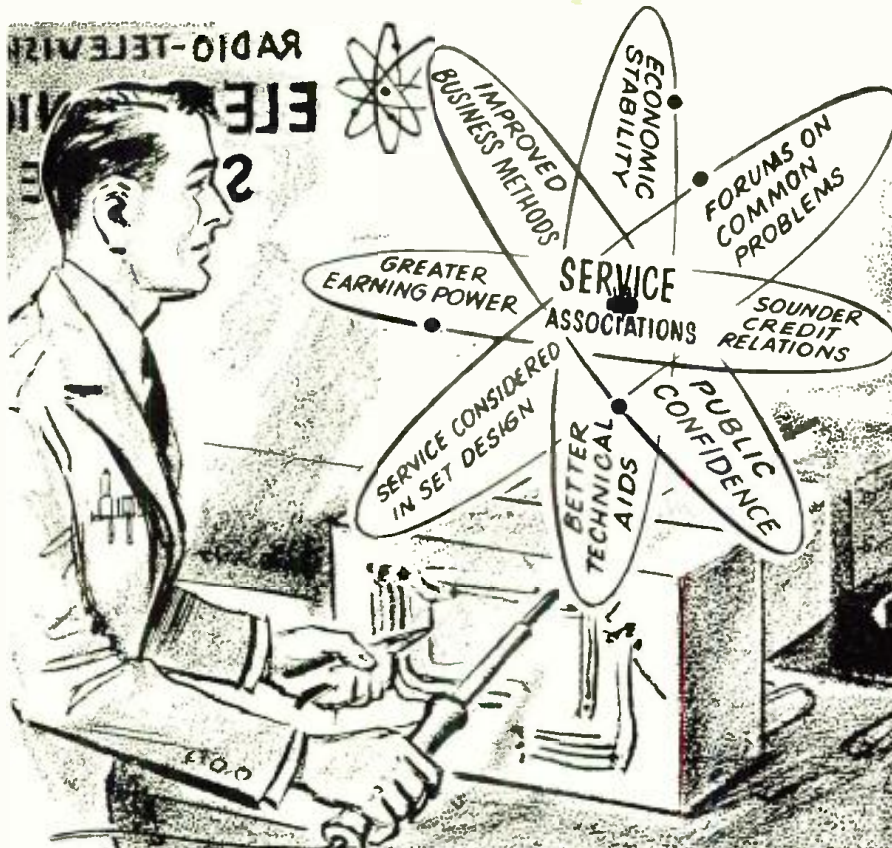

THE MODERN ELECTRONIC TECHNICIAN HAS A NEW VIEWPOINT!

A changing attitude on the part of the radio and television service technician is the thing that is pulling the electronic service profession out of the doldrums. He is learning that he cannot call himself a success, as an individual, until he can look around and see other technicians who have assets he can admire or compare with his own. As long as there are too many in his profession operating without scruples, and trying to get along under a "hand to mouth" economic operation without adequate testing instruments and other technical aids, there is not much to measure one's success by.

His interest and attendance at the local service association meeting shows that the modern Electronic Technician is beginning to look beyond the "tip of his soldering iron." Through these associations, he is rapidly gaining recognition, not only in his own community, but also in the vast electronic industry, as being an essential link between the manufacturer and consumer.

In addition to getting valuable technical "know-how" from non-commercial sponsored lectures and demonstrations, he is finding out how to make his business bring a fair return on his rather large investment in training, experience,

and testing instruments. He is also learning how to be fair to both his customers and himself by keeping his "know-how" and test equipment up-to-date and not resorting to price cutting for his service in diagnosing trouble.

As technicians gain that feeling of mutual respect and esteem among themselves by regarding each other as business associates instead of raw competition, their most valuable asset—technical "know-how"—will no longer be obscured. The technician's interest in matters which affect his economic welfare will lead him and the entire service industry to greater economic stability.

The time and money you devote to your service organization is not an expense—it is an investment in your future that will be paid back many, many times.

Our 25th Year

SUPREME

Testing Instruments

"SUPREME BY COMPARISON"

TUBE TESTERS • SIGNAL GENERATORS
PANEL METERS • MULTI-METERS
OSCILLOSCOPES

Supreme, Inc., Greenwood 1, Mississippi

PORTUGUESE EDITION

RADIO & TELEVISION NEWS is now being published in a Portuguese edition as a 16-page supplement to the magazine "Antenna," "Antenna," which is published in Rio de Janeiro, Brazil, has a circulation of over 14,000 copies which makes it one of the largest technical publications in South America. It is the leading publication in the radio field.

Each month timely articles from the current issue of RADIO & TELEVISION NEWS are being translated into Portuguese and reproduced for the benefit of "Antenna's" many readers.

How to use

KRYLON®

to cut down
contract
service calls

Krylon is a tough, quick-drying Acrylic coating with many important TV applications. To apply, just push the button on the aerosol can and spray—that's all you do!



Because of its high dielectric strength, Krylon helps prevent corona. Here technician Bernard Vanella—on the staff of dealer Mort Farr, Philadelphia—"Krylon-izes" high voltage coil and insulation, the socket of the high voltage rectifier, component parts of the rectifier circuit.



Edward Weigand, Farr service man, sprays Krylon on entire antenna. Krylon shuts out moisture, rain, salt spray—prevents corrosion and pitting—keeps picture quality at peak.

"Krylon-izing" increases your customer's satisfaction and jumps your own profits! Nationally advertised to your customers!

TECHNICAL CHARACTERISTICS

Dielectric constant—2.8 to 2.4
(1,000 cycles)
Dielectric strength—400 to 800 (number of volts necessary to cause electric arc through Krylon coat one mil thick)
Electrical resistance — 10^{10} ohms/om²

See your jobber, or write direct.

KRYLON, Inc., Dept. 2710
2601 N. Broad St., Phila. 32, Pa.

RADIO-TV Service Industry News

AS REPORTED BY THE
TELEVISION TECHNICIANS LECTURE BUREAU

THIS commentary from the August issue of the "ARTSD News" (Columbus, O.) is an appropriate harbinger of what's ahead for the servicing industry from now until the November elections: "All of the ARTSD members reported a complete 'breakdown' during the Republican and Democratic conventions. Well you have *not seen* anything *yet*. Just wait until the real campaign gets started. Better start clearing the decks for the biggest and best Fall business you will experience for many years to come. And you had better put some of those extra dollars away for the rainy day which is bound to come one of these days."

Service business was excellent throughout July in all TV areas. In sections where the steel strike was a major economic factor the service operators who were able to gather in the most business were those who were able to handle the business on credit. In one city a major service contractor and dealer discovered that selling picture tube replacements on a time payment plan erased all of his problems of price competition from rebuilt tube vendors. By handling only reliable brands of new picture tubes the time payment arrangement permitted him to get the list prices for the tubes. The six per-cent finance charge that the customer paid on the four-month contracts adequately took care of his own bank financing costs. This time payment plan has been so successful with him that he is planning to feature pix tube replacements on budget payments in all of his promotions.

TV Industry Moves Fast

Back in 1947 a skeptical industry stood back to see what was going to happen when television was first introduced on a broad scale and the public urged to buy receivers. The consensus among industry "seers" and crystal ball experts was that it would take a long time to sell John Q. Public *en masse* on TV. The radio business was booming then and most major set manufacturers felt they were pretty secure in sticking to radio production while the optimistic few who tackled TV tilled the hard soil of consumer education.

What happened in New York and Philadelphia is now history. Buyers stormed dealers' stores to buy TV sets. Manufacturers raided TV engineering departments to get qualified men to belatedly design sets. Some businessmen with political connections in high places even tried, through political pressures, to get priority consideration for materials that would enable them to get into this lush business bonanza.

"Well," said the seers, "television is 'in'; the public likes it and will buy it. But," they added, "it will take a long time to build the necessary transmitters to give TV to more than a few of the biggest cities. Maybe the industry will really get moving in about five years or so."

Two years later so many transmitters were on the air interfering with each other that the Federal Communications Commission had to step in and freeze all further expansion until they could determine what to do with this lusty young giant.

Last May the FCC lifted the freeze with the provision that the processing of applications for station permits would not start until July 1st. Appraising the probable speed of processing applications on the basis of FCC's past performances, the "experts" predicted that the first permit would not be issued until after the first of August. But before the end of July permits for eighteen stations had been granted, six in the v.h.f. range and twelve in the u.h.f. section of the spectrum. Of the cities which were to get these stations Denver, Colo., headed the list with three; Austin, Tex.; Spokane, Wash.; Springfield, Mass.; Youngstown, O.; and York, Pa., each got two; and single stations went to Portland, Ore.; Flint, Mich.; New Bedford, Mass.; and New Britain, Conn.

The speed with which the first station in Denver got on the air amazed everyone. It had been assumed that it would take at least ninety days to complete a station and get it on the air after the construction permit was issued. When Denver went on the air early in August, in less than a month after the CP was granted, it caught installers and service companies completely unprepared. *Central Television*

RADIO & TELEVISION NEWS

Service of Chicago, establishing a branch operation in Denver, had to "get going" within six days after they opened their operating headquarters. They had thought they would have at least ninety days in which to perfect their organization before they would have to be ready with competent crews to make complete installations. The RCA Service Company employed an "air lift" to man their Denver branch with competent technical personnel.

What About U.H.F.?

The experts say that u.h.f. will develop slowly during the next two years because it will take time to develop and prove out equipment capable of giving adequate performance in these higher frequencies. Your editors, who listen to a lot of speeches by experts in the business, have heard quite a few lately predicting that for some time to come u.h.f. stations will be of the low-powered variety, possibly on the order of 1 kw. output. While listening to the experts make these predictions we recalled the *G-E* press release of a few months ago in which it was stated they had perfected a transmitting tube capable of 5 kw. output over the entire u.h.f. TV band from 470 mc. to 890 mc. Feed this output into one of those new high-gain transmitting antennas and they'll have a lots higher effective radiated power than 1 kw.

Now that the shackles have been removed from television development and expansion the industry will move forward fast to capitalize on the opportunities that this new lease on life has provided. True, u.h.f. television will pose a lot of new problems both in the development of equipment to handle it and in the installation of receivers that will produce satisfactory pictures. But these problems do not present any greater barriers to the rapid expansion of u.h.f. than those that confronted the industry on v.h.f. back in 1947.

The important thing for those who are in proposed u.h.f. areas is to start right now to get acquainted with television service business requirements and the specific problems of u.h.f. It has been the consistent story in newly opened television areas that when TV arrived it caught the radio people unprepared. The statement heard most often has been the sad tale, "wish we had started to study this stuff a year ago."

Service Branches

During the past two years the editors of this department have consistently predicted that when the freeze was lifted and new TV areas were created, experienced TV installers and contractors would move in rapidly from the older TV sections to set up either branch operations or completely new service businesses. This is happening on a wide scale.

It is problematical, of course, how much of a "boom and bust" will occur



AN/ARC-5
 R-28/ARC-5 RECEIVER 100-156 MC. **\$49.50**
 With tubes. Like New.
 T-23/ARC-5 TRANSMITTER 100-156 MC. With tubes. Like New. **\$47.50**
BOTH UNITS FOR ONLY \$92.50

SCR-625 FAMOUS MINE DETECTOR
 For prospectors, miners, oil companies, plumbers, etc. New. **\$59.50**
WHILE THEY LAST!
 DY-1 12 V. DYNAMOTOR
 For converting command receivers to 12 V. operation. Prices on request.

Check these Items - Write for Prices!

- BC-733-D LOCALIZED RECEIVER. Complete with tubes and crystals.
 DM-53-A DYNAMOTOR for above.
 FT-293 MOUNT for 733
 BC-732 CONTROL BOX for 733.
 PLUGS for 733.
 ARN-7 Complete installation.
 SCR-269-G Complete installation.
 BC-639 VHF TUNABLE RECEIVER 100-156 MC.
 SCR-522 VHF. Complete installation.
- R89/ARN-5 GLIDE PATH RECEIVER.
 R57 GLIDE PATH RECEIVER.
 BC-638-A FREQUENCY METER.
 BC-376-H TEST OSCILLATOR.
 ID6/APN-4 LORAN INDICATOR.
 R9/APN-4 LORAN RECEIVER POWER SUPPLY.
 RT34/APS-13 TAIL-WARNING TRANSCIEVER 420 MC.
 BC-640 50 W. VHF TRANSMITTER Crystal control 100-156 MC.

COMMAND EQUIPMENT (SCR-274N)

	Used	New		Used	New
BC-442 ANTENNA RELAY. Less cond.	\$1.95		BC-453 With tubes	\$19.95	
with cond.		\$ 3.95	Less tubes	14.95	
BC-451 TRANSMITTER CONTROL BOX		1.50	MC-211 90° ANGLE COUPLING UNIT		\$0.95
BC-450 3-RECEIVER REMOTE CONTROL BOX		2.95	FT-234 MOUNTING RACK for single transmitter	2.95	3.50
MC-215 MECHANICAL DRIVE SHAFT. Per length		2.95	FT-226 MOUNTING RACK for 2 Command Xtrs.		3.95
BC-496 2-POSITION RECEIVER CONTROL BOX		2.95	FT-221 MOUNTING PLATE for FT-220		1.50
BC-459 Less tubes	12.95		FT-220 MOUNTING RACK for 3 receivers		2.25
BC-455 6-9 MC RECEIVER. With tubes	9.95	14.95	FT-225 MOUNTING PLATE for BC-456		2.25
Less tubes	7.95		BC-456 MODULATOR. For SCR-274.		4.50
BC-454 (1-6 MC) With tubes	9.95		Complete set of 4 tubes for transmitter		1.95
Less tubes	6.95				

Monthly Specials!

RT-34/APS-13 420 MC. TRANSCIEVER with 5 stages of 30 MC. 1F amplifier strip. Less tubes. RF cable set. With dynamotor. **\$12.95**

2 TRANSMITTERS
 BC-457 (4-5.3 MC) and BC-458 (5-3.7 MC). Command transmitters. Shipment just in. Limited Quantity. Less tubes and xtals. Good cond. EACH\$4.95 PER SET.....\$9.50

MOTOR
 24 VDC. Series wound, reversible, with clutch. Turns 11,000 RPM, geared to 1,100 RPM. Complete with junction box, 2 adjustable limit switches. Excellent condition. **\$9.95**

REVERSIBLE MOTOR
 RL-42 24 VDC. With antenna reel and clutch. USED\$4.50
 NEW 6.75

BC-604 30 W. FM TRANSMITTER. For 20-27 MC. band. Ideal for 10-11 meters. Complete with tubes, temperature controlled crystal oven and technical manual with all instructions for BC-603 and BC-604. Less dynamotor and crystals. Excel. cond. **\$12.95**

ARC-4 TRANSCIEVER
 140-144 MC. Complete with control box, tubes. 12/24 VDC dynamotor with schematic. This is a special reduction for this month only. **\$32.50**
 Like new
 MT-101 ARC-4. New\$4.50

Miscellaneous Specials!

- T-32 DESK STAND MICROPHONE. Good, used cond. \$ 2.75
 HS-23 HEADSET. High imp. New 4.95
 HS-1R HEADSET. Used, excel. cond. 1.49
 NEW 3.50
 CW-49-505 HIGH IMP. HEADSET. Excel. cond.98
 BC-700 INTERPHONE AMPLIFIER. With tubes. less batt. w/o dynam. NEW 3.95
 PE-101 DYNAMOTOR. Used. ONLY FEW LEFT! 1.95
 CD-307 EXTENSION COIL. For HS-23-33. NEW95
 HS-38 MIKE. NEW 4.95
 Used 1.75
 PE-125 AX POWER SUPPLY. For BC-223 Xmr. 12/24 VDC input. NEW 14.95
- HS-18 HEADSET. 8,000 ohms. New \$ 2.45
 HS-33 HEADSET. Low imp. New 6.95
 HS-30 HEADSET. Featherweight type. Low imp. New 2.49
 USED 1.49
 T-28 CHEST TYPE MIKE. With cord and plug. NEW 2.75
 BC-605 INTERPHONE AMPLIFIER. With dual mike input circuit. NEW 5.95
 LIP MIKE. Navy type. NEW98
 TU-6 TUNING UNIT. (3-4.5 MC.) for BC-375 and BC-191. Used. 2.95
 FL-8 RANGE FILTER. 1.95

TUBES!		TUBES!		TUBES!		TUBES!		TUBES!	
10JP4 ..	\$19.95	304TH ..	\$8.95	5CP1 ..	\$4.95	3FP7 ..	\$2.25	5FP7 ..	\$2.25
10AP4 ..	24.95	304TL ..	8.95	5BP4 ..	4.95	4AP10 ..	1.49	9002 ..	.89
10DP4 ..	19.95	830-B ..	2.75	5FP7 ..	2.25	21D ..	.69	9001 ..	.99

- TU-17 TUNING UNIT. (2-3 MC.) For BC-223 Xmr. Used 2.95
 I-70 "S" TUNING METER. NEW 2.50
 WOHUATOR. See p. 43 Dec. '51 RADIO NEWS 5.95
 BC-1023 75 MC. MARKER BEACON RECEIVER. Complete with tubes, dyn. rack. NEW 10.95
 TU-25 TUNING UNIT. (3.5-5.2 MC.) For BC-223 Xmr. Used 2.95

- IN-4A L/R TUNING METER. Used \$ 3.95
 FL-5 RANGE FILTER. 1.25
 TS-13 HAND SET TELEPHONE. NEW 7.75
 MS-116-17-18 WHIP ANTENNA SECTIONS. NEW. Price upon request. P.U.R.
 FIELD TELEPHONE. EE-8. Complete BRAND NEW. SPECIAL. ONLY. 27.50

MC-217
 LOOP MOTOR AND AUTOSYN TRANSMITTER ASSEMBLY. Complete with instructions for matching to I-82 Indicator. Used, excellent condition. **Only \$12.50**

COMBO
 BC-624 VHF RECEIVER. Freq. range 100-156 MC. Less tubes & crystals, with conversion dope. Used, good cond. **\$19.95**
 BC-625 VHF TRANSMITTER. Freq. range 100-156 MC. Less tubes & crystals, with conversion dope. Used, good condition. **\$12.95**
BOTH TRANSMITTER & RECEIVER. \$29.95
 Per Set

INDUSTRIAL CORPORATIONS
 Write or wire for our new Catalogue listing complete line of Military Electronics Equipment. **\$5.00 MINIMUM ORDER ACCEPTED.** All shpts. F.O.B. whse. Cal. residents add sales tax with remittance. 20% dep. Specify shpg. instructions.

ARROW SALES, INC. 7460 N. Varna
 North Hollywood, California
 Sunset 3-7319

★
★
ULTRA-LINEAR
WILLIAMSON
Amplifier Kit
featuring
ACRO TO-300
TRANSFORMER



★
★
Send for Reprint

"Ultra-Linear Operation of the Williamson Amplifier"
Hafner and Keroes
(Audio Engineering
— June issue)

Build the finest amplifier ever developed. Ultra-linear construction gives you the ultimate in Williamson performance. Complete with all components, punched chassis, and easy-to-follow instructions.

- ✓ 30 Watts from an Ultra-Linear Williamson
- ✓ Frequency = .02 db from 20 to 20,000 cps. ± 1 db from 2 cycles to 200,000 cycles
- ✓ Distortion less than 1% at 20 watts
- ✓ Phase shift—not over 4°—20 to 20,000 cps.
- ✓ Unexcelled square wave performance

ACRO TO-300 now available separately with conversion information to convert your Williamson to Ultra-Linear operation.

★
\$74.50
★

KIT IS COMPLETE
NOTHING ELSE TO BUY

Radio Electric
SERVICE CO. OF PENNA., INC.

7th & Arch Streets, Phila. 6, Pa.

Please ship complete Ultra-Linear Amplifier Kit

Check or Money Order enclosed (Include postage, shipping-wt. 25 lbs.)

Name

Address

City Zone ... State

in these new sections. With an adequate supply of TV receivers available, dealers will be able to handle a maximum volume of sales. It is quite probable that the new sections will reach a point of effective saturation for sets in a matter of months as compared with the year or more that it required in older TV areas.

Many dealers are setting up their own TV servicing departments. They have observed that retailers like *Mort Farr's* in Upper Darby, Pa., and *Price's* in Norfolk, Va., have been able to weather the slack periods better than most non-servicing dealers. So a growing number of TV and appliance retailers have set the wheels in motion to install and service their customers' sets.

However, set retailers in the new TV areas are carefully planning to avoid the mistake of service over-expansion that finally embarrassed a lot of good companies in the early days of TV in other areas. With ample statistics available to enable them to chart their probable sales potentials after the business levels off, they plan to handle only a part of their installation and service volume while the boom is on. The surplus business will be farmed out to the independent service businesses that have moved in for the "killing."

At the end of the first year in these new TV areas it will be interesting to observe how many newly-formed TV service businesses will be able to survive the post-boom letdown. The prospects are not good for inexperienced TV service operators to get a substantial quantity of installation and service contracts in these new areas. Local Better Business Bureaus have been alert to the hazards of inexperienced businessmen handling a large volume of installation and service contracts. Consequently, service business men are having to show the possession of both "know-how" and "adequate financial resources" if they are to avoid a negative report from the BBB. The day when capital for operating equipment and working supplies could be financed out of installation and service contracts is gone.

But despite all of these precautions, these new areas will not be able to slide through the boom days without some repercussions on service. The "sharp" set dealer will be trying to filch an extra few dollars' "profit" out of installation and service income. His parasitical tendencies will breed the fringe TV technician who will be happy to put in some extra time for some fast dollars. Since neither of these men is interested in building substantial, honorable businesses they will give the customer as little as possible in the way of service. The public will squawk and legitimate service businesses will catch the blame.

How Much Protection?

When you study the case histories of service "gyppery" that have been reported to the Better Business Bu-

BE A RADIO ENGINEER

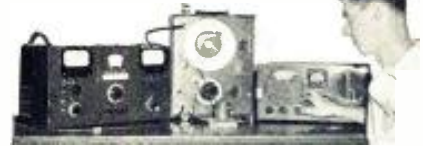

You can enter this uncrowded, interesting field. Defense expansion, new developments in electronics demand trained technicians. Study all phases radio and electronics theory and practice: TV, FM; broadcasting; servicing; aviation, marine, police radio, 18-month course equal in radio content to 4 yrs. college. H.S. or equivalent required. Begin Jan., March, June, Sept. Campus life. Write for catalog.

VALPARAISO TECHNICAL INSTITUTE
Dept. RD Valparaiso, Indiana

Moody Kit TOOLS ARE A MUST
IN RADIO, T.V. AND ELECTRONICS

Your tool box is incomplete if it lacks Moody Kit precision small tool sets. The PA-5 Kit shown contains five interchangeable Allen type and Phillips head screw drivers. Ask to see the complete Moody line at your local stores.

SEND FOR FREE DESCRIPTIVE BOOKLET
Moody MACHINE PRODUCTS CO., INC.
4 Culver Street, Providence 5, Rhode Island

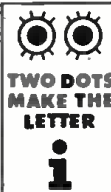

GET IN on the fun of operating your own licensed transmitter. I guarantee you will memorize the International Morse Code alphabet within two hours by my simple picture method, or return method within five days and I will refund your money.

COMPLETE COURSE ONLY \$1
NOTHING ELSE TO BUY!
OTTO LUTHER, NEW PRESTON, CONN.

TURN YOUR EXCESS GEAR INTO READY CASH!

Especially Need R-101/ARN-6 or Parts
For Top Prices, Write

BOB SANETT
4668 Dockweiler Los Angeles, Calif.
Phone: WEbster 1-7414

CODE SENDING RECEIVING SPEED

HIGH SPEED WITHOUT NERVOUS TENSION
REVEALING BOOK shows how "crack" operators develop high speed and proficiency. Learn code for Amateur or Commercial Radiotelegraph License, or improve your sending and receiving with the Candler system which develops radio-telegraph experts and code champions. **FREE**
CANDLER SYSTEM CO.
Box 928, Dept. 2-L, Denver, Colo. **BOOK!**

You Will Not Want to Miss the Big November Issue of

RADIO & TELEVISION NEWS

ON SALE OCTOBER 24TH

Be Sure to Reserve Your Copy Now!

RADIO & TELEVISION NEWS

reau you cannot help but feel a little disgusted over the number of them that were caused by the complainant's attempt to get "something for nothing." It's hard to believe that anyone who owns a television set isn't acquainted with a few fundamentals about the cost of operating a business. And when the set owner selects a service company or technician for TV repairs because advertised price for labor or home service is ridiculously low, normal common sense should tell him that he is just asking for trouble.

Only a moron would go for a jewelry ad offering "a genuine 1/4-carat blue-white diamond for \$10.00" and expect to get a bonafide jewel. We are inclined to feel the same way about a set owner who would call a TV service company because they offered home service for ninety cents.

When a set owner selects a service technician because of a low price for home service he is asking for trouble. And when he calls the Better Business Bureau to complain that the man charged \$10.90, which included the ninety cent "service" charge, \$3.50 for a 5U4 and \$6.50 for a 6N6, the BBB should be sufficiently informed on prices to tell the complainant that he actually paid the legitimate charge of \$4.50 for the service call and the regular list prices for the two tubes.

We do not condone the practice of jacking up parts prices to hide labor charges. The service businesses that employ those tactics will not build customer good-will. But we do feel that the public should not be babied in their efforts to gyp the legitimate service industry out of its rightful costs of doing business. The BBB would do well to publicize the fact that "when you buy service on price alone you can expect to be gyped."

Capehart Service Theme

In presenting their new TV chassis model CX-36 recently to their distributors and service managers, the *Capehart-Farnsworth Company* conducted a service forum on the theme that service is a business activity that must be directed with managerial skill equal to that required in sales and other departments of the business.

Under the seasoned direction of Ted Ostman, their general service manager, the *Capehart-Farnsworth* service planning department has pioneered many forward-looking programs for the service industry. The sound film titled "The Sale After the Sale" produced by the *Capehart* organization is rated by service businessmen as tops for graphically presenting the simple fundamentals for maintaining good relations with service customers. This interesting and instructive film is available for service meetings through *Capehart-Farnsworth* distributors. It should be scheduled for at least one showing by every service group during this Fall and Winter season.

An important part of the *Capehart* program is that it focuses particular

YOU FIND BEST BUYS at PLATT

NOW YOU CAN SHOP AT EITHER OF NEW BRANCH STORES!
 MAIN STORE: 489 Broome St., N.Y.C.
 all Mail Orders here.

PLATT ROLLS BACK PRICES!

TUBES	BRAND	NEW!	TUBES
	JANI	BOXED!	
1H22	89c	100R	49c
1H23	\$3.75	14B	29c
2H22	49c	215A	09c
2C22	14c	221A	29c
2C28	09c	304TH	\$5.95
2C28A	09c	316A	29c
3H22	\$1.19	371B	29c
3H21	39c	385A	29c
3C24	98c	471A	\$1.19
3H31	39c	532A	\$1.19
3H41	\$1.70	722A	99c
7C4	39c	801A	19c
10Y	39c	820	39c
12K8Y	39c	11	39c
13R	39c	843	17c
35/44	29c	864	19c
			054
			1010
			1019
			1025
			1026
			1029
			1030
			1034
			1103
			9002
			99c
			HY1148
			HY115
			RC14
			VR12
			14c
			19c



ARC-5/R-28 2 MTR RCVR \$29.95

Here is the 2-motor superhet you have been looking for! Absolutely one of the BEST available today! Times from 100 to 13.9 Mcs. in four crystal channels. (Easily converted to continuous tuning.) Tube lineup is as follows:
 717A—R.F., 717A—Mixer, 2-12NH7—1st and 2nd I.F. 16.0 Mc.
 12S1, 7—Det. AVC Spuehch. 12S1, 7—1st audio-speech amplifier.
 12A6—2nd audio, 12S1H7—R.F. Osc., 4th Harmonic Gen.
 717A—Tripl. 12th Harmonic Gen., 717A—Dihr., 12th Harmonic.
 Excellent, used \$29.95

TURBO AMPLIFIER

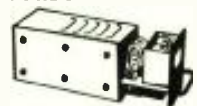

4 tube Amplifier used by U. Air Force, 115 V. input at 400 cycles. Without tubes—**BRAND NEW**
\$1.19
 SPECIAL

FIRE EXTINGUISHER TIRE INFLATOR



Made by leading Detroit Auto Mfr. Especially recommended for oil, gas and electrical fires. Guaranteed by mfr. against defects. Order two—one for your home; one for your car in case of flats or fires.
ONLY \$2.29 each

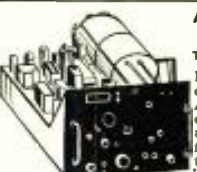

AIRBORNE EQUIPMENT
 Designed for Aircraft
 T-85/APT-5 UHF Transmitter
 Radar Set AN/APT-5 operates on 80 or 115 volts A.C. at 400 to 2600 cycles requiring 640 volts amperes at 0.90 power factor. Complete with all tubes. Brand new in original packing.
\$149.50

A TERRIFIC BUY AT ONLY

NEW SUPPLY ARRIVED! LIMITED QUANTITY TRANSMITTER-RECEIVER



Navy Model ABA-1 (CG-43AAG)
 Army Model SCR-515A, known as the BC-645
 450 MC — 15 Tubes

BRAND NEW—ORIGINAL CARTON
 Can be easily converted for phone or CW 2-way communication. Covering for the following bands: 420-450 MC ham band, 450-460 MC for fixed or mobile, 460-470 MC for citizens, 470-500 MC television experimental. Size 10 1/2 x 13 1/2 x 4 1/2. Contains 15 tubes: 4—7F7, 4—7H7, 2—7E6, 2—6F6, 2—955, 1—WE-316A door knob
 Price includes Dynamotor, Control Box, Mount, Tubes **\$34.95**

BC-221 Frequency Meter

Real Value! QUANTITY IS LIMITED—50 first come, first served. They are just like new, with original calibration charts. Range 125-20,000 KC with crystal check points in all ranges. Complete with crystal and tubes. **\$129.50**
 MODULATED TYPE WITH AC POWER SUPPLY \$159.50
 These Frequency Meters are factory tested, checked for frequency alignment and GUARANTEED.



HEADSETS

HS-33 low impedance with cord and plug; used, fine condition	\$2.79
HS-23 high impedance, BRAND NEW with ear pads, cord	4.95
HS-33 low impedance, BRAND NEW with ear pads, cord and PL-54 plug	\$4.95
HS-35—BRAND NEW—Western Electric	\$9.95
CD-307A Cords, 6 ft. NEW89
H-16/U high impedance. Includes two receiving units	3.95
HS-16 high impedance—used	2.49

MINIMUM ORDER \$2.00
 Immediate Delivery—Send 25% deposit on C.O.D. orders. All shipments F.O.B., N.Y.C. (N.Y.C. residents add sales tax to your remittance.)

ORDER NOW at these REDUCED PRICES!



	USED	EXCELLENT	NEW
RECEIVERS			
BC-453—190 to 550 KC	\$29.95		\$48.95
BC-454—3 to 6 MC	8.95	\$9.95	19.95
BC-455—6 to 9 MC	9.95	11.95	16.95
TRANSMITTERS			
A-958—2.1 to 3 MC		7.95	29.95
BC-458—5.3 to 7 MC		9.95	17.95
ARC-5-T-19—3 to 4 MC		24.95	34.95
BC-459—7 to 9.1 MC			24.95

ADDITIONAL EQUIPMENT	2.49	2.95	5.95
BC-456 Modulator	1.49	1.95	2.75
BC-451 Control Box (Receiver)	1.29	1.79	2.39
BC-442 Relay Unit (ANT)	2.39	2.89	3.69
Plugs: PL-147, 148, 151, 152, 153, 154, 156—EACH		1.25	
Flexible Shafting with gear to fit receivers			2.69
3 Receiver Rack	1.79	2.29	2.98
2 Transmitter Rack	1.69	2.39	3.97
Single Transmitter Rack			3.97
DM-33 Dynamotor for Command Set		3.95	5.95
Shock Mounts for 3 Receiver Rack, 2 Trans. Rack, Modulator or Antenna Relay Unit		2.95	3.95

LIMITED QUANTITY

COMMAND SET BC-455—6 to 9.1 MC. Excellent, 95% completely wired—a few minor parts included require assembling. Instructions included,
ONLY \$7.95
 COMMAND TRANSMITTER—Navy and Army Type—3 to 4 MC. 75% complete spare parts—LIMITED QUANTITY. **\$10.95**



20 POUNDS OF ASSORTED RADIO PARTS
 A TERRIFIC BUY AT ONLY **\$2.79**
ARMY TEST UNIT I-236
 Meter is contained in a metal box 5 1/2" long x 3 3/4" wide x 3 1/4" deep. Comes complete with test leads and instruction book. Can be used for testing between AC and DC measuring resistances of circuits, checking fuses and testing capacitors.
SPECIAL \$4.19

Multitester Foundation BIAS METER 1-97A

Contains a zero center 3 1/2" round Marion voltmeter calibrated 0-100 volts each side. Movement is one mill each side of center. The unit is mounted in a steel box 7" x 5" x 4 1/2" and contains 8 contact push button, line cord dual 100 MFD at 200 V DC condenser, a potentiometer 6 1RC 1% wire wound non-inductive resistors: one 400 ohm, two 2500 ohm, one 5000 ohm, one 10,000 ohm, one 15,000 ohm. Excellent for building a zero center multitester with ranges of 1, 10, 100, 1000 volt.
COMPLETE BRAND NEW \$5.95

SPECIALS-OF-THE-MONTH!

NOW! Fill Your Battery Only Twice a Year
 with Automatic Battery Filler
 Made by leading Detroit Auto Mfr. Doubles battery life over ordinary care, prevents battery breakdowns, fits all cars. Instantly installed.
ONLY 89c COMPLETE

CD 307A CORDS
 with PL 55 Plug and JK 20 Jack, long cord.
SPECIAL! 79c

PRE-AMPLIFIER MODEL K-1
 The K-1 is used to amplify output level for microphones and phonographs. Operates on 24-28 VDC. Can be converted to 110 AC. Comes complete with PL 55 plug and 2-foot 110-B cord, 2 terminal blocks and instruction book.
BRAND NEW SPECIAL! \$3.95

PLATT ELECTRONICS CORP.
 DEPT. A, 489 BROOME ST., NEW YORK 13, N. Y.
 PHONES: WO 4-0827 and WO 4-0828

Makes
TV
Servicing
easy
to
learn!



THE BIGGEST \$4 WORTH IN TELEVISION TRAINING HISTORY!

**Practical
on-the-job
data based
on actual
service shop
experience**

No involved mathematical! No confusing theory! The two well-known engineers who wrote PRACTICAL TELEVISION SERVICING actually operated a TV service shop to get the specific, down-to-earth information they now pass along to you in easily understood form. They show exactly how to troubleshoot, diagnose and repair television troubles; how to locate troubles quickly with less testing; how to make repairs fast and more profitably.

Dozens of actual service case histories greatly simplify thinks and help make puzzling jobs easier to handle. Over 250 illustrations and pattern photos explain details step by step. Other subjects include component replacement data, wiring details, helpful hints on testing and a wealth of information on a broad range of subjects from fringe area reception to improving picture linearity in difficult locations.

**HELPS YOU
PASS
SERVICE
LICENSE
EXAMS!**

This great book can be invaluable in helping you pass service licensing examinations with flying colors!

**CASH IN
ON TV
SERVICE
PROFITS**

Lots more TV stations are scheduled to operate this year in new areas. Get in "on the ground floor" for the profitable new service business that will result!



READ IT 10 DAYS... At Our Risk!

Dept. RN-102, RINEHART BOOKS, Inc.,
Technical Division,
232 Madison Ave., New York 16, N. Y.

Send PRACTICAL TELEVISION SERVICING for 10-DAY EXAMINATION. If I decide to keep the book, I will then remit \$4.00 plus a few cents postage. Otherwise, I will return book postpaid and owe you nothing.

Name

Address

City, Zone, State

Employer's Name & Address

OUTSIDE U.S.A.—Price \$4.50 cash only. Money back in 10 days if book is returned.

attention on the set distributor's responsibility to his dealers and their customers to help build a strong, business-managed independent servicing industry. Manufacturers, increasingly alert to the training and information needs of a growing service industry, go to great expense to provide many valuable training aids for independent service businessmen. Unfortunately, many of these valuable aids are completely lost in the distributor's organization.

This year *Capehart* will make the first award of its prized "President's Cup" to the *Capehart* distributor who excels in "service cooperation." This award, a striking sterling silver cup, will be made annually. It is intended to inspire more active participation on the part of *Capehart* distributors in the programs of their local independent service people.

Pittsburgh TSA Fall Program

The Television Service Association of Pittsburgh, Pa., organized by a group of Pittsburgh service executives early this year, will launch its 1952-53 program for industry cooperation with a well planned service business forum in the early Fall. As planned by the association, the program will cover the following important phases of service responsibility:

1. The set distributor's responsibility to his dealers and their customers for providing reliable, efficient service on the sets he handles. Particular attention will be given to the service aids and business helps that a set distributor can make available to the independent service organizations that handle his dealers' servicing. The importance of cooperation in local service industry programs will be shown.

2. The share of responsibility of the independent parts distributor in upgrading service practices. The importance to the parts distributors of broad industry training programs will be shown. Particular attention will be given to u.h.f. TV and the importance of training in the handling of conversion equipment.

3. How the non-servicing dealer can work with his independent service depot for their mutual profit in furnishing set buyers with reliable, efficient service.

4. The man on the firing line—the service technician—is the set owner's yardstick for measuring the caliber of the entire servicing industry. Continuing customer relations training for field technicians is vitally important.

5. When a set owner is unhappy about the service he gets on his TV set he will usually call the Better Business Bureau about it. The BBB will discuss the failings of service in the Pittsburgh area as revealed by complaints and give suggestions about how they can be corrected.

6. In the complex social order in which we live every man in business has a responsibility to so manage his business that it will pay him and his

**SAVE THAT TV TUBE
SAVE YOUR PROFITS**

THE ORIGINAL

PICBOOST

**RESTORES BRILLIANCE
to OLD TV PICTURE TUBES
NOT A "HOT SHOT" REJUVENATOR**



MODELS #1 & #2

OTHER MODELS SLIGHTLY HIGHER

**\$7.95
LIST**

1-MINUTE INSTALLATION

- Adds over a year to tube life
- Universal for all types of picture tubes, regardless of socket
- Filament heater voltage applied to picture tube instantly
- Smooth continuous control
- Limits peak inrush current
- Reduces tube contract risks

**NO DANGLING LINE CORDS
NO MOVING PARTS
NO TIME DELAY TO DAMAGE
PICTURE TUBE**

WRITE TODAY FOR CATALOGS

SOLD THROUGH RECOGNIZED DISTRIBUTORS

C-B-C ELECTRONICS CO.

620 ARCH ST., PHILADELPHIA 6, PA.

employees sufficient incomes to enable them to maintain the accepted standard of living. The service operator who is content to work for a sub-standard income is no credit to the community in which he lives.

7. Service is a business. A capably managed service business can be operated at a profit. When a profit-showing business needs operating cash it can borrow from a bank. The profit-producing factors of a service business as seen by a business analyst.

Major TV Service Jobs

Only *time* can disclose how long the average TV set will function with only nominal adjustments or repairs until heat exacts its toll in the breakdown of the major components of a set. Unlike radio in which audio distortions from baked components seldom impelled a user to get them corrected through major repairs, video distortions will send a set owner to the telephone fast for a service technician.

Although it is still too early to develop authentic figures, mounting service calls in the older TV areas indicate that a five-year cycle for major repairs or set replacements may prove to be the TV pattern. Paul V. Forte, executive secretary of the TCA of Philadelphia, reported in the "Almo Broadcaster" that:

"After five years and the installation of 1,052,000 television sets in the Philadelphia area, the long-expected is beginning to happen: CR tubes and the bigger, more expensive components are beginning to fail in large numbers among the early installations. Repair bills on these sets are going up and up and causing understandable pressures and reactions.

"First, the TV owner is still not able to distinguish between a padded bill (a product of some undesirable members of our industry) and a true bill which reflects the actual cost of maintaining the customers' enjoyment of television. As a result, squawks are going up and again the Better Business Bureau is hearing from disgruntled set owners.

"A few service operators—those who are, primarily, good business men—have been doing a careful and conscientious good-will and educational job among their customers and are reaping the benefits." —30—

CLEVELAND HAMFEST

THE Cleveland Area Council of Amateur Radio Clubs has scheduled its 1952 hamfest for Saturday, October 4th at Grey's Armory, E. 14th and Bolivar in downtown Cleveland.

The committee in charge has provided a varied program of events including exhibits, talks and discussions, an auction, a buffet supper, a Civil Defense movie, drawings for prizes, etc.

Tickets purchased before September 30th are available for \$3.50 with the price being upped to \$4.10 if tickets are purchased at the door.

Write Julius Mosonics at 7715 Newport Ave., Parma 9, Ohio for tickets or further information. —30—

October, 1952

 ★ Get window-size
 ★ reprints of this ad
 ★ free from your
 ★ Sprague distributor,
 ★ or send 10c to
 ★ Sprague to cover
 ★ handling costs.



HERE'S YOUR ANSWER, MR. AND MRS. SETOWNER!

999 times out of a thousand, when this happens . . . *don't blame your service technician!*

The repair to your television receiver made several days ago or even several months ago probably had no relation to the new trouble that developed today.

Actually, there are more than 300 electrical parts in even a small table model television receiver. Trouble in any one of them might cause the picture or sound to disappear or to be received poorly.

Take your automobile for instance. Tuning up the motor today is no guarantee against a tire blowout tomorrow!

Such a thing is easier to understand because most of us are more familiar with automobiles than with today's highly complicated TV and radio sets. But such unconnected troubles occur in TV and radio nevertheless—and because they are so

hard to explain in non-technical terms, it is always embarrassing to your service technician when they do.

His continued business existence is based on gaining the full confidence of you and other set owners like you. He isn't in business to "gyp" you or to overcharge you. His success is based on doing each and every job to the level best of his ability, at a fair price for his skilled labor. It's only when you patronize the shops that feature "bargains" at ridiculously low prices that you need worry. Good radio and TV service can't be bought on the bargain counter! Set owners who recognize this aren't likely to get "gypped."

Sincerely yours,

Harry Kalker

(HARRY KALKER, President)

SPRAGUE PRODUCTS COMPANY
 (Distributors' Division of the Sprague Electric Company)
 51 Marshall Street, North Adams, Massachusetts



WORLD'S LARGEST MANUFACTURER OF ELECTRIC CONDENSERS

NEW! MORROW CAR GENERATOR NOISE FILTER

Just released . . . a new MORROW filter to connect in series with armature on car generator for high attenuation of generator hash. A really effective tunable filter designed by the makers of the famous Morrow Converters. Model GC-10 is for 10 meter operation.

GC-10 filter with mounting bracket. Net **\$3.75**

SPLINED TUNING KNOB FOR 274N RECEIVERS

An exclusive O-R item manufactured for us. Fits BC-453, BC-454 and other 274N receivers. This is a really hard-to-obtain item. Only. . . 89c ea.



NOVICE CRYSTALS

Offering a high quality quartz crystal in standard holder for Novice 80 meter band. Made by P-R A Good buy at. **\$2.75 ea.**

NOVICE 500V POWER SUPPLY KIT

Here is all the makin's for a sweet little power supply suitable for 807's. Includes: Power transformer. 2—4mfd, 600V oil filled condensers, 1—10 henry choke. 1—5U4 rectifier, 1—socket, 1—chassis, line cord, power switch and terminal board. Supply output voltage is 500 volts at 200 ma. Only **\$16.95 kit**

TRANSFORMERS-CHOKES:

325-0-325 @ 225 ma. 6.3 @ 5A. 5V @ 3A. Pri. 110V, 60 cy AC. Size, 4 1/2" x 4 1/2" x 3 1/4". Only **\$6.95 ea.**

920-0-920 or 740-0-740 AC @ 200 ma. Pri. 115V, 60 cycle. AC. Upright shielded case. Excellent for 807's. Only **\$10.80 ea.**

5V. 25A. Pri. 115V. 60 cy. AC. A real rugged job excellent for 304TL—4-250A etc. Limited quantity. Only **\$4.50 ea.**

10H. 200 ma choke. Hermetically-sealed steel case. Also has hum-bucking tap. A beautiful item only **\$1.98.**

Power transf. Pri. 115V. AC. 60 cy. Sec. 520-0-520 @ 200 ma. **\$5.25 ea.**

350-0-350 @ 300 ma. 6.3 @ 4A. 6.3 @ 8A. 5V @ 3A. Pri. 115V. 60 cy. AC. only **\$7.95 ea.**

450-0-450 @ 200 ma. Pri. 115V, 60 cy. AC. 5V @ 3A. 6.3 @ 5 amp. In shielded case. Only **\$8.90 ea.**

350-0-350 @ 350 ma. 6.3 @ 10A. 5V @ 6A. Pri. 115V. 60 cycle. Only. **\$8.95 ea.**

NEW! PORTABLE GEIGER COUNTER

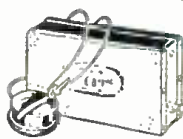

A small light-weight unit (2 pounds), with a sensitivity that compares favorably with instruments many times its purchase price. Rugged and dependable and intended for professional use. Batteries used provide long life and low replacement cost. Each Geiger counter comes complete ready for use with instructions and radio-active ore sample for comparison tests. **\$35.00**

110V, AC POWER SUPPLY FOR ANY 274-N RECEIVER



Just plug it into the rear of your 274-N RECEIVER . . . any model. Complete kit and black metal case, with ALL parts and diagrams. Simple and easy to build in a jiffy. Delivers 24 volts plus B voltage. No wiring changes to be made. Designed especially for the 274-N receiver. Only **\$8.95.**

Filament trans. for 274N receivers. Pri. 110V. 60 cy. AC. Sec. 24V @ .6A. An excellent buy at **\$1.95 ea.**

SPECIAL PURCHASE! VIBRATOR POWER SUPPLY

A fortunate special purchase has made it possible for us to offer this fine little vibrator power supply at such a low price.

Manufacturer, Electronic Labs, Type 605A. Voltage input 6V. DC. Voltage output: four different voltages available from a tapping system. 150, 200, 250 or 275 volts. Secondary current, 75 ma, maximum.

Complete with vibrator. only **\$8.95**

LOOK! NO HANDS!



This mike leaves both hands free for mobile QSO's. Fastens to operator by simple snap strap. Adjustable. Double action sw. operates push-to-talk or holds on. Only **\$2.00 ea.**

Minimum order \$2.00. All items subject to prior sale. All prices subject to change without notice. 20% deposit must accompany all orders, balance C.O.D.

OFFENBACH-REIMUS
1564 MARKET STREET
SAN FRANCISCO, CALIF.

TVI Checker

(Continued from page 71)

full scale. If it does not, R_1 should be replaced. A lower value of grid leak will increase the meter reading, while a higher value will decrease it.

As a carrier is tuned in, you'll notice that the receiver hiss drops and the meter dips. The amount of hiss reduction and meter deflection is dependent on the strength of the received signal. Although the response of the meter is not particularly linear, the stronger the signal the greater will be the deflection. The lack of linearity is no real handicap because, in a device of this nature, we are not too interested in knowing absolute values. The main thing we want to discover is whether or not a harmonic is present and if so, is it stronger or weaker than the TV signal.

The reading on M_1 will vary somewhat as C_1 is tuned. R_1 should be of such value that the meter does not go off scale at any setting of C_1 .

After the field strength meter is installed in the case, the amount of coupling between L_1 and L_2 should be adjusted tight enough for good signal transfer and yet not so tightly that the detector fails to superregenerate.

A field strength meter of this type is a tremendous improvement over an absorption wavemeter for checking harmonics which leak through shielding or follow power leads. It really comes into its own, though, when you want to track down harmonics generated by the strong r.f. field of the transmitter's fundamental. These insidious signals are caused by rectification which takes place whenever r.f. flows through a corroded metallic joint. For example, a metal clothesline touching a heating duct in the basement can cause a very annoying harmonic. Old plumbing and housewiring may also give forth unwanted signals.

No matter how hard you work on the transmitter, you won't be able to cure TVI caused by rectification. The only remedy lies in locating the trouble at its source. If the TVI is caused

Fig. 5. Details on an alternate housing.

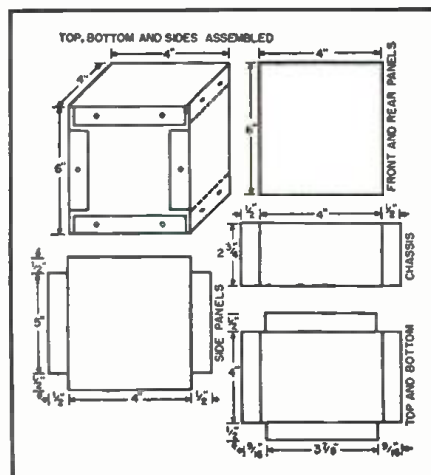

Advance with ELECTRONICS ICITY

You need firm grasp of fundamentals to keep pace with these complex, fast-growing fields. In thorough 2-year course learn electricity, electronics, physics, mathematics, drafting, etc. Other engineering and technical courses. Coed. Day, evening, 44th year. Write for Catalog.

FRANKLIN TECHNICAL INSTITUTE
46 Berkeley Street Boston 16, Mass.

WANTED: DM-21, 433-G, ARN-7, ARC-3, BD-77, DM-28

and spare parts. Also interested in other airborne electronics.

V & H Radio & Electronic Supply Co.
2033 W. Venice Blvd. Los Angeles 6, Calif.
Phone: REpublic 3-1127

IT SELLS BEST because IT PERFORMS BEST DAVIS SUPER-VISION ALL-CHANNEL ANTENNA

FOR FRINGE AREA or DX
With ELECTRONIC DIPOLE SEPARATORS
"THE ORIGINAL ANTENNA SOLD WITH A MONEY-BACK GUARANTEE"

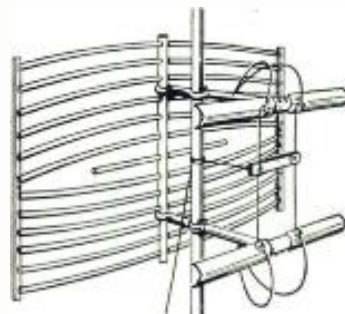

1. EXCELLENT FOR FRINGE AREA and DX RECEIVING—and broad band receiving with high gain on all channels—2 through 13.
2. CLEARER PICTURES UP TO 125 MILES OR MORE—from the station.
3. GHOST PROBLEMS REDUCED or eliminated due to excellent pattern.
4. PROVIDES 10 DB OR MORE GAIN ON HIGH CHANNELS where gain is needed most.
5. EXCELLENT FRONT TO BACK RATIO on all channels. No co-channel interference.
6. MINIMIZES INTERFERENCE: Airplane Flutter—Diathermy and Ignition—F.M.—Neon Signs—X-Ray—Industrial—Etc.
7. ELIMINATES DOUBLE STACKED ARRAYS, and out-performs 2 bay yagis on low band and 4 bay yagis on high channels.
8. ONLY ONE TRANSMISSION LINE NECESSARY.
9. NO WORRY OVER POSSIBLE CHANNEL CHANGES on either high or low channels.
10. CAN BE TIPPED WITHOUT TILTING MAST to take advantage of horizontal wave lengths.
11. Can be used with ANTENNA ROTOR.

AT YOUR JOBBERS, OR WRITE TO:

DAVIS ELECTRONICS 1-17
4313 West Magnolia Blvd., Burbank, California
SIRS: RUSH INFORMATION TO ME AS CHECKED BELOW:

- Send Free Technical Data on new SUPER-VISION ANTENNA.
 Send Name and Address of NEAREST JOBBER.

Name _____
Street _____
City _____ State _____

by two metallic objects which accidentally touch each other, it is possible that a cure can be effected by putting a piece of insulation between them. When rectification occurs where two items are mechanically joined, all rust or corrosion should be cleaned away and then a tight, low resistance joint should be made.

Judging from the dearth of signals on ten and twenty meters during the evening hours, television interference is still an unsolved problem for the majority of metropolitan hams. If, despite a good dose of shielding, bypassing, and filtering, you are still a member of this unhappy group of radiomen, I recommend that you build a gadget similar to the one I have described. It will be a real help in ferreting out those faint but annoying harmonics which keep your rig silent when the XYL and the jr. op desire an unobstructed view of Channel 2.

-50-

Novice Transmitter (Continued from page 55)

denser. The voltage is fed to the tube through a *National* R-300U r.f. choke, *RFC*s. A *National* Type TMK, 50 μ fd. condenser (*C*₁) is used to tune the plate circuit.

Spade lugs are used to mount the insulators which hold the coil socket in place above the tuning condenser. An end-link *B & W* coil is used with a 25 μ fd. high voltage ceramic condenser mounted inside this coil. *C*₂ is a *Centralab* Type 850S condenser.

A parasitic suppressor was found necessary in the plate circuit of the oscillator tube. This was made by winding 14 turns of #24 enamel wire over a 50 ohm, 1 watt carbon resistor with the resistor acting as the coil form.

A *National* FWB insulator is used with two binding posts for making the necessary connections to the antenna tuner. This antenna tuner is used a short distance away from the transmitter. Details on its construction can be found in any antenna handbook and are not given here as the circuit selected will depend on the type of antenna used.

Novice license holders will find this little rig easy to build and handy to operate. Good contacts, fellows!

-30-

Under chassis view of novice transmitter.

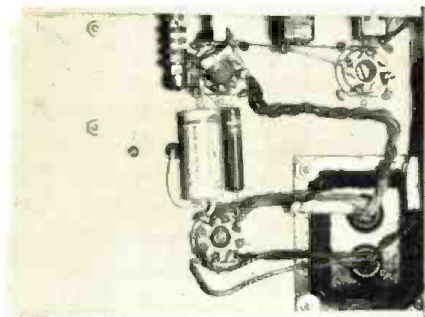

NOW! AT TREMENDOUS SAVINGS!

MIKES and HEADSETS

HS-33 Low Impedance Headset, exc. \$2.95	new \$4.95	
HS-23 Headset used \$2.95	new \$4.95	
CD-307 Ext. cord for HS 23-33	like new .79	
Throat Mike—T 30	New .98	
Lip Mike—Navy Type	New .98	
Extension Cord and Switch Assembly for lip and throat Mikes	New .98	
CW 49505 High Impedance headset complete with leather headband and rubber cushions.	Used \$1.95	
T-17, Microphone	new \$5.95	
TS-10 sound powered HAND SET	used, ea. 5.95	
HS-38	exc. \$1.95	new 2.29
HS-30, miniature headset	new 2.49	used 1.49
HB-7 Headband, used, exc.	1.25	

RT/34 APS 13 Transceiver used as a tail warning radar on 415 MC. Containing a 30MC IF Strip and various other parts, these units have been stripped of RF sections and all tubes but are an excellent buy if only for parts and IF Strip. Used \$4.95

BC 624 receiver (SCR 522), less tubes, 100 A 156	used \$19.95
BC 625 transmitter (SCR 522) less tubes,	used 14.95
SCR 522 transceiver, complete in case with top bracket, less tubes	29.95
Transceiver—100-156 mc, 2 meter, used, excellent condition, less dynamotor, with tubes	only 24.95

MONTHLY SPECIAL SURPRISE PACKAGE

20 pounds of assorted radio parts. A real value at **\$1.95**

DYNAMOTORS

14 Volt input—285 output	\$ 4.95
PE 103	used exc. 19.95
DM 53A	used exc. 7.95
DY 16 APG 5	new 5.95
PE 109	new 89.50
DM 21	used exc. 7.95
BD 83	used exc. 8.50
BD 77	new 39.95
PE 73	used 8.95
PE 98	new 75.00
DM 34	used exc. 9.95
DM 35	used exc. 19.95
DM 36	used exc. 9.95
DM 37	used exc. 14.95

MN-26Y INSTALLATION



MN-26Y Receiver—Remote control commercial type navigational. Indicates direction of any desired transmitting station. Frequency range: 150 to 325 KC, 325 to 695 KC, 3.4 to 7 megacycles in 3 bands. Has 12 —6V type tubes. GOOD, used.

YOUR PRICE: Complete Installation... \$69.50
Receiver alone... 35.95

AIRBORNE EQUIPMENT Designed for Aircraft

T-85/APT-5 UHF Transmitter Radar Set AN/APT-5 operates on 80 or 115 volts A. C. at 400 to 2600 cycles requiring 640 volts amperes at 0.90 power factor. Complete with all tubes. Brand new in original packing.

A TERRIFIC BUY AT ONLY \$159.50

WRITE FOR PRICES

BC1033	BC376	MP10
BC939	BC638	LP21LM
APS13	RA42	TS167
ARN7	RA52	TS61
SCR269F&G	RTA1B	TS92
SCR619	TA2J	BC1277
BOONTON SIG.		
GEN. I. 26 B	CRT3	BC1287
TS 100/AP	SCR510	APR-4

WANTED!

All TS, APR, APS, ARC, ARN, ART, SCR, R89 and BC equipment... write today!
Quote prices in your first letter.

Closing Out All TUBES

16JP4	\$16.95	9002	\$.59
16DP4	16.95	9003	.98
14CP4	16.95	6A35	2.29
304TH	5.95	6AC7	.69
304TL	5.95	4AP10	.95
830B	1.69	5CP1	3.95
805	2.69	5BP4	2.95
9001	.99		

DYNAMOTOR PE-101C

The best dynamotor for conversion to 6v. Multiple windings! After conversion you get choice of 190 or 350 v. at 50 MA or 250 v. at 100 MA. Complete dope sheet furnished. **\$465**
BRAND NEW (See "CQ" Aug. issue)

SCR-274N COMMAND and ARC-5 EQUIPMENT

RECEIVERS	AS IS (Less tubes)	EXC. USED (With tubes)	NEW
BC-453—190 to 550 KC.	\$10.95	\$23.95	
BC-434—3 to 6 MC	4.95	11.95	
BC-453—6 to 9 MC	4.95	11.95	\$16.95
TRANSMITTERS			
BC-457, 4 to 9.3 MC	4.95	6.95	
BC-458, 5.3 to 7 MC	4.95	6.95	
BC-459, 7 to 9.1 MC	10.95	14.95	
ADDITIONAL EQUIPMENT			
BC-156 Modulator	2.25	2.75	5.75
BC-450 Control Box (3 Receiver)		1.75	2.55
BC-451 Control Box (Transmitter)		1.69	2.29
BC-442 Relay Unit ANT With Condenser Without Condenser		2.79	3.50
Plugs: PL-147, 148, 151, 152, 153, 154, 156 Each		1.25	
Flexible Snapping with Gear to fit receivers		1.00	2.45
3 Receiver Rack		2.29	2.98
2 Transmitter Rack		2.39	3.97
Single Transmitter Rack		1.00	2.95
DM-32 Dynamotor for Command Set		3.25	4.95
DM-33 Dynamotor for Command Set		2.95	3.95
Shock Mts. for 3 Receiver Rack, 2 Trans. Rack, Modulator or Ant. Relay Unit		1.95	2.45

WOBLULATOR

BUILD TV-FM-AM SWEEP GENERATOR

(See Dec. Radio & TV News)
You can build "Versatile Sweep Frequency Generator" with APN-1 magnetic units... \$5.95

RT7/APN1 TRANSCIVER UNIT—Used as an altimeter, it may be converted for signaling control circuits, etc. Complete with 14 tubes and dynamotor they are in good used condition at the amazingly low price of... \$17.95
Used, less tubes, with wobulator... 9.95

BROADCAST BAND & AERO

MN-26-C Remote Controlled navigational direction finder and communications receiver. Manual DF in any one of three freq. bands, 150 to 1500 KC. 24 V. Self contained dynamotor supply. Complete installation, including receiver, control box, loop, azimuth control. Left-Right Indicator, plugs, loop transmission line and flex. shafts.
BRAND NEW \$69.50
MN-26-C alone, New 39.50
MN-20-E Loop, Brand New 6.95
MN-52 Crank drive, New 2.50

BC 604 FM TRANSMITTER
20-27MC used, exc. \$12.95

MISCELLANEOUS EQUIPMENT

MS-49 to 56, each 39c	BC 347 each	\$1.95
RM-29	RL 42 each	3.95
FL 8 used, exc.	BC433 less tubes	12.95
BC 906 each	with tubes	19.95

SELSYN TRANSMITTER

Loop Motor and Autosyn Transmitter Assembly for matching to I-82 Indicator. Used, excellent condition.
ONLY \$5.95 Complete with Indicator... \$14.95

SCR 625 Famous Army Mine-Detector

For Prospectors, Miners, Oil Companies, Plumbers, etc.

This unit is being offered now at a considerable reduction in price. Recently advertised at \$79.50 it is now available in the same brand new wrappings in suitcase style carrying case (less batteries) at **\$59.50** WHILE THEY LAST! Used, like new, \$39.50

Shipments FOB warehouse. 20% Deposit on orders. Minimum order \$5.00. Illinois residents, add regular sales tax to remittance. Prices subject to change without notice.

R W ELECTRONICS

Dept. N, 1712-14 S. Michigan Ave., Chicago 16, Ill.

PHONE: HArrison 7-9374

SAVE 2-WAYS WITH University DRIVER UNITS & TRUMPETS

1. Higher Conversion Efficiency Lowers Amplifier Costs
2. Highest Quality Eliminates Maintenance Expense

RUGGEDIZED TRUMPETS



UNIVERSITY trumpets are built to the highest standards in the industry—by the pioneers of the reflex trumpet. They are completely weather-proof, super conditioned for any locale or climate. Achievement of highest obtainable conversion efficiencies reduce amplifier requirements. Get the facts.

* Less Driver Unit

MODEL	GH	LH	PH	SMH
Low Frequency Cutoff	85 cps.	120 cps.	150 cps.	200 cps.
Sound Distribution	65°	75°	85°	95°
Air Column Length	6 1/2 ft.	4 1/2 ft.	3 1/2 ft.	2 1/2 ft.
Bell Diameter	30 1/4"	25 1/4"	20 1/4"	16 1/4"
*Horn Length	27 1/2"	19"	15 1/4"	12"
*Shipping Weight	25 lbs.	20 lbs.	11 lbs.	9 lbs.

HIGH EFFICIENCY DRIVER UNITS



MODEL SA-MF — Workhorse of the sound industry for general PA and industrial use. Very high efficiency delivers extra punch to cut through heavy noise. Response to 10,000 cps.—ideal for both speech and music. Tropically and hermetically sealed for trouble-free service anywhere.

MODEL MA-25 — A low cost unit for use where response to 6000 cps. meets requirements. No compromise in quality — incorporates all the famous UNIVERSITY quality features — high efficiency magnet structure, tropicallized full size 2" voice coil, rim-centered break-down proof bakelite diaphragm, etc.



MODEL PA-30 — A "de-luxe" unit incorporating every advance design feature including famous University W Alnico 5 Magnet and built-in transformer with terminals available thru housing base. For all amplifiers including 70 volt systems. Response 80-10,000 cps. with 30 watt cont. power.

MODEL SA-30 — Similar to the SA-MF in response and efficiency but includes a multi-impedance line matching transformer with taps accessible through water-tight cover. Taps designated in impedance values and watts for "constant voltage" lines. Die-cast aluminum housing affords lasting protection.



Write for catalog describing the complete line of University Hi-Fi and PA reproducer equipment, including Radial Type Projectors. Address Desk N-10



What's New in Radio

For additional information on any of the items described herein, readers are asked to write direct to the manufacturer. By mentioning RADIO & TELEVISION NEWS, the page, and the issue number, delay will be avoided.

MASTER AUDIO CONTROL

Fisher Radio Corporation, 41 East 47th Street, New York 17, New York has developed a master audio control which has been designed to meet the requirements of the audio enthusiast. The circuit comprises a self-con-

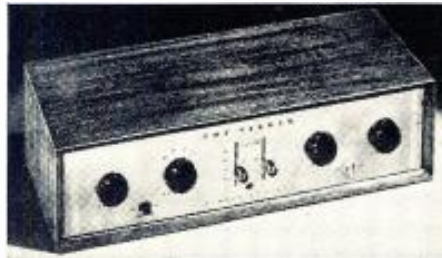

tained power supply, completely shielded, with d.c. for all filaments, a feature which results in a hum level so low as to be inaudible even under extreme operating conditions. The circuit is all-triode, with all tubes fully shock-mounted. Cathode-follower input and two cathode-follower output stages insure isolation of all control circuits in addition to independence from load conditions, lead lengths, etc.

The Model 50-C, which can be used with any make of amplifier, incorporates five inputs (three high-level, one magnetic phono, and one low-level-microphone), with preset channel controls on all inputs.

AUTO ANTENNA DISPLAY

A completely new and redesigned display board to handle its line of auto radio antennas is currently being offered dealers by Snyder Manufacturing Company of Philadelphia 40, Pa.

Designed to be used as a counter exhibit, the new display is available with any set of four aerials, including one 4-section cowl, one 3-section cowl, one top cowl, and one fender mount. Each board with its set of aerials is individually packed.

Details and catalogues on the company's line of antennas and displays are available on request.

"UNIVERSAL BREADBOARD"

Electro Manufacturer's Corporation, 2105 Ludlow Street, Philadelphia 3, Pa. has developed a "universal breadboard" for experimental use.

The new "Ezy-Mount" chassis kit utilizes individual component brackets which may be mounted on a perforated chassis in practically any position. The kit also includes a swivel mount on which the component mounts may be mounted away from the chassis and turned at various angles to the chassis.

Component parts which go to make

up the entire unit include a perforated chassis base, a blank component mount, a fusepost mount, switch mount, swivel mount, meter mount, potentiometer mount, an Amphenol snap-ring tube socket mount, a novel tube socket mount, miniature tube socket mount, a standard tube socket mount, and miscellaneous hardware items for mounting the various components.

A data sheet describing all of these units in detail is available from the company.

"PHONO-GARD"

Grayline Engineering Company, Avenue "O" at 122nd Street, Chicago 33, Illinois is in production on a new unit of interest to record shop owners. radio engineers, manufacturers of professional audio equipment, etc.

The new "Phono-Gard" features automatic push-button sequence of operations, prevention of tone arm handling, tone arm placement by remote control, complete elimination of record scratching, and the absolute inaccessibility of the tone arm and stylus.

According to the company, no damage can be done to either the record or the mechanism when playing or replaying a portion of a selection since all mechanical movements are operated by remote control. The "Phono-Gard" provides a protective barrier between the user and the tone arm mechanism. Descriptive literature on the new mechanism is available upon written request to Edward Gray at the above address.

HIGH-FIDELITY AMPLIFIER

Bell Sound Systems, Inc., 555 Marion Road, Columbus 7, Ohio, has added a medium-priced radio-phono amplifier



to its line of units for custom installation.

The new Model 2200 has a power output of approximately 20 watts at less than .3 per-cent harmonic and intermodulation distortion. Six controls, including a five-position equalizer switch for all types of foreign and domestic records, give the user

control of tone quality and volume. Inputs for a radio tuner, crystal microphone, two magnetic phonograph pickups, television sound, and tape recorder are selected by means of a five-position switch.

The unit is housed in a chassis measuring 16" long, 8 $\frac{3}{4}$ " deep, and 7 $\frac{1}{2}$ " high. All switches, input sockets, output taps, etc. are plainly marked and easily accessible.

Additional information on the Model 2200 is obtainable from H. H. Seay, general sales manager of the company.

COMPACT STATION

Deltronic Company, 9010 Bellanca Avenue, Los Angeles 45, California has announced the availability of a compact transmitter-receiver which has been designed to meet the require-



ments of hams, boat owners, police departments, forest rangers, and Civil Defense authorities.

The CD 144 transmitting-receiving unit weighs only 7 pounds, is self-contained, and can be plugged into an ordinary 117-volt receptacle or into the cigar lighter of an automobile. Its range is up to 40 miles.

Calibrated for the range 143.8 to 148.1 mc., this 6 $\frac{1}{2}$ " x 6" x 9 $\frac{1}{2}$ " unit comes equipped with a 19" whip antenna but is provided with a jack suitable for coupling to other antennas.

TERMINAL ADAPTER

The Instrument Division of *Allen B. Du Mont Laboratories, Inc.* has announced the availability of a new terminal adapter which increases the flexibility of connections to cathode-ray oscilloscopes.

The adapter, designated as the Type 2592 terminal adapter, permits the easier use of coaxial cables for carrying signals to the banana-jack type terminals of scopes and other test equipment and also provides correct impedance-matching termination for the coaxial cables.

The new unit may be used with any instrument having banana-jack type terminals spaced on $\frac{3}{4}$ " centers. The input signal to the terminal adapter is fed through a standard coaxial connector which fits *Amphenol* plugs Types 82-1SP, 83-1SPN, 83-776, UG18B/U, UG21B/U, UG94A/U, UG88/U, and UG260/U.

Impedance-matching resistors are



FOR FINEST TV RECEPTION

FOR USE WHEREVER TOUGH WEATHER CONDITIONS PREVAIL
TESTED AND RECOMMENDED FOR FINEST UHF - VHF RECEPTION

GOODLINE SHEATH-LEED—a NEW DON GOOD PRODUCT—is our fine Standard ***GOODLINE AIRLEAD** encased in a tubing of pure polyethylene of finest quality to protect it under all-weather and all-climatic conditions. It is especially recommended for use in coastal areas where salt spray encrusts the regular leadline, in hot humid areas, where much alternate rainfall and strong sunlight prevails and where leadlines are subjected to frost, snow and icy conditions.



Exhaustive tests made after two years have shown that the average flat or round 300 ohm leadline installed within two blocks from the ocean will give but 2 to 4 weeks of satisfactory operation due to salt spray deposits encrusting the leadline. With **GOODLINE SHEATH-LEED** protection, the product gives highly satisfactory service for a year and more.

For finest trouble-free reception—even in areas where more favorable weather Prevails—INSIST UPON HAVING **GOODLINE SHEATH-LEED** INSTALLED FOR YOUR LEADLINE.

NO. 803-GS SHEATH-LEED: STANDARD BROWN **GOODLINE AIRLEAD**. Sheathed in pure Polyethylene Standard Brown **LEED-SHEATH** (another new Dan Good product). For 300 ohm use. 1,000 foot reels—standard length... Shorter lengths available.

NO. 823-GS SHEATH-LEED: Color—Golden-Clear **Goodline Air Lead**. Sheathed in Silver-Gray Pure Polyethylene **LEED-SHEATH** (another new Dan Good Product). **GOLDEN-CLEAR GOODLINE AIRLEAD** is electronic polyethylene in its purest form, and when shielded from ultra-violet light with Silver-Gray **LEED-SHEATH**, the installation will give years of trouble-free service. For 300 ohm use. 1,000 foot reels—standard length... Shorter lengths available.

NO. 733-GA: *GOODLINE AIRLEAD. THE BASIS OF FINEST TV RECEPTION.

FEATURES: 1—Sharp, clean, "snaw-free" pictures—with 80% of loss producing dielectric web removed. 2—Correct impedance for "ghost-free" reception. Nominal 300 ohms. 3—Lower in cost than other leadlines purported to accomplish same results. 4—Correct spacing for minimum radiation loss. Less than 1% of operating wave length. 5—Fully insulated—approved by safety experts. 6—Pure, electronic polyethylene insulation—specially treated by our chemists for extreme weather. 7—Highly efficient conductors: Flexible, stranded—to insure long life. 8—Easily installed with standard insulators. 9—Packaged: 100'—250'—500'—1,000'—2,500'. Colors: Standard Brown, Golden-Clear and Silver-Gray.

IF YOUR JOBBER or TV DEALER CANNOT SUPPLY, WRITE FOR SAMPLES AND NEW LITERATURE

*Patent Pending. *Trade Mark. U.S. and Foreign Patents Pending

EXCLUSIVE LICENSEE AND SOLE MANUFACTURER

Don Good, INC.

1014 FAIR OAKS AVENUE
SOUTH PASADENA, CALIFORNIA

OUTSTANDING GOODLINE PRODUCTS:

DON GOOD, INC. Manufacturers: Sheath-Leed & Leed-Sheath Protection. Goodline Airlead.



Write for illustrated Catalog No. 400

Ungar ELECTRIC TOOLS, INC., Los Angeles 54, Calif.

MERIT

tv full-line*
components give
universal coverage



NEW IMPROVED HVO-7 FOR GREATER COVERAGE
Tapped AFC Winding, Covers Admiral Chassis 21-24 Series.
MWC-1 UNIVERSAL WIOTH COIL
(3-27 MH) A Tapped Secondary For AGC or AFC.



IF-RF COILS
Only complete line of TV replacements.



"COSINE" YOKES
Complete with leads & network.



MATCHED FOR DIRECT DRIVE

MDF-30 HVO-8
A-3080 Vert. Mig.
A-3081 Horiz. Mig.
Autotformer



KIT NO. 1000
MATCHED SET FOR SPEEDY PROFITABLE SERVICE!

MERIT . . . HQ FOR PRACTICAL TV Service Aids

MERIT'S 1952 Catalog No. 5211 with new MERIT IF-RF Coils.

Other MERIT service aids:

TV Repl Guide No. 404, 3500 models & chassis.

Cross Ref Data, IF-RF Coils, Form No. 14.

See your Jobber or write: Merit Coil and Transformer Corp., 4425 Clark Street, Chicago 40.



These three MERIT extras help you:
Exclusive: Tapemarked with specs and hook-up data.
Full technical data packed with every item.
Listed in Howard Sams Photo-facts.



*Merit is meeting the TV improvement, replacement and conversion demand with a line as complete as our advance information warrants!

built into the adapters. Currently available are 52, 75, and 93 ohm terminal adapters for use with u.h.f. and BNC coaxial connectors and 52 and 75 ohm terminal adapters for use with Type N coaxial connectors.

Full details are available from the Instrument Division at 1500 Main Avenue in Clifton, New Jersey.

"CAN SEALER"

Wasserlein Mfg. Co., Inc., of 126 W. Cass Street, Joliet, Illinois has a new "Can Sealer" accessory unit for its "Glo-Melt" soldering equipment which is designed to seal all can-type containers used in the manufacture of relays, condensers, crystals, transformers, etc.

The new sealer is designed to be universally adaptable and completely adjustable. The unit includes a set of eight adjustable carbon tip holders mounted on a plastic base. It may be used for soldering enclosures up to 4" wide and 4" or more in height. The base is bored with a multi-hole pattern for various size and shape housing set-ups. The base is easily drilled for unusual set-ups when necessary.

Companies interested in this new concept of resistance soldering can obtain technical assistance on their particular production problems by sending prints or samples of products directly to the Research Engineering Department of the company.

MICROFILM RESISTOR

Televac Laboratories, Inc., 100 Metropolitan Avenue, Brooklyn 11, New York has developed a small precision resistor for microwave applications which has been designated as the Type R.

The resistor, which is small in size, has a high power rating, and is of specialized construction ideally suited to impedance matching in coaxial lines and wave guides.

The Type R is available in 5 and 10 per-cent tolerances. A bulletin giving complete technical details on these new units is available on request.

EQUALIZER-PREAMP

McIntosh Laboratory, Inc., 322 Water Street, Binghamton, New York has recently added a new equalizer-preamplifier to its line of audio equipment, the Model C-104 and C-104A.

The new unit is similar to the com-

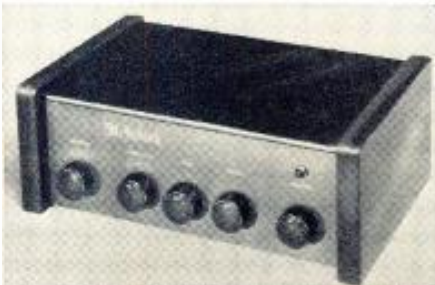

pany's previous model AE-2A but features greater simplicity of control and an additional turnover frequency. Five input channels are provided: TV tuner, FM-AM tuner, low-level micro-



SALE OF BEST SELLERS!!!

BC-625 TRANSMITTER: Part of SCR-522. Freq. range: 100-156 MC. Less tubes. A **\$13.95**
HOT BUY!
BC-624 RECEIVER: Part of SCR-522. Freq. range: 100-156 MC. Less tubes. **\$19.75**
TERRIFIC THE FAIR ONLY \$29.95

HEAVY DUTY JACK-KNIFE SWITCH: \$1.49
20-2 WILLARD 2 V. WET CELL: New, Boxed. 2.95
FLC-FILTER: Brand new. Boxed. This month—**51.50**
Used: 95c
0-25 MILLIAMETER WESTON: 2" rd. **1.95**
0-9 AMP. RF. WESTINGHOUSE METER: 2" rd. **2.99**
New **2.99**

CONDENSERS—COST-CUTTING CLEARANCE! Guaranteed!
2 MFD. 5000 VDC: 2 MFD. 4000 VDC.
New **\$9.95** New **\$7.95**
8 x 8 MFD. 800 VDC: 10 MFD. 600 VDC.
Used **.98** New **2.25**

TUBES
807 \$1.50
829B 9.95
803 3.95
832-A \$9.95
811 2.95

→ SURPRISE PACKAGE! ←
Valued at over \$5.00! With any purchase of \$2.99 or more, you get package for only \$1.50!

ARC-4 VHF TRANSCIVER: For novices. 2-meter. CB or CAP. All tubes. Excellent cond. **\$32.50**
JEFFERSON-TRAVIS 5 W. MARINE RADIO TELE.: 8 1/2" dia. Comp. 100-12 V. input. **\$89.95**
BC-225 PORTABLE 10-METER TRANSCIVER: Freq. range: 28-32 MC. V.F.O. Battery operated, with tubes. Telephone type handset. Less antenna and base. **\$32.50**

THUMBNAIL INFO ON NEW REDUCTIONS!
TRANSMITTER: BC-373; 100 W. Phone or CW. Complete with 24 V. dynamotor, tuning unit, all tubes & plugs. Excel. cond. **\$47.50**
DYNAMOTOR: PE-103. 9 or 12 V. input. 500 V. 160 ma. With filter base and cords. Excel. cond. **24.95**
T-23 VHF ARC-5 TRANSMITTER: 2 meters. novice. CAP. Excel. cond. With ALL tubes **37.50**
MARKER BEACON RECEIVER: BC-1206 CM. New. **9.95**
BC-659 10' METER FM MOBILE TRANSCIVER: Power supply, hand set and antenna. Complete. **55.00**

EXIDE 24 V. AIRCRAFT BATTERY: New. **\$15.95**
BEAT COMMAND EQUIPMENT: Sold as is.
TUBE KIT FOR COMMAND TRANSMITTER: **1.25**
MD-7 PLATE MODULATOR: **6.50**
5-3-7 MC: **7-9.1 MC:** **5.50**
PE-101 DYNAMOTOR: 12 or 24 V. input; 400 ma. 130 ma. output. See AUG. '52 CO. for conversion to 6 VOLTS. Brand New, Boxed **4.95**
MIKES: T-24. New. **4.95**
T-17 Used. Guar. Cond. **4.95**
BC-375 TUNING UNITS: (TU-5 excluded) Used, good cond. **1.95**

ARC-5 OR 274-N TRANSMITTERS
2-1-1 mcs. **5.95**
4 mcs. Used, good cond. **6.95**
4-3-3 mcs. **5.95**
7-9-1 **12.50**

ARC-5 OR 274-N RECEIVERS
19-55 kc. Excel. cond. **\$14.95**
55-1.5 mcs. Used, Excel. cond. **27.50**
1-3 mcs. Brand new **24.50**
3-6 mcs. Less tubes **9.95**
3-6 mcs. With tubes **9.95**
6-9-1 mcs. Brand new **14.95**
6-9-1 mcs. Used **9.95**
RACK FOR DUAL TRANSMITTER (274-N): **3.95**
RACK FOR DUAL TRANSMITTER ARC-5: **3.95**
TRIPLE RECEIVER RACK: **2.95**
BC-442A ANTENNA RELAY: with 50 mmfd. condenser. Excel. cond. **3.95**

AIRCRAFT EQUIPMENT
ARN7 MN-26-C SCR-266 ARR-5
ARR-7 ER-33 Headset VHF ARC-5 MN24C
FL-8 Filter—New and used. Loop (CAA)
APN-9 ARC-5 APR-4 APR-5
APN-13 CRT-1B SCR-522 APR-4 APR-5

WANTED! Every bit of your new and used radio gear. We'll swap for it—or buy it at top price! Write today for clean, quick deal!

All orders F.O.B. Los Angeles. 25% deposit required. All items subject to prior sale.

COLUMBIA ELECTRONIC SALES
522 South San Pedro St. Los Angeles 13, Calif.

MODEL RADIO CONTROL EQUIPMENT BUYS
COMPACT 27MC XMITTER ASSY, complete w/ dual triode easily reworked for CIT. BAND. **\$ 4.95**
PREPAC. GRID CRYSTAL, 27.500 kc./vol. **3.95**
VIBRATOR PACK, 6V in 250V/50ma used cond. **3.95**
CARTER GENMOTOR, same specs as above. **4.95**
COMPACT ELTRON PACK, 6V in 250V/50ma 90V/15 ma. suitable portable equip. 2 1/4 dia. 3 1/4 H 12 oz. **2.95**
HAND DRIVE GENERATOR, set 6.3/3A 315/1.2A **9.95**
W.E. 18B MOBILE 32-40MC RECEIVER, 7 tubes used cond.; bargain \$24.95, less tubes **21.95**
LINK & BOSCH POLICE AUTO RADIO 2-3 MC. 5 tubes w/6V supply, suitable car or boat, used condition going fast at **8.95**
WHP ANTENNA SECTIONS, MS-49 to MS-56 12 1/2 ft. \$1.60; 16 1/2 ft. \$1.95; 24 1/2 ft. **2.95**

POPULAR RELAY BUYS
A.E. TYPE 13 STEPPER RELAY, 25 pos. 3 bank **8.95**
ALLIED B1, 12 & 24 volt, DPDT **7.75**
ALLIED B1, 42 ohm (6V) PNO **.45**
ALLIED DOBDS, 14 ohm (6V) 3PDT/10A **2.35**
CLARE SK5032, 6 volt, DPDT sealed plug-in **3.45**
E. 7000 ohm/6 ma plate type PNO, compact **1.75**
SIGMA 41F, 8000 ohm .04 watt sensit. AC-DC. **2.75**
SIGMA 3H, 2-85 ohm coils. 2-24V. cased. **2.75**
KURMAN BK-35 super sensitive, 10K ohm 1gma **4.95**

600 VOLT D.C. OIL CAPACITORS
2 MFD bathtub. \$0.95 **2 MFD TJ type.** \$1.15
4 MFD TLAD type. 1.10 **4 MFD TJ type.** 1.25
8 MFD TJ type. 1.75 **4 MFD TJ type.** 2.25
10 MFD TJ type. 2.45 **20 MFD TJ type.** 3.95

BATTERIES SUPPLIED—OTHER TYPES STOCK.
BATTERY CHARGER, 6 volt, 2-6 amp. **3.75**
MINIATURE INSTRUMENT SELENIUM RECTIFIER, 110V/15 ma. cased. **.65**
MODULATION TRANSF. ASSY. write input. **1.45**
MOTOR DRIVE TORQUE AMPLIFIER, suitable many types precision actuation service. 1.5 VAC widely advertised at \$24.95. Our price **14.95**
5 AMP KW HOUR METER, 115 VAC. used. **1.95**

IF TRANSFORMER SPECIALS
262 kc. \$0.45; 239 kc. \$0.65; 35 me mtl. **.60**
FREE BONUS 2 LB. WIRE KIT W/\$3.00 ORDER. SAVE C.O.D. FEES. INCL. POSTAGE. EXCEPT REFUNDED.

ELECTRONIC SPECIALTY SUPPLY CO.
56 Lispenard St., NYC 13, N. Y. BRclay 7-2684

phone, high-level magnetic cartridge, and low-level magnetic cartridge. There are separate, continuously variable bass and treble controls providing 20 db bass boost and 20 db bass attenuation, independent of treble control, as well as 15 db of treble boost and 20 db of treble attenuation, independent of bass control.

The Model C-104 is available as a chassis only, measuring 10" x 7½" x 3¾". The Model C-104A comes enclosed in a mahogany case measuring 11" x 7¾" x 4½".

V.T.V.M. KIT

Electronic Instrument Co., Inc. of 84 Withers Street, Brooklyn 11, New York has recently added a new vacuum-tube voltmeter to its line of test equipment, the Model 214.

Available in either kit or factory-wired form, the new instrument in-



corporates a rugged 7½ inch meter movement for faster, easier reading. Fifteen different ranges are covered by the unit including five a.c. and d.c. ranges and five ohms ranges. The decibel scale covers from -20 to +55 db. A double-triode balanced-bridge circuit is employed.

The company will supply full details on request. The ready-wired unit has been designated as the Model 214 while in kit form it is known as the Model 214-K.

SCREWDRIVER ASSORTMENT

J. H. Williams & Co., 400 Vulcan Street, Buffalo 7, New York has added an assortment of eight screwdrivers to its line of tools.

The new drivers are designed for servicing Nos. 2 through 14, ¼, ⅝, and ¾ clutch-head screws. The blades are round, made of selected alloy steel, and are hardened and tempered. They are securely anchored in handles of tough, transparent composition which is an insulator for electricity. Handles are fluted for a sure, comfortable grip.

MINIATURE CONDENSERS

A new series of monolithic-porcelain miniature condensers is now available from *Vitramon, Inc.,* Box 544, Bridgeport 1, Conn.

According to the company, redesign has permitted the inclusion of the full range from .5 to 2000 µfd. in both 250 and 500 volt ratings, in only three body types. The condensers are as small as .24 x .40 x .25 inch.

Silver electrodes are fused into a rock-like mass of porcelain which

MATTISON SILVER ROCKET 630 CHASSIS WITH • TUNEABLE • BUILT-IN BOOSTER FOR BETTER DX RECEPTION

Featuring NEW CASCODE TUNER
made for UHF interchangeable tuning
strips and NEW COSINE YOKE

• Broad band single knob control pre-amplifier built in to eliminate long leads which may cause regeneration and attenuation of signal.

• ONLY THE MATTISON 630 CHASSIS HAS ALL CHANNEL TUNEABLE BUILT-IN BOOSTER THAT INCREASES SIGNAL STRENGTH UP TO 10 TIMES. THE SILVER ROCKET WILL OUTPERFORM ANY CHASSIS MADE—IS PRICED RIGHT TO SELL FAST WITH AN EXTRAORDINARY MARGIN OF PROFIT FOR YOU. WRITE FOR CONFIDENTIAL PRICE SCHEDULE

• Mattison features a complete line of cabinets MADE IN MATTISON'S OWN CABINET FACTORY. 36 breathtaking designs that blend perfectly in any setting, traditional or modern.

Tube Complement:
28 tubes
3 rectifiers
1 CRT

32

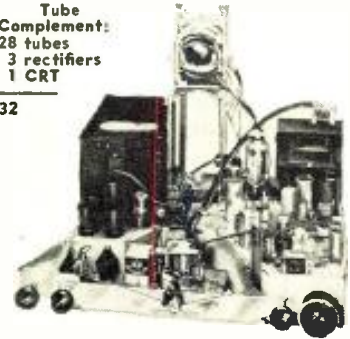

All Channel ↑ Booster

Here are some unsolicited, sincere reactions to the MATTISON TV LINE!

From Ashland, Ohio

"—only one word could describe it—TERRIFIC!"

signed H. E. B.

From Tigard, Oregon

"—Yours is the best picture that I have seen of all custom sets. It brought in a picture from Seattle just like a picture from any local station that I have seen in the east last winter!"

signed G. E. B.

From Throop, Pa.

"—I am in a section where reception is poor, and I am the only one to get the above channels!"

signed J. A. H.

From Peru, Illinois

"—Your Silver Rocket Chassis is one of the finest chassis on the market today!"

signed G. A. B.

From Crossville, Tennessee

"—As for performance, both your chassis were outstanding. Everybody who has watched them concedes that they are the hottest things on the market. In the few days we used it in my home we got almost incredible results. They produce a remarkably good picture."

signed J. M.

DEALERS! SERVICE-DEALERS! Here is YOUR opportunity to become the "important" TV Dealer in your area for THE FINEST CUSTOM-BUILT LINE OF TELEVISION RECEIVERS. FREE!! Write for Mattison's merchandising portfolio explaining "THE MATTISON UNASSEMBLED PLAN" and "THE MATTISON \$1,000,000 FLOOR PLAN." **SALESMEN — AGENTS!** Choice territories available. Become a Factory Sales Representative. Prefer men with experience selling direct to dealers. WRITE TODAY!



Manufactured with integrity

When you buy from Mattison you need only one source of supply! You can buy a Mattison Chassis, a Mattison Cabinet or a complete Mattison TV Set!

Mattison Television & Radio Corporation

893 Broadway, Dept. RN10, New York 3, N. Y.

No Time to Lose... So Lose No Time To

PLACE YOUR WIRE ORDER

N-O-W!



• JSC is currently running 3 and 4 times above normal production with a steadily mounting backlog in 300-Ohm TV Transmission Wire. Lifting of credit controls, new TV channel openings, overwhelming demands from Canadian and South American sources, Presidential contest interests and enlarged scope of video's top-drawer entertainers—these factors point to even greater demand for TV wire. Remember, first come first served for world-famous truly-dependable JSC Wire Products.

See Your Nearest JSC Distributor Who Proudly Displays The Blue & Orange Disc of Quality!

NOW! BECOME EXPERT AT RADIO- TELEVISION IN 4 EASY STEPS!



Complete Self-Training Library in RADIO and TV by Famous Experts — Takes You BY SIMPLE STEPS From Basic Theory to Problems of Repair, Installation, Color TV, etc.

NOW you can do ANY Radio-TV installation, service, or repair job like an expert; operate field-testing equipment; understand problems of TV, FM-AM transmission, etc. Step into a good-paying job—or start your own service business. Train yourself AT HOME . . . IN SPARE TIME . . . with the McGraw-Hill Radio and Television Servicing Library.

2296 Pages—
1611 Illustrations

The men who wrote this complete 4-volume Library are among the outstanding radio and TV instructors in America today. Every detail is clearly explained in over TWO THOUSAND PAGES of step-by-step instruction and over SIXTEEN HUNDRED "how-to-do-it" illustrations, cross-section diagrams, etc. The review questions and answers "nail down" everything you learn. At-a-glance "trouble-shooting" charts show how to diagnose instantly any radio or TV breakdown . . . and how to repair it expertly and quickly.

The Library will pay for itself many times over. It gives all you need to know for FM and TV in the FCC's 1st-class license exam: gives an experienced technician more confidence and skill.

SEND NO MONEY

Mail coupon below to examine complete four-volume Library FREE for 10 days. No obligation. Or you may examine individual books FREE for 10 days by checking the proper boxes in coupon.

FREE 10-DAY TRIAL COUPON

McGraw-Hill Book Co., Inc., Dept. RTN-1D-52
327 West 41st St., New York 18, N. Y.

Send me for 10 day free examination the Radio and TV Servicing Library, 4 Vols. (Regular retail price is \$26.00; Special Course Price only \$21.95 in easy installments.) If not satisfied with Course, I will return it, pay nothing. Otherwise, I'll send \$1.95 plus delivery then and only \$4.00 in monthly installments. If you wish to examine any of these books individually, check below the ones you wish us to send you for 10 Days' FREE EXAMINATION:

- | | |
|--|--|
| <input type="checkbox"/> Essentials of Radio, \$6.75 | <input type="checkbox"/> Elements of Radio Servicing, \$5.25 |
| <input type="checkbox"/> Basic Television, \$7.50 | <input type="checkbox"/> Television Servicing, \$6.50 |

For any book I keep, I'll send \$2.00 plus delivery in 10 days, balance in easy monthly installments.

Name
Address
City Zone State
Position RTN-10-52
Company

WE PAY FOR DELIVERY if you send first payment of \$1.95 when ordering Library or full price when ordering individual books (prices above). Same return privilege.

forms both the dielectric and the encasing insulation. Because of this, the new units are virtually immune to the effects of humidity and temperature. Their stability is indicated by their absolute retrace over a range greater than -50 to +200 degrees C.

Literature on these new miniatures is available from the company on request.

CROSSHATCH GENERATOR

Simpson Electric Co., 5200 W. Kinzie Street, Chicago 44, Illinois has announced the availability of a cross-hatch pattern generator which provides a synchronized signal, modulated



on the carrier frequencies of Channels 2 through 6, which can be tuned and sent through the receiver under test.

When the receiver has been properly adjusted, the signal shows equally spaced lines in vertical, horizontal, or crosshatch patterns on the picture tube.

The Model 485 has an output cable which includes a variable termination network adaptable to provide 75 or 300-ohm terminations.

FUSE POSTS

Littelfuse, Inc., 1865 Miner Street, Des Plaines, Illinois has introduced a line of mold-sealed, watertight fuse extractor posts to be used with its three principal lines of fuses for radio and television receivers and transmitters, and for aircraft use.

Molded of black bakelite, leakage is prevented because top and bottom body contacts are actual inserts at the time of molding. Rubber "Q" rings seal the front panel and the knob seats squarely in the molded-in shell. Side connection will not break the seal.

The posts are designed for the company's 3AG, 4AG, and 5AG series of fuses.

ALL-PURPOSE CEMENT

Singer Home Products, 121-03 Sutphin Blvd., Jamaica 4, New York is distributing a new all-purpose cement which has been tradenamed "Weldit."

The new product, which the manufacturer claims is completely unaffected by water, alcohol, naphtha, oil, gas, etc., can be used indoors or out. It can be used to insulate and waterproof electrical connections. Although it seals and bonds permanently, it

FLASH! Tube Prices SMASHED!

All tubes listed below carry 6-month guarantee—excepting only burnouts and breakages. At these sensationally low prices, these tubes must be ordered in quantities of AT LEAST 10 ASSORTED TYPES. (Add 10% for orders under 10 tubes.) All individuals boxed in attractive GREEN and BLACK cartons.

SPECIAL OFFER: Additional 5% discount on all shipments of 100 tubes or more—assorted!

024M	\$.59	6J6	\$.79	7W7	\$.79
1A7GT	\$.79	6BK7	\$.89	7X7	\$.79
1B3GT	\$.99	6BL7GT	1.09	807	1.79
1H5GT	\$.69	6BN6	1.09	12A8GT	..
1L4	\$.49	6DQGT	..	12AL5	..
1LA4	\$.89	6BQ7	1.49	12AT6	..
1X2	\$.79	6C4	..	12AT7	..
1LD5	\$.99	6CSGT	..	12AUG	..
1LN5	\$.89	6C6	..	12AU7	..
1N5GT	\$.59	6CB6	..	12AV6	..
1R5	\$.49	6CD6G	1.49
1S5	\$.49	6E5	..	12AX4GT	..
1U4	\$.49	6F6GT	..	12X7	1.59
1U5	\$.49	6H6	..	12AZ7	..
1X2	\$.49	6J5	..	12BA6	..
3A4	\$.59	6J7	..	12BE6	..
3AS	..	6K6GT	..	12BD6	..
3A5	..	6L6GA	1.19	12BE6	..
3A4	1.09	6L6GT	..	12C7	..
3Q4	..	6S4	..	12F5GT	..
354	..	6S4	..	12Q7GT	..
3V4	..	6S6GT	..	12R7GT	..
5U4G	..	6S7GT	..	12SK7GT	..
5V4G	..	6SC7	..	12SN7GT	..
5X4	..	6SC7GT	..	12TQGT	..
5Y3GT	..	6SG7	..	12S8GT	..
5Y4G	..	6SH7	..	14A7	..
6A84	..	6S17GT	..	14B6	..
6AC7M	1.09	6SK7GT	..	14C7	..
6AG5	..	6SL7GT	..	18B6G	1.29
6AG7M	1.19	6SN7GT	..	18T8	..
6AH6	..	6SQ7GT	..	25BQ6GT	..
6AK5	..	6SR7	..	25L6GT	..
6AQ5	..	6U4GT	..	25Z5	..
6AQ6	..	6U5	..	25Z6GT	..
6AR5	..	6U8	..	3B5	..
6AR6	2.49	6V3	1.59	3C3	..
6AS5	..	6V6GT	..	35L6GT	..
6AT6	..	6W4GT	..	35Q7GT	..
6AU6	..	6W6GT	..	35Y4	..
6AV6	..	6X4	..	35Z5GT	..
6AX4GT	..	6X6GT	..	4C7	..
6AX5GT	..	6Y6	..	7A5	..
6BA8	..	7A4	..	5B5	..
6BC5	..	7A5	..	50C5	..
6BG5GT	1.09	7B6	..	50L6GT	..
6BD6	..	7C6	..	80	..
6BE6	..	7C7	..	89	..
6BF5	..	7L7	..	FM-1000	..
6BG6	1.29	7JP4	16.50
6BH6

Write TODAY for our Bargain Supplement N100-4, and get your name in line to receive our GREAT NEW COMPLETE 1953 CATALOG, now in preparation!

All Prices F.O.B. N.Y.C. Please include postage and insurance with your remittance. 25% deposit required on C.O.D. orders. 50¢ handling charge on orders under \$5.

GREYLOCK ELECTRONICS Dept. N-10
SUPPLY CO. 115 Liberty Street New York 6, N. Y.

WALDOM SUPERIOR COMPONENTS

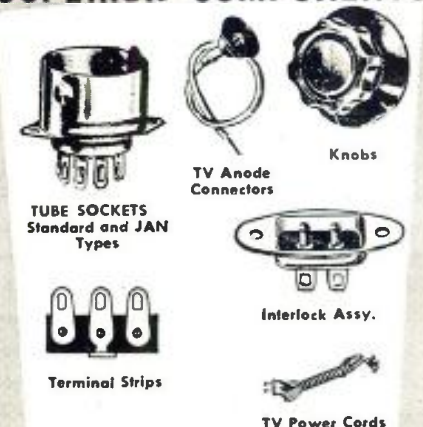

WALDOM also supplies quality CRO-NAME parts

- TV Mask, Glass and Escutcheon Kits.
- Croflex Tuners
- Escutcheons
- Title Plates
- Dial Plates
- Switch Plates
- Radio Knobs
- Instrument Drives
- Instrument Dials

FREE
SEND FOR 1952
WALDOM
CATALOGS

SC1—WALDOM Superior Electronic Components and CRONAME Products.

52—WALDOM Replacement Speaker Cone Manual.

WALDOM ELECTRONICS, INC.
911 N. Larrabee St., Chicago 10, Ill.

never gets hard or brittle but remains pliable to allow for natural expansion or contraction of sealed or cemented materials due to weather conditions.

"PIN-POINT" IRON

Hexacon Electric Company, 119 W. Clay Avenue, Roselle Park, New Jersey is now marketing a new soldering iron that has been designed for pin-point accuracy in precision soldering applications.

Weighing only 3 ounces (less cord), the iron has a $\frac{1}{8}$ " diameter tip and is rated at 25 watts. This design is suitable for soldering instruments, small electronic devices, and wherever fine soldering is required.

No transformer or other cumbersome equipment is needed to operate this unit. The elements, tips, and other parts may be easily replaced by the user. Designated as Catalogue No. P-25, the iron can be furnished for either 110 or 220 volts, d.c. or any-cycle a.c.

JENSEN CONTEST

JENSEN Industries, Inc., 336 S. Wood St., Chicago 12, Illinois is sponsoring a \$5000 cash-prize contest for technicians in which the top man among the 187 winners will receive \$1000.

The total number of Jensen needle packages used in sales and the completed official entry blank will be used to determine the winner. The contest closes at midnight, December 31, 1952.

CIRCUIT CHANGES

By DAVID ZAAVER, PAON

WITH the opening of the 21 mc. amateur band, there are a few changes which should be made in the circuit described by this author in the July 1952 issue of RADIO & TELEVISION NEWS (A Novel Multi-Band Tuning Circuit).

In the circuit, as described, V_1 displays some tendency toward instability. The required changes are shown in the circuit diagram below.

Specifications for winding coils L_7 and L_{17} to cover the 21 mc. band are as follows: L_7 should be 6 turns, #20 en., closewound on $\frac{3}{4}$ " dia. form. L_{17} should be 14 turns, #14 en., $1\frac{3}{4}$ " long. R_8 should be changed from a 20,000 ohm, 2 w. resistor to a 19,000 ohm, 2 w. unit.

With the changes suggested above, hams operating in the 21 mc. band should experience no difficulty with this transmitter.

Circuit changes for "A Novel Multi-Band Tuning Circuit" to eliminate instability of V_1 when operating on the 21 mc. band.

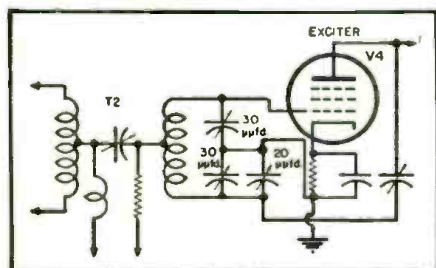

October, 1952

"CONICAL-V-BEAMS"

REGISTERED TRADE MARK

3 BIG REASONS WHY Telrex is your logical ANTENNA CHOICE!



TELREX "FISHBONE" WITH TEN WORKING ELEMENTS GUARANTEED TO OUTPERFORM ANY YAGI ANTENNA! Recommended for superior reception in suburban and outlying areas, the "Fishbone" is constructed for lasting, trouble-free installations.



"BAT WING" the finest top-of-set antenna made REQUIRES NO TUNING, PRUNING OR ADJUSTMENTS! Outperforms any other indoor type and features modern, rich styling to harmonize with finest furnishings.

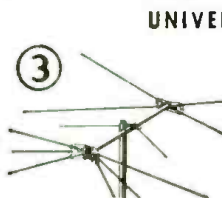

UNIVERSAL SERIES "CONICAL-V-BEAMS"

WITH HI-V-REFLECTOR AVAILABLE NOW CUSTOMIZED FOR YOUR OWN RECEPTION AREA! These famous-for-superior-performance antennas are supplied to your distributor custom-cut for best reception in your particular location.

NOW! THE DUAL-DRIVEN FISHBONE JR.

FOR ALL VHF CHANNELS—New six element TV series. Extremely high forward gain and front to back ratio exceeds most 8 element beams—compares favorably with many 10 element antennas. Supplied to distributors custom cut.

"CONICAL-V-BEAMS" are covered by Patent No. 23,346
CANADIAN and FOREIGN PATENTS PENDING

Telrex INC.
CONICAL-V-BEAMS

AMERICA'S
OUTSTANDING
TELEVISION
BEAM

Originators and
Manufacturers of
"CONICAL-V-BEAMS"
—INSIST on
the original!

ASBURY PARK 7, N. J.

MAKE THIS YOUR HOME FOR IMPORTANT! WORK UNDER IDEAL CONDITIONS!

- TEST & INSPECTION ENGINEERS • FIELD ENGINEERS
- ELECTRONIC ENGINEERS • LAB. TECHNICIANS
- TV RECEIVER DESIGN ENGINEERS

NEEDED TO WORK ON: YOU BENEFIT FROM high wages, a Radar, G. C. A., Mobile modern, air-conditioned plant, paid Radio, Auto Radio, Airborne vacations and holidays, group insurance Communication & Navigation and a good chance for advancement. Antennas, Microwave Housing immediately available in the Equipment, Servo Mechan beautiful suburban and country areas isms and Guided Missiles. that surround the Bendix Radio plant.

Write, Phone or Wire Mr. E. O. COLE, Dept. O

Bendix Radio

DIVISION OF BENDIX AVIATION CORPORATION
BALTIMORE 4, MARYLAND





630 STANDARD TV KIT

For 12 1/4" tube. With the new Cascade Tuner. Complete set of finest selected parts for the well-known and original RCA 630. Comes complete with all tubes, hardware and step-by-step instruction manual. **\$99.99**
Less CRT & wire

630 SUPER DELUXE 31-TUBE TV KIT
Same as above including voltage doubler & AGC. For all tubes 16" to 21" **\$119.44**

BUILD YOUR OWN 630!
New Life-Size Set of Instructions
Everything at a Glance on
4 GIANT 25" x 38" CHARTS
Each step broken down, indispensable for building, converting, modernizing or even troubleshooting any 630 TV receiver **\$2.49**

SIGNAL TRACER KIT

Complete with probe, tubes, 4" speaker. Battery operated. Make servicing a pleasure with a signal tracer. Can trace a signal from antenna to voice coil. Locate those devilish intermittents with ease. Will pay for itself the first week. Comes in beautiful gray metal cabinet. **\$10.95**



Less batteries
Kit of Eveready 467 & 2 flashlight cells **\$1.99**

FILAMENT TRANSFORMERS ALL PRIMARIES 115 VOLTS

6.3v c.t. @ 1.2 amps. Channel mt. . .	\$1.24
6.3v c.t. @ 3 amps. Cased . . .	1.95
6.3v c.t. @ 5 amps. Cased . . .	2.95
2.5v c.t. @ 3 amps. Channel mt. . .	.98
2.5v c.t. @ 10 amps. Channel mt. . .	1.98
6.3v a 6 amps. OR 12.6v @ 3 amps. . .	2.69

POWER TRANSFORMERS

STANCOR: Pri. 110v. 125v. 50-60 cy. Sec. 900v c.t. @ 325 mls. 6.3v @ 3.5 amps; 6.3v @ 4.5 amps; 5v @ 6 amps. upright mt. Ship. Wt. 21 lbs. Reduced to **\$8.95**

RCA: Pri. 115v. 50-60 cy. Sec. 750v c.t. @ 225 mls; 6.3v @ 8 amps; 6.3v @ 1.2 amps; 5v @ 3 amps. Half-shell mtg. Ship. Wt. 13 lbs. Reduced to **\$8.99**

PHILCO: Pri. 115v. 50-60 cy. Sec. 650v c.t. @ 150 mls; 6.3v @ 4.5 amps; 6.3v @ .3 amp; 5v @ 3 amps. Half-shell mtg. Ship. Wt. **\$3.69** Reduced to

10 MFD-600V OIL CONDENSERS

Rated at 220v AC, these Sprague and C.D. condensers will operate safely at voltages up to 1000 volts. (Write for Quantity Prices). Ea. **99c**
Mounting Brackets Each **15c**

SPECIAL! CASCADE TV TUNER

Type 2223—Has four times the sensitivity of ANY previous tuner. Less snow—less noise—more brilliant picture on all channels. Uses new GBC7—For use with any 630 or similar type set. **\$19.95**
21.25 MC sound IF—25.75 MC pix IF
STANDARD TV 201 TUNER. Over 3 million in use. SPECIAL **\$18.95**

WILLIAMSON TYPE HIGH FIDELITY OUTPUT TRANSFORMER

Pri-0000 ohms, Sec-8 ohms. Freq. range 30 cy. to 20 KC ± 12 db. Used for PP 8075-KT668. Made by Chicago Transformer Co. Selling at a fraction of its original cost. **\$4.89**

NEWEST 630 TV CHASSIS

With the amazing Cascade Tuner. 4 Micro-volt sensitivity. Takes all size picture tubes to 21". Unsurpassed for fringe area reception. This Chassis succeeds in providing clear pictures where others fail. New AGC; 15 KV output. Three stage sync separator and clipper. Armstrong FM sound, complete with RCA concert 12" speaker, factory aligned, ready to play, less CR tube. Why Pay More!! Fed. Tax Incl. **\$149.95**
Tube mounting brackets, as shown **\$6.50**

SLEEPER SPECIALS!!

2 1/2" Simpson RF 0-8 ammeter. **\$2.69**
Built-in thermocouple . . . ea. **35c**
GE 2 meg. volume control . . . 3 for **\$1.00**

Complete catalogue of test equipment, including kits, available upon request. When you deal with Acorn you save. Write for Quantity Prices.

TERMS: 20% cash with order, balance C.O.D. unless rated. Prices F.O.B. our warehouse in N. Y. C. Minimum order \$10. NOTE: Due to conditions beyond our control, prices are subject to change.

Phone WOth 4-3270

ACORN ELECTRONICS CORP.
76 Vesey St., Dept. N-10, New York 7, N. Y.



WE'VE heard some interesting news about magnetic tape music. The information comes from quite reliable sources but we regret that we have been asked to withhold names for a while. A large steamship line is installing long-time tape players and is acquiring a library of music for passenger entertainment at sea. Also, several airlines are field-testing similar apparatus for airborne entertainment. (We wonder how much audio power is needed to overcome propeller engine roars!) In addition, a wired music service is now quietly field-testing tape music systems, without wires!

Further news, a major magnetic tape recorder manufacturer is tying in with pre-recorded tape reels in a big push to get over the sales doldrums. We think he can make it.

Tapes of the Month

All of the tapes reviewed this month were reproduced on the following equipment: a *Concertone* "Network Recorder," a *McIntosh* 50W-2 amplifier, *Altec-Lansing* 604B speaker system, with *Jensen* RP302 tweeter and A402 network mounted in a bass reflex enclosure.

A-V #302 (MOMENTS IN MUSIC)

How Can I Ever Be Alone—Naughty Waltz—Wizard of Oz—Star Dust—Cynthia's In Love—Swan Lake (Tchaikowsky)—Excerpts—Dance of the Swans Valse No. 2, Act 3—Roses from the South—Allegretto (Mozart). (Available in 7.5" single-track; 7.5" double-track; or 3.75" double- or single-track)

This is one of the original reels offered by A-V in its initial catalogue. We have reviewed other A-V program reels in the "Moments in Music" category and stated then that the selections contained therein were among our favorites. It is known as "cocktail music" only because the wired-music services have been "piping" it into cocktail lounges for years.

A glance at the titles reveals that all of them are long-time standards. However, we will review the release from the standpoint of technical quality and play no music favorites. This particular reel displayed several technical faults. There is a distinct "print through" which is actually so low in level that it does not create any echo effect. However, it is audible during silent leaders between selections. It doesn't seem to be due to excessive levels (there is no distortion due to tape saturation) but could have been caused by a long storage period on the shelf. Whereas a disc will warp, curl, or become noisy when shelf-stored and exposed to changes in temperatures and humidities, magnetic tape develops "print through" (most noticeable among several other effects). The tape otherwise has just adequate fidelity.

LEARN CODE THEORY

AND AS LOW AS \$6.95

ECONOMICAL HOME STUDY COURSES PREPARE YOU TO PASS AMATEUR AND COMMERCIAL CODE EXAMS, AND AMATEUR THEORY EXAMS THE EASY, FAST WAY. BEAT THE ADVANCED CLASS DEADLINE (closes RPM Dec. 31).

3 "AMECO" COURSES AVAILABLE:
#1—NOVICE CODE COURSE. You get and keep 10 recordings (alphabet through S W.P.M.). Includes typical F.C.C. type code exams. Free instruction book on learning how to send and receive code the simplest, fastest way; plus charts to check your receiving accuracy all for the low price of only **\$7.95**
#2—SENIOR CODE COURSE. You get and keep everything given the Novice Course except that you get 22 recordings (alphabet through 18 W.P.M.) plus an album, plus typical F.C.C. type code exams for General class and 2nd class commercial telegraph licenses. All this for **\$12.95** only
#3—COMPLETE RADIO THEORY COURSE. A complete, simplified home study theory course in radio, covering the Novice Technician, conditional, general, and advanced classes—all under one cover—with hundreds of typical F.C.C. type questions to prepare you for license exams. No technical background required. You also get, FREE, one year of consultation and a guide to setting up your ham station. All for the amazingly low **\$6.95** low price of

All Courses Have Money-Back Guarantee
See Them at Your Dealer or Write for Free Information
AMERICAN Electronics Co., Dept. RN-10
1451 Wilkins Ave., N.Y. 59, N.Y.
Tel. No. DAYTON 9-4815

Read
RADIO & TELEVISION NEWS
Every Month

NEW RAPID TROUBLE SHOOTING & ALIGNMENT TV CONSULTANT

THIS AMAZING NEW TV BOOK YOURS TO TRY 5 DAYS FREE!

WITHOUT EXPERIENCE or knowledge, this fast, easy, new method of TV servicing enables the novice to diagnose TV troubles as rapidly as an expert.

NO THEORY—NO MATH—copyrighted method locates all faults in record-breaking time, regardless of make or model. Shows simple, quick step-by-step **ALIGNMENT** methods and explains by pictures, diagrams and in easily understood language **HOW, WHEN and WHERE** to use **TV TEST INSTRUMENTS**.

Most complete and practical book on **TV TROUBLE SHOOTING and ALIGNMENT** ever written! Contains over 300 picture, raster and sound troubles and more than 135 **RAPID CHECKS**, many requiring no instruments. Instead using picture tube as guide.

This book has a complete section on installation and servicing of UHF units; addition of **UHF CONVERTERS** to VHF sets; servicing **UHF**; tracing faults in **UHF** sets and converters; test instruments for **UHF** servicing. Also contains over 125 illustrations including TV picture faults, station patterns, scope waveforms, diagrams—everything needed to take the mystery out of TV servicing.

TV CONSULTANT is the ideal reference book for the TV expert, the service bench, the TV tool kit and for schools.

GUARANTEED, MONEY BACK IN 5 DAYS IF NOT SATISFIED

Mail this coupon with **ONLY \$2**—send name and address today! We ship postpaid.

RUSH COUPON NOW!

H. G. CISEN, Consulting Engineer, Dept. N-7
200 Clinton Street, Brooklyn 2, N. Y.
Please RUSH postpaid, your new book on TV Trouble Shooting and Alignment—"TV CONSULTANT." Enclosed find \$2.

Name.....
Address.....
City.....Zone.....State.....

RADIO & TELEVISION NEWS

The gamut of music from the light pops beginning to the ballet music ending is peculiar. Fortunately, A-V has learned a great deal since those early days and has made improvements.

A-V #601 (ORGAN REVERIES)

The Touch of Your Hand—Bill—All the Things You Are—They Didn't Believe Me—My Blue Heaven—Peggy O'Neill—My Heart Stood Still—Blue Room—Love—Suppose I Had Never Met You—Smoke Gets in Your Eyes—Why Do I Love You?
(Available in 7.5" single-track; 7.5" double-track; 3.75" single- or double-track)

This reel is chock full of some of our favorite old-time tunes that will make you hum, whistle, or sing along—very good programming. Technically there are defects—wow, flutter, distortion, noise, severe level changes from selection to selection, no bass, and shrill treble. But, we loved the music.

A-V #603 (ORGAN REVERIES)

The Rosary—Oh Promise Me—I Love You Truly—Because—Ave Maria—The Bells of St. Mary's—Thine Alone—Smilin' Through—To a Wild Rose—Girl of My Dreams.
(Available in 7.5" single-track; 7.5" double-track; or 3.75" single- or double-track)

The label on the box gives the order of music to be heard as listed above. However, on playing the reel we were astonished to hear "Ave Maria" as the first selection. From then on disorder reigns supreme.

The reel is made with the same organ and apparently the same artist as heard on Reel #601. His name is not revealed. Higher noise and fringe distortion on this one, but, rounder sound and fuller bottom, too.

A-V #605 (CAROLS FOR CHRISTMAS)

Joy to the World—What Child Is This—From Heaven on High—Silent Night—Good Christian Men Rejoice—O Little Town of Bethlehem—All My Heart This Night Rejoices—Good King Wencelas—Lo How a Rose E'er Blooming—Deck the Halls—God Rest Ye Merry Gentlemen—Noel Nouvelet—O Holy Night—Angels We Have Heard on High.
(Available in 7.5" single-track; 7.5" double-track; or 3.75" single- or double-track)

The organist is Robert Owen, a man we've met in earlier Reel Reviews. Reels #605 and #606 are "Carols for Christmas" and make us realize that the Christmas season is only weeks away.

We've commented favorably regarding the fine reel of Easter music which Mr. Owen performed—and perhaps Easter is Robert Owen's forte. Certainly after hearing some of the discords on this reel, Christmas is not his best effort.

A-V #606 (CAROLS FOR CHRISTMAS)

Adeste Fidelis—It Came Upon the Midnight Clear—The First Noel—Mary and Joseph—Puer Es Nobis—We Three Kings of Orient Are—Angels from the Realms of Glory—Noel—Away in a Manger—Gevaert 13th Century Carol—From Heaven on High—Venite Adoremus—Break Forth Most Beautiful Heavenly Light—Hark! The Herald Angels Sing.
(Available in 7.5" single-track; 7.5" double-track; or 3.75" single- or double-track)

Robert Owen was apparently suffering from the same off-day he dis-

ORDER BY MAIL FROM WHOLESALE RADIO

Low Prices • Complete Stocks • Fast Shipments

Get Snyder's Amazing New ALL DIRECTIONAL TV AERIAL

Same Clear Pix As Motor Rotating Aerial Systems Costing Triple This Price

FOR FRINGE AREA Only \$1895

COMPLETE with three 3 1/2 ft. masts 75 ft. 3 conductor cable. Beam selector sw., guy rings and mtg base.

Electronically beams in complete 360° rotation to give clear picture on all channels. You choose direction with Directronic selector switch mounted on or near TV set. Complete double-stacked arrays with 18 hi-tensile double-alloy aluminum elements.

Model AX-599 same as above less three 3 1/2 ft. mast sections, guy ring and mounting base. \$16.95

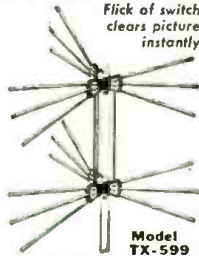

Flick of switch clears picture instantly

Model TX-599

Reg. \$4.95 CONICAL ARRAY

For TV-FM band. Use with any lead-in 72 to 300 ohms. Hi-tensile 3/8" aluminum alloy elements. Mast clamp for poles up to 1 1/4" d. inc. Buy at this low price before aluminum price rise. Order Snyder XA-44.



Special Price \$3.95 lots of 6 \$2.95 ea.

YAGI TV ARRAYS

For Fringe & Ultra Fringe



Highly directional and closely tuned to each channel. Cuts interference and noise to a minimum. Five elements: one folded dipole, three directors and one reflector. Individual array for each channel desired.

\$7.95 \$4.95

TIE RODS for stacking 2 Yagi Arrays Specify Hi or Lo band. \$85c

Address Orders to Dept. RN-10

Price Slashing Closeout SKY CHIEF TV BOOSTER

Made by one of America's most famous electronic houses. Takes 300 ohm twin lead or 75 ohm coaxial. Two 6J6's and set. rect. One tuning control. UL app. Reg. \$40 List

\$16.95



"PRECISE" RF-AF-TV MARKER GENERATOR KIT

Fundamental thru 110 mc. 330 mc on Harmonics. Audio: 20-20,000 cycles. Cathode follower output; variable per cent modulation. Stepping attenuator. External modulation. Speech amplifier, crystal marker.

With pre-assembled RF head. 630 KA... \$38.95 Model 630 K Kit \$33.95

Finest Hobby of All! AMATEUR RADIO It's Easy to Begin With This 25 Watt NOVICE TRANSMITTER & POWER SUPPLY KIT \$29.40

A Real Value For The Beginner! 25 watts power input. 2 band operation. Oscillates freely with any type crystal. Works with simple single wire antenna. No meters required for tuning and loading. Complete with tubes, standard key and foolproof pictorial wiring diagrams. 3.7 mc to 3.75 mc and 26.96 mc to 27.23 mc. Order Philmore model NT-200. • Easy to assemble • Easy to operate • Complete, less crystals.



TV ANTENNA ACCESSORIES

- STEEL EXTENSION POLES. Weather treated. 10 ft. long, 1 1/2" d. Straight ends..... \$1.95 5 ft. long, 1 1/2" d. Crimped ends..... 1.19
- CHIMNEY MOUNT BRACKETS. CM-100 Complete with strap. Pr..... 1.59
- HEAVY DUTY MAST BRACKETS WB-2. Adj. to 18" from wall..... 3.75
- ANTENNA SWIVEL BASE. Aluminum. File 3/2" O.D. mast section..... .39
- GUY WIRE. 50 Foot..... .39 24 interconnected 50 ft. reels. 1200 ft..... 6.00
- 300 OHM TWIN LEAD. Per ft. 2 1/2c; 100 ft. \$1.95; 1000 ft..... 25.00
- DOUBLE POLE DOUBLE THROW KNIFE SWITCH. Res Lightning Arrestor. Model LA-3. Standard or open 300 ohm line. UL approved..... .59
- ANTENNA WALL MOUNTS. PAM-1 for poles 1"-1 1/2" d. 8" from mast to wall..... 1.15 PAM-4 for poles 1"-1 1/2" d. Up to 12 1/2" from wall..... 1.89 PAM-6 for poles 3/4"-1 1/2" d. Adj. 1"-10" from wall..... 3.45

Write for Free FYI Bulletin

WHOLESALE RADIO PARTS CO., Inc.

311 W. BALTIMORE ST., BALTIMORE 1, MD.

NEW! MOSLEY WALL-THRU



Cat. No. 625 List Price \$1.95
Cat. No. 625-PK Wall Thru, complete with MOSLEY Universal TV Lead-In Socket and Plug. List Price \$3.00

- For TV, FM and Amateur Transmission Line
- Fits Any Wall Up to 13" Thick!
- Completely Weather-Proof!
- For Standard Flat 300 Ohm Line or RG-59/U Co-ax Cable!
- MOSLEY Lead-In Socket Can Be Mounted Direct to Inside Plate!
- Precision Molded Polystyrene End Plates!
- Easily, Quickly Installed!

MOSLEY ELECTRONICS

2125 Lackland Road Overland, Missouri

Laboratory Test Leads

Pencil Type Test Leads

Phono Needle Test Leads

Slim Handle Test Leads

Unbreakable Test Leads

Slim-Line Test Leads

insuline

... world's largest producer of TEST LEADS and PROBES

Multiple Probe

• INSULINE has been the leading maker of test leads and probes (standard and special types) for 32 years. Over 2000 items . . . including tools, hardware, components, metal goods, antennas, accessories . . . for every electronic requirement. INSULINE jacks, plugs and connectors are used by practically every major manufacturer as standard equipment.

PLUGS

CONNECTORS

JACKS

Write Dept. RN-10 for latest catalog illustrating and describing complete line.



insuline

CORPORATION OF AMERICA
INSULINE BUILDING • 36-02 35th Ave. • Long Island City, N. Y.

West Coast Branch and Warehouse:
1335 South Flower Street, Los Angeles, Calif.
Exclusive Canadian Sales Agents:
CANADIAN MARCONI COMPANY, Toronto

PLASTIK-707

THE NEW *Spray-On* INSULATION AND PROTECTIVE COATING FOR TELEVISION • RADIO ELECTRONICS

A CRYSTAL CLEAR - WATER WHITE ACRYLIC RESIN

ONE COAT LASTS indefinitely DRIES IN 10 minutes

There are hundreds of uses **HERE ARE A FEW:**

- ★ On T.V. antennas and lead-in connections; masts, guy-wires, turntables to prevent weathering and corrosion.
- ★ On high voltage components of T.V. receivers; terminals, rectifier parts, coils, condensers to reduce corona losses.
- ★ On all T.V., radio and electronic metalware to preserve original brightness. Keeps equipment looking brand new!
- ★ On all household, industrial and marine metalware subject to tarnish and rust. No more polishing!
- ★ On canoes, boats, model aircraft as an improved form of "dope."
- ★ On packing labels, papers, documents, maps to moistureproof and keep clean.

Possesses high dielectric strength and resistivity. Is unusually inert to attack by acids, alkalis, alcohol, sun, hot water, chemical fumes and salt spray.

TRY A 12 OZ. CAN TODAY ON OUR MONEY-BACK GUARANTEE

At your local distributor. Write us for FOLDER #34

UNITED TECHNICAL LABORATORIES
Engineers • MORRISTOWN N. J. • Manufacturer

50% More for Your Money!

with "SILENCER"
... the amazing new Volume Control and Contact Restorer!

3 OZ. (NOT 2 OZ.)
for \$1.00
(dropper included)

- One drop of "Silencer" instantly eliminates all noise indefinitely.
- Cleans, restores volume controls, band switches, push button assemblies, tuners, etc.
- Far superior to temporary carbon tetrachloride.
- Not an oil that changes capacities and gums controls.
- Tested, approved and used extensively by thousands of servicemen.



FREE See your jobber for FREE Sample of "Silencer" . . . or write factory direct for sample.

ORDER FROM YOUR JOBBER TODAY!
Dept. RN-10-52

ILLINOIS RESEARCH LABORATORIES
Suite 900, 22 West Madison St., Chicago 2, Ill.
Financial 6-0456

played on Reel #605. In all fairness, it must be noted that "carols" without "caroling" are likely to lack something rather important.

On the technical side, both reels #605 and #606 are not recommended for audio checks. The bass is apparently overboosted to the point of unnatural sound. The result, over-all distortion and high fatigue factors on the full range system unless the treble is attenuated at least 12 db at 10 kc. with cut-off starting at about 5 kc.

-30-

Mobile Radio

(Continued from page 45)

be noted.* This information may be obtained from topographic or aeronautical maps or from a surveyor. For mobile station applications, item #17 may be marked "not applicable" except for checking of the appropriate box at the top line.

At item #18, if the applicant does not know of the existence of commercial or government receiving station antenna systems within three miles of the proposed location of the transmitter, the answer may be "not known." Item #19 requires a simple "yes or no" and if "yes," item #20 must be completed. If "no," item #20 may be marked "not applicable."

If the over-all antenna height is to exceed 170 feet above ground level form 401-A must be filled in and submitted with the application in quadruplicate. However, if the antenna height exceeds 170 feet above ground level with the antenna mounted on an existing man-made structure and the over-all height of the man-made structure is not increased by more than 20 feet because of the antenna, it is not necessary to file form 401-A.

In the vicinity of airports and landing areas where the antenna height does not exceed 20 feet above the ground or where the mounting of the antenna on an existing man-made structure or natural formation does not increase its over-all height by 20 feet, form 401-A is not required. However, form 401-A is required where the over-all height of the antenna system exceeds one foot above the airport elevation for each 200 feet or fraction thereof from the nearest boundary of such landing area except as noted previously.

Information for completing form 401-A may be obtained from aeronautical charts and by personal observation. Such a map, called a Sectional Aeronautical Chart, may be purchased for your specific locality from the U. S. Coast and Geodetic Survey, Washington 25, D. C. In addition, an Instrument Approach Chart, available from the same agency, should be consulted when the proposed station is within 10 miles of an airport.

* "The World Almanac" lists the latitude and longitude of most of the cities and towns in the United States.

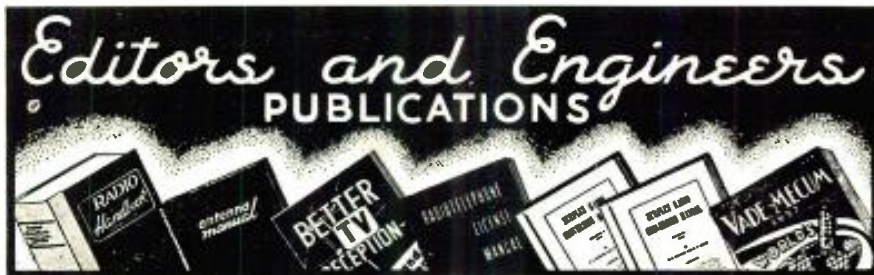

GET THE MOST FOR YOUR MONEY!

THIRTEENTH EDITION RADIO HANDBOOK

A ONE-VOLUME LIBRARY. Practical, how-to-build and how-to-do-it. Extensive simplified theory. Reference data. Profusely illustrated and fully indexed. 734 pages at less than a cent a page.

TWENTY-EIGHT BIG CHAPTERS include: Introduction, D.C. Circuits, Vacuum Tube Principles, V. T. Amplifiers, Radio Receiver Fundamentals, Generation of Radio-Frequency Energy, Amplitude Modulation, FM and Single-Sideband Transmission, Transmitter Design, Keying and Control, Transmitter Adjustment and Loading, Radiation, Propagation and Transmission Lines, Antennas and Antenna Matching, High-Frequency Directive Antenna Arrays, V-H-F and U-H-F Antennas, Rotatable Antenna Arrays, TV and Broadcast Interference, Workshop Practice, Mobile Equipment and Installation.

HOW-TO-BUILD-IT CHAPTERS on: Receiving Equipment (8 items), Exciters and Low-Power Transmitters (7 items), High-Frequency Power Amplifiers (5 items), Speech and Amplitude Modulation Equipment (11 items), Transmitter Construction (4 items), Power Supplies (14 items), Test and Measurement Equipment (16 items), Radio Mathematics and Calculations, and Reference Data. **\$6.00** per copy

RADIOTELEPHONE LICENSE MANUAL

Now, in one convenient volume, complete study-guide questions with clear, concise answers for preparation for all U.S.A. commercial radiotelephone operator's license examinations. Contains four elements: I. QUESTIONS ON BASIC LAW; II. BASIC OPERATING PRACTICE; III. BASIC RADIOTELEPHONE; IV. ADVANCED RADIOTELEPHONE. **\$3.75** per copy

BETTER TV RECEPTION In Fringe and Low-Signal Areas NEW SECOND EDITION

The book which has taken the failure out of many unsuccessful fringe area installations, and has improved the picture for many discouraged TV owners. Practical, easy to understand. How to reduce interference, minimize fading, eliminate ghosts. How to choose the best boosters and receivers, transmission lines and antennas. **\$2.50** per copy

12TH EDITION RADIO HANDBOOK (All-constructional)

Detailed constructional information on a wealth of radio communication equipment. Simple, easy-to-understand text and clear, detailed photographs. **\$3.00** per copy
12th edition RADIO HANDBOOK in Spanish, \$4.50 postpaid

9TH EDITION WORLD'S RADIO TUBES (Brans' Vade Mecum)

THE ONLY BOOK which includes ALL MAKES OF U.S. TUBES and all foreign. More than 15,000 receiving and transmitting tubes from 253 manufacturers. **\$5.00** per copy

ANTENNA MANUAL, a Necessity for Every Radio Man

300 pages of help on antenna, feed line, radiation, and propagation for all frequencies up to 1000 Mc. including FM and TV. **\$3.50** per copy

SURPLUS RADIO CONVERSION MANUAL (in Two Volumes)

Conversion data for most common items of surplus electronic equipment. All conversions shown yield a useful item of equipment; send for list. **\$2.50** for either volume

BUY FROM YOUR DISTRIBUTOR
AT PRICES SHOWN, OR ADD 10% ON DIRECT MAIL ORDERS TO
EDITORS AND ENGINEERS, Ltd., 1302 KENWOOD ROAD, SANTA BARBARA, CALIF.
Bookstores order from BAKER AND TAYLOR CO., Hillside, New Jersey

EASY TO LEARN CODE

It is easy to learn or increase speed with an INSTRUCTOGRAPH Code Teacher. Affords the quickest and most practical method yet developed. For beginners or advanced students. Available tapes from beginner's alphabet to typical messages on all subjects. Speed range 5 to 40 WPM. Always ready—no QRM.

ENDORSED BY THOUSANDS!
The Instructograph Code Teacher literally takes the place of an operator-instructor and enables anyone to learn and master code without further assistance. Thousands of successful operators have "acquired the code" with the Instructograph System. Write today for convenient rental and purchase plans.

INSTRUCTOGRAPH COMPANY
4711 SHERIDAN ROAD, CHICAGO 40, ILLINOIS

No Experience Needed To PRINT YOUR OWN POST CARDS

The GEM STENCIL DUPLICATOR saves money... gets results quickly! Hundreds of uses for every type of business and organization. We ship the GEM complete with all supplies, Guide Board for accurate printing and 60-page Book of Ideas at the special low price of only **\$9.50** (a \$15.00 value) *Our 21st Year*

FREE TRIAL OFFER
Use the GEM FREE at our expense! SEND NO MONEY. Write and complete GEM outfit will be sent you postpaid. After ten days, send us only **\$9.50** or return the GEM. You must be satisfied! WRITE TODAY.

BOND EQUIPMENT CO. Dept. 111
6633 Enright • St. Louis 5, Mo.

For better, quicker servicing



USE Mandl's

Television Servicing

Here are detailed, illustrated instructions for locating and correcting EVERY flaw or failure that may occur in each stage of today's TV receivers. You'll learn simple signal tracing procedures; trade tricks in diagnosing troubles in minimum time; the essentials of successful VHF and UHF servicing; how to trouble-shoot A.G.C. circuits, syncroguide circuits, and all other circuits, including the latest improvements. A complete master trouble index enables you to QUICKLY find the cause of and procedures for correcting any trouble, including those hard-to-find troubles. Hundreds of diagrams, original photographs of flaws as they appear on the TV screen, oscilloscope patterns and other illustrations further aid you in locating trouble, testing, and making adjustments.



Noll's Television for Radiomen

Very clear, thorough, non-mathematical explanations of the function and operating principles of every element and circuit in TV reception; how the receiver is constructed; basic principles of transmission; and the techniques of installing, adjusting, and aligning today's receivers, with full instruction on test equipment and its use. Here, in the simplest, clearest terms, is the basic knowledge that is a MUST for good TV work.



AND Noll & Mandl's Television and FM Antenna Guide

Are fringe area reception, ghost reception, interference your problems? This book shows you how to overcome them—how to improve gain; minimize noise on the transmission line; get the MOST out of the antenna system at any location. It tells how to determine the right type of antenna for the site and the best position for it; gives full data on all types of antennas including those for the new UHF and VHF locations, yagi antennas, stacking, boosters, and other fringe area aids.

NOW MORE THAN EVER, YOU'LL NEED THESE EXPERT SERVICE AIDS.

SEE THEM ON APPROVAL

The Matmillen Co., 60 Fifth Ave., N. Y. 11

Please send me the books checked below. I will either remit in full or return the books in 10 days.

- Mandl's TV Servicing \$5.50 TV & FM Antenna Guide \$6.25
 TV for Radiomen \$7.75

Signed

Address

(This offer good only within continental limits of U.S.A.)

If the transmitter is to be installed in the same room with the operator the answer at the top of item #20 should be "no" and items #20 (a), #20 (b) and #20 (d) may be marked "not applicable." Item #20 (c) may be filled in "under constant attendance" or "under lock and key," whichever is applicable.

In the case of a station operated by remote control, all parts of item #20 must be completed and the answer to item #20 (d) must be "yes" on the application and in fact. In the case of an application for mobile units, item #17, except for the top line, items #18, #19, #20 and #21 may be marked "not applicable."

Item #21 (e) which applies only to remotely controlled base stations requires specific information on how the station will be monitored. A typical answer would read, "Pilot light will indicate continuously when power is being applied to transmitter to produce radiation, a volume level indicating meter across the remote line indicates presence and level of modulation and a fixed tuned receiver monitors all emissions of this transmitter and other nearby transmitters operating on the same frequency."

When the base station transmitter and receiver are to be installed at the same location, which is generally the case, the first three lines of item #22 may be filled in, "same as item #17." For base station applications the fourth line may state, "mobile units operating in the general vicinity of this station. Call letters and frequency not yet assigned, see accompanying application."

The fifth line may carry the state-

ment, "not a communications common-carrier," if this is the case. This also requires "no" and "none" as answers to the first two parts of item #23 and item #24 and "none" to the third part of item #23.

At item #25 a strong statement should be made as to why the operation of this station will be in the public interest, convenience, or necessity. For example, a taxicab applicant could state, "the operation of this station will permit the applicant to render better and faster service to the public."

"Not applicable" is an appropriate answer to item #26 unless the application is in the experimental service. At item #27, the first line should note the date at which installation of the proposed radio station is to be commenced, and on the second line, the expected completion date should be noted. The latter is generally less than 6 months from the date of application.

In the case of a new application, all parts of item #28 should be marked "not applicable." At item #29, all exhibits attached with the application should be tabulated with exhibit numbers or letters and titles of the exhibits.

Item #30 must be executed by the individual applicant, member of applicant partnership, or an officer of the corporation or the association. The name of the applicant should be the formal name of the individual, partnership, association, or corporation as shown on the first page of the application.

For example, Thomas C. Jones operating "Jones Taxi Service" as an individual should list the name of the

Two views of the new communications car for the Presidential train recently put into service by the Signal Corps. (Right) Part of the console designed and installed by the U.S. Signal Corps. Included are four Hammarlund "Super-Pro 600" receivers covering a frequency range of 540 kc. to 54 mc. Three clocks show local, Eastern, and Greenwich Mean Time. (Below) Overall view of the "General Albert J. Myer"—the Presidential communications car. Note antennas folded down against roof. By means of the equipment installed in this car the President can maintain continuous communications with Washington. The equipment will be operated by personnel of the White House Signal Branch of the Signal Corps. The car, which is a self-contained communications center, can be hooked onto any train on which the President's private car is to be attached.



for dependable sound, INDUSTRY relies on ATLAS



DR Double-Reentrant Projectors

DEPENDABLE QUALITY:

The latest electro-acoustic research and engineering—and over 20 years of manufacturing know-how—are behind every ATLAS product.

DEPENDABLE SERVICE:

Coast-to-coast and around the world today—in every Industrial, Marine, Railroad, Military, Educational, Civic, U.S. and Foreign Government application—under every kind of climate and noise condition—ATLAS sound equipment is famous for highest efficiency and durability. That's the proof of ATLAS performance dependability.

DEPENDABLE DELIVERY:

Yes, ATLAS gives our Government highest priority. And yes, we too feel the pinch of material shortages. But our customers will continue to get our usual dependable delivery—because we believe in equitable and dependable distribution to all ATLAS users.

DEPENDABLE PROFITS:

Completeness of line, excellence of product, dependable delivery, right prices—that's the ATLAS combination that means high, steady Industrial Sound profits for You!

JUDGE for yourself, COMPARE ATLAS at your local Jabber today. See why ATLAS is the preferred line for utmost dependability. Write NOW for FREE latest Catalog 551.



Paging & Talk-Back speakers



ALNICO-V-PLUS Driver Unit



Dual Speakers



FUL-GRIP, VELVET-ACTION Mike Stands

ATLAS SOUND CORP.
1446-39th Street, Brooklyn 18, N. Y.
In Canada: Atlas Radio Corp., Ltd., Toronto, Ont.

ON-THE SPOT BATTERY RECORDER
WALKIE-RECORDALL 8 lb. miniature BATTERY RECORDER-PLAYBACK
Continuous, permanent, accurate, indexed recording at only 5c per hr. Instantaneous, permanent playback. Picks up sound up to 60 ft. Records conferences, lectures, dictation, 2-way phone & sales talks; while walking, riding or flying. Records in closed briefcase with "hidden mike"! Write for Detailed Literature.
MILES REPRODUCER CO., INC.
812 BROADWAY (Opp. TEN-10) NEW YORK 3, N. Y.

BARGAIN HUNTING? **RADIO SERVICEMEN!**
Write for SENSATIONAL CATALOG
HENSHAW RADIO SUPPLY
3619 TROOST KANSAS CITY, MO.

applicant as: "Thomas C. Jones, dba Jones Taxi Service." The "dba" means "doing business as." If he has a partner named Elsie C. Jones, the applicant is: "Thomas C. Jones and Elsie C. Jones, dba Jones Taxi Service."

Both copies of form 401 should be signed before a notary public and affixed with the seal of the notary.

Applications for radio station construction permits should be filed at least sixty days in advance of the proposed installation. After the permits have been granted the applicant may proceed with the installation of the radio equipment. When the station is ready to be tested, the permittee must send notice in writing at least two days in advance of the test date to the Engineer in Charge of the local Radio District giving the name to whom the permits have been issued, call letters of the stations, and the frequencies on which the tests are to be made.

Equipment tests may then be made but the station may not be put on the air for operational purposes until radio station applications have been filed. After FCC form 403, application for radio station license, has been filed in duplicate for both the base station and the mobile units with the Commission in Washington, the stations may be operated as though licensed until formal licenses have been issued or authority has been revoked for cause provided the expiration date of the radio construction permit has not been passed.

It must be borne in mind that equipment tests and transmitter adjustments must be made by or under the direct supervision of a person holding a first or second class radio operator's license. Thereafter, in most mobile service, the base station may be operated by a person holding a restricted radio-telephone operator's permit. No license is required by operators of mobile units when operating with the consent of the licensee at frequencies above 25 megacycles, provided a licensed operator is on duty at the associated base station.

Obtaining a Citizens Radio Station License is easier than finding suitable equipment, at least at this date. An interested applicant should purchase a copy of "FCC Rules part 19 Governing the Citizens Radio Service" from the Superintendent of Documents, Government Printing Office, Washington 25, D. C., for ten cents. FCC application form 505 is available free from the Federal Communications Commission, Washington, D. C.

Form 505 is very simple and easy to complete. In addition to information on citizenship of corporation and association directors and officers as well as individual applicants, brief data on the equipment is required. A space is provided for the FCC type-approval number of the equipment to be used. If equipment is to be used which does not have FCC type approval, complete technical data must be supplied with the application, as prescribed by the rules.

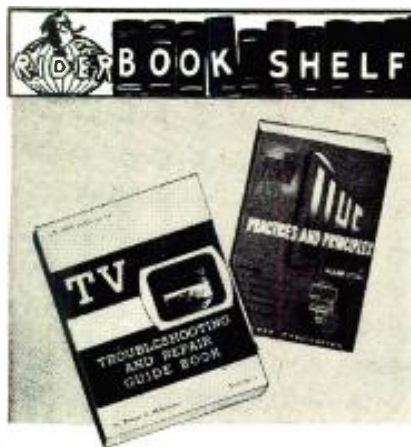

TV TROUBLESHOOTING AND REPAIR GUIDE BOOK

by R. G. Middleton

A new practical book designed to make your tv servicing easy. It tells—in easy-to-read language—how to spot receiver troubles... and how to correct them permanently. You'll find enough practical data in one chapter to repay the low cost of this book many times over. Typical chapters include: Receiver Differences and Waveforms; Visual Alignment; Troubleshooting Sync Circuits; Locating Sweep Troubles; Causes and Cures of Receiver Buzz; Test Equipment Kinks. Indexed and illustrated with over 190 (8½ x 11") pages bound in durable art cover -----\$3.90

UHF PRACTICES AND PRINCIPLES

by A. Lytel

A new, up-to-the-minute book that clears away the confusion and misunderstanding most people have about UHF. Written in clear, easy-to-understand terms, this book covers both fundamental theory and practical, working applications with special emphasis on television. Present-day brand name converters are thoroughly covered, including circuit descriptions and schematics. Here is profitable and practical reading for anyone who will be working with UHF. Typical chapters include: UHF Receiving Antennas; Electromagnetic Radio Waves; Transmission Lines; Waveguides. Illustrated and indexed with approx. 400 (5½ x 8½") pages bound in cloth cover. \$6.60

Buy these books now at your jobbers... leading bookstores... or—

---MAIL THIS COUPON—TODAY---
JOHN F. RIDER, Publisher, Inc.
480 Canal Street, New York 13, N. Y.
Please send me book(s) circled. I understand, if not satisfied, I may return them within 10 days for full refund. 1 2
NAME _____
ADDRESS _____
CITY _____ ZONE _____
STATE _____ (Please Print) RN-10

THE ORIGINAL

Television
tube caddy

TRADE MARK



IT COUNTS
and CARRIES
your TUBES

**CARRIES EASIER
LOOKS NEATER
PAYS FOR ITSELF**

The Customer only knows what she sees. She probably wouldn't know a rectifier from a resistor, and couldn't read a meter. But she can read the writing on a wall—and on her floor when you set your tools down.

Servicemen who carry the Tube Caddy make the right impression. No "fishing" a tube out of the bottom of a tool kit. Every tube has its place. The customer recognizes systematic efficiency—the kind that builds confidence, and makes your business grow through recommendations from one customer to another.

Tube Caddy. Holds up to 248 tubes.
20x13 1/2 x 19 in. . . Net 16 Dealer

\$13.50*

Tube Caddy Jr. Holds up to 143 tubes.
15 1/2 x 13 x 8 in. . . Net 16 Dealer

8.95*

*Higher on West Coast
Also TV Cabinets, Wall Boffles
Ask your jobber today or write

ARGOS PRODUCTS CO.

317 MAIN STREET • GENOA, ILLINOIS

APC

Craftsmanship in Cabinets

Some excellent equipment is being manufactured which is suitable for use in the Citizens Radio Band. However, the tiny hearing-aid type of portable Citizens radio is still in the laboratory. When equipment of this type is made available at popular prices, the Citizens Radio Band will probably be busier than the regular mobile radio bands.

Operation on some frequencies, such as those in the 450 megacycle band, is being authorized on a "developmental" basis. The term "developmental" has in some instances frightened the prospective user from investing in equipment for use under a developmental grant.

The use of the term "developmental" does not infer that the FCC is apt to revoke authority arbitrarily, thus endangering the investment of the licensee. Instead the term "developmental" is applied to grants in such services or on frequencies where adequate experience has yet to be gained to draft specific applicable rules and regulations.

Practically all of the microwave relay systems now in use are licensed on a developmental basis. As more experience is gained, it is anticipated that licensing will be made on a regular basis governed by rules based on standards suggested by the manufacturers and users.

At the present time, it is not practical to determine what degree of frequency stability, for example, is necessary or economically feasible. Many technical standards will be developed through experience. It is possible that some equipment now licensed on a developmental basis will have to be modified to meet standards which will be set at a later date but it is unlikely that licensees will be required to junk existing equipment before the investment has been amortized.

The Federal Communications Commission has demonstrated fairness to an extreme degree in dealing with obsolescence of equipment due to technological advances. For example, tightened restrictions have often been applied only to new licenses granted after a widely publicized future date.

(To be continued)

MARS APPOINTS

DRIG. GEN. IVAN L. FARMAN, USAF, Deputy Director of Communications, USAF, has been elected chairman of the MARS advisory committee for a one year term.

Col. William D. Hamlin, Signal Corps, Acting Chief of the Army Communications Service Division, was named vice-chairman of the committee.

The MARS advisory committee is composed of military and civilian members representing the Armed Forces, Civil Defense Administration, FCC, RED CROSS, ARRL, and others. Its chief duties are to advise the Chief Signal Officer, USA, and the Director of Communications, USAF, on MARS operations, and to recommend policy pertaining to the coordination of civilian and military amateur radio activities.

International Short-Wave

(Continued from page 141)

Japan—A Japanese heard irregularly on 6.005 was noted recently signing off 0700, some days may sign off as early as 0600. The 7.285 NHK outlet appears to have *English* 0500-0530 on Thursdays; may be on Mondays also and probably is an *English* lesson. (Stark, Texas) *Radio Japan*, 7.180, noted 0600 with news; heard on 6.069 at 0615, only fair level in Australia; 11.705 heard 0700 with news, commentary, music; 9.675 is at good level 0705 with news commentary, music. (Sanderson) Heard on 15.235 at fair level with news 0000-0015 for North America. (Lane, Wyo.)

Lebanon—Beirut, 8.036, noted 1620 with news in Arabic, then closing 1630 with French march. (Pearce, England)

North Korea—Although the North Korean outlets were off shortly after the bombing of the power plants on the Yalu River, Dilg, Calif., has been hearing them off and on lately on 4.400V and 6.250V early mornings (EST), with about the same signal strength and quality as previously; heard on 6.250V by Balbi, Calif., after 0200 and at 0800. Ido, Japan, informs *Radio Australia* that Pyongyang announces use of 1800 kc., 970 kc., 4.400, and 6.250.

Panama—HOJA, 9.645, Chitre, noted with news in Spanish 2300-2305 and then signed off with *English* and Spanish announcements 2305. (WRH)

South Africa—*Springbok Radio*, 4.945, noted at good level some days 2345-0045 with *English* session of music, time checks, commercials, and a gong that is used between commercials; sign-off seems around 0048; has plane phone QRM. (Saylor, Va.) SABC, 11.937, Johannesburg, noted on a Saturday 1200 with all-*English* session—news, weather report, program summary; some days uses Afrikaans instead of *English*—noted on a Sunday 1245 with church services in Afrikaans. (Pearce, England) Should sign-off 1505.

Spain—Cartagena relays *Radio Nacional de Espana* from 1545 on 7.233. (ISWC, London) La Voz de la Falange, Madrid, is still noted near 7.380 at 1645 tune-in; strong signal yet at 1725. (Pearce, England) Heard signing off 1857. *Radio Mediterraneo*, 7.037, Valencia, noted recently 1750-1836 with recorded music. *Radio Juventud de Cadiz*, 7.200, noted from 1710 to sign-off 1803. (Kary, Pa.) Madrid, 9.363, still noted to North America 1800-1840 at good level. (Hoffman, N. Y.) Also at 2210-2245.

The Spanish-speaking station on 7.310A, heard by Kary, Pa., and Pearce, England, from around 1630 to after 1800 appears to be *Radio Murcia*, formerly on 7.100A.

Turkey—*Radio Ankara*, 15.160, noted starting French session 1515. (West, Va.) And to Europe in *English* 1600-1645, then in Turkish to 1715 close-

down, strong signal. (Niblack, Ind., others) Still fine level 1815-1900 over TAT, 9.515, to North America. (Lund, Iowa, others)

Radio Ankara will soon begin transmissions over the 20 kw. transmitter using TAN, 6.000; TAM, 7.240; TAK, 11.760, and TAD, 17.720. (WRH)

USI (Indonesia)—An Australian DX-er reports PLB9 and PLQ2 have been testing to the Philippines; PLB9 was heard on 11.000 at 0630; identification which followed a series of 8 chimes was—"This is the Voice of Indonesia trying out transmitters PLQ2 on 19.345 and PLB9 on 11.000." PLQ2 on 19.345 could not be found. (Radio Australia) Djakarta, 11.94A, still noted signing on 0430 with nice level. (Balbi, Calif.) Djakarta noted over YDF, 6.045, with Home Service around 0515 to 0700 fade-out. (Kary, Pa.)

USSR—The 0800-0830 period in *English* to North America from *Radio Moscow* is announced for 17.83, 15.44, 15.36, 15.18, 15.12, 11.91; strong in Iowa on some of these channels. (Lund)

Radio Moscow noted around 15.300 with news 0000, then recorded music, strong signal in Wisc. (Shaver) Heard on 11.98A at 1900 in Spanish. (West, Va.) Noted on 7.165 with news in Spanish 1700-1715, then music. (Kary, Pa.) *Radio Moscow*, 11.74, noted in Germany with news 0630-0700, some CWQRM. Vladivostok, 9.480, heard 0800-0830 at strong level. (Jones) A Soviet has been noted on 9.545 with *English* talk 0200; at 0230 in Chinese. (Balbi, Calif.) Heard daily on 15.36 from 1130-1157 in *English*, news 1130; at 1200 is back in a European language to 1230 when again has *English* to 1257; at 1300 again has European language; plays quite a bit of music. (Alcock, Ky.)

Vatican—ISWC, London, says the Vatican has new 100 kw. transmitters on the air with *English* 1000 and 1315 over 15.120, 11.740, 11.685, 9.550. Saylor, Va., reports HVJ, 5.968A, with Arabic program to Africa 0100-0200 (heard on a Tuesday). HVJ noted on 7.280 at 1545 with celeste interval signal, then in Hungarian to 1600, reports Kary, Pa.

Yugoslavia—*Radio Yugoslavia*, Belgrade, noted with news and commentary 1645-1700 on 15.240A (formerly used 9.505 for this *English* session). (Pearce, England) Noted on 11.890 with news in French 0200. (Sanderson, Australia) WRH says the 6.100 outlet is now 100 kw., scheduled with *English* 1100, 1315, 1645.

Press Time Flashes

Predicted Sunspot Count for October is 26, according to *Radio Switzerland*. (Ferguson, N. C.) The Zurich Sunspot Number for October is 43; was 46 for September. (Stark, Texas)

A weak signal on 5.838 around 1730 (music) probably is from Bissau, Portuguese Guinea. (Kary, Pa.)

When this was written, Brussels had started operation of its two new 100 kw. transmitters—using 11.850 around 1400-1815, and from around 1830-2400

1 UNIT DOES THE WORK OF 2

ENTIRELY NEW

SUTCO

UHF CONVERTER VHF BOOSTER

PATENT APPLIED FOR

Here it is in one compact unit—a fully-tested all UHF channel converter and a top-quality all VHF channel booster! It's easy to install and easy to operate with absolutely no additional adjustments required on the receiver! Has built-in UHF antenna. You will find the price in line with most UHF converters alone!

Make Sales Now for Today and Tomorrow with the New Sutco Two-in-One Combination Unit!

For further information about this versatile unit contact your Sutco distributor right away!

SUTTON ELECTRONIC COMPANY, Inc., Lexington, Ky.

RADIO and TELEVISION ELECTRONICS

in all Technical Phases
New Classes (Day and Evening) Start 1st of Dec., Mar., June, Sept.

Free Placement Service for Graduates
For Free Catalog write Dept. RN-52

RCA INSTITUTES, INC.
A Service of Radio Corporation of America
350 WEST 4th ST. NEW YORK 14, N. Y.

Another Outstanding Jobber

ALL-STATE DISTRIBUTING COMPANY
2407 Ross Ave.ue, Dallas 1, Texas

has all 24 KITS & INSTRUMENTS in stock!

425K 5" SCOPE KIT 544-95 See EICO ad on Page 115

LOOK! KLIPZON FREES BOTH HANDS!

UNIQUE SELF-HOLDING POINTS bring new convenience and timesaving to service work.

- * V.H.F. CRYSTAL PROBES
- * ADAPTORS
- * STREAMLINED TEST PRODS
- * CONNECTORS
- * LOW LOSS — LOW CAPACITY LEADS

See KLIPZONS at your distributor.
Send for FREE folder #36.

UNITED TECHNICAL LABORATORIES
Engineers • MORRISTOWN N. J. • Manufacturers

standard brands TUBES SAVE!

individually boxed

OZ4\$.45	5V4G ...\$.79	6B4G ...\$.89	6E5\$.69	6V6GT ..\$.51	19B6GG \$1.59
114\$.59	5Y3G ...\$.35	6BA6 ...\$.49	6F6GT ...\$.49	6W4GT ...\$.49	19T8\$.79
1R5\$.59	6AB4 ...\$.55	6BA7 ...\$.69	6H6\$.51	6W6GT ...\$.59	25AV5GT .95
1S4\$.69	6AC7 ...\$.89	6BC5 ...\$.59	6J5GT ...\$.49	6X4\$.44	25BQ6GT .98
1S5\$.59	6AG5 ...\$.59	6BE6 ...\$.52	6J6\$.69	6X5GT ...\$.39	25L6GT .49
1T4\$.59	6AG7 ...\$.95	6BF5 ...\$.63	6K6GT ...\$.49	12AT6 ..\$.42	25Z6GT .45
1U4\$.63	6AH6 ...\$.95	6BG6G .1.49	6L6GA .95	12AT7 ..\$.59	35B5 ...\$.55
1U5\$.55	6AK5 ...\$.85	6BH6 ...\$.65	6SA7GT .55	12AU6 ..\$.49	35C5 ...\$.55
1X2A ...\$.69	6AL5 ...\$.39	6BJ6 ...\$.55	6SC7 ...\$.59	12AU7 ..\$.52	35L6GT .55
1B3GT ...\$.72	6AQ5 ...\$.45	6BL7 ...\$.89	6SN7GT .66	12BA6 ..\$.49	35W4 ...\$.37
3Q4\$.68	6AQ6 ...\$.45	6BN6 ...\$.85	6SF5 ...\$.52	12BE6 ..\$.52	35Z5GT .35
3Q5GT .65	6ARS ...\$.49	6BQ6 ...\$.98	6SH7 ...\$.59	12BH7 ..\$.69	50B5 ...\$.55
3S4\$.59	6AS5 ...\$.56	6BQ7 ...\$.98	6SJ7 ...\$.49	12SA7GT .56	50C5 ...\$.55
3V4\$.59	6AT6 ...\$.41	6C4 ...\$.44	6SL7GT .59	12SG7 ..\$.55	50L6GT .54
5T4\$.1.19	6AU6 ...\$.47	6C5 ...\$.51	6SQ7GT .45	12SK7GT .57	117N7GT 1.35
5U4G ...\$.47	6AV5GT .95	6CB6 ...\$.59	6SR7 ...\$.45	12SN7GT .66	117P7GT 1.35
	6AV6 ...\$.41	6CD6G 1.65	6T8\$.79	12SQ7GT .57	117Z3 ..\$.49

Many other types equally low priced—include all your tube needs with your order.

Above prices effective Sept. 15, 1952

One of the largest stocks in the country

Min. Order \$25.00. Terms: 25% with order, balance C.O.D.

All merchandise subject to prior sale. F.O.B. New York City. Mail order division.

TeleVision Materials Corp.

125 Cedar St., New York 6, N. Y. • COlrlantl 7-4307

STAN-BURN E-D-A-D-K-E

ANTENNAE SPECIALS

DOUBLE V 3/4"	1.11	12 or more
DOUBLE V 3/8" Dowel	\$2.98	\$2.20
DOUBLE V 1/2" Dowel	3.45	2.45
10 Element Conical 3/4"	3.95	2.99
10 Element Conical 1/2"	3.55	2.55
Folded Hi Straight Low Quick Rig		
1/2" elements	4.25	3.25
WINDOW CONICALS	4.95	3.75
5 FOOT SWEDGED MASTS79	.69
10 FOOT PLAIN TV WIRE	1.39	1.29
55 Mil. 300 OHM	\$14.95	M Ft.
72 OHM COAXIAL	45.00	M Ft.

CATHODE RAY TUBE SPECIALS

Standard Brands—Unconditionally Guaranteed			
10BP4A Sheldon	\$13.95	17BP4A Federal	23.00
10BP4A N.U.	18.95	19AP4A Sheldon	29.95
12LP4 Sheldon	15.95	19AP4A GE	38.00
12LP4A Thomas	19.95	19BP4A Thomas	39.95
16AP4 Sheldon	24.00	19DP4A Sheldon	29.95
16AP4A GE	34.20	20CP4A Dumont	37.00
16DP4A Thomas	28.80	20CP4A Sheldon	31.00
16DHP4A Sheldon	24.00	21EP4A Federal	29.00
16GP4 Sheldon	24.00	21EP4A Dumont	39.00
16GP4A Rautand	30.25	24AP4A Sheldon	63.00
16JPA Sheldon	24.00	24AP4A GE	68.40
16RP4A GE & N.U.	24.40	Single ion traps39
16KP4A Sheldon	24.00	Double ion traps59
CHASSIS 630 REGAL with Cascade Tuner	\$139.50		
211 T3 FLY BACK (Similar to RCA)	2.98		
OPEN FACE CABINET	39.00		

TRANSFORMERS

RCA type for 16" to 24" X032	\$3.85
G.E. type for 16" to 24" X045	3.85

These are very special prices while they last!

DEFLECTION YOKES

COSINE FERRITE TODD YOKE 70"	\$4.20
------------------------------------	--------

SPECIALS

4 Prong Vibrators, each	\$ 1.29
Lots of 12 or more	1.19
Standard TV Tuners	18.95
12" Heavy Sling Sawblade	Special 4.98

Audio Devices, Discs and Scotch Tape in Stock

Audio Plastic Red Oxide Plastic tape—	
Half-hour spool	\$2.30
One-hour spool	53.30

WIRE RECORDERS IN STOCK

WILCOX GAY—Model 2A10	\$ 89.97
PENTRON — Model 9T3C — 2-speed Tape Re-	
recorder	134.50

RADIO CRAFTSMAN

Model RC2—HiFi Amplifier	Net 42.89
Model RC1G—AM-FM Tuner	Net 130.84
Model CS—Williamson Amplifier	Net 99.45

Cascade Guaranteed Tuners (with tubes)

SPECIAL: While they last. \$21.95

AUTHORIZED DISTRIBUTORS for: General Electric, Kenrad, Tung-Sol, National Union, Jewel, De Wald, Regal, Automatic and Satchel Carlson.

We carry a complete line of popular makes of Radio and TV tubes, at 50% discount. Also many other special purpose and transmitting types, and all electronic parts and equipment at lowest prices. Send us a list of your requirements for prompt quotations.

Terms: 20% with order. Balance C.O.D. All prices FOB. NEW YORK Warehouse. Minimum order \$5.00.

Write for our latest price list to Dept. RN-9

STAN-BURN RADIO and ELECTRONICS CO.

1697 BROADWAY • NEW YORK 19, N.Y.

SEND FOR OUR BIG BULLETIN

DOW RADIO, INC.

1759 E. Colorado St. Pasadena 4, Calif.
PHONE: SYcamore 3-1196

Now— a "Money-Maker" FOR THE Fringe Area Servicemen! THE NEW PORTABLE "Sensi Meter"

The Missing Link in Television Testing—
Take the Guesswork out of TV Service—
Checks Receiver from Antenna Terminals to Picture Tube



Pat. App. For

- The SensiMeter accurately measures the sensitivity of any television receiver in microvolts.
- The SensiMeter microvolt scale is divided into VERY SENSITIVE RECEIVER-MEDIUM SENSITIVITY—INSENSITIVE RECEIVER—to enable the serviceman to quickly determine the condition of the receiver.
- The SensiMeter will enable you to determine within three minutes whether or not a television receiver will operate in a weak signal area.
- Sensitivity testing is accepted by servicemen as the best method of determining the cause of bad pictures in fringe areas.

NET \$129.50

APPROVED BY LEADING TV MANUFACTURERS Order from your jobber. If he cannot supply you, send us his name.

SERVICE INSTRUMENTS COMPANY

422 So. Dearborn Chicago, Ill.

using 9.745, 9.665, or 9.770, the latter transmission being for North America with English 2200-2400. Schedules and frequencies were subject to change. Asked for airmail reports to the Belgian National Broadcasting Service, P. O. Box 26, Brussels 1, Belgium. Transmitters are at Wavre, near Brussels. (OTC2, 9.767, Belgian Congo, was still being used to relay the beam 1830-2400 to America.) The Brussels call is ORU and frequencies allocated include 5.970, 7.170, 9.665, 9.745, 9.770, 11.720, 11.850, 11.893, 15.280, 15.335, 17.845, 17.860, 21.510, 21.715, 25.630, 25.760. (Leopoldville has been allocated 6.140, 7.200, 9.745, 9.770, 11.760, 15.170, 17.745, 21.680.)

According to press dispatches—the Voice of America "Truthship" Courier was en route to the Mediterranean, probably to the island of Rhodes. The dispatches said the State Department stated that the 338-foot Courier underwent extensive tests, including the six-weeks shakedown cruise in the Caribbean, before undertaking the new operation. Its medium-wave transmitter was heard clearly throughout the Caribbean and its two short-wave transmitters as far away as Europe and New Zealand during the tests. From the American Embassy in Panama, many SWL's who sent reports to the Courier on reception of tests from the Panama Canal Zone area some time ago are now receiving an attractive booklet, mostly in Spanish, that describes, with illustrations, the visit of the Courier to Panama.

According to Arthur Cushen, New Zealand, Uganda in Africa is to have a new broadcast and short-wave service to be constructed by BBC technicians. (ISWC, London)

Rome's special Sunday broadcast in English called "Radio Information" (technical and musical program) is 1250-1300; heard on 11.905; announced 9.570, 6.010 as parallel. (Pearce, England)

Radio Free Europe continues to operate on an ever-increasing number of frequencies—latest list reads 5.970, 5.985, 6.122, 6.150, 6.225, 7.145, 7.190, 7.284, 9.090, 9.248, 9.608, 9.696, 9.735, 11.450, 11.680, 11.917, and 12.190; the 9.090 outlet has been heard in Europe with American dance music to 0850 when started a transmission for Poland (Radio Amateur, London) An official of Radio Free Europe has informed Boice, Conn., that RFE is on the air daily 2300-1900 and that channels most used are 5.970, 5.985, 6.020, 6.095, 6.130, 6.150, 7.105, 7.145, 7.193, 7.300, 9.607, 9.695, 9.717.5, 11.675, 11.725, 11.760, 11.855. Verifies with QSL card and desires reports, especially regarding interference from other stations or from intentional jamming; QRA is Radio Free Europe, 110 West 57th St., New York 19, New York, USA.

Direct from T. Takashashi, short-wave editor of "The Radio Experimenter's Magazine," Tokyo, comes this current schedule for Radio Japan—to

North America 0000-0100, JOA5, 15.235, JOB4, 11.705, news 0002; to North China 0600-0700, JOA4, 11.705, JOB3, 9.675, news 0602; to Central China 0700-0800, JOA4, 11.705, JOB3, 9.675, news 0702; to Philippines-Indonesia 0900-1000, JOA4, 11.705, JOB5, 15.235, news 0920; to India-Pakistan 1030-1130, JOA4, 11.705, JOB5, 15.235, news 1032.

From October 10, Sweden Calling DX'ers, from *Radio Sweden*, will be Fridays 1015 on 11.705, Fridays 1730 and Saturdays 0215, 6.065. (*Radio Sweden*)

Radio Chad, 15.595, Brazzaville, French Equatorial Africa, was noted recently 0045-0145 with Arabic session; still uses flute when leaves the air and also between announcements; fair level in Va. (Saylor)

"*Radio Free Japan*" has been operating on 10.180 and 11.896 at 0630-0700 with program in Japanese; good strength in Tokyo; presentation is similar to that of Peking and Moscow—male and female speakers are used alternately. (Ido, Japan, via *Radio Australia*) May be a clandestine Chinese transmitter.

Radio Free Asia, currently relayed by Manila, 6.110, 11.940, and by Guam, 9.490, at 0700-0920, verifies from Box 3223, San Francisco, Calif., USA. (Fox, N. Z., via *Radio Australia*)

Catch, England, has received word from *Radio Borborema*, Campina Grande, Paraiba, Brazil, that it operates ZYJ21, 3.325, 1 kv.; transmitter is a *Byington*, made in Brazil.

Acknowledgment

With DX improving as we enter the autumn-winter season, please keep those reports coming to Kenneth R. Boord, 948 Stewartstown Road, Morgantown, West Virginia, USA—and many thanks for the splendid cooperation during the summer months! K.R.B.

A comparison between Motorola's new plated circuit receiver and a set manufactured by the hand assembly process. The set on the left, the first plated circuit radio in the industry, contains the same number of tubes and other essential components as the set on the right but is considerably more compact, simpler, and provides a greater uniformity of circuitry.

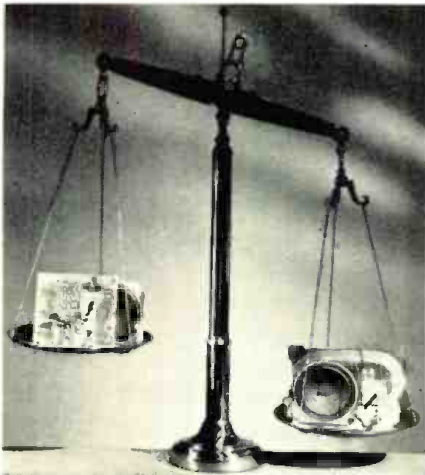

October, 1952

SEE LEO FIRST FOR . . .
hallicrafters



I can SAVE you money . . . Liberal Trade-ins

SPECIAL NOTICE—NEW SX-73 NOW AVAILABLE AND IN STOCK — \$975.00



\$169.50

S-76 RECEIVER

Extra selectivity with double superheterodyne circuit. One RF, two conversion and 3 IF stages. Range 550-1550 Kc, 1.7-34 Mc in four bands. 8 tubes plus voltage regulator and rectifier. Complete with tubes, less speaker.



\$199.50

SX-71 RECEIVER

Double Conversion sharp selectivity, plus built-in NBFM at moderate cost. 11 tubes plus voltage regulator and rectifier. Low down payment.

NAME YOUR TERMS • LOW DOWN PAYMENTS • PERSONALIZED SERVICE

HALLICRAFTERS RECEIVERS AVAILABLE FOR IMMEDIATE SHIPMENT

S-38B	\$49.50	S-72 Portable	\$109.95
S-40B	\$99.95	SX-62	\$289.50
S-81	\$49.50	S-78A	\$89.50
S-82	\$49.50	R-46 Speaker	\$19.95

Famous WRL RADIO REFERENCE MAP 25c



CU on 10-20 & 75 Meters

NEW LOG BOOK 25c

For mobile or fixed station. Spiral binding. Full column log listing all FCC required info. Will accommodate 1,525 stations. "Q" signals, phonetic alphabet, amateur international prefixes.

PHONE 7795

**ORDER TODAY!
WRL 1952 CATALOG**

Send for your copy today. Contains everything new in radio and television. Jam-packed with bargains. Leo I. Meyerson, WØGFO



FREE

WORLD RADIO LABORATORIES
744 West Broadway
Council Bluffs, Iowa R-10

Please send me:

- Radio Map
- New Catalog
- Used Equipment List
- S-76 Info
- SX-71 Info
- New Log Book

Name

Address

City..... State.....



MORE CASH

For Your Radio Equipment

We've moved—and need Radio & Aircraft parts and equipment to fill our new warehouse. Write:

CANDEE-AIRCO
Dept. T-6, 4109 Burbank Blvd.
Burbank, Calif.

SPEAKER RECONING

Complete line Cones, Spiders, Rings and Voice Coils. Custom Built Voice Coils. Low prices. Write for Parts List and Reconing Information.

WESTERN ELECTRONICS CO.
3164 West Colfax Denver 4, Colo.

RADIO ENGINEERING DEGREE IN 27 MONTHS

Radio engineering is a big field. There's room for you in it—if you're good. Get first-class training at Indiana Tech—intensive specialized course, including strong basis in mathematics and electrical engineering, advanced radio theory and design, television, electronics, Modern laboratories. Low rate. Also B.S. DEGREE IN 27 MONTHS in Aeronautical, Chemical, Civil, Electrical and Mechanical Engineering. G.I. Government approved. Enter December, March, June, September. You can earn part of your expenses right here in Fort Wayne while you are studying.

INDIANA TECHNICAL COLLEGE
9102 E. Washington Blvd., Fort Wayne 2, Indiana

Please send me free information on B.S. Engineering Degree in 27 months as checked.

- Radio-Television
- Civil
- Mechanical
- Aeronautical Electrical

Name

Address

The C-800 is here
to bring you new
record performance!

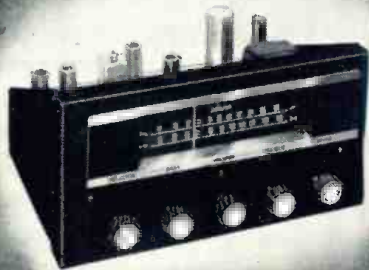

the new
craftsmen 800
FM-AM TUNER
with built-in phono
preamplifier and
record equalizer

Now—Craftsmen brings you a tuner that matches all your finest records... is selling new records for versatility, too. The C-800 is further evidence that Craftsman leadership in high fidelity is something you can put your finger on, something you can hear.

- Front-panel-selected equalization for AES, LP or EUROpean recording characteristics. Inverse feedback compensated dual-triode phono preamp for correct turnover and roll-off characteristics.
- Improved AM reception. Wider bandwidth for better fidelity, and sharper IF bandpass "skirts" for greater selectivity.
- Double-shadow tuning eye and AFC (no drift) on FM simplifies tuning. Front-panel AFC cut-out for tuning weak stations.
- Efficient new layout. Bottom plate, completely shielded chassis minimize oscillator radiation, assure tuner isolation.
- Cathode follower audio output for remote installations; 2 volts at less than 1/2% dist. Detector output also has cathode follower for recording applications.
- Bass and treble controls continuously variable from attenuation to boost—flat position clearly marked. Selector positions: FM, FM with AFC, AM, TV, LP, AES, EUR, and SPare.
- Mahogany-finish wood cabinet available.

HIGH FIDELITY — LOW COST! C-400 audio amplifier offers 10 watts ± 1 db., 15 — 20,000 cps., less than 1% distortion. New streamlined chassis design.

Write today for information
THE RADIO
craftsmen INC.
Dept. R-10, 4401 N. Ravenswood Ave.
Chicago 40, Ill.

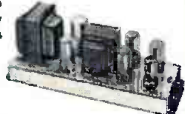

Speaker System (Continued from page 69)

the opening at the back of the cone of the bass speaker.

When wiring the speakers, it is vitally important to phase them properly. This is best done by the conventional "flashlight battery" method, that is, connect the speakers together and apply the battery voltage through a 100-ohm resistor as shown in Fig. 2C. If all the speakers move in the same direction, they are properly phased. If not, it is merely a matter of reversing the polarity of the offending speaker.

The circuit diagram of the speakers, shown in Fig. 2C, is for use when the crossover network in the coaxial speaker is inaccessible. The value of the condenser depends upon the amount of treble reinforcement desired in the system. To save trouble, a variable potentiometer can be used as shown and the output can be adjusted to suit the listener.

If the crossover network of the coaxial speaker is accessible, then it is merely a matter of hooking the two small extra tweeters across the coaxial speaker.

In common with all labyrinth enclosures, it is necessary to damp the interior of the system heavily. Regular acoustic *Celotex* is very good for this purpose and is reasonably inexpensive.

The enclosure described gives very clean notes with a good set of speakers and does not have the characteristic bass thump that is common to open back and reflex enclosures. There is no detectable speech resonance and the response seems to be very smooth down to the bass cone resonance of the bass speaker.

To check the degree of sound diffusion, several listeners were blindfolded, twirled around, and then asked to point out the sound source. They were unable to do so with any degree of accuracy, although several tests were made.

USING THE BC-221

By H. C. CARMICHAEL

In many instances an audio oscillator having a frequency range from zero to 20,000 cycles and above is desired when none is available. The Army Signal Corps type BC-221 can be substituted with good results. For this use, a BC-221, headphones, and a type PL-55 plug with two leads connected to the PL-55 and with the ends open are needed.

Set the BC-221 on the "Crystal Check" position, with the dial set on one of the lowest check points on the low frequency band. By use of the headset it can be determined when the output is highest. Any tone can be produced by varying the dial setting on the BC-221, and this output can be fed to the equipment under test or to a line by means of the test leads attached to the phone plug. The audio signal can be attenuated by means of the gain control on the BC-221.

WINCHARGER

NEW LOW COST TELESCOPING TV ANTENNA SUPPORT

Pat. Applied For

Wincharger... pioneer in guyed tower, presents a new design in HIGH QUALITY, RUGGED, DURABLE TV Antenna Support Masts at a budget price. Properly guyed, these masts will support large antenna arrays against high winds and heavy ice loads.

**SAFER
EASIER
FASTER**

Exclusive 3-Point SAFETY CLAMPING RING

with a smoother guying surface, provide maximum rigidity against tubes twisting and loosening inside each other due to high winds. Aids in erecting a straighter mast.



AUTOMATIC SAFETY CLIP

Assembly Tool. Snaps in place with a "click", warning that tube has been pulled out as far as it can safely go. Made of heavy-gauge spring steel wire. This is an exclusive Wincharger safety feature.



A WINCHARGER BASE FOR EVERY TYPE ROOF

Hinged Foot for flat and sloping roofs.

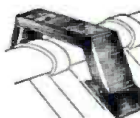

Ridge Straddler... for use on broad or ridged roofs, such as tile, etc.

Ridge Straps... A simple mounting where there is no ridge roll to bridge.



Sell **WINCHARGER**

**SAFETY and FASTER,
EASIER INSTALLATION.**

Sell **WINCHARGER**

**TELESCOPING TV
ANTENNA SUPPORT
MASTS**

Order now from your jobber—
or write for complete details

**WINCHARGER
CORPORATION**
SIOUX CITY 2, IOWA

Pentron

MULTI-SPEED
Pentron
TAPE RECORDER



Regular \$179.50
**OUR SPECIAL
PRICE \$134.50**

Specifications

Model—9T-3C
Frequency Range—
7 1/2" per sec.—50 to 8000 cycles
3 3/4" per sec.—50 to 5000 cycles
Recording Time—2 hours on 7" reel
Fast Forward—20 to 1, or 70 seconds for 1200 feet
Fast Rewind—20 to 1, or 70 seconds for 1200 feet
Capacity—2 channel operation
1 hour at 7 1/2" per second
2 hours at 3 3/4" per second
Speaker—6" Alnico V
Power Output—5 watts to the speaker
Power Consumption—80 watts full load
Line Voltage—105/120 volts AC 60 cycles
Signal to Noise Ratio—50 db
Flutter—less than 0.5%
Weight—27 lbs. with accessories

• All Pentron Accessories 40% discount

We carry Pentron's mike mixers, Micro-phones, 10 1/2" adaptors, Tape carrying cases, Radio tuners, Telephone attachments, Extension speakers, etc. Literature sent on request.

• We stock a full line

of famous make tape recorders at large discounts.

• Recording blanks, cutting needles, magnetic tapes, "Magneasers" and all recording supplies, 40% off.

NOW! Professional grade #211 RPA IRISH BRAND MAGNETIC TAPE



Irish Tape Costs no more than regular plastic tape. 211RPA Green-Brand (plastic base) red oxide.

600' Reel \$ 3.50
1200' Reel 5.50
2400' Reel 13.85
4800' Reel 26.75

* (These lengths supplied on heavy cast aluminum reels.)

Prices: Single rolls 30% off; 2-5 rolls 35% off; 6 or more 40% off (for large quantity users, write for special prices)

• **EMPTY Plastic REELS, 3" 10c; 5" 24c; 1" 30c.** Other sizes write for prices.

P. S. We will ship **FREE** any order over \$20. Providing Check or Money Order Accompanies Order.

**COMMISSIONED
ELECTRONICS CO.**
2405 18th St. N. W., Washington 9, D. C.

21 mc. Interference (Continued from page 50)

strong that the entire chassis appears to pick it up and no amount of shielding can remove it. The remedy in such a case is to shield the entire chassis. One method of accomplishing this is as follows:

Remove the chassis from the cabinet and line the entire cabinet with copper screening. Bond the copper screening together by soldering in many different places. Next make sure that the picture tube has a grounded conductive coating on the outside. In the case of metal shell tubes install a 500 μ fd. high-voltage condenser from the metal shell to the chassis. Finally, insert the chassis in the cabinet so that it rests on insulating material. Bakelite or varnished wood is sufficient. The copper screening should be grounded to a water pipe or radiator and small openings should be left for the antenna lead-in and the a.c. line cord. At the point where the antenna lead-in enters the copper mesh an effective antenna filter should be installed with the shield connected to the copper mesh. The a.c. line filter should be similarly mounted at the entrance to the copper screening.

Cases of ham interference in the new 21 to 21.45 mc. band will vary greatly in intensity. Most affected will be receivers using a split-sound i.f. falling into this band. Depending on the strength of the interfering signal, the elimination of this interference may range from fairly simple to quite complex and expensive. Not until several methods have been tried out is it possible to determine where the interference enters the receiver or how it can be eliminated. The technician called to remedy this sort of trouble will be wise to take along several types of filters for the transmission line as well as for the a.c. power line.

PHOTO CREDITS

Page	Credit
39, 41	Signal Corps Engineering Laboratories
42	Ryan Aeronautical Company
43, 45 (top)	General Electric Company
45 (bottom), 169	Motorola, Inc.
62	Telematic Industries, Inc.; Vidair Television Co.; Great Laboratories, Inc.; Electronic Beam Corp.; Perma-Power Company; Television Communications Institute
63	Electronic Beam Corp.; Rysel Electronic Mfg. Co.
64	Radio Corporation of America
66	Sarkis Tarzian, Inc.
72	British Broadcasting Corporation
164	Hammarlund Manufacturing Company

ERRATA

In Fig. 4 (page 39, June 1952 issue) of the article "Front End Control Unit for Williamson Amplifier," there are two errors which should be corrected. C₃ should be a .0015 μ fd. mica condenser and C₁₀ should be a .001 μ fd. unit. Positions 4 and 5 (listed on the chart accompanying Fig. 4) should be 400 and 500 cycles respectively for the LP records.

In the item "Circuit Improvement" appearing on page 114 of the August issue, the resistor shown between terminals 4-4 should be a 40,000 ohm unit instead of the 150,000 ohms as shown.

from now on . . .



**nothing is beyond
your control!**

The controlling factor in the quality of your home music system . . .



The **CRAFTSMEN® 300**
Equalizer-Preampifier

Combines in one central panel complete tone compensation, phonograph equalization, and control of all audio channel switching.

- Completely self-contained power supply permits flexibility for use with any audio power amplifier.
- Continuously variable loudness control correctly compensated at different listening levels for loss of response to low and high audio frequencies.
- Preampifier for all popular magnetic phono cartridges, compensated exactly for all types of recordings.
- Bass and treble tone controls, continuously variable from attenuation to boost—flat clearly marked.
- Two 4-position filters: for reduction of noise and record scratch . . . for reduction of turntable rumble and hum.
- Cathode follower output permits extremely remote installations without loss of response.
- The first preampifier performance-matched to the Craftsman 500 Ultra-Fidelity audio amplifier.

HAVE YOU HEARD the C500? Williamson all-triode circuit. It's 99.99% distortion-free!



Write today for information

THE RADIO
craftsmen INC.

Dept. R-10, 4401 N. Ravenswood Ave.
Chicago 40, Ill.

Examine FREE



Prentice-Hall ELECTRONICS & UHF LIBRARY

Edited by W. L. EVERITT

5 VOLUMES 1662 ILLUSTRATIONS

Pay Easy Installments If You Keep Set

Turn to this new, up-to-date Library with complete confidence, for dependable facts on any phase of modern electronic theory and practice. These volumes, by outstanding authorities, give you thorough guidance—clearly written, logically arranged, profusely illustrated.

Electronic Fundamentals and Applications

By Prof. John D. Ryder, Univ. of Illinois

Complete, logical, easy-to-follow treatment of (a) physical principles underlying electron tubes, (b) characteristics of vacuum tubes, (c) all basic tube circuits. Includes: Electron Ballistics, Cathode-Ray Tubes, Emission of Electrons, Space Charge in Vacuum Tubes, Diode Rectifiers, Triodes, Multi-Element Tubes, Small-Signal Amplifier Circuits, Audio-Frequency Amplifiers, Radio-Frequency Amplifiers, Oscillator Circuits, Modulation Systems, Wave-Shaping Circuits, Gaseous Conduction, Gas Diodes, Gas Control Tubes and Circuits, Photoelectric Cells, Solid-State Electronics.

Electromagnetic Waves and Radiating Systems

By Prof. Edward C. Jordan, Univ. of Illinois

Covers entire field of electromagnetic engineering. Includes propagation as well as radiation and transmission. Full treatment of UHF transmission lines, wave guides, antennas, slot antennas, radiation and diffraction, ground-wave and sky-wave propagation.

Ultra High Frequency Engineering

By Thomas L. Martin, Univ. of New Mexico

Theory and technique of ALL the new fields of electronic engineering: Radar, Telemetering, Electronic computing, Facsimile, Television, Blind landing systems, Pulse-time modulation, Ionosphere measurements . . . and the others.

Networks, Lines and Fields

By Prof. John D. Ryder, Univ. of Illinois

Network transformations and theorems. Resonance, Impedance transformation and coupled circuits. Filters, General transmission line, High-frequency line, Equations of the electromagnetic field, Radiation, Transmission and reflection of plane waves at boundaries, Guided waves between parallel planes, Wave guides.

Elements of Television Systems

By George E. Anner, New York University

Complete basic theory, plus current practice, covering: Closed TV Systems, Commercial Telecasting Systems, Color TV Systems. Gives clear exposition of all phases of picture transmission, including the new technique of dot interlace.

SEND NO MONEY — EXAMINE FREE

Just mail coupon below to get complete 5-Volume Set on 10 DAYS' FREE TRIAL. If not completely satisfactory, return in ten days and owe nothing. Or keep the set and pay only \$5.35 down and \$8 a month for five months until full price of \$45.35 is paid. Decide for yourself—without risk or obligation—just mail coupon to examine Library ten days free.

PRENTICE-HALL, Inc., Dept. M-RN-1052
70 Fifth Avenue, New York 11, N. Y.

Send me the Prentice-Hall, ELECTRONICS & UHF LIBRARY (5 Volumes) for ten days' free examination. If fully satisfied in ten days I will send you \$5.35 plus few cents postage and then \$8 a month for five months until full price of \$45.35 is paid. Or I will return the Library in ten days and owe nothing.

Name
Address
City and State

INDEX OF Advertisers

OCT.
1952

While every precaution is taken to insure accuracy, we cannot guarantee against the possibility of an occasional change or omission in the preparation of this index.

NAME	PAGE	NAME	PAGE
Acorn Electronics Corp.	160	MacMillen Co.	164
Airex Radio Corp.	97	Mallory & Co., P. R.	73, 4th Cover
Allied Radio Corp.	9	Matson Television Co.	157
Alprodec Inc.	99	Merit Coil & Transformer Corp.	156
Altec Lansing Corp.	144	Midway Co.	128
American Electronics Co.	160	Miles Reproducer Co.	165
American Television & Radio Co.	90	Milwaukee School of Engineering	112
Amplifier Corp. of America	128	Moody Machine Products Co.	148
Argos Products Co.	166	Mosley Electronics	161
Arkay Radio Kits Inc.	96	National Electronics of Cleveland	98
Arrow Electronics	132	National Radio Institute	3
Arrow Sales Corp.	147	National Schools	11
Ashe Radio Co., Walter	123	Newark Electric Co.	122
Astatic Corp.	143	Newark Surplus Materials Co.	130
Atlas Sound Corp.	165	Newcomb Audio Products Co.	32
Barry Electronics Corp.	102	Offenbach & Reimus Co.	152
Bell Telephone Labs.	24	Ohmite Mfg. Co.	107
Belmont Radio Corp.	29	Olson Radio Warehouse	93, 94, 95
Bendix Radio	159	Olympic Electronics Supply	119
Berlant Assoc.	134	Peak Electronics	142
Bond Equipment Co.	163	Perma Power	140
Brook Electronics Inc.	112	Photocon Sales	114
Brooks Radio & Television Corp.	126	Pickering & Co.	124
Burstein Development Co.	28	Platt Electronics Corp.	149
Burstein Applebee Co.	109	Porter Radio Sales Co.	96
CBC Electronics	150	Poly Tech Co.	134
C & M Sales Co.	173	Premier Radio Tube Co.	125
Candee Aircro	169	Prentice Hall Inc.	86, 172
Candler System Co.	148	Private Ear Corp.	104
Capitol Radio Engineering Inst.	111	Progressive Electronics Co.	129
Centralab Inc.	30, 31	Pyramid Electric Co.	25
Channel Master Corp.	22, 23	Quietrole Co.	118
Cisn, H. G.	160	R W Electronics	153
Cleveland Inst. of Radio Electronics	121	RCA Institutes	27
Columbia Audio Products	20, 21	RCA Institutes, Inc.	167
Columbia Electronic Sales	156	Radcom Engineering Co.	138
Commissioned Electronics Co.	171	Radio City Electronics Co. Inc.	173
Communications Equipment Co.	140	Radio Corp. of America	Second Cover
Concord Radio Corp.	137	Radio Craftsmen Inc.	170, 171
Coyne Electrical School	114	Radio Electric Service Co.	148
Crest Labs. Inc.	132	Radio Ham Shack Inc.	113
Davis Electronics	152	Radio Merchandise Sales Co.	116
DeForst's Training Inc.	5	Rad Tel Tube Co.	169
Delco Radio Parts	87	Rauland Corp.	33
Dow Radio Inc.	168	Rayco Mfg. Co.	141
Editors & Engineers Ltd.	163	Rek O Kut Inc.	112
Edlie Electronics Inc.	120	Rider Publishers Inc., John F.	165
Eitel-McCullough Inc.	122	Rinehart Books	108, 150, 130
Electro Products Labs.	153	Rose Co.	143
Electronic Specialty Supply Co.	156	Rytel Co.	136
Electronics Institute Inc.	138	Sams Co., Howard W.	74, 126
Electronic Instrument Co.	167, 3rd Cover	Sarett, B. J.	148
Equipto	128	Sarkis Tarzian Inc.	19
Fair Radio Sales	98	Service Instruments Co.	168
Federated Purchaser	133	South River Metal Products Co.	122
Feller Engineering Co.	18	Speyer	118
Fisher Radio	110	Sprague Products Co.	151
Franklin Technical Institute	152	Spragberry Academy of Radio	15
G. L. Electronics	115	Stan Burn Radio & Electronics	168
Garrard Sales Corp.	173	Star Electronics Dist. Inc.	135
General Electric	6, 34, 103	Stevie El Electronics Corp.	86
General Test Equipment	96	Stevens Walden Inc.	8
Good Inc., D. S.	154	Superior Instrument Co.	105, 136
Goodheart, R. E.	138	Supreme Inc.	145
Gonsert Co.	141	Supreme Publications	133
Grayburne Corp.	92	Sutton Electronic Co.	167
Greenlee Tool Co.	126	Sylvania Electric Products	13
Green Tele Radio Distr. Inc.	132	TAB	174
Greylock Electronics Supply	124, 158	Tapemaster	142
Halldorson Co.	120	Tech Master Products Co.	86
Mallicrafters Co.	7	Telephone Engineering Co.	128
Harvey Radio Co.	106	Telex Communications Institute	102
Heath Co.	75 thru 85	Television Materials Corp.	168
Henry Radio Stores	114	Television Supply Co.	134
Hennaw Radio Supply	166	Telrex Inc.	159
Hickok Electrical Instrument Co.	Gatefold	Teraco Co.	110
Hi-Fidelity, Mag.	117	Transvision Inc.	138, 139
Hytron Radio & Electronics Co.	91	Triad Transformer Mfg. Co.	16
Illinois Research Labs.	162	Trio Mfg. Co.	88, 89
Indiana Technical College	169	Triplet Electrical Instrument Co.	14
Intelectograph Co.	163	Tri-State College	163
Insuline Corp. of America	153	Tung Sol Electric Inc.	26
J. F. D. Mfg. Co.	10	Ungar Electric Tool Co.	155
Jensen Industries Inc.	130	United Technical Labs.	162, 167
Jersey Specialty Co.	157	University Loudspeakers Inc.	154
Kydon Inc.	146	V & H Radio & Electronics	152
LaFayette Radio Corp.	131	Valparaiso Technical Inst.	148
LaPointe Pilsamold Corp.	12	Valpey Crystals	102
Leeds Radio Co.	118	Waldom Electronics Inc.	158
Leotone Radio Corp.	124	Wells Sales Inc.	98
Luther, Otto	148	Western Electronics Co.	169
McGee Radio Co.	100, 101	Western Television Inst.	172
McGraw-Hill Book Co.	158	Wholesale Radio Parts Inc.	161
		Winlarger Corp.	170
		World Radio Labs. Inc.	169

TV SERVICING Practical Shop Training

DO YOU want to get into TV servicing . . . operate your own TV shop . . . get into the \$5,000 a year income bracket? YOU CAN, BUT . . .
You need the BEST—the MOST complete TV servicing & maintenance training available. You must understand the function of every TV part; how to use professional test equipment; how to diagnose and "track-down" TV troubles; how to service ALL brands of TV receivers. Only fully equipped TV trade school with daily shop training can give you this. Western TV students actually work on some 20 different kinds of TV sets. Western TV students actually use some 13 types of test & measuring instruments.
Without obligation, write for our illustrated Booklet E-10. You'll be glad you did.

APPROVED FOR VETERANS
WESTERN TELEVISION INSTITUTE
341 W. 18th St., Los Angeles 15, Calif.

Unlimited Opportunities in RADIO ENGINEERING

DEGREE IN 27 MONTHS

Complete Radio Engineering course, including Telev., C.H.P. and E.M. Bachelor of Science Degree also in Mech., Civil, Elect., Chem., and Aero. Eng.; Bus. Adm. Act. Extensive campus, modern buildings, well equipped labs. Low cost. Prep courses. Personalized, practical instruction. Founded 1884. Placement service. Growing shortage of engineers. Prepare now for unlimited opportunities ahead. Enter September, January, March, June. Write for catalog.



TRI-STATE COLLEGE

16182 College Ave. ANGOLA, INDIANA

RADIO & TELEVISION NEWS

Classified

Rate 50c per word. Minimum 10 words

RADIO ENGINEERING

COMPLETE radio, electronics theory & practice; television; broadcasting; servicing; aviation, marine, police radio. 12 or 18 months. Catalog. Valparaiso Technical Institute, Dept. N, Valparaiso, Ind.

SALE

FOR Sale. Leeco-Neville power package. Alternator, rectifier, regulator. Alternator 14v three phase 50A per phase. Twin pulley belt driven. Total 150A in output. For use on 12v systems. Any sensible offer considered. L. J. Smith, 1059 W. District, Tucson, Ariz.

HEARING aids, used. Zeniths, less accessories, \$7. One-piece Nationals, \$10. One-piece overhauled, with accessories, \$20.00. Shelby Instrument, 321 W. 7th St., Long Beach, Calif.

DIAGRAMS Radio, Record Changers, Recorders, 75c; Television with Service Data, \$1.25 up. State manufacturer and model number. Kramer's Radio Service, Dept. N8, 36 Columbus Ave., New York 23, N. Y.

TUBES and equipment bought, sold, and exchanged. For action and a fair deal, write B. N. Gensler, W2LNL, 136 Liberty, N. Y. 6, N. Y.

RADIO-Television service business. K. B. Ames, 52 S. E. 4th Ave., Delray Beach, Fla.

NEW RCA 3AP1A original cartons, \$6.75 each. Tubes, surplus—bought, sold. Free list. Write, Mark, Box 14, New York City 72.

FOR SALE. Plans for high-gain intercommunication system. 2-station drawings. Send \$1.00. Messenger Radio Workshop, 81 Mechanic St., Foxboro, Mass.

TV and FM Antennas. Yagi, Conical, Bow-Tie, Mounts, accessories. Lowest prices. Wholesale Supply Co., Dept. H, Lunenburg, Mass.

FIVE element TV Yagi Beams, Aluminum Tubing, etc. Write for prices. Willard Radcliff, Fostoria, O.

WANTED

AN/APR-4, other "APR-" "ARR-" "TS-" "IE-" ARC-1, ARC-3, ART-13, everything surplus; Tubes, Manuals, Laboratory equipment. Desirable, price in first letter. Engineering Associates, 434 Patterson Rd., Dayton 9, Ohio.

WANTED: Federal type 101B voice-frequency ringers Signal Corps type TA-3/PT. Box 529, % Radio & Television News, 185 N. Wabash Ave., Chicago 1, Ill.

WANTED: Western Electric gray-finished equipment cabinets for 19" panels. Heights of 2'6", 3'6", 7'0" and 7'6". Box 530, % Radio & Television News, 185 N. Wabash Ave., Chicago 1, Ill.

WANTED: All types of Receiving and Transmitting tubes. Surplus receivers & Transmitters. Williams Elect. Co., 168 Washington St., N. Y. C.

WE wish to purchase military and laboratory quality test equipment of all descriptions. Also components, special tubes and instruction book relating thereto. Highest prices paid. Weston Laboratories, Weston 93, Mass.

CORRESPONDENCE COURSE

USED Correspondence Courses and Books sold and rented. Money back guarantee. Catalog free. (Courses bought.) Lee Mountain, Pisgah, Ala.

USED correspondence courses and educational books, bought, sold, rented. Catalog free. Educational Exchange, Summerville, Ga.

MISCELLANEOUS

TRYING for commercial operator's license? Guide your preparation by a complete multiple choice test similar to current FCC exams. Answer key. Elements 3 or 4. \$2.00 each. Radiotest, Box 1106, Portland 7, Ore.

BOOKLET, "Running Your Own Service Shop," \$1.00. F. Tuel, 55 E. Penn St., Uniontown, Pa.

SPEAKERS repaired, wholesale prices, guaranteed workmanship. Amprite Speaker Service, 70 Vesey St., New York City 7.

BUY wholesale, 25,000 items, Catalog 25c. Matthews, 1472-R1 Broadway, N.Y.C. 36.

October, 1952

NOW!...RCP gives you 2 sensational new test instruments for all your TV SERVICING needs!

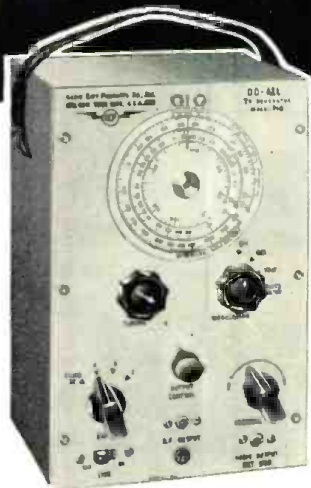

MODEL 740
TV "Do-All" Generator

IT'S A SIGNAL GENERATOR:

Covers every channel (VHF and every IF band on any TV or FM receiver—ALL ON FUNDAMENTALS.

AN AUDIO GENERATOR A MARKER GENERATOR:

Accurate to within 1/10 of 1% on 9-11 megacycle band, and better than 1/2 of 1% overall. Perfect for alignment.

A PATTERN GENERATOR

THE only single easily portable instrument that provides for testing and alignment of: Front Ends, IF's, Horizontal and Vertical Linearity, Syncs, Sweeps, Size, Position, Focus Coil, Deflection, Coil, Ion Trap.

MODEL 740—Complete with \$69.50 NET
output cable, ready to operate



MODEL 808
TV SET & TUBE TESTER
(Includes VT Voltmeter and Reactivator)

ALL IN ONE UNIT:

- A TUBE TESTER
- A CATHODE RAY TUBE TESTER
- A CATHODE RAY TUBE REACTIVATOR
- A VACUUM TUBE VOLTMETER (AC-DC)
- AN OHMMETER

Housed in handsome hand-rubbed oak carrying case with test leads, isolation probe, batteries, etc. Size: 12 1/2" x 12 3/4" x 4 3/4". Weight: 12 lbs.

MODEL 808—Complete, \$99.95 NET
ready to operate

High voltage multiplier Probe for Model 808, extends range of VTVM to 30,000 volts. \$8.95 NET
MODEL No. HVMP-1

Write for the latest RCP Catalog to Dept. RN-10

RADIO CITY PRODUCTS CO., INC.

152 WEST 25th ST • NEW YORK 1, N. Y.



GARRARD

WORLD'S FINEST
AUTOMATIC RECORD
CHANGER



MODEL RC 80
\$42.30 net
less cartridges

3 Speeds
...fully
automatic
with
automatic
stop

Garrard Sales Corp., Dept. R-10
164 Duane St., N. Y. 13, N. Y.
Send GARRARD Fact Sheet.

Name.....
Address.....
City.....Zone.....State.....

Can be used with your present set.

RADIO Surplus Buys

500 KC CRYSTALS

500 KC Crystals in FT 241-A holders with 1/2" pin spc.

ONLY LIMITED QUANTITY AVAILABLE \$1.95 ea.

ALL EQUIPMENT F.O.B. PASADENA UNLESS OTHERWISE SPECIFIED. PLEASE ENCLOSE FULL AMOUNT WITH ORDER

C & H SALES CO.

BOX 356-O.T., East Pasadena Station, Pasadena 8, Calif.

EICO
TEST INSTRUMENTS

Guard

CBS-Columbia Inc.
HIGH STANDARDS OF
TELEVISION PRODUCTION QUALITY



In the CBS-Columbia design laboratories, Al Goldberg takes some important readings with the EICO Model 221 Vacuum Tube Voltmeter and Model 535 Multimeter, as Harry R. Ashley looks on.

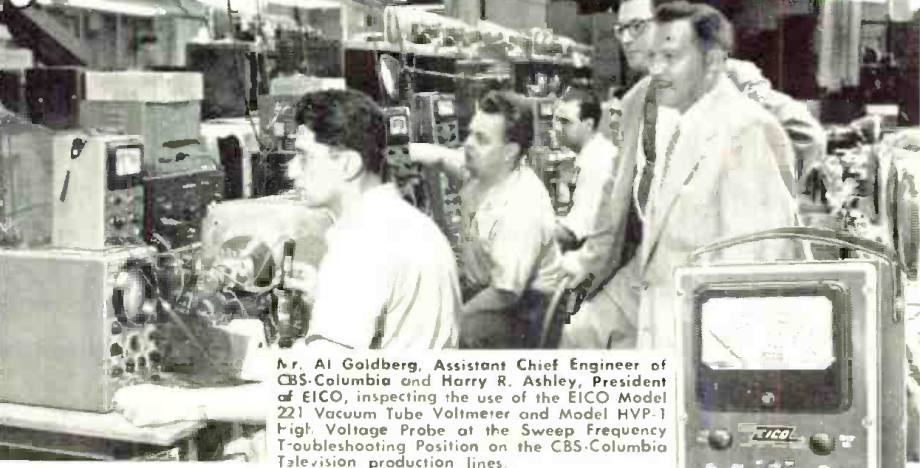

Mr. Al Goldberg, Assistant Chief Engineer of CBS-Columbia and Harry R. Ashley, President of EICO, inspecting the use of the EICO Model 221 Vacuum Tube Voltmeter and Model HVP-1 High Voltage Probe at the Sweep Frequency Troubleshooting Position on the CBS-Columbia Television production lines.



221K VTVM KIT \$25.95
WIRED \$49.95



HIGH VOLTAGE
PROBE \$6.95



425K 5" PUSH-PULL
SCOPE KIT \$44.95 WIRED \$79.95

KITS
WIRED INSTRUMENTS

*For Laboratory Precision at Lowest Cost—
the Leaders Look to EICO!*

WHY does CBS-Columbia, Inc., one of America's great headline-makers in Television set production, use EICO Test Instruments on both its new Television production lines and in its design laboratories?

BECAUSE — like Emerson, Tele-King, Teletone, Majestic, and many another famous TV manufacturer coast to coast, CBS-Columbia knows that . . .

*Only EICO Test Equipment delivers
All 10 EICO nomical Features!*

1. Laboratory Precision
2. Lowest Cost
3. Lifetime Dependability
4. Speedy Operation
5. Rugged Construction
6. Quality Components
7. Latest Engineering
8. Super-Simplified Assembly and Use Instructions
9. Laboratory-Styled Appearance
10. Exclusive EICO Make-Good Guarantee

Before You buy any higher-priced equipment, look at the EICO line—in *Wired and Kit form!* Each EICO product is jam-packed with unbelievable value. *Compare, see EICO instruments today—in stock at your local jobber—and SAVE!* Write NOW for FREE newest Catalog 10-R.

**FOLLOW THE LEADERS
... INSIST ON EICO!**



320K SIG. GEN. KIT \$19.95. WIRED \$29.95

NEW 377K Sine & Square Wave
AUDIO GEN. KIT \$31.95 WIRED \$49.95



950K R-C BRIDGE &
R-L COMP KIT \$19.95
WIRED \$29.95



NEW 214K
VTVM KIT \$34.95
WIRED \$54.95
7 1/2" METER

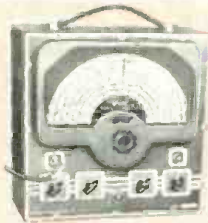

315K DELUXE SIG. GEN. KIT \$39.95
WIRED \$59.95



625K
TUBE TESTER KIT \$34.95
WIRED \$49.95



360K SWEEP GEN. KIT \$34.95
WIRED \$49.95

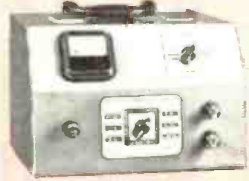

1040K BATTERY ELIM. KIT \$25.95. WIRED \$34.95



1171K RES. DECADE BOX KIT \$19.95
WIRED \$24.95



NEW 536K MULTIMETER KIT \$12.90
WIRED \$14.90
1000 ohms/volt

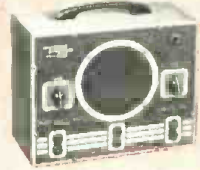

145K SIG. TRACER KIT \$19.95
WIRED \$28.95

NEW CRA PIX TUBE ADAPTOR for above \$4.50

EICO Reg. U. S. Pat. Off.

ELECTRONIC INSTRUMENT CO., Inc.
84 WITHERS STREET, BROOKLYN 11, NEW YORK

©1952 Electronic Instrument Co., Inc.
Prices 5% higher on West Coast. Due to unstable conditions, prices and specifications are subject to change without notice.

*Ready
Now-*

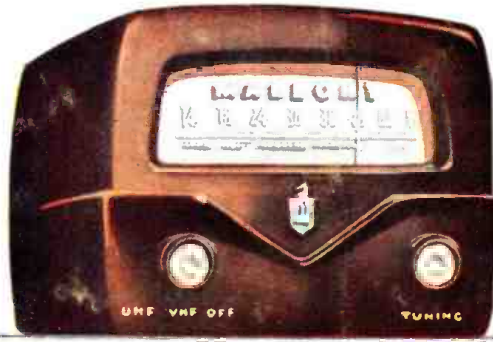

MALLORY **UHF** CONVERTER

to make profits for you when UHF comes to town

Take a look—and you'll agree—that the Mallory UHF Converter really has what it takes to please your customers . . . make sales for you when UHF broadcasts start in your area. It's . . .

Designed to give reception of *all* UHF channels to any TV set without sacrifice of VHF channels.

Built to Mallory precision-standards to insure high quality reception . . . easy to use . . . easy to install.*

Styled in mahogany-finished plastic . . . only 9 inches wide, seven inches high.

Tested and Proved in laboratory and field.

AND THAT'S NOT ALL! The Mallory UHF Converter has a built-in UHF antenna which gives satisfactory reception within reasonable distance of the transmitter.

ASK YOUR MALLORY DISTRIBUTOR TODAY for complete details about the easy-to-sell Mallory UHF Converter. And find out about the advertising and sales promotion campaign that will help you sell more Mallory Converters.

*It IS easy to install

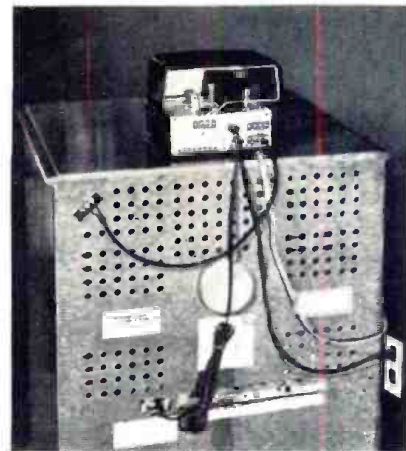

Installation involves just two easy steps in connecting antenna leads and power lines . . . right in your customer's home. No special tools . . . no soldering . . . no long interruption of set use.

*Make Sure . . .
Make it Mallory*

P. R. MALLORY & CO., Inc.
MALLORY

CAPACITORS . . . CONTROLS . . . VIBRATORS . . .
SWITCHES . . . RESISTORS . . . RECTIFIERS . . .
VIBRAPACK* POWER SUPPLIES . . . FILTERS
*Reg. U. S. Pat. Off.

APPROVED PRECISION PRODUCTS

P. R. MALLORY & CO., Inc., INDIANAPOLIS 6, INDIANA