

# RADIO & TELEVISION NEWS

ANC



**AUGUST**  
1952

**35¢**

In Canada 40¢

## IN THIS ISSUE

MICROWAVES FOR THE "HAM"

UNIVERSAL DESIGN CURVES  
FOR TONE CONTROL CIRCUITS

TELEVISION PICTURE TUBE  
REPLACEMENT GUIDE  
(“D&P-Print” No. 3)

THE “DIAL AUDIO” SYSTEM

SERVICING PICTURE TUBES

MULTI-SIGNAL GENERATOR

UNIQUE TV SIGNAL TRACING  
PROBE

IMPROVED SPEECH CLIPPER

CINEMAG ET C RECORDING  
(See Page 46)



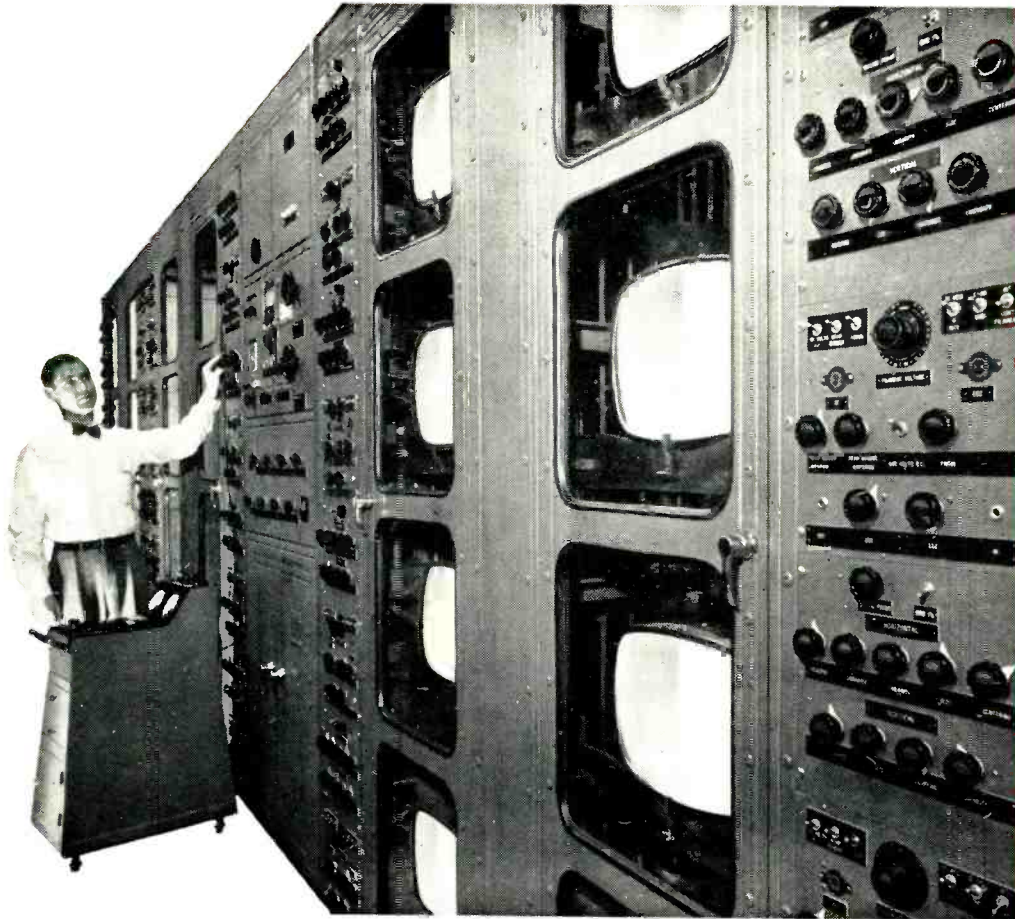

*Specialized racks like these are used to life-test RCA Kinescopes.*

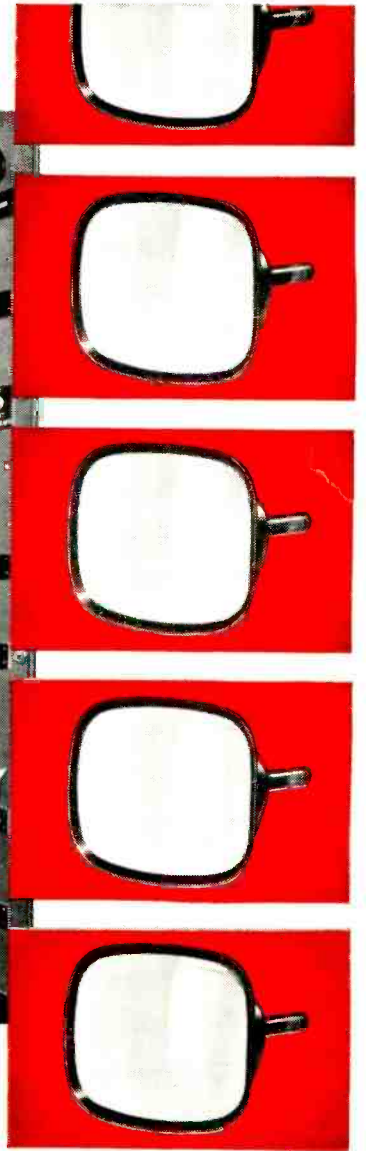

## The Million-Dollar Test Equipment

**... that pays off in better picture tubes**

AT RCA's picture tube plants, constant vigilance over quality is maintained with specialized test equipment valued at well over one million dollars. This huge investment is one reason why RCA picture tubes are the best you and your customers can use.

In one phase of the quality-control program, random samples of picture tubes are taken directly from the pro-

duction lines and subjected to rigorous life tests in racks such as those shown. Any deviation from prescribed quality standards is promptly noted and corrected at the source. In addition, a portion of these samples is given an extended life test equivalent to *years* of actual service in the home.

RCA's constant vigilance at all stages of manufacture is your assur-

ance that only top-quality RCA Kinescopes leave the factory. In this way, RCA closely guards its own reputation . . . and yours as well.

With RCA Receiving Tubes, as well as RCA Kinescopes, TOP-QUALITY CONTROL makes the difference.



**RADIO CORPORATION of AMERICA**  
ELECTRON TUBES

HARRISON, N. J.

TMKS. ®



# I Will Show You How to LEARN RADIO-TELEVISION SERVICING OR COMMUNICATIONS by Practicing in Spare Time



## YOU PRACTICE RADIO SERVICING

You build the modern Radio shown below as part of my Servicing Course. I send you speaker, tubes, chassis, transformer, loop antenna, everything you see pictured and **EVERYTHING** you need to build this modern Radio Receiver. Use it to make many tests, get practical experience.

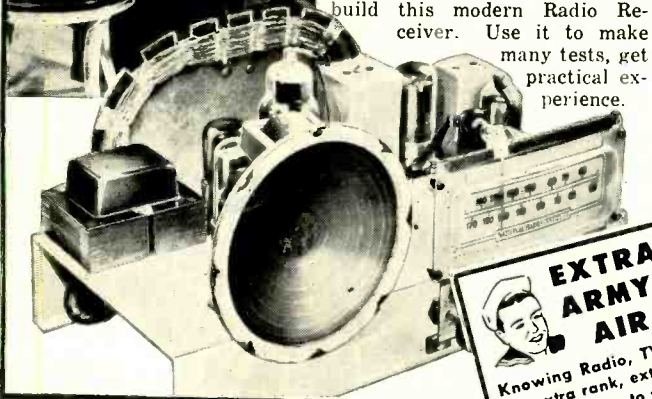

## YOU PRACTICE RADIO COMMUNICATIONS

I send you all the parts to build Transmitter shown below as part of my new Communications Course. Conduct actual procedure of Broadcast Operators, practice interesting experiments, learn how to actually put a transmitter on the air.



**EXTRA PAY IN ARMY, NAVY, AIR FORCE**  
Knowing Radio, TV, Electronics can help you get extra rank, extra prestige, more interesting duty at pay up to several times a private's base pay. You are also prepared for good Radio-TV jobs upon leaving service. Mail coupon TODAY.

**NEW**

## I TRAINED THESE MEN

- "After graduating, worked for servicing shop. Now Chief Engineer of three Police Radio Stations."—S. W. DINDWIDIE, Jacksonville, Illinois.
- "I accepted a position as Radio and Television Technician . . . was promoted to manager of Television Service and Installation."—L. HAUGER, San Bruno, California.
- "Four years ago, a bookkeeper on a hand-to-mouth salary, am now a Radio Engineer ABC network."—N. H. WARD, Ridgely, Park, New Jersey.
- "While learning, made \$5 to \$10 a week in spare time. Now have a profitable spare time shop."—L. ARNOLD, Pontiac, Mich.
- "Have my own shop. An authorized serviceman for five manufacturers and do servicing for 7 dealers."—P. MILLER, Maumee, O.
- "When I enrolled, had no idea it would be so easy to learn. Have equipped my shop out of spare time earnings. I am clearing about \$40 to \$60 a month."—J. D. KNIGHT, Denison, Tex.

## I Will Train You at Home with MANY KITS OF PARTS I SEND

Do you want good pay, a job with a bright future and security? Would you like a profitable shop of your own? The fast growing, prosperous RADIO-TELEVISION industry is making these opportunities for you. Radio alone is bigger than ever. 90 million home and auto Radios, 3100 Broadcasting Stations, expanding use of Aviation and Police Radio, Micro-Wave Relay, Two-Way Radio for buses, taxis, etc., are making opportunities for Servicing and Communications Technicians and FCC-Licensed Operators.

**Many Soon Make \$10 A Week Extra in Spare Time**  
Keep your job while training at home. Hundreds I've trained are successful RADIO-TELEVISION TECHNICIANS. Learn Radio-Television principles from illustrated lessons. Get **PRACTICAL EXPERIENCE** experimenting with circuits common to Radio and Television. Many students make \$5, \$10 a week extra fixing neighbors' Radios in spare time. Special Booklets start teaching you the day you enroll.



**A TESTED WAY TO BETTER PAY...MAIL COUPON NOW**

**Television is TODAY'S Good Job Maker**  
In 1946 only 6,000 TV sets sold. In 1950 over 5,000,000. By 1954, 25,000,000 TV sets will be in use, according to estimates. Over 100 TV Stations are operating in 35 states. Authorities predict there will be 1,000 TV Stations. This means new jobs, more jobs, good pay for qualified men.

**Send Now for 2 Books FREE—Mail Coupon**  
Send for my **FREE DOUBLE OFFER**. Get actual Servicing lesson. Also get my 64-page book, "How to Be a Success in Radio-Television." Read what my graduates are doing, earning. Send coupon in envelope or paste on postal. J. E. SMITH, President, Dept 2HE, National Radio Institute, Washington 9, D. C. OUR 39TH YEAR.

**Good for Both—FREE**

**MR. J. E. SMITH, President, Dept. 2HE  
National Radio Institute, Washington 9, D. C.**  
Mail me **FREE** Lesson and 64-page book.  
(No salesman will call. Please write plainly.)

NAME.....AGE.....  
ADDRESS.....  
CITY.....ZONE.....STATE.....

Approved for Training Under G. I. Bill

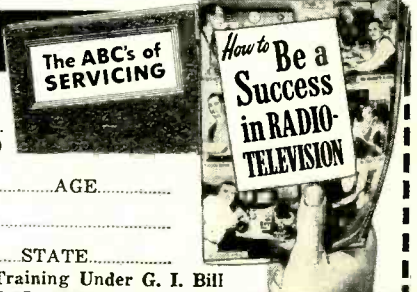

RADIO & TELEVISION NEWS is published monthly by the Ziff-Davis Publishing Company at 185 N. Wabash Ave., Chicago 1, Ill. Entered as second-class matter, July 21, 1948, at the Post Office, Chicago, Ill., under the act of March 3, 1879. Authorized by Post Office Department, Ottawa, Canada as second-class matter. SUBSCRIPTION RATES: Radio & Television News—one year, U. S. and Possessions, Pan-American countries, and Canada \$4.00; all other foreign countries \$5.00; Radio-Electronic Engineering Edition—one year, U. S. and Possessions, Pan-American countries, and Canada \$6.00; all other foreign countries \$7.00. Postmaster—Please return undelivered copies under form 3589 to 64 E. Lake St., Chicago 1, Ill.

Editor  
**OLIVER READ, D.Sc., D.Litt.**

Managing Editor  
**WM. A. STOCKLIN, B.S.**

Technical Editor  
**H. S. RENNE, M.S.**

Associate Editor  
**HAROLD BECKER**

Service Editor  
**CHARLES TEPPER**

Assistant Editor  
**P. B. HOEFER**

Television Consultant  
**WALTER H. BUCHSBAUM**

Short-Wave Editor  
**KENNETH R. BOORD**

Staff Artist  
**FRANK SAYLES**

Draftsmen  
**A. A. GANS, W2TSP**  
**J. A. GOLANEK**

Advertising Manager  
**L. L. OSTEN**

Midwest Adv. Manager  
**JOHN A. RONAN, JR.**

Western Adv. Manager  
**JOHN E. PAYNE**

Color Art Editor  
**HERMAN R. BOLLIN**



COVER PHOTO: Robert Mitchum, star of the Wald-Krasna production "The Lusty Men," on location. RCA's portable magnetic recorder-reproducer equipment was used in this filming. (Ektachrome by J. Dale Healy and Alex Kahle)

Chairman of the Board and Publisher  
**WILLIAM B. ZIFF**

President  
**B. G. DAVIS**

Secretary-Treasurer  
**G. E. CARNEY**

Vice-Presidents  
**H. J. MORGANROTH**  
Production Director

**LYNN PHILLIPS, JR.**  
Advertising Director

**H. G. STRONG**  
Circulation Director

**BRANCH OFFICES**

CHICAGO (1)  
185 N. Wabash, AN 3-5200  
LOS ANGELES (14)  
815 S. Hill St., TUCKER 9213

# RADIO & TELEVISION NEWS

Reg. U.S. Pat. Off.

Radio News Trademark Reg. U. S. Pat. Office • Television News Trademark Reg. U.S. Pat. Office.

First in  
radio-television-electronics

Average Paid Circulation over 200,000

## CONTENTS

## AUGUST, 1952

Microwaves for the "Ham".....	Samuel Freedman, W6YUG	31
Audio Goes Mobile.....		35
Servicing Picture Tubes.....	John B. Ledbetter	36
Electronic Growth in the Pacific Southwest.....	S. K. Painter	38
The R.C.O.—A Remote Control Oscillator.....	John F. Clemens, W9ERN	40
Universal Design Curves for Tone-Control Circuits (Part 2).....	M. B. Knight	42
The Multi-Signal Generator.....	Louis E. Garner, Jr.	44
Cinemagnetic Recording.....	A. C. Blaney	46
Unique Sound Alarm for Deaf Persons.....	H. G. Davis, Jr., M.D.	48
The TV Picture Tube.....	Walter Buchsbaum	50
Television Picture Tube Replacement Guide—Data-Print 4 (Insert).....		51
Constant K Type High-Pass Filter Design.....	Seizo Yamasita	54
An Improved Speech Clipper.....	L. C. Watkins, Jr., W5JXO	55
A Unique TV Signal Tracing Probe.....	E. G. Louis	58
Mac's Radio Service Shop.....	John T. Frye	60
The "Dialaudio" System.....	Budd Meyer	61
Industrial Electronics.....	Ed Bukstein	64
Convert Your Signal Generator into a Grid-dip Oscillator.....		
.....	Hartland B. Smith, W8VVD	66
WCEMA-IRE West Coast Meet.....	Ralph L. Power	80
What Is Eidophor?.....		94
Radio-TV Service Industry News.....		134

### DEPARTMENTS

For the Record.....	The Editor	8	What's New in Radio.....	76
Spot Radio News.....		16	Manufacturers' Literature.....	88
Within the Industry.....		24	Reel Review.....	98
Short-Wave.....	K. R. Boord	65	New TV Products.....	118
Technical Books.....		124		



VOLUME 48 • NUMBER 2



Member  
Audit Bureau of  
Circulations

Editorial and Executive Offices, 366 Madison Ave., New York 17, N. Y.

**SUBSCRIPTION SERVICE:** All communications concerning subscriptions should be addressed to Circulation Dept., 64 E. Lake St., Chicago 1, Ill. Subscribers should allow at least two weeks for change of address.

**CONTRIBUTIONS:** Contributors are advised to retain a copy of their manuscripts and illustrations. Contributions should be mailed to the New York Editorial Office and must be accompanied by return postage. Contributions will be handled with reasonable care, but this magazine assumes no responsibility for their safety. Any copy accepted is subject to whatever adaptations and revisions are necessary to meet the requirements of this publication. Payment covers all author's, contributor's, and contestant's rights, title, and interest in and to the material accepted and will be made at our current rates upon acceptance. All photos and drawings will be considered as part of the material purchased.

Copyright 1952 by Ziff-Davis Publishing Company. All rights reserved.

**RADIO & TELEVISION NEWS**

"PREPARE NOW... IN SPARE TIME AT HOME TO GET INTO

# TELEVISION RADIO - ELECTRONICS

*says*  
**ART LINKLETTER!**



## Tells Why "People Are Funny" Program Relies On D. T. I. In Program Tie-Ups.

"Most people would be just as amazed as we are if they were privileged to see the remarkable results obtained through DeForest's Training, inc.'s laboratory and home study training program," declared Art Linkletter, star of one of the nation's most popular radio network shows "People Are Funny."

"There have been many examples through the years," said Linkletter, "but let me cite you one to illustrate my point. One of our winning contestants who won a scholarship to D.T.I.'s Chicago laboratory was a wounded war veteran.

"This young man lost his left arm on the battlefield. Although he had no previous training, and had a hook for a left hand, he was prepared so effectively to be a television technician that after he completed his training he was able to establish his own profitable television and radio service shop. Imagine what this same training could do for the ambitious young man who is not impaired by the same handicap," said Linkletter.

"We must be careful of the quality of the gifts we give on our program. They must be tops. We also must watch the integrity of those who give them. Never once in all of the years that we have done business with DeForest's Training, Inc., have they ever failed to keep their word. Almost on all occasions their gifts far exceeded their obligations."



R-F SIGNAL GENERATOR

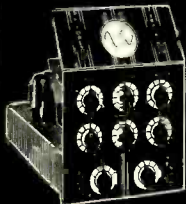

OSCILLOSCOPE

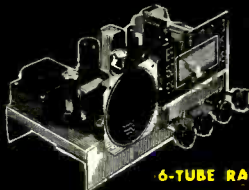

6-TUBE RADIO

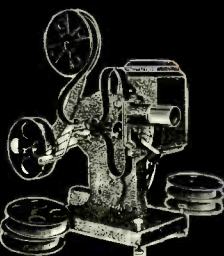

HOME MOVIES



MULTIMETER

### ENJOY YOUR OWN HOME LABORATORY

In addition to modern lessons, you get the PRACTICAL EXPERIENCE YOU NEED from working over 300 electronic experiments at home, including building and keeping all of the electronic equipment shown above. You also get the use of a motion picture projector and 16 reels of visual film to help you learn important points FASTER... EASIER at home. And upon completing training, you also have the optional privilege of building and keeping a 17-INCH TV SET at moderate added cost. Send for full facts. Mail coupon today!



### MILITARY SERVICE!

If subject to military service, the information we have for you should prove very helpful. Mail coupon today.



## JACK DEMPSEY Tells Why

FORMER WORLD'S HEAVYWEIGHT CHAMPION

## He's Proud To Be With D. T. I.

1. I have been greatly impressed with D.T.I.'s wonderful spirit of friendliness and sincere determination to help its students make good in Television-Radio-Electronics.
2. I admire its remarkable 20 year record of helping men build brighter futures.
3. I also admire the business policy of its management and the thoroughness of its large faculty of instructors.
4. Never have I heard young men praise a school as enthusiastically as do the students and graduates of D.T.I. They are its best boosters.



**ACT NOW! MAIL COUPON TODAY!**  
Get BOTH of these publications FREE!

**DE FOREST'S TRAINING, INC.**

2533 N. Ashland Ave., Chicago 14, Ill.

I would like your Opportunity News Bulletin showing "89 Ways to Earn Money in Television-Radio-Electronics"; also, the folder showing how I may prepare to get started in this thrilling field.

Name \_\_\_\_\_ Age \_\_\_\_\_

Address \_\_\_\_\_ Apt. \_\_\_\_\_

City \_\_\_\_\_ Zone \_\_\_\_\_ State \_\_\_\_\_

RN-8-1

"ONE OF AMERICA'S FOREMOST TELEVISION TRAINING CENTERS"

**De FOREST'S TRAINING, INC.**  
AFFILIATED WITH  
**De VRY Technical INSTITUTE**  
CHICAGO 14, ILLINOIS

# SMASH HIT!

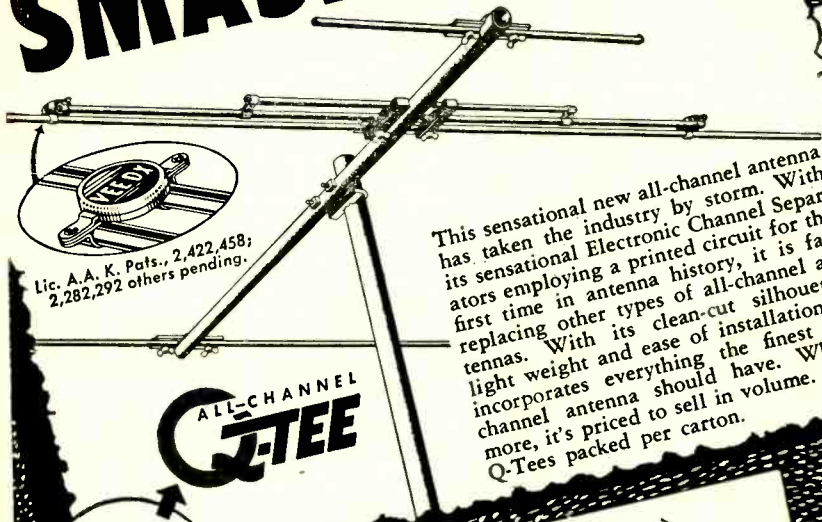

Lic. A.A.K. Pats., 2,422,458;  
2,282,292 others pending.

ALL-CHANNEL  
**Q-TEE**

This sensational new all-channel antenna has taken the industry by storm. With its sensational Electronic Channel Separators employing a printed circuit for the first time in antenna history, it is fast replacing other types of all-channel antennas. With its clean-cut silhouette, light weight and ease of installation, it incorporates everything the finest all-channel antenna should have. What's more, it's priced to sell in volume. Four Q-Tees packed per carton.

## KEEP AHEAD WITH VEE-D-X

**NEW**

### STACKED ARRAYS OF THE Q-TEE

#### Q-TEE QUAD

The ultimate in a four-stacked array for fringe areas. Supplied complete with necessary harnesses. Shipped one to a carton.

#### Q-TEE DOUBLE

A double-stacked array complete with harness. Two Doubles packed per carton.

### THE GREATEST FRINGE AREA YAGI

**41% MORE GAIN**  
THAN THE BEST FIVE ELEMENT YAGI

Here is the original and most powerful eight element Yagi ever produced. Produces as much gain as a double-stacked Yagi array yet it costs less, is easier to install, and provides better rooftop appearance. Only VEE-D-X makes the Long John. Beware of Chinese copies.

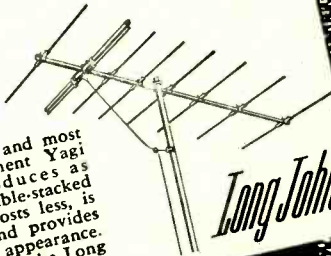

*Long John*

### OUTBOARD BOOSTER

Now available with By-pass Switch and priced at only

**\$22<sup>95</sup>**

With Switch

For single channel use, delivers powerful 18 db gain with full 5 megacycle bandwidth. By-pass switch permits single channel boosting on all-channel antenna.



### The Sensational MAST-MOUNTED ROCKET

- 18 DB Gain
- Easy to Install
- Low in Price



Amplifies signal at antenna height where most favorable signal-to-noise ratio exists. Powerful 18 db gain. Easy to install and lower priced. Uses 300 ohm transmission line to both operate the booster and receive the amplified signal.

### New! Improved MIGHTY MATCH

Here it is! The new, improved MIGHTY MATCH that permits the use of a single 300 ohm transmission line between separate high and low channel antennas mounted on the same mast. Saves transmission line — saves installation time and money — saves extra accessory costs. Now, a compact single unit, 3 1/4 inches long, 2 1/4 inches wide, and 1/4 inch thick, replaces the former four-cartridge style. Firehouse-red, weather-proof polystyrene case houses printed circuit.

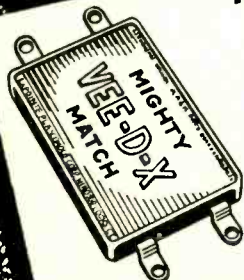

Lic. A.A.K. Pats., 2,422,458;  
2,282,292 others pending.

BE SAFE . . . BE SURE!

FEATURE  
**VEE-D-X**  
LIGHTNING ARRESTERS



THE LAPOINTE-PLASCOMOLD CORPORATION  
Rockville, Connecticut

praised to the skies...  
for precision

# hallicrafters

Everyone in radio knows that Hallicrafters is the Brand Name for "precision". Priced from \$49.50 to \$199.50, these four receivers have in common the utmost performance to be found at each price level. This performance is achieved only through the matchless engineering and precision craftsmanship that is the tradition of Hallicrafters.



**TOP HAM PERFORMANCE**—The **SX-71**—Expressly designed for the advanced amateur, Communications Receiver SX-71 is a double conversion set, built-in NBFM limiter stage. 538 kc to 35 Mc, 46-56 Mc in 5 bands. Temperature comp.; voltage regulator. 1 r-f, 2 conversion, 3 i-f stages. Xtal. filter, 3-position selectivity. 115 V AC, 11 tubes, regulator, rectifier. . . . . \$199.50

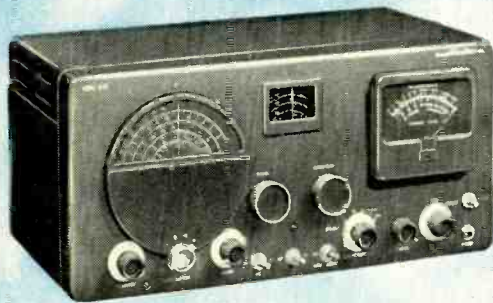

**"FIRST IN SELECTIVITY"**—The **S-76**—Hallicrafters new communications receiver with amazing selectivity. Double conversion with 50 kc 2nd i-f. Giant 4-in. "S" meter. 540-1580 kc, 1.72-32 Mc in 4 bands. 1 r-f, 2 conversion, 2 i-f stages. 5 position selectivity. Phono input jack, 3 watt output. 115 V. AC 9 tubes, regulator, rectifier. . . . . \$169.50



**MEDIUM-PRICED COMMUNICATIONS RECEIVER**—**S-40B**—540 kc to 43 Mc in 4 bands. Electrical band spread. Temperature compensated. 1 r-f, 2 i-f. 3 watt output. Built-in speaker. 115 V AC only, 7 tubes, plus rectifier. (S-77—same as S-40B, for 115 V. AC or DC) \$99.95

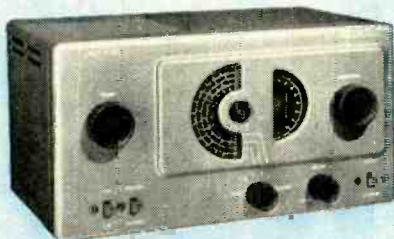

**OVER HALF A MILLION SOLD!**—The **S-38C**—Value-packed with performance, the S-38C is the outstanding low priced set on the market. 540 kc to 32 Mc in 4 bands. Maximum sensitivity per tube—far outperforms ordinary broadcast sets. Built-in speaker. 115 V. AC or DC. 4 tubes plus rectifier . . . . . \$49.50

WORLD'S LEADING MANUFACTURER OF PRECISION  
RADIO AND TELEVISION • CHICAGO 24, ILLINOIS



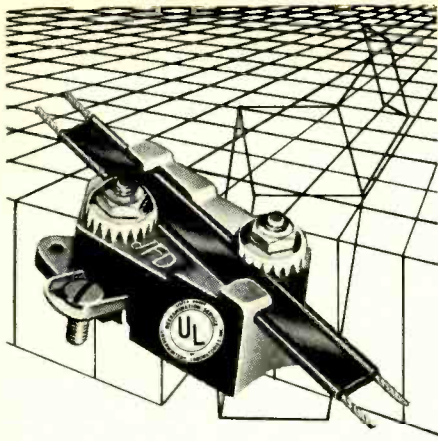

"LITTLE GIANT"

TV lightning arresters

millions sold!

because they have proved their worth in safety and sales!

no. AT105 \$1.25 list  
no. AT105S \$1.50 list (with strap)



write for Form No. 84

JFD Mfg. Co.

Brooklyn 4, N. Y.

BEensonhurst 6-9200

world's largest manufacturer of TV antennas & accessories

# For the RECORD.

BY THE EDITOR

## A REPORT ON EIDOPHOR—FCC, PLEASE NOTE!

THE long-awaited and much-touted CBS *Eidophor* color TV projection system (see page 94) made its initial bow in New York City, Wednesday, June 25 at a closed preview. We had looked forward for many months to the opportunity to compare the new CBS projection system with that demonstrated last fall by RCA. We had anticipated at least a comparable quality of color projection and had even hoped that we might see major (or even minor) improvements over those systems which we had viewed on previous occasions.

Such was not the result and the telecast, being transmitted via closed circuit, was under way less than a minute before we found ourself reaching for a pencil to make suitable observation notes.

Our first note was that the production appeared quite fuzzy and that there was a distinct multiple ghost-like effect on the right side of the emcee. Vertical colored stripes remained on the left side of the screen during the entire half-hour show and, except for occasional close-ups, the registration was far inferior to that seen at the RCA demonstration.

Our next note was favorable. The color renditions of red and blue were excellent, especially on a close-up. The only times that we considered over-all reproduction to be acceptable was during the many close-ups, but here again there was a noticeable effect in the changing from tan to light flesh color of the performers. Continuing our notations, we find an underscored reference "colors fade out on left." The effect was that not only did the over-all production lose its sharpness, but became washed out progressively towards the left-hand side of the screen.

One of the outstanding qualities of the RCA system, which we well remember, was that costume jewelry or other gold colors were startlingly true. With the *Eidophor* system, gold appears as a faded yellow, at least at this particular demonstration.

An excellently produced choreographic sequence with the chorines dressed in vivid colors was very startling in its realism. However, and par-

ticularly on the long shots, the skin tones varied between tan and near white. A short boxing skit with two professional heavyweights served to show the dramatic effects possible with any color system. Here was realism at its best!

Other notations include "shirt color (lavender) on head." This refers to a dramatic skit which included the principal actor dressed in a lavender sport shirt. This lavender color also appeared on the actor's face (unintentionally) directly below the hair-line and was quite noticeable.

From a technical viewpoint, we were attempting to identify a peculiar traveling white spot that slowly made its way from left to right across the screen. It looked like two inverted kidney beans. There were additional weird effects that appeared on the lower right of the screen and these appeared to be reflections being picked up by part of the lens system, either from cameras or through the projection medium. Our final notation refers to the "stroboscopic effect" during any fast movement. It was particularly noticeable as a dancer with a whirling skirt concluded her routine. Individual vertical color bars replaced the patterns on the skirt and were very conspicuous. This illusion would be most bewildering to the layman.

All in all, and in fairness to the *Eidophor* system, it should be mentioned that according to the developers, "the medium is not as yet perfected." We heartily agree with that statement.

Following our notations, we went to the extremities of the theater to witness the color from approximately 100 feet. We attempted to analyze the effect from the standpoint of the average movie-goer and came to the conclusion that the *Eidophor* system, as demonstrated, would in no way compare favorably with our accepted standards for *Technicolor* movies and as far as the TV medium is concerned, we are more convinced than ever before that the public, if given the opportunity, would certainly choose the system which the FCC did not see fit to wait for. . . . . O.R.

RADIO & TELEVISION NEWS



always in stock at  
**ALLIED!**

# HICKOK TEST INSTRUMENTS

Precision

### Model 533AP Tube Tester

Dynamic Mutual Conductance portable tester for radio and TV technicians. Reads in micromhos—tests tubes under simulated operating conditions. Tests all type tubes including miniature and subminiature. Accurately detects weak, borderline tubes; checks for gas. Carrying case has detachable cover. For 110-130 volts, 50-60 cycle AC. Size, 16 $\frac{1}{4}$  x 18 $\frac{3}{4}$  x 7 $\frac{1}{2}$ ". Shpg. wt., 33 lbs. **84-187. Net. \$168.00**

**Model 533AC.** As above, but in counter-type blue enameled steel case. Size, 17 $\frac{1}{2}$  x 18 $\frac{1}{2}$  x 6". Shpg. wt., 32 lbs. **84-186. Net. \$168.00**

**Model 539A.** Lab model; measures mutual conductance in micromhos; vernier adjustment. Durable leatherette case. For 110-130 volts, 50-60 cycle AC. Size, 16 $\frac{1}{4}$  x 18 $\frac{3}{4}$  x 7 $\frac{1}{2}$ ". Shpg. wt., 39 lbs. **84-180. Net. \$271.50**

### Model No. 600A Tube Tester

Dynamic Mutual Conductance tester for highly accurate radio servicing, and for lab and industrial applications. Tests for gas content; reads in micromhos; applies separate voltage to each element; easily detects weak tubes. Triple-scale meter has ranges of 0-3000-6000-15,000 micromhos and REPLACE—?—GOOD. Replaceable roll chart gives setup data at a glance. Leatherette-covered case. Size: 16 $\frac{1}{4}$  x 7 $\frac{1}{2}$  x 11 $\frac{1}{2}$ ". For 110-130 volts, 50-60 cycles AC. Shpg. wt., 21 lbs. **84-185. Net. \$155.00**

**Model 605.** As above, but has built-in VOM. A compact, low-cost portable tube and set tester. Shpg. wt., 27 lbs. **84-189. Net. \$167.60**

**Cathode Ray Tube Tester Adapter.** For use with tube testers above; permits checking of all present TV picture tubes without removing tube from set. Shpg. wt., 1 lb. **84-184. Net. \$9.90**

### Model No. 680 VHF-UHF Marker Generator

A new RF signal and marker generator. For aligning VHF and UHF TV front ends. Provides crystal calibrated markers from 53-89 mc and 174-217 mc on fundamentals and from 522-651 mc and 696-868 mc on harmonics. A magic eye insures accurate calibration. Choice of 3 calibrating crystals is provided by front panel switch (a 2.5 mc crystal is supplied). RF output, .15 v. Portable steel case, 11 $\frac{1}{2}$  x 9 x 6". For 110-130 v. 50-60 cycle AC. With tubes. Shpg. wt., 18 lbs. **84-188. Net. \$129.50**

### Model 650 Videometer

A specialized signal generator for quickly localizing any TV trouble. Fundamental output on all 12 channels. Can be externally video modulated on all channels. Crystal-controlled circuit generates 60-900-15,750 cycle and 315 kc video pulses—produces horizontal and vertical bar patterns individually, or together; also dot pattern. Pulses also available externally; metered in peak-to-peak. Has 1 to 100,000 microvolt calibrated attenuator. Has video amplifier with substitution in TV set. Reads AC line voltage. Blue Hammertex case, 13 x 16 x 7". With test leads, output cable, and instructions. For 105-125 volts, 50-60 cycles. Shpg. wt., 40 lbs. **84-183. Net. \$310.90**

180° phase control, for use as substitution amplifier. Sawtooth outputs for

### Model 610A TV Alignment Generator

For complete visual alignment of TV receivers—only a scope is required. Covers 10-250 mc with 0-15 mc variable sweep width, for alignment of RF on all 12 channels, alignment of sound and video IF's, and alignment of traps. Provides both pip oscillator markers and absorption markers, directly calibrated from 20-48 mc. Output multiplier is 5-stage type, with vernier control. Attenuator accuracy, 5%. Panel jack takes separate calibrating crystals (not supplied) for local channels. Also provides horizontal sweep voltage (phasing control). Standby switch. In blue Hammertex steel case, 14 x 16 $\frac{1}{2}$  x 7". Less crystals. For 105-125 v., 50-60 cycles. Shpg. wt., 35 lbs. **84-139. Net. \$219.00**



**Model 630.** TV voltage calibrator. Permits exact peak-to-peak voltage measurements—regardless of waveform. Size, 11 $\frac{1}{4}$  x 8 $\frac{1}{2}$  x 6". For 110-120 volts, 50-60 cycles. Wt., 15 lbs. **84-176. Net. \$87.50**

**Model 292X Microvolt Signal Generator.** Covers 125 kc to 110 mc and 150-220 mc, on fundamentals, with 1.0% accuracy. Size: 14 x 16 $\frac{1}{2}$  x 7". With cables and 1000 kc crystal. For 105-125 v., 50-60 cy. AC. Shpg. wt., 36 lbs. **84-145. Net. \$266.00**

### New Model 670 5" Oscilloscope

For the service technician. Direct-coupled, P-P amplifiers for vertical and horizontal deflection provide perfect square wave response on low frequency signals. Vertical amplifier has useable response beyond 2 mc. Horizontal amplifier response from 0 to 100 kc. Sensitivity: vertical amplifier, 10 millivolts rms per inch; horizontal amplifier, 70 millivolts rms per inch. Input impedance: vertical amplifier, 2.2 meg and 30 mmf; horizontal amplifier, 1 meg and 35 mmf. Recurrent linear sweep from 3 to 50,000 cps and fixed sweeps at 30 and 7,875 cps. Demodulator for viewing modulation on RF signals. Line phasing control. Internal 60 cycle or external Z-axis modulation. Hammertex blue case, 12 $\frac{1}{4}$  x 9 $\frac{1}{2}$  x 18". Complete with 5UP1 CRT, tubes and instructions. For 105-125 volts, 50-70 cycles AC. Shpg. wt., 35 lbs. **84-160. Net. \$199.98**

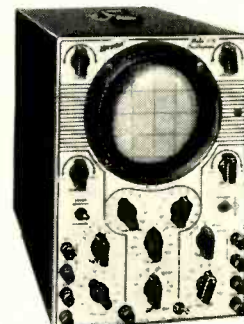

**Model 640 5" Oscilloscope.** Professional quality. Response: 0-4.5 mc (down only 3 db). Vertical—10 mv/inch (low sens. pos. 25 mv/inch); horizontal—50 mv/inch full gain, 20 v/inch direct. Size: 14 x 11 $\frac{1}{4}$  x 19". For 105-125 v., 60 cycles. Shpg. wt., 45 lbs. **84-179. Net. \$355.00**

**Model 34 Probe.** For above scopes; extends RF range to 500 mc. Shpg. wt., 1 $\frac{1}{2}$  lbs. **84-138. Net. \$9.80**

### Model 209A Electronic VOM

Lab-size instrument. Zero-center scale for fast discriminator alignment. Measures AC rms and peak-to-peak volts directly from 30 cycles to 300 megacycles. 42 ranges: AC-DC volts, 0-3-12-30-120-300-1200; DC current, 0-3-12-30-120-300-1200 ma; resistance, .1 ohm to 10,000 megs in 8 ranges; capacity, 0-10,000 mmf and 0-1000 mfd (7 ranges); inductance, 50 mh to 100 henries; db, -20 to -25 in 3 ranges; AC peak-to-peak volts, 0-3-12-30-120-300. Input impedances: DC, 12 megs; AC, 12 megs and 6 mmf. 9" meter has easy-to-read scales. Separate jack for 1200 volt AC range. Case is blue Hammertex; 16 $\frac{1}{4}$  x 13 $\frac{1}{4}$  x 7". With tubes, high-frequency probe, leads. For 105-125 v., 60 cycle AC. Wt., 25 lbs. **84-136. Net. \$132.50**



**Model PR30A Probe.** High voltage DC probe for use with above. Extends range to 30,000 volts DC. With 4-foot cable and connector. Shpg. wt., 1 $\frac{1}{2}$  lbs. **84-149. Net. \$11.90**

**Model 450 VOM.** Lightweight, portable general-purpose VOM: 5" meter; high sensitivity; 20,000 ohms/volt on DC; 5000 ohms/volt on AC. Only 8 $\frac{3}{4}$  x 5 $\frac{3}{4}$  x 2 $\frac{1}{2}$ ". Shpg. wt., 4 lbs. **84-182. Net. \$46.50**

**Model 215 VTVM.** A professional unit of high accuracy. Reads RMS and peak-to-peak AC volts (7 ranges each), and DC volts: 0-1.5, 3-12-30-120-300-1200. 5" meter. 8 $\frac{3}{4}$  x 5 $\frac{3}{4}$  x 4 $\frac{1}{2}$ ". Shpg. wt., 8 lbs. **84-181. Net. \$67.50**

All HICKOK instruments are available on ALLIED'S Easy Terms: Only 15% Down, 12 Full Months to Pay

## FREE 212-PAGE 1952 BUYING GUIDE

Send today for ALLIED's authoritative, complete catalog, listing the world's largest stocks of tubes, parts, test instruments, audio equipment, industrial components—everything in electronics at lowest prices. Look to ALLIED for speedy delivery, expert personal help and complete satisfaction. Get your FREE catalog now.



# ALLIED RADIO

ALLIED RADIO CORP., Dept. 1-H-2  
833 W. Jackson Blvd., Chicago 7, Illinois

Send FREE 1952 ALLIED Catalog

Please ship the following HICKOK instruments:

..... \$ ..... enclosed

Name .....

Address .....

City .....

Zone .....

State .....

# SPECIAL INTRODUCTORY OFFER!

*the Sensational New*

## GONSET

# ROCKET

ALL CHANNEL  
TV ANTENNA

*Tomorrow's Antenna Today!*

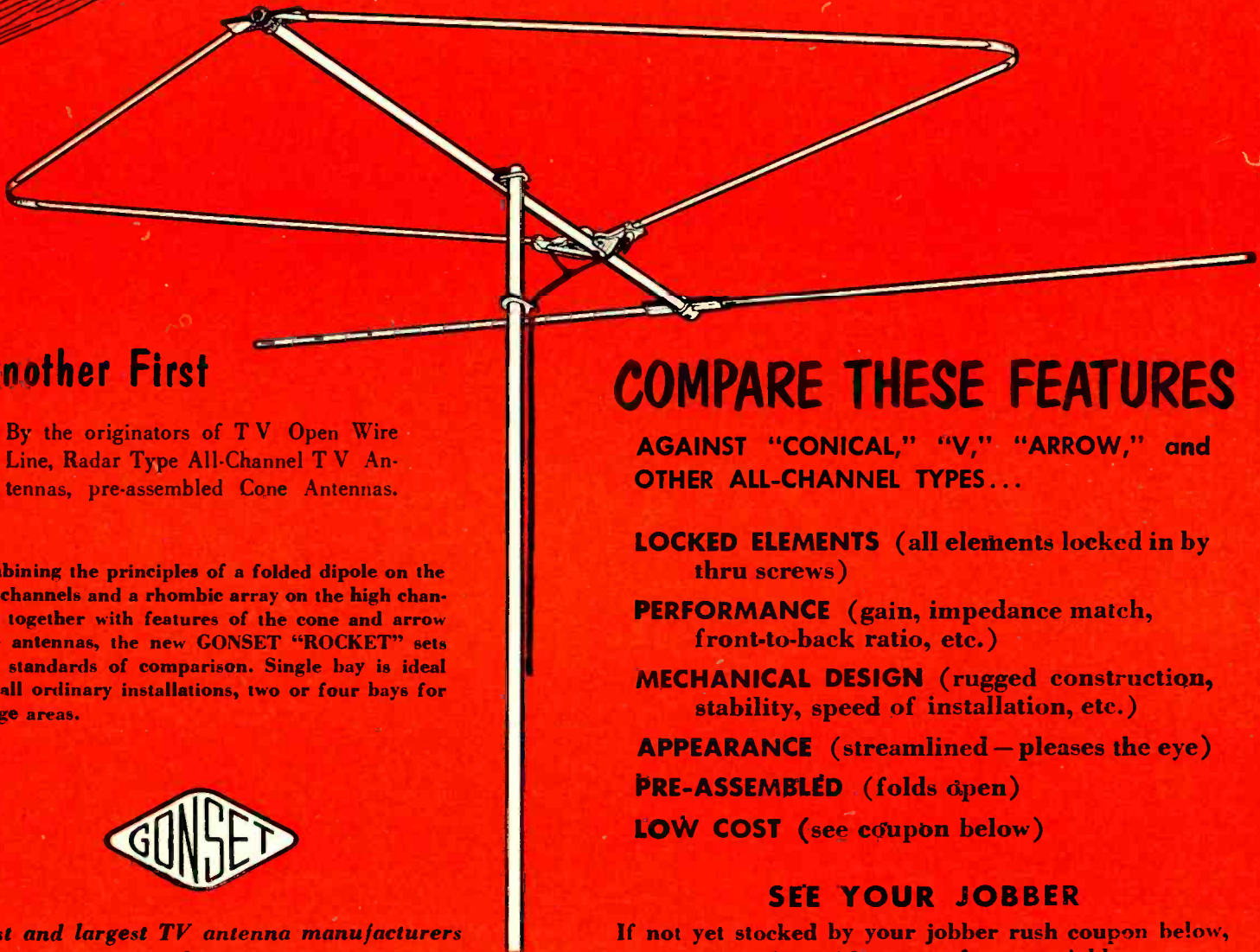

### Another First

By the originators of TV Open Wire Line, Radar Type All-Channel TV Antennas, pre-assembled Cone Antennas.

Combining the principles of a folded dipole on the low channels and a rhombic array on the high channels together with features of the cone and arrow type antennas, the new GONSET "ROCKET" sets new standards of comparison. Single bay is ideal for all ordinary installations, two or four bays for fringe areas.



*Oldest and largest TV antenna manufacturers in the west*

### COMPARE THESE FEATURES

AGAINST "CONICAL," "V," "ARROW," and OTHER ALL-CHANNEL TYPES...

**LOCKED ELEMENTS** (all elements locked in by thru screws)

**PERFORMANCE** (gain, impedance match, front-to-back ratio, etc.)

**MECHANICAL DESIGN** (rugged construction, stability, speed of installation, etc.)

**APPEARANCE** (streamlined - pleases the eye)

**PRE-ASSEMBLED** (folds open)

**LOW COST** (see coupon below)

### SEE YOUR JOBBER

If not yet stocked by your jobber rush coupon below, together with name of nearest jobber.

GONSET CO., 801 S. Main St., Burbank, California.

Please RUSH SAMPLE GONSET "ROCKET" on 2 week MONEY BACK basis.

		List	Net
#1506	<input type="checkbox"/> one GONSET "ROCKET" (less mast) . . . . .	\$ 6.45	\$ 3.87
#1508	<input type="checkbox"/> one GONSET "ROCKET" (with 8' mast) . . . . .	9.35	5.61
#1510	<input type="checkbox"/> one GONSET "ROCKET" (2 Bay, less mast) . . . . .	15.02	9.01
#1511	<input type="checkbox"/> one GONSET "ROCKET" (4 Bay, less mast) . . . . .	29.85	17.91
	<input type="checkbox"/> Send bulk quantity net price list		

All prices F.O.B. Burbank, Calif.

Name \_\_\_\_\_

Address \_\_\_\_\_

City \_\_\_\_\_ Zone \_\_\_\_\_ State \_\_\_\_\_

Jobber's Name \_\_\_\_\_

Address \_\_\_\_\_

City \_\_\_\_\_ Zone \_\_\_\_\_ State \_\_\_\_\_

# TRAIN

# for Security! Good-Paying Jobs!

## MAKE THE MONEY YOU'VE ALWAYS DREAMED OF!



# LEARN RADIO -TELEVISION

## AND ELECTRONICS BY EASY SHOP METHOD TRAINING AT HOME!

**You get  
all the parts—even tubes!—**  
for this modern Superheterodyne Receiver. You learn to build it step by step. And you keep it! Get all the facts. Mail coupon now.

Let **NATIONAL SCHOOLS**—a resident-training school for nearly 50 years—train you at home for today's unlimited opportunities in Radio-Television-Electronics. National Schools is one of the largest schools of its kind. It is located in Los Angeles—the center of Radio and TV world! It has four large buildings of modern shops and labs. Its faculty is considered tops in the business.



You learn from lessons prepared by experienced instructors and engineers. Men who are successful Radio and Television technicians. Men who have trained 1000's of men like YOU!



## FREE BOOK TELLS YOU HOW!

Page after page—in color—tells you everything you want to know. Mail the coupon. Get this valuable book today. And if you hurry—YOU GET A FREE SAMPLE LESSON, TOO! Shows how easy National Schools Home Training is. Mail the coupon today.

### Today's Shortage of Trained Technicians Creates Chance of a Lifetime For You!

Think of it! With guided missiles, radar, and other electronic devices so important to national defense! With big, new developments in TV. With over 90,000,000 home and auto radios, over 12,000,000 TV sets. With more than 3100 radio stations...over 100 TV stations—and more building every day...yes, imagine the great opportunity you have today! YOU are wanted in Radio-Television-Electronics! America's fastest-growing field. High-pay jobs—the kind you've always wanted—are waiting for YOU!

### Job Security! Big Money! For YOU! in Today's Expanding Industries!

Trained Radio and Television technicians really make important money these days. Thousands of National Schools graduates—men just like you—are earning good money all over the country. Why not you? And—National Schools graduates get the personal satisfaction of being highly-skilled technicians. Men people respect. Men who enjoy their work—rather than having to drag along in just any old job.

### National Schools Has Trained 1000's of Successful Men! Why Not YOU?

In almost every state—and many foreign countries—National Schools graduates are filling big jobs with famous companies. Or running their own successful businesses. What are YOU waiting for? National Schools training is complete training. So when you graduate you can take advantage of today's big opportunities in Radio-Television-Electronics—fast.

### You Train At Home—In Your Spare Time

National Schools Shop Method Home Training gives you basic and advanced instruction in all phases of Radio-TV-Electronics. And remember—your training is based on resident school training principles. You learn fast from hundreds of diagrams and pictures. All instructions are written by experienced technicians who work in Radio and TV every day. All instructions have been developed and tested in National Schools' own labs and studios, which are equipped with the latest RCA equipment. No wonder this National Schools course is so up-to-date, practical, interesting. And so easy to learn! And no wonder it is held in such high regard by leaders of American industry! Approved for eligible Veterans.

### We Teach You How To Make Welcome Extra Money—While You Learn!

Many National Schools students—men like you—make plenty of extra dollars each week in spare time! Fixing neighbors' radios, appliances—and other ways we teach you. You start learning and earning from the day you enroll. From the very first lesson!

### WE SEND YOU LOTS OF PARTS LIKE THIS!



With National Schools Shop Method Home Training, you get basic principles and plenty of practical training. You learn by doing. No wonder you learn so fast! We send you many parts—all of professional, modern quality. You do lots of practical experiments. You advance day by day, step by step. Until you can even build the modern Superheterodyne Receiver you see above—plus other important testing units. The free book tells you all about it. The free sample lesson shows how easy the training is. Use the coupon. Send today—without fail!

**DON'T PUT  
IT OFF!  
GET THE  
BIG SALARY  
YOU HAVE  
ALWAYS  
WANTED!**



### Only National Schools Gives You This Professional Multi-Tester!

You get this amazing, new testing instrument—factory-made and tested—complete—ready to use! Simple to operate. Accurate and dependable. An instrument every Radio-TV man needs. Light enough to carry around—so you can use it at home or on service calls. You'll be proud to own this valuable equipment.

### Here are only a Few of the Good-Paying Jobs You Can Choose

Radio Station Engineer, District Service Manager, Aircraft Radio Inspector, Own Your Own Repair Shop, Inspector Technician, Service Specialist, Special Government Jobs, Complete TV Service, Sound Truck Operator. Many more!

National Schools graduates have secure, good-paying jobs like these! So don't wait—mail the coupon today. Now—while you're thinking about it!

### Attention! Men Going into Service Soon!

National Schools' course quickly prepares you for many important jobs in the Armed Services. With National Schools Training you have an opportunity to get into special service classifications—with higher pay and grade—immediately!

### FREE SERVICE FOR GRADUATES

National Schools uses its great influence and prestige to help you find your place in the field of your choice. Don't put it off! Start yourself toward a skilled trade! Get the big pay you've always wanted!

## NATIONAL SCHOOLS

LOS ANGELES 37, CALIFORNIA • ESTABLISHED 1905  
In Canada: 193 Hastings St., Vancouver 4, B.C.

### MAIL THIS COUPON TODAY—WITHOUT FAIL!

NATIONAL SCHOOLS, Dept. RH-82  
4000 South Figueroa Street  
Los Angeles 37, California

Mail in envelope  
or paste on  
penny post card.

Mail me FREE the book mentioned in this ad. Also a free sample lesson. I understand no salesman will call on me.

NAME \_\_\_\_\_ AGE \_\_\_\_\_

ADDRESS \_\_\_\_\_

CITY \_\_\_\_\_ ZONE \_\_\_\_\_ STATE \_\_\_\_\_

Check here if you were released from the Service less than 4 years ago.

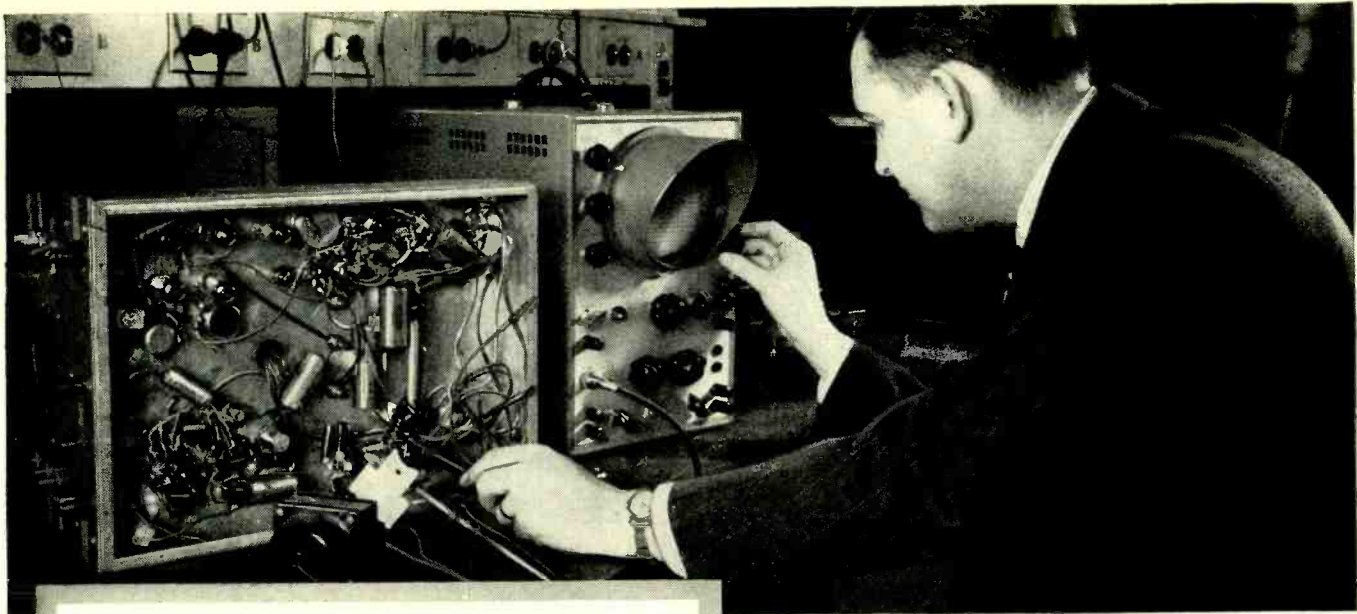

### SPECIFICATIONS—MODEL ST-2B

#### FREQUENCY RESPONSE

##### Vertical Amplifier

DC—0 to 400 kc.  $\pm 0$ , -20%, not more than 50% down at 700 kc.  
 AC—10 cycles to 400 kc.  $\pm 0$ , -20%, not more than 50% down at 700 kc.  
 Probe—2 cycles to 400 kc.  $\pm 0$ , -20%, not more than 50% down at 700 kc.  
 Response independent of gain or attenuator setting.

##### Horizontal Amplifier

DC—0 to 400 kc.  $\pm 0$ , -20%, not more than 50% at 700 kc.  
 AC—10 cycles to 400 kc.  $\pm 0$ , -20%, not more than 50% down at 700 kc.  
 Response independent of gain or attenuator setting.

#### SENSITIVITY

Vertical .....	AC—10 mv. rms/inch
	DC—28 mv. dc/inch
Horizontal .....	AC—15 mv. rms/inch
	DC—42 mv. dc/inch
Probe .....	130 mv. rms/inch
Deflection Plates Direct	
Vertical .....	22 volts rms/inch
Horizontal .....	25 volts rms/inch

#### SWEEP

Range—Triggered or recurrent—2 cycles to 30 kc (may be extended downwards by adding external capacity across panel jacks).  
 Sync— $\pm$  Internal,  $\pm$  line and -Ext. (requires .3 volts peak to peak for external sync).  
 Sweep Expansion—At least 4 times tube diameter.

PHASE SHIFT—Negligible phase shift between amplifiers from 0 to 300 kc.

BLANKING—Z-axis blanking requires 20 volts peak to blank.

CALIBRATION—Seven voltages available by selector switch: .1, .3, 1, 10, 30, 100 and 300 volts peak to peak  $\pm 15\%$ .

DIRECT CONNECTIONS TO DEFLECTION PLATES—Available through capacitors—internal positioning circuits still function.

AMBIENT TEMPERATURE RANGE—0° to 40° C.

POWER REQUIREMENTS—105-125 volts, 50/60 cycles power consumption approximately 120 watts. (By a simple wiring change, may be operated from 210-250 volt line.)

# PRECISION THAT

**Reliable General Electric Instruments Offer Extreme Versatility in Lab and Industrial Applications**

**S**TABILITY is the keynote of the ST-2B all-purpose scope, shown in the picture above. Designed to permit a choice of short, medium or long persistence CR tubes, the unit incorporates identical direct coupled vertical and horizontal amplifiers. Filaments and screens on the first amplifier stages are regulated. Vertical selector switch allows choice of probe, calibration, AC or DC inputs.

Across the board against 4 conventional scopes, the General Electric ST-2B tests superior in 11 different characteristics.



**Type ST-2C**—A 5-inch scope particularly useful where wide frequency response plus portability are required. Ideal for maintenance of microwave installations and TV stations. Low capacity input probe . . . Z-axis input . . . calibration voltages provided . . . deflection plates available . . . hard tube sweep.

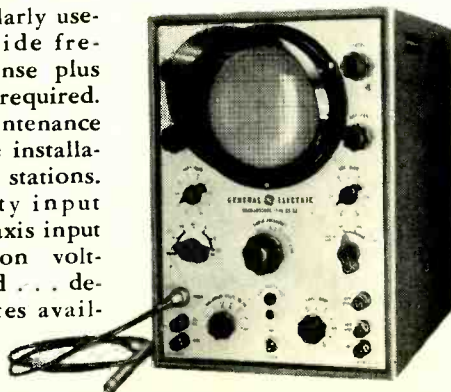

**Type ST-2A**—For general purpose use in laboratories. Excellent wide frequency response for TV receiver circuit work and industrial testing. Special features include a DC vertical amplifier to adapt the equipment to a wide range of applications. Deflection pattern can be expanded to several times the diameter of 5-inch tube.

**Germanium Diode Checker Type ST-12A**  
 —A new G-E instrument for use in laboratories, quality control groups, service shops —wherever there is need for checking the static characteristics of diodes. *Specifications*  
 —POWER REQUIREMENTS: 105-125 volts, 50/60 cycle, approximately 10 watts. FORWARD RANGES: Current—0.3, 1.2, 6 and 12 milliamperes full scale. Voltage—.3 and 1.2 volts full scale. INVERSE RANGES: Current—60, 120, 300 and 1200 microamperes full scale. Voltage—3, 12 and 120 volts full scale.

Other applications: general resistance checker (10 ohms to 6 megohms) . . . accurately-metered power supply . . . forming electrolytic capacitors and checking DC leakage current.



# LABORATORY EQUIPMENT PAYS BIG DIVIDENDS

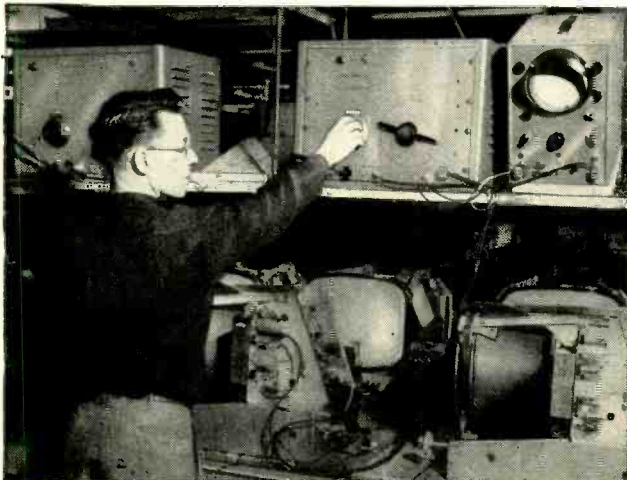

**TV Channel Sweep Generator Type ST-11A**  
 —Covers all 12 VHF television channels and is designed primarily for TV receiver production line testing. Simple to operate: one front-panel control selects the sweep range and markers simultaneously. On-off switch and side-band control switch are also on the front panel. Separate crystal for each TV channel . . . picture and audio carrier markers available simultaneously.

This instrument combines the characteristics of General Electric's ST-4A Variable Permeability Sweep Generator and ST-5A Crystal Controlled Marker Generator.

## CHECK OFF THE FREE BULLETINS THAT YOU NEED

- |   |   |
|---|---|
| <input type="checkbox"/> Type ST-2A Scope<br>Bulletin X52-127           | <input type="checkbox"/> Type ST-12A<br>Diode Checker<br>Bulletin ECL-3     |
| <input type="checkbox"/> Type ST-2B Scope<br>Bulletin ECL-4             | <input type="checkbox"/> Type ST-4A<br>Sweep Generator<br>Bulletin X52-014  |
| <input type="checkbox"/> Type ST-2C Scope<br>Bulletin X52-147           | <input type="checkbox"/> Type ST-5A<br>Marker Generator<br>Bulletin X52-128 |
| <input type="checkbox"/> Type ST-11A<br>Channel Sweep<br>Bulletin ECL-1 |   |

General Electric Company, Section 982  
 Electronics Park, Syracuse, New York

Please send me without charge the bulletins checked at left.

NAME.....

COMPANY OR TITLE.....

ADDRESS.....

CITY..... STATE.....

**GENERAL**  **ELECTRIC**

# Lafayette Radio

**FOR OVER 32 YEARS  
HEADQUARTERS FOR SERVICEMEN, SET-BUILDERS, ENGINEERS, EXPERIMENTERS.**

## Lafayette NEW!!! 1952 TV CHASSIS



Everything you have ever wanted in a TV receiver is here now in Lafayette's new, precision-engineered circuit. Cascade tuner — a new development to provide the best signal in fringe areas, with double shielding to reduce radiation; low-noise bi-filter system to provide wideband response. Receiver can be modified for U.H.F. reception when available. Automatic Gain Control circuit to provide stabilized picture and reduce adjustments of operating controls. Local-fringe switch. Designed to receive all channels. 8" PM speaker included.

Tubes Used: 6BK7; 6J6; (2) 6CB6; (3) 6AL5; 6AC7 8AU6; AV6; 6V6; (2) 12AU7; 12BH7; 6SN7GT; 6BQ6; 1X2A; 6W4; 5U4G; TV Picture Tube.

**FOR CUSTOM INSTALLATION IN YOUR OWN BOOKCASE, WALL OR CABINET.**

- \*Lafayette Chassis Model 200R with 8" PM Speaker, Complete with Tubes and 17" Picture Tube... Net **144.50**
  - \*Lafayette Chassis Model 201R with 8" PM Speaker, Complete with Tubes and 20" Picture Tube... Net **159.50**
  - Lafayette Model 194R Complete 17" Console Set... Net **174.50**
  - Lafayette Model 196R Complete 20" Console Set... Net **199.50**
  - Lafayette Model 193R Complete 17" Table Model... Net **159.50**
  - Lafayette Model 195R Complete 20" Table Model... Net **179.50**
- \*with 12" speaker add \$3.50



Prices include Federal Tax and R.M.A. Warranty

## Lafayette 2-Way Inter-Coms For Home and Business Use

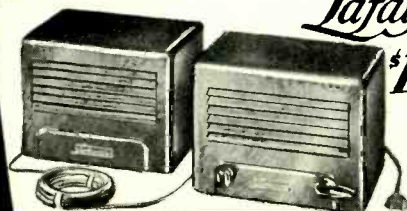

**\$17.95**

The handiest, most practical Inter-Communication System you've ever seen for instant voice communication in your home and office. Lafayette offers these Inter-Com units at LOW, LOW pre-inflation prices to fit the most modest budget. Complete with tubes, power cord, 50 ft. of wire. Operates on both AC and DC. Handsome mahogany finish plastic cabinet.

LAFAYETTE — KNOWN FOR THE LARGEST STOCK OF T.V. ANTENNAS, ACCESSORIES AND REPLACEMENT PARTS.



### "JETENNA" T.V. ANTENNA

	NET
No. JeT660, Single Bay.....	<b>5.65</b>
No. JeT661, 2-Bay.....	<b>11.95</b>
No. JeT664, 4-Bay.....	<b>26.04</b>

JETENNA, the conical with the jet-action assembly. Just swing out the elements, tighten two "T" bolts and two wing nuts and it's assembled! Reflector elements are spring-loaded to lock into position for tightening. 1" square butt seam crossarm, butt seam elements and element brackets are of high tensile strength aluminum — unbreakable head is of all weather, high dielectric material. Solid, unbreakable "vibration dampers" do not absorb moisture or swell and will not rot out.



### GRAYBURNE MODEL TSB-1 TV SIGNAL BOOSTER

Increases video and sound output over 20%. Consists of complete IF stage which easily plugs into any receiver inside the cabinet, thus eliminating external switches and connections. Has advantages of broad band boosters but without separate tuning for each channel. Ideal for poor signal areas. Grayburne TSB1 \$ **5.65** less tube



EVERY MAKE OF BOOSTER IN STOCK

**SPECIAL \$9.95**  
ASTATIC MODEL BT-1  
Quantity Limited

NEW Regency DB-520.....	Net 19.11
NEW Astatic CT-1.....	Net 19.11
Electro-Voice Model 3002.....	Net 23.23
Electro-Voice Model 3100.....	Net 40.87
NEW Bogen Model BB1-A.....	Net 19.11
Masco Sky Chief.....	Net 23.85
Masco Super Sky Chief.....	Net 44.42

### YAGI TV ARRAYS

For Fringe & Ultra Fringe

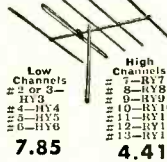

Low Channels	High Channels
22 or 2	13
3	14
4	15
5	16
6	17
7	18
8	19
9	20
10	21
11	22
12	23
13	24

**7.85**      **4.41**

A remarkably effective TV antenna for fringe and poor signal areas. Brings in signals impossible to get otherwise! These 5-element Yagis, custom-cut for each individual channel from 2 to 13, provide a forward gain of approximately 14 db on high bands, and 7 to 8 db on low bands.

TIE RODS for stacking 2 Yagi Arrays Specify Hi or Lo band.....Pair **85c**

**LAFAYETTE LARGEST STOCK,**

ALL BAND CONICAL ARRAYS

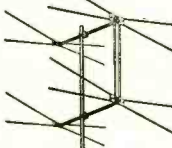

Double stacking TV array for exceptionally high db gain. Especially designed for fringe area operation. Conical arrangement minimizes noise interference, reduces multipath reflections and prevents picture fading. 20° broadside reducing angle. Elements are all 5/8" diameter.

Model P21861, SHPG. wt. 13 lbs.....Net **8.45**  
Model P21860, similar to above but single array. Shpg. wt. 7 1/2 lbs. Net **3.95**

**BEST PRICES, FINEST SERVICE**

**OPEN WIRE TV LINE** \*Use in Place of 300 Ohm Line  
Ideal for fringe area installations. Not affected by moisture or sun. Made of #18 copperweld wire with genuine polystyrene insulators spaced 6" apart. Tensile strength 400 lbs. 250 ft. coll. Shpg. wt. 4 lbs. **\$5.45**      100 ft. coll. Shpg. wt. 2 lbs. **\$3.50**

**TWIN LINE** 300 Ohm Poly Twinline  
High quality, low loss. For all TV and FM installations. Shpg. wt. 2 lbs. **\$7.95**  
100 ft. coll. **\$1.75**  
Lots of 10, ea. **\$1.95**  
Single, ea. **\$1.95**

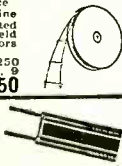

### LAFAYETTE HI-FIDELITY FM-AM CHASSIS WITH PHONO PRE-AMPLIFIER AND 12" PM SPEAKER

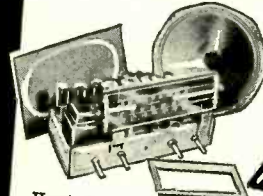

**\$69.50**  
**30 DAY FREE TRIAL**

Here's a terrific value in an FM-AM radio with a built-in pre-amplifier for the new variable reluctance pickups. The 10 watt, true-fidelity audio system, plus the wide-range 12" PM speaker give better quality of reproduction than many of the highest priced radios.

We're so sure you'll be enthusiastic about this buy that we'll permit you to return it within 30 days of purchase date for a full refund, less transportation charges.  
1 TUBES PLUS RECTIFIER include 6BA6, 7F8, 7Q7, 7AH7, 7A6, 7F7, 6SH7, 6AT6, 6SC7, 6Y3-GT rectifier.  
FREQUENCY RANGE: 88-108 mc on FM and 550-1700 kc on AM. Complete with tubes and 12" PM speaker. Operates on 105-125 v-a-c, 60 cycles. Chassis dimen. 9"x13"x9 1/4". SHPG. weight 25 lbs. **1F215..... 69.50**

### HEADQUARTERS FOR HIGH-FIDELITY PHONO-EQUIPMENT

GENERAL ELECTRIC PICKERING • AUDAK

3 SPEED RECORD CHANGERS Garrard • VM Triomatic Markel • Webster-Chicago



Webster Model 701-1, with dual needle turnover crystal cartridge.....Net **37.24**  
Webster Model 101-270, as above, but with G.E. RPX-050 triple-play magnetic cartridge in standard tone arm. Less pre-amp.....Net **38.81**  
V-M Model 951, with turnover crystal cartridge and dual needles.....Net **29.62**  
V-M Model 951GE, with G.E. triple-play variable reluctance cartridge and dual needles, less base. Requires pre-amp. Net **32.80**  
Garrard Model RC-80 Changer.....Net **41.45**  
Markel Model 74 Changer.....Net **63.39**

### GE Pre-Amplifiers

Self powered preamp UPX003— NET **10.55**  
External powered preamp SPX001—NET **7.00**

### CARTRIDGES AND STYLII

G.E. RPX-041 Single-Play Cartridge LP. **5.85**  
G.E. RPX-040 Single-Play Cartridge Std **5.85**  
G.E. RPJ-050 Triple-Play Cartridge **8.20**  
G.E. RPJ-010 Sapphire .001" .003" Needle **3.50**  
G.E. RPJ-005 Sapphire .001" Needle **2.06**  
G.E. RPJ-001 Sapphire .003" Needle **2.06**  
G.E. RPJ-004 Diamond .001" Needle **16.17**  
NEW: G.E. RPJ-013 Triple-Play Needle Has .001" Diamond Tip and .003" Sapphire Tip **18.23**  
NEW: G.E. RPX-052 Triple-Play Cartridge, 1 MIL Diamond and 3 MIL Sapphire Tips **22.90**

# Lafayette Radio

NEW YORK 13	100 SIXTH AVE.
BRONX 58	542 E. Fordham Rd.
NEWARK 2	24 Central Ave.
BOSTON 10	110 Federal St.

### Mail Orders Filled

20% deposit with order please, balance C.O.D. Postage and shipping charges are extra.

# 102 BILLION

## FREE SALES BOOSTS A YEAR FOR YOU!

**NEW  
CBS-HYTRON  
BRAND  
gives you:**



### Acceptance



1,973,326,000 times a week! 102,612,952,000 times a year! The magic letters "CBS" are seen and heard on radio and TV station breaks. Impact is terrific. An average of 13 sales impressions weekly for every man, woman and child in the country. Every one of your customers knows CBS. Knows he can depend upon CBS. Consumer acceptance of your CBS-Hytron brand grows hourly.

### Engineering



As a division of the Columbia Broadcasting System, Inc., CBS-Hytron commands tremendous engineering resources for you. Because CBS embraces the field of electronic entertainment: Radio broadcasting. TV broadcasting. Radio, television, and phonograph sets. Records. Electronic research laboratories. And CBS-Hytron tubes.

### Leadership



For example, CBS-Hytron originated: the GT tube . . . the subminiature tube . . . the rectangular picture tube . . . specialized, low-cost TV receiving tubes. CBS-Hytron's new picture-tube and miniature-tube plants are the most modern in the world. Such aggressive leadership guarantees you the newest and best in tubes.

### YOU CAN'T BUY BETTER

Demand the CBS-Hytron brand. You get the finest electron tubes that progressive engineering skill and craftsmanship can make. You get the brand known and respected by every one of your customers. You get the brand they see and hear the most . . . CBS-Hytron.



MAIN OFFICE: SALEM, MASSACHUSETTS

For sound trucks • parades  
carnivals • resorts • busses  
outdoor meetings

## ECONOMICAL MOBILE AMPLIFIERS

by  
*Newcomb*



MODEL E-25MP

Newcomb mobile amplifiers are carefully built for the rugged conditions of mobile use and to deliver consistently the top quality performance you expect from any Newcomb amplifier. Dollar for dollar they give you more good service, more convenient operational features and more all around, long-time satisfaction.

MODEL E-25MP delivers 25 watts from either 6 volt battery or 117 A.C. It has a standby switch, separate power and phono switches and inputs for 2 mikes and 1 phono. Heavy duty plugs. 2000 volt hermetically sealed buffer condenser. Phase correction capacitor for phono motor.

MODEL E-25M is the same amplifier without phono top.

MODEL E-10M is a rugged, low cost, 10 watt unit also for either battery or A.C. power. Has standby switch, inputs for 1 mike, 1 phono. Special mounting simplifies installation and removal.



E-10M

*Send for full  
information  
today!*

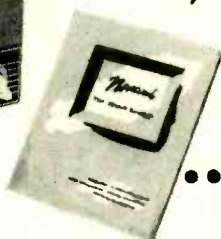

# NEWCOMB AUDIO PRODUCTS CO.

Dept. F, 6824 Lexington Ave., Hollywood 38, Calif.

# Spot Radio News

★ Presenting latest information on the Radio Industry.

By RADIO & TELEVISION NEWS'  
WASHINGTON EDITOR

**TELEVISION**, since its inception a topic of teeming interest, has sparked, with the appearance of that famous sixth report on allocations, the most fiery debates on record, not only within industry circles, but also within the official family of Commissioners in Washington. Even those who have been quite docile have begun hammering away.

In a pounding effort to support the government's decision and its plan, veteran radioman and FCC Commissioner, George Sterling, told members of the Maryland-DC Radio and TV Broadcaster's Association, meeting in Ocean City, Maryland, that it seems as if some of the critics of the decision have relayed a frightening impression that the freeze-lift program was based on a . . . "conglomeration of master gimmicks dreamed up by a bunch of diabolical bureaucrats whose main purpose in life was to do damage to the television broadcasters and viewers." Emphasizing that such a distressing view was unwarranted, Sterling asked his listeners to take a closer look at these opinions and determine for themselves if there is ". . . any justification for the belief that the majority's decision was spawned by Satan himself or five or six of the fallen Angels."

Declaring that he was quite perplexed by the criticism that the Commission did not make adequate provision for the interests of the smaller cities, the FCC's technical expert said that if there was any aspect of the decision which should not be criticized, it was the Commission's recognition of the small cities. To support this comment, the record was described, and it was pointed out that 1274 cities now have one or more assignments, with 892 having one channel, while 176 have a couple of assignments. "I think it is clear," Sterling said, "that adequate provision has been made for potential local television service." Comparing the TV plan with AM broadcasting provisions, the Commissioner added that 1359 cities have one or more stations, and of this number 971 have but one station and 199 but two stations. The present decision, it was noted, permits cities without assignments in the table to come in at any time to obtain an assignment.

Commenting on the critics' views that the separations between the very-high stations were too wide, the Commissioner said the wider separations

permitted more assignments. "As a matter of fact," Sterling added, "unless we reduce separations substantially, the number of additional assignments that we would pick up by reduced separations would be few. . . . And if we did take such action, we would be employing separations below those necessary to insure interference-free service." Such a move, he noted would roar us back to the ice age.

Hitting at the allegations that the Commission has been arbitrary and capricious in refusing to add a third or fourth very-high channel to one of the larger cities, Sterling asked his audience if they heard about . . . "those persons who live far away from larger cities, those persons who would receive interference rather than service because of the addition of this third or fourth channel for a large city?" He pointed out that grade B service, upon which sparsely settled and rural areas depend, would be destroyed, if the giant metropolitan center received the additional grade A service, so boldly requested. The Commissioner felt that only if the interests of the smaller cities and those residing in outlying areas were disregarded at this time, could mileage separations be reduced. However, he added . . . "this does not mean that the Commission cannot at a future date make changes in the table, when television is started and we have more engineering data. . . . We might very well some day reduce the mileage separations. . . . We shall learn more as new stations are activated. . . . But the existing propagation data does not permit a reduction in separations at this time."

Striking away at those who declared that the safety factor was a "mumbo-jumbo created to justify wider separations" the Commissioner declared that this . . . "is far from the truth." Describing the safety factor as a means of insurance to prevent interference, with the service information now available, Sterling said that regardless of which licensing procedure is used, a safety factor would have to be included to determine separations. "The data which currently exists must be the basis of any plan, whether it be the Commission's or one proposed by our critics," the FCC rep said. Continuing his blast, Sterling added: "Our critics are faced with the same problem of the completeness of the engineering data, and it is no answer for

RADIO & TELEVISION NEWS



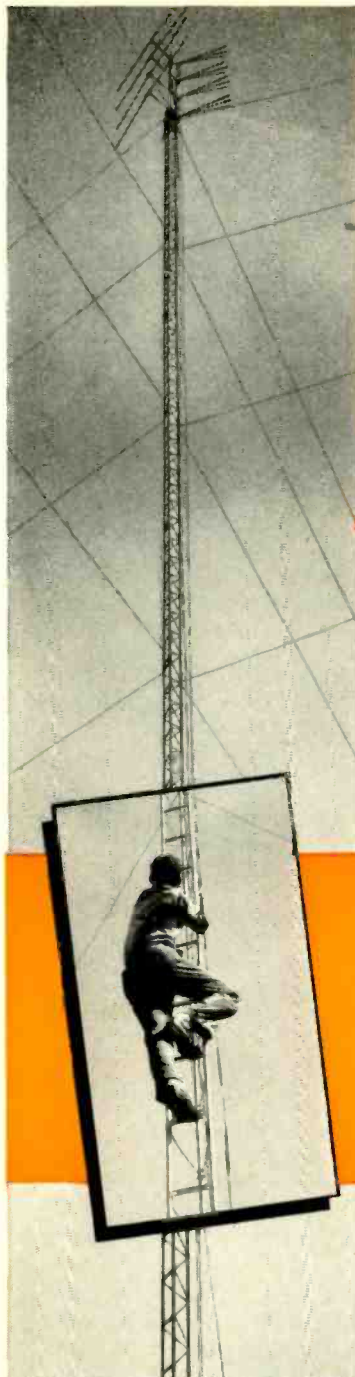

Reaches farther for single-channel reception.

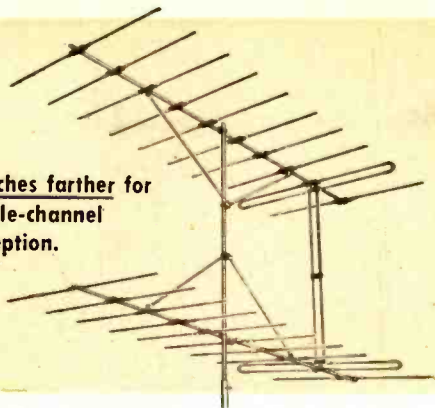

- "Boom Braced" on the low band to prevent picture flicker.

the **BIG 10**  
is terrific!

### Fabulous 10 Element Z-Match Yagi

- Highest gains in TV history: 12 DB single, 14½ DB stacked (78% stacking gain!).
- Eliminates mismatch to 300 ohm line, single and stacked.
- You don't pay for stacking bars!

Here's the most sensitive

## 5 Element Yagi of them all

600 Series Z-Match Yagi

- Perfect match to 300 ohm line, single and stacked.
- Over 9 DB single, 12 DB stacked (100% stacking gain!)
- Wider spread elements for higher gain.
- You don't pay for stacking bars!

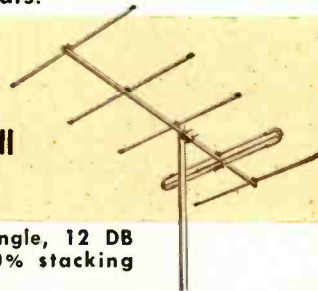

All antennas completely preassembled.

developed by

**CHANNEL MASTER**



For "Far Reaching" Results

There's only ONE

# SUPER FAN

313 Series

The most widely used antenna in the nation.

The highest gain broad-band antenna ever developed.

New reinforced fibreglas inserts in all elements and reflectors.

Write for new catalog

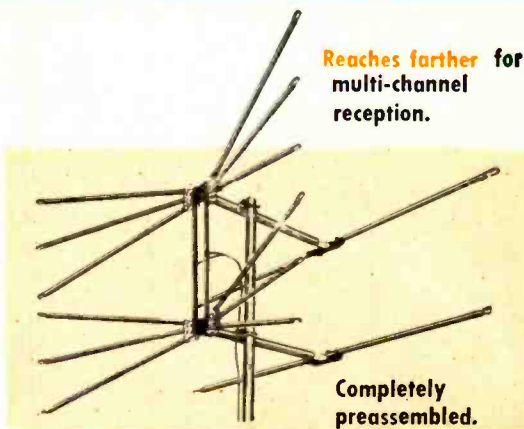

Reaches farther for multi-channel reception.

Completely preassembled.

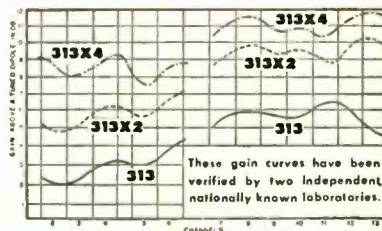

## Safe, Rugged TOWERS

by Channel Master

- Steel tubular uprights.
- Built-in ladder with no obstructions.
- One standard interchangeable section which can be used as a top, middle or bottom section.
- Universal base mount.
- Dual purpose mast or rotor mounting brackets.

**CHANNEL MASTER CORP.** ELLENVILLE, N. Y.

# Brush

## CRYSTAL HEADPHONES CRYSTAL MICROPHONES

# for every use!...



**BA-109 MICROPHONE**—Superior microphone for public address, home recording and amateur applications. List price . . . . . \$22.50



**BA-116 MICROPHONE**  
Rugged . . . uniform response. Unexcelled in its price range. Particularly suitable for home recording and industrial paging applications. List price . . . . . \$14.75



**BA-106 MICROPHONE**—Unexcelled in its price range. Particularly useful for P.A. systems and home recording. List price. \$19.75

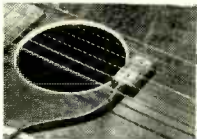

**VM-1 VIBROMIKE\***—Useful for many types of direct contact pickup. Applicable to musical instruments and industrial uses. List price . . . \$19.50



**BL-2 LAPEL MICROPHONE**—Only 1 1/2" x 2 1/4". Virtually flat response. Can also be used in hand or as instrument pickup. List price . . . . . \$25.00



**MODEL A HEADPHONES**  
Fullest response available from medium priced headphones. Useful for many studio, amateur and industrial applications. List price, \$12.00

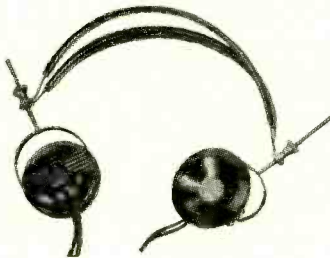

**BA-206 CRYSTAL HEADPHONES**—Highest fidelity with exceptional bass response. Suitable for all studio and amateur uses. List price . . . . . \$28.00  
These highest quality crystal headphones are also available in single headphone and lorgnette models.

*Lorgnette and Single Phone Models also available in the A series.*



**BA-303 HUSHATONE\***  
Miniature extension speaker for under-pillow use. Hermetically sealed. Can be dipped into disinfecting solution. List price . . . . . \$9.75

All Brush crystal products feature the famous Brush **BIMORPH\*** crystal drive element. Brush crystal products are leaders in their fields because for many years Brush laboratories have specialized in research, development and applications of Piezoelectric crystal materials.

\*T. M. Reg.

THE **Brush**  
DEVELOPMENT COMPANY



Piezoelectric Crystals and Ceramics  
Magnetic Recording Equipment  
Acoustic Devices  
Ultrasonics  
Industrial & Research Instruments

3405 Perkins Avenue • Cleveland 14, Ohio

them to state only that the Commission admits its ignorance of the ultimate in engineering facts. Manifestly, our critics can only rely on the very self-same facts."

Reviewing the so-called disparity between very-high and ultra-high coverage, the Commissioner indicated that he felt that eventually this problem will be minimized. "One thing is certain," he said, "u.h.f. will, in general, provide a TV service free from the effects of several forms of interference that plague v.h.f. frequencies. . . . I sincerely believe that u.h.f. will be a success. Despite all of the criticisms, and what might almost be termed a campaign of terror to scare people away from u.h.f., some of our most prominent and experienced AM broadcasters are reportedly ready to seek u.h.f. assignments in many cities."

Drawing a parallel between the early lack of interest in TV and the present reluctance on the part of some to accept the higher frequencies, Sterling said that . . . "those entrepreneurs who were willing to risk their capital in order to bring a new medium of communication to the public are now very successful, and are reaping the benefits of their courage and faith. . . . Let us hope that all who are not yet in television heed the lesson to be learned from those who could have afforded to enter television early but did not."

**ELSEWHERE**, allocation decision dissenter Commissioner Robert Jones continued his stinging tirade against the ruling, painting bleak outlooks for TV. In Pittsburgh, before a combined session of the Radio and Television Club and Advertising Club, he said that it might be five years before the "Steel City" would get its second TV station. Jones' attack so disturbed the city's mayor that he asked for appointments with House Speaker Sam Rayburn and Commissioner Frieda Hennock, hoping that discussions with them might provide a solution to the problem. The Commissioner's words irked and simply scared many too, who felt that his outbursts would delay issuance of authorization, by lending support to the modification briefs now being prepared for the examiners and courts.

**MEMBERS OF CONGRESS** also displayed an active interest in the allocations, seeking to secure funds for more examiners who can approve authorizations. Aroused by the fact that it will be impossible to process the flood of applications that are expected, unless the examining staff is expanded, twelve members of the Senate Interstate and Foreign Commerce Committee petitioned the appropriation subcommittee to secure at least \$800,000 for . . . "salaries and other expenses necessary for the employment of 20 examiner teams to be used exclusively for processing and hearing television applications during the fiscal year ending 1953."

The Senators told their colleagues (Continued on page 103)

**RADIO & TELEVISION NEWS**

# PRESENTING COLLINS AM-FM "PRE-FAB" TUNERS

**NOW** you can  
build a Collins  
AM-FM tuner from  
the Pre-Fab units  
shown below!

**COMPLETE VERSATILITY** is the byword in this new tuner design. Through the addition of the AM circuit, the Collins tuner will meet all requirements for home music systems and installations where a fine tuner is required.

**ECONOMY:** The very finest in tuner design is offered you at exceptionally low prices. Collins quality is your assurance of a fine product that will work to your complete satisfaction. You cannot duplicate this tuner in its completed form at twice the price!

**3 Ways to purchase  
COLLINS Tuner . . .**

1. As an AM tuner kit
2. As an FM tuner kit
3. As an AM-FM tuner kit

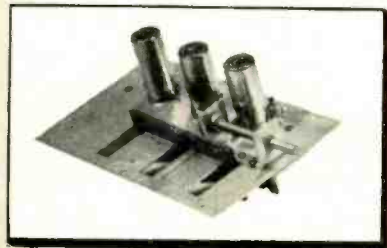

FM Tuning Unit **\$15.25**

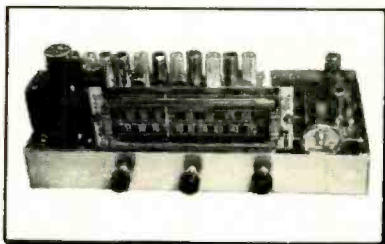

The Collins FM-AM Pre-Fab Tuner Kit As it Looks  
After You Assemble It (Total Kit Cost **\$69.00**)



AM Tuning Unit  
(Includes IF and  
Audio Amplifier) **\$19.25**



FM IF Amplifier **\$19.75**

Tuning Eye Kit  
Available At

**\$2.85**

UC-2 Universal Chassis Kit **\$14.75**



**ALL PRE-FAB UNITS ARE ASSEMBLED, WIRED, TESTED, AND ALIGNED AT FACTORY. PRICES SHOWN INCLUDE TUBES.**

The FM tuning unit employs a 6J6 dual triode RF amplifier, 6AG5 converter, and 6C4 oscillator. Permeability tuned, stable, and drift-free. High sensitivity of between 6 and 10 microvolts. Dimensions: 7 1/4" x 4 1/2". The IF amplifier for FM uses 6 tubes: 6BA6, (4) 6AU6, and 6AL5 discriminator. High gain, wide band response for highest fidelity reception. Frequency response of FM section, plus or minus 2 DB, 20 to 20,000 cycles. Distortion less than 1/2 of 1%. Dimensions: 11 3/8" x 2 1/2".

The AM tuning unit utilizes a super-het circuit employing three tubes: 6BE6 converter, 6BA6 IF amplifier, and 6AT6 detector. Extremely high sensitivity and selectivity is accomplished through the use of new, high gain iron-core transformers. Careful alignment provides widest response available from this type of circuit. If builder desires, triode amplifier section of 6AT6 tube may be used as first audio stage.

Chassis Kit includes all necessary parts. Nothing else to buy. Instruction Manual included with detailed, step-by-step procedure, pictures and schematic diagrams. Chassis measures 8" x 17" x 2 1/2". Overall, the tuner, when assembled, measures 8" x 17" x 6".

**MAIL ORDER COUPON  
TODAY!**

TO: COLLINS AUDIO PRODUCTS CO. INC.  
P.O. Box 368, Westfield, N.J.

Enclosed Find  Check  Money Order For

AM Tuning Unit

FM Tuning Unit

FM IF Amplifier

UC-2 Chassis Kit

M-1 Tuning Eye Kit

NAME \_\_\_\_\_

ADDRESS \_\_\_\_\_

CITY \_\_\_\_\_

STATE \_\_\_\_\_

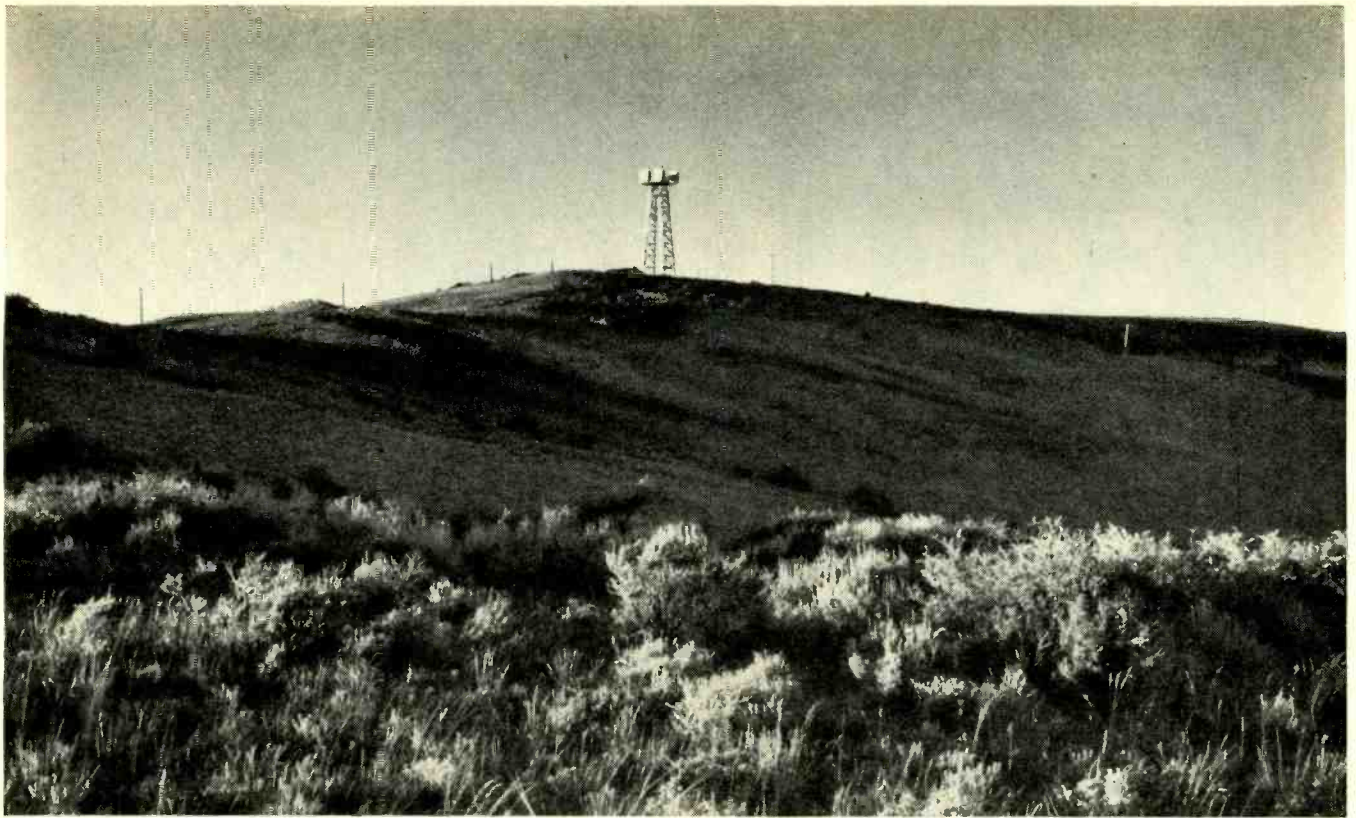

Radio-relay station at Evanston, Wyoming

# a **W**atcher for lonesome places

Many of the Bell System's 107 radio stations connecting New York and San Francisco by microwave radio-relay stand on hills and mountains far from towns. Day after day, the apparatus does its duty; no man need be there to watch it. But when trouble threatens, an alarm system developed by Bell Telephone Laboratories alerts a testman in a town perhaps a hundred miles away.

A bell rings. The testman sends a signal which asks what is wrong. A pattern of lights gives the answer—a power interruption, an overheated tube, a blown fuse, a drop in pressure of the dry air which

keeps moisture out of the wave-guide. At intervals the testman puts the system through its paces to be sure it is on guard.

Sometimes the testman can correct a trouble condition through remote control, or the station may cure itself—for example, by switching in an emergency power supply. Sometimes the trouble can await the next visit of a maintenance man—sometimes he is dispatched at once.

This is one of the newest examples of the way Bell Laboratories adds value to your telephone system by reducing maintenance costs and increasing reliability.

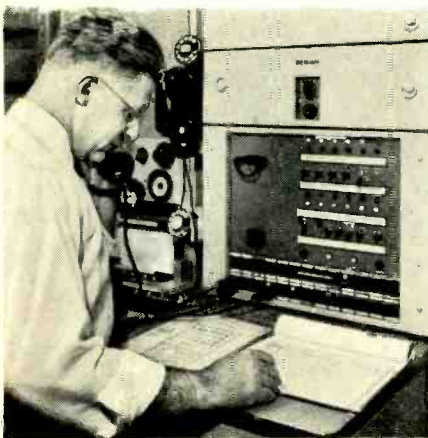

Alarm-receiving bay in town. Lights on a chart report on 42 separate conditions affecting service. Telephone is to communicate with maintenance crews. Eleven alarm centers across the country cover all 107 radio-relay stations. Stations too far off the beaten trail for wire connections signal by very high frequency radio.



## **BELL TELEPHONE LABORATORIES**

IMPROVING TELEPHONE SERVICE FOR AMERICA PROVIDES CAREERS FOR CREATIVE MEN IN SCIENTIFIC AND TECHNICAL FIELDS.



# Learn RADIO TELEVISION

**-New Package Unit Plan- PAY AS YOU LEARN  
NO MONTHLY PAYMENT CONTRACT TO SIGN!**

**I Send You  
18 BIG  
KITS  
OF RADIO-  
TELEVISION  
EQUIPMENT**

**TRAIN IN 10 MONTHS OR LESS  
At Home in Your Spare Time**

Now . . . be ready for Radio-Television's big pay opportunities in a few short MONTHS! Frank L. Sprayberry's completely new "Package" training unit plan prepares you in just 10 MONTHS . . . or even less! Equally important, there is NO monthly payment contract to sign . . . thus NO RISK to you! This is America's finest, most complete, practical training—gets you ready to handle any practical job in the booming Radio-Television industry. In just 10 months you may start your own profitable Radio-Television shop . . . or accept a good paying job in this fascinating expanding field at work you've always wanted to do. Mr. Sprayberry has trained hundreds of successful Radio-Television technicians—and stands ready to train you in less than one year, even if you have no previous experience. You learn by DOING . . . actually working with your hands with equipment of special design to illustrate basic theory instead of relying on books alone.

**VALUABLE EQUIPMENT INCLUDED WITH TRAINING**

The new Sprayberry "package" plan includes many big kits of genuine, professional Radio-Television equipment. While training you actually perform over 300 demonstrations, experiments and construction projects. In addition, you build a powerful 6-tube standard and short wave radio set, a multi-range test meter, a signal generator, signal tracer, many other projects. All equipment is yours to keep . . . you have practically everything you need to set up your own service shop. The interesting Sprayberry book-bound lessons and other training materials . . . all are yours to keep.

**EARN EXTRA MONEY WHILE YOU LEARN!**

All your 10 months of training is AT YOUR HOME in spare hours. Keep on with your present job and income while learning . . . and earn EXTRA CASH in addition. With each training "package" unit, you receive extra plans and ideas for spare time Radio-Television jobs. Many students pay for their entire training this way. You get priceless practical experience and earn generous service fees from grateful customers. Just one more reason why the Sprayberry new 10 MONTH-OR-LESS training plan is the best Radio-Television training in America today. If you expect to be in the armed forces later, there is no better preparation than good Radio-Television training.

**FREE 3 BIG RADIO TELEVISION BOOKS**

I want you to have ALL the facts about my new 10-MONTH Radio-Television Training—without cost! Act now! Rush the coupon for my three big Radio-Television books: "How to Make Money in Radio-Television," PLUS my new illustrated Television Bulletin PLUS an actual sample Sprayberry Lesson—all FREE with my compliments. No obligation and no salesman will call on you. Send the coupon in an envelope or paste on back of post card. I will rush all three books at once!

**SPRAYBERRY ACADEMY OF RADIO**  
Dept. 25-M, 111 North Canal St., Chicago 6, Ill.

Approved for  
Veterans Under  
the G. I. Bill

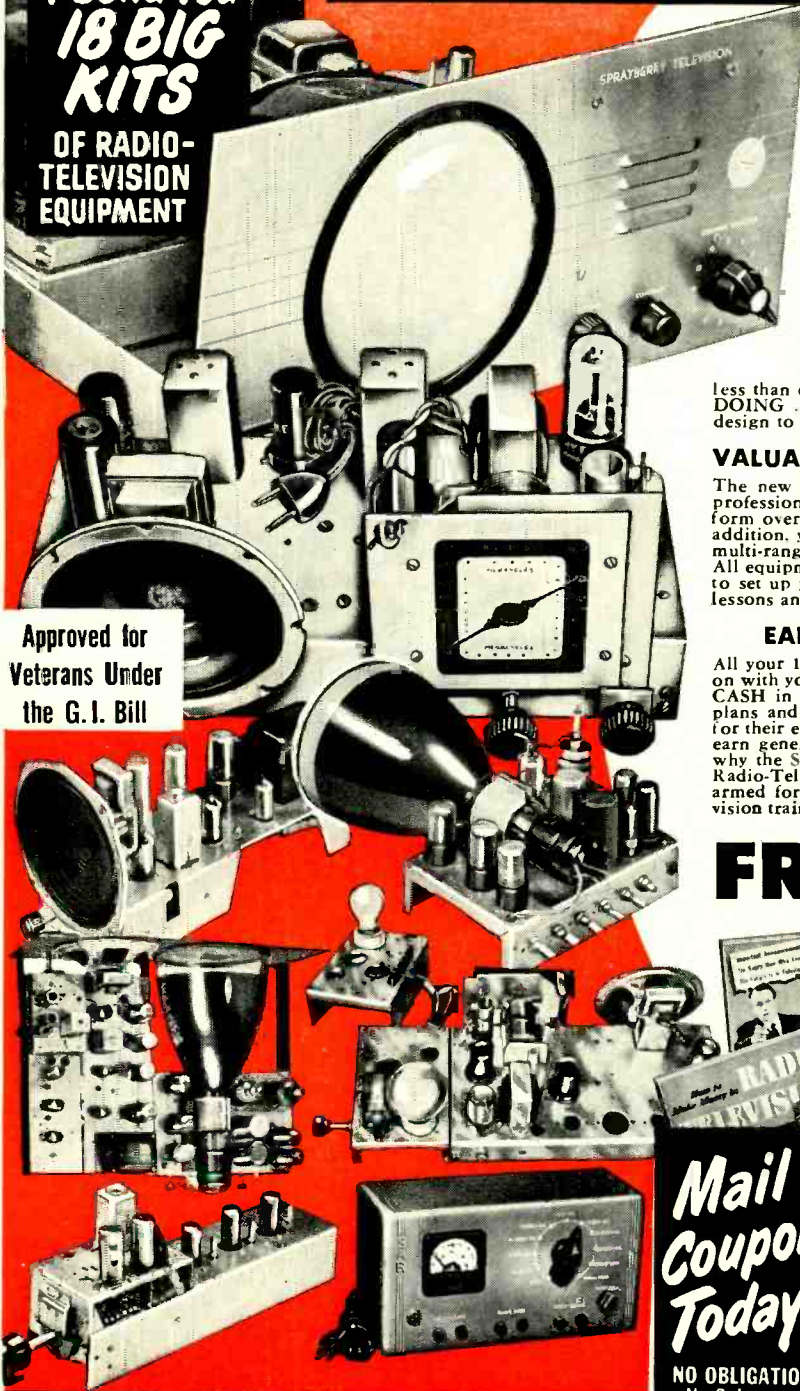

**IF YOU ARE  
EXPERIENCED IN RADIO**

Men already in Radio who seek a short intensive 100% TELEVISION Training with FULL EQUIPMENT INCLUDED are invited to check and mail the coupon at the right.

**Mail  
Coupon  
Today!**  
NO OBLIGATION  
No Salesman  
Will Call

**SPRAYBERRY ACADEMY OF RADIO, Dept. 25-M  
111 North Canal St., Chicago 6, Ill.**

Please rush to me all information on your 10-MONTH Radio-Television Training Plan. I understand this does not obligate me and that no salesman will call upon me.

Name.....Age.....

Address.....

City.....Zone.....State.....

Please check Below About Your Experience

Are You Experienced?  No Experience

# RADIO-TV SERVICE

## Get this important **NEW**



# Free



# ENGINEERS!

## CENTRALAB catalog!

**Hundreds of new components pictured and described with exact specifications and details . . . for faster, more profitable servicing!**

Centralab's Catalog 28 will keep you up-to-date on latest developments in the fast-changing radio and TV servicing market. It's a complete, 32-page index to Centralab's line of parts . . . filled with essential information and features about this superior line. You'll want your copy because when you use guar-

anteed Centralab parts, you're sure to get better, safer servicing . . . satisfied customers.

Don't delay! Ask your distributor for your copy now. Or clip the coupon and send to Centralab. You'll get your copy of the Centralab catalog in the next mail.

### NEW CATALOG INCLUDES ALL THIS . . .

- **A new, expanded line** of switches, *including* a complete line of miniature sizes.
- **Ceramic Capacitors** — most complete line in industry. Includes higher voltages and wider capacity ranges not previously shown, plus new items exclusive with CRL.
- **Centralab Printed Electronic Circuits**—the complete line from small resistor plates to complete speech amplifiers . . . in new, still smaller sizes.
- **CRL "Blue-Shaft" Volume Controls** — newest developments for TV-AM-FM service. Factory assembled, tested and guaranteed. More value, greater flexibility.
- **New kit packages**—for volume controls, switches and capacitors. Handy and convenient.
- **Famous CRL steatite insulators**—the best ceramic insulators anywhere — *and the only packaged line!*

# Centralab

A Division of Globe-Union Inc. • Milwaukee 1, Wis.

**CENTRALAB, A Division of Globe-Union Inc.**  
910 E. Keefe Avenue, Milwaukee 1, Wisconsin

Please send me my copy of the new Centralab Catalog No. 28 at once and without charge.

Name.....  
Address.....  
City.....State.....  
Company..... Check One: My Own   
Work For

We will appreciate it if you tell us — name of principal distributor you do business with —

Name.....  
Address.....  
City.....State.....

# ATR

## AUTO RADIO VIBRATORS

have Ceramic Stack Spacers



Free VIBRATOR MANUAL

### A COMPLETE LINE OF VIBRATORS . . .

Designed for Use in Standard Vibrator-Operated Auto Radio Receivers. Built with Precision Construction, featuring Ceramic Stack Spacers for Longer Lasting Life. Backed by more than 20 years of experience in Vibrator Design, Development, and Manufacturing.



- ✓ NEW MODELS
- ✓ NEW DESIGNS
- ✓ NEW LITERATURE

"A" Battery Eliminators, DC-AC Inverters  
Auto Radio Vibrators

See your jobber or write factory

**AMERICAN TELEVISION & RADIO CO.**

Quality Products Since 1931

SAINT PAUL 1, MINNESOTA-U. S. A.

# Within the INDUSTRY

**M. J. McNICHOLAS** has been advanced to the post of manager of the special apparatus division of *Andrea Radio Corporation*, Long Island City manufacturer of television receivers.



Mr. McNicholas joined the company in May of 1951 and has been assisting in the procurement and expediting of government contracts. Prior to his association with *Andrea*, he was purchasing agent for *North American Philips, Inc.* with headquarters at Mount Vernon, New York.

**VICTOR MUCHER**, president of *Clarostat Mfg. Co.*, and Austin C. Lescarbourea, advertising counsel, were recently honored by *Clarostat* officials and sales reps at a banquet held to pay tribute to the former shipping clerk who became president of the multimillion dollar corporation and the former science magazine editor who now heads his own advertising agency catering to the radio-electronic industry.

Both men received the company's traditional 25-year gold wrist watches and testimonial scrolls as tokens of appreciation for their quarter-century service to the organization.

**FREDERICK PALMER** has been named president of the newly-formed San Diego County Electronic Association, Incorporated.

Other officers named to serve with Mr. Palmer are: Upton Hildebrand, vice-president; William E. Stout, secretary; and C. J. Mahoney, treasurer. Directors of the Association include: John R. Dorsen, John Miner, George N. Cocoronis, Sonny Kahn, and Thomas O. Crawford.

The Association, with a growing membership of over one hundred electronic technicians, has been formed to establish, promote, and maintain the highest standards of ethical business practice and service among Association members and to render service to the public.

**CAPITOL RADIO ENGINEERING INSTITUTE** of Washington, D. C. recently celebrated its 25th anniversary in the radio and electronics field with a series of special events.

The highlight of the Silver Anniversary program was a banquet held at the Mayflower Hotel in Washington. George Bailey, executive secretary of the Institute of Radio Engineers, Inc., and president of the ARRL, was the principal speaker at this commemorative affair.

The school, which originally started as a one-man organization, now has expanded until it includes both resident and home-study curricula. During the war, the school prepared programs for training thousands of Army, Navy, and Coast Guard radio technicians. The extension courses are now being used by government agencies and a large number of private industries.

**OLIN INDUSTRIES, INC.** has acquired **RAMSET FASTENERS, INC.** of Cleveland, Ohio. The new subsidiary will continue operation under its present management as one division of the parent company's Arms and Ammunition Division . . .

**ETRACO MANUFACTURING COMPANY** has announced a change in its corporate name and will henceforth be known as **HINDLE TRANSFORMER COMPANY**. The firm manufactures transformers and wire and cable assemblies at its plant in Flemington, New Jersey . . .

**CONSOLIDATED ENGINEERING CORPORATION** of Pasadena, California has announced the formation of a new corporation, **CEC INSTRUMENTS, INC.**, which will function as a subsidiary organization to handle sales and service work on instruments manufactured by the parent firm.

**NEWELL J. CORWIN** has been appointed manager of the *General Electric Company's* Scranton, Pennsylvania, tube works.



The Scranton Works was purchased recently by the Tube Department from the company's Electric Sink and Cabinet Department and will continue under the direction of Neil C. Mulcock, present works manager, until the change in manufacturing operations has been completed.

Mr. Corwin has been associated with *G-E* since 1937. He is an engineering graduate from Rensselaer Polytechnic Institute. Prior to joining *G-E*, he was associated with the Boonville, New York, Power and Light Commission, and *Barker and Wheeler*, a New York City engineering firm.

**"THE REPRESENTATIVES"** of Radio Parts Manufacturers, Inc. recently named a new slate of national officers at its annual national delegates' and general members' meeting held in Chicago.

Norman B. Neely of the Los Angeles Chapter was named president; Russ Diethert (Chicagoland) was named first vice-president; Wally B. Swank (Empire State) is the new second vice-president; Dean A. Lewis (California)



6-color displays  
that prospects  
can't pass by!



Striking Ann Blyth  
and June Havoc  
streamers!



4 sets of  
mailers with  
postage already  
attached! Radio  
announcements!

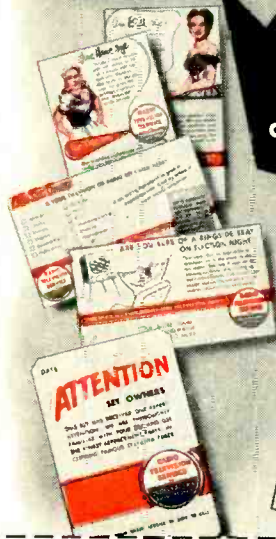

You can double your fall  
service business with this

## NEW SYLVANIA CAMPAIGN

Two gorgeous movie stars, Ann Blyth and June Havoc, feature their personal endorsements of your service in this brand new Sylvania advertising campaign for service dealers. On life-like window displays and streamers, they recommend you just the way they will in the big Sylvania ads in *Collier's*, *Life*, *Look*, and *The Saturday Evening Post*, which will appear this Fall.

In addition, the Sylvania Campaign offers you four sets of personalized mailings imprinted

with your name, address and phone number. All of the mailing pieces have stamps already attached. You pay **NO POSTAGE!** Radio spot announcements, and reminder stickers for your customers' sets round out this sure business-attracting kit!

And all you pay is just 2 cents per prospect per month for the mailers. All the rest is absolutely FREE . . . even the postage on the mailers! Call your Sylvania Distributor today, or mail the coupon below.

# SYLVANIA



RADIO TUBES; TELEVISION PICTURE TUBES; ELECTRONIC PRODUCTS; ELECTRONIC TEST EQUIPMENT; FLUORESCENT TUBES, FIXTURES, SIGN TUBING, WIRING DEVICES; LIGHT BULBS; PHOTOLAMPS; TELEVISION SETS

Sylvania Electric Products Inc.  
Dept. R-2308, Emporium, Penna.

Please send me full details on Sylvania's big Fall Campaign for Radio-TV Service Dealers.

Name \_\_\_\_\_

Street \_\_\_\_\_

City \_\_\_\_\_ Zone \_\_\_\_\_ State \_\_\_\_\_

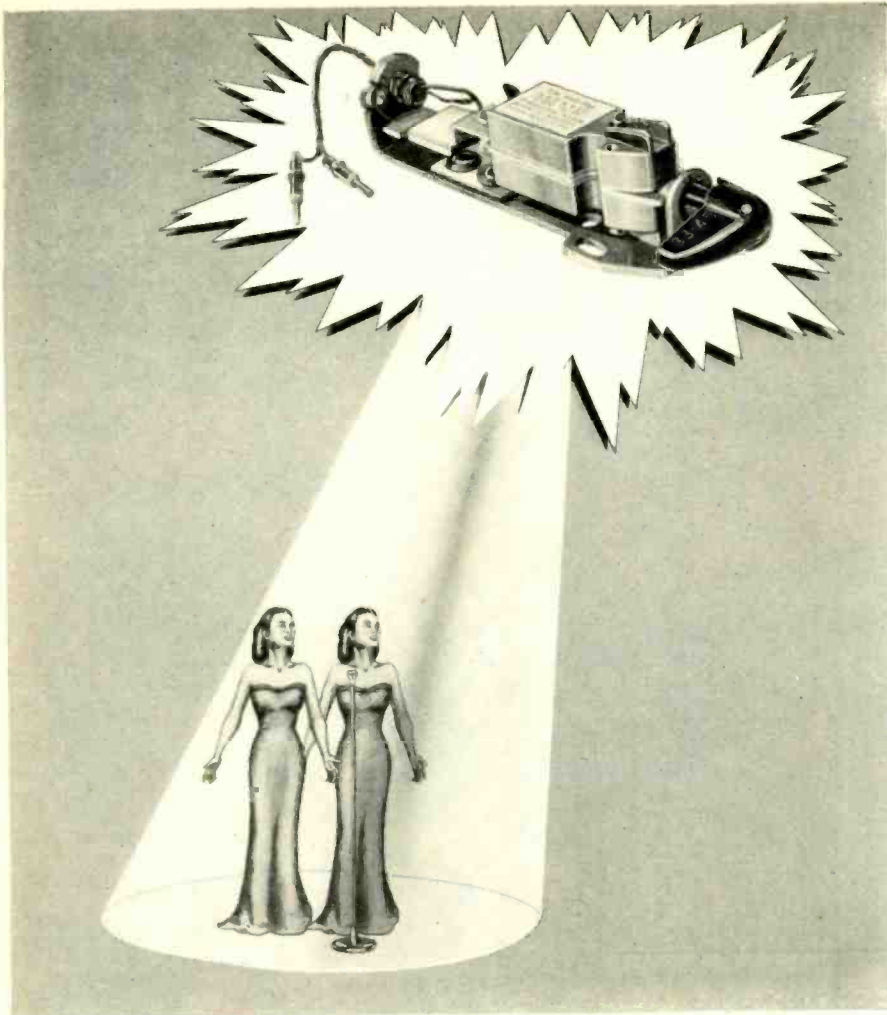

## The highest praise of technical critics now goes to **Twin Performers**

Astatic's "Twin CAC" Turnover Cartridge Captures, as No Other Turnover Cartridge Can, the Full Glory of the Finest Music on Records.

Laboratory test it, or simply listen to it. On all high fidelity counts, for brilliance of tone, for smoothness of response, for frequency range, by any standard . . . you, too, will recognize the unmatched excellence of Astatic's new "Twin CAC," turnover pickup cartridge, the Model CAC-D-J.

You can see the great difference as readily as you can hear it. The radical design principle combines two complete CAC cartridge assemblies, back to back, on a common plate. No chance for needle interaction! For the first time in a turnover cartridge, the ideal output and response characteristics for EACH side can be established, independently, in one such record reproducing unit! Why not write for complete details of this sensational new Astatic product?



The single needle Astatic CAC-J has been acclaimed the perfect cartridge for microgroove records by many impartial experts. Model CAC-78J designates the single needle 78 RPM version.



EXPORT DEPARTMENT: 401 Broadway, New York 13, N. Y. Cable Address: ASTATIC, New York

Astatic Crystal Devices manufactured under Brush Development Co. patents

will serve as third vice-president; James P. Kay (Missouri Valley) is the new secretary; while Royal J. Higgins (Chicagoland) will serve as treasurer.

\* \* \*

**JOSEPH S. WRIGHT** has been appointed assistant general counsel for *Zenith Radio Corporation* of Chicago.

Mr. Wright has been an attorney with the Federal Trade Commission since 1936 and since 1947 has been the Commission's assistant general counsel and chief of its compliance division.



Prior to 1947, he served variously as an attorney-examiner, reviewing attorney, special legal assistant to the chairman, and trial attorney. From 1942 to 1945 he was on active duty with the U. S. Navy, attaining the rank of lieutenant-commander before his discharge.

\* \* \*

**SYLVANIA ELECTRIC PRODUCTS INC.** has leased 20,000 square feet of warehouse and office space in a new building in Seattle, Washington, that will serve as the company's headquarters for sales and service operations in the Pacific Northwest. The new building is located at 3466 East Marginal Way, Seattle . . . **ELECTRONIC SUPPLY CORPORATION** has moved to new and larger quarters at 41-08 Greenpoint Avenue, Long Island City, N. Y. The new location provides over 4000 sq. ft. of floor space to house the firm's distribution activities . . . A new plant for the manufacture of "Speed Nut" fasteners in Canada has been opened by **DOMINION FASTENERS, LIMITED** of Hamilton, Ontario. The plant will supply Canadian industry with more than 100 million units annually . . . **MOTOROLA INC.** has opened a new West Coast parts and service department at 811 South B Street in San Mateo, California . . . **CONRAC, INC.**, manufacturers of custom-built television receiving sets, etc., has opened a new sales and display room at 7264 Melrose Avenue in Hollywood, California . . . **GERBER SALES CO.** of Boston, Mass. has opened a new Connecticut office in the First National Bank Building, 42 Church Street, in New Haven . . . The **SHELDON ELECTRIC DIVISION** of **ALLIED ELECTRIC PRODUCTS INC.** has acquired new branch office and warehousing facilities at 2724 Leonis Boulevard in Los Angeles. The new quarters provide 21,000 square feet of air-conditioned space . . . **MOTOROLA INC.** has leased certain manufacturing facilities from **STROMBERG-CARLSON CO., LTD.** in Toronto Canada and has formed a new subsidiary, **MOTOROLA CANADA, LTD.** which will manufacture and sell television receivers as well as a complete line of home and portable radios for the Canadian market . . . **H-B INSTRUMENT COMPANY** is in production in its newly-acquired plant at American and Bristol Streets in Philadelphia.

(Continued on page 85)

**RADIO & TELEVISION NEWS**

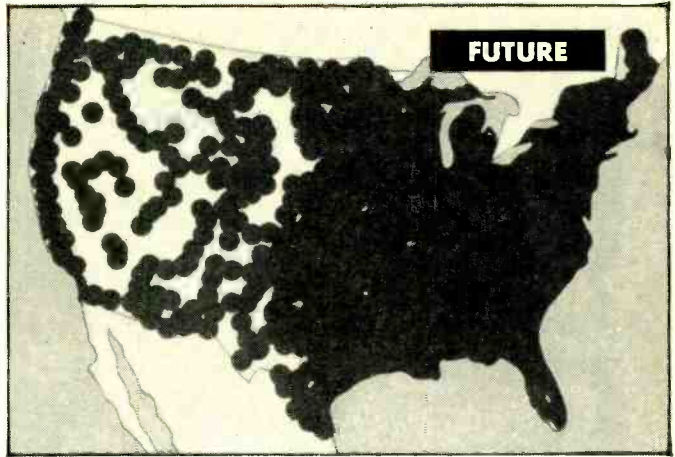
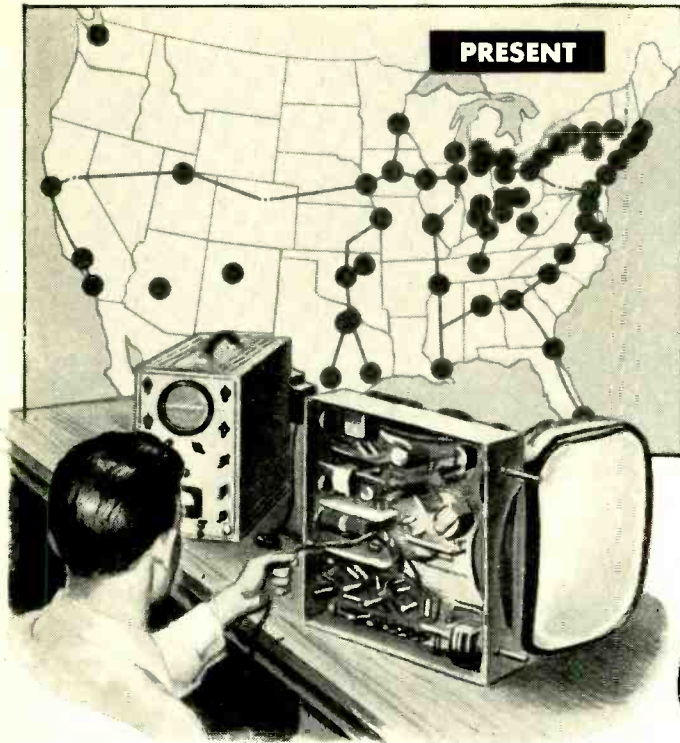

**FUTURE**—How new TV stations are expected to cover the nation.  
**PRESENT**—Chart shows extent of current coverage.

# Cash in on this Great Opportunity

## ... for good-pay jobs in TV SERVICING

**YES**, thousands of opportunities are going begging right now for good-pay jobs in TV Servicing.

The lifting of the "freeze" on new television stations clears the way for the expansion of the industry for 2,053 new stations, in 1,291 communities in the United States, its territories and possessions. There are only 108 stations telecasting now.

This is your golden opportunity to get all set for a good job that can mean employment security and a bright future for years to come. It's a great opportunity that can lead you, as a trained and experienced TV Serviceman, into establishing a profitable business of your own.

### Big shortage of TV Technicians creates opportunities—NOW

Industry experts have estimated over 130,000 experienced TV technicians will be needed for the installation, trouble-shooting and repairing of television receivers in use by 1955. There are fewer than 50,000 fully trained TV service technicians available today. What an opportunity this creates for you!

Here are some of the good-pay jobs you can

choose—installation and trouble-shooting of TV receivers in homes . . . bench technician in radio-TV service shops . . . inspector, tester, repairman, field serviceman for TV receiver manufacturers, distributors and dealers . . . testing and servicing with electronic instrument manufacturers and companies with military contracts for electronic equipment . . . civilian serviceman with U. S. Military Bases . . . your own TV service shop—and many more.

### RCA Institutes home study course trains you in your spare time

If you are associated with the radio-electronics industry, with no experience in TV servicing, the addition of the RCA Institutes Home Study Course in TV Servicing to your present experience will quickly qualify you to step out and grasp the good jobs now open in television.

The RCA Institutes course gives you a sound knowledge of television fundamentals . . . intensive practical instruction on the proper maintenance and servicing of TV receiver circuits . . . teaches you the "short cuts" on TV installation and trouble-shooting. Learn TV servicing (based on actual experience of hundreds of skilled technicians) from RCA engi-

neers and experienced instructors—pioneers and leaders in radio, television and electronic developments.

### RCA Institutes home study course planned to your needs

You keep your present job. In your spare time, you study at home. You learn "How-to-do-it" techniques with "How-it-works" information in easy-to-study lessons prepared in ten units. Cost of RCA Home Study Course in Television Servicing has been cut to a minimum—as a service to the industry. You pay for the course on a "pay-as-you-learn" unit lesson basis. You receive an RCA Institutes certificate upon completion of the course. The RCA Institutes Home Study Course in Television Servicing is approved by leading servicemen's associations.

Don't pass up this lifetime opportunity for financial security and a bright future in TV.

### SEND FOR FREE BOOKLET

Mail the coupon—today. Get complete information on the RCA INSTITUTES Home Study Course in Television Servicing. Booklet gives you a general outline of the course by units. See how this practical home study course trains you quickly, easily. Mail coupon in envelope or paste on postal card.

RCA Institutes conducts a resident school in New York City offering day and evening courses in Radio and TV Servicing, Radio Code and Radio Operating, Radio Broadcasting, Advanced Technology. Write for free catalog on resident courses.



**RCA INSTITUTES, INC.**  
 A SERVICE OF RADIO CORPORATION OF AMERICA  
 350 WEST FOURTH STREET, NEW YORK 14, N. Y.

August, 1952

## MAIL COUPON NOW!

RCA INSTITUTES, INC., Home Study Department RN-852  
 350 West Fourth Street, New York 14, N. Y.

Without obligation on my part, please send me copy of booklet "RCA INSTITUTES Home Study Course in TELEVISION SERVICING." (No salesman will call.)

Name \_\_\_\_\_ (please print)

Address \_\_\_\_\_

City \_\_\_\_\_ Zone \_\_\_\_\_ State \_\_\_\_\_



# COMMON SENSE about easy tv servicing

Make your servicing job easier than you ever thought possible

## Complete Servicing Facts Method Proved Outstanding Success

Tens of thousands of service technicians throughout the country have learned this key to fast, easy, profitable servicing: They *insist* on having the complete servicing facts for every receiver they repair! They know that by having the complete story... and only by having the complete story... can they spot trouble quickly and do an easy, permanent servicing job.

Here's an example: On Philco models 52-P-1810, 52-P-1812, 52-P-1840, 52-P-1842, 52-P-1844, 52-P-1882, 52-P-2110, 52-P-2142, codes 122 and 123, the manufacturer released 32 pages (8-1/2 x 11") of official service data. (That is what we published in Rider TV Manual Vol. 9 and in Rider TV Tek-File Pack 22.)

These models were made in a variety of production runs; using three different chassis... each with its own schematic. These chassis are identical in many respects... but the vital differences can make servicing a real headache. For instance, three types of power transformers are used. Each has different electrical constants—and a different part number. In the C2 deflection chassis, the power transformer has one high voltage winding of 635 volts, center-tapped, and four low voltage windings: one 5 volts, two 6.8 volts and one 6.4 volts. In the CP1 deflection chassis, the power transformer has one high voltage winding of 635 volts, center tapped, but only three low voltage windings: one 5 volts, one 6.8 volts and one 6.4 volts. In the F2 chassis, the power transformer has one high voltage winding of 675 volts, center-tapped, and four low voltage windings: one 5 volts, two 6.8 volts and one 6.4 volts.

Suppose you were the service technician faced with one of these receivers. A single schematic showing just *one* of these chassis and *one* of these power transformers certainly would not be coverage for all production runs. If you were lucky, the single schematic might happen to match the receiver you had before you. But—and it's a very big but—you might also be unlucky and be faced with a receiver not described by the schematic! This is only one example in thousands of why you need *complete*, factory-prepared and factory-issued data for every set you service.

Here is how you can get this vital information. Insist on Rider Servicing Data. For 22 years Rider Servicing Data has been the *only* publishing source for the complete servicing facts: Exactly as issued by the manufacturer who made the set. Unabridged facts... everything is here to make your diagnosis and repair *EASY*. You get page after page of troubleshooting test patterns... large, easy-to-follow *complete* schematics... circuit explanations... stage by stage alignment curves... clear, enlarged chassis views... all circuit changes... and much, much more. For example: Rider tv servicing data has shown 'scope waveforms in tv receivers ever since the first tv receiver was made!

*To meet your individual needs, Rider Servicing Data comes in two forms... both with these important, new features:*

### Manufacturers' Trouble Cures

These 3" x 5" standard index cards called Rider Handies contain vital manufacturer-issued permanent trouble cures plus production changes. Each Handy is identified with a manufacturer and a receiver model. With Rider Handies you save countless hours of diagnosis and repair time... because Handies contain the data you *must* have to make *permanent* repairs on many manufacturers' models. (Rider Handies information appears in Rider TV Tek-File packs, and Rider TV Manuals beginning with Vol. 9.)

### Guaranteed Replacement Parts Listings

Beginning with Rider T.V. Manual 10 and Rider T.V. Tek-File Pack 57, replacement parts listings are included. All the replacement parts listed in Rider tv servicing data meet the physical and electrical performance ratings of the original equipment!

### Rider T.V. Manuals Vols. 1 to 9 (covering more than 4,200 models)



Each contains full data for manufacturers' receivers produced during a certain period. (The latest, T. V. 9, recently published, covers October 1951 through February 1952.) Each manual has over 2,000 (8-1/2" x 11") pages in permanent binder, with an index covering the contents of all manuals. Rider manuals are perfect for shop use and permanent reference. Price—\$24 each.

### Rider T.V. Tek-Files (Packs now cover 2,200 models)

A typical T.V. Tek-File pack is shown below. In Rider Tek-File packs you buy complete Rider servicing data for whatever receivers you want... when you want it. You buy according to your needs with the assurance of getting the *complete servicing facts* for every repair. Notice that each pack consists of handy, standard file folders for easy use. Only \$2 each pack.



**FREE** Rider T.V. Tek-File indexes covering the contents of all published packs are at your jobber's. If he doesn't have them, write us.

### DON'T BE SWITCHED!

Rider Tek-File is **DEFINITELY NOT** the same as any other publisher's service. If your jobber doesn't carry them, **DON'T BE SWITCHED**. Write us direct... we'll sell you. (Please include your jobber's name.)

### TRY A PACK

Prove to yourself that Rider Tek-File makes tv servicing easy. Buy one pack for the next receiver you service. If you don't agree it's better than anything you ever used, return the pack to us within seven days... we'll send you a full refund.

**Rider Radio Manuals. Vols. 1 to 22.** Contain complete, factory-issued, official AM, FM radio servicing data... plus auto radios, record changers, tuners and recorders.

### OUT SOON!

Rider **RADIO** Tek-Files! Same style as T.V. Tek-Files. Now, get your complete radio servicing data this easy economical package way. Ask your jobber.

**John F. Rider Publisher, Inc., 480 Canal St., New York 13, New York. West Coast Office: 4216-20 W. Jefferson Blvd., Los Angeles, California.**

**RADIO & TELEVISION NEWS**



Got "Dual Control  
headaches?"

**MALLORY  
MIDGETROLS®**  
*will cure them!*

Why wait for delivery—why scour distributors' stocks for special controls? You can replace *any* dual control in only a few minutes, by assembling the *exact* combination you need with Mallory Midgetrol Companion Units.



Factory Equipment

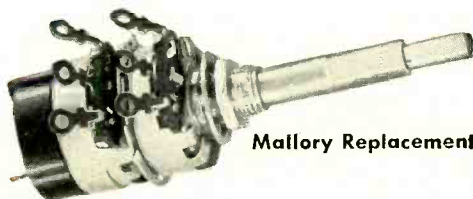

Mallory Replacement

Here's how easy it is to get an *exact replacement* for the original control. You just combine the Mallory factory-assembled front and rear control sections... add the easily attached switch... insert the shaft tip. The job takes less than five minutes. No soldering, no special tools.

**Quick—sure—economical.** Here's the way to get the control you need, with these features:

- **Exact match**, electrically and mechanically, for original components.
- **Highest quality**—quiet, drift-free resistance elements, accurate tapers, wobble-free, two-point suspension.

Best of all, you won't have to carry big inventories. A small selection of standard sections will equip you to service all the popular radio and TV sets. Your Mallory distributor has a complete stock of control sections, switches and hardware ready for immediate delivery. See him today!

P. R. MALLORY & CO. INC.

**MALLORY**

CAPACITORS... CONTROLS... VIBRATORS...  
SWITCHES... RESISTORS... RECTIFIERS...  
VIBRAPACK\* POWER SUPPLIES... FILTERS  
\*Reg. U.S. Pat. Off.

**APPROVED PRECISION PRODUCTS**

**P. R. MALLORY & CO., Inc., INDIANAPOLIS 6, INDIANA**

*Make Sure...  
Make it Mallory*

*Yours for the asking...*

this new set of  
**PYRAMID  
CAPACITOR**  
*catalogs!*

**CATALOG IMP-1** describes Pyramid's new line of molded plastic tubular capacitors. "IMPS" are rugged — impervious to moisture and withstand a temperature of 100° C.

**CATALOG MP-2** gives detailed information on ultra-compact metallized paper capacitors. Minimum size and weight, and self-healing qualities are characteristics of these units.

**CATALOG PG-1** lists miniature Glasseal capacitors. These tubular units perform at temperatures ranging from -55° C. to +125° C.

**CATALOG J-7** is a 32-page compilation of paper, electrolytic, oil-paper and metallized paper capacitors. Complete data on eighteen different types, including construction variations, sizes and prices are listed.

*Free copies of these colorful, attractive publications are available on letterhead request to Dept. R1*

**PYRAMID  
ELECTRIC COMPANY**

1445 Hudson Boulevard, North Bergen, New Jersey

# MICROWAVES for the "HAM"

Fig. 1. A 6V6 tube mounted in a wave guide and cavity system for generating microwaves with a conventional receiving tube.

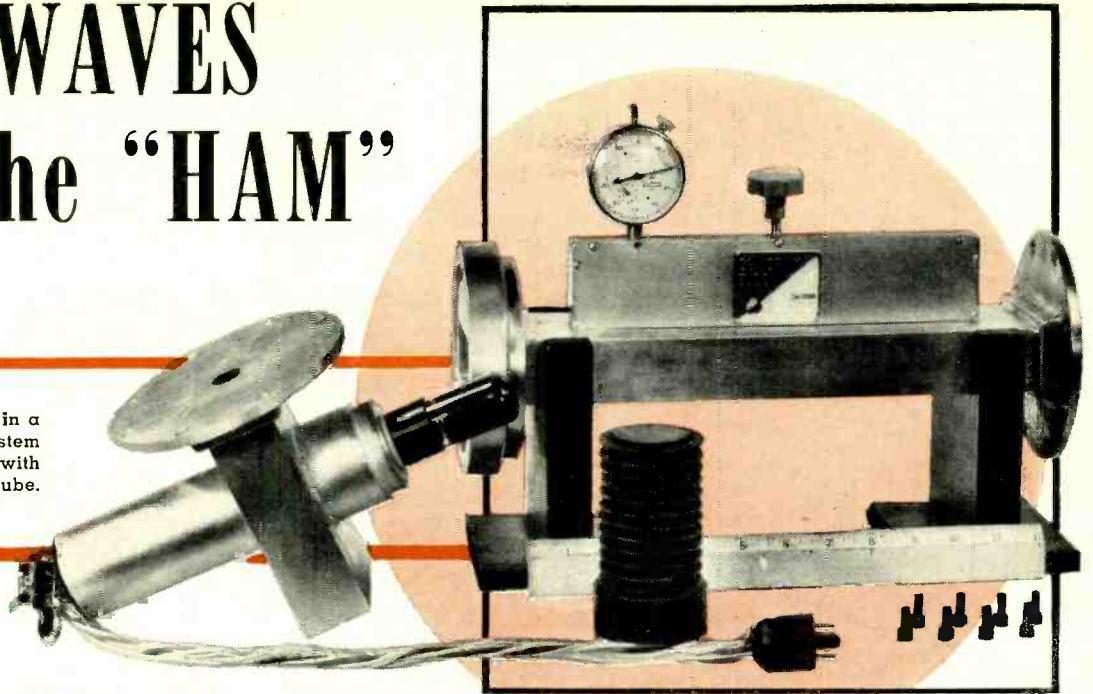

By

**SAMUEL FREEDMAN**  
W6YUG

**S**INCE May 1945 the Federal Communications Commission has reserved seven bands of microwave frequencies for the exclusive use of hams. Ideally located between 420 and 22,000 mc., this allocation provides over 2,000,000 kilocycles of spectrum as compared to the 16,000 kilocycles now used for approximately 99 percent of all ham transmissions.

It is now seven years since these bands were assigned to the hams yet, with the exception of the 420-450 mc. band, activity in these bands is negligible. This state of affairs is inconsistent with the ham's traditional role as a "radio pioneer."

The fact that 15,000,000 television receivers are now in the hands of the public with more to come as new stations bring larger areas of the country within the fold will provide a powerful impetus in "kicking the amateurs upstairs." If there is to be any lasting peace and harmony between the millions of viewers and the thousands of amateurs, the only real solution lies in a voluntary, or perhaps involuntary, exodus of radio hams to the high frequency, or microwave, side of the television frequency bands.

Ham transmissions on the present popular amateur bands will continue to cause interference in nearby receivers with the attendant protests from irate TV fans. Although it is technically and theoretically possible to eliminate such interference, it is sometimes financially unfeasible to do so. The mere fact that one amateur station can operate in a certain area without causing interference in nearby television receivers is no guarantee that the equipment will continue free from TVI. All the ham has to do is change frequencies or equipment or for a neighbor to buy a dif-

***The growing problem of TVI will eventually force hams to "move upstairs" into the microwave bands.***

ferent type of TV receiver and the problem of interference becomes critical.

The public's investment in television receivers now aggregates three billion dollars as compared to the approximately thirty million dollars which hams have tied up in their equipment. Thus the hams' stake in radio gear has been exceeded a hundredfold by the public's investment in home receivers. In terms of the number of households affected (or in votes at election time), the relationship is even more top-heavy. At the present time there are over 200 times more television households than there are ham radio homes. Even the ham often finds himself in the unenviable position of having his ham equipment interfere with his own television reception! A showdown is in the making at the present time and eventually the ham will wind up in the microwave region and, in the opinion of the author, when this happens it will be the greatest "blessing in disguise" ever vouchsafed the radio art.

The situation is even more critical than it was in 1922 when radio broadcasting developed virtually overnight into a hydra-headed monster of gigantic proportions. At that time, amateur radio had to move up in the radio spectrum and operate on the high frequency side of radio broadcasting. This enforced move made the ham's equipment and techniques obsolete and unsuitable. Specifically he had to discontinue operations on frequencies of 1500 kc. and lower where he had employed a spark coil or rotary spark transmit-

ter, crystal receivers, monstrous antennas, and wireless telegraphy. He was forced to operate in the band from 1500 kc. upward with equipment requiring the use of vacuum tubes and careful attention to impedance matching.

In a matter of months this enforced move resulted in several important developments. The move led to the discovery of the Kennelly-Heaviside layer, reliable determination of sky wave skip phenomena, and the establishment of the advantages of short-wave operation.

The ham was delighted to discover that with a fraction of the power needed on the lower frequencies he could communicate world-wide—even to the antipodes. Even a small receiving tube, such as the now-obsolete UV201A, was sufficient to serve as a transmitter to reach all the way to Australia. The range of communication jumped from the usual hundred miles or less to distances circling the globe. Furthermore the ham could make his contacts by voice or radiotelephony instead of code or radiotelegraphy.

Today a similar situation exists except that now the amateur will move to a much higher and more spacious spectrum. He can achieve efficiencies in circuitry never before possible since he can dispense with lumped or specially-provided inductances, condensers, and even resistors with their losses. He can develop and control the electric and magnetic fields through distributed inductance, capacitance, and impedance by means of the physi-

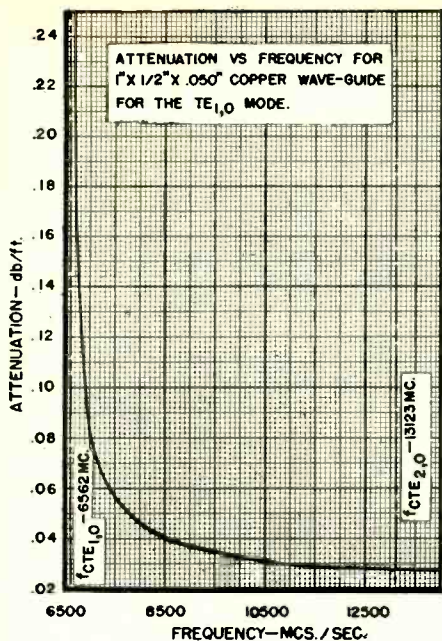

Fig. 2. Graph of attenuation vs frequency for a 1 x 1/2 inch wave guide suitable for 10,000 to 10,500 mc. ham band operation.

cal arrangement of simple metallic shapes.

On microwaves, the amateur will again be recognized as one of the nation's most valuable sources of original research and experimentation instead of a mere nuisance as he has now become in the opinion of millions of viewers. On microwaves, where amateur radio now more properly belongs, hams by their very number and geographical distribution will open a new era in amateur radio. They will quickly overtake the billions of dollars' worth of professional microwave development that has thus far taken

MEDIUM FREQUENCIES	TOTAL KC.
1800-1825 kc.	25 kc.
1875-1925 kc.	50 kc.
1975-2000 kc.	25 kc.
	100
HIGH FREQUENCIES	
3500-4000 kc.	500 kc.
7000-7300 kc.	300 kc.
14,000-14,350 kc.	350 kc.
21,000-21,450 kc.	450 kc.
26,960-27,230 kc.	270 kc.
28,000-29,700 kc.	1700 kc.
	3,570
VERY-HIGH FREQUENCIES	
50,000-54,000 kc.	4000 kc.
144,000-148,000 kc.	4000 kc.
220,000-225,000 kc.	5000 kc.
	13,000
ULTRA-HIGH FREQUENCIES	
420-450 mc.	30,000 kc.
1215-1300 mc.	85,000 kc.
2300-2450 mc.	150,000 kc.
	265,000
SUPER-HIGH FREQUENCIES	
3300-3500 mc.	200,000 kc.
5650-5925 mc.	275,000 kc.
10,000-10,500 mc.	500,000 kc.
21,000-22,000 mc.	1,000,000 kc.
	1,975,000
Total Spectrum	2,256,670

Table 1. Currently authorized ham bands.

place without his participation. He can ultimately save the taxpayers untold sums which are now going into microwave research and development. In the past decade it has been demonstrated that professional microwave activities have been unable to keep microwaves simple and inexpensive enough to encourage their widespread usage. Only the radio amateur is in a position to substitute empirical (cut-and-try) methods for the calculated complex and planned procedures of government and industry. There are relevant discoveries yet to be made which can best be made by a free exchange of information and experiences by amateurs operating largely "without rhyme or reason" techniques.

The radio amateur today has a large number of frequencies in which he is free to operate. These frequency bands are listed in Table 1.

It is estimated that most of the licensed amateur radio activity in the United States is concentrated in the high frequency band, representing a total of only 3570 kc. out of the total 2,256,670 kc. assigned to hams. They, plus the bulk of the rest of the hams operating on the 50-54 mc. and 144-148 mc. bands, are the source of the TVI. The hams have congregated into 11,670 kc. of the amateur spectrum subject to TVI while doing little to equip themselves and engage in operations on the balance of the 2,245,000 kc. assigned to them. They are jammed into less than one-half of one per-cent of the spectrum and are ignoring the more than 99 1/2 per-cent of the spectrum in which TVI would be virtually nonexistent.

Microwaves have been generally recognized to be the frequencies between 300 and 3000 mc. (known as ultra-high frequencies) and between 3000 and 30,000 mc. (known as super-high frequencies). The FCC has allocated 9.8 per-cent of all ultra-high frequencies and over 7.3 per-cent of all super-high frequencies for the exclusive use of hams. On a non-exclusive basis, the amateurs may also use all frequencies above 30,000,000 kc. on to infinity or cosmic rays, including the bands known as "infrared," "light," "ultra-violet," "x-rays," "gamma rays," and beyond.

#### Microwave Techniques

Basically, the difference between microwave operation and transmissions at the lower frequencies is a matter of equipment. In the case of microwave operation there is no need for specially-provided transformers, coils, condensers, or resistors. As shown in Fig. 3, all of these components are replaced by positions taken along a closed or shorted pipe (called a wave guide). In practice, this pipe is usually rectangular with its wide dimension exceeding a half wavelength. Fig. 4 is a photograph of a commercially-available model and an improvised unit made of screen wire. The home-built unit can be made out of foil or any other conductive or non-conductive material as long as the inner surface is a good conductor. If a simple can is used instead of a pipe, the unit is called a "cavity." Only the frequencies which have electric and magnetic field distributions that fit inside of such a can or cavity will exist in same. Thus, it is a frequency controlling element that replaces quartz crystals on the lower frequencies. For the amateur frequencies, the cavities can have a "Q" on the order of 10,000 or more.

On the frequencies that the radio amateur best understands (frequencies below 450 mc.), he has been conveying energy by means of conductors such as circuit wiring. On the microwave frequencies, he conveys the current by means of electric and magnetic field displacements within the wave guide. In other words, microwaves are characterized by the displacement technique while conventional frequen-

Fig. 3. How coils and condensers, alone or as series or parallel circuits, can be eliminated by moving along a quarter wavelength within any over-all half wavelength.

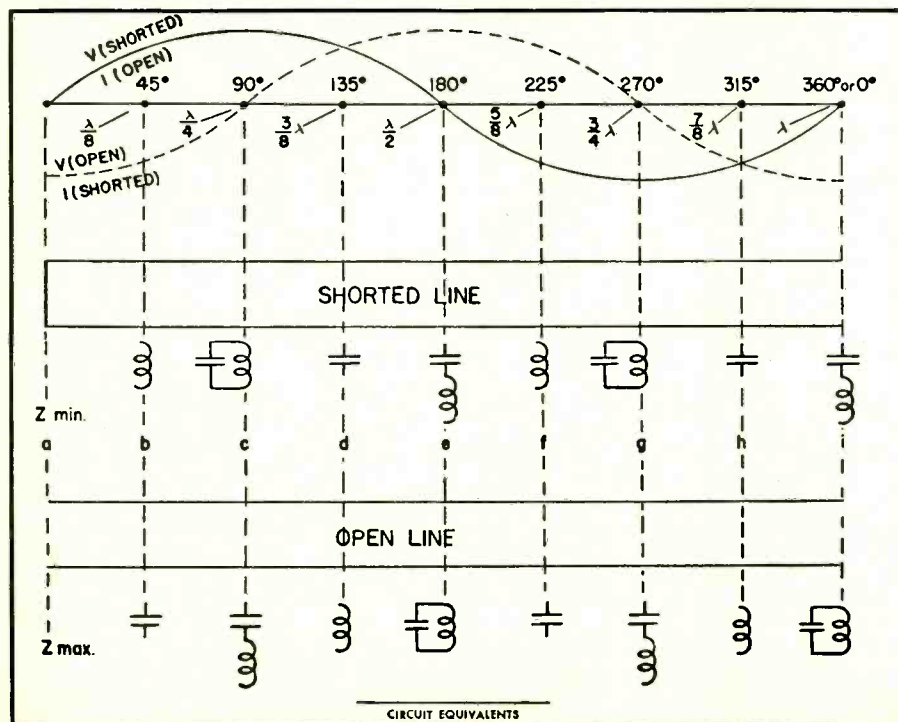



cies use conduction or the cumbersome electric power line technique.

On microwaves, the phenomenon of space radio propagation is extended to the passage of energy within the equipment itself and the transmission line system. The method by which this takes place is shown in Fig. 5. One side of the wave guide pipe (Fig. 4) simulates the ionosphere while the opposite side simulates the earth. Fig. 5 shows a several-hundred-foot medium frequency broadcasting tower used for sky wave transmissions by reflections between the ionosphere and the earth. Fig. 5A shows a rectangular pipe (artificial or fabricated wave guide) which replaces "Nature's wave guide" and performs the same function. In Fig. 5A the pipe is less than a half wavelength or at cut-off. Energy will not proceed down the pipe and attenuation is maximum. Fig. 5B shows what happens if the wave guide is wider than a half wavelength. Energy will propagate down the wave guide. Fig. 5C shows what happens if the wave guide is made even wider. Energy will be propagated even better with less attenuation or losses. In order to keep this explanation simple it is desirable that the dimension of the guide not approach or exceed a full wavelength. If the guide is wider than a full wavelength, the energy divides itself and becomes similar to two wave guide pipes. Two energy patterns or modes would then exist side by side. In addition, the narrow side of the rectangular wave guide would accommodate a pattern. The narrow side walls function to keep the other two walls properly spaced. They also determine how much power can be handled by the wave guide. The wave guide of Fig. 4 can handle up to 3,200,000 watts of power without breakdown or flashover. Fig. 2 is a graph of the performance of a wave guide suitable for the 10,000 to 10,500 mc. amateur microwave band. The rectangular pipe has an inside dimension of .9" x 4". Part A in Fig. 5 corresponds to 6562 mc. on the graph of Fig. 2. Part B in Fig. 5 might correspond to 7500 mc. on the graph of Fig. 2. Part C might correspond to 10,500 mc. on the graph of Fig. 2. At 13,123 mc., two modes of energy will form, changing this particular energy designation from "cut-off frequency of transverse electric mode 1,0" to "cut-off frequency of transverse electric mode 2,0."

It is preferable to operate in the dominant or first mode for reasons of simplicity. It is feasible, and research has been conducted along these lines, to use several modes, each a separate channel of communication. If the wave guide is two wavelengths in width, there would be four modes of energy. If it is three and one-half wavelengths in width, there would be seven modes of energy, etc. Fig. 2 also shows the attenuation in decibels-per-foot for a particular size wave guide. In this case, in the 10,000 mc. amateur microwave band, it is less than .035 db-per-foot. The wave guide could be over 28

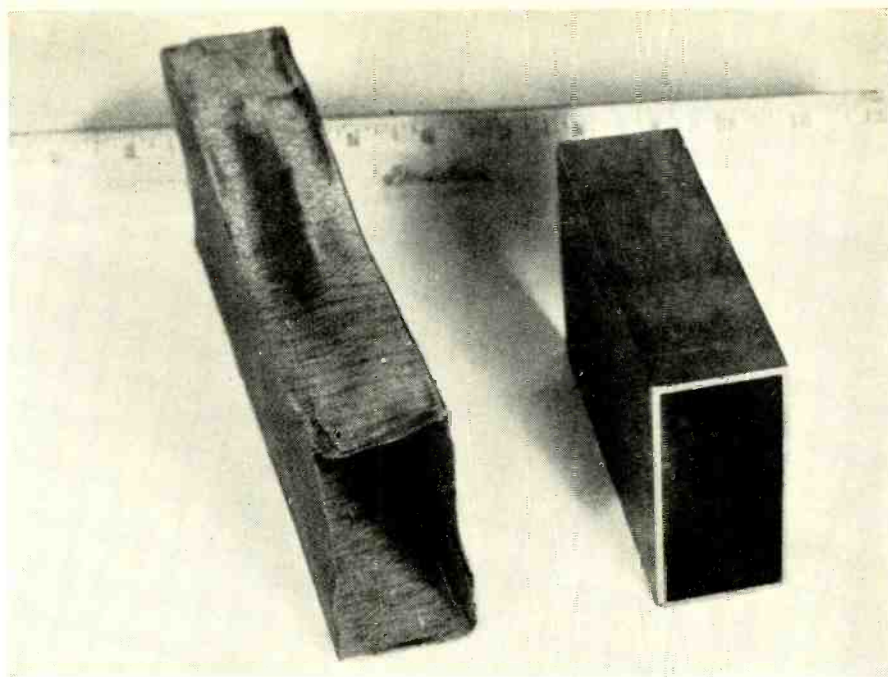

Fig. 4. Commercial vs homemade wave guide for the 3300-3500 mc. band. This 3"x1½" wave guide has a power handling capacity of nearly 3,200,000 watts.

feet long before the energy would be attenuated 50 per-cent. By selecting an appropriate size wave guide, minimum attenuation can be obtained for any frequency. This same concept holds true even on low frequencies except that at 4000 kc., for example, the wave guide pipe would have to be substantially greater than a half wavelength, or 123 feet in width. It is only because of the shorter wavelengths which make possible convenient physical dimensions that it is possible to take advantage of microwave techniques that would be impossible or unfeasible to employ on lower frequencies. The technique would otherwise function on any wavelength as long as physical dimensions and associated costs are not prohibitive. The amount of power which such a wave guide can handle depends upon the height of the guide. For the wave guide of Fig. 2, the power handling capacity is 235,000 watts. The smallest size wave guide, such as the one required for 21,000 to 22,000 mc., will still exceed 60,000 watts power handling capacity. Since communication at microwave frequencies can be carried on with a fraction of a watt power (even microwatts) there need be no concern that the user might, in any way, exceed the power handling capacity of a wave guide.

To further appreciate wave guide phenomena, one need but recall what happens to an auto radio receiver when the car is driven through an underpass. The underpass is, in reality, a wave guide. Since the broadcast might be 1000 kc. (300 meter wavelength), such an aperture or wave guide would have to exceed 500 feet in diameter in order for the signals to go through. Police radios and two-way vehicular systems have no difficulty in communicating in such a wave guide since

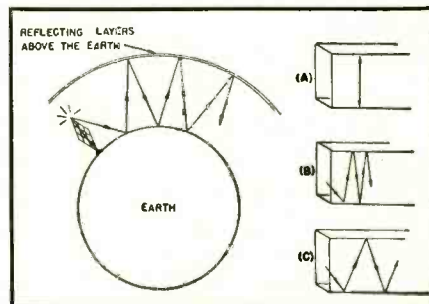
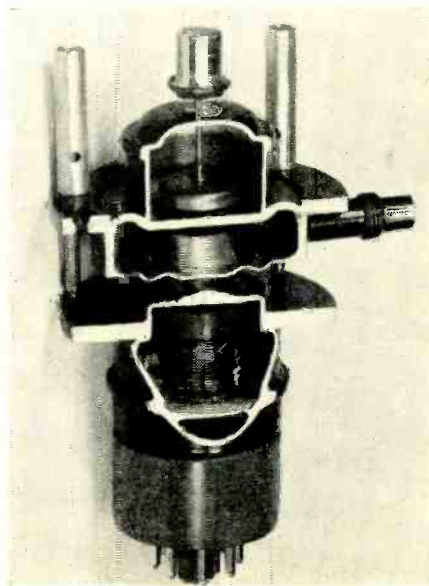

Fig. 5. Nature's wave guide on low frequencies vs fabricated wave guides on microwaves. Wave guide is shown at cut-off, above cut-off, and at even higher values.

Fig. 6. Cutaway view of reflex klystron. The negatively biased repeller atop the tube turns the electrons back to the positively biased grids. A cavity circuit is set up between pairs of grids. A tube of similar type can be used at 3300-3500 mc.



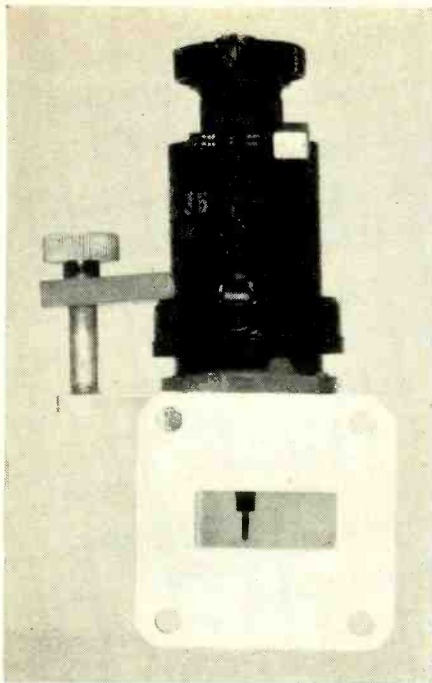

Fig. 7. A reflex klystron tube with its output coupled into a wave guide as required for operation in the 10,000 to 10,500 megacycle ham band.

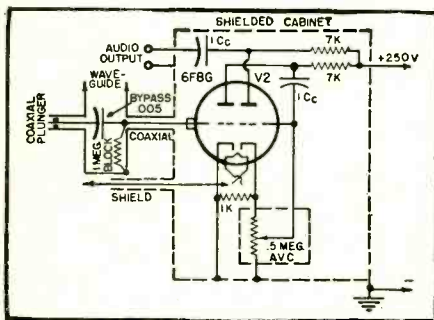
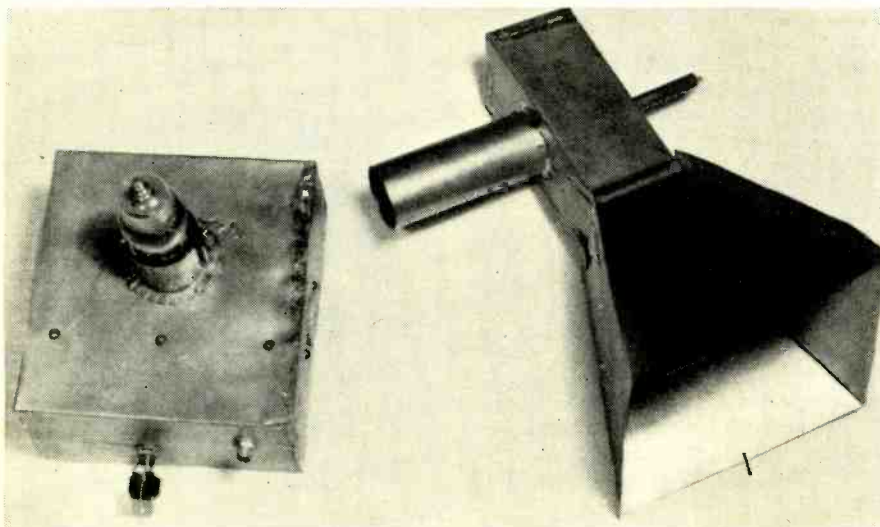

Fig. 8. Circuit of one-tube microwave receiver using conventional-type tube.

their operating wavelength is substantially shorter and will fit inside such boundaries. The wavelengths involved for the amateur microwave bands

Fig. 9. One-tube microwave receiver using single 6F8G tube. The horn unit comprises the antenna and transmission line when placed over the tube.



range from as little as a half inch on 22,000 mc. to as much as 14 inches on 1200 mc.

There are many other methods of handling microwave energy of which the "G string" and the "helical coil" are particularly interesting examples. In the case of the helical coil, the coaxial inner conductor connection is extended into a coil which serves as a wave guide. With the "G string," the coaxial connector inner connection extends as a straight wire while the coaxial connector outer connection flares out into a horn which focuses the energy onto this straight wire.

#### Tubes for Producing Microwaves

There are several tube types or tube techniques for generating microwaves. Where one can be purchased at surplus, a reflex klystron is a useful means of generating microwave frequencies. Fig. 6 is a cross-section view of a type which is approximately correct for the 3300-3500 mc. amateur band. It has a cathode, a pair of grids, and a repeller. A repeller is equivalent to a plate but is biased negatively instead of positively. The grids operate at a high positive potential. A cavity connects to the grid extremities to form a tuned circuit. If modulation or audio is impressed on the repeller voltage, the tube will serve as an FM transmitter.

Fig. 7 shows how a reflex klystron tube is coupled to the wave guide. The output electrode extends into the wave guide as if it were a quarter-wave grounded antenna, in low frequency applications. Energy then propagates down the wave guide. An adjusting screw tunes the cavity contained within the tube itself. Such a tube and wave guide is nearly correct for the 10,000 to 10,500 mc. amateur microwave band.

Fig. 1 shows a conventional tube enclosed within a wave guide cavity. In this application only the tube frequencies which can exist for that size microwave plumbing are available and utilizable. The grid and plate leads

can be adjusted external to the guide. The photograph also shows an elaborate wave guide attenuator consisting of a carbon-coated resistor that can be inserted into or withdrawn from the wave guide. A gauge is used to indicate how much attenuation is being inserted.

Other means of providing microwave energy include:

1. Tubes having very close inter-electrode spacings while maintaining low orders of interelectrode capacitance by their geometrical design.

2. By using conventional tubes with the transit time between cathode and plate equal to more than a period of oscillation in order to maintain proper phase relations even though the transit time is too long with respect to the same period or cycle of oscillation. It can be corrected for a subsequent period. The electron transit time may take two or more periods of time to reach the plate from the cathode but it must arrive at the plate during the correct part of the period. This is accomplished by means of suitable voltages.

3. By use of a spark gap within a shielded wave guide. A spark gap generates the frequency spectrum while the wave guide plumbing enclosing or connected to it permits only the microwaves to propagate.

In its simplest form, a microwave transmitter is merely a signal source which may be a tube or a spark gap and a wave guide pipe. The outer end of the pipe will squirt energy into space from the end of such a wave guide. If a horn extends from that end, the energy may be concentrated or directed as desired. The beam may be sharpened or broadened by changing the length and angle of the flared horn.

The simplest microwave receiver is a silicon or other type of receiving crystal connected to a pair of headphones. A more elaborate receiver may consist of a crystal detector followed by several stages of audio or video amplification. Still more elaborate is a crystal mixer stage in which the crystal output is mixed with a local oscillator (which may be the transmitting tube) to yield an i.f. frequency which is then handled by a superheterodyne circuit similar to the one used on the lower frequencies.

Fig. 8 is the schematic of a one-tube microwave receiver used by the author in his laboratory experiments. The same tube serves as a combination r.f. amplifier, detector, first audio amplifier, as well as providing for possible a.v.c. connections. Fig. 9 shows how this receiver appears, complete with its antenna system made of brass foil. The horn and wave guide section slips over the tube with a coaxial tuning plunger connecting to the grid of the first half of the Type 6F8G tube. The antenna system comprises an electromagnetic horn, tapering to a round wave guide. The coaxial plunger, consisting of a movable short, permits ad-

(Continued on page 131)

# AUDIO GOES MOBILE

Over-all view of Electro-Voice's "Audio CaraVan"—a mobile sound studio and demonstration unit.



**B**ELIEVING that high-quality audio equipment need only be heard to be sold, *Electro-Voice, Inc.* of Buchanan, Michigan has developed a unique mobile demonstrator which will tour the country and bring a flexible assortment of audio gear to the small-town listener as well as the urban music lover.

Designed to permit the customer to make his own "comparative listening tests," the "Audio CaraVan" has been set up to simulate rooms in a home or studio. Approximately 1850 cubic feet of space is available in the 12,000 pound, 38-foot trailer which is pulled by a *Chevrolet* cab-over-engine tractor.

Inside the "CaraVan" is displayed the company's line of cabinets, speakers, and speaker systems—all fed by broadcast-quality recording equipment such as *Ampeex* and *Magnecord* tape recording and playback units, and *Rek-O-Kut* turntables equipped with *E-V* phono cartridges. All of this equipment is hooked into a console switching control system which enables the customer to make his own listening comparison tests.

In addition to these purely audio items, the "CaraVan" also carries a display of the company's television boosters and distribution systems.

The new "CaraVan" made its debut at the Parts Show held in Chicago in May. During the Show thousands of persons visited this unusual display-room-on-wheels and

***By making a complete line of high quality audio equipment accessible to the customer one firm hopes to stimulate its sales.***

voiced their approval of the idea of taking the merchandise to the customer. This wholehearted endorsement of the scheme presages its enthusiastic acceptance by dealers throughout the country.

Should the idea go over as expected, the company plans to equip several more such trailers in order to cut down the time required to cover the country. Dealers will be invited to visit the "CaraVan" and, if they wish, bring along their prospective customers who will be allowed to test various combinations of the equipment that is displayed within the mobile unit.

The "CaraVan" may be headed your way—so look for the distinctively-designed trailer unit in your community. When it reaches your town, stop in and look around. You will be more than welcome to try out the equipment in various combinations until you find the audio units that best suit your needs.

—30—

A customer selects audio equipment by means of control console.



August, 1952

Over-all view of trailer showing assortment of audio equipment.



# SERVICING

# PICTURE TUBES

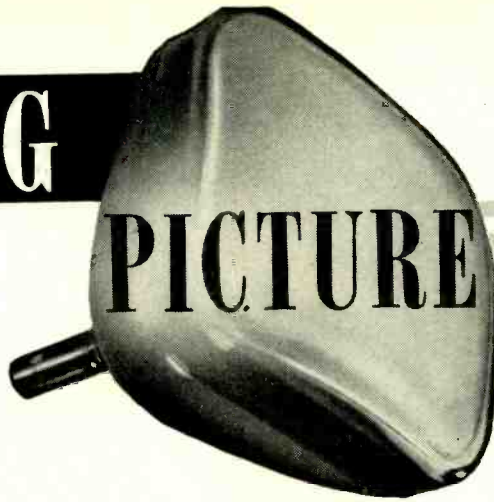

By  
**JOHN B. LEDBETTER**  
Eng., WKRC, WKRC-TV

## Some useful hints on extending the life of TV picture tubes and improving tube performance.

**W**HAT would you do if restrictions suddenly were placed on picture tubes? This is a serious enough question at the present time, but it assumes even more serious proportions when you consider the rising popularity of large-screen receivers and the possibility of shortages in the near future. Obviously, the only course to follow would be the replacement of *inoperative* picture tubes as your supply allows and the disregarding of all other picture-tube troubles until the situation has been improved.

In many cases, a defective picture tube can be serviced or returned to normal by one of several simple operations. These are important to you *now* because their successful employment not only will extend the present life of the tube but will ease replacement problems later. These methods will be covered in detail in this article. Picture tube troubles usually are limited to one of the following:

1. **DEFECT: Loss Of Brilliance.** A gradual drop is normal (brightness usually drops off rapidly during the first 500 hours of use, then tapers off exponentially from then on). These changes are usually not too noticeable because the customer automatically compensates by adjusting the brightness control.

**CAUSE:** Barring possible troubles in the horizontal output circuit or in the

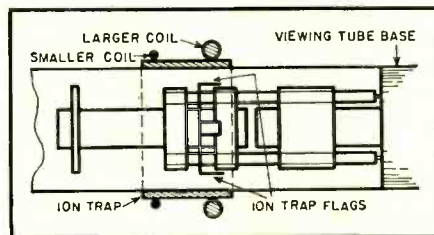

Fig. 1. Correct positioning of ion trap to give maximum brightness on the tube.

high-voltage power supply (*i.e.*, weak tubes, defective filter condensers or second anode resistor, leaky terminal strip, etc.), low brightness can be caused by (1) a weak picture tube, (2) weak or misadjusted ion trap magnet, or (3) a heavy collection of dust

and soot on the picture tube face and inside of the safety glass.

**REMEDY 1:** Substitute a new picture tube. If a new tube is handy, this may save time by either clearing the old tube from suspicion or positively identifying it as the defective unit.

**REMEDY 2:** Readjust the ion trap or try a new one. The original trap may be misadjusted as a result of tampering or accidental jarring, or the magnet may be partially demagnetized either from an accidental blow or from having been placed near an a.c. or strong d.c. field. Be sure the new ion trap is a duplicate type (single and double-magnet traps are *not* interchangeable), and see that the identifying arrow or colored dot on the magnet faces *toward* the bell or front of the picture tube.

**Ion Trap Adjustment:** Set the brightness control slightly above normal and slide the ion trap magnet slowly back and forth, at the same time rotating it slightly from side to side. Adjust for maximum brightness. Next, adjust the focus control for sharpest scanning lines and increase the brightness as far as possible before "blooming" or loss of focus occurs. Readjust the magnet carefully at this point for maximum brightness.

**Note:** On some picture tubes, *two* different positions of the magnet will give maximum brightness. The correct position is the one nearest the picture tube base (approximately over the gun flags. See Fig. 1). If neck shadow or rounded corners (Fig. 2) appear while adjusting, you may have to readjust the focus and deflection coils and recheck the centering adjustments.

**REMEDY 3:** Clean the picture tube. This is the most obvious but is often overlooked. (It has been estimated that in a typical industrial city enough soot can be collected in 6 months or less to reduce the brightness by more than 50 per-cent!). Use mild soap and water, or regular glass cleaner. Clean the rubber mask with carbon tetrachloride.

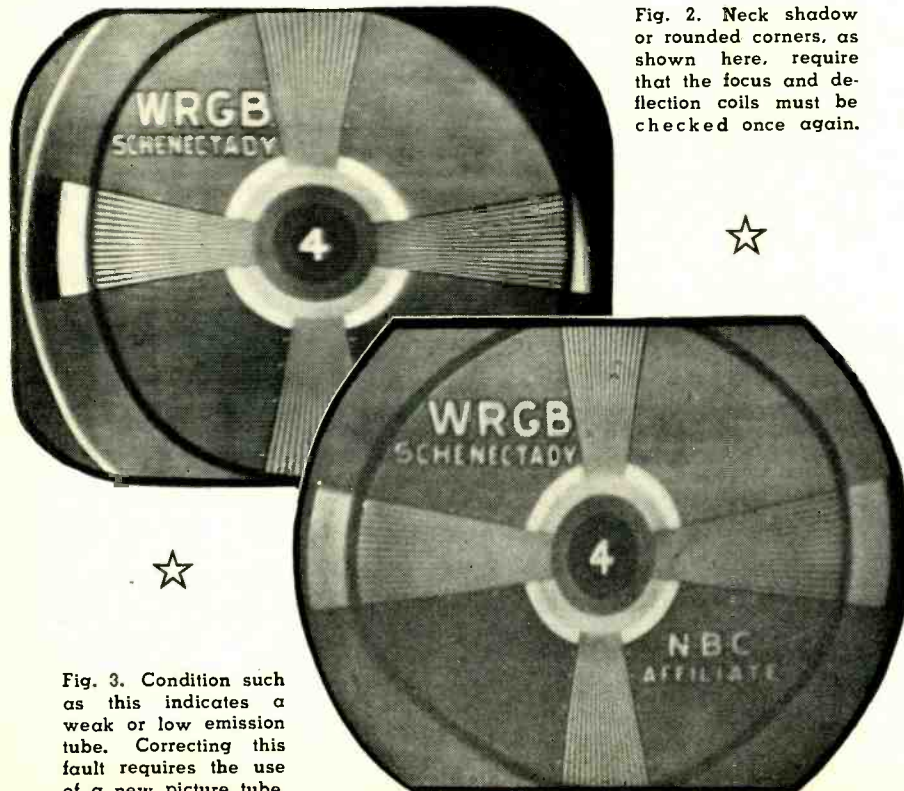

Fig. 2. Neck shadow or rounded corners, as shown here, require that the focus and deflection coils must be checked once again.

Fig. 3. Condition such as this indicates a weak or low emission tube. Correcting this fault requires the use of a new picture tube.

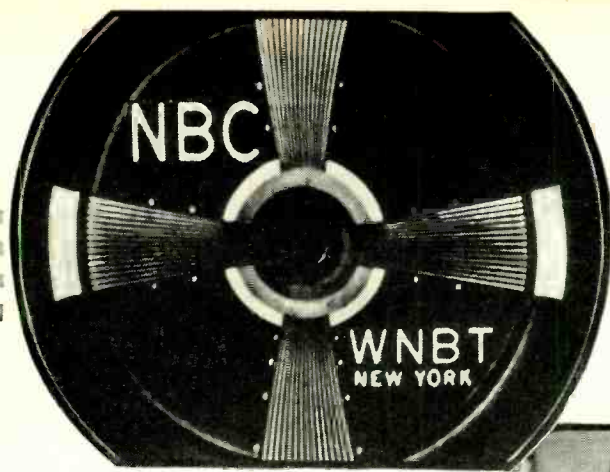

Fig. 4. Grid-cathode or heater-cathode short in TV picture tube may produce this extremely "contrasty" effect.

2. **DEFECT:** "Blooming"; increase in picture size, loss of focus when brightness is increased.

**CAUSES:** Defective second anode resistor; weak high-voltage rectifier; defective horizontal output transformer, or other high-voltage troubles. Very seldom is the picture tube at fault in this instance.

**REMEDY:** Check out the high-voltage supply as usual. Particularly, replace the second anode resistor.

3. **DEFECT:** Flicker; varying brightness, or intermittent picture (raster may or may not disappear).

**CAUSE 1:** Intermittent or poorly-soldered connections on the picture tube socket or base pins.

**REMEDY:** Sweat out the old solder and resolder all base pins and socket connections. Use a very hot iron and a good grade of solder.

**CAUSE 2:** Intermittent grid-cathode or cathode-heater leakage or short.

**REMEDY:** Substitute a new tube. If leakage or short is indicated, use one of the methods described under Defect No. 5.

4. **DEFECT:** Ion Spot.

**CAUSE:** Incorrectly-adjusted ion trap (allows heavy ions to bombard screen in concentrated force).

**REMEDY:** If the picture tube is covered in the customer's warranty, contact his dealer or distributor for adjustment. (Customers should be advised to call you or their dealer the moment a discoloration or ion burn appears.) An ion trap adjustment may keep the spot from spreading, even if the tube is out of warranty and replacement is not desired immediately.

**Note 1:** On some receivers, the beam will remain in a concentrated spot for some time after the set has been turned off. On tubes like the 16JP4, this may eventually discolor or burn the screen. Advise your customer (if this occurs) to turn the brightness full on immediately after the set has been turned off. (This aids in draining the charge off the high-voltage condensers.) If this trouble is too serious, you might try a non-inductive bleeder resistor (2 megohms or higher) across the high-voltage output filter condenser. (Continued on page 125)



Fig. 5. If a metal-cone picture tube has been magnetized, a condition such as shown here results. The tube must be demagnetized. See text for instructions.



Fig. 6. Another case of metal-cone tube magnetization. The servicing procedure outlined for Fig. 5 applies in this case.

Fig. 7. Hum in picture causes curved or distorted raster edges as shown here and in Fig. 8. Try replacing the TV picture tube.



Fig. 9. When the picture inverts or goes negative when brightness control is advanced, several tubes must be checked. In this illustration the picture is on the verge of inverting. See text for method of correction.

Fig. 8. Another example of hum in the picture tube. Replace the tube first before checking the power supplies.

# ELECTRONIC GROWTH

## in the

# PACIFIC SOUTHWEST



New store of Radio Specialties Company showing center island sample boards, RCA murals above test equipment displays, and the indirect lighting fixtures in the center of island displays.

By

**S. K. PAINTER**

Pres., Radio Specialties Co., Los Angeles

***The meteoric rise of the Pacific Southwest as an electronics center has stimulated the growth of specialized distributor warehouses and stores.***

**T**HE growth of electronics in the Pacific Southwest has been at a faster rate than in any other section of the country. When the West Coast Electronics Manufacturers' Association was founded in 1943, the area was producing electronic equipment at the rate of approximately \$25,000,000 a year. Production increased ten-fold by the end of World War II and is currently at the rate of a half-billion dollars a year.

According to a survey made by the Department of Labor, there are more people employed in military and commercial electronics manufacturing in the Los Angeles area than there are in Chicago. A recent report by the U. S. Navy estimated that approximately 50,000 persons are employed in Southern California by electronic prime contractors and component manufacturers. More than 6,700,000 square feet is devoted to electronic work alone.

California has been important in the research and development of radio and

other electronic applications ever since the birth of "wireless." Its many engineering schools, such as Cal-Tech, Stanford, California, UCLA, and USC, have been leaders in electronic research. The radio handbooks of F. E. Terman of Stanford University are used throughout the world. Even the first regular telecasts in the U. S. originated from Los Angeles, circa

1931, when programs were scheduled one hour per day, six days a week.

With motion picture studios concentrated in Southern California, it was to be expected that some of the finest sound research would originate and audio equipment would be developed in this area. Moreover, an entertainment center so important could not help but create a need for outstanding recording studios and television program sources.

With the advent of commercial telecasting, many predicted that motion picture studios would soon be out of business. It is interesting to note, therefore, that more films are now made for television than are made for theater viewing. Many of the smaller motion picture studios devote their entire facilities to the production of kinescoped programs which are shipped throughout the world.

The number of television transmitters in Los Angeles is the same as for the combined New York-New Jersey metropolitan area and considerably more than those of any other centralized location. Seven transmitters are located a short distance from Los Angeles on Mt. Wilson (at an elevation of approximately 6000 feet). This excellent location permits the transmitting of a signal which is picked up reg-

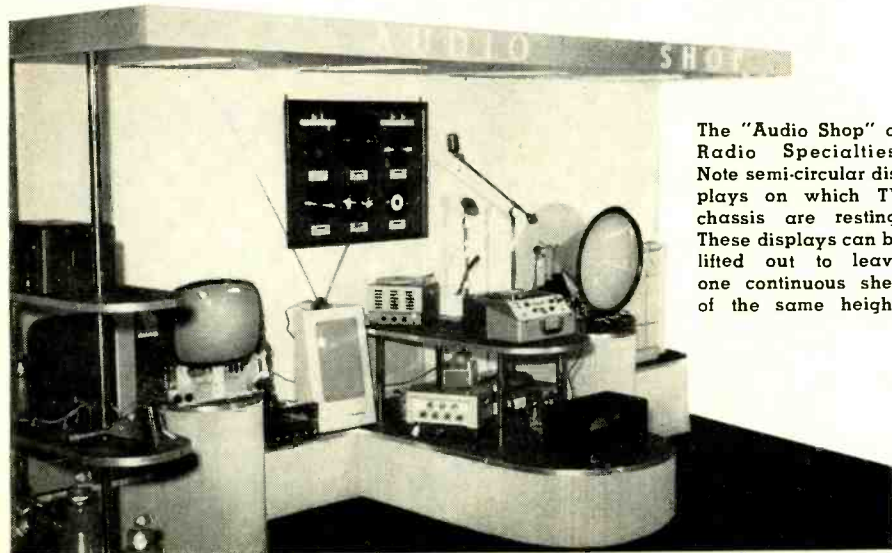

The "Audio Shop" at Radio Specialties. Note semi-circular displays on which TV chassis are resting. These displays can be lifted out to leave one continuous shelf of the same height.

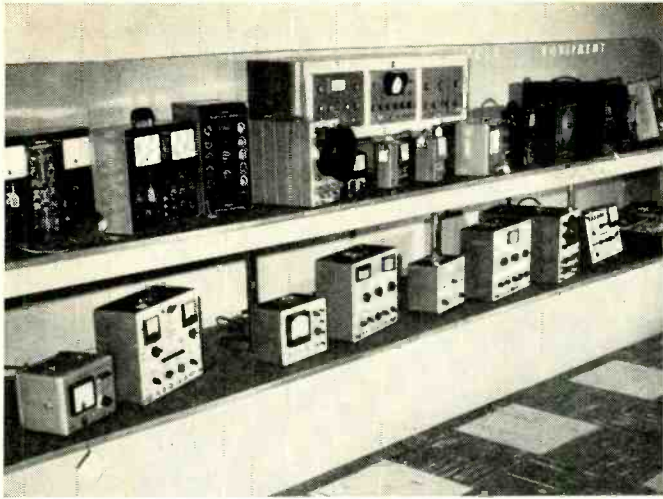

The test equipment display. The molding along the back drop has electrical outlets spaced at intervals of 12 inches.



Close-up of one of center island display boards with its glass covered samples. Record changer display is shown in background.

ularly in fringe areas as far away as 225 miles.

The importance of the television receiving field in the Los Angeles area is attested by its rating as second in the nation, New York City being the only area with a greater number of sets in use. On May 1, 1952, according to the Electric League, there were 1,252,184 television receivers in the Los Angeles signal area, or 7.5 per-cent of the total number in the United States. In the calendar year 1951, 437,172 sets or 8.6 per-cent of the U. S. total were shipped to California. These sets were handled by the approximately 1800 television retail stores in addition to the other outlets which retailed TV in addition to other merchandise.

To electronics, as found in other metropolitan centers, is added the fast-growing aircraft industry. California had 32 per-cent of the total employment of the U. S. aircraft industry by the end of 1951. Aircraft and allied activities currently involve more than 185,000 persons in California, an increase of 110 per-cent over the pre-Korea level.

The aircraft industry has become more and more closely associated with electronics. A number of aircraft and air parts firms now are concerned almost exclusively with the electronics involved in guided missiles, radar, and communications equipment.

Major prime military awards to California in the fiscal year ended June 30, 1951, amounted to \$3,899,450,000 or 13.2 per-cent of the total for the United States. California had the second largest total for any state. The importance of aircraft in the Southern California industrial picture is evidenced by the fact that aircraft accounts for 27.6 per-cent of all manufacturing employment in Los Angeles.

The exceptional diversity of electronics in the Los Angeles area has given rise to a new local industry of electronic parts manufacturers; fabricators of antennas, masts, lead-in wire, and other accessories; television installation firms; and radio and television schools. More and more Eastern manufacturers, taking note of the growth of demand and of the local firms which have sprung up to meet

this need, have met the new competition by establishing Los Angeles warehouses to service their distributors and manufacturing customers more quickly.

To help meet the demand for an on-the-spot source of supply, *Radio Specialties Company*, a twenty-year-old electronics parts distributing company, has recently opened a unique type of wholesale display store and enlarged and redesigned parts warehousing facilities.

Probably the most unusual feature of this new outlet is that it is a parts store without an apparent small parts stock and that with its contemporary design has a singularly uncluttered look. There is only one sample each of the basic small parts in each line on display. These items are shown on sample boards with the warehouse stock accessible but out-of-sight.

As one of the largest distributors of RCA industrial tubes in the nation, *Radio Specialties Company* has long supplied a large part of the replacement needs of the television and broad-

(Continued on page 122)

Sample boards act as facades for the stock bins behind counter. These boards, which are indirectly lighted for easy parts selection, help hide the warehoused stock while selling parts.

Wall-type sample boards and the record player-changer display. Construction is of combed plywood in a "free form" design.



# The R.C.O. • A Remote Control Oscillator

By  
**JOHN F. CLEMENS**  
W9ERN

*Details on a unit which permits the transmitter frequency to be varied by means of a compact control box which is connected to the oscillator tube through coaxial cables.*

**T**HE variable frequency oscillator is becoming increasingly popular among mobile station operators. To obtain the full benefit of the v.f.o. the frequency control dial must be located in such a way so as to permit convenient manipulation by the driver. At the same time, most mobile transmitters are located in the trunk compartment where the equipment may be easily mounted and at the same time not snag the XYL's stockings.

Various stratagems have been employed in separating the v.f.o. and the remaining stages of the transmitter or mechanical remote control devices have been devised. Very often the resulting layout is a disheartening array of interconnecting cables and complex coupling circuits.

A new circuit, originated for remote control of an oscillator, promises a number of advantages. The control box itself need be only large enough to house the oscillator coil and tuning condenser so that under-dash mounting of the control is no problem. The frequency control circuits could be easily installed in the regular switch control box found in most mobile installations. The heat generating elements, tubes and resistors, are completely isolated from the frequency control box so that frequency stability is not affected by temperature changes in the transmitter. Only two coax cables connect between the control box and the transmitter and the length of the interconnecting cable is not critical.

The remote control oscillator or r.c.o. is designed around the very popular series-tuned oscillator circuit. This circuit is characterized by a high degree of isolation between the oscillator tube and the oscillator tank circuit. This isolation is achieved by the relatively large bypass capacities shunting the grid-cathode and plate-cathode circuits. This capacity is not critical, having only second order ef-

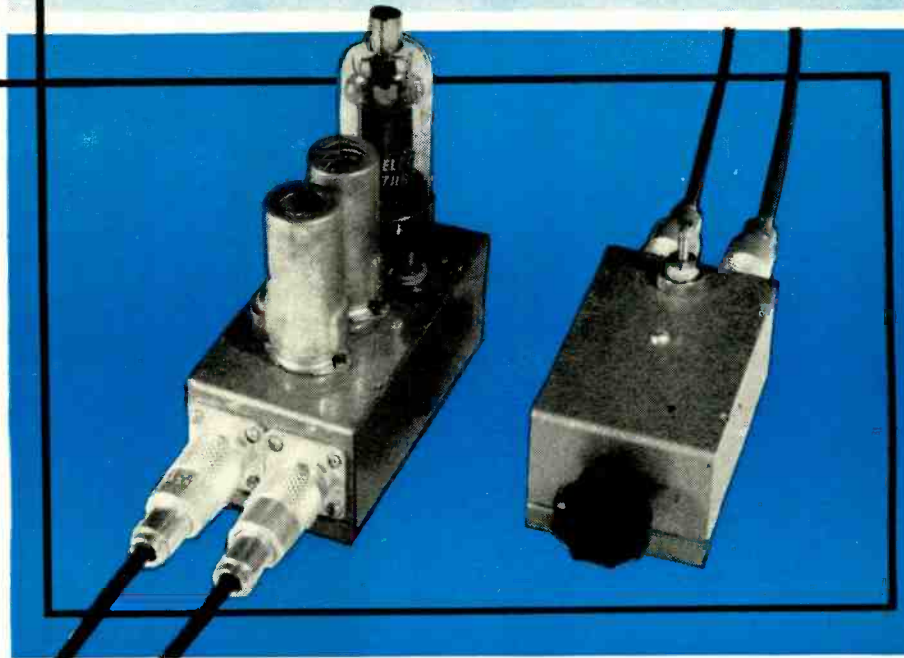

Over-all view of exciter and control box. The tiny frequency control box (right) may be installed remote from the oscillator and exciter unit shown at the left.

fects on the oscillator frequency, the usual design criterion being that the capacity should be as large as possible up to the limiting point where the circuit ceases to oscillate, although good stability is obtainable well before reaching this limit.

In the most popular version of the series-tuned oscillator, the plate, or screen, if a pentode is used, is operated at ground potential. This connection places the cathode and common junction of the large shunt capacities at a potential above ground for r.f. In developing the r.c.o. circuit, the ground point has been moved to the cathode of the tube. This means that one terminal of each of the large shunt capacities is grounded. It is now a simple step to substitute a length of coaxial cable for each of the bypass condensers, utilizing the internal capacitance of the cable. The capacity of 50-ohm cable is approximately 28  $\mu\mu\text{fd.}$  per foot so that in a length of cable suitable for connection between the dashboard and the trunk compartment, a shunt capacity is obtained which is adequate for operation of the oscillator in the 7 mc. band. On the lower frequency bands additional fixed capacity may be shunted across each cable or the cable length may be extended. At 7 mc. the cables are still electrically "short," meaning that the capacity can be considered as lumped

and the inductance of the cable may be disregarded.

The benefit of grounding the common junction of the bypass condensers is now evident since the shield of each cable is at ground potential. The cables may be moved about freely, either together or separately, without affecting the oscillator frequency.

An experimental transmitter r.f. section incorporating the r.c.o. is shown in the photographs. This unit was constructed to test the workability of the r.c.o. idea and is not necessarily recommended as the optimum layout, although circuit elements have been varied to obtain the best operating conditions.

A 6AG5 is used as a pentode oscillator-doubler. A 6J6 was first tested in the circuit, using the first triode section as oscillator and the second section as frequency doubler. It was found that the 6AG5 was considerably more efficient than the 6J6 and since an interstage coupling resistor and condenser are not necessary in the 6AG5 due to the electron coupling, the pentode circuit has more advantages.

A second 6AG5 was chosen as the second doubler to 28 mc. after comparison with a 6C4 and one-half of a 6J6 showed the superiority of the 6AG5. The 14 mc. plate tank of the oscillator and the 28 mc. tank of the multiplier are both broadband circuits with very



low tuning capacity, using slug-tuned coils.

The 2E26 stage is incomplete as shown since the plate circuit is mounted on a separate sub-chassis with the output coupling circuit. The rectified grid current of the 2E26 has been used as a criterion of oscillator and doubler performance throughout the tests.

With a plate voltage of 275 on the circuit, grid current to the 2E26 was 5 ma. maximum with both 6AG5 plate tanks peaked at 29 mc. The grid current did not drop below 4 ma. when the r.c.o. was tuned over the entire 28 mc. phone band, 28.5-29.7 mc. Total plate and screen current to the two 6AG5's was 26 ma. at 29 mc., rising to 28 ma. at both ends of the tuning range. Although some decrease in the 2E26 grid current is to be expected when plate voltage is applied, the grid current obtained is almost twice the rated requirements, so that adequate excitation is assured.

The tuning condenser shown in the development model has a capacity of 50  $\mu\text{fd}$ . which is larger than necessary to cover the 28 mc. phone band. A 15  $\mu\text{fd}$ . variable condenser, shunted by a 30  $\mu\text{fd}$ . fixed ceramic condenser, will bandspread the 28 mc. phone band over the entire scale. The slug-tuned oscillator grid coil may be adjusted to the proper frequency after the control box is installed. The shaft of the tuning condenser is not grounded and an insulated shaft coupling must therefore be used. The rotor of the tuning condenser should be connected to the lead to the coax center conductor rather than the junction of coil and condenser, since the former is at a lower r.f. potential. A double-bearing tuning condenser is highly recommended for greatest mechanical stability.

The interconnecting cables used in obtaining all the above data were each ten feet long. RG-29/U, 50-ohm cable was used. Cable lengths up to 13 feet were tested with similar results. If longer lengths are required, a 72-ohm coax cable may be used since its capacity per foot is lower. Operation with cable lengths up to 20 feet with the oscillator on 7 mc. should be possible with 72-ohm cable. On lower frequencies the cables may be proportionately longer. As a general rule, the capacity shunting each cable circuit should be approximately 300  $\mu\text{fd}$ . at 7 mc., twice this value at 3.5 mc., etc. For very short cables having insufficient internal capacity, the difference may be made up with fixed condensers shunted across the cable circuits.

Another obvious application of the r.c.o. is frequency control of a rack-mounted transmitter and v.f.o. from an operating table. The elimination of frequency drift troubles due to the absence of heat in the tuned circuit compartment, plus the compactness and simplicity of the control unit make this system attractive.

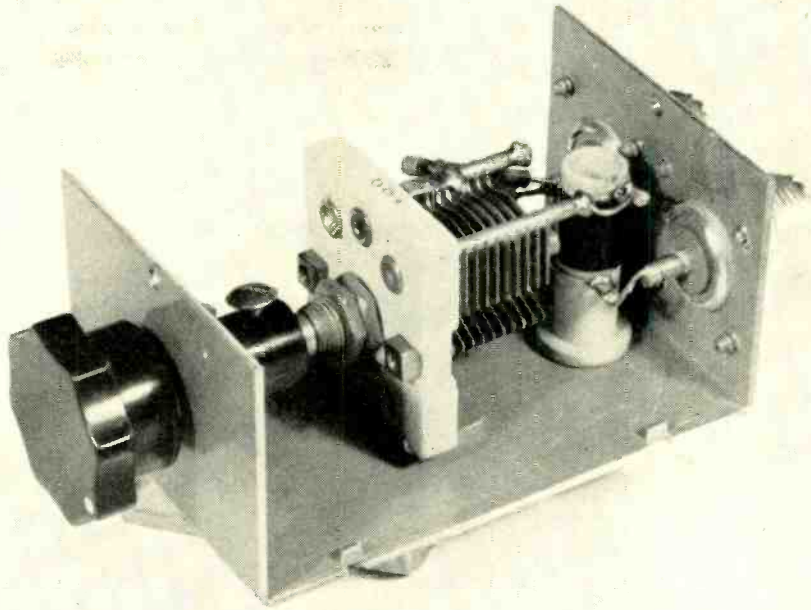

Frequency control box contains just a series coil and condenser tuning circuit.

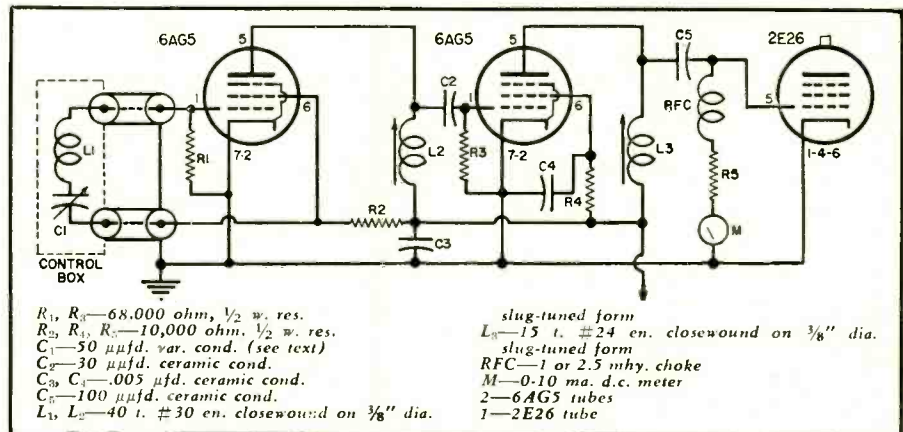
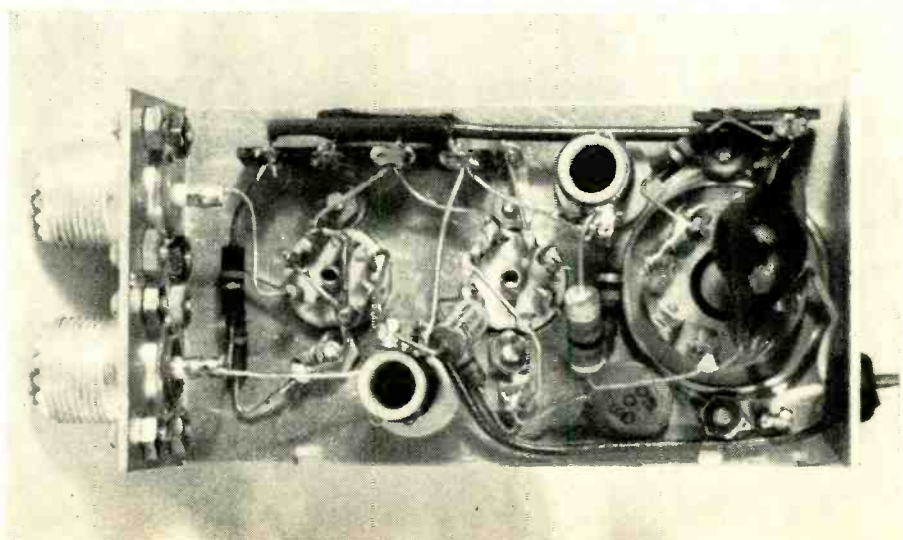

Diagram of remote control exciter. The "B+" supply (indicated by arrow at right of diagram) is 275 volts which is obtained from the transmitter's power supply.

Underchassis view of exciter oscillator. Shielding and heat isolation difficulties are eliminated since frequency control elements are physically separated.



# UNIVERSAL DESIGN CURVES

## for Tone-Control Circuits

By  
**M. B. KNIGHT**  
RCA Victor Division  
Harrison, N. J.

**Part 2. Design data on two circuits which may be used to provide variable bass tone control.**

**T**HIS is the second article in the current series on practical RC tone-control circuits. These articles describe simple circuit arrangements suitable for particular types of tone control and include frequency-response curves obtained with each circuit. The curves permit rapid evalu-

ation of the ability of a circuit to fulfill specific design requirements. They also indicate the preferred potentiometer taper and facilitate the choice of component values.

The first article of this series and the author's article in the November 1951 issue presented universal design curves for three treble tone-control circuits which are also useful for fixed bass compensation. This article will cover two circuits designed for variable bass tone control.

### Variable Bass-Boosting Circuit

A circuit which will accomplish variable bass boosting is shown in Fig. 1 and the equivalent circuit used for analysis is shown in Fig. 2. In many designs, the resistor  $R_3$  will be so large compared to the source impedance of the tube and its plate load resistor  $1/(1/r_p + 1/R_p)$  that, for practical purposes, the resistance  $R_1$  may be considered to be equal to  $R_3$ . This relationship will usually be true if the tube  $V_1$  is a medium- $\mu$  triode. If  $V_1$  is a pentode, its plate resistance,  $r_p$ , is so high compared to the plate load resistor,  $R_p$ , that  $r_p$  may be neglected, but  $R_p$  will not usually be negligible and  $R_1$  will equal  $R_3$  plus  $R_p$ .

There are two advantages in making  $R_2$  and  $R_3$  relatively large in value. First, a smaller coupling condenser is required for good low-frequency response. Second, the danger of distortion in  $V_1$ , because of small load im-

pedance is avoided. On the other hand,  $R_2$  cannot be excessively large, or the value of the potentiometer  $R$  becomes impractically large.

The universal design curves for this circuit are shown in Figs. 3, 5, 6, and 9. The zero db reference level represents the output at frequencies high enough so that the output is unaffected by the adjustment of the tone control. As was mentioned in the November 1951 article, a boosting circuit should not be designed for more boost than is required because the boost is obtained at the expense of gain. The loss of gain for the middle and high frequencies caused by this circuit may be determined from the curves and is equal to the highest value of boost on the curves when  $R$  equals infinity.

As an example of the use of these curves, let us set up some design objectives and see if we can meet them. Suppose we would like to use a triode for  $V_1$  and want as much gain from the amplifier stage as can be reasonably obtained. We shall seek a tone control capable of about 15 db of boost so that 3 db of boost occurs at 500 cycles. The curves of Fig. 6 show that 15 db of boost can be obtained with a ratio of  $R_1/R_2$  equal to 5. In the interest of obtaining the maximum possible gain from the amplifier, the potentiometer should be as large as practicable, say one megohm. Next, the value of  $R_2$  may be determined. Examination of the curves reveals that

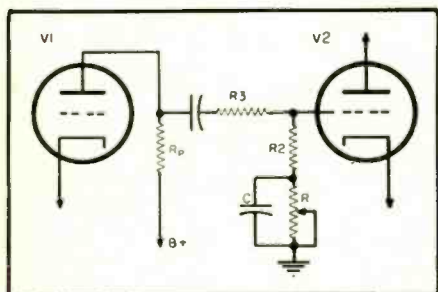

Fig. 1. Circuit for providing variable bass boosting. Fig. 2 is the equivalent circuit.

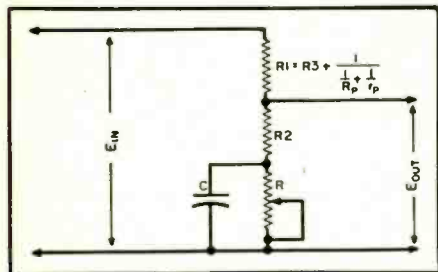

Fig. 2. The equivalent circuit for Fig. 1.

Fig. 3. Curves for Figs. 2 and 4 when  $R_1/R_2$  is equal to 1.

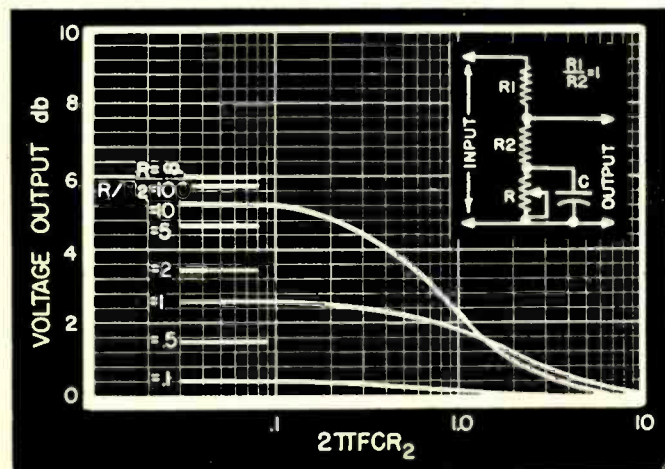
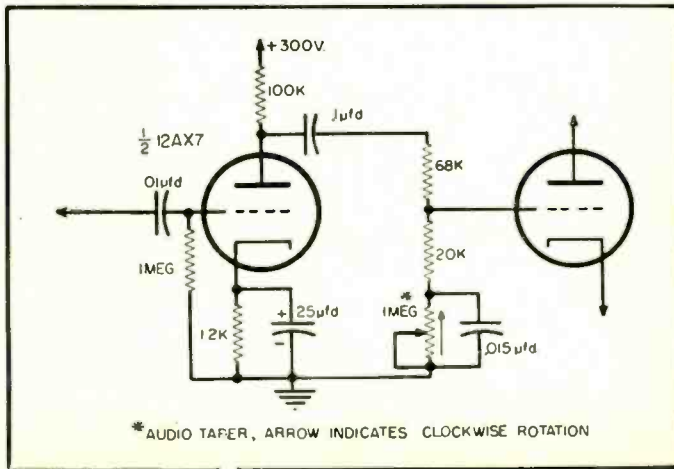

Fig. 4. Bass boost circuit which gives 14 db at 50 cps.



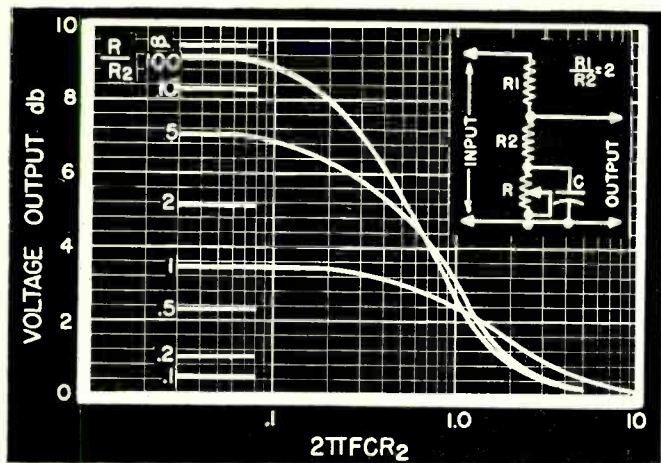

Fig. 5. Curves for Figs. 2 and 4 when  $R_1/R_2$  is equal to 2.

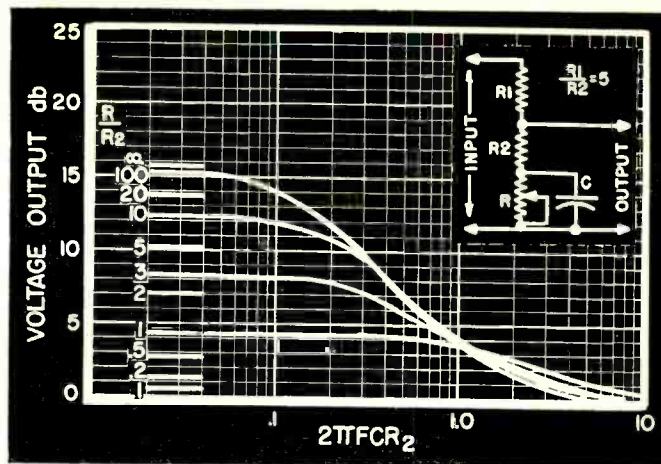

Fig. 6. Curves for Figs. 2 and 4 when  $R_1/R_2$  is equal to 5.

slightly more than 15 db boost can be obtained with the ratio of  $R/R_2$  equal to 100. If the ratio is 50, however, only about one-half db of boost is sacrificed, and we shall see that it is easier to obtain the desired gain if the values of  $R_1$  and  $R_2$  are made as large as possible. Using the ratio of  $R/R_2$  equal to 50, the value of  $R_2$  will be 20,000 ohms. Then, because the ratio of  $R_1/R_2$  is 5, the value of  $R_1$  is 100,000 ohms. Now the choice of a tube for  $V_1$  can be made. We would expect to obtain the most gain from a high- $\mu$  triode, so let us select one section of a 12AX7 and use the circuit values from the "Resistance-Coupled Amplifier Charts" found in tube handbooks. The value of the grid resistor  $R_g$  to be used with these charts is equal to the impedance of the tone-control network at high frequencies (or with  $R$  adjusted to zero). Using the constants selected above, this value of impedance is approximately 100,000 ohms. Examination of the "Resistance-Coupled Amplifier Charts" shows that 100,000 ohms is a good choice for the plate load resistor,  $R_p$ . The cathode resistor,  $R_k$ , should be 1200 ohms, the nearest RTMA value to the value of 1300 ohms given in the chart. The  $\mu$  of the tube, obtained from the tube data, is 100. In order to determine the value of  $R_o$ , we must find the equivalent source impedance of the tube and its plate load resistor,  $1/(1/r_p + 1/R_p)$ . To

find this impedance, we first calculate  $R_o$ , the effective parallel value of the grid resistor,  $R_g$ , the plate load resistor,  $R_p$ , and the plate resistance,  $r_p$ , of the tube. As stated in the previous articles, we have found a formula which may be used to calculate  $R_o$  directly with fair accuracy. It should be remembered that this formula is empirical and applies only to triodes operated in accordance with the values given in the "Resistance-Coupled Amplifier Charts."

$$R_o = .17 \mu R_k + 5000 \text{ (ohms)}$$

$$= .17 (100) (1300) + 5000$$

$$R_o = 27,100 \text{ ohms}$$

Then, using the formula for  $R_o$ ,

$$R_o = \frac{1}{\frac{1}{r_p} + \frac{1}{R_p} + \frac{1}{R_g}}$$

We can rearrange the terms to solve for the source impedance of the tube and its plate load resistor.

$$\frac{1}{\frac{1}{r_p} + \frac{1}{R_p}} = \frac{1}{\frac{1}{R_o} - \frac{1}{R_g}}$$

$$= \frac{1}{\frac{1}{27,100} - \frac{1}{10^5}}$$

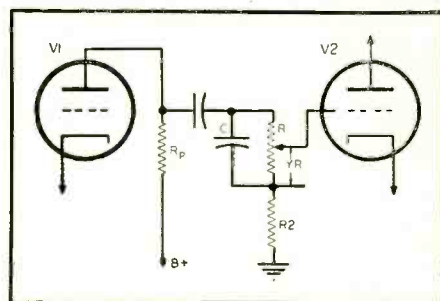

Fig. 7. Circuit for variable bass attenuation.

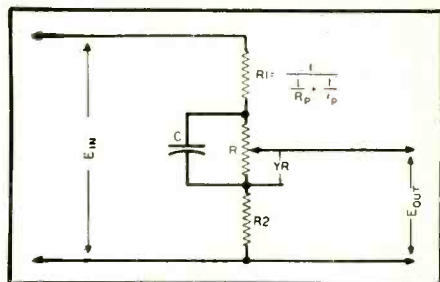

Fig. 8. The equivalent circuit for Fig. 7 assuming the same value of impedance.

$$= \frac{1}{2.69 \times 10^{-5}} = 37,000 \text{ ohms}$$

The value for  $R_3$  is  $R_1$  minus the source impedance value determined by the  
(Continued on page 93)

Fig. 9. Curves for Figs. 2 and 4 when  $R_1/R_2$  is equal to 10.

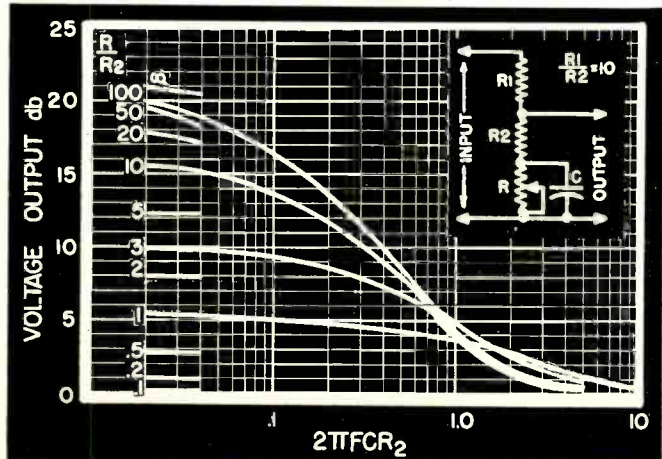
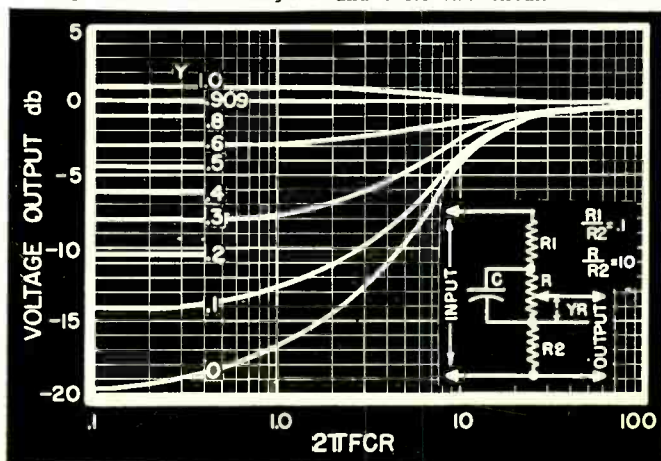

Fig. 10. Curves for Figs. 7 and 8 for two circuit values.



# The MULTI-SIGNAL GENERATOR

By  
LOUIS E. GARNER, JR.



Fig. 1. Over-all view of the "Multi-Signal Generator." The entire unit measures  $7\frac{1}{2}$ " x 5" but provides 60-cycle sine-wave, saw-tooth, and square-wave signals.

## Construction details on a combination power supply, square-wave and saw-tooth generator for home use.

**T**EACHERS, lab technicians, and home experimenters often need a d.c. and filament power source to supply experimental circuits. This need is generally met by having a small power supply chassis available. In addition, however, the experimenter often requires a signal of a particular waveshape, either to check the operation of a filter or attenuator circuit to signals other than sine waves. Where the need is a continuing one, or the financial resources of the experimenter large, this need can be filled by appropriate special signal generators.

On the other hand, where the need for special signal waveshapes is not continuous, an ordinary power supply chassis may be modified, by adding only a few readily available parts, to supply a square-wave signal, a saw-tooth signal, and a sine-wave signal, in addition to acting as a source of d.c. voltage.

The small chassis shown in Fig. 1 (only  $7\frac{1}{2}$ " x 5") supplies "B plus" (350 volts at 40 ma.), a 60-cycle sine-wave signal (which may also be used as a 6.3 volt, 2.5 amp. filament supply), a 60-cycle square-wave signal, and a 60-cycle saw-tooth signal. The cost of the additional parts necessary to supply these special signal waveshapes over the cost of the power supply components alone was less than two dollars. Only about an hour's additional wiring time was required.

Where the builder does not wish to assemble a special chassis, the addi-

tional parts needed can generally be fitted easily on any available power supply chassis.

### Circuit Description

Reference to the schematic diagram of Fig. 2 shows that a conventional d.c. power supply circuit is employed.  $V_1$  is connected as a full-wave rectifier, with filtering provided by choke  $CH_1$  and electrolytic filter condensers  $C_2$  and  $C_3$ . Bleeder resistor  $R_1$  provides a slight degree of voltage regulation.

The 6.3 volt winding of the power transformer is used to supply filament voltage to the clipper tube,  $V_2$ , and also acts as the sine-wave signal source. Since the filament current requirements of  $V_2$  are small, this winding may also serve to supply filament voltage to external circuits.

A neon-bulb relaxation oscillator is used to supply a saw-tooth signal. Condenser  $C_4$  is charged slowly through resistor  $R_2$ . As soon as the charge across  $C_4$  reaches the firing potential of  $V_2$  (a neon bulb), the gas in this tube ionizes and acts as a practical short-circuit across  $C_4$ , discharging this condenser until the voltage is no longer sufficient to sustain ionization.  $V_2$  then stops conducting and  $C_4$  starts to charge again, with the action repeating itself at a rate dependent upon the supply voltage and upon the time-constant of  $R_2$ - $C_4$ . By making  $R_2$  variable, the output frequency of the saw-tooth signal may be varied to suit the individual experimenter.

$C_5$  acts as a blocking condenser to eliminate the d.c. component of the

saw-tooth signal appearing across  $C_4$ . Thus, only a pure saw-tooth is available at the output terminal of the chassis.

To obtain a 60-cycle square-wave signal, a portion of the voltage available across one-half of the high-voltage secondary winding is applied through coupling condenser  $C_6$  to a series-diode clipper circuit.  $C_6$  and  $R_3$  act as a voltage divider to reduce this high voltage slightly. At the same time, however,  $R_3$  acts as part of the clipper circuit.

The series diode clipper has been previously described by the author (RADIO & TELEVISION NEWS, March, 1950, "Wide Frequency Range Square-Wave Clipper") but a brief review of its operation may be appropriate here.

The flashlight cell,  $E$ , acts to place a small bias on the cathodes of the dual-diode tube,  $V_3$ , so that this tube is normally conducting. As long as the amplitude of any applied signal does not exceed the battery voltage, the diode acts simply as a closed circuit, permitting any signal appearing across  $R_3$  to appear, without modification, across  $R_4$ .

When the negative peak of the applied signal is sufficient to drive the plate of the left-hand diode section negative with respect to its cathode, this half of the tube stops conducting and acts as an open circuit, thus clipping the remainder of the negative peak.

Similarly, when the positive peak of the applied signal is sufficient to make the cathode of the right-hand diode section positive with respect to its plate, this half of the tube stops conducting and acts as an open circuit, clipping the remainder of the positive peak.

Either condition will occur when the applied signal exceeds the voltage of battery  $E$ .

Since the sine-wave signal applied through  $C_6$  greatly exceeds the battery voltage, excellent clipping is obtained and an almost perfect square wave appears across  $R_4$ .

The entire chassis thus serves to supply, simultaneously, a "B" voltage, a square-wave signal (Fig. 3A), a sine-wave signal (Fig. 3B), and a saw-tooth signal (Fig. 3C).

Since r.f. or other high frequency signals are not present in the circuit, wiring and layout is not at all critical. It is only necessary to take reasonable care and follow conventional wiring techniques.

A word of caution, however. The battery should either be mounted below chassis or, if mounted above chassis, should be located well away from the rectifier tube and power transformer. This is to insure that the heat of these two components will not adversely affect the life of the flashlight cell.

Parts values are not at all critical and considerable variation from the values given in the parts list are permissible. This is especially true as far as the power supply components are concerned. A much heavier power transformer may be used; almost any suitable rectifier tube may be employed for  $V_1$ ; a much larger filter choke or filter condensers may be substituted. In fact, if the builder prefers, the simple power supply circuit shown may be replaced with a complex voltage-regulated circuit, incorporating regulator and control tubes as well as the rectifier.

$V_2$  may be either an NE-2 or an NE-51. Other neon bulbs may be substituted by varying the sizes of  $R_2$  and  $C_4$ .

The 6AL5 used for  $V_3$  may be replaced, without circuit modification, by a twin-triode tube, diode connected (grids and cathodes tied together), or by other twin-diode tubes, such as the 6H6.

If a square-wave signal of greater amplitude is desired, substitute a  $4\frac{1}{2}$  volt bias battery for  $E$ . If a control over amplitude is desired, use a 50,000 ohm pot. in place of  $R_5$ .

As can be seen by reference to the under-chassis view (Fig. 4), the additional parts required occupy very little space, even on the small chassis used by the author. Where space is at a premium, however, these components may be mounted in a small metal utility box, which, in turn, may be connected to the power supply chassis through a multi-conductor cable.

Except for  $C_1$ , all the special parts required are shown to the right of the dotted line in Fig. 2.

The applications of the "Multi-Signal Generator" are many and varied, but a detailed listing would be out of place here. Each experimenter or reader can best tell, from his own experience, where such a piece of equipment would fit in his home or shop laboratory.

Several important points should be remembered when connecting this piece of equipment to other apparatus for tests, however.

First, the saw-tooth signal source is a high-impedance source. Thus, if loaded too greatly, the waveshape and amplitude may suffer considerably. Where it is mandatory that the output saw-tooth signal be used in a low-impedance circuit, interpose a simple

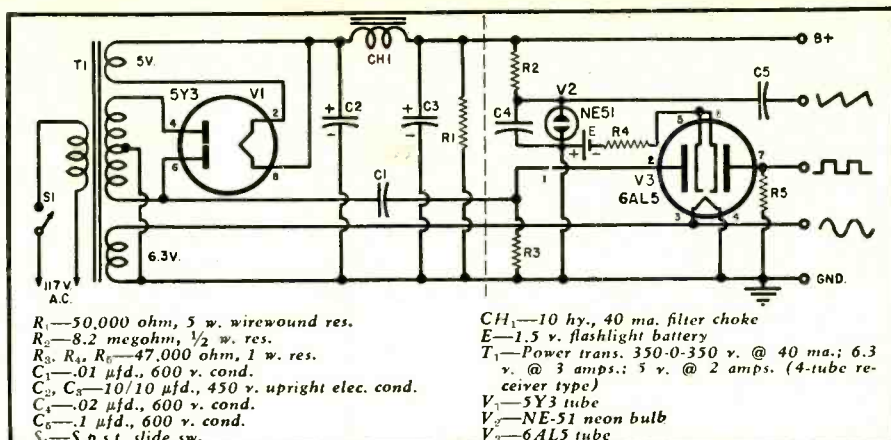

Fig. 2. Circuit diagram of the "Multi-Signal Generator." Except for  $C_1$ , all the special parts required are shown to the right of the dotted line in the schematic.

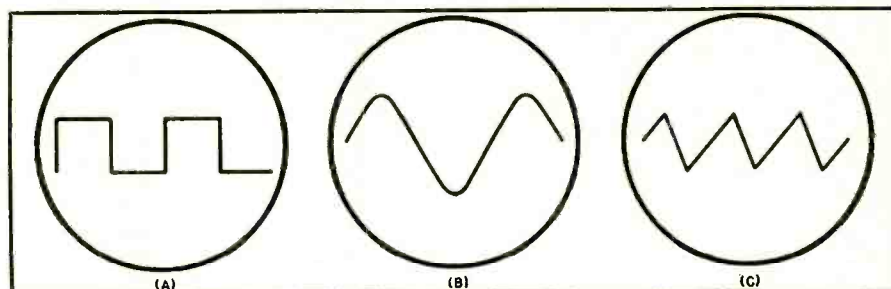

Fig. 3. Output of unit. (A) square-wave, (B) sine-wave, and (C) saw-tooth signals.

buffer amplifier between the saw-tooth output terminal of this unit and the experimental circuit. The size to use will be determined by the impedance of the circuit to which the square-wave signal is applied. For high impedance circuits, a .5  $\mu$ fd. condenser will generally give satisfactory results. For low impedance circuits, it may prove necessary to go to 2  $\mu$ fd. or even higher if good waveshape is to be preserved.

Secondly, a d.c. component appears with the square-wave signal across  $R_5$ . While this component is small in amplitude, it may cause trouble if an attempt is made to connect the square-wave output terminal directly to the grid of an amplifier tube. Thus, when d.c. cannot be tolerated in the experimental circuit, connect an ordinary paper condenser between the

square-wave output terminal and the experimental circuit. The size to use will be determined by the impedance of the circuit to which the square-wave signal is applied. For high impedance circuits, a .5  $\mu$ fd. condenser will generally give satisfactory results. For low impedance circuits, it may prove necessary to go to 2  $\mu$ fd. or even higher if good waveshape is to be preserved.

These limitations are not serious, of course, and do not affect the operation of the "Multi-Signal Generator" in most of its applications.

Fig. 4. Under chassis view of the "Multi-Signal Generator" showing parts layout.

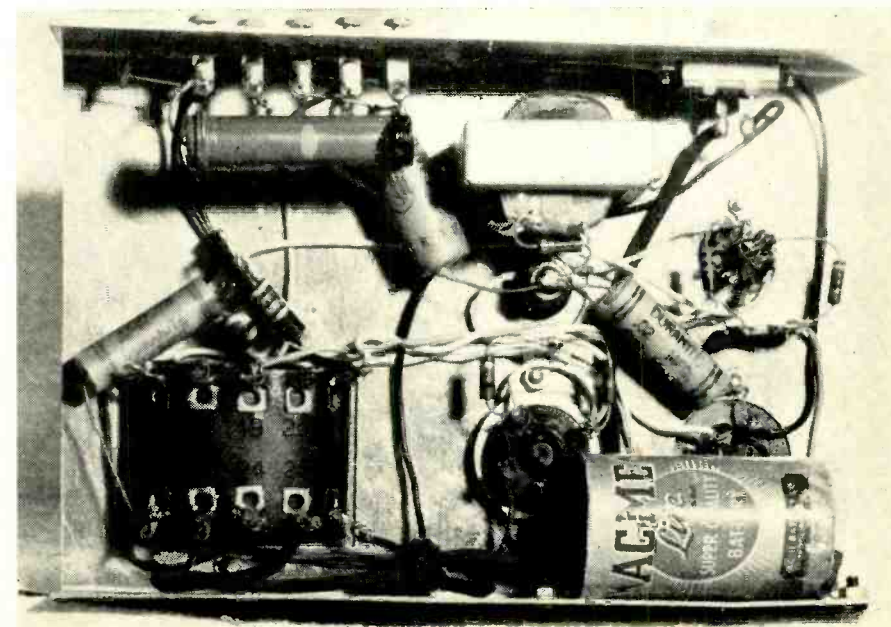

# CINEMAGNETIC RECORDING

By  
**A. C. BLANEY**  
Manager, Film Recording Engr.  
Radio Corporation of America

***New tape techniques, adapted to movie work, presage substantial savings and efficient film processing for Hollywood studios.***

**A** NEW and useful tool for making motion pictures was first publicly presented to the film industry in May, 1948 by the *Radio Corporation of America* at the Society of Motion Picture and Television Engineers' convention in Santa Monica. This new tool was magnetic sound recording. The art of magnetic recording had shown steady improvement for more than a decade. Recording on  $\frac{1}{4}$  inch magnetic tape and wire had advanced to a degree which permitted its use in many commercial applications. All of these previous methods, however, did not provide the exact synchronism required by the motion picture industry.

While there was no question regarding the quality that could be obtained by recording on magnetic materials, *RCA* film recording engineers realized through their close association with Hollywood that many practical prob-

lems would develop in the operation of this new tool. It was therefore decided to explore this new medium by first adapting photographic recorders, then in operation, to handle the perforated magnetic film. This gave the film industry the opportunity to experiment with the new medium with a minimum investment in equipment. In retrospect, this proved to be a wise and conservative decision.

Although it was realized from the first that magnetic recording would enable motion picture producers to extend the volume range and the frequency range of their original sound recordings, it was necessary that the new sound recording technique show other advantages. Photographic re-

ording had served the film industry quite well for many years.

Those who were willing to experiment soon found that magnetic recording could be made to pay dividends. First, the greater volume range of the magnetic film was found to be quite useful in the original recordings where wide variations in sound level exist. Quite often a recording was found to be entirely satisfactory when recorded on magnetic film although when recorded on photographic film the level proved to be too low and therefore too close to the noise level. The photographic films depended upon the transmission of light for the reproduction of sound and therefore were subject to noise due to handling which picks up dirt and causes scratches on the film. Magnetic films were found to be comparatively free from this type of problem.

Again, the handling of magnetic film could all be done in daylight which proved a distinct advantage for the operator. Still another advantage of the magnetic medium was that it could be played back concurrently with the recording and the operator was assured that he had a record of the sound. While it was possible to listen to the modulated light in the photographic process and gain some assurance that recording was satisfactory, still it was not as positive as playing back the signal from the film. All of these advantages added up to faster operation and more assurance that a satisfactory record had been made of the sound at the time the recording was made.

Here we may ask why the industry has not changed over more rapidly to use magnetic films for all of their

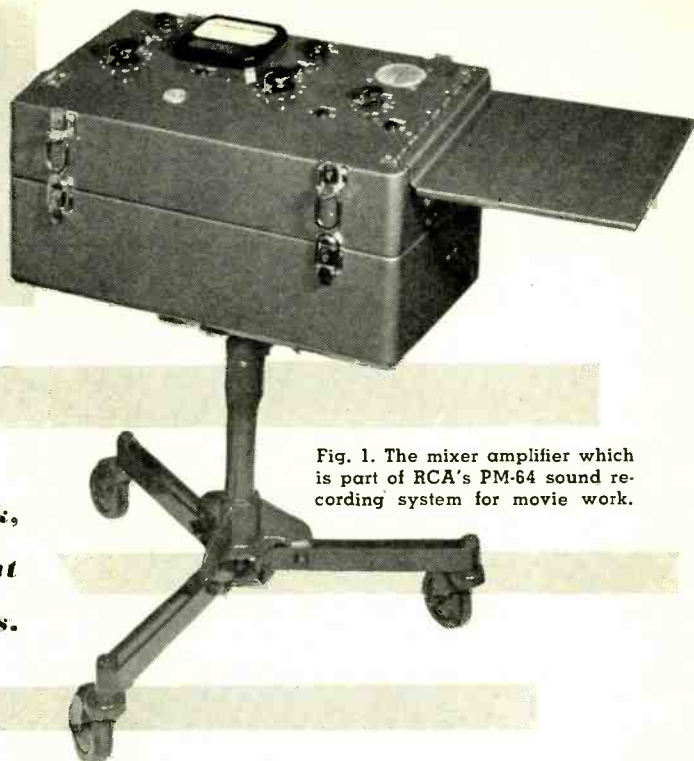

Fig. 1. The mixer amplifier which is part of *RCA's* PM-64 sound recording system for movie work.

Fig. 2. The portable *RCA* sound recording system shown in use on movie location.



sound recording work. Aside from the resistance to changeover in equipment, the new recording technique does offer several new problems for solution. One of these is the problem of identification. Photographic films carry footage numbers and each "take" or scene is identified by some visible characters on the original negative. It follows, therefore, that any and all prints made from this original carry the same identification marks. At the present state of the art, copies of magnetic recordings must be made by the re-recording process. The identification must therefore be done manually which requires more time and expense.

Another rather serious problem with magnetic recording is that of editing. Film editors have been accustomed to working with visible soundtracks and depend on this extensively for accurate cutting. Magnetic soundtracks are not visible (although they can be made visible) and thus add to the time required by the editor to do his work. Splicing also has been a problem. Engineers and technicians in the film industry are finding ways and means of overcoming all of these problems and no doubt as the state of the art grows and there is time to develop the specialized equipment for handling magnetic film, this new medium will replace photographic recording at least up to the release negative point, with conventional photographic prints distributed to the exhibitors.

At the present time, Hollywood is making most original recordings on magnetic film. The "OK" magnetic takes are then re-recorded on a photographic track which is then edited in the conventional manner. In some cases the transfer is made to a direct positive which eliminates the necessity for a negative-to-positive printing operation. Some studios are using this process in conjunction with an anticipatory noise reduction system for which RCA recently won a citation from the Academy of Motion Picture Arts and Sciences. This system makes provision for minimizing the introduction of extraneous noise, thus achieving clearer and truer reproduction of speech, music, and other wanted sound.

Quite recently RCA has developed a new high-quality portable magnetic recorder-reproducer especially for original recordings whether in the studio or on location. This equipment is pictured on the front cover with Robert Mitchum as part of *RKO Radio's* location unit filming "The Lusty Men" in the ranch country north of Hollywood. The *Wald-Krasna Production* stars Susan Hayward, Mitchum, and Arthur Kennedy and was directed by Nicholas Ray. This sound system is expected to greatly change the recording picture and provide many studios with the means for low cost magnetic sound recording. This recorder handles 17½ mm. film at 45 feet-per-minute. This "half" speed provides ample frequency range for the motion picture industry with a safe margin, since 500 feet of film at 45 feet-per-minute in the sound

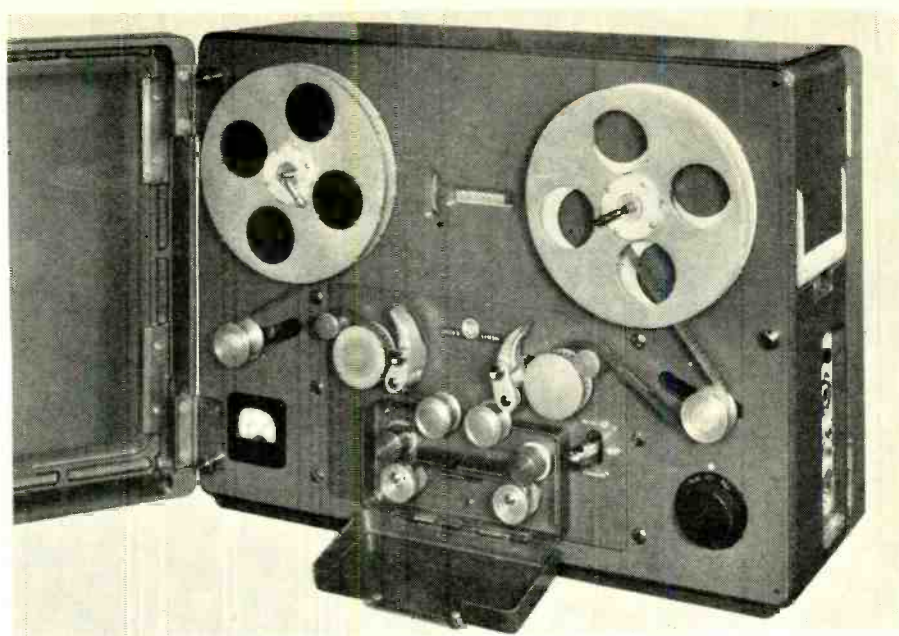
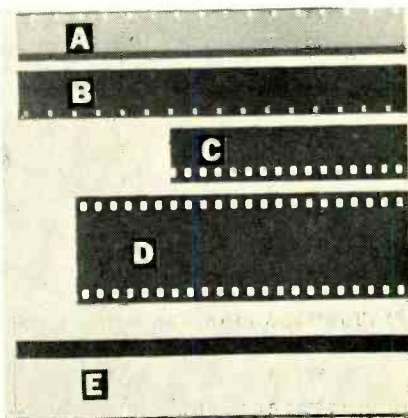

Fig. 3. Front view of RCA's Model PM-64 magnetic sound recording unit, with cover open.

recorder is equivalent in time to 1000 feet of picture film such as would normally be used in the motion picture camera. This reduction in speed has not only cut the film cost for the sound track in half but has also permitted the development of a smaller, more portable recorder. This is important where the equipment must be taken on location. The use of 17½ mm. film reduces film costs to approximately one-fourth of that required if the normal 35 mm. film were used at the normal speed of 90 feet-per-minute. Magnetic film has the further advantage that the soundtrack can be erased and used over again.

The complete RCA PM-64 sound recording system consists of a mixer amplifier, the recorder-reproducer, and the power supply. This equipment is  
(Continued on page 116)



The five different magnetic tape types used for film recording. (A) 16 mm. striped magnetic-photographic raw stock; (B) 16 mm. full-coated; (C) 17½ mm. full-coated; (D) 35 mm. full-coated; and (E) 35 mm. striped.

Fig. 4. Rear view of the recorder with the door open to show component layout.

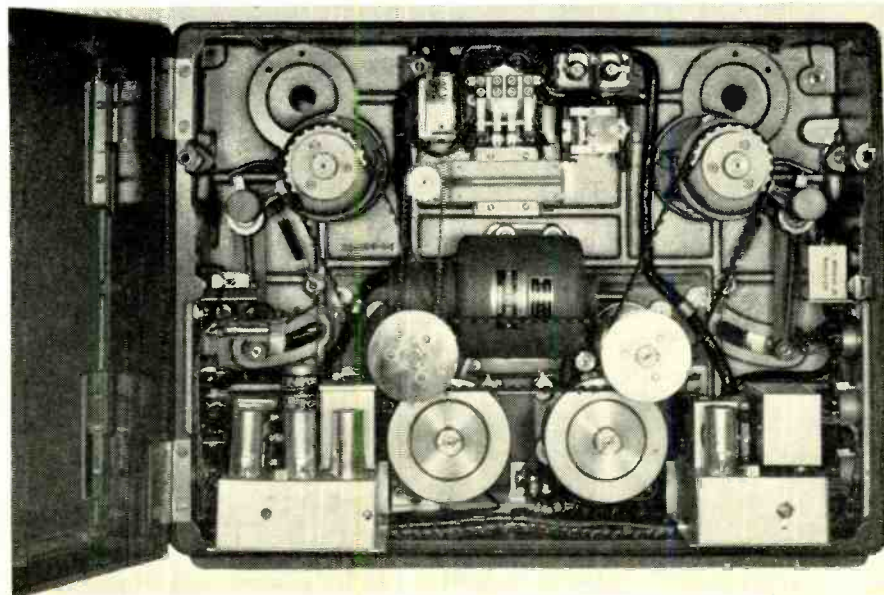

# UNIQUE SOUND ALARM for DEAF PERSONS

By  
H. G. DAVIS, JR., M.D.

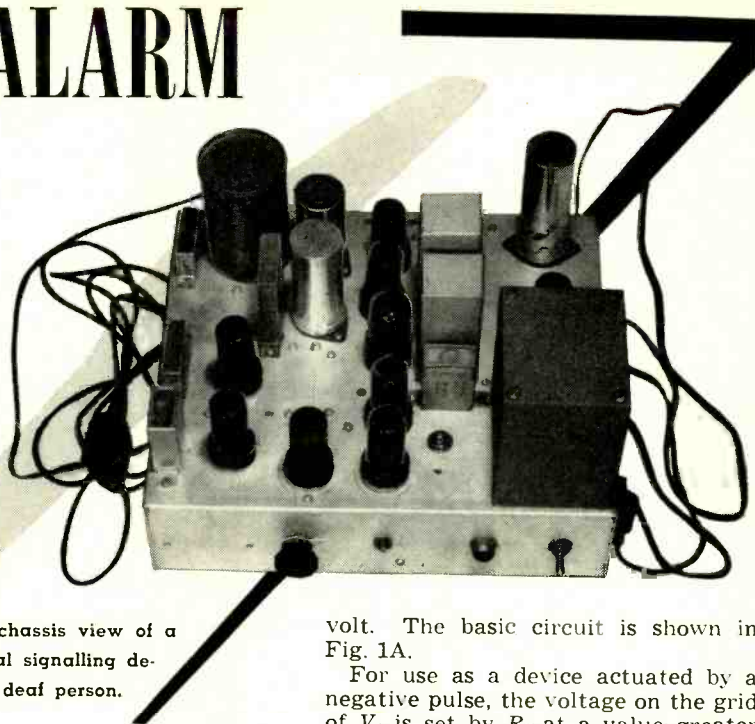

Top chassis view of a practical signalling device for a deaf person.

**Although designed to aid a deaf mother in caring for her child, this visual signal has many uses.**

**T**HE device to be described solved an interesting, but not unique problem. While it is simple in conception, certain definite limitations in operation and original cost made it difficult to execute. So it is thought that the special circuits utilized might warrant description for their individual usefulness, not limited to this single application.

The problem was to notify a deaf mother when her infant cried. The device had to be sensitive, relatively inexpensive, compact, and entirely automatic. Since the patient's hearing at the point of minimum loss (512 cps) was 90 db below normal, an ordinary amplifier and speaker would not work. Something to actuate a warning light had to be devised.

The simplest solution seemed to be a microphone pickup placed near the child, operating an ordinary speech amplifier, the output of which was rectified and used to cause conduction in a tube biased beyond plate-current cut-off, thus actuating a plate circuit relay. This was impractical because of the extraneous a.c. pickup in the high impedance microphone line. This voltage, plus that developed by ambient noise in the room, was not sufficient to trip the relay, but was enough to prevent fallout once the relay was actuated. Use of a low impedance microphone and shielded input transformer was precluded in this special case because of cost.

Measurement demonstrated that the instrument had to discriminate between a noise and noise-plus-signal voltage, differing by about one volt

peak. Obviously a relay directly operated could not be relied upon to do this consistently. However, the Schmitt switch often used to trigger a synchroscope sweep is capable of resolving these small differences. It can be arranged to operate on positive or negative pulses differing by less than 0.5

Fig. 1. (A) Simplified circuit of Schmitt switch. (B) Simplified circuit of relay switch. (C) Block diagram of the alarm.

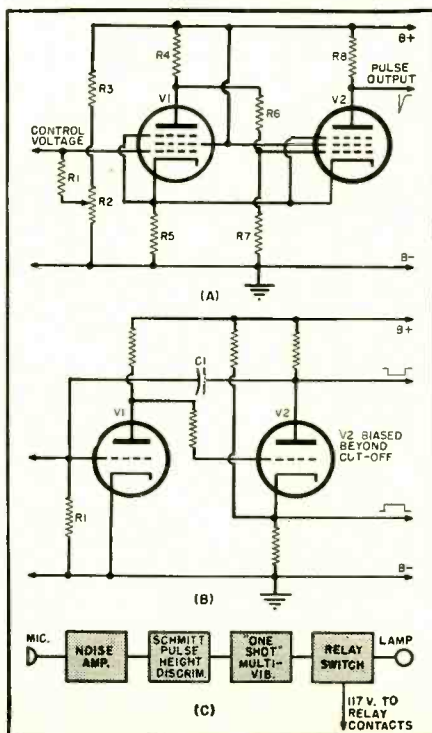

volt. The basic circuit is shown in Fig. 1A.

For use as a device actuated by a negative pulse, the voltage on the grid of  $V_1$  is set by  $R_2$  at a value greater than that on the grid of  $V_2$ . Plate current flowing in  $R_4$  then keeps the grid of  $V_2$  biased to cut-off so that the voltage at the plate of  $V_2$  is nearly that of the high voltage supply. A negative pulse applied to the grid of  $V_1$  gives it a negative reference to the voltage applied to the grid of  $V_2$  and increases the current through  $R_6$ , allowing  $V_2$  suddenly to conduct, thereby producing a negative pulse at its plate. The reverse process occurs when the grid voltage of  $V_1$  rises again. This switch has two stable limiting conditions dependent on the voltage on  $V_1$  and may be used to actuate a relay if the input pulse is of sufficient duration. The amount of voltage required to change the condition of operation depends on the difference in voltages applied to the grids of the two tubes.

Using the Schmitt circuit solved the noise-vs-signal problem, but its output would not actuate a relay when operated directly from the signal amplifier. This is due to the fact that speech (and a baby's howling) is a series of relatively short bursts. Since the Schmitt switch works very rapidly, keying on and off with each burst, it would not remain conducting for the finite time required to close the relay. Also it was necessary to hold the light on a short while after keying.

To give a pulse of sufficient duration to close the relay and prevent instantaneous opening, the discriminator output pulse is used to key a "one shot" multivibrator with a relatively long time constant. The basic circuit arranged for negative pulse keying is shown in Fig. 1B. A positive-going relatively square pulse may be had from the cathode of  $V_2$  provided the loading does not appreciably alter the operating condition of  $V_2$ . It was impossible to operate the relay directly from the multivibrator so another Schmitt switch, direct-coupled to the



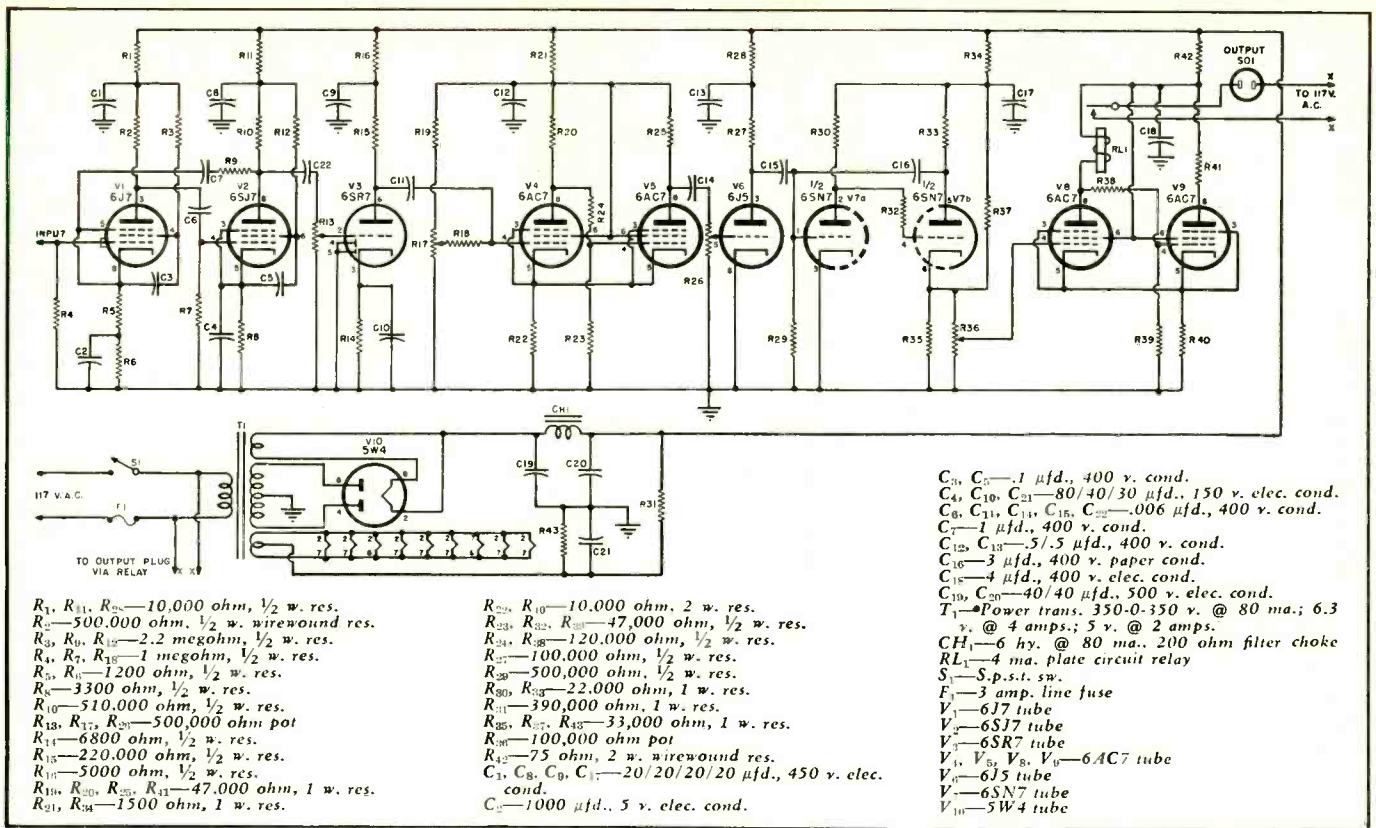

Fig. 2. Complete circuit diagram and parts list for a sound alarm unit which is designed to provide a visual warning signal.

cathode of the multivibrator, is used as a relay switch. In this case  $V_1$  of the switch is biased to cut-off and a relay inserted in its plate circuit. Since the resting current here may be as near zero as desired, there is no problem of relay fallout not occurring when the unstable regime of the multivibrator has been completed.

Fig. 1C shows the block diagram of the unit. It can be seen that the timing of the whole sequence of events depends on the duration of the unstable portion of the multivibrator's cycle and that it will automatically reset and be ready for another stimulus at the end of this period. The input to the multivibrator and its output to the relay-actuating switch circuit must be adjusted to give a positive switching action, yet not be so great as to cause these circuits to draw grid current and block them for undesirably long periods.

Fig. 2 shows the circuit of the complete instrument.  $V_1, V_2$ , and  $V_3$  comprise a simple, high gain amplifier. Extended range of response is actually undesirable in this application, since low rumbles (street noises) and very high-pitched sounds should not actuate the relay. The inverse feedback over  $V_1$  and  $V_3$ , therefore, is not for the purpose of range extension, but to reduce internal noise and stabilize gain.  $R_{13}$  is a standard gain control and is used to adjust the sensitivity of the instrument.

The output of this amplifier triggers the first switch circuit,  $V_4$  and  $V_5$ , whose output is tapped off  $R_{36}$  and used to trigger the multivibrator  $V_7$ .  $R_{17}$  controls the voltage at which the

switch triggers, thus the degree of discrimination between noise and signal.  $R_{26}$  and the pulse amplifier,  $V_6$ , control the height of the trigger signal to  $V_7$ .

The potentiometer,  $R_{36}$ , couples the multivibrator to the second switch circuit,  $V_8$  and  $V_9$ , and also controls the steady-state bias on the grid of  $V_8$ , thus

determining when the switch will change from one regime to another and close the relay.

The circuit may seem complex for so simple a job, but does fulfill the requirements of stability and reliability which the many simpler circuits which were tried could not do.

Under chassis view. Standard and readily-available parts are used throughout.

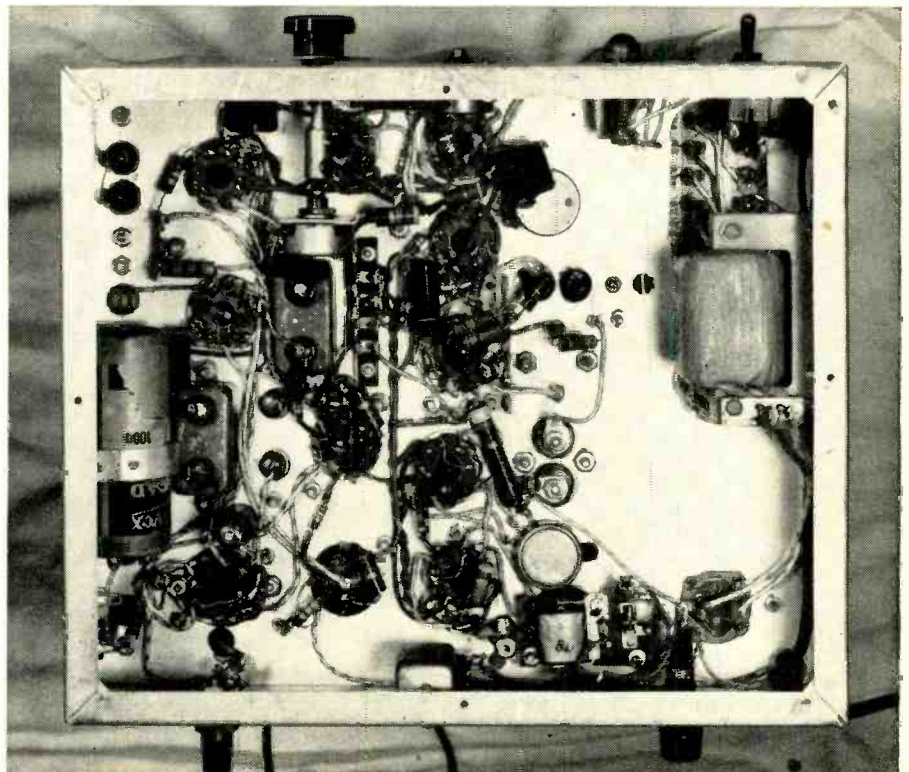



# THE TV PICTURE TUBE

By

**WALTER BUCHSBAUM**

Television Consultant, RADIO & TELEVISION NEWS

***Points to remember when replacing your picture tubes. Article covers basic tube types, their characteristics, and data on substitution.***

Metal picture tubes, like the RCA 17-inch unit shown above, combine a large face with light weight for ease of handling.

**T**HE picture tube is the heart of the television receiver, not only because it is the most bulky and expensive item, but because it produces the desired end result—the picture. Since the early days of TV the improvement in picture tubes has been the greatest concern of the industry, since bigger and better pictures depend on the tube. Thus we have seen the 5-or 7-inch round tubes of 1946 evolve as today's 20-and 30-inch round and rectangular picture tubes. Just how extensive this development has been is evidenced by the long list of picture tubes given on the "Data-Print" in this month's issue. Although there is considerable variation between tubes, certain basic features permit us to group them and classify them. The purpose of this article is to acquaint the technician with the great variety of available picture tubes and the use of each type in replacement and conversion work.

Three main classifications can be made immediately: electrostatic deflection, projection types, and magnetic deflection direct view tubes. We shall discuss them in this order.

**Electrostatic deflection tubes:** These tubes use deflection plates mounted inside the tube to sweep the beam vertically and horizontally. Focusing is also done electrostatically. The largest electrostatic deflection tube used in commercial sets is the 10HP4 although we list a 20AP4 which uses electrostatic deflection. This latter tube is

found only in a few experimental receivers. The most common type is the 7-inch all-glass and the 8-inch metal-shell tubes used widely in portable TV sets. All of these tubes use less than 8 kv. second anode voltage and none require an ion trap. Before replacing an electrostatic picture tube with a different number, be sure that socket connections and voltages are correct. Some use a 12-pin and others a 14-pin socket.

**Projection picture tubes:** The 3NP4 is used in the so-called "folded Schmidt System" of projection TV manufactured by *North American Philips Co.* Careful handling because of the fragility and the critical adjustment of the optical system is the major factor when replacing this tube. The tube requires a special socket and is magnetically focused and deflected. Both focus coil and deflection yoke are specially made for this tube alone. The other projection tube is the 5TP4, used in practically all other projection-type receivers. The focus is electrostatic and requires a high voltage at the tube socket which often causes arcing and breakdowns. A special deflection yoke is also required for the 5TP4.

**Magnetic deflection, direct view types:** The vast majority of TV re-

ceivers use this type of picture tube. Ranging from 7-inch round to 30-inch round, these tubes all have several features in common. All sockets are of the 12-pin type and almost all socket connections are identical and interchangeable. Some of the latest electrostatic focus tubes utilize Pin 6 which is unused on other types. On all tubes Pins 1 and 12 are the filaments, 2 is the grid, 11 the cathode, and 10 is the first anode. Thus it is possible to interchange tube sockets without much difficulty. The second common feature is that they all need a deflection yoke.

Different deflection yokes, however, are required for different deflection angles and this is a particularly important consideration when converting to a larger picture tube. Larger screens require wider deflection angles and this, in turn, calls for a different deflection yoke and more sweep power, especially in the horizontal section. More powerful focus coils are also used on many of the larger tubes. This is indicated on the "Data-Print" by an asterisk which means that an RTMA #109 type (470 ohms) must be used instead of the standard RTMA # 106 (264 ohms). It is also important to have the correct anode voltages, focus

*(Continued on page 139)*

## COMING IN NEXT MONTH'S ISSUE—"DATA-PRINT" NO. 5 "Television Conversion Guide"

This "Guide," when used with this month's "Data-Print," will provide pertinent information and circuit data for the rapid conversion of small-screen television receivers to large-screen operation.



**MAKESHIFT  
REPLACEMENTS  
reduce picture quality**

Right  
for  
Sight

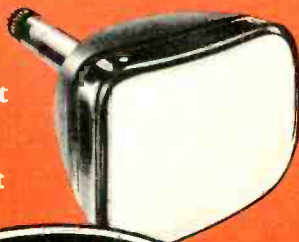

Replacements with  
Raytheon Television Tubes  
assure picture quality

*Remember! Raytheon Picture Tubes with Corona Inhibitor  
give constant picture clarity whatever the weather.*



*Excellence in Electronics*

**RAYTHEON MANUFACTURING COMPANY**

Receiving Tube Division

Newton, Mass., Chicago, Ill., Atlanta, Ga., Los Angeles, Calif.

RECEIVING AND PICTURE TUBES • RELIABLE SUBMINIATURE AND MINIATURE TUBES • GERMANIUM DIODES AND TRANSISTORS • RADIAC TUBES • MICROWAVE TUBES

# REPLACEMENT GUIDE

	ANODE connection	B.V. (k.v.)	FOCCS*	MISC.	TUBE TYPE	FACE SHAPE	ENVELOPE	LENGTH (inches)	TYPE DEFLECTION	DEFLECTION ANGLE (degrees)	ION TRAP	ANODE connection	B.V. (k.v.)	FOCCS*	MISC.
e	Cavity	14	Automatic	Filterglass	17SP4	Rect.	Glass	19¼	Magnetic	70 diag.	Single	Cavity	12	Automatic	Cyl. face
e	Cavity	14	Automatic		17TP4	Rect.	Metal	19¼	Magnetic	70 diag.	Single	Rim	14	E 0 to 500 v.	Etched face
e	Cavity	13	E -60 to +350 v.	Filterglass	17UP4	Rect.	Glass	19¼	Magnetic	70 diag.	Single	Cavity	12	M 95 ma.*	Cyl. face
le	Rim	12	M 90 ma.*	Filterglass Etched face	17VP4	Rect.	Glass	19¼	Magnetic	70 diag.	Single	Cavity	14	E -50 to +300 v.	Cyl. face
le	Rim	12	M 110 ma.*		17YP4	Rect.	Glass	19¼	Magnetic	70 diag.	Single	Cavity	12	M 90 ma.	Cyl. face
le	Cavity	12	M 110 ma.*		19AP4										
le	Cavity	14	M 115 ma.*		19AP4A	Round	Metal	21½	Magnetic	66	Single	Rim	16	M 140 ma.	Filterglass
le	Cavity	12	M 115 ma.*	Filterglass,‡	19AP4B										Etched face
					19AP4C										Filterglass
					19AP4D										Etched face
le	Rim	12	M 100 ma.*	Filterglass	19BP4A	Round	Glass	21½	Magnetic	66	Single	Cavity	14	M 110 ma.	
le				Etched face	19DP4	Round	Glass	21½	Magnetic	66	Double	Cavity	13	M 140 ma.	Filterglass
le	Ball	13	M 145 ma.*		19DP4A	Round	Glass	21½	Magnetic	66	Double	Cavity	13	M 140 ma.	Filterglass
				Filterglass	19EP4	Rect.	Glass	21¼	Magnetic	70 diag.	Double	Cavity	14	M 100 ma.*	Filterglass,‡
					19FP4	Round	Glass	22	Magnetic	66	Double	Cavity	14	M 100 ma.*	Etched face,‡
le	Rim	12	M 100 ma.*	Etched face	19GP4	Round	Glass	21¾	Magnetic	60	Single	Cavity	14	M 100 ma.*	Filterglass,‡
				Etched face	19JP4	Rect.	Glass	21¼	Magnetic	70 diag.	Single	Cavity	12	M 95 ma.*	Filterglass,‡
					19QP4	Rect.	Glass	21¼	Magnetic	70 diag.	Single	Cavity	12	E -50 to +350 v.	Filterglass
le	Cavity	12	M 110 ma.	Filterglass	20AP4	Round	Glass	27¾	Elec.	---	None	---	8	E 4 kv.	Discontinued,‡
le	Cavity	11	M 115 ma.	Filterglass	20BP4	Round	Glass	28¾	Magnetic	54	None	Cap	15	M 135 ma.	Discontinued,‡
				Filterglass	20CP4										
				Filterglass	20CP4A	Rect.	Glass	21¼	Magnetic	70 diag.	Single	Cavity	12	M 95 ma.*	Filterglass
				Filterglass	20CP4C										Etched face,‡
le	Cavity	12	M 110 ma.*	Filterglass	20DP4										
					20DP4A	Rect.	Glass	21¼	Magnetic	70 diag.	Single	Cavity	12	M 95 ma.*	Filterglass
le	Cavity	12	M 110 ma.*	Filterglass	20FP4										
				Filterglass	20FP4A	Rect.	Glass	21¼	Magnetic	70 diag.	Single	Cavity	12	E 2-3 kv.	Filterglass
le	Cavity	11	M 130 ma.	Filterglass,‡	20GP4	Rect.	Glass	21¾	Magnetic	70 diag.	Single	Cavity	12	E 2-3 kv.	Filterglass
le	Cavity	12	M 100 ma.*	Filterglass	20HP4										
					20HP4A	Rect.	Glass	21¾	Magnetic	70 diag.	Single	Cavity	12	E -50 to +270 v.	Filterglass
le	Cavity	12	M 110 ma.*	Filterglass	20HP4B										
le	Cavity	12	M 110 ma.*	Filterglass	20JP4										
le	Cavity	12	M 100 ma.*	Filterglass,‡	20JP4A	Rect.	Glass	21¼	Magnetic	70 diag.	Single	Cavity	13	Automatic	Filterglass
le	Cavity	12	M 110 ma.*	Filterglass,‡	20MP4	Rect.	Glass	22¼	Magnetic	70 diag.	Single	Cavity	14	E -50 to +350 v.	Filterglass
le	Cavity	12	M 110 ma.*	Filterglass	21AP4	Rect.	Metal	22¼	Magnetic	70 diag.	Single	Rim	14	M 105 ma.*	Etched face
le	Cavity	12	M 100 ma.*	Filterglass,‡	21DP4	Rect.	Metal	22¾	Magnetic	70 diag.	Single	Rim	16	E 2-3 kv.	Etched face
le	Cavity	12	M 100 ma.*	Filterglass	21EP4										
le	Cavity	12	M 110 ma.*	Filterglass	21EP4A	Rect.	Glass	23	Magnetic	70 diag.	Single	Cavity	16	M 95 ma.*	Cyl. face
					21EP4B										Cyl. face
le	Cavity	12	M 100 ma.*	Filterglass,‡	21FP4										
				Filterglass,‡	21FP4A	Rect.	Glass	23	Magnetic	70 diag.	Single	Cavity	14	E -50 to +350 v.	Cyl. face
le	Cavity	12	M 100 ma.*	Filterglass	21GP4	Rect.	Metal	22¼	Magnetic	70 diag.	Single	Rim	18	Automatic	Filterglass
				Filterglass	21KP4	Rect.	Glass	22¾	Magnetic	70 diag.	Single	Cavity	14	Automatic	
				Etched face,‡	21KP4A	Rect.	Glass	22¾	Magnetic	70 diag.	Single	Cavity	14	Automatic	Cyl. face
le	Rim	12	M 95 ma.*	Etched face	21MP4	Rect.	Metal	22¾	Magnetic	70 diag.	Single	Rim	14	E -50 to +350 v.	Etched face
				Filterglass	22AP4										
				Filterglass	22AP4A	Round	Metal	23¾	Magnetic	70	Single	Rim	14	M 105 ma.*	Filterglass
le	Cavity	12	E 2-3 kv.	Filterglass	24AP4										
le	Rim	12	E 2-3 kv.	Etched face	24AP4A	Round	Metal	24¼	Magnetic	70	Single	Rim	16	M 100 ma.*	Filterglass
le	Cavity	14	E -50 to +270 v.	Filterglass	24BP4	Round	Metal	24¼	Magnetic	70	Single	Rim	14	E -50 to +270 v.	Filterglass
le	Cavity	14	M 95 ma.*	Filterglass											
le	Cavity	14	Selfocuss	Filterglass											
e	Cavity	14	E -50 to +270 v.	Cyl. face											
e	Cavity	14	M 110 ma.*	Cyl. face											
e	Cavity	14	Zero focus	Filterglass											
e	Cavity	14	E -100 to +100 v.	Filterglass											
					27AP4	Rect.	Metal	21¼	Magnetic	90 diag.	Single	Rim	15	E -60 to +300 v.	Filterglass
					30BP4	Round	Metal	23½	Magnetic	90	Single	Rim	27	M 95 ma.*	Filterglass

\* Require RTMA # 109 focus coil (470 ohms) or equivalent.

† M Magnetic focus  
‡ E Electrostatic focus

§ Tube requires use of a 1000 µpfd. condenser between 2nd anode lead and chassis ground.

All cylindrical faced tubes have Filterglass.

ing for grounding of the second anode require the use of a 1000 µpfd. condenser between the second anode terminal or lead and chassis ground.

Tubes having cylindrical faces may require a change or modification of the tube mask to allow the tube to fit snugly into the frame. This should be investigated before making a replacement.

In the 50 to 60 degree deflection angle group, a difference in deflection requirements up to about 5 degrees can be tolerated. In going from 60 to 70 degree deflection tubes, however, new deflection yokes are necessary. The deflection angle for rectangular tubes represents the diagonal deflection; for round tubes, the deflection along the diameter is given.

**RADIO & TELEVISION NEWS**

DATA-PRINT # 4

(Copyright 1952)

# TELEVISION PICTURE TUBE

TUBE TYPE	FACE SHAPE ENVELOPE		LENGTH (inches)	TYPE DEFLECTION	DEFLECTION ANGLE (degrees)		ION TRAP	ANODE connection	H.V. (h.v.)	FOCUS	MISC.	TUBE TYPE	FACE SHAPE ENVELOPE		LENGTH (inches)	TYPE DEFLECTION	DEFLECTION ANGLE (degrees)		ION TRAP
	SHAPE	ENVELOPE			ANGLE	TRAJ.							SHAPE	ENVELOPE			ANGLE	TRAJ.	
3KP4	Round	Glass	11 3/4	Elec.	—	—	None	—	2	E 450 v.	‡	16ABP4	Rect.	Glass	18 3/4	Magnetic	70 diag.	60	Singl
3NP4	Round	Glass	10	Magnetic	—	—	None	Ball	24	M 120 ma.	‡	16ACP4	Round	Glass	20 3/4	Magnetic	70 diag.	60	Singl
5TP4	Round	Glass	12 1/2	Magnetic	—	—	None	Cavity	27	E 4.9 kv.	‡	16AEP4	Rect.	Glass	18 3/4	Magnetic	70 diag.	60	Singl
7AP4	Round	Glass	13 3/8	Magnetic	55	—	None	—	3.5	E 600 v.	‡	16AP4	Rect.	Metal	22 3/8	Magnetic	53	—	Doul
7CP4	Round	Glass	13 3/8	Magnetic	57	—	None	—	6	E 1.1 kv.	‡	16AP4A	Round	Metal	22 3/8	Magnetic	53	—	Doul
7DP4	Round	Glass	14 3/8	Magnetic	50	—	Double	Cavity	6	E 1.4 kv.	‡	16AP4B	Round	Glass	21 3/8	Magnetic	52	—	Doul
7EP4	Round	Glass	15 1/2	Elec.	—	—	None	—	2.5	E 650 v.	‡	16CP4	Round	Glass	21 3/8	Magnetic	53	—	Doul
7GP4	Round	Glass	14 3/8	Elec.	—	—	None	—	3	E 1 kv.	‡	16CP4A	Round	Glass	22 3/8	Magnetic	60	—	Singl
7HP4	Round	Glass	13 3/8	Magnetic	50	—	None	Ball	6	M —	‡	16DP4	Round	Glass	21	Magnetic	60	—	Singl
7JP4	Round	Glass	14 3/8	Elec.	—	—	None	—	6	E 1 kv.	‡	16DP4A	Round	Glass	21	Magnetic	60	—	Singl
8AP4	Round	Metal	14 3/8	Magnetic	54	—	Single	Rim	9	M 112 ma.	‡	16EP4	Round	Metal	20	Magnetic	60	—	Doul
8AP4A	Round	Metal	14 3/8	Magnetic	54	—	Single	Rim	9	M 112 ma.	Filterglass	16EP4A	Round	Metal	20	Magnetic	60	—	Singl
8BP4	Round	Glass	16 3/8	Elec.	—	—	None	—	6	E 2 kv.	‡	16EP4B	Round	Metal	20	Magnetic	62	—	Singl
9AP4	Round	Glass	21 3/8	Magnetic	—	—	None	Cap	6	E 1.2 kv.	‡	16FP4	Round	Glass	20 3/8	Magnetic	62	—	Singl
10BP4	Round	Glass	17 3/8	Magnetic	50	—	Double	Cavity	10	M 130 ma.	‡	16GP4	Round	Metal	17 3/8	Magnetic	70	—	Singl
10BP4A	Round	Glass	17 3/8	Magnetic	50	—	Double	Cavity	10	M 130 ma.	Filterglass	16GP4A	Round	Metal	17 3/8	Magnetic	70	—	Singl
10CP4	Round	Glass	17 3/8	Magnetic	50	—	None	Ball	10	M 150 ma.	‡	16GP4B	Round	Metal	17 3/8	Magnetic	60	—	Doul
10DP4	Round	Glass	18	Magnetic	50	—	None	Cavity	10	E 2.9 kv.	‡	16GP4C	Round	Metal	17 3/8	Magnetic	60	—	Doul
10EP4	Round	Glass	18	Magnetic	50	—	Double	Cavity	9	M 132 ma.	‡	16HP4	Round	Glass	21 3/8	Magnetic	60	—	Doul
10FP4	Round	Glass	18	Magnetic	50	—	None	Cavity	10	M 115 ma.	‡	16HP4A	Round	Glass	21 3/8	Magnetic	60	—	Doul
10FP4A	Round	Glass	18	Magnetic	50	—	None	Cavity	10	M 115 ma.	Filterglass	16JP4	Round	Glass	21 3/4	Magnetic	60	—	Doul
10GP4	Round	Glass	18 3/8	Elec.	—	—	None	—	5	E 1.5 kv.	Discontinued	16KP4	Rect.	Glass	19 3/8	Magnetic	70 diag.	—	Singl
10HP4	Round	Glass	19 3/8	Elec.	—	—	None	—	5	E 1.5 kv.	Discontinued	16KP4A	Rect.	Glass	19 3/8	Magnetic	70 diag.	—	Singl
10MP4	Round	Glass	17 3/8	Magnetic	52	—	Double	Cavity	10	M 150 ma.	No 2nd grid	16LP4	Round	Glass	22 3/8	Magnetic	52	—	Doul
10MP4A	Round	Glass	17 3/8	Magnetic	52	—	Double	Cavity	10	M 150 ma.	Filterglass	16LP4A	Round	Glass	22 3/8	Magnetic	52	—	Doul
12AP4	Round	Glass	25 3/8	Magnetic	50	—	None	Cap	7	E 1.5 kv.	Discontinued	16MP4	Round	Glass	22 3/8	Magnetic	60	—	Doul
12CP4	Round	Glass	18 3/8	Magnetic	50	—	Double	Cap	7	M —	No 1st anode	16MP4A	Round	Glass	22 3/8	Magnetic	60	—	Doul
12JP4	Round	Glass	18	Magnetic	50	—	None	Ball	12	M 146 ma.	‡	16QP4	Rect.	Glass	19 3/4	Magnetic	70 diag.	—	Doul
12KP4	Round	Glass	18	Magnetic	54	—	None	Cavity	12	M 135 ma.	‡	16RP4	Rect.	Glass	19 3/8	Magnetic	70 diag.	—	Doul
12KP4A	Round	Glass	18	Magnetic	54	—	None	Cavity	12	M 135 ma.	Filterglass	16SP4	Round	Glass	17 3/4	Magnetic	70	—	Doul
12LP4	Round	Glass	19 3/8	Magnetic	57	—	Double	Cavity	12	M 125 ma.	‡	16SP4A	Round	Glass	17 3/4	Magnetic	70	—	Doul
12LP4A	Round	Glass	19 3/8	Magnetic	57	—	Double	Cavity	12	M 125 ma.	Filterglass	16TP4	Rect.	Glass	18 1/2	Magnetic	70 diag.	—	Singl
12QP4	Round	Glass	17 3/8	Magnetic	55	—	Single	Ball	10	M 135 ma.	‡	16UP4	Rect.	Glass	18 3/8	Magnetic	70 diag.	—	Singl
12QP4A	Round	Glass	17 3/8	Magnetic	55	—	Single	Ball	10	M 135 ma.	Filterglass	16VP4	Round	Glass	17 1/2	Magnetic	70	—	Singl
B1034	Round	Glass	17 1/2	Magnetic	55	—	Single	Cavity	10	M 135 ma.	Repl. for 12QP4	16WP4	Round	Glass	18 1/2	Magnetic	70	—	Doul
12RP4	Round	Glass	18	Magnetic	56	—	Single	Ball	10	M 135 ma.	‡	16WP4A	Round	Glass	18 1/2	Magnetic	70	—	Doul
12TP4	Round	Glass	19 3/8	Magnetic	54	—	Double	Cavity	10	M 110 ma.	‡	16XP4	Rect.	Glass	19 3/8	Magnetic	70 diag.	—	Doul
12UP4	Round	Metal	19	Magnetic	54	—	Double	Rim	10	M 120 ma.	‡	16YP4	Round	Glass	17 3/8	Magnetic	70	—	Singl
12UP4A	Round	Metal	19	Magnetic	54	—	Double	Rim	10	M 120 ma.	Filterglass	16ZP4	Round	Glass	22 3/8	Magnetic	52	—	Doul
12UP4B	Round	Glass	17 3/4	Magnetic	55	—	Single	Special	12	M 110 ma.	Etched face	17AP4	Rect.	Glass	19	Magnetic	70 diag.	—	Singl
12VP4	Round	Glass	18 3/8	Magnetic	55	—	Double	Cavity	10	M 150 ma.	No 2nd grid	17BP4	Rect.	Glass	19 3/8	Magnetic	70 diag.	—	Singl
12VP4A	Round	Glass	18 3/8	Magnetic	55	—	Double	Cavity	10	M 150 ma.	Filterglass	17BP4A	Rect.	Glass	19 3/8	Magnetic	70 diag.	—	Singl
12WP4	Round	Glass	18 3/4	Magnetic	54	—	Single	Cavity	12	M 110 ma.	Filterglass	17BP4B	Rect.	Glass	19 3/8	Magnetic	70 diag.	—	Singl
12YP4	Round	Glass	18 3/4	Magnetic	54	—	Single	Cavity	12	Automatic	‡	17BP4C	Rect.	Glass	19 3/8	Magnetic	70 diag.	—	Singl
14AP4	Round	Glass	24 1/4	Elec.	—	—	None	—	8	E 4 kv.	Discontinued	17CP4	Rect.	Metal	19	Magnetic	70 diag.	—	Singl
14BP4	Rect.	Glass	16 3/8	Magnetic	70 diag.	—	Double	Cavity	10	M 110 ma.*	Filterglass	17CP4A	Rect.	Metal	19	Magnetic	70 diag.	—	Singl
14CP4	Rect.	Glass	17 3/8	Magnetic	70 diag.	—	Single	Cavity	12	M 115 ma.*	Filterglass	17FP4	Rect.	Glass	19 3/8	Magnetic	70 diag.	—	Singl
14DP4	Rect.	Glass	17 3/8	Magnetic	70 diag.	—	Double	Cavity	11	M 100 ma.*	Filterglass	17FP4A	Rect.	Glass	19 3/8	Magnetic	70 diag.	—	Singl
14EP4	Rect.	Glass	16 1/2	Magnetic	70 diag.	—	Single	Cavity	12	M 110 ma.*	Filterglass	17GP4	Rect.	Metal	18 1/2	Magnetic	70 diag.	—	Singl
14FP4	Rect.	Glass	16 1/2	Magnetic	70 diag.	—	Single	Cavity	12	M 115 ma.*	Filterglass	17HP4	Rect.	Glass	19 3/8	Magnetic	70 diag.	—	Singl
14GP4	Rect.	Glass	17 3/8	Magnetic	70 diag.	—	Single	Cavity	12	E 2.5 kv.	Filterglass	17JP4	Rect.	Glass	19 3/4	Magnetic	70 diag.	—	Singl
14GP4A	Rect.	Glass	17 3/8	Magnetic	70 diag.	—	Single	Cavity	12	E 2.5 kv.	Filterglass	17KP4	Rect.	Glass	19 3/4	Magnetic	70 diag.	—	Singl
15AP4	Round	Glass	20 3/8	Magnetic	57	—	None	Ball	12	M 160 ma.	‡	17LP4	Rect.	Glass	19 3/4	Magnetic	70 diag.	—	Singl
15CP4	Round	Glass	21 3/8	Magnetic	50	—	Double	Cavity	12	M 110 ma.	‡	17LP4A	Rect.	Glass	19 3/4	Magnetic	70 diag.	—	Singl
15DP4	Round	Glass	20 3/8	Magnetic	57	—	Single	Cavity	13	M 145 ma.	‡	17QP4	Rect.	Glass	19 3/4	Magnetic	70 diag.	—	Singl
B1014P4	Round	Glass	20 3/8	Magnetic	57	—	Single	Ball	13	M 145 ma.	Repl. for 15DP4	17RP4	Rect.	Glass	19 3/4	Magnetic	70 diag.	—	Singl
												17RP4A	Rect.	Glass	19 3/4	Magnetic	70 diag.	—	Singl

Replacement of picture tubes in television receivers (as opposed to conversion) ordinarily involves the substitution of the same type number tube for a defective original. In many cases, this is not possible because the same tube type may not be available or desirable. Under such conditions, the correct replacement of a picture tube depends upon finding a tube whose physical and electrical characteristics match, as closely as possible, those of the tube to be replaced. In replacement, the only physical characteristics that must be checked are the over-all length of the tube and the face diameter or diagonal. The flare dimensions do not vary greatly for tubes of equivalent face size.

To find the correct replacement for any tube type, first, find the size group on the above chart in which the origi-

nal tube falls. Then, within that group, compare the tube to be replaced with the others as regards each of the characteristics given for the tubes. If all electrical characteristics of two tubes match, a difference in over-all length may be tolerated depending upon the space available on the chassis and in the cabinet.

For example, the 12RP4 is a perfect replacement for 12QP4A. The difference of 1/8 inch in over-all length between the tubes can obviously be accommodated by the cabinet. However, the 16LP4 or 16LP4A is a perfect electrical replacement for the 16CP4 except for a difference of 3/4 of an inch in length. Some cabinets may accept the difference, others may not.

Those glass tubes which do not have an external coat-

# CONSTANT K TYPE HIGH-PASS FILTER DESIGN

By SEIZO YAMASITA

*The constants of a "T" or "pi" type constant K high-pass filter may be determined rapidly with acceptable accuracy with the aid of this chart.*

**I**N DESIGNING an electrical filter, it is customary to determine the constants of the elements to a fairly high degree of accuracy. However, the damping characteristic of the constant  $K$  type filter is not sharp, so that calculations to an accuracy of better than a few per-cent are seldom required, and effective use can be made of charts to determine inductance and capacitance.

Fig. 1 shows both the "T" and "pi" types of constant  $K$  high-pass filter. In this figure:

$$L = R/4\pi f_0$$

$$C = 1/4\pi f_0 R$$

where  $f_0$  is the cut-off frequency and  $R$  is the image impedance.

From the chart (Fig. 2) it is possible to determine  $L$  and  $C$  if  $f_0$  and  $R$  are known. For example, the chart shows that a filter with a cut-off frequency of 10,000 cycles and an image impedance of 600 ohms would call for  $L = 4.8$  mh. and  $C = 0.014$   $\mu$ fd.

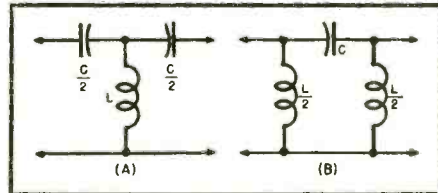
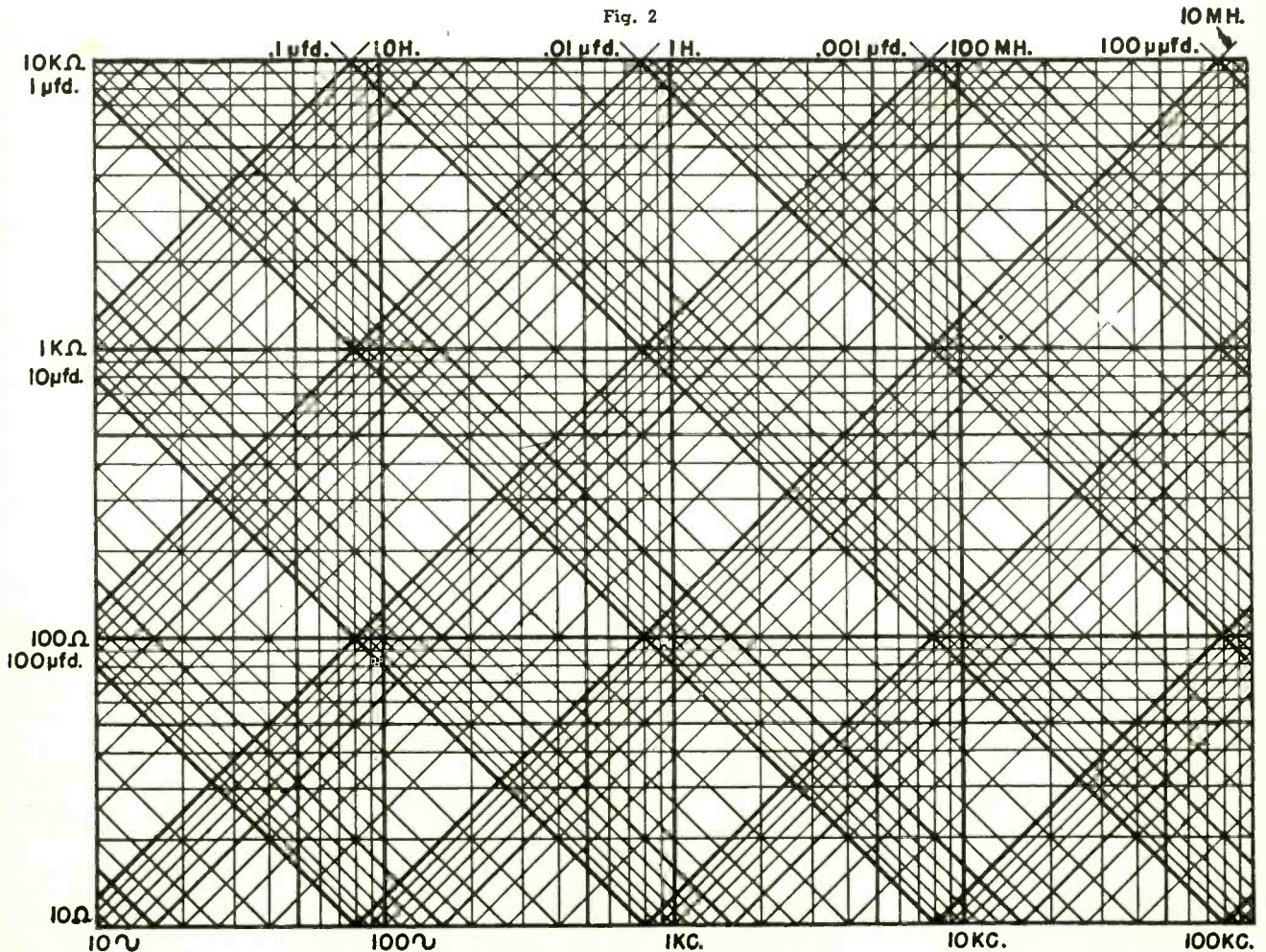

Fig. 1. (A) "T" type and (B) "pi" type constant  $K$  high-pass filter.



# An Improved SPEECH CLIPPER



Fig. 1. Front panel view of clipper. The unit indicates clipping level directly in decibels by means of flashing neon lamps.

*Although designed for the ham, this unit may also be used by soundmen in connection with p.a. systems.*

By  
**L. C. WATKINS, JR.**  
W5JX0

**P**REMODULATION speech clipping and filtering has become an accepted and proven method of obtaining increased sideband power from phone transmitters. The theory and benefits have been discussed so frequently that space will not be devoted to a detailed summarization here. A review of the more pertinent articles will be helpful to those persons interested. 1, 2, 3, 4, 5

The disappointing results often obtained when clipping is attempted may usually be traced to one or more of the following situations: (1) Overmodulation due to phase shift in the filter that is necessary to use after the clipper, and phase shift in the audio circuits following the clipper-filter. (2) Skimpy or improper modulator design. (3) The use of an excessive amount of speech clipping, usually due to the lack of an accurate method of determining how many decibels of clipping are in use at any given instant. (4) Failure to eliminate noise and hum voltages from the low-level speech stages ahead of the clipper. (5) The use of clipping, in excess of a very few decibels, when the transmission path is subject to selective fading conditions.

Most of these problems have obvious solutions. Perhaps not so obvious is the fact that phase shift accounts for a major part of the unsatisfactory results which are sometimes noted.

The voice, as far as the instantaneous conditions are concerned, can be considered as various sine-wave combinations and even-order harmonics. A sine wave clipped 10.5 db has a shape factor of 0.9, which is nearly as great as the 1.0 shape factor of a square

wave. A square wave is found to have only odd harmonics, being composed of an infinite number of sine-wave components of different frequencies and amplitudes.

In order to preserve a square-wave signal through an audio system, the system must have (1) flat amplitude response and, (2) uniform time delay, so that the frequency components will retain the same alignment relative to one another that they had originally.

Any filter arrangement that provides a sharp cut-off, of which the common  $m$ -derived filter is an example, does not exhibit a linear phase-shift characteristic. The phase shift increases rapidly as the filter cut-off frequency is approached. This gives rise to a realignment of the frequency components present in the clipped wave, such that the new peak amplitude at the filter output is greater than that of the fundamental. In other words, full advantage cannot be taken of the original reduction in the waveform peak factor that clipping accomplished, since it is mandatory that the transmitter not be overmodulated.

Some relief may be afforded by using a constant- $k$  filter section after the clipper instead of the  $m$ -derived type. The constant- $k$  filter exhibits a much improved phase-shift characteristic for the purpose at hand, although it does not cut off as sharply as the  $m$ -derived filter. More important, it gives better attenuation at frequencies farther out from cut-off. In addition, the rather gradual attenuation characteristic seems to afford a greater element of voice "naturalness."<sup>6</sup>

One other situation inherent in the

filter system is the loss in the average power of the clipped wave as it goes through the filter. Let us assume a filter cut-off frequency of 3000 cps and examine the clipped waveform at the filter output terminals. Assuming 200 cps as the fundamental frequency, then the fundamental and the 3rd through the 15th harmonics lie within the filter passband. The output waveform will be very square and will contain high average power. At a fundamental frequency of 400 cps, only the 3rd, 5th, and 7th harmonics lie within the passband. The output waveform is still quite square. With a 600 cps fundamental, the 3rd and 5th harmonics are passed, and the square waveshape has deteriorated considerably. Finally, with a 1000 cps fundamental, only the 3rd harmonic is passed, and the average power has suffered a large reduction. At frequencies higher than 1000 cps, only the fundamental components are passed and show up as sine waves, with their usual contribution to the average power of the total waveform.

The end result is to cause the voice frequencies lower than about 600 cps. to modulate the transmitter with a greater average power than the higher frequencies. This often results in the excessive "boominess" of some signals from a clipper-filter rig, especially if the voice characteristics of the operator tend to be on the "bass-y" side. In any case, frequencies below about 200 cps should be attenuated in the speech amplifier stages ahead of the clipper, and the operator with an unusually bass voice should carry the attenuation as high in frequency as is necessary to avoid excessive "boomi-

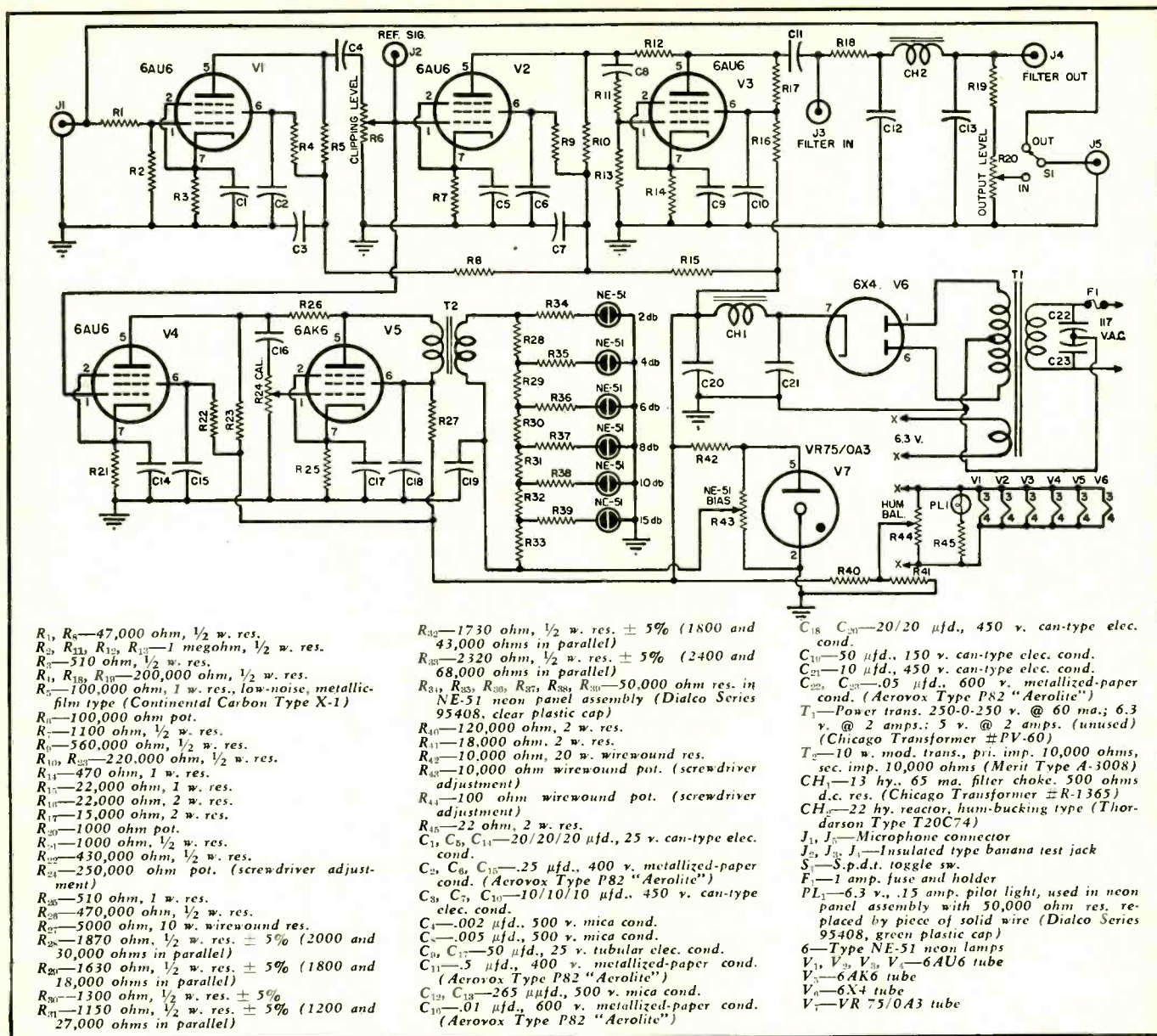

Fig. 2. Complete schematic diagram and parts list for the clipper. The unit is entirely self-powered.

ness." The lower audio frequencies add very little to the signal intelligibility and may be easily attenuated by the use of smaller-than-normal coupling condensers in the amplifier stages preceding the clipper.

The clipper described in this article was designed as a complete unit so that it could be connected to the input jack of nearly any existing speech amplifier. It incorporates a clipping indicator circuit to enable the operator to know accurately at all times the peak clipping level directly in decibels.

The unit is quite compact, constructed of readily available components, and requires no elaborate calibration procedure. A special effort was made to reduce noise and hum voltages at the output terminals to a very low value. The circuit constants have been chosen to permit a passband of approximately 200 cps to 3000 cps.

### Clipper-Filter Circuit

Reference to the schematic diagram, Fig. 2, will show the clipper amplifier

to be an adaptation of a standard and well-proven handbook circuit. V<sub>1</sub> and V<sub>2</sub> are merely linear voltage amplifiers, and V<sub>3</sub> is the overdriven amplifier wherein the clipping actually occurs. A clipper system should be quite linear up to the point where clipping takes place in order to introduce the least amount of distortion into the signal. The degenerative feedback network from the plate of V<sub>3</sub> back to the preceding stage makes the amplifier-clipper considerably more linear than any of the series- or shunt-clipper diode systems on which the author has made measurements.

Resistor R<sub>5</sub> is a low-noise, metallic-film type and results in a substantial reduction in noise voltage output at the signal amplification values necessary to obtain 10-15 db of clipping. The lower right corner of the photograph of Fig. 5 will reveal that the author used two 50,000 ohm resistors in series to make up R<sub>5</sub>, since they were already on hand in the desired type.

Potentiometer R<sub>6</sub> controls the clip-

ping level and is one of the front panel controls.

The filter, made up of CH<sub>2</sub>, C<sub>13</sub>, and C<sub>14</sub>, is of the constant-k type with a cut-off frequency such that the output signal voltage is down 3 db at 3000 cps, with reference to the output voltage at 1000 cps. A major stumbling block has been removed by designing the filter so that a readily available choke of accurately known characteristics could be used. It is the 22 hy. reactor of hum-bucking construction made by Thorndarson for use in dual tone-control circuits. If the specified components are used, the reader will be able to duplicate the filter successfully without recourse to elaborate test equipment.

The filter is terminated in its design impedance of 200,000 ohms by R<sub>10</sub>. The output-level potentiometer, R<sub>20</sub>, forms a voltage divider with R<sub>10</sub> to limit the maximum output voltage available at J<sub>5</sub> to about 80 millivolts, more than sufficient to drive the usual speech amplifier. About 20 volts of signal out-



put is available at the top end of the resistor  $R_{10}$ .

Banana jacks  $J_2$  and  $J_3$  are for calibration purposes, to be explained later.  $J_3$  may be omitted, as it was included in the unit pictured to permit the convenient oscilloscopic examination of the filter output waveform during a group demonstration of the unit.

### Clipping Indicator Circuit

The indicating circuit is a simple linear amplifier consisting of a voltage amplifier stage,  $V_1$ , and a power amplifier stage,  $V_2$ . The power amplifier and its output transformer,  $T_2$ , must be capable of handling a watt or so of power to provide a distortion-free signal with which to operate the six NE-51 neon indicating lamps. The lamps, when lighted, consume a small amount of power and also tend to vary the load impedance somewhat, as presented to the secondary of  $T_2$ . Inverse feedback around  $V_2$  helps to stabilize the power stage against load variations and also lowers the distortion content of its output signal.  $T_2$  is a small and inexpensive modulation transformer, set up for a one-to-one turns ratio.

Resistors  $R_{24}$  through  $R_{30}$  are current-limiting resistors for the neon lamps and are already provided in the neon panel assembly sockets. The values of resistors  $R_{25}$  through  $R_{33}$  are such as to cause the neon lamps to flash with the desired decibel relationship in accordance with the amplitude of the voltage across the secondary of  $T_2$ . The 4 db lamp is connected across 81.3 per-cent of the total voltage divider resistance; the 6 db lamp at 65 per-cent; the 8 db lamp at 52 per-cent; the 10 db lamp at 40.5 per-cent; and the 15 db lamp at 23.2 per-cent of the total resistance.

The NE-51 bias control,  $R_{18}$ , varies

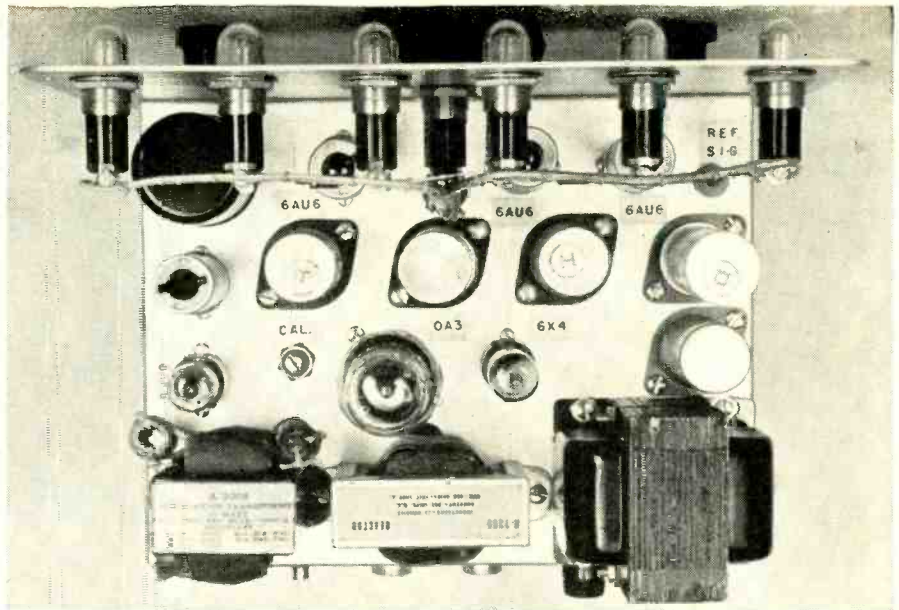

Fig. 3. Top chassis view of the speech clipper showing recommended parts layout.

the regulated positive bias voltage applied to the six neon lamps. The bias is adjusted so that the lamps normally are just on the verge of firing, resulting in a much smaller amplitude of audio signal voltage needed to trigger them. Condenser  $C_{10}$  provides a low impedance path to ground for the audio voltage, without short-circuiting the bias voltage. The condenser should be large, at least 50  $\mu$ fds.

An audio signal applied to the grid of  $V_1$  is amplified linearly, and so on through  $V_2$  and  $V_3$  unless the signal is increased enough so that  $V_3$  begins to clip. After clipping commences, the signal at the grid of  $V_2$  will continue to rise linearly, as the clipping level control is advanced. If a certain refer-

ence signal voltage at the grid of  $V_2$  will just cause clipping to commence, then any desired number of decibels of clipping may be determined by allowing the  $V_2$  grid signal to increase by the proper multiplying factor. A ratio of 1.3:1 will provide about 2 db of clipping, and a ratio of 5.6:1 will provide 15 db of clipping.

These figures indicate that a large increase in the amplifier gain is necessary ahead of the clipper to produce substantial amounts of clipping. Even an inch or two of variation in the speaking distance from the microphone, or a slight variation in the voice level, will change the clipping level by several decibels. A truthful indicating circuit should possess no operational inertia and should be activated by the instantaneous voice peaks, instead of the average voice level.

The indicating amplifier is linear in operation, so all that is necessary is to adjust  $R_6$  for a 2 db clipping level, then adjust  $R_{21}$  until the 2 db lamp just lights. Further increases in the setting of  $R_6$  will produce corresponding increases in the output of  $V_2$ , and the remaining lamps will light, one after another, in the proper decibel relationship.

This unit was designed for a maximum normal clipping level of 10 db, as it is doubtful whether clipping much in excess of this figure is practical. Acoustic background in the operating location may even then prove annoying. Another important factor that should be emphasized is that the voice quality is still very acceptable at the 10 db figure.

Hum voltage in the output is reduced practically to the vanishing point by using a hum-balancing potentiometer across the power transformer 6.3 volt heater winding, and by placing about 35 volts of positive bias on the tube heaters. The brilliance of the 6.3 volt pilot lamp is reduced by a series voltage-dropping resistor,  $R_{15}$ , to provide

(Continued on page 129)

Fig. 4. Top-rear view of chassis. The neon lamp voltage divider resistors are soldered directly to the lamp socket terminals as shown in the photograph.

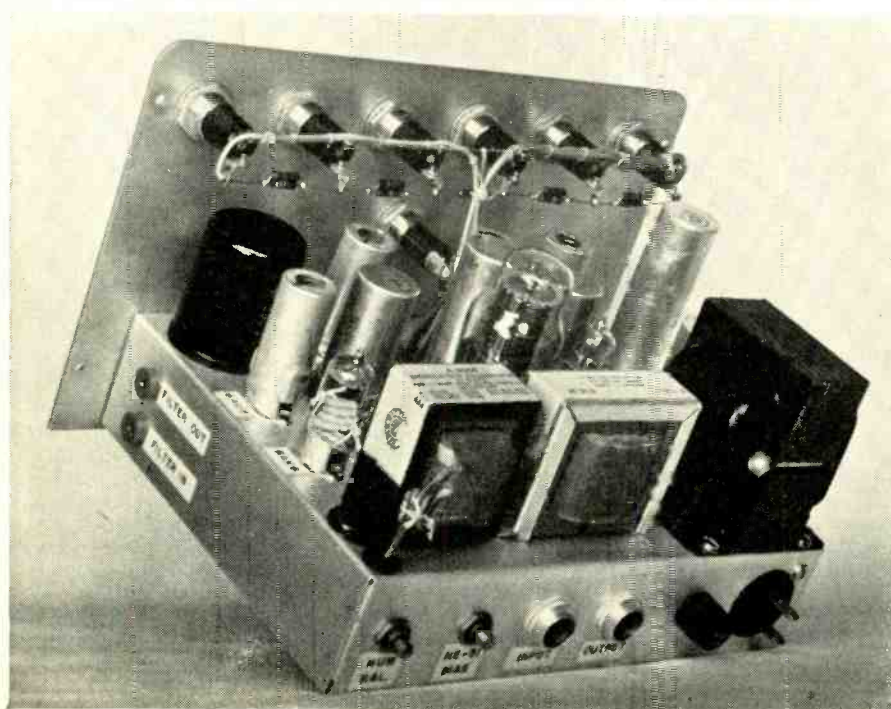

# A UNIQUE TV SIGNAL TRACING PROBE

By  
E. G. LOUIS



Fig. 1. Over-all view of probe which can be used with both medium and high-gain scopes.

**Unit permits detection of r.f. and i.f. signals and has a stage of direct-coupled wide-band amplification.**

**S**IGNAL tracing, as a servicing technique, probably offers the most rapid and accurate method for definitely isolating distortion, hum, or weak operation to a specific stage. Unfortunately, this valuable technique has, in the past, been somewhat difficult to apply to TV receivers due to the comparatively low signal levels present in the video i.f. stages. The difficulties stem primarily from the fact that many service type cathode-ray oscilloscopes do not have sufficient gain in the vertical amplifier to permit direct observation of a detected TV signal unless the signal level is quite high.

To overcome these difficulties, the probe shown in Fig. 1 and diagrammed in Fig. 2 was designed. This probe not only permits detection of an r.f. or i.f. signal, but also provides a stage of *direct-coupled wide-band amplification*. Although designed originally for TV servicing, the probe may be readily adapted for use in signal tracing AM and FM receivers.

In actual servicing tests, the probe shown in Fig. 1 was used with both medium and high-gain oscilloscopes. It was found that the video signal could be detected and observed up to the output of the TV front-end when local TV stations were being received. Thus, it is possible to make gain and quality tests of individual stages in the entire i.f. strip. Since the scope, alone, may be used to observe signals following the video second detector and in the sweep and sync circuits, the addition of this probe to the tools of the service shop or laboratory permits the technician to observe and study signals present in any section of the TV receiver. The advantages in servicing are obvious.

## Circuit Description

Referring to Fig. 2, a twin-triode tube is used. One-half of the tube is

connected as a diode detector with  $R_1$  and  $R_2$  acting as the diode load resistors. The probe condenser  $C_1$  is kept low in value to minimize loading and detuning when the probe is used to check signals in tuned i.f. stages.

A demodulated signal appears across  $R_2$  having both a.c. and d.c. components. The d.c. component serves as a bias voltage for the direct-coupled amplifier following the detector. Note that the grid of the triode amplifier is connected directly to  $R_2$ .

An amplified video signal appears across the amplifier load resistor  $R_3$ , and this is applied to the input of the vertical amplifier of a cathode-ray oscilloscope.  $R_4$  has purposely been kept low in value to minimize the effects of distributed capacity and the input capacity of the CRO, thus assuring good bandwidth and an accurate reproduction of the video signal. For the signal tracing technique to be

really useful in tracking down the source of distortion, it is important that the probe itself introduce no distortion of the video signal.

$R_1$  and  $C_1$  together act as a decoupling filter, preventing or minimizing any effects due to power supply coupling. This permits the power supply of either the TV receiver or the CRO to be used for operating the probe. (A separate power supply may be used if available, of course.)

If the builder plans to use the probe primarily for servicing AM or FM receivers where extreme bandwidth of the amplifier is not important,  $R_3$  may be made several times larger, with a resulting increase in stage gain.

## Construction Hints

If a metal, plastic, or fiber tube is available, the probe may be assembled in it, using conventional construction techniques. An old electrolytic "can" may also be used.

However, it has been the author's experience that when a tube is needed, one can seldom be found even at the local radio wholesalers. And electrolytic condensers seem to suddenly acquire a new lease on life if a defective one is needed. Therefore, an effort was made to design the probe so that construction could be undertaken with parts which are almost always available in the service shop or in an experimenter's "junk box." The probe shown in Fig. 1 was the result.

Fig. 4 is an "exploded" view of the probe, showing the essential features of construction. The only machine work necessary is a single drilled hole in the side of the i.f. can for the power

Fig. 2. Complete schematic diagram of the TV probe which uses a twin-triode tube.

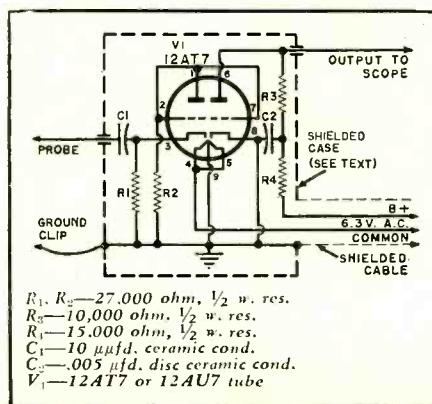

cable and signal lead. The hole in the end of the i.f. can is already present—this is where the coil or trimmer condenser was mounted.

The probe "point" is a 2½" length of #12 tinned bus bar, with the end pointed and a piece of spaghetti tubing slipped over its length (see Fig. 1).

The end of the power supply cable may be terminated in several ways, depending on the power supply to be employed. If an experimental supply is to be used, terminate the cable in spade lugs, so that easy connections may be made to a screw-type terminal strip. The power supply of the TV receiver being serviced may be used to supply the probe; in this case, terminate the power leads in alligator clips for ease in making connections in the receiver.

Since the power required by the probe is small, the scope itself can easily furnish the necessary filament and "B" voltages. In this case, terminate the power cable in a power plug and mount an appropriate socket on the scope.

The signal lead should be terminated in a spade lug for ease of connection to the scope vertical input binding post. This lead may be shielded if necessary to keep hum and noise pickup to a minimum, but a low-capacity coaxial cable should be used to minimize high-frequency loss. If the scope power supply is used for the probe, a separate ground connection to the scope is not necessary. Otherwise, provide ground bonding between the scope and the TV receiver.

The "B plus" may be any value from 150 volts to 250 volts. If greater voltages are available, use a resistance voltage divider to obtain the necessary operating voltage.

### Applications

Once the construction and wiring is completed and checked, the builder should connect the probe to a power source and CRO, not only to check its operation, but also to gain familiarity with its use and limitations.

In Fig. 3 are shown, in block diagram form, the video i.f. stages of a typical TV receiver. Other portions of the receiver, including the power supply, have been omitted for purposes of clarity. The points at which the probe may be used for checking the video signal are indicated as A, B, C, D, and E. After the video 2nd detector, the scope may be used without the probe for checking signal quality.

To use the probe, connect the flexible ground lead to a convenient chassis point and touch the probe end to the grid or plate terminal of the stage to be checked. Check the input to the stage by touching the grid, the output by touching the plate.

A local TV station should be tuned in and controls on the TV receiver adjusted for normal operation.

The scope controls should be adjusted for a linear sweep, using internal sync. A sweep frequency of from 20 to 30 cps may be used to observe the field signal, while a sweep

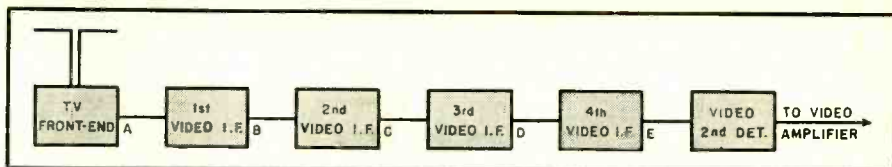

Fig. 3. Block diagram of the video i.f. stages of a conventional television receiver.

from 5000 to 8000 cps may be used to observe the line signal. Adjust the vertical gain control until the observed video signal is of the desired amplitude. "Sync" and "Fine Frequency" controls should be adjusted for a stable pattern.

With the set operating normally, the observed video signal (using approximately 20 cps sweep in scope) will appear somewhat as shown in Fig. 5A. A hazy band representing the sync pulses should be clearly visible at the top of the video signal (1 in Fig. 5A), while the lower edge of the video signal will be uneven and ragged (2 in Fig. 5A). If a test pattern or fixed signal is being transmitted, the video pattern will be fixed between pulses. A program, on the other hand, will give a video signal in which the pattern between pulses is constantly shifting in form and shading.

To measure stage gain check the relative amplitude of the input and output signals of a single stage, dividing the output level by the input level.

As an example, suppose it was desired to check the gain of the 2nd video i.f. stage of a TV receiver (Fig. 3). First, touch the probe to point B and adjust the vertical gain control of the scope for a small deflection (two squares on the scope graph scale would be satisfactory). Now, without touching the vertical gain control of the scope, transfer the probe to the plate of the i.f. stage (point C). Check the amount of deflection obtained and divide by the deflection obtained in the previous test.

If 22 squares of deflection are obtained when checking the signal amplitude at point C, with 2 squares of deflection obtained at point B, the gain of the 2nd video i.f. stage is 11.

Hum in the video i.f. stages may be caused by stray coupling, an open grid circuit, heater-to-cathode leakage, or defective bypass or filter condensers. Sixty-cycle hum is usually caused by one of the first three defects listed,

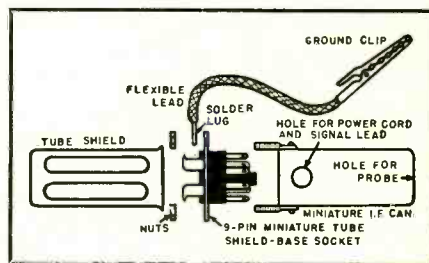

Fig. 4. "Exploded" view of probe showing the most important construction features.

while 120-cycle hum is generally caused by the last two defects.

When the probe is used to check the video signal directly in the i.f. stages, hum is readily apparent as a ripple superimposed on the video signal as shown in Fig. 5B. Where the field signal is observed, 60-cycle hum will produce one complete cycle for each "cycle" of video signal, while 120-cycle hum will cause twice as many ripples in the signal.

Checking each i.f. stage individually permits rapid isolation of the stage at which hum is introduced. Components in that stage may be checked using conventional techniques.

Open bypass or filter condensers may be easily identified by using the probe to check for the presence of a video signal at the bypassed point. As an example, a screen-grid bypass condenser may be checked by touching the probe point to the screen-grid terminal of the tube. The presence of a video signal at this point indicates an open or partially open bypass condenser.

Open condensers in the i.f. stages may cause regeneration and oscillation, distortion, and other complaints.

Individual stage oscillation is readily identified by checking the video signal at each point in the TV receiver i.f. strip, starting at the front-end and working towards the video 2nd detector stage.

Distortion in the video i.f. stages may cause a number of complaints, ranging

(Continued on page 84)

Fig. 5. (A) "Normal" video signal as seen on scope. (B) 60-cycle hum appears as a ripple superimposed on video signal. (C) Flattened or clipped signal. See text.

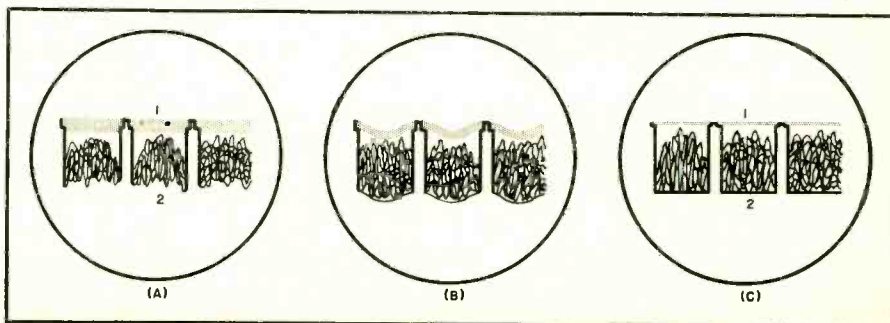

# Mac's RADIO SERVICE SHOP

By JOHN T. FRYE



## DOG DAY DISCUSSIONS

**T**HE August afternoon heat was hot and oppressive, but both men in Mac's Radio Service Shop were too busy to notice it. Barney was fussing away at a little a.c.-d.c. chassis on the service bench, and behind him his boss was checking out a TV set that had just been returned to its cabinet. Mac kept switching the receiver from one weak signal to another and listening intently to the sound as the snow came and went on the screen.

"Now that," he finally said as he stepped away from the set, "is my idea of a really successful fringe-area conversion job."

"Let's not break our arm patting ourselves on the back, shall we?" Barney suggested sarcastically as he looked up from the receiver that was very obviously giving him a hard time. "What's so good about that particular conversion?"

"The fact that it was really engineered in the laboratory of the manufacturer who built the set. This receiver was a good performer in the strong-signal area for which it was designed, but the intercarrier sound became very weak and buzzy when the set was used out here in this ultra-fringe location. When the manufacturer began getting complaints of noisy sound in fringe areas, he did not take the easy way out of explaining that the receiver was not intended for fringe-area use; instead he set his engineers to the task of seeing what could be done to help technicians clear up this condition in the field.

"The result is a kit that comes with all needed parts and is complete with detailed diagrams, drawings, and step-by-step instructions for performing some thirty operations on this particu-

lar chassis that will result in bringing up the sound without, in any way, impairing the picture."

"Thirty operations! Whew! That must take a lot of time and cost the customer a lot of dough."

"On the contrary, and that is why I like the conversion job. All of the time-consuming cutting-and-trying and de-bugging has been done by the engineers. The technician has only to follow the action-by-action instructions which are so clearly prepared that he can do this at a gallop. The complete rewiring job can be done in a couple of hours at the outside, and another half-hour is ample for the required realignment. The important thing, though, is how well it works. Notice that right now the picture is so snowy you can hardly make it out, yet the sound is clear and strong. Before, on a signal that weak, all you would be getting from the speaker would be a loud roar. When the customer gets this set back, he is going to have to quit calling it his 'Pantomime Special.'"

"What kind of changes did you make, anyway?"

"Put in two new traps; changed the loading resistors across the i.f. transformers; cut the first i.f. tube off the a.g.c. bus; put a new sound i.f. transformer in place of the former inductance-capacity coupling arrangement; and then realigned the video and sound i.f. channels and reset all traps."

"I gather you are not very enthusiastic about technicians working out their own methods of souping up sets for fringe-area reception."

"If by 'souping up' you mean making unauthorized circuit changes or radical changes in alignment, you are right. It is not that I question the technicians' knowledge, for many of

them really do have a sound grasp of both theory and practice; but practically none of them have the kind of equipment needed to do design engineering work. Modern service equipment is good, but it makes no pretense of equaling laboratory equipment; yet without such precision instruments it is impossible to measure the exact effects of a particular circuit change. When a technician is working without the original performance data and when he has only service instruments for doing his measuring, it is very, very easy for him to cure one particular fault but to produce two other faults in the process. You and I have seen some cases of that come into the shop.

"So-o-o," Mac went on, "I think the technician will do well to follow the advice of the old adage: 'Let the cobbler stick to his last.' I know it is a great temptation to him to display his knowledge and ability by completely reworking a television receiver, and by doing so he can often build up a cheap local reputation for himself as an electronic wizard who knows 'more about a TV set than the men who built it'; but no matter what the layman believes, there is often a great and important difference between changing a set and improving it, especially when accurate equipment for checking the complete results of any change is lacking.

"Personally, I am content to follow the manufacturer's recommendations with regard to changing the original design. If I spot what I believe is a weakness or shortcoming in that design, I do not hesitate to call it to the set-maker's attention and ask for advice in correcting it. Invariably I receive a courteous answer that usually includes specific instructions for straightening out the trouble. I have confidence in those suggestions because I know they have been worked out by men who make design their business, who know the receiver as they know the backs of their hands, and who have thousands of dollars worth of precision equipment for checking every move they make."

"Yeah, but aren't you afraid that people will say the guy who cooks up his own changes is a better electronics man than you are?"

Mac's eyes twinkled in a grin as he answered, "That won't seem so important when you get a little older. I don't want to be known as a good 'electronics man.' I just want to be a first-class technician whose primary job it is to see that radio and television sets keep playing as well as they did the day they left the factory. Maybe the frustrated-engineer type of technician feels apologetic about being 'just a technician,' but I don't. I think the service problems I solve require just as much intelligence and knowledge of practical theory as do the design problems worked on by the engineer, but the schooling, technique, and equipment that each of us uses is different. It is like the difference between the

(Continued on page 126)

# THE "DIALAUDIO" SYSTEM

**Telephone dial is used as a simple remote control to permit the selective switching of audio inputs.**

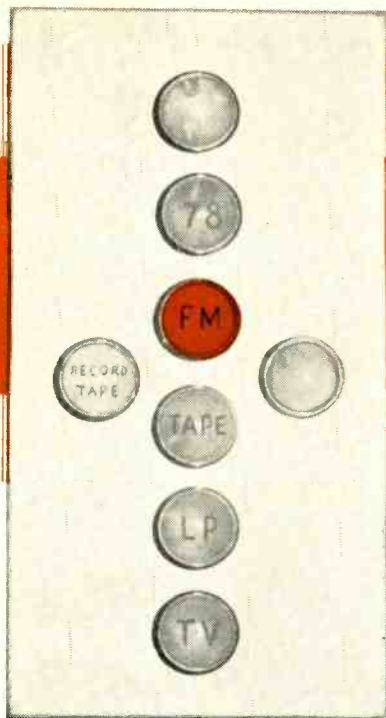

Pilot light assembly. See Chassis A in Fig. 1 for data on how this is set up.

By  
**BUDD MEYER**  
Audio Consultant

ONE of the great problems involved in the design and installation of custom high fidelity equipment is that of switching the various inputs. Most of the commercially available amplifiers and preamps have provision for five inputs, namely: FM and AM radio, tape recorder output, records, and TV. There are, of course, many variations, but the aforementioned sources of program material are the ones usually provided.

There have been many instances where the average consumer has become quite confused by the great number of controls and switches incorporated in some custom installations. The unit described herein, although designed for a particular installation, has the advantage of great flexibility. The same basic components can be used not only to switch various sources of program material into the amplifier but can be used to switch various speaker combinations and, in many cases, provide power to the various units comprising the complete installation.

Although the author designed this particular equipment to handle the audio equipment which made up his "home entertainment center," this same "Dialaudio" system can be adapted to operate a wide variety of units. It can be used by dealers to tie-in various pieces of audio equipment for demonstration purposes, etc., and can even be employed in miniature train operation and other similar applications.

The "Dialaudio" system utilizes a

telephone-type dial and a rotary step switch to accomplish rapid and positive switching with a minimum of components. In combination with a pilot lamp panel it is not a difficult task to route the desired program material to the amplifier or the output of the amplifier to any speaker or combination of speakers throughout a home. It is also possible to control this routing remotely by running wires to the dial chassis located at a convenient point. The dial chassis with associated push-button switches used in this system was designed so that it could be removed in its entirety from the mounting panel and used remotely.

As will be noted from Fig. 1, the system is designed around a type 44 rotary step switch manufactured by *Automatic Electric Co.* Technical specifications for the switch used in this particular design include: 4 level, 10 bank, 2 bridging and 2 non-bridging

wipers, 110 volt d.c. coil for use with selenium rectifier power supply; Type 1C "off-normal" and 1C interrupter spring contacts. It seems as though telephone system engineers have a lexicon of their own because when translated into terms used by radio engineers it becomes a 4-pole, 10-position switch with 2 shorting and 2 non-shortening contacts. The 1C designation indicates single-pole, double-throw switches.

To explain the function of the "interrupter" and "off-normal" springs it is necessary to describe briefly the operation of the switch. The switch is indirectly driven, i.e., it is stepped when the power is removed from the coil after a momentary application of power. Application of the power pulls a pawl from a toothed wheel which stores energy in a driving spring, and also releases a detent. Interruption of power allows the drive spring to drive

Over-all view showing main telephone dial panel and the audio amplifier.

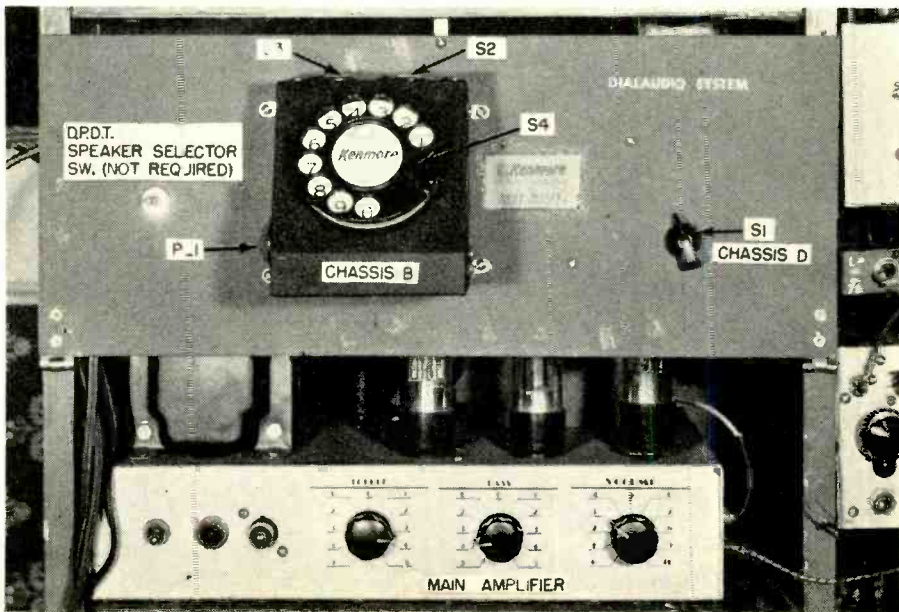

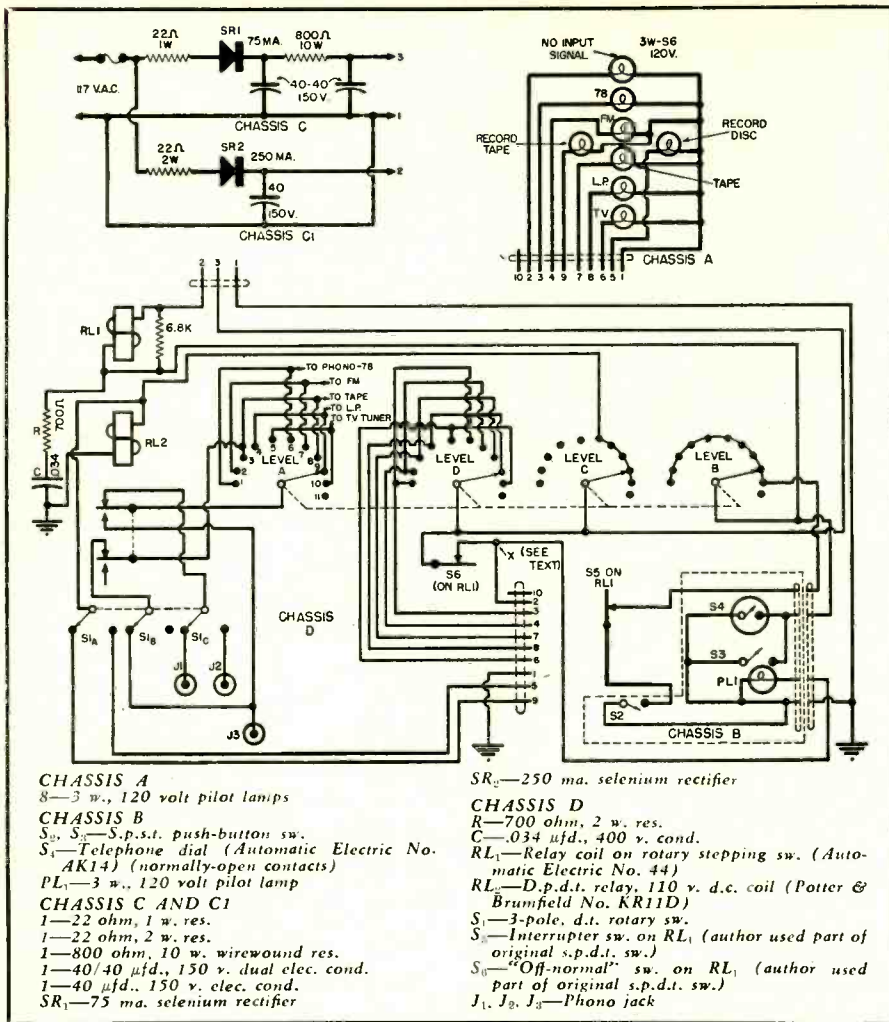

- CHASSIS A**  
8—3 w., 120 volt pilot lamps
- CHASSIS B**  
S<sub>2</sub>, S<sub>3</sub>—S.p.s.t. push-button sw.  
S<sub>1</sub>—Telephone dial (Automatic Electric No. AK14) (normally-open contacts)  
PL<sub>1</sub>—3 w., 120 volt pilot lamp
- CHASSIS C AND C1**  
1—22 ohm, 1 w. res.  
1—22 ohm, 2 w. res.  
1—800 ohm, 10 w. wirewound res.  
1—40/40 μfd., 150 v. dual elec. cond.  
1—40 μfd., 150 v. elec. cond.  
SR<sub>1</sub>—75 ma. selenium rectifier
- SR<sub>2</sub>—250 ma. selenium rectifier
- CHASSIS D**  
R—700 ohm, 2 w. res.  
C—034 μfd., 400 v. cond.  
RL<sub>1</sub>—Relay coil on rotary stepping sw. (Automatic Electric No. 44)  
RL<sub>2</sub>—D.p.d.t. relay, 110 v. d.c. coil (Potter & Brumfield No. KR11D)  
S<sub>1</sub>—3-pole, d.t. rotary sw.  
S<sub>2</sub>—Interrupter sw. on RL<sub>1</sub> (author used part of original s.p.d.t. sw.)  
S<sub>3</sub>—“Off-normal” sw. on RL<sub>1</sub> (author used part of original s.p.d.t. sw.)  
J<sub>1</sub>, J<sub>2</sub>, J<sub>3</sub>—Phono jack

Fig. 1. Schematic of "Dialaudio" system. Although author built Chassis C and C1 separately, it is possible to build both into a single unit. Jack J<sub>1</sub> goes to tape recorder for recording, J<sub>2</sub> goes to disc recorder, and J<sub>3</sub> goes to the main amplifier.

Top view of the main telephone dial panel showing the position of Chassis D.

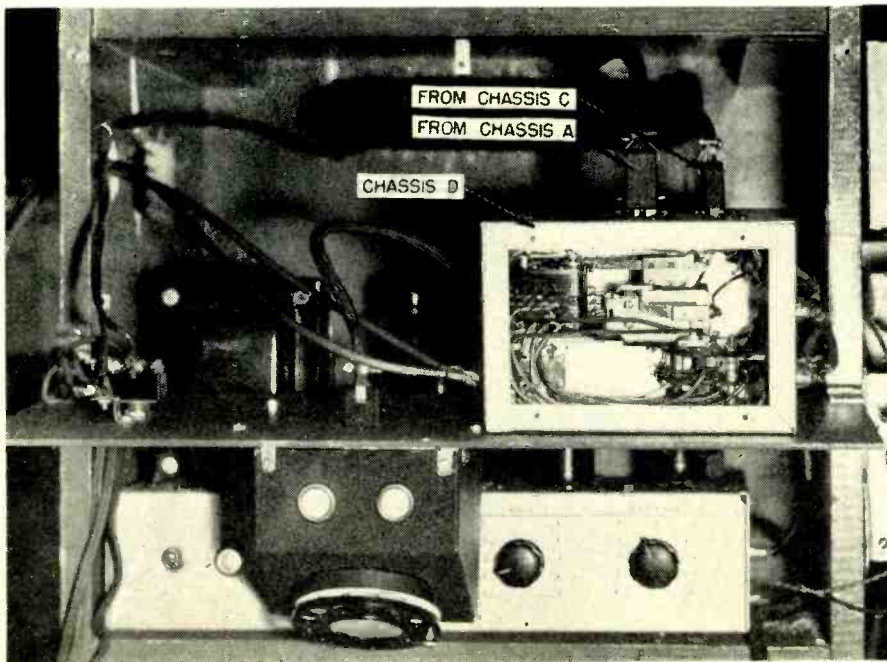

the pawl forward, engaging the toothed wheel and driving it forward one step until the detent stops its forward motion. This action positions the movable contacts (brushes) on one of the stationary contacts. The relay rotates in one direction only and all contacts are traversed in one-third of a revolution.

The brush assembly incorporates an indicator wheel which has cams spaced 120 degrees apart. When the brushes are not engaging any of the contacts (Pos. 11), the cam closes the contact on the "off-normal" springs. "Off-normal" means that the brushes are resting on any one of the contacts. The "off-normal" contacts are actuated every one-third revolution. The interrupter contacts are so arranged physically that when the relay coil is energized an armature actuates the switch lever which opens a contact on the interrupter assembly, thereby providing the power interruption needed to step the switch.

The five inputs for this particular system are: Position 1—Output from dynamic noise suppressor (for 78 rpm records); Position 2—Output from FM tuner; Position 3—Tape playback and monitor; Position 4—Output from pre-amp-equalizer for LP records; and Position 5—Output from TV audio strip for recording. These inputs are fed into Positions 1 through 5 on level A of the rotary switch. Positions 6 through 10 are paralleled with 1 through 5 when recording. Level C is used to power the relay for recording. Level D is used to provide pilot light indication. Level B is used to "home" the relay.

"Homing" is another word peculiar to telephone system engineers. By "homing" is meant the rapid return to normal position, i.e., when brushes are not resting on any of the contacts and therefore no signal is being fed into the amplifier. It will be noted that Level B is wired so that when switch S<sub>2</sub> is closed, the rotary switch drive magnet circuit is completed to ground through all the contacts on that level and through the interrupter springs. This provides the power interruption needed to step the switch. This feature is extremely useful when using the dial as it provides a definite starting point for the dialing, eliminating the necessity for counting how many steps to advance the step switch in order to stop on the desired position. By skipping a contact on Level B it is possible to have the brushes come to rest on a predetermined contact by merely pressing the "homing" switch S<sub>2</sub>.

Although the contacts will carry 3 amperes when at rest, it is not advisable to exceed 11.5 watts while they are in motion.

The system herein described was designed around a particular installation which was complicated by the fact that it was necessary to provide a means of automatically monitoring the tape while recording, a feature which made the use of an additional relay mandatory. Switch S<sub>1</sub> provides a means of

routing the signal to either the tape or disc recorder and giving an indication on the pilot panel. It also serves as routing switch for the monitor signal from the tape unit.

Fig. 1 also shows the power supplies used for the entire system. It had been originally planned to use one supply for the step-switch, the record relay, and the pilot lights. However, as the step-switch draws approximately 180 ma. during operation, the voltage drop across the filter circuit resistor was too high to insure positive record relay operation. In addition to the filtering action of the 800 ohm resistor, it also serves to drop the voltage for the record relay and pilot lights to 125 volts. In the "record" position with two lights and the record relay actuated, the total current is 56 ma. Both supplies can, of course, be mounted on the same chassis but provision should be made for adequate ventilation.

The chassis used to mount the dial also contains push-buttons  $S_2$  and  $S_3$  for single stepping and "homing." A meter case for a 2" meter just fills the bill as all the large holes are already punched. For other types of mounting, the dial dimensions are given in Fig. 2. It is not necessary to use the dial, as the relay may be single-stepped using just an s.p.s.t. push-button switch. The dial is a type AK14, also manufactured by *Automatic Electric*. The number dialed indicates the number of steps the relay brushes will move. For example, if the brushes are on contact 2 and it is desired that they rest on contact 7, it is necessary to dial 5.

The dial assembly proper has an additional s.p.d.t. switch. As supplied by the manufacturer this switch has two of the contacts tied together by a metal link. In order to eliminate "key clicks" when the dial is executing its return motion, this link was removed and a shielded wire run from the amplifier input to the center lug of the switch. Another wire is run from the normally open contact to ground. Now when any number is dialed a cam closes the contacts and the amplifier



Over-all view of part of the author's home sound reproduction system. The "Dialaudio" selector system may be seen in the lower right hand corner.

input is shorted. At the completion of the return motion these contacts open, thereby removing the ground and permitting the program material to be fed into the amplifier.

A pilot light has been incorporated on the dial chassis to show when the step-switch is in the "home" position. This feature is desirable when the dial chassis is used at a position remote from the pilot light panel. By making the connection at point "X" a semi-permanent one, this pilot light can be used to indicate any predetermined setting of the step switch.

On the levels which contain the bridging brushes (Levels A and B) will be found twelve contacts. Contact 11 is the one used to connect the level (pole) to the external circuit. Contact 12 (not shown in Fig. 1) on Level A is used to ground the amplifier input when the step-switch is in the "home" position. If this contact is not grounded the amplifier input will be open and

(Continued on page 100)

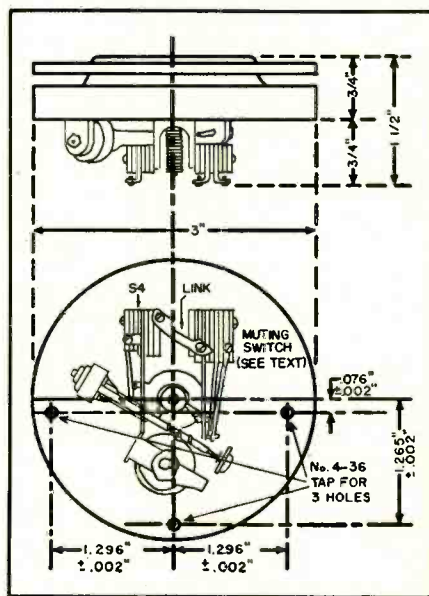
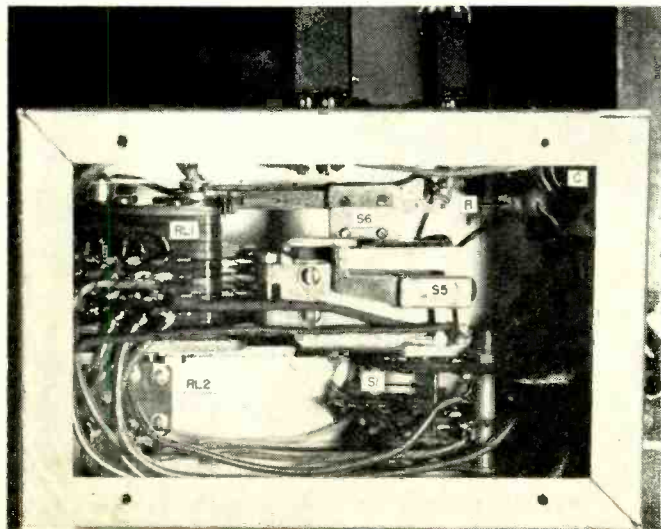
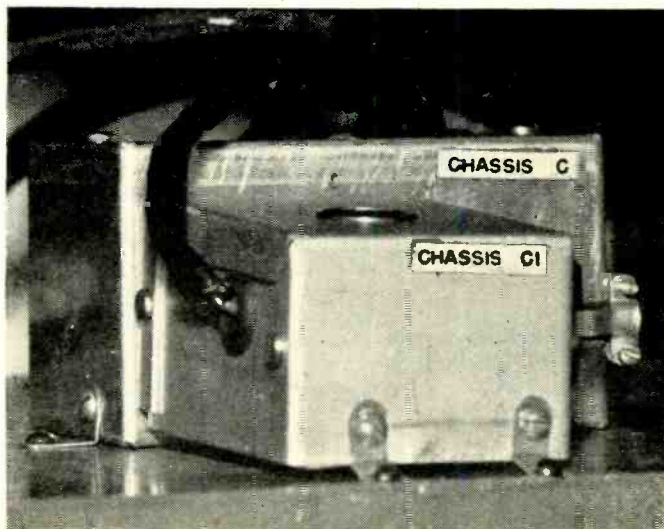

Fig. 2. Mechanical drawing of dial assembly.

Bottom view of the subassembly, designated as Chassis D.



Over-all view of power supply chassis, C and C1 (Fig. 1).



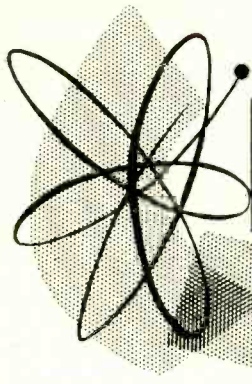

# Industrial ELECTRONICS

By

**ED BUKSTEIN**

Northwestern Vocational Institute

**Process and sequence timers have helped to improve the quality of a variety of manufactured products.**

**T**HE success of innumerable manufacturing and processing operations depends, to a large extent, on accuracy of timing. In welding, electronic heat treating, x-ray exposure, etc., the quality of results is directly related to precise control of the time during which the product is subjected to the influence of the machine. Many mechanical timing devices involving motor-driven gears and cams have been evolved and used, but none with the same degree of success as electronic timers. Mechanical timers exhibit many shortcomings. They are comparatively slow and inaccurate, and since they employ many moving parts; vibration, wear, and breakdown are common. In timing devices, as in so many other types of apparatus, electronics stands out as the superior method.

Most electronic timers operate by virtue of the fact that when a voltage is applied to a resistor and a condenser in series, a finite and calculable

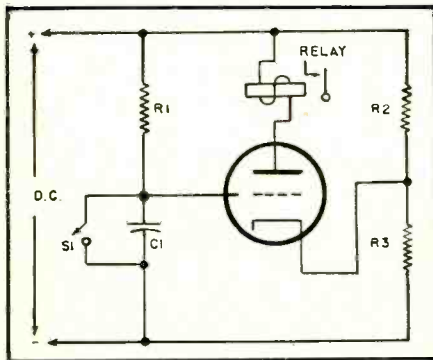

Fig. 1. Basic type of time delay circuit. As the condenser charges, it drives the grid of the tube increasingly positive until the relay in the circuit closes.

time elapses before the condenser becomes fully charged. In some of its variations, the electronic timer involves an initially charged condenser which is subsequently discharged in the required length of time.

### Time Delay Circuits

A basic type of time delay circuit is shown in Fig. 1.  $R_2$  and  $R_3$  form a

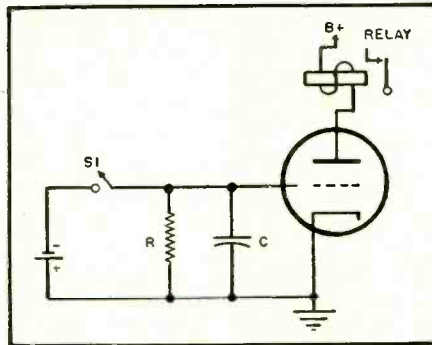

Fig. 2. A time delay circuit which utilizes the discharge time of a condenser. As the condenser discharges through  $R$ , the grid becomes less and less negative, the plate current increases, and the relay closes.

voltage divider across the d.c. supply. That portion of the voltage which appears across  $R_3$  is applied as bias to the cathode of the tube. This bias is sufficient to produce cut-off, so that no plate current flows and the relay is open. The timing interval is initiated by opening switch 1. At this time,  $C_1$  begins to charge through  $R_1$  from the d.c. supply. The positive terminal of the supply attracts electrons from the upper plate of the condenser. At the same time, the negative terminal of the supply repels electrons to the lower plate of the condenser. Since the upper plate of the condenser loses electrons, it, and the grid of the tube which is connected to it, become increasingly positive. After an interval of time, the positive potential on the grid becomes sufficient to overcome the cut-off bias on the cathode. At this time, the tube conducts plate current and the relay closes.

The timing interval is therefore the length of time which elapses between opening of the switch and closing of the relay. The duration of this interval depends upon the values of  $C_1$  and  $R_1$ . A larger condenser will require more time to charge, and a larger resistor will slow down the charging rate. Consequently, increasing the value of either  $C_1$  or  $R_1$  will increase the timing interval. Conversely, decreasing  $C_1$  or  $R_1$  will result in a shorter time delay.  $R_1$  is usually

made variable to permit control of the timing interval. When a wide range of timing intervals is desired, several different values of condensers and a selector switch may be employed.

Fig. 2 shows a circuit diagram of a time delay circuit in which the discharge time of a condenser is utilized. When the switch is closed, the condenser is charged to the potential of the battery. This charge makes the grid of the tube negative, so that no plate current flows and the relay is open. The timing interval is initiated by opening the switch. Under these conditions, the condenser begins to discharge through the resistor connected across it. As the condenser discharges, the potential on the grid becomes less and less negative. After an interval of time, this negative potential has decreased to the point at which the tube conducts current and the relay closes. The duration of the timing interval is dependent upon the values of  $C$  and  $R$ .

The circuits of Figs. 1 and 2 both require a d.c. source of power. In the interest of simplicity and compactness, a timing circuit which will operate directly from the a.c. power lines is desirable. A circuit which fulfills this requirement is shown in Fig. 3. When the switch is open and the upper power line is negative, electrons flow in the circuit as shown by the arrows. Here, the grid-cathode circuit of the tube is acting as a diode, and the resultant current charges the condenser.

To initiate the time delay, the switch is closed. The tube is now cut off because the charge of the condenser makes its grid negative. However, as the condenser discharges through the resistor connected across it, the grid becomes less negative. After an interval of time determined by the values of  $R$  and  $C$ , the negative potential on the grid has diminished to the point at which the tube conducts and the relay closes.

To prevent the relay from opening during the alternations when the plate of the tube is negative, a condenser is connected across its winding. This condenser charges when the tube conducts and discharges through the relay  
(Continued on page 139)

Fig. 3. A time delay circuit designed to operate directly from the a.c. power line. The grid-cathode circuit acts as a diode to charge the condenser. When switch is closed, the condenser discharges, the grid becomes less negative, and relay closes.

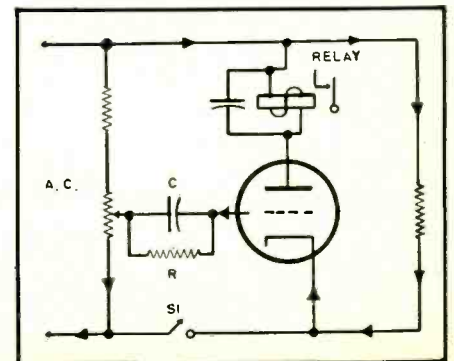

**RADIO & TELEVISION NEWS**





# International SHORT-WAVE

Compiled by **KENNETH R. BOORD**

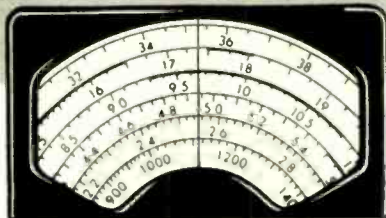

**I**N THE first DX Contest of the United 49'ers Radio Society, top winners included Gary Rinton, Le-Roy, New York, first with 1386 points; Robert Green, Ridgetown, Ontario, Canada, 1287; James R. Pickering, Highstown, N. J., 1024. (Boice, Conn.)

### This Month's Schedules

**Albania**—Radio Tirana, 6.560 and 7.850, has programs in French 1345-1400 and in English 1615-1630. (Radio Sweden) Heard by Pearce, England.

**Algeria**—Radio Algerie now operates on 7.280 instead of 6.145. (ISWC, London)

**Anglo-Egyptian Sudan**—Radio Omdurman noted 1225 with news in Arabic on 9.737, 7.385A. (Pearce, England)

**Angola**—CR6RB, 9.165, Benguela, has weak level in Sweden 1330-1400; often has nice musical session. (Engberg) Noted closing 1400 weekdays with "A Portuguesa" but runs to after 1430 Sundays. (Pearce, England) Luanda, 11.862, noted in Newfoundland around 1430-1530. (Peddle) Closes 1730.

Officials of Radio Diamang, CR6RG, Dundo, recently reported that of reception reports received, about 40 per cent have been from Sweden; about 20 per cent from Britain, and about 10 per cent from Australia. (Radio Australia) Radio Clube de Huila, Sa da Bandeira 10.050, noted closing 1530; bad CWQRM. (Pearce, England)

**Argentina**—LRU, 15.29, noted with English 2300-0100 sign-off. (Bishop, Ohio) By this time the English session 1730-2030 probably will be on 9.69 instead of 17.720.

**Radio Splendid**, 9.315A, noted at strong level 2245 with Latin American music. (Niblack, Ind.)

**Australia**—Radio Australia now has a session for Central Europe 1300-1500 on 11.760, 9.580.

**Austria**—BDN, 9.617, Salzburg, noted 0455. (Pearce, England)

**Azores**—CSA92, 11.090, Ponta Delgada, still noted in Portuguese 1400-1500. (Kary, Pa.)

**Belgian Congo**—OTC2, 9.767, now lists QRA as Belgian National Broadcasting Service, P.O. Box 505, Leopoldville, Belgian Congo; sent fine QSL card. (Harris, Ind.) Recently announced over the air that the station will be moved soon to Brussels, Belgium.

**Radio Congo Belge**, Leopoldville, now uses 11.720 around 1400-1600; has

QRM from VOA, Tangier. (Engberg, Sweden) Is heard in Eastern USA.

**Bolivia**—CP38, 9.497A, La Paz, opens 0555 with "Onward, Christian Soldiers" and identifies in Spanish. (Stark, Texas) Radio Sweden lists schedule for this one as Sundays 0655-0815, 1100-2100, weekdays 0555-0730, 0930-1245, 1755-2115 (closing time is only approximate).

**Brazil**—PRL5, 11.950, Rio de Janeiro, noted Saturdays around 1630-1700 with English "literary" program, then continuing in Portuguese. (Kary, Pa.) Heard in Sweden at 1500 in Portuguese and English. (Engberg)

PSF, 14.687, is noted transmitting prior to scheduled 1730 sign-on; announces "Agencia Nacional;" at 1730 has news in Portuguese which is relayed by all Brazilian commercial stations. (Kary, Pa.) Radio Sweden says PRS4. Radio Cultura da Sao Paulo, has been heard on 2.470 at 1930-2030.

**Radio Inconfidencia**, Belo Horizonte, is now using approximately 15.190; weak signal in Sweden from 1500. (Engberg) "Brazil Calling" (English) now appears to be aired (at least weekdays) on 11.825 around 1935-1955, and on 9.565 around 2005-2025.

**British Guiana**—ZFY, 5.980A, Georgetown, noted at good level around 2100. (Cox, Dela.)

(Note: Unless otherwise indicated, all time is expressed in American EST; add 5 hours for GCT. "News" refers to newcasts in the English language. In order to avoid confusion, the 24 hour clock has been used in designating the times of broadcasts. The hours from midnight until noon are shown as 0000 to 1200 while from 1 p.m. to midnight are shown as 1300 to 2400.) The symbol "V," following a listed frequency indicates "varying." The station may operate either above or below the frequency given. "A" means frequency is approximate.

**British Somaliland**—VQ6MI, Radio Somali, 7.125, Hargeisa, 1 kw., is on the air 0815-1215, according to a letter from station officials. (Radio Sweden)

**Bulgaria**—Radio Sofia, 7.671, 6.070, noted with news 1500. (Engberg, Sweden) Also with news 1600. (Pearce, England) Heard on 7.671 at 2340 in Bulgarian. (Cox, Dela.)

**Canary Islands**—Tenerife, 7.515, noted at fair level from 1600. (Engberg, Sweden)

**Cape Verde Island**—Praia is noted on 7.110A signing off 1700 in Portuguese. (Engberg, Sweden) Heard by Ferguson, N. C., from 1630 tune-in. Leaves air with "A Portuguesa."

**Ceylon**—Radio Ceylon, 15.120, noted opening 2045. (Bellington, N. Y.) Relays BBC news 2100.

**Chile**—CE1515, 15.150, noted recently ending dance music with English announcements 1825; continued in Spanish. (Niblack, Ind.) Has nice signal evenings to 2330 closedown.

**China**—WRH lists summer schedule for Radio Peking's Overseas Service as 6.100, 1530-1630, 0330-0500, 0800-0830; 9.040, 0400-0430, 0800-0830; 10.260, 1530-1600, 0330-0500, 0800-0830; 11.690, 1530-1600, 1730-2100, 0400-0700, 0730-1030; 15.060, 1530-1600, 1730-2100, 0400-1030; 15.170, 0330-0430, 0800-0830; 7.500, 0330-0400, 0800-0830; English at 1730-1800 on 11.69, 15.06; 0400-0430 on 6.100, 9.040, 10.260, 11.690, 15.060, 15.170; 0830-0900 on 11.690, 15.060.

Dilg, Calif., notes Peking fairly good late mornings (EST) on 10.200 (this one is not announced), 10.260, 11.690, 15.060V; the 9.03A channel also has a fairly good signal at times.

(Continued on page 108)

Programs of the Danish State Radio originate in Radio House in Copenhagen. This modern building provides excellent facilities for both domestic and foreign programs.



# Convert Your Signal Generator into a Grid-dip Oscillator



## into a Grid-dip Oscillator

By  
**HARTLAND B. SMITH,**  
WBVVD

Fig. 1. Three units must be added to the panel of your signal generator if it is to be used as a grid-dip oscillator. Jack  $J_1$ , labeled "Probe," is in the upper left-hand corner.  $S_1$ , the link switch, is just below and to the right of  $J_1$ .  $C$ , depending on the type of indicator used, mounts on the right side of the panel above and to the left of the pilot light.

**Add a useful piece of equipment to your test bench at small cost and a nominal expenditure of time.**

**W**ITHIN recent years a great many hams and service technicians have learned what a useful piece of equipment a grid-dip oscillator can be. Unfortunately, most of the oscillators which have been described in radio magazines or sold in kit form cover only the high frequency ham bands and TV channels. Thus, if one is interested in checking i.f. coils and other low frequency components, he has to build a special unit, just for this purpose.

Despite the circuit simplicity of a grid-dip oscillator, construction and calibration is a rather time-consuming task. Because of this, a lot of radio-men keep putting off the project, thereby depriving themselves of a very worthwhile instrument. Many of these fellows, unknown to themselves, already possess a device which, with the addition of three or four inexpensive parts, can be easily converted into a calibrated, bandswitching grid-dip oscillator capable of tuning from 160 kc. to 50 mc. The basic unit is an r.f. signal generator, several inexpensive versions of which are now on the market. One of these instruments can be changed into a grid-dip oscillator in jig time. What is more, the conversion has little or no effect on the generator's ability to perform its primary job of receiver alignment. Although the changes to be described were made in a Heath Model SG-6 signal generator,

the process can also be applied to earlier models of the same make or to similar generators produced by other manufacturers.

Most grid-dip oscillators use coils which plug into a socket on the outside of the case. This arrangement makes it relatively easy to couple the oscillator to a circuit under test. Since the coils of the SG-6 are mounted inside the case, some additional means must be provided for transferring r.f. from the oscillator to the resonant

circuit being checked. One satisfactory way of accomplishing this is to use link coupling.

A probe coil, as shown in the photograph of Fig. 3, is energized by r.f. fed to it through  $J_1$  in Fig. 2, from links wound around the cold ends of the SG-6's coils. Before winding the links, be sure to apply a layer of Scotch electrical tape or some other suitable insulation to the coil forms to reduce the possibility of short circuits. Then wind on the prescribed number of turns and apply enough coil dope or cement to hold the links in place.

The proper link is selected by switch  $S_1$  and connected to output jack  $J_1$ . The regular output cable test lead plugs into  $J_1$  and carries r.f. from the oscillator to the probe coil. In most cases the probe shown in Fig. 3 can be employed. However, the alligator clips on the signal generator's test lead cable make it a simple matter to change to a coil of different size or shape for use in hard-to-reach spots.

There are two types of indicator which may be employed with the converted signal generator. A vacuum-tube voltmeter can be used to measure grid bias as shown in Fig. 4A, or the grid current may be measured by inserting a meter in series with the grid leak to ground as in Fig. 4B.

Between 160 kc. and 20 mc., the grid bias averages 5 volts and the grid current is in the neighborhood of 200 microamperes. From 20 mc. to 50 mc. the bias is about  $1\frac{1}{4}$  volts and the grid current 50 microamperes. The bias is sufficient to provide plenty of deflection on the low voltage range of a vacuum-tube voltmeter. If you own one of these instruments, I would suggest that you use it for an indicator. Nevertheless, measuring the grid current will prove quite satisfactory if a 0-500 microammeter is employed. A

Fig. 2. Circuit showing how links are coupled to  $J_1$  by means of the rotary switch,  $S_1$ .

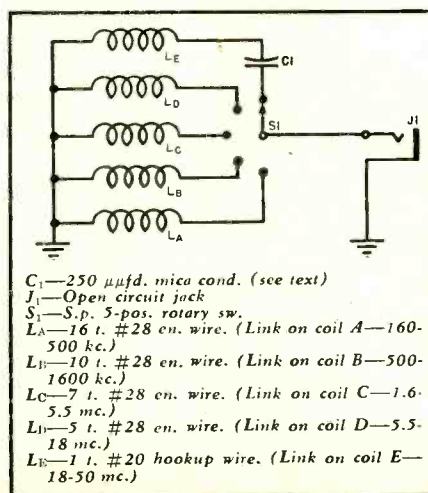

0-1 milliammeter can be used in a pinch, but because of low grid current it will be rather difficult to read when the unit is operated between 20 mc. and 50 mc.

There are those who may wonder about the advisability of adding links to the SG-6 because of the effect which they may have on the inductance of the coils in the signal generator. Actually, there is only a slight shift in inductance and what frequency change does take place can be fairly well compensated by readjustment of the calibrating trimmer in parallel with the main tuning condenser.

On the author's particular signal generator, with the links in place, the average accuracy of the dial readings is within .75%. The highest error is only about 2.2%, while many points are within .5% or better. These checks were made with switch  $S_1$  set on band "A" (160 kc. — 500 kc.), and with the test lead plugged into the regular r.f. output jack. For greatest accuracy,  $S_1$  should always be left in position "A" when the SG-6 is operated as a signal generator. Accuracy of the instrument when used as a grid-dip oscillator will depend upon how tightly the probe coil is coupled to the circuit being tested. The least amount of coupling will produce the most nearly correct dial reading.

When a grid-dip oscillator is constructed, a portion of the circuit sometimes resonates at one particular frequency and whenever the oscillator is tuned past this frequency, a pronounced dip in grid current occurs. The unwanted dip can prove quite annoying if it happens to fall in a range where you expect to do very much testing. The only resonance of this nature which showed up in the SG-6 landed right smack in the middle of the 10 meter band. The distributed capacity of the test lead was tuning the link on the 20 mc. to 50 mc. coil. The purpose of condenser  $C_1$ , placed in series with  $L_E$ , is to raise the unwanted resonance to around 40 mc., a test frequency which is not often used. The lower the capacity of  $C_1$ , the higher will be the frequency of the spurious dip.  $C_1$  cannot be made too small, though, or it will reduce the sensitivity of the oscillator on the 20-50 mc. range. 250  $\mu\text{mfd.}$  appears to be the most practical value.

The panel of the SG-6 is so filled with controls that there is little room for mounting the required jacks and switch. While the placement of these items might not please an esthete, I am convinced that the advantage of having a grid dip oscillator on hand far outweighs the slight panel unbalance resulting from the necessary additions.

After the conversion has been completed, plug the test lead into link jack,  $J_1$ , and attach the alligator clips to the probe coil. Clip the ground lead from the vacuum-tube voltmeter to the metal handle on the case of the SG-6 and plug the d.c. prod into  $J_2$ . If a microammeter dip indicator is to be



Fig. 3. Over-all view of probe coil. The unit consists of 6 turns of No. 14 enamel wire,  $1\frac{3}{8}$ " in diameter. After the turns are cemented together, the coil is cemented to the end of a wooden handle. The leads are fastened to soldering lugs mounted on the handle by means of 6-32 machine screws. Alligator clips on signal generator's output test lead attach to the lugs and energize the coil with r.f.

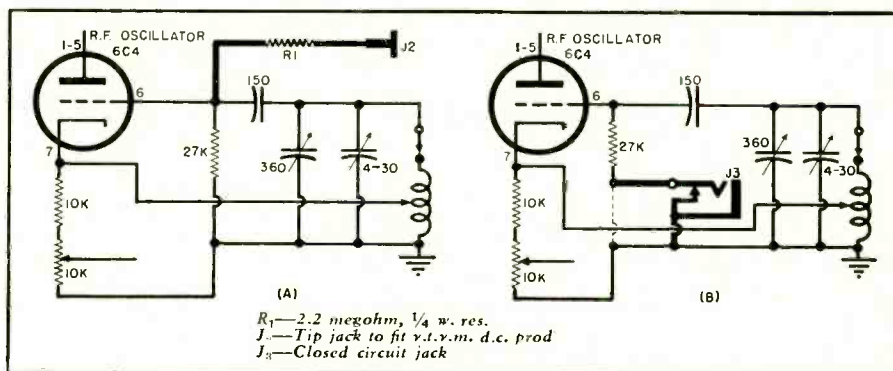
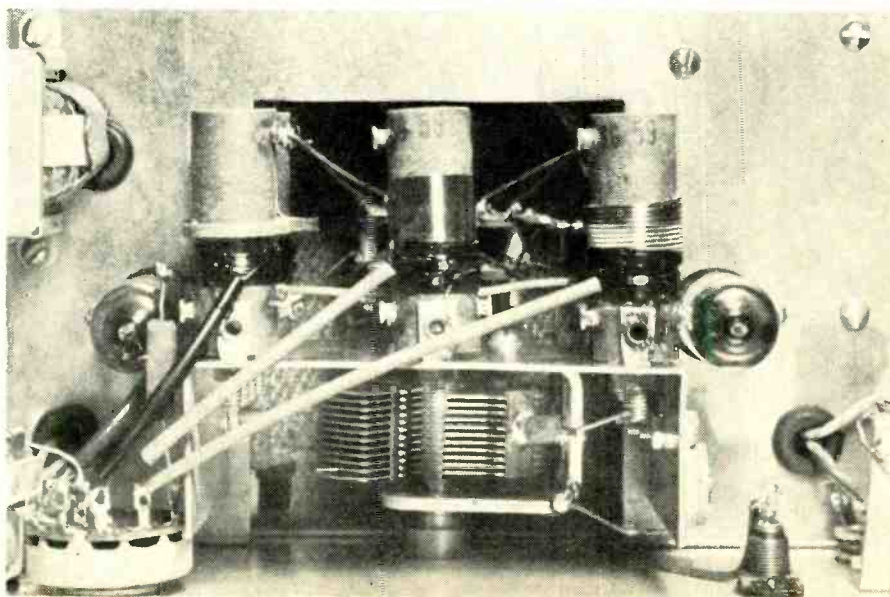

Fig. 4. Wiring changes for two versions of the grid-dip oscillator. (A) Circuit for use in conjunction with a v.t.v.m. The d.c. prod of the voltmeter should be plugged into  $J_2$  and the meter's ground lead clipped to the signal generator's metal handle. (B) Added parts and wiring are shown in heavy lines, deletions are dotted. If a microammeter indicator is employed, it is plugged into  $J_3$  of the circuit.

used in place of a v.t.v.m., it should be plugged into  $J_3$ . Couple the probe coil closely to any resonant circuit you wish to test and tune the signal generator until the indicator shows a pronounced

dip. If no dip can be found on one band, change to another, making certain that both  $S_1$  and the bandswitch are always on the same frequency range.

Fig. 5. A layer of "Scotch" electrical tape is put over the ground ends of the oscillator coils before the links are wound, thus preventing shorts between units.



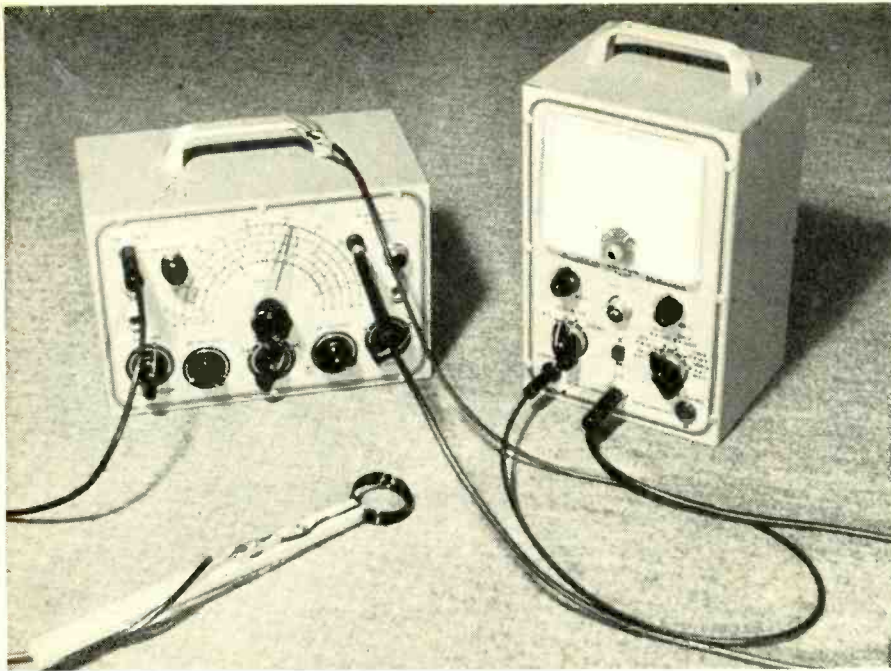

Fig. 6. Converted signal generator. Output test lead is plugged into J, and its alligator clips are attached to probe coil. The d.c. probe of v.t.v.m., used as a dip indicator, is plugged into J<sub>2</sub>. Ground lead is clipped to handle of generator.

When resonance is finally encountered, move the probe coil away until the dip is barely perceptible. The dial reading of the signal generator will then closely approximate the resonant frequency of the circuit being tested. In most cases the accuracy of the dial will be adequate. However, if you desire a more exact check, tune in the signal from the oscillator on an accurately-calibrated, all-wave receiver. The highest frequency band of the SG-6 is calibrated for both its funda-

mental range and for its third harmonic. Since a grid-dip oscillator only functions on the fundamental, the top frequency of the SG-6 when used as a grid-dip oscillator is restricted to 50 mc., even though the dial reads to 150 mc.

The principal use of a grid-dip oscillator is in finding the resonant frequencies of tuned circuits. In addition, if the value of either the inductance

<sup>1</sup> Allied Radio Corp., 833 W. Jackson Blvd., Chicago, Ill. 37-995. 35c postpaid.

or the capacitance of the circuit under test is known the value of the other component may be calculated by means of the following formulas.

If  $C$  is known:  $L = 25,330/CF^2$  or if  $L$  is known:  $C = 25,330/LF^2$  where  $L$  is the inductance in microhenrys,  $C$  is the capacitance in micromicrofarads, and  $F$  is the frequency at which dip occurs.

If mathematical computations are as distasteful to you as they are to me, you can obtain painless solutions to these formulas by using either a "Share Reactance Slide Rule" or an "Allied Rapid R.F. Resonance and Coil Winding Calculator."<sup>1</sup>

In conclusion, it would be well to again point out that this circuit can be added to almost any signal generator and is not confined to the Heath unit alone. The author happened to have the Heath Model SG-6 on his test bench so the circuit was worked out using the Heath circuit and panel layout as the model. For your particular signal generator, a few alterations will be required.

The slight investment in time and parts required for the conversion will begin to pay off the moment construction has been completed. Until there is an all-wave grid-dip oscillator available on your work bench you'll never realize how much time can be saved when ancient trial and error methods of resonance checking are tossed into the wastebasket. Besides, the ability to check values of unmarked condensers, i.f. coils, etc., is an added dividend which must not be discounted. Convert your signal generator and I am certain you'll be pleased with the results.

Fig. 7. Schematic diagram of the Heath Model SG-6 signal generator. Points "A" and "B" correspond to Figs. 4A and 4B. The probe coils shown in Fig. 2 are air-coupled to the band coils shown on right-hand side of diagram as "Band A," "Band B," etc.

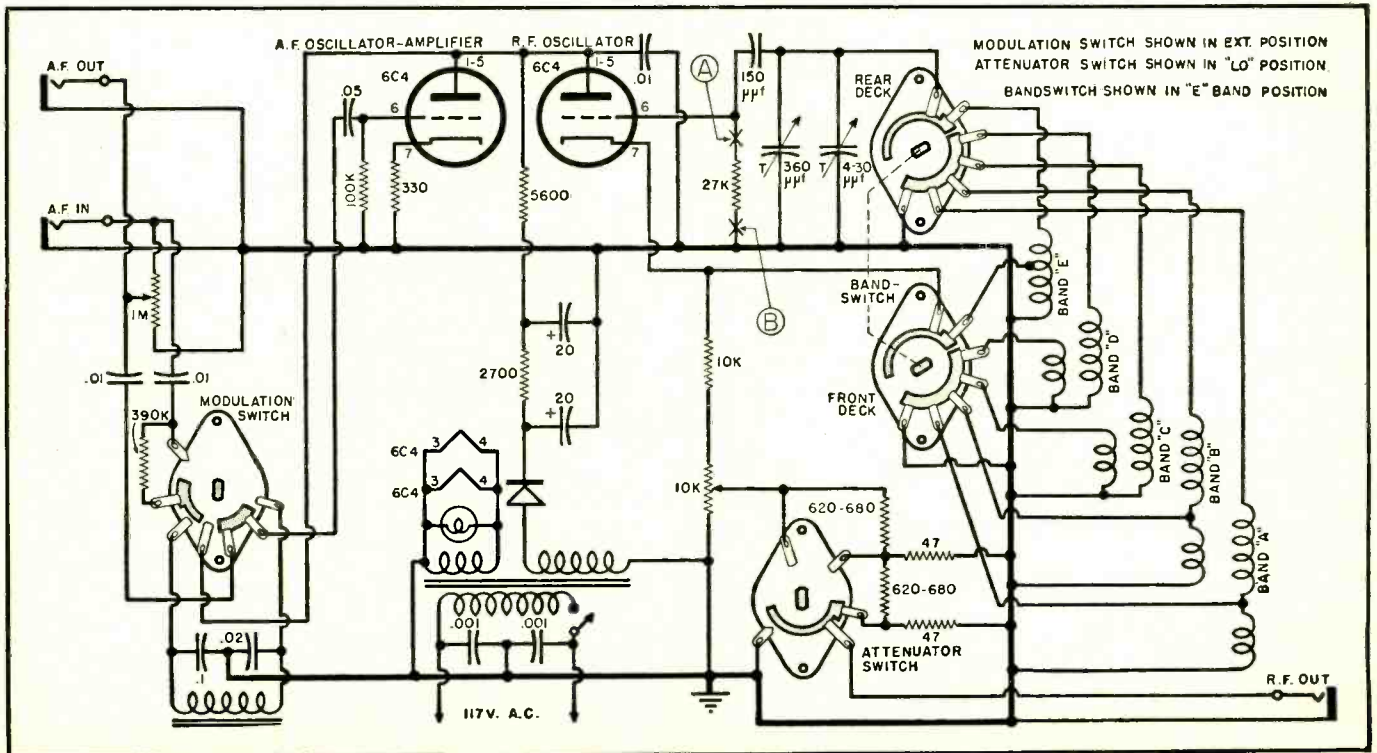



# RADIO-TV-ELECTRONICS

*Will these fast-growing industries  
leave you behind...  
or skyrocket you up with them?*

← Send for this free CREI booklet today... and find out!

When you find success in your chosen field, you may look back on one small incident that changed the course of your career. It may be a conversation you had. It may be the day your father bought you a radio kit, or the day you applied for a job just when somebody was needed. It may well be (as it has for thousands) the day you took two minutes to request the free CREI booklet called "Your Future in the New World of Electronics."

When you read this fact-packed booklet, you will get a complete picture of the electronics industry: where it is going, and what you can do to rise with it. For here is a field expanding so rapidly that the most optimistic experts fall short in their predictions.

Consider the 108 TV stations now operating, and the 2,053 more made possible by the recent FCC "unfreeze." Consider the 17,000,000 TV sets and 100,000,000 radios now in operation. Consider the gigantic defense orders for electronic equipment and installations. Consider the thousands of radio-equipped fire and police departments; the radio-equipped railroads; the hundreds of cities with 2-way radio service for cars and cabs; the wide-ranging field of aviation communications—radio-controlled aircraft, navigation-and-traffic control, airport stations.

Consider the maritime world with its radar and navigation aids, fathometers, ship-to-shore and ship-to-ship communications. Think of electronic heating, Fax and ultra-Fax, electronic medicine, electric computers, and all the industrial applications of electronic know-how.

Then think of the unlimited number of positions to be filled—in development, research design, production, testing and inspection, manufacture, broadcasting, telecasting, and servicing. Luck won't get you a job. Contacts won't. Knowledge *will*. You will have knowledge if you prepare now—if you are alert enough and ambitious enough to obtain that knowledge—if you take two minutes to send for "Your Future in the New World of Electronics" and then follow the plan it describes.

This helpful book shows you how CREI Home Study leads the way to greater earnings through the inviting opportunities described above. However, being an accredited technical school, CREI does not promise you a "short-cut." You must translate your willingness to learn into salable technical knowledge—via *study*. CREI knows what it means to grow along with a booming industry. This year CREI is celebrating its 25th Anniversary, having started in 1927 in the early days of radio-electronics. Since then CREI has provided thousands of pro-

CREI Resident Instruction (day or night) is offered in Washington, D. C. Here work is done with the latest equipment, in ideal surroundings, under close personal supervision. New classes start once a month. For a CREI Residence School catalog, check the last line of the coupon below.

fessional radiomen with technical educations. During World War II, CREI trained thousands for the Armed Services. Leading firms use CREI courses for group training in electronics at company expense; among them are United Air Lines, Canadian Broadcasting Corporation, Trans-Canada Airlines, Sears Roebuck & Co., Bendix Products Division All-American Cables and Radio, Inc., and RCA-Victor Division and Mochlett Laboratories.

CREI courses are prepared by recognized experts, in a practical, easily-understood manner. You get up-to-date study materials; your work is under the personal supervision of a CREI Staff Instructor who *knows* and *teaches you* what industry needs. You choose your own hours of study *at home*. Upon completion you join the many CREI graduates who have found their diplomas keys-to-success in Radio, TV and Electronics. CREI alumni hold many top positions in America's leading firms.

At your service is the CREI Placement Bureau which finds positions for students and graduates. Although CREI does not guarantee jobs, the bureau now has many more requests for personnel than can be filled.

Talk to men in the field and check up on CREI's high standing in electronics

instruction. Determine for yourself right now that your earnings are going to rise with your knowledge—and that you will rise *with* this booming industry. All this CREI offers you, provided you sincerely want to learn. Fill out the coupon and mail it today. We'll promptly send you your free copy of "Your Future in the New World of Electronics." The rest—your future—is up to you.

## MAIL COUPON FOR FREE BOOKLET

### CAPITOL RADIO ENGINEERING INSTITUTE

Dept. 118D, 16th & Park Rd., N.W., Washington 10, D. C.

Send booklet "Your Future in the New World of Electronics" and course outline.

CHECK }  TV, FM & Advanced AM Servicing  Aeronautical Radio  
FIELD OF }  Practical Television Engineering  Engineering  
GREATEST }  Broadcast Radio Engineering (AM, FM, TV)  
INTEREST }  Practical Radio Engineering

Name .....

Street .....

City ..... Zone ..... State .....

If residence school in Wash., D. C., preferred, check here



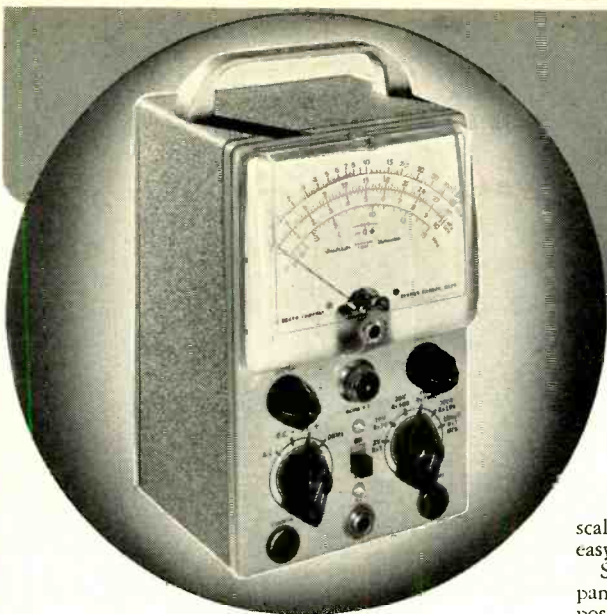

# THE *New* 1952 Heathkit VTVM KIT

MODEL V5-A  
SHIPPING WT. 7 LBS.

## \$24.50

Designed to take up a minimum of space, yet designed to be the most important and useful instrument on your workbench. Really handsome looking — note the rounded edges on front panel and rear cover. New compact size has cabinet dimensions of only 4 1/8" deep x 4 1/16" wide x 7 3/8" high.

Tremendous coverage — will read from 1/2V to 1000V AC, 1/2V to 1000V DC, .1 to over 1 billion ohms resistance, and Db. Meter scale has zero-set mark for FM alignment — all scales clearly marked for easy and fast readings and Db scale is in red for easy identification.

Simple to operate. Ohms adjust and zero adjust controls located on front panel along with selector and range switches. Selector switch has four positions: AC, DC-, DC+ and Ohms to set up the instrument for type of reading desired. DC- position allows negative voltages to be taken without reversing test leads. AC and DC voltage ranges are full scale 3V — 10V — 30V — 100V — 300V — 1000V and resistance ranges are RX1, X10, X100, X1000, X10M, X1 Megohm. Convenient ranges for fast and accurate readings.

Strictly highest quality components used throughout — 1% precision resistors in multiplier circuit, Simpson 200 microampere meter movement, sturdy cabinet, excellent positive detent smooth acting switches, etc. New miniature tube used in meter balancing circuit and new battery holding clamp and spring clip assure good contact to ohms string of resistors.

Kit comes complete — and the instruction manual with its step-by-step instructions, pictorials, figures, and schematic makes assembly a pleasure.

- New styling, — formed case for beauty.
- New truly compact size. Cabinet 4 1/8" deep by 4-11/16" wide by 7-3/8" high.
- Quality 200 microamp meter.
- New ohms battery holding clamp and spring clip — assurance of good electrical contact.
- Highest quality precision resistors in multiplier circuit.
- Calibrates on both AC and DC for maximum accuracy.
- Terrific coverage — reads from 1/2V to 1000V AC, 1/2V to 1000V DC, and .1 to over 1 billion ohms resistance.
- Large, clearly marked meter scales indicate ohms, AC Volts, DC Volts, and DB — has zero set mark for FM alignment.

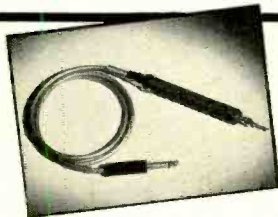

### Heathkit RF PROBE KIT

Extends range of Heathkit VTVM to 250 MC ± 10%. Designed for taking RF measurements. All parts furnished including probe housing and crystal diode detector. Shipping Weight 1 lb.

\$5.50

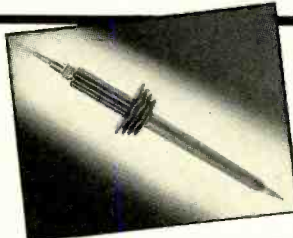

### Heathkit 30,000 V DC PROBE KIT

For taking readings up to 30,000 V DC when used with the Heathkit VTVM (or any standard 11 megohm VTVM). Comes with two color molded plastic probe body and all parts. Shipping Wt. 2 lbs.

\$5.50

### Heathkit A. C. VACUUM TUBE VOLTMETER KIT

Now — as a Heathkit — at a price anyone can afford, an AC VTVM. Makes possible those sensitive AC measurements required by audio enthusiasts, laboratories, and experimenters. The kit audio men have been looking for. Ten ranges consisting of full scale .01, .03, .1, .3, 1, 3, 10, 30, 100, 300 volts RMS assure easy and more accurate readings. Ten ranges on DB provide for measurements from -52 to +52 DB. Frequency response within 1 DB from 20 cycles to 50 KC.



MODEL AV-1  
SHIP. WT. 5 LBS.

\$29.50

The ingenious circuitry incorporates precision multiplied resistors for accuracy, two amplifier stages using miniature tubes, a unique bridge rectifier meter circuit, quality Simpson meter with 200 microampere movement, and a clean layout of parts for easy wiring. A high degree of inverse feedback provides for stability and linearity. Extremely compact. cabinet size — 4-1/8" deep x 4-11/16" wide x 7-3/8" high. Newly designed cabinet makes this the companion piece to the VTVM.

### Heathkit SQUARE WAVE GENERATOR KIT

The Heathkit Square Wave Generator is an excellent square wave frequency source with features you won't want to be without. Especially notable is the wide range of the instrument — 10 cycles to 100 kilocycles continuously variable. This wide range makes it useful for television and wide band amplifier work as well as audio experimentation. The output impedance is low, and the output voltage is continuously variable between 0 and 20 volts. Because a multivibrator stage cannot be accurately calibrated, terminals on the front panel can be used for synchronization to an external source should it be desired.



MODEL SQ-1  
SHIP. WT. 14 LBS.

\$29.50

The circuitry consists of a multivibrator stage, a clipping and a squaring stage, and a cathode follower output stage. The power supply is transformer operated and utilizes a full wave rectifier tube with 2 sections of LC filtering.

For a good, wide range, and low priced square wave generator, the SQ-1 just can't be beat.

YOU SAVE BY ORDERING DIRECT FROM MANUFACTURER—USE ORDER BLANK ON LAST PAGE

EXPORT AGENT  
ROCKE INTERNATIONAL CORP.  
13 E. 40th ST.  
NEW YORK CITY (16)  
CALL: AREA-N.Y.

## The HEATH COMPANY

... BENTON HARBOR 15, MICHIGAN

# Heathkit SIGNAL GENERATOR KIT

Model SG-6  
Shipping Wt. 7 lbs.

The new Heathkit Signal Generator Kit has dozens of improvements. Covers the extended range of 160 Kc to 50 megacycles on fundamentals and up to 150 megacycles on useful calibrated harmonics; makes this Heathkit ideal as a marker oscillator for TV. Output level can be conveniently set by means of both step attenuator and continuously variable output controls. Instrument has new miniature HF tubes to easily handle the high frequencies covered.

Uses 6C4 master oscillator and 6C4 sine wave audio oscillator. The kit is transformer operated and a husky selenium rectifier is used in the power supply. All coils are precision wound and checked for calibration making only one adjustment necessary for all bands.

New sine wave audio oscillator provides internal modulation and is also available for external audio testing. Switch provided allows the oscillator to be modulated by an external audio oscillator for fidelity testing of receivers. Comes complete, all tubes, cabinet, test leads, every part. The instruction manual has step-by-step instructions and pictorials. It's easy and fun to build a Heathkit Model SG-6 Signal Generator.



## Heathkit CONDENSER CHECKER KIT

Only  
**\$19.50**

Model C-2  
Shipping Wt. 6 lbs.

Checks all types of condensers — paper — mica — ceramic — electrolytic. All condenser scales are direct reading and require no charts or multipliers. Covers range of .00001 MFD to 1000 MFD. A Condenser Checker that anyone can read. A leakage test and polarizing voltage for 20 to 500 V provided. Measures power factor of electrolytics between 0% and 50% and reads resistance from 100 ohms to 5 megohms. The magic eye indicator makes testing easy.

The kit is 110V 60 cycle transformer operated and comes complete with rectifier tube, magic eye tube, cabinet, calibrated panel and all other parts. Has clear detailed instructions for assembly and use.



## NEW Heathkit SIGNAL TRACER AND UNIVERSAL TEST SPEAKER KIT

**\$19.50**

Model T-2  
Shipping Wt. 7 lbs.

The popular Heathkit Signal Tracer has now been combined with a universal test speaker at no increase in price. The same high quality tracer follows signal from antenna to speaker — locates intermittents — saves valuable service time — finds defective parts quicker hour. Works equally well on broadcast, FM, or TV receivers. The test speaker has an assortment of switching ranges to match phones, pickups and PA systems. Comes complete: cabinet, 110V 60 cycle power transformer, tubes, test probe, all necessary parts, and detailed instructions for assembly and use.

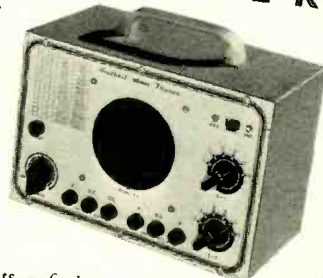

Model TC-1  
Shipping Wt. 12 lbs.

**\$29.50**

## Heathkit TUBE CHECKER KIT

The Tube Checker is a MUST for radio repair men. Often customers want to SEE tubes checked, and a checker like this builds customer confidence. In your repairing, you will have a multitude of tubes to check — quickly. The Heathkit tube checker will serve all these functions — it's good looking (with a polished birch cabinet and an attractive two color panel) — checks 4, 5, 6, 7 prong Octals, Locals, 7 prong miniatures, 9 prong miniatures, pilot lights, and the Hytron 5 prong types. AND IT'S FAST TO OPERATE — the gear driven, free-running roll chart lists hundreds of tubes, and the smooth, acting, simplified switching arrangement gives really rapid set-ups.

The testing arrangement is designed so that you will be able to test new tubes of the future — without even waiting for factory data — protection against obsolescence.

You can give tubes a thorough testing — checks for opens, shorts, each element individually, emission, and for filament continuity. A large BAD-?-GOOD meter scale is in three colors for easy reading and also has a "line-set" mark.

You'll find this tube checker kit a good investment — and it's only \$29.50.

YOU SAVE BY ORDERING DIRECT FROM MANUFACTURER—USE ORDER BLANK ON LAST PAGE

EXPORT AGENT  
ROCKE INTERNATIONAL CORP.  
13 E. 40th ST.  
NEW YORK CITY (16)  
CABLE: ARPAD N.Y.

The **HEATH COMPANY**

... BENTON HARBOR 15, MICHIGAN

RADIO & TELEVISION NEWS



NEW 1952 *Heathkit*  
**BATTERY ELIMINATOR  
 KIT**



**\$24<sup>50</sup>**

Model BE-3  
 Shipping Wt. 17 lbs.

- Can be used as battery charger.
- Continuously variable output 0 - 8 Volts — not switch type.
- Heavy duty Mallory 17 disk type magnesium copper sulfide rectifier.
- Automatic overload relay for maximum protection. Self-resetting type.
- Ideal for battery, aircraft and marine radios.
- Dual Volt and Ammeters read both voltage and amperage continually — no switching.

The new Heathkit Model BE 3 incorporates the best. Continuously variable output control is of the variable transformer type with smooth wiper type contacts.

There are no switches or steps and voltage between 0 and 8 Volts is available at 10 Amperes continuous and 15 Amperes intermittent. Maximum safety from overloads and shorts provided by automatic overload relay which resets itself when overload is removed.

The new rectifier is a 17 plate Mallory magnesium copper sulfide type. This is the most rugged type available for long trouble-free use.

Output is continuously metered by both a 0 - 10 Volt Voltmeter and a 0 - 15 Amp Ammeter. Shorted vibrators indicated instantly by ammeter.

Equip now for all types of service — aircraft — marine — auto and battery radios — this inexpensive instrument vastly increases service possibilities — better be ready when the customer walks in.

NEW *Heathkit*  
**SINE AND SQUARE WAVE  
 AUDIO GENERATOR KIT**

Designed with versatility, usefulness, and dependability in mind, the AG-7 gives you the two most needed wave shapes right at your fingertips — the sine wave and the square wave.

The range switch and plainly calibrated frequency scale give rapid and easy frequency selection, and the output control permits setting the output to any desired level.

A high-low impedance switch sets the instrument for either high or low impedance output — on high to connect a high impedance load, and on low to work into a low impedance transformer with negligible DC resistance.

Coverage is from 20 to 20,000 cycles, and distortion is at a minimum — you can really trust the output wave shape.

Six tubes, quality 4 gang tuning condenser, power transformer, metal cased filter condenser, 1% precision resistors in the frequency determining circuit, and all other parts come with the kit — plus, a complete construction manual — A tremendous kit, and the price is truly low.



Model AG-7  
 Shipping Wt. 15 lbs.

**\$34<sup>50</sup>**

THE NEW *Heathkit*  
**HANDITESTER KIT**

A precision portable volt-ohm milliammeter. Uses only high quality parts — All precision 1% resistors, three deck switch for trouble-free mounting of parts, specially designed battery mounting bracket, smooth acting ohm adjust control, beautiful molded bakelite case, 400 micro-amp meter movement, etc.

DC and AC voltage ranges 10 - 30 - 300 - 1000 - 5000V.  
 Ohms range 0 - 3000 and 0 - 300,000. Range Milliampères 0 - 10 Ma, 0 - 100 Ma.  
 Easily assembled from complete instructions and pictorial diagrams.



**\$13<sup>50</sup>**

Model M-1  
 Shipping Wt. 3 lbs.

NEW *Heathkit*

**T.V. ALIGNMENT GENERATOR KIT**

Here is an excellent TV Alignment Generator designed to do TV service work quickly, easily, and properly. The Model TS-2 when used in conjunction with an oscilloscope provides a means of correctly aligning television receivers.

The instrument provides a frequency modulated signal covering, in two bands, the range of 10 to 90 Mc. and 150 to 230 Mc. — ALL ALLOCATED TV CHANNELS AS WELL AS IF FREQUENCIES ARE COVERED.

An absorption type frequency marker covers from 20 to 75 Mc. in two ranges — therefore, you have a simple, convenient means of frequency checking of IF's, independent of oscillator calibration.

Sweep width is controlled from the front panel and covers a sweep deviation of 0-12 Mc. — all the sweep you could possibly need or want.

And still other excellent features are: Horizontal sweep voltage available at the front panel (and controlled with a phasing control — both step and continuously variable attenuation for setting the output signal to the desired level — a convenient instrument stand-by position — vernier drive of both oscillator and marker tuning condensers — and blanking for establishing a single trace with base reference level. Make your work easier, save time, and repair with confidence — order your Heathkit TV Alignment Generator now!

Model TS-2  
 Shipping Wt. 20 lbs.

**\$39<sup>50</sup>**

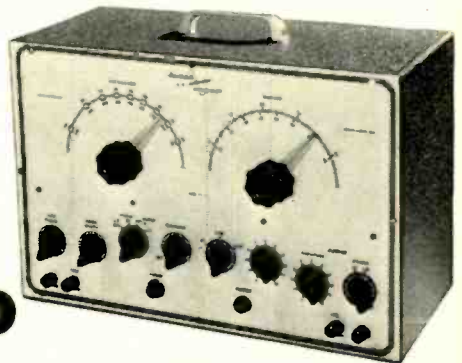

**YOU SAVE BY ORDERING DIRECT FROM MANUFACTURER — USE ORDER BLANK ON LAST PAGE**

EXPORT AGENT  
 ROCKE INTERNATIONAL CORP.  
 132 E. 40th St.  
 NEW YORK CITY (16)  
 CABLE: ARLOS N.Y.

**The HEATH COMPANY**

**... BENTON HARBOR 15, MICHIGAN**

# Heathkit IMPEDANCE BRIDGE KIT



Model 1B-1B  
Shipping Wt. 15 lbs.

**\$69<sup>50</sup>**

This Impedance Bridge Kit is really a favorite with schools, industrial laboratories, and serious experimenters. An invaluable instrument for those doing electrical measurements work. Reads resistance from .01 Ohms to 10 meg., capacitance from .00001 to 100 MFD, inductance from 10 microhenries to 100 henries, dissipation factor from .002 to 1, and storage factor from 1 to 1000. And you don't have to worry about selecting the proper bridge circuit for the various measurements—the instrument automatically makes the correct circuit when you set up for taking the measurement you want. Bridge utilizes Wheatstone, Hay, Maxwell, and capacitance comparison circuits for the wide range and types of measurements possible. And it's self powered—has internal battery and 1000 cycle hummer. No external generator required—has provisions for external generator if measurements at other than 1000 cycles are desired. Kit utilizes only highest quality parts. General Radio main calibrated control.

Mallory ceramic switches, excellent 200 microamp zero center galvanometer, laboratory type binding posts with standard 3/4 inch centers, 1% precision ceramic-body type multiplier resistors, beautiful birch cabinet and ready calibrated panel. (Headphones not included.)

Take the guesswork out of electrical measurements—order your Heathkit Impedance Bridge kit today—you'll like it.

## Heathkit LABORATORY RESISTANCE DECADE KIT



**\$19<sup>50</sup>**

Shipping Wt. 4 lbs.

An indispensable piece of laboratory equipment—the Heathkit Resistance Decade Kit gives you resistance settings from 1 to 99,999 ohms IN ONE OHM STEPS. For greatest accuracy, 1% precision ceramic-body type resistors and highest quality ceramic wafer switches are used.

Designed to match the Impedance Bridge above, the Resistance Decade Kit has a beautiful birch cabinet and attractive panel. It's easy to build, and comes complete with all parts and construction manual.

## Heathkit LABORATORY POWER SUPPLY KITS

*Limits:*

No load .....	Variable 150-400V DC
25 MA .....	Variable 30-310V DC
50 MA .....	Variable 25-250V DC

Higher loads: Voltage drops off proportionally



**\$29<sup>50</sup>**

Model PS-1.....Ship. Wt. 20 lbs.

Every experimenter needs a good power supply for electronic setups of all kinds. This unit has been expressly designed to act as a HV supply and a 6.3 V filament voltage source. Voltage control allows selection of HV output desired (continuously variable within limits outlined), and a Volts-Ma switch provides choice of output metering. A large plainly marked and direct reading meter scale indicates either DC voltage output (Range of meter 0-500V D.C., 0-200 Ma. D.C.). Instrument has convenient stand-by position and pilot light. Comes with power transformer, filament transformer, meter, 5Y3 rectifier, two 1619 control tubes, completely punched and formed chassis, panel, cabinet, detailed construction manual, and all other parts to make the kit complete.

## Heathkit ECONOMY . . . 6 WATT AMPLIFIER KIT



MODEL A-7  
Shipping Wt. 8 lbs.

**\$14<sup>50</sup>**

- Choice of 4-8-15 ohm output impedances.
- Response flat  $\pm 1\frac{1}{2}$  db from 20—20,000 cycles.
- 6 watts output.
- Good fidelity at low cost.
- Output tubes working in push pull.
- Volume, bass, and treble controls.
- Two separate inputs.

The purpose of this kit is to provide to the kit builder a low cost amplifier with excellent fidelity. The circuit consists of four tubes with following functions: a 12SL7, one section working as an amplifier and one as a phase splitter, two 12A6 output tubes working in push pull,

and a 5Y3 rectifier in a full wave rectifier circuit.

The unit operates from a husky power transformer, and has good output transformer with a choice of 4—8—15 ohm output impedances. (Speaker not included).

The kit provides excellent listening pleasure and the price is really low. Compare it with all others. You won't find a better buy.

MODEL A-7: For tuner and crystal phono inputs. Has two position selector switch for convenient switching to type of input desired.

Model A-7-A: Has a 12SI17 preamplifier stage with special compensation network for operation with reluctance phono input. Shipping Wt. 8 lbs. .... **\$16.50**

## Heathkit HIGH FIDELITY 20 WATT AMPLIFIER KIT



MODEL A-8  
Shipping Wt. 18 lbs.

**\$33<sup>50</sup>**

The A8 (or A-8A) is a high quality amplifier for those who want high fidelity output at moderate cost. Frequency response within  $\pm 1$ db from 20-20,000 cycles. Distortion at 3db below maximum power output (at 1,000 cycles) is only .8%. Kit has a Chicago power transformer in drawn steel case and a Peerless output transformer with output impedances of 4—8—16 ohms. Bass and treble controls permit listener to select output with tonal qualities of his own liking. The tube lineup is composed of a 6SJ7 voltage amplifier, a 6SN7 amplifier and phase splitter, two 6LA's in push-pull output and a 5U4G rectifier. All parts furnished (speaker not included) and the construction manual makes assembly easy.

MODEL A-8: For tuner and crystal phono inputs. Has two position selector switch for convenient switching to type of input desired.

MODEL A-8A: Features an added 6SJ7 stage (preamplifier) for operating from variable reluctance cartridge phono pickup, mike input, and either tuner or standard crystal phono pickup. A three position selector switch provides flexible switching. Shipping Wt. 18 lbs. .... **\$35.50**

**YOU SAVE BY ORDERING DIRECT FROM MANUFACTURER—USE ORDER BLANK ON LAST PAGE**

EXPORT AGENT  
ROCKE INTERNATIONAL CORP.  
13 E. 40th ST.  
NEW YORK CITY (16)  
CABLE: ARAB N.Y.

**The HEATH COMPANY**

**... BENTON HARBOR 15, MICHIGAN**

**RADIO & TELEVISION NEWS**

# Heathkit RECEIVER & TUNER KITS for AM and FM



Model BR-1 Broadcast Model Kit covers 550 to 1600 Kc. Shipping Wt. 10 lbs.

**\$19.50**

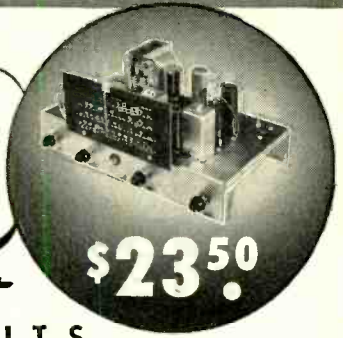

Model AR-1 3 Band Receiver Kit covers 550 Kc. to over 20 Mc. continuous. Extremely high sensitivity. Shipping Wt. 10 lbs.

**\$23.50**

## TWO HIGH QUALITY Heathkit SUPERHETERODYNE RECEIVER KITS

Two excellent Heathkits. Ideal for schools, replacement of worn out receivers, amateur and custom installations.

Both are transformer operated quality units. The best of materials used throughout—six inch calibrated slide rule dial—quality power output transformers—dual iron core shielded. I.F. coils—metal cased filter condenser. The chassis has phono input jacks, 110 Volt output for phono motor and there is a phono-radio switch on panel. A large metal panel simplifying installation in used console cabinets is included. Comes complete with tubes and instruction manual incorporating pictorials and step-by-step instructions (less speaker and cabinet). The three band model has simple coil turret which is assembled separately for ease of construction.

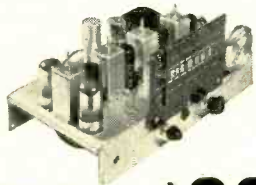

Model FM-2  
Ship. Wt. 9 lbs.

**\$22.50**

## TRUE FM FROM Heathkit FM TUNER KIT

The Heathkit FM Tuner Model FM-2 was designed for best tonal reproduction. The circuit incorporates the most desirable FM features—true FM.

Utilizes 8 tubes: 7E5 Oscillator, 6SH7 mixer, two 6SH7 IF amplifiers, 6SH7 limiter, two 7C4 diodes as discriminator, and 6X5 rectifier.

The instrument is transformer operated making it safe for connection to any type receiver or amplifier. Has ready wound and adjusted RF coils, and 2 stages of 10.7 Mc IF (including limiter). A calibrated six inch slide rule dial has vernier drive for easy tuning. All parts and complete construction manual furnished.



MAIL TO THE  
**HEATH COMPANY**  
BENTON HARBOR 15,  
MICHIGAN

## ORDER BLANK

From \_\_\_\_\_

SHIP VIA

- Parcel Post
- Express
- Freight
- Best Way

Quantity	Item	Price	Quantity	Item	Price
	Heathkit Oscilloscope Kit — Model O-7			Heathkit H.V. Probe Kit — No. 336	
	Heathkit VTVM Kit — Model V-5-A			Heathkit R.F. Signal Gen. Kit — Model SG-6	
	Heathkit FM Tuner Kit — FM-2			Heathkit Condenser Checker Kit — Model C-2	
	Heathkit Broadcast Receiver Kit — Model BR-1			Heathkit Handitester Kit — Model M-1	
	Heathkit Three Band Receiver Kit—Model AR-1			Heathkit Power Supply Kit — Model PS-1	
	Heathkit Amplifier Kit — Model A-7 (or A-7-A)			Heathkit Resistance Decade Kit — Model RD-1	
	Heathkit Amplifier Kit — Model A-8 (or A-8A)			Heathkit Impedance Bridge Kit — Model IB-1B	
	Heathkit Tube Checker Kit — Model TC-1			Heathkit A.C. VTVM-KIT — Model AV-1	
	Heathkit Audio Generator Kit — Model AG-7			Heathkit Intermodul. Analyzer Kit—Model IM-1	
	Heathkit Battery Eliminator Kit — Model BE-3			Heathkit Audio Freq. Meter Kit — Model AF-1	
	Heathkit Electronic Switch Kit — Model S-2			Heathkit Square Wave Gen. Kit — Model SQ-1	
	Heathkit T.V. Alignment Gen. Kit — TS-2				
	Heathkit Signal Tracer Kit — Model T-2				
	Heathkit R.F. Probe Kit — No. 309				

On Parcel Post Orders, include postage for weight shown and insurance. (We insure all shipments.)

On Express Orders, do not include transportation charges—they will be collected by the Express Agency at time of delivery.

Enclosed find  Check  Money Order for \_\_\_\_\_

Please ship C.O.D.  Postage enclosed for \_\_\_\_\_ lbs.

ALL PRICES SUBJECT TO CHANGE WITHOUT NOTICE

EXPORT AGENT  
ROCKE INTERNATIONAL CORP.  
13 E. 40th ST.  
NEW YORK CITY (16)  
CABLE AREAS N.Y.

# The HEATH COMPANY

... BENTON HARBOR 15, MICHIGAN

# TRY WELLS

## First!



### FOR ELECTRONIC COMPONENTS

We offer immediate delivery from our vast stock of more than 25,000 items—all standard make, carefully inspected and fully guaranteed. Our prices are below market.

### Always Check Wells' Stock First!

Quotations and quantities available will be given immediately upon request.

#### ADEL CLAMPS

ANTENNAS

Insulators, Mast Sections

BINDING POSTS

BLOWERS

CABLE ASSEMBLIES

CHOKES

COILS

CONDENSERS

Oil Filled, Bathub, Hearing Aid, Transmitting  
Micas, Silver Micas, Ceramic, Variable, Trimmer

CRYSTALS

DYNAMOTORS & BRUSHES

FILTERS

FUSES & MOUNTINGS

GENERATORS

GROUND RODS

HEADSETS

IF COILS

JACKS

JACK BOXES

KEYS, Telegraph

KNOBS

LAMPS

LORD MOUNTS

LUGS

MOTORS & BRUSHES

PLUGS

RECTIFIERS

Selenium, Copper Oxide, Meter, Diode

RESISTORS—All Types

SELSYNS

SOCKETS

SWITCHES

Aircraft, Micro, Switchettes, Toggle

TIMERS

TUBING—Flexible

TUNING SHAFTS

TRANSFORMERS—All Types

VIBRATORS

WALKIE TALKIES



### Available Now!

A complete signal corps stock number listing of items in our stock. Write for listing No. SG-200. (For government agencies and contractors only.)

Manufacturers and distributors—write for Radio-Electronics Catalog No. H 501.

Write, Wire, Phone Your Requirements

all phones: **SEeley 8-4143**

# WELLS

## SALES, INC.

833 W. CHICAGO AVE., DEPT. R, CHICAGO 22, ILL.

76

# What's New in Radio

For additional information on any of the items described herein, readers are asked to write direct to the manufacturer. By mentioning RADIO & TELEVISION NEWS, the page, and the issue number, delay will be avoided.

### CRAFTSMEN AMPLIFIER

The Radio Craftsmen, Inc., 4401 N. Ravenswood Avenue, Chicago 40, Illinois has introduced a new high-fidelity audio amplifier which has been designed for custom installations.

The Craftsmen 400 circuit features a direct-coupled, split-load triode

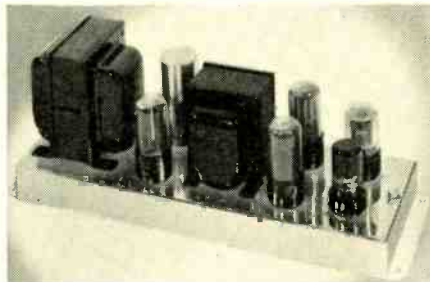

phase inverter driving push-pull 6V6 power output tubes. Use of 13½ db inverse feedback around the entire amplifier results in a 4:1 output damping factor or an output internal impedance of 2 ohms at the 8 ohm tap.

Specifications on the 400 include a response of ± 1 db from 15 to 20,000 cps at 10 watts output; total harmonic distortion of less than 1% at 10 watts output; intermodulation distortion of less than 5% at 10 watts (60 and 7000 cps, 4:1); frequency response of ± 1 db from 10 to 30,000 cps at ½ watt; and a hum and noise level 70 db below the rated output. 4, 8, and 16 ohm speaker outputs are provided. The entire unit measures 14" x 4½" x 5¼".

### TAPE RECORDERS

Masco Electronic Sales Corporation of 32-28 49th Street, Long Island City 3, New York has announced six new tape recorders which feature fast forward speeds and new duo-motor drives.



Of the six models the 52R, 52LR, and 52CR have a built-in AM tuner; the 52 and 52R have a carrying case; the 52C and 52CR have a self-contained metal cover; and the 52L and 52LR have no covers.

All of the units have dual speed 3.75 or 7.5 inches per second, with automatic amplifier equalization for each speed. The dual-track feature permits up to 2 hours of recording on a seven-inch reel. In conjunction with the duo-motor drive there is a separate idler take-up mechanism for lowest wow and flutter.

Complete specifications on this new series are available from the company on request.

### FOLDED-HORN ENCLOSURE

Electro-Voice, Inc., Buchanan, Michigan is now marketing a moderately-priced folded-horn corner enclosure which has been designed for use with the E-V SP8-B or SP8-BT 8" speaker or any other 8" loudspeaker.

Utilizing the Klipsch principle of folded corner horn loading, the "Baronet" conceals in approximately 1½ cubic feet of furniture housing the



throat of a horn formed by the walls of the room itself.

The new unit measures 23½" high, 14½" wide, and 10½" deep at the top and 14½" deep at the bottom. The enclosure is available in mahogany and blonde finishes. For complete details on the "Baronet" write direct to the company.

### TEST INSTRUMENT

Precise Development Corp., Ocean-side, New York has released a new test instrument in its line, the Model 635 universal a.f. sine, square, and pulse generator.

Designed to facilitate audio and video troubleshooting, the new unit features a Wien bridge oscillator; provides sine waves, square waves, and pulses; has a variable impedance, cathode-follower output; voltage regulation to insure a constant output; minimum overshoot and round-off through 30,000 cycles on square waves and pulses; sine waves through 200,000

RADIO & TELEVISION NEWS

# FREE

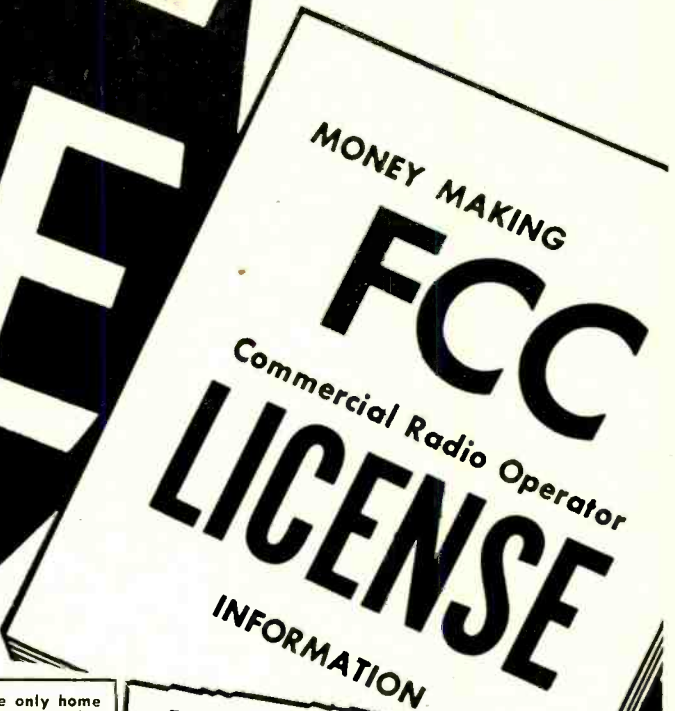

**TELLS HOW—**

**WE GUARANTEE**  
**TO TRAIN AND COACH YOU AT HOME**  
**IN SPARE TIME UNTIL YOU GET**  
**YOUR FCC LICENSE**

If you have had any practical experience—Amateur, Army, Navy, radio repair, or experimenting.

Ours is the only home study course which supplies FCC-type examinations with all lessons and final tests.

**TELEVISION ENGINEERING** included in our Training and Coaching

**TELLS HOW—**

**OUR AMAZINGLY EFFECTIVE JOB-FINDING SERVICE HELPS CIRE STUDENTS GET BETTER JOBS. HERE ARE JUST A FEW RECENT EXAMPLES OF JOB-FINDING RESULTS:**

**GETS CIVIL SERVICE JOB**

"Thanks to your course I obtained my 2nd phone license, and am now employed by Civil Service at Great Lakes Naval Training Station as an Equipment Specialist."  
 Kenneth R. Leiser, Fair Oaks, Mtd. Del., McHenry, Ill.

**GETS STATE POLICE JOB**

"I have obtained my 1st class ticket (thanks to your school) and since receiving same I have held good jobs at all times. I am now Chief Radio Operator with the Kentucky State Police."  
 Edwin Healy, 264 E. 3rd St., London, Ky.

**GETS BROADCAST JOB**

"I wish to thank your Job-Finding Service for the help in securing for me the position of transmitter operator here at WCAE, in Pittsburgh."  
 Walter Koschik, 1442 Ridge Ave., N. Braddock, Pa.

**GETS AIRLINES JOB**

"Due to your Job-Finding Service, I have been getting many offers from all over the country, and I have taken a job with Capital Airlines in Chicago, as a Radio Mechanic."  
 Harry Clare, 4537 S. Drexel Blvd., Chicago, Ill.

**TELLS HOW—**

**EMPLOYERS MAKE JOB OFFERS LIKE THESE TO OUR GRADUATES EVERY MONTH!**

Letter from Chief Engineer, Broadcast Station, North Carolina. "Need men with radiotelephone 1st class licenses, no experience necessary. Will learn more than at average station for we are equipped with Diesel Electric power, transmitting and studio equipment."

Telegram from Chief Engineer, Broadcast Station, Wyoming. "Please send latest list available first class operators. Have November 10th opening for two combo men."

Letter from Chief Engineer, Broadcast Station, Texas. "Please send list of latest licensed graduates."

These are just a few of the examples of the job offers that come to our office periodically. Some licensed radioman filled each of these jobs; it might have been you!

**HERE IS YOUR GUARANTEE**

If you fail to pass your Commercial License exam after completing our course, we guarantee to continue your training without additional cost of any kind, until you successfully obtain your Commercial license, provided you first sit for this examination within 90 days after completing your course.

**ACT NOW!**

**Get All 3 FREE**

**HERE'S PROOF FCC LICENSES ARE OFTEN SECURED IN A FEW HOURS OF STUDY WITH OUR COACHING AT HOME IN SPARE TIME:**

Name and Address	License	Lessons
Lee Worthy, 2210 1/2 Wilshire St., Bakersfield, Cal.	2nd Phone	16
Clifford E. Vogt, Box 1016, Dania, Fla.	1st Phone	20
Francis X. Foerch, 38 Beucier Pl., Bergenfield, N. J.	1st Phone	38
S/Sgt. Ben H. Davis, 317 North Roosevelt, Lebanon, Ill.	1st Phone	28
Albert Schoell, 110 West 11th St., Escondido, Cal.	2nd Phone	23

**CLEVELAND INSTITUTE OF RADIO ELECTRONICS**  
 Carl E. Smith, E.E., Consulting Engineer, President  
 Desk RN-44, 4900 Euclid Bldg., Cleveland 3, Ohio



Your FCC ticket is Recognized in All Radio Fields as Proof of Your Technical Ability.

**MAIL COUPON NOW**

Cleveland Institute of Radio Electronics  
 Desk RN-44—4900 Euclid Bldg., Cleveland 3, Ohio  
 (Address to Desk No. to avoid delay.)

I want to know how I can get my FCC Ticket in a minimum of time. Send me your FREE booklet, "How to Pass FCC License Examinations" (does not cover exams for Amateur License), as well as a sample FCC-type exam and the amazing new booklet, "Money-Making FCC License Information."

Tell me about your Television Engineering Course.

Name .....

Address .....

City..... Zone..... State.....

Paste on 2 cent postcard or send air mail.

# TV RECEPTION UP TO 200 MILES

ON ACTUAL FIELD TESTS WITH

## NEW DX630 CHASSIS

USING THE CASCODE TUNER

will operate in fringe areas or in localities remote from TV broadcast stations up to 200 miles.

HAS 4 MICROVOLT SENSITIVITY—10 times any other TV receiver. Will pick up distant stations without use of booster or special antenna arrays—and with less noise. Will operate any tube including 24", greater brilliance, improved keyed AGC circuit (eliminating flickering and fading). Uses the best materials with a high factor of safety to insure trouble-free operation. STD. RTMA GUARANTEE free replacement of defective parts or tubes for 90 days. Completely factory-wired chassis ready to operate with 12" P.M. Speaker. **\$144.50**  
Price Including Excise tax

## TELEVISION PICTURE TUBES Standard Brands

ONE-YEAR GUARANTEE

12½" (Black or White)	Glass 16" Round (Black)	\$22.50	\$24.50
Glass 14" Rectangular (Blk.)	Glass 16" Rectangular (Blk.)	\$23.50	\$24.50
17" Rectangular (Blk.)		\$24.50	
19" Round (Blk.)		\$34.50	
20" Rectangular (Blk.)		\$34.50	
21" Rectangular (Blk.)		\$36.50	
24" Metal		\$67.25	

Console cabinet of beautiful design made of the finest veneers and good finish. Size 39" high x 24" wide x 22¾" deep. Finished in mahogany or walnut. Cut for 630 chassis with 12" speaker; will take either 16, 17, or 20" tube. (Please Specify Size.)

Price including mask and excise tax.....\$43.95  
Extra for glass.....\$2.75

For the various other cabinets in our large selection we will furnish photos and other NECESSARY INFORMATION, ON REQUEST.

## TELEVISION COMPONENT SPECIALS

"Faster Than Hotcakes!"

That's how these original 13-channel RCA Tuners are selling. Uses 3—6J6 tubes. Sold as is, less tubes, only **\$3.95**

## NEW STANDARD COIL CASCODE TUNER

The tuner that will give you stronger, better and clearer reception. Uses 1—6J6 and 1—6BK7 Intercarrier **\$19.95**

New—DuMont Tru Focus Conversion Kit

Convert your old set for even focus over entire screen.

DuMont 70° Yoke, Model Y2A1—distributed winding.....\$6.57

DuMont 70° Flyback Transformer Model H1A1.....\$6.57

DuMont Linearity Control— for above units.....\$0.75

DuMont Width Coil—for above units.....\$0.75

## AUTOMOBILE RADIOS

Custom-Built for any of the following 1949-1950-1951-1952 automobiles—Dodge, Plymouth, Chevrolet, Hudson, Studebaker, Henry J. and Ford. Every Radio is a powerfully built, 6 tube superhet with R.F. Stage and 3 gang condenser. Each radio is Custom Built and can be mounted in the dashboard within 4 minutes. Your price including aerial \$38.47 ea.

All Merchandise Subject to Prior Sale. All Prices Subject to change without Notice.

WRITE FOR COMPLETE CATALOG N-5

## EDLIE ELECTRONICS INC.

154 Greenwich St. New York 6, New York

cycles; coaxial type fittings; 1% ceramic resistors; an illuminated drum dial; and a completely shielded, wrinkle steel cabinet.

The Model 635 has five ranges cov-



ering 20-40 cycles; 40-200 cycles; 200-2000 cycles; 2000-20,000 cycles; and 20,000-200,000 cycles.

## RECORD-REPRODUCE HEAD

The Brush Development Company, 3405 Perkins Avenue, Cleveland 14, Ohio has expanded production on the BK-1500 series multi-channel magnetic record-reproduce heads to include two additional variations which are available at standard prices.

The BK-1500A series are supplied in cartridge form less housing. These units are wrapped in Mumetal foil and are available with from 1 to 14 channels. These heads have a channel width of .050" with center-to-center channel spacing of .125". Gap width is .0005". Four free lead wires per channel are provided.

The BK-1500N series may be supplied in cartridge form or in housing. The channel width has been reduced to .044" to provide a wider land be-

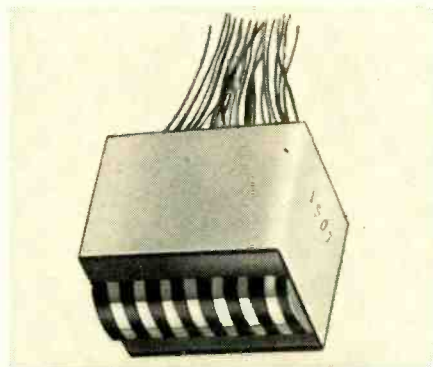

tween tracks so that two multi-channel units may be mounted in staggered fashion with interlacing channels.

Design features include precise gap alignment, balanced magnetic construction, and Mumetal shields between channels. The entire assembly is cast into one integral block of specially selected synthetic resin which makes the units moistureproof and non-microphonic.

## 5-INCH SCOPE

Hickok Electrical Instrument Company, 10677 Dupont Avenue, Cleveland 8, Ohio has recently released data on its new Model 670 5-inch scope which has been designed to permit the visual

testing and alignment of AM-FM and TV receivers when used with a frequency-modulated r.f. oscillator or sweep generator.

This model has a sensitivity of 10 mv. r.m.s. per inch to permit the proper viewing of TV response curves. The instrument covers from d.c. to 500 kc. and is usable to beyond 2 mc.

Provision is made for the direct connection to both horizontal and vertical plates of the cathode-ray tube. In addition, line phasing control, negative and positive synchronizing, reversing switches for both horizontal and vertical deflection, and provision for "Z" axis modulation, are included.

Complete information on the Model 670 is available on request.

## PRESSURE GAUGE

Garrard Sales Corp., 164 Duane Street, New York, N. Y. has introduced a new accessory unit which is designed to measure the stylus pressure of phonograph pickups.

The new stylus pressure gauge

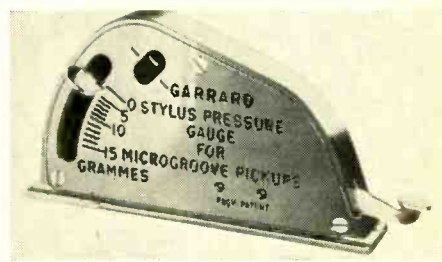

checks the weight exerted by any tone arm or pickup on the record grooves. The unit is scientifically calibrated with large, easy-to-read markings at one gram intervals. All moving parts are of lightweight alloy and completely sealed so that no damage can be done to the delicate spring mechanism. Performance characteristics will not alter due to weather conditions or continued use. The gauge is housed in a red and ivory plastic case.

## POWER UNITS

Opad-Green Company, 71-3 Warren St., New York 7, N. Y., has announced a new series of industrial power units that supply 115 or 230 volts d.c. from existing a.c. power lines.

Starting at 125 w. capacity, the series includes 42 standard models. Units are available for use with 115, 230, or 440 volts, 60 cycle a.c. All of the units are housed in ventilated cabinets.

## NEW INSULATION

Gustin-Bacon Manufacturing Co., 1412 W. 12th Street, Kansas City, Missouri, has recently introduced an improved double-duty glass fiber insulation which has been tradenamed "Ultralite."

The new insulating product is made of long, fine textile-type glass fibers, bonded together with a thermal-setting plastic resin to form a resilient, semi-rigid insulation material. It is available in varying densities. It is ex-  
(Continued on page 101)

# Rauland Tubes give you a prettier profit picture



Rauland picture tubes are first choice of an ever growing number of service dealers and men. First, because of the completeness of the Rauland replacement line.

Second, because you get the benefit of acknowledged leadership in picture tube engineering. Rauland research has developed more picture tube improvements since

the war than any other company.

You get quality you can count on, too. Rauland production employs machines unique in the industry —many of them designed by Rauland engineers and built in Rauland's own plant.

And finally, you get assurance of customer satisfaction beyond

what any other line can give you. Installation and adjustment of Rauland tubes is faster and better. The Indicator Ion Trap gives you the surest known protection against ion burn and shortened tube life.

Specify Rauland—deliver Rauland—and assure yourself of pleased picture tube customers.

## THE RAULAND CORPORATION



*Perfection Through Research*

4245 N. KNOX AVENUE • CHICAGO 41, ILLINOIS





can you  
call the  
close ones?

Much like the umpire—you can call them, if you can see them—so in television it's the "picture quality" that determines whether or not you can see them.

Be sure the TV set is "picture powered" with an Amphenol In-line Antenna—one of the first TV antennas created and still the best broadbanded type providing uniform gain and signal strength across the entire range of VHF channels.

Call the close ones with Amphenol.

AMERICAN PHENOLIC CORPORATION  
1830 SO. 54TH AVE. • CHICAGO 50, ILLINOIS

**AMPHENOL**



Dealers, Installers, and Owners of TV sets will all be interested in this free book. Write Department 13A.



## WCEMA-IRE WEST COAST MEET

By  
**RALPH L. POWER, Ph.D.**

*Western Electronic Show to be held  
August 27, 28, and 29 in Long Beach.*

ONE of the highlights of the year, as far as the West Coast electronics industry is concerned, will be the Western Electronic Show and Convention held this year at Long Beach, California, August 27, 28, and 29.

Co-sponsored by the West Coast Electronic Manufacturers' Association and the Seventh Region of the Institute of Radio Engineers, this year's event will include a comprehensive display of electronic equipment which will be on view in the more than 200 booths that will occupy two floors of the Long Beach Municipal Auditorium.

The Show Committee, which is made up of representatives from both the IRE and WCEMA, is headed by R. G. Leitner with Hecker Parker serving as business manager. Howard Grove is vice-chairman for the IRE on the committee while Leon B. Ungar, president of WCEMA, is vice-chairman representing that group.

The technical papers committee, headed by Frederick Suffield, has planned a well-rounded program which will feature well-known speakers discussing topics of interest to IRE members and other technically-minded conventioners.

The committee has planned several papers and sessions under each of twelve professional sections: airborne electronics; antennas and propagation; audio; broadcast transmission systems; circuit theory; electron devices; electronic computers; information theory; instrumentation; data handling; radio telemetry; and remote control. In addition they have planned some evening sessions on engineering management and engineering patents for those interested in these specialized topics. The lecture hours have been staggered to permit those attending the convention to cover as many of the meetings as possible.

The annual IRE luncheon will be one of the highlights of the action-packed three-day schedule. The Seventh Region's annual achievement award winners will be announced at the luncheon. A prominent speaker will address the gathering.

The all-industry cocktail party, which is open to all segments, is expected to be a sell-out.

The Los Angeles and San Francisco chapters of "The Representatives" which have always assisted with the liaison work, manning the information booths, etc., will again help smooth the way for convention delegates.

### WCEMA'S BACKGROUND

The West Coast Electronic Manufacturers' Association was organized in 1943 to assist West Coast factories in obtaining government contracts for electronic equipment.

While individual manufacturers tried the direct approach to obtain such contracts, it was not until WCEMA spokesmen went after the orders did the West Coast receive its fair share of the electronics business.

By pooling industry resources, government officials could get an over-all picture of existing facilities in the west, the potentiality of the field, the availability of skilled craftsmen, designing and engineering facilities, and the type of "know-how" which could be utilized.

Once a year WCEMA publishes a directory in which are listed information about the member-companies, an index of products manufactured, and a compilation of the Association officers, and other pertinent data.

Publication office for the Directory is at 767 Castelar Street in Los Angeles. The secretary of the San Francisco Council (J. J. Halloran) can be reached at 6021 College Avenue, Oakland 18, California. George B. Clark, the Los Angeles Council secretary, is located at 4054 Ocean Park Avenue, Venice, California.

-30-



# BUY TEST EQUIPMENT ON THIS RADICALLY NEW TIME PAYMENT PLAN

## NO INTEREST!! - NO CARRYING CHARGES!!

USE CONVENIENT TIME PAYMENT ORDER BLANK BELOW

### Superior's New JUNIOR SUPER-METER

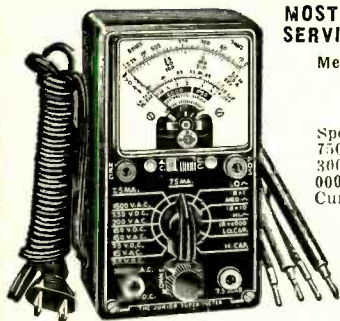

**MOST COMPLETE AND COMPACT MULTI-SERVICE INSTRUMENT EVER DESIGNED**

Measures: \* Voltage \* Decibels  
\* Capacity \* Resistance  
\* Current \* Inductance  
\* Reactance

Specifications: D.C. Volts: 0-7.5/75/150/750/1500 Volts. A.C. Volts: 0.15/150/300/1500/3000 Volts. Resistance: 0-10,000/100,000 ohms. 0-10 Megohms. D.C. Current: 0-7.5/75 Ma. 0-7.5 amps. Capacity: .001 Mfd.—2 Mfd.—1 Mfd.—20 Mfd. Electrolytic Leakage: Reads quality of electrolytics at 150 Volt test potential. Decibels: -10 Db to +18 Db. +10 Db. to +38 Db. +38 Db. to +58 Db. Reactance: 15 ohms—25 K ohms 15 K ohms—2.5 Megohms. Inductance: 5 Henry—50 Henries 30 Henries—10 K Henries. Plus Good-Bad scale for checking the quality of electrolytic condensers.

Handsome round cornered molded bakelite case 3 1/2" x 5 7/8" x 2 1/4" complete with all test leads and instructions

**\$2140**  
NET

### Superior's New Model TV-11 TUBE TESTER



• Uses the new self-cleaning Lever Action Switches for individual element testing. Because all elements are numbered according to pin number in the RMA base numbering system, the user can instantly identify which element is under test. Tubes having tapped filaments and tubes with filaments terminating in more than one pin are truly tested with the Model TV-11 as any of the pins may be placed in the neutral position when necessary. • Uses no combination type sockets. Instead individual sockets are used for each type of tube. Thus it is impossible to damage a tube by inserting it in the wrong socket. • Free-moving built-in roll chart provides complete data for all tubes. • Phono jack on front panel for plugging in either phones or external amplifier detects microphonic tubes or noise due to faulty elements and loose external connections.

Operates on 105-130 Volt 60 Cycles A.C. Hand-rubbed oak cabinet complete with portable cover

**\$4750**  
NET

### Superior's New Model 670-A SUPER-METER

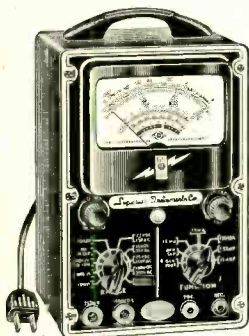

**A COMBINATION VOLT-OHM MILLIAMMETER PLUS CAPACITY REACTANCE INDUCTANCE AND DECIBEL MEASUREMENTS**

**SPECIFICATIONS:**

D.C. VOLTS: 0 to 7.5/15/75/150/750/1,500/7,500 Volts  
A.C. VOLTS: 0 to 15/30/150/300/1,500/3,000 Volts  
OUTPUT VOLTS: 0 to 15/30/150/300/1,500/3,000 Volts  
D.C. CURRENT: 0 to 1.5/15/150 Ma. 0 to 1.5/15 Amperes  
RESISTANCE: 0 to 1,000/100,000 Ohms 0 to 10 Megohms  
CAPACITY: .001 to 1 Mfd. 1 to 50 Mfd. (Quality test for electrolytics)  
REACTANCE: 50 to 2,500 Ohms, 2,500 Ohms to 2.5 Megohms  
INDUCTANCE: .15 to 7 Henries 7 to 7,000 Henries  
DECIBELS: -6 to +18 +14 +38 +34 to +58

**ADDED FEATURE:**

The Model 670-A includes a special GOOD-BAD scale for checking the quality of electrolytic condensers at a test potential of 150 Volts.

The Model 670-A comes housed in a rugged, crackle-finished steel cabinet complete with test leads and operating instructions. Size 6 1/4" x 9 1/2" x 4 1/2".

**\$2840**  
NET

### Superior's New TV BAR GENERATOR



**Throws an Actual Bar Pattern on Any TV Receiver Screen!!**

**Two Simple Steps:**

1. Connect Bar Generator to Antenna Post of any TV Receiver.
2. Plug Line Cord into A.C. Outlet and Throw Switch.

**RESULT:** A stable never-shifting vertical or horizontal pattern projected on the screen of the TV receiver under test.

TV Bar Generator comes complete with shielded leads and detailed operating instructions. Only

Power Supply: 105-125 Volt 60 Cycles. Power Consumption: 20 Watts. Channels: 2-5 on panel, 7-13 by harmonics. Horizontal lines: 4 to 12 (Variable). Vertical lines: 12 (Fixed). Vertical sweep output: 60 cycles. Horizontal sweep output: 15,750 Cycles.

**\$39<sup>95</sup>**  
NET

### New Model 200 AM and FM SIGNAL GENERATOR

Provides complete coverage for A.M.-F.M. and TV alignment

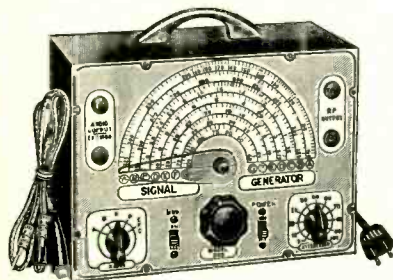

\* Tubes used: One 954 as oscillator; one 954 as modulated buffer amplifier; T-2 as modulator; 7193 as rectifier.

The Model 200 comes complete with output cable and operating instructions

**\$2185**  
NET

## NEW TIME PAYMENT PLAN ORDER BLANK

MOSS ELECTRONIC DISTRIBUTING CO., INC.

Dept. B-29, 38 Murray Street, New York 7, N. Y.

Please send me the units checked below. I am enclosing the down payment with order and agree to pay the monthly balance as shown. It is understood there will be no carrying interest or any other charges, provided I send my monthly payments when due. It is further understood that should I fail to make payment when due, the full unpaid balance shall become immediately due and payable.

- JUNIOR SUPER METER. Total Price \$21.40  
\$5.40 down payment. Balance \$4.00 monthly for 4 months.
- MODEL TV-11. Total Price \$47.50  
\$11.50 down payment. Balance \$6.00 monthly for 6 months.
- MODEL 670-A. Total Price \$28.40  
\$7.40 down payment. Balance \$2.50 monthly for 6 months.
- TELEVISION BAR GENERATOR. Total Price \$39.95  
\$9.95 down payment. Balance \$5.00 monthly for 6 months.
- MODEL 200. Total Price \$21.85  
\$5.85 down payment. Balance \$4.00 monthly for 4 months.
- I enclose \$..... as down payment.
- Ship C.O.D. for the down payment.

Signature.....

Name.....

Address.....

City.....

Zone.....

State.....

# IT'S A BIG PUBLIC ADDRESS SYSTEM YEAR—LOOK AT MCGEE'S VALUES

## ESPEY 12-TUBE FM-AM CHASSIS, \$64.50

- ★ BUILT-IN PRE-AMP FOR G.E. VARIABLE RELUCTANCE PICK-UP
- ★ WIDE RANGE AUDIO
- ★ WHY NOT ORDER WITH A COAXIAL SPEAKER AND A RECORD CHANGER? SEE OUR SPECIAL OFFERING

McGee's new 1952 model 12-tube FM-AM chassis. Latest design with phono inputs for all types of record players, crystal or G.E. variable reluctance. Receives standard broadcast 540 to 1700 kc and FM 88 to 108 mc. Wide range audio response (push-pull 6V6 output) and bass boost tone control. Loop antenna for broadcast and 300 ohm line type FM antenna may be selected in cabinet. Also equipped with rule dial, Chassis size, 13 1/2" x 9" high and 9" deep. Complete with tubes: 6BE6, 6BA6, 12A7, 6SN7, 6AL5, 6SQ7, 6X4, 12AT7, 2-6V6GT and 5Y3GT rectifier. Shipping weight 20 lbs. Stock No. 7C-X Espey 12-tube FM-AM chassis, sale price, \$64.50, less speaker. Output matches voice coil of our 12" or 15" coaxial speakers.



**ESPEY DEAL (1), \$104.95**  
Espey 7-C chassis complete with 12" coaxial FM speaker CU-14Y and VM-550 G.E. 3-speed changer equipped with a G.E. turnabout variable reluctance cartridge. A better home music system than ordinarily available. Espey Deal #1. Sale price \$104.95. With 15" coaxial FM speaker P15-CR instead of CU-14Y. \$10.00 extra.

**ESPEY DEAL (2), \$118.95**  
Espey 7-C chassis complete with 12" coaxial FM speaker CU-14Y and the English Garrard 3-speed changer equipped with a G.E. variable reluctance turnabout cartridge. Our best home music system. Espey Deal #2. Sale price \$118.95. With 15" coaxial FM speaker P15-CR instead of CU-14Y. \$10.00 extra.

**ESPEY DEAL (3) \$138.95**  
Espey 7-C chassis complete with THREE 12" coaxial FM speakers CU-14Y (these three 12" coaxial speakers give a cone area equal to an 18" speaker) and a Garrard 3-speed changer with G.E. variable reluctance turnabout cartridge, Espey Deal #3. Sale price \$138.95.

## CAPEHART CABINET, \$79.95

BLANK OR CUT TO FIT ESPEY CHASSIS

Buy this cabinet with Espey chassis and the VM changer listed above and have a fine radio-phonograph combination for less than the value of the cabinet alone. This beautiful cabinet was included for the Capehart \$500.00 combination. It is the finest possible furniture quality cabinet workmanship, 37" high, 40" wide and 21" front to back. Hinged top fits in two sections. 1 1/2" lid covers the changer compartment and is the same width of the radio compartment. Changer mounting panel is furnished blank. Radio panel is shipped ready cut to fit the 7-C Espey chassis. The changer compartment and lid are made of top quality walnut veneer. 7/8" material used throughout. Shipped via truck, rail or express only. Shipping wt. 160 lbs. Espey Deal #4. Sale price \$79.95. Stock No. C-175. With 15" coaxial FM speaker and radio panel. \$79.95. Buy 2—12" 32 oz. Alnico FM speakers for use in this cabinet for only \$15.00. (\$7.50 each).

## McGEE'S \$62.50 LIST 15" COAXIAL SPEAKER, \$24.95

21 OZ. ALNICO V MAGNET—5" TWEETER  
This is the finest 15" coaxial FM speaker value that we have ever offered. Production of a famous manufacturer of fine speakers. The 15" speaker has a 2 1/2 oz. Alnico V magnet, equal to 68 oz. of the Alnico 3 type magnet. The cone is free floating, of one piece construction. Will reproduce low frequencies down to 20 cps. The 5" tweeter is coaxially suspended and has a rigid cone to reproduce only the high frequencies. It will respond up to 17,500 cps. The high-pass filter is constructed under the pot cover, leaving only two wires to connect both the tweeter and woofer to any 8 ohm output transformer of a radio, audio, or high fidelity music lover's amplifier. Stock No. P15-CR. Shipping weight 10 lbs. 2 for \$47.95.



Another McGee Scoop! Jensen Concert 12" 14 1/2 oz. Alnico V magnet PM speaker, 8 ohm voice coil. Will take 25 watt output. You save dollars on this speaker. Just 100 to sell. Shipping weight 8 lbs. Stock No. P-12P. Sale price \$15.95; 2 for \$30.00.

**12" COAXIAL SPEAKER, \$12.95**  
McGee offers the new 1952 model 12" coaxial FM speaker. Quality you would put in your finest sets if you were a manufacturer. 12" woofer has 6.8 oz. Alnico V magnet. Tweeter is coaxially suspended and has a metal diffuser. High pass filter under the pot cover. Only two wires to connect to your radio or audio amplifier. 8 ohm with 18 watt peak and 10 watt average. Shipping weight 8 lbs. Response from 30 to 17,500 cps. Stock No. CU-14Y. Sale price \$12.95 each; 2 for \$25.00.



**12" JENSEN PM, \$15.95**  
Another McGee Scoop! Jensen Concert 12" 14 1/2 oz. Alnico V magnet PM speaker, 8 ohm voice coil. Will take 25 watt output. You save dollars on this speaker. Just 100 to sell. Shipping weight 8 lbs. Stock No. P-12P. Sale price \$15.95; 2 for \$30.00.

## 3-SPEED CHANGERS ON SALE AT MCGEE

**WEBSTER CHICAGO MODEL 100-2 ONLY \$26.95**  
For the first time we offer the world famous Webster-Chicago, model 100-2. Features a newly designed spindle, that drops the records flat, cushioned to the turntable. Pickup arm sets down automatically after the last record plays. Plays all records automatically at 33 1/3, 78 and 45 rpm. New 1/2" tone arm with Electro-Voice P15-A-MC cartridge with dual needles. Ordinarily cost over \$37.00. McGee offers them with only \$26.95 each. Base size 12"x12 3/4". Shipping weight 14 lbs.

**V.M. 3-SPEED MODEL 406 \$22.95**  
VM model 406, deluxe 3 speed automatic record changer. Plays them all. Intermixes records of the same speed with a flip over crystal pickup with twin needles. Base size, 12"x13". Shipping weight 12 lbs. VM-406. Net price \$22.95.

**G.I. 3-SPEED CHANGER WITH G.E. \$22.95**  
Another tremendous McGee Scoop! Brand new General Instruction 3-speed automatic record changers. Complete with IPN-050 G.E. variable reluctance cartridge with turn-about stylus. Plays all 3 speeds automatically. 7", 10" or 12" records. Has reject button. Repeats last record. Base size, 12"x12 3/4". Shipping weight 14 lbs. Stock No. 700-GE. Scoop price, \$22.95.



## ELECTRONIC RADIO and TV TUBES

• 6 MONTHS' GUARANTEE • INDIVIDUALLY CARTONED  
• IN RED AND BLUE DE LUXE VARNISHED CARTONS  
• EVERY TUBE SET TESTED FOR YOUR PROTECTION  
ORDER 50 ASSORTED—TAKE 10% OFF. Prices as Low as 36c

024	59	6A05	59	6SA7GT	89	724	69
106	59	6AT6	49	6SD7GT	59	12A7	69
104	69	6AU6	49	6SE7GT	59	12A7B	69
1H5	59	6B7	49	6SK7GT	59	12AV7	89
1J6	59	6BB6	69	6S67	69	12AX4GT	69
1L4	59	6BA6	69	6SK7GT	59	12BA6	59
1L5	59	6B7	69	6SN7GT	69	12B6	59
1LCS	79	6BC5	59	6SL7GT	69	12B7A	69
1LE3	79	6BE6	59	6SN7GT	69	12B7B	59
1LCS	79	6BC6	1.59	6R6GT	69	12BF6	79
1RS	59	6BH6	59	6U7G	69	12J5GT	69
1LN5	59	6BJ6	59	6U6GT	59	12J7GT	69
1S5	59	6BK7	59	6V6GT	59	12K7GT	69
174	59	6BQ6GT	99	6W4GT	59	12O7GT	69
1U4	59	6C4	49	6X	49	12S7GT	59
1U4	59	6B7GT	59	6X5GT	59	12S7GT	59
2X2	89	6C8B	59	6Y7G	99	12S7GT	59
3A4	69	6CD6C	1.49	6Z55G	59	12SK7	59
3V4	69	6BE6T	59	6Z6GT	69	12S8GT	59
3V4	69	6IS6T	49	7E5	69	12SR7	69
3V4	1.49	6K6GT	49	7E6	69	14A4	69
5X4	69	6K7	49	7E7	69	14A4	69
5X4	69	6K7C	59	7H7	79	14C5	1.09
5Y3	40	6L6G	1.09	7N7	59	14A7	79
6AB4	69	6C6	99	7Y7	99	14D6	99
6A5	69	6P5GT	59	7X7	99	19T8	89
6AK5	69	6S4	59	7Y4	79	25BQ6GT	99

## 50-WATT BOOSTER AMPLIFIER—\$39.95



**25-Watt Horn \$28.95**  
**50-WATT BOOSTER** A sensational value, 50 watt booster amplifier with push-pull parallel 6L6 output tubes. Connect to your present amplifier as a booster or use with the PL-3X crystal or dual diode type one low level input. The booster amplifier has one input jack and with 1 volt input gives 50 watts of audio. Booster has a 6 lb. potted case high fidelity output transformer, matches speaker with 4-16 ohm voice coil, also 60 ohm and 250 ohm line booster. Has a 2.5 mill power supply with 5U4 rectifier. Price includes tubes: 4 6L6, 7N7 and 5U4. The two variable controls are for master volume control and bass boost tone control. Size 8 x 6 1/2 x 1 1/2. Stock No. PA-55N. Shipping weight 25 lbs. Sale price \$39.95 ea.

**2-MIKE PRE-AMP.** Pre-amplifier plugs in directly to the PA-55N Booster amplifier. It enables use of 2. Crystal or Dynamic Mikes plus one low level input. Furnished with 4 foot cables and plugs for remote control of the 55 watt Booster Amplifier. Small chassis size 5 x 3 1/4 x 4". Stock No. PR-2X, with tubes 7F7 and 7B7. Net price \$12.95 ea.

**25-WATT HORN** 25-Watt Driver and 3 1/2-foot air column re-entrant Trumpet. The standard type trumpet and driver you see the most. Drivers are 100% weatherproof, horn is spun aluminum, offered to you at a considerable savings. Stock No. MA-33. Shipping weight 20 lbs. Net price \$28.95.

## 25-WATT 6-110 VOLT MOBILE AMPLIFIER, \$115.95

REGULAR \$190.00 LIST—1952 MODEL  
**25-WATT TRUMPETS AND DRIVER \$28.95 EACH EXTRA**



25 watt Mobile Amplifier has built-in phono unit, illuminated control panel, separate volume controls for microphone and phono and tone control. Power output 25 watts at less than 5% distortion. Peak power 38 watts. Frequency response: plus or minus 2 db. to 15,000 cps. Overall gain: Microphone channel 115 db.; phono channel 82 db. Hum level: 60 db. below rated output. One microphone and one phono input. Impedance 10 meg. microphone channel, 1/2 meg. phono channel. Controls: Microphone volume, phono volume, tone with AC switch, standby switch and 100% weatherproof horn is spun aluminum, offered to you at a considerable savings. Stock No. MA-33. Shipping weight 40 lbs. Net price \$115.95. Use either 2, 3, or 4 of our MA-33 25 watt trumpet and driver combinations, pictured at top of this page. Net price, \$28.95 each, or any combination of PM speakers and baffles shown below. Astatic JT-30 crystal mike and desk stand, \$9.95 extra.

## TERRIFIC VALUES IN SPEAKERS AND Baffles

**8" PM AND LEATHERETTE Baffle, \$4.95**  
LOTS OF 10, \$4.75  
The finest Leatherette Baffle we have ever offered. New self-supporting plastic grill material, baffle is covered tan with matching grill. Offered with a good heavy duty 8" Alnico PM speaker with 3.2 ohm voice coil. Stock No. 8R. Speaker and Baffle, \$4.95 ea.; lots of 10, \$4.75. Baffle only. Stock No. NV-8, \$2.29 ea.; 10 for \$19.95.

**12" PM AND WALNUT Baffle, \$9.95**  
LOTS OF 3, \$8.95  
The finest built 12" Walnut plywood wall baffle we know of. Factory cost of the famous juke box manufacturer exceeds \$7.00. We offer with 12" Alnico PM for 10% more. You pay only \$9.95 in single lots, or \$8.95 in 3 lots for both a 12" Quam Alnico V PM with 3.2 ohm voice coil and the beautiful wall baffle. 12" Speaker Baffle combination, Stock No. BS-12Q, \$9.95 ea.; lots of 3, \$8.95 ea. 12" Baffle only, \$2.62. \$4.95 each.

## MIKES AND STANDS

**4D-T, high impedance dynamic mike with 12 feet of cable.** Said to be the highest quality microphone. 6 1/2" chrome floor stand for mike, \$5.88.

**McGee's Super High Fidelity Best Value in U. S. A.**  
**OUTPUT TRANS. 20-20,000 CPS. \$7.95**  
Model A-403 High fidelity output transformer. Why pay \$20 or \$30 for an output transformer when A-403 is available at \$7.95? Impedance, 6000 ohms plate to plate for PP 6L6 or 6V6, 10% feedback winding, 4-8 15-250 and 500 ohm secondary. Housed in a potted case. Net weight 6 lbs. Recommended for all amplifiers up to 34 watts.

## TERRIFIC FLUORESCENT FIXTURE SALE

IS YOUR SERVICE DEPT. PROPERLY LIGHTED? SAVE 50% ON THIS 4-LIGHT FIXTURE \$12.95, TWO FOR \$25.00 WITH LAMPS  
TOP ILLUSTRATION—This is the finest value in a fluorescent fixture that we have ever offered. Constructed of heavy gauge metal with lustre white enamel finish. Furnished with General Electric 37" 30 on chains. These fixtures are beautifully constructed. Use them over your service bench. In your new factory cartons properly packed for shipment. These fixtures sold for up to \$30.00. We bought 6 truck loads and are passing our bargain on to you. Why pay more than this to modernize your shop. Shipping weight 26 lbs. each. Shipped via Express, Rail Freight or Truck only. Stock No. MK-430 fixture complete, Net \$12.95; 2 for \$25.00.

## DELUXE MODEL WITH GLASS, \$14.95; CEILING CANOPY, \$1.95

Deluxe Model No. MK-430N, same as No. MK-430, but that it has translucent glass over the lamps to diffuse the light. CEILING CANOPY that is shown, \$4.95 extra. Shipping weight 23 lbs. Net price \$14.95; 2 for \$28.00.

Canopy for suspending either of the above fluorescent fixtures 30" from the ceiling. For use where it isn't advisable to mount fixture flush or suspend it on chains. Canopy kit is complete with stamped metal box cover with hardware for mounting to any outlet box and 2-30" lengths of 3/8" white enameled tubing. Ship. wt. 6 lbs. Fixture canopy kit, No. 1-30, \$1.95.

McGEE RADIO COMPANY Prices F.O.B. K.C. Send 25% Deposit with Order, Balance Sent C.O.D. With Parcel Post Orders, Include Postage TELEPHONE VICTOR 9045. WRITE FOR FLYER 1422 GRAND AVE., KANSAS CITY, MISSOURI



# MERIT

tv full-line\*  
components give  
universal coverage

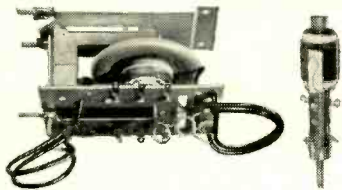

**NEW IMPROVED HVO-7 FOR GREATER COVERAGE**  
Tapped AFC Winding. Covers Admiral Chassis 21-24 Series.

**MWC-1 UNIVERSAL WIDTH COIL**  
(3-27 MH) A Tapped Secondary For AGC or AFC.



**IF-RF COILS**  
Only complete line of TV replacements.



**"COSINE" YOKES**  
Complete with leads & network.

MATCHED FOR DIRECT DRIVE



**MDF-30 HVO-8**  
A-3080 Vert. Mtg.  
A-3081 Horiz. Mtg.  
Autoformer



**KIT NO. 1000**  
MATCHED SET FOR SPEEDY  
PROFITABLE SERVICE!

**MERIT . . . HQ for PRACTICAL TV Service Aids**

MERIT'S 1952 Catalog No. 5211 with new MERIT IF-RF Coils.

Other MERIT service aids:

TV Repl Guide No. 404, 3500 models & chassis.

Cross Ref Data, IF-RF Coils, Form No. 14.

See your Jobber or write: Merit Coil and Transformer Corp., 4425 Clark Street, Chicago 40.



These three MERIT extras help you:  
Exclusive: Tapemarked with specs and hook-up data. Full technical data packed with every item. Listed in Howard Sams Photo-facts.



\*Merit is meeting the TV improvement, replacement and conversion demand with a line as complete as our advance information warrants!

## Signal Tracing Probe

(Continued from page 59)

from poor sync stability to "over-contrasty" pictures lacking in definition. In most cases, the exact cause of the complaint is difficult to find, especially when using conventional servicing techniques.

Where a signal tracing technique is used, on the other hand, distortion is readily apparent as a change in the detected video signal.

Either the top or bottom (or both) of the video signal may be flattened or clipped. See Fig. 5C. Where the top of the video signal is flattened, as at 1 in Fig. 5C, the complaint will be either loss of sync or sync instability. Sync instability usually shows up first in the horizontal sweep circuits.

Where the picture portion of the composite video signal is flattened or clipped, as at 2 in Fig. 5C, the uneven and jagged video signal is replaced by a bright and straight line. The "body" of the signal will still be shaded, however. With this type of distortion, the picture will lack definition and may be over-contrasty.

Under some circumstances, both types of distortion may occur at the same time—compare the distorted video signal in Fig. 5C with the appearance of the "normal" video signal of Fig. 5A, noting particularly the differences in the top and bottom portions of the signal.

Distortion may be caused by incorrect operating voltages, a defective tube, too strong an input signal, improper operation of the a.g.c. circuit and similar defects. Once the distortion is isolated to a specific stage, using the probe, it is a simple matter to identify the exact cause of the trouble by making voltage checks and trying a substitute tube.

Under some circumstances, distortion may cause the output signal amplitude to be less than the input—a symptom similar to that obtained with a "weak" stage. Extreme overload may cause a reversal in signal phase due to detector action in the i.f. stage itself.

Since the detection of the i.f. normally takes place in the probe, the video signal seen on the screen of the CRO will maintain the same phase relationship regardless of which i.f. stage is being checked. If the pulses are at the top of the video signal (on the scope screen), they should remain there regardless of the point at which the probe is touched in the i.f. strip. If detection occurs in one of the i.f. stages, on the other hand, the video signal may be seen to reverse phase on the screen of the CRO when that stage is checked.

As experience is gained in using the probe, the technician will soon be able to tell the most probable cause of the distortion from the appearance of the distorted video signal.

-50-

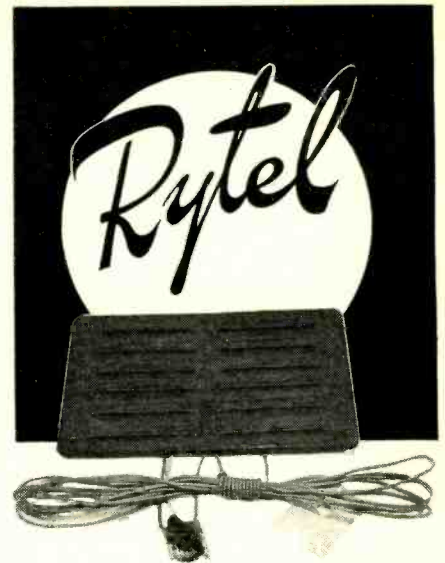

**tops again!**



with our latest  
product - the new  
**R E A R  
S E A T  
S P E A K E R  
G R I L L E**

EASY TO FORM  
ALUMINUM  
FITS ANY CAR  
BEAUTIFULLY FINISHED

**No. RSG 60K**

with mounting screws, switch,  
bracket and wire.

**No. RSG 60**

with mounting screws only.  
SEE YOUR LOCAL DISTRIBUTOR



**ELECTRONICS MFG. CO.**

9820 IRWIN AVENUE  
INGLEWOOD, CALIFORNIA

**RADIO & TELEVISION NEWS**

## Within the Industry

(Continued from page 26)

The move provides additional facilities for the manufacture of the company's line of relays, thermostats, etc. . . .

**AJAX CONDENSER CO., INC.** of Chicago has opened a West Coast factory at 10905 Chandler Boulevard in North Hollywood, California. The new firm will be known as **AJAX CONDENSER CORP.** and will supply condensers for the electronic and electrical industries on the West Coast . . .

**ALPHA METALS, INC.** has a new address. The firm is now located at 56 Water Street in Jersey City, New Jersey. The mail address is P.O. Box 34, Bergen Station . . .

**GENERAL ELECTRIC COMPANY** is building a multimillion dollar transformer manufacturing plant in Rome, Georgia. Completion is scheduled for mid-1953. The plant will provide employment for about 1700 persons . . .

**JERSEY SPECIALTY COMPANY**, manufacturers of TV lead-in wire, etc., is scheduled to move into its new and modern plant on Route 23 in Mountainview, New Jersey by mid-September. The new factory will provide 1250 square feet of manufacturing space . . .

**COLUMBIA BROADCASTING SYSTEM** has purchased a depot and office building at West 56th Street in New York which will be converted into the largest TV programming plant on the Atlantic seaboard. The present building contains over 405,000 square feet of floor space.

\* \* \*

**H. EVERETT SMITH** has been named president of *The Wilcox-Gay Corporation* and *Garod Radio Corporation* of Charlotte, Michigan, and Brooklyn, New York.



Mr. Smith recently resigned his position as senior vice-president of the *Marine Midland Trust Company* of New York to accept this new post. He will occupy the position formerly held by Leonard Ashbach, who continues as chairman of the board of directors of the two companies and chief executive officer.

Mr. Smith had been associated with the *Marine Midland Trust Company* for a period of 11 years and prior to that served 14 years with the *Manufacturers Trust Company*. He will maintain offices at the company's Brooklyn plant at 70 Washington Street.

\* \* \*

**JOHN Q. CANNON**, assistant secretary of *Radio Corporation of America*, has been named secretary of the company by the board of directors. He has been with the company since 1945 . . . The French Government has conferred the rank of Chevalier in the National Order of the Legion of Honor on **DR. ALLEN B. DU MONT**. The honor was bestowed in recognition of his services on behalf of the Allied cause during

August, 1952

# outsells all others combined

## MODEL 260 VOLT-OHM-MILLIAMMETER

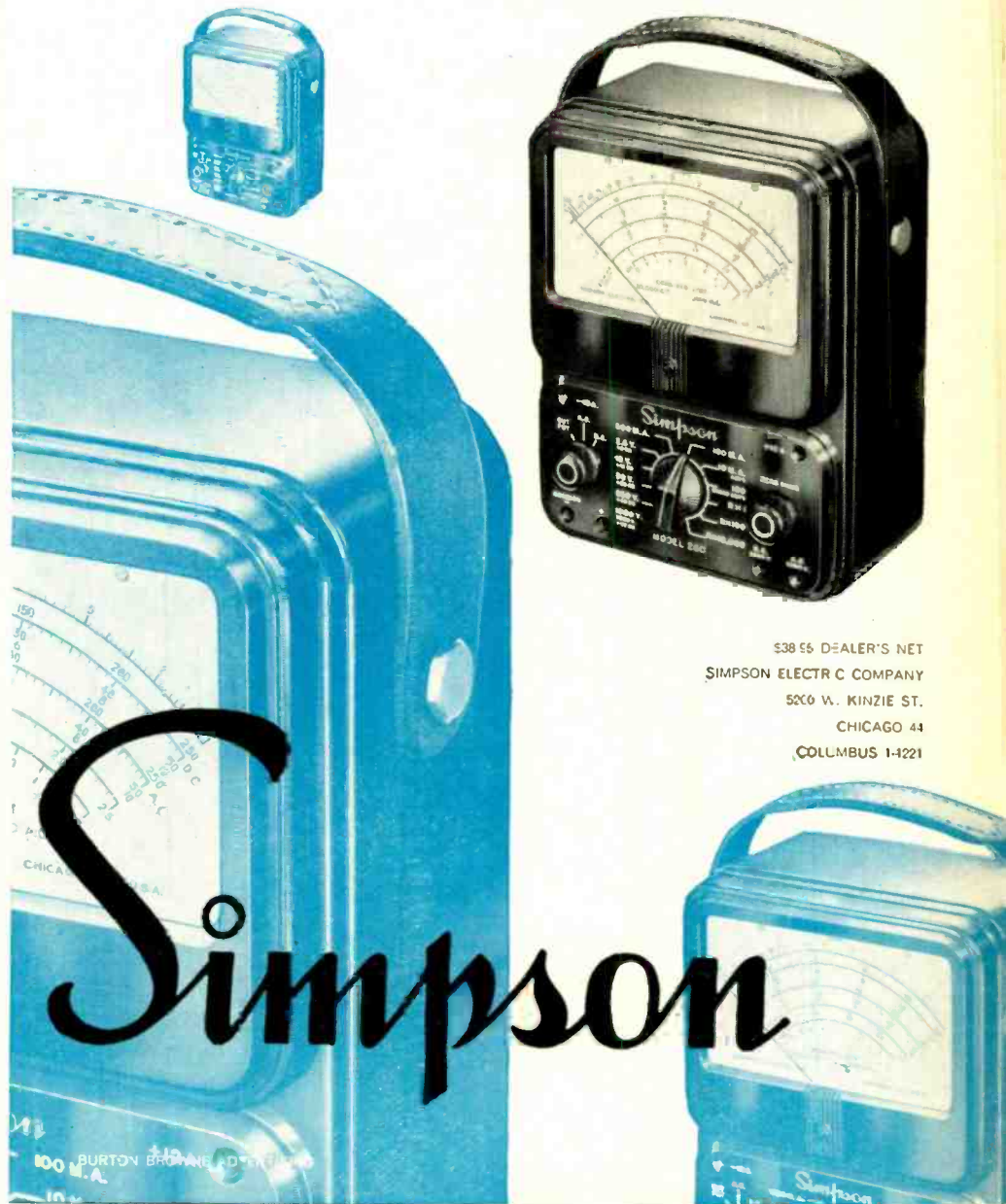

538 55 DEALER'S NET

SIMPSON ELECTRIC COMPANY

5206 W. KINZIE ST.

CHICAGO 44

COLUMBUS 1-1221

# Simpson

**Moody Kit** TOOLS ARE A MUST  
IN RADIO, T.V. AND  
ELECTRONICS

Your tool box is incomplete if it lacks Moody Kit precision small tool sets. The PA-5 Kit shown contains five interchangeable Allen type and Phillips head screw drivers. Ask to see the complete Moody line at your local stores.

SEND FOR FREE DESCRIPTIVE BOOKLET  
**Moody MACHINE PRODUCTS CO., INC.**  
4 Culver Street, Providence 5, Rhode Island

## EASY TO LEARN CODE

It is easy to learn or increase speed with an Instructograph Code Teacher. Affords the quickest and most practical method yet developed. For beginners or advanced students. Available tapes from beginner's alphabet to typical messages on all subjects. Speed range 5 to 40 WPM. Always ready—no QRM.

ENDORSED BY THOUSANDS!

The Instructograph Code Teacher literally takes the place of an operator-instructor and enables anyone to learn and master code without further assistance. Thousands of successful operators have "acquired the code" with the Instructograph System. Write today for convenient rental and purchase plans.

## INSTRUCTOGRAPH COMPANY

4711 SHERIDAN ROAD, CHICAGO 40, ILLINOIS

# AMAZING NEW TRANSMITTING-RECEIVING STATION

**weighs 7 lbs...  
sends 40 miles**

**plugs into ordinary 110V  
AC receptacle...6V battery  
or auto cigar lighter**

Now, you can have a completely portable, transmitting and receiving station that operates from either a fixed or mobile location, for only a fraction of the cost you ever thought possible. Today, the new Deltronic simple, low-cost unit makes all other complicated systems obsolete.

### SIMPLE! FOOLPROOF!

Weighing approximately 7 pounds, the CD 144, measures only 6½" wide, 6" deep and 9½" high. Equipped with 19" whip antenna and jack suitable for coupling to other antennas. It plugs into an ordinary 110 volt AC receptacle...plugs into the cigar lighter of your car...or runs on an ordinary 6 volt battery. The range...UP to 40 miles!

### ENJOY THESE FEATURES

Deltronic Company, with its vast resources and electronic "know-how" has built the new CD 144 Transmitter-Receiver to assure you of reliable foolproof

Also  
available  
for 6 and 10  
meters and  
commercial  
frequencies

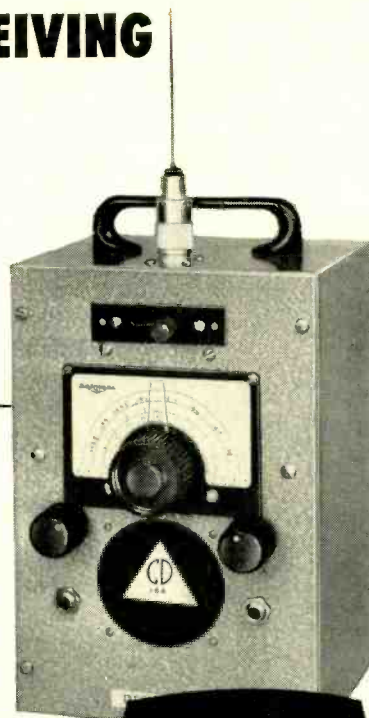

**MODEL CD 144  
ONLY  
\$169<sup>50</sup>**  
Includes Federal Excise  
Tax. Microphone and  
crystal not supplied.

two-way communication. The unit contains complete line isolated power supply and vibrator, a built-in noise limiter and crystal controlled transmitter using the newest miniature tubes. Its two meter band is calibrated for 143.8 to 148.1 Mc.

See your distributor or write direct for complete information about the new Deltronic CD 144 Transmitter-Receiver.

### MAIL COUPON TODAY

DELTRONIC COMPANY  
9010 Bellanca Ave., Los Angeles 45, Calif.  
Rush to me AT ONCE complete information about the new  
CD 144 Transmitter-Receiver Station.

I Am A Jaber     Dealer     Radio Operator

Name \_\_\_\_\_

Firm Name \_\_\_\_\_

Street Address \_\_\_\_\_

City \_\_\_\_\_ State \_\_\_\_\_



World War II, through his scientific work, and for his contributions to commercial relations between the U. S. and France . . . **HENRY MARKS** has been named assistant general manager of *Jerrold Electronic Corporation* of Philadelphia. He has been with the firm since 1948 . . . **AL FRIEDMAN** is the new national field sales engineer for *Ram Electronics Sales Co.* He has been associated with several well-known electronics firms and is familiar with all phases of the radio and electronic industry . . . **DONALD C. CARTER** has joined *The Magnavox Company* as assistant to the president. He joins the Fort Wayne firm after three years as a plant manager for *Ford Motor Company* . . . **THOMAS F. JOYCE** has been elected president of *Raymond Rosen & Company, Inc.* and the *Philadelphia Appliance Service Corporation.* Prior to joining the distributing firm in 1945, he served in various executive capacities with *Radio Corporation of America* . . . **DARRELL KNIGHT** has been named manager of trade press relations for *Motorola Inc.* He succeeds **DALE SAMUELSON** who has left the company to accept a position as national sales promotion manager for a well-known electronics manufacturer in the East . . . The board of directors of *P. R. Mallory & Co., Inc.* has elected **FRANK B. POWERS** to the post of vice-president in charge of manufacturing. He was formerly associated with *Federal Telephone and Radio* where he was vice-president in charge of operations and a member of the board of directors . . . **SAMUEL B. WILLIAMS** has been named assistant to **PRESIDENT DON G. MITCHELL** of *Sylvania Electric Products Inc.* He has been director of public relations for the firm since 1949 . . . **ED FALLS** is the new regional manager for *Motorola's* southwest sales area. He will cover the states of Texas, Oklahoma, Arkansas, Louisiana, and New Mexico . . . **VIRGIL B. DAY** has been named manager of employee and plant community relations for *General Electric Company's* receiver department . . . **JACK ABEL** has joined the *Insuline Corporation of America* where he will take charge of the company's mechanical engineering department . . . *CBS-Columbia, Inc.* has appointed **BERNARD M. DOVER** to the post of project engineer. He was formerly associated with *Emerson Radio and Phonograph Corporation* in charge of its tuner department . . . **IRVING HERRIOTT, JR.**, district sales manager for *Zenith Radio Corporation*, passed away recently while in Washington, D. C. on a business trip. He had been associated with the firm since 1937 . . . **GEORGE W. HENYAN** has resigned as chief of the components branch of the National Production Authority's Electronics Division to rejoin *General Electric Company* as assistant to the general manager of the Tube Department . . . **JAMES M. SKINNER, JR.** has been named vice-president-distribution for all domestic divisions of *Philco Corporation* of Philadelphia.

# Fill your parts requirements from a single dependable source

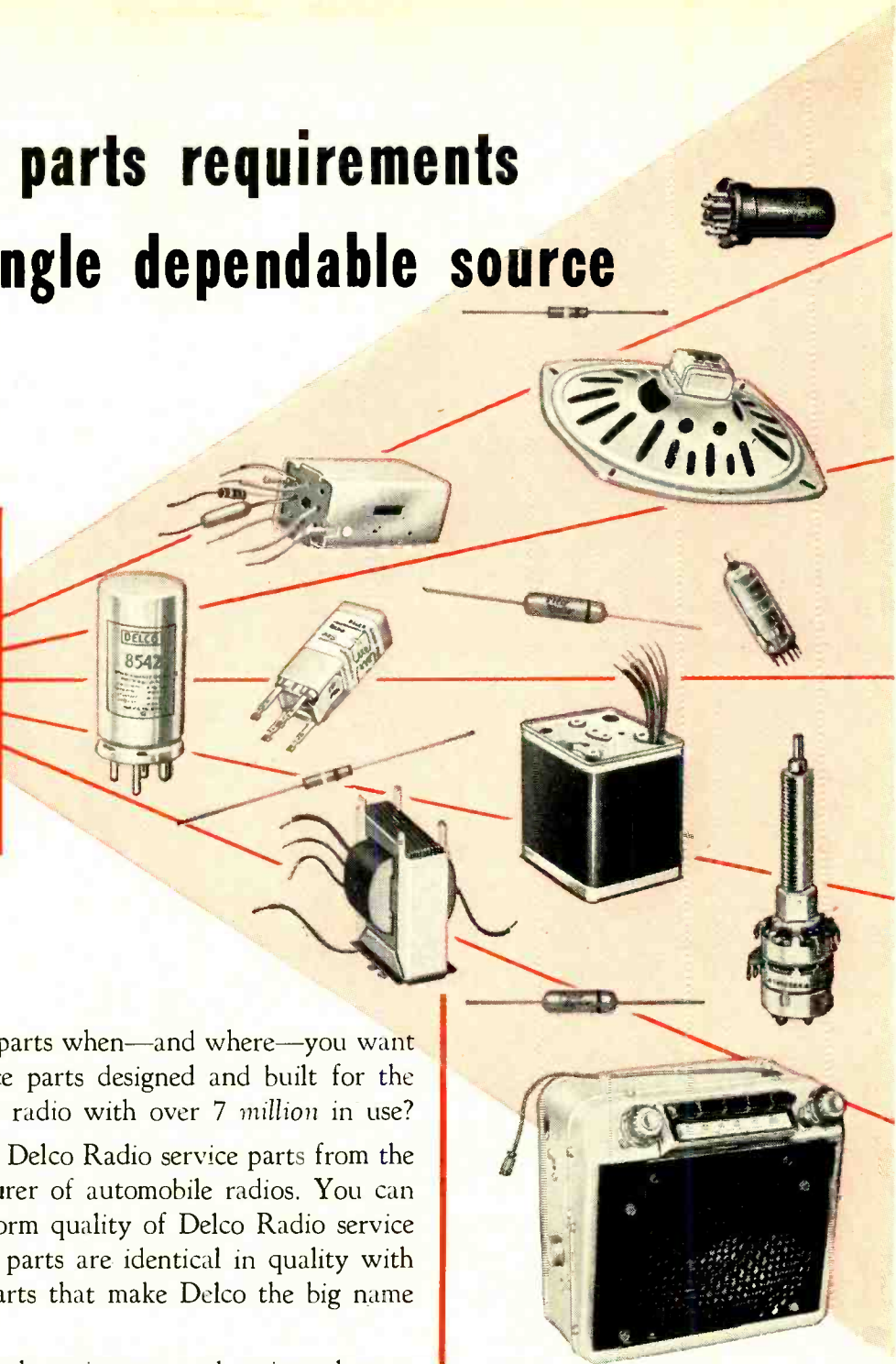

Want good radio service parts when—and where—you want them? Want radio service parts designed and built for the world's most popular car radio with over 7 million in use? If you do . . . you want Delco Radio service parts from the world's largest manufacturer of automobile radios. You can depend on the high, uniform quality of Delco Radio service parts. These replacement parts are identical in quality with the original equipment parts that make Delco the big name in car radios.

Both Delco Radio original equipment and universal service parts are available promptly through United Motors wholesalers.

## DELCO RADIO PARTS

A GENERAL MOTORS PRODUCT   A UNITED MOTORS LINE

**DISTRIBUTED BY WHOLESALERS EVERYWHERE**

## DELCO RADIO

DIVISION OF GENERAL MOTORS CORPORATION  
KOKOMO, INDIANA

### THINGS TO REMEMBER ABOUT DELCO RADIO SERVICE PARTS

- 1 Offer largest market for original-equipment replacement parts.
- 2 Backed by world's largest factory devoted exclusively to automobile radios.
- 3 Designed by one of the largest and most forward-looking engineering groups devoted exclusively to automotive radio.

THE 3 Bs... BEETHOVEN, BRAHMS AND BACH

they're different  
they're improved  
they're better than ever!

Yes, Bach, Beethoven and Brahms are now better than ever—we don't mean we've improved their music, but we do mean we've improved the reproduction of their recorded music.

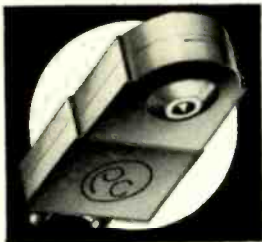
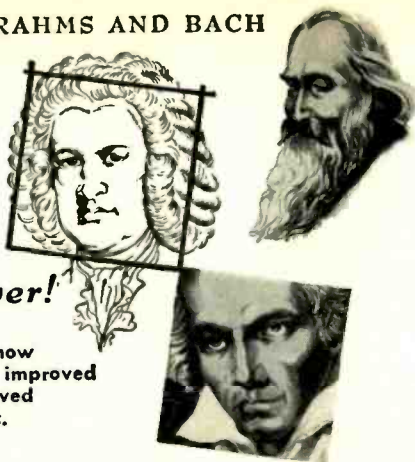

It's the new, improved Pickering Cartridges that give credence to this claim. Yes, Pickering Cartridges are different. They're improved. They're better than ever. Pickering patented Cartridges with Dynamic Coupling\* are superior in every way, by providing: HIGHER FREQUENCY RESPONSE • NEGLIGIBLE INTERMODULATION DISTORTION • BETTER TRACKING CHARACTERISTICS  
\*DYNAMIC COUPLING ASSURES constant stylus contact with the record grooves over the entire audio spectrum (20-20,000 cps) • full frequency response • full transient response • no resonances • no mistracking • no grinding of groove walls

PICKERING and company, incorporated



Pickering High Fidelity Components are available through leading Radio Parts distributors everywhere; detailed literature sent upon request. Address Department C

Oceanside, L. I., New York



SUMMER SALE  
PRICES SLASHED

T.V. TUBES—ROCK BOTTOM PRICES  
In lots of 6 each No. only

6BG6	99c	4BQ6	74c
19BG6	99c	6AQ5	49c
12AX7	59c	1CD6	\$1.29
6CB6	59c	6S4	49c
6AK5	79c		

Westinghouse Kuprox Rectifier 0.64 Amp. 28 Volts. Reg. \$11.00 ea. Special... \$1.95

12 BRAND NEW 10" PHONO RECORDS—Ass't. Jazz—Popular, Rhythm—Blues. Please specify \$1.79

Single Pole—10 Pos. 2 Gang Switch... 29c

2 piece, 5 pole Male and Female separable Amphenol plugs. Both with Flex. shielded cables. Approx. 5 ft. long. 35c pair... 3 pr. for \$1.00

Grind your own Crystals. Pure Brazilian Quartz. Various sizes and thicknesses. 1/4 lb. pkg. \$1.00

4 Tube Drilled Chassis. 4 1/2" x 6 1/2" x 1 1/2". 29c each

4 inch P.M. SPEAKER... \$1.50

5 in. 450 ohm Dynamic Speaker... \$1.35

Signal Corps Phones—2 M. Ohms (8 M. Ohms Imp.)... \$1.25

2 Ft. Ext. Cord (and Plug)... 40c

TOBE TUBULAR ELECTROLYTICS

20-20 MFD. 150 V... 49c 30-30 MFD. 150 V... 57c 40-40 MFD. 150 V... 59c

Low-Loss Short Wave Lock Type Air Trimmer Variable Condensers

5 Pl.—20Mmfd. . . . 14c

7 Pl.—25-30 Mmfd. . . . 15c

8 Pl.—30-35 Mmfd. . . . 16c

14 Pl.—56 Mmfd. . . . 24c

1,000 OHM WIRE WOUND POTENTIOMETER... 15c

30 HY-FILTER CHOKE SHIELDED... 3 for \$1.25

PIEZO CRYSTAL HOLDERS. 12 for \$1.00—\$6.00 per C

RCA Band Switches—3 gang, 3 pos. 3 band. 30c 6 gang, 4 pos. 4-5 band. 40c

Trimmer-Padder Ass't. all Isolantite—singles. (Half triples—100 ass't.)... \$2.25

Philco push button Rotary Switch Double Pole... 35c

ATTENTION: Prospectors, Explorers for Hidden Treasures! Construct a U.S. Army Type of Metallic Mine Detector Amplifier. Amplifier unit only (less tubes and batteries) with cables, headphone cord, and jack. Army wiring diagram. Type AN/PRS-1... \$1.95

RCA Ass't Mica By-Pass Cond. .001. 100 for... 95c 8 or 9 Gang Push Button Switch... 49c

DRILLED CHASSIS FOR 5-8 tubes 5"x10"x1 1/2". 25c

PHONE JACKS—OPEN & CLOSED AUTO... 18c

156-1 RATIO VERNIER DIALS—4 in., 3/8 in. Hub. 35c

SALE—PHONO RECORD ALBUMS—12"—3 comp. 15c; 10"—3 comp.—15c; 4 comp. 20c; 12 comp. 69c

VULCAN HEAVY DUTY 100 WATT SOLDERING IRON. Built for U.S.N.—Brand New—Envi. sells for \$8.50. OUR PRICE \$2.99

MINIMUM ORDER \$3.00—NO C.O.D. SHIPMENTS—PLEASE INCLUDE POSTAGE

NEWARK SURPLUS MATERIALS CO.

324 Plane Street Dept. AU NEWARK 1, N. J.

BUILD UR OWN  
NOVICE 10 W. XMITTER!

Based on article in the 1952 RADIO AMATEUR'S HANDBOOK INEXPENSIVE XTAL-CONTROLLED 2-TUBE KIT for the BEGINNER! Complete with Power Supply!



Arrow Electronics has brought out in kit form all the parts needed to build the novice or beginner's crystal-controlled 80 meter transmitter described on pages 154-158 in the 1952 Radio Amateur's Handbook. Arrow has modernized it so that the entire unit, including power supply, will mount on one metal chassis. Simple to wire, almost anyone can assemble it in a few hours. Operates with almost any random length of wire as antenna.

Look At These Many Features!

- 10 Watts Input
- 350 V. Power Supply
- 0-100 Ma DC Meter
- Xtal-Controlled, 3700-3750 Kc
- 115 V. AC Line
- Built-in Antenna Tuner
- Built-in Keying Jack
- 80 Meter Operation
- Uses 6AG7 & 6X5 Tubes

COMPLETE KIT OF PARTS only \$19.95 less crystal, wire & solder

Prices f. o. b. N. Y. 25% deposit with C.O.D. orders

Complete kit of parts, including 2 tubes, blank aluminum chassis, template, 80 M. coil, condensers, resistors, meter, power supply components, chokes, lugs, wiring diagram and instructions, etc., less wire, solder and crystal... \$19.95 80 meter crystal... additional \$2.70

W2PGP • W2JRF • W2UG2 in attendance will help you with any of your "ham" problems.

ARROW ELECTRONICS INC.

82 CORTLANDT ST., Dept. C. N. Y. 7, N. Y. • Cable: "AROLECTO—N. Y."

Manufacturers' Literature

Readers are asked to write directly to the manufacturer for the literature. By mentioning RADIO & TELEVISION NEWS, the issue and page, and enclosing the proper amount, when indicated, delay will be prevented.

NEW MACHINE BROCHURE Chicago Rivet & Machine Co., 9600 W. Jackson Blvd., Bellwood, Illinois, is currently offering copies of its two-color broadside which describes in detail the company's new No. 214 double riveter.

This unit, which is suitable for various types of assembly work, can set two rivets at a time on either one of two selected fixed centers. The foot-operated pneumatic control instantly shifts one riveting head from one selected riveting position to the other at the will of the operator. Adjustable stops permit a wide selection of any desired riveting centers ranging from 3/8" to 2 1/2" with a maximum of 6".

The new bulletin describes in detail the operation and setting up of the unit and lists complete specifications. A copy of the broadside is available without charge from the company direct.

STEEL FASTENINGS

A new 20-page catalogue which provides detailed product specifications to aid in selecting and ordering stainless steel fastenings has just been issued by Star Stainless Screw Company, 195 Union Avenue, Paterson 2, New Jersey.

Illustrations of the products in each classification quickly identify the various items. Specifications such as measurements and materials are clearly listed in easily-read chart form. The product categories include all types of screws, nuts, bolts, washers, pins, studs, rivets, nails, etc.

On the four pages devoted to stainless steel specialties, diagrammatic drawings are provided to fully describe the various fittings. In addition, several pages are devoted to decimal equivalents of pertinent fractions and the structural quality and suitability of the standard stainless steels.

HAM BOOKLET

A little booklet, designed to stimulate interest in becoming a ham, has been issued by the American Radio Relay League, West Hartford 7, Conn.

Entitled "You Can Be There," the booklet describes many international adventures awaiting amateur operators and points up one highlight of recent years—direct radio contact with "Kon-Tiki."

Distribution of the first 100,000 copies of the pamphlet will be through youth



organizations, educational and civic groups, and electronics manufacturers and distributors.

#### SNAP-ACTING THERMOSTATS

*Stevens Manufacturing Company, Inc.*, 69 S. Walnut Street, Mansfield, Ohio, is currently offering copies of a new illustrated bulletin on the company's line of snap-acting thermostats for operation on wide or narrow differentials.

In addition to suggested applications, the bulletin describes the operating principle and illustrates it with schematic diagrams. Ratings, typical performance curves, dimensions, and construction data are included.

Copies of Bulletin L-4144 will be forwarded without charge to those making their requests direct to the company.

#### TEST LAMP DATA

Details on the company's "Bull's-Eye" lamp are included in the new bulletin just released by *Lindly & Co.*, 248 Herricks Road, Mineola, N. Y.

The lamp, which has been especially designed for close work and assembly operations, is illustrated and its advantages and construction features described.

Copies of the bulletin are available without charge.

#### FLASH HANDBOOK

A new 16-page handbook on home construction of electronic flash equipment for amateur photographers has been published by *Sprague Products Co.*

The new publication gives complete circuit details on four different photo-flash units using the company's new Type FF-1 low-leakage condensers, rated at 525  $\mu$ fd., 450 volts in a can 2" in diameter by 4½" long.

Copies of the "Electronic Flash Handbook," Form C-703, are available from all *Sprague* distributors for 35 cents or may be obtained by sending 35 cents in coins or stamps directly to the company at 51 Marshall Street, North Adams, Massachusetts.

#### PYRAMID CATALOGUES

*Pyramid Electric Company*, 1445 Hudson Boulevard, North Bergen, New Jersey, has announced publication of four new catalogues which provide specifications, construction and engineering data, sizes, and prices on the company's line of condensers.

Catalogue PG-1 lists miniature "Glasseal" condenser types PGH, PGM, and PGX. These units operate at temperatures ranging from -55 degrees to +125 degrees.

Catalogue IMP-1 describes the company's newest line of molded plastic tubular units. The "IMPS" are impervious to moisture and will withstand a temperature of 100 degrees C.

Catalogue MP-2 gives detailed information on the company's ultra-compact metallized paper types while Catalogue J-7 is a 32-page compilation of paper, electrolytic, oil-paper, and metallized paper condensers.

August, 1952

## SERVICEMAN'S DIARY... by Ben Grim



# NEW!

## UNIVERSAL REPLACEMENT HI-VOLTAGE "DOORKNOB" CERAMIC...



### FURNISHED WITH SCREW-IN TERMINALS TO MEET EVERY NEED!

An ingenious screw-in terminal system makes Sprague's new type 20DK-T5, 500 mmf, 20,000 volt molded case ceramic capacitor fit most *every* TV set. All you have to do is select the proper set of terminals, two twists of the wrist, and there you are!

With this new Sprague development, you need only one capacitor in your kit to service sets up to 21" tubes.

Sprague's 20DK-T5 "Doorknob" ceramic is molded in genuine thermosetting plastic, non-flammable and moisture-resistant. Guard rings are molded in both faces to lengthen the surface leakage path. Write for complete catalog C-608 to Sprague Products Co., 51 Marshall St., North Adams, Mass.



Don't Be Vague!  
Insist On Sprague

WORLD'S LARGEST  
CAPACITOR MANUFACTURER

Free copies of any or all of these catalogues are available on letterhead request to the company.

**ELECTRONIC WATTMETER**

Keithley Instruments, 3868 Carnegie Avenue, Cleveland 15, Ohio, has released a two-page bulletin which describes its Model 109 electronic wattmeter in some detail.

The new unit, which is especially useful where a high input impedance or sensitivity to low-voltage and low-power circuits are required, is described fully. Specifications and suggested uses are also outlined.

Copies of the bulletin will be supplied without charge on request.

**RIDER CATALOGUE**

John F. Rider Publisher, Inc., 480 Canal Street, New York, New York, now has copies of its revised catalogue available for distribution.

The 8-page, 8 1/2" x 11" catalogue contains a complete up-to-date listing of the company's Manuals, "Tek-File", and books. Information on the company's books to be published soon is also included.

Copies of the catalogue are available from the organization's distributors or directly from the publisher.

**CLIP BULLETIN**

Prestole Corporation of Toledo, Ohio, has just issued a data sheet covering its new and improved condenser clip.

The new bulletin provides complete descriptive data and specifications on the seven different sizes of clips now currently available.

Copies of the bulletin, along with a price list, will be mailed to executives, engineers, and purchasing agents who make their requests on their company letterheads.

**CONVERTER CATALOGUE**

Carter Motor Co., 2644 N. Maplewood Avenue, Chicago, Illinois, has released a new catalogue which lists its entire line of d.c.-to-a.c. converters.

This 16-page catalogue provides complete electrical and mechanical specifications, the company's selector chart which has been revised to contain the latest in television and recording equipment, and a complete directory of the company's sales representatives.

The new publication is punched to fit all standard loose-leaf binders. Copies are now obtainable from the manufacturer. Ask for Catalogue No. 452.

**HAMMARLUND CATALOGUE**

The Hammarlund Manufacturing Company, 460 West 34th Street, New York 1, New York, has announced publication of a new 1952 condenser catalogue which is being offered to electronic manufacturers, the military services, research and design engineers, and other interested individuals and groups.

This detailed and illustrated two-color, 12-page brochure includes complete drawings and electrical and mechanical specifications covering a broad selection of standard variable air condensers. The items described are stock items which are available from jobbers and dealers throughout the country.

Requests for copies of this catalogue should be addressed direct to the company.

**TV CATALOGUE**

The LaPointe Plascomold Corporation, Windros Locks, Connecticut, now has available copies of its 1952 "Vee-D-X" TV catalogue which are being offered to service technicians and others concerned with television installations.

The new catalogue contains a complete listing of the company's antennas and accessories. Containing 24 pages and printed in two colors, the catalogue features not only the company's standard products but its special developments in the television field.

First released at the Radio Parts Show in Chicago, the new catalogue is being distributed by "Vee-D-X" representatives and jobbers. Copies may also be obtained from the company direct.

**VIBRATOR REPLACEMENT**

A complete and concise replacement vibrator guide has just been issued by

**OLSON'S PENNY PROFIT POLICY MEANS GREATER BARGAINS**

**DON'T MISS THIS AMAZING VALUE**

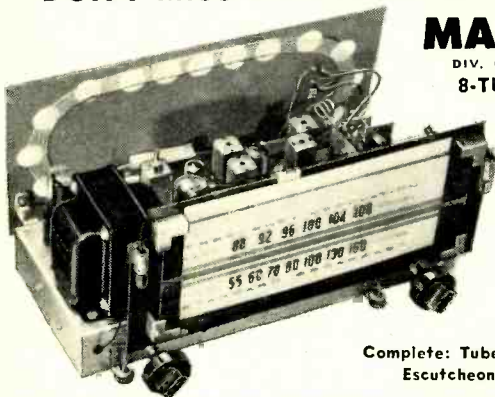

**MAJESTIC**  
DIV. OF WILCOX-GAY  
**8-TUBE AM-FM RADIO CHASSIS**  
**\$44.95 EA.**

Stock No. RA-52A  
LATEST MODEL

Complete: Tubes, Loop Antenna, Escutcheon, Knobs, etc.

This is not a kit or a tuner. It's a real high-powered AM-FM Radio Chassis that will pull in distant stations with amazing volume and brilliance of tone. Makes a perfect custom installation in existing cabinets, book-cases, walls, etc. Servicemen and Experimenters: Make money installing these for friends and customers.

The circuit is modern and employs 8 tubes (12AT7, 6BE6, 2-6BA6, 6AL5, 6AV6, 6V6 and 5Y3). The entire R. F. assembly and the 4-section tuning condenser is rubber mounted. Tuned R. F. stage plus two I. F. stages give this set terrific FM sensitivity. Separate FM oscillator tube for extreme stability, and Wide R. F. and mixer circuits plus radio detector assure noise free, high fidelity FM reception.

Two modern dual knobs control on-off, volume and tone plus AM-FM. Phone switch. Equipped with two panel lamps and edge lit dial. Phono input socket and AC receptacle at rear of chassis. Chassis size 1 1/2" wide, 7 1/2" deep, 7 1/4" high. Cut out in cabinet requires 8x3 1/4". Output impedance 8 ohms operates on 110-125V AC, 60 cycles. Shpg. wt. 20 lbs. In factory sealed cartons.

**COMBINATION DEAL**

**RADIO AND 12" CO-AXIAL SPEAKER**

You get the above Majestic AM-FM Radio chassis exactly as described above PLUS a model S-168A 12" Co-axial speaker, 1952 model, as described on opposite page. Both packed in factory sealed cartons.

**\$49.95**  
DEAL NO. RA-5268A

**PHONO PRE-AMPLIFIER**

For use with G.E. and other low level magnetic pickups. Can be attached to any radio or amplifier. Built on aluminum chassis, finest workmanship throughout. Ample bass boost provided. Operates on 115 volt AC. Sizes 4 1/4" x 2 1/8" x 3 1/2". Complete with 12AX7 tube. Shpg. wt. 2 lbs.

**\$8.95**  
No. RA-101A



**OLSON RADIO WAREHOUSE • 275 E. Market St., Akron 8, Ohio**

**10 WATT HI-FI PUSH-PULL AMPLIFIER**



**\$32.95**  
with Tubes  
Stock No. RA-102A

- Bass & Treble Boost.
- Inputs for crystal and magnetic pickups, radio tuner and crystal mike.
- Aluminum Chassis.

Bombshell Value! It's unbelievable. A full 10 watt Hi-Fi Amplifier, completely assembled and ready to play. This built-in PEE-AMP for G.E. and similar types of magnetic pickups. 4 inputs: 1 crystal phono, 1 magnetic phono, 1 radio, 1 mike. 4 Controls: 1 Bass, 1 Treble, 1 Volume, 1 Phono-radio Switch. Output Impedances: 4, 8, 16 ohms. Peak power output 17 watts. Order this amplifier today and see what brilliant, realistic tone it will deliver. Supply is limited. Everyone in factory sealed carton. You couldn't buy the parts alone for this price. Remember this is a full size amplifier, transformer operated, not an AC-DC job. Frequency response 20 to 20,000 cps at less than 1% of 1% distortion. 5 Tubes: 1-6SL7, 1-6SC7, 2-6V6, 1-5Y3. Complete with tubes. Size 12" x 6 1/2" x 5 1/4". Shpg. wt. 15 lbs. Can be used with any phono or speaker.

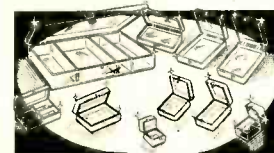

**TRANSPARENT BOXES**

Stock No. A5-65A **\$1.95**  
Complete set of 10 assorted sizes . . .

Made of Styron, the miracle plastic. Clear as glass but won't break with ordinary use. You get 10 different, all popular size boxes. All with hinged covers. Boxes range from 8" x 3 1/2" x 1 1/2" to 1" x 1" x 1/2". Handy for nuts, bolts, lug resistors, small parts, etc. Get several kits today. Shpg. wt. 2 lbs.

**1c**  
With every Kit of Transparent Boxes you order you can get an Ak-rad 1 mfd 600 volt Condenser -retail value 45c-your cost only 1 cent.



**PLASTIC RECORDING TAPE**

Get the buy of your life. Save up to 64% on high quality RECORDING TAPE. A huge manufacturer had to sell his inventory and he unloaded the whole deal. Olson now offers you this high grade recording tape at prices which defy competition. Standard 1/4" wide. Frequency response 50 to 8,000 cy. Plastic Reel included with each.

600 Ft. Reel Stock No. X-275A, Single, each \$1.49, LOTS OF 10, \$1.29  
1200 Ft. Reel Stock No. X-249A, Single, each \$2.19, LOTS OF 10, \$1.99

**1c**  
With every 10 rolls of Plastic Recording Tape you order, you can get a 50 ft. roll of hook-up wire-retail value \$1.00-your cost only 1 cent.



**Don't Throw Away Old Picture Tubes**

You can get excellent pictures on old dim kineoscopes for an additional 900 to 3200 hours by simply attaching the new Perma-Power TV Tube "Britener". Fully automatic. Just plugs onto back of old TV Tube. Not a gadget. Laboratory tested and approved. Regular retail price \$9.75. Order yours now. Make big money selling TV "Briteners" to your friends and customers. Shpg. wt. 5 lbs. Stock No. 7-98A . . . ea. **\$5.73**

USE ORDER BLANK ON NEXT PAGE

**1c**  
With every TV Tube Britener you order, you can get a 10,000 volt TV Condenser -retail value \$1.25 - your cost only 1 cent.

# GIANT READ EVERY WORD



# SALE LOOK WHAT 1¢ BUYS

## 5" ALNICO 5 PM SPEAKERS

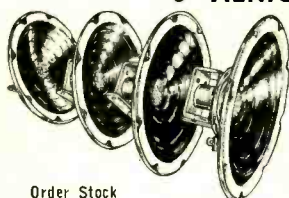

### 1¢ SPEAKER SALE

- Thousands have been sold by Olson for \$1.79
- We must make room in our warehouse

**Buy 3 and get the 4th for only 1¢**

At 1¢ Olson will sell plenty of 5" PM Speakers. No one else would dare make this offer. But our new Fall merchandise is coming in any day now and we need ROOM. Buy 3 speakers at our bargain price of \$1.79 each and get the fourth speaker for only 1¢. Order 6 speakers at \$1.79 each and get 2 speakers for only 2¢ additional. Remember, for every 3 speakers you buy, an additional speaker is only 1¢. Don't miss this offer. IT CANNOT be repeated when sold out. Every speaker is brand new in original factory cartons. Full 5" diameter. Rugged inside and out. Alnico 5 magnet. Voice coil 3.2 ohms. The perfect speaker for extension speakers, auto sets, AC-DC radios and intercoms. Shpg. wt. per speaker 1 lb.

Order Stock No. S-169A

- 1st Speaker \$1.79  
2nd Speaker 1.79  
3rd Speaker 1.79  
4th Speaker .01

All Four For \$5.38



## 12" CO-AXIAL SPEAKER

Our new 1952 Model. Guaranteed to outperform any speaker in its price class. Equipped with two "high concentration" Alnico 5 magnets and a high frequency diffuser. The 12" section delivers the bass while the inner 3" tweeter speaker section covers the treble tones. Together they give you "living tone." This speaker is unconditionally guaranteed for 100 hours. Most critical user or Olson promises to refund your money. Only two wires to connect to any radio or amplifier. Voice coil impedance 8 ohms. Frequency response 30 to 17,500 cps. Shpg. wt. 10 lbs.

\$1295

Stock No. S-168A

## 1¢

With every S-168A Coaxial Speaker you order, you can get a line matching transformer to match a 500 line to any speaker—retail value \$3.00—your cost only 1¢.

## 2-STATION INTERCOM SYSTEM



Stock No. RA-96A

Olson Special Price for Master Station Substation and 50 ft. of cable only

\$1983

## PRESTO—Call Intercom

The Modern Electronic Communication System. Now talk with anyone, anywhere at the mere flick of a button. All electric master station and sub-station give clear, powerful voice reproduction to rooms or other buildings up to 1000 ft. away. Thousands have been sold for use in restaurants, on farms, offices, stockrooms, factories and in homes. Just plug master station into any 115 V AC electrical outlet—connect 2 wires and you're operating. Modern design. Each unit measures 4 1/2 x 4 1/2 x 5 1/2. Equipped with rubber feet and easy slide switches. Handsome appearance—gray crackle finish. High amplification—use 3 tubes. Power output 2 1/2 watts. Regular list price is \$37.50. You get the master station, substation and 50 ft. of 3 conductor cable. Complete with tubes. Shpg. wt. 8 lbs.

## 1¢

With every 2-Station Intercom you order, you can get a Kit of 10 popular 10 W Wire Wound Resistors—retail value \$10.00—your cost only 1¢.

## VM 2 SPEED AUTOMATIC RECORD CHANGER



Stock No. RA-99A  
Each

\$1999

Now you can take advantage of this deal that Olson ran across. Incorporates the latest design to play the records in most demand, 33 1/3 and 78. Records may even be intermixed on the spindle. Will hold twelve 10" or ten 12" discs in one loading. Records slide down center shaft with utmost precision. Low pressure tone arm is equipped with an RCA turn-over cartridge and two permanent needles. Shuts off air last needle. Has reject button also. Size 12" x 13". Operates on 115 volts AC. 60 cycles. Shpg. wt. 15 lbs.

## 1¢

With every VM Changer you order, you can get an approved 6 foot AC Cord with plug—retail value 75¢—your cost only 1¢.

## 5 TO 50 WATT WIREWOUND KIT



\* Contains 50 Resistors

Stock No. AS-63A

\$349

Think of it. You get 50 brand new Wirewound Resistors in a wide range of ohmages from 5 watts to 50 watts. That's less than 7¢ each. These resistors would cost you at least \$20.00 if bought separately. But Olson bought the entire stock of a tremendous manufacturer and you can cash in during this big summer sale.

## 1¢

With every Wirewound Kit that you order, you can get an 8 mfd 450 volt condenser—retail value \$1.25—your cost only 1¢.

## NOTICE—RADIO MANUFACTURERS

Olson Radio has established a tremendous market among radio servicemen, amateurs, universities and industrialists all over America as well as principal foreign countries. Our famous rapid mailing service is the talk of the trade. If you have any good, clean surplus radio material which you wish to dispose of, contact Olson at once. We can use Radios, amplifiers, condensers, chassis, phono motors, pickup arms, volume controls, test equipment, speakers, in fact any radio or electronic part or piece of equipment. Here is your opportunity to turn idle inventory into cash. Write, wire or call Olson, the popular name in radio.

SEND FOR OLSON'S BRAND NEW BARGAIN CATALOG. GET NATIONALLY FAMOUS RADIO PARTS AND SUPPLIES AT BIG DISCOUNTS

**CLEVELAND, OHIO**  
2020 Euclid Ave.

**CHICAGO, ILLINOIS**  
623 W. Randolph Street

If you live in or near Cleveland visit our store, get these and many more bargains.

If you live in or near Chicago visit our store, get these and many more bargains.

MAIL ORDERS SHOULD BE SENT TO AKRON, OHIO



## OLSON RADIO WAREHOUSE • 275 E. Market St., Akron 8, Ohio

August, 1952

## KINESCOPE TESTER

Tests all picture tubes \$2995  
Model 106A

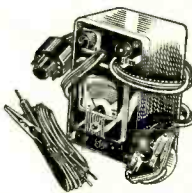

At last you can test picture tubes quickly, easily and positively WITHOUT removing them from the chassis or cabinet. Tests magnetically and electrostatically focused picture tube and shows exact condition on a 3 1/2" meter. Checks for: high voltage breakdown, leakage, gas between elements, conductance, high voltage on anode, screen or cathode to control grid voltage from set and brightness control voltage. Also has built-in ohm-meter and volt-meter with scales 0-500 and 15 kV. Complete with plugs, sockets and instructions. Shpg. wt. 7 lbs.

## 1¢

With every Kinescope Tester you order, you can get a kit of 24 assorted C-D and Solar By-pass condensers—retail value \$6.00—your cost only 1¢.

## STANDARD COIL TV BOOSTER



Model B-51A  
\$1095

This is the latest model and only Olson is making this exclusive offer of 100 ft. of 300 ohm Polyethylene Twin Line for 1¢ with each Booster you order. The Standard Coil TV Booster is the latest Model H-51 which regularly sells for \$35.00. This offer will not be repeated when supply is gone. Brand new, factory-sealed cartons and fully guaranteed. This Booster has proved high frequency circuits and gives superior reception on all channels. Does not distort sound or picture but does give them tremendous boost. Perfect for fringe areas. Continuous one-knob tuning and channel selecting. If you have trouble with "snow" or if any channels are weak in your area—this booster will do wonders in overcoming these. Get brilliant, clear, "snow-free" pictures with this booster and get the 100 ft. spool of 300 ohm twin-lead for just 1¢. Cabinet size 8" x 4 1/4" x 4 1/2". For 115 volt AC operation. Shpg. wt. 5 lbs.

## 1¢

With every standard coil TV Booster you order, you can get a big 100 ft. spool of 300 ohm poly twin-lead—retail value \$5.00—your cost only 1¢.

## 12" Magnavox Speaker and Baffle Close-Out



Stock No. AS-66A  
Get both for only \$795

You get Magnavox's fine 12" PM speaker with Alnico 5 magnet. (Same as you'll find in those expensive Magnavox Super-Radio-Phono Combinations.) Power output 8 watts. Voice coil fully dust-proofed. Impedance 6-8 ohms. In addition you get a walnut Speaker Baffle to bring out the full rich rounded tones of the Magnavox Speaker. Baffle may be mounted on a wall or it will stand on a table. Here's the ideal combination for extension speakers for porches or other rooms. Can be connected to any radio or amplifier. Order 3 or more sets and install them in restaurants, auditoriums, halls, etc.

## 1¢

With every Magnavox Speaker and Baffle you order you can get a 50' roll of 2 conductor extension wire—retail value \$3.00—your cost only 1¢.



\$250 Phono Amplifier  
Stock No. RA-98A

Only 1000 amplifiers to be sold by Olson during this sale at this remarkable low price. Efficient 2-tube amplifier. Input for crystal mike. Can be used with any PM speaker from 4" to 12". Delivers 3 watts of audio with excellent fidelity. Equipped with both volume control and tone control. Less tubes.

Shpg. wt. 3 lbs.

Kit of 2 tubes (35W4 and 50B5) for above amplifier. Both for \$1.28

## 1¢

With every Amplifier you order you can get an output transformer—retail value \$1.75—your cost only 1¢.

## IT'S EASY TO ORDER FROM OLSON'S

How to order: Order directly from this ad. For convenience use this order blank. Fill in columns below with quantity desired, stock number, description and price. You may send remittance with order (include enough for postage or parcel post shipment), or if you prefer SEND NO MONEY. Olson will ship C.O.D. and you may pay mail or expressman for merchandise and postage.

### MONEY BACK GUARANTEE:

Everything you order from Olson is guaranteed as advertised, if you are not more than satisfied, you may return merchandise for cash refund.

Please Minimum Order \$3.00

## WE SHIP SAME DAY WE GET YOUR ORDER

QUANTITY	STOCK NUMBER	DESCRIPTION	PRICE EACH	TOTAL
NAME			TOTAL	
ADDRESS			ADD POSTAGE	
CITY			TOTAL AMOUNT	
ZONE				
STATE				

RN-852

# INDISPENSABLE! PHOTOFACT BOOKS



**Photofact Television Course.** Covers TV principles, operation and practice. 216 pages; profusely illustrated; 8 1/2 x 11". Order **TV-1**..... Only **\$3.00**

**Television Antennas. New 2nd edition.** Describes all TV antenna types; tells how to select, install, solve troubles. Saves time; helps you earn more. 200 pages; illustrated. Order **TAG-1**..... Only **\$2.00**

**Television Tube Location Guide. Volume 2.** Accurate diagrams show position and function of all tubes in hundreds of TV sets; helps you diagnose trouble without removing chassis. 224 pages; pocket-size. Order **TGL-2**. Only **\$2.00**

**Television Tube Location Guide. Vol. 1.** Over 200 pages of TV receiver tube position diagrams on hundreds of models. Order **TGL-1**..... Only **\$1.50**

**Making Money in TV Servicing.** Tested proved methods of operating a profitable TV service business. Covers all important phases. Authoritative, valuable guide to success. Over 130 pages. Order **MM-1**..... Only **\$1.25**

**Servicing TV in the Customer's Home.** Shows how to diagnose trouble using capacitor probe and VTVM. Short-cut methods help save time, earn more on outside service calls. Order **TC-1**..... Only **\$1.50**

**1949-1950 Record Changer Manual. Vol. 3.** Covers 44 models made in 1949, including multi-speed changers and wire and tape recorders. Original data based on actual analysis of equipment. 286 pages; 8 1/2 x 11"; paper-bound. Order **CM-3**..... Only **\$3.00**

**1948-1949 Changer Manual. Vol. 2.** Covers 45 models made in 1948-49. Paper bound. Order **CM-2**. Only **\$4.95**

**1947-1948 Changer Manual. Vol. 1.** Covers 40 post-war models up to 1948. Order **CM-1**..... Only **\$3.95**

**Recording & Reproduction of Sound. 2nd Edition.** New, completely revised and vastly enlarged edition of the outstanding original volume. The most authoritative treatment of all phases of recording and amplification ever written. Over 800 pages. 6 x 9". Order **RR-2**. Only **\$7.95**



**Audio Amplifiers. Vol. 3.** Clear, uniform, accurate data on 50 important audio amplifiers, plus full coverage of 22 FM and AM tuners, produced during 1950. 362 pages, 8 1/2 x 11". Order **AA-3**..... Only **\$3.95**

**Audio Amplifiers. Vol. 2.** A complete analysis of 104 well-known audio amplifiers and 12 tuners made 1949-50. 368 pages, 8 1/2 x 11". Order **AA-2**..... Only **\$3.95**

**Audio Amplifiers. Vol. 1.** 102 amplifiers and FM tuners made through 1948. 352 p. Order **AA-1**..... Only **\$3.95**

**Auto Radio Manual.** Complete service data on more than 100 post-war auto radio models. Covers over 24 mfrs. 350 pages, 8 1/2 x 11". Order **AR-1**..... Only **\$4.95**

**Communications Receiver Manual.** Complete analysis of 50 popular communications models. 246 pages, 8 1/2 x 11". Order **CR-1**..... Only **\$3.00**

**Radio Receiver Tube Placement Guide.** Accurate diagrams show where to replace each tube in 5500 radio models, covering 1938-1947 receivers. 192 pages, pocket-size. Order **TP-1**..... Only **\$1.25**

**Dial Cord Stringing Guide. Vol. 2.** Covers receivers made from 1947 through 1949. Shows you the one right way to string a dial cord in thousands of models. Pocket-size. Order **DC-2**..... Only **\$1.00**

**Dial Cord Guide. Vol. 1.** Covers sets produced 1938 through 1946. Order **DC-1**..... Only **\$1.00**

Order from your Parts Jobber or write direct to  
**HOWARD W. SAMS & CO., INC., 2201 E. 46th St., Indianapolis 5, Indiana**  
**HOWARD W. SAMS & CO., INC.**

P. R. Mallory & Co., Inc. of Indianapolis 6, Ind.

The new publication contains complete cross-reference charts, specifications, and illustrated installation instructions for replacing car radio and other types of mobile communication equipment vibrators and their accessory buffer condensers, along with a list of the company's recommended replacements.

Listed are the original equipment receiver manufacturer and his model numbers with the numbers of the corresponding Mallory replacement vibrators. The capacity values of secondary buffers and the correct replacement units are also given.

Other cross-reference charts include vibrator types with their applications, original equipment vibrator numbers with correct replacements, and replacement vibrator numbers with correct replacements.

### PICTURE TUBE DATA

The Cathode-Ray Tube Division of Allen B. Du Mont Laboratories, Inc. has announced the availability of a new edition of its "Picture Tube Data Chart."

The chart, printed on heavy stock and suitable for wall mounting, lists the electrical and physical characteristics of any modern RTMA-registered TV picture tube.

Now in its fifth printing, the new chart has been especially designed for those concerned with television receiver design, research, and servicing.

Copies of the new chart are obtainable from the company's tube distributors.

A multi-purpose test lamp finds many uses on Fred J. Lingel's test bench. A three-way bulb is mounted to the bench with a short piece of metal strap of the type used to hold packing crates together. The lamp may be used as an eye-level source of light for small work or for servicing in dark corners of the chassis. By connecting the lamp in series with the set or appliance to be repaired, the lamp can be used as a load check thus speeding the location of a fault. It can also be used as a continuity tester for transformer, motor, or heater windings. Mr. Lingel also uses the lamp with its twisted cord as a dummy antenna load when he operates as W2ZGY.

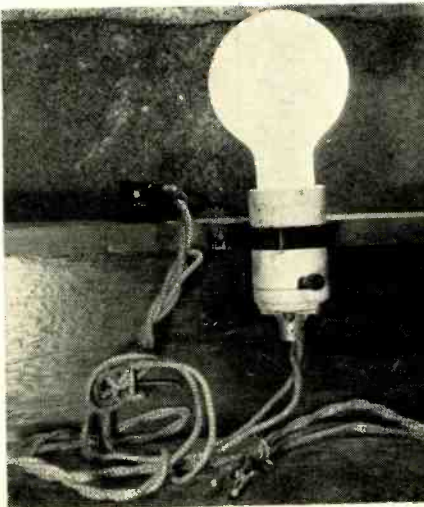

**630 STANDARD TV KIT**  
For 12 1/2" Tube  
With the new Cascade Tuner. Complete set of finest selected parts for the well known and original RCA 630. Comes complete with all tubes, hardware and step by step instruction manual. Less CRT **\$99.99** & wire.

**630 SUPER DELUXE 31-TUBE TV KIT**  
Same as above, including voltage doubler & AGC. For all tubes 16" to 24" **\$119.44**

**SIGNAL TRACER KIT**  
Complete with probe, tubes, 4" speaker. Battery operated. Make servicing a pleasure with a signal tracer. Can trace a signal from antenna to voice coil. Locate those devilish intermittents with ease. Will pay for itself the first week. Comes in beautiful gray metal cabinet. Less batteries. **\$10.95**

**THE FAMOUS WILLIAMSON AMPLIFIER FOUNDATION KIT**  
1 Power trans. 810 volts CT @ 225 mils. 6.3V @ 8 amps. 5.0V @ 3 amps. \$1.14 ea. 2.28  
2 10 Mfd 600 volt oil cond. with brackets. 17.07  
1 12"Hy 250 mil choke 70 ohms. 2.95  
1 Hi fidelity Chicago output trans. (See below) 4.89  
If purchased as unit **\$15.99**

**WILLIAMSON TYPE HIGH FIDELITY OUTPUT TRANSFORMER**  
Pri-9000 ohms. Sec-8 ohms. Freq. range 30 cy. to 20 KC ± 1/2db. Used for PP 807S—KT66S. Made by Chicago Transformer Co. Selling at a fraction of its original **\$4.89**

**THE NEW CASCADE TUNER**  
For all sets: 630, etc. Complete with schematic. Our new low price..... **\$19.95**

**RAM TV CONVERSION KIT**  
For all sets. Convert your 10" or 12" set to any size up to 24". Consists of 16KV High Voltage Flyback Trans. 70". Full focus cosine yoke, linearity coil, width coil and 500 Mmfmd 20KV mica cond. List \$25.00. **\$11.95**

**OIL FILLED CONDENSER**  
10 Mfd. 600V. Rated at 220 v.a.c. 10 for Standard brands..... 99¢ ea. **\$9.25**  
Brackets..... 15¢ ea.

**CARTER DYNAMOTOR**  
Stock No. 4037 AS input—6 **\$26.95**  
VDC Output—400 V @ 375  
mils. List \$71.50 Brand new

Complete catalogue of test equipment, including kits, available upon request.  
When you deal with Acorn you save  
Write for Quantity Prices  
TERMS: 20% cash with order, balance C.O.D. unless rated. Prices F.O.B. our warehouse in N. Y. C. Minimum order \$3. NOTE: Due to conditions beyond our control, prices are subject to change.  
Phone Worth 4-3270  
**ACORN ELECTRONICS CORP.**  
76 Vesey St., Dept. N-8, New York 7, N. Y.

**AUDIO (SOUND) ENGINEERING COURSE HOME STUDY TRAINING**  
Prepare yourself, in your spare time for a B.G. PAY JOB as an AUDIO ENGINEER. Practical, easy-to-understand lessons, written by nationally recognized Audio Engineers and Educators.  
Prepare for a SUCCESSFUL CAREER in the TELEVISION, RADIO, DISC AND TAPE RECORDING, ELECTRONICS AND MOTION PICTURE INDUSTRIES.  
Training will not interfere with present employment.  
**EARN WHILE YOU LEARN WRITE FOR COMPLETE DETAILS—TODAY**  
B. M. Klekner, D.Sc., Ph.D.  
President  
**HOLLYWOOD TECHNICAL INSTITUTE**  
3359 Cahuenga Boulevard  
Hollywood 28, California

## Design Curves

(Continued from page 43)

formulas. The nearest available value of 68,000 ohms is suitable for  $R_2$ .

The only other value to be determined is that of condenser  $C$ . Reference to Fig. 6 shows that 3 db of boost is obtained at an abscissa value of approximately 1.0. We may now solve for  $C$ .

$$2\pi f CR_2 = 1.0$$

$$C = \frac{1}{2\pi f R_2} = \frac{1}{2\pi (500) (20,000)}$$

$$C = 1.59 \times 10^{-8} = 0.0159 \text{ microfarad}$$

A suitable value is 0.015 microfarads. We note from the curves that for this example the boost at 50 cycles can be about 14 db. Fig 4 shows these values placed in the circuit.

It may be of interest to determine the gain of the circuit including the tone control. The "Resistance-Coupled Amplifier Chart" shows a gain of 45 to the plate of the 12AX7. Subsequent to the tube gain of 45 our circuit has a voltage divider formed by  $R_3$  and  $R_2$  which attenuates the voltage by a factor  $(R_2 + R_3)/R_2$ , or 4.4. The over-all voltage gain, therefore, is about 10. This value of gain corresponds to the zero db reference level used in the curves.

### Bass-Attenuating Circuit

A circuit designed to accomplish variable bass attenuation is shown in Fig. 7. This design requires that the equivalent source impedance of the tube  $V_1$  be small compared to  $R_2$ . In order to be practical we have assumed some source impedance in the equivalent circuit of Fig. 8 which was used for analysis.

Because the use of this circuit does not cause any loss of gain, only one sheet of design curves was considered necessary; there is no harm in designing for more attenuation than may be required. The curves of Fig. 10 were computed with the ratio  $R_1/R_2$  equal to 0.1 and  $R/R_2$  equal to 10. The curves are also substantially accurate if the ratio of  $R_1/R_2$  is less than 0.1. It may be noted that this circuit gives a small amount of bass boost, the specific amount depending upon the value of  $R_1$ . This circuit is actually a special case of a circuit to be described in the next article which will give either bass boost or bass attenuation with a single control.

The method of applying the curves to a design problem should be apparent from a review of previous examples. We can think of no particular pitfalls which might be encountered in the use of this circuit. The only advice which seems appropriate is that a medium- $\mu$  triode is usually the best choice for  $V_1$  in order to satisfy the requirement for a small source impedance ( $R_s$ ) to the tone control.

(To be continued)

August, 1952

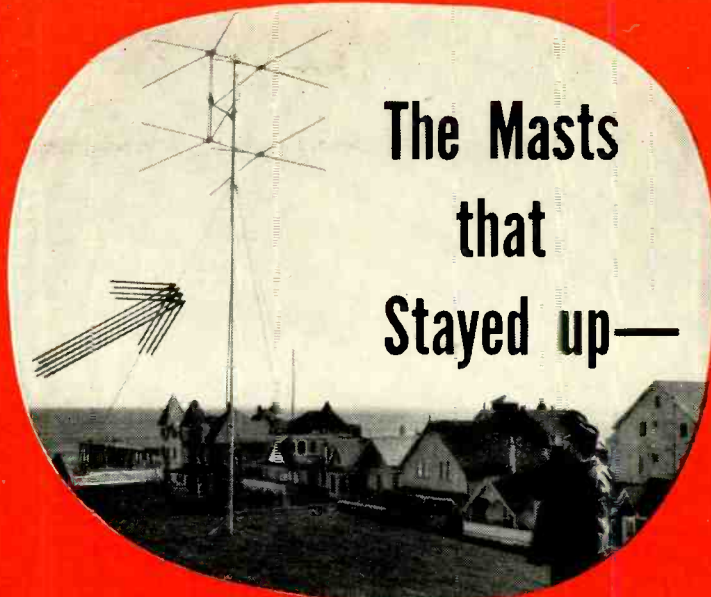

when others  
went  
**DOWN!**

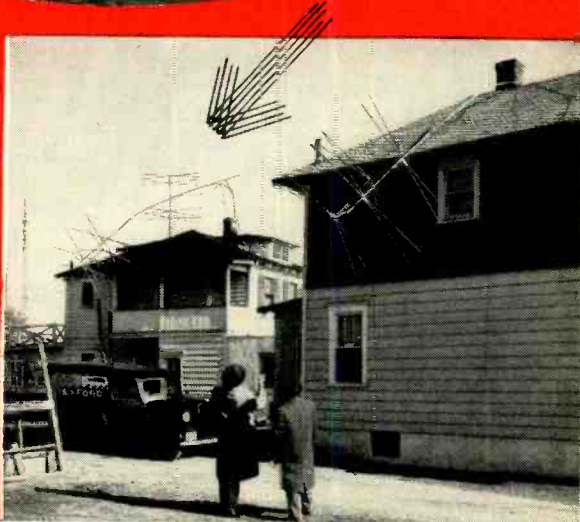

## PERMA-TUBE

... the Steel Television Mast that's UP to STAY!

... it was a *big blow*—the hurricane of November 1950 that hit the New York area with devastating force. Television masts were crumpled and flattened like straws in the path of the wind ... all but those made of PERMA-TUBE. PERMA-TUBE Masts *Stayed Up!* ... and why did PERMA-TUBE Masts *stay up?* For the very good reason that they're made of sturdy, corrosion-resistant steel ... Jones & Laughlin Tele-

vision grade PERMA-TUBE Steel ... a product that is pre-treated with Vinsynite and coated with a metallic-pigmented vinyl resin base *inside and outside.*

... what's more, they're easily, quickly and economically installed. Their new Fitted Joints can be slipped together in a matter of seconds. And you can obtain PERMA-TUBE in standard lengths, diameters and wall-thicknesses.

FOR COMPLETE INFORMATION—MAIL THIS COUPON TODAY!

**J&L  
STEEL**

Jones & Laughlin Steel Corporation  
495 Jones & Laughlin Building  
Pittsburgh 30, Pennsylvania

Without charge please send me:—

- Name of nearest distributor  
 Complete information on Perma-Tube

NAME \_\_\_\_\_

COMPANY \_\_\_\_\_

ADDRESS \_\_\_\_\_

# WHAT IS EIDOPHOR?

**Details on CBS's color system for theater TV viewing, as recently unveiled in New York City.**



Tung-Sol "Quality Control" recognizes but one standard. All Tung-Sol Tubes meet the highest original equipment requirements of leading radio and tv set manufacturers! Use Reliable Tung-Sol Tubes.

**TUNG-SOL ELECTRIC INC.**  
Newark 4, N. J.

Sales Offices: Atlanta • Chicago • Culver City  
Dallas • Denver • Detroit • Newark

### TUNG-SOL MAKES:

All-Glass Sealed Beam Lamps, Miniature Lamps, Signal Flashers, Picture Tubes, Radio, TV and Special Purpose Electron Tubes.

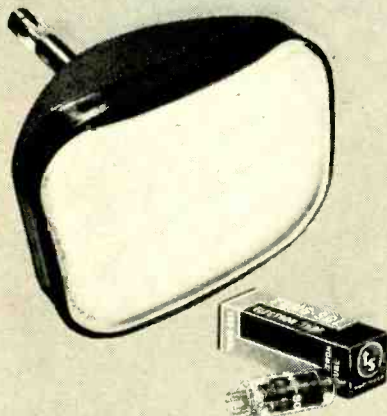

**TUNG-SOL®**  
RADIO, TV TUBES, DIAL LAMPS

Here's a real lively "stopper" to attract attention to your place of business and emphasize the quality of your service. Colorful—bright red and two shades of blue. 15 inches high. Your jobber salesman will tell you how to get one.

**T**HE EIDOPHOR projector, a development of a group of Swiss scientists at the Federal Institute of Technology and Dr. Edgar Gretener A.G. of Zurich, is similar to a motion picture projector. The arc lamps are practically identical and projection lenses are used to magnify the desired images on the theater screen.

Through the joint efforts of this Swiss group, CBS, and the technical staff of *Twentieth Century-Fox Film Corporation*, the original black-and-white equipment has been converted in order to provide color transmissions for theater projection.

In the case of the motion picture projector, a band of film carrying a series of images is passed intermittently through the light beam, a shutter being provided to cut off the light while the film is traveling. In the *Eidophor* projector, instead of photographic images on a strip of film, a sequence of images is created on a thin layer of a special liquid (about the consistency of honey) which is placed on a slowly rotating mirror surface in a position optically equivalent to the position of the film in an ordinary projector. The succession of images on the thin liquid layer is produced by means of electrons deposited on the surface of the liquid. These electrical charges are proportional to, and controlled by, the television signal, in much the same manner that a television signal is used to produce an image on a regular TV picture tube.

The essential difference is, of course, that in the home receiver tube the

electron beam strikes the end of the tube and causes the phosphor material to glow point-by-point and line-by-line, with a brightness which is proportional to the point-to-point brightness of the original scene.

In the *Eidophor* projector, however, the electron gun causes the liquid to take on tiny surface irregularities and thus to change its optical properties. The picture thus produced appears very much like the relief image in hardened gelatin used in some photographic processes, after the silver image has been bleached away. By means of auxiliary lenses and properly arranged mirrors the instantaneous picture on this "image bearing" layer of liquid is projected to the screen.

The *Eidophor* image is in a position "optically equivalent" to the position of the film in a standard projector. This point should be explained further. In the motion picture projector the center line or the light beam passes through the center of the picture being projected and along the same line through the center of the lens to the center of the screen. In the *Eidophor* system, however, the light from the arc passes through auxiliary lenses to a plane mirror arranged in parallel bars—and set at about 45 degrees to the light beam direction—which reflect half the light downward. (Half of the light because the width of the mirror bars and the spaces between them are substantially equal). Thus half the light is lost, just as it is lost by the shutter blades in the standard motion picture projector. The light

Mechanical layout of the Swiss-inspired "Eidophor" theater projection system.

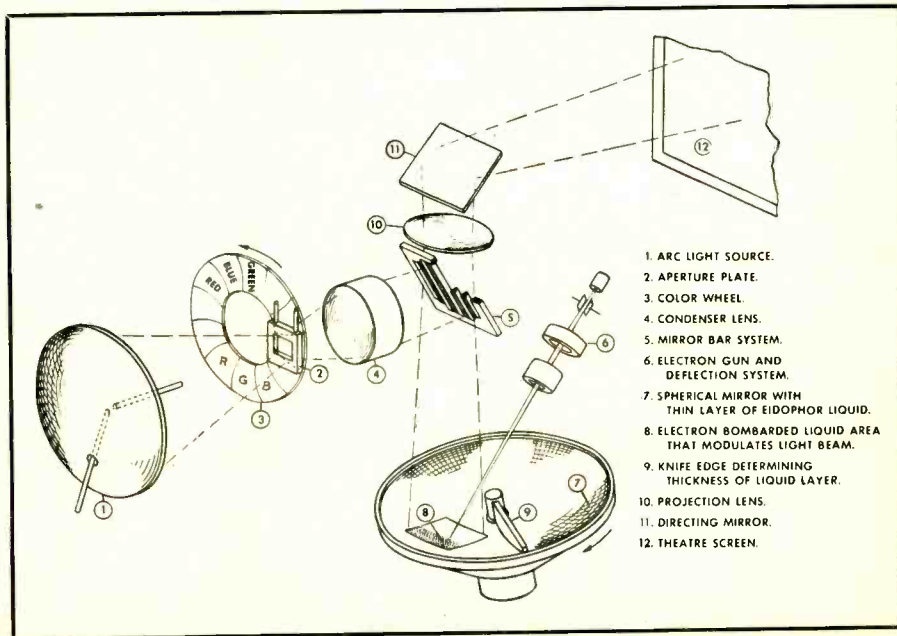

**RADIO &  
TELEVISION  
NEWS**

AUGUST,  
1952

**RADIO &  
TELEVISION  
NEWS**

SEPTEMBER  
1952

IN THIS ISSUE

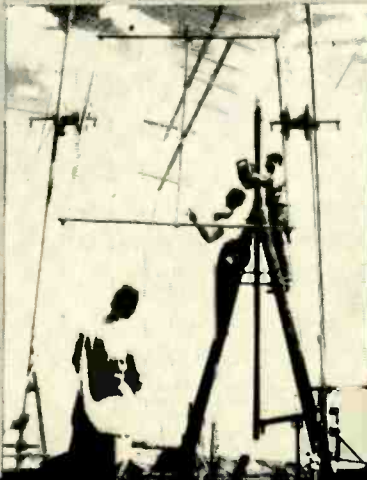

## Look —

just part of the September issue

A converter which receives both phone and C.W.! This unit transforms any a.c.-d.c. midget receiver into a full-fledged "communications" receiver! Ideal for the novice — a godsend for the seasoned amateur!

A Remotely Controlled AM Tuner! Five relays — five different stations! Expand this great idea for operation of other type units!

"Data Print" No. 5! Pertinent details for conversion of small screen Television receivers to large screen operation!

A Two-Station Intercom! Build it for two-way conversational system in your home! No "push-to-talk" switch needed!

other top-flight articles • regular features

**subscribe today!**

(lower per-copy cost saves you money)

Publishers also of: RADIO-ELECTRONIC ENGINEERING edition of RADIO & TELEVISION NEWS • PHOTOGRAPHY PHOTOGRAPHY ANNUAL, 1953 Edition • MODERN BRIDE • FLYING • FICTION GROUP • ZIFF-DAVIS COMICS

# never static!

## RADIO & TELEVISION NEWS

**you can't afford  
to miss  
a single vital  
issue!**

Each month RADIO & TELEVISION NEWS is charged with new ideas, new concepts, new profit methods in all phases of electronics.

# USE PHOTOFACT

the world's best Radio and TV Service Data...

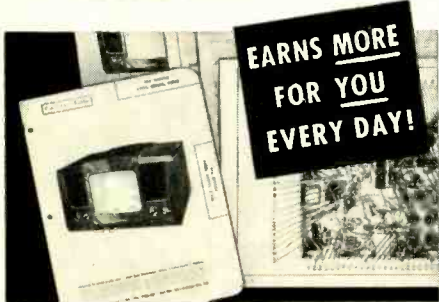

WE'LL PROVE YOU'LL SAVE TIME and EARN MORE WITH PHOTOFACT

**FREE** Service Technicians: We'll send you any Photofact Folder listed in the "PF INDEX and Technical Digest." If you haven't an Index, get a free copy from your local Photofact distributor or write for it today. To obtain Free Folder, be sure to state Photofact Set and Folder Number as shown in the Index.

NOW—learn for yourself how PHOTOFACT makes your Radio and TV work quicker, easier, more profitable! Just get and use an actual PHOTOFACT Folder. Discover why over 35,000 successful service technicians count on this invaluable data daily. No other service gives you PHOTOFACT's completeness, accuracy, uniformity and lowest cost. PHOTOFACT is the only Radio-TV service data prepared from laboratory analysis on the actual equipment. Get your FREE Folder now. Examine, use, compare. See why you can't afford to be without PHOTOFACT!

NOTE: Our FREE Folder offer is limited to Service Technicians only. Attach coupon below to your letterhead and mention your jobber's name. Experimenters and others may obtain the Photofact Folder by remitting amount shown below.

## HOWARD W. SAMS & CO., INC.

HOWARD W. SAMS & CO., INC.  
2201 E. 46th St., Indianapolis 5, Ind.

I am a Service Technician. Send me Free Folder No. .... which appears in Photofact Set No. .... (as listed in the PF Index).

I am an Experimenter. Enclosed \$..... Send me Folder No. .... which appears in Photofact Set No. .... (TV—\$1.00. AM/FM—50c. Record Changer. or Communication Receiver—75c)

Name.....

Address.....

City.....Zone.....State.....

**EASY  
PAY  
PLAN!**

**PAY AS YOU EARN!** Ask your distributor about this amazing plan. Only \$18.39 puts the entire profit-boosting Photofact library in your shop now!

A catalogue covering the new "Stabelex D" units is now available from the company on request.

### CAPACITY BRIDGE

Simpson Electric Co., 5200 W. Kinzie, Chicago, Ill., has developed an improved version of its Model 381 capacity bridge which makes it more compact and easier to use.

A button is pressed for the desired range, the bridge arm is adjusted for maximum meter deflection, and the capacity is read on the scale.

Ideally suited for radio and TV service work, the new Model 381 is housed in a bakelite case with etched aluminum panel.

Further information on this bridge will be supplied by the company.

### NEW CRYSTAL MIKE

The Turner Company, Cedar Rapids, Iowa, is now in production on a new crystal microphone which features extremely compact construction.

Although not much larger than a cigarette, the frequency response is 80

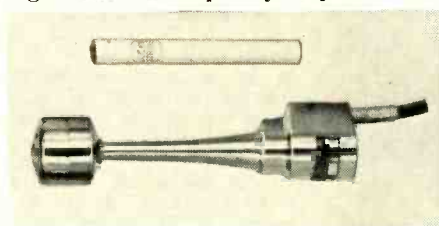

to 7000 cps with a sensitivity of approximately 58 db below 1 volt/dyne/sq. cm.

Additional details on the Model 80 microphone are available from the company on request.

### SINGLE-PHONE HEADSET

Airphone Co., Suite 309, Calumet Building, Miami, Florida, is now offering a new CAA-approved single-phone type headset to the trade.

The new "Airphone" consists of a specially designed miniature earphone similar to those used in hearing aids, but more rugged in design. The ear-



phone is attached to a supporting, individually-fitted earpiece by means of a snap fastener. Component parts include a personal volume control with lapel clip, two double-twisted vinyl covered cords, and a PL-55 plug.

The complete assembly weighs only 2½ ounces but is said to be 12 times more sensitive than conventional head-phones.

## MALE HELP WANTED

ENGINEERS - SCIENTISTS  
MATHEMATICIANS - STATISTICIANS  
TECHNICIANS - DESIGNERS  
COMPUTERS

MACHINISTS, Precision

Specialties: electronic, optical, mechanical, servo-mechanisms, etc.

Fields: measurement, recording, transcription, computation and analysis of guided missile and guidance systems performance.

Work Types: operation, maintenance, design, development, construction, research, study.

Work at: lab, shop and/or outdoors.

### INSTRUMENTATION

of guided missiles and aircraft blind navigation systems.

Equipment worked with: cinetheodolites, special optical instruments, recorders, radars, telemeters, data transcription devices, digital computers, many types of IBM equipment.

Locations: Air Force bases near Alamogordo, New Mexico and Dayton, Ohio.

Other openings: throughout U. S. A. and world.

Advantages: excellent opportunity for advancement, rapidly expanding organization. Personnel and family transportation reimbursed, company-paid insurance, and other benefits.

Salary: you'll be interested!

Write for application form to:

### LAND-AIR, INC.

Holloman Air Force Base

New Mexico

## NEW PRECISION ELECTRONICS SIGNAL TRACERS



MODEL 201 A  
\$34 50

MODEL 251 A  
\$49 75

Write for literature and name of your nearest Jobber

PRECISION ELECTRONICS, Inc.  
641-643 MILWAUKEE AVENUE  
CHICAGO 22, ILLINOIS

SIGNAL TRACER SPECIALISTS

RADIO & TELEVISION NEWS



**Spot Radio News**  
(Continued from page 18)

that the . . . "welfare of the people and not the happiness of the FCC is at stake in this situation. . . . Every applicant is entitled to his day in court without years of delay and it cannot be given to him unless we provide the money to hire the minimum of examiner teams." According to the Senators, the appropriation of \$800,000 can . . . "set in motion a chain reaction which in two years' time will create \$3-billion in business . . . figures which are ultra-conservative."

"We ought not to shirk our duty," members of the committee declared. "We ought to appropriate the money to authorize the recruiting of the 20 examiner teams or frankly tell the people that because money is not available for processing their television applications, they must wait 6 to 10 years for TV in many areas of the United States."

**DOLLARS REQUIRED** for the examiners and other members of the Commission was also the subject of a fighting talk by Commissioner Ed Webster, before the Indiana Broadcasters Association.

Noting that often many have asked why the Commission with over a thousand employees should have any difficulty disposing of the matters that come before it, Webster declared that the average person has no conception of the innumerable duties and responsibilities of the Commission and its staff. Explaining the structure of the Commission's staff, the Commissioner said that of the 1115 persons employed, 393 are located in field offices throughout the country. There are 722 employees sparsely scattered throughout Washington, with 35 assigned to the Commissioner's offices, 16 to the general counsel's office, 22 to the chief accountant's office, 77 to the chief engineer, 59 to the field engineering and monitoring bureau, 127 to administration, 7 to the opinion and review section, 32 to the secretary's office, 20 to interdepartmental activities, 110 to the safety and special radio services bureau, 84 to the common carrier bureau and 121 to the broadcast bureau. In addition, there are a dozen clerical assistants in various offices. Of the 121 in the broadcast bureau, only 61 are professionals: 27 engineers, 22 lawyers, and 12 accountants. It is to this group that the problems of modifications, license renewals, assignments, and transfers are relayed. And, declared Webster, only thirteen members of this staff, or 6 engineers, 2 lawyers, 2 accountants and 3 secretaries, are in the television division, which is expected to handle the forthcoming avalanche of applications for new stations.

Describing the processing problems that are expected, on the basis of prior experience, the Commissioner said that



**MN26C BENDIX RADIO COMPASS**  
 . . . complete with tubes, MN28C control box, loop transmission cable, MN20E loop, flexible cables, plugs, etc. . . . . **\$67.50**

**SCR 625 Famous Mine Detector**  
 For Prospectors, Miners, Oil Companies, Plumbers, etc.  
 This unit is being offered now at a considerable reduction in price. Recently advertised at \$79.50 it is now available in the same brand new wrappings in suitcase style carrying case (less batteries) at  
**\$59.50** WHILE THEY LAST!

**Check these Items - Write for Prices!**

**BC-733-D LOCALIZED RECEIVER.** Complete with tube and crystals.  
 DM-53-A DYNAMOTOR for above.  
 FT-293 MOUNT for 733.  
 BC-732 CONTROL BOX for 733.  
 PLUGS for 733.  
**ARN-7 AUTOMATIC DIRECTION FINDER.** Complete installation.  
**SCR-269-G AUTOMATIC DIRECTION FINDER.** Complete installation.

**SCR-522 VHF TRANSMITTER & RECEIVER.** Available as complete installation or just transmitter.  
**R89/ARN-5 GLIDE PATH RECEIVER.**  
**R57 GLIDE PATH RECEIVER.**  
**BC-638-A FREQUENCY METER.**  
**BC-376-H TEST OSCILLATOR.**  
**ID6/APN-4 LORAN INDICATOR.**  
**R9/APN-4 LORAN RECEIVER POWER SUPPLY.**  
**RT34/APS-13 TRAIL-WARNING TRANSMITTER.** 420 MC.

**COMMAND EQUIPMENT (SCR-274N)**

	Used	New		Used	New
BC-442 ANTENNA RELAY. Less cond. with cond.	1.95	3.95	BC-453 With tubes less tubes	\$19.95	14.95
BC-451 TRANSMITTER CONTROL BOX	1.50	1.50	MC-211 90° ANGLE COUPLING UNIT		\$0.95
BC-450 3-RECEIVER REMOTE CONTROL BOX	2.95	2.95	FT-234 MOUNTING RACK for single transmitter	2.95	3.50
MC-215 MECHANICAL DRIVE SHAFT. Per leg 2.00	2.95	2.95	FT-226 MOUNTING RACK for 2 Command Xmt's.	3.95	1.50
BC-496 2-POSITION RECEIVER CONTROL BOX	12.95	2.95	FT-221 MOUNTING PLATE for FT-220		2.25
BC-459 Less tubes	9.95	14.95	FT-220 MOUNTING RACK for 3 receivers		2.25
BC-455 6-B MC RECEIVER. With tubes less tubes	7.95	14.95	FT-225 MOUNTING PLATE for BC-456		4.50
			BC-456 MODULATOR. For SCR-274		4.50

**Monthly Specials!**  
**2 TRANSMITTERS**  
 BC-457 (4-5.3 MC) and BC-458 (5-3.7 MC). Command transmitters. Shipment just in. Limited Quantity. Less tubes and xtals. Good cond. EACH . . . . \$4.95 PER SET . . . . 9.50

**REVERSIBLE MOTOR**  
 RL-42 24 VDC. With antenna reel and clutch.  
 USED . . . . . \$4.50  
 NEW . . . . . 6.75

**MOTOR**  
 24 VDC. Series wound, reversible, with clutch. Turns 11,000 RPM. geared to 1,100 RPM. Complete with junction box, 2 adjustable limit switches. Good condition. **\$9.95**

**ARC-4 TRANSCEIVER**  
 140-144 MC. Complete with control box, tubes, 12/24 VDC dynamotor. This is a special reduction for this month only.  
 Like new **\$32.50**

**Miscellaneous Specials!**

T-32—DESK STAND MICROPHONE. Good used condition	\$ 2.75
HS-18—HEADSET. 8,000 ohms. New	2.45
HS-30—HEADSET. Featherweight type, low impedance. New, \$2.49. Used	1.49
HS-38—HEADSET. Used, excel. condition. \$1.49. New	3.50
HS-23—HEADSET. High imp. New, \$4.95. HS-33—HEADSET. Low imp. New	6.95
CD-307—EXT. CORD for HS-23-33. New, 95c. LIP MIKE. Navy Type, new	.98
EXTENSION CORD and SWITCH ASSEMBLY for lip and throat mikes. New	.98
RS-38—MIKE. New, \$4.95. RS-38—MIKE. Used	1.75
I-97—BIAS METER. New, \$3.95; Used	2.95
TU-6—TUNING UNIT. (3-1.5 MC) for BC-375 and BC-191. Used	2.95
PE-125—AN POWER SUPPLY for BC-223 Xmtr. 12/24 VDC input. New	14.95

**CATHODE RAY TUBES**

3FP7 . . . . . \$ 1.95	5FP7 . . . . . \$1.95	4AP10 . . . . . 95c
5CP1 . . . . . 4.50	5BP1 . . . . . 4.95	16JP4 . . . . . \$19.95
16DP4 . . . . . 19.95	5BP4 . . . . . 3.95	All these carry a 90-day guarantee!

TU-17—TUNING UNIT (2-3 MC.) for BC-223 Transmitter. Used . . . . . 2.95  
 TU-25—TUNING UNIT (3.5-5.2 MC) for BC-223 Xmtr. Used . . . . . 2.95  
 I-70—"S" TUNING METER. New, \$2.50. IN-4A—L/R TUNING METER. Used . . . . . 3.95  
 FL-8—RANGE FILTER. . . . . \$1.95  
 FL-5—RANGE FILTER. . . . . 1.25  
**WOBLULATOR:** See Page 43, Dec. '51 RADIO NEWS. . . . . 5.95  
**BC-709—INTERPHONE AMPLIFIER.** Battery operated, light wt. Complete with tubes, shock mount and Instruction Manual. New . . . . . 3.95  
**RC-43—MARKER BEACON ANTENNA INSTALLATION KIT.** Complete with plugs and insulators. Less wire. New . . . . . 1.95  
**BC-1023—75 MC. MARKER BEACON RECEIVER.** Complete with tubes, mtg. rack. New . . . . . 10.95

**MC-217**  
 LOOP MOTOR AND AUTOSYN TRANSMITTER ASSEMBLY. Complete with instructions for matching to I-82 Indicator. Used, excellent condition.  
**Only \$12.50**

**COMBO**  
 BC-624 VHF RECEIVER. Freq. range 100-156 MC. Less tubes & crystals, with conversion dope. Used, good cond. **\$19.95**  
 BC-625 VHF TRANSMITTER. Freq. range 100-156 MC. Less tubes & crystals, with conversion dope. Used, good condition. **\$12.95**  
**BOTH TRANSMITTER & RECEIVER. Per Set \$29.95**

**INDUSTRIAL CORPORATIONS**  
 Write or wire for our new Catalogue listing complete line of Military Electronics Equipment.  
**\$5.00 MINIMUM ORDER ACCEPTED.** All shpts. F.O.B. whse. Cal. residents add sales tax with remittance. 20% dep. Specify shpg. instructions.

**ARROW SALES, INC.** 7460 N. Varna North Hollywood, California SUUnsel 3-7319

## OIL FILLED CONDENSERS

ALL NEW! ALL GUARANTEED! ALL BARGAINS!

1 mfd	600 vdc	C-D T6010	\$ 0.79
2 mfd	600 vdc	C-D TJJ-6020	.89
3 mfd	600 vdc	Aerovox 605	.89
8 x 8 mfd	600 vdc	Tobv 600 in.	1.59
12.75 mfd	330 vac	C-D XX3127A	2.95
10 mfd	600 vdc	C-D TJJ-15100	4.75
15 mfd	2000 vdc	C-D TJJ-15150	6.95
5 mfd	2000 vdc	C-D TJJ-20050	4.95
6 mfd	2000 vdc	C-D TJJ-20060	4.95
10 mfd	2000 vdc	C-D TJJ-20100	6.95
2 mfd	2500 vdc	Industrial 255AU200	3.39
4 mfd	2500 vdc	Industrial 250B	5.95
10 mfd	2500 vdc	C-D TJJ-25100A	7.95
1 mfd	3000 vdc	C-D TJJ-30010	3.50
0.1 mfd	4000 vdc	C-D TJJ-40010	2.50
0.5 mfd	4000 vdc	C-D TJJ-40005	3.45
2 mfd	4000 vdc	Aerovox 4009	5.69
4 mfd	4000 vdc	C-D TJJ-40040B	11.95
0.02 mfd	5000 vdc	C-D MV-843	1.98
0.1 mfd	5000 vdc	Aerovox 6012	2.75
1 mfd	5000 vdc	C-D TJJ-QS1010A	6.95
0.01 mfd	7500 vdc	Aerovox 7512	1.65
0.03 mfd	7500 vdc	Aerovox 7512	1.85
0.1 mfd	7500 vdc	Aerovox 7512	2.95
1 x 1 mfd	7500 vdc	Aerovox 7520	27.50
0.02 mfd	8000 vdc	Aerovox 10233	1.95
0.65 mfd	12500 vdc	C-D TJJ-12063	15.95
3 mfd	12500 vdc	West Inerteen 258043	49.50
0.25 mfd	15000 vdc	Aerovox 15020	17.50
0.03 mfd	15000 vdc	C-D TJJ-15003	2.50
0.25 mfd	20000 vdc	GE 14F64	27.50
1 mfd	25000 vdc	West Inerteen 1166899	49.50

### G-E PYRANOL SUPER SPECIALS

0.5 mfd 5000 vdc.	GE 26F405, with mounting brackets, 3 3/4" x 4 1/2" x 2 1/4"	\$ 3.95
1 mfd 5000 vdc.	GE 27A39, 3 3/4" x 4 1/2" x 4 1/2"	4.95
1 mfd 10000 vdc.	GE 14F104, 7 1/2" x 9 1/4" x 4 1/2"	27.50

12 mfd 1500 vdc	0.5 mfd 2000 vdc
Industrial 155AU1200	C-D Dykanol TJJ-20050
3 3/4" x 4" x 4 3/8"	1 1/2" x 2 1/4" (with bracket)
\$4.95	\$1.45

### RELAY BARGAINS (Save up to 75%!)

8P-ST ..... \$1.89 4P-ST ..... \$1.69

KILXON circuit breaker, 5 A, bakelite handle, two hole mount with ON-OFF plate. Price \$5.95. Only 69c. 10 for \$5.95

### NOVICE 80 METER CW XMTR

Here's a neat and compact surplus item which converts very simply to 4700-9750 kc crystal controlled. Condition? Guaranteed suitable. Instructions? Yes, we furnish them! Complete, comprehensive, step-by-step, nothing left out. The same plug-in command transmitter which has been such a favorite with old-timers. By the time this ad appears, the BC-477, described in November, 1952, will have been so worked out the conversion on 5.3-7. It had to be converted anyway, so why not convert the lower priced and available unit? Just as easy. Now you wait until these are all gone! ONLY \$7.95

### COMMAND EQUIPMENT

With free dope sheets and schematics  
RECEIVERS  
BC-455, 6-9 mc. NEW \$12.95. GOOD USED \$7.95  
TRANSMITTERS  
T-19/ARC-5, 3-4 mc. Excellent \$17.95  
BC-457 or T-20/ARC-3, 3-4 mc. Like new \$12.95  
MOD BC-456, Brand new \$5.95. Excellent used \$2.49  
As is, for parts, . . . . . 1.29  
27AN PLUG, 7-prong male plug to fit back of command revs. and xmtrs. In the same plug as used in the racks. NEW, each 21c; five for \$1.00  
Local Control Adapter Parts for 27AN or ARC-3. Exact, not given. Knows circuit plate and instruction data. Ready to mount. . . . . \$1.29  
SPINE TUNING KNOB. . . . . 79c

### BUILD TV-FM-AM SWEEP GENERATOR

Now you can build that "VERSATILE SWEEP FREQUENCY GENERATOR" we've got a few more of those vital AFN-1 magnetic units. With reprint of the article. . . . . \$6.95

### SUPER HI-FI HEADSET BUY!

Uses annular-grooved plastic fibre cones with voice coils as in speakers, and padded chamois ear muffs to obtain spacing for correct acoustical load. Gives finest music reproduction, flat far beyond upper and lower limits of auditory perception. Pair in series has measured impedance of correct acoustic load. Gives finest music reproduction. However, severe mismatching makes no apparent difference. Far superior to crystal ear. This high quality unit uses step-down transformer and dry disc rectifier, with pilot lamp in output to indicate and regulate charging rate. With secondary eye battery filled and instructions. ALL 4 ITEMS, BRAND NEW. . . . . \$4.95  
2. Six volt Vibrapak kit. Vibrator plus non-synch transformer with two outputs: 345 v, 145 ma for plates, 15 v for bias. With schematic. . . . . BRAND NEW \$2.95

CHAMOIS HEADSET PADS. Clean, in glassine bag. They're a real pleasure to wear. . . . . Pr. \$1.50

### BROADCAST BAND & AERO

MN-26-C Remote Controlled navigational direction finder and communications receiver. Manual DF in any one of three freq. bands, 150 to 1500 KC, 24 V. Self contained dynamotor supply. Complete installation, including receiver, control box, loop, azimuth control, Left-Right Indicator, plugs, loop transmission line, and flex. shafts. \$69.50  
BRAND NEW, ORIG. PACK . . . . . \$69.50  
MN-26-C alone, New. . . . . \$39.50  
MN-20-E Loop, Brand new. . . . . 8.95  
MN-52 Crank drive, New. . . . . 2.50

### PORTABLE POWER KITS

1. Includes 2 volt, 20 AH wet cell, lightweight transparent plastic, fibrite separators, 3 ball hydrometer, 4" x 3" x 5 1/2" high, shipped dry; also 2 volt synchronous vibrator, no tube needed; also 2 volt charger, 11.5 x 60/60 cy in. This high quality unit uses step-down transformer and dry disc rectifier, with pilot lamp in output to indicate and regulate charging rate. With secondary eye battery filled and instructions. ALL 4 ITEMS, BRAND NEW. . . . . \$4.95  
2. Six volt Vibrapak kit. Vibrator plus non-synch transformer with two outputs: 345 v, 145 ma for plates, 15 v for bias. With schematic. . . . . BRAND NEW \$2.95

ANTENNA MAST SECTIONS, MS-49, 50, 51, 52, 55. New, original packing. . . . . Each 39c

### G.I. ELECTRONICS

905 S. Vermont Ave., Los Angeles 6, Calif.  
All Prices F.O.B. Los Angeles, Calif. Buyers Add Sales Tax  
SEND FOR OUR CATALOGUE.

undoubtedly, hearings on at least 500 applications will be obtained soon after summer has set in. With the present staff of seven examiners, it might be possible to take care of 84 cases a year, it was noted. But, he said, there's more to it than this, for hearings must be held on matters involving services other than broadcast. As a matter of fact, he noted, there are now two common carrier matters designated for hearings which may take six months from the beginning to the issuance of initial decisions by each of the two examiners designated to hear the cases, leaving five examiners for TV and all other hearings. In view of this, Webster felt that it would not surprise him if no more than 60 to 70 TV application hearings would be conducted within the next year.

It is sincerely hoped that everyone will realize the seriousness of the Commission's plight and funds will become available immediately to hire the urgently needed legal staff.

**TRANSIT RADIO**, providing for the pickup of programs in buses or streetcars, which has been subjected to some rough treatment in the courts, finally won its freedom, and from the highest bench in the land. In a 7-to-1 vote, the Supreme Court declared that it is perfectly legal to broadcast news, music, and commercials to vehicles, and it is not an invasion of privacy as cited by the Circuit Court of Appeals a year ago.

According to Associate Justice Harold H. Burton, this form of broadcasting does not violate the First and Fifth Amendments to the Constitution, which guarantee freedom of speech and protection against taking away liberty or property without due process of law. In his decision, Justice Burton wrote that however complete the passenger's privacy . . . "may be at home, it is substantially limited by the rights of others when its possessor travels on a public thoroughfare or rides in a public conveyance."

Associate Justice William O. Douglas, writing the lone dissent, declared that outside the house, one . . . "has immunities from controls bearing on his privacy." In his opinion . . . "if liberty is to flourish, government should never be allowed to force people to listen to any radio program." He felt that forcing people to listen to the ideas of others created a powerful propaganda weapon. "Today it is a business enterprise working out a radio program under the auspices of government," the Justice continued, "and tomorrow, it may be a dominant political or religious group. . . . Once privacy is invaded, privacy is gone. . . . Once a man is forced to submit to one type of radio program, he can be forced to submit to another. . . . It may be but a short step from a cultural program to a political program."

The decision, won by WWDC-FM in Washington, created quite a flurry of activity along transit-radio row, with temporary plans for expansion an-

nounced by several operators. No definite programs can be set up until the FCC decides whether the present rules permit the use of a beep signal for switching talk programming. It is expected that a general rule-making hearing on the subject will be held soon so that industry will be able to plan accordingly.

Before the courts called transit-radio illegal last year, about a dozen cities featured a transit-radio service: St. Louis, Cincinnati, Houston, Washington, Worcester, Tacoma (Wash.), Evansville (Ind.), Wilkes-Barre (Penna.), suburban Pittsburgh, Allentown (Penna.), Huntington (W.Va.), Des Moines (Ia.), Topeka (Kan.), and suburban Washington.

Before transit-radio was introduced in many communities, assorted surveys were made to determine its virtues. In St. Louis, a study made by a newspaper and a university indicated that nearly 75% favored radio in buses and trolley cars. Commenting on the survey in an editorial, the *Post-Dispatch* said that the poll revealed some interesting results: "Young people are overwhelmingly for music on the streetcars. Nearly 93% of them favor it. Older people, those 50 years of age and more, are less enthusiastic. That the objectors object, there can be no doubt. . . . At this point, the 'ayes' seem to have it."

**TREATER TV**, whose future has been questioned by many because of the repeated hearing delays, will now have to wait until next year, or specifically January 12, 1953, before its place in the sun can be determined. Originally delayed by the pressure of allocation business and other acute communication problems, a shortage of manpower has now been cited as the reason for postponement.

**DESPITE A CONSIDERABLE** tendency toward more extensive use of very-high frequencies for voice communications between aircraft and ground, high-frequencies will continue to be used in many parts of the world for the foreseeable future. Thus reported Edgar A. Post, superintendent of navigational aids for the *United Air Lines*, in an interview on a symposium on international air transportation conducted in Copenhagen recently, during which communications and electronics experts of 20 airlines, 30 manufacturers, and 6 other international organizations and agencies, plus the civil aviation departments of 7 states and the military air forces of 3, participated.

One of the interesting technical subjects discussed at the meeting was the possible operational advantage of single-sideband over double-sideband transmission on the high frequencies. It was pointed out that the ssb system consists basically of transmission of messages on a carrier tone and one sideband, rather than with the two sidebands which is customary. A form of ssb using a voice-suppressed carrier

# THE NEW IMPROVED AIREX "630 FA" TV CHASSIS . . . DESIGNED SPECIALLY FROM RECOMMENDATIONS OF TV SERVICEMEN AND ENGINEERS ALL OVER THE COUNTRY

Tube Mfg. Brackets \$6.50  
Specify Tube Size

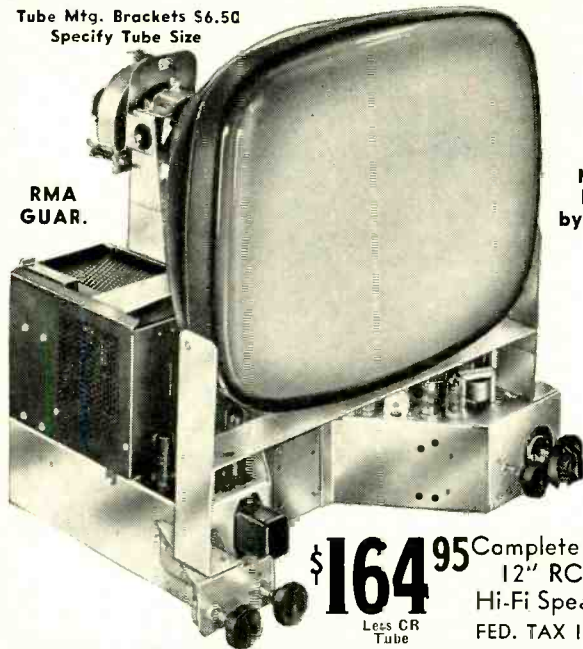

RMA  
GUAR.

Mfr.  
Lic.  
by RCA

This amazingly advanced 30 tube TV chassis is years ahead in engineering and gives you the ultimate in TV viewing and listening pleasure. To assure you trouble free TV our engineering staff has incorporated into the "630 FA" design the experiences of hundreds of TV servicemen and engineers. Receiving range includes stations up to 200 miles away. Nothing has been spared to bring you this finest of TV chassis. Only the best and most expensive parts are used. There is no other chassis that compares with the "630 FA" \*For fringe area.

## ✓ CHECK THESE EXCLUSIVE FEATURES ✓

- 10 WATT push-pull audio output. Frequency range from 60 to 12,000 cycles •
- Link coupled Standard Coil Cascade Tuner prevents radiation • Retrace Blanking Circuit allows you to raise the brightness without the annoying vertical retrace lines • Heavy duty front focus control • Automatic gain control potentiometer allows you to adjust the threshold sensitivity as low as 4 microvolts & still keep the full 4MC band width • Separate high & low frequency sync amplifiers • Set aligned for 21.75 MC. New Ham band will not interfere • Improved fused high voltage power supply gives full 14.5 KV under load • Will handle all picture tubes up to 24 inch with full sweep • Improved video amplifier has a gain of 32 • All moulded plastic condensers give long life & trouble-free operation • New 110GA tube. Thermal delay allows filaments & parts to warm up before B+ is applied—preventing parts & small tubes from breaking down because of surge voltage. Protects cathode emission of picture tubes & gives longer tube life • Easily adapted to new UHF stations in 2 minutes by just changing a strip in the tuner • Extra heavy duty power transformer with large safety factor • 6CB6 tubes in Video IF to give full gain • Extra filtering in power supply for hum & ripple free operation • Color connection on chassis which is adaptable to the cathode follower circuit of color converter • Phono Connection & switch on chassis allows you to play your phonograph or tuner through the built-in 10 watt hi-fidelity amplifier • Extra heavy duty focus coil, which runs cool.

**\$164<sup>95</sup>** Complete with  
12" RCA  
Hi-Fi Speaker  
FED. TAX INCL.  
Less GR  
Tube

Complete Service Manual  
For "630FA" or Super 630DX—S1

SEND FOR FREE NEW TV PARTS &  
HI-FIDELITY EQUIPT. CATALOG

**SUPER 630 DX 30 TUBE TV CHASSIS  
WITH STANDARD COIL  
CASCADE TUNER. \$149<sup>95</sup>**  
INCLUDES 12" RCA HI-FI SPEAKER  
Fed. Tax  
Incl.

38 BARGAIN-PRICED CABINETS FOR THE 630 AND OTHER TV CHASSIS . . . Send for FREE folder and price list. Full line table models, consoles, consolettes and Radio-TV Phono combinations. Many styles. Mahog., Blond etc.

All merchandise is brand new, factory fresh & fully guaranteed. Mail & phone orders filled upon receipt of certified check or money order for \$25 as deposit on TV chassis, 20% on other items. Balance C.O.D., F.O.B. N. Y. Prices subject to change without notice. No Fed. taxes to pay. Prices lower than OPS Regs.

**AIREX RADIO CORP.** 171 Washington St., N.Y.C. 7, N.Y.  
Phone Worth 2-4029

TV TUBE EXTRA	
Standard Brands—Black Glareless	
Factory New—1st Qual.—Guar. 1 Year	
7JP4* . . . \$14.95	17BP4 . . . \$27.95
10BP4 . . . 17.95	20" TV Tube . . . 34.95
16GP4* . . . 24.95	21" TV Tube . . . 39.95
16JP4* . . . 24.95	24" TV Tube . . . 69.95
Ring and Sleeve for 24" Tube . . . \$7.50	
*Guaranteed for 6 months only	
TV GOLD PLASTIC MASKS	
16" & 17", \$4.95;	20" & 21", \$7.95;
24", \$14.95	

# LEARN Practical RADIO AT HOME



COMPLETE ONLY . . . **\$19<sup>95</sup>**

## BUILD 15 RADIOS

ABSOLUTELY NO PREVIOUS TRAINING NEEDED  
EXCELLENT BACKGROUND FOR TELEVISION

### 10-DAY MONEY-BACK GUARANTEE

#### WHAT THE 1952 PROGRESSIVE RADIO "EDU-KIT" OFFERS YOU:

This is a practical home radio course. You learn theory, construction, operation, trouble shooting, code. You build RECEIVERS, TRANSMITTERS, AMPLIFIERS, CODE OSCILLATOR, SIGNAL TRACER.

You start with a simple radio circuit, and gradually advance to more complex circuits. No previous background is required. No instructor is needed. All parts and instructions are included and every single step is clearly explained.

All parts are guaranteed, individually packaged, identified, and explained. There is nothing extra to buy. You receive all parts, tools and instructions at once. You keep everything; there is absolutely nothing you return to us.

You can easily pay for the kit in a short time by repairing radios. Use the tester and signal tracer for servicing. The signal tracer alone is worth more than the price of the entire kit.

#### USED BY RADIO SCHOOLS AND GOVERNMENT AGENCIES!

The Progressive Radio "Edu-Kit" includes tubes, paper condensers, mica condensers, electrolytic condensers, variable condensers, selenium rectifiers, chassis, hardware, tie strips, tube sockets, solder, wire, soldering iron, tubing, coils, instruction book, radio tester, etc.; in brief, everything you need in a practical radio course.

Send for further information and receive FREE Radio & TV Trouble-Shooting Guide. Or order direct from this ad and receive FREE Code Oscillator Key (Value \$2.95) in addition to Radio and TV Trouble Shooting Guide.

Postage prepaid on Cash orders—C.O.D. orders accepted in U.S.A.

**PROGRESSIVE ELECTRONICS CO.**  
497 UNION AVE. DEPT. RN-8 BROOKLYN, NEW YORK

## FREE RADIO TESTER & SOLDERING IRON

GET A WELL-PAYING JOB

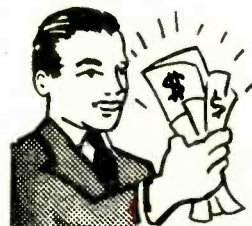

GO INTO A PROFITABLE BUSINESS  
AND PLAN FOR A FUTURE



# Standard Brands TUBES

Individually Boxed **PRICES SLASHED**

0Z4	\$ .45	6B06	\$ .45	12BA6	\$ .43	50L6GT	\$ .50	6AX5GT	\$ .40	6SH7	\$ .59
1T4	.55	6BE6	.46	12BE6	.48	183GT	.63	6B4G	.95	6S17	.47
1T5	.64	6B06GT	1.49	12BH7	.63	1N5GT	.55	6BA7	.65	6SL7GT	.65
1X2A	.63	6B06GT	.90	12SA7GT	.50	1R5	.54	6BF5	.55	6SR7	.38
30S5GT	.63	6C86	.53	12S7GT	.47	1S4	.63	6B16	.60	6SS7	.48
5U6	.40	6J5GT	.40	12S7GT	.50	1S5	.45	6B16	.50		
5Y3G	.28	6J6	.63	12SN7GT	.55	1U4	.55	6BN6	.81		
6AG5	.53	6K6GT	.39	12S07GT	.45	1U5	.45	6C4	.39		
6AK5	.95	6SA7	.45	19BG6G	1.39	3A5	1.06	6C5	.51	12A07	.52
6AL5	.40	6SN7GT	.52	25AV5GT	.83	304	.60	6CD6G	1.55	12SG7	.52
6AQ5	.46	6S07GT	.45	25B06GT	.90	354	.57	6D6	.65	19T8	.75
6AR5	.35	6V6GT	.51	25L6GT	.47	3V4	.58	6E5	.66		
6AS5	.36	6W4GT	.49	35B5	.47	5T4	1.08	6F5	.48	25Z6GT	.41
6AT6	.36	6W6GT	.50	35C5	.47	5V4G	.73	6FG6T	.48	117N7GT	1.09
6AUG	.41	6X4	.35	35L6GT	.47	6AB4	.46	6H6	.49	117P7GT	1.09
6AV5GT	.87	6X5GT	.35	35W4	.31	6AC7	.80	6L6G	.81	117Z3	.42
6AV6	.36	12AL5	.48	35Z5GT	.30	6AG7	.84	6S4	.42	17BP4	19.50
6BA6	.43	12AT6	.40	50B5	.47	6AH6	.75	6SC7	.68		
6BC5	.53	12AUG	.46	50C5	.48	6AS7G	2.88	6SF5	.51	20CP4	24.50

Many other types equally low priced—include all your tube needs with your order. One of the largest stocks in the country.

Terms: DEDUCT 2% when enclosing full payment with order; C.O.D.'s 25% with order; Min. Order: \$25.00; F.O.B. New York City

All merchandise subject to prior sale

## Television Materials Corp.

125 Cedar St., New York 6, N. Y. • COrtlandt 7-4307

### STAN-BURN SPARKS

- ANTENNAE SPECIALS**
- CIRCLE X Limited quantities..... 1-11 \$2.98 each, 12 or more \$2.20
  - DOUBLE V 3/8" Dowel..... \$2.98
  - DOUBLE V 1/2" Dowel..... 3.45
  - DOUBLE V 3/4" Dowel..... 3.95
  - 10 Element Conical 3/8"..... 3.55
  - Folded Hi Straight Low Quick Rig 3/8" elements..... 4.25
  - WINDOW CONICALS..... 4.95

- MASTS**
- 5 FOOT SWEDGED..... .79
  - 10 FOOT PLAIN..... 1.39
- TV WIRE**
- 55 Mil. 300 OHM..... \$14.95 M Ft.
  - 72 OHM COAXIAL..... 45.00 M Ft.
- CATHODE RAY TUBE SPECIALS**
- 10BP4 ZETKA \$14.95 16TP4A DUMONT \$26.00
  - 10BP4 N. U. 19.95 17BP4A FEDERAL 23.00
  - 10BP4A N. U. 19.95 17BP4A DUMONT 28.00
  - 12LP4 ZETKA 18.95 19AP4 SHELTON 29.95
  - 12LP4 THOMAS 19.95 19AP4 G. 39.95
  - 16AP4 ZETKA 26.00 19BP4A THOMAS 39.95
  - 16AP4A G.E. 38.00 20CP4A DUMONT 41.00
  - 16DP4A THOMAS 28.80 20CP4A SHELTON 37.00
  - 16GP4A RAULAND 33.00 21EP4A DUMONT 42.95
  - 16GP4A ZETKA 26.00 24AP4A SHELTON 63.00
  - 16JP4A THOMAS 28.80 24AP4A G. 76.00
  - 16RP4A GE & NU 26.00 Double Ion Traps..... 39c
  - 16RP4A GE & NU 26.00 Single Ion Traps..... 59c

- CHASSIS 630 REGAL with Cascade Tuner..... \$139.50  
 21" FT FLY BACK (Similar to RCA)..... 2.98  
 OPEN FACED CABINET..... 39.00

- TRANSFORMERS**
- RCA type for 16" to 24" X032..... \$3.85
  - G.E. type for 16" to 24" X042..... 3.85
- These are very special prices while they last!

- DEFLECTION YOKES**
- COSINE FERRITE TODD YOKE 70"..... \$4.20

- SPECIALS**
- 4 Prong Vibrators, each..... \$ 1.29
  - Lots of 12 or more..... 1.19
  - Standard TV Tuners..... 18.95
  - 12" Heavy Slug Speaker..... Special 4.98

- AUDIO DEVICES, DISCS and SCOTCH TAPE IN STOCK**
- Audio Plastic Red Oxide Plastic Tape..... \$2.30
  - Half hour spool..... 3.30
  - One hour spool..... 3.30

- WIRE RECORDERS IN STOCK**
- WILCOX GAY—Model 2A10..... \$ 89.97
  - PENTRON—Model 9T3C—2-speed Tape Rec. Net 134.50
  - Radio Craftsman.....
  - Model RC2—11P1 Amplifier..... Net 42.89
  - Model RC10—V1-FM Tuner..... Net 136.84
  - Model CS—Williamson Amplifier..... Net 99.45

- Cascade (Guaranteed Tuners (with tubes) SPECIAL! While they last..... \$21.95

**AUTHORIZED DISTRIBUTORS for:** General Electric, Kenrad, Tung-Sol, National Union, Jewell, De Wald, Regal, Automatic and Setchel Carlson.

We carry a complete line of popular makes of Radio and TV tubes, at 50% discount. Also many other special purpose and transmitting types, and all electronic parts and equipment at lowest prices. Send us a list of your requirements for prompt quotations. Terms: 20% with order. Balance C.O.D. All prices F.O.B. NEW YORK Warehouse. Minimum order \$5.00. Write for our latest price list to Dept. RN-8

### STAN-BURN RADIO and ELECTRONICS CO.

(C.B.S. THEATRE BLDG.)  
 1497 BROADWAY • NEW YORK 19, N. Y.

### EASY MONEY!!

If you don't get our postcards telling the cash we'll pay for that surplus gear you bought when the buying was good, then YOU ARE LOSING MONEY! So send us your name and address NOW and GET ON OUR MAILING LIST!

**G. L. ELECTRONICS**  
 905 S. VERMONT AVE., LOS ANGELES 6

### ON-THE SPOT BATTERY RECORDER

**WALKIE-RECORDALL** 5 lb. miniature BATTERY RECORDER-PLAYBACK. Continuous, permanent, accurate, indexed recording at only 5c per hr. Instantaneous, permanent playback. Picks up sound up to 60 ft. Records conferences, lectures, dictation, 2-way phone & sales talks; while walking, riding or flying. Records in closed briefcase with "hidden mike"! Write for Detailed Literature.

**MILES REPRODUCER CO., INC.**  
 812 BROADWAY Dep't RN-9 NEW YORK 3, N. Y.

### BUILD YOUR OWN GEIGER COUNTER!

It's EASY to build your own Searchmaster Geiger Counter with this COMPLETE kit. Contains everything you need! Heads, tubes, batteries, metal case. Fully guaranteed! Sensitive to both beta and gamma radiation! Illus. instructions. FREE radioactive specimen.

**MODERN SCIENCE LABS \$29.95**  
 8049 St. Clair • North Hollywood, Calif.

Write for FREE Catalog "Creative Tools for the Scientist of Tomorrow"

### RADIO and TELEVISION ELECTRONICS

in all Technical Phases  
 New Classes (Day and Evening) Start 1st of Dec., Mar., June, Sept.

Free Placement Service for Graduates  
 For Free Catalog write Dept. RN-52  
**RCA INSTITUTES, INC.**  
 A Service of Radio Corporation of America  
 350 WEST 4th ST. NEW YORK 14, N. Y.

system is now under experimental test in Britain and has been reported to have exhibited five advantages: A large improvement of 9 db in signal strength; better intelligibility in the face of interference; almost complete absence of distortion due to selective fading; a halving of the probability of jamming by a single strong interference signal within the broadcast band; and the ability to pack more channels into a given frequency space. The disadvantages of *ssb*, revealed thus far, lie in the necessity for accurate crystal control, using a close synchronizing tolerance of  $\pm 300$  cycles, as a matter of course, and the increasing complexity of the receiver due to the need for automatic-frequency control.

Airborne equipment using *ssb*, it was said, would be generally equal in weight and bulk to the *dsb* type, and create a lighter drain on the power supply, but would require a more complicated transmitter and receiver circuit. It was also disclosed that the *ssb* receiver used on the ground will accommodate *dsb* reception as well, without any alteration, but with some loss.

French technicians at the meeting suggested that a slight variation of the basic *ssb*, using an unsuppressed carrier, would eliminate some of the troubles stemming from the need for very stable crystal-controlled radio carriers. While this would sacrifice a substantial amount of the theoretical advantage of *ssb*, it was said to be more adaptable to airline use.

**INDUSTRY'S** striking contribution to the critical material stockpile received a stirring tribute from Donald S. Parris, deputy director of the electronics division of NPA, during a meeting of management personnel at the recent Parts Show in Chicago. Complimenting industry on their conservation plans, voluntarily put into effect to save critical metals, Parris said that substantial quantities of copper and nickel were saved through ingenious production and design techniques. Without such self-imposed programs, both the civilian and military fronts would have been seriously affected, Parris declared. The component and accessory makers deserve a round of applause for their enviable efforts, he added. ....L.W.

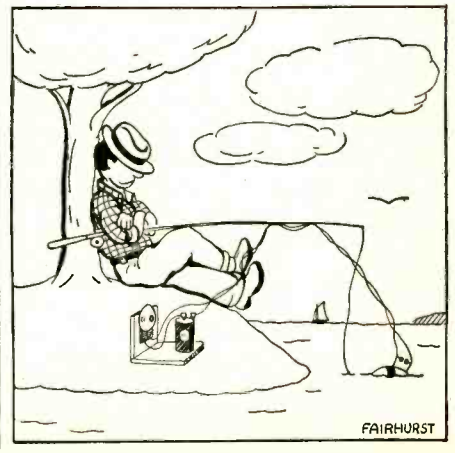

**NOW ... VOLUME III!**  
**96 new photos**  
**over 200 pages!**

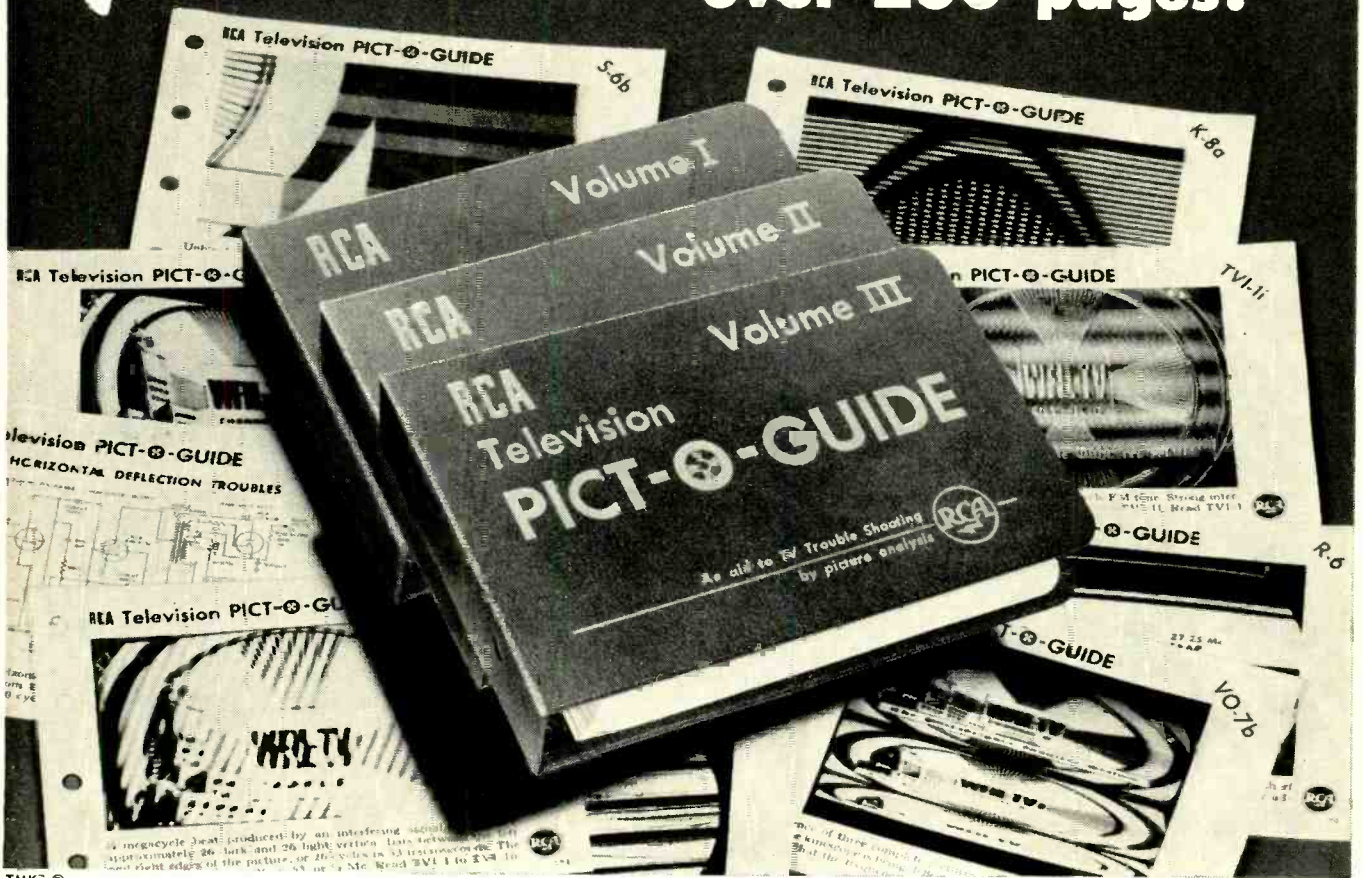

**YOURS** — Vol. I, II, or III... with each order for 75  
**RCA receiving tubes or 3 RCA kinescopes**

THE RCA Tube Department proudly announces the publication of Volume III of the famous RCA TELEVISION PICT-O-GUIDE... another significant addition to the PICT-O-GUIDE series, recognized as the most useful, practical servicing information in the industry for helping you locate and solve TV troubles by picture analysis.

Authored by John R. Meagher, RCA's noted TV Service Authority, Volume III contains completely new data on television interference, built-in and external ghosts, hum troubles, and a host of

trouble-shooting techniques applicable to all TV sets. It's information you can't afford to be without.

For a limited time only, you can have your choice of PICT-O-GUIDE Volume I, II, or III with each order for 75 RCA receiving tubes or 3 RCA kinescopes. It's as simple as that.

This is your chance to get the complete set of three matched volumes to bring your library up-to-date. But don't miss out on this limited offer! Place your qualifying tube order with your RCA Tube Distributor at once.

**PLUS THIS BONUS**

"TV Servicing Supplement"—*Trouble Shooting "Tough" Sets or "Dogs."* This indispensable book by John Meagher tells you how to handle the really tough TV sets... the ones that take the most time to analyze and repair. It's a "Post-graduate course" in TV trouble-shooting. You get a bonus copy with each Pict-O-Guide volume you earn. This is a bonus offer you won't want to miss!



**RADIO CORPORATION of AMERICA**

**ELECTRON TUBES**

**HARRISON, N. J.**

August, 1952

107

# WE GREW UP WITH THEM

**T**ver since radio was in "knee pants," Supreme has been providing aids to help electronic technicians use their training and experience more efficiently and profitably. We know that in television today, as it was with the TRF's and neutrodynes of yester-year, they must have high quality, dependable test equipment to save time and keep up with this progressive electronic industry. We also know that service technicians do not want Supreme to sacrifice quality by substituting unproven materials in place of those temporarily under control due to our nation's mobilization program. They will, as they have in other emergencies, give us extra time, if needed, to deliver a product that is "Supreme By Comparison" in every respect.

Supreme's mission in our defense program, just as it was during World War II, is to help the technicians in our armed forces locate that faulty part or maladjustment quickly by supplying them with well designed and reliable testing equipment. For a quarter century Supreme has been a major contributor to the efficiency of the electronic technician—we grew up with them. By continuous research, development, improvement, and production of equipment for maintenance of electronic devices—plus our close contact with the electronic technician—knowing the job he has to do—what it could mean if he fails—leads us to accept new challenges with confidence and pride. Supreme's "know-how," gained both in peace and war, is one of this nation's assets in times like these.

Our 25th Year

# SUPREME

Testing Instruments

"SUPREME BY COMPARISON"

TUBE TESTERS • SIGNAL GENERATORS  
PANEL METERS • MULTI-METERS  
OSCILLOSCOPES

Supreme, Inc., Greenwood 1, Mississippi

108

## International Short-Wave

(Continued from page 65)

**Colombia**—HJXC, 6.018, noted Sunday to after 0200 at excellent level. (N. Z. DX Times)

**Curacao**—Willemstad, 5.014A, noted with *English* program on Wednesdays 2000-2030. (Kolberson, N. J.)

**Czechoslovakia**—Prague, 9.55, noted with *English* for North America 1930-2000; fair. (Boggs, Mo., others)

**Denmark**—By this time, Copenhagen should have a *new* program on the air for Greenland daily 1900-2000 on OZF, 9.520, with the program for South America changed to 1730-1830 on Mon., Wed., Fri., on same channel. (WRH) Is now scheduled to Australia, New Zealand over 15.180 on Tue., Thur., Sat. 0400-0500; to India, Burma, Malaya, Indonesia on Tue., Thur., Sat. at 0900-1000; broadcasts are followed by a 20-minute program for Danish seamen in areas to which the transmissions are directed. (Radio Australia)

**Dominican Republic**—HI2A, 9.680, Ciudad Trujillo, is noted in Sweden at fine level from around 1855. (Engberg) HI2T, 9.735, noted recently with *Eng-*

*lish* talk 2100-2110. (Kary, Pa.) Is parallel on HI4T, 5.970.

**Dutch New Guinea**—A station heard on 7.126 signing off around 0700 is believed to be *Radio Hollandia*. (Stark, Texas)

**Egypt**—The Chief Engineer of *Radio Cairo*, 9.715, states that schedule remains 1345-1700. (Bellington, N. Y.) Noted with news in French after 1345 sign-on. (Pearce, England) Has news in *English* 1400.

**Ethiopia**—*Radio Addis Ababa*, 15.047A, noted 1230-1245 with native music and singing; faded severely around 1250. (Cox, Dela.) Reported to sign off now around 1306. (Pearce, England, others)

**France**—Current schedule for the Overseas Service in French from Paris includes 1830-2000, 9.685, 11.700 to Antilles, Guiana; 2230-2245, 7.105 to Madagascar, Reunion, Fr. Somaliland; 0030-0130, 9.550, 17.850, to Tahiti, Pacific; 0145-0230 to Fr. East and Fr. West Africa and 0230-0300 to New Caledonia, New Hebrides, 15.240, 17.850; 0530-0600, 17.850, to Antilles, Guiana; 0800-1000, 15.400, 15.350, 17.850, to Indo-China; 1500-1600, 9.540, 11.700, 15.240, to Fr. East and Fr. West Africa; 1730-1800, 9.675, 11.920, to Indo-

## USE YOUR GDO FOR ALIGNMENT

by LEWIS S. HUGHES

**T**HE grid dip oscillator is well-known to most hams but very few service technicians are aware of its usefulness around the shop. It can be used as a marker generator for TV and FM alignment, for setting traps in television sets, and, believe it or not, for checking condensers in a set while the set is turned on—without unsoldering one side of the condenser. It's wonderful for catching that intermittent condenser that heals itself the minute you touch a test prod to it.

To use the GDO as a marker generator, set the grid dipper near the receiver being aligned and tune it to the desired marker frequency. You may have to move it around a bit to get just the right amount of coupling you need to keep the pip as small as possible. If the pip is too large, it will change the shape of the curve. Use the grid dipper and marker generator to get two pips on the curve. In this way you will not have to keep running the marker generator back and forth to check the other side of the curve.

For setting traps, the GDO is not as accurate as the sweep generator and scope, but it serves the purpose by permitting the touching up of the traps in the field. Set the grid dipper at the trap frequency and tune the trap for dip on the meter. It has been the experience of the writer that complete alignment on stagger-tuned sets with this method is not accurate enough for service work.

Where the GDO shines is in checking condensers while the set is in operation. An eight inch loop of wire in series with a condenser of the proper capacity is hooked across the suspected condenser. See chart. Couple the grid dipper to the loop and tune to the frequency specified on the chart. If you can't get

a dip near the frequency given in the chart, the condenser is bad. (The frequencies given on the chart may vary slightly from the frequencies at which the dip occurs because of differences in lead length and distance between the two sides of the loop. If the frequency varies too much, it would be well to compile your own chart.)

For that condenser you suspect of being intermittent, you can clip your loop across it, couple the grid dipper to the loop, and wait for the set to fail. When it goes out, a quick glance at the meter will show whether it is the suspected condenser or not. The added capacity across the condenser in the set will not throw the circuit off enough to bother the picture or sound to any appreciable extent. If the condenser in the set opens up, it is very possible the condenser in your loop will take over and do the job, so the set will not fail as long as the loop is clipped into the circuit. However, the meter will still show the condition of the condenser in the set.

Frequency settings on the GDO when unit is used to check the condition of condensers. No dip on the meter shows that the condenser being tested is no good.

SERIES		
CONDENSER	CONDENSER	TUNE GDO TO
2.5 $\mu$ fd.	220 $\mu$ fd.	225 mc.
10 $\mu$ fd.	220 $\mu$ fd.	100 mc.
50 $\mu$ fd.	220 $\mu$ fd.	51 mc.
100 $\mu$ fd.	220 $\mu$ fd.	42 mc.
220 $\mu$ fd.	220 $\mu$ fd.	31 mc.
390 $\mu$ fd.	.001 $\mu$ d.	22.5 mc.
470 $\mu$ fd.	.001 $\mu$ d.	19 mc.
680 $\mu$ fd.	.001 $\mu$ d.	17.5 mc.
1000 $\mu$ fd.	.001 $\mu$ d.	16 mc.
.002 $\mu$ d.	.005 $\mu$ d.	9 mc.
.005 $\mu$ d.	.005 $\mu$ d.	7 mc.
.01 $\mu$ d.	.005 $\mu$ d.	6.2 mc.
.02 $\mu$ d.	.005 $\mu$ d.	5.5 mc.

RADIO & TELEVISION NEWS

China; these periods are over 100 kw. transmitters. (WRH)

*French Equatorial Africa*—Brazzaville, 11,970, noted with news 0015. (Hoffman, N. Y.)

*French West Africa*—WRH says *Radio Dakar* has been logged on 7.198 with news in French 1515; verified this channel with new QSL card.

Noted on 11.896A with French news now at 1800 and signing off around 1813. (This is an additional news period.) (Bellington, N. Y.) Noted at good level from 0130 with all-French session, mostly music. (Saylor, Va.)

*Germany*—Hamburg, 6.270, is heard in Sweden around 0400. (Engberg) *Radio Free Europe* now operates on approximately 9.080 at 1500 and on 5.960 around 1000. (Engberg, Sweden) *Leipzig*, 9.728A, noted from around 2300 with fair signal. (Cox, Dela.)

*Greece*—The North American transmission from *Radio Athens*, 9.607, at 2000-2100, is only poor to fair; news in Greek 2002 and 2055; news in *English* 2043-2055; fills in with music; has severe QRM. (Kary, Pa.) Heard on this channel with *English* 1430, French 1445. (Pearce, England)

*Guatemala*—TGNA uses 9.668 and 11.850 for *English* daily 2200-2230; Wednesday's Mailbag feature ("Script by You") runs around 2230-2300; still asks for reports. (United 49'ers Radio Society) TGWA, 9.760A, noted recently ending *English* session at 2259 (may be only Mon., Wed., Fri.) (Bellington, N. Y.) TGWB, 6.180A, is heard at fair level to 2300 when has interference from Munich, 6.185. (N. Z. DX Times)

*Hawaii*—WVH, 10.000, Maui, noted recently through WVV's modulation at 2230. (Peddle, Newfoundland)

*Holland*—*Radio Nederland*, 9.59, noted with news 2130. (Hord, Ind.) Heard on 15.220 at 1050 with program in Dutch; weak to fair. (Cox, Dela.) Heard on 11.730 at 1630 with *English*, good level. (Baetz, Ill.)

*Honduras*—HRP1, 6.354, San Pedro Sula, noted lately with improved signal; news in Spanish 2230. (Ferguson, N. C.)

*Hong Kong*—ZBW3, 9.525, heard best around 0530-0630. (Sanderson, Australia)

*India*—Engberg, Sweden, notes Delhi with news 0300 on 17.760 parallel with 17.740.

AIR, 11.850, noted with news 1930. (West, Virginia) Parallels 15.290.

Delhi, 15.160, noted in External Service to East Asia, Southeast Asia, Australia, New Zealand opening 2030.

*Indo-China*—"Voice of Vietnam," Saigon, is noted on 9.62 and 7.09A with news daily 0845-0900 sign-off; at present, 9.62 is best signal. (Balbi, Calif.) *Radio France-Asie* noted on 11.924 with French news 1745; on 15.420 at 0500 with (*English*) news, music. (Sanderson, Australia)

*Iran*—*Radio Teheran* is now broadcasting its Overseas Service over EQA, 896 kc., EQB, 6.155, and EPB, 15.100—1345 *English*, 1400 Persian, 1430 German, 1445 French, 1500 *English*, 1515 Russian; EQB is "announced" as 6.16.

# CHICAGO

## has the "specials" IN STOCK

### "SPECIAL" FOR AIRCRAFT

CAT. NO. HP3-140. Three-phase 400 cycle step-down transformer Y-Y connected. Pri: 115 volts per phase, 3 phase, 400 cycle. Sec: 28.5 volts per phase, 140 va capacity. "H" type mounting; meets MIL-T-27 Grade A, Class 1 specifications. Dimensions: 2 7/8 x 2 1/16 x 3 3/4 high.

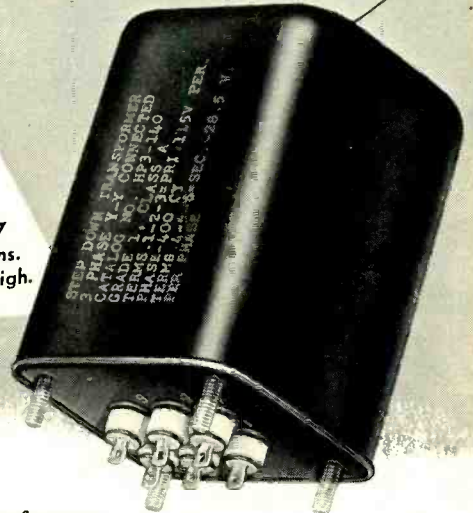

The HP3-140 unit is just one of many "specials" regularly stocked in the CHICAGO New Equipment Line. CHICAGO makes a practice of stocking "specials" that are hard-to-get elsewhere. You'll find the answers to your transformer needs for practically any of today's circuit requirements in CHICAGO's exclusive "Sealed-in-Steel" New Equipment Line—in stock at leading electronic parts distributors. Whether your transformers must pass the most rigid MIL-T-27 specifications or are intended for average applications, it's wise to choose CHICAGO "Sealed-in-Steel" units (the world's toughest) for that extra margin of dependability under all operating conditions.

### "Special" or "Standard"—the world's toughest transformers are in CHICAGO'S "Sealed-in-Steel" NEW EQUIPMENT LINE!



**H-TYPE**  
Hermetic sealing meets all MIL-T-27 specs. Steel base cover is deep-seal soldered into case. Ceramic bushings. Stud-mounted unit.



**S-TYPE**  
Steel base cover fitted with phenolic terminal board. Convenient numbered solder lug terminals. Flange-mounted unit.



**C-TYPE**  
With 10" color-coded leads brought out through fibre board base cover. Lead ends are stripped and tinned for easy soldering. Flange-mounted unit.

All CHICAGO "New Equipment" transformers feature one-piece drawn-steel cases—the strongest, toughest, best-looking units you can buy. The one-piece seamless design, enclosing an electronically perfect construction, provides the best possible electrostatic and magnetic shielding, affording complete protection against adverse atmospheric conditions. For every application: Power, Bias, Filament, Filter Reactor, Audio (in 3 ranges), MIL-T-27, Step-down—there's a CHICAGO "Sealed-in-Steel" transformer, available in a choice of 3 mountings.

#### Free "New Equipment" Catalog

Get the full details on CHICAGO'S New Equipment Line—covering "Sealed-in-Steel" transformers designed for every modern circuit application. Write for your Free copy of this important catalog today, or get it from your electronic parts distributor.



# CHICAGO TRANSFORMER

DIVISION OF ESSEX WIRE CORPORATION

3501 ADDISON STREET • CHICAGO 18, ILLINOIS



TRADE MARK REG.

# Become an Electrical Engineer



## MAJOR IN ELECTRONICS



- B. S. Degree in 36 Months
- Radio-Television Technician Certificate in 18 Months

By 1954 there will be at least two positions for every engineering and technician graduate. This College offers a tested plan that permits you to enter these vast employment opportunities at an early date. First — you save a valuable year through optional year-round study. Second — you can receive advanced credit for prior training gained in the armed forces, other schools or field experience.

### Enter Both Radio and Television Through This Plan

12 months or one-third of the B. S. degree course (Electronics major) — also brings you the Radio Technician's certificate. An added 6-month course qualifies you for the Radio-TV Technician's Certificate. Recent developments open unlimited opportunities for TV technicians and engineers.

### The Proven "UNIT CHASSIS SYSTEM"



of teaching was developed here. It "breaks down" the TV set by stages. You learn every component of all types and makes — and are prepared for future design changes, including the advent of color.

### General Preparatory Course

Exclusive 3-month course is tailor-made to help young men fulfill academic deficiencies and meet engineering admission requirements. Terms open October, January, April, July Over 48,000 former students from all states and 23 overseas countries. Faculty of trained specialists. Modern laboratories and equipment. Nonprofit technical institute and college in its 49th year.

## MILWAUKEE SCHOOL OF ENGINEERING

FREE — Write for "Occupational Guidance Bulletin," "Your Career" booklet, and catalog.

Milwaukee School of Engineering  
Dept. RN-852, 1025 N. Milwaukee  
Milwaukee, Wisconsin

Without obligation send Catalog for Electrical Engineering, B. S. Degree, major in  Electronics;  Power;  "Your Career"; Occupational Guidance Bulletin on:  Radio-TV;  Electrical Power;  Welding;  Heating, Refrigeration Air Conditioning;  Mechanical Engineering, B.S. Degree;  Preparatory.

Name..... Age.....  
Address.....  
City..... Zone..... State.....  
If veteran, indicate date of discharge.....



(WRH) EPP, 3.835, Teheran, noted through ham QRM at 2130-2200; frequency varies a great deal. (Peddle, Newfoundland)

*Iraq*—In verifying, *Radio Baghdad* stated that the *English* session ("Date With Baghdad") opens 1413 with the song of the Bulbul (the nightingale of Iraq). Station operates on 11.724 and closes 1500. (Pearce, England)

*Israel*—Tel Aviv, 9.010A, still noted with *English* 1515-1600 sign-off. (Saylor, Va.)

*Italy*—New schedule for *Radio Italiana's* European Service is 0615-0715, 6.010, 9.570; 0810-0910, 6.010, 7.110, 9.570, 9.630, 11.900; 1220-1710, 6.010, 9.570, 11.900 (with French 1340-1420, German 1420-1500, 1620-1640); 1245-1340 on 11.810, 15.400 (*English* 1245-1320), 1415-1615 on 9.630, 11.810; 1620-1710 on 11.810, 15.400 (Portuguese 1620, Spanish 1645); 2215-2245 Russian on 6.010, 7.110, 9.710, 11.900, 15.400. (WRH)

Rome, measured 17.802, noted with news when tuned 1510; news ended 1520, then had talk; continued with music 1525; good signal in N. C. Heard on 15.400 at 1244 with interval signal followed by news to 1300 after which had a talk. (Ferguson) Heard at nice level closing down 2200 on 11.81. (Lund, Iowa) Noted with news to Britain, Ireland 1245-1300 on 15.400. (Cox, Dela.) Heard at excellent level 1930 on 11.905A. (Golden, Mass.)

*Italian Somaliland*—Mogadishu, 7.385A, noted around 1220 tune-in to 1300A closedown; news in Italian 1225. (Pearce, England)

*Japan*—The Japanese Standard Frequency Station JJY, Tokyo, broadcasts 1600-0600 on 4.000 and 8.000; every ten minutes has radio propagation warning in Morse code; has been testing at 1900 on Mondays on 2.500, Wednesdays 5.000, Fridays 10.000; power of each outlet is 1 kw. (Wada, Japan, via WRH)

According to verification, the Far East Network, AFRS, Tokyo, is now on the air 1600-1800, 6.080, 4.860; 0815-0330, 11.825, 9.605; 0345-1000, 4.860. (WRH) *Radio Japan*, 15.235, has strong signal on West Coast in the North American period 0000-0100; 11.705 is parallel. JBD3, 15.225, has fair level in Home Service from 2200 onwards. (Balbi, Calif.) *Radio Japan* is noted daily 1030-1130 using announced JOB2, 11.705, and JOA2, 9.675; news is 1030-1045, then 5 minutes of commentary, followed by 15 minutes of Japanese music; at 1105 uses Japanese until 1130 sign-off. (Graybill, Wash. State) Heard on 7.180 in *English* 0700, fair level in Missouri. (Boggs) JKI, 4.910, Nazaki, has been coming in at fair level lately from 0300 with programs in Japanese. (Saylor, Va.)

*Kashmir*—*Radio Kashmir*, Srinagar, is now scheduled 2130-2330 (Sun. to 2345) on 4.860; 0100-0230, 6.110; 0630-1200, 3.335. (WRH)

*Kenya Colony*—Forces Broadcasting Service, East Africa Command, 7.265, Nairobi, noted 2302 with BBC news relay. "Nairobi Calling," 4.855, heard



An active DX'er—Lee Neeley of California.

with BBC news relay 1300; closes down 1500 with "God Save the Queen." (Pearce, England)

*Lebanon*—Beirut, 8.036A, noted with news in French 1400; news in Arabic 1300. (Pearce, England)

*Luxembourg*—*Radio Luxembourg*, 6.090, noted with sponsored programs in *English* 1600. (Pearce, England)

*Malaya*—BFEB, Singapore, noted at fine level on 15.435 at 0845, good on 11.955. (Balbi, Calif.) Heard on 9.690 to 0615 sign-off when announced was parallel 6.175; good level. (Ferguson, N. C.) Lists current schedules as daily to India, Pakistan 0800-0900 on 17.755; 0915-1030, 15.435; 1030-1145, 17.755. 15.435; to Burma and Thailand daily 0800-0815 on 11.955, 7.120; 0815-0900, 7.120; 0900-1030, 11.955; 1030-1145, 11.955, 7.120. To offset poor reception conditions from London, BFEB has been relaying BBC news 0800-0815 on 11.820 to listeners in Australia and the Islands. (United 49'ers Radio Society)

*Monaco*—*Radio Monte Carlo* is now on the air Sundays 0100-1730; weekdays 0100-0310, 0600-1730; on Fridays, Saturdays remains on air to 1800. (Engberg, Sweden)

*Mozambique*—Lourenco Marques still noted on 9.795A with Portuguese session around 0030. (Bellington, N. Y.) *English* session noted on 11.760 around 2345. (Kary, Pa.) Opens weekdays 2300, Sundays 0000 and parallels 4.913A which is also audible in Eastern USA.

*Pakistan*—*Radio Pakistan* noted on announced 9.484 at 1500-1600 sign-off with program of Western symphonic music; is interspersed with Arabic recordings; weak to fair with severe QRM. (Kary, Pa., Ferguson, N. C., others) Still tests to Turkey and United Kingdom 1430-1600 on 7.010, 9.484. Is heard on these channels also 1210-1230 with news at slow speed, and in Arabic to 1400 or later. (Pearce, England) *Radio Pakistan* has recently been heard on a new channel of 6.195 until 1030. (Engberg, Sweden) Karachi, 7.035A, noted 2130-2200. (Peddle, Newfoundland) And on 11.845 to 0915 or later. (Stark, Texas) Noted by Sanderson, Australia, on 15.325 at 2130 with news, music; this one is believed to be Dacca.





# DOW SURPLUS

**TELECHRON SYNCHRONOUS MOTOR**  
Type C2M 115V-60 cycle Model 822 M.-6-  
RPM-Removed from new Surplus \$3.95

**MISCELLANEOUS ITEMS—ALL NEW**

Rubber Grommets—100 ass't. \$0.99  
BC 461 control box with counter 1.49 ea.  
T44C mike and plug .95 ea.  
Leeds & Northrup Graph Paper, Type 578,  
0 to infinity. Boxed per Roll. .49 ea.  
APC condensers, all sizes 5.95  
1000-ft. #WL130 twisted Telephone wire 4.95  
50 Watt—Tube Sockets—new .85  
Antenna Insulators—10 for .50  
6 V VIBRAPACK KIT: Vibrator plus non-  
sync transformer with two outputs: 345  
V 145 ma for plates, and 15 V for bias.  
BOTH FOR 2.95  
FILAMENT TRANSFORMERS—110V-60 cycle  
input, output 9V to 13V in 1V steps—out-  
put, rated 3 amps 1.89  
G.E. Solenoids—14V DC—25 ohms—Mycalex  
arm, many applications—new .49

**GP7 TUNING UNITS, A TO F, for ECO. \$2.95 ea.**

**PANEL METERS, NEW STANDARD BRANDS SPECIAL SCALE 50-SQUARE CASE**

**3" METERS**

0-150 V AC	\$ 5.95
0-130 V AC	5.95
0-120 V AC	5.95
0-15 V AC	3.95
0-8 V AC WES	2.95
0-2 V DC	3.95
0-1.5 V DC	3.95
0-1 Mill DC 50	6.95
100-0-100 DC Mill	3.95
Freq. 350 to 450 cycles, 115 V.	17.95

**2" METERS**

0-150 Micro Amp.	8.25
0-8 RF Amp.	3.95
0-3 DC Mill	1.95
0-1 RF Amp.	5.95
S Tuning D.C.	1.95

**RHEOSTATS**

Watts	Ohm	ea.
25	1	\$0.98
25	8	.98
25	15	.98
25	25	.98
25	75	.98
25	100	.98
25	145	.98
25	370	.98
25	500	1.49
25	1,950	1.95
100	5	3.95
100	10	5.00
100	50	2.95
150	5000	4.95

**BUY TUBES HERE SURPLUS**

1LDS	\$ .59	4/ \$2.00
3F7	1.95	4/ 6.00
6AK5	1.19	4/ 4.00
6AL5	1.95	4/ 6.00
6SN7GT	.79	4/ 3.00
6S7	.59	4/ 2.00
13-4	Ballast	4/ 5.00
15E	1.49	4/ 5.00
41	.59	4/ 2.00
RK73	.79	4/ 3.00
HY615	.39	4/ 1.35
801A	.79	4/ 3.00
837	1.49	4/ 5.00
843	.39	4/ 1.35
958A	.79	4/ 3.00
1816	1.95	4/ 6.00
1625	.59	4/ 1.80
1626	.49	4/ 1.50
1629	.59	4/ 1.80
2051	1.19	4/ 4.00
2121A	8.95	
38P1	3.95	
58P1	3.95	
58P4	3.95	
6C4	8.95	
250R	8.95	
RK39	2.75	
30ATL	3.95	
531	3.95	
803	2.95	
804	1.95	
807	1.50	
849	19.95	
860	1.95	
861	19.95	
8012	1.49	

**KEYS**

J-5A	.50	.95
J-30	1.25	
J-32	1.25	
J-38	1.25	
J-41A	1.25	
J-47	1.25	
J-48	1.25	

**VARIABLE CONDENSERS—ALL NEW**

Dual 35 mmd per Section, Miniature	\$1.49
Dual-100 mmd	1.49
3 Gang 365 per Section	.98
4 Gang 147 mmd per Section	1.25
5 Gang 365 per Section	2.95

**SHOCK MOUNTS**

Most Types. Send us your requirements for price.

12V and 24V Soldering Iron \$2.95 ea.

**EDWARDS BUZZERS**

#1892-115 V-60 cycle .05 amp	\$0.98
#15-size 0-12V DC works on 6V less cover. Fine for Code Practice Sets, Ea.	.69c
10 for	\$4.95

**4 Speed Hobby Motors. \$12.95**

Dry Air Pumps for Co-Ax Lines 4.95  
Voltage Regulators, Made by Leiland 2.49  
Mike Cable, Per Foot. .04  
HRH 28-Put-Put 1500W 28 Volts DC 59.50  
30 ft. hookup wire, Plastic Co. 1.20  
Luminous Paint Kit For Dusting, Painting or Mixing, Glows in the Dark. Complete. .79  
5 ft. AC line cords 1.15 ea.  
Single Hole mfg. Push Button Switch. .19  
Flux Gate Amp. Less Tubes. 1.65  
Toggle B9A 50W-SPDT-center off. 3/ 1.00  
Toggle B18 SPDT 3 for 1.00  
Toggle B11 SPDT Momentary 3 for 1.00  
Micro Switch BZ-RQ41 SPDT 7.99  
Resistor Kit, All Good Sizes 100/ 2.89  
A62 Phantom Antenna for 10 Meters—new .75  
35 FOOT STEEL ANTENNA MAST KIT. 7-Five foot sections—new 12.95  
Soldering Paste 1/2 lb. can. Big Bargain. .10

Write us for your meter wants. Over 3,000 in stock. Write for Our 16-Page Bulletin.

**DOW RADIO, INC.**  
1759 E. Colorado St. Pasadena 4, Calif.  
PHONE: SYcamore 3-1196  
\$1.50 min. order 25% deposit with orders  
Send full remittance to save C.O.D. charges  
All merchandise fully guaranteed. Subject to prior sale.

**New Zealand**—When this was compiled, ZL4, 15.280 (to Pacific), and ZL10, 15.220 (to Australia) were coming through fairly well around 2005 and later. (Kary, Pa., others)

**Nicaragua**—YNVP, 6.758, noted at fair level 2340 in Spanish. (Hoffman, N. Y.)

**Nigeria**—Lagos is testing on 6.100 at 0000-1115 and on 4.990 at 1145-1700; the 7.255 outlet is audible in Britain from around 1430 to closedown 1715; has BBC news relay 1500. (Radio Amateur, London)

**North Korea**—The Pyongyang Central Broadcasting Station now uses 4.400 and 6.250; programs are mostly in Korean but Japanese is heard 0830-0900. (Wada, Japan, via Radio Australia)

**Norway**—Radio Norway, 15.175, Oslo, noted opening 2000 with program for Norwegians abroad, specifically in North America and North Atlantic waters. (Kary, Pa.) LLK, 11.850, is fair level around 2100. (England, New Hampshire)

**Roumania**—Radio Bucharest is noted on 6.208 (listed 6.210) at fair strength to closing 0700. (Engberg, Sweden) Heard with English 1400 on new channel of 12.032A in parallel with 9.252, 6.210A. (Pearce, England)

**Sao Tome**—CR5SB, 17.677, still noted Sundays in Portuguese 0700-0800. (Pearce, England)

**Saudi Arabia**—Djeddah is noted in Sweden at good strength around 1115 on 11.950, 11.850. (Engberg) Also heard by Pearce, England.

**South Africa**—Johannesburg, 4.895, is noted from 2345-0045 in Afrikaans. (Saylor, Va.) "Springbok Radio," 4.945, is at fair level some days around 2345 in English; uses commercials, has frequent time checks.

**Spain**—Radio S.E.U., 7.140, Madrid, 0.8 kw., has Ukrainian session on Tue. 1430-1500, has Esperanto on Wed. 1430-1500, is in French on Thur. 1430-1500, and in Portuguese on Sun. 0800-0830; news in Spanish is daily 1635-1645. (WRH) Radio Nacional de Espana, 9.363, Madrid, noted signing off second English period for North America at 2245; fair strength in Oregon. (Gardner) Cadiz, 7.200, is heard well in the United Kingdom until 1800 closedown. (ISWC, London)

**Sweden**—Radio Sweden, 11.705, noted coming on air 2300 to Australia; opens in English. (Gardner, Ore.) Noted with English on 11.88 at 1900; fair level but bad QRM. (Lund, Iowa) Heard on 15.155 with English 1600-1630; some QRM. (Graybill, Wash. State) Heard with English on 15.155 at 0700 and again 0900. (Ferguson, N. C.)

**Switzerland**—SBC is again using HED7, 15.12, at 1145-1330; rather good strength in Sweden. (Engberg) Noted at good level here in West Virginia; ends English session around 1220.

HEI3, 7.210, heard 2210 at good level in North American beam. (Hoffman, N. Y.)

**Syria**—Boggs, Mo., reports Damascus on 7.145 at fair level at 0735; on 11.913 at 1630 (beginning English pe-

## GOING OVER BIG—NEW DAVIS SUPER-VISION

### ALL-CHANNEL ANTENNA FOR FRINGE AREA or DX

with ELECTRONIC DIPOLE SEPARATORS

"THE ONLY TV ANTENNA SOLD WITH A MONEY-BACK GUARANTEE"



**10 OUTSTANDING FEATURES:**

1. EXCELLENT FOR FRINGE AREA and DX RECEIVING — and broad band receiving with high gain on all channels—2 through 13.
2. CLEARER PICTURES UP TO 125 MILES OR MORE—from the station.
3. GHOST PROBLEMS REDUCED or eliminated due to excellent pattern.
4. PROVIDES 10 DB OR MORE GAIN ON HIGH CHANNELS where gain is needed most.
5. EXCELLENT FRONT TO BACK RATIO on all channels. Eliminates co-channel interference.
6. MINIMIZES INTERFERENCE: Airplane Flutter—Diathermy and Ignition—F.M.—Neon Signs—X-Ray—Industrial—Etc.
7. ELIMINATES DOUBLE STACKED ARRAYS, and out-performs 2 bay yagis on low band and 4 bay yagis on high channels.
8. ONLY ONE TRANSMISSION LINE NECESSARY.
9. NO WORRY OVER POSSIBLE CHANNEL CHANGES on either high or low channels.
10. CAN BE TIPPED WITHOUT TILTING MAST to take advantage of horizontal wave lengths.

AT YOUR JOBBERS, OR WRITE TO:

**DAVIS ELECTRONICS** 1-13  
4313 West Magnolia Blvd., Burbank, California

SIRS: RUSH INFORMATION TO ME AS CHECKED BELOW:

Send Free Technical Data on new SUPER-VISION ANTENNA.

Send Name and Address of NEAREST JOBBER.

Name \_\_\_\_\_  
Street \_\_\_\_\_  
City \_\_\_\_\_ State \_\_\_\_\_

---

*Unlimited Opportunities in*

## RADIO ENGINEERING

**DEGREE IN 27 MONTHS**

Complete Radio Engineering course, including Telev., U.H.F. and F.M. Bachelor of Science Degree also in Mech., Civil, Elect., Chem., and Aero. Eng.; Bus. Adm. Acct. Extensive campus, modern buildings, well equipped labs. Low cost. Prep courses. Personalized, practical instruction. Founded 1884. Placement service. Growing shortage of engineers. Prepare now for unlimited opportunities ahead. Enter September, January, March, June. Write for catalog.



**TRI-STATE COLLEGE**  
1682 College Ave. ANGOLA, INDIANA

**RADIO & TELEVISION NEWS**

riod) with strong signal; signs off 1730.

Engberg, Sweden, says *Radio Damascus* is noted irregularly around 1200 on 9.525.

*Tahiti*—*Radio Tahiti*, 6.980A, Papecte, is again audible around 0000-0100 in parallel with 6.135. (McPhadden, Calif.) Noted on 6.980A around 0050-0130 sign-off; mostly in French; closes with "La Marseillaise." (Kary, Pa.)

*Taiwan*—BED3, 15.235, fair 2300-2400 in *English*; from 2400 has QRM by *Radio Japan*. (Balbi, Calif.) BED26, 10.080, noted 1700 with American marches, then news in Chinese, music. (Sanderson, Australia) Taipeh, 11.735, noted 0800 at fair level. (Boggs, Mo., others) Engberg, Sweden, says Taipeh is operating now on 11.915A in Chinese to 1115; has QRM from Rome on 11.905.

*Tangier*—*Pan-American Radio* is now on 7.290, 2 kw., daily 0700-1000, 1500-1900 in Spanish, French, *English*. (WRH) *Radio Africa*, 7.126, noted 1638 in Swedish; at 1705 goes into Spanish and French. (Pearce, England)

*Thailand*—Bangkok, 6.240, noted 0615 with news; parallel on 11.960. (Sanderson, Australia)

*Trinidad*—*Radio Trinidad* is installing new equipment and during the next few months will be making changes in both power and frequencies. (Radio Amateur, London)

*Turkey*—*Radio Ankara's English* program for Western Europe is noted now around 1600-1645 on TAU, 15.160A, excellent level; in Turkish 1645-1700 sign-off. (Kary, Pa.) TAP, 9.465, parallels but has poor level and much CWQRM here in West Virginia. According to WRH, has German 1445-1515; French 1515-1545; Turkish 1545-1600; *English* 1600-1645; Turkish 1645-1700 over TAU, 15.160, and TAP, 9.465; *English* for USA-Canada is still on TAT, 9.515, 1815-1900.

*USI*—*Ambon*, 11.097A, is still noted around 0645 to 0800 or later; some days fades in before 0500. (Stark, Texas) Programs in *English* are radiated daily by *Radio Republik Indonesia*, Djakarta, on 4.910 and 15.150 at 0600-0700; on 4.910, 11.770, 15.150 at 0930-1030; for Europe and New Zealand on 11.770 and 15.150 at 1400-1500. (Radio Sweden, others)

*USSR*—Moscow, 11.920, noted in Turkish session 1250 and heard to 1300, then in German. Noted on 11.950 with news in Spanish at dictation speed to 2130 sign-off; a channel of 11.980 is noted beginning relay of the "main" Home Service with news in Russian 2205. (Kary, Pa.) Yakutsk, 5.980, noted 2350 with program in Russian; weak level, slight heterodyne. (Cox, Dela.) Moscow announces these outlets for its "evening" beam to North America in *English* 1820-0100—15.33, 15.25, 15.23, 15.11, 11.91, 11.83, 11.81, 11.71, 9.67, 9.65, 9.55, 7.24; news is listed for 1830, 2000, 2100, 2200, 0000, 0030. (England, New Hampshire) (Some of these outlets are satellite countries relaying Moscow.—KRB)

*Vatican*—HVJ has *English* daily 1000 on 9.646, 11.740, 15.120; at 1315

August, 1952



### NEW GOODLINE AIRLEAD has everything you want!

- Sharp, clean, "snow-free" pictures.
- Correct impedance for "ghost-free" reception. Nominal 300 ohms.
- Lower in cost than other leadlines purported to accomplish same results.
- Correct spacing for minimum radiation loss—Less than 1% of operating wave length.
- Fully insulated—approved by safety experts.
- Pure, unadulterated polyethylene insulation—specially treated by our chemists for extreme weather.
- High-efficiency conductors: Flexible, stranded—to insure long life.
- Easily installed—with standard insulators.
- Packaged in convenient lengths: 100', 250', 500', 1,000', 2,500'.
- AT YOUR DEALERS, or Write For Free Samples and Literature.

\*Patent Pending \*Trade Mark U.S. and Foreign Patents Pending  
EXCLUSIVE LICENSEE AND SOLE MANUFACTURER

Don Good, INC.

1014 FAIR OAKS AVENUE  
SOUTH PASADENA, CALIFORNIA

#### OTHER OUTSTANDING GOODLINE PRODUCTS:

VARIABLE TELETRAPS—2: Highly effective for eliminating interference from FM STATIONS, and DIATHERMY and AMATEUR SIGNALS within its tuning range.

HI-PASS FILTER: Eliminates or greatly reduces interference picked up by I. F. AMPLIFIER or TV RECEIVER—interference arising from strong, local low-frequency fields: X-Ray, Diathermy Equipment, Neon Lights, Etc., Etc.

## A Word to the WISE! STOCK UP NOW at Low Summer Prices

With credit controls lifted and TV sets available with no down payment at many dealers, it is natural to expect greatly increased sales. Lifting of the freeze on TV stations in many parts of the nation also means more sets sold at dealer level.

300-Ohm TV Lead-In Wire—finest quality J.S.C. Wire—is now at low Summer prices. With prices certain to rise in the Fall, it's WISE TO STOCK UP NOW. . . . Be Protected . . . Stock Up!

SEE YOUR NEAREST J.S.C. DISTRIBUTOR



You Get Highest Quality and Top Efficiency When You Buy Wire Products from the Dealer Displaying the Orange and Blue J.S.C. Disc!!

## NOW! TWO GREAT PLATT BARGAIN STORES IN N. Y. C.

Yes, for the convenience of his many customers who can shop in person, PLATT has opened another BIG BARGAIN STORE at 159 GREENWICH ST., N.Y.C. It is centrally located for easy access by BMT, IRT, Hudson Tubes & Independent Lines. In addition to the FERRITE VALUES in Surplus Equipment, you will find the top standard lines stocked—such as Omnitone, Cornell-Dubilier, Bud Products, RCA Tubes and many other nationally advertised lines. Why not make it a joint right now to stop in at either of PLATT'S BARGAIN STORES? (Main office is to continue going to the main store and warehouse at 489 BROOME ST., N.Y. 13, N.Y.)

TUBES	BRAND NEW!	JAN! BOXED!	TUBES
826	39c	22c	2C26A
1625	29c	19c	3D6
VT-127	15c	801A	15R
3C24	99c	841	29 44
8K34	55.95	864	215A
304TH	46c	954	722A
1619	19c	E1148	9006
1626	19c	2C26	9002



RECEIVERS	USED	EXCELLENT USED	NEW
BC-453—190 to 550 KC		\$29.95	
BC-454—3 to 6 MC	\$8.95	9.95	\$16.95
BC-455—6 to 9 MC	9.95	11.95	16.95

TRANSMITTERS	USED	EXCELLENT USED	NEW
A-958—2.1 to 3 MC		7.95	29.95
BC-458—5.3 to 7 MC	7.95	9.95	17.95
ARC5-T-19—3 to 4 MC		24.95	34.95
BC-459—7 to 9.1 MC	13.95	15.95	24.95

ADDITIONAL EQUIPMENT	USED	EXCELLENT USED	NEW
BC-456 Modulator	2.49	2.95	5.95
BC-450 Control Box (3 Receiver)	1.49	1.95	2.75
BC-451 Control Box (Transmitter)	1.29	1.79	2.39
BC-442 Relay Unit (ANT)	2.39	2.89	3.69
Plugs: PL-147, 148, 151, 152, 153.			
154, 156—EACH		1.25	
Flexible Shafting with gear to fit receivers			2.69
3 Receiver Rack	1.79	2.29	2.98
2 Transmitter Rack	1.69	2.39	3.97
Single Transmitter Rack			3.97
DM-32 Dynamotor for Command Set		3.95	5.95
DM-33 Dynamotor for Command Set		2.95	3.95
Shock Mounts for 3 Receiver Rack.			
2 Trans. Rack, Modulator or Antenna Relay Unit		1.95	2.45

### TURBO AMPLIFIER

4 tube Amplifier used by U. S. Air Force. 115 V. input at 100 cycles. Without tubes—**BRAND NEW SPECIAL \$119**

### FIRE EXTINGUISHER TIRE INFLATOR

Made by leading Detroit Auto Mfr. Especially recommended for oil, gas and electrical fires. Guaranteed by mfr. against defects. Order two—one for your home; one for your car in case of flats or fires. **ONLY \$2.29 each**

### HEADSETS

HS-33 low impedance with cord and plug, used, fine cond.	\$2.79
HS-23 high impedance, BRAND NEW with ear pads.	4.95
HS-23 low impedance, BRAND NEW with ear pads, cord and PL-54 plug.	\$4.95
CD-307A Cordis, 6 ft., NEW	.89
11-16/17 high impedance. Includes two ear-celving units.	3.95
HS-16 high impedance—used	2.49

### ARC-5/R-28 2 MTR RCVR \$29.95

Here is the 2-meter superhet you have been looking for! Absolutely one of the BEST available today! Tuning clear, range 1.5-20.000 KC with crystal check points in all ranges. Complete with crystal and tubes. **\$129.50**

MODULATED TYPE WITH AC POWER SUPPLY 179.50

These Frequency Meters are factory tested, checked for frequency alignment and GUARANTEED.

### BC-221 Frequency Meter

Real Value! QUANTITY IS LIMITED—so first come, first served. They are just like new, with original calibration charts, range 1.5-20.000 KC with crystal check points in all ranges. Complete with crystal and tubes. **\$129.50**

MODULATED TYPE WITH AC POWER SUPPLY 179.50

These Frequency Meters are factory tested, checked for frequency alignment and GUARANTEED.

### PLATT ELECTRONICS CORP.

Dept. A, 489 Broome St., N. Y. 13, N. Y.  
PHONES: WO 4-0827 and WO 4-0828

on 5.968, 9.646, 11.740; also Tuesdays 1030 on 11.740, 17.840. (Engberg, Sweden) Noted on 9.646 with German 1445. (Ferguson, N. C.)

**Venezuela**—YVNB, 4.820, Coro, noted announcing at 0615; YVMM, 4.910, *Radio Coro*, is heard to after 2030. (Stark, Texas)

**Yugoslavia**—*Radio Yugoslavia*, Belgrade, recently sent QSL by registered mail. (Harris, Mich.) Noted on 9.505 with bad QRM, with news 1645. (Bellington, N. Y., others) Summer schedule is 6.100, 0830-1030, 1630-1845; 6.150, 2300-0015, 1700-1800; 7.240, 0130-0230; 9.505, 1030-1300, 1600-1800; 11.735, 1315-1545; *English* is at 0215-0230 on 7.240; 1100-1115 on 9.505; 1315-1330 on 11.735, and 1645-1700 on 6.100, 9.505. (WRH)

\* \* \*

### Press Time Flashes

Predicted Zurich Sunspot Number for August is 49, down 2 from July. (Stark, Texas)

The first transmission of "Sweden Calling DX-ers" is now aired Fridays 1045 over 6.065. (Radio Sweden)

A powerful "clandestine" outlet is noted in Sweden on 6.680 opening 1100; probably is located in Yugoslavia. (Engberg) *Radio Espana Independiente* is currently noted on approximately 14.880 with news in Spanish 1730; unusually strong level in Pa. (Kary)

SWL's who sent reports to the "Courier," VOA's "Floating Truthship," on reception of test transmissions some weeks ago when the ship was in Panama Canal Zone waters, are receiving

cards which show the Coast Guard insignia and a sketch of the "Courier." (Bellington, N. Y.)

**Radio Indonesia**, Djakarta, USI, states it will put a new 50 kw. transmitter into service in October; the new 100 kw. transmitter will be located at Kelejoran, near Djakarta. (N. Z. DX Times)

**Radio Sweden** says the Home Service of *Radio Eireann*, Ireland (Eire), is now heard in Europe on 3.400, 5.110 around 0800-1700; may be harmonics.

HJEF, Cali, Colombia, is noted on 4.765 to 2300 sign-off weekdays, to 0100 Sundays. (Cushen, N. Z.)

HCJB, Quito, Ecuador, is now operating in the 31-m. band on 9.745A (moved from 9.970A); now is on the air most days to 0300 (last hour and a half in *English*); by this time should have ceased use of 12.455 (10 kw.) and should be using a new frequency of 11.915. (Boice, Conn.)

**Radio Pakistan** still noted testing to Indonesia 0630-0715 on 17.835, 15.270; with news 1015-1030 on 11.845 (probably moved from 11.675); with news 0200 on 17.710A. More recently was noted using 11.914 (instead of 7.010) in parallel with 9.484 with the test period for Turkey and Britain at 1430-1600. (Pearce, England)

"Voice of Free China," 11.920, now has *English* 1320-1345 (schedule is one hour earlier than formerly); Chinese music 1400; news in Arabic 1420; Russian (jammed) at 1350. (Pearce, England)

BFEB, Singapore, 11.955, Malaya, noted signing on 0700 at weak level.

## CIRCUIT IMPROVEMENT

By GEORGE A. OSMUNDSEN

I HAVE built one of the amplifiers suggested by Mr. Boegli into a control unit and am very pleased with the result. Being cramped for space, it occurred to me that with so many elements in common, a considerable reduction in size could be effected if a suitable switching arrangement could be developed.

The circuit diagram, as shown in the solid lines, is based on Mr. Boegli's new chart and is the one I used in building up my present unit. The new data simplifies the problem somewhat and, except for the Columbia LP characteristic, could be made up on a 3-gang switch.

Since Mr. Boegli's latest article mentioned the use of a 3-gang switch as a means of making the unit more compact, I thought I would pass along a few additional changes I made (shown dotted in the diagram).

Lug "D" can be used as a tie-point for the junction of the two .01  $\mu$ f. condensers and the 33,000 ohm resistor. Any of the spare contacts (C2, D1, D2, D3, or D5) may be bent down, broken off, or otherwise altered so as not to make contact. These contacts can be used as a ground terminal for connection to a common ground bus. A .003  $\mu$ f. condenser, connected between switch points C4 and C5, may be used in place of the .0015  $\mu$ f. condenser shown connected between C5 and ground. The switch used in this simplified version is a two-deck, 4-pole, 5-

position shorting type. Either the Centralab Type 1414 or Mallory Type 1225L would work nicely.

Proposed simplification of an equalizer circuit based on "Phono-Equalizer Chart" by Charles Boegli in the April 1952 issue. Two versions are shown: one in solid lines and an improved one in dotted lines.

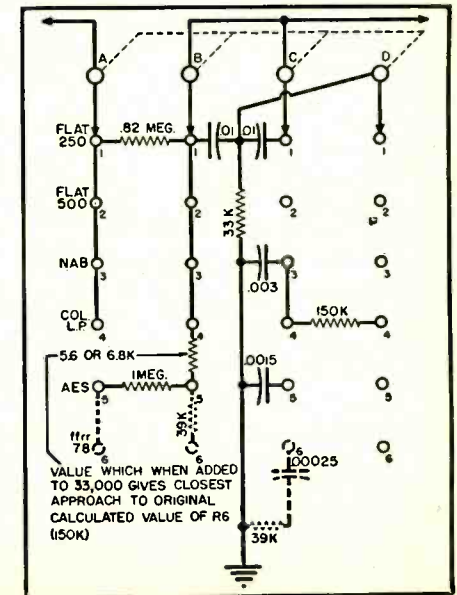

OTM2, 9.380A, *Radio Congo Belge*, Leopoldville, Belgian Congo, heard 1440 to after 1500 with uninterrupted recorded music. (Kary, Pa.)

*Radio Nederland*, 9.59, noted on Saturdays at 2230 with Mail Bag program; good level; also heard on 15.220 at 1100-1140 with *English to Africa*, Asia, much fade but readable. *Radio Sofia*, 15.33, Bulgaria, noted signing off in *English* 2315, good level. (Alcock, Ky.)

*Radio Peking*, 15.06A, noted with *English* by woman at 1745, weak signal; not audible at that time on 11.69A, 10.260. ZL8, 9.62, Wellington, New Zealand, is now used instead of ZL3, 11.78, from 0200 onwards in parallel with ZL10, 15.22; *Radio Sofia*, 15.33, Bulgaria, heard with news 0100; signal fair; signs off 0115. (Balbi, Calif.)

*Radio Nacional de Espana*, 15.620, noted 1045 in Spanish with S-6 signal; is Madrid. Montevideo, 11.835, Uruguay, noted in Spanish signing off 2200; 4VRW, 9.988A, Port-au-Prince, Haiti, heard 1100, and found there also when rechecked 1400 and 2145. (Cleveland, Md.)

\* \* \*

### Acknowledgement

Thanks for the fine reports. *ISW DEPARTMENT* monitor cards for 1952-53 are now being sent out to active reporters; they are *gratis*—and newcomers are welcomed! Send reports to Kenneth R. Boord, 948 Stewartstown Road, Morgantown, West Virginia, USA. . . . . K.R.B.

### HAMFESTS SCHEDULED

**THE** Federation of Long Island Radio Clubs, Inc., representing nine radio clubs on Long Island and in Brooklyn, has scheduled its 16th annual hamfest and dance for Friday evening, September 12th, at Lost Battalion Hall, Elmhurst, Queens.

Hams from the metropolitan New York area as well as those from other sections are invited to attend. A prize will be awarded to the amateur coming the greatest distance to attend this affair. Tickets are \$2.00 for hams, and \$1.25 for XYL's when ordered in advance. An additional 50 cents will be collected on each ticket sold at the door. Tickets may be obtained from Julian N. Jablin, W2QPQ, FLIRC Secretary, at 147-14 Charter Road, Jamaica 35, New York.

\* \* \*

**THE** Baltimore Amateur Radio Club is holding its fifth annual hamfest-picnic at Triton Beach, Mayo, Maryland on Sunday, August 10th. Tickets are \$1.00 with 50 cents payable at the entrance to the beach and the balance payable at the pavilion. This fee includes bathing, bath house, and locker facilities, and the use of the picnic tables and pavilion.

Prizes will be awarded for the best home-made mobile installation and the best commercially-built installation. There will be an interesting variety of contests for all. The affair will start at 10:00 a.m. and all hams are invited to pack a picnic basket and join the fun.

For full details write Chairman Ernie Dobos, W3JCL, 2208 N. Fulton Avenue, Baltimore 17, Md.

-50-

August, 1952

# ORDER BY MAIL FROM WHOLESALE RADIO

Low Prices • Complete Stocks • Fast Shipments

Get Snyder's Amazing New

## ALL DIRECTIONAL TV AERIAL

Same Clear Pix As Motor Rotating Aerial Systems Costing Triple This Price

FOR FRINGE AREA Only \$1695

Complete with beam selector switch and 75 ft. 3 conductor cable.

Electronically beams in complete 360° rotation to give clear picture on all channels. You choose direction with Directronic selector switch mounted on or near TV set. Complete double-stacked arrays with 18 hi-tensil double-alloy aluminum elements. Model TX-599 same as above plus three 3 1/2 ft. mast sections, guy ring and mounting base. \$18.95

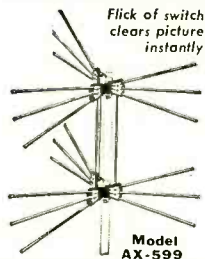

Flick of switch clears picture instantly

Model AX-599

### SAVE with "AUTOMATIC" Custom Built Auto Radios



- All with 6 tubes
- 3 Gang Condensers
- Easily Installed

FOR ALL PASSENGER Cars & Trucks

Model A-15 Five tubes Universal Mfg. \$27.97

	Dealer Net
F-100 '48, '50 Ford	\$39.97
D-200 '49, '50 Dodge	39.97
C-300 '49, '50 Chevrolet	41.97
F-151 '51 Ford	39.97
F-152 '52 Ford	39.97
D-251 '52, '51 Dodge	39.97
C-351 '52, '51 Chevrolet	39.97
H-451 '48, '51, '50, '49, '48 Hudson	39.97
S-551 '52, '51, '50 Studebaker	39.97
P-651 '52, '51 Plymouth	41.97
K-751 '51 Henry J.	39.97

### Stop Monkeying Around with "Rabbit Ears" INDOOR ALL DIRECTIONAL SNYDER TV ANTENNA



\$5.95

COMPLETE Nothing else to buy

- Stick in closet
- Stick in attic
- Stick it anywhere

Adheres to any surface. Ceiling, attic, closet, etc. Electronically switch-beamed to cover 360° area. Flick of switch clears picture on any channel. Model ID-303. You get antenna, selector switch, 25 ft. lead-in, selector switch & hardware. COMPLETE - NOTHING ELSE TO BUY.

### Price Slashing Closeout Famous Make TV BOOSTER

Made by one of America's most famous electronic houses. Takes 300 ohm twin lead or 75 ohm coaxial. Two 6J6's and set. rect. One tuning control. UL app.

Reg. \$40 List

\$16.95



### YAGI TV ARRAYS

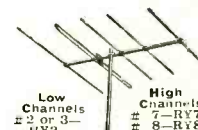

For Fringe & Ultra Fringe

Low Channels 2 or 3—HV3 HV4—HV4 HV5—HV5 HV6—HV6

High Channels 7—R17 8—R18 9—R19 10—R10 11—R11 12—R12 13—R13

\$7.95

\$4.95

THE RODS for stacking 2 Yagi Arrays Special III or Lo band pair 85c

### "PRECISE" RF-AF-TV MARKER GENERATOR KIT



Fundamental thru 110 mc. 330 mc on Harmonics. Audio: 20-20,000 cycles. Cathode follower output; variable per cent modulation. Stepping attenuator. External modulation. Speech amplifier, crystal marker. 630 K Kit... \$33.95

With pre-assembled RF head. 630 KA... \$38.95

Completely factory wired. 630 W... \$53.95

Address Orders to Dept. RN-8

Write for Free FYI Bulletin

# WHOLESALE RADIO PARTS CO., Inc.

311 W. BALTIMORE ST., BALTIMORE 1, MD.

### TRAIN AT HOME FOR UHF-TV AND



Learn practical, professional type TV Servicing without leaving your present job. Included are money-making extras such as set conversion, master antenna installation, UHF-TV, field servicing short cuts. You can start earning Television money after first few lessons. You learn to test, trouble shoot and repair all types of TV sets.

#### HERE'S HOW YOU GET EXPERIENCE!

You train on a large screen, modern TV receiver, furnished with the course and yours to keep! As an optional feature you can get two weeks actual experience with Chicago's largest independent servicing organization. You learn by doing! Age is no barrier. Most students are over 20. ACT NOW! Send for FREE Catalog and SAMPLE LESSON today!

TELEVISION COMMUNICATIONS INSTITUTE 205 W. Wacker Dr., Dept. 1-Z, Chicago 6, Ill.

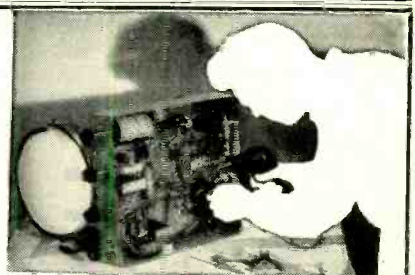

### MAIL NOW FOR FREE BOOKLET

MILTON S. KIVER, President TELEVISION COMMUNICATIONS INST. 205 W. Wacker Dr., Dept. 1-Z, Chicago 6, Ill. Rush FREE Catalog and Sample Lesson. I am not obligated. Salesman will not call. Name..... Age..... Address..... City..... Zone..... State.....  BEGINNERS check for Pre-TV Radio Course.

# SPINTITE

REG. U. S. PAT. OFFICE



120  
STYLES  
and  
SIZES

THE  
ORIGINAL  
WRENCH  
WITH THE  
SCREWDRIVER  
ACTION

for

- ASSEMBLY WORK
- REPAIR WORK
- RADIO
- TELEVISION
- INDUSTRIAL
- AIRCRAFT



STEVENS WALDEN, Inc.  
WORCESTER 4, MASS.

## Cinemagnetic Recording

(Continued from page 47)

operated from 117 volts a.c. but other models are available which can be operated from 220 volts a.c., 50 or 60 cycles, and also from d.c. for location work. It can be adjusted to handle 16, 17½, or 35 mm. film at the normal speeds for these film widths. A special feature of the recorder is that the takeup and feed spindles can be quickly set in another location so they will handle 1500 feet of film. At 45 feet-per-minute or at the normal 16 mm. speed of 36 feet-per-minute, a continuous half-hour program can be recorded. This is quite important to the growing television film industry. Figs. 3 and 4 show detail construction of the recorder.

The mixer amplifier (Fig. 1) provides two microphone inputs; high level mixing; dialogue equalization; high and low-pass filters; oscillator for channel line-up; audio slater and talk-back system; intercom between mixer operator, recordist and microphone boom man; and monitoring from either the direct signal or from the recorded signal at the press of a button. The recordist monitors from the recorded track during a take and his headphones are automatically switched back across the line when the recorder is stopped so that he can be aware of what is taking place on the stage. In short, all of the convenient features for doing production recording are provided in this channel of equipment.

As pointed out previously, all the "OK" takes on the magnetic film are transferred to photographic tracks. These are then edited and made ready for re-recording. At this stage of the process, magnetic film has again been found very helpful in saving time and doing a better job. Dubbing or re-recording a picture for release involves mixing together at least three and perhaps as many as twenty or more different soundtracks. Controlling the level, frequency response, and possibly the amount of compression of all of these tracks places a severe burden on the mixer operators. The use of magnetic film makes it possible for these mixer operators to play back immediately the results of their efforts rather than wait until the next day as is necessary when using the photographic process. Dubbing mixer operators are enthusiastic about the use of magnetic film for this purpose since it represents an improvement in quality as well as a significant saving in time. When they have dubbed a reel satisfactorily on the magnetic film, it is then transferred to the photographic release negative.

Still another extensive use of magnetic film is for the storage of soundtracks. It is becoming common practice to record the three separate soundtracks of a picture on one piece of 35 mm. film. RCA was the first to supply equipment for this purpose. All of the



### 62 SENSATIONAL BUYS!

**BC-222 PORTABLE 10-METER TRANSMITTER:** Freq. range: 28-32 MC. V.F.O. Battery operated, with tubes, telephone-type handset and antenna. Less batteries. Like new. \$32.50  
**COLUMBIA MARINER:** 100 W. 4-channel. X-tal controlled. FCC approved. 12 or 24 V. input. COMPLETE. READY TO GO. Unconditional 90-day guarantee. \$349.50  
**JOHNSON MARINE TRANSMITTER:** 90 W. VERY EASY TO OPERATE. 12, 24, 32, 115 V.D.C. input. COMPLETE. ONLY \$298.95  
**Unconditional 90-day guarantee.**  
**BC-223 TRANSMITTER:** 25 W. 4-channel. X-tal controlled. 12 or 24 V. input. Less crystals. A SUPER BUY. With 12 or 24 V. power supply, all tubes & factory-made cable with plugs. Brand new. \$85.00  
**RB-RADIO COMPASS RECEIVER:** 10-900.5 kc. MOST COMPLETE MARINE RECEIVER MADE! Checked out with ALL accessories. \$85.00  
**DJ-1-6007** for above item. ONLY \$27.50  
**JEFFERSON-TRAVIS 5 W. MARINE RADIO TELEPHONE:** 6 V. input. COMPLETE. Less crystals. SPECIAL. \$89.95

#### THUMBNAILED INFO ON NEW REDUCTIONS!

**TRANSMITTER:** BC-375. 100 W. Phone or CW. Complete with 24 V. dynamotor, tuning unit, all tubes & cables. Excel. cond. \$47.50  
**DYNAMOTOR:** PE-103. 6 or 12 V. input. 500 V. 160 ma. With filter base and cord. Excel. cond. 24.95  
**T-23 VHF ARC-5 TRANSMITTER:** 2 meters, novice. CAP. Excel. cond. With ALL tubes. \$37.50  
**MARKER BEACON RECEIVER:** BC-357. used. 5.00  
**ARC-4 VHF TRANSMITTER:** For novice, CD or 2-meter. With tubes. 32.50  
**BC-659 10 METER FM MOBILE TRANS-CEIVER.** Power supply, hand set and antenna. Complete 55.00  
**SCR-625 MINE DETECTOR:** New \$59.50. Like New 39.50

#### SURPRISE PACKAGE!

15 lbs. of radio equip.—tubes, cond., coils, resistors, X-formers, pots, coils, tools, etc., etc! PER PACK \$1.50

**BEAT COMMAND EQUIPMENT:** Limited quantity! Sold as is, less tubes. Rebuild 'em or use for parts.  
 2-4 MC. \$7.95 5-3.7 MC. \$2.95  
 4-3.3 MC. 2.95 7-9.1 MC. 5.50  
**MD-7 PLATE MODULATOR** 6.50  
**TUBE KIT FOR COMMAND XMITR** 1.25

#### TV TEST EQUIPMENT

**DUMONT OSCILLOSCOPE:** Model 208-B. Excel. cond. \$175.00  
**HICKOK OSCILLOSCOPE:** Model 195-B. Excel. cond. 115.95  
**JACKSON OSCILLOSCOPE:** Model CRO-2. Like new 149.95  
**RCA TV CALIBRATOR:** Model WR-39A. Like new 169.50  
**RCA TV SWEEP GENERATOR:** Model Wt-59A. Like new 179.50  
**HICKOK TV DC KILO VOLT METER:** Model 465. With probe. Excel. condition 39.95

#### ARC-5 OR 274-N TRANSMITTERS

2-1-3 mcs. \$19.95  
 4-3-3 mcs. Used, good cond. 6.95  
 5-3-7 mcs. 5.50  
 7-9-1 12.50

#### ARC-5 OR 274-N RECEIVERS

19-55 kc. Excel. cond. \$14.95  
 .55-1.5 mcs. Used. Excel. cond. 27.50  
 1.5-3 mcs. Brand new 24.50  
 3-6 mcs. Less tubes 8.95  
 3-6 mcs. With tubes 9.95  
 6-9-1 mcs. Brand new 11.95  
 6-9-1 mcs. Used. 7.95  
**RACK FOR DUAL TRANSMITTER (274-N)** 2.95  
**RACK FOR DUAL TRANSMITTER ARC-5.** 3.95  
**TRIPLE RECEIVER RACK** 5.00  
**BC-442A ANTENNA RELAY** with 50 mmfd. condenser. Excel. con. 3.95

#### AIRCRAFT EQUIPMENT

ARN7 MN-24C SCR-260 ARR-5 AR1-5  
 ARR-7 HS-33 Headset VHF ARC-5 MN24C  
 FL-8 Filter—New and used. Loop (CAA)  
 AIN-9 ARC-1 ARC-3 APR-4 APH-5  
 ART-13 RTA-1B SCR-522  
**NOTE:** We stock most complete line of TS gear in West Coast. Write us for prices and types available.  
**MONEY TALKS!** Especially when you're planning a vacation! If YOU need DOUGH sell YOUR new or used radio gear to us! We pay top bucks!  
 All orders F.O.B. Los Angeles. 25% deposit required. All items subject to prior sale.

#### COLUMBIA ELECTRONIC SALES

522 South San Pedro St., Los Angeles 13, Calif.



**SOUND POWERED PHONES RCA-MI-2454**  
 Complete with 24' of Rubber Covered Wire.  
**NEW EXPORT PACKED**  
 Shipping weight 6 lbs.  
**\$9.95 per set**  
**2 for \$19.50**  
 EACH SET GUARANTEED  
 Brand New Gov't. Cost. \$42.00  
 INCLUDE POSTAGE WITH ORDER  
**McCONNELL'S**  
 3834 Germantown Ave.  
 Phila., Pa. RA 5-6033

**GET OUR PRICE FOR YOUR RADIO & AIRCRAFT EQUIPMENT!**

We'll go the limit to buy your parts or equipment. Send us a description of the type and condition of equipment you have—tell us your top dollar asking price—and be pleasantly surprised at the fast action you'll get!

**ALVARADIO SUPPLY CO.—Division R-1**  
 4665 Melrose Avenue • Los Angeles 29, California

### RADIO & TELEVISION NEWS

dialogue is recorded on one track, the music on another, and the sound effects on the third. Such a film is quite useful in making foreign versions where the dialogue can be omitted but all of the other sounds are mixed together at the proper level.

Engineering knowledge is available to introduce magnetic soundtracks into the theaters on the release prints. It would of course be necessary to modify theater equipment to reproduce magnetic soundtrack and in many theaters the sound systems should be improved to benefit from the extended volume and frequency range of such magnetic soundtracks. It would cost more to re-record the magnetic soundtrack on each release print than it now does for the photographic track because the photographic soundtrack is printed simultaneously with the picture in the same machine on the same film stock, whereas a magnetic strip would have to be applied to the film and the magnetic soundtrack re-recorded thereon.

However, magnetic sound recording is developing rapidly, and many new devices are now being designed to make better use of magnetic film. This will undoubtedly continue because this new medium of sound recording offers so many possibilities not readily attainable with the photographic process.

-30-

### A SUGGESTION

By RAYMOND D. BRYANT

HAVING noticed an item on page 173 of your May 1952 issue (TV Troubleshooter), I wish to offer my comments.

The idea of the so-called trick is good, so good that I've been using it for a year and a half. However, I am convinced that I obtain better results. Plastic alignment tools, being somewhat soft, do not give the best results. I find that with a 1/8-inch diameter fiber alignment tool with a plastic handle, I can locate internal arcing in the windings of a high voltage transformer, arcing or leakage in a high voltage filter condenser, arcing in "open" high value resistors, etc.

It seems the fiber will reproduce and conduct the vibration better than will the softer plastic materials. I hope other readers will benefit from my experience in this matter.

-30-

A simple method for keeping tester leads from draping over the meter scale, as suggested by Fred J. Lingel, W2ZGY. As the picture shows, this is done by running the leads through the slot in the end of the leather carrying strap. It also prevents the accidental disconnection of the plugs when there is too much tension on the lead wires.

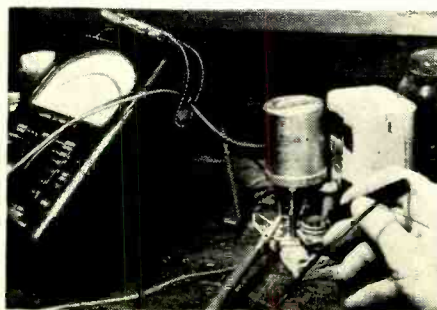

August, 1952

SEE LEO FIRST FOR . . .

# hallicrafters

I can SAVE you money... Liberal Trade-ins



**SPECIAL NOTICE—NEW SX-73 NOW AVAILABLE AND IN STOCK — \$975.00**



\$169.50

### S-76 RECEIVER

Extra selectivity with double superhetrodyne circuit. One RF, two conversion and 3 IF stages. Range 550-1550 Kc, 1.7-34 Mc in four bands. 8 tubes plus voltage regulator and rectifier. Complete with tubes, less speaker.



\$199.50

### SX-71 RECEIVER

Double Conversion sharp selectivity, plus built-in NBFM at moderate cost. 11 tubes plus voltage regulator and rectifier. Low down payment.

**NAME YOUR TERMS • LOW DOWN PAYMENTS • PERSONALIZED SERVICE**

### HALLICRAFTERS RECEIVERS AVAILABLE FOR IMMEDIATE SHIPMENT

S-38B .....	\$49.50	S-72 Portable .....	\$109.95
S-40B .....	\$99.95	SX-62 .....	\$289.50
S-81 .....	\$49.50	S-78A .....	\$89.50
S-82 .....	\$49.50	R-46 Speaker .....	\$19.95

### Famous WRL RADIO REFERENCE MAP 25c

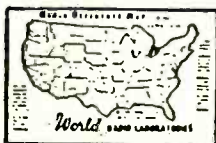

CU on 10-20 & 75 Meters

### NEW LOG BOOK 25c

For mobile or fixed station. Spiral binding. Full column log listing all FCC required info. Will accommodate 1,525 stations. "Q" signals, phonetic alphabet, amateur international prefixes.

PHONE 7795

WRITE—WIRE



COUNCIL BLUFFS, IOWA

### JUST OFF THE PRESS!

### WRL 1952 CATALOG

Send for your copy today. Contains everything new in radio and television. Jam-packed with bargains. Lea I. Meyerson, WØGFO



FREE

WORLD RADIO LABORATORIES  
744 West Broadway  
Council Bluffs, Iowa

Please send me:

- |  |                                       |
|--|---------------------------------------|
| <input type="checkbox"/> Radio Map           | <input type="checkbox"/> S-76 Info    |
| <input type="checkbox"/> New Catalog         | <input type="checkbox"/> SX-71 Info   |
| <input type="checkbox"/> Used Equipment List | <input type="checkbox"/> New Log Book |

Name .....

Address .....

City..... State.....

### MAKE THIS YOUR HOME FOR IMPORTANT WORK UNDER IDEAL CONDITIONS!

- TEST & INSPECTION ENGINEERS
- ELECTRONIC ENGINEERS
- FIELD ENGINEERS
- LAB. TECHNICIANS
- TV RECEIVER DESIGN ENGINEERS

NEEDED TO WORK ON: YOU BENEFIT FROM high wages, a modern, air-conditioned plant, paid vacations and holidays, group insurance and a good chance for advancement. Housing immediately available in the beautiful suburban and country areas that surround the Bendix Radio plant.

Write, Phone or Wire Mr. E. O. COLE, Dept. O

## Bendix Radio

DIVISION OF BENDIX AVIATION CORPORATION  
BALTIMORE 4, MARYLAND





**The very popular  
Elmac Transmitter  
for portable or fixed  
station service**

An outstanding little transmitter designed primarily for under-dash mounting with features that make it well suited for fixed station service. Pi-network output permits operation into lines or antennas from approx. 30 to 600 ohms. Crystal control provisions for novice use. Also has excellent, built-in calibrated VFO.

Coverage: Four bands. 3.5-4, 14-14.4, 26.96-27.23 and 28-29.7 mcs.  
Power: 50 watts input max. Requires 6V @ 4.5A and 300-500V @ 250 ma. max.  
Microphone: Any standard carbon type. Special hi-impedance mike models also available at slightly higher price.  
Metering: Uses dual scale meter with switching for final grid or plate current.  
VFO or Xt: Built-in VFO with excellent stability. Calibrated dial scale for each band.  
Size: 7 1/2" x 7 1/2" x 12"  
Tubes: 6X4, 6AR5, 6AV6, 6BE6, 6BD6, 6CA4, 6CA6, 6CG6, 6DE6, 6EA6, 6F6, 6F7, 6G6, 6G7, 6H6, 6H7, 6L6, 6L7, 6M6, 6M7, 6N6, 6N7, 6P6, 6P7, 6Q6, 6Q7, 6R6, 6R7, 6S6, 6S7, 6T6, 6T7, 6U6, 6U7, 6V6, 6V7, 6W6, 6W7, 6X6, 6X7, 6Y6, 6Y7, 6Z6, 6Z7.  
Complete with tubes. (less carbon mike) **\$139.00**

**TRANSFORMERS-CHOKES:**

325-0-325 @ 225 ma. 6.3 @ 5A. 5V @ 3A. Pri. 110V. 60 cy AC. Size. 4 1/8" x 4 1/8" x 3 1/2". Only **\$6.95** ea.

920-0-920 or 740-0-740 AC @ 200 ma. Pri. 115V. 60 cycle. AC. Upright shielded case. Excellent for 807's. Only **\$10.80** ea.

5V. 25A. Pri. 115V. 60 cy. AC. A real rugged job excellent for 30-4TL-4-250A etc. Limited quantity. Only **\$4.50** ea.

10H. 200 ma choke. Hermetically-sealed steel case. Also has hum-bucking tap. A beautiful item only **\$1.98**.

Power transf. Pri. 115V. AC. 60 cy. Sec. 520-0-520 @ 200 ma. **\$5.25** ea.

350-0-350 @ 300 ma. 6.3 @ 4A. 6.3 @ 8A. 5V @ 3A. Pri. 115V. 60 cy. AC. Only **\$7.95** ea.

450-0-450 @ 200 ma. Pri. 115V. 60 cy. AC. 5V @ 3A. 6.3 @ 5 amp. In shielded case. Only **\$8.90** ea.

350-0-350 @ 350 ma. 6.3 @ 10A. 5V @ 6A. Pri. 115V. 60 cycle. Only **\$8.95** ea.

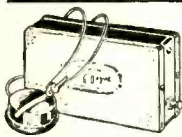

**NEW! PORTABLE  
GEIGER COUNTER**

A small light-weight unit (2 pounds), with a sensitivity that compares favorably with instruments many times its purchase price. Rugged and dependable and intended for professional use. Batteries used provide long life and low replacement cost. Each Geiger counter comes complete ready for use with instructions and radio-active ore sample for comparison tests. **\$35.00**

**110V. AC POWER SUPPLY FOR  
ANY 274-N RECEIVER**

Just plug it into the rear of your 274-N RECEIVER . . . any model. Complete kit and black metal case, with ALL parts and diagrams. Simple and easy to build in a jiffy. Delivers 24 volts plus B voltage. No wiring changes to be made. Designed especially for the 274-N receiver. Only **\$8.95**.

Filament trans. for 274N receivers. Pri. 110V. 60 cy. AC. Sec. 24V @ .6A. An excellent buy at **\$1.95** ea.

O-R exclusive . . . tuning knobs for 274N Receivers, a hard-to-obtain item. . . . Only **89c** ea.



**LOOK! NO HANDS!**

This mike leaves both hands free for mobile QSO's. Fastens to operator by simple snap strap. Adjustable. Double action sw. operates push-to-talk or holds on. Only **\$2.00** ea.

**ULTRA-VIOLET LIGHT SOURCE**

Again available . . . 8 watt ultra-violet light source that has found wide usage for experimenters, schools, labs and fluorescent lighting of rock specimens. A thousand uses in medical, chemical, art, stamps, etc.  
In kit form including Sylvania 8 watt black light tube, ballast, starter, tube clips, mounting panel, reflector, line cord/plug, hardware, instructions. Simple to make shadow box for outer housing. Sure-fire, easy to assemble.  
Complete kit. (less outer housing) . . . only **\$4.95**

**NOVICE POWER SUPPLY PARTS**

Filter condensers. 4 mfd. 600V oil. . . **\$1.25** ea.  
Filter choke. 10H @ 200 ma. . . . . **1.98** ea.  
Bleeder resistors. 20,000 ohms. 100 watt. A regular \$1.50 ea. net value. only **.75** ea.

Minimum order \$2.00. All items subject to prior sale. All prices subject to change without notice. 20% deposit must accompany all orders. Balance C.O.D.

**OFFENBACH-REIMUS**

1564 MARKET STREET  
SAN FRANCISCO, CALIF.

# NEW TV PRODUCTS on the Market

**REPLACEMENT PARTS**

Standard Transformer Corporation, 3580 Elston Avenue, Chicago, Illinois has announced the availability of fourteen new television replacement components.

The new additions to the line include six power transformers, two filament transformers, two horizontal deflection and high voltage transformers, two filter chokes, a vertical deflection output transformer, and a width control with a.g.c. winding.

Replacement recommendations for these new units are listed in the new "Stancor TV Replacement Guide and Catalogue" which lists 2416 TV models and chassis.

**NEW REGENCY BOOSTER**

A new and exclusive circuit stabilizer is the principal of ten features of the new television signal booster made by the Regency Division of I.D.E.A., Inc., 7900 Pendleton Pike, Indianapolis 26, Indiana.

The stabilizer provides both inductive and capacitive neutralization to assure maximum stability on all 12 v.h.f. channels. Other features of the new Model DB-520 include ease of installation with the TV set plugging into the booster and the booster into the wall outlet; an "on-off" switch of 3 amp. capacity; a single tuning knob; a push-pull triode in a balanced circuit; link coupling for optimum im-



pedance match; improved circuit control for greater tracking accuracy; a compact cabinet; and a broadband response. This model carries UL approval.

**TV BYPASSES**

Erie Resistor Corporation of Erie, Pa. is offering two new high voltage "Ceramicon" TV bypass condensers which have been designed especially to supply high voltage power supply filtering for television receivers.

The Style 412 is rated at 20 kv. and the Style 414 at 10 kv. The case insulation is of low-loss, molded thermosetting plastic, which provides excellent moisture sealing properties.

Ring convolutions are molded into the surface of the 20 kv. condenser to prevent surface leakages that are caused by ordinary handling and a consequent deposit of conductive materials.

A catalogue covering these bypass condensers is available on request.

**MARKER GENERATOR**

Precise Development Corp., Ocean-side, New York is now in production



on an r.f.-a.f.-TV marker generator, the Model 630.

Available in kit form, the Model 630 will reach 110 mc. on fundamentals and 330 mc. on harmonics. The unit is furnished with the r.f. head pre-assembled and calibrated.

Audio frequencies from 20 to 20,000 cycles can be measured with the modulation variable in both per-cent and frequency from 20 to 20,000 cps. The unit has a cathode-follower output, stepping attenuator, external modulation, speech amplifier, crystal marker, and crystal amplitude control. The circuit also incorporates r.f. and a.f. standby, a Wien bridge a.c. oscillator, a Colpitts r.f. oscillator, individually tuned coils, constant output impedance, vernier tuning on a.f. and r.f., a separate r.f. section, and complete shielding. Each band is separately loaded for constant output from range to range.

**NEW TRIO PRODUCTS**

Trio Manufacturing Company of Griggsville, Illinois has just introduced three new products in its line of TV equipment.

The new units include a television rotator and direction indicator, a new all-aluminum tower, and an accessory control unit.

The rotator which utilizes two heavy-duty 24 volt motors, will support the heaviest arrays even in 80 m.p.h. winds. A positive-acting electrical stop at both ends of the 360 degree turn eliminates lead damage. The rotator may also be used for the 10, 6, and 2 meter ham bands. It turns at 1 rpm and can be fastened to any pipe up to 2" o.d.



The all-aluminum tower weighs less than one pound per foot. The tower may be raised from a horizontal position in heights up to 40 feet. For additional height, sections can be added from the bottom. The tower comes in 5-foot sections: a bottom section, a top section, and as many center sections as desired.

The accessory control unit provides an automatic line switch for booster, rotator, TV lamp, or other accessories. By plugging the line cords from these accessories into the control relay unit, all such accessories can be turned on with the one switch controlling the TV set.

#### TV "SERVISET"

Lee Electronic Labs. Inc., 233 Dudley Street, Roxbury 19, Massachusetts has developed a handy, compact circuit analyzer which has been trademarked the "Serviset."

The unit, which is self-contained, can be used as an r.f. and a.f. signal tracer, as an r.f. and a.f. signal injector, can measure a.c. and d.c. voltages from 0 to 20,000 volts in four ranges, indicate d.c. polarity, act as a low ohms continuity and short indicator, serve as a high ohms continuity and leakage checker, function as a substitute condenser or resistor, and check speakers or phones for acoustical coupling as well as continuity.

The Model EC is compact, light, and portable. It is simple to operate and has no controls to adjust. Its use will not load or detune the circuit under test.

The unit comes complete with an instruction manual; a high-impedance, high-sensitivity Alnico phone; special phone extension cord; an insulated "Klipzon" type extension tip; a high voltage adapter; a kinkless test lead with built-in lamp remover; and a fabric pouch which houses all of the accessories and the manual.

#### ASTATIC BOOSTER

The development of a new and improved television booster has been announced by the Astatic Corporation of Conneaut, Ohio.

Trademarked the "Scanafar," the new booster is claimed to provide a

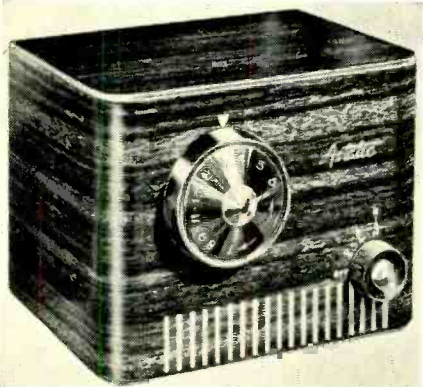

lower noise figure and higher gain whether used with new or old style receivers. The circuit is a balanced, cascaded type with a neutralized 6J6 tube driving a 6BQ7. Both tubes are

August, 1952

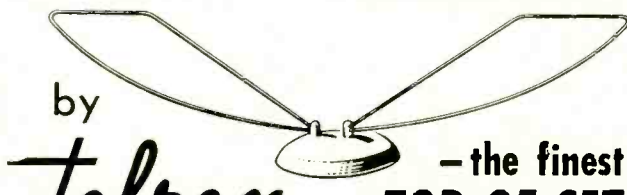

# "CONICAL-V-BEAMS"

\*REGISTERED TRADE MARK

## "BAT WING"

by *Telrex* — the finest **TOP-OF-SET** antenna ever produced!

SUPER-PERFORMANCE!

Beyond a doubt, the finest top-of-set TV antenna ever offered the trade. Outperforms any other indoor type and requires no tuning or pruning. No fuss, bother or time consuming adjustments. SUPERIOR STYLING! Featuring modern design that enhances any living room. Rich aluminum elements are mounted on a finely finished, tip-proof base. WRITE FOR NEW LITERATURE with complete information on the whole Telrex line for TV, UHF and FM.



NEW! Telrex "FISHBONE". Ten WORKING elements. Guaranteed to outperform any yagi on the market.

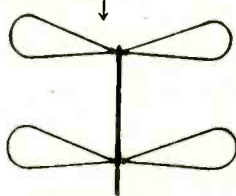

CLOVER-V-BEAM E-Z RIG design. A high gain, compact array for attic or outdoor installation.

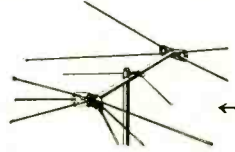

NEW! "CONICAL-V-BEAMS" WITH HI-V-REFLECTOR — UNIVERSAL SERIES — customized for your locality.

"CONICAL-V-BEAMS" are covered by Patent No. 23,346  
CANADIAN and FOREIGN PATENTS PENDING

Telrex INC.

AMERICA'S  
OUTSTANDING  
TELEVISION  
BEAM

Originators and  
Manufacturers of  
"CONICAL-V-BEAMS"  
—INSIST on  
the original!

CONICAL-V-BEAMS ASBURY PARK 7, N. J.

# NEW! MOSLEY WALL-THRU



For TV, FM and Amateur Transmission Line

- Fits Any Wall Up to 13" Thick!
- Completely Weather-Proof!
- For Standard Flat 300 Ohm Line or RG-59/U Co-ax Cable!
- MOSLEY Lead-In Socket Can Be Mounted Direct to Inside Plate!
- Precision Molded Polystyrene End Plates!
- Easily, Quickly Installed!

MOSLEY ELECTRONICS

2125 Lackland Road
Overland, Missouri

Cat. No. 625 List Price \$1.95

Cat. No. 625-PK Wall Thru, complete with MOSLEY Universal TV Lead-In Socket and Plug. List Price \$3.00

# HARVEY

For the **FINEST** in **AUDIO**

## WILLIAMSON HR-15 AMPLIFIER KIT

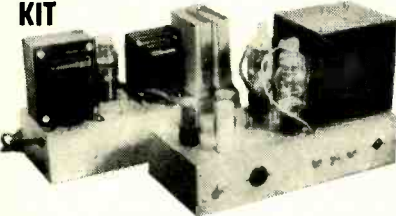

The famous, original Williamson HR-15... still acclaimed the leader... in kit form, with the original Partridge output Transformer. Assemble this kit, and in 3 hours or less, enjoy the finest sound you ever heard. Operates from a tuner, phono-preamp, crystal pick-up, or other signal source. Absolute gain is 70.8 db with 20 db of feedback. Frequency response:  $\pm .5$  db, from 10 to 100,000 cps. Output impedances to match all speakers from 1.7 to 109 ohms. Kit is complete with 5 tubes (1-5V4, 2-6SN7, and 2-5881 (or 807 if requested), 2-Punched Chassis, 2-Resistor Mounting Strips, Sockets, Partridge WWFB Output Transformer, Assembly Instructions, and All Other Necessary Parts for Amplifier and Power Supply. ....\$76.50

HR-15, as above, but with Partridge CFB Output Transformer (Hermetically Sealed) .....\$90.00

PARTRIDGE OUTPUT TRANSFORMERS - Available Separately. WWFB.....\$26.00 CFB.....\$40.00

HR-15T WILLIAMSON Kit-Furnished as above, with TRIAD Transformers and Chokes .....\$69.50

NOTE: HR-15 and HR-15T Kits may be had with British KT-66 Output tubes for \$3.00 additional.



### FIRST AT HARVEY!

The Sensational 'Hit' of the New York and Chicago Audio Fairs

### The New R-J SPEAKER ENCLOSURE

Designed for use with ANY 12 or 15 inch speaker, this new sensation in high-fidelity has no counterpart in anything available today. The R-J is a new concept. Large enough only to accommodate the speaker, it reproduces tones to the lowest limits of audibility, cleanly and without hangover. The R-J is the amazing solution to the problem of space versus quality.

Now Available for Immediate Delivery. Specify for 12 or 15 inch speaker.

Model FM (Mahogany) .....\$49.95  
Model FB (Blonde) .....\$4.50

## HI-FI PICKUP CARTRIDGES

### AUDAX POLYPHASE

DL-6 "Chromatic"-.001" Diamond and .003" Sapphire Styli .....\$41.70  
L-6 Sapphires, .001" and .003" ..... 20.70  
KL-4 Same as L-6, but higher output (for record changers) ..... 20.70

### G. E. VARIABLE RELUCTANCE

RPX-040 Sapphire .003" .....\$5.97  
RPX-041 Sapphire .001" ..... 5.97  
RPX-050 "Triple Play"-.001" & .003" Sapphires ..... 8.37

### PICKERING

S-140S Sapphire .001" .....\$15.00  
D-140S Diamond .001" ..... 36.00  
S-120M Sapphire .0027" ..... 9.90  
D-120M Diamond .0025" ..... 24.90  
.001" for 33 $\frac{1}{3}$  & 45 rpm  
.003" & .0025" for 78 rpm

NOTE: In view of the rapidly changing market conditions, all prices shown are subject to change without notice and are net, F.O.B., N.Y.C.

Telephone **hrc** LUxemburg 2-1500

**HARVEY**  
RADIO COMPANY, INC.  
103 West 43rd St., New York 36, N. Y.

used over the entire TV frequency range.

Bandwidth is over 7 mc. on all channels. Two control knobs operate the booster, one an "on-off" switch and low or high band selector and the other a fine-tuning control. The metal cabinet is finished in simulated mahogany woodgrain and gold.

Additional information on the Model CT-1 is available from the company on request.

### TV CABINETS

Standard Wood Products Corp., 43-02 38th Street, Long Island City 4, New York has added seven new period-style models to its Series 503 TV cabinet line.

One of the new cabinets is the Series 503 French Provincial. This unit will



house all 630-type chassis and other models of similar dimensions and all sizes of round and rectangular tubes. Like the other models in the line, this cabinet is supplied complete with all necessary mountings for the picture tube and yoke and can be furnished with a record changer pull-out drawer at the bottom at a slight additional charge.

The cabinets measure 40" high by 24" wide by 24" deep. The line is available in mahogany, walnut, ebony, or blonde finishes.

### COLINEAR ARRAY

Fretco, Incorporated, 1041 Forbes Street, Pittsburgh 19, Pa. is now in production on a new television antenna which has been tradenamed the "Fret-array."

This broadband colinear array retains high gain on all channels. It is light in weight and of sturdy construction. One antenna will receive all channels. Only one transmission line is required. Assembly consists of tightening the unit and mounting it.

A data sheet on this new fringe area antenna is available from the company on request.

### TV CONTROL LINE

International Resistance Company, 401 North Broad Street, Philadelphia 8, Pa. has announced a completely new TV control line which includes 295 factory-assembled "Exact Duplicate Concentric Dual Controls" individually packaged in uniform size cartons, each

of which is marked with the manufacturer's part number as well as with the IRC stock numbers.

The new line also includes the company's "Concentripaks" with a special selection of universal parts for specific makes of TV concentric dual controls, all housed in a sturdy plastic box; a new dealer "Concentrikit" assortment in a standard IRC all-metal, four-drawer cabinet; and the Form SO12 which lists replacements by tradename and part number along with the IRC equivalent.

For complete information on the new control line, write for a copy of Catalogue DCIC.

### ANTI-STATIC AGENT

A new anti-static agent developed by Chemical Development Corporation of Danvers, Massachusetts is now available for a wide variety of electrical equipment applications.

Although originally developed to eliminate dirt and dust attraction on plastic surfaces, it has been found that it can be used on glass, painted surfaces, and on other areas where charges accumulate.

The product can be applied by spraying, brushing, dipping, or other conventional methods; polishing is not necessary.

Tube and electrical instrument companies are invited to secure complete details on this new product by writing the company.

### TV TRANSMITTER

The General Electric Company has announced the availability of a line of u.h.f. television transmitters which have been tailored to the needs of different sized communities.

A lower power transmitter for small towns is already in production at the company's Electronics Park plant at Syracuse, New York. Three models will comprise the line for the present, a 100 watt, a 1000 watt, and a 12,000 watt unit. A specially-designed antenna gives the three transmitters effective radiated powers of 1 kw., 100 kw., and 200 kw.

Under average conditions, the low-power u.h.f transmitter and the special G-E antenna will provide satisfactory reception 8 to 10 miles away.

### TV MAST

The Baker Manufacturing Company of Evansville, Wisconsin has added a new unit to its television mast line.

The 10 AM is a ten-foot mast with a special tapered joint for stacking ten-foot sections together to provide a mast of any desired height. This special joint insures tight and rigid connections. Constructed of 1 $\frac{1}{4}$ " o.d. "Perma-Tube" steel, this mast is electrically welded for strength and long life.

Complete details on the mast line are available from the company.

### CHECKER-REACTIVATOR

Electronic Beam Corp., 923 Old Neperhan Avenue, Yonkers 3, New York

**RADIO & TELEVISION NEWS**

has added a cathode-ray tube checker and reactivator to its line.

According to the company, with this portable unit the television technician can check picture tubes without removing them from the TV sets or their

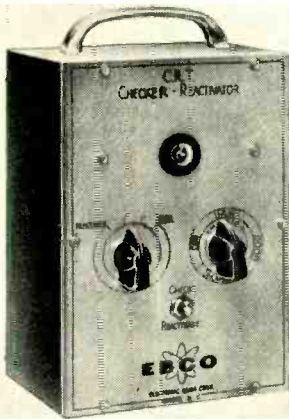

shipping cartons. He can also reactivate the tube without removing it from the set.

The new Model 10 is housed in a cabinet measuring 9" x 6" x 5" and weighs 2½ pounds. It is self-powered and operates from standard 117 volt a.c. lines. As a tube checker the Model 10 can test for shorts, cathode emission, leakage, etc. in cathode-ray tubes.

#### MASTER TV SYSTEM

Technical Appliance Corporation of Sherburne, N. Y. has introduced a new TV master antenna distribution system which has been designated as the "Super Series 2500."

The new system features an output of 6 volts peak-to-peak and provides a voltage gain of more than 500. This gain results in better fringe-area performance. Proper stability is maintained in output stages so that no distortion is present in the 6 volt peak-to-peak output. Amplifier strips employ 6AK5 tubes with 6AN5 output tubes.

The master chassis provides the power for the amplifier strips. Rectification of the line current is handled by the tube circuit, thus eliminating selenium rectifiers. The amplifier strips mount directly on the master chassis by means of Jones plugs. The mixer unit for the transmission of amplified signals into a single transmission line is an integrated part of the master chassis. Two high-strength outputs are provided on the master chassis.

#### "KINE-LITE"

Vidaire Electronics Mfg. Co. of Lynbrook, New York is currently marketing a picture tube brightener and rejuvenator which has been tradenamed the "Kine-Lite."

The new unit is designed to add increased brightness to any TV picture tube having low emission and may be used on all standard picture tubes having duo-decal bases.

No soldering or other circuit alterations are required to install this unit. A data sheet giving all pertinent data is available.

## WANTED!

All TS, APR, APS, ARC, ARN, ART, SCR, R89 and BC equipment . . . write today!  
Quote prices in your first letter.

### Closing Out All TUBES

16JP4	\$16.95	304TH	\$8.95	805	\$2.69	9003	\$1.29	4AP10	\$1.95
16DP4	16.95	304TL	8.95	9001	.99	6AJ5	2.29	5CP1	3.95
14CP4	16.95	830B	1.69	9002	.79	6AC7	.79	5BP4	3.95

**RT7/APN1 TRANSCEIVER UNIT**—Used as an altimeter, it may be converted for signaling control circuits, etc. Complete with 14 tubes and dynamotor they are in good used condition at the amazingly low price of **\$24.95**  
Used, less tubes, with wobulator. **9.95**

**BC 604 FM Transmitter**—20-27 mc. 10 Channel crystal controlled push-button, excellent for conversion to 10 and 11 meters, small quantity on hand, in good used condition, less dynamotor, some missing side covers, etc.—otherwise complete, **\$7.95**  
including tubes. **\$12.95**  
Like new **\$12.95**

	Used	New
BC-453, less tubes	\$10.95	
BC-454, 3-6 mc receiver, less tubes	5.95	
BC-455, 6-9 mc receiver, with tubes	9.95	\$14.95
less tubes, as is	5.95	
BC-457, 4-513 mc transmitter, less tubes	4.95	
BC-458, less tubes, as is	4.95	
BC-459, less tubes, as is	10.95	
BC-496, 2 position Rec. Control Box		1.95
MC-215 Mechanical Drive Shaft, per length		2.45
BC-450 3 Receiver Remote Control	1.29	2.95
BC-451 Transmitter Control Box	.69	1.50
BC-442 Antenna Relay, less condensers—used	1.29	

#### MONTHLY SPECIAL

**RT 34 APS 13** Transceiver used as a tail warning radar on 415 MC. Containing a 30MC IF Strip and various other parts, these units have been stripped of RF sections and all tubes but are an excellent buy if only for parts and IF Strip. Used **\$4.95**

#### WOBULATOR

See page 43—December "Radio News"  
**\$5.95 ea.**

#### SURPRISE PACKAGE

20 pounds of assorted radio parts. A real value at **\$2.45**

Shipments FOB warehouse. 20% Deposit on orders. Minimum order \$5.00. Illinois residents, add regular sales tax to remittance.

Prices subject to change without notice.

### SCR 625 Famous Army Mine-Detector

For Prospectors, Miners, Oil Companies, Plumbers, etc.

This unit is being offered now at a considerable reduction in price. Recently advertised at \$79.50 it is now available in the same brand new wrappings in suitcase style carrying case (less batteries) at

**\$59.50** WHILE THEY **Used, like**  
**LAST!** **new, \$39.50**

### MIKES and HEADSETS

HS-33 Low Impedance Headset	exc. \$2.95	new \$5.50
CD-307 Ext. cord for HS 23-33	like new	1.29
Throat Mike—T 30	New	.98
Lip Mike—Navy Type	New	.98
Extension Cord and Switch Assembly for lip and throat Mikes	New	.98
CW 49505 High Impedance headset complete with leather headband and rubber cushions.	Used	1.95
RS-38, Microphone	new	\$4.95
TS 10 sound powered HAND SET	used, ea.	5.95
HS-38	exc. \$1.95	new 2.29
HS-30, miniature headset	new	2.49
	used	1.49
HB-7 Headband, used, exc		1.25

#### Complete MN26C

200-1750KC, manual directional finder, complete with all parts **\$79.50**

### DYNAMOTOR

The best dynamotor for conversion to 6v. Multiple windings! After conversion you get choice of 190 or 350 v at 50 MA or 250 v at 100 MA. No brushes to shift around, no mechanical work. Or use it as a 2:1 or 1:2 step-up or step-down transformer for DC voltage! Changes 6 to 12, or 12 to 24, or vice versa, up to 3A. Or use it as a GENERATOR. Turn with motor, get 12 v DC at 12.6 A or 24 v DC at 6.3 A, plus high voltage. Includes easily removable self-contained 800:1 sealed-in-oil gear reduction unit. Complete dope sheet furnished.

BRAND NEW **\$4.65**

BC 624 receiver (SCR 522), less tubes, used **\$19.95**

BC 625 transmitter (SCR 522) less tubes, used **14.95**

SCR 522 transceiver, complete in case with top bracket, less tubes **29.95**

Transceiver—100-156 mc, 2 meter, used, excellent condition, less dynamotor, with tubes **\$32.95**

### WRITE FOR PRICES

BC1033	BC376	SCR510
BC610	BC639	MP10
BC939	BC638	LP21LM
APS13	RA42	TS170
ARN7	RA52	TS34
SCR269F&G	RA62	TS61
SCR619	RTA1B	TS92
JB70	TA2J	BC1277
R70/APS15	CRT3	BC1287

## R W ELECTRONICS

Dept. N, 1712-14 S. Michigan Ave., Chicago 16, Ill.

PHONE: HARRISON 7-9374

## WANTED . . .

RADCOM pays highest prices for surplus equipment, parts and tubes.

- TCS-7 and up
- SCR 274N, BC 696
- SCR 399 Equipment JB 70, JB 60, BC-939A BC-610-E RA-63, EE8, BC-614-E, PE95, PE197, Trailer K-52, Cords, LS-3
- SCR-508 . . . BC-604, BC-603, FT-237, Crystal Sets.
- SCR-506 . . . BC-653-A, BC-652-A, DM-40-A, FT-253-A, BC-658-A.
- BC312, 342, 348 Receivers.
- SCR522 Equipment, SCR-211 Freq. Meters. RA-34 Rectifiers.

Phone Blgelow 2-6666

MANUALS TUBES TEST SETS

Always Right With Earl White

**RADCOM Engineering Co.** 8 Livingston St. Newark 3, N. J.

**TOP QUALITY! LOW COST!**

# FISHER

## HIGH QUALITY Phonograph Preamplifier

■ Here is the *top quality, reasonably priced* preamplifier you have always wanted. The FISHER provides exact equalization for low-level magnetic pickups of *any* make, such as GE, Pickering, Audax, Clarkstan and others; also used as a microphone preamplifier.

List \$20.95



### Outstanding Features:

- Uniform response, 30 to 20,000 cycles.**  
Self powered. Two stages of triode amplification. Extremely low hum.
- Full low-frequency equalization.** High gain. Completely enclosed chassis with bottom cover. Plugs supplied.
- Output cable can be up to 50 feet in length.** size: 3¼ x 3⅝ x 3⅝ high.

WRITE FOR FULL DETAILS  
FISHER RADIO CORPORATION  
39 E. 47TH ST., NEW YORK

## Concertone MAGNETIC TAPE RECORDERS



NETWORK  
RECORDER  
NWR-1

*"just like being there"*  
THE ONLY low cost high fidelity tape recorders delivering professional performance. Professional users' net prices begin at

**\$345.00**

Write for Bulletin #102  
Manufactured By

**Berlant Associates**  
4917 W. Jefferson Boulevard  
Los Angeles 16, California

## ★ STAR SPECIALS

NEWEST ITEMS! LOWEST PRICES!

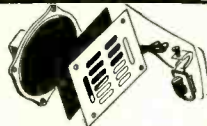

### PERMOFLUX REAR DECK SPEAKER KITS

Easy to install; provides greater radio enjoyment in your car. Requires only connection to speaker terminals in auto radio. 3-way wired switch permits speakers to operate separately or together. Complete with metal grille and protective speaker screen, hardware, template, instructions, etc.

RS46A 4" x 6" Speaker Kit..... **\$7.94**  
RS96J 6" x 9" Speaker Kit..... **\$10.29**

### NOVICE TRANSMITTER KIT

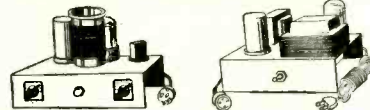

Ideal for beginning amateur or for use as a stand-by rig. Operates on 80 and 11 meters. Big pictorial and schematic diagrams for easy assembly by anyone. Complete with two punched chassis, coil forms and wire, tuning indicator, and all other assembly parts plus standard telegraph key and tubes (6V6, 6L6 and 5Y3GT). Less crystal and small amount of hookup wire and solder required.

Novice Transmitter Kit..... **\$32.58**

### BARGAIN LOW PRICE FLYBACK TRANSFORMER (Similar to GE 77J 1)

Regular \$11.00 list price high voltage transformer similar to General Electric 77J1. Used for general replacement in many sets up to 14KV and with up to 19" tubes. Not available elsewhere at our low price!

A-1827 Flyback Transformer..... **\$2.49**

COMPLETE STOCKS  
All Standard Brands

Just off the press  
**BIG BARGAIN BULLETIN**

**STAR ELECTRONIC DISTRIBUTORS, INC.**  
Dept. RN-8—7736 S. Halsted, Chicago 20, Ill.

## Electronic Growth (Continued from page 39)

casting stations and the motion picture studios in California. In keeping with its credo that a modern electronic parts distributor must be more than a passive vehicle for the supply of parts, the company has sponsored educational meetings for both its industrial and dealer customers. For example, the company recently sponsored an "Image Orthicon Seminar" which was attended by virtually all key television camera technicians located in Southern California.

In addition, the company developed early in 1949 a series of charts and paper invoice forms which dealers could use to break down their charges for the repair of television sets. These invoice forms, which the company printed and sold to its dealers without profit, allowed the dealer to estimate his charges intelligently and to explain to his customers the breakdown of his repair bill at the time when television repair was an uncharted field. These dealers report that these forms have greatly helped them in customer relations and have been responsible for many repeat sales.

Today ten dealer-salesmen regularly cover a territory extending from the Pacific Ocean into Arizona and from Fresno and Paso Robles far into Mexico. Resident salesmen are located in Bakersfield, Santa Barbara, Riverside, and San Diego. The company's export department has been in existence for fourteen years. Five industrial salesmen call regularly on every important industrial account in Southern California and counter salesmen of long-standing amateur status take care of the ham customers.

The design and construction of *Radio Specialties Company's* new home was based on years of experience. Where the average parts distributor displays most of his stock, which consumes from 60 to 100 per-cent of his total area, this firm's store takes up less than 10 per-cent of the total area with the other 90 per-cent being given over to warehousing facilities. No stock is located in the store itself. Only one sample of each basic part is displayed, the small parts being shown on sample boards located along the walls and in specially designed glass-covered islands on the sales floor. Large items which need to be demonstrated, *i.e.*, test and sound equipment, record players and changers, etc., have one sample each located along the walls under the sample boards and under a large mural showing *RCA* products and factory processes. These large units are the only items which can be touched by the customers.

There are no inefficient ladders to climb in either the warehouse or store, all shelves being designed at a height a normal person can reach while standing on the floor. The warehouse has a conveyor system which permits the merchandise to be unloaded and rolled

**RADIO & TELEVISION NEWS**

to the receiving room, checked, and then rolled on into the warehouse without lifting. The merchandise locations have been carefully studied with the result that heavy or bulky items are located either close to the receiving door or immediately adjacent to the conveyor system. Merchandise sold primarily over the counter is located as near the counter as possible while merchandise sold mostly through outside salesmen is located close to the order filling and shipping departments.

The entire new layout and decorative scheme was an attempt to keep pace with the changing emphasis and rapid growth of electronics in a fast-growing area. *Radio Specialties* believes that it has succeeded and that the gamble on the future of the Pacific Southwest's electronics industry was a shrewd one. The industry is sound and the company has invested heavily to prove its point.

-30-

### MID-SOUTH AUDIO SHOW

MUSIC lovers and audio enthusiasts in the area around Memphis, Tenn. are looking forward to the "Mid-South Audio Show" to be held at the Peabody Hotel in Memphis August 4th through 7th.

Sponsored by the W & W Distributing Company of Memphis, the show will feature an extensive display of such well-known high fidelity equipment as that made by Jensen, Stromberg-Carlson, Electro-Voice, University, Stephens, McIntosh, Newcomb, Bell, Radio Craftsmen, Meissner, Browning, Ampex, Concertone, Presto, Pentron, Crestwood, Rek-O-Kut, Garrard, V-M, Webster, and others.

Hotel reservations will be made by W & W Distributing Company, P. O. Box 436, for any out-of-town guests planning to attend this event.

-30-

### CHECK TUBE OPERATION

By H. LEEPER

TV receivers using a type 1B3 rectifier can be easily checked for operation of this tube by holding a neon bulb near the tube's top cap. If r.f. energy is being delivered to the rectifier tube, the r.f. voltage nearby will cause the neon tube to glow.

While a two-watt neon lamp is shown in the photograph, a smaller (1/4 watt) bulb works even better.

Use only one hand when making this check. Keep the other hand away from the chassis and be sure not to contact the rectifier tube cap with the fingers.

-30-

Checking the 1B3 rectifier in a TV set.

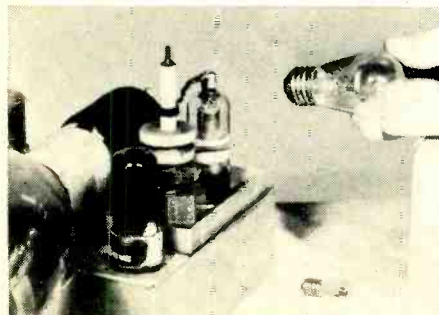

August, 1952

# Sensational TUBE SAVINGS



80% to 90%  
off list!

## UNBEATABLE! UNPRECEDENTED!

Tried and true performance plus economical service make these low, low priced, high quality, fully guaranteed tubes the sensation of the nation. Every tube rigidly tested, every tube a standout value.

## All Tubes Individually Boxed! Same Day Service!

Check this list for Fully Guaranteed Tubes

Type	Price	Type	Price	Type	Price	Type	Price		
OB3 VR90	.75	3Q5GT	.49	6BC5	.44	6SQ7GT	.37	12SK7GT	.48
1A5GT	.46	354	.46	6BC7	.70	6T8	.56	12SL7GT	.47
1A6G	.59	3V4	.47	6BD5GT	.59	6U5	.44	12SN7GT	.52
1A7GT	.47	5AX4	.37	6BD6	.45	6V8	.61	12SR7	.49
1A85	.59	5AZ4	.39	6BE6	.39	6V3	1.10	14A7	.44
1B5	.59	5U4G	.40	6BF5	.41	6V6GT	.39	14AF7	.53
1B7GT	.59	5V4	.73	6BF6	.37	6W4GT	.44	14B6	.40
1C5GT	.43	5V4G	.54	6BG6G	.94	6W6GT	.44	14J7	.60
1G6	.60	5X4	.40	6BH6	.46	6X4	.37	14W7	.60
1H5GT	.40	5Y3GT	.32	6BJ6	.39	6X5GT	.37	19B6G6	.95
1L4	.46	5Y3G	.32	6BL7	.59	6Y6G	.48	19C8	.80
1L6	.43	5Y4G	.35	6BQ6GT	.59	7A4	.47	19T8	.79
1LC5	.51	5Z3	.39	6BQ7GT	.72	7A7	.48	19V8	.97
1LC6	.48	6A3	.59	6C4	.37	7A8	.46	25BQ6GT	.62
1LN5	.51	6A7	.59	6C3GT	.39	7AF7	.53	25L6GT	.39
1N5	.46	6BA4	.44	6C86	.44	7B4	.40	25W4	.56
1P5	.57	6AG5	.43	6CD6G	1.11	7C6	.44	25Z3	.40
1Q5	.61	6AJ5	.90	6E3	.48	7E6	.49	25Z6GT	.37
1R5	.45	6AK3	.75	6F3GT	.39	7F7	.59	32L7	.85
1S5	.39	6AL5	.38	6F6	.37	7N7	.59	35B5	.40
1T4	.45	6AQ3	.39	6G6G	.52	7X7	.69	35C5	.39
1T5	.53	6AQ6	.37	6H6GT	.41	12AL5	.37	35L6GT	.41
1U4	.45	6AR5	.37	6J3GT	.37	12AT6	.37	35W4	.37
1U5	.39	6AS5	.50	6J6	.52	12AT7	.56	35Z4	.39
1X2	.63	6AT6	.37	6J7G	.43	12A6	.38	35Z3GT	.37
2A3	.70	6AU6	.38	6K6GT	.37	12A7	.43	36	.60
2A5	.47	6AV6	.37	6K7	.44	12AV6	.39	42	.42
2X2	.59	6AX4	.53	6L6	.64	12AV7	.59	45	.55
3A4	.45	6B4G	.64	6L6G	.64	12AX4	.48	30B5	.39
3E5	.46	6B5	.64	6Q7	.45	12AX7	.48	50C5	.39
3Q4	.48	6BA6	.39	6S4	.38	12AZ7	.68	50C6	.59
		6BA7	.57	6S8	.53	12BA6	.38	50L6GT	.41
				6SA7GT	.43	12BA7	.46	50Y6	.46
				6SD7GT	.41	12BE6	.39	50Y7	.50
				6SG7GT	.41	12BH7	.63	70L7GT	1.09
				6SH7	.73	12K7GT	.46	75	.41
				6SJ7GT	.41	12Q7G	.39	76	.44
				6SK7GT	.41	12S8	.70	78	.47
				6SL7GT	.48	12SA7GT	.44	11Z3	.37
				6SN7GT	.52	12S7	.44	807	.99

**Rad Tel**  
TUBE CO.

"Integrity Is Our Chief Asset"

Phone: Essex 5-2947

### TERMS

A 25% deposit must accompany all orders—balance C.O.D. All shipments FOB Irvington warehouse. Orders under \$10—\$1.00 Handling Charge. Subject to prior sale.

Now In New, Enlarged Quarters at

**115 COIT STREET  
IRVINGTON 11, N. J.**

### WE'LL PAY SWEET PRICES for Your RADIO & AIRCRAFT EQUIPMENT

We want to buy your parts or equipment—and we'll pay top dollar to get it! Just send us the dope on your equipment, its type and condition—and your asking price. You'll get fast, profitable action. It's just like taking "Candee" from a baby! Write today.

**CANDEE-AIRCO, Dept. T-4**  
3306 Burbank Blvd. Burbank, California

QUALITY · SERVICE · DEPENDABILITY  
PERFECTLY CENTERED

**DUMONT**  
COMPLETELY MOLDED CAPACITORS

Sold and Preferred Everywhere

**DUMONT Electric Corp.**  
308 Dyckman Street, New York 34, N. Y.

### ANNOUNCING THE VTMM\* KIT

At last every Engineer, Technician, Serviceman and Experimenter who owns a Simpson 260, Triplett 630 or similar multimeter can have a vacuum tube voltmeter at a very nominal cost. The sensational VTMM plugs directly into your multimeter to convert it into a DC VTMM with an 11 megohm input resistance. Measures DC volts to 300 volts. Accommodates a crystal diode type probe for AC and RF voltage measurements. Self contained transformer type power supply for complete isolation. Highly degenerative circuit offers excellent stability. Very compact in size, 5 1/4" x 3" x 2 1/4".

Complete kit including tubes. Model MM-1K \$13.95. Crystal diode probe completely assembled. Model CP-1 \$5.95. Specify your meter make and model.

Send check with order, we pay postage.

\* Vacuum tube meter modifier.

AIR-O-TRONICS

Box 31

LANCASTER, Calif.

123

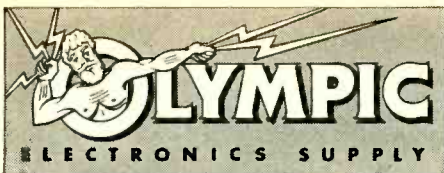

**ELECTRONICS SUPPLY**

**MID-SUMMER CLEARANCE SALE!**  
Try to Beat These Values!

**TV DEFLECTION YOKES**



Major brand names. Most popular types at **LOWEST PRICE!**  
Ea. ONLY ..... **89c**

**TV ANTENNA CONNECTOR CLIP:** Clothes pin type. List price: 50c. **YOUR COST ONLY** ..... Ea. 22c  
**100'S OF 25' VERY SPECIAL** ..... Ea. \$4.75  
**OPEN WIRE TV LINE:** Copperweld ±18. Ideal for fringe areas! 100 ft. .... \$ 5.20  
**250 ft. SPECIAL** ..... Ea. 12.50

**VIDEO BEAM** ..... Ea. **\$1.49**

**TUBES! NAME BRANDS! 100% GUARANTEED!**

OZ4A	.....	\$0.59	35L6	.....	\$0.59
1B3	.....	.89	35W4	.....	.49
3U4	.....	.59	35C5	.....	.72
6W4	.....	.59	12AT6	.....	.61
30L6	.....	.59	12BE6	.....	.69
50A5	.....	.83	12BE6	.....	.69

**G.E. HIGH VOLTAGE FLYBACK TRANSFORMERS**

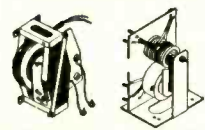

**Standard Replacement: Ea., \$1.89**

**FUSE HOLDERS**  
SAG Extractor type. Mounts 2" behind panel. Easy to mount. **THIS MONTH SPECIAL** ..... Ea. 15c

**PUSH-ON KNOB KIT**  
De luxe assortment of 40 receiver type knobs in 11 different styles! Match any cabinet styles. Serviceman or set builder—**THIS IS FOR YOU!**  
Kit only ..... **89c**

**J.F.D. 3 1/2" SCREW-EYE INSULATORS:**  
100 ..... \$2.49 500 ..... \$10.00  
1,000 FOR ONLY ..... **\$17.50**

**GUY WIRE:** 4/20 Stranded. 1,000 ft. .... \$5.25  
 6/20 Stranded. 1,000 ft. .... 6.95  
**C.R. TUBES! NEW! NAME BRAND! 1-YR. GUARANTEED!**  
 16AP4A ..... Ea. \$24.95  
**PLASTIC RECORDING TAPE:** Red oxide. 1,200 ft. .... **\$2.29**

**FLYBACK TRANSFORMER:** R.C.A. type. With 6500 and 1B3 windings. **SPECIAL ONLY** ..... **\$1.49**

**MALLORY TUBULAR CONDENSERS**  
 40 MFD-150V ..... \$0.42 16 MFD-450 V ..... \$0.57  
 40/20 MFD-150V ..... .62 40 MFD-450 V ..... .69  
 30/30 MFD-150 V ..... \$0.69

**WESTINGHOUSE DIAL LIGHTS:** 100 to the box  
 #34, #46, #47 ..... \$5.29  
 #51 ..... 4.29

**SANGAMO MOLDED BY-PASS CONDENSERS**  
 .01-600V ..... \$0.12 .001-600V ..... \$0.10  
 .02-600V ..... .12 .002-600V ..... .10  
 .05-600V ..... .16 .005-600V ..... .12  
 .1-600V ..... .19 .006-600V ..... .10

**SENSATIONAL SPEAKER VALUES**



Most popular types for replacement and new construction!

4-inch PM	.....	\$1.39	10-inch PM	.....	\$2.69
5- " PM	.....	1.49	12- " PM	.....	3.49
6- " PM	.....	1.69	8- " Electro-	.....	1.49
4x6- " PM	.....	1.49	dynamic	.....	1.49
6x9- " PM	.....	2.49	10- " 500 ohm	.....	1.89
8- " PM	.....	2.29	12- " 1,000 ohm	.....	2.29

**PAPER CONDENSERS**  
 Midget, tubular types. 100 V. or more. Many are less than 3/4" diam. **EACH ONLY** ..... 3c  
 10 for ..... 25c  
 (Specify value: .001, .002, .003, .005, .01, .015, .02, .03, .04.)

**PILOT LIGHT SOCKETS**  
 Miniature, bayonet-base type. With spring type mounting clip. Load up at this low price.  
**EACH ONLY** ..... 3c  
 10 for ..... 27c

**OUTPUT TRANSFORMERS**

25L6	.....	Ea. 29c
6L6	.....	Ea. 59c
6V6	.....	Ea. 49c

**MISCELLANEOUS SPECIALS!**  
 6-volt VIBRATOR (Oak) ..... 1.29  
 2-volt VIBRATOR ..... .49  
 MIDGET I.F. TRANSFORMER. 456 KC. .... .49

**VOLUME CONTROLS**  
 With switches. 10,000, 250,000, 500,000 ohms. 1 meg., 2 meg. Each ONLY ..... 49c  
 In lots of 10. Each ONLY ..... 44c

All orders F.O.B. Los Angeles, and all goods subject to prior sale. 25% deposit required with all orders.

**Olympic Electronics Supply**  
 DISTRIBUTORS  
 1400 West Olympic Blvd., Dept. RN  
 LOS ANGELES 15, CALIFORNIA

# Technical BOOKS

**"DESIGN AND CONSTRUCTION OF A WHEATSTONE BRIDGE"** prepared and published by *Technological Developments*, 475 Fifth Avenue, New York, N. Y. 6 pages. Price \$1.00. Paper bound.

This 6-page booklet contains complete construction and design information on a Wheatstone Bridge. The function of the bridge is explained in some detail including the necessary mathematical computations. The author has also outlined the various points which must be considered when such a unit is to be designed.

The balance of the text covers the actual construction of the instrument and explains how various measurements can be made with the unit. The text is illustrated with large, clear diagrams which can be used in constructing the bridge.

**"20 BASIC POINTS FOR TV RECEIVER SERVICE"** by A. C. W. Saunders. Published by *Paul H. Wendel Publishing Co., Inc.*, Indianapolis. Fifth "Notebook" in the Television Technicians Lecture Bureau series. 44 pages. Price \$1.00. Paper bound.

This new technician's notebook covers twenty of the basic parts of a television receiver which can be used as the basis of a troubleshooting and servicing system.

The author's servicing technique, as developed in the text, involves the statement of twenty fundamental principles and then the detailed explanation and amplification of the "theorem." Using this method, the author deals with such subjects as the design of video amplifiers for broadband response, control of stage gain, the function of a.g.c., tuned circuit response, gain and bandwidth comparison, stagger tuning of i.f. stages, parallel effect of the grid circuit on the plate load, design requirements of video detectors, the phase inversion properties of a conventional amplifier, etc.

As with most of Mr. Saunders' lectures, the text is written in a down-to-earth style omitting extraneous material. Technicians who have worked with the "Notebooks" in the past will find this newest release up to standard.

**"AUDELS TELEVISION SERVICE MANUAL"** by Edwin P. Anderson. Published by *Theo. Audel & Co., Publishers*, New York. 384 pages. Price \$2.00.

This compact, pocket-size handbook is a practical how-to-do-it presentation of television receiver installation and servicing.

The book contains eighteen chapters dealing with the placement of the TV receiver, test patterns and adjustments, TVI, interference traps, television antennas and transmission lines, master antenna systems, installation

procedures, broadcasting, receiver circuit fundamentals, typical receiver circuits, picture tubes, projection receivers, TV test equipment, servicing, troubleshooting, waveform analysis, color television, and color conversion methods. A separate chapter carries a television glossary.

The text material is lavishly illustrated with line drawings, circuit diagrams, and photographs which serve to amplify and supplement the author's explanation of the principles involved. The book is written clearly and without resorting to involved mathematics or complicated calculations.

The book should meet the requirements of the budding television technician very handily.

**"PRIMER OF ELECTRONICS AND RADIANT ENERGY"** by Don Caverly. Published by *McGraw-Hill Book Company, Inc.*, New York. 334 pages. Price \$5.50. Second Edition.

This is a layman's book designed to make the subject of electronics understandable to persons without technical training in that field.

The author has attained the often-impossible goal of presenting a potentially-complex subject in a thoroughly lucid style. Without condescension or purposely "talking down" to his audience, the writer has presented a quantity of interesting data covering a wide range of topics.

The book itself is divided into four parts dealing with electricity, magnetism, electromagnetic radiation, and electron tubes and sources of radiant energy. Each of these main headings is subdivided into chapters which cover the major aspects of the primary topic.

By using familiar analogies and a large number of diagrams and photographs to amplify the text material, the author has provided the reader with at least an intelligent speaking acquaintance with many of the man-made marvels of this century.

**"TEST INSTRUMENT APPLICATIONS MANUAL"** by Edward M. Noll. Published by *Paul H. Wendel Publishing Co., Inc.*, Indianapolis. Sixth "Notebook" in the Television Technicians Lecture Bureau series. 48 pages. Price \$1.00. Paper bound.

The practical application of various types of television test equipment is the subject of this information-packed booklet which has been prepared especially for the service technician.

The text material is divided into three main sections covering the features and characteristics of various types of TV test gear, how to know your test equipment, and how to use it. The use of the test equipment is clearly explained by means of specific examples and service-tested procedures.

The equipment covered includes such instruments as oscilloscopes, sweep oscillators, v.t.v.m.'s, instrument probes, and signal generators. Diode modulators, u.h.f. test equipment, and service bench arrangements are also considered in some detail.

## Servicing Picture Tubes

(Continued from page 37)

Note 2: Some customers have been concerned over a luminous "flashing" which occurs for some time after the set is turned off. This trouble will not harm the screen. If it is bothersome to the customer, try readjusting the ion trap slightly or try the high-voltage bleeder resistor just described.

5. **DEFECT:** Picture either washed-out or extremely "contrasty" (Fig. 3 or 4); brightness control will not affect brightness.

**CAUSE:** Grid-cathode or heater-cathode short in picture tube. (In certain models, a shorted or leaky condenser in the brightness control circuit will cause the same trouble.)

**REMEDY 1:** If the tube is within warranty, contact the dealer or distributor for replacement.

**REMEDY 2:** Try burning out the short by applying a.c., d.c., or r.f. across the shorted elements. The author has found that r.f. voltage obtained from an amateur transmitter, high voltage power supply of the TV receiver, or a similar source of low-current, high-potential is much more effective in clearing shorted elements (in any tube) than either 117 volts a.c. or 117 volts d.c. The apparent reason is that most shorts of this type are not caused by direct contact between sagging or displaced elements, but rather from dislodged particles of the emitting surface. The application of r.f. tends to burn out or anneal these particles so that they cause no further trouble. (A number of such tests by the author have been entirely satisfactory.)

**REMEDY 3:** If the above method will not clear the short, isolate the shorted element by installing a separate filament transformer for the picture tube. (Any small, inexpensive transformer which will handle the picture tube's heater voltage and current requirements will do.) Tie the cathode to one of the heater terminals but do not ground the transformer secondary or center-tap. (Isolating the cathode circuit in this manner allows the brightness control to function normally and in many cases will actually improve picture quality by reducing transient and line noise effects.)

Note 1: The above method obviously will not work in receivers which feed the video signal in through the cathode instead of the grid, or in tubes which have a cathode-grid short. Burning out the short or replacing the tube are the only solutions here.

Note 2: The effect shown in Fig. 3 can also be due to a weak or low-emission picture tube. In this case, however, the brightness control will function normally. Substitution will prove this condition.

6. **DEFECT:** Magnetized picture tube (Fig. 5 or 6).

**CAUSE:** Metal-cone picture tubes (16EP4, 19AP4, etc.) can become mag-

## JUST WHAT YOU NEED . . .

Standard Test Leads, 4"x1 1/2" Prods., Pair	39c	-3 f/	1.00
Phone Plug-Nickel Plated, Screw			
Terminals	Ea.	39c	-3 f/ 1.00
Instrument Knobs-Bar, Octagon, Round, Set Screw, Skirts, Asst.			10 f/ 1.00
Line Cord-Bro. Rubber 7 ft., Molded Rubber Plug	Ea.	29c	-4 f/ 1.00
Line Cord-Black Rubber 6 ft., Angle Molded Plug	Ea.	39c	-3 f/ 1.00

## TRANSFORMERS AND CHOKES

<b>TRANSFORMERS—110 V. 60 CYCLE PRIMARIES:</b>			
600-0-600 V. 200 MA.—6.3 V. 3 A.; 6.3 V. 4 A.; 5 V. 3A.—3 1/2"x4 1/2"x3 1/2" Stator, No. 4-6170			\$6.95
325-0-325 V. 50 MA.—6.3 V. 2.5 A.; 6.3 V. 1.6 A. (Rect. 6x5) Half Shell—2 1/2"x3 1/2"x3 1/2"—No. T-23-28			2.75
6.3 V. 1 Amp.	1.25	24 V. 1 Amp.	1.95
24 V. 1/2 Amp.	1.50	24 V. 6.5 Amp.	5.95
6-24-or 30 Volt 8 Amp			5.95
Two 12 V. 4 A. windings, gives 12 V. 8 A. or 24 V. 4 A.			5.95
6.3 Volt 6 Amp.—6.3 Volt 4 Amp.			2.25
440 VCT/70 MA.—5 V. 2 A.; 6.3 V. 4 A.			3.35
700 VCT/200 MA.—6.3 V. 3 A.—6.3 V. 4 A.—5 V. 3 A.			4.95
700 VCT/120 MA.—5 V. 3 A.; 6.3 V. 4 A.; 32 V. 2 A.			4.75
490 VCT/60 MA.—5 V. 2 A.; 6.3 V. 4 A.; 6.3 V. 2 A.			3.25
460 VCT/90 MA.—5 V. 3 A.; 6.3 V. 4 A.			3.75

## CHOKES:

5 Henries—150 MA., 85 ohms DC—Res., Cased, 2 1/2"x2 1/2"x3 1/2"—No. 3769	\$1.95
8 Henries—500 MA., 80 ohms, 5000 V. Ins.	8.95
7.5 Henries—400 MA., 60 ohms, 5000 V. Ins.	6.95
6.2 Henries—300 MA., 82 ohms, 5000 V. Ins.	4.75
15 Henries—300 MA., 260 ohms	4.75
4-12 Henries—300 MA., 110 ohms, 1000 V. Ins.	3.95

BC-223 TRANSMITTER—With Tubes & TU-17 Tuning Unit, Gov't Reconditioned	\$26.50
CABLE—Transmitter to Power Supply	\$2.00
TUNING UNITS—TU-17—2000-3000 KC. TU-25—3500-5250 KC.	\$3.50 EACH
OPERATING MANUAL for BC-223AX	2.50
SHOCK MOUNTING for PE-125	1.50
FT-173 MOUNTING for BC-223	2.50

## BLOWERS—115 VAC 60 CYCLE

COMPACT TYPE: 108 CFM, motor built inside squirrel cage, 4 1/2" Intake; 3 1/2"x3" Dis. Comp. size: 4 1/2" W x 8 3/4" H x 8 3/4" D.	Order No. RN-860	\$13.50
FLANGE TYPE: 140 CFM, 3 1/2" Intake; 2 1/2" Dis. Comp. size: 7 1/2" W x 7 1/2" H x 6 3/4" D.	Order No. RN-865	\$12.95
SINGLE TYPE: 100 CFM, 2 1/4" Intake; 2" outlet. Complete size: 5"x6". Order No. RN-520		\$7.99
DUAL TYPE: 100 CFM, 4" Intake; 2" Dis. Each Side. Complete size: 8"x6". Order No. RN-800		\$12.95
FLANGE TWIN: 275 CFM, 4 1/2" Intake; 3 1/2"x3" Dis. Comp. size: 11 1/2" W x 8 3/4" H x 8 3/4" D.	Order No. RN-134	\$20.95

## AMPLIFIERS

BC-367—Uses two 6V6GT Tubes, Carbon Mic. Input, Tapped output. Ideal for intercom. With Tubes & Schematics, less Dyn. and Case—Used	\$4.95
BC-605—With Tubes, Used	3.95
BC-709—With Tubes—New	\$4.95
BC-347—Less Tubes—New	\$2.95

Address Dept. RN • Minimum Order \$5.00 • Prices F.O.B., Lima, O. • 25% Deposit on C.O.D. Orders

## CORDS—CABLES

CD-501 Cord f/GN-45 Generator	\$2.50
CD-318 Cord w/PL-68 & SW-141 & JK-48F	.89
CD-307 Cord—6.5 Ft. w/PL-55 & JK-26	.89
CD-604 Cord w/C-410 Trans. & PL-54 Plug	.89
CD-365 Cord for LP-21 Loop	1.50
MC-215 Tuning Shaft for 274N	2.00

## ANTENNA EQUIPMENT

### MAST BASE—INSULATED

MP-132 Base—as illustrated at left. 1" heavy coil spring, 2" insulator. Overall length: 11 1/2". Weight: 2 1/2 lbs. Price—\$3.95

### MAST SECTIONS FOR ABOVE

BASE—Tubular steel, copper coated, painted, in 3 foot sections, screw-in type. MS-53 can be used to make any length, with MS-52-51-50-49 for taper. Price for any section—50c Ea.

**AIRCRAFT CONTROL CABLE**  
3/32"—7x14 Strand, Weatherproofed, Galvanized, 320 lb. Test. Ideal for Television Guying and many other uses. Prices: 3 1/2c per Ft.—1000 Ft. or more @ 3c per Ft.

**AERIAL WIRE**—Phosphorus Bronze #16 Stranded, 200 lb. test, Weatherproof. 150 Ft. on Reel, RI-3 w/Clips \$1.50  
Telephone Wire—3 Cond. copper & steel, 525 Ft. \$5.95

85 KC IF COIL—7267—for BC-453 \$3.50  
BF0—85 KC...75c 1415 KC-1F... 1.50 Ea.  
TU-7-8-9-10-26 for BC-191/BC-375...Used: 3.95

## DYNAMOTORS:

DYNAMOTOR and BLOWER: 9 Volts DC input; output 450 Volts 60 MA. 4500 RPM. At 6 Volts DC input; output 260 Volts 65 MA. 3000 RPM. Price—\$4.95

INPUT:	OUTPUT:	STOCK NO.	PRICE:
14 V. DC	600 V. 300 MA.	BD-89	\$9.95
12 V. DC	220 V. 70 MA.	DM-24	6.95
12 V. DC	220 V. 100 MA.	DM-18	4.95
14 V. DC	375 V. 150 MA.	DM-375	8.95
14 V. DC	330 V. 135 MA.	DM-330	7.95
14 V. DC	500 V. 500 MA.	PE-59	14.95
12 or 24 V. DC	275 V. 110 MA.	USA-0516	3.95
12 V. DC	250 V. 50 MA.	DM-25	8.95
28 V. DC	250 V. 60 MA.	DM-22	(Used) 2.95
12 or 24 V. DC	500 V. 50 MA.	USA-0515	3.95
14 V. DC	1000 V. 350 MA.	BD-77	(Used) 8.95
28 V. DC	1000 V. 350 MA.	PE-73	(Used) 6.95
28 V. DC	250 V. 60 MA.	PR-86	8.95

## POWER SUPPLIES:

VIBRATOR TYPE—6 Volt DC input; output 230 Volt DC 50 MA.—not filtered—w/tube. Ideal for Command Receiver operation, as receiver is filtered internally. Size: 4 1/2"x4 1/2"x3 1/2" \$4.95  
PE-157 POWER SUPPLY—2 Volt Vibrator Supply, operates from BB-54 2 Volt Battery mounted in Case. Output voltage 1.4 V. 1/2 Amp 125 V. 50 MA. Less Battery, Speaker, & External Power Cord—with Vibrator \$4.95  
BB-54 2 Volt Dry Battery \$2.95

# FAIR RADIO SALES 122 SOUTH MAIN ST. LIMA, OHIO

## NEW TUBES GUARANTEED

0B2 . . . \$1.39	6AK6 . . . \$1.10	450TH . . . \$39.50
0B3 VR90 . 1.10	6AN5 . . . 3.99	CK512AX . 1.98
0C3 VR105 1.10	6AS6 . . . 3.30	702A . . . 2.75
003 VR150 . 95		703A . . . 4.95
1B22 . . . 2.25		705A . . . 1.95
1B23 . . . 7.95		707A . . . 7.95
1B24 . . . 8.50		708A . . . 14.95
1B35 . . . 12.95		708A . . . 3.95
1N23 . . . 1.25		715B . . . 8.95
1N23A . . . 2.25		721A . . . 1.95
2A1 . . . 9.95		722A . . . 4.95
2C40 . . . 8.50		723A/B . 16.95
2C43 . . . 24.50		726A . . . 2.75
2C44 . . . 1.19	6AS7G . \$4.50	726B . . . 8.95
2C52 . . . 3.95	6J4 . . . 6.95	803 . . . 3.75
2D21 . . . 1.09	6K4 . . . 4.50	807 . . . 5.99
2E22 . . . 1.95	6L6M . 1.85	807 . . . 10.25
2E26 . . . 2.95	6SN7WGT. 2.10	813 . . . 8.50
2E30 . . . 1.98	6SE . . . 1.95	814 . . . 1.85
3A5 . . . 1.59	RK60/1641 2.25	829B . 11.95
3A8GT . 1.39	75TL . . . 6.50	832 . . . 7.95
3AP1 . . . 9.95	83V . . . 1.10	832A . 9.95
3B24 . . . 4.95	85V . . . 21.50	833A . 34.95
3B26 . . . 3.50	304TH . 8.95	884 . . . 1.75
3B28 . . . 6.50	304TL . 8.95	955 . . . .49
3BP1 . . . 5.95	304TL . 8.95	955 . . . .49
3DP1 . . . 3.95	350A . . . 6.95	959 . . . 1.50
3D2 . . . 24g.	350B . . . 4.95	1631 . 1.25
3C33 . . . 9.95	350B . . . 4.95	2051 . 1.19
3FP . . . 1.95	417A . . . 8.50	8005 . 4.95
3Q5GT . 1.50	446A . . . 1.19	8020 . 1.25
4C35 . . . 24.50		8025 . 4.95
4E27 . . . 14.50		9001 . 1.50
4L50A . 35.00		9002 . 1.25
5B1 . . . 4.50		9003 . 1.50
5B4 . . . 4.50		9004 . . .69
5C2 . . . 1.98		9006 . . .49
5C5 . . . 4.50		
5C6 . . . 1.98		

Complete Line of Transmitting & Receiving Tubes. Send Cash With Order and Save C.O.D. Charges!

## J. S. H. SALES CO.

Dept. R-15, 7552 Melrose Ave., Los Angeles 46, Calif.

## TAKES THE "PORTERING" OUT OF PORTABLE RECORDING

# THE Magnemite

### Battery-Operated Spring-Motor PORTABLE TAPE RECORDER

Field recording can now be made with as little effort as studio or home recording. Light and compact, the tiny Magnemite® is the first completely portable tape recorder! Earphone monitoring and playback facilities built in. Powered by self-contained dry cells that last 100 operating hours. Choice of four models, including a unit designed to NAB recording standards.

**Model 610-B: Compact** (11 1/2"x8 1/2"x5 1/2 in.)! Light (10 lbs., including batteries)! Economical (\$225, complete)!

## AMPLIFIER CORP. of AMERICA

398 Broadway New York 13, N. Y.

# Sensational TV BARGAINS!



## Rocket YAGI

### 5 ELEMENT TV ANTENNA

#### Excellent Pictures in Fringe Areas

**HIGH GAIN.** Clearer, sharper, steadier pictures. **PERFECT PICTURES IN FRINGE AREAS.** Minimum interference from ghosts and noise due to a directive pattern. Five elements include one folded dipole, three directors, and one reflector. Supplied less mast. **MATCHES 300 OHMS IMPEDANCE.** Molded insulator provides additional strength. Exclusive design mast clamp prevents antenna twisting or canting under any conditions. **STURDY, TROUBLE-FREE CONSTRUCTION.** No return calls. No broken elements. Stands the test of severest weather. Elements of extra heavy aluminum-clamped top and bottom. **QUICK RIG.** Completely pre-assembled. Just swing elements into line and tighten wing nuts. Simple, quickly, or easy. Available for any channel, high or low band.

Channels 2 or 3 **\$7.95** each 4, 5, or 6 **\$6.95** each  
Channels 7 to 13 **\$3.95** each

EACH CHANNEL requires a DIFFERENT Yagi. When Ordering specify exact channel number desired.

## Rocket DIRECTRONIC MOTORLESS TV ANTENNA

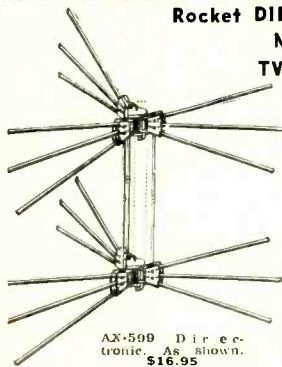

360° Electronically Switched Beam

- No Motors
  - No Roof Orientation
  - Flick of Switch Clears Picture
  - No Electric Power
  - No Ghosts
- The Directronic 18 element, 360° antenna is the finest for ultrafringe or metropolitan reception. The Hi-PAC model insulator is a material of tensile strength not affected by weather or temperature, either mechanically or electrically. Included in the AX-599 "Servicemen's Array" are:

AX-599 Directronic, As Shown, **\$16.95**

18 hi-tensile aluminum alloy elements.  
Universal U Clamps for masts to 1 1/2".  
Directronic Beam Selector.  
75 feet of Tri-X Cable.

AX-59 Directronic, 9 element Single, **10.35**

## SENSATIONAL INDOOR ANTENNA

Indoor Directronic for use on ceilings, attics, closets. 360° coverage. Finest reception on all channels. No ghosts. Clearer, sharper pictures. Hidden installation. Steadier focusing. Strongest signal. Minimum noise or interference. Beam selector switch for best picture on every channel. Kit contains three tape elements with insulators, mounting fasteners for use if needed, Directronic Beam Selector Switch, 25 feet Tri-X Cable, and Twin-X Cable Extension.



Only **\$5.95** complete. Model ID-303

## OTHER ANTENNA BARGAINS

ALL CHANNEL CONICALS	ALL CHANNEL IN LINE	\$3.75
Single Bay	ALL CHANNEL FOLDED	\$3.95
Stacked Array with Tie Rods	DIPLOLE	\$3.95
	ALL CHANNEL DOUBLE VEE	\$3.75

## LOWEST PRICES ON TV ACCESSORIES

Mast Steel (Dualcoated 5' Crimped) 1 1/2" O.D.	\$ 1.05
Mast Steel (Dualcoated 10') 1 1/2" O.D.	1.95
Mast Steel (Zinc Plated 10') 1 1/2" O.D.	1.59
Mast Connectors for 1 1/2" O.D. Mast	1.49
Chimney Mount Complete with Straps	1.19
Peak Roof Saddle (will take up to 1 1/2" O.D.)	1.49
Lightning Arrestor-TV	.69
Galvanized Guy Wire—6 strand	20
Galvanized Guy Wire—11 strand	20
Aluminum Guy Wire, 300 ft. Reel	\$4.95
Tri-X 3 Conductor Lead-In, 300 ohm Twin Lead	55 Mil Stranded (500' Reel \$8.50)
300 ohm Open Line Twin Lead, 500' Reel	\$22.50
300 ohm Low Loss Twin Lead, 100 mil Stranded	4c ft.
Mast Stand-off Insulators—3"	8.50 C
Stand-off Screw Insulators—3"	2.75 C
Stand-off Screw Insulators—7"	5.50 C

Rocket Products sold only by mail by National Electronics

Prices Subject to Change Without Notice

ALL PRICES P.O.R. CLEVELAND, OHIO

Do not remit more than complete purchase price. Pay shipping charges on receipt of goods. 25% deposit on C.O.D. orders, please. Money-back guarantee.

INSTALLATION PROBLEMS BOTHERING YOU? Write for FREE help. No obligation.

## FREE CATALOG OF BARGAINS

TV antennas, accessories at lowest prices. Tells about our fast service, free installation help. Send name, address now.

**National Electronics**  
OF CLEVELAND  
**THE HOUSE OF TV VALUES**  
108 OELCO BUILDING, CLEVELAND 3, OHIO

netized if they are operated near a PM speaker or other strongly-magnetized object.

**REMEDY:** Remove the chassis and move a small pocket compass over the metal cone. The affected area will usually be sufficiently magnetized to give an indication on the compass. Then *de-magnetize the affected area* by holding an a.c.-energized coil over the picture-tube cone for a minute or so. (An old focus coil will serve if suitable series resistance is used to prevent its overheating when used on 117 volts a.c. If you prefer, you can make your own coil by winding 1300 to 1400 turns of #24 cotton-covered wire on a form 6" in diameter and 3" to 4" in length. A piece of linoleum rug core, cardboard jelly container, etc., will do.) Hold the coil endways over the magnetized area for a minute or two. When you remove the coil, keep it energized until away from the tube; otherwise, magnetization may again occur. The distorted raster edges should straighten when the cone has been thoroughly demagnetized.

7. **DEFECT:** Hum in picture; curved or distorted raster edges similar to Fig. 7 or 8.

**CAUSE:** In some cases due to internal damage (caused by dropping, excessive vibration, etc.).

**REMEDY:** Try substituting a new picture tube before checking for troubles in out-of-the-way places in the high or low-voltage supply. (Experience will indicate whether a defective filter, tube, etc., is most likely.)

8. **DEFECT:** Picture inverts or goes negative when brightness control is advanced (Fig. 9).

**CAUSE:** Defective picture tube; weak high-voltage rectifier tube; defective video i.f. or r.f. tube; weak or misadjusted ion trap magnet.

**REMEDY:** Check tubes listed above. Before trying picture tube, try adjusting ion trap or replace it with a new one.

Correcting the foregoing troubles will be left mainly in your hands. The customer, however, can help extend the life of his picture tube by following these four basic suggestions:

(1) *Never turn the brightness full on for any length of time.* In large tubes (i.e., 20 to 30-inch), only a few seconds at full brilliance can cause permanent damage to the screen coating, especially if the ion trap is not properly adjusted.

(2) *Make sure the ion trap magnet (if your set has one) is properly adjusted.* (Check with your technician or dealer if you are not sure about this).

(3) *For daytime viewing, keep the set away from direct sunlight.* If it is located near a window, draw the blinds or shades at least half-way. (The more unnecessary light in the room, the higher you will have to set the brightness control to get a satisfactory picture. *Excessive brightness will reduce the life of your picture tube.*

(4) *Don't leave the set on while you visit with neighbors.* If you leave the

room to answer the phone, doorbell, etc., or if you listen to the sound only when preparing lunch or dinner, turn the brightness down. This will prevent damage to the screen if one of the sweep tubes should fail. If you are near the set, you will be able to turn it off if this occurs. (Sweep failure will leave a bright, thin horizontal line if the trouble is in the vertical circuit; some sets will have a bright vertical line if horizontal sweep fails, while others will lose screen brilliance entirely if this occurs).

You can do your customers a favor and improve picture quality of their older-model receivers by replacing type 10BP4 and 12LP4 tubes with 10FP4 and 12KP4's, respectively. These aluminum-backed types will increase both brilliance and contrast. Since neither requires an ion trap magnet, discard the old trap or, if coils are used, simply tape them out of the way on the chassis.

-30-

## Mac's Service Shop

(Continued from page 60)

obstetrician and the general practitioner: one brings the babies into the world, and the other keeps them in it; and who dares say which has the more important job?

"You know it's a kinda funny thing, but almost every technician has a favorite story about a case in which a design engineer tried his hand at servicing and was a miserable flop; yet nine out of ten of us secretly fancy that we could give the engineering boys some pretty sharp suggestions about their job if we were just a mind to."

"Well, you're not talking to me," Barney said as he turned back to the little set on the bench. "I'm about ready to admit that I'm a complete idiot who knows nothing about either design or service. I've spent a half a day on this stinker and have not helped it a bit."

"What's the beef?"

"It picks up ignition noise. Noise from a car as much as a block away will ride right in over a broadcast station as though you were listening on ten meters. In every other way the set is normal. Sensitivity and selectivity are good. All voltages check right on the nose. I've put in a whole new set of tubes."

"Did you use the signal tracer to see where the noise seems to begin?"

"Yes, I can first hear it on the grid of the i.f. tube. That makes me think it starts in the 12SA7 mixer. Of course the oscillator rush drowns out everything else on the plate of that tube."

"Got any theories?"

"None that seem to lead anywhere. I keep wondering how the set could be receiving a broadcast station on around a thousand kilocycles and at the same time be sensitive to ignition noise that likely peaks up around fifty megacycles."



"Try putting a resistor of about 1000 ohms in the lead from the oscillator grid to the oscillator tank circuit," Mac suggested.

Barney's diagonal cutters were at work almost as soon as Mac finished speaking, and the resistor was clipped in place. A pleased grin spread over Barney's freckled face as he tuned across the band without hearing any sound from the cars that were passing up and down in front of the shop.

"Give!" he commanded his boss.

"Well I'll confess that I did not just whip up the answer to that one right now," Mac said. "I sweated over just such a problem for a whole day before getting the answer. The trouble is a parasitic oscillation in the oscillator grid circuit that peaks up somewhere around thirty megacycles. The ignition noise mixes with this high frequency oscillation and goes right on through the i.f. system along with the signal produced by the beat between the regular oscillator and the broadcast station. That resistor simply serves as a parasitic suppressor."

"Well I'm certainly glad that is out of the way," Barney commented. "Now I can get started on putting a new power transformer in that console."

"Are you sure it needs a new transformer?"

"Can't you tell by the smell?"

"I can tell the transformer has been overheated, but that does not always call for a new transformer. Those jobs will often take a lot of punishment. Pull the rectifier and check the voltages of the two filament windings. If both are normal, let the set run for a few minutes with the rectifier out of the socket. Listen carefully for any frying sounds coming out of the transformer and notice if it heats up. If either of these symptoms is present, you are safe in telling the customer he will have to have a new transformer; but if it runs cool and makes no noise, find out why it got hot before.

"Usually you will find a short in the 'B-plus' circuit that is causing a heavy overload on the transformer when the rectifier is in its socket. Cathode type rectifiers often develop cathode-to-plate shorts that cause transformers to overheat quickly. Filament leads sometimes become shorted, especially around dial lamp sockets or where a 'hot' filament lead passes around a sharp-edged chassis projection or right where these leads issue from the hole in the transformer shell. That is why I wanted you to check for low filament voltages, indicating a possible short, before letting the set run.

"Once the cause of the overloading has been located and removed, put the rectifier back in the socket and let the set run for at least a couple of hours, noting carefully if the transformer overheats. Remember that most transformers eventually reach a temperature where the hand can barely stand the heat. If everything seems normal, do not replace the transformer. It may not hold up, but the odds are that it will."

August, 1952

# Equipto **STEEL** DRAWERS

12-inch

Will Not Damage Costly Parts!



Ignitions • Voltage Regulators • Lead-in Cables • Anchors • Pipe Hangers • Any thing with loose wire ends kept completely safe from accidental damage • Small Transformers • MC Pickup Cartridges • Small "Mikes" • Small brackets • Phonograph Needles • Bolts & Nuts • Drive Rings • Bridle Rings

One piece construction - front, back, bottom, with all-welded sides—**NO HOLES**  
Embossed grooves along the sides for cross dividers—**NO HOLES**

Instantly visible, extra large label holders on all cross dividers and on front of drawer—**NO HOLES**

**STOCK SAVING • MONEY SAVING WASTE PREVENTION**

What good are parts that have been mangled? None! And they cost the repair man money. Too much money to overlook the fact that Equipto drawers and cabinets are designed to prevent waste and damage to valuable parts. When stopping to realize that every time you pull an ordinary drawer out, one with open slots along the sides, small parts can not help protruding and very easily catch on the frame and either break or damage beyond repair; and every time this happens it costs you from a few cents to many dollars. Multiply this by a very few times and you are really losing money. After all, you are in business to make money. Stop wasting your parts and money!

**NO. 8** 8 DRAWERS 12" DEEP  
**NO. 11** 18 DRAWERS 12" DEEP  
**NO. 22** 18 DRAWERS 18" DEEP

◀The handiest unit you ever had for taking care of your small parts. Stack, use individually or as insert in shelving or under counters. A wonderful item for sales in stores or for keeping small parts handy in Electrical, Radio and TV repair shops. Equipto's most popular item

Stack them high for the convenience ▶ of lots of drawer space.



**Equipto** Division of Aurora Equipment Co.  
800 Prairie • Aurora, Illinois  
Phone: Aurora 9231

Write for **FREE** Catalog

**40** YEARS

## CRONAME TV CONVERSION KIT

Be Proud of Your Big Tube Conversion or Custom Installation

3 Professional Quality Components

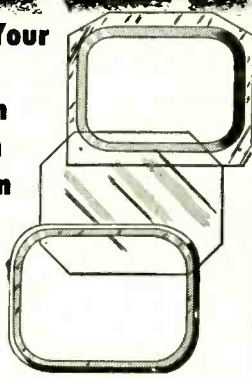

1. Metal Mask Tailored for Perfect Fit.
2. Heavy 1/4" Tempered Safety Glass.
3. Beautiful Gold Finished Metal Escutcheon.

All Popular Sizes: 14", 16", 17" and 20"

Easy installation Instructions Included

Order CRONAME TV CONVERSION KITS; CRONAME TUNING DIALS, KNOBS and ACCESSORIES from Your Parts Jobber.

Send for New CRONAME Catalog.



**ELECTRONICS, INC.**

911 N. Larrabee St., Chicago 10, Ill.

Mfrs. of Replacement Speaker Cone Assemblies

LEARN

## Television-Radio Electricity

REFRIGERATION-ELECTRONICS IN THE GREAT SHOPS OF **COYNE**

**TRAIN QUICKLY! OLDEST, BEST EQUIPPED SCHOOL of ITS KIND in U.S. Draft Age and Older Men..**

Come to the Great Shops of Coyne in Chicago. Get practical training in TELEVISION-RADIO or ELECTRICITY—vital in Defense Program. Prepare now for a better job or better service rating.

**START NOW—PAY LATER**

You can finance most of your tuition, pay for it later in easy monthly payments. Special plan for men of Draft Age. Part time employment service available.

**FREE BOOK** Clip coupon for Big Free Illustrated Book. Indicate below, course that interests you. No salesman will call. Act NOW.

**COYNE** [SCHOOL] B. W. Cooke, President A TECHNICAL TRADE INSTITUTE CHARTERED NOT FOR PROFIT Established 1899 500 S. Paulina, Chicago

ELECTRICITY ★ TELEVISION RADIO ★ REFRIGERATION ★ ELECTRONICS

B. W. COOKE, Pres. COYNE School 500 S. Paulina St., Chicago 12, Ill. Dept. C2-85H

Send FREE BOOK and full details on:

TELEVISION-RADIO  ELECTRICITY

NAME.....

ADDRESS.....

CITY..... STATE.....

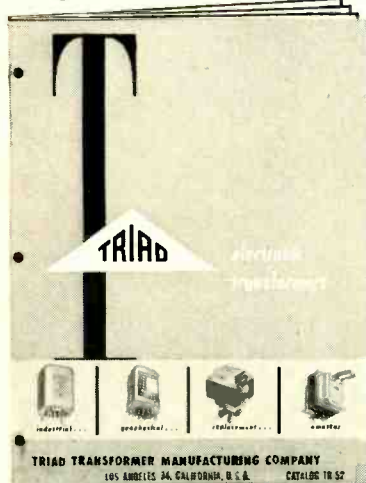

## TRIAD CATALOG TR-52 featuring:

- "HS" (hermetically sealed) transformers to MIL-T-27 specifications
- High quality Audio transformers
- 400-cycle Power transformers
- "TRIJET" Miniature transformers
- Toroids
- General Purpose transformers for television and radio replacement
- Geophysical transformers
- Amplifier Kits

Write for Catalog TR-52 today  
or pick up your copy at  
**BOOTH 1201**  
**WESTERN ELECTRONIC  
SHOW & CONVENTION**  
Long Beach, California  
August 27-28-29



"How come so many transformers go bad in the summer time?"

"The hot, humid weather is an important factor. When the surrounding air is around ninety degrees, the transformer has more difficulty in getting rid of the heat generated inside itself. Then, too, lightning often comes in over the power line, even jumping an open switch, and breaks down the insulation between adjoining turns. Once a transformer has shorted turns, it will heat up rapidly with or without external load and must be replaced.

"Whether you put in a new transformer or not, be sure and clean off any of the sticky mess that runs out of a hot transformer onto the chassis and cabinet. If you don't, a strong, pungent odor will be given off by the set as soon as it gets warm, and this may last for weeks.

"If you do have to replace the transformer, do your darndest to get one with the exact voltage windings as the original and also with the identical current ratings or just a little higher. Do not go all out on the 'safety factor' and try to use a transformer with much heavier current ratings than will be needed, for this will mean that voltages in the set and cost to the customer will both be higher than necessary. Always fuse the primary of a new transformer. A two-ampere fuse is about right for consoles, and a three-amp fuse will carry most TV sets. Putting in this fuse is just good insurance on your service job. A new transformer is a pretty costly affair to the customer, and he is going to be very unhappy if he has to repeat the operation as long as he has the set. I often drill a nest of half-inch holes in the cabinet shelf directly beneath the transformer to give it added ventilation—"

"Can't we talk about a cooler subject," Barney broke in plaintively, as he wiped the sweat from his forehead with his handkerchief.

—30—

### PROTECT CORD TIPS

By ARTHUR TRAUFFER

**T**o PROTECT my phone cords which are continually bending at the tips, I slip 2" lengths of small diameter rubber tubing over the tips and cords as shown in the photo.

Natural rubber tubing, about 1/4" o.d. and 1/8" i.d., such as sold in hospital and medical supply stores or by chemical supply houses, is ideal for this purpose.

The rubber covering for the tips reduces body capacity effects when using the tips in experimental circuits.

—30—

Protect phone cord tips with rubber tubing.

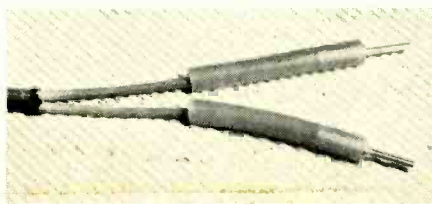

## Special Purchase NAVY SURPLUS Transmitting Triode VT 2

EQUIVALENT TO TYPES 931 AND 205B  
WHILE THEY LAST

**99c**

**6 FOR \$5** SHIPPED  
PREPAID

CHARACTERISTICS AND APPLICATION DATA  
SENT UPON REQUEST WITH ORDER

### PARK ELECTRONICS

1447 Riverside Drive  
LOS ANGELES 31, CALIF.

### Used Recording Tape (Plastic Base)



**199** For 7"—1200  
foot Plastic reel.  
Save \$3.51 on  
every reel.

Money cheerfully refunded if you do not find this tape cleanly erased and as good as new. (If you are skeptical and from Missouri, send us 10¢ and we'll roll you a sample on a 3" plastic reel).

● We buy commercial and government surplus plastic tape. Tape must be Irish (#211 RPA), Scotch, or Audio (same, or other tape that will meet government specifications and must not have more than one splice in any 1200 foot spool).

New Empty Plastic Reels in boxes for easy labeling. 5" and 7" reels, 24c each.  
● We also carry new, famous make tapes, recording blanks, and tape recorders at large discounts.  
**COMMISSIONED ELECTRONICS CO.**  
2405 18th St., N.W. Washington 9, D. C.

### SCHEMATICS—CONVERSIONS FOR SURPLUS GEAR

NEW LIST! MANY ADDITIONS!

Send stamped, self addressed envelope for List B. Add 25c for chart explaining AN nomenclature.

R. E. BOX 1220  
GOODHEART BEVERLY HILLS, CAL.

### AN/APR-4 COMPONENTS WANTED

In any condition. Also top prices for: ARC-1, ARC-3, APR-1, APR-5A, etc.; TS-34 and other "TS" and standard Lab Test equipment, especially for the MICROWAVE REGION: ART-13, BC-348, BC-221, LAE, LAF, LAG, and other quality Surplus equipment; also quantity Spares, tubes, plugs and cable.

ENGINEERING ASSOCIATES

432 Potterson Road Dayton 9, Ohio

## SELL Jensen PHONO NEEDLES For Any Type Record Player

Please send me FREE Jenselector. Picks the proper replacement needle.

Name \_\_\_\_\_  
Address \_\_\_\_\_  
City \_\_\_\_\_ State \_\_\_\_\_  
Jensen Industries, Inc., 336 S. Wood St., Chicago 12

RADIO & TELEVISION NEWS

## Improved Speech Clipper

(Continued from page 57)

a suitable contrast between the pilot lamp and the flashing neon lamps.

The filter condenser cans containing  $C_{20}$  and  $C_{21}$  should be mounted on insulating plates and all ground connections for the power supply components made with insulated wire and connected at one point only to the chassis. Shielded wire should be used between  $J_1$ ,  $J_2$ ,  $J_3$ ,  $J_5$ , grid of  $V_1$ ,  $S_1$  and their associated connections in the circuit. No trouble will be experienced if the normal precautions for the construction of a high-gain audio amplifier are taken.

The component layout may be seen from the photographs and it is suggested that this layout be followed if possible. In Fig. 3,  $V_1$ ,  $V_2$ , and  $V_3$  are mounted in line along the front edge of the chassis with  $V_1$  near the clipping level control, and  $CH_2$  near the output level control.  $V_1$  and  $V_2$  are located in line between  $CH_2$  and  $T_2$ . The calibration control,  $R_{21}$ , is mounted through the top of the chassis between  $V_5$  and  $V_7$ .  $J_2$  is mounted next to  $V_1$  near the top edge of the chassis, and  $J_3$  is mounted on the opposite chassis-end near  $CH_2$ . The hum-balance and bias controls,  $R_{14}$  and  $R_{15}$ , are mounted on the rear chassis drop, along with  $J_1$ ,  $J_5$ , the fuse holder, and the a.c. receptacle. Tube shields should be used on  $V_1$ ,  $V_2$ ,  $V_3$ , and  $V_4$ .

The entire unit is constructed on an aluminum chassis, 9 x 7 x 2 inches. The aluminum panel was cut to 10 $\frac{3}{4}$  x 6 $\frac{1}{2}$  inches to fit a small cabinet that was on hand.

### Calibration and Operation

Connect a sine-wave signal source of about 30 millivolts to  $J_1$  and a vacuum

tube audio-frequency voltmeter to the reference signal jack,  $J_2$ . Connect the vertical input of an oscilloscope from  $J_3$  to ground.\* Increase the setting of  $R_6$  until the scope pattern shows that the sine-wave peaks are just starting to be clipped. Note the value of signal voltage at  $J_2$ . (It was 30 millivolts in the unit described here.) Now increase the setting of  $R_6$  until 1.3 times the previous voltage reading is obtained at  $J_2$ . The waveform at  $J_3$  will show that clipping is now taking place. Reduce the setting of  $R_{21}$  to minimum, and increase  $R_{13}$  until the neon lamps are lighted. Slowly reduce the  $R_{13}$  setting until all of the lamps are completely extinguished. This procedure is necessary because the gas-filled neon lamps, once lighted, will not be extinguished until the bias voltage is reduced several volts below the ignition voltage. Now increase  $R_{21}$  just enough to cause the 2 db lamp to light, and the calibration is complete.

Before the unit is calibrated it might be well to test the operation of the neon lamps to eliminate the possibility of one or more being defective. This may easily be accomplished by varying the bias control  $R_{13}$ . The lamps should all light within two volts of each other. Any which do not operate within this range should be replaced to avoid errors in calibration.

After connecting to the regular microphone and speech amplifier, switch the clipper out of the circuit and adjust the gain control on the regular speech amplifier for 100 per cent modulation. Set the clipper output level control to zero and increase the clipping level control so that the desired amount of clipping is obtained as indicated by the flashing lamps. Switch

\* If necessary test equipment is lacking, the unit may be calibrated in a short time at nearly any local radio service shop.

Fig. 5. Under chassis view. Ample room is available despite small over-all size of unit.

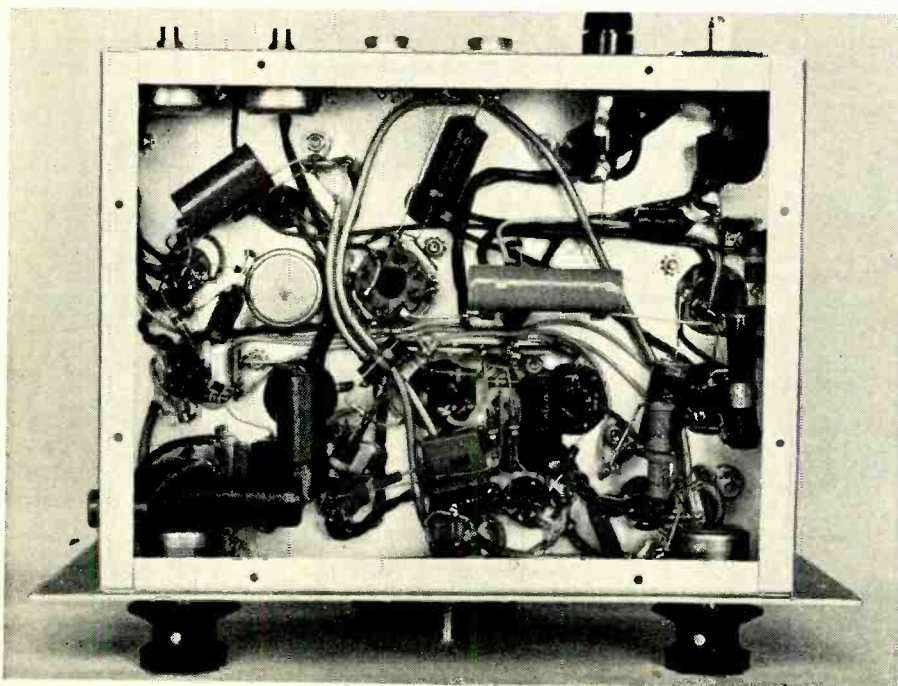

August, 1952

## Alprodco TRIPLE PURPOSE EREC- TOWER

MADE OF LIGHTWEIGHT  
AIRCRAFT ALUMINUM  
QUICKLY PORTABLE  
SAVES TIME AND LABOR

TEST SIGNALS  
UP TO 80 FT.

With the Erec-Tower, you can determine the height of the strongest signal . . . as high as 80 feet.

ERECT PERMANENT  
ALPRODCO TOWERS

With the Erec-Tower, two men can erect a 100-foot Alprodco tower faster, safer, easier . . . eliminating four to ten men on every job!

DEMONSTRATE  
TV SETS

Build Volume Sales. Show your prospects in fringe areas close-to-perfect TV reception right in their own homes.

ALL PACKED  
UP READY  
TO GO!



WRITE TODAY

for free literature and full information on the new, heavy duty, Alprodco Erec-Tower . . . made by the makers of the famous Alprodco Aluminum Towers. Address Dept. B.

Alprodco, Inc.

Kempton, Indiana  
Mineral Wells, Texas  
Dublin, Georgia

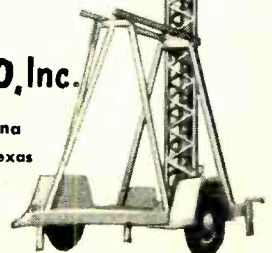

129

# NEW LOW PRICES

**BUY NOW and SAVE!**

**WESTINGHOUSE OIL CAPACITOR**  
 10 MFD, 1000 VDC (Marked 440 VAC)  
 A Terrific Bargain at \$1.95 Each  
 3 for \$4.98

### G.E. RELAY CONTROL

Contains a sigma midget 8,000 ohm. relay. (trips at less than 2 MA), high impedance choke, bi-metal strip, neon pilot and many useful parts. The sensitive relay alone worth much more than the total low price  
**\$1.25 each, 10 for \$9.90**

### POWER TRANSFORMER BARGAINS

(110 V. 60 cycle primaries)  
 750 volts CT @ 200 MA. 6.3V @ 10 amps.  
 5V @ 3A. Fully cased, removed from TV equipment. Guaranteed Electrically. each **\$2.95**

### FILTER CHOKE BARGAIN

Fully cased 5 Henry 200 M.A., removed from TV Equipment Guaranteed **.95 each**

### FILTER CONDENSER BARGAIN

8x8 M.F.D. 600 vdc oil compound filled. Only **.98 each**

### POWER SUPPLY KIT

Uses Power Transformer, choke, and 8x8 mfd Filter Condenser described above. All for **\$3.98**

### SCOPE TRANSFORMER BARGAIN

2500 V @ 3 ma. 2.5 V @ 2 A. 6.3 V @ .6 amp. Removed from TV equipment. Guaranteed. Terrific value @ **\$1.49**

### SENSITIVE RELAY

D'Arsonval moving coil type, mounted in meter case. Adj. 700 microamps to 1 ma. Made by Triplett. ea. **\$5.75**

### MICROAMMETERS

#### 3" METERS

0-200 U.A. **6.95**  
 0-500 U.A. **9.95**

#### 4" METERS

0-200 U.A. **8.95**  
 0-500 U.A. **12.95**

#### GE KV METER

0-15 kv DC, 3 1/2" sq. Bakelite case, 500 UA movement. Includes 30 Meg. 1% Ext. multiplier **\$12.75 ea.**

#### 2" GE Voltmeter

0-30 Volts DC Aircraft type B-60 **\$1.95 ea.**

### OIL CONDENSERS

3.75 mfd 660 vdc **\$2.45**  
 50 mfd 600 vdc **5.95**  
 15 mfd 1000 vdc **4.95**  
 1 mfd 1500 vdc **.89**  
 1 mfd 2500 vdc **2.25**  
 1 mfd 3600 vdc **1.95**  
 .1 mfd 7500 vdc **1.95**  
 .5 mfd 7500 vdc **3.95**  
 .02 mfd 20,000 vdc **9.95**

### Non-Inductive Resistors

Ohms: 500, 12,500, 100 watts **\$0.75**

### BAKELITE CASED MICAS

MFD	VDC	Price	MFD	VDC	Price
.001	600	\$1.18	.024	1500	\$0.65
.002	800	.24	.02	2KV	.90
.01	600	.26	.005	2500	.55
.02	600	.26	.002	2500	.45
.01	1KV	.45	.004	2500	.50
.002	1200	.35	.00015	5KV	.70

### BLEEDER RESISTOR

100,000 ohm  
 150 watt vitreous enamel resistor.  
**\$59** each

### WIRE WOUND RESISTORS

5 watt ohms: 25-50-84-200-2500 **\$0.09 ea.**  
 10 watt ohms: 25-40-1325-2K-4K **.15 ea.**  
 20 watt ohms: 150-300-750-1K-1.5K, 2.5K-2.7K-10K-20K **.20 ea.**  
 30 watt ohms: 100-250-5300-18K **.22 ea.**

### ADJUSTABLE SLIDER RESISTORS

20 Watt: 1, 5, 300 ohms **\$0.25**  
 75 Watt: 100, 150, 200 ohms **.39**

## PEAK ELECTRONICS CO.

378 Great Neck Rd., Great Neck, New York  
 Phone Great Neck 2-0082

the clipper back into the circuit and advance the output level until 100 percent modulation is obtained. The clipper may now be switched in or out at will with no further adjustment of controls necessary. The clipping level may be varied at will from no clipping at all to the maximum available, with no adjustment of output level required, since the output voltage cannot exceed the value previously set.

The regular speech amplifier and modulator should be modified to improve the bass response as much as possible. The aim should be to improve the over-all response of the system to a square-wave signal and to eliminate as much phase shift as possible. The reader may refer to standard reference sources to ascertain what course of action is indicated for his particular circuit conditions.

### REFERENCES

1. Klippel, K. L.; "Clipper and Filter Distortion Problems." *CQ*, October, 1948.
2. Stultz, S. E.; "Premodulation Clipping and Filtering." *QST*, November, 1950.
3. Neil, J. P.; "Cut-Off Frequencies and Audio Quality." *QST*, November, 1950.
4. Technical Topics; "Some Facts of Modulation." *QST*, March, 1951.
5. Buene, W. B.; "High-Level Clipping and Filtering." *QST*, November, 1951.
6. Technical Topics; "Frequency Response and Intelligibility." *QST*, November, 1950.

-50-

### MORE TV LINKS

**THE** Long Lines Department of American Telephone and Telegraph Company has several projects underway which will eventually provide additional television facilities for various sections of the country.

Work has already started on laying coaxial cable between Little Rock and Memphis. When completed, the cable will handle hundreds of telephone conversations simultaneously and provide the basic facilities required for TV service when Little Rock is to be connected into the nationwide television network.

The company has also made application for authority to construct a microwave radio-relay system from Dallas to Austin where it will connect with the existing Austin-San Antonio system. The new system, scheduled for completion late this year, will make possible the addition of hundreds of telephone circuits and will provide two TV channels between Dallas and San Antonio. Along the 192 mile route between Dallas and Austin six intermediate radio-relay stations will be built to beam signals from one tower to the next. The tapered steel towers on which the Bell System antennas will be mounted will range in height from 162 to 325 feet.

Temporary radio-relay equipment, which was installed between Dallas and Austin for the national political conventions, will be removed upon completion of the new system.

The third project is the addition of Phoenix, Arizona to the Bell System intercity television network. Television signals are to be routed from Los Angeles over a coaxial cable, already in service for telephone use. The addition of Phoenix to the nationwide TV network makes live network programs available to 107 stations in 65 cities.

-50-

## CONDENSERS

Mfd.	2000 V.	Each	Mfd.	5000 V.	Each
.005		\$0.85	.001		\$1.95
.007		.85	.002		1.95
.0003		.85	.0025		1.95
.0015	2500 V.	.95	.0002		1.95
.0025		.95	.0008		1.95
.0006		.95	.00035		1.95

Mfd.	3000 V.	Each	Mfd.	5000 V.	Each
.003		\$1.65	.0062		\$1.65
.004		1.65	.0005		1.65
.005		1.65	.0009		1.65
.00015		1.65	.000091		1.65
.0003		1.65			

Mfd.	1200 V.	Each	Mfd.	2500 V.	Each
.01		\$0.70	.01		\$0.90
.02		.70	.015		.90
.01		.70	.001		.90
.002		.70	.002		.90
.005		.70	.003		.90
.0025		.70	.004		.90
.0001		.70	.005		.90
.0005		.70	.00015		.90

Mfd.	600 V.	Each	Mfd.	1200 V.	Each
.01		\$0.35	.01		\$0.60
.02		.35	.04		.60
.03		.35	.008		.60
.015		.35	.0022		.60
.001		.35	.0003		.60
.002		.35	.0008		.60
.004		.35	Mfd. 2500 V.		
.009		.35	.01		\$0.90
.0002		.35	.02		.90
.00005		.35	.0015		.90

Mfd.	50V	Terminal Loc.	Each
4	15V	1s,2s	\$0.50
30	200V	2s,1s	.50

Mfd.	600 V.	Each	Mfd.	1200 V.	Each
2X.5	100	3t	.02		\$0.50
2X.1	400	3t,3s			.60
3X.1	400	3s,3t			.60
.75	400	2s			.60
.35	400	1b			.60
.5	400	2b,2s,1t			.60
.025	600	2t			.70
.1	600	2s,2t			.70
2X.1	600	3b			.70
3X.1	600	3t			.70
2	600	2s			.70

Mfd.	Volts	Price	Mfd.	Volts	Price
6	600	\$0.99	12	2500	\$9.95
4	600	1.89	1	3600	3.95
10	600	3.29	3X.2	4000	7.95
1	1200	.90	1	4000	4.95
1	1200	.85	3	4000	8.95
1	1500	1.79	2	7500	19.95
.5	2500	1.49	2X.15	8000	1.95
2	2500	3.95	.05	15,000	8.95

\*Oil impregnated paper

Mfd.	Volts	Price	Mfd.	Volts	Price
.06	1000	.0002	3000		
.025	1000	.00015	5000		WRITE
.04	1000	.0002	5000		
.08	1500	.0009	6000		FOR
.09	1500	.0002	10,000		
.03	2000	.001	25,000		PRICES

\*CD PL-254-46  
 Cash with order. California orders please include 3 1/2% Sales Tax. Prices include approximate postage. Excess will be refunded.

### ESEGE SALES COMPANY INC.

1306 Bond St.  
 Los Angeles 15, California

## Read RADIO & TELEVISION NEWS Every Month

### A SMALL AD—BUT B-I-G MONEY!

Here's What I'll Pay for the Following:

BC-848 or BC-812	up to \$70.00
ATC or T-47 Type ART-13	up to 250.00
BC-221 or R5/ARN-7	up to 45.00
TS-231	up to 175.00
FL-30 or F-21/ARA-9 audio filters	each up to 6.00

Also want TS-147, TS-148, MG-149, RTA-1B or parts.  
 I'll buy almost anything—and I'm not kidding.  
 Write or wire:  
**BOB SANETT, 4668 Dockweiler, Los Angeles, Calif.**  
 Telephone: YOrk 4637

## LEARN TELEVISION

ELECTRONICS and RADIO  
 Engineering Laboratory and Classroom  
 Training. Day and Evening Classes.  
 for illustrated Catalog

### ELECTRONICS INSTITUTE, Inc.

21 HENRY, DETROIT 1, MICH.

## Microwaves for "Hams"

(Continued from page 34)

justment of the wave guide system.

### Propagating Characteristics

The statement or belief that microwaves can only be used within the unobstructed horizon is completely erroneous. Such ideas were also prevalent before the amateurs opened up the short-wave band in 1922 and when "five-meter" radio opened up in 1932. Skepticism was rampant when police two-way radio began expanding on v.h.f. around 1935 and when radar on microwaves moved up into the 200 mc. region and above in 1940-41. In every case, equipment has operated beyond the horizon, with many instances having been recorded showing transmissions of several thousands of miles. Once this fact was established, our research experts were able to lay out study programs for yielding an explanation as to how this could occur. New and relevant factors became known. On short-waves, it was the Kennelly-Heaviside layer, first believed to be a single layer and later found to consist of several layers—each of which was responsible for a new set of radio communications ranges. On very-high frequencies, it was the dispersion effect at the horizon plus natural wave guide paths resulting from walls of buildings, sides of hills or mountains, walls of a canyon, or boundaries set by wayside wires and fences, etc.

On microwaves, the possible range of operations is unlimited if the following conditions affecting propagation through space are recognized.

1. *Direct path communication within the unobstructed horizon.* This is approximately equal (in miles) to 1.41 times the square root of the antenna height (in feet) above the intervening terrain plus the same conditions for the second station. For example:

Station 1	Station 2
2300 ft.	0 ft. (sea level)
200 ft. Height above intervening terrain	9 ft.
2500 ft. Antenna height	
2500 ft. Total effective height	9 ft.

Station 1 has a radio horizon of  $1.41 \sqrt{2500} = 1.41 \times 50$  or 70.5 miles while Station 2 has a radio horizon of  $1.41 \sqrt{9} = 1.41 \times 3$  or 4.23 miles. The two stations can thus intercommunicate over a distance of 74.73 miles by direct path.

2. *Indirect path or reflected communication.* This type of transmission may exist either within the horizon, beyond the horizon, or by a reflection within the horizon passing the energy on to another reflecting or pickup point beyond the horizon of the originating station. To understand how this happens, one should consider the source signal as a beam of light and every solid object encountered enroute as a reflecting mirror. Whatever a mirror of such shape would do

# Big Savings at NEWARK

## on Top Notch Audio Equipment

Save On Every Item

Save More By Buying the Complete System



The Complete System  
only \$82.50

**PILOT HI-FI FM-AM TUNER.** Save more than half on this deluxe tuner worth \$89.95. Bandswitch has 4 positions: AM, FM, Phono and TV. Circuit includes 1-stage audio amplifier with response,  $\pm 2$  db, 20 to 15,000 cps. Separate 3-gang tuning condensers and tuned RF stages on both FM and AM. FM section has temperature compensated oscillator for minimum drift; AM section has IF wave trap for rejection of signals in the IF passband. Sensitivity: FM, 20 mv for .3 volt output with quieting; AM, 3 mv for .3 volt output. With: 6-6BA6, 1-6BE6, 1-6AL5, 1-6AT6, 1-6X5GT. Self-contained power supply. Has built-in FM and AM antennas, plus provision for external ones.  $11\frac{1}{2} \times 6 \times 9\frac{1}{2}$ ". Wt.,  $8\frac{1}{2}$  lbs.  
**81F003. Special Price..... 42.95**

**NEWARK LOW-COST AMPLIFIER.** Compact 8-watt amplifier using 2-6V6 or 6K6 push-pull output tubes. Employs 6SN7 as Audio Driver and Phase Inverter; 5Y3GT is rectifier. Response, 50 to 12,000 cycles. Has continuously variable tone and volume controls. Outlet for AC phono motor plug on back. Output impedance, 8 ohms. Chassis size,  $6 \times 8\frac{1}{2} \times 5\frac{3}{8}$ ". Wt., 7 lbs.  
**81F001. Special Price..... 21.50**

### The Famous Regency



Model DB-410  
Television  
Booster  
Special Price  
\$14.11

Handsome mahogany plastic case,  $5\frac{1}{4} \times 4\frac{1}{8} \times 3\frac{3}{8}$ ". All brand new, in original cartons. With 6J6 tube, 6 lbs.  
**90F150. Special... 14.11**



**G.I. 3-SPEED CHANGER.** Tone arm uses crystal cartridge with single .002" needle to play both standard and microgroove records. Size:  $12\frac{3}{4} \times 12 \times 5\frac{7}{16}$ ". Requires 4-1/16" above,  $3\frac{1}{2}$ " below. Wt., 12 lbs.  
**81F000. Special Price..... 17.88**

**NEWARK 12" SPEAKER.** Handles 10 watts of audio power. Has heavy Alnico V magnet. 6-8 ohms voice coil. Wt., 5 lbs.  
**81F104. Special Price..... 6.95**

**COMPLETE FM-AM SYSTEM.** Wt., 15 lbs.  
**81F010. Special Price..... 82.50**

FREE! CATALOG No. 51

**NEWARK**  
ELECTRIC COMPANY

223 W. MADISON ST.  
CHICAGO 6, ILLINOIS



NEW!

### Transformer Catalog and TV Replacement Guide

Halldorson's new one-source catalog has the components you need, well classified for easy use.

This highly active line has been super-charged with 114 new items. Special attention is given to TV replacements. A self-contained guide section tells you where they are used.

Here's extra value, too. Halldorson prices actually have been reduced, but Halldorson quality is even better than ever.

Ask for a copy at your distributor, or write direct.

The HALLDORSON COMPANY

4500 N. Ravenswood Ave, Dept. RN-43  
Chicago, 40, ILL.

**Halldorson**  
QUALITY Transformers SINCE 1913

## CUT HOLES $\frac{1}{2}$ " to $3\frac{1}{2}$ " IN RADIO CHASSIS

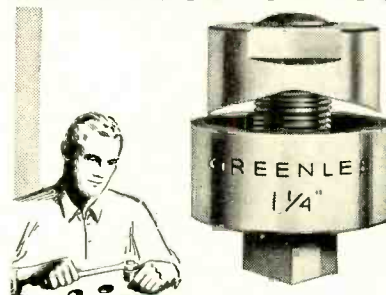

WITH A GREENLEE  
RADIO CHASSIS PUNCH

• Save hours of work... no reaming or tedious filing. Punch cuts through chassis quickly... makes accurate, clean holes for sockets, plugs, and other receptacles. Just turn with an ordinary wrench. There's a GREENLEE Punch in each of these sizes:  $\frac{1}{2}$ "",  $\frac{3}{8}$ "",  $\frac{3}{4}$ "",  $\frac{7}{8}$ "", 1",  $1\frac{1}{8}$ "",  $1\frac{1}{4}$ "",  $1\frac{3}{8}$ "",  $1\frac{1}{2}$ "",  $1\frac{3}{4}$ "",  $1\frac{7}{8}$ "",  $2\frac{1}{8}$ "",  $2\frac{1}{4}$ "",  $2\frac{3}{4}$ "",  $3\frac{1}{2}$ ". Write for complete facts. Also get information on Knockout Punches and Cutters for conduit and meter holes up to  $3\frac{1}{2}$ ". Greenlee Tool Co. 1888 Columbia Avenue, Rockford, Illinois.

TOOLS FOR CRAFTSMEN

**GREENLEE**



*New  
Low Prices!*



**FAMOUS SUN RADIO  
ALL-TRIODE AMPLIFIERS**

The continued and increasing demand for Sun Radio's "Great All-Triode Amplifier" has enabled us to reduce prices in the face of rising costs.

Two models engineered by us from a design published by CONSUMERS' RESEARCH, INC., Washington, N. J. (Special Bulletin No. 31). PEERLESS TRANSFORMERS used throughout on both models. Clear, rich, full, brilliant High Fidelity at a low price.

- Output transformers especially designed for this amplifier. CR-10 uses a standard quality "husky" transformer, response from 30-15,000 c.p.s.; CR-10Q uses the famous Peerless S240Q, 20-20 line transformer, vacuum impregnated and moisture resistant, response from 20-20,000 c.p.s.
- All triodes in this unique circuit employing self bias. Seven tubes including rectifier.
- Harmonic distortion less than 2%; hum level 60 to 70 db below rated output.
- Built in preamplifier for magnetic cartridges, input for radio tuner, crystal microphone or other signal source. Selector switch, volume control, bass and treble controls and power switch are the controls on the front panel.
- Kits supplied with punched chassis, finished in bronze hammetone, with control designations silk screened on the front panel; all necessary components; transformers and choke; tubes. Easy to follow instruction book containing step-by-step instructions, schematic and pictorial diagrams.

- Model CR-10 Kit..... \$49.50
- Model CR-10W wired & tested \$76.50
- Model CR-10Q Kit..... \$59.50
- Model CR-10QW wired & tested \$86.50

**NOW AVAILABLE -  
BASIC FOUNDATION KITS**

Contains all Peerless Transformers, punched chassis plus 12 page step-by-step instructions.

- CR-10B..... \$27.95
- CR-10BQ..... \$34.95

WRITE FOR SUN RADIO'S FREE  
"AUDIO EQUIPMENT HANDBOOK"

**Sun Radio**  
& ELECTRONICS CO., INC.  
122-G DUANE ST. NEW YORK 7, N. Y.  
Barclay 7-1840

to light, a similar thing will happen with respect to microwaves. Reflections will be more effective when obstructions enroute are substantially larger than the wavelength. This is quite likely to happen since microwaves are normally less than one foot long. Even dense cloud formations have reflective possibilities. At their greatest height, they can develop great ranges, even for stations operating at sea level with very small unobstructed horizon.

3. *Wave guide paths.* Microwave energy may recognize the space between two wires as the equivalent of the two walls of a wave guide pipe. It will treat one wire as if it were the ionosphere, and the other the earth, and try to propagate sky-wave fashion between such boundaries. The limit of such a communications range is the limit of the availability and existence of suitable wire arrangements around the country. Even the space between railroad tracks can serve as a wave guide, as can tunnels, underpasses, canyons, gorges, etc.

4. *Atmospheric ducts.* These are a function of weather and can make microwaves a tremendously valuable tool in weather forecasting. Microwave propagation at great distances can be tied in with weather conditions. Microwave energy recognizes the boundaries of a stratification of temperature or pressure aloft as a wave guide. It also considers the adjacent boundaries of two strata a wave guide. If signal energy from a transmitter can enter one of these atmospheric ducts or wave guides, the range of communication can become very great—often up to thousands of miles. This fact has been verified on many occasions and is undergoing continuing research by governmental and subsidized institutions. In investigations of this type the hams will be invaluable because of their large groups, geographical distribution, and the number of hours they spend on the air. The phenomenon is often missed by the professional groups working the modern 40-hour week.

Although thousands of persons are currently employed in the microwave industry involving the expenditure of billions of dollars, very few of these persons and only a small portion of the total funds are actually used for propagation studies. Instead, most of the time and money has gone into the design and construction of complex and expensive radar and microwave relay systems.

The author feels confident that when the hams really get into microwaves in sufficient number, the "CQ" call will yield just as interesting responses as those enjoyed now. Microwaves also offer infinite possibilities for a ham organization like the ARRL to live up to its name. Microwaves are an excellent medium for radio relaying and for working out communications networks with a wide selection of echelons to communicate during emergencies and civil defense operations.



**RADIO ENGINEERING  
TELEVISION  
ELECTRONICS**

Thorough training in all phases of radio and electronics, open to high school and junior college graduates. Old established school specializing in Radio training exclusively. Modern laboratories and courses. Enrollment limited. Approved for veterans.  
**VALPARAISO TECHNICAL INSTITUTE**  
Dept. RD Valparaiso, Ind.

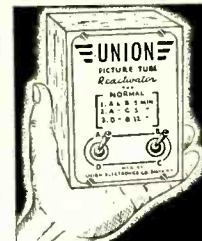

**NEW!  
POCKET SIZE  
PICTURE TUBE  
Reactivator**

A sturdy compact unit that effectively restores brilliance to most low emission tubes without removal from set.

**GIVES NEW BRILLIANCE TO OLD TUBES  
For All Size Picture Tubes. Simple to Operate  
BIG MONEY MAKER FOR SERVICEMEN**

Adds extra months to tube life. First application pays for device. **\$995**  
SOLD ON MONEY BACK GUARANTEE Only Postpaid or COD plus Postage  
**UNION ELECTRONICS COMPANY**  
394 Metropolitan Ave., Bklyn 11, N. Y.

**TRAIN FOR A SUPERVISORY POSITION IN  
ELECTRONICS**

Thorough 2-year course covers electrical circuits and machinery, basic electronics and industrial electronics. Franklin Technical Institute graduates are in demand as junior engineers for research and test work, sales engineering, supervisory work on production lines and drafting room design work. Other engineering and technical courses. Coed. Day, evening. 44th year. Write for catalog.

**FRANKLIN TECHNICAL INSTITUTE**  
46 Berkeley Street Boston 16, Mass.

**PEN-OSCIL-LITE**

Extremely convenient test oscillator for all radio servicing; alignment • Small as a pen • Self powered • Range from 700 cycles audio to over 600 megacycles u.h.f. • Output from zero to 125 v. • Low in cost • Used by Signal Corps • Write for information.

**GENERAL TEST EQUIPMENT**  
38 Argyle Buffalo 22, N. Y.

**SPEAKER RECONING**

Complete line Cones, Spiders, Rings and Voice Coils. Custom Built Voice Coils. Low prices. Write for Parts List and Reconing information.

**WESTERN ELECTRONICS CO.**  
3164 West Colfax Denver 4, Colo.

**GARRARD**

*The World's  
Finest*



MODEL RC 80  
\$42.30 net,  
less cartridges

3 Speeds  
...fully  
automatic  
with  
automatic  
stop

Garrard Sales Corp. Dept. R 8  
164 Duane St., N. Y. 13, N. Y.

Send GARRARD Fact Sheet.

Name.....

Address.....

City.....Zone.....State.....

Can be used with your present set.

To utilize the microwave frequencies, the radio ham has to become more of a mechanic than an electrician. He must get used to pipes called wave guides and metallic structures having certain shapes, configurations, and dimensions. He will use "cut-and-try" methods and simple arithmetic in his computations. He will be required to perform simple sheet metal and machining operations in building his apparatus but will probably purchase certain of his gear such as the wave guide probes and coaxial connectors, if they are readily available, otherwise he will build or improvise them from whatever is at hand. There is not one single thing connected with microwave operation on the ham bands that cannot be built or improvised very cheaply if the ham is willing to experiment. Microwaves offer a real challenge to the alert ham—a challenge very few hams will be able to resist!

-50-

## MIXER/MASTER CONTROL

By OLIVER BERLINER

OFTEN in the design of audio mixing equipment there is not enough space on the front panel to include a master gain control, or if a master gain is absolutely necessary, one of the mixer positions must be sacrificed or the panel parts layout becomes crowded and/or inefficient.

Here is a single-wire block diagram of a mixer circuit designed for larger consolelets but which can be adapted to portable mixers. With this circuit, each and every one of the mixer gain controls can be used temporarily or permanently as the master gain control. In addition, the master gain control can, at any time, be eliminated and all mixers become gain controls, thus increasing the number of inputs by one.

As can be seen from the diagram, by patching any one of the "normalled" A jacks to the "normalled" B jack, that particular gain control becomes the "Master Gain." Removing the patch will return the associated jacks to their normal positions and all the controls again become separate input gain controls.

This system works equally well with both high and low impedance circuits.

-50-

Special hookup which permits mixer gain controls to be used as the master gain.

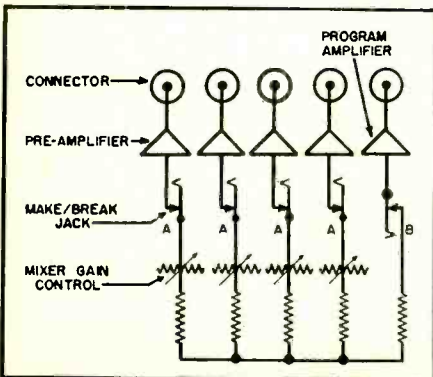

**New**  
**WILLIAMSON**  
**TYPE**

**AMPLIFIER Features**

- First Williamson Type Amplifier supplied with matching preamplifier
- Uses Altec Lansing Peerless output transformer.
- Practically distortionless — Harmonic and intermodulation distortion both less than 1/2 of 1% at 5 watts output.
- Frequency response ± 1 db from 10 cycles to 100 kc.
- Output impedance 4, 8, or 16 ohms.

The new Heathkit Williamson Type Amplifier kit is the best obtainable in amplifiers today—the choice of the really discerning listener. You can hear the difference and measurements actually bear out the superb performance. Frequency response ± 1 db from 10 cycles to 100 kc allow you to hear the highs and lows with equal crispness and clarity. Harmonic and intermodulation distortion both less than 1/2 of 1% at 5 watts output eliminate the harsh and unpleasant qualities which contribute to listening fatigue.

The circuit is similar to the one published in Audio Engineering Magazine for November, 1949, and is considered by engineers throughout the audio field as one of the best ever developed. The Main Amplifier (which may be purchased separately) consists of a voltage amplifier and phase splitter using a 6SN7, a driver stage using a 6SN7, and a push-pull output stage using a pair of 807 tubes. The output transformer is manufactured by the Peerless Division of Altec Lansing and is built to their highest standards. Output impedances of 4, 8, and 16 ohms are available. The power supply uses a separate chassis with husky Chicago Transformer power transformer and choke, and 700V Mallory filters for long life operation. A 5V1G rectifier is used.

The main amplifier and power supply are each on a chassis measuring 7" high by 5 1/2" wide by 11" long.

**PREAMPLIFIER AND TONE CONTROL UNIT KIT**  
The preamplifier kit consists of: a 12AX7 (or 12AY7) dual triode first amplifier stage with a turn-over control for LP or 78 record types, and a 12AU7 amplifier stage with individual bass and treble tone controls which each provide up to 15db of boost or attenuation. A switch on panel selects either magnetic, crystal, or tuner inputs. Preamplifier also is well suited to custom installations — it will operate in either vertical or horizontal position, and special notched shafts of the controls and switches allow a variety of shaft lengths. Dimensions: 2 3/4" high by 10 1/4" wide by 7 1/4" deep.

WRITE FOR **Free CATALOG**

**The HEATH COMPANY**  
BENTON HARBOR 15, MICHIGAN

**WA-A1 Amplifier kit — Combination 1 —** (Main Amplifier and Power Supply) complete with WA-P1 Preamplifier kit. Total Ship. Wgt., 34 lbs. (Shipped Express only) **\$69.50**

**WA-A1 Amplifier kit only — Combination 4 —** (Main Amplifier and Power Supply). Less WA-P1 Preamplifier. Total Ship. Wgt., 29 lbs. (Shipped Express only) **\$49.75**

**WA-P1 Preamplifier Kit only.** (less power supply) (Tubes included). Total Ship. Wgt., 7 lbs. (Shipped Express or Parcel Post) **\$19.75**

*You SAVE BY ORDERING DIRECT!*

### SELENIUM RECTIFIERS—FULL-WAVE BRIDGE TYPES

Current (Continuous)	18/14 Volts	36/28 Volts	54/42 Volts	130/100 Volts
1 Amp.	\$ 1.25	\$ 2.10	\$ 3.60	\$ 8.00
2 Amps.	2.20	3.60	6.50	10.50
2 1/2 Amps.	.....	.....	.....	13.00
4 Amps.	3.75	6.75	8.75	.....
5 Amps.	4.95	7.95	12.95	27.00
6 Amps.	5.50	9.00	14.00	36.00
10 Amps.	6.75	12.00	20.00	45.00
12 Amps.	8.50	16.00	25.50	52.50
20 Amps.	13.25	24.00	36.00	90.00
24 Amps.	16.00	31.00	39.50	98.00
30 Amps.	18.50	36.00	.....	.....
36 Amps.	25.50	45.00	.....	.....

100,000 plates stocked for standard and special rectifiers and rectifier supplies. Also XMFERS to Specs.

- **New, Selenium Rectifier Transformers**  
PRI: 115 V., 60 cycles in. ( 4 Amps. .... \$ 8.75  
SEC: 9, 12, 18, 24, and 36 } 24 Amps. .... 16.45  
volts. .... } 24 Amps. .... 35.75
- 115V. PRI.—36V. 50 amp second XFMR. \$39.95
- 115V. PRI.—5V. @ 190 AMP. SEC. .... \$59.95
- 115/230V. 60 cy. PRI. SEC. 1, 30.5, 33.5, and 36.5V @ 4 AMPS. Herm. sealed. .... \$6.50

• **CARTER DYNAMOTORS 6 V DC Input—400 VDC Output @ 375 MA. Only 7" x 4" x 3". \$28.00**  
Brand New. Only.....

• **AR-11—SUPERHET RCVR & 50 Watt XMTR w/ Built-in Pwr supply. Only 12" x 9" x 5" for 20, 40, & 80. A complete station for only \$99.50**

• **ART-1—DE LUXE MOBILE 75 meter AM XMTR w/ vibrator supply—only 6" x 6". \$19.95**  
Close Out .....

• **NC-183-D—3 sets w/Spkrs in stock in sealed National cartons. Write.**

Standard R.M.A. Warranty		TUBES	
0A2	50.95	4032	\$22.40
0B2	1.10	4X150-A	35.00
1L4	.69	5F7	1.95
1N21-B	3.00	5U4-G	.59
1N23-A	2.00	5X4-G	.79
1N23-B	3.10	6AJ5	1.20
1N34	.62	6AK5	.75
1N34-A	.75	6AN5	1.95
1N44/4		6BM6	.65
400-B	1.21	6C4	.49
1N45/5		6J6	.59
400-C	1.39	7C30	.85
1N54	.89	12A6	.65
2C43	15.95	12AU7	.69
2E24	3.00	104-TH	7.75
2E30	2.15	304-TL	7.75
354	.90	40B-A (WE)	2.75
		717-A	50.98
		805	2.00
		807	1.45
		829-B	11.00
		832-A	7.95
		872-A (GE)	3.25
		1616	.74
		1625	.39
		5516	5.95
		5654	1.95
		9008	5.50
		8020	.90
		9001	1.35
		9002	.95
		9003	1.50
		9004 (RCA)	.35
		9006	.25

**BARRY ELECTRONICS CORP.**

136 Liberty Street, N. Y. 6, N. Y. Rector 2-2563  
Terms: 25% with order, balance C.O.D.—Send a few cents for postage—All merchandise guaranteed, F.O.B. N.Y.C. Remember, you may order tubes not listed!

## Trav-Electric miniature Converter

Input 6 Volts D.C.—  
Output 110 V. 60 Cycle 40 Watts

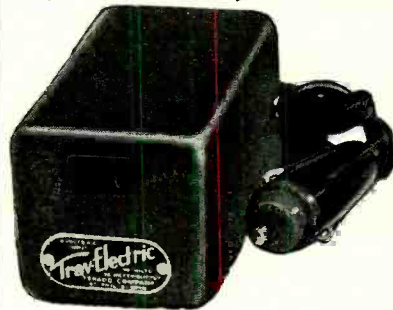

Size—  
2 1/2" x 2 1/2" x 3 1/2" **\$15.95**  
List Price

### Operates—

- Radios—Short and Broadcast Band
- Phono—Turntables
- Small Dictating Machines
- Test Equipment
- Electric Shavers
- Incandescent Lights

**Just Plug in Cigar Lighter**  
THOUSANDS IN USE  
Fully Guaranteed

See Your Dealer or Jobber—or Write Direct  
**TERADO CO.** 1068 RAYMOND AVE.  
ST. PAUL 8, MINN.

**SO IMPORTANT**— it was  
 Featured in Special Article  
 in  
**The New York Times**

Jan. 28, 1952  
 FREE copy  
 of article on request

**UNIT REACTIVATES  
 TV PICTURE TUBES**

Small Electronic Device Tests  
 Sets at Home and May Add  
 Year or More of Use

By T. K. KENNEDY Jr.

A small electronic device that can be applied to home television receivers to test and reactivate the picture tube without removing it from the set, resulting in renewed brightness in many and considerably longer useful life, has been placed on the market for the first time by a New York manufacturer.

In some cases, it was said, the picture tube may be made almost as good as new and given as much as a year's useful life before replacement is necessary. The instrument is small and compact. It weighs three pounds, is as large as the average lunch box, costs little and is simple to operate. Picture tubes used in them new and new-

The almost immediate urgent need for such an instrument, which also soon may be produced in kit form for home assembly, is apparent. Eight to ten million TV picture tubes, Transvision engineers estimate, have now been in use for three to four years or more, and "probably are in need of test and reactivation to 'renew' their brightness." Unfortunately, their brightness, it was pointed out, seldom can be detected short of comparing the old tubes with of new ones in lately produced sets. Furthermore, picture tubes in their original cartons in stores may have lost some of their brightness, which has been described as a "kind of aging process" to which all large cathode-ray tubes and similar devices are subject. Such tubes, in the current sizes most in use today, cost from \$25 to \$65.

New picture tubes can be tested and reactivated without removing them from their cartons, and tubes in TV sets without removing the tube socket from the receiver. This is done by attaching a standard picture tube socket to the instrument by wires from the top, and noting the "reading" on the meter. The meter is a vacuum tube voltmeter, and re-activates the tube in less than five minutes.

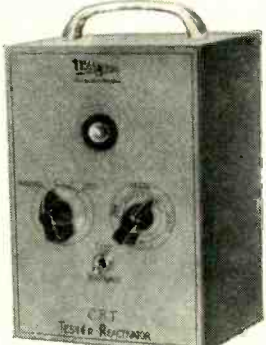

**TRANSVISION CR TUBE  
 TESTER - REACTIVATOR**  
*performs 2 vital functions:*

- Tests Picture Tubes
- Renews Brightness of Dim Picture Tubes

**It's a TESTER:**

Without removing picture tube from set, you apply this precise instrument to:—

- Measure Cathode emission
- Locate shorts between elements
- Locate high resistance shorts or leakage as high as 3 megohms

**It's a REACTIVATOR**

for dim CR Picture Tubes

Revives dim TV Picture Tubes, without removal of tubes from sets. Reactivation works on tubes with low light output, if there's no mechanical break in tube, 110 V—60 cycles. Weighs only 3 lbs. One or two applications pays for instrument.

**SATISFACTION GUARANTEED**  
 or money refunded if you return the instrument in 10 days in good condition.

**\$19.95**  
 NET

RUSH THIS COUPON  
 TRANSVISION, INC.

DEPT. RN-8 NEW ROCHELLE, N. Y.

- ( ) Send me CR Tube Tester-Reactivator(s).
- ( ) Enclosed find \$\_\_\_ deposit. Balance C.O.D.
- ( ) Enclosed find \$\_\_\_ in full. Send prepaid.

Name \_\_\_\_\_  
 Address \_\_\_\_\_  
 City \_\_\_\_\_ State \_\_\_\_\_

**RADIO-TV  
 Service Industry News**

AS REPORTED BY THE  
 TELEVISION TECHNICIANS LECTURE BUREAU

**WE ARE** entering the season when business normally starts a steady, uphill climb toward the Christmas season peak. This year, however, the renewed activity of building new TV broadcasting stations and in changing channels and increasing power on others will probably usher in one of the swiftest periods of growth and expansion this industry has ever experienced. Records will probably reveal that starting in July, when the first of the two very important quadrennial political conventions got underway, the radio-television business has been experiencing a better summer season than it has in a couple of years. The deep and extensive interest in the Presidential candidates and in the issues involved will, in itself, keep public interest in TV at a high level throughout the late Summer and early Fall.

The continuing interest in getting good television programs that these political campaigns will serve to maintain affords an excellent opportunity for creating the "service sales promotional" programs that are needed so badly by TV service businesses in the established TV areas. It is obvious that the "boom" days in the older major TV areas are past. There is no development now on the visible horizon that would impel large numbers of set owners to discard their present receivers and buy new ones. There is no likelihood of a big upsurge in business when new u.h.f. stations go on the air. In short, the television service business in those areas has settled down to the regular maintenance of receivers and accessory equipment now in use with the expansion possibilities tied to the normal increase in set ownership that may be accomplished by good receiver merchandising.

A maintenance and service business may be managed in either of two ways. It can keep its identity known through advertising in the hope that a certain percentage of people who recognize the need for service on their sets will call their number for that service. This plan of operation—if it may be called a plan—causes a business to suffer severely from seasonal slumps in consumer calls for service. In fact, service volume fluctuates so much from month

to month in this type of operation that it is unable to take full advantage of the peak periods of business and takes an undue loss during the slumps.

In contrast to this type of service business management, the service business that employs "service selling" programs regularly is able to level up its volume by intensifying these programs during the periods when business is most needed. Television becomes a vital part of the family life in every home where a set is installed. Set owners feel the same need for good, consistent performance from their TV receivers as they want from their automobiles. Auto manufacturers and dealers have sold car owners on the need for regular maintenance work to insure dependable service from their cars. Any television service operator who will institute a "TV set check-up" program on sets in the immediate area of his shop will quickly discover that there are a lot of people who will welcome that kind of service.

This type of maintenance service could include a regular chassis cleaning (a small, suction-type vacuum cleaner as a part of the maintenance technician's kit would be useful and effective for this function), face washing, and an operational check. The set owner's card carried by the technician on these maintenance calls should include a complete record of all radios, record players, and changers and any other electronic equipment that the customer owns. A regular part of the maintenance call should be to inquire about the condition of this other equipment and to check it if there is any question in the customer's mind about whether or not it is operating properly.

This method of business operational planning will not only serve to level up the periods of low business volume but it will also add many extra dollars of service income from replacement parts and repairs on other radio equipment that is normally neglected.

**New Channels—More Power**

The broadest effects of the renewed activity to expand television broadcasting into unserved areas will probably be felt in the twenty-five current TV areas in which present stations are scheduled to change channels. In shift-



ing channels these stations are authorized to boost their power. This power boost will extend the range of each of these stations by a number of miles, bringing new sections into their fringe areas. These newly opened fringe areas will create new markets for TV receivers and antenna installations while the increase in power and the channel changes will develop a large spot market for touch-up realignments and set adjustments throughout the affected areas.

The kind of "boom" that can hit a fringe area city when a station extends its range through an increase in effective radiated power was dramatically demonstrated in Indianapolis, Indiana, last Spring. Station WTTV in Bloomington, fifty miles distant from Indianapolis, put a new high-gain antenna in service when it increased its power on Channel 10. This put its signal into Indianapolis with sufficient strength to give good pictures wherever a satisfactory antenna system was installed.

Indianapolis had a Channel 6 station, WFBM-TV, for several years which most set owners were receiving satisfactorily with built-in or indoor antennas. Since there was no effective service association in existence in Indianapolis there was no planned public relations campaign to educate the set owning public about the long-range economy in having Channel 10 antenna systems installed by experts. Set retailers ran ads tying in Channel 10 antenna installations in a "package" to sell sets, but there was no real program directed to the thousands of set owners who would be in the market for antenna system installations and perhaps a touch-up alignment of their sets on Channel 10. The result was that a large percentage of this new antenna installation work was done either by the set owners themselves or by the host of fringe installers who jumped into the business to make a quick buck.

If the established service businesses in the Indianapolis area had gotten together and pooled their resources to put on a public educational program on the reasons why experienced TV installation companies should be employed to put up antennas and make the necessary set adjustments, it would have prevented a lot of confusion and would have helped to build public acceptance of the importance of employing competent service companies if they want to get top performance from their TV receivers.

#### Effects of Power Increases

In areas where stations have increased their effective radiated power three new reception problems have arisen. These are: (1) the added power put too much signal in the area close to the transmitter; (2) it extended the co-channel interference belts; and (3) it increased the possibility of adjacent channel spillover.

Tremendous signal levels put a strain on even the more modern a.g.c. systems and particularly if the a.g.c.

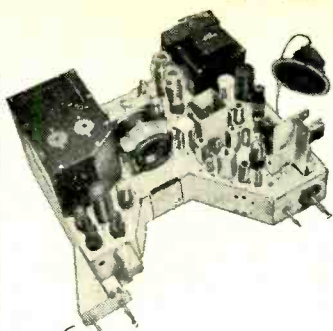

With Hi-Gain standard coil tuner and R.C.A. Hi-Fi 12" Speaker, complete with knobs and hardware. Complete with Fed. Taxes Paid. Less Cathode Ray Tube .....



**\$127<sup>50</sup>**

All Mahogany CABINET  
Most beautiful console in a de. Solid 3/4" mahogany wood including panels. Measures 31" W. x 24" D. x 39" H. Equipped with 20" mask

**\$95.00**

20CP4A Pix Tube—\$32.00 (Not a rebuilt) Guar. one year

**Special Offer!**

Chassis, Picture Tube and Cabinet **\$239.50** (with 630DX chassis \$249.50)

Send for Latest Catalog

**HERE IS THE BIGGEST BARGAIN YOU EVER SAW!**

**World's Finest 630 DX Chassis**

New CASCODE tuner assures best reception in fringe areas without a booster. Handles all Cathode Ray tubes from 16" to 21". Improved 30-tube super-quality TV receiver (including 3 rectifiers) mfd. under license by RCA. Complete, Less Picture Tube.

**\$138<sup>50</sup>**

### STANDARD BRAND TUBES

Individually Boxed and Guaranteed (Manufacturer of tubes refuses permission to mention name because tubes are FAR BELOW FAIR TRADE.)

1A7	\$.89	6BH6	\$.86	12AT7	\$.99
1B3	\$.89	6BK7	1.15	12AU7	\$.86
1H5	\$.71	6BQ6	1.24	12AX7	1.19
1N5	\$.71	6BQ7	1.15	12AX7	\$.99
1S5	\$.79	6C1	\$.54	12BA6	\$.69
1T4	\$.79	6CB6	\$.54	12BE6	\$.69
1U5	\$.78	6CD6	2.39	12BH7	\$.99
1X2A	\$.94	6L5	\$.54	12SA7	\$.77
3Q4	\$.89	6L6	\$.94	12SK7	\$.77
3Q5	\$.89	6K7	\$.66	12SN7	\$.77
3V4	\$.89	6SA7	\$.74	12SQ7	\$.68
5U4	\$.73	6SH7	\$.64	14A7	\$.84
5V4	\$.63	6SJ7	\$.74	14BE6	\$.94
5Y3	\$.97	6SL7	\$.72	25BQ6	1.29
6AC7	\$.94	6SL7	\$.72	25L6	\$.64
6AG5	\$.79	6SN7	\$.74	25W4	\$.78
6AK5	1.29	6SQ7	\$.74	25Z6	\$.67
6AL5	\$.68	6T8	\$.99	35L6	\$.86
6AQ5	\$.59	6V6GT	\$.64	35W4	\$.86
6AT6	\$.68	6W4	\$.64	35Z5	\$.51
6AU6	\$.69	7C5	\$.62	50A5	\$.96
6BA6	\$.69	7F7	\$.74	50B5	\$.79
6BC5	\$.74	7K7	1.09	50C5	\$.66
6BE6	\$.79	7N7	\$.84	50L6	\$.64
6BG6	1.76	12AT6	\$.65	117Z3	\$.64

Above partial listing only. Send for complete list.

## STEVE-EL ELECTRONICS CORP.

VISIT OUR NEW STORE

Dept. N-8 61 Reade St., New York 7, N. Y. COrtlandt 7-0086



Radio Handbook. Giant 13th Edition. A one-volume library of radio information with extensive, simplified theory. Detailed how-to-build-it data on dozens of items of practical radio equipment. 734 pages. Order Book No. E&E-RH13 .....

Radio Handbook. 12th Edition. Selected constructional items only. English Edition: Order Book No. E&E-RH12 .....

Spanish Edition: Order Book No. E&E-RHSP12 .....

Antenna Manual. A practical, comprehensive book on antennas, for everyone interested in transmission and reception. Over 300 pages. Order Book No. E&E-AM1 .....

Better TV Reception (in fringe and low-signal areas). The standard guide for installation technicians. A popular text for all TV enthusiasts. Order Book No. E&E-TR1 .....

Radiotelephone License Manual. Typical study questions with concise answers for any commercial U.S.A. radiotelephone operators license. Order Book No. E&E-RL1 .....

World's Radio Tubes. (Brans' Vade Mecum.) Lists over 15,000 tubes from every tube making country. Printed in 16 languages. New 9th Edition. Order Book No. E&E-VM9 .....

Surplus Radio Conversion Manual. Volume 1. Practical conversions. Write for list of contents. Order Book No. E&E-SM1 .....

Surplus Radio Conversion Manual. Volume 2. Companion to Volume 1. Order Book No. E&E-SM2 .....

\*Plus any tax.

### BUY FROM YOUR DISTRIBUTOR

ADD 10% ON DIRECT MAIL ORDERS TO EDITORS AND ENGINEERS, LTD. BOX 689A, SANTA BARBARA, CALIF. Bookstore; order from BAKER & TAYLOR, Hillside, N.J.

**SELLS ON DEMONSTRATION**  
**DUKANE**  
**MAGNETIC TAPE RECORDER**



**THE FINEST IN HIGH FIDELITY RECORDING**

**at LOW COST!**

**DEALERSHIPS AVAILABLE NOW!**  
**MAIL COUPON FOR INFORMATION TODAY!**

DUKANE CORP. Dept. RTN-82, St. Charles, Ill.

Please send information on the Dukane Magnetic Tape Recorder.

I am interested in a dealership.

Name \_\_\_\_\_

Address \_\_\_\_\_

City \_\_\_\_\_ State \_\_\_\_\_

ESTABLISHED AS "OPERADIO" 1922

# MATTISON

SILVER ROCKET  
630 CHASSIS with  
• TUNEABLE •

BUILT-IN BOOSTER  
for Better DX Reception

Featuring NEW CASCODE TUNER  
made for UHF interchangeable  
tuning strips and 70° COSINE YOKE

Tube  
Complement:  
28 tubes  
3 rectifiers  
1 CRT

32

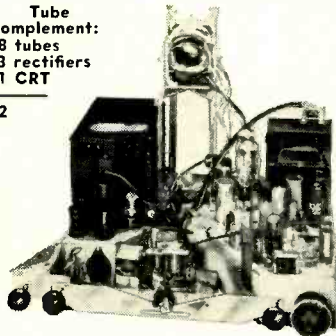

## All Channel Booster

• Broad band single knob control pre-amplifier built in to eliminate long leads which may cause regeneration and attenuation of signal.

• ONLY THE MATTISON 630 CHASSIS HAS AN ALL CHANNEL TUNEABLE BUILT-IN BOOSTER THAT INCREASES SIGNAL STRENGTH UP TO 10 TIMES. THE SILVER ROCKET WILL OUT-PERFORM ANY CHASSIS MADE AND IS PRICED RIGHT TO SELL FAST WITH AN EXTRAORDINARY MARGIN OF PROFIT FOR YOU. WRITE FOR CONFIDENTIAL PRICE SCHEDULE.

• Mattison features a complete line of cabinets MADE IN MATTISON'S OWN CABINET FACTORY. 36 breathtaking designs that blend perfectly in any setting, traditional or modern.

## DEALERS!

### SERVICE-DEALERS!

Here is YOUR opportunity to become the "important" TV Dealer in your area for THE FINEST CUSTOM-BUILT LINE OF TELEVISION RECEIVERS.

FREE! Write for MATTISON'S merchandising portfolio explaining:

"THE MATTISON UNASSEMBLED PLAN"

and

"THE MATTISON \$1,000,000 FLOOR PLAN"

## SALESMEN—AGENTS

Choice Territories Available. Become a Factory Sales Representative. Prefer men with experience selling direct to dealers.



Manufactured with integrity

When you buy from Mattison you need only one source of supply! You can buy a Mattison Chassis, a Mattison Cabinet or a complete Mattison TV Set!

Mattison Television & Radio Corp.

893 Broadway, Dept. R8, N. Y. 3, N. Y.

must be set to receive a relatively weak signal as well as a strong one. The best solution for this condition in many cases is to use a resistor attenuator pad to drop the signal level before it reaches the antenna terminals. Set owners, however, do not understand these technicalities that are peculiar to television. The average set owner knows only that the picture on his receiver is good or bad; if it is bad he wants the trouble corrected as cheaply as possible.

The co-channel interference problem is a difficult one. The too familiar "venetian blind" effect is prevalent throughout the flat Midwestern states and extends into most sections of the country on nights of abnormal refraction (often during hot, humid nights). A highly directional antenna (strictly uni-directional pattern) and careful orientation will help to minimize the interference.

Here again, though, the set owner is ignorant of a serious condition that may affect the quality of the picture on his receiver. When these stations boost their powers many set owners may suddenly find that the quality of the picture they get on the new channel is inferior to what it had been on the former channel. And, unless they are informed in advance about what may happen, there will be a lot of confusion and it will be an extremely difficult job to advise them about the causes of the trouble after the trouble starts.

When there is an increase in effective radiated power, the adjacent channel picture and sound levels are correspondingly higher. This becomes a particularly troublesome problem when strong and weak signals fall on adjacent channels. Technicians must be instructed to align traps carefully—preferably when spillover is observed on the screen.

An antenna with a pattern that can be oriented in the direction of the desired weak station and away from the interfering strong station will be of substantial help. The added selectivity of a booster can make the desired signal dominate adjacent channel interference to a greater extent.

In addition to these reception problems that may occur in every one of the areas where channel changes and power boosts are scheduled, few of the sets now in service will produce the best picture they can deliver without at least a touch-up alignment for maximum response at the new frequency. Since most TV set owners think of tuning in TV stations as being about the same as switching stations on their old push-button radios, there may be a lot of consternation among set owners who are not familiar with the need for alignment when they tune in these stations on their new channels.

Both parts distributors and legitimate TV service businessmen in these twenty-five areas which are slated for channel changes should pool their efforts in conducting educational programs for TV set owners, advising

them about what they may expect in the way of reception troubles when the station changes its channel and what to do about it if it occurs.

These campaigns should be put in effect in advance of the change in channels. When set owners understand the reasons why service may be needed when the change is made they will most likely arrange with an established service company to handle the adjustments on their receivers if they are necessary. A planned program of this kind will do much to eliminate the confusion that causes many set users to turn to the first technician who offers his services when unexpected troubles occur.

## Immediate Effect of New Stations

The new stations that will get the "go ahead" as the Federal Communications Commission proceeds with its program of granting channel assignments and issuing station construction permits will have a sectional effect on the TV business. The priority schedule recently released by the FCC shows that sections of eighteen states will be affected in the first twenty-five cities to be considered for new—and their first—telecasting stations.

Of these 25 cities, five have channel allocations only in the u.h.f. band. Assuming that construction permits are granted for u.h.f. stations in these cities they will become the center of attention of all segments of the industry. They will probably be the "proving ground" for u.h.f. receivers, equipment and accessories.

The Springfield-Holyoke, Mass., area tops the u.h.f. priority list with Channels 55 and 61 available to broadcast station applicants. Youngstown, O., is second with Channels 27, 33, and 73 assigned to that area; then follows Fort Wayne, Ind., with Channels 21, 27, and 33; Scranton, Pa., with Channels 16, 22, and 73, and South Bend, Ind., to which Channels 34, 40, and 46 have been assigned.

Of these five areas the Youngstown, Ohio, section will undoubtedly provide some of the most useful information on the extent and limitations of reception in the u.h.f. band.

It is quite possible that some of the major television service contractors will set up small branches in the first u.h.f. areas in order to acquire first-hand experience with the problems of installation, alignment, and servicing that will be created by propagation at these higher frequencies.

Denver, Colo., heads the entire list of cities for priority consideration for station assignments. With Channels 2, 4, 6, 7, and 9 in the v.h.f. region and Channels 20 and 26 in the lower end of the u.h.f. band allocated to that city, Denver will experience lively activity in TV station construction and receiver sales and installations. Portland, Ore., follows with v.h.f. Channels 6, 8, 10, and 12 and u.h.f. Channels 21 and 27 available for stations. Other cities on the list for priority consideration of v.h.f. applications include Tampa-

RADIO & TELEVISION NEWS

St. Petersburg, Fla., with Channels 3, 8, and 13 available; Wichita, Kans., where Channels 3 and 10 are open; Flint, Mich., due for a Channel 10 station; Spokane, Wash., for Channels 2, 4, and 6; Duluth, Minn., Channels 3, 6, and 8; and Sacramento, Cal., with Channels 3, 6, and 10 allocated.

#### Assn. Distributor Cooperation

One city that has been little affected by television service racketeers is Columbus, Ohio. A strong, aggressive service association, the Associated Radio-Television Service Dealers of Columbus, has been functioning in that city for many years. It started originally as a radio service association but made a quick transition to cover television when telecasting started in that area. However, even with such a strong association of conscientious service businessmen cooperating with the Better Business Bureau, the Columbus newspapers and the parts and set distributors, once in a while a service "sharpie" managed to edge his way into the business. It required a high order of cooperation between the better business elements to weed out those slick operators who managed to work themselves into the business.

One of the major reasons for the success of the ARTSD in keeping the service industry free from racketeering has been the cooperation they have had from all set and parts distributors in the city. The focal point of this program of cooperation is the quarterly annual dinner meetings which bring Association members together with distributors for discussions of mutual problems. Activities of common interest are discussed at these meetings, gripes are aired, and points of contention are freely discussed in an atmosphere of mutual respect and cooperation. Because of this cooperative activity the citizens of Columbus are assured of efficient, reliable service unexcelled in any other city.

In attending a recent joint meeting of the ARTSD with their distributors, the editor of this department was able to observe at first-hand why this program has worked so successfully. The meeting, which was presided over by Fred C. Colton, dynamic president of ARTSD and the originator of many fine technical training ideas now used by a number of organizations, was attended by a representative of the Columbus Better Business Bureau, a local newspaper columnist, top level executives of the parts and set distributing organizations, and members of the Association.

The BBB representative discussed the type of complaints they were receiving, how they were being handled, and gave an analysis of the results. He also outlined the actions that had been instituted to keep the last of the local service racketeers under control. Representatives of the various organizations were invited to voice their opinions on any subject of common interest and the parts distributors reported on new equipment shown at the annual

## What is Your Musical Preference?

Classic symphonies—Chamber Music  
Red-Hot Jazz Band?  
*Enjoy...* one or all in natural,  
lifelike reproduction with a

Available in 10 or 30 watt models, featuring:

- All triodes.
- Attractive, remote-control pre-amplifier with inputs for tuner, TV and phono; or single-chassis units.
- Exclusive BROOK 8-position stepped bass & treble control circuits.
- BROOK-designed transformers and "transient peak" circuits.
- Harmonic distortion and intermodulation reduced to vanishing point.

**BROOK**  
ALL TRIODE HIGH QUALITY  
**AUDIO AMPLIFIER**

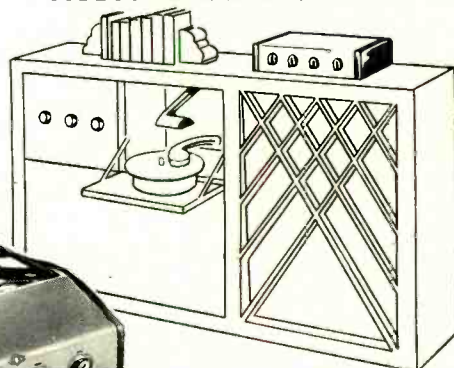

Write for technical data, free booklet, "Better Listening" and name of local dealer. Dept. RH-2.

**BROOK ELECTRONICS, INC.**  
34 DeHART PLACE, ELIZABETH 2, N.J.

### PHOTOCON SALES

417 N. Foothill Blvd. SYcamore 2-4131  
Pasadena 8, Calif. RYan 1-6751

**FREE 24-PAGE SUMMER SURPLUS  
SALES CATALOG**

**WANTED** new or clean used electronic surplus. Please state exact description of the condition and details of modification. Include lowest price in first letter.

TS-12 Test Set for X-Band Box 1 & 2 complete	Exc.	PUR*
Audio Oscillator Hewlett-Packard 200BR	Exc.	510.00
4286 Kelvin Bridge Ohmmeter, Leeds & Northrup, .0001-11 ohms	Exc.	100.00
8041X-1 Signal Generator UHF 8-330mc.	Exc.	425.00
TS-13/AP X-Band Signal Generator, Wave Meter, Watt Meter	Exc.	PUR*
I-96A Signal Generator SCH-522 Test Equipment	Like New	350.00
LM & IC-221 Frequency Meter with cal. book, crystal, and tubes	Exc.	99.50
TS-132/U Weston Test Set	Exc.	150.00
TS-174/U Frequency Meter 20-280 mc. with cal. book, and crystal	Exc.	450.00
TS-173/UR Frequency Meter 90-450 mc.—Complete with crystal, cal. book, & 115 VAC. Power Supply	Like New	600.00
TS-146/UP X-Band Signal Generator	Like New	PUR*
TS-34/AP Portable Oscilloscope	Exc.	350.00
Industrial Circuit Tester Weston Model 785	Like New	125.00
Electronic Analyzer Weston 769	Like New	225.00
APR-4 Search Receiver	Exc.	PUR*
Tuning Units for APR-4 Receiver	New & Like New	PUR*
BC-348, BC-312, BC-342 Receivers	New & Like New	PUR*
Communication Receivers—made by Hallcrafters, National, & Hammarlund. Many models	Prices start	79.50
T-47/AIT-13 Transmitter	Exc.	PUR*
Measurements Corp. Signal Generator Model 84 300-100mc.	Exc.	PUR*
PU-14 Inverter Input 24 VDC. Output 115 V., 3 Phase, 400 C.P.S. 5 amps	Exc.	PUR*
T-17 Hand Microphone with cord and PL-6B	Exc.	4.50
HS-23 8000 ohm	Used	\$2.95
HS-18 8000 ohm	Used	1.75
HS-29 600 ohm	Used	3.50
HS-38 600 ohm	Used	1.75
HS-38 600 ohm	Used	1.75
HS-38 600 ohm	Used	1.75

\*PUR—Price upon request.

**NOTE:** One of the largest and most complete electronic surplus stocks in the country. We have thousands of tubes, capacitors, plugs, accessories, transmitters-receivers, test equipment, etc. Send us your requirements.

**TERMS:** Prices F.O.B. Pasadena, California. 25% on all C.O.D. orders. Californians add 3% Sales Tax. Prices subject to change without notice.

FOR A FEW CENTS MORE YOU CAN GET THE ORIGINAL AND MOST RELIABLE PRODUCT OF ITS TYPE. WHY RISK YOUR REPUTATION TO SAVE A FEW PENNIES? ORDER FROM YOUR DISTRIBUTOR

**Back Again By Popular Request!**  
**Special Purchase FM Radio Chassis**

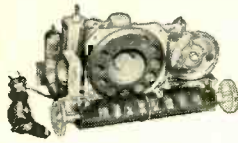

88-108 MC

Complete with 6 tubes. Built-in Antenna and Speaker. Product of Famous Radio & TV Manufacturer whose name we promised not to mention.

**TUBE LINEUP**

1-12BA7 1-12S8  
2-12BA6 1-35W4  
1-35B5

Regularly \$29.95  
Brand New

**\$16.95**

May also be used as an FM Tuner by picking signal off detector.

Maroon Plastic Cabinet for above..... **\$5.95**

**HERE'S A REAL BUY**



**Two Station Intercom System**

Less than half the original price. Built for America's leading dept. store chain, whose name we cannot mention because of this low price. Consists of master station, remote station and 20 ft. of 3 conductor wire. Can be used as a private or non-private system. 115V AC or DC. Brand New. Now only \$17.95. Additional wire, per ft., 5c.

**BRAND NEW**

now only **\$17.95**

**VARIABLE CONDENSERS**

From SCR-5-22  
2-GANG 25 MMF Per Section \$1.29  
3-GANG 25 MMF Per Section \$1.59  
Brand New with Concentric Air Trimmers

**SPECIAL PURCHASE Record Changer Gen. Instruments 3-speed Automatic**

Reg. \$34.95  
Brand New

**\$19.97**

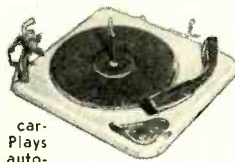

With all purpose cartridge & needle. Plays 33 1/3-45 RPM records automatically.

**Manufacturer's Closeout!**

EVERY READER KNOWS THIS FAMOUS MAKER OF WIRE WOUND FIXED AND VARIABLE RESISTORS. MARKED GENERAL ELECTRIC.

We've bought up a tremendous supply of these and now you can buy them below manufacturer's 5000 lot prices.

<b>10 WATT FIXED</b>		<b>10 WATT ADJ.</b>	
1,100-5,000	..... .75	1,100-5,000	..... \$1.47
6,000-10,000	..... .90	1250-5,000	..... 1.53
11,000-20,000	..... 1.03	6000-10,000	..... 1.63
22,500-35,000	..... 1.22	Your Cost. Each .39	
30,000-50,000	..... 1.32	<b>20 WATT FIXED</b>	
Your Cost. Each .24		5-1000	..... \$ .95
<b>25 WATT ADJ.</b>		1200-5000	..... .97
1-1000	..... \$1.87	6000-10,000	..... 1.12
1250-5000	..... 2.88	12,500-20,000	..... 1.20
6000-10,000	..... 3.03	25,000-40,000	..... 1.37
12,000-20,000	..... 3.08	45,000-60,000	..... 1.58
25K	..... 3.28	65,000-80,000	..... 1.83
Your Cost. Each .47		85,000-100,000	..... 2.11
<b>50 WATT ADJ.</b>		100,000	..... 2.22
1-1000	..... \$2.37	<b>100 WATT ADJ.</b>	
1250-5000	..... 2.47	1-1000	..... \$3.58
6000-10,000	..... 2.63	1500-5000	..... 3.67
12,000-20,000	..... 2.83	10,000	..... 3.87
25,000-40,000	..... 3.08	15,000-20,000	..... 4.12
50,000-60,000	..... 3.30	25,000-40,000	..... 4.37
80,000	..... 3.67	50,000	..... 4.53
100,000	..... 3.92	75,000	..... 4.75
Your Cost. Each .69		100,000	..... 4.95
Deduct 10%—Lots of 100 or more. Deduct 20%.		Lots of 1000 to 10,000. Minimum Order—\$2.00.	

**Attention Prospective Novice Hams!!**

Code Oscillator Kits—All Parts—Phones Key—Battery—Instructions—Complete **\$7.95**

TERMS: All items F.O.B., Washington, D. C. All orders \$30.00 or less, cash with order. Above \$30.00, 25 per cent with order, balance C.O.D. Foreign orders, cash with orders, plus exchange rate.

**GUN RADIO**  
OF WASHINGTON, D. C.  
938 F STREET, N. W. WASH. 4. D. C.

**Electronics Parts and Equipment Show in Chicago.**

The speaker for the evening's meeting was Paul H. Wendel, managing director of the Television Technicians Lecture Bureau, who discussed "Areas of Cooperation Between Parts Distributors and Servicing Organizations." He pointed out that the industry is standing on the threshold of the period that will witness its greatest expansion. While attention has been focused on television for home entertainment, great strides have been made in the development of television for industrial and commercial applications and the entire field of industrial electronics will open up vast new opportunities for parts distributors and competent independent service companies.

Taking the specific subject of industrial television, the speaker described the work that has been accomplished by the Lecture Bureau staff in developing an industrial TV camera unit that could be priced so low that it could be sold for use in a myriad of applications. He cited the following as just a few of these possibilities: 1. Window advertising displays; 2. Store-room pick-up of customers as they enter shop; 3. Monitoring of small plant operations; 4. Store-room advertising displays; 5. Use in service shops as a source of signal to check receiver performance; 6. Estate and farm applications; 7. Remote observation of recording instruments; 8. Applications in various departments of local governments; 9. Novelty and other applications at night clubs, carnivals, fairs, auditoriums, etc.; and 10. Television operations studies for radio amateurs, students, and experimenters.

Since every installation will have to be tailored to accomplish a specific purpose, industrial television will require the services of competent installation and maintenance organizations. It is a natural field for independent TV service organizations.

The speaker pointed out, however, that servicing organizations should be studying industrial television now in order to be prepared and equipped to move into the business quickly when it starts to develop.

Readers of this department who are interested in the subject of industrial television may obtain a copy of a bulletin on it by sending a stamped, addressed envelope to: The Service News Editor, RADIO & TELEVISION NEWS, 366 Madison Ave., New York 17, N. Y.—30—

"Will whoever has the remote control gadget stop playing with the channels!"

**TELEPHONE EQUIPMENT & PARTS**

- New TS9 Handsets with butterfly switch..... \$6.50
- Rebuilt TS9 Handsets with new shell..... Each 4.95
- Rebuilt Solid Type Handset with new 3 conductor cords..... Each 4.95
- New Western Electric Handsets with rubber cord & PL47 plug..... Each 7.50
- New Receiver & Transmitter Elements interchangeable with W.E. Elements F1 & HA1. Each 1.00
- Reconditioned Upright Desk Telephones (for intercoms, extensions, etc.)..... Each 2.95
- W.E. 202 Desk Telephones..... Each 8.50
- New 6-Foot Rubber Cords with Alligator clips. Each .60
- New Weatherproof Cook Commando type Pole Jacks..... Each 1.00
- New W.E. UA 38 Relays..... Each 2.50
- New, unused R.C.A. Amplifiers—90 Watt, 50-60 Cycles, 105-125 Volts, with spare part kits.

Terms: Check with Order—F.O.B. Brooklyn, New York

**EASTERN TELEPHONE CO.**

321 Vanderbilt Ave. Brooklyn 5, N. Y.

**YOU GET 2**

ABSOLUTELY THE GREATEST CABINET BUY IN YEARS.

101 uses for this sturdy, handsome, black plastic cabinet. Can be used for TV boosters, remote control units, meters, etc.



A genuine bargain you can't afford to miss.

**2 For only \$3**

Postpaid anywhere in the United States

No C.O.D. Send check or money order.

**MANUEL KLEIN CO.**

94-N CHAMBERS ST. NEW YORK 7, N. Y.

**TUBES 50¢**

A REPEAT OFFER

5U4G 6AU6 6AL5 6BQ6  
ALL AMERICAN SERIES—\$2.50

12SA7 12SK7 12SQ7 35Z5 50L6

Our Flyer contains a terrific FREE BONUS—send for your copy today

THIS MONTH'S SPECIAL

Crow. 807—2 for \$2.50

**CROWN TELEVISION**

P. O. Box 194 Hicksville, N. Y.

**CODE SENDING SPEED**

**HIGH SPEED WITHOUT NERVOUS TENSION**  
REVEALING BOOK shows how "crack" operators develop high speed and proficiency. Learn code for Amateur or Commercial Radiotelegraph License, or improve your sending and receiving.

With the Candier System which develops radio-telegraph experts and code champions. **FREE**

Box 928, Dept. 2-J, Denver, Colo. **BOOK!**

**WALKIE TALKIES \$4.99 Set of 2**

**POCKET SIZE** —ELECTRONIC VOICE POWERED  
No tubes, batteries, adjustments, license or permit needed! Guaranteed to work anywhere up to 1/4 mile with extra wire. Swell for garage to house, etc. Your own private, talk-listen phone. Not war surplus. Brand new. Solid Aluminum Case. Two complete units with wire—READY TO USE! SEND ONLY \$1.00 deposit and pay postman \$3.99 C.O.D. or send \$4.99 for PP delivery. Sold only by mail from: MIDWAY CO., Dept. WRT-8, KEARNEY, NEBRASKA.

**RADIOS** 1, 2 & 3 band Electric and/or battery  
**TELEVISION** AC/DC Operation  
**TEST INSTRUMENTS**  
Write for FREE Catalog  
**ARKAY—Radio Kits, Inc.**  
120 Cedar St., New York 6, N. Y.

## The TV Picture Tube

(Continued from page 50)

current, and the proper type of ion trap for each tube. If it is desired to replace a tube with a similar type be sure that all values given in the "Data-Print" for both tubes are almost identical. A variation of 2 kv. in second anode voltage, 5 ma. in focusing current and  $\frac{1}{4}$  inch in length will not affect the tube's operation, but larger deviations will often require circuit modifications. When a metal shell tube is used be sure to obtain the correct plastic insulating frame and apron. Another frequent source of difficulty is the variation in high-voltage terminals used for the second anode. When the new tube requires a different type of terminal it is best to purchase the correct mating part rather than use a makeshift arrangement which will later produce arcing or corona.

Picture tube screens come clear, with a filter glass, or etched. The latter two type screens are designed to reduce glare. A third type of glare-reducing tube has recently been introduced. It has a cylindrical outer face to reduce reflections from incident light. A

few new tubes combine two or more of these features.

Practically all picture tubes use the same 6.3 volt, 0.6 amp. filament, which permits us to neglect this item in any changes of picture tubes.

On studying the tube chart on the "Data-Print" it appears that some of the more recent large-screen tubes are identical although different numbers are assigned them. In most cases the differences are in gun structure, external conductive coating, and other minor variations which do not affect the function of the tube. If a tube having an external coating is used, some means of grounding this coating must be provided and almost all TV sets have a ground spring, clip, or other contact for that purpose.

It would be impossible to mention all the details and different features of the host of TV tubes now in use, but the chart will answer all pertinent questions which arise in either replacement or conversion work. Just be sure to check every one of the columns for both the new and old tube and make a note of the differences. Then it can be determined whether these differences can be overcome and how, or if a different tube type offers some advantages.

-30-

## Industrial Electronics

(Continued from page 64)

on the negative alternations. In this manner, relay chattering is prevented even though an alternating voltage is used on the plate of the tube.

The potentiometer to which the grid is connected serves as a voltage divider across the power lines, and determines the voltage to which the condenser charges. Since a larger voltage will take longer to discharge, the potentiometer serves to control the duration of the timing interval.

### Sequence Timing

In many applications, resistance welding for instance, power is alternately applied and disconnected. The "power on" intervals may be of the same or different durations, and they may be uniformly or irregularly

spaced. Electronic timers control such complex sequences with precision and reliability. The sequence timer consists of two or more time delay circuits connected in cascade. Fig. 4 shows the diagram of a sequence timer made up of four circuits like that of Fig. 1. To start the timing sequence, switch 1 is opened. After an interval of time relay 1 is energized. This relay has normally-closed contacts which serve as the switch for the second timing circuit. In this manner, when relay 1 is energized it initiates the timing interval in the second circuit; when the second relay closes, it initiates the time delay in the third circuit, etc. The relay in the last circuit may be connected back to the first in order to repeat the same timing sequence over and over. Additional contacts on each relay serve to apply or disconnect the power of the associated equipment.

-30-

Fig. 4. The sequence timer consists of several time delay circuits connected in cascade. The contacts of each relay serve as the switch for following circuit.

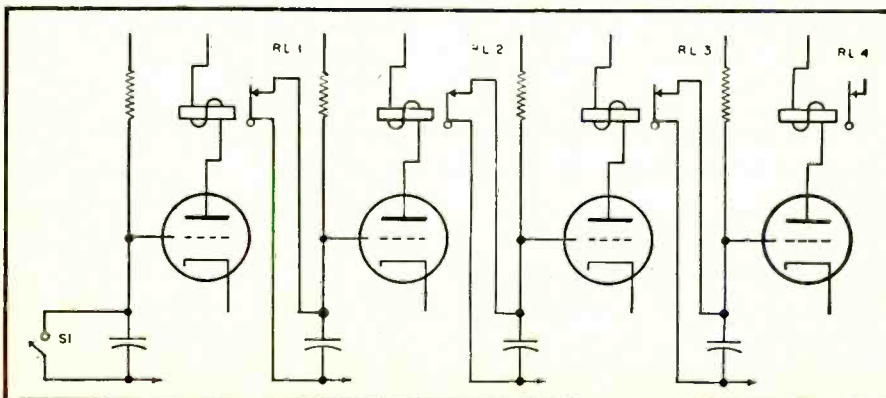

from now on . . .



nothing is beyond  
your control!

The controlling factor in the quality  
of your home music system . . .



The CRAFTSMEN<sup>®</sup> 300  
Equalizer-Preamplifier

Combines in one central panel complete tone compensation, phonograph equalization, and control of all audio channel switching.

- Completely self-contained power supply permits flexibility for use with any audio power amplifier.
- Continuously variable loudness control correctly compensated at different listening levels for loss of response to low and high audio frequencies.
- Preamplifier for all popular magnetic phono cartridges, compensated exactly for all types of recordings.
- Bass and treble tone controls, continuously variable from attenuation to boost — flat clearly marked.
- Two 4-position filters: for reduction of noise and record scratch . . . for reduction of turntable rumble and hum.
- Cathode follower output permits extremely remote installations without loss of response.
- The first preamplifier performance-matched to the Craftsman 500 Ultra-Fidelity audio amplifier.

HAVE YOU HEARD  
the C500? Williamson  
all-triode circuit. It's 95.99%  
distortion-free!



Write today for information

THE RADIO  
craftsmen INC.

Dept. R-8, 4401 N. Ravenswood Ave.  
Chicago 40, Ill.

# RADIO Surplus Buys



## 500 KC CRYSTALS

500 KC Crystals in FT 241-A holders with 1/2" pin spec.

ONLY LIMITED QUANTITY AVAILABLE

**\$1.95** ea.

## TUNER FROM NAVY "BN" EQUIPMENT

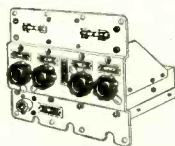

Simply modified into 2-meter converter for car or communications receiver. Uses 1-6J6, 1-6SH7, 1-9006, 1-6J5 (Not Furnished).

Slug is tuned from 157 to 187 Megacycles. Includes schematic diagram for "BN" equipment.

Now—A New LOW Price..... **\$4.95**

## SENSITIVE ALTIMETERS



Pioneer Sensitive Altimeters. Range 0-35,000 ft., calibrated in 100's of feet. Barometric setting adjustment. No hook-up required. . . . mounts easily in auto or aircraft. Used. Good. Each **\$12.95** Postpaid

## ALTIMETER, AIRCRAFT



U. S. Navy surplus Altimeters, range 0-10,000 feet. Adjusts to sea level setting of terrain. Simply installed. requires no hook-up . . . for auto or aircraft installation.

BRAND NEW. . . . Each **\$7.95** Postpaid

## CONTACT MIKE ASSEMBLY BRAND NEW!

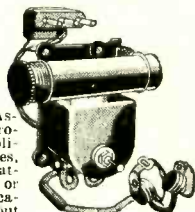

Complete Contact Mike Assembly includes: Two microphones, on-off switch, amplifying transformer, batteries, battery case. Connector to attach to any radio, AC, DC or battery portable. Amplification up to full volume output of radio or sound system used. Fit for watch or clock repair. Diesel engine injector adjustment, gas engine diagnosis, etc. Specially Priced at **\$3.95** Postpaid

ALL EQUIPMENT F.O.B. PASADENA UNLESS OTHERWISE SPECIFIED. PLEASE ENCLOSE FULL AMOUNT WITH ORDER

## C & H SALES CO.

BOX 356-AT East Pasadena Station, Pasadena 8, Calif.



## 3-YEAR WARRANTY

on  
SPEAKERS and  
TRANSFORMERS

Write for

Catalog

**Cinaudagraph**



**Speakers**

7334 North Clark Street

Chicago 26, Illinois



GET in on the fun of operating your own licensed transmitter. I guarantee you will memorize the International Morse Code alphabet within two hours by my simple picture method, or return method within five days and I will refund your money.

COMPLETE COURSE ONLY **\$1**  
NOTHING ELSE TO BUY!  
OTTO LUTHER, NEW PRESTON, CONN.

# INDEX OF

# Advertisers

AUG.  
1952

[While every precaution is taken to insure accuracy, we cannot guarantee against the possibility of an occasional change or omission in the preparation of this index.]

NAME	PAGE	NAME	PAGE
Acorn Electronics Corporation	92	Land-Air, Inc.	102
Airex Radio Corporation	105	La Pointe Placemold Corporation, The	6
Air-O-Tronics	123	Leotone Radio Corp.	141
Allied Radio Corporation	9	Luther, Otto	140
Aluminum Products Corporation	129	McConnell's	116
Alvaradio Supply Company	116	Metjee Radio Company	82, 83
American Phenolic Corporation	80	McGraw-Hill Book Company	100
American Television & Radio Co.	24	Mallory & Company, P. R. 29, Fourth Cover	
Amplifier Corporation of America	125	Mattison Television Company	136
Arkay-Radio Kits, Inc.	138	Merit Coil & Transformer Corporation	84
Arrow Electronics, Inc.	88	Midway Company	106
Arrow Sales, Inc.	103	Miles Reproducer Company, Inc.	130
Ashe Radio Company, Walter	97	Milwaukee School of Engineering	110
Astastic Corporation	26	Modern Science Labs.	106
Astron Corporation, The	96	Moody Machine Products Co., Inc.	85
Atlas Sound Corporation	100	Mosley Electronics	119
		Moss Electronic Distr. Co., Inc.	81
Barry Electronics Corp.	133	National Electronics of Cleveland	126
Bell Telephone Laboratories, Inc.	20	National Radio Institute	3
Bendix Radio	117	National Schools	11
Berlant Associates	122	Newark Electric Company, Inc.	131
Brook Electronics, Inc.	137	Newark Surplus Materials Co.	88
Brush Development Company, The	18	Newcomb Audio Products Company	16
		Offenbach & Reimus Company	118
C & H Sales Company	140	Olson Radio Warehouse	90, 91
Candee-Airco	123	Olympic Electronics Supply	124
Candler System Company	138		
Capitol Radio Engineering Institute	69	Park Electronics	128
Centralab, Inc.	22, 23	Peak Electronics	130
Channal Master Corporation	17	Photocon Sales	137
Chicago Transformer Company	109	Pickering and Company, Inc.	88
Cleveland Institute of Radio Electronics	77	Platt Electronics Corp.	114
Collins Audio Products	19	Precision Electronics Inc.	102
Columbia Electronic Sales	116	Premier Radio Tube Company	99
Commissioned Electronics Company	128	Progressive Electronics Company	105
Communications Equipment Company	111	Pyramid Electric Company	30
Consolidated Radio	140		
Coyne Electrical School	127	Quietrol Company	137
Crest Laboratories, Inc.	96		
Crown Television	138	RCA Institutes, Inc.	27, 106
		RW Electronics	121
Davis Electronics	112	Radeom Engineering Company	121
DeForest's Training, Inc.	5	Radio & Television News	95
Deleo Radio Parts	87	Radio Corporation of America	Second Cover, 107
Del Tronics	86	Radio Craftsmen, Inc.	139
Dow Radio, Inc.	112	Rad-Tel Tube Company	123
Dukane Corporation	135	Rauland Corporation, The	79
Dumont Electric Corporation	123	Raytheon Manufacturing Company	53
		Rider Publishers Inc., John F.	28
Eastern Telephone Company	138	Rytel Electronics Mfg. Co.	84
Editors & Engineers, Ltd.	135		
Eddie Electronics, Inc.	78	Sams & Company, Inc., Howard W.	92, 102
Electronics Institute	130	Sanett, Bob	130
Electronic Instrument Co., Inc. Third Cover		Simpson Electric Company	85
Engineering Associates	128	South River Metal Products Co., Inc.	141
Egipto	127	Sprague Products Company	89
Esege Sales	130	Sprayberry Academy of Radio	21
		Stan Burn Radio & Electronics	106
Fair Radio Sales	125	Star Electronic Distr., Inc.	122
Fisher Radio Corporation	122	Stevens-El Electronics Corporation	135
Franklin Technical Institute	132	Stevens-Walden, Inc.	116
		Sun Radio & Electronics Co., Inc.	132
G. L. Electronics	104, 106	Sun Radio of Washington D. C.	138
Garrard Sales Corporation	132	Supreme, Incorporated	108
General Electric Company	12, 13	Sylvania Electric Products Inc.	25
General Test Equipment	132		
Gonsel Company	10	TAB	142
Good Inc., Don	113	T.V. Installation Equipment Co.	96
Goodheart, R. E.	128	Television Communications Institute	115
Greenlee Tool Company	131	Television Materials Corporation	106
		Telrex, Inc.	119
Hallforsen Company	131	Terado Company, The	133
Hallcrafters Company, The	7	Transvision, Inc.	101, 134
Harvey Radio Company	120	Triad Transformer Mfg. Co.	128
Heath Company, The	70 thru 75, 133	Tri-State College	112
Henry Radio Stores	141	Tung-Sol Electric, Inc.	94
Hollywood Technical Institute	92		
Hytron Radio & Electronics Co.	15	Ungar Electric Tool Company, Inc.	111
		Union Electronics Company	132
Indiana Technical College	85		
Instructograph Company	100	Valparaiso Technical Institute	132
J.F.D. Manufacturing Company	8	Waldon Electronics, Inc.	127
J.S.H. Sales Company	125	Wells Sales, Inc.	76
Jensen Industries Inc.	128	Western Electronics Company	132
Jersey Specialty Company	113	Wholesale Radio Parts, Inc.	115
Jones & Laughlin Steel Corporation	93	World Radio Laboratories, Inc.	117
Klein Company, Manuel	138		
Krylon, Inc.	98		
Lafayette Radio Corporation	14		

**Class**  
Rate 50c per word. Minimum 10 words.

**RADIO ENGINEERING**  
COMPLETE radio, electronics theory & practice: television; broadcasting; servicing; aviation, marine, police radio, 12 or 18 months. Catalog. Valparaiso Technical Institute, Dept. N, Valparaiso, Ind.

**SALE**  
RECORDERS, leading makes; tape, wire, blanks, largest discounts. Commissioned Electronics, 2405 18th St., N.W., Washington, D. C.

HEARING aids, used. Zeniths, less accessories, \$7. One-piece Nationals, \$10. One-piece overhauled, with accessories, \$20.00. Shelby Instrument, 321 W. 7th St., Long Beach, Calif.

DIAGRAMS Radio, Record Changers, Recorders, 75c; Television with Service Data, \$1.25 up. State manufacturer and model number. Kramer's Radio Service, Dept. N8, 36 Columbus Ave., New York 23, N. Y.

TUBES and equipment bought, sold, and exchanged. For action and a fair deal, write B. N. Gensler, W2LNI, 136 Liberty, N. Y. 6, N. Y.

ENJOY television with a 3 color filter screen. Thirty seconds to attach. Reduces glare, blur, and snow. Send only \$1. Mention screen size. Zingo Products, Dept. B, Johnstown, N. Y.

FIVE element TV Yagi Beams. Aluminum Tubing, etc. Write for prices. Willard Radcliff, Fostoria, Ohio.

RIDERS Manuals 1 thru 15 in eleven volumes. Like new. Best offer. Ivan Beal, 3913 Oakland Ave., So. Minneapolis, Minn.

TELEVISION Towers direct from factory. Write Youngstown Steel Towers Co., Youngstown 8, Ohio.

SENSATIONAL bargains! Standard brand tubes, bought, sold. Free list. Mark, P.O. 14, New York City 72.

SURPLUS Electronic material, tubes. Ham gear. Free list. Albert Arnold, Box 706, Amarillo, Tex.

TV and FM Antennas. Yagi, Conical, Bow-Tie. Mounts, accessories. Lowest prices. Wholesale Supply Co., Dept. H. Lunenburg, Mass.

**WANTED**  
WANTED: AN/TRC-1 equipments, T14 transmitters, R19 receivers, TS32 test oscillators. Any condition or quantity. Box 525, Radio & Television News, 185 N. Wabash, Chicago 1, Ill.

AN/APR-4, other "APR-" "ARR-" "TS-" "IE-" ARC-1, ARC-3, ART-13, everything surplus; Tubes, Manuals, Laboratory equipment. Describe, price in first letter. Engineering Associates, 434 Patterson Rd., Dayton 9, Ohio.

**CORRESPONDENCE COURSE**  
USED Correspondence Courses and Books sold and rented. Money back guarantee. Catalog free. (Courses bought.) Lee Mountain, Pisgah, Ala.

LEARN Code, theory for amateur, commercial FCC exams. Free information. American Electronics, 1451 Wilkins, Dept. RN-8. N. Y. C. 59.

**MISCELLANEOUS**  
SPEAKERS repaired, wholesale prices, guaranteed workmanship. Amprite Speaker Service, 70 Vesey St., New York City 7.

**PHOTO CREDITS**

Page	Credit
31, 32 (Fig. 3), 33 (Fig. 5)	De Mornay Budd
33 (Fig. 6)	Sperry Gyroscope Co.
34 (Fig. 7)	National Bureau of Standards
35	Electro-Voice, Inc.
36 (Figs. 2, 3), 37 (Figs. 5, 6, 7, 8, 9)	General Electric Company
37 (Fig. 4), 46, 47, 50	Radio Corporation of America
38, 39	Radio Specialties Co.
65	Danish State Radio

# What Do You Want to Trade In on a New Hallicrafters?

I have a complete stock of Hallicrafters receivers and transmitters. We will give you the best doggone trade-in in the world because we need used receivers badly for our trade. What do you have? Write me about it. I give you prompt delivery, 90-day FREE service and the world's lowest credit terms. Write, wire, phone, or visit either store today for the best deal. Export orders solicited.

*Bob Henry*  
W9ARA



**Popular Double-IF Model SX-71**  
A double superheterodyne circuit receiver at modest cost. Built-in narrow band FM reception. Temperature compensated, voltage regulated. 5 position band selector for 538-1650 kc, 1600-4800 kc, 4.6-13.5 mc, 12.5-35 mc, 46-56 mc. 11 tubes plus voltage regulator and rectifier. Only \$199.50



**All-Wave Receiver Model SX-62**  
Covers 540 kc to 109 mc—including AM, FM, and SW broadcasts. Six bands: 540-1620 kc, 1620 kc-4.9mc, 4.9 mc-15 mc, 15-32 mc, 27-56 mc (AM-FM), 54-109 mc (AM-FM). Only \$289.50. Other popular Hallicrafters models: S-76, \$169.50; S-40B, \$99.95; S-72, \$109.95; S-72L, \$119.95; S-81, \$49.50; S-82, \$49.50.

**HENRY RADIO STORES** 11240 Olympic Blvd. LOS ANGELES 25 CALIF.

**WORLD'S LARGEST DISTRIBUTORS OF SHORT WAVE RECEIVERS**

**Leotone**

AN-130A WHIP ANTENNA . . . 34" . . . goose-neck . . . \$0.98  
19 FT. WHIP ANTENNA . . . steel screw sets . . . 2.98  
CRYSTAL HEADPHONES (Brush) . . . 50,000 . . . 4.95  
Imped. With adjust. band & tipped coils . . .  
INDIVIDUAL UNSEALED CARTRIDGE TUBES: 11 in. . .  
TEE Standard brands . . .  
41, 42, 6K7, 11A4, 11B6, or 11C . . . ea. \$0.39  
#46, 55, 77, 78, 85, 89, 11A, 5Y3, 5Y4, 6B7, . . .  
6B8, 6B9, 6C5, 6B9, 6SA7, 6SD7, 6SH7, . . .  
6BK7, 6BT, 6C5, 6U7 or 716 . . . ea. . . . .59  
#1A7, 1L6, 11L14, 2A5, 2A6, 6AG, 6AG, 6B8, . . .  
6SC7, 7A7, 7A7, 7C6, 7C7, 7Y4 or 9T . . . ea. . . . .79

BC-604 10 CHANNEL PUSH BUTTON TUNER  
ASSEMBLY, Brand new . . . . . \$5.95  
HS-30 HEADSET . . . ear-plug type . . . . . 2.49  
MATCHING TRANSFORMER for HS-30 . . . . . 59  
HS-30 REPLACEMENT PHONE UNITS . . . less  
case . . . . . 59  
20 FT. SPEAKER EXT. CORDS . . . tip-clip . . . . . 69  
PORTABLE METAL UTILITY BOX (8x6x6 3/4") . . .  
Snap-lock hinged lid, Web strap, 69c; 3/1.98  
6V. PILOT BULBS . . . min. screw 10/3pc; 100/3.49  
5" C.R. TUBE FRONT BEZEL . . . black crackle . . . . . 89  
5" SCOPE VISOR . . . leather; rubber overpiece . . . . . 98  
RADIO HARDWARE TREASURE . . . FULL LB.  
of Nuts, LugS, Washers, etc. . . . .  
hinged lid can . . . . . 89c; 3 lbs. 2.49  
32MFD-450V ELECTROLYTICS, can 2"x4" . . . . . 6/2.49  
ea. 49c

**A REAL BUY**

1/20 H.P. GE MOTOR . . . 1725  
RPM, 110V. DC, .7 Amp. 52.95  
3/8" shaft. 434" O.D. x 5 1/2"

CABINET DRAW SLIDES . . . silent, ball-bearing  
13" (9" ext.) \$2.10 pr.; 15" (11" ext.) . . . . .  
\$2.25; 16 1/2" (12 1/2" ext.) . . . . . 2.39  
Heavy duty, all-steel 16 1/2" (12 1/2" ext.) . . . . . 3.25

HOOK-UP WIRE SPECIAL! Solid, stranded,  
colors; ends stripped & tinned. 3" to 10"  
lengths . . . . . 3 lbs./1.98  
100W-50 of 75 OHM W.W. RESISTORS . . . . .  
ea. 59c; 4/1.98

MIDGET PLUG & JACK (Pl-29) (JK-18) 39c; 6/1.98  
CRYSTAL HAND MIKE . . . HI-FIDELITY . . . High  
impedance. Moulded bakelite case, 5 1/2 ft.  
cable . . . . . 3.95

DYNAMIC HEADSET & HAND MIKE (press-on  
talk) . . . . . 3.49

6V. AC-DC PLUNGER SOLENOID (1 1/2 x 1 1/2") 3/8"  
action . . . . . .89

EXPERIMENTAL TUBES . . . for Test. Research,  
etc. Fit. tested. 40 asstd. revir. types . . . . . 1.98

"ALNICO" MAGNETS . . . "U" type. 2"x  
1 1/2"x 3/8" . . . . . \$1.25  
FLAT BAR . . . 1 1/2"x 1 1/2"x 5/16" . . . ea. 79c; 6/4.25  
ROUND BAR . . . 2"x 3/8" O.D. . . . ea. 59c; 10/5.50  
BLOCK MAGNET 1/2" sq. x 3/8" . . . 25c; 12/2.50

ALNICO CHIP MAGNETS . . . small irreg.  
shapes. Approx. 90 pcs/oz. . . . . 1 lb. 1.50

ALNICO MAGNET KIT . . . Powerfil Bar,  
Block, "U" Rod, etc. Kit of 10 asstd. . . . . 1.98  
(WRITE FOR LATEST "ALNICO" SUPPLEMENT)

LOOK! SUPER-SAVING!! "JUMBO RADIO  
PARTS KIT" . . . 17 FULL LBS. of SWITCHES,  
SOCKETS, WIRE, CONDENSERS, RESISTORS,  
CONTROLS, COILS, HARDWARE, ETC., ETC. \$3.95  
"DIRECT FACTORY SPEAKER REPAIRS SINCE 1927"  
Min. Order \$3.00. 20% deposit req. on all C.O.D.'s.  
Full remittance with foreign orders. Please add suf-  
ficient postage—express refunded.

**LEOTONE RADIO CORP.**  
67 Dey Street  
New York 7, N. Y.

*South River*  
**NEWS**

**South River Replacement Banding Kits Now Available**

**KIT A:** (Consists of)  
2—12' 3/4" GALV. STEEL STRAPS  
with eyebolts attached  
2—Eyebolts Unattached  
4—Nuts to Fit Eyebolts  
2—KWIK KLIP Strapping Fasteners

**KIT B:**  
Similar to KIT A, except furnished with 1/2" width stainless steel banding and special plated hardware.

**KIT C:**  
Similar to KIT B, except furnished with 3/4" width stainless steel banding.

**NOTE: ALL SOUTH RIVER CHIMNEY MOUNTS ARE NOW AVAILABLE WITH STAINLESS STEEL STRAPPING.**

South River Antenna Mounting Accessories are carried by every leading TV Parts Jobber from coast to coast.  
New catalog mailed to all Dealers and Service Men.  
Write, if you haven't received yours!

**SOUTH RIVER METAL PRODUCTS CO., INC.**  
SOUTH RIVER, N. J.

PIONEER AND OUTSTANDING PRODUCER OF FINEST LINE OF ANTENNA MOUNTS

**TV PICTURE TUBES**

10-in. Rnd. \$14.95 17-in. Rect. \$24.85  
 12-in. Rnd. 17.95 19-in. Rnd. 28.50  
 14-in. Rect. 20.95 20-in. Rect. 29.95  
 16-in. Rnd. 24.95 21-in. Rect. 32.95  
 16-in. Rect. 23.85 24-in. Metal. 67.00  
 Your old pict tube is worth money. Write for trade-in allowance on RCA coded and dated tubes with one year guarantee. Ship your defective picture tubes prepaid only. When ordering metal tube, defective Metal Tube is Required.

**TUBE SPECIALS**

**WITH BROKEN KEYS**  
**ELECTRICALLY TESTED PERFECT**  
 1B3 .6HG, 6J6GT, 6V6GT, 6SN7GT, 12SN7GT, Ea. 50c; 5 for 2.00  
 6BG6G, 6H6G, 12SG7, 19HG6G, 6L6G, Ea. 79c; 3 for 2.00



**OIL CAPACITORS**

Mfd	Each	Mfd	Each
3K25	1.09	.03	3.49
1000wvdc	12.00	wvdc	
4.5	.79	.02	4.98
50wvdc	4.25	1500wvdc	
1	1.49	2500wvdc	
1-135	.98	5	1.49
250wvdc	1.75	75	1.49
2x.25	.35	1.79	
400wvdc	1.35	3.49	
1	1.49	95.00	
4.5	.49	3.49	
59	.05	.79	
161	1.49	2000wvdc	
2.29	2x.1	1.49	
6	2.49	1.89	
10	2.89	1.89	
2.5	1.39	3.69	
2x.5	.94	3.69	
3x.5	.99	2500wvdc	
600wvdc	1.25	.89	
.034	.52	1.75	
1.61	1.25	1.09	
2.5	1.61	1.09	
2x.5	.65	3.8	
7.5	.65	3.8	
1	1.49	1.29	
2.1	1.09	1.49	
3.4	1.09	8.98	
1.98	2.49	405vac	
5	2.49	1200vac	
10	3.29	15.15	1.29
2x.1	.80	600vac	
2x.25	.85	1800vac	
3x.25	.95	1.69	6.98
1.2	1.19	1.98	
2x.1	1.39	1.49	
2x.2	1.39	2.00vac	
2x.8	3.49	0.3	4.49
3x.05	.89	0.3	4.98
3x.05	.89	1.000wvdc	
2MFD/330VAC/1000VDC	3	for \$1.00; 12 for \$3.50	

**MODEL HF-1 OSCILLOSCOPE**  
 Laboratory Features, 5 MC Bandwidth, 10MV Sens, PP Horiz & Vert Amp, Cathode Coupled, Beam Shift, Cal Compensated Attenuators, Sync Pos or Neg Inhibit or Ext. Inj. Inj. Cathode Ray, for Tracing with Phones, Tech. Manual, 13 Tube, Line up, 3-104, 6-66, 6-10, 6-10, All Data Diagrams, 13 Tubes, Including 3BP1 C'Ray Tube.

**A "TAB" SPECIAL only \$99.50**  
**UHF ANTENNA**  
 UHF ANTENNA 12" /30CM ATTS /ARRI Usable Citizen & Home Bands, Coax. Term. Sil. Pl. Cont. Wpf Gask & H-wave Mobile Mtg. New 12" 39c; 4 for \$1.00  
**FL259 HiWave**  
 MICROWAVE ANT. AS125/APR. 1000 to 3400Mc W/UG55U Term Inbuilt HiPass Filter. Range 6-10 W/ware. Ea. \$1.98  
**ANT-AN130B, 3" Whip** Ea. \$1.69  
 MS49-52, 16 ft. \$1.69  
 MS49-53, 16 ft. \$2.49  
**BASES: MP22, \$3.98; MP47, MP48, 3.85**

**RHEOSTATS**

2 ohm 50W Ohmite	\$2.59
6 ohm 25W Ohmite	1.98
15 ohm 25W Ward L	1.98
15 ohm 75W Ohmite	3.74
20 ohm 50W Ohmite	2.35
60 ohm 50W Ward L	2.69
100 ohm 50W Ohmite	2.25
200 ohm 25W Model 1	1.98
250 ohm 25W Model 1	1.98
300 ohm 200W Model P	5.49
350, 500, 5000 ohm Watt 79c; 3 for 2.00	
1000 ohm Type J Ohmite	2.19
7500 ohm 50W Model J	2.59

**END EQUIPMENT BUYS**

TG5 Keyer, New \$5.98  
 RM29 Control Unit, BRAND NEW \$12.98  
 VPS/TP3 Good, As Is, Less Tubes. 29.98  
 I-81 Compass Indicator, Like New. 7.95  
 I-82 Compass Indicator, Like New. 4.95  
 PE97 Plate Supply Unit, Less Tubes. 9.98  
 I-108 Range Calibrator, Metal Case. 29.98  
 I-198 Sig. Gen. Good Cond. Less Tubes. 14.95  
 BC456 Mod. Less Tubes, Dyn. As Is. 1.98  
 SCR595 HF, Less Tubes, As Is. 3.98  
 BC605 Amp. Less Tubes, As Is. 3.98  
 BC606 Freq. Mtr., exc. cond. 29.95  
 F-1 "A" Sig. Gen. 115V/60 Cy. 125.00  
 EC221 Sig. Gen. Exc. Cond. 125.00  
 SCR522A Less/Txtls w/Tubes. 69.95

**STORAGE BATTERIES**

36 Volt Willard Mini-BRAND NEW! Portable Equip. Models. 98c; 4 for \$3.00  
 2V/20AH Willard Int. US. 2V. 5.00  
 6V/60AH Willard Int. US. 6V. 1.98  
 6V/40AH Willard Int. US. 6V. 6.98  
 Hydrometer 1.06 to 1.24 Sp. Grav. 1.98  
 Spec Grav Ind. & Merc. Thermom. 1.98

**PLATE TRANSFORMERS**

750VCT/650MA W/600V TAP 510.95  
 1100VCT/1212MA PRI. 115 or 230V Csd 6.50  
 1500W A.S. Vdbr. W/ 51G 3M5629/7500V/35MA 19.95  
 3000V/10MA Csd WE161913 HVins. 8.95  
 5500VCT/650MA USN Wtghs Csd 69.95

**866A KIT AND XFMR**  
 2 Tubes, Sects & Xfmr 115V 60cy Inpt. Output 2.5VCT 10AMP HV Insulation 115V \$6.98

**"TAB" THAT'S A BUY**

**POWER TRANSFORMERS**  
 2500V for Cr. 3.3V/2A 2.5V/1.75 cnd HVins. 6A BC412 replant \$7.98  
 1320V & 375VCT/10ma, 5V/3V 20 2.5V/3.25A, 6.3V/24 2.75A Hld HVins. \$9.98  
 1000VCT/200MA, 18V \$5.98  
 6.3V/3.5A, 5.3V/3.5A \$6.98

1000VCT 45MA, 795VCT/80MA, 300 vct/35ma, 35V/3A, 6.3VCT/1A, 6.3VCT/3A, 5.3V/3.5A 2x rating Raytheon Hypersol Core. 4.98  
 900V/35MA, 2x2.5V/2A, xelit 1800 3.49  
 840VCT/110MA, 530VCT/21ma, 2x5 V/3A 6.3VCT/1A, 6.3VCT/3A, 5.3V/3.5A 3.98  
 750VCT/200MA, 6.3V/5A, 5V/4amp, 720VCT/115MA, 2x6.3V/6A, 8.0V/2A, 6.3V/3.8A 5.95  
 700VCT/120MA, 2x6.3V/3A, 6.3V/1A 3.98  
 600VCT/100MA, Tapped 350vct, 6.3 V/3A, 2.5V/3A Isolation Wndg 115 3.25  
 550VCT/150MADC, 5V/3A, 6.3V/5A, 500VCT/60MA, 6.3V/4A Hld. 3.49  
 2.98

**FILAMENT TRANSFORMERS**  
 2X12V/2A or 24V/2A 2Kvins. \$3.89  
 6.3Vct/4A (gud 0.5A) H/SD HVins. 2.69  
 2.5V/2A, 79c 1.5Vct/12A 15Kvins. 10.98  
 24V/6a cnd \$4.98; 24V/1.25 cnd 1.98  
 2.5V/2A 10AMP, 6.3V/3A \$3.99; 2x12 V/2A or 24V/2A 2Kvins. 3.89

**SELENIUM POWER SUPPLY**  
 0-12 VDC/2amps. Un-cased Variable DC supply & completely built—115 VAC Inpt. Usable for Lab, D.C. Plating, batt charging model railroad. Includes voltage or speed control w/center tap reversing switch, 2.5A, 10A, 15A locomotives. Special \$10.95; 2 for \$20.00

**CONNECTORS AND CABLE**  
 UG9/U . \$1.90 UG2/U . \$1.25  
 UG12/U . 2.20 UG16/U . 3.40  
 UG21/U . 1.20 UG25/AU . 3.40  
 UG22/U . 1.60 CW123AU . .55  
 UG24/U . 1.00 1/8" Pig . 75  
 831R/O239 Receptacle, 50c; 10 for 3.99  
 8318N/P1250A Plug . 65c; 10 for 5.50  
 2.5V/2A 10AMP, 6.3V/3A \$3.99; 2x12 V/2A or 24V/2A 2Kvins. 3.89  
 CG30A W/JK26 & PL55, 5 Ft. 1.09  
 RG59 Cable, Per Ft. .08; 100 Ft. 7.00  
 300 Ohm Twine; Durable HV Web, 100 Ft. \$1.80; 1M Ft. 16.00

**"TAB" TESTED & GUARANTEED**

Write for Complete Listing. (Price Subject to Change)

OA2	1.98	6A87/1853	1.39	6F5	.89
OA2 VR75	1.2	6AC5GT	1.09	6F6	.89
OA4G	1.45	6AC6G	1.49	6G7	1.39
OB2	1.37	6AC7	.99	6SH7	.99
OC3/VR90	1.03	6AD6	.99	6J1	.99
OC3/VR105	1.19	6AD7G	1.49	6K7GT	.99
OD3/VR150	.98	6AF6G	1.33	6SL7GT	.89
1E1	1.03	6A5	.99	6T	2.25
1B4P	.89	6AG7	1.99	6SW7WGT	.25
1B5/255	.99	6AH5G	1.46	6SQ7GT	.79
1B7	1.49	6AG6	1.49	6J1	1.12
1B21 471A	2.85	6AJ5	1.40	6S5T	1.12
1B22	2.20	6AK5	1.99	6ST	1.31
1B23	2.20	6AK6	2.49	6SU7GT	3.37
1B24	17.49	6AK5	1.49	6V6	2.25
1B26	2.45	6AL5	1.69	6V6GT	.99
1B27	14.99	6AG7GT	1.06	6V6GT	1.79
1B32 532A	3.90	6AN5	1.40	6X5GT	.75
1B35	10.98	6AQ5	.99	6Y6G	1.27
1B37	1.99	6AG5W	1.06	12AT7GT	1.45
1B38	29.95	6AQ6	1.00	12AK5	1.98
1B40	4.95	6AQ7GT	1.29	12AK5W	2.98
1B41	1.49	6AQ6	1.06	12AT6	1.11
1B42	18.00	6AR6	2.98	12AT6	.99
1B46	1.98	6AS5	.79	12AT7	.93
1B47	1.49	6AS6	2.89	12AT7	.79
1B56	38.50	6AS7G	4.35	12AU7	.74
1B58	350.00	6AT6	1.82	12AV6	1.69
1B60	50.00	6AU6	1.69	12AW6	1.79
1B63A	75.00	6AV5GT	1.29	12AX4GT	1.20
1K25	1.39	6AS7	1.06	12BY7	1.79
K25/F	1.39	6AV6	1.89	12AY7	2.95
723A/B	39.00	6AX4 604	.79	12AZ7	.49
K28	29.95	6AS7	1.06	12B6	.79
K29	23.95	6B4G	1.59	12BA7	.79
K233	300.00	6B6A	1.79	12B6E	1.85
K248	118.00	6B7G	1.27	12BE6	.89
		6B5	.69	12BF6	.69
		6B7	1.23	12BH7	1.29
		6B8	1.39	6E7	1.45
		6B9	.89	12BZ7	1.05
		6C0	.79	FG1	3.05
		6C1	1.49	19T8	1.99
		6C2	1.69	19V8	1.69
		6C3	2.55	19V8	1.69
		6C4	1.69	25B6GT	1.19
		6C5	1.98	25L6GT	1.27
		6C6	.89	25Z6	.79
		6C7	.89	6Z7A	.89
		6C8	2.15	6Z7A	.89
		6C9	1.45	6V27	10.95
		6D0	1.49	6K26A	1.39
		6D1	1.69	28D7	1.39
		6D2	1.29	FG3Z	13.85
		6D3	1.15	558	.79
		6D4	2.15	35L6GT	.69
		6D5	1.69	35Z6GT	.69
		6D6	1.69	45Z6GT	.69
		6D7	2.49	45Z6GT	.69
		6D8	2.70	50L6GT	.69
		6D9	2.70	50L6GT	.69
		6E0	6.45	6F81A	.69
		6E1	7.65	80	.69
		6E2	.59	83	1.19
		6E3	.59	83	1.19
		6E4	1.09	82	1.45
		6E5	1.19	83	1.19
		6E6	1.19	83	1.19
		6E7	1.19	83	1.19
		6E8	1.19	83	1.19
		6E9	1.19	83	1.19
		6F0	1.19	83	1.19
		6F1	1.19	83	1.19
		6F2	1.19	83	1.19
		6F3	1.19	83	1.19
		6F4	1.19	83	1.19
		6F5	1.19	83	1.19
		6F6	1.19	83	1.19
		6F7	1.19	83	1.19
		6F8	1.19	83	1.19
		6F9	1.19	83	1.19
		6G0	1.19	83	1.19
		6G1	1.19	83	1.19
		6G2	1.19	83	1.19
		6G3	1.19	83	1.19
		6G4	1.19	83	1.19
		6G5	1.19	83	1.19
		6G6	1.19	83	1.19
		6G7	1.19	83	1.19
		6G8	1.19	83	1.19
		6G9	1.19	83	1.19
		6H0	1.19	83	1.19
		6H1	1.19	83	1.19
		6H2	1.19	83	1.19
		6H3	1.19	83	1.19
		6H4	1.19	83	1.19
		6H5	1.19	83	1.19
		6H6	1.19	83	1.19
		6H7	1.19	83	1.19
		6H8	1.19	83	1.19
		6H9	1.19	83	1.19
		6I0	1.19	83	1.19
		6I1	1.19	83	1.19
		6I2	1.19	83	1.19
		6I3	1.19	83	1.19
		6I4	1.19	83	1.19
		6I5	1.19	83	1.19
		6I6	1.19	83	1.19
		6I7	1.19	83	1.19



**EICO**  
TEST INSTRUMENTS

*guard*

*CBS-Columbia Inc.*  
HIGH STANDARDS OF  
TELEVISION PRODUCTION QUALITY

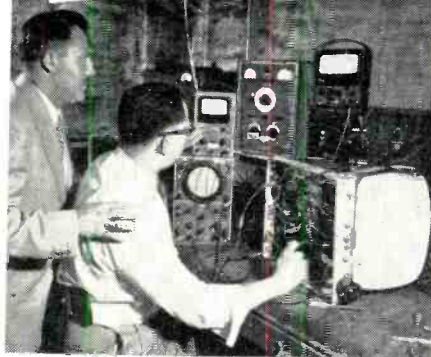

In the CBS-Columbia design laboratories, Al Goldberg takes some important readings with the EICO Model 221 Vacuum Tube Voltmeter and Model #52 Multimeter, as Harry R. Ashley locks on.



Mr. Al Goldberg, Assistant Chief Engineer of CBS-Columbia and Harry R. Ashley, President of EICO, inspecting the use of the EICO Model 221 Vacuum Tube Voltmeter and Model HVP-1 High Voltage Probe at the Sweep Frequency Troubleshooting Position on the CBS-Columbia Television production lines.



**NEW**  
221K VTVM KIT \$25.95  
WIRED \$49.95



HIGH VOLTAGE  
PROBE \$6.95

**KITS**  
WIRED INSTRUMENTS



**NEW** 565K MULTIMETER  
KIT \$24.95 WIRED \$29.95  
20,000 ohms/volt



320K SIG.  
GEN. KIT \$19.95. WIRED \$29.95

**NEW** 322K SIG. GEN.  
KIT \$23.95. WIRED \$34.95



**NEW** 377K Sine & Square Wave  
AUDIO GEN. KIT \$31.95 WIRED \$49.95



**NEW** 950K R-C BRIDGE &  
R-L COMP. KIT \$19.95  
WIRED \$29.95

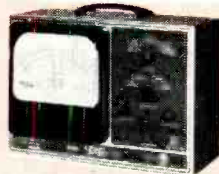

**NEW** 214K  
VTVM KIT \$34.95  
WIRED \$54.95  
7 1/2" METER

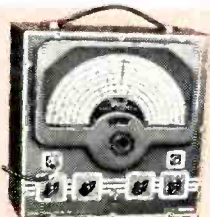

**NEW** 315K DELUXE SIG.  
GEN. KIT \$39.95  
WIRED \$59.95

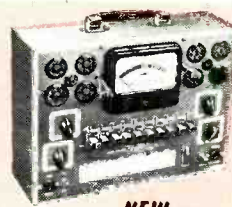

**NEW** 425K  
TUBE TESTER KIT \$34.95  
WIRED \$49.95  
**NEW** CRA CR ADAPTOR  
FOR ABOVE \$4.50

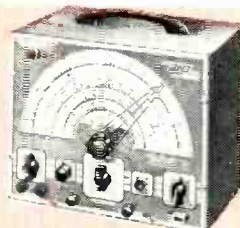

360K SWEEP GEN. KIT \$34.95  
WIRED \$49.95

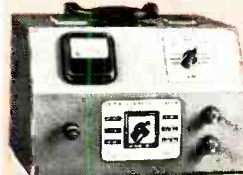

**NEW** 1040K BATTERY ELIM.  
KIT \$25.95. WIRED \$34.95



**NEW** 536K MULTI-  
METER KIT \$12.90  
WIRED \$14.90  
1000 ohms/volt

**NEW** 1171K RES.  
DECADE BOX KIT  
\$19.95  
WIRED \$24.95



145K SIG.  
TRACER KIT  
\$19.95  
WIRED  
\$28.95

For Laboratory Precision at Lowest Cost—  
the Leaders Look to **EICO!**

**WHY** does CBS-Columbia, Inc., today's headline-maker in Television set production, use EICO Test Instruments on its new Television production lines and in its design laboratories?

**BECAUSE** —like Emerson, Tele-King, Teletone, and many another famous TV manufacturer coast to coast, CBS-Columbia knows that ...

*Only EICO Test Equipment delivers*  
**All 10 EICO nomical Features!**

1. Laboratory Precision
2. Lowest Cost
3. Lifetime Dependability
4. Speedy Operation
5. Rugged Construction
6. Quality Components
7. Latest Engineering
8. Super-Simplified Assembly and Use Instructions
9. Laboratory-Styled Appearance
10. Exclusive EICO Make-Good Guarantee

Before You buy any higher-priced equipment, look at the EICO line—in *Wired and Kit form!* Each EICO product is jam-packed with unbelievable value. Compare, see *EICO instruments today*—in stock at your local jobber—and **SAVE!** Write **NOW** for FREE newest Catalog 8-R.

**FOLLOW THE LEADERS**  
... **INSIST ON EICO!**

**EICO** Reg. U. S. Pat. Off.

**ELECTRONIC INSTRUMENT CO., Inc.**  
84 WITHERS STREET, BROOKLYN 11, NEW YORK

©1951, Electronic Instrument Co., Inc. Prices 5% higher on West Coast. Due to unstable conditions, prices and specifications are subject to change without notice.

Boost your **VHF** set sales right now

with the Mallory **UHF** Converter

**NO MISTAKE** in that statement because the Mallory UHF Converter *can* help you sell more VHF sets right now.

**HERE'S WHY** that's true . . . Many non-TV owners as well as those who have old sets, are not putting cash on the line now because they fear they will miss out when UHF transmission comes along.

**HERE'S HOW** you can overcome this resistance to immediate sales. Buy a Mallory UHF Converter now . . . show it to your customers. Point out that they can safely buy any set now. Then, when UHF comes to town, they can be sure of combined UHF-VHF reception by buying the Mallory Converter. In the long run, that's a double sales opportunity for you!

**RING UP** immediate VHF sales by putting the Mallory UHF Converter to work for you in your store . . . in your advertising . . . in your promotion material.

### WHEN UHF COMES TO YOUR TOWN . . .

the Mallory UHF Converter offers you a great opportunity to increase sales and profits . . . and give your customers real satisfaction.

Here's what the Mallory UHF Converter offers . . . reception of all UHF channels . . . no sacrifice of VHF channels . . . built-in UHF antenna . . . high quality picture definition . . . fast, easy installation.

**SEE YOUR MALLORY DISTRIBUTOR TODAY**  
for complete details about the Mallory UHF Converter.

*Make Sure . . .  
Make it Mallory*



**P. R. MALLORY & CO., INC.**  
**MALLORY** CAPACITORS . . . CONTROLS . . . VIBRATORS . . .  
SWITCHES . . . RESISTORS . . . RECTIFIERS . . .  
VIBRAPACK® POWER SUPPLIES . . . FILTERS . . .  
\*Reg. U.S. Pat. Off.  
**APPROVED PRECISION PRODUCTS**  
**P. R. MALLORY & CO., Inc., INDIANAPOLIS 6, INDIANA**