

RADIO & TELEVISION NEWS

FEBRUARY
1952
35¢
In Canada 40¢

TEST SET FOR TV TUBES

*By spot checking production runs,
this engineering test unit insures
high quality CR tubes. (SEE PAGE 49)*

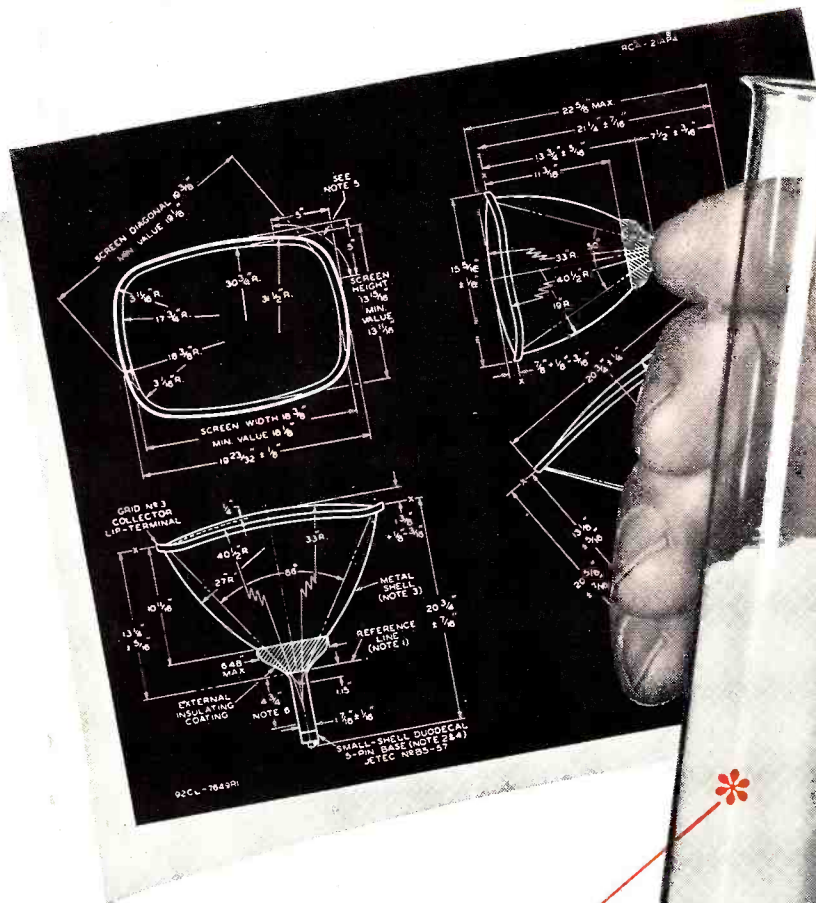

99⁹⁹/₁₀₀%

pure phosphor . . . yet we threw it away

PURE by most standards, this batch of phosphor was discarded because it contained more than our prescribed limits of 2 parts in one million of copper salts . . . sufficient, in our experience, to impair the performance of the fluorescent screen of a picture tube.

To avoid any such occurrence, every process in the manufacture of RCA picture tubes is closely guarded . . . from the control of raw materials to the final

evacuation and sealing operations.

By exercising rigid control over every step in production, RCA has achieved the exceptional quality for which RCA picture tubes are noted . . . a quality that is unmatched for reliability and uniformity.

In RCA picture tubes, the difference is TOP-QUALITY CONTROL. That's why —dollar for dollar—RCA picture tubes have no equal.

With RCA Receiving Tubes, as well as RCA kinescopes, TOP-QUALITY CONTROL makes the difference.



RADIO CORPORATION of AMERICA
ELECTRON TUBES
HARRISON, N. J.

NEW



I'LL TRAIN YOU FOR YOUR FCC LICENSE

A Federal Communications Commission Commercial Operator's License puts you in line for a good job in Radio or Television Broadcasting, Police, Marine, Aviation, Two-way, Mobile or Micro-wave Relay Radio. Mail coupon below for 64-page book FREE. It will give you complete facts about my NEW Communications course.



YOU BUILD THIS TRANSMITTER

with parts I send. With this Transmitter you practice how to put a station "on the air." You perform procedures demanded of Broadcast Station Operators, conduct many experiments, make many practical tests.

LEARN COMMUNICATIONS by PRACTICING at Home in Spare Time

I Send You Many Kits of Special Equipment

MY COURSE INCLUDES TELEVISION

Course Is New! Different!

Mail coupon now for facts about my NEW, intensely practical course in Radio-Television Communications. Let me send you FREE book. Read outlines of 78 lesson texts written by leaders in Communications and edited for you by my practical staff. See the nine big Kits of Parts I send that "bring to life" theory you learn. Read about the Transmitter you build and operate, about the Electronic Multitester you get. All equipment yours to keep. My NEW course covers Theory thoroughly and you get Practical Experience building units like those shown at the left. It's backed by N. R. I.—the world's oldest and largest home study Radio-Television school.

Mail Coupon For Book FREE

Send today! See what my NEW course is like. Find out how I get you ready for a brighter future, better earnings, more security in Radio-Television. Send coupon now in envelope or paste on a postal. **NO OBLIGATION. NO SALESMAN WILL CALL!** My book, sent to you FREE, tells the full story. J. E. SMITH, President, Dept. 2BE, National Radio Institute, Washington 9, D. C.



YOU BUILD this Transmitter Power Supply used in the basic experiments in RF and AF amplifiers, frequency multipliers, buffers, etc.

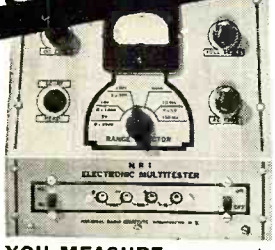

YOU MEASURE current, voltage (AC, DC and RF), resistance and impedance in circuits with Electronic Multitester you build. Shows how basic transmitter circuits behave; needed to maintain station operation.



YOU PRACTICE setting up code, amplitude and frequency modulation circuits (put voice, music, etc., on "carrier signals" you produce). You learn how to get best performance.

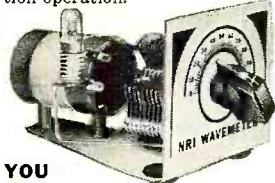

YOU BUILD this Wavemeter and use it to determine frequency of operation, make other tests on transmitter currents.

Ever think HOW FAST Radio-Television Communications is changing, developing, growing? Have you considered what this amazing progress can mean to you?

Look at these facts. In 1946 only 6,000 Television sets were sold. In 1950, over 5,000,000. By 1954, 25,000,000 Television sets will be in use, according to estimates. 100 Television Stations are operating in 35 states. Authorities predict there will be over 1,000 Television Stations. This rapid growth means new jobs, more jobs, good pay for qualified men all over the U. S. and Canada. Then add development of FM, Two-way Radio, Police, Marine, Aviation and Micro-wave Relay Radio! Think what all this means! New jobs, more jobs for beginners! Better jobs, better pay for experienced men!

Are you a beginner who wants steady work in this growing field? My NEW course can help you get an FCC License and prepare for the job you want. Are you a man with some training in Radio or Radar, or a Licensed Operator? My NEW course modernizes, increases the value of your knowledge and experience!

Servicing Training Also Offered by N. R. I.

If you prefer a good-pay job in Radio-Television Servicing or your own money-making Radio-Television Sales and Service Shop, I'll train you at home. My famous Servicing Course also includes many Kits of Radio Parts. You use them to get PRACTICAL EXPERIENCE with circuits common to Radio and Television. I also show you how to make \$5, \$10 a week or more EXTRA MONEY fixing neighbors' Radios while training. Full information in my 64-page book. Mail coupon.

EXTRA PAY IN ARMY, NAVY, AIR FORCE

Knowing Radio, TV, Electronics can help you get extra rank, extra prestige, more interesting duty at pay up to several times a private's base pay. You are also prepared for good Radio-TV jobs upon leaving service. Mail Coupon TODAY.

I TRAINED THESE MEN



"N.R.I. has been my stepping stone from a few hundred to over \$4,000 a year as a Radio Engineer."—ALTON B. MICHAELS, Trenton, Georgia.



"I am employed by WKBO as transmitter operator. Have more than doubled salary since starting in Radio full time!"—A. H. H. H. H., New Cumberland, Penna.



"Am Broadcast Engineer at WLP. Your NEW Communications course shows the kind of equipment we use."—J. BANGLEY, JR., Suffolk, Virginia.



"4 years ago, I was a book-keeper with hand-to-mouth salary. Am now Radio Engineer with ABC network."—N. H. WARD, Ridgefield Park, N. J.

MAIL NOW-BOOK FREE

MR. J. E. SMITH, President, Dept. 2BE National Radio Institute, Washington 9, D. C.

Mail me your 64-page Book about Radio and Television Communications opportunities and training. (No salesman will call. Please write plainly.)

Name.....Age.....

Address.....

City.....Zone.....State.....

Approved Under G. I. Bill

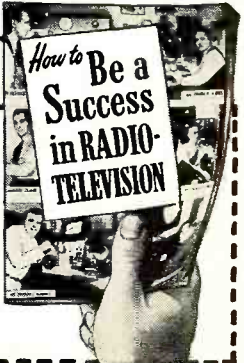

Editor
OLIVER READ, D.Sc., D.Litt.

Managing Editor
WM. A. STOCKLIN, B.S.

Technical Editor
H. S. RENNE, M.S.

Associate Editor
HAROLD BECKER

Midwest Editor
RAY FRANK, W9JU

Assistant Editor
P. B. HOEFER

Television Consultant
MILTON S. KIVER

Short-Wave Editor
KENNETH R. BOORD

Staff Artist
FRANK SAYLES

Chief Draftsman
B. L. NEWMAN, W9ROB

Advertising Manager
L. L. OSTEN

Midwest Adv. Manager
JOHN A. RONAN, JR.

Western Adv. Manager
JOHN E. PAYNE

Color Art Editor
HERMAN R. BOLLIN

RADIO & TELEVISION NEWS

Reg. U.S. Pat. Off.

Radio News Trademark Reg. U. S. Pat. Office • Television News Trademark Reg. U.S. Pat. Office.

First in
radio-television-electronics

Average Paid Circulation over 200,000

CONTENTS

FEBRUARY, 1952

A Professional Type Geiger Counter.....	Loren C. Watkins, Jr., W5JXO	35
A High-Quality Audio Amplifier.....	Edw. S. Miller	38
A Low Cost Exciter Unit.....	John F. Clemens, W9ERN	40
An "Extra" Superhet.....	Leon Wickfield	43
A Laboratory Quality Square-Wave Generator.....	Seymour Berkoff	46
Quality Control of TV Tubes.....	Bertrand W. Squier, Jr.	49
A High Gain Signal Tracer-Amplifier.....	Robert H. Deller, W8ALV	50
Evolution of the 630TS.....	Walter H. Buchsbaum	52
The Aluminum Foil Beam.....	Major Harry L. Ulyat, W3PTW	55
Stability Plus with the Franklin Oscillator	Merritt Kirchoff, W2FAR & David D. Bulkley, W2QUJ	56
D.C. Voltages in Television Receivers.....	John K. Frieborn	59
Crystal Diodes in Modern Electronics (Part 5).....	David T. Armstrong	62
A Sharply Tuned A.F. Amplifier.....	Rufus P. Turner, K6AI	65
Build This Mixer-Equalizer.....	Lloyd B. Hust	66
Mac's Radio Service Shop.....	John T. Frye	68
Audio Simplified (Part 6).....	David Fidelman	70
Horizontal and Vertical Suppression Circuits and Their Use.....	Dan Lerner	82
Tube Substitutions for TV Receivers.....	Meyer Chertock	98
Blinking Lights.....	Stanley Sienkiewicz	102
Radio-TV Service Industry News.....		106

DEPARTMENTS

For the Record.....	The Editor	8	What's New in Radio.....	88
Spot Radio News.....		20	Technical Books.....	92
Within the Industry.....		28	New TV Products.....	156
Short-Wave.....	K. R. Boord	69	Manufacturers' Literature.....	161



VOLUME 47 • NUMBER 2



Member
Audit Bureau of
Circulations

Editorial and Executive Offices, 366 Madison Ave., New York 17, N. Y.
RADIO & TELEVISION NEWS is published monthly by the Ziff-Davis Publishing Company at 185 N. Wabash Ave., Chicago 1, Illinois. Entered as second-class matter July 21, 1948, at the Post Office, Chicago, Ill., under the act of March 3, 1879. Entered as second-class matter at the Post Office Department, Ottawa, Canada. Postmaster—Please return undelivered copies under form 3589 to 64 E. Lake St., Chicago 1, Ill.
SUBSCRIPTION RATES: RADIO & TELEVISION NEWS—in U.S., Canada, Mexico, South and Central America, and U.S. Possessions, \$4.00 for twelve issues; in British Empire, \$5.00; all other foreign countries, \$5.00 for twelve issues. RADIO-ELECTRONICS ENGINEERING EDITION—in U.S., Canada, Mexico, South and Central America, and U.S. Possessions, \$6.00 for twelve issues; in British Empire, \$7.00; in all other foreign countries, \$7.00 for twelve issues. SUBSCRIPTION SERVICE: All communications concerning subscriptions should be addressed to Circulation Dept., 64 E. Lake St., Chicago 1, Ill. Subscribers should allow at least two weeks for change of address.
CONTRIBUTIONS: Contributors are advised to retain a copy of their manuscripts and illustrations. Contributions should be mailed to the New York Editorial Office and must be accompanied by return postage. Contributions will be handled with reasonable care, but this magazine assumes no responsibility for their safety. Any copy accepted is subject to whatever adaptations and revisions are necessary to meet the requirements of this publication. Payment covers all author's, contributor's, and contestant's rights, title, and interest in and to the material accepted and will be made at our current rates upon acceptance. All photos and drawings will be considered as part of the material purchased.

Copyright 1952 by Ziff-Davis Publishing Company. All rights reserved.

RADIO & TELEVISION NEWS

**NOW... GET EVERYTHING YOU
NEED TO LEARN AND MASTER**

TELEVISION

RADIO-ELECTRONICS AT HOME!

Use REAL commercial-type equip-
ment to get practical experience

Your future deserves and needs every advantage you can give it! That's why you owe it to yourself to find out about one of the most COMPLETE, practical and effective ways now available to prepare AT HOME for America's billion dollar opportunity field of TELEVISION-RADIO-ELECTRONICS. See how you may get and keep the same type of basic training equipment used in one of the nation's finest training laboratories... how you may get real STARTING HELP toward a good job or your own business in Television-Radio-Electronics. Mail the coupon today for complete facts — including 89 ways to earn money in this thrilling, newer field.

D.T.I., ALONE, INCLUDES BOTH MOVIES and HOME LABORATORY In addition to easy-to-read lessons, you get the use of HOME MOVIES — an outstanding training advantage — plus 16 big shipments of Electronic parts. Perform over 300 fascinating experiments for

Get BOTH of these
information packed
publications FREE!

practical experience. Build and keep real commercial-type test equipment shown at right

MODERN LABORATORIES

If you prefer, get all your preparation in our new Chicago Training Laboratories—one of the finest of its kind. Ample instructors, modern equipment. Write for details!

MILITARY SERVICE!

If you're subject to military service, the information we have for you should prove very helpful. Mail coupon today.

**89 WAYS
TO
EARN
MONEY
IN TELEVISION
RADIO ELECTRONICS**

**YOU GET
ALL 6**

ACT NOW! MAIL COUPON TODAY!

DE FOREST'S TRAINING, INC. Dept. RN-2-1
2533 N. Ashland Ave., Chicago 14, Ill.

Without obligation, I would like your Opportunity News Bulletin showing "89 Ways to Earn Money in Television-Radio-Electronics"; also, the folder showing how I may prepare to get started in this thrilling field.

Name.....Age.....
Address.....Apt.....
City.....Zone.....State.....



ABOVE: Build and keep a real 17 INCH commercial TV receiver. Optional after completing regular training at moderate added cost.

**Here's the
REAL THING!
SET UP YOUR OWN
HOME LABORATORY**

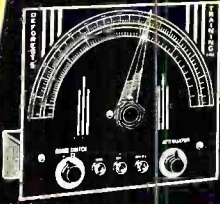

R-F Signal Generator



Oscilloscope



6-Tube
Radio
Home
Movies

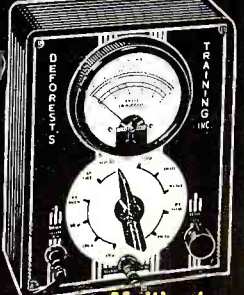

Multimeter

"ONE OF AMERICA'S FOREMOST
TELEVISION TRAINING CENTERS"

De FOREST'S TRAINING, INC.
CHICAGO 14, ILLINOIS
A De VRY INSTITUTION



ALL RANGES WITH THIS ONE CONTROL

Just *one* knob—extra large—easy to turn—flush with the panel, controls all ranges. This one knob saves your time—minimizes the chances of “burn-outs” because you don’t have to remember to set another control. You can work fast with Model 630 with your eyes as well as your hands. Look at that scale—wide open—easy to read, accurately. Yes, this is a *smooth TV* tester. Fast, safe, no projecting knobs, or jacks, or meter case. Get your hand on that single control and you’ll see why thousands of “Model 630’s” are already in use in almost every kind of electrical testing



**Model
630**

ONLY \$39.50 AT YOUR DISTRIBUTOR
Prices Subject to Change

FOR THE MAN WHO TAKES PRIDE IN HIS WORK

Triplet

TRIPLETT ELECTRICAL INSTRUMENT COMPANY - BLUFFTON, OHIO, U.S.A.

RADIO & TELEVISION NEWS

Life-like window displays and counter cards!



Bright exciting streamers!



Personalized postal cards. Giant mailers! Radio announcements and reminder stickers!



STOP! DON'T PASS THIS PAGE

...until you've read about SYLVANIA'S power-packed Service-Dealer Campaign

Talk about an exciting, sales-building Radio-TV Service Dealer campaign! Mister, this is it!

Featuring personal endorsements of some of the most glamorous and newsworthy people in the entire country, this campaign ties you in with big-space ads in *Life*, *The Saturday Evening Post*, *Collier's* and *Better Homes and Gardens*.

Just see what you get: . . . brilliant life-like cut-outs of the celebrated stars . . . counter cards, streamers, appealing mailers . . . also radio spot announcements, and reminder stickers. You pay only two cents per prospect per month for the mailers. The rest is FREE. Don't delay! Call your Sylvania distributor or mail coupon N-O-W!

SEND COUPON NOW FOR DETAILS ON THIS BIG CAMPAIGN



Sylvania Electric Products Inc. Dept. R-2302, Emporium, Pa.

I'd like full details about Sylvania's big 1952 Campaign for Service Dealers.

Name _____

Street _____

City _____ Zone _____ State _____

SYLVANIA

RADIO TUBES; TELEVISION PICTURE TUBES; ELECTRONIC PRODUCTS; ELECTRONIC TEST EQUIPMENT; FLUORESCENT TUBES, FIXTURES, SIGN TUBING, WIRING DEVICES; LIGHT BULBS; PHOTOLAMPS; TELEVISION SETS

NO SHADOWS

with new
DUAL SPOTLIGHT
Soldering Gun

Pull the trigger of your new light-duty Weller Soldering Gun, and instantly twin spotlights focus on the job—banish every shadow. Five seconds later the tip is at soldering heat! No waiting. No wasted current. This streamlined 135-watter—newest of the famous Weller line—is fast! Built compactly for working in crowded chassis, too. And the time and power you save pays for your Weller Gun in a few months.

New
135-Watt
Weller
Soldering
Gun

Specially Designed
for TV and Radio Work

- **DUAL SOLDERLITE**—Two prefocused spotlights completely eliminate shadows.
- **OVER/UNDER DESIGN**—Tube construction braces tip and improves visibility.
- **5-SECOND HEATING**—Pull the trigger and you solder!
- **LONGER REACH**—Slides easily into deep chassis; reaches the tightest corners.
- **GREATER CAPACITY**—Smaller, lighter, with greater soldering capacity.
- **TRIGGER-SWITCH CONTROL**—Adjusts heat to the job. No need to unplug gun between jobs.
- **DUAL HEAT**—Single heat 100 watts; dual heat 100/135 watts; 120 volts; 60 cycles. Handles all light-duty soldering.

See new Models WS-100 and WD-135 at your distributor, or write for bulletin direct.

• **SOLDERING GUIDE**—Get your new copy of "Soldering Tips"—revised, up-to-date, fully illustrated 20-page booklet of practical soldering suggestions. Price 10¢ at your distributor, or order direct.

WELLER
ELECTRIC CORP.

810 Packer Street, Easton, Pa.

For the **RECORD.**

BY THE EDITOR

CONFUSED TV PUBLIC

THE television set owner continues to damn the TV industry for not fulfilling its claims of flawless performance. Newspaper ads, in particular, tend to oversell television. Glowing claims (24 hour service, etc.) have clinched many a sale to a gullible public which has been led to believe that the manufacturer and the dealer would rush a service technician to his home, day or night, at the customer's convenience.

The public has its most intimate contact with the technician—not the dealer, distributor, or manufacturer. The technician, accordingly, is the "fall guy" in the great majority of customer complaints. For example:

The evening meal is finished and Joe Doaks, proud new owner of a 17" TV console, hastens to his easy chair to watch the evening's programs. After the usual warmup period he hears his local station announcing a new booklet for only one dollar that shows the set owner exactly how to fix any television set, no matter what, right in his home, but—alas—no picture. Cursing the service technician who installed his set, he rushes for the telephone to call the dealer who sold him "the thing." No answer! Why, it's only eight o'clock and the salesman had promised service on his set any time it was required. Another call—no answer! Joe, his temper playing hard on his nerves, remembers the name of the technician and quickly checks the phone directory.

"Hello—is this Pete? This is Mr. Doaks on Lovers' Lane. My new television set's on the fritz. Can you come right over? I called your store but no one answered. You can't come tonight? Whaddaya mean you can't come tonight—your salesman said you would come anytime I needed service and I want this thing fixed now or you'll be out of a job tomorrow."

Slamming the receiver in its cradle, Joe storms into the living room and grabs one of the monthly science magazines from beneath Junior's funny paper. Joe remembers an article on fixing his television set—right in his own living room. He finds it on page 94 and scurries through to the part that tells what to do when no picture appears.

At this moment the doorbell rings. It's none other than Pete with his service kit and instruments. He makes excuses on behalf of the dealer and the salesman and proceeds with the job at hand. Joe watches the procedure, magazine in hand, to see if Pete tries to pull a fast one on him.

Out comes the v.t.v.m. and its high voltage probe. "This is ridiculous," mutters Mr. Doaks to himself. "This character is putting on an act to impress me that it's a complicated problem when it's just a simple matter of reaching in for that plastic wire and making it spark by touching the gizmo on the cup to the chassis."

After replacing the rectifier, Pete completes the job of readjusting all of the controls that Junior had been playing with after school and starts for the door. Joe, still doing a burn, points to the magazine article and sarcastically states, "It's about time you guys who sell television sets to the public are forced to stop charging we poor suckers for service when we buy a set. Who do you think you're fooling? Even the stations themselves advertise booklets on TV home servicing, so there can't be anything complicated about it. How come I'm forced to pay for something I can do myself? Crooks like you should be licensed to protect me against this racket."

The purpose of the above incident is to show how the public can be misled and confused. It's the old story of the three blind men and the elephant.

Service operators cannot afford to overlook the dangers inherent in this problem. As individuals they should make their sentiments known to their local newspapers and telecasters.

One large metropolis we know was faced with the singular problem of a local telecaster carrying an advertising message from the publisher of a book on "How to Fix Your Own Television Set." This town had a local contractor's association and their collective disapproval was immediately voiced to the station's manager. When he was made cognizant of the over-all effect, he pulled the ad off the air. The telecaster was made to realize that his sales story was dependent upon sets in use, and the local service operator was his best assurance of their optimum operation. After recognizing the complexities involved in TV servicing, the station manager pictured himself as the average non-technical consumer and came to the conclusion that the home service story was invalid.

The public has been placed in an unenviable position where it hears conflicting stories from different portions of the industry. There is apparently a need for a coordinated approach to the consumer by all facets of the television industry. The public expects, and is entitled to, an educational program designed to provide them with facts—not fancy.....O.R.

RADIO & TELEVISION NEWS

always
in stock at
ALLIED

TRIPOLET
test instruments

exceptional
quality and value

Choose reliable equipment for your service or lab bench—and save! Order Triplet test instruments from ALLIED—for top value and continuously dependable service.

OUTSTANDING VALUES IN DEPENDABLE VOLT-OHM-MILLIAMMETERS



Model 630: 33 Ranges
For high accuracy testing of TV and other high-resistance circuits. Completely enclosed single selector switch; 5 1/2" meter with 4 3/8" scale. Uses 1% resistors, each sealed separately in bakelite. "Unit-constructed" provides direct connections without cabling.

Ranges: DC and AC volts, 0-3-12-60-300-1200-6000; DC at 20,000 ohms/v; AC at 5000 ohms/v; DC current 0-60 microamps, 0-1-2-12-120 ma. and 0-12 amps; res. 0-1000-10,000 ohms and 0-1-100 meg; db. -30 to +70 in 6 ranges; output v. 0-5-12-60-300-1200-6000. 20-position switch selects both circuit and range. Black molded case, 3 1/2" x 5 1/2" x 7 1/2". With batteries, 50" leads. Shpg. wt., 4 1/2 lbs. **84-568. Only \$38.71**

Model 630-A. As above but uses 1/2% resistors for greater accuracy. With mirror scale. **84-574. Only \$48.51**

New Model 650

A compact, highly sensitive instrument with single selector switch for all ranges. Complete frequency coverage from 20 cps to over 140 mc with one probe. Ranges: DC v., 0-1-5-10-50-100-500; 1000; AC-RF v., 0-1-5-10-50-100-500; peak-to-peak v., 0-2.8-14-28-140-280-700; ohms, 0-1000-10,000-100,000-1 meg.-100 meg.-1000 meg. Has large 5 1/2" meter with 4 3/8" scale; separate 1 ACV and 5 ACV scales for greater accuracy; high input impedance 11 meg. on DC for accurate measurements without loading circuit under test. In molded case, 3 1/2" x 5 1/2" x 7 1/2"; complete with power cord, DC v. and ohms lead, AC-RF volt tube probe, battery. Shpg. wt., 6 lbs. **84-558. Only \$68.11**
84-563. UHF Probe flat from 20 kc—980 mc, using 9005 diode. **Only \$16.17**
84-564. HV Probe. **Only \$14.21**

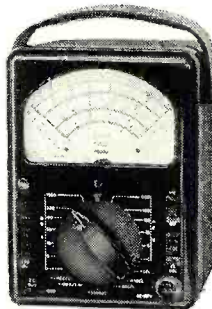

Popular Model 666R

An economical, dependable pocket-size VOM featuring a single range-selector switch. Only 2 controls—the range switch and the ohms adjust control. 1000 ohms-per-volt sensitivity on AC and DC volt ranges. Red Dot 3" 0-200 microammeter movement with 250 millivolt sensitivity. Ranges: DC and AC volts, 0-10-50-250-1000-5000; DC ma, 0-10-100; DC amps, 0-1; ohms, 0-3000-300,000; meg., 0-3. Provision for connecting external resistors to extend current ranges. Parts housed in base integral with selector switch. Black molded insulated case and panel. Size: 3 1/2" x 5 1/2" x 2 1/4". Supplied complete with batteries, 50" test leads with banana plugs and alligator clips. Shpg. wt., 3 lbs. **84-557. Only \$25.97**
Model 666 RL. Same as above, but in camera-type black leather case. May be used without removal from case. Shpg. wt., 4 lbs. **84-538. Only \$31.85**

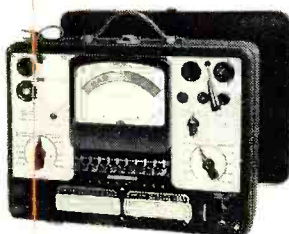

Model 3413A Tube Tester

Tops for flexibility and simplicity. Has slide-lever switches numbered to correspond with RTMA tube pin numbers, and connected to bring out each active tube element. Simple up or down motion of the lever instantly makes connection. Tests all modern tubes (including the new 9-pin noval type), pilot lamps, ballast tubes, resistors, etc. Oversize 6" Red Dot lifetime guaranteed meter gives quick, accurate BAD—?—GOOD tests. Checks emission, shorted and open elements. Built-in Speed-Roll chart. Counter-portable case. 15 1/2" x 11 1/2" x 6 1/8". For 110-120 v., 50-60 cycles. Shpg. wt., 28 lbs. **84-591. Only \$77.91**

TYPE BV ADAPTOR. Checks TV picture tubes with 3413A. Shpg. wt., 1 lb. **84-539. Only \$7.74**

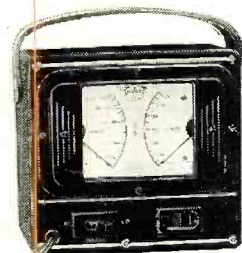

Model 660 Load-Chek

Wattmeter-voltmeter invaluable for service work. Tests by power consumption measurement. Quickly detects overloads caused by shorts. Also indicates whether replacement resistors have sufficient power handling capacity. Shows total power being drawn from line by unit under test. Just plug the chassis into the Load-Chek.

If equipment draws excess power, you can check chassis with soldering iron and pliers. Not necessary to lay down tools or to check with test leads. Ranges: 0-500-1000 AC-DC watts; 0-130 AC-DC volts. Housed in black molded case. 6 x 5 1/2 x 2 1/4". Shpg. wt., 3 lbs. **84-537. Only \$28.91**

Model 3441 TV-FM Oscilloscope

Features push-pull vertical and horizontal amplifiers. Vertical response usable beyond 4 mc. Horizontal, 20 cps to 150 kc; deflection sensitivity, .1 rms v./inch. Vertical input impedance, 2 megs, 20 mmf (with probe). Reads peak-to-peak volts, 0-1000 in 8 ranges. Linear sweep: 10 cps to 60 kc/second. Phased 60 cycle horizontal sweep and return trace eliminator for use with sweep generators. Synchronizing and horizontal sweep selector combined in one simple control. Has phone jack for hearing wave-form under observation; simplifies audio circuit tracing. Uses 5" cathode-ray tube (5UP1). Fully shielded and fused. Complete with tubes, 2 coaxial cables, rubber-covered test leads, low capacity probe and instructions. Size: 15 1/2" x 16 x 11 1/2". For 105-125 volts, 50-60 cycles AC. Shpg. wt., 65 lbs. **84-530. Only \$195.51**

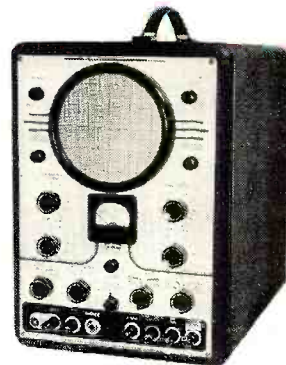

ALL TRIPLET TEST EQUIPMENT IS AVAILABLE FROM ALLIED

We can supply promptly any test instrument made by Triplet, including the following models:

- 84-575.** Model 625-NA Volt-Ohm-Milliammeter. Only..... \$ 48.51
- 84-555.** Model 666-HH Volt-Ohm-Milliammeter. Only..... 24.01
- 84-592.** Model 3432 Signal Generator. Only..... 77.91
- 84-534.** Model 3434A Sweep Generator. Only..... 195.51
- 84-532.** Model 3435 Sweep Generator. Only..... 112.21
- 84-533.** Model 1235 Marker Generator. Only..... 28.91

All Triplet instruments over \$45 available on Easy Terms—ask for details.

FREE 212-PAGE 1952 BUYING GUIDE

Send today for ALLIED's authoritative, complete catalog, listing the world's largest stocks of tubes, parts, test instruments, audio equipment, industrial components—everything in electronics at lowest prices. Look to ALLIED for speedy delivery, expert personal help and complete satisfaction. Get your FREE catalog now.



ALLIED RADIO

ALLIED RADIO CORP., Dept. 1-B-2
833 W. Jackson Blvd., Chicago 7, Ill.

- Send FREE 1952 Allied Catalog.
- Please ship the following Triplet instruments.....

.....\$.....enclosed

Name.....

Address.....

City.....Zone.....State.....

Rauland - the Original

LOW FOCUS VOLTAGE ELECTROSTATIC TUBE

**Perfected in Rauland Electronics Laboratories,
this tube that gives edge-to-edge sharpness of focus
without coils and magnets is proved and ready
as the materials pinch becomes painful**

BETTER in all ways! Gives better over-all focus—hair-line sharpness from edge-to-edge—with NO critical materials for focusing . . . and **STAYS SHARP** under considerable variation in line voltages.

REQUIRES NO re-engineering of present television chassis . . . NO added high voltage focus circuit . . . NO added receiver tubes . . . NO additional components except an inexpensive potentiometer or resistor.

FOCUSES by using D.C. voltage already available in the receiver.

ELIMINATES focusing coils and magnets . . . saves critically scarce copper and cobalt.

• • •

This new Rauland development is now available in substantial quantities in 17 and 20 inch rectangular tubes. For further information, address . . .

THE RAULAND CORPORATION



Perfection Through Research

4245 N. KNOX AVENUE • CHICAGO 41, ILLINOIS



TRAIN

for Security! Good-Paying Jobs! MAKE THE MONEY YOU'VE ALWAYS DREAMED OF!



LEARN RADIO -TELEVISION AND ELECTRONICS BY EASY SHOP METHOD TRAINING AT HOME!

You get all the parts—even tubes!—
for this modern Superheterodyne Receiver. You learn to build it step by step. And you keep it! Get all the facts. Mail coupon now.

Let **NATIONAL SCHOOLS**—a resident-training school for nearly 50 years—train you at home for today's unlimited opportunities in Radio-Television-Electronics. National Schools is one of the largest schools of its kind. It is located in Los Angeles—the center of Radio and TV world! It has four large buildings of modern shops and labs. Its faculty is considered tops in the business.



You learn from lessons prepared by experienced instructors and engineers. Men who are successful Radio and Television technicians. Men who have trained 1000's of men like YOU!

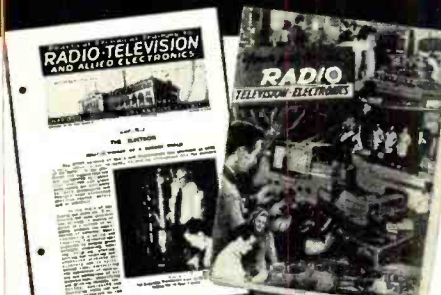

FREE BOOK TELLS YOU HOW!

Page after page—in color—tells you everything you want to know. Mail the coupon. Get this valuable book today. And if you hurry—YOU GET A FREE SAMPLE LESSON, TOO! Shows how easy National Schools Home Training is. Mail the coupon today.

You Train At Home—In Your Spare Time

National Schools Shop Method Home Training gives you basic and advanced instruction in all phases of Radio-TV-Electronics. And remember—your training is based on resident school training principles. You learn fast from hundreds of diagrams and pictures. All instructions are written by experienced technicians who work in Radio and TV every day. All instructions have been developed and tested in National Schools' own labs and studios, which are equipped with the latest RCA equipment. No wonder this National Schools course is so up-to-date, practical, interesting. And so easy to learn! And no wonder it is held in such high regard by leaders of American industry! Approved for eligible Veterans.

We Teach You How To Make Welcome Extra Money—While You Learn!

Many National Schools students—men like you—make plenty of extra dollars each week in spare time! Fixing neighbors' radios, appliances—and other ways we teach you. You start learning and earning from the day you enroll. From the very first lesson!

WE SEND YOU LOTS OF PARTS LIKE THIS!

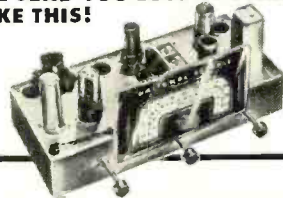

With National Schools Shop Method Home Training, you get basic principles and plenty of practical training. You learn by doing. No wonder you learn so fast! We send you many parts—all of professional, modern quality. You do lots of practical experiments. You advance day by day, step by step. Until you can even build the modern Superheterodyne Receiver you see above—plus other important testing units. The free book tells you all about it. The free sample lesson shows how easy the training is. Use the coupon. Send today — without fail!



Only National Schools Gives You This Professional Multi-Tester!

You get this amazing, new testing instrument—factory-made and tested—complete—ready to use! Simple to operate. Accurate and dependable. An instrument every Radio-TV man needs. Light enough to carry around—so you can use it at home or on service calls. You'll be proud to own this valuable equipment.

Here are only a Few of the Good-Paying Jobs You Can Choose

Radio Station Engineer, District Service Manager, Aircraft Radio Inspector, Own Your Own Repair Shop, Inspector Technician, Service Specialist, Special Government Jobs, Complete TV Service, Sound Truck Operator. Many more! National Schools graduates have secure, good-paying jobs like these! So don't wait—mail the coupon today. Now—while you're thinking about it!

Attention! Men Going into Service Soon!

National Schools' course quickly prepares you for many important jobs in the Armed Services. With National Schools Training you have an opportunity to get into special service classifications—with higher pay and grade—immediately!

FREE SERVICE FOR GRADUATES

National Schools uses its great influence and prestige to help you find your place in the field of your choice. Don't put it off! Start yourself toward a skilled trade! Get the big pay you've always wanted!

Today's Shortage of Trained Technicians Creates Chance of a Lifetime For You!

Think of it! With guided missiles, radar, and other electronic devices so important to national defense! With big, new developments in TV. With over 90,000,000 home and auto radios, over 12,000,000 TV sets. With more than 3100 radio stations...over 100 TV stations—and more building every day...yes, imagine the great opportunity you have today! YOU are wanted in Radio-Television-Electronics! America's fastest-growing field. High-pay jobs—the kind you've always wanted—are waiting for YOU!

Job Security! Big Money! For YOU! in Today's Expanding Industries!

Trained Radio and Television technicians really make important money these days. Thousands of National Schools graduates—men just like you—are earning good money all over the country. Why not you? And—National Schools graduates get the personal satisfaction of being highly-skilled technicians. Men people respect. Men who enjoy their work—rather than having to drag along in just any old job.

National Schools Has Trained 1000's of Successful Men! Why Not YOU?

In almost every state—and many foreign countries—National Schools graduates are filling big jobs with famous companies. Or running their own successful businesses. What are YOU waiting for? National Schools training is complete training. So when you graduate you can take advantage of today's big opportunities in Radio-Television-Electronics—fast.

**DON'T PUT IT OFF!
GET THE BIG SALARY YOU HAVE ALWAYS WANTED!**

NATIONAL SCHOOLS LOS ANGELES 37, CALIFORNIA • ESTABLISHED 1905

MAIL THIS COUPON TODAY—WITHOUT FAIL!

NATIONAL SCHOOLS, Dept. HR-22
4000 South Figueroa Street
Los Angeles 37, California

Mail in envelope or paste on penny post card.

Mail me FREE the book mentioned in this ad. Also a free sample lesson. I understand no salesman will call on me.

NAME _____ AGE _____

ADDRESS _____

CITY _____ ZONE _____ STATE _____

Check here if you were released from the Service less than 4 years ago.



DUMMY LOAD
DA 22/U



WAVE METER
Model WM-660
6 to 60cm range



COAXIAL SWITCH
Single-pole, four-throw



POLAR RECORDER
Model PRS-1A



STREAMLINED
AIRCRAFT ANTENNA

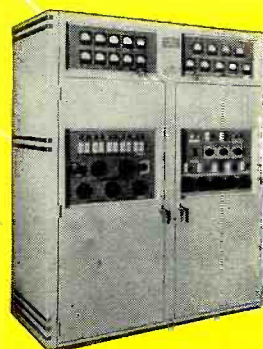

RADAR CROSS-SECTION
MEASURING EQUIPMENT

NOW Thompson Products Expands Its Electronic Facilities

We are pleased to announce the affiliation of the Antenna Research Laboratory, Inc. of Columbus, Ohio with the Electronics Division of Thompson Products, Inc. The Antenna Research Laboratory is now a wholly-owned subsidiary of Thompson Products. This company has had extensive experience in the design and development of antennas, electronic instrumentation, and microwave components for both

military and commercial requirements.

This affiliation makes available to the industry research and development facilities and production capacity for antennas, dummy loads, polar recorders, coaxial switches and allied electronic equipment.

Address inquiries concerning your requirements to Thompson Products, Inc., Electronics Division, 2196 Clarkwood Rd., Cleveland 3, Ohio.

Thompson Products, Inc.

ELECTRONICS DIVISION • 2196 CLARKWOOD RD. • CLEVELAND 3, OHIO

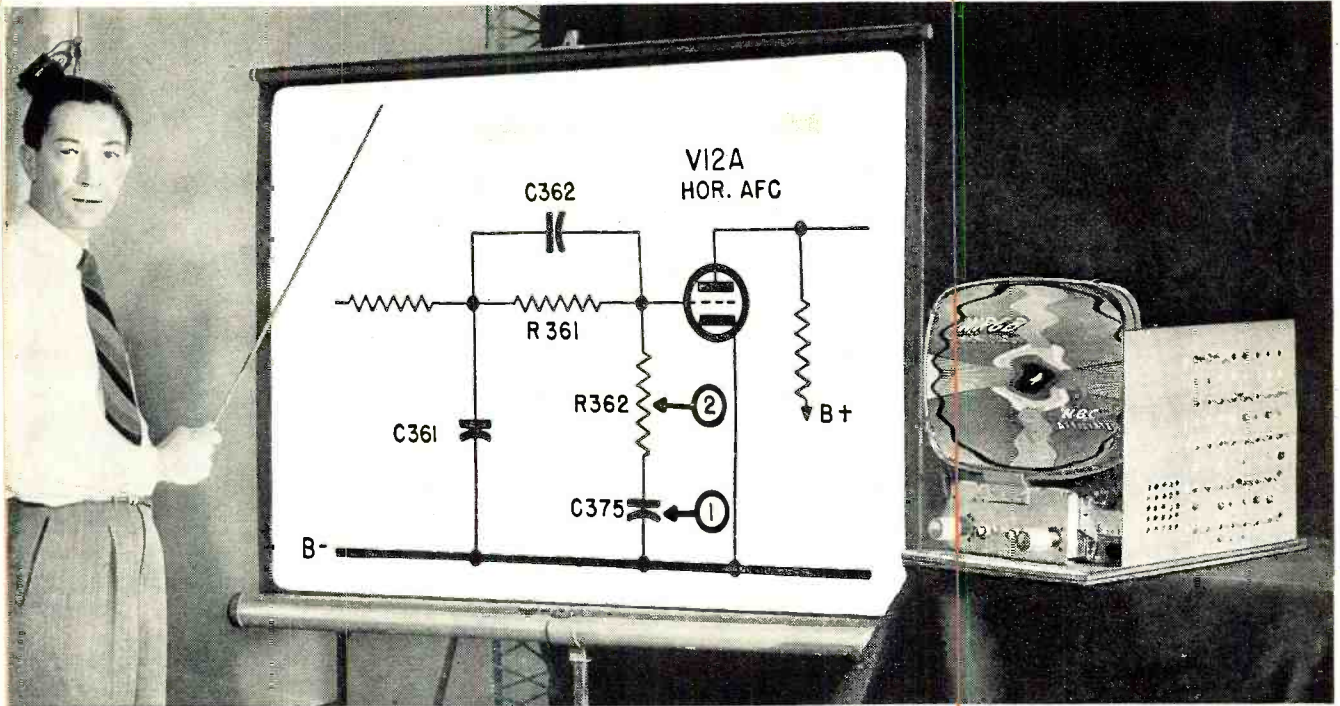

IT'LL PAY YOU TO SIT IN ON A G-E FIELD CLINIC LIKE THIS!

Dramatic demonstrations of 33 different TV troubles that may occur in any set—and how to fix them—shown by resident G-E Field Engineers right in your own TV area—without charge.

WHAT you see in the picture above is the business end of a G-E field service meeting. By flicking one of the 33 toggle switches on the Dynamic Analyzer, the operator shows a typical example of sync trouble right on the screen. On the chart appears a diagram showing a portion of the horizontal AFC circuit—and the General Electric Field Engineer tells you how to fix it.

Meetings like this are being held all over the country by resident G-E Field Engineers to help service men and dealers diagnose any

TV problems quickly and surely and know what to do to fix them.

Big service operators like Norm Liberman of San Fernando, Cal., and Sam Barriette of Garden City, L. I., say G-E television sets are better built—parts and replacements are easier to get—servicing is more profitable. *These men already know what you can learn at these field meetings!*

See the nearest G-E television distributor and tell him you want to attend the next meeting in your territory. In the meantime fill out and mail the coupon today.

General Electric Company, Receiver Department, Syracuse, New York.

You can put your confidence in—

GENERAL  ELECTRIC

February, 1952

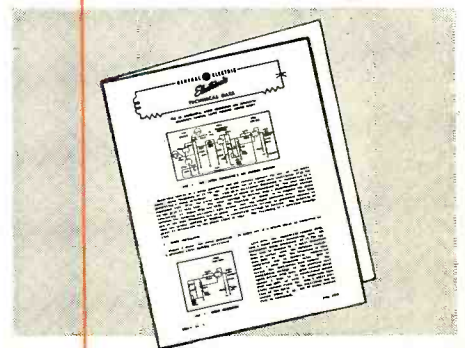

GET THIS FREE BULLETIN

General Electric Company, Section 922
Electronics Park
Syracuse, New York

Please send me your free bulletin "Transformerless Power Supply RSM-5, No. 2".

NAME.....

ADDRESS.....

CITY.....STATE.....

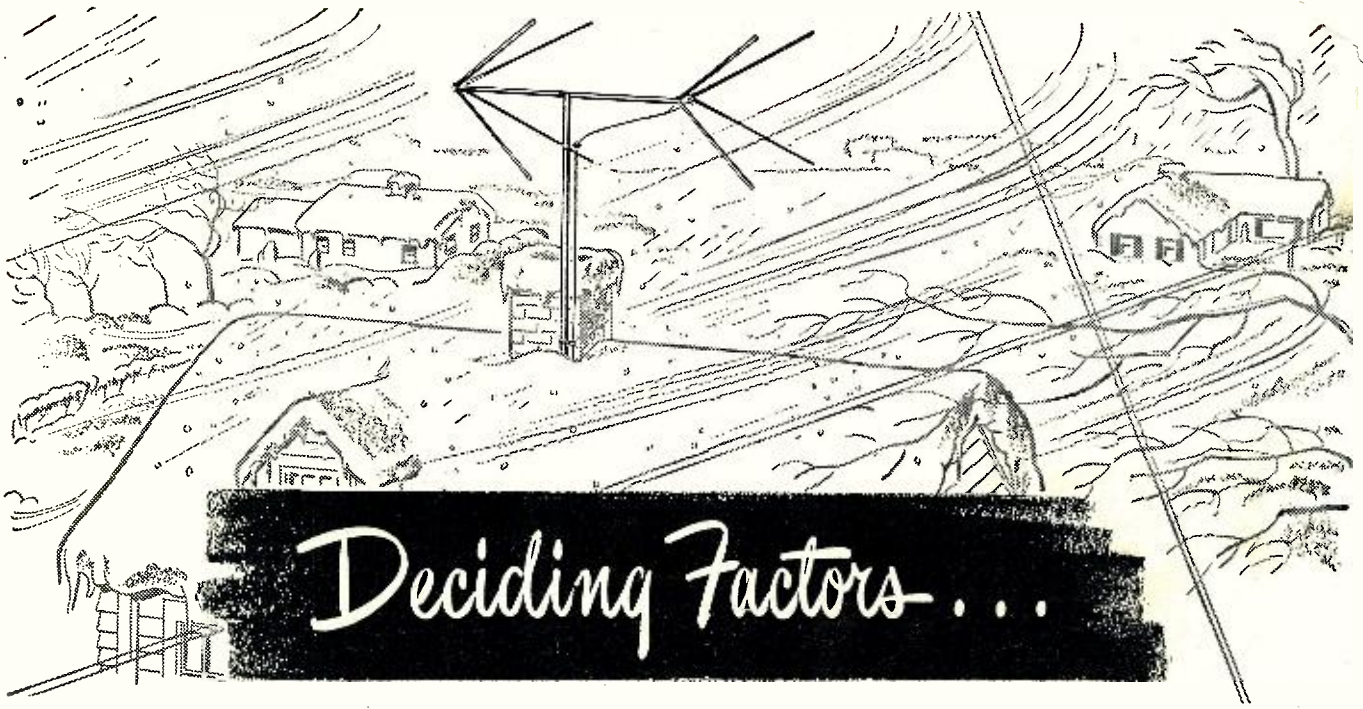

WITH **WARD** ANTENNAS INSTALLATIONS *Stay Put!*

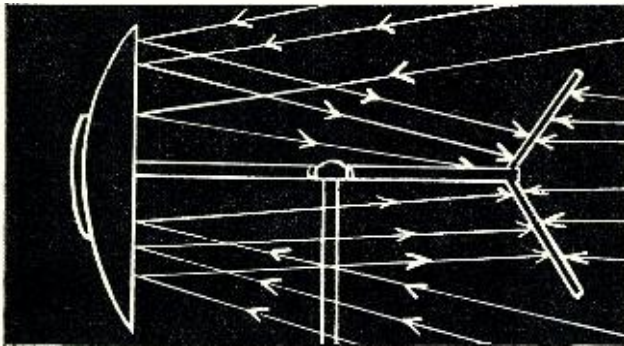

Diagrammatic sketch showing how parabolic reflectors gather in and concentrate energy on conical elements.

WARD ANTENNA INSTALLATION KITS . . .
time savers . . . money makers . . . cut the cost of stocking and storing parts . . . give everything you need at your fingertips at installation time. **KIT MODELS TV-105 and TVS-103** contain necessary 6 element Ward Conical bays, including mast, base, stand-offs, lead-in, lag bolts all in one kit. Write for catalog.

Ward mechanical superiority is a deciding factor weighing heavily with men in the field. Ward installations "stay put" . . . eliminate call-backs.

WARD PARA-CON* Antenna not only combines parabolic and conical principles to assure maximum picture clarity on all channels in most reception areas—but it features a material and structural strength that defies the elements, and assures a permanent installation. Aluminum tubing, molded plastic insulators, heavy duty crossarm and other construction features make for rugged strength and unsurpassed durability. Write for catalog.

*T.M.

As the oldest, largest exclusive antenna manufacturer, Ward combines a complete, widely-diversified line of Radio and TV antennas. A single source of supply gives you every advantage and every superiority that means satisfied customers and bigger profits to retailers and service technicians.

THE **WARD** PRODUCTS CORPORATION

Division of The Gabriel Co.

1523 East 45th Street • Cleveland 3, Ohio

In Canada: Atlas Radio Corp., Ltd., Toronto, Ont.

WARD

WORLD'S OLDEST AND LARGEST
EXCLUSIVE MANUFACTURER OF
ANTENNAS



Even under the most HUMID CONDITIONS

AYTHEON PICTURE TUBES

are 100% efficient...

thanks to Raytheon's new

CORONA INHIBITOR



Ordinary picture tubes are adversely affected by humidity and wet weather — may lose up to 10% of their brightness on damp days. Not so Raytheon made Television Picture Tubes with new CORONA INHIBITOR.

This amazing Raytheon development puts a "raincoat" on Raytheon Picture Tubes, guarantees the same *clear picture* rain or shine. Exhaustive tests proved conclusively that even under a water spray on the high voltage contact, Raytheon made Tubes showed *no loss of brightness*.

Give your customers the tubes that give constant clarity no matter what the weather. Ask your Raytheon Tube Distributor for Raytheon Television Picture Tubes.



Right for Sight!



Excellence in Electronics

RAYTHEON MANUFACTURING COMPANY

Receiving Tube Division

Newton, Mass., Chicago, Ill., Atlanta, Ga., Los Angeles, Calif.

RECEIVING AND PICTURE TUBES • RELIABLE SUBMINIATURE AND MINIATURE TUBES • GERMANIUM DIODES AND TRANSISTORS • RADIAC TUBES • MICROWAVE TUBES

Now! Get the TV chassis that has everything you want.

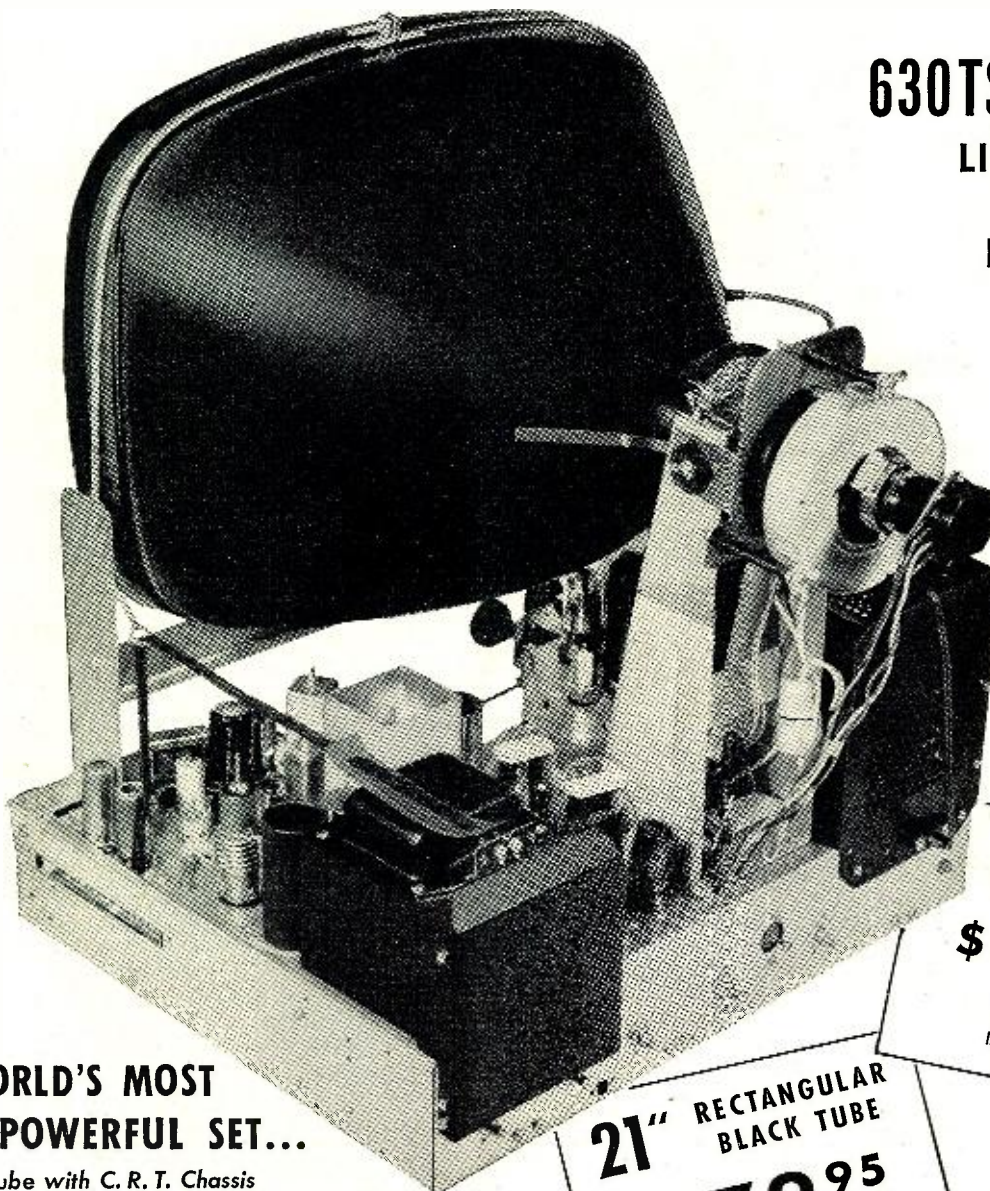

630TS CHASSIS

LICENSED
BY
R. C. A.

WORLD'S MOST POWERFUL SET...

31 Tube with C. R. T. Chassis

- Best for fringe area reception
- Improved keyed A. G. C.
- Full 4 megacycles 14,000 to 16,000 output
- A. F. C. Sync Separator Syncrolok Improved
- 25 Microvolts or better
- Complete chassis with tubes aligned
- Use 70° to 90° deflection yoke coil
- Standard tuner F.M. Radio
- 6-inch 'True-to-Life' speaker

17" RECTANGULAR
BLACK TUBE

\$159⁹⁵

Complete Chassis
Including Speaker

21" RECTANGULAR
BLACK TUBE

\$179⁹⁵

Complete Chassis
Including Speaker

NO EXTRA CHARGES

— R. M. A. guarantee on all parts

IMMEDIATE DELIVERY—15% Down—Balance

C.O.D. Remit in full—save C.O.D. charges

(Chassis equipped with 12-inch speaker, \$5.00 additional)

Export Orders Filled

GEM RADIO & TELEVISION CORP.

900 Passaic Avenue • East Newark, N. J.

RADIO & TELEVISION NEWS

REMEMBER THESE CBS-HYTRON TV FIRSTS?

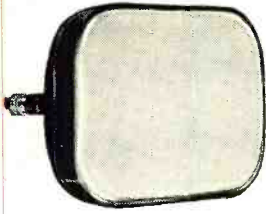

16RP4
original studio-matched rectangular picture tube.



12BH7
twin-triode sweep amplifier with superior efficiency.



1X2A
compact, high-voltage TV rectifier.



6BQ6GT
25BQ6GT
extra-performance deflection amplifiers.



← **NEW 12BY7**

Very - high - gain miniature pentode amplifier. Gives gains — within its power capabilities — equal to those of 6AG7. As video amplifier, provides better contrast in high-quality TV receivers. And in low-cost receivers, adequate amplification at low plate voltages.



← **NEW 12BZ7**

High-mu, 9-pin miniature dual triode. Especially designed for sync. separators and sync. amplifiers, high-gain audio amplifiers, and gating circuits.

Meet 4 more
CBS-HYTRON
TV Firsts!

NEW 12A4 →

High-efficiency, medium-mu, 9-pin miniature triode. Used as vertical amplifier, class C oscillator, or low-distortion audio output amplifier in push-pull.



NEW 12B4 →

High-efficiency, low-mu triode with 6/12 volt heater. Designed for vertical amplifiers with limited B supply voltages. Gives more sweep than 6W6GT. In proper circuit, sweeps any 70° rectangular.



YOU'LL BE SEEING THEM . . . BUYING THEM SOON
Because these tubes are specifically designed for high-performance, low-cost TV for the mass market. Watch for them in new models of famous TV sets. When you buy these CBS-Hytron TV firsts, follow leading set manufacturers. Buy the original. Buy CBS-Hytron!



PRESENTING COLLINS AM-FM "PRE-FAB" TUNERS

NOW you can
build a Collins
AM-FM tuner from
the Pre-Fab units
shown below!

COMPLETE VERSATILITY is the byword in this new tuner design. Through the addition of the AM circuit, the Collins tuner will meet all requirements for home music systems and installations where a fine tuner is required.

ECONOMY: The very finest in tuner design is offered you at exceptionally low prices. Collins quality is your assurance of a fine product that will work to your complete satisfaction. You cannot duplicate this tuner in its completed form at twice the price!

**3 Ways to purchase
COLLINS Tuner . . .**

1. As an AM tuner kit
2. As an FM tuner kit
3. As an AM-FM tuner kit

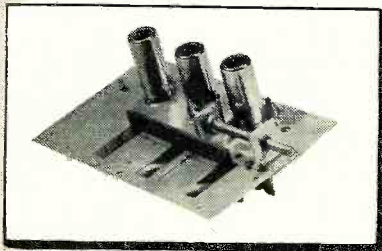

FM Tuning Unit **\$15.25**

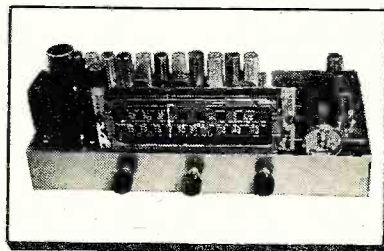

The Collins FM-AM Pre-Fab Tuner Assembled
(Total Kit Cost **\$69.00**)

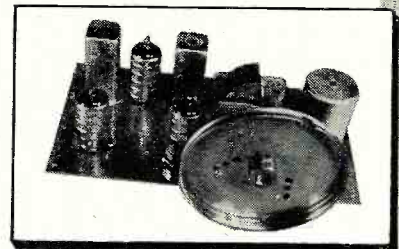

AM Tuning Unit
(Includes IF and Audio Amplifier) **\$19.25**

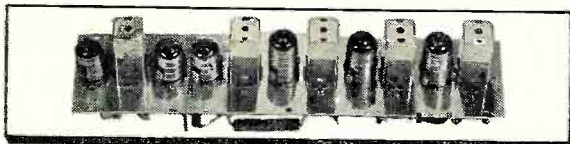

FM IF Amplifier **\$19.75**



UC-2 Universal Chassis Kit **\$14.75**

Tuning Eye Kit Available At **\$2.85**

The FM tuning unit employs 6J6 RF amp., 6AG5 converter, and 6C4 oscillator. Permeability tuned, stable, and drift-free. The IF amplifier for FM uses 6BA6, (4) 6AU6, and 6AL5 discriminator high gain, wide band for high fidelity reception. Distortion less than 1/2%. Frequency response 20 to 20,000 cycles at detector output.

The AM tuning unit employs three tubes, one of which performs the function of both detector and first audio amplifier stage. AM IF amplifier also is included in the tuning unit. Tubes used: 6BE6, 6BA6, and 6AT6.

Tuner kit is supplied with AM/FM selector switch, volume control and AC switch, and tuning knob. Complete instruction manual with schematics and pictures included.

**MAIL ORDER COUPON
TODAY!**

TO: COLLINS AUDIO PRODUCTS CO. INC.
P.O. Box 368, Westfield, N.J.

Enclosed Find Check Money Order For

AM Tuning Unit

FM Tuning Unit

FM IF Amplifier

UC-2 Chassis Kit

M-1 Tuning Eye Kit

NAME _____

ADDRESS _____

CITY _____

STATE _____

RADIO & TELEVISION NEWS

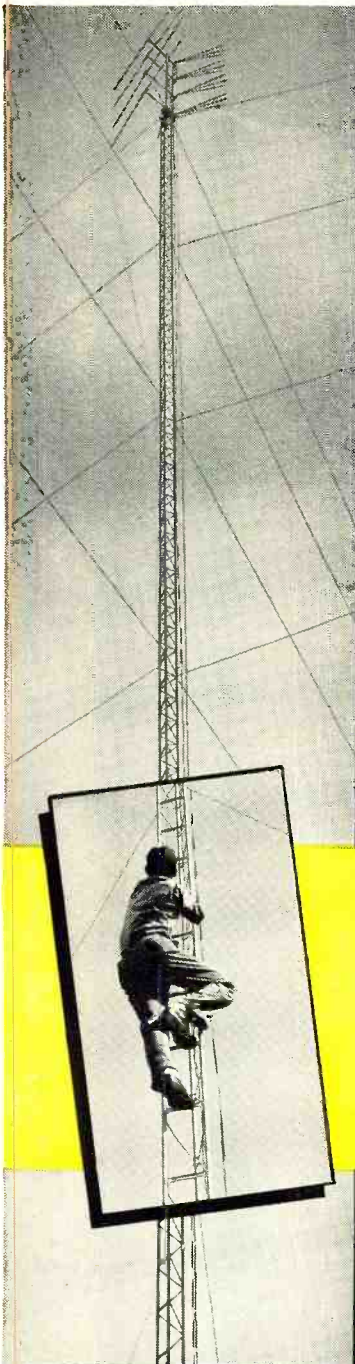

new!
TOWERS

by Channel Master

- Steel tubular uprights.
- Built-in ladder with no obstructions.
- One standard interchangeable section which can be used as a top, middle or bottom section.
- Universal base mount.
- Dual purpose mast or rotator mounting brackets.

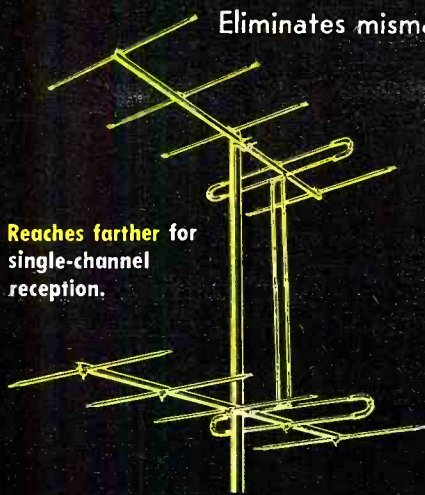

Reaches farther for single-channel reception.

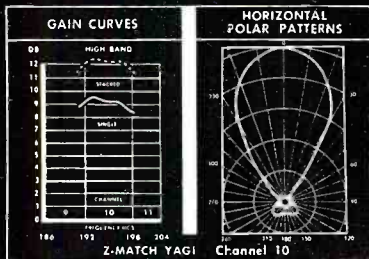

*Patent Applied For

Eliminates mismatch! Outperforms standard Yagis!

Z-MATCH YAGI*

600 Series

- Perfect match to 300 ohm line, single or stacked.
- Wider spaced elements for higher gain.
- 100% gain in stacking!
- Completely preassembled.

How The Z-Match Yagi Works

When antennas are stacked, the center feed bars of the folded dipoles are removed, automatically creating a perfect 300 ohm match for the entire stacked Yagi array. These same center bars are then used as half-wave connecting rods. This means

YOU DON'T PAY FOR STACKING BARS!

developed by

CHANNEL MASTER



For "Far Reaching" Results

There's only ONE

SUPER FAN

313 Series

The most widely used antenna in the nation.

The highest gain broad-band antenna ever developed.

New reinforced fibreglas inserts in all elements and reflectors.

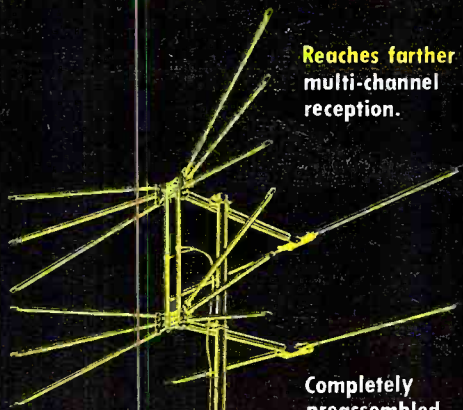

Reaches farther for multi-channel reception.

Completely preassembled.

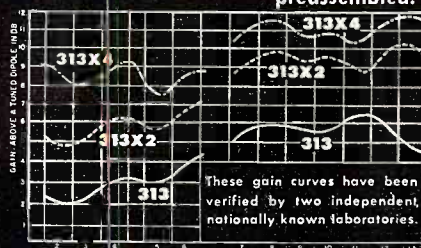

These gain curves have been verified by two independent, nationally known laboratories.

Write for technical literature on these 3 outstanding products.

CHANNEL MASTER CORP. ELLENVILLE, N. Y.

Simpson model 480 genescope

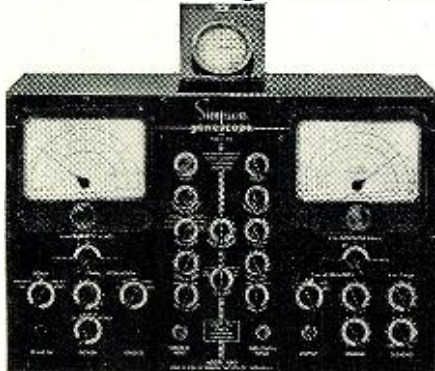

DON ANDERSON
HOFFMAN

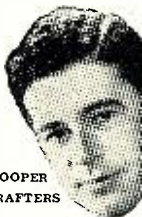

NORM COOPER
HALLCRAFTERS



FRANK SMOLEK
ZENITH



MAX SCHINKE
ADMIRAL



FLOYD MAKSTEIN
EMERSON



TIM ALEXANDER
MOTOROLA

RECOMMENDED

by service managers of leading manufacturers

These leading service managers agree the Simpson Model 480 Genoscope is the instrument for accurate testing and alignment of TV and FM receivers.

It provides ALL the necessary signal sources and includes the famous Simpson high sensitivity oscilloscope completely equipped with a high frequency crystal probe for signal tracing. Also available without the oscilloscope as Simpson Model 479 TV-FM Signal Generator. For complete specifications see your Parts Distributor or write SIMPSON ELECTRIC COMPANY, 5200 W. KINZIE ST., CHICAGO 44.

BURTON BROWNE ADVERTISING

Spot Radio News

Presenting latest information on the Radio Industry.

By RADIO & TELEVISION NEWS'
WASHINGTON EDITOR

PRODUCTION PROPHECIES, the perennial favorite topic of newsdom during the last days of the year, which often do not create too much of an impression on those who have to live with the statistics, were not so blandly discounted during the '52 offerings, when presented by the experts in Washington, and industry. For, as in the early '40s, the figures were not gilded or resplendent with optimism. Instead, they represented rather frank and conservative estimates, predicated on the demands of the accelerated defense program.

While the crystal-ball seers did not indicate that manufacturing would dip to serious lows, it appeared as if the bulging warehouses would really begin to empty out, because of curtailments. Specifically, members of government declared that we'd have about 5,000,000 TV chassis coming off the line during the year. Some estimates of industry were not so hopeful, with a production rate of 3,000,000 presented in some quarters. One survey specialist declared that his private analysis disclosed that 4,300,000 sets would be made and 4,600,000 chassis would be sold. Substantially brighter guesses were issued on the home set-portable-auto radio production front. About 10,000,000 models in this category would be made, it was said.

Comparisons of '52's expected output with the shipments of '50 and '51, particularly during the first halves of the years, revealed graphically the effects of material allocations on production. During the first six months of '50, over 3,000,000 television sets were made, while in the January-April period of '51, over 2,000,000 chassis were fabricated. During the first quarter of the new year, the processing of only about a half-million sets is in the offing. Some believe that there will be considerably more units shipped, thanks to the conservation programs which have, in many instances, doubled and tripled inventories of essential components, accessories, and hardware parts. One manufacturer felt that industry ingenuity would permit at least another five to ten per-cent output. According to one of the country's leading set makers, industry's conservation efforts, which have resulted in such developments as the electrostatic type of picture tube and reduced substantially the amount of copper required, should permit production of over 800,000 sets

during the first three months of the new year. Pacific Coast manufacturers indicated that in the first quarter they'll probably be able to produce about 75 per-cent of the output achieved in the October-December period of '51.

AS THE SET PRODUCTION FORECASTS appeared, the military were clamoring for more material and hammering away at the ODM office and, especially, Headman Charles E. Wilson. In their opinion, the civilian world was receiving too much of the essentials required by defense for guns and aircraft. During closed-door sessions, Wilson was told that it is important to race armament production, even at the risk of halting many types of civilian output. The production chief reported that the defense program was in full swing and that there were no lags anywhere. The three-year mobilization program was being followed as planned, he said, and the goal set will be reached as per schedule.

In one review of the preparedness effort, a Senate committee praised the mobilization authorities for following a middle-of-the-road approach in converting the nation to military production. If all-out requests had been issued, the Congressional group pointed out, an economic crisis would have been precipitated. In their opinion, it cannot be reasonably concluded that . . . "the nation has failed to maintain its minimum military strength in an effort to place butter before guns."

THE FREEZE ERA, which struck the telecasting world over three years ago, and a few months ago hit the color front with that edict from the defense officials to stop all red, green, and blue chassis making, entered the prophesy ring too, as the year '51 came to an end. Practically everyone in Washington released statements announcing that the ice blocks across broadcast road would start disappearing during the early spring. The most enthusiastic supporter of this belief was none other than the Commission's chief, Wayne Coy, who during several talks declared that by April 1 he hopes the FCC will begin issuing construction permits.

Speculating on the eventual construction pace that will prevail, Coy said that in five years . . . "we will have 1200 to 1500 stations on the air

RADIO & TELEVISION NEWS

Be Sure of Your Installations

Get the *Aptitude-Tested*
**RG/U TRANSMISSION
 LINE CABLES**

• You know what you are doing when you use Belden RG/U Transmission Line Cables—they're aptitude rated. They are designed to provide desirable electrical characteristics, and rigid control assures constant quality. Specify Belden Radio Wires.
 Belden Manufacturing Co., 4681 W. Van Buren St., Chicago 44, Ill.

FOR 50 YEARS
*Wiremaker for
 Industry*

To You,
 Belden's Golden Anniversary Means

—product performance that can come only from a "know-how" that has grown through actual service since the inception of Radio.

—an ability to co-operate in pioneering new wires to meet or anticipate industry's growing needs.

In the years that follow

This Belden Program Is—

—TO BE CONTINUED

APTITUDE RATING No. 8236		APTITUDE RATING No. 8237		APTITUDE RATING No. 8238		APTITUDE RATING No. 8239		APTITUDE RATING No. 8241	
Frequency (Mc)	Attenuation per 100 ft	Frequency (Mc)	Attenuation per 100 ft	Frequency (Mc)	Attenuation per 100 ft	Frequency (Mc)	Attenuation per 100 ft	Frequency (Mc)	Attenuation per 100 ft
100.	2.65	100.	2.10	100.	1.90	100.	3.10	100.	3.75
200.	3.85	200.	3.30	200.	2.85	200.	4.40	200.	5.60
300.	4.80	300.	4.10	300.	3.60	300.	5.70	300.	7.10
400.	5.60	400.	4.50	400.	4.35	400.	6.70	400.	8.30



Belden
Radio **WIRE**

The
Aptitude-Tested **LINE**

Here it is!

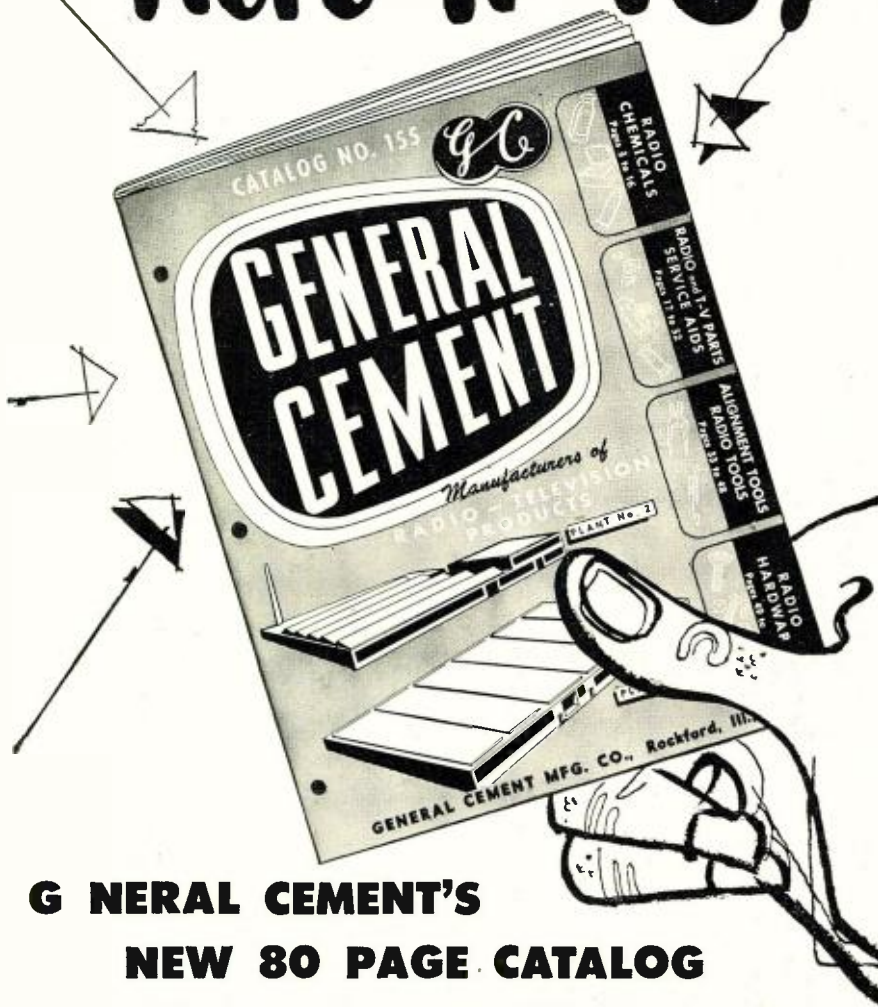

GENERAL CEMENT'S NEW 80 PAGE CATALOG OF TV AND RADIO SERVICE NEEDS

80 pages crammed with everything the serviceman needs in the way of radio and TV chemicals, service aids, tools, hardware, antennas, and parts. See your distributor for a free copy or write direct to company.



SPEDEX AUTOMATIC WIRE STRIPPER MODEL 744-1

A heavy duty wire stripper that features a delayed action release which prevents wires from being crushed or bent.



TELEVISION TUBE KOAT No. 49-2

For recoating peeling or scratched picture tubes. Coat inside of TV cabinets to prevent high voltage leaks.

FREE

Please rush me your new 80 page catalog of TV and Radio Service Needs

Company Name _____

Street Address _____

City _____ Zone _____ State _____



**GENERAL CEMENT
MANUFACTURING
COMPANY**

904 Taylor Avenue
Rockford, Illinois

and in ten years we may have 2500.”
“Soon after the freeze is lifted, we expect to have some 1000 applications for construction permits,” the communications headman reported. In his opinion, it appears as if . . . “almost a billion dollars has already been earmarked by various corporations and individuals to construct our new television stations.”

THE FREEZE WORLD was also treated to an oddity in the form of a statement on color from NPA. Earlier industry had been asked to curtail production immediately and everyone agreed to comply. Shortly after this unanimous approval was received, the lawmakers began to worry. They found that the agreement among the set makers might be a violation of the Sherman and other anti-trust acts. So, it became necessary to legalize the desire to halt with an official ruling. Thus, Order M-90, officially banning color production, was issued and now it's perfectly proper not to make color sets. Technically, the ruling prescribes that . . . “no person shall . . . produce or assemble any television set designed to receive . . . color television, nor shall any person produce or assemble any product, attachment, or part designed solely to permit or facilitate . . . the reception of color television.”

The official ban did not cover research or test programs. Neither did the ruling restrict the manufacture of color television equipment for closed circuit operations for industrial purpose or by hospitals and educational institutions for instructional applications.

THE CLARIFICATION OF THE COLOR ban, which revealed that experimentation on color systems could continue, was greeted effusively by the proponents of the compatible techniques, since they could continue with their intensive industry study and submit a report which might reopen hearings on color and prompt the Commission to establish new standards.

As this column was being prepared a comprehensive on-the-air test survey of the electronic method, evolved by the various panels of the National Television Systems Committee, was under way. The tests, which were expected to last until the first days of spring, were being conducted in five cities: New York, Philadelphia, Chicago, Syracuse, and Washington. Among those transmitting color signals are RCA and Du Mont in New York, Philco in Philadelphia, Zenith in Chicago, General Electric in Syracuse, and RCA-NBC in Washington.

In a description of the characteristics of the signals being aired, NTSC said that the power of the aural-signal transmitter will be not less than 50 per-cent nor more than 150 per-cent of the peak power of the visual-signal transmitter. It was also noted that the color subcarrier frequency will be 3.898125 mc. ± .001 per-cent, with a
(Continued on page 134)

RADIO & TELEVISION NEWS

There's No Comparison!

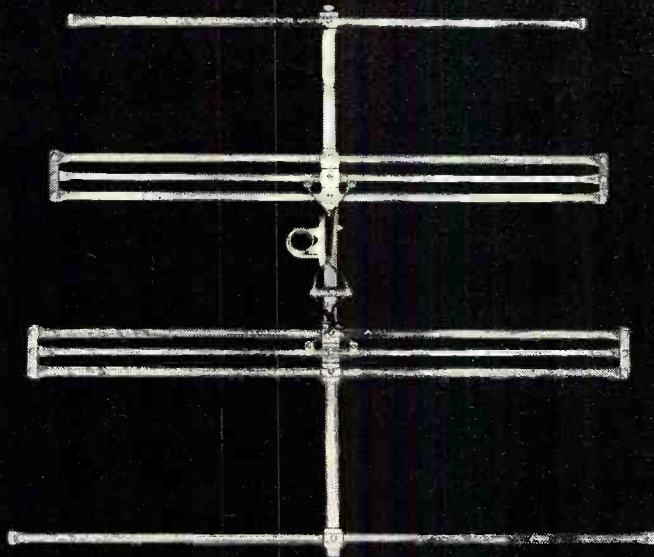

THE TRIO 2-CHANNEL YAGI FULL 10 DB GAIN ON TWO CHANNELS.

MODEL 445 FOR CHANNELS 4 AND 5
MODEL 479 FOR CHANNELS 7 AND 9

Patent pending — no licensing arrangements granted for duplicating principle of this antenna.

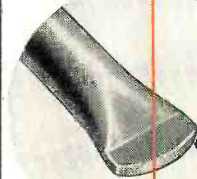

Yagi elements of .035" thick seamless aluminum, are full 5/8" in diameter. Ends are crimped for greater strength and to cut down vibration. Prevents entrance of dirt and moisture.

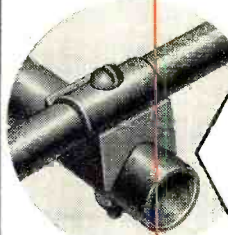

An extra clamping member permits taking up bolts tight without putting undue strain on element. Cast aluminum V block assures perfect right angle alignment. No detail of design or construction has been overlooked to make the TRIO 2-Channel Yagi the finest fringe area TV antenna available anywhere — at any price!

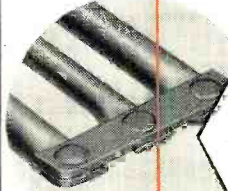

Double-folded dipole sections have heavy gauge aluminum brace bars securely riveted to element ends thus providing positive electrical connection and extreme rigidity. Workmanship throughout is of the highest order.

TRIO — TOPS ALL IN DESIGN, CONSTRUCTION, PERFORMANCE

The Original
2-CHANNEL YAGI

One of the most widely imitated antennas on the market today, the TRIO 2-Channel Yagi still stands alone in efficiency and strength.

TV buyers — and sellers — are discovering that "look alike" is not enough — that imitations are never as good as the original.

There is no secret to TRIO's marked superiority. The simple truth is that TRIO slights no construction detail, overlooks no design feature. This means unparalleled

efficiency — rugged dependability for both installer and TV set owner.

Installers! Avoid profit eating call-backs caused by poorly made imitations! Set owners! Enjoy years of dependable, efficient TV reception! Compare the TRIO 2-Channel Yagi with any other TV antenna at any price. Yes, compare — then you, too, will insist on an original TRIO — the 2-Channel Yagi that set the standards.

RIO the "Trouble-proof" TV Rotator



For years of dependable, unfailing service — in good weather and bad — you can't beat the new TRIO TV Rotator and Direction Indicator.

Sturdy and completely weatherproof, the TRIO Rotator will support the heaviest TV arrays — even in 80 MPH winds! Its sound design and construction has been proven by 3 years of extensive field testing under every extreme of weather. The TRIO Rotator will not freeze up!

2 HEAVY DUTY MOTORS

Two separate 24 volt motors are used — one for each direction of rotation. Thus, each motor operates just 50% of the time — cannot burn out. Positive acting electrical stops at both ends of 360° turn eliminates lead damage.

Housing is die-cast aluminum for greater strength, lighter weight and perfect alignment of parts. The TRIO Rotator is precision built throughout.



**SMARTLY STYLED
DIRECTION
INDICATOR**

The TRIO Direction Indicator is housed in a sturdy plastic cabinet of graceful lines. It is a beautiful instrument that will blend harmoniously with any furniture style.

Utmost ease in selecting the desired antenna direction is provided by a new "finger-tip" control that operates at a light touch and the easy-to-read dial face that clearly and instantly indicates the exact antenna position.



TRIO

MANUFACTURING COMPANY
GRIGGSVILLE, ILLINOIS

available

from your Teletron distributor...

1

Tele-lead

Handiest TV servicing aid yet. Permits power connection to receiver chassis when safety interlocking switch is broken by opening protective back. At the same time, it provides a trouble light to see what's what.



2

TV Picture Tube Selector

Replaces those bulky and seldom-at-hand charts and booklets formerly necessary to find correct replacements. Merely dial the type to be replaced—presto! there's the correct Teletron replacement. Also electrical and mechanical characteristics for those profitable conversion jobs!

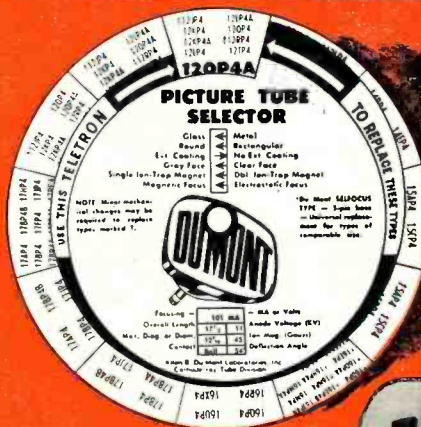

3

Teletron Decal

Colorful decal easily transferred to store window, doors, inside displays, or on your truck or car. Immediately marks you as a quality-wise service organization. Ties right in with Du Mont fame!

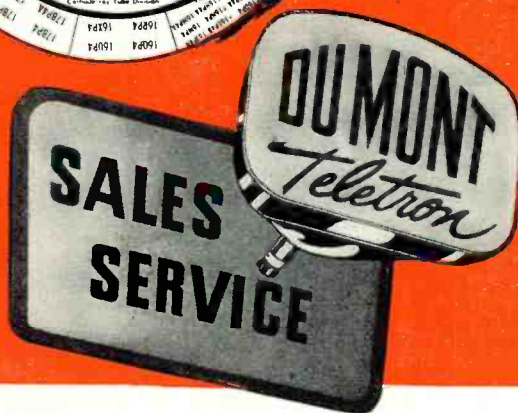

Geared to your TV servicing! It's up to you to get these aids from your Du Mont Teletron distributor. They represent *plus* values above and beyond that biggest bonus—Du Mont's reputation for *quality, progressive engineering* and *customer satisfaction*. Drop in on your Du Mont Teletron distributor today. Ask for the aids. And get in on the fastest road to more profitable TV servicing.

DUMONT



CATHODE-RAY TUBE DIVISION ALLEN B. DU MONT LABORATORIES, INC., CLIFTON, N. J.

*Trade-mark

RADIO & TELEVISION NEWS

For the sharpest,
clearest pictures
in television...

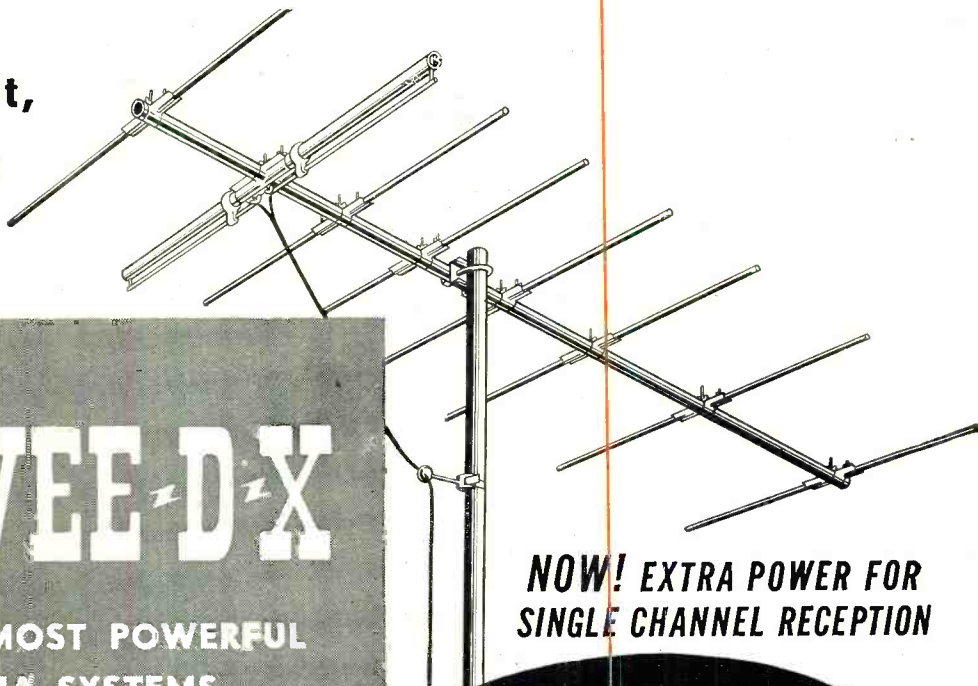

INSTALL
Genuine **VEE-D-X**
THE WORLD'S MOST POWERFUL
TV ANTENNA SYSTEMS

**NOW! EXTRA POWER FOR
SINGLE CHANNEL RECEPTION**

NEW VEE-D-X
Long John
8 Element Yagi

OUTBOARD BOOSTER

For single channel use. Delivers powerful 18 db gain with full 5 megacycle band width. Only \$19.95

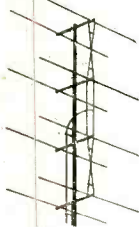
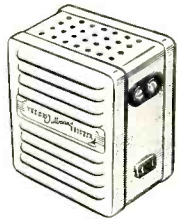

COLINEAR ARRAY

Lowest priced all-channel 4 bay array with pre-assembled construction. \$23.75 less mast

ANTENNA SWITCH

3-way switch for stacked arrays or multiple antennas. Instant changeover to each antenna. Attractive ivory or mahogany plastic case. \$4.95

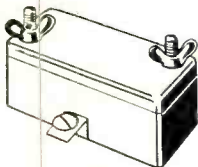

RW-200 ARRESTER

Positive protection against lightning. The full sized arrester that costs no more than a midget. Only \$1.25

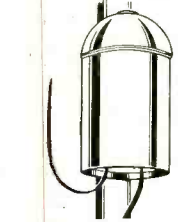

ROCKET BOOSTER (Patent Pending)

Powerful new single channel mast-mounted booster. Amplifies signal at antenna height where most favorable signal-to-noise ratio exists. List \$34.95

PROVIDES
41% MORE GAIN

Than The Best 5 Element Yagi

Gives Equal Gain To A Double Stacked 5 Element Yagi Array

VEE-D-X engineers have perfected this entirely new 8 element Yagi to meet the increasing demands throughout the trade for a single bay antenna that produces as much gain as a stacked Yagi array, yet lower in cost, easier to install, and better in appearance. Long John is the answer. Compare these time and money-saving features.

at lower cost! **\$12.50** LIST

for Channels 7-13
MODEL LJ—Ch. 2 or 3 ... \$29.85 list
MODEL LJ—Ch. 4 or 5 ... \$26.15 list
MODEL LJ—Channel 6 ... \$23.65 list
All Prices Less Mast

- Faster, easier to install than stacked arrays
- Better roof-top appearance
- Higher front-to-back ratio eliminates co-channel interference
- Full 6 megacycle band width
- Rugged pre-assembled construction

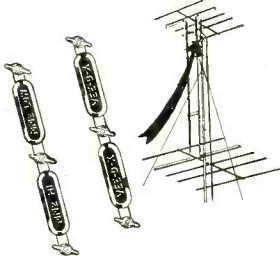

MIGHTY MATCH

(Lic. A.A.K. Pats., 2,422,458; 2,282,292 others pending) Permits use of single transmission line between separate high and low antennas mounted on same mast. List \$4.20

THE LaPOINTE-PLASCOMOLD CORPORATION
Windsor Locks, Connecticut

Gentlemen:
Send me information on the following:

.....

Name

Street

City Zone State

Know "WHY" Ceramic Capacitors...

Here are the facts about Ceramic Capacitors — why they are the most permanent capacitors . . . why they do a better job . . . give a better performance . . .

Up until a few years ago, capacitor design was based on one idea — "the bigger the better." Paper and mica, etc., were cheap, readily available materials, and their use was the only known art for making commercial capacitors (or "condensers" as they used to be called).

Now don't misunderstand us . . . those old condensers were really OK as far as they went. *But today there's something more to talk about . . . CERAMIC CAPACITORS.*

Actually, the idea of ceramic capacitors isn't new. They've been used as electronic components for more than 20 years. We call them new because it's only in the last few years that service-engineers have paid any attention to them . . . and because some of these modern ceramic capacitors really are new . . . with *new* higher voltages, *new* and better physical characteristics. So if ceramic capacitors were overlooked by service-engineers during the last few years . . . we feel it's because you didn't know about just how *good* they really are—or because what you needed wasn't available.

Let's take a look at modern ceramic capacitors and the story behind them. It was in the early 1900's when German scientists discovered the dielectric properties of ceramic materials. In the U.S.A., we had an abundant supply of mica and other materials, so U.S. research men never bothered with ceramics. Then came World War I, and ceramics became mighty important in European radio manufacture. Ceramics were a long way from perfected but they did the job . . . and continual improvement made them increasingly important in the electronic field. Meanwhile, at Centralab, we had started to investigate these new materials. It was soon found that U.S.A. had a bigger source of raw ceramic materials and that our stocks were of vastly superior physical and electrical characteristics.

Then one of our foreign representatives supplied us with a complete set of foreign-made ceramic components. Result — Centralab developed a ceramic research program. The program was big and thorough . . . and it's still going on.

In a few years, Centralab put on the market its first ceramic capacitors. With World War II, came tremendous developments in electronics. Radio, radar and other electronic equipment de-

manded the finest in component parts . . . and ceramic capacitors came into their own. *In fact, independent research has shown that during World War II, in some classes of military equipment, there was not a single known instance of a failure of a ceramic capacitor!*

Thus, through the lessons learned over a period of 20 years of intensive research — Centralab Ceramic Capacitors have today become the best capacitor buy for safe guaranteed servicing. For when you use CRL ceramic capacitors, you're using the benefits of hundreds of thousands of man-hours of research—experiments with over 20,000 different ceramic compounds!

That's why any ceramic isn't the best ceramic for the job. Each of those 20,000 ceramic mixes had definite physical and electrical characteristics . . . and when we say that Centralab today uses only 250 of those 20,000 tested compounds, you can be sure that those discarded did not perform to the exacting requirements of sensitive electronic circuits.

Yes, and if you compare the old-style paper and mica capacitors with modern ceramic capacitors . . . point for point, based on your own technical experience, you'll see why ceramics are vastly better . . . the safe, dependable way to assure a good service job.

For example, every serviceman is aware of the moisture absorbing quality of paper condensers . . . and how moisture can seep in along the leads on mica units. Compare these old designs with modern ceramic tubular and disc types . . . Centralab's Ceramic-X capacitor bodies are nonhygroscopic . . . moisture absorption being only .007% or less! That fact alone means Centralab Capacitors give you and your service customer the ultimate in reliability—even under severe tropically humid conditions.

Old-timers in the service field . . . yes, and young ones, too, will recall the bulky size . . . the difficulty of handling old-fashioned large size capacitors . . . when size seemed to be an important factor in design. Now, look at modern ceramic capacitors. They're less than 1/4 the size . . . you can fit them anywhere!

When you look at this chart of the development of capacitors using various materials . . . the tremendous improvement of the dielectric con-

stant "K" with the entry of ceramics into the field is dramatically evident.

One of the most serious problems with old-time capacitors was that they broke down under high temperatures. Here again, ceramics have more than proven their superiority. 85° C. will not harm the modern ceramic capacitor. In fact, the ceramic body itself can easily withstand any temperature encountered in electrical apparatus. High capacity is

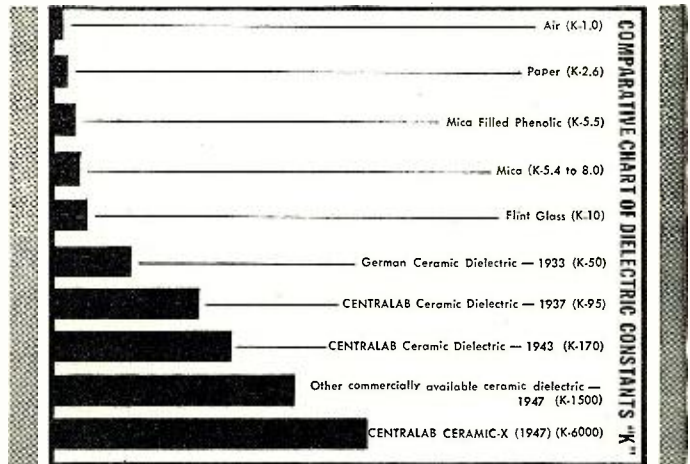

well maintained under wide temperature variation. What's more, the copper-silver electrodes are electro-bonded to the ceramic with a tensile strength of 30,000 lbs. per square inch — thus preventing any possible change of the relative position of the electrodes.

A typical example of the high degree of perfection and performance offered by ceramic capacitors is contained in CRL Hi-Vo-Kaps. These units are rated at 10 — 20 and 30 KV and are intended exclusively for TV. You'll find that practically the entire TV industry has standardized on these CRL units as original equipment for this most exacting application.

When it comes to low power factors—check ceramics against all others. With ceramics, initially it's .1% to .6%. After 100 hours at 95% humidity, it's .5% to 3% and they'll return to normal! That's ceramic high efficiency! If it's accuracy you want, ceramic capacitors can give you unusually close tolerances in wide range of values.

In r.f. circuits, where drift is critical, one of the likely causes is temperature change. Stabilization can be effected by capacitors which compensate for temperature variations. Centralab pioneered ceramic capacitors for this purpose. This important research resulted in Centralab's famous TC-Hi-Kaps Zero Temperature and Negative Temperature Compensating units. These are a Centralab exclusive "First". For service-engineers they are the industry's last word in accurate stabilizing capacitors.

Service-engineers today are called upon for more exacting work — more downright customer satisfaction. Every job that comes into your shop is a challenge to your reputation. Regardless of the care in workmanship, no service job is better than the components you put into it. To stay in business tomorrow — you can't take chances today.

Field research shows that smart service-engineers everywhere are replacing all old-fashioned or dangerously old capacitors with ceramic capacitors, within the capacity ranges available. Particularly if there is any indication of possible failure within a reasonably short period. For by-pass and coupling applications . . . they're using Centralab BC Hi-Kaps. For tuning applications, they're using temperature compensating TC Hi-Kaps. It's their own assurance of a good job well done . . . and their customer's insurance of complete satisfaction. What's more, to the serviceman and customer alike . . . *there's little or no premium in price.*

You'll find Centralab ceramic capacitors are available in a wide variety of capacities from any recognized better radio parts distributor. Ask him. And remember, Centralab is the pioneer in the field of electronic ceramics. That fact alone is your best assurance of engineering know-how, production know-how, and performance know-how that permits no compromise with quality.

and you'll Buy Ceramic Capacitors

Choose the exact capacitors you need from the world's widest line of ceramic capacitors — for jobs that demand the best in guaranteed TV-AM-FM servicing . . .

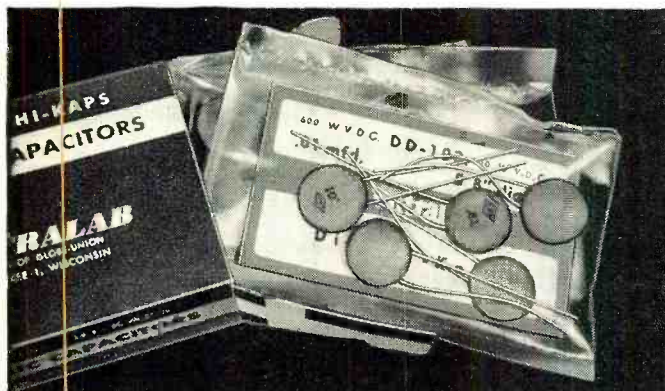

CERAMIC DISC HI-KAP CAPACITORS — provide very high capacity in extremely small size, with minimum thickness. For by-pass, coupling and general applications. Superior power factor and low inductance.

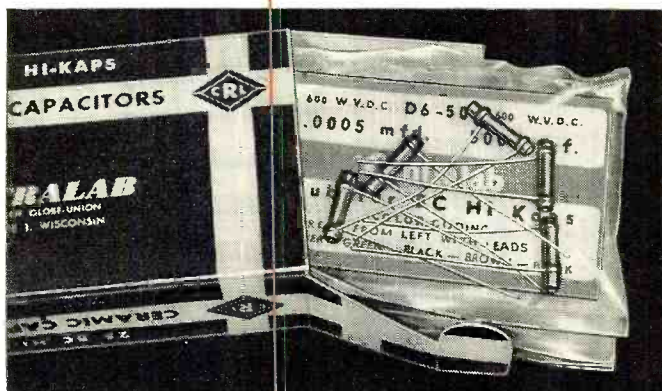

CERAMIC BC TUBULAR HI-KAP CAPACITORS — for by-pass or coupling applications and most general circuit work. Smallest size on the market. Remarkable stability under high temperatures or humidity.

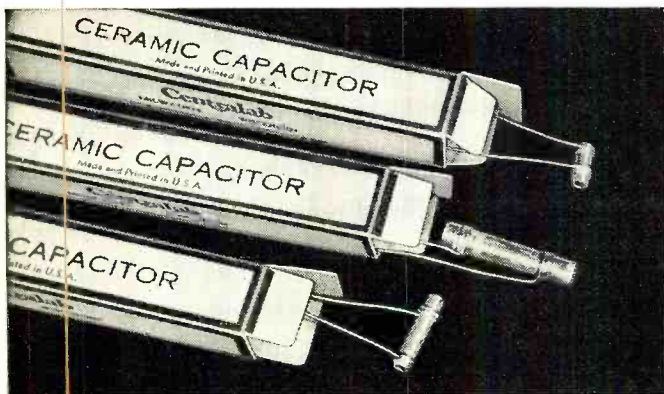

TC TEMPERATURE COMPENSATING CERAMIC CAPACITORS — stable units that do not change in capacity under wide temperature variations—or may be selected to correct for frequency drift in resonant circuits caused by temperature changes. Also superior replacement for close tolerance micas.

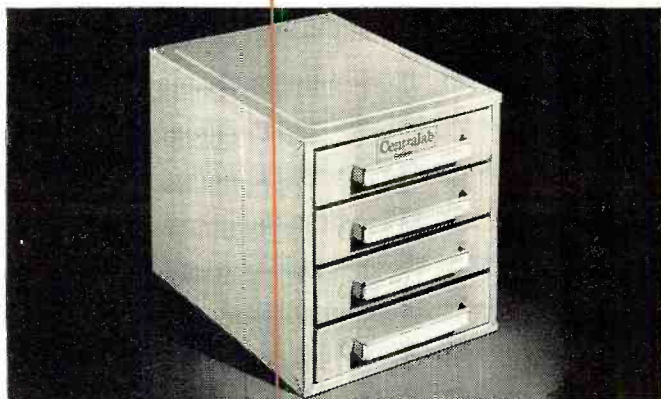

CAPACITOR KITS — several are available. Illustrated is assortment of 200 units of most generally used values, supplied in a four-drawer metal cabinet. Often assures required values will be on hand when needed in labs or for service. No charge for cabinet.

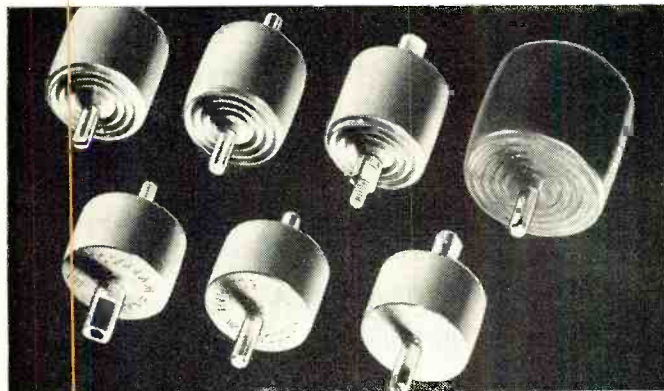

TELEVISION HIGH VOLTAGE CAPACITORS — are the accepted standard for the TV industry. Used for filter and by-pass in TV high voltage power supply and pulse filter for cathode ray tubes. Ask for Centralab Hi-Vo-kaps.

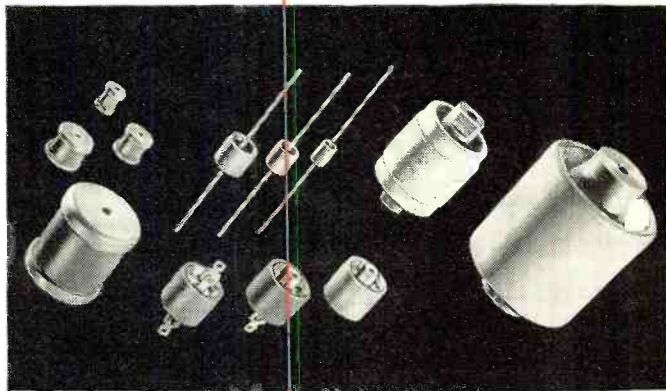

TRANSMITTING AND HIGH ACCURACY CERAMIC CAPACITORS — for applications involving rigid frequency control. Used for holding oscillator frequencies to close limits. Excellent as secondary Standards.

Yes, for the safest, quickest guaranteed servicing . . . standardize on Centralab Ceramic capacitors. You'll have the world's widest line to select from — as made by Centralab, America's pioneer builder of ceramic capacitors. You can get complete information on all the capacitors described here — plus other valuable service information from Centralab's Catalog 27 . . . available at your distributor's.

Centralab

Division of Globe-Union Inc.

910 E. Keefe Avenue • Milwaukee 1, Wis.

new!

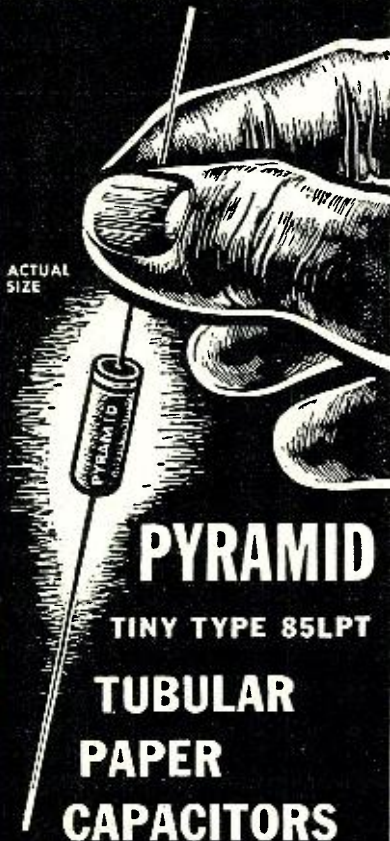

PYRAMID TINY TYPE 85LPT TUBULAR PAPER CAPACITORS

Fit anywhere!
Suitable for
85°C. operation!

CAPACITANCE RANGE:
0.001 TO .5 MFD.

VOLTAGE RANGE:
200 TO 600 V., INCLUSIVE

Sturdily built in phenolic-impregnated tubes. Ends are plastic-sealed.

WRITE FOR COMPLETE LITERATURE
Representatives and Distributors
Throughout the U.S.A. and Canada



PYRAMID

PYRAMID ELECTRIC COMPANY

1445 Hudson Boulevard
North Bergen, N. J., U. S. A.

TELEGRAMS: WUX North Bergen, N. J.
CABLE ADDRESS: Pyramidusa

Within the INDUSTRY

LOUIS MARTIN is the new general sales manager of *Standard Coil Products Co. Inc.* of Chicago, Los Angeles, and Bangor, Michigan.

Mr. Martin brings to this newly-created post a wide knowledge of the radio, television, and electronic field as well as over 25 years of experience in the business.

He started his radio career in 1924 with *Colonial Radio Corporation* and subsequently became affiliated with *RCA* as manager of the Tube Department's equipment field force.

He comes to his new position from *General Instrument Corporation* where he was general sales manager of the Elizabeth and Sickles Divisions.



HERMON H. SCOTT received the John H. Potts Memorial Award for outstanding contributions to audio engineering in 1951 at the annual convention of the Audio Engineering Society held recently in New York.

The award was made by Dr. Harry F. Olson on behalf of the AES. Mr. Scott is president and director of engineering of *Hermon Hosmer Scott, Inc.* of Cambridge, Mass.

Presentation of the award was made in recognition of the work done by Mr. Scott and his organization in the reproduction and measurement of sound.

LARRY Le KASHMAN is the new vice-president of *Electro-Voice, Inc.*, Buchanan, Michigan, manufacturer of electronic equipment.

He was formerly associated with the Tube Department of *RCA* where he was the advertising and sales promotion manager for that department.

Mr. LeKashman is an enthusiastic ham, and during the war he served in the Naval Air Transport Command. Prior to that he was associated with a number of distributors in the electronics parts field. He is the author of many technical and popular radio articles and is the editor of several radio handbooks.



RTMA has launched a triple-pronged educational and information program designed to provide more trained service technicians and to improve service practices in the radio-television industry.

The program involves the recom-

mendation of television servicing courses in the approximately 2500 vocational schools and in as many adult education schools as possible throughout the country.

To further this program, *RTMA* has engaged *RCA Institutes, Inc.* to write a three-year vocational high school syllabus on radio and television and a 10-12 month syllabus for adult educational institutions. The courses are being edited by Gilbert Weaver, training director of the New York State Board of Education.

A second phase of the project is the distribution of a booklet on the care of television receivers being sponsored jointly by the *RTMA Service Committee* and the National Better Business Bureau.

The third prong of the offensive involves cooperation by the *RTMA* with various service associations and other television technician groups which are also endeavoring to raise servicing standards.

ARTHUR RICHENTHAL, attorney, has been elected to the post of secretary of *Standard Coil Products Co. Inc.* of Chicago.

The appointment was made in recognition of Mr. Richenthal's services and his unusual contributions to the growth of this Midwestern television components firm.

He is a graduate of Harvard Law School and at one time was an attorney for the Securities and Exchange Commission. He has been a director of *Standard Coil* for some time.



CBS-COLUMBIA, INC., has recently acquired a new plant in Long Island City, New York which will provide a total of 500,000 square feet of manufacturing space for civilian and military production requirements. . . Construction of a \$5,500,000 defense production plant at Evendale, Ohio was begun recently by the **CROSLY DIVISION OF AVCO MANUFACTURING CORPORATION**. Limited production is expected to start in June. . . **SIMPSON ELECTRIC COMPANY** has recently completed a new addition to its Lac du Flambeau, Wisconsin branch. . . **HENRY & MILLER INDUSTRIES, INC.**, has announced the recent opening of a new metal fabricating and finishing plant in Jersey City, N. J. The company makes radar and television parts in addition to various military items. . . **INTERNATIONAL RECTIFIER CORP.** has purchased a new factory building located at 1521 E.

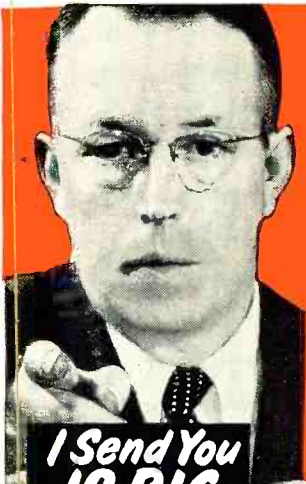

NOW-Be a Fully Trained, Qualified RADIO TELEVISION TECHNICIAN IN JUST **10 MONTHS OR LESS**

**I Send You
18 BIG
KITS
OF RADIO-
TELEVISION
EQUIPMENT**

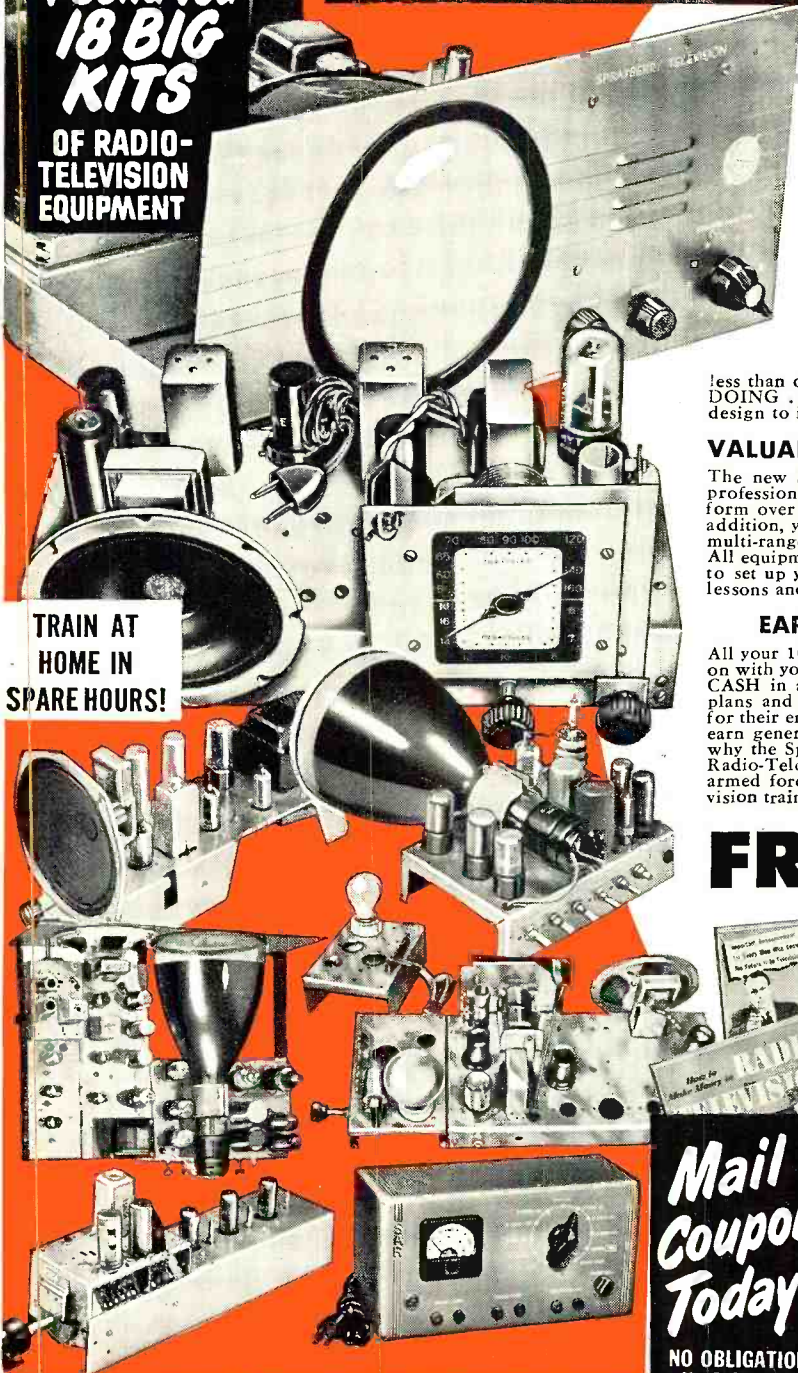

**TRAIN AT
HOME IN
SPARE HOURS!**

**New "Package" Unit Training Plan
PAY AS YOU LEARN—YOU SET THE PACE!**

No Monthly Payment Contract to Sign!

Now . . . be ready for Radio-Television's big pay opportunities in a few short MONTHS! Frank L. Sprayberry's completely new "Package" training unit plan prepares you in just 10 MONTHS . . . or even less! Equally important, there is NO monthly payment contract to sign . . . thus NO RISK to you! This is America's finest, most complete, practical training—gets you ready to handle any practical job in the booming Radio-Television industry! In just 10 months you may start your own profitable Radio-Television shop . . . or accept a good paying job in this fascinating expanding field at work you've always wanted to do. Mr. Sprayberry has trained hundreds of successful Radio-Television technicians—and stands ready to train you in less than one year, even if you have no previous experience. You learn by DOING . . . actually working with your hands with equipment of special design to illustrate basic theory instead of relying on books alone.

VALUABLE EQUIPMENT INCLUDED WITH TRAINING

The new Sprayberry "package" plan includes many big kits of genuine, professional Radio-Television equipment. While training you actually perform over 300 demonstrations, experiments and construction projects. In addition, you build a powerful 6-tube standard and short wave radio set, a multi-range test meter, a signal generator, signal tracer, many other projects. All equipment is yours to keep . . . you have practically everything you need to set up your own service shop. The interesting Sprayberry book-bound lessons and other training materials . . . all are yours to keep.

EARN EXTRA MONEY WHILE YOU LEARN!

All your 10 months of training is AT YOUR HOME in spare hours. Keep on with your present job and income while learning . . . and earn EXTRA CASH in addition. With each training "package" unit, you receive extra plans and ideas for spare time Radio-Television jobs. Many students pay for their entire training this way. You get priceless practical experience and earn generous service fees from grateful customers. Just one more reason why the Sprayberry new 10 MONTH-OR-LESS training plan is the best Radio-Television training in America today. If you expect to be in the armed forces later, there is no better preparation than good Radio-Television training.

FREE 3 BIG RADIO TELEVISION BOOKS

I want you to have ALL the facts about my new 10-MONTH Radio-Television Training—without cost! Act now! Rush the coupon for my three big Radio-Television books: "How to Make Money in Radio-Television," PLUS my new illustrated Television Bulletin PLUS an actual sample Sprayberry Lesson—all FREE with my compliments. No obligation and no salesman will call on you. Send the coupon in an envelope or paste on back of post card. I will rush all three books at once!

SPRAYBERRY ACADEMY OF RADIO
Dept. 25-F, 111 North Canal St., Chicago 6, Ill.

**Mail
Coupon
Today!**
NO OBLIGATION
No Salesman
Will Call

SPRAYBERRY ACADEMY OF RADIO, Dept. 25-F
111 North Canal St., Chicago 6, Ill.

Please rush to me all information on your 10-MONTH Radio-Television Training Plan. I understand this does not obligate me and that no salesman will call upon me.

Name..... Age.....

Address.....

City..... Zone..... State.....

Please check Below About Your Experience

Are You Experienced? No Experience

IF YOU ARE EXPERIENCED IN RADIO Men already in Radio who seek a short intensive 100% TELEVISION Training with FULL EQUIPMENT INCLUDED are invited to check and mail the coupon at the right.

The New Astatic
"TWIN CAC"
THE INDUSTRY'S FIRST MAJOR ADVANCEMENT
IN TURNOVER TYPE
PICKUP CARTRIDGES

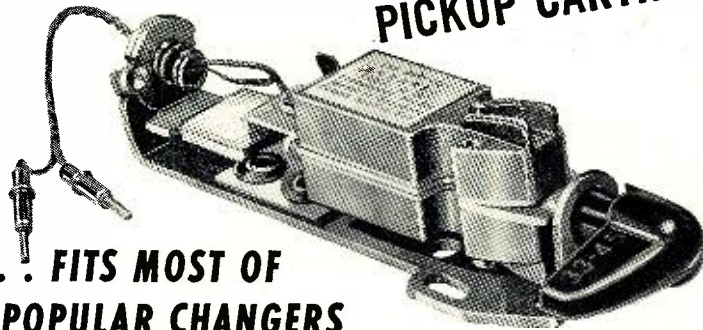

**... FITS MOST OF
 THE POPULAR CHANGERS**

INTERACTION between the two needles has long reduced the performance quality of conventional designs in turnover pickup cartridges. Another difficulty has been that, if output and response characteristics are made ideal on one side, for one record type, reproduction on the other side is poor; so a compromise has to be made. It took a revolutionary new design in turnover cartridges to eliminate these problems . . . and that is exactly what Astatic engineers have come up with. The new "Twin CAC," Astatic cartridge model CAC-D-J, is the first turnover unit offering unlimited reproduction clarity, fidelity and brilliance of tone. It is the equal of the finest single-needle cartridge of them all, Astatic's own famous CAC-J.

LIST PRICE \$10.50 Code ASXDJ

FEATURES

- 1** Basic design principle combines two complete CAC assemblies, back to back, on a common plate.
- 2** Output and response characteristics of each side established independently of the other: 0.8 volt at 1 kc. on Audiotone 78-1 Test Record and 0.7 volt on RCA 12-5-31-V Test Record. Frequency range, 30 to 11,000 cycles.
- 3** Needles are, of course, entirely independent of each other, free of interaction. Needle pressure, 10 grams.
- 4** Unique but simple switching device in turnover mechanism connects only the cartridge or side being used to amplifier phonograph input.
- 5** Furnished complete with turnover bracket and knob assembly, with standard 1/2" mounting holes. Wiring terminating in pin connectors, graduated for two dimensions now standard on lead wire connectors. Easily installed without soldering.
- 6** Equipped with Type Q (3-mil) and Type Q-33 (1-mil), sapphire tipped needles.

Write for complete details on the new Astatic "TWIN CAC" Turnover Cartridge. Ask also about the three new Astatic Pickup Models now available complete with this superb new cartridge.

EXPORT DEPARTMENT
 401 Broadway, New York 13, N. Y.
 Cable Address: ASTATIC, New York



Grand Ave., El Segundo, California. Its present facilities in Los Angeles will be used for research and development work . . . An application engineering office, designed to service Midwestern accounts, has been opened by **SPRAGUE ELECTRIC CO.** at 3 E. Second Street, Dayton, Ohio . . . **RAYTHEON MANUFACTURING COMPANY** has leased a new one-story brick plant on Seyon Street in Waltham, Massachusetts to house sections of its research, engineering, and manufacturing divisions . . . **HOFFMAN RADIO CORP.** has acquired a one-story fireproof building immediately adjacent to its No. 5 plant at 6200 S. Avalon Blvd. in Los Angeles . . . **SWEDLOW PLASTICS COMPANY** has begun construction on its third manufacturing facility in Los Angeles. The new plant, which will provide 36,000 square feet of floor space, will be used as general offices and for manufacturing.

* * *

E. W. MERRIAM has been named service manager of the Radio and Television Division of *Sylvania Electric Products Inc.*



He was recently affiliated with the Radio - Television Manufacturers Association as service manager, and for two years prior to that was chairman of the RTMA Service Committee. He was formerly associated with the *Allen B. Du Mont Laboratories* as service manager.

In his new capacity as service manager, he will be responsible for all service activities including the supervision of a nationwide organization of parts distributors and service contractors handling *Sylvania* products.

* * *

ROGER E. GAY, president of *The Bristol Brass Corporation*, has been elected president of the American Standards Association . . . *Hytron Radio & Electronics Co.* has recently promoted **GEORGE DETERS** to the post of sales manager in the Midwest section . . .

HERMAN S. SACKS has been named to the newly-created post of assistant general sales manager of *Bendix Television and Radio* . . . The appointment of **PAUL HINES** as director of engineering for *The Workshop Associates* has been announced by the parent firm, *The Gabriel Company*. He will be in charge of the company's newly-announced laboratory now being built in Natick, Massachusetts . . . **GUS W. WALLIN** is the new vice-president in charge of engineering at *Webster-Chicago Corporation* . . . **FRANK H. EDELMAN**, formerly chief chemist for *International Resistance Co.*, has been named technical director of the Resistor Division of *Electronic Devices, Inc.* . . . **REAR ADMIRAL T. A. SOLBERG, USN (Ret.)** has been named general consultant to *Arma Corporation*, manufacturers of precision electronic and mechanical equipment for the Armed

(Continued on page 94)

WHAT DO YOU LOOK FOR IN TV TEST EQUIPMENT?

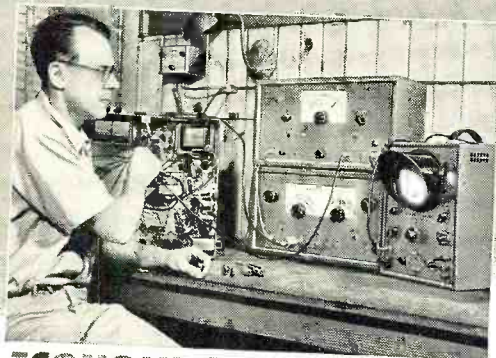
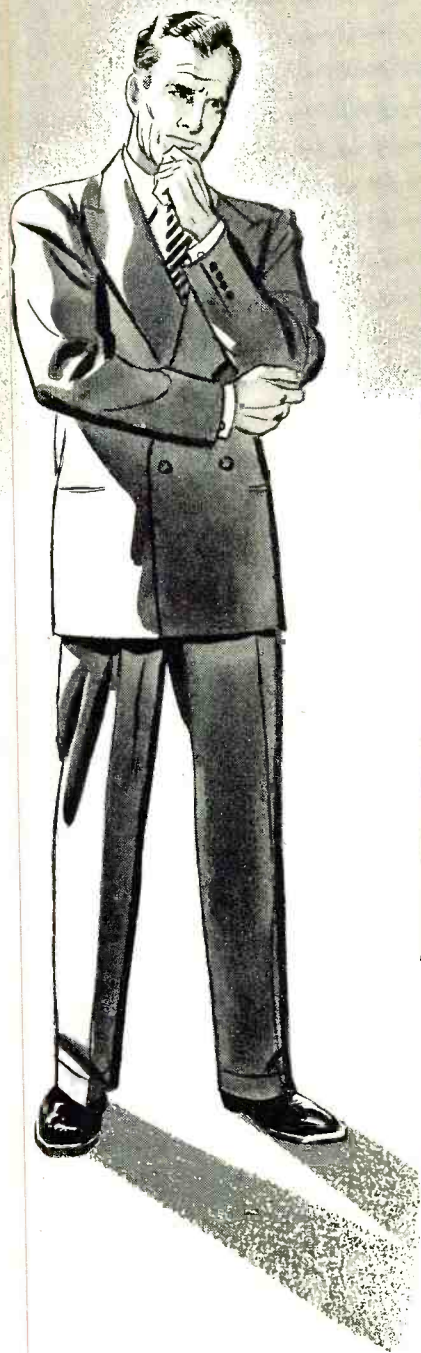

ECONOMY? "I look for long-range value. My 21 years in the electronics business have taught me that G-E instruments outperform them all." *Harold Robbins, Paramount Radio & TV Service, Des Moines.*



COVERAGE? "I don't have to buy new equipment to service UHF. These G-E units cover everything and cut my costs in half." *Ralph L. Crooks, Boulevard Radio & Television Co., Kansas City, Mo.*



RELIABILITY? "No guesswork, no re-checking with my General Electric Test Package. It does the job right the first time." *Warren Herbicek, Herbicek & Mathews, Newton Square, Pa.*

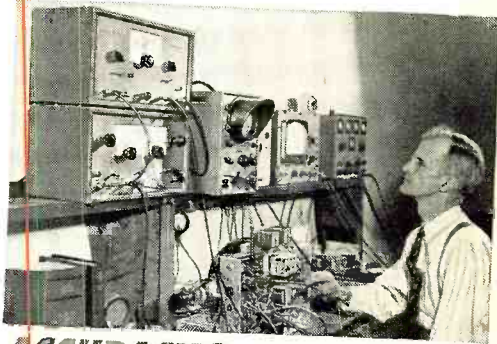

ACCURACY? "The combination of crystal controlled markers and variable permeability sweep gives us true alignments with fewer call-backs." *Tom Jacobs, Apex Radip Shop, Detroit, Mich.*

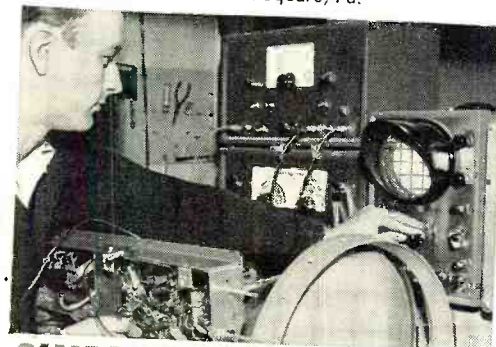

SIMPLICITY? "Easy to operate, these G-E units increase our work output per man, cut training problems and boost profits." *Charles Floring, Syracuse Electronics Corp., Syracuse, N.Y.*

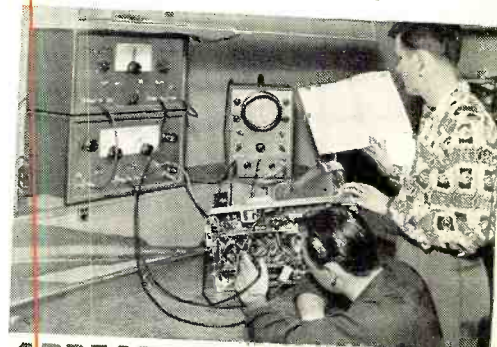

APPEARANCE? "Customers have confidence in our clean, business-like shop. General Electric test equipment helps keep it that way." *J. H. Sampson, Sampson Television, Inc., Dayton, Ohio.*

YOU GET THEM ALL WITH GENERAL ELECTRIC

• You can't afford to invest in TV test equipment that doesn't pay its way, with 15 million TV sets in use, and new UHF stations coming up. The successful businessmen shown above know the importance of this; read what they say.

REMEMBER: General Electric makes TV Test Equipment that covers *both* VHF and UHF. Hence, you have only *one* investment when you buy G-E.

General Electric Company, Section 922
Electronics Park, Syracuse, N. Y.

Please send me the latest bulletins on
General Electric Test Equipment.

NAME _____

ADDRESS _____

CITY _____ STATE _____

GENERAL  **ELECTRIC**

hallicrafters

new communications "TOOL" for industry!

the

littlefone®

2-WAY FM RADIO-TELEPHONE



10 lb. lower powered models also available

HAND CARRY

HT-21 (25-50 Mc.)
HT-22 (150-174 Mc.)

- FULL TWO-WATT ANTENNA OUTPUT*
- Weighs only 14 pounds!
- Complete, self-contained 2-way radio-telephone station!
- Powered by Dry, or Wet Rechargeable Batteries (can be recharged from car battery or 117 Volts AC)
- Rugged, weatherproof
- 22 sub-miniature tubes!

*On 25-50 Mc. • One-Watt output on 150-174 Mc.

CENTRAL STATION

HT-23 (25-50 Mc.) HT-24 (150-174 Mc.)

Same performance and specifications as the "Littlefone" Hand Carry.

- AC-operated Central Station
- Audio-amplifier, providing one watt of audio for loudspeaker
- Power consumption is 35 watts
- Plugs in any AC outlet (117 Volts)

Where one or more extra stationary receiving stations are desired, Hallicrafters economical S-81 receivers may be added.

A new Hallicrafters product—the "littlefone"—is now ready for thousands of important uses in hundreds of industries.

This light, rugged, dependable radio-phone will be offered through Hallicrafters distribution organization—by the men who know communications best.

USES OF "LITTLEFONE" CHALLENGE YOUR IMAGINATION!

There are literally thousands of industrial uses for the "littlefone" radio—anywhere where powerful, dependable, "on the move" contact is required.

AMONG THE MORE IMPORTANT PRESENT USES ARE:

- RAILROADING
- FREIGHT HANDLING
- WAREHOUSE OPERATIONS
- RANCHING & LARGE FARMS
- MINING (Above & Below Ground)
- PIPE LINE INSPECTION
- ROAD BUILDING
- SHIPPING (Dock Operations)
- CONSTRUCTION
- LUMBERING



hallicrafters
"The Radio Man's Radio"

World's Leading Manufacturer of Precision Radio and Television — Chicago 24

RADIO & TELEVISION NEWS

AVOID RESISTOR BREAKDOWNS



OHMITE LITTLE DEVIL RESISTORS

Provide EXTRA MARGIN of SAFETY

Where dependability is of the utmost importance, play safe with Ohmite Little Devil molded composition resistors. While they are tiny in size, these units have exceptional ruggedness, stability, and current carrying capacity. Little Devils are completely sealed and insulated by molded plastic. Under continuous full load for 1000 hours, their resistance change is less than 5%.

Ohmite Little Devils are available in 1/2, 1, and 2-watt sizes, in $\pm 5\%$ or $\pm 10\%$ tolerance. Standard RTMA values, 10 ohms to 22 megohms are furnished. In the 1-watt size, $\pm 10\%$ tolerance, values as low as 2.7 ohms are provided.

AVAILABLE ONLY FROM YOUR DISTRIBUTOR

OHMITE MANUFACTURING CO.

4883 Flournoy Street, Chicago 44, Ill.

- **RATED AT 70C**—Little Devils have a wide margin of safety—being rated at 70C instead of 40C.
- **WITHSTAND TEMPERATURE, HUMIDITY**—Meet all JAN-R-11 requirements, including salt water immersion and humidity tests.
- **RESISTANCE AND WATTAGE CLEARLY MARKED**—In addition to color coding, the resistance value and wattage are marked on every unit.
- **TEMPERED LEADS**—Tinned copper leads are differentially tempered to prevent sharp bends.

Be Right with **OHMITE** [®] RHEOSTATS
RESISTORS
TAP SWITCHES

Now in **MASS PRODUCTION...**

PYRAMID ULTRA-COMPACT
metallized
paper capacitors

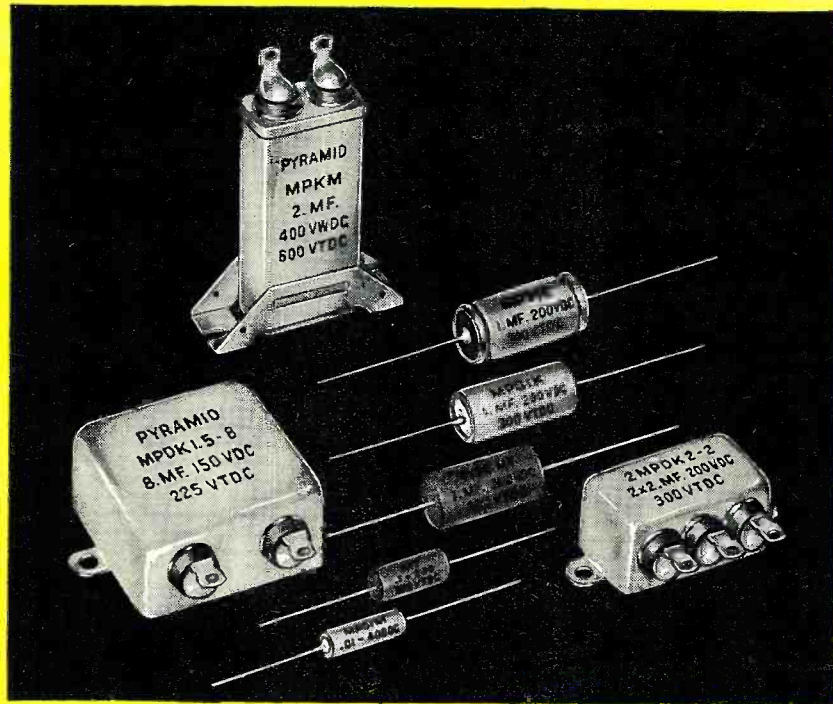

PYRAMID Series M CAPACITORS use a specially-prepared metallized paper, providing all-important savings in size and weight... Pyramid now produces large quantities of these capacitors in a wide variety of cardboard or hermetically sealed metal containers.

Your letterhead inquiries are invited



PYRAMID ELECTRIC COMPANY • 1445 HUDSON BLVD., North Bergen, N. J.

A PROFESSIONAL TYPE GEIGER COUNTER

By

LOREN C. WATKINS, Jr.

W5JXO

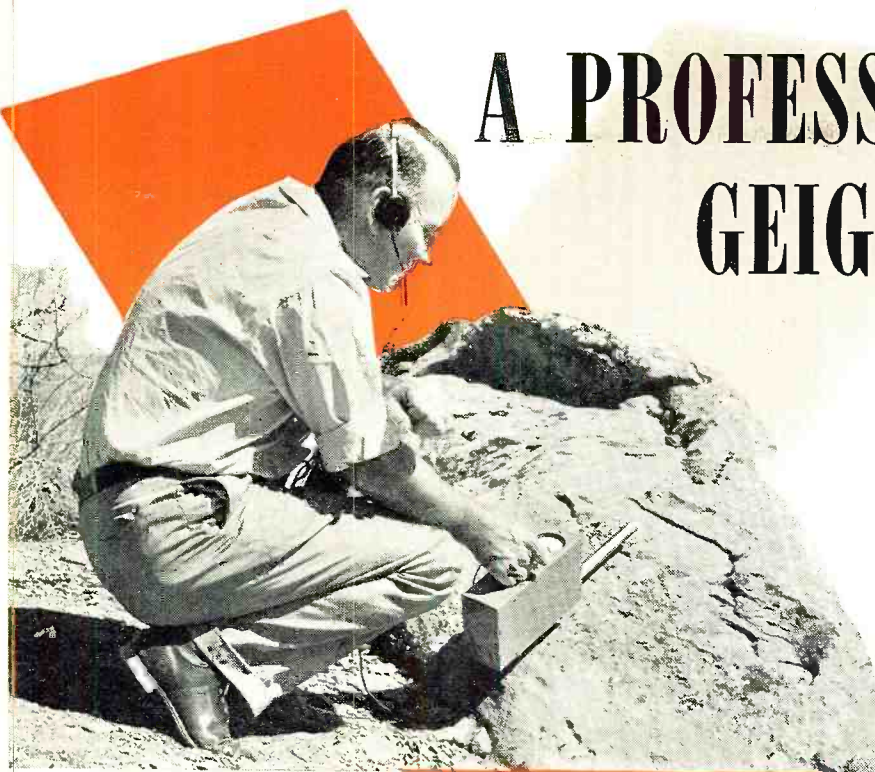

Fig. 1. W5WRS demonstrates how counter is used in making field tests.

Construction details on a thoroughly tested and practical low-cost counter which is easy to build.

INTEREST continues at a high level in the matter of prospecting for uranium deposits. The \$10,000 bonus, and other attractions, offered by the Atomic Energy Commission has been enough to awaken the gambling instinct in large numbers of us. The amateur or professional electronics engineer, or technician, is in an excellent position to construct the necessary Geiger-Mueller detector unit.

Field experience has established several points for consideration. The counter should be as small and lightweight as possible. The layout of operating controls and physical construction of the unit should be such that the maximum of convenience is enjoyed in its use, and the chance of physical damage slight.

A direct and fairly accurate indication of the G-M tube high voltage is most useful, so that the voltage may be checked with the data furnished by the tube manufacturer, and the operating point of the tube kept on the Geiger plateau. In this same respect, and to compensate for battery aging, a variable control should be included for adjusting the high-voltage output of the power supply.

Headphones, of course, should be provided as they will normally be used when searching with the instrument. Their response to an increased count

is immediate and the indication unmistakable. A meter should be included for indicating the integrated counting rate, and switched to act as a high-voltage indicator.

Several types of portable high-voltage power supplies have been devised and exploited commercially for G-M counter use. Each circuit has its particular advantages and disadvantages; however, it appears that two of the more successful arrangements to date are the vibrator type and the neon-

ORE SAMPLES

Radioactive ore samples, suitable for testing purposes, may be obtained from Earle E. Fletcher, 2908 N. Sandia Dr., Albuquerque, N. M., for 25 cents postpaid.

oscillator type. Either circuit is good and will perform in an excellent manner.

The present article will be confined to a description of the construction of a neon-controlled type counter and the reader is referred to the bibliography for sources of additional information relating to the use of G-M counters in prospecting and circuits in general.

The particular counter described here, and shown in the photographs, is the handiwork of Earle Fletcher, W5WRS, who doubles as an electronics engineer and amateur prospector. The

unit contains no special, hard-to-get components and is easily duplicated by the average technician. The batteries are of the type commonly used in personal-type radios and are readily available at low cost in nearly any locality. They consist of two series-connected 67½ volt "B" batteries and three parallel-connected standard flashlight cells.

Reference to the circuit diagram of Fig. 2 will show that voltage is applied to only one-half of the filament in V_1 and V_2 . The battery drain is thereby cut in half and no decrease in performance is detectable in this circuit application.

V_1 and associated components form the oscillator stage. "B" battery voltage is supplied to the type NE-2 neon lamp through R_1 , and C_1 is the neon lamp shunt condenser. The saw-tooth grid signal for V_1 is generated by the voltage rise across C_1 and the sudden drop when this voltage reaches the ionization potential of the gas in the NE-2 lamp. The complete cycle is repetitive at a rapid frequency rate, on the order of 800 cps in this instance.

The saw-tooth voltage applied to the grid of V_1 causes a rapid change in its plate current, which induces large voltages across the winding of the high inductance choke, T_1 . In this particular case, the choke is actually an audio interstage transformer with the primary and secondary connected in series aiding. This induced fluctuating voltage is then rectified by the cold-cathode gas rectifier tube, V_2 , and smoothed by the resistance-capacity network, C_2 , R_2 , and C_3 , which reduces the ripple to an insignificant value.

The variable resistor, R_3 , controls the high voltage output of the power supply over a range of about 500 to 1250 volts, with new batteries in use. This resistance in the plate circuit of V_2 acts to vary the efficiency of the circuit. As the batteries age, the control is adjusted to insert less resistance in the circuit, thereby increasing the efficiency, and permitting operation at 900 volts output until the batteries are expended. This point will have been reached when the battery voltage drops from its original 135 volt value to about 95 volts. The output voltage changes slightly with aging of the filament batteries, until they have dropped from the original 1.5 volts to about 0.8

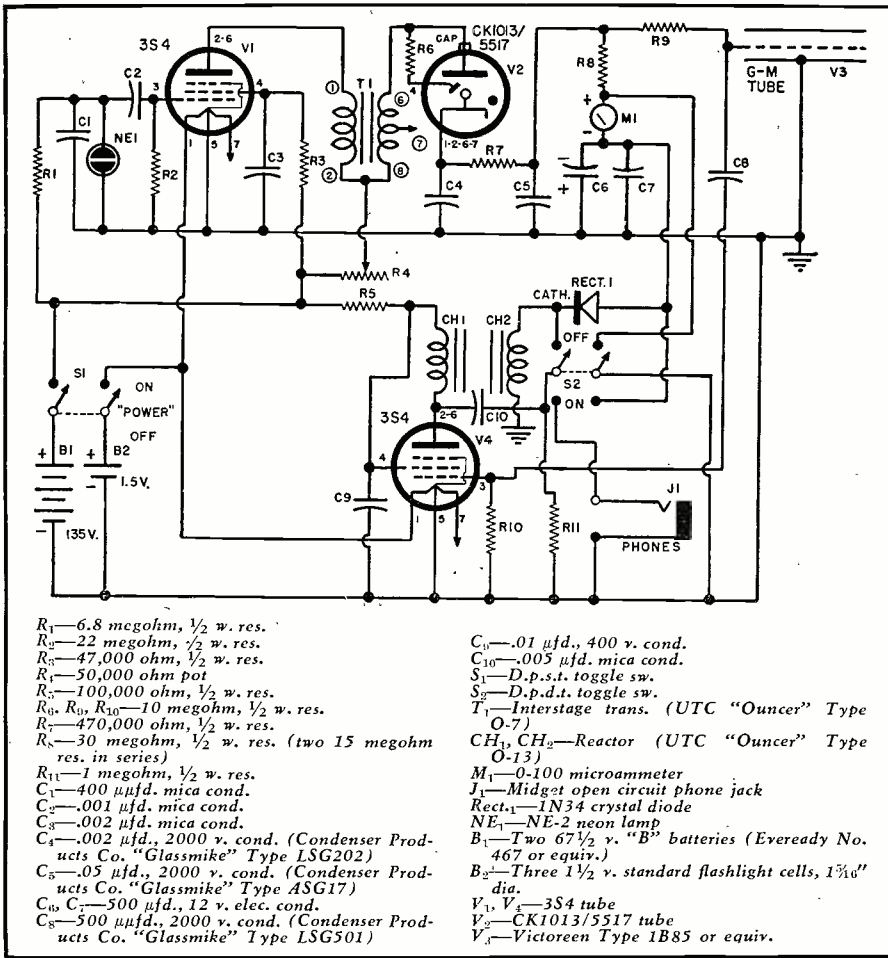
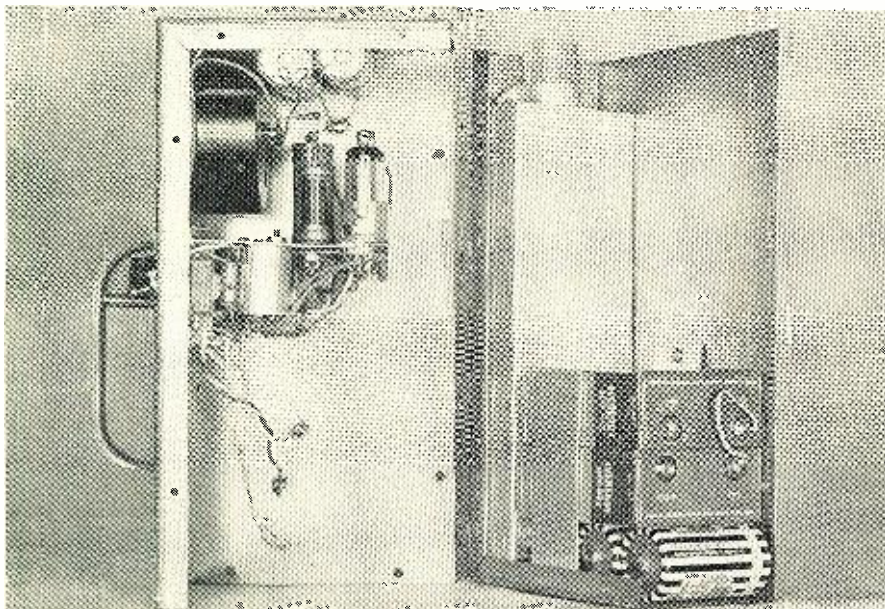

Fig. 2. Complete circuit diagram and parts list for the professional type counter.

volt. The output voltage regulation, as a function of the external load, is quite adequate for a G-M tube having a normal flat-plateau characteristic. If the tube does not have a flat characteristic, and at unusually high counting rates, the voltage is readjusted to the proper operating potential by varying the output control, R_1 , slightly.

The amplifier stage, V_4 , has a switch in its output circuit so that either headphones or the meter, M_1 , may be used to monitor the count. The signal pulses from the G-M tube are coupled into the signal grid of V_4 via C_8 . The amplified pulses appear across the plate circuit inductance, CH_1 , where they are capacitively coupled to the

Fig. 3. Completed assembly view showing sub-chassis and battery mounting details.



indicating circuit. The "phones" switch, S_2 , is connected so that in its "on" position the headphone jack, J_1 , is connected across the output of V_4 , allowing individual pulses to be counted. Stray circuit capacity from the neon oscillator and associated circuits provides a weak audio tone in the V_4 amplifier output, serving nicely as an indication that the instrument is operating, and that the batteries are not expended.

In the same switch position, the negative terminal of M_1 is returned directly to ground. The meter, therefore, is effectively connected in series with the bottom end of the high voltage bleeder resistor, R_9 , to ground, and provides an accurate indication of the power supply output voltage. This assumes that the bleeder resistance value is accurately known. For example, if the bleeder resistance is 30 megohms, an indicated current of 30 microamperes requires the presence of 900 volts at the top of the bleeder, according to Ohm's Law. Other current values are interpreted accordingly, as the voltage output control is varied.

When S_2 is thrown to its "off" position, the headphones are disconnected and the amplifier output is connected into the 1N34 rectifier circuit. The rectified pulses are fed to the integrating condensers, C_6 and C_7 , which allows the meter to indicate the average counting rate. The other side of S_2 has now connected the positive terminal of the meter and the bottom of the bleeder resistance, directly to ground, thereby removing the meter from the bleeder circuit.

It is unnecessary to provide a scale on the meter other than its original calibration, as the instrument is used mainly in a relative sense, with the background count as the reference.

The high voltage adjustment control should not be advanced to a position where the voltage applied to the G-M tube is great enough to cause it to "spill" or discharge continuously. A reduced G-M tube life will be the result.

Construction

Figs. 1, 6, and 7 show the over-all appearance of the counter. When the unit is not in use the search probe is pushed down into the case. The probe is pulled about three-quarters of its length from the case for normal use, and is removed completely for exploring otherwise inaccessible areas. The probe is a 10-inch length of thin wall brass tubing, $\frac{7}{8}$ -inch outside diameter. Seven $\frac{1}{2}$ -inch diameter holes are drilled in a straight line through one side of the brass tube. The delicate G-M tube is floated inside the brass shell by wrapping several layers of *Elastoplast*, an elastic adhesive bandage material, around the tube at each end so that it is a snug sliding fit for the inside of the shell. Rubber corks are then forced tightly into each end of the tube and trimmed off flush. The cork that goes into the cable end of the probe should be of the type that has a center hole in it, so that the cable is

grasped firmly when the cork is pushed into place, thereby relieving any strain on the G-M tube connections when the probe is moved about. The cable is made about four feet in length and should be of the small lightweight type, single conductor and shield braid, with an outer insulating cover. It is pushed down into the case when the probe is not completely removed.

As partially seen in Fig. 3, the probe housing in the case is a 5-inch length of lucite tubing, with an inside diameter very slightly greater than the outside diameter of the brass probe, for a free sliding fit. The lucite tube is held to the rear of the case by two U-shaped brackets. The bracket mounting bolts are tightened sufficiently to deform the lucite tubing just very slightly so that enough friction is maintained against the probe to prevent its accidentally slipping out of the case. A hole is cut in the end of the metal case to permit insertion of the probe.

The case itself may be easily fabricated from a standard 10x12x3 inch aluminum chassis. Refer to Fig. 5 and cut the chassis as indicated. The result will be two pieces, 10 inches long and 5 inches wide, as seen in Fig. 3. In the same photograph, if the two halves of the cabinet are thought of as the pages of an open book, and then merely folded together, the case will appear in its final form. Two holes, for self-tapping metal screws, are drilled in each lip of the two halves. An aluminum tray, 8x2 $\frac{3}{4}$ x1 inches, is bent up from sheet stock to provide a battery platform over the probe housing. The batteries are held in place by a single strap, as shown in Fig. 3. The "B" batteries are already provided with snap connectors, and connecting wires are merely soldered to the three parallel flashlight batteries. Spring clips are out of the question in the available space, and are very liable to develop high resistance contacts.

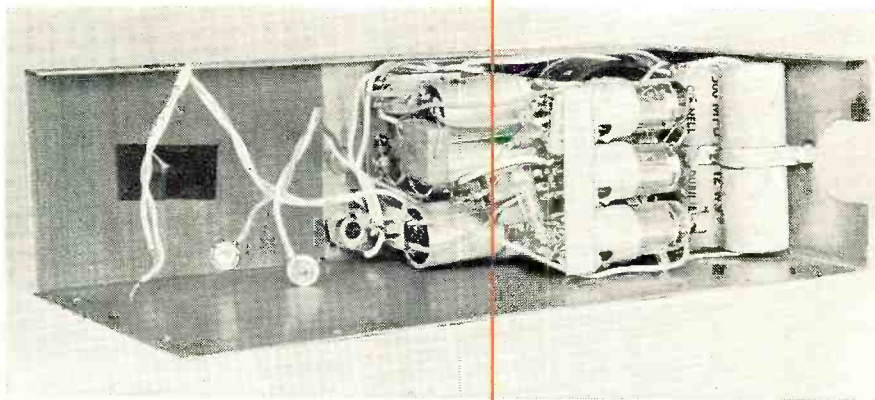

Fig. 4. Rear view of instrument. Construction is compact but easy to service.

Thin strips of insulating board are slid in behind each end of the flashlight cells for protection against accidental short-circuiting. A third strip, approximately 4 $\frac{1}{4}$ x2 $\frac{3}{4}$ inches, is cut for a snug fit in the opposite half of the case, as seen in Fig. 4, to prevent short-circuiting the exposed "B" battery terminals when the case is finally assembled. The mounting screw for the lower end of the handle passes through the strip, and the exposed nut is covered by a piece of electrical insulating tape.

A hole is punched in the probe end of the case to accommodate the outer diameter of the lucite probe-sleeve, which projects through the case about $\frac{1}{8}$ -inch. A 2 $\frac{3}{8}$ -inch hole is cut in the top face of the case for the meter. The round 3-inch meter had to have its mounting flange sawed off on two sides so that it would fit into the case. A piece of lucite 2 $\frac{3}{4}$ x3 $\frac{1}{2}$ inches, and $\frac{3}{16}$ -inch thick, is placed between the glass meter face and the case, to provide protection against accidental breakage of the meter glass. A hole is drilled in the lucite to allow access to the meter zero-adjustment screw. The machine screw which passes through the upper

(Continued on page 160)

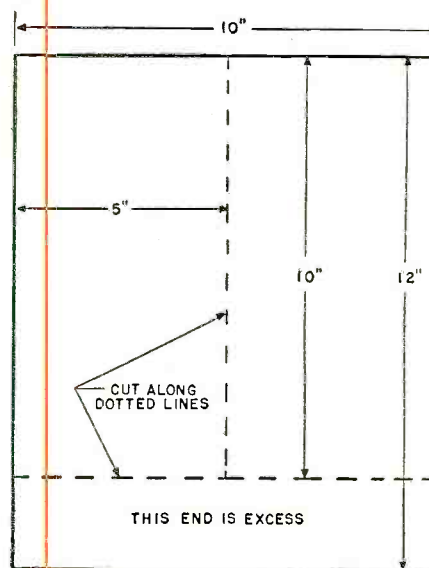
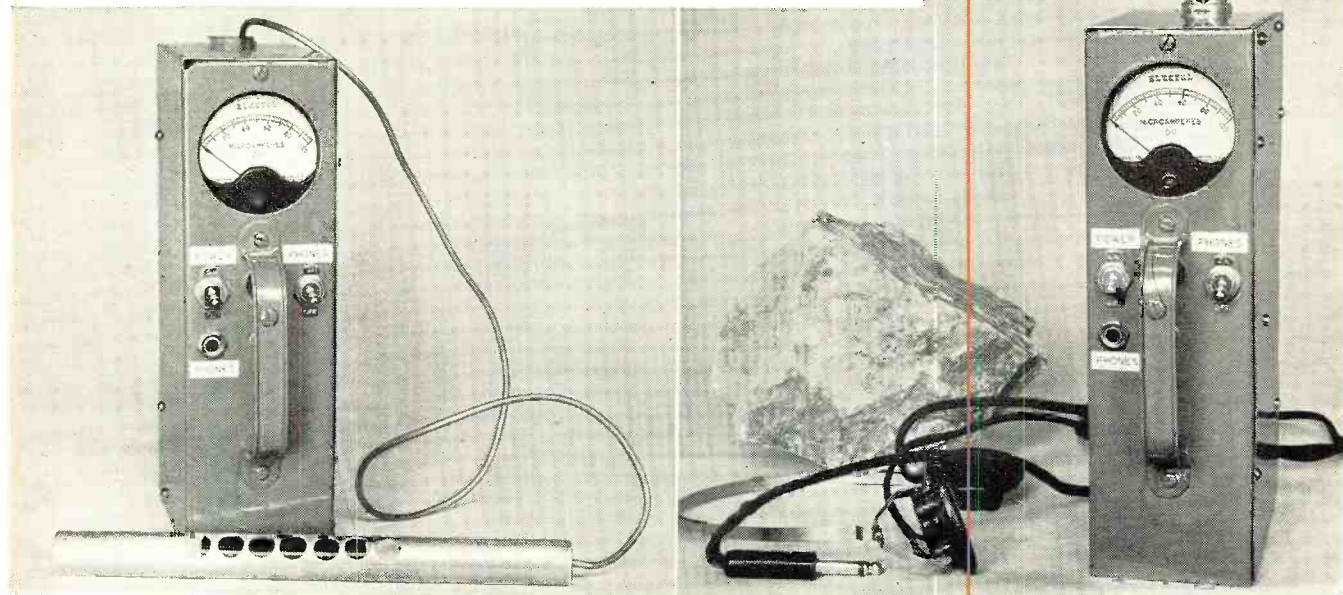

Fig. 5. Method for cutting standard 10"x 12"x2" chassis to provide case for counter.

Fig. 6. Front view showing search probe partially extended.

Fig. 7. Front view with probe completely removed from case.



A High-Quality

AUDIO AMPLIFIER

By

EDW. S. MILLER

Chief Engr., The Radio Craftsmen, Inc.

Commercial version of the Williamson amplifier, the Radio Craftsmen Model 500.



ALTHOUGH the now-famous Williamson all-triode amplifier circuit, originally described in 1947, has been reproduced in the literature many times with various modifications, only recently has a complete amplifier based on this circuit been manufactured commercially. This chassis, known as the Craftsmen 500, was designed by *The Radio Craftsmen, Inc.*, Chicago. In the design, particular emphasis was placed on a unit that not only provided good operation over the range from 20 to 20,000 cps but also could be manufactured with consistent performance characteristics. Some of the many factors considered in this design are described.

Circuit Modifications

The Williamson all-triode circuit, which includes a direct-coupled, split-load phase inverter feeding triode drivers and class A operated triode output tubes, is notable for its basic simplicity. Even without feedback, this amplifier provides the characteristics of an extremely high-fidelity amplifier.

It was found desirable to make modifications in the original circuit in order to obtain optimum performance and increase manufacturing margins to insure meeting specified characteristics on all units.

In one modification of the circuit, the center tap of the heater string is re-

turned to the positive voltage appearing at the output tube cathodes. In this way the application of positive bias to the heater of the first 6SN7GTA reduces the flow of heater-cathode or heater-grid "hum" currents so that a hum and noise level of 90 db or more below rated output is maintained for the amplifier.

By referring to the schematic diagram (Fig. 2) it will be noted that the output tube cathode resistance has been split into two matched 400 ohm resistors connected at the cathodes with a removable link. Use of this linked resistor pair not only greatly simplifies the adjustment of the bias and balance of the power output tubes but also increases the accuracy of the operation with commonly available metering equipment. In making the adjustment, the link is temporarily

opened while a voltmeter is connected between the two output-tube cathodes. R_{10} is now adjusted for a zero reading on the meter. Now with the meter across either 400 ohm resistor, R_{20} is adjusted for a 25 volt reading. The link is now replaced for normal operation. Each KT66 is now operating with the correct bias for exactly $62\frac{1}{2}$ ma. plate current, which with 400 volts d.c. from plate to cathode, represents a plate dissipation of 25 watts.

Further modifications were also made to improve performance near the extremes of the operating range. They are described below.

KT66 Output Tube

The unusually low-distortion and excellent damping action obtained with this amplifier can be attributed to the use of class A operated triodes throughout the circuit along with the application of 20 db inverse feedback around the entire amplifier. For the output stage, beam tetrode type power output tubes are used connected as push-pull triodes and matched to 10,000 ohms plate-to-plate for a very low distortion class A operation. An additional advantage is obtained with the use of this type tube in that only a relatively low grid voltage is required to drive the tubes to full output; this amount of driving voltage is easily obtainable from a resistance-coupled 6SN7GTA.

Various tube types have been used for this stage and the resulting operating performance of some typical tubes are given in tabular form for the convenience of the reader. The higher power output and adequate ratings, as shown in the chart, confirmed the choice of the KT66 for the output stage as used in the original design.

In any feedback amplifier, one of the

Complete data on a commercially built Williamson amplifier which uses special low-distortion tubes.

Fig. 1. (A) Gain-frequency and (B) phase-frequency characteristics of amplifier.

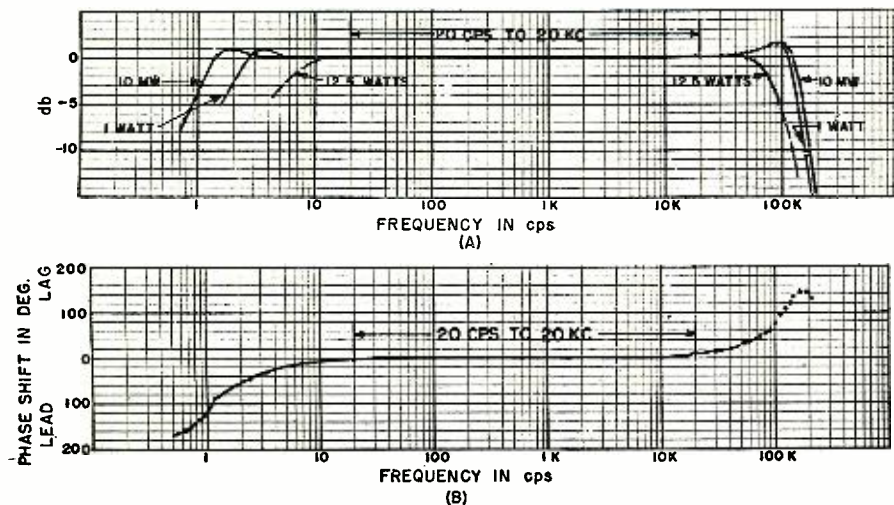

most important measurements of the amplifier's performance is its margin of stability. In order to eliminate variations in amplifier performance throughout its operating frequency range, this margin must be as great as possible for the amount of inverse feedback being used. Of course, the most important component determining this margin of stability is the output transformer. Out of numerous transformer designs tested, the design finally selected had interleaved windings, 120 hy. primary inductance, 25 mhy. leakage inductance, and full power output from 10 to 50,000 cps. The other circuit components determining the degree of stability margin are investigated by considering first the low frequency range operation, and then operation through the higher frequencies.

Low Frequency Operation

Because of the unusually flat gain characteristic and low phase shift required throughout the frequency range of 20 to 20,000 cps, the amplifier operation necessarily should be checked over the entire range of 1/2 cps to 2 mc. to insure conservative stability margins.

Components determining the low frequency performance are, besides the transformer primary inductance, the four interstage coupling condensers and their associated grid input resistances, and the power supply filtering or decoupling components. The power supply component values do not appreciably affect the amplifier operation in any frequency range except for a 20° phase correction furnished by R₂₇, C₁₁, and R₇, C₁₀ at 2 cps.

The greatest stability margin in any feedback amplifier design is obtained by staggering the time-constants of the interstage coupling networks. Thus, improved low frequency stability was accomplished by altering the values of these interstage coupling components from those found in the original design: R₉, C₂ and R₁₀, C₃ in the schematic each has the same time constant of 0.2 sec., R₁₄, C₄ = R₁₈, C₅ = .01 sec., and L_p (120 hy.) / R_p (2500 ohms in parallel with 10,000 ohms = 2000 ohms) = .06 sec. The first amplifier stage, being d.c. coupled, is not a factor to be considered because of its infinite time constant.

Low frequency performance is further complicated by the fact that the primary inductance, L_p, is not constant but varies with both signal level and d.c. saturation, according to the characteristics of the transformer core. In order to minimize this effect, the transformer was designed with a large core utilizing high-permeability laminations, stacked to provide a higher than normal air gap. The result of these precautions was a considerable increase in the margin of stability throughout the low-frequency range as compared to previous designs based on the Williamson circuit.

On the high end of the operating frequency range, the transformer characteristics again are the most important

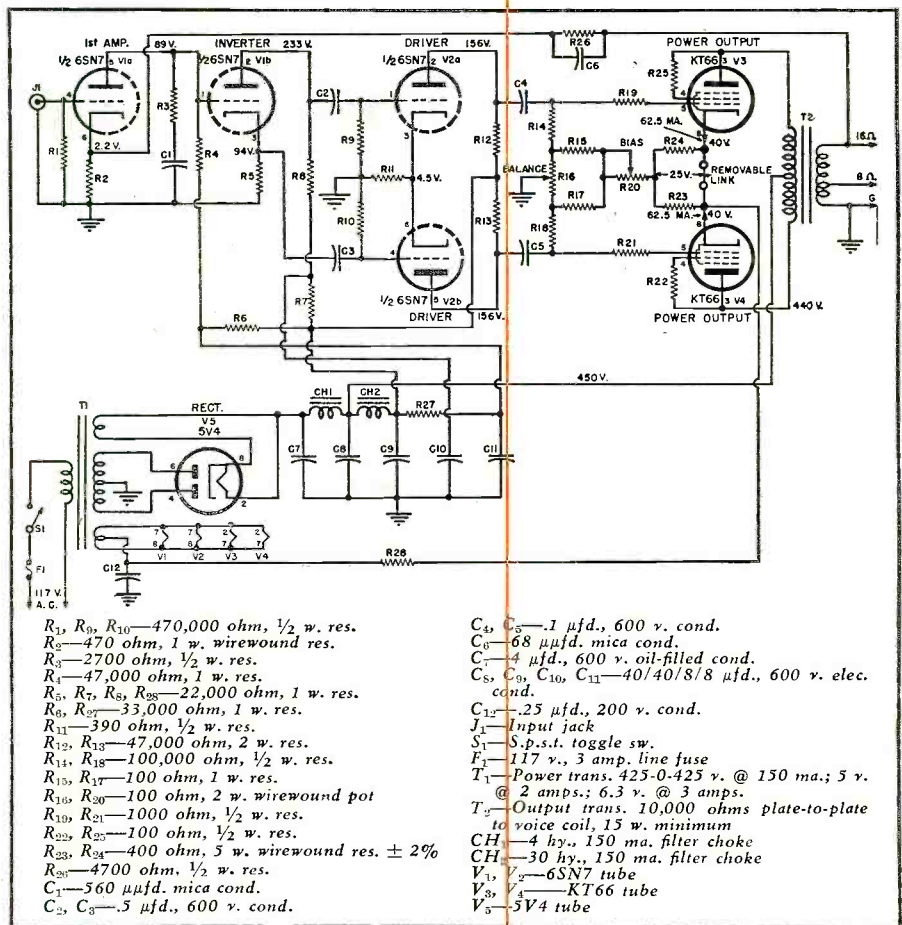

Fig. 2. Schematic diagram of amplifier. The KT66's specified on diagram are British tubes and may be difficult to obtain locally. Suitable substitutes are given below.

factors in determining the stability margins. Considerable care was used in selecting the transformer from numerous high-fidelity designs, considering both stability and frequency range. Analysis of the circuit operation for this range is not as simple as at low

frequencies. Although the 25 mhy. leakage inductance of the output transformer determines the frequency above which the amplifier gain begins to fall, the many, seldom-measured interwinding capacities and leakage inductances
(Continued on page 95)

Comparative ratings and operation of popular tubes used in the Williamson circuit.

	KT66	5881	6L6	1614	6AR6	807
Description	British tube with ratings higher than 6L6 and different characteristics	Tung-Sol improved 6L6 with higher ratings		Single-ended 807 but lower ratings	Radar power tube	Transmitting tube requiring plate cap
Socket Arrangement	Single-ended like 6L6	Single-ended like 6L6	Single-ended	Single-ended like 6L6	Single-ended but different	Plate cap
Manufacturers' Ratings: Plate Voltage (max.)	400 v.	400 v.	270 v. (screen rating)	375 v.	300 v. (screen rating)	400 v.
Plate Dissipation (max.)	25 w.	26 w.	19 w. (Triode Ratings)	19 w.	21 w. (controversial)	25 w.
G. O. L. Output†	10 w.	8 w.	8 w.*	8 w.*	10 w.*	8 w.

*Voltage and dissipation ratings inadequate for commercial dependability.
 †G. O. L. (grid overload) is level where grids just begin to draw current. With resistance coupling, distortion increases markedly beyond this point. Above readings are as operated in Williamson circuit: 400 v. plate; 25 w. dissipation; 10,000 p.p. load.

A LOW COST EXCITER UNIT



Author's operating desk. An NC-100X receiver is flanked by a 150-watt amplifier and two exciters (one covering ten meters and the other the 3-band unit described). A single sideband adaptor is also used with this equipment on 75 and 20 meters.

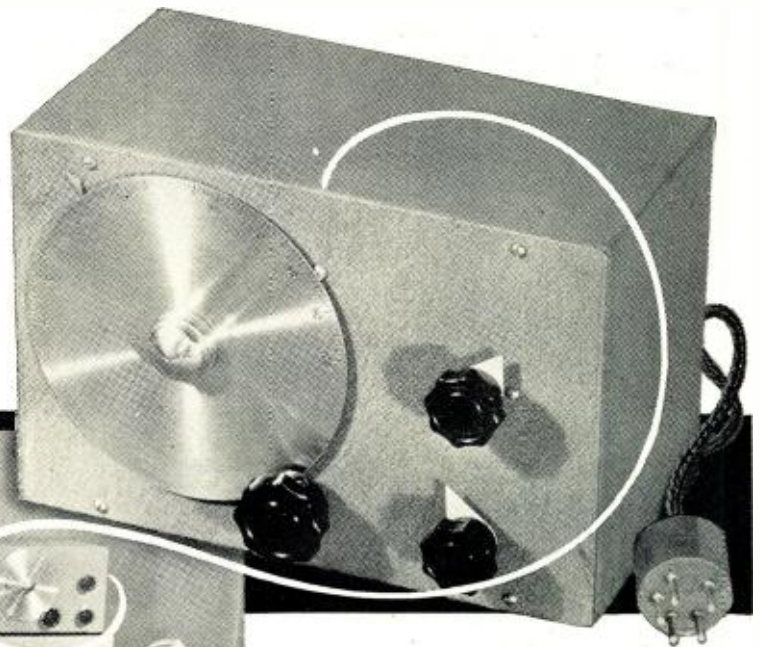

Front view of exciter. Frequency dial, a bandswitch (lower knob), and output trimmer (upper knob) are only controls used. Power supply is through shielded cable.

By
JOHN F. CLEMENS
W9ERN

This v.f.o. exciter gives one watt of output on 80, 40 and 20 meters with crystal-like stability. It features small size, low power consumption, and bandswitching with simple construction.

THE first requisite for a good radio signal is a good exciter. Variable frequency operation has now become accepted as a necessity by all avid amateurs and at the same time modern transmitting techniques, like single sideband, have set new standards of performance for the exciter. Many excellent commercial transmitters have achieved a degree of stability and flexibility which has frightened many hams out of the competition. It is the purpose of this article to show that equal results are not too difficult to obtain from equipment that anyone can duplicate with simple hand tools. The final result is an exciter which is simple to operate and should be free of instability, drift, TVI, and any of the other ills which have plagued all of us at one time or another.

If you would like to know before building the unit what kind of stability you can obtain from this design, here is a simple test to make on your present exciter as a comparison: Tune in your own signal with the receiver r.f. gain reduced to prevent overload and the b.f.o. switched on. Now alternately open and short circuit the r.f. output circuit of your exciter. Is there any frequency change shown by a change in the pitch of the signal? If so, your signal could stand some improvement.

This exciter shows no change in the beat note. An exciter such as the popular BC-459A is likely to give a poor account of itself with such a test since the isolation between output circuit and frequency determining circuit is quite small.

Drift is another problem due to temperature variations of the constants of the tuned circuits which control frequency. This problem can be attacked several ways but possibly the best way is to prevent the temperature variations rather than try to compensate for them. The first step in preventing temperature rise is the selection of tubes which have low heater power consumption since the heater wattage will often be the largest component of the total heat generated. The 6C4 triode is an excellent choice for the oscillator in this respect and it has other advantages as well. It has a large plate well spaced from the other electrodes. Wide interelectrode spacing is desirable to minimize microphonic effects which are due to vibration of the tube elements and the resultant capacity variations. All other tubes used in the exciter compartment are similarly chosen to provide the most gain and power-handling capability with the smallest possible heater drain. Tubes such as the 6F6, 6AG7,

and 6V6 should be avoided in the design of a compact unit since the heater of any of these tubes consumes enough power to cause temperature rises of twenty degrees or more in a small cabinet. Leave the power generation to the stages in the transmitter and let the v.f.o. concentrate on the job of controlling frequency—that's the easy way to stability.

Since every ham is not a "Village Smithy" we cannot all turn out those custom designed cabinets which are often essential to the electrical performance of high-grade commercial rigs. This exciter is constructed in a standard 9 x 5 x 6 inch steel utility box with a 7 x 5 x 2 inch aluminum chassis. Both of these items are inexpensive and generally available at radio stores. The oscillator shield compartment is built up of small pieces of 1/16 inch aluminum, each part being small enough so that the necessary bends can be made easily in a vise. This compartment is 3 inches higher than the chassis, 3 inches deep, and 3 3/4 inches wide. Number 4 self-tapping screws are used to fasten all metal parts together, providing a good electrical bond between parts of the shield as well as a very rigid mechanical assembly.

The circuit diagram and the photograph of the oscillator compartment will reveal a few of the more important constructional points which contribute to the over-all stability. The oscillator tube, first selected to generate the minimum amount of heat, is

RADIO & TELEVISION NEWS

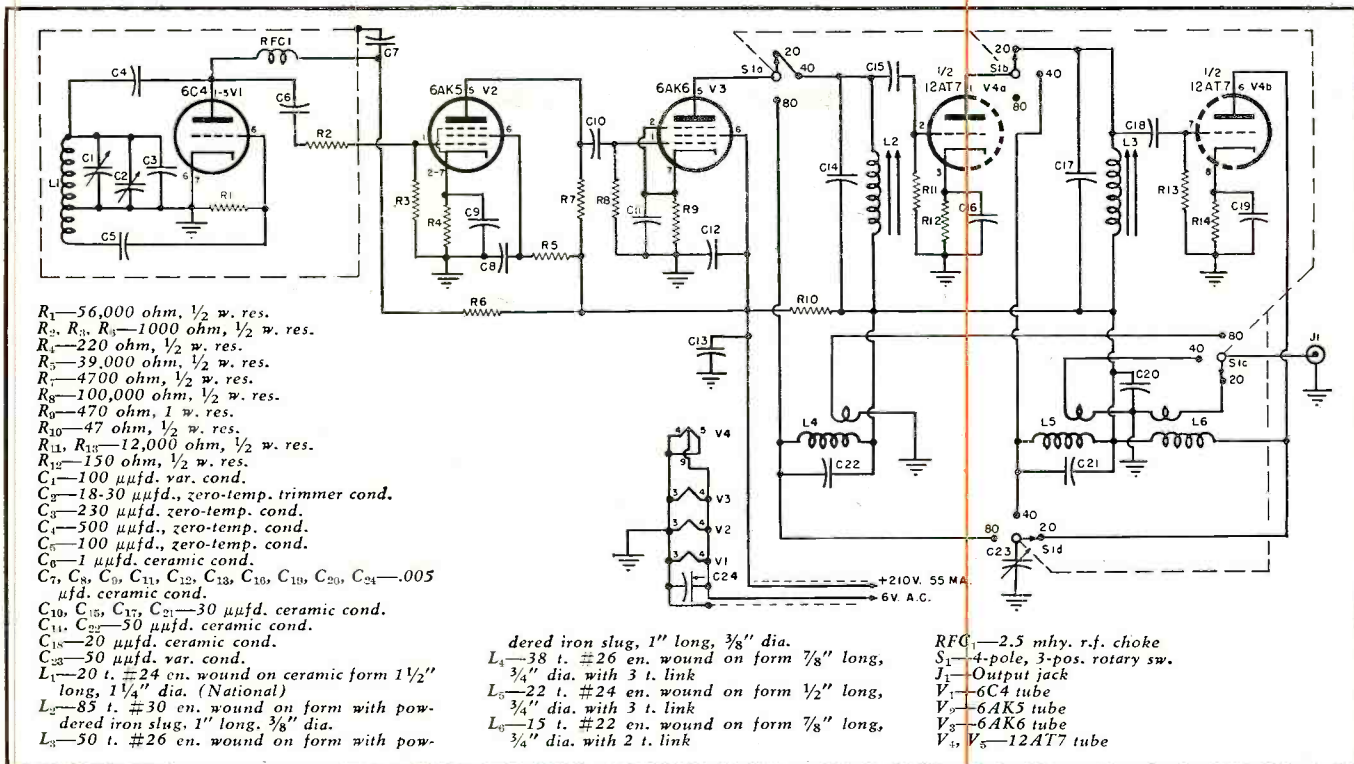

Circuit diagram of the exciter which provides output on 80, 40, and 20 meters with unusually high stability.

mounted outside the oscillator shield so that it is well ventilated to the back of the oscillator cabinet which is operated with the back open. Heat from the tube does not, therefore, reach the oscillator tuning condenser and coil which are completely shielded for r.f. A coil form should be used which has the best possible thermal stability and no other materials equal the ceramics in this respect. Plastic coil forms are to be avoided. After the coil is tightly wound, a thin coat of coil dope or cement should be applied to hold the wire in place. This procedure also provides a measure of protection against humidity effects on the coil, although there is not too much that can be done in simple equipment of this type to make the oscillator completely impervious to humidity changes. Complete shielding prevents rapid changes in the air inside the compartment so that frequency jumps or drifts are not noticeable. A seasonal change in calibration, due to humidity variations, is to be expected, however, although this is a rather fine point.

Zero-temperature coefficient ceramic condensers are used across the oscillator coil and the trimmer condenser is also of the zero-temperature type. The tuning condenser is ceramic insulated and must have a double bearing if smooth tuning and good reset accuracy of the calibration is expected. It is also important to mount the tuning condenser with an insulated shaft extension so that the metal shaft of the condenser does not protrude from the shield compartment. This is necessary to prevent radiation of the oscillator output, particularly the very high frequency harmonics, as well as to prevent pickup of r.f. currents from

the strong fields of the output stages of the transmitter which can wreck the stability of the v.f.o. by feedback. For the same reason the frame of the tuning condenser is mounted on the chassis by means of insulating washers and only a single ground point is used between the oscillator circuits and the shield compartment, right at the tube

socket. The theory here is that higher power transmitter stages will cause currents to flow in the shield walls due to the strong local fields from antenna and tank circuits. These currents must be prevented from interlocking with oscillator currents by flow through common paths. By avoiding this situation, where feedback currents reach

Rear view of exciter. Tube line-up, from left to right includes 6C4 oscillator, 6AK5 buffer, 6AK6 80 meter output, and 12AT7 40 and 20 meter output. The r.f. output is to the coaxial connection visible on the leading edge of the chassis.

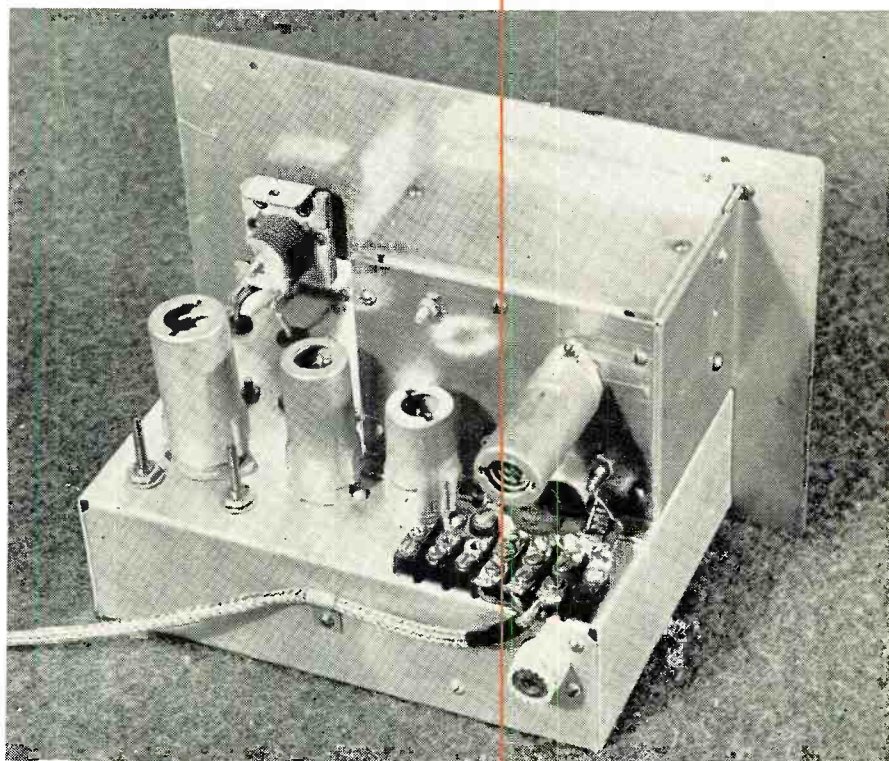

the oscillator, a major source of v.f.o. instability is avoided. "B-plus," filament, and r.f. output leads are brought out through the rear wall of the oscillator compartment with feedthrough insulators, in this case made of number 4 machine screws through fiber grommets.

The tuning range of the oscillator is 3490 to 4040 kc. so that when operating on the 80 meter band no doubling is necessary. It is desirable to operate the v.f.o. on the highest frequency possible to avoid TVI since there will be less trouble from harmonics if there is one possible harmonic every 3.5 mc. throughout the television spectrum than if there are two harmonics, as would be the case with operation of the oscillator on the 160 meter band. Output is taken from the oscillator through an attenuator made up of C_6 , R_2 , and R_3 . This method of taking off the oscillator signal results in a virtually constant load on the oscillator, regardless of fluctuations in the impedance of the grid circuit of the following stage. Both plate voltage and heater voltage leads are bypassed at the feedthrough connections with .005 μ fd. ceramic disc type condensers. This measure is further insurance against the entry of r.f. feedback currents via these leads. The r.f. feedback of this type is often responsible for roughening of the note and variations in the oscillator frequency as subsequent stages are tuned through resonance. The output attenuator provides a large

measure of protection against feedback currents, also, because of the very high reactance of C_6 which has a capacity of only 1 μ fd.

Only voltage amplification is required in the second stage—a 6AK5, resistance coupled. The low input and output capacity of this tube permits substantial amplifications at 3 or 4 mc. without tuned plate circuits. Resistance coupling in this stage is also permissible since the following stage runs class A so that the 6AK5 is not required to deliver any power to the following grid circuit. With only resistors in the plate and grid leads, it is practically impossible for the 6AK5 to give any trouble from parasitics or self oscillation.

The 80 meter power output stage is a 6AK6, selected for its low heater drain as well as its high gain and adequate power rating. This stage easily develops over one watt of r.f. output with a plate current of under 20 ma. The output coil for this stage is under the chassis, as are all the output tank coils, to afford maximum spacing and isolation from the oscillator.

A rather novel bandswitching circuit has been designed especially to use an inexpensive and standard single-deck bandswitch—a *Mallory* type J. This switch is listed in any catalog, a fact that will be appreciated by anyone who has tried to duplicate one of the elaborate bandswitching transmitters current in the literature. The switch has four poles and three positions. One

section transfers the panel controlled output tuning condenser, C_{23} , to the output coil in use. The second section selects the proper output link, connecting it to the output coax connector on the rear of the chassis. The third and fourth sections select the proper plate circuits for the 6AK6 80 meter power amplifier and the 40 meter doubler section of the 12AT7.

This same bandswitching section may be extended to add a 10 meter output stage if desired. In this case a 5 circuit, 4 position switch would be necessary. Such a switch is available from *Mallory*, slightly larger in diameter but of similar construction to the switch shown. A 6AB4, which is equivalent to one section of the 12AT7, is suggested as the 10 meter doubler, with circuit values equivalent to the values used in the 20 meter section of the 12AT7. An output coil would be required for the 10 meter stage and an additional slug-tuned 20 meter coil, similar to L_2 and L_3 , may be required. No ten meter stage has been incorporated in the unit shown because a separate ten meter FM exciter is used at W9ERN.

On 80 meters the 12AT7 is not used. The plate voltage is disconnected from the 40 meter doubler section with the bandswitch in the 80 meter position and the plate current of the 20 meter section of the 12AT7 is limited to a few ma. by cathode bias. As part of the bandswitching system, slug-tuned coils

(Continued on page 104)

Under view of chassis. The two slug-tuned coils are near rear of chassis. Output coils are grouped around bandswitch. Bus wiring and spaghetti are used freely in bandswitch wiring.

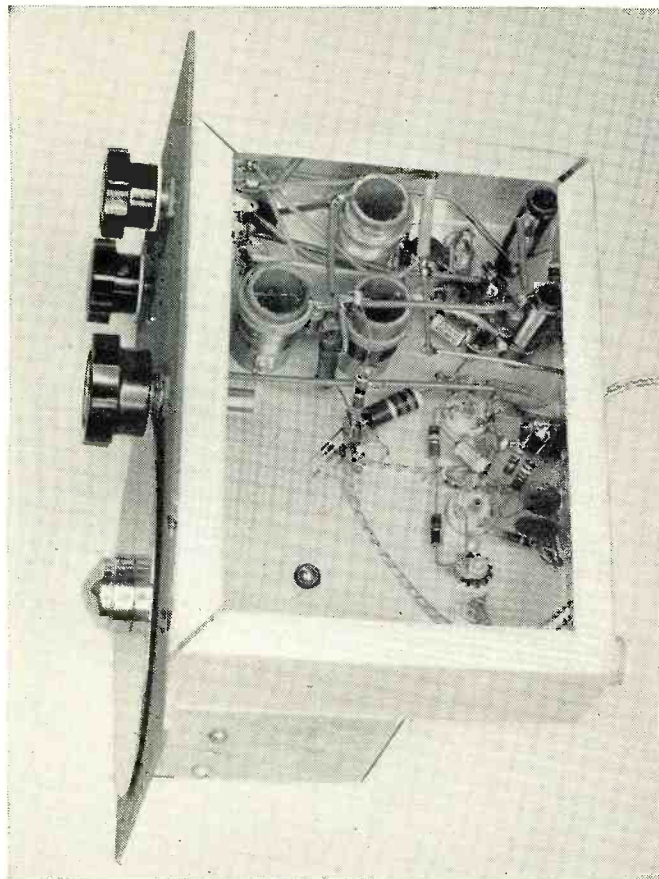

Internal view of oscillator compartment. A ceramic coil form is used for stability. Trimmer C_2 , used to set oscillator tuning range, is adjusted through hole in side of compartment.

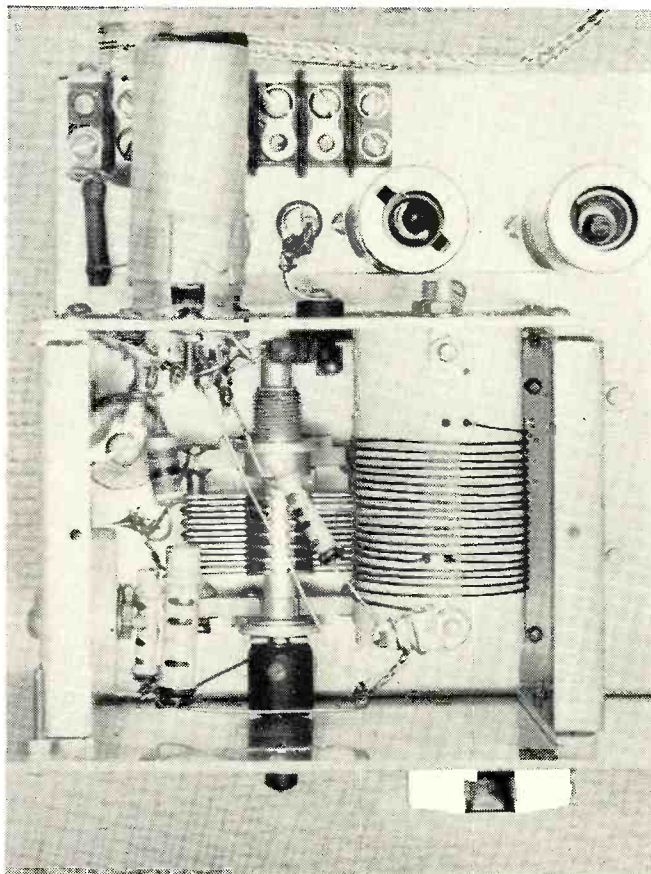

An "Extra"

SUPERHET

By
LEON WICKFIELD

Construction details on a 5-tube superhet broadcast receiver. Its compact size, good performance, and versatility are outstanding.

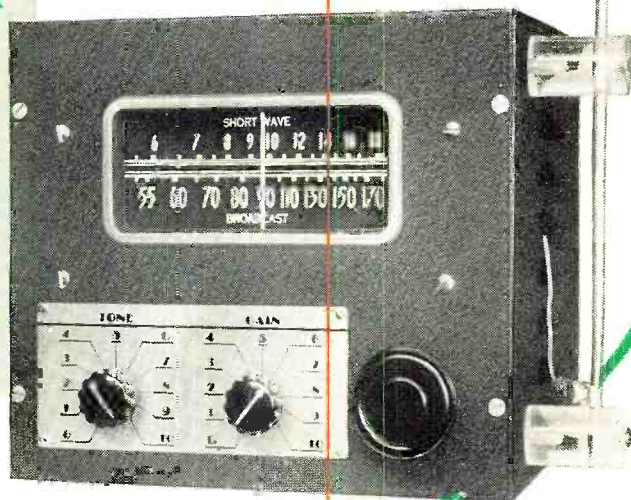

Fig. 1. Front view of completed receiver. The whip antenna shown in photo is an optional accessory.

THE "extra" standard broadcast receiver is still much in demand, television notwithstanding. Here is a rugged pint-sized set with giant-sized performance, whose continued reason for existence is to have something easily movable around the house that will make companionable noises when called upon (with apologies to the XYL). It fills a definite need for that extra set in the bedroom, kitchen, workshop, guest room, children's room, or for vacation or weekend trips. The finished product is attractive enough to grace the top of a bass reflex speaker enclosure in the living room upon occasion.

That great bugaboo of "home brewed" radio receivers, mistracking of the tuned circuits, is virtually eliminated by the use of adjustable iron core coils and a manufactured dial assembly. An alignment procedure that gets the most performance from the set and a lack of "corner-cutting" circuitry provides a degree of performance not often found in present-day mass produced receivers of the five tube variety.

Good selectivity and sensitivity were of more concern in the design of the set than was super high fidelity and audio power output. However, an oversize output transformer and the incorporation of inverse feedback in the audio stages provides excellent low and high frequency response with ample power to drive a large external speaker. Plug-in connections for this purpose are provided at the rear of the receiver, as well as a toggle switch to allow convenient changeover from the internal speaker to the external speaker.

The output of the first audio stage (Fig. 3) is also available at the rear of the receiver for feeding an external higher powered amplifier or for using headphones. After the receiver was completed it became desirable to utilize the capabilities of the audio system as a phonograph amplifier. Another mid-gut phone jack, not shown in the photographs, was installed at the rear of the

receiver between the toggle switch and the headphone jack. The receiver volume and tone controls may be used with the external crystal pickup, and over three watts of power is available at the secondary of the output transformer with 0.8 volt input to the phono jack. The amplifier is perfectly hum free and the inverse feedback arrangement provides excellent speaker damping.

A total of four resonant bypass condensers contribute greatly to the final stability and performance of the set. Now commonly available the country over, these condensers are actually inexpensive series-resonant 455 kc. filters. They are of the same sizes as

conventional tubular condensers having the same voltage and capacitance ratings. An increase of 3 to 4 times in bypassing efficiency is obtained in circuits operated at the resonant frequency of the condenser, as compared to the usual paper condenser of the same capacity value.

One V_2 diode unit (Fig. 3) is the automatic volume control rectifier and the other diode is the detector. The diode linear detector represents one of the simplest and most widely used detection methods. It is also probably the least understood circuit of those that make up a "conventional" broadcast receiver. Reference to Terman¹ indicates that diode detector distortion may result due to curvature in the tube characteristic, causing the rectification efficiency to vary according to

¹ Terman, F. E.: "Radio Engineering," 2nd ed., McGraw-Hill Book Co., Inc., New York, 1937, p. 425-434.

Fig. 2. Side view. Note angle pieces bolted to rear chassis drop to support weight.

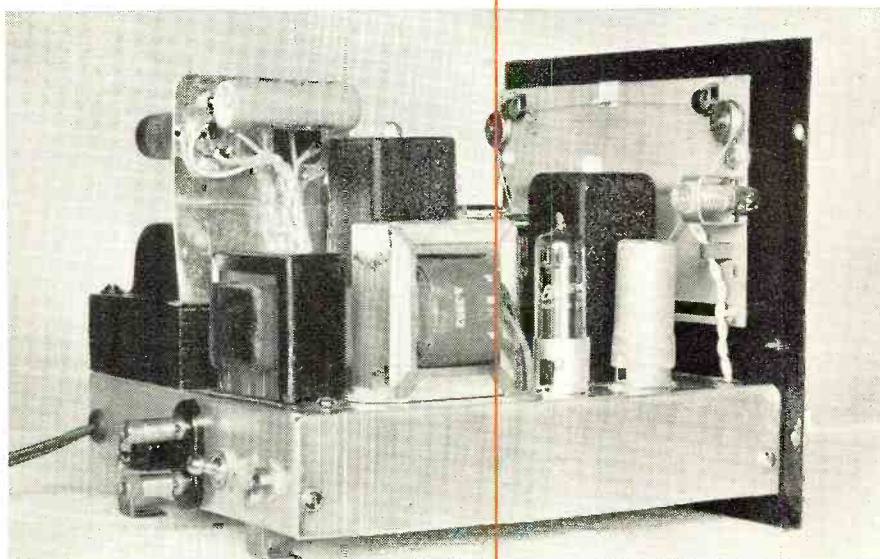

to unity by means of negative resistance.

For the sake of simplicity the diode detector in the receiver of Fig. 3 does not utilize negative resistance or negative capacitance. However, an acceptable Z_m/R_o ratio is obtained by reducing the a.c. shunting to a minimum, accomplished in two ways. The a.v.c. voltage is derived from a separate diode, fed through a small condenser from the primary side of the last i.f. transformer. Thus the a.v.c. filter is not shunted across the detector load. An additional advantage is that the a.v.c. diode receives a greater signal voltage from the i.f. transformer primary than it would from the secondary, and the result is a larger a.v.c. voltage. Zero bias operation of V_3 allows the use of a 10 megohm grid resistor, R_{11} , thereby reducing the shunting effect from this source to a relatively low figure. The detector distortion is thus reduced to a value sufficiently low to satisfy all but the most critical requirements. J_1 is the phono input jack, and J_2 is the output jack for headphone use.

The tapped volume control, R_{10} , along with C_{17} , R_9 , and C_{18} , provides a certain amount of high and low frequency boost at low settings of the volume control, in order to compensate somewhat for the normal deficiencies of the human ear. The tone control circuit, R_{15} , R_{16} , and C_{19} , operates by degenerating the higher audio frequencies. The individual constructor may change the values of these components to obtain a different tone control characteristic for a particular installation.

A portion of the circuit that should not be eliminated is the over-all feedback loop from the secondary of the output transformer to the cathode of V_3 . Resistors R_{13} and R_{14} form the feedback voltage divider. If the amplifier oscillates when turned on initially, reverse the connections of R_{13} and ground

to the secondary of T_1 . The transformer should have a generous power rating if a falling off in power output and distortion at the lower frequencies is to be avoided.

The power supply output voltage is dropped to 250 volts by R_{21} . The common return circuit for C_{23} , C_{21} , C_{25} , C_{26} , and the T_1 secondary center taps should be made with insulated wire and grounded at only one spot on the chassis, to avoid hum-inducing circulating current in the chassis. This requires the can of C_{23} - C_{26} to be insulated from the chassis with a bakelite insulating mount.

Construction

The receiver is housed in a standard lid-type cabinet, 7 inches high and 8 inches in width and depth. A special chassis was made of sheet aluminum to fill the available cabinet space more completely than a commercial chassis. The dimensions are 7 x 7 $\frac{1}{4}$ x 1 $\frac{1}{2}$ inches. A *Croname* double dial plate for the tone and gain controls is available as a stock item. A *Croname* Type 231 tuning control just fits into the available panel space and the edge-lighted glass scale is quite attractive. The scale furnished with the tuner has a combination short-wave-broadcast calibration, as seen in Fig. 1. For a few cents additional, an extra scale is available calibrated for the broadcast band only.

Referring to Fig. 5, the antenna coil is mounted nearest the tuning knob. The oscillator coil is adjacent to it, near the power transformer. Next is the 6A8 mixer tube, between the oscillator coil and input i.f. transformer. Then comes the 6BA6 tube and the output i.f. transformer. The 6AV6, 6AQ5, and audio output transformer are mounted along the left side of the chassis, with the filter choke at the rear. V_2 and V_3 should be shielded. The

r.f. transformer and tube layout is such, that by suitable orientation of the tube sockets, very short and direct leads from stage-to-stage are obtained. The oscillator padding condenser is mounted on a bracket fastened to the side of the chassis, directly under the oscillator coil. The padder is adjusted through a hole drilled in the side of the chassis. Shielded wire should be used for the leads going to the two jacks at the rear of the chassis. The 6X4 rectifier tube, the dual filter condenser can, and R_{21} are mounted on a metal bracket fastened to the top of the power transformer. The cabinet lid has several holes drilled for the 4-inch speaker, and a protective grille of wire mesh. When the lid is closed the rear of the speaker fits into the space between the two i.f. transformers. A 58 inch chrome plated collapsible whip antenna, cut down from a regular automobile type, was mounted on the cabinet of our receiver. The two supporting insulators are polystyrene $\frac{7}{8}$ -inch diameter rod, 1 $\frac{1}{2}$ inches long. The antenna lead from L_1 is brought through a grommet lined hole drilled in the side of the coil shield can, then fed through a side louver in the cabinet and attached to a small spring clip. The antenna lead is thus available for clipping to the whip antenna, if used, or to a longer antenna. The receiver regularly provides excellent long distance reception on nothing but the whip antenna.

Alignment

The first adjustment is to align the i.f. amplifier at 455 kc. Connect an output meter from the plate of the 6AQ5 to ground, and connect the signal generator to the cap of the 6A8 mixer tube through a small condenser. Temporarily short circuit the oscillator section of the two-gang tuning con-

(Continued on page 148)

Fig. 4. Under chassis view. Note the chassis cutouts to accommodate the dial mechanism and the tuning condenser lead wiring.

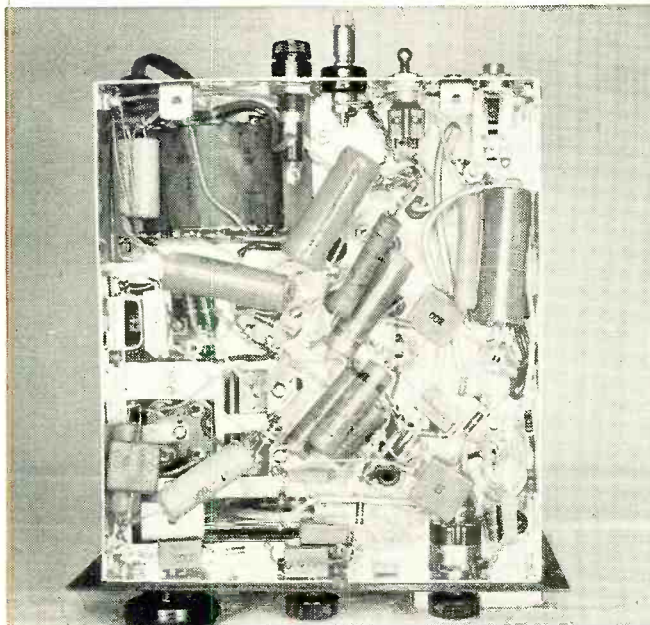
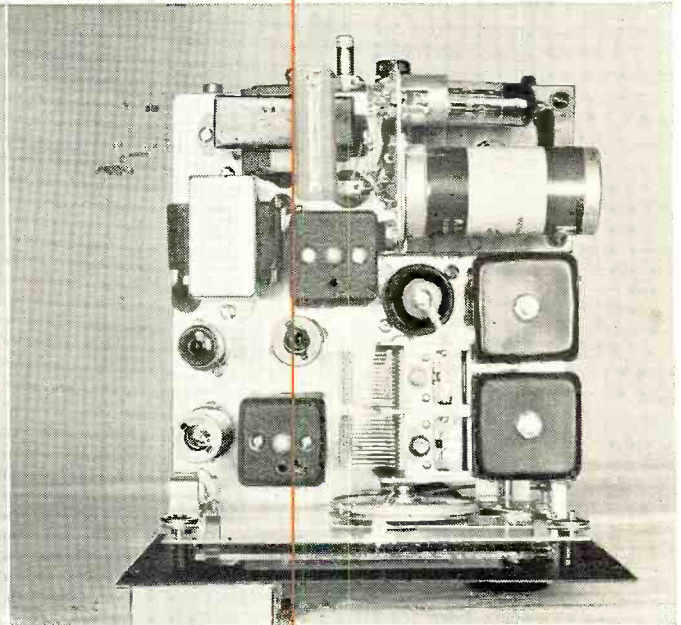

Fig. 5. Top chassis view of the completed receiver showing the location of components. Careful parts placement is required.



A Laboratory Quality SQUARE-WAVE GENERATOR

By
SEYMOUR BERKOFF

THE square-wave generator is an important and useful tool in the laboratory or home workshop. Square-wave testing of amplifiers, for example, is well known, and yields probably more information on an amplifier's frequency, phase, and transient response than any other single test. The square-wave generator may also be used as a basic part of an electronic switch for simultaneous observation of two waveforms on an oscilloscope, or to operate relays in repetitive switching circuits. Other waveforms, such as exponential, triangular, or variable width pulse shapes may be readily derived from square waves by simple resistance-capacitance circuits, and may be used in a variety of experiments. Square waves may even be applied for amplitude calibration of a.c. vacuum tube voltmeters or oscilloscopes. Many other uses will undoubtedly suggest themselves to the user.

The purpose of this article is to present detailed information on a carefully designed square-wave generator which fulfills basic requirements for a variety of laboratory and home workshop uses. In addition to a circuit description of the generator, the writer feels that it would be helpful to the reader to discuss some general circuit techniques governing the production of square waves.

The ideal square-wave generator should produce signals resembling those of Fig. 1A. The waveshape has flat tops and bottoms and very steep vertical sides. The reasons for producing this exact shape may be understood by considering the type of distortion that may be produced at the output of an amplifier under test with a square wave. For example, an amplifier having deficient or excessive low frequency response will impart a slope to the

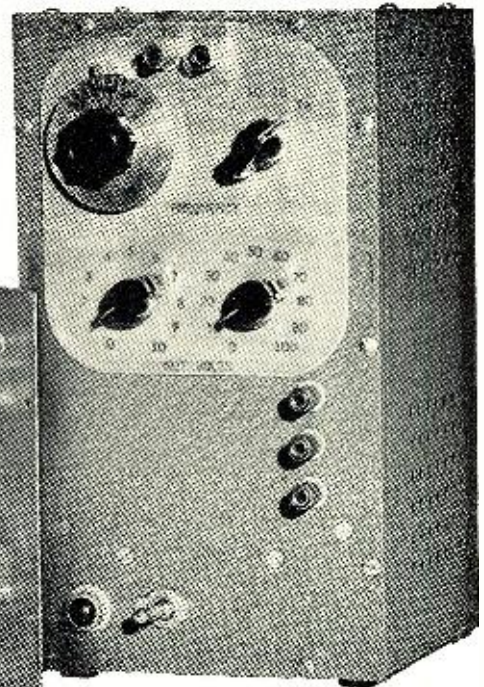
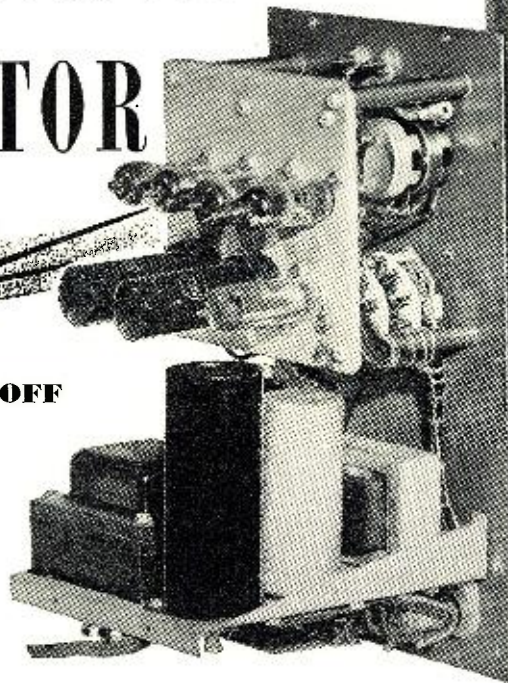

Front and rear views. The unit produces two square-wave outputs, oppositely phased, in four frequency ranges: 6-150, 60-1500, 600-15,000, and 6000-150,000 cps. The amplitudes of both outputs are simultaneously variable from 0 to 100 volts, peak-to-peak, in steps of 1 volt or smoothly variable at the discretion of the builder.

Construction details on a useful test instrument which covers from 6 to 150,000 cps in four ranges.

tops and bottoms of the wave, as shown in Figs. 1B and C. On the other hand, an amplifier having poor high frequency response will slow up the rate of rise and fall of the vertical sides and round off the corners, as shown in Fig. 1D. Still further, the shape shown in Fig. 1E represents distortion produced by an amplifier's tendency to regenerate in the high frequency region. This condition, incidentally, is not always readily revealed by testing the sine-wave response of an amplifier.

It is evident from these examples that the square-wave generator itself must not produce distorted waveshapes like these in order to provide a meaningful test of the performance characteristics of an amplifier.

The generator pictured produces two square-wave outputs, oppositely phased, in four frequency ranges: 6-150, 60-1500, 600-15,000, and 6000-150,000 cycles-per-second. The amplitudes of both square-wave outputs are simultaneously variable from 0 to 100 volts, peak-to-peak, in steps of 1 volt (or smoothly variable, at the discretion of the individual builder). Tops and bottoms of the wave output are flat within 0.5% of the peak-to-peak amplitude. The time of rise and fall of the vertical edges varies with output

voltage from .03 to .17 microsecond. Both of these characteristics are independent of the generated frequency. In addition, synchronizing means are provided by which the generated wave may be locked in at the same frequency, or submultiple, of any other signal within the range of the generator.

The physical arrangement of the generator shown in the photographs was adopted with the object of conserving bench space. The unit is only 6 inches wide, 10 inches high, and 5½ inches deep, which was found to be very convenient on a crowded workbench. The physical layout is not at all critical, however, and many other arrangements are possible without detriment to the performance.

Generation of Square Waves

Two methods are in common use for generating square waves—the sine-wave-clipper type, and the relaxation oscillator, such as the multivibrator. In the first method, a sine-wave oscillator generates the fundamental frequency and feeds several cascaded clipper circuits. The clippers are merely amplifier tubes operating between plate current saturation and cut-off to lop off the tops and bottoms of the sine-wave, and with proper de-

sign will amplify sufficiently to steepen the sides.

The sine-wave-clipper type has two desirable characteristics. First, the frequency of the sine-wave oscillator can be accurately calibrated, independent of tube replacements or power supply voltage variations. Secondly, the generator as a whole can be used to produce both sine and square-wave outputs, thus combining two functions in one unit.

There are several disadvantages to this method, however. First, the rate of rise and fall of the vertical edges of the output square-wave varies with frequency, unless a large number of clippers is used, being slowest at low frequencies and more rapid as the frequency is raised. This is evident when it is remembered that the resultant square-wave is merely an amplified portion of a sine-wave, whose own rate of rise and fall varies with frequency. A second disadvantage lies in the expense and complication of the sine-wave oscillator itself. Ordinary Hartley or Colpitts oscillators are impractical for wide range audio frequency work, owing to the restricted tuning range of *LC* tuning circuits and the large physical size of these elements required to produce low audio frequencies. Beat-frequency oscillators can be used, but require much shielding and are subject to frequency drift to a large degree. The popular resistance-tuned Wien bridge oscillator is practical, but is large and expensive if the frequency calibration is to be made accurate.

The second method of generating square-waves, which is used in the present unit, is the multivibrator. A multivibrator is a two-stage resistance-coupled amplifier in which the output of the second stage is fed back to the input of the first stage in the correct phase to produce oscillations. The oscillation frequency is determined principally by the *RC* time constants of the coupling circuits. With proper design, the waveform produced resembles a square-wave in that it has approximately equal half cycles, with extremely steep sides and roughly flat tops and bottoms.

The multivibrator has the advantage over the sine-wave-clipper circuit in simplicity, compactness, ease of frequency control and synchronization, and quality of waveform, the latter being substantially independent of generated frequency. The principal disadvantage of the multivibrator, like other relaxation oscillators, lies in the dependence of its frequency upon power supply variations and tube replacements. Calibration of its frequency control is therefore not as precise as that of a sine-wave oscillator, although it can be held within about 5%. Fortunately, it is seldom necessary to know the square-wave frequency with exactness, and in the rare exceptions, the generator may be readily synchronized with an accurate frequency source.

Fig. 2 shows the schematic of the

complete square-wave generator. Tube V_1 , 12AU7, is the multivibrator, whose frequency is controlled by the variable *RC* elements in its two grid circuits. Four frequency ranges, in steps of 10, are provided by the two-gang *Frequency Range* switch S_{1a} and S_{1b} , which changes the condenser elements in the circuit. The frequency is also made smoothly variable through the use of a two-gang potentiometer, R_7 and R_{10} . These, incidentally, have a standard logarithmic resistance taper to avoid crowded calibration at the low frequency end of the dial. Only the middle terminal and one end terminal on each potentiometer are wired into the circuit; the proper end terminal to use is the one which gives the most rapid resistance variation with rotation at the high frequency end.

The "B" supply to the multivibrator is regulated at 150 volts by the 0A2 voltage regulator tube in order to prevent line voltage variations from affecting the square-wave frequency.

The multivibrator will readily lock in at the same frequency as another signal by applying that signal to almost any point in its circuit. A simple way of doing this is to inject the synchronizing signal through a small condenser to one grid or plate of the multivibrator. This method is in fairly common use, but is undesirable for certain applications because a component of the square wave itself is fed out to the *Sync* terminal of the generator as an unwanted signal, which then appears as part of the synchronizing signal and causes difficulty in making certain kinds of experiments.

A better way of synchronizing the multivibrator, to eliminate this condition, is to isolate the *Sync* terminal from the multivibrator by means of an extra tube. The circuit of V_2 -6J6 is arranged to provide symmetrical synchronization, that is, both halves of the

multivibrator receive equal and oppositely phased sync signals. The multivibrator normally produces a symmetrical square-wave in which the time duration of the positive and negative halves of the cycle are approximately equal. With asymmetrical sync, either half of the wave will generally shorten with respect to the other half; further, the multivibrator will not lock in with equal ease and stability on positive *vs* negative going signals, such as pulses. On the other hand, the use of the V_3 circuit will allow the multivibrator to synchronize without instability on any signal, irrespective of the latter's waveshape, principal polarity, or amplitude; further, the shape of the multivibrator output will be undisturbed by symmetrical sync waveforms, such as sine-waves.

Output Circuits

In addition to frequency stability and ease of synchronization, the major design requirement of the square-wave generator is to produce a waveshape with steep vertical sides and flat tops and bottoms. Capacitive effects in the circuit, which would impart a slope to the vertical edges of the wave, must therefore be minimized as far as possible, and this can be done by extracting the output waveform from small load resistances. Small resistances are introduced into the cathode circuits of the multivibrator, and the voltages formed across them are used to feed the output circuits of the generator. The waveshape across resistors R_{10} and R_{11} has extremely steep sides and flat bottoms, but the tops have an appreciable slope. It is necessary to flatten the tops and then to feed the signals to the output terminals of the generator through a power amplifier. Several basic considerations govern the design of a square-wave power amplifier, and these will be discussed here briefly.

The first problem that presents itself is the method of feeding the multivibrator signals to the power amplifier. Using ordinary resistance-capacitance coupling circuits is very impractical, for at low square-wave frequencies these circuits will impart a distortion to the waveshape like that shown in Fig. 1B. Extremely large *RC* time constants in the coupling circuits would be needed in order to avoid this distortion, or as an alternative, large square-wave amplitudes must be fed to the power amplifier grid in order to enable the latter to clip off the sloping tops and bottoms. From the standpoint of simplicity, cost, space, and quality of waveform, another method, namely d.c. coupling, is much to be preferred.

A second major problem in the design of the output circuits lies in the effect of the power amplifier on the power supply. The plate current of a square-wave power amplifier swings alternately between low and high values; the power supply is therefore required to furnish large pulses of current (as contrasted with steady d.c. current) in accordance with the frequency of the square-wave. At very

Fig. 1. Types of square-wave distortion produced by amplifiers having non-uniform frequency response. (A) Original square wave. (B) Amplifier deficient in low frequency response. (C) Amplifier with excessive low frequency response. (D) Amplifier deficient in high frequency response. (E) Unit with tendency to regenerate at high frequency.

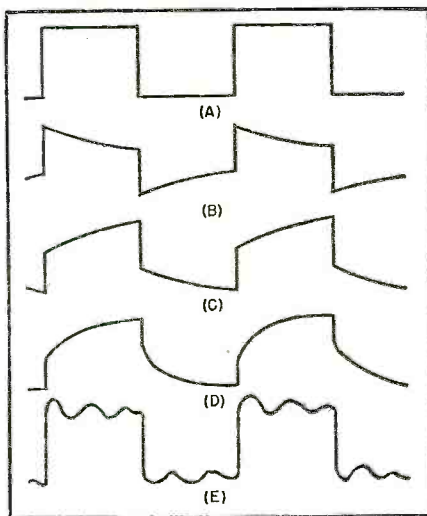

low square-wave frequencies, this effect would cause a large saw-tooth voltage to be superimposed on the d.c. voltage of the power supply, for the output filter condenser of the supply, unless prohibitively large in size, would be incapable of smoothing out the modulation produced by the power amplifier. The saw-tooth voltage on the supply, in turn, would modulate the power amplifier to produce a tilt on the tops and bottoms of the square-wave exactly like that of Fig. 1C.

The simplest way of avoiding this effect is to employ a push-pull square-wave power amplifier. Thus, two tubes draw pulses of current, but being in push-pull they do so alternately, with the result that the power supply is required to furnish only a steady d.c. current.

The foregoing methods are generally adequate to preserve the flat tops and bottoms of the waveshape at low frequencies. At high frequencies on the other hand, the principal consideration must be given toward maintaining the speed of rise and fall of the vertical edges. Practically, the only solution here is to make the power stage a good

video amplifier, with a frequency response well into the megacycles. Cathode followers can be used, but they do not maintain their speed of response at large signal outputs. Push-pull pentode power amplifiers feeding small plate load resistors generally provide the best and most economical performance.

The power amplifier in the present square-wave generator meets the requirements outlined. Tubes V_1 and V_2 (6AG7's) are operated as direct-coupled push-pull stages, with the output square-wave signals developed across low values of load resistors. Plate current swing in each tube is from 0 to 50 ma., and a 2000 ohm load resistor in each plate will thus develop 100 volts peak-to-peak square-wave amplitude. In order to adjust the output amplitude, the plate load resistors of both 6AG7's are made variable. Plate current swings in the tubes are substantially unaffected by the load resistor settings.

It is necessary to use non-inductive load resistors, for excessive inductance will produce unwanted pulses in the output waveform. Several different

non-inductive variable resistor schemes may be used at the discretion of the individual builder. One of them which suited the writer's purpose is shown in detail in the inset of Fig. 2. Here, a number of fixed resistors, carbon or composition type (not wirewound) are wired onto two switches so that the plate load resistance is varied in discrete steps. Switch S_3 produces 1 volt output increments, and switch S_1 , 10 volt steps. Each switch is a two-gang arrangement operating on both 6AG7 plates at the same time. Thus both square-wave outputs are equal and simultaneously variable.

A second scheme, which is less expensive, is to use the variable arrangement on only one 6AG7 plate, leaving a fixed resistor of a 2 watt rating and any value up to 2000 ohms on the other plate. Only one of the square-wave outputs is then adjustable in amplitude.

If desired, the outputs may be made smoothly variable by substituting a two-gang, 200 ohm carbon or composition potentiometer for R_{13} to R_{12} on the 6AG7 plates in the schematic, keeping the switching arrangement for R_{23} to R_{22} . In general it is not advisable to use ordinary composition potentiometers for R_{23} to R_{12} owing to the relatively large power dissipation in this circuit, and wirewounds are also objectionable because of their self inductance.

The two 6AG5 tubes, V_3 and V_6 , are used as part of the over-all scheme to obtain flat tops and bottoms on the square wave. As mentioned previously, the signals at the multivibrator cathodes do not have flat tops. These signals are inverted by the 6AG5's and amplified sufficiently to cut off the 6AG7 plate currents during the negative-going 6AG5 plate swing. The 6AG7's clip off the sloping bottoms, leaving the desired waveshape at the output.

It will be noted that direct coupling is employed throughout. The 6AG5 grids are connected directly to the 12AU7 cathodes without coupling condensers. Each 12AU7 cathode swings positive with respect to "B-," so it is necessary to place a positive bias on the 6AG5 cathodes to maintain their grids in the negative region. The use of a common unbypassed cathode resistor for the 6AG5's is a simple and effective way of maintaining a steady d.c. voltage there, for both tubes conduct plate current alternately. Similarly, a common screen resistor is used for both tubes, being bypassed only for high frequencies with a .1 μ f. condenser; this helps maintain steep edges on the output waveform.

Direct coupling is again used from 6AG5 plates to 6AG7 grids through 100 ohm anti-parasitic resistors. These resistors are ordinary carbon or composition types, and should be wired directly on the 6AG7 sockets with the shortest possible leads. Tubes having a high transconductance are prone to oscillate at very high r.f. frequencies

(Continued on page 119)

Fig. 2. Complete schematic of square-wave generator. Switch details are also given.

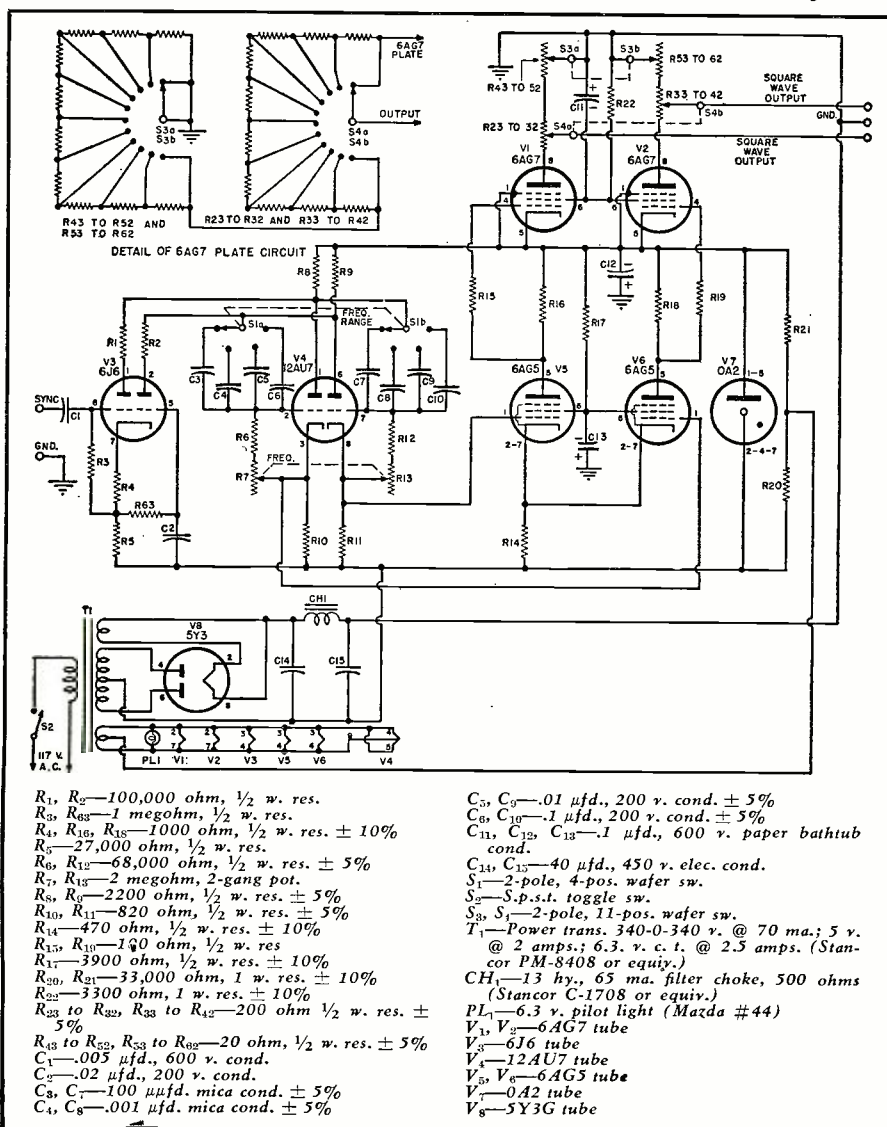

QUALITY CONTROL of TV TUBES

Deflection yoke can be moved vertically on its support and horizontally on track. It is spring-mounted to insure proper positioning of tube neck.

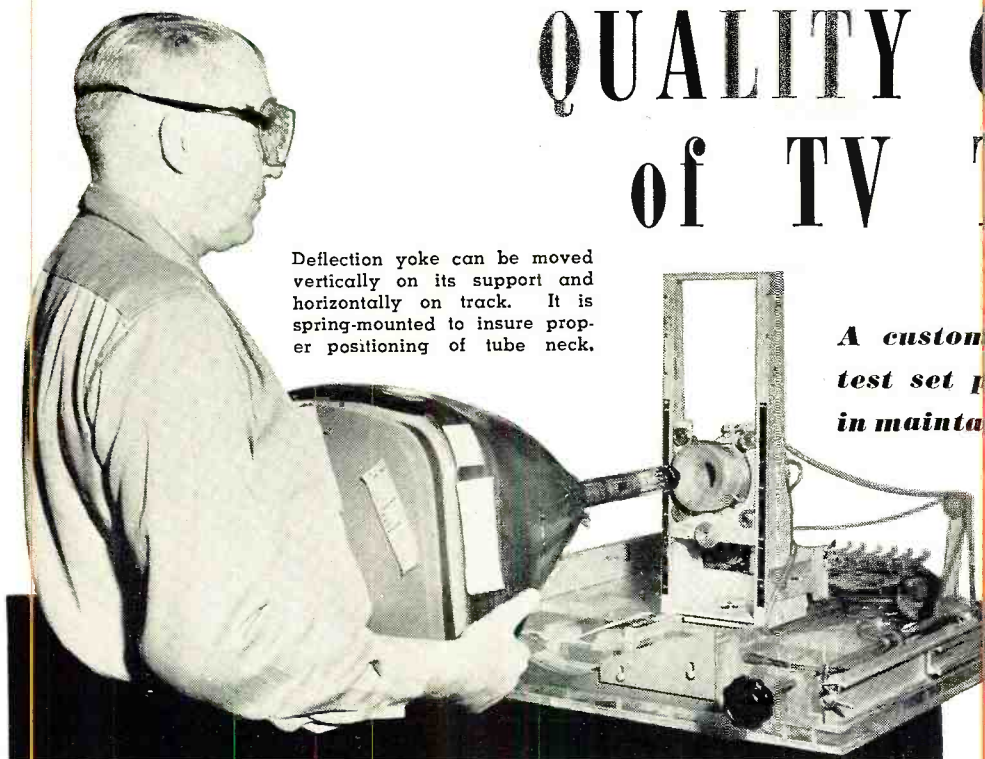

A custom-designed picture tube test set plays an important role in maintaining CR tube standards.

By

**BERTRAND W.
SQUIER, JR.**

Chief Eng., Cathode-Ray Tube Dept.
Raytheon Manufacturing Company

THE mass production of cathode-ray tubes has necessitated a streamlining of test procedures. In regular production, five major characteristics are checked on each tube. They are grid cut-off voltage, screen appearance, gas, emission, and voltage breakdown. By the use of preset voltages switched by a series of push-buttons, these five characteristics can be checked in less than 30 seconds.

Such modern test procedures can only be justified when backed up by sound engineering, uniform production methods, and by the use of statistical quality control data. When a new tube type goes into production, the engineers involved decide which characteristics must be checked on every tube and which can be "controlled" by engineering analysis. The prime consideration in making these decisions is—Would a tube with this defect be inoperative in, or damage, a customer's set?

The engineering test set, pictured on this month's cover, is used to control the quality level of the outgoing product. This set is designed to read current and voltage in every circuit used to operate a television picture tube. Its meters are sensitive and calibrated weekly. In other words, this set is designed for extreme accuracy.

Each day a certain percentage of the day's production is selected from the five-hour hold conveyer and tested on the engineering test set. These tubes are given "the works"—a total of 22 separate tests. These tubes are then held for a week and tested a second time for changes in gas readings, emission, and leakages. The changes, as well as the initial readings, are plotted and the average is closely followed. For instance, if the average cut-off increases several volts a day for two or three days, an adjustment is made in the mounting operation to compensate for this change. Any tendency of a characteristic to stray from the bogie is reversed *before any actual scrap occurs*.

The engineering test set has several features which are unique and ingenious in design. One of these is the tap tester shown in the picture. The tap tester is operated by a push-button on the front of the test set. The unit can be moved to accommodate the various tube types. In the proper position, the core of the small solenoid raps the tube base below the brass sleeve. When testing for a loose cathode weld, a small spot on the screen is used. This spot will vary in intensity when the tube is tapped if the cathode structure is defective. Such a microphonics test has proved useful in judging new cathode structures and in the development of electrostatic focus tube types.

Since an engineering set must be versatile, this unit has been designed for quick changeovers between tube types and for easy loading. The lucite platform rolls out so that the front and side of the mounting unit are readily accessible. The machine will handle all tubes up to 30" in diameter. The accompanying photograph shows the platform in the loading position. The deflection yoke is enclosed in a thin, brass case for protection. This yoke has been wound to industry specifications and costs about 100 times the price of a standard television deflection yoke. Quick mounting is obtained by using a fixed support for the face of the tube and by changing the yoke height and yoke distance from the face. When the platform has been rolled out, it locks into position and all voltage lead wires make contact with electrical ground by means of roller switches. Thus, even though the operator is fully protected by interlocks, all residual charges are removed by the ground contacts. The ion trap is wound to standard specifications and is controlled by varying the current through it and by physical rotation of the trap by means of a chain drive. The tube socket is on flexible leads and is mounted by hand. A wire brush serves to ground external conductive coatings.

(Continued on page 165)

Close-up of the base tapping mechanism. The ion trap, which rotates on a thin brass sleeve, can also be seen in photo.

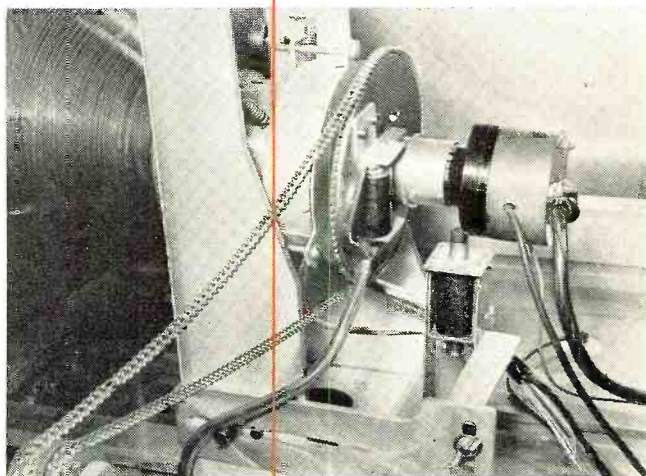
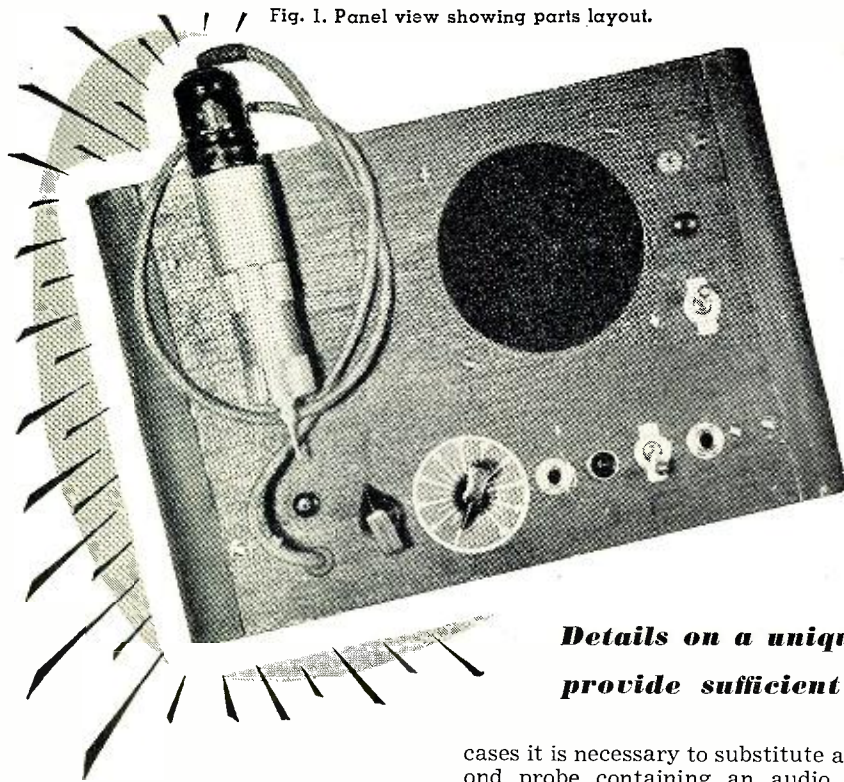

Fig. 1. Panel view showing parts layout.



A High Gain SIGNAL TRACER- AMPLIFIER

Details on a unique test unit which is designed to provide sufficient sensitivity for rural servicing.

By
ROBERT H. DELLER
WBALV

THE signal tracer method of radio servicing has gained increasing popularity during the past several years as exemplified by the many articles on the subject which have appeared in this and other technical magazines. Probably the greatest single factor that has contributed the most to the popularity of signal tracing devices has been the application of crystal diodes, such as the type 1N34, as the rectifying element in small, compact tracer probes. So versatile are these units that perhaps one loses sight of the fact that these diodes are, after all, simply rectifiers and contribute nothing toward the amplification of the signal. Since these diodes rectify indiscriminately from low audio to upwards of 100 mc., they cannot be used satisfactorily as probes in the audio circuit of a receiver or amplifier without introducing considerable distortion to the audible signal. In such

cases it is necessary to substitute a second probe containing an audio coupling condenser. A properly designed vacuum tube probe, on the other hand, suffers from none of these disadvantages. It detects the audio component with facility from the very low frequency to the very high r.f.; it introduces no distortion to audio, produces only slight loading effect to tuned circuits, and at the same time provides a high degree of amplification.

Many of the signal tracers now in general use, using either diode or vacuum tube probes, seem to suffer from one common defect—lack of sufficient voltage gain. This condition is not detrimental to the technician living in a metropolitan area since his shop is practically saturated with strong signals from nearby stations. For the rural technician, however, whose shop may be located 50 miles or more from the nearest broadcast station, this lack of voltage gain could constitute a serious problem, particularly when attempting to detect a signal at the front end of a weak or misaligned receiver.

The signal tracer described in this article has been designed with the rural technician in mind. It is an extremely sensitive device devoid of unnecessary

extras such as built-in r.f. meters, output meters, substitution speaker, or multiple circuits. It is simply a signal tracer that does nothing but trace signals. It is assumed that the technician already has the proper test equipment for making the usual voltage and continuity checks and therefore there is no need to increase the expense of the tracer by duplicating this equipment. However, provision is made so that an output meter may be connected to the tracer when necessary. The tracer may also be used for testing crystal and dynamic microphones and can serve efficiently as a phonograph amplifier or small p.a. system.

The extremely high voltage gain (more than 70 db) depends on the use of two high mu triodes operated at zero bias. This method of operation permits the use of high input and output circuit impedances in order to realize a voltage gain comparable to that obtained from high mu pentodes. Two distinct advantages result from this use of triodes rather than pentodes: an economy of parts through the elimination of cathode resistors and bypass condensers and the fact that the inherent tube noise is much lower in triodes. The result is a higher signal-to-noise ratio than could be realized from the use of pentodes. The problem of feedback or unwanted interstage coupling is eliminated due to the complete isolation of the probe tube from the rest of the circuit. Further decoupling is provided through the use of isolating resistors R_3 and R_7 and condensers C_2 and C_5 . A somewhat unconventional method of coupling the probe tube plate circuit to the grid of the 6SF5 is also used. It will be noted that the volume control, R_4 , is isolated from both the plate load resistor, R_2 , and the grid resistor, R_5 , by means of condensers C_3 and C_4 . With this arrangement no d.c. voltage appears on the

Fig. 2. Comparative response at audio frequencies of the probe (curve A) and the microphone-phonograph input (curve B). Although not flat, the unit performs adequately.

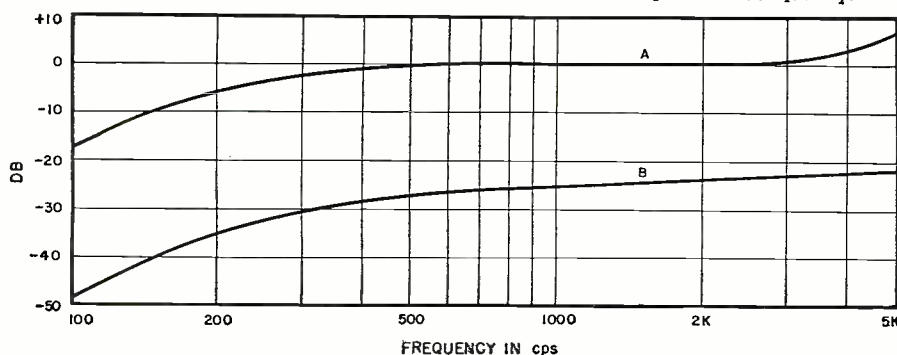

control, resulting in noise-free operation and at the same time the input impedance of the 6SF5 grid is maintained constant regardless of volume control setting. Shunt capacity represented by the 2 foot shielded plate lead in the probe cable effectively bypasses to ground any r.f. voltage which might otherwise appear at the grid of the 6SF5.

The front panel layout is shown in Fig. 1. To the left of the 4 inch speaker grille is located the probe tube held securely in a clip bolted to the panel. The clip was originally intended to hold a flashlight and can be obtained in any hardware or auto supply store. Directly below the probe is pin jack J_2 , which provides a ground connection to equipment under test. The entrance hole for the probe cable is located just under the pin jack. Immediately to the right is switch S_1 , which disconnects the probe tube when the amplifier is used for testing microphones or record players. Volume control R_1 is next with input jack J_1 just to the right of the control. The pilot light, power switch S_2 and the output phone jack J_3 are shown next in the order named. Output pin jacks J_4 and J_5 just to the right of the speaker grille, provide a convenient connection when an a.c. voltmeter or output meter is used. Switch S_3 is located just below the pin jacks and is used to disable the speaker when using earphones or when an output meter is used and it is unnecessary to listen to the ear-splitting screech of a test oscillator during receiver alignment.

As shown in Fig. 4, the probe consists of a metal 6F5, a tube base connector and cable, and a brass shield fitted with a probe tip. The 2 foot connecting cable requires one shielded plate lead and one heater wire. Ground return for both cathode and heater is made by way of the shield. A cable containing an extra wire is desirable since it can be paralleled with the heater wire to prevent a possible voltage drop. The cable is wired permanently into the circuit through a hole in the front panel. Grid resistor R_1 is mounted directly on top of the 6F5 with one end

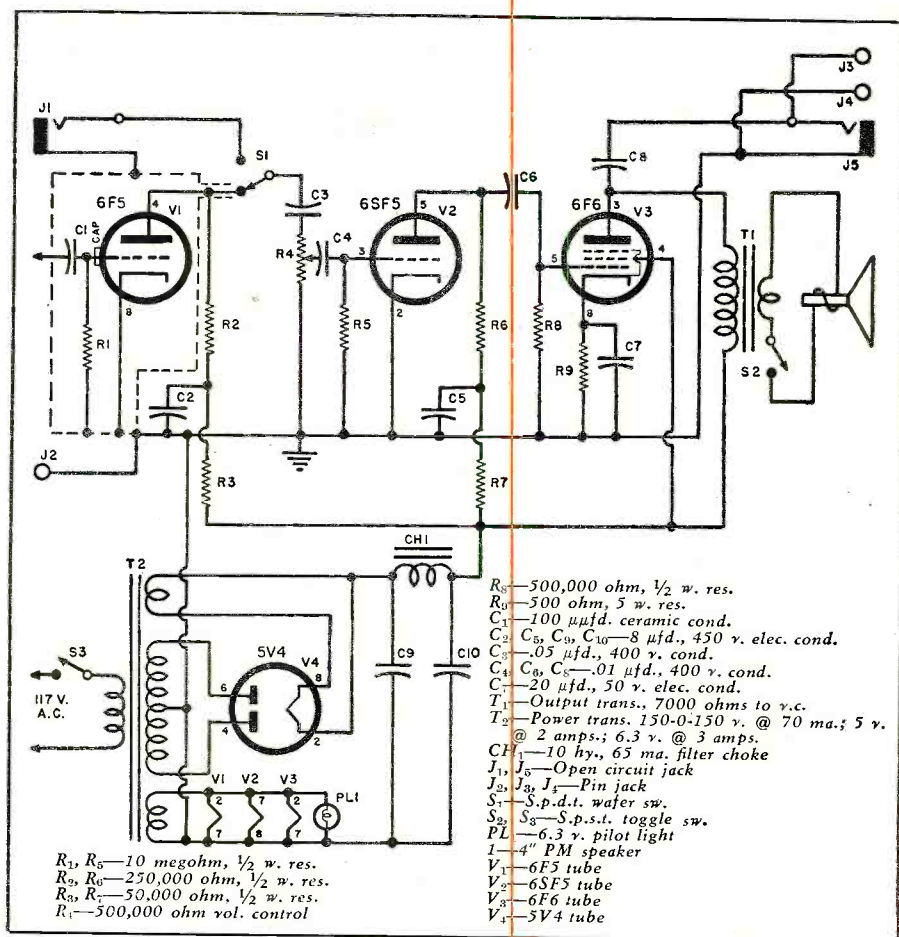

Fig. 3. Circuit diagram and parts list for the high gain signal tracer-amplifier.

soldered to the grid cap and the other end to the tube shell adjacent to the grid cap insulating disc. The small coupling condenser, C_1 , is likewise soldered to the grid cap with the free end fished through the probe tip when assembly is completed. The probe shield is made from a piece of brass bearing stock turned down on a lathe with an inside diameter to provide a tight fit when the 6F5 is forced into the shield. The probe tip mounted on a bakelite disc and fitted into the end of the shield completes the assembly. Possibly the reader may desire to construct the

probe in some manner other than that described, using perhaps a section of a 6L6 tube shell or other metal tubing of suitable diameter. Any method will be satisfactory as long as the grid resistor and coupling condenser are contained within the shield. A small spot on the 6F5 shell should be scraped free of paint and wiped with solder to insure a good electrical connection between the shell and shield.

The under chassis layout is shown in Fig. 5. Arrangement of parts on the 7" x 9" x 2" chassis is not critical; how-

(Continued on page 149)

Fig. 4. The 100 μ fd. ceramic condenser and the 10 megohm grid resistor can be seen soldered to the 6F5 grid cap. The brass shield housing and probe tip assembly are shown in lower photo.

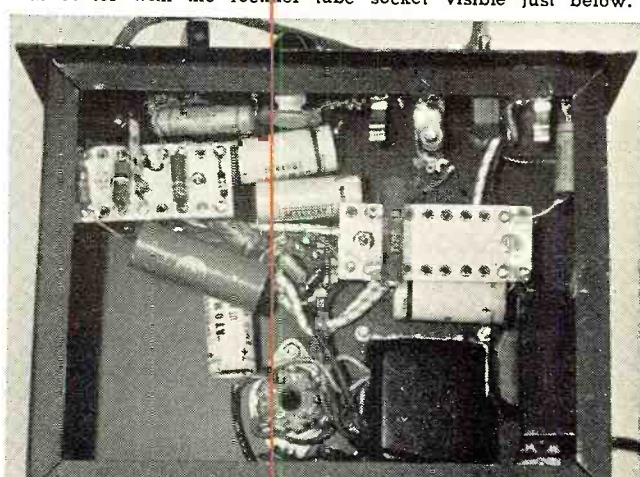
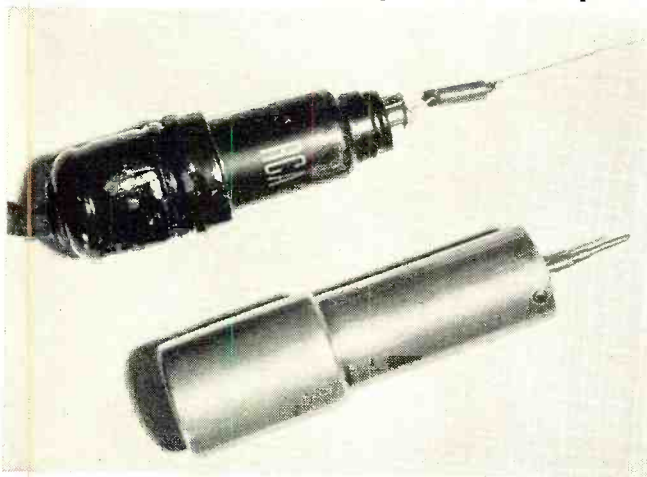

Fig. 5. Underchassis view. The 6SF5 tube socket is under terminal strip in upper left-hand corner. The 6F6 tube socket is at center with the rectifier tube socket visible just below.



Early RCA receiver which used the 630TS chassis and either a 7" or 10" tube. The photo below shows a more recent model which uses a 17" tube and incorporates several improvements on original circuit.

EVOLUTION of the 630TS

By
WALTER H. BUCHSBAUM
Author, "Television Servicing"

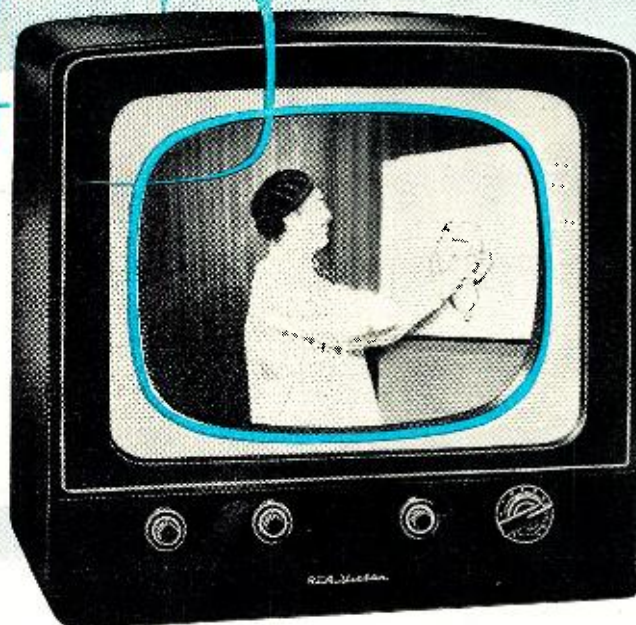

Data on a popular television chassis which appeared in 1946 and has since been revised and improved.

IN THE fall of 1946 RCA delivered the first mass produced television receiver in this country. Two models were offered, a 7-inch set and a "large screen" 10 inch table model or console. The 10 inch set was designated chassis model number 630, and had 30 tubes including the picture tube. Since that time more 630 type TV receivers have been sold than any other single model.

The model 630 quickly became a standard of performance and was copied in its essential features by many TV manufacturers, large and small. RCA's patent licensing service enabled other manufacturers to use the identical tubes and components in their TV models. After RCA discontinued the 630, smaller manufacturers bought up chassis and parts and continued to use the original circuit and layout. Even today the 630 is being sold in kit form, finished chassis, and as complete TV sets for custom installations and private label merchandise. Its model number has become a symbol of reliable performance, extra sensitivity, and stability. Even the lay public knows that the 630 is a very well designed TV receiver.

The outstanding features of the 630 were its good sound and picture sensitivity, its extremely stable synchronizing system, and its sharp detail picture. Resistors and condensers were rated very conservatively, minimizing failure of these components. Unfortunately the 10 inch picture tube was the largest size available in quantity at the time the 630 was designed. To operate with present-day picture tubes drastic changes had to be made in the original version.

Fig. 3 is a block diagram of the original 630 set with the number and tube types shown in each section. Those sections marked with a star have been subject to considerable modification since 1946. The ion traps on the first receivers were of the electromagnetic type, having two small coils with part of the bleeder current going through them. Only a year after the 630 came out these coils were replaced by a permanent magnet type ion trap. The 10BP4 picture tube was superseded by a 12 inch or, in a few custom installations, by a round 15 inch tube. The original loudspeaker for the 630 table model was a 5 inch speaker of the electromagnetic type with the field acting as "B plus" choke. Most competing manufacturers replaced this with a larger speaker, usually of the PM type, and a choke coil. The single 6K6 audio output tube was often replaced by a push-pull audio amplifier, sometimes by part of a combination radio-TV set. These changes did not require too many new components and were all done during the first few years the 630 was on the market.

Three other major modifications have been added during the past three years and they have greatly extended the utility of the original 630 design. A new tuner, an automatically biased i.f. system, and a really large screen picture tube bring the 630 completely up-to-date. Many articles have appeared in this and other magazines on the mechanics of converting a 630, but

little has been said on the circuit theory of the new *versus* the old circuits. To clarify the theory behind these three major changes, we shall briefly touch on the operation of both the original and the present circuits.

Tuner Change

The original 630 offered a thirteen-channel, switch-type tuner using three 6J6 double triodes. One 6J6 operated as a push-pull r.f. amplifier with an untuned input (300 ohms), the second 6J6 as a push-pull oscillator, and the third as the mixer. The tuned elements consisted of a tapped tuned line mounted on a wafer switch with the moving arm acting as a shorting bar. Alignment of this tuner, the KRK2, was tricky for the technician, to say the least.

Present-day tuners, such as the *Standard Coil* tuner—the one most widely used in recent years, usually feature two tubes, a pentode r.f. amplifier and a double triode as oscillator and mixer. The tuning is provided by a separate set of coils which is switched in for each channel. This permits the design of a tuned, impedance matched input circuit and individual, replaceable coil plates for each channel. Other types of tuners such as the *DuMont-Mallory* "Inductuner" or the *Sarkes Tarzian* switch tuner, all feature tuned input, pentode r.f. amplifiers, and much simpler alignment. In late 1951 a new "cascode" r.f. amplifier appeared which greatly reduces snow in extreme

fringe areas. The major advantages of present-day tuners are: increased r.f. gain, better signal-to-noise ratio, and better rejection of images and various types of interference. Reduced oscillator radiation is another feature, but this is of benefit to the neighbors rather than the individual set owner.

So widespread is the use of the 630 that most of the new tuners can be mounted in the original chassis pan with only minor alterations in the tuner cut-out. Electrically any tuner having an i.f. range between 21 and 26 mc. and a separate coil for the sound i.f. can be used in the 630 chassis. The "B plus," filament, and bias connections on most commercial tuners are so similar as to present no special problem.

Automatic Gain Control

One of the major complaints on the original 630 concerned the tricky adjustment of the contrast control. On a weak station a good picture would be received and on a strong station the picture disappeared or was distorted until the contrast and brightness controls were very accurately reset. This was due to the circuit of the contrast control. A fixed negative voltage was applied across the contrast potentiometer and a divider network in such a way that the contrast control varied the grid bias on the r.f. amplifier and the first three i.f. tubes. The i.f. and r.f. gain was thus varied by adjusting the fixed bias. On a strong signal the correct bias to prevent overload might be 4 volts while on a weak signal only 0.5 volt might be desired.

The first modification of the contrast circuit was the addition of a peak detection type a.g.c. system (Fig. 1). This required an additional diode, connected to the i.f. side of the second detector and furnishing a negative voltage output. This negative voltage is then applied through proper filters to the grids of the i.f. amplifier and the first three i.f. tubes. On a strong signal the diode will receive a larger i.f. signal and produce more negative voltage. A rise in negative voltage will reduce the gain of the i.f. and r.f. sections and thus overcome the increased signal strength. This action is basically the same as the a.v.c. circuit found in most modern radio receivers. To obtain the additional diode section many designers removed the d.c. restorer network and used half of the 6AL5 double-diode as a.g.c. tube. A better approach is to add a crystal diode such as the IN34 or some of the more recent types. Since this eliminates the contrast control, another spot must be found for this function. In many instances a circuit was provided to maintain a fixed negative voltage across the contrast potentiometer and apply the variable bias from the contrast control in series with the bias supplied by the a.g.c. bias. Varying the screen voltage of the 6AU6 first video amplifier is another possible method of varying the contrast.

The most widely used type of a.g.c.

in today's 630 models is a special keyed type. First described by the author in the December 1949 issue of RADIO & TELEVISION NEWS, this keyed a.g.c. system is being used in many other television models today. See Fig. 2.

The principle of this circuit is the keying action by the horizontal output section. The a.g.c. tube can conduct only during the horizontal retrace time, the exact period during which the sync pulse appears at the video amplifier. As a result, the a.g.c. bias voltage is dependent only on the sync pulse level, and noise occurring during the long picture period cannot affect the a.g.c. Furthermore, since only the 15,750 cps pulses can affect the a.g.c. bias, the a.g.c. filter can have a much shorter time constant. This, in turn, enables the a.g.c. to follow rapid changes in signal strength and thus compensate for fading due to airplanes or antenna sway.

Keyed a.g.c. has been in use for over two years now and many modifications of the original circuit have been made. The main features, however, are still the same. The 6AU6 is invariably used as the a.g.c. tube, and in the 630 model this requires an additional chassis hole and a socket. In some 630 kits the a.g.c. tube is mounted on a small bracket underneath the chassis. The keying pulse is invariably obtained from a special coil wound over the regular width coil. The contrast control is disconnected from the negative bleeder and the a.g.c. bias is connected to the grid of the r.f. and the first three i.f. amplifiers. To vary the contrast, some manufacturers use the old contrast control on the screen of the first video amplifier or else in the cathode of the a.g.c. tube. In the latter system the contrast control will determine the level of the a.g.c. bias and this provides a smooth and wide range of control. A further modification of the video amplifier circuit consists of a direct connection from the second detector to the first video amplifier which is then coupled directly to the a.g.c. tube. This assures a constant level for the sync pulses.

Most of the deluxe 630 models of the past year feature keyed a.g.c. and, in addition, new and better video i.f.

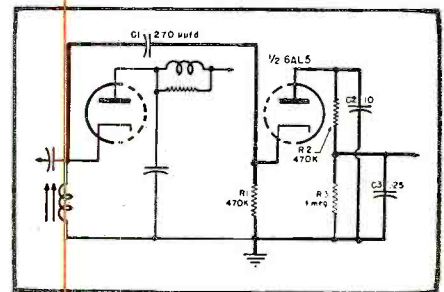

Fig. 1. Simple diode a.g.c. for the 630.

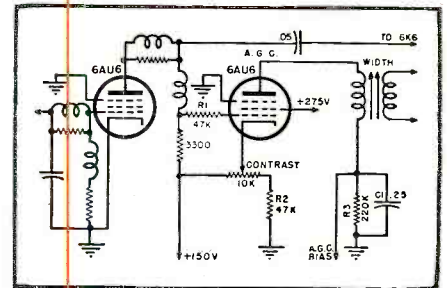

Fig. 2. Basic keyed a.g.c. for 630 model.

tubes are used. In the original design the i.f. amplifiers used four 6AG5 tubes which, at the time, were the best miniature pentodes for this application. Now the 6AG5 is becoming obsolete and its successor is the 6CB6. This miniature pentode has 20% greater transconductance than the 6AG5 and therefore greater gain. The suppressor grid is brought out independent of the cathode. The suppressor grid in the 6CB6 is pin 7 which is invariably grounded. Pin 2, the cathode of the 6CB6, usually has a small resistor, 39 ohms in the 630, going to ground. In the original 630 either pin 2 or 7 was used for the cathode since the suppressor in the 6AG5 was internally connected to the cathode. When servicing a late model 630 it is important to know whether a 6CB6 or a 6AG5 is used in the i.f. so that repairs can be made accordingly.

Large Screen Picture Tubes

The original 630 was designed with ample sweep for the 45 degree 10BP4 and with a high voltage of about 9000 volts. When a 52 degree tube, such as

Fig. 3. Block diagram of the original RCA 630TS television receiver chassis.

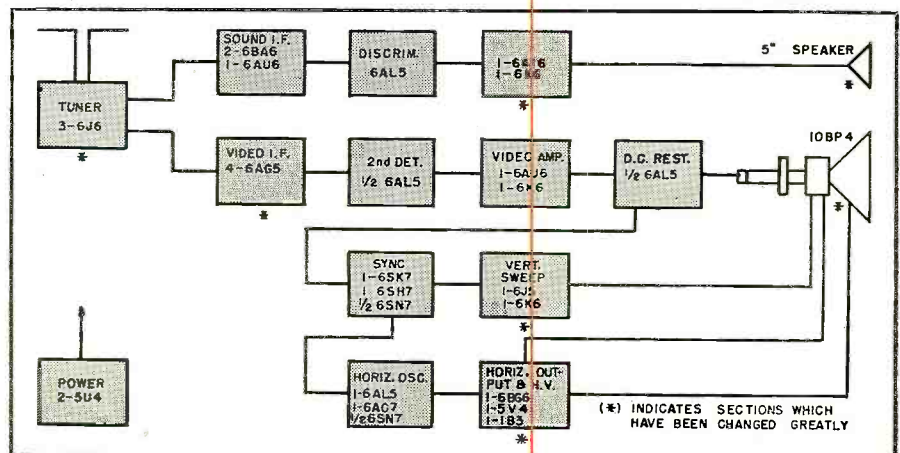

(*) INDICATES SECTIONS WHICH HAVE BEEN CHANGED GREATLY

the 15CP4, was used the deflection and high-voltage were barely sufficient, but with 63 and 70 degree tubes, the old 630 was not usable. Two separate deficiencies appeared. First, the deflection angle became so wide that the old deflection yoke gave neck shadow as well as insufficient sweep. Secondly, the required voltage for the second anode was higher than the maximum available from the 630. The remedy for both defects consists of a completely new horizontal flyback system. Here again several different systems are in use today. The first RCA-developed sweep system for wide angle, large screen tubes involves the use of a high-voltage doubler to achieve the higher second anode voltage and a powdered iron core flyback transformer. This system is used in such well-known 630 models as the *Regal*, *Philmore*, and many others. The flyback transformer is the RCA #211T5, which has two high-voltage filament loops for the two 1B3 high-voltage rectifiers used in the doubler circuit. The output of this system ranges up to 16 kv. which is sufficient even for a 24 inch picture tube. This type of system is shown schematically in the diagram of Fig. 4B. In some models the original 6BG6 is retained, in others a 6CD6 is substituted. The latter tube draws more "B plus" and more filament current, which is sometimes supplied by using a higher rating power transformer than was originally used with the 630. Circuit modifications are also made in the horizontal oscillator and discharge networks to obtain more drive and thereby more sweep and high-voltage.

The second system used for large screen picture tubes involves the original, single 1B3 high-voltage rectifier, but a new, high efficiency flyback transformer is used. Instead of a large powdered iron core, a relatively small ferrite core is used which reduces the losses and greatly improves the "Q" of the entire circuit. To get full efficiency from this circuit the deflection yoke must be of special design, usually featuring, in addition, a ferrite core. Again, circuit changes in the oscillator and discharge networks are necessary to drive the flyback section hard enough. Although most models use the original 6BG6 output tube, some have

substituted a 6BQ6 or a 6CD6 to get better results with a particular type of flyback transformer. It is important to note that many ferrite flybacks, such as the *G-E 77J1*, require a special width and linearity coil. In the case of a keyed a.g.c. system, the a.g.c. winding must be wound on the special width coil. Both the voltage doubler and the high efficiency flyback circuit have certain advantages and disadvantages. In the case of the doubler a second 1B3 and two additional high-voltage condensers are required. This cramps the already limited space in the high-voltage compartment and often leads to arcing and corona which may be very difficult to eliminate. The high efficiency flyback has a longer retrace time than the powdered iron type. Too long a retrace time results in horizontal foldover. This foldover can be minimized by adjusting the phasing slug on the "Synchrolok" transformer or by shunting the .015 μ fd. condenser across the phasing winding of this transformer with an additional .002 μ fd. Another scheme blanks out the foldover by connecting the first anode of the picture tube to a portion of the horizontal flyback pulse, thus cutting the tube off during the period of the retrace and foldover.

Some of the circuit details of the 630 circuit using a high efficiency flyback transformer are given in the diagram of Fig. 4A.

In both types of high-voltage flyback a wide angle deflection yoke must be used to avoid neck shadow and insure adequate sweep. Most of these yokes have a smaller vertical winding than the original 630. The vertical deflection for a 10 or even 15 inch tube which the 630 provided is not sufficient for the wide angle picture tubes with the smaller vertical yoke winding. To increase the vertical sweep, many 630 models simply raise the voltage to the vertical oscillator and output tube by connecting them to the boost voltage from the horizontal flyback transformer. In some cases the 6J5 oscillator is changed for a 6SN7 which permits using one half of the tube as the oscillator like the 6J5 and using the second half as a discharge tube, thus getting more vertical drive for the output amplifier. The 6K6 output ampli-

fier in the original 630 was connected as a triode, and in some later versions, a triode like the miniature 6S4 or the 6SN7 connected in parallel, is used instead. New output transformers designed to match the output tube to the new vertical deflection yoke also help in getting sufficient vertical sweep.

Other Changes

Many minor electrical changes are found in the new 630 versions. For example, in the old 630 the filaments for all 6AL5 tubes were heated through a resistor providing less than the 6.3 volts rated. The reason for this was the concern of the designers for the performance of the 6AL5 under rated voltage, since this was a relatively new tube. Now the 6AL5 has been considerably improved and the filament dropping resistor is eliminated in most late 630 versions. Substitution of a 6W4 for the 5V4 damper is another minor change. The 6W4 requires no separate filament and does the job just as well as the 5V4. In the original version a pilot light was used in the high-voltage cage as fuse for the flyback transformer. In many newer 630 sets this is either omitted or a fuse is wired into the circuit. Some of the condensers and resistors have been changed slightly to get better performance with large screen picture tubes, but these are all minor electrical changes.

Mechanically the only major change has been in the mounting brackets used for the picture tube, deflection yoke, and focus coil. In the original 10 inch version, the picture tube is mounted on the chassis between the front controls. As the picture tubes gained in diameter, they had to be mounted higher above the chassis. The rectangular picture tubes are usually mounted entirely above the chassis on both front and rear supporting brackets. In many late versions the picture tube is mounted in the cabinet and cables and plugs connect the deflection yoke and focus coil to the main chassis.

Reviewing the past five years, it is indeed remarkable how one particular design has been maintained in its essentials yet is still an up-to-date TV model. With the additional improvement of better tuners, a.g.c., and large screen picture tubes, the 630 is today considered a high quality receiver with exceptional fringe performance, good resolution, and consistent trouble free operation.

While we have pointed out the important changes that have taken place in the past in the design of this particular receiver, new refinements are being added all the time.

In addition to circuit changes, the next few years will see many new developments in picture tube design, including the popularization of the electrostatic focus type tube which not only permits drastic savings in critical materials but allows important simplification of television receiver circuits. An article on this topic will be included in next month's issue.

Fig. 4. Two flyback circuits designed for use in the 630 circuit. (A) A high-efficiency type circuit. (B) A doubler-type circuit for large screen 630 receivers.

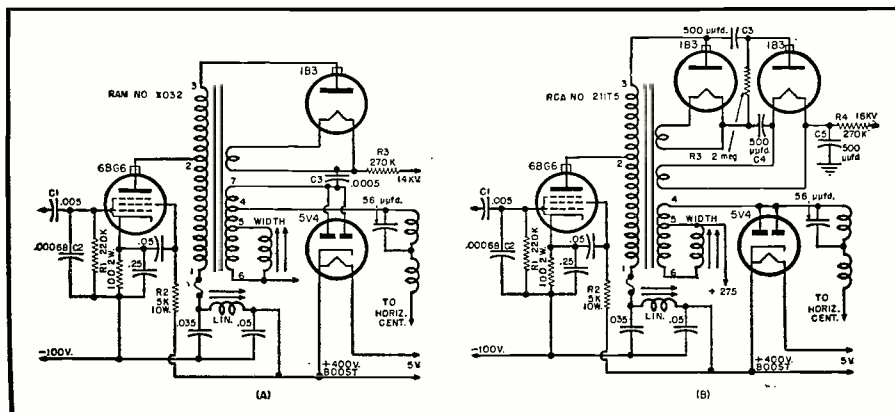

THE ALUMINUM FOIL BEAM

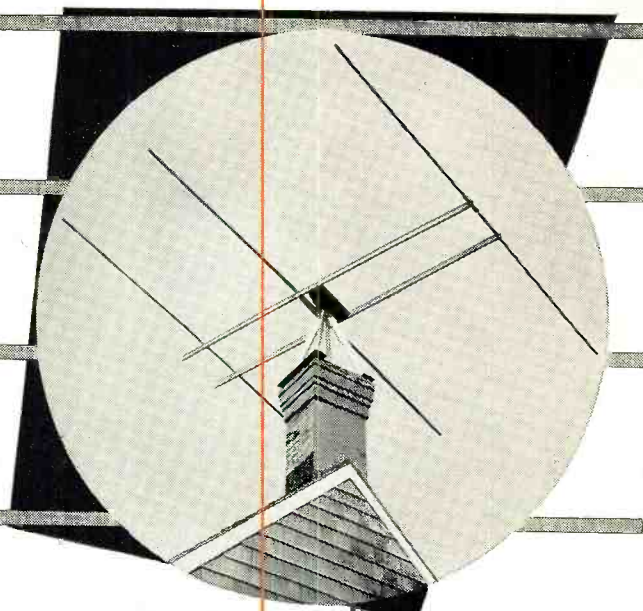

By
MAJOR HARRY L. ULYAT,
W3PTW

Beam antenna on author's home. It has withstood several hard storms.

Details on a priority-free antenna for operation in the 10 meter band. Only hand tools are needed.

THERE are a lot of us fellows who have thought about building a 10 meter beam but the trouble and expense have been big factors in making us decide against it. If it could be made of something we already had in the shack or in the kitchen, we wouldn't mind getting started on the thing.

The author had come to this "dead end" state of affairs when one day his wife was fixing dinner and started unrolling some long sheets of aluminum foil. A duck was to be wrapped in this foil and placed in the oven.

But about that time an idea was born and the wife was told to hold everything. Quickly getting out the yardstick the remaining length of foil was measured. Yep; it would do. My 10 meter beam was as good as made!

Leaving the duck to get along the best way it could (also the wife) the tool shed was ransacked and brought forth three long wooden poles 1½ inches in diameter. I had all I needed!

But would it work? Hastily looking through some articles for ideas on 10 meter beams I came across just what I wanted. Experiments had been made with some 1½ inch aluminum tubing and the results had been tabulated giving the element spacing and lengths.

Cutting the poles the lengths suggested, they were first painted with a good grade of wood filler. Strips of aluminum foil 5 inches wide were cut the same length as the poles and wrapped around them lengthwise while the poles were still wet, the edges lapping and held down with more wood filler. The filler proved to be a very good glue as well as serving to make the wood waterproof.

These aluminum covered poles were then temporarily mounted on the edge of a couple of pieces of 1 x 4, sixteen feet long. A "T" match was made on the driven element and the thing was hoisted to the roof and placed on the chimney to see what it would do. A

piece of 300 ohm twin-lead connected the antenna to the transmitter.

A test was arranged with another ham who lived about a half mile away. On the first test the transmitter seemed to load nicely but he reported that my signals were very weak. There was no noticeable reading on his "S" meter. Of course I was only running 50 watts but surely the signal ought to be stronger than that. He had thought it might work too so we were both quite disappointed. It had looked like a swell idea but I now had to admit that it was a failure.

But just for the fun of it, I suggested that we try once more and turn the beam a little bit. Perhaps it had not been pointing exactly towards his house. Reluctantly he agreed. So once more a test was made, this time checking the exact direction with a map.

To his surprise (as well as mine when he told me) his "S" meter showed an "off scale" reading and my signals were coming in like a ton of bricks! Other tests were made and it proved to have a very good gain and also a high front-to-back ratio.

Since the aluminum foil comes in 25 foot lengths, 12 inches wide, two rolls are more than enough to make a three

element beam. Enough will be left over to bake several ducks. The elements should be handled with care during the process of construction as the aluminum foil can be easily torn.

It is quite evident that beam elements made in this way behave the same as the regular aluminum tubing of the same length and diameter. Any formulas for aluminum tube beams can therefore be used if the wooden poles are the same diameter as the tubes.

After making sure that the beam was really working, certain tests were made with the aid of a field strength meter to determine the exact spacing of the elements. As no holes are bored in the 1 x 4 support, the outside elements may be rolled back and forth on this support while the beam is in the operating position on the roof.

No experiments were made involving changing the length of the elements as this was not as practical as in the case of aluminum tube type beams. It was found that the original spacings, set according to the formula, were practically identical with those that gave maximum readings on the field strength meter.

The measurements used in my particular case were designed to operate best at a frequency of 28.6 mc. The director length was 15 feet, 10 inches; the driven element length was 16 feet, 6 inches; the reflector length was also 16 feet, 6 inches. The spacing of the director from the driven element was 4 feet, 11 inches. The spacing of the reflector from the driven element was 6 feet, 7 inches.

Round wooden poles may be purchased from many lumber companies. So-called 16 foot lengths will usually

(Continued on page 111)

Mechanical details of the aluminum foil beam. Unit is fairly simple to construct.

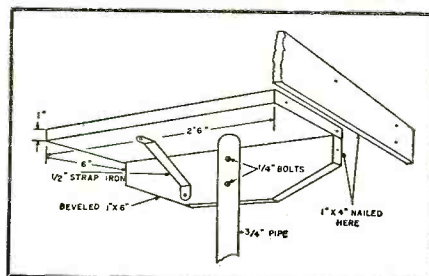

STABILITY PLUS

A serviceable v.f.o. exciter which insures stability in amateur radio transmissions.

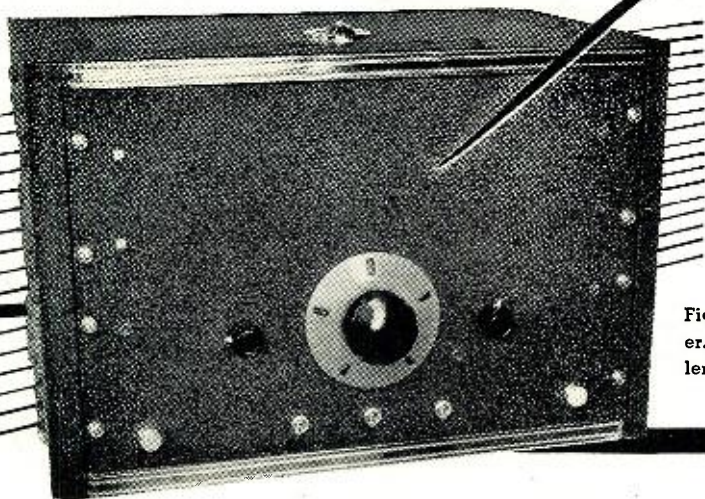

Fig. 1. Panel view of v.f.o. exciter. A minimum number of controls lends a professional appearance.

... with the Franklin Oscillator

By

MERRITT KIRCHHOFF*

W2FAR

and

DAVID D. BULKLEY**

W2QUJ

GREAT strides have been made in recent years in the improvement of amateur radio equipment. Receivers with greater sensitivity, greater selectivity, and greater frequency coverage today provide unsurpassed reception facilities for amateur communications. There are available vacuum tubes of such versatility that transmitters have become streamlined wizardries of the amateur art. However, it is evident that much may be done to enable the some 80,000 American hams to carry on with their hobby with a minimum of interference.

Frequency stability has become increasingly important with the adoption of variable frequency oscillators, for the FCC is exercising greater vigilance than ever before. The ham today is more and more conscious of "how his signal sounds" and "where his signal is." The many plaudits heaped on the Clapp variable frequency oscillator are well-earned, for the Clapp approaches the epitome of flexible amateur transmitter frequency control. However, the ingenuity of C. S. Franklin of the Marconi Company of England has given us a variable frequency control circuit with stability equivalent to that of the finest crystal-controlled circuits. The Franklin oscillator has found application in many laboratory devices in

recent years. It is most often used in precision frequency meters and audio oscillators.

The Franklin oscillator differs from the conventional oscillator circuits in that it makes use of two cascaded tubes to obtain the "negative resistance" effect to sustain oscillation. Fig. 2 is a representative circuit wherein it may be seen that the second tube acts as a phase inverter to provide a very high effective transconductance. If the tuned circuit LC were replaced by an RC circuit, the oscillator would become a multivibrator.

The stability of the Franklin oscillator depends on two factors: first the quality or "Q" of the tank circuit and second, the degree of loose coupling between the circuit and the tubes. In most forms of conventional oscillator circuits, the resonant circuit is quite tightly coupled to the tube and, as a

consequence, is heavily loaded. Irrespective of circuit "Q" when measured alone, the "Q" will be considerably lower when measured in a "working" circuit. In the basic circuit of the Franklin oscillator, as shown in Fig. 2, C_a and C_b are extremely small—on the order of 1 to 2 μfd . This effectively reduces tube loading to a negligible value. As a result, the isolation of the circuit LC from tube effects is quite complete. Since the interelectrode capacities of the two tubes can only act across the circuit in series with C_a and C_b , no changes of any kind in the tube circuits can alter C by more than 1 μfd . or so. Thus, it is possible to exchange the tube for another of a different type, alter the plate or filament voltages widely, and even allow tube heating to occur. The resonant circuit LC cannot possibly be changed in effective capacity by more than approximately 0.2 per-cent (assuming a total tank capacity of 500 μfd .) Of course, in practice, such drastic changes do not ordinarily occur, so the effect upon the frequency would be considerably smaller than even 0.2 per-cent. It is this singular immunity to tube and voltage variations and from the effects of tube heating and consequent drift that makes the Franklin such a useful circuit.

The Franklin lends itself to practical construction for it is tuned with a simple tank circuit with one end grounded, thus, the variable condenser may be mounted directly on the chassis. Should bandchanging be required, it is effected by providing several coils all joined together at one end and ground-

Fig. 2. The basic Franklin oscillator circuit. A separate phase-inverter tube is used to feed a portion of the output into the input circuit in the correct phase to insure sustaining the oscillation.

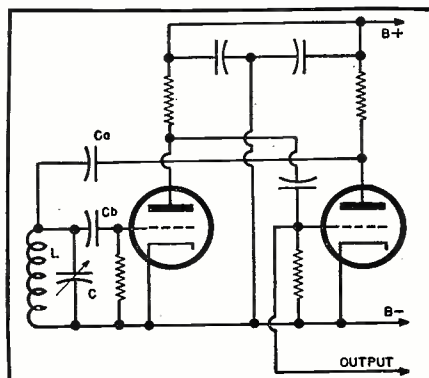

* Columbia Broadcasting System.
** International Telephone and Telegraph Corp.

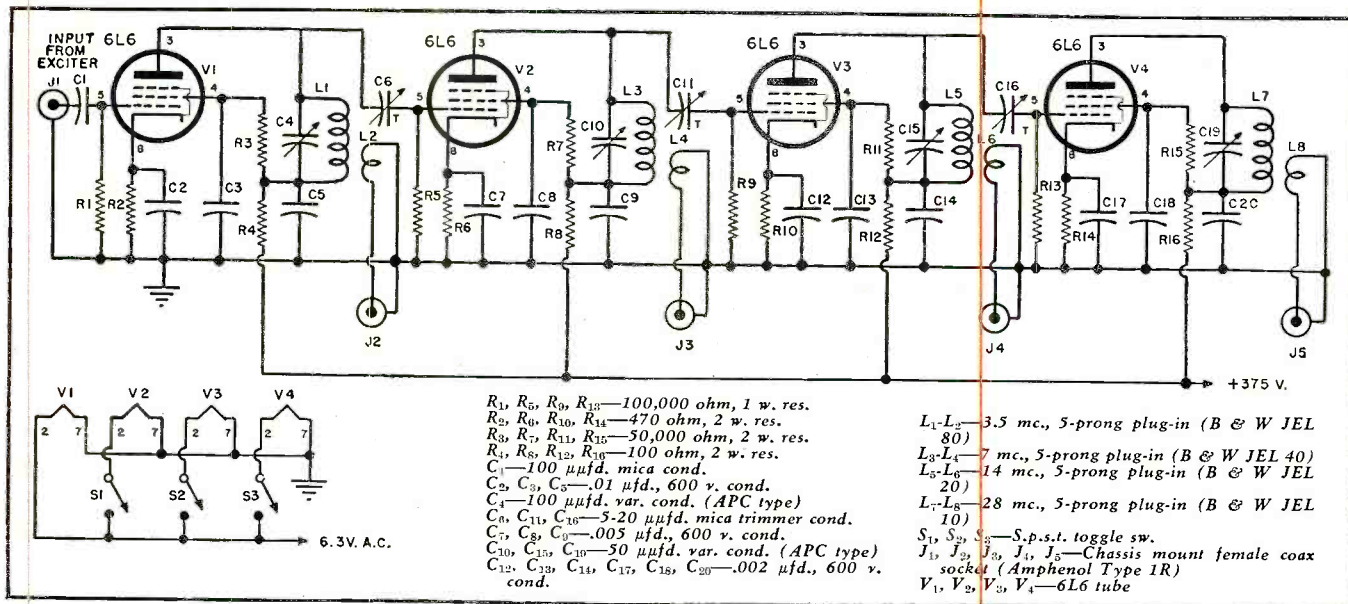

Fig. 3. Circuit diagram and parts list covering the frequency multiplier section.

ed. It is a simple matter to switch them with a single-pole selector switch. It is for this reason that the Franklin circuit is frequently referred to as a "Single Terminal" oscillator.

By merely substituting a crystal for the tank circuit LC it is possible to convert the Franklin circuit into a crystal oscillator. Owing to the high amplification of the two-tube arrangement, oscillation is very readily obtained from "difficult" crystals, particularly at low frequencies. It may be applied, for example, to 100 kc. bars and will oscillate quite satisfactorily with resonator crystals (such as those designed for i.f. bandpass filters), which seldom perform in conventional single-tube circuits.

Now, with a thumb-nail sketch of the operation of the Franklin oscillator, we may proceed to the construction of a sensationally stable variable frequency exciter delivering a minimum output of 15 watts in every amateur band from 3.5 to 28 megacycles. Output on 1.7 and 50 to 54 megacycles is possible with very minor changes, which will be discussed.

General. The photograph in Fig. 1 shows the functional, simple, and attractive layout of the front panel of the exciter. To the left of the HRO type main tuning dial is the v.f.o. buffer/doubler tuning control. There is very little need to adjust this control except when endeavoring to get the last milliwatt of drive from the v.f.o. The control knob to the right of the main tuning dial is merely a dummy knob to balance the front panel for appearance sake. The filament indicator light is found in the lower left-hand corner of the panel while the plate-voltage indicator light is in the lower right-hand corner. The left-hand toggle switch controls "on-off" of all filaments in the exciter. The center switch applies plate voltage to the v.f.o. unit alone, so that "spotting" of a frequency may be accomplished without transmitting a signal on the air.

The right-hand switch applies plate voltage to the frequency multiplier cascade. This switch might also be used to relay-control the remainder of the transmitter.

Variable Frequency Oscillator Unit. Referring to Fig. 7, we see a top view of the Franklin oscillator and v.f.o. amplifier unit with its cover removed. Although the authors chose to mount the oscillator in a war-surplus cast-aluminum case formerly used in the RAK-RAL Navy receivers, it is not necessary to go to such extremes of construction.

The left-hand compartment, as seen

in the photograph, contains the tank circuit section of the oscillator circuit. The 6SN7GT/G oscillator tube (V_1 of Fig. 6), with its allied components, is mounted in the center compartment. This arrangement prevents heating of the tank circuit with possible frequency changes due to mechanical distortion.

As the output of the Franklin oscillator is extremely low, it is followed by a direct-coupled 6AG5 voltage amplifier stage (V_2 , Fig. 6). The use of this stage also prevents any possible reaction on the oscillator when low-level modulation is employed in one of the

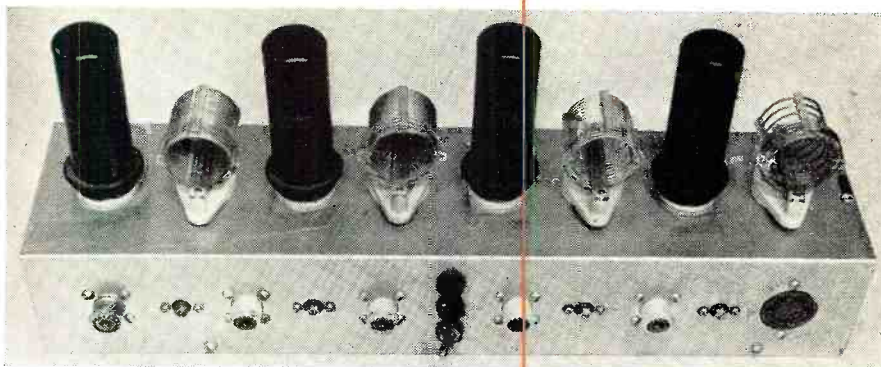
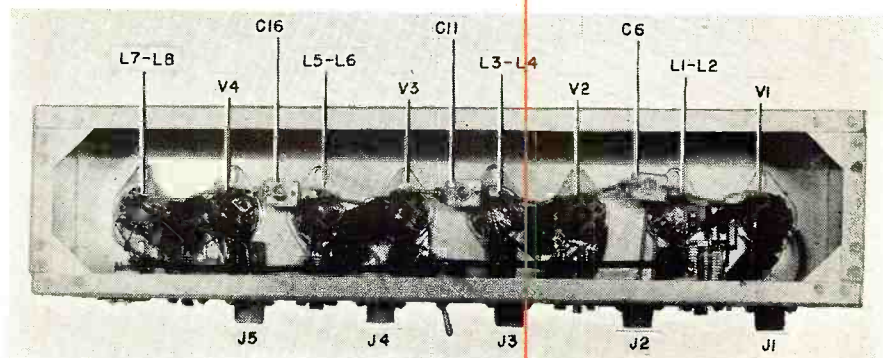

Fig. 4. The frequency multiplier cascade. This layout insures trouble-free operation.

Fig. 5. Bottom view of unit in Fig. 4. Adjustable trimmers are used with flexible drive.



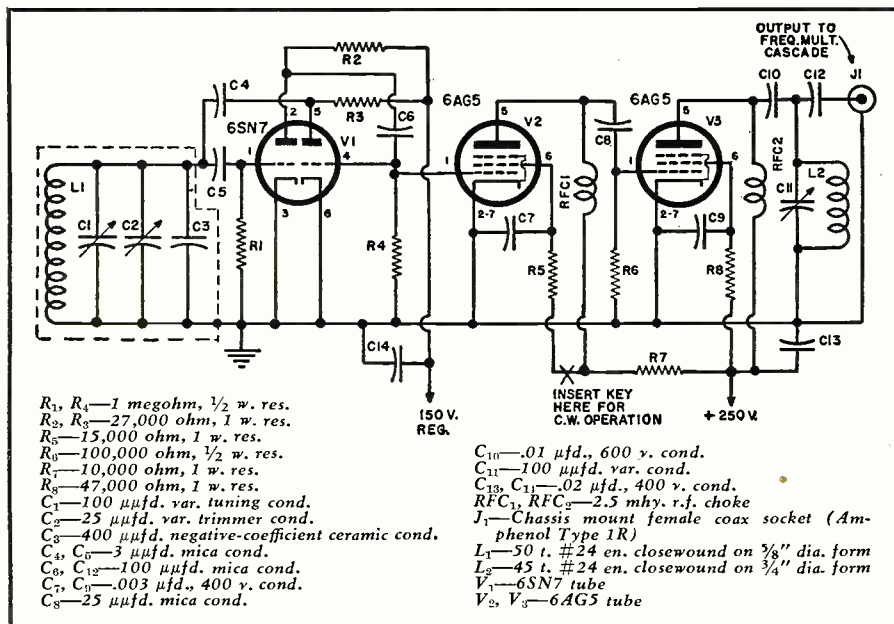

Fig. 6. Complete circuit diagram and parts list of the v.f.o. section of unit.

succeeding buffer or amplifier stages. Following the voltage amplifier is a buffer/doubler stage (V_3 , Fig. 6) employing another 6AG5. The voltage amplifier and the buffer/doubler stages are contained in the right-hand compartment of Fig. 7.

If it is desired to key the exciter, it may easily be done by inserting a closed-circuit jack (insulated from the chassis) in the screen lead of the 6AG5 voltage amplifier stage (V_2 , Fig. 6) of the v.f.o. This arrangement is noted on the circuit diagram of Fig. 6.

Frequency Multiplier Cascade. Fig. 4 is a top view of the four-stage frequency multiplier cascade utilizing 6L6's throughout. Any reasonable combination of frequency multiplying functions may be performed, but for the sake of simplicity, it was decided to drive each 6L6 as a doubler, except in the case of the 21 megacycle band, which will be discussed later.

The first 6L6 doubler (V_1 , Fig. 3) re-

ceives a 3.5 megacycle signal from the v.f.o. and provides 3.5 or 7.0 megacycle output at J_1 . Therefore, it is possible to obtain outputs from the succeeding stages as follows: 7 or 14.0 megacycle output from V_2 and J_3 , 14 or 28 megacycle output from V_3 and J_4 , and 28 or 50 megacycle output from V_4 and J_5 . For 21 megacycle output, V_3 would be used as a tripler with output from J_4 .

It is therefore a simple matter to obtain r.f. to drive the intermediate or final amplifier of any transmitter by merely choosing the coaxial output delivering the desired frequency. This simple and efficient system eliminates complicated switching circuits with their attendant losses and radiation.

Auxiliary filament switches are provided which allow V_2 , V_3 , and V_4 to be turned off when they are not needed; the three toggle switches in Fig. 4 are: S_1 , the auxiliary filament switch for V_2 , S_2 for V_3 , and S_3 for V_4 .

As shown in Fig. 4, the tuning con-

densers for each frequency multiplier tank circuit are screwdriver adjusted as these stages tune broadly enough to provide adequate drive to the succeeding stage.

Fig. 5 is the bottom view of the frequency multiplier cascade. With rigid construction throughout, components are mounted to facilitate assembly and servicing. It should be noted that variable trimmers are used for interstage coupling to permit drive changes to be made if necessary. No metering circuits are embodied as the non-critical drive requirements of the tubes are adequately attained using the components specified in the circuit diagram.

The plate and screen voltages supplied to the frequency multiplier tubes are below the maximum ratings of the tubes. Ample output is obtained to drive the average medium- to high-power amplifier, and is more than enough to drive any of the beam power tubes used by amateurs. If greater output is required, or if it is desired to operate this exciter as a low-power transmitter, the plate and screen voltages may very safely be raised to the full value prescribed for ICAS operation. With full voltages applied, the power output approaches 25 watts.

Power Supplies. Two separate power supplies are used; one for the v.f.o. and one for the frequency multiplier cascade. Although surplus components were used in the original power supply chassis, comparable commercial components are specified in the parts list accompanying Fig. 10.

As has been stressed in the circuit description, the Franklin oscillator is immune to voltage changes, so a regulated power supply is *not* necessary. Indeed, an unregulated selenium rectifier power supply would do just as well as the power supply shown in Fig. 10.

Interconnecting cables, for power supply voltages, are used in the interest of neatness. They are terminated in convenient power plugs. It is urged

(Continued on page 151)

Fig. 7. Top view of Franklin oscillator with its allied amplifier and buffer/doubler. Assembly is compact yet uncluttered.

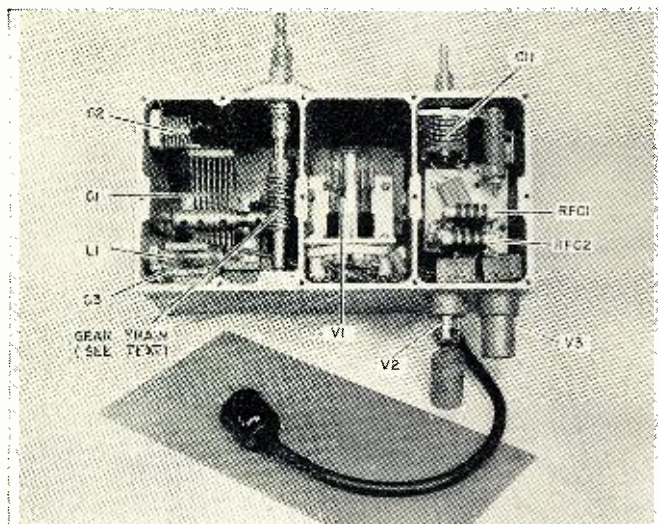
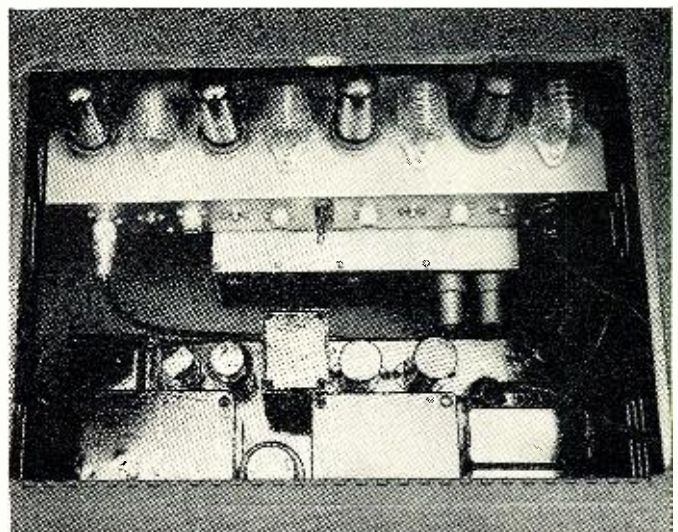

Fig. 8. Top view looking into cabinet. The unitized mounting system allows easy removal for servicing or modifications.





D.C. VOLTAGES in TELEVISION RECEIVERS

By
JOHN K. FRIEBORN

A discussion of TV sets having complicated voltage distribution circuits and how to troubleshoot them.

MEASURING voltages between chassis or "B minus" and the various electrodes of each tube is a standard method of troubleshooting radio and television receivers. In radio, it will not find all troubles, but when used with other simple checks, it will find most. In television, the method can be misleading or it can find troubles which are otherwise hard to figure, depending upon how the measurements are made and how they are interpreted. This method is based upon the fact that a fault which interferes with performance of a receiver's intended functions usually will also change d.c. or 60 cycle a.c. voltage measurements. If the technician has data to tell him what the readings should be, his only problem is interpretation, but it is often desirable or necessary to service without specific data for the receiver.

In dealing with radio receivers, an experienced technician can do this with reasonable confidence, because almost all radios have d.c. voltages within certain ranges, depending upon the tube type and its function in the set. He can save time by making all measurements with the meter common lead connected to chassis or "B minus." Of course, the effective grid, screen and plate voltages of a tube are those with respect to the cathode. However, the cathodes of most tubes in a radio receiver are at or only slightly above the potential of the reference point, so measurements of screen and plate voltage with respect to chassis or "B minus" are sufficiently accurate.

In television receivers, measurements from chassis or "B minus" to electrodes of the tubes vary too much between different makes and models of

receivers for any range to be called typical for a certain tube and stage in the receiver. In some television receivers, conditions are similar to radio, the chassis is at "B minus" potential or approximately that, all cathodes are at or slightly above the potential of the chassis, and plates and screens, with a few exceptions, are positive from one hundred to three hundred volts. In other television receivers, the chassis may be one hundred volts or more positive with respect to "B minus," cathodes may be a similar amount positive or negative with respect to the chassis, and plates of some tubes may be less positive than cathodes of others. Voltage measurements with respect to chassis or "B minus" are found normally in some receivers which would indicate trouble in others.

One can avoid confusion, of course, by making all measurements with respect to individual tube cathodes, but this takes more time than the use of a common reference point. Another possibility is to subtract the potential of the cathode from the potentials of the other electrodes to get effective grid, screen, and plate voltages. A method which needs no mathematics and is accurate enough is to measure the potential of each cathode before other electrodes and, only in case of tubes whose cathodes are not near ground potential, shift the common lead of the meter to the cathode to measure screen and plate voltages.

The wider ranges of voltage readings in television receivers than in radios result from the greater variety of connections of tubes with respect to the power supply. In radio receivers, cathodes of all tubes are connected to "B minus," either directly or through

bias resistors, while plates are connected to "B plus," usually through plate resistors or other loads and dropping or decoupling resistors. All of these combinations of cathode resistor, tube, plate load, and decoupling or dropping resistor are in parallel, just as tube heaters are in most transformer-type radios.

In television receivers, the available d.c. voltage from the power supply is considerably more than that required by many of the tubes. Tubes in deflection circuits usually require from 250 to 500 volts, so that amount must be available from the power supply. Tubes in r.f. and i.f. sections usually receive only 100 to 150 volts and other tubes may be operated with similar voltages. Reducing power supply voltage to such a value is accomplished by connecting tubes with dropping resistors in various series-parallel combinations, sometimes resulting in tube cathodes having potentials very different from those of the chassis. Some cathodes are considerably above ground in certain models of receivers made by *Admiral, Crosley, Gard (Majestic), Philco, Sentinel, Sperton, Stewart-Warner, and Westinghouse. Capehart, Du Mont, Emerson, Magnavox, Silvertone, and Sylvania* receivers have some cathodes very much below ground. *Arvin, Bendix, Hallicrafters, Motorola, and RCA Victor* have made receivers both ways.

In *RCA Victor* Model 8T241, cathodes of audio output, 1st and 2d video, and nearly all of the sync channel and deflection channel tubes are negative with respect to chassis. These cathodes are returned directly or through resistors to the negative lead of the low voltage power supply, which is 120 volts negative with respect to chassis. Fig. 1 shows that R_{103B} and R_{103C} are connected between the negative lead and chassis. Voltage drop

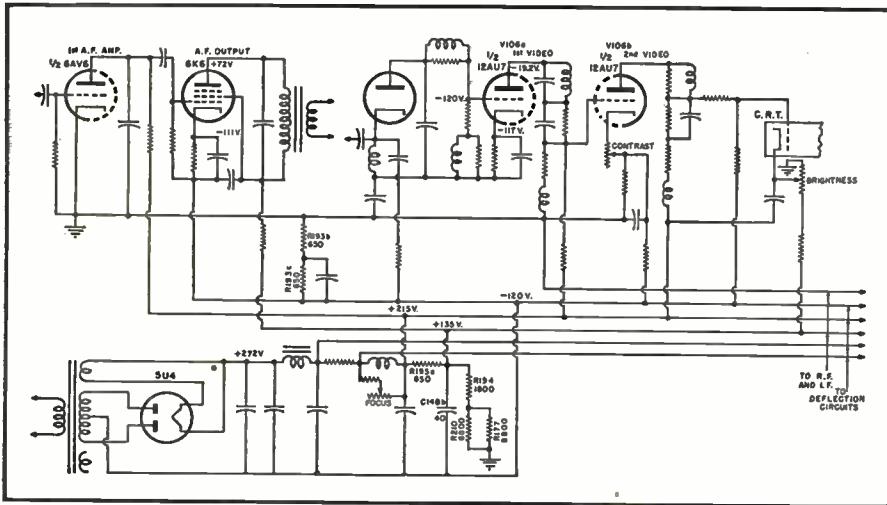
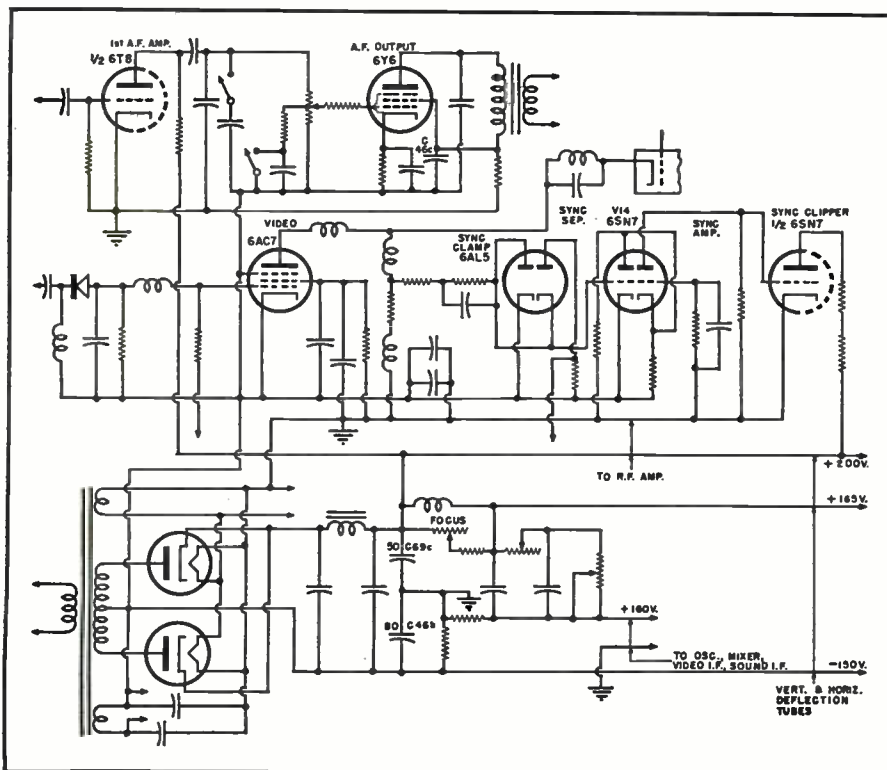

Fig. 1. Partial schematic diagram of the RCA Victor Model 8T241 television receiver.

across them is produced by current drawn not only by R_{103A} , R_{104} , R_{210} , and R_{117} , but also other tubes in the receiver whose cathodes are connected directly or through resistors to chassis. Tubes and other components which pass d.c. current are arranged in a rather complicated series-parallel fashion, but of course in such a way as to apply appropriate voltages to each tube. In the 1st video amplifier, the plate is marked -19.2 volts and the grid -120 volts, but the cathode is -117 volts, so the effective plate voltage is 97.8 volts less negative than the cathode, that is, 97.8 volts positive, while the grid is only 3 volts more negative than the cathode. The audio output plate is only 72 volts positive with respect to chassis, but since the cathode is -111 volts, the effective

plate voltage is 183 volts positive. From Fig. 1 we can see the effects of certain troubles. If R_{103C} should open, no current could flow through tubes whose cathodes are connected above it, so sound and video signals would disappear, but both horizontal and vertical deflection circuits and the high voltage supply would still function and produce a raster. However, voltages even on these stages would be changed. Since less current would be drawn from the power supply, its total output voltage would increase from the normal 392, but less current would also flow through components between the positive terminal and chassis, producing less voltage drop, so the filament of the rectifier would measure less than 272 volts positive, while the center tap of the low voltage

Fig. 2. A portion of the schematic covering the Bendix Model 235M1 video receiver.



power transformer would measure more than 120 volts negative. Less current would flow through the focus coil and none through the brightness control.

If the audio output tube heater should open, less current would flow through R_{103A} and voltages on all tubes whose plates are connected below it would increase, as would voltage across the brightness control. Current through the focus coil would also decrease, but by a smaller percentage.

If C_{143B} should short, both the 135 volt positive lead and the 120 volt negative lead would assume ground potential and much more current would flow through R_{103A} .

A common method of tracing troubles in television receivers is: (1) to determine the section of the receiver at fault, by interpreting visible and audible symptoms; (2) to determine the stage at fault, by signal or function tracing of the section; (3) to determine the faulty component, by measurements or other checks in the stage. Troubles in receivers with complicated voltage distribution systems are often hard to find by this method, since one fault may affect several sections. Except in case of a very obvious trouble, the technician usually can save time by measuring a few key d.c. voltages before final interpretation of symptoms or signal tracing. In the RCA Victor Model 8T241, key voltages are those between chassis and various points on the low voltage power supply voltage divider.

While the RCA Victor Model 8T241 has tubes connected in series with various dropping resistors, more and more television receivers have tubes connected in series with each other for plate and screen voltage distribution, on the same principle as the series heater arrangement of transformerless receivers. Such an arrangement for plate and screen voltage reduces the amount of power lost in resistors. Thus it is unnecessary to use resistors of such high power rating and reduced heat radiation makes it possible to place parts in the receiver closer together and make the chassis and cabinet smaller.

Bendix Model 235M1 is a receiver in which some tubes are arranged in series-parallel with others. Total d.c. voltage available from the power supply is 350 volts, 200 volts positive with respect to chassis and 150 volts negative. Some tubes and associated components are connected across the entire 350 volts, some are connected between "B plus" and chassis, and others are connected between "B minus" and chassis. Fig. 2 shows d.c. voltage distribution. Plates and screens of audio output and video tubes are negative with respect to chassis, but their cathodes are more negative. A substantial part of the current for r.f. and i.f. tubes flows through the audio output tube; if it should become weak, the voltage drop across it would increase and the voltage and current for r.f. and i.f. tubes would decrease, result-

ing in decreased picture contrast, among other things. If the audio output tube were gassy, voltages would be affected the opposite way.

Sync separator, amplifier, and clipper tubes are substantially in series. This arrangement can be used because little plate voltage is required for each stage and direct coupling is an advantage in this channel.

In this receiver, heaters of audio output, video, sync clumper, sync separator and amplifier, and vertical and horizontal deflection tubes are connected to a separate winding on the power transformer, which is connected to negative 150 volts. This is done to place the heaters and cathodes of these tubes at approximately the same potential and reduce heater-cathode leakage. Both sides of these heaters have the same high negative d.c. potential with respect to chassis, although the usual a.c. voltage is across each heater.

Key d.c. voltages to check are those between chassis and "B plus" and "B minus" for all troubles and, for synchronizing troubles, voltages at various points in the sync channel.

In any amplifier tube, plate current varies instantaneously with the signal. Where plate current of one tube flows through another tube in series with it, the signal in the first tube will affect the signal in the second. In this particular receiver, coupling would take place especially from the audio output stage to r.f. and i.f. sections. To reduce such coupling, C_{50C} and C_{46B} are connected across positive and negative parts of the d.c. voltage, respectively, while C_{46C} is connected across the audio output tube and its associated components. Thus, although the voltage across each load can change with the proper signal, the total voltage across each load and its tube is prevented from changing rapidly enough to follow any of the signals. If one or more of these condensers should open, voltages could change more rapidly and coupling from audio to r.f. and i.f. would increase.

In the *Admiral 20X1*, Fig. 3, audio and video output tubes are in parallel with each other and the combination is in series with r.f., i.f., and sync channel tubes, but audio and video cathodes are above ground. The same comments apply to faulty audio tubes and decoupling condensers in this receiver as in the *Bendix*.

Fig. 4 shows part of the circuit of *Westinghouse Model H604T10*. Audio output, damper, and horizontal output tubes are substantially in series. Most of the current through each tube flows through the other two. This arrangement makes use of part of the voltage developed by the damper to add to the audio output plate and screen voltages, as well as to the horizontal output plate voltage. It is conventional to use voltage produced by action of the damper in rectifying the horizontal deflection signal, to boost horizontal output plate voltage. This has the effect of salvaging some of the energy

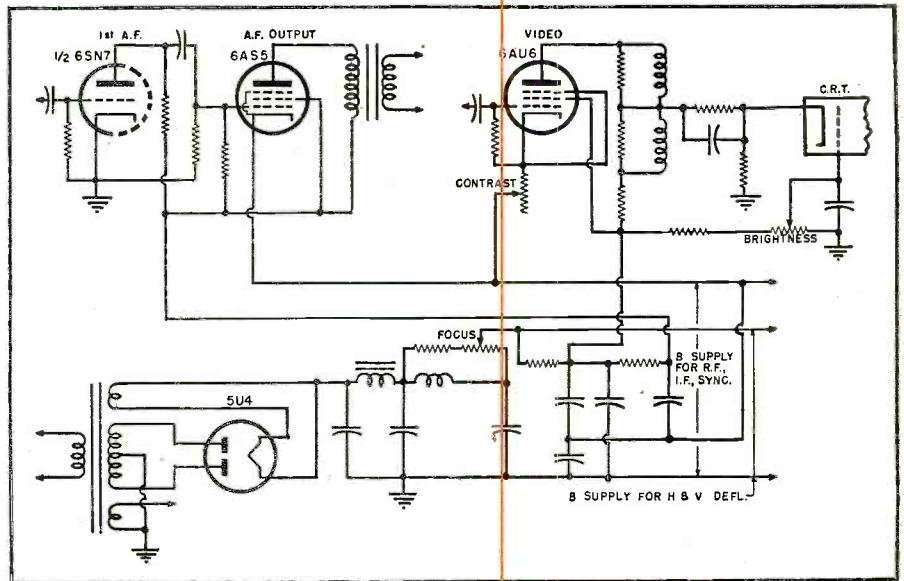

Fig. 3. One section of the *Admiral Model 20X1* TV receiver. See text for details.

which must be dissipated when the field of the deflection coils collapses. Increased efficiency of the horizontal output stage is particularly useful in receivers using flyback type high voltage supplies, where high voltage as well as horizontal deflection pulses are obtained from this stage. In this *Westinghouse* receiver, the high voltage supply is of the separate r.f. oscillator type and the horizontal output stage does not need to furnish so much power. Some boost voltage is available for use elsewhere and it is applied where it will do the most good, to the audio output tube. The ratio between voltages supplied to horizontal and audio output tubes depends upon capacities of C_{410} and C_{424} , which are charged when the damper conducts, to voltages inversely proportional to their capacities. Decoupling networks, $R_{412}-C_{405}$ and $R_{204}-C_{204}$, keep the audio signal

from affecting horizontal deflection and *vice versa*.

This receiver has the peculiarity that failure of any of the three tubes would eliminate both sound and horizontal deflection, although brightness and vertical deflection would still be present.

Key voltages are those across each of the tubes in series, but, because of the presence of large pulses, d.c. measurements ordinarily should not be made at the plate of the horizontal output tube or cathode of the damper. However, one may measure voltages between "B minus" and the cathode and plate of the audio output tube. Improper voltages in this receiver could be due not only to such usual things as faulty tubes, resistors of improper value, and leaky or shorted condensers, but also C_{410} or C_{424} being open or of improper capacity. -30-

Fig. 4. Partial schematic diagram of the *Westinghouse Model H604T10* TV receiver.

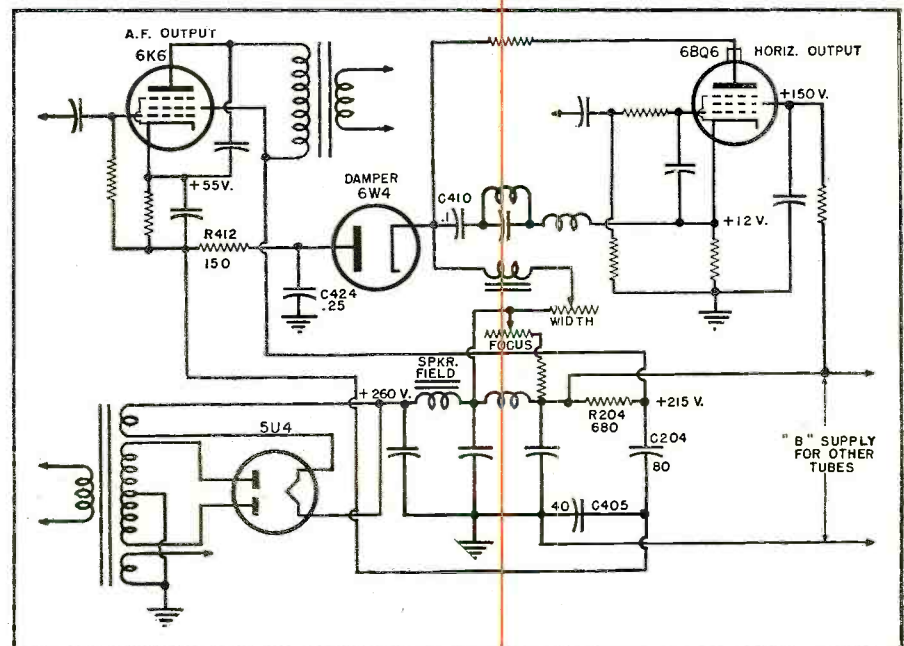

CRYSTAL DIODES

In Modern Electronics

By
DAVID T. ARMSTRONG

Part 5. A discussion of some of the applications of crystal diodes to television receiver circuits.

IN EARLIER articles of this series we discussed the uses of crystal diodes in AM and FM applications. In this and the next article we will consider several of their applications in modern television receiver circuits.

Fig. 3 shows several applications of crystals in TV receivers. As far as it is possible to discover, no manufacturer uses crystals at all these points, but some manufacturer uses crystals at each of these points. This block diagram indicates the possible applications of known germanium diode crystals in modern television receivers, based on present knowledge of circuitry and the performance characteristics of crystals. In general, the number of germanium diodes that may be used in a given television circuit is limited only by the number of diodes required.

To be quite optimistic, with the recent development of crystal triodes, which may be used in place of certain vacuum tube triodes, the future is bright with possibilities for small TV receivers that may become virtually tubeless!

Germanium diode type crystals have a definite place which they are now assuming on a large scale. It will be well for the experimenter and technician to know something about them for they are quite likely to supplant the 6H6's and the 6AL5's in many TV circuit designs.

When color comes along the fellow who knows the fundamentals of the application of germanium crystals will be able to apply this knowledge to the uses of germanium and silicon crystals in the ultra-high frequency color spectrum. Be ready for it. That will be the day for germanium and silicon

diodes! While eventually crystals are likely to displace tubes at high frequencies, even at low frequencies, certain types of crystals are proving more stable than presently available tube type diodes.

Basic Video Detector Circuits

At the present time the most widely accepted application of germanium diodes in television receivers is as video detectors. The chief function of a video detector is to demodulate the high frequency i.f. signal to obtain the video modulation. The most common component used for this purpose, until recently, has been half of a 6AL5. With but minor circuit changes a germanium diode may be substituted for the vacuum tube as a high quality detector element.

This substitution is not a simple problem, however. It is necessary to find ways and means of eliminating the other half of the 6AL5 vacuum tube diode in order to dispense entirely with the tube, socket, and associated wiring. This problem has been solved in various ways, such as using another germanium crystal as the diode d.c. restorer, sync clipper, or a.g.c. peak detector. Of course it is possible to design and use a full wave detector circuit using germanium diodes, but no manufacturer seems to have done this.

It is possible to design a very fine full-wave video detector, but most design engineers feel that the improvement in greater output and higher efficiency would not be worth the cost nor the circuit complication.

In Part 2 (November 1951 issue) both series and shunt rectifier circuits were described. Both can be used in video detector applications. Consider the simple germanium diode TV detector circuits shown in Fig. 1. *A* is a series type circuit and *B* is a shunt type circuit. Both types of circuits are widely used and both will perform equally well in properly designed systems.

The shunt circuit shown at *B* in Fig. 1 is used primarily when a closely coupled i.f. transformer is used and capacitive coupling to the detector is desirable to prevent "B+" voltages from being impressed upon the diode crystal. With the diode crystal connected in such a shunt arrangement it provides its own d.c. return path; this path is normally restricted by the coupling condenser in the series hook-up.

For a shunt circuit the back resistance characteristic of the diode is important. It is necessary that the back resistance be at least ten times the load resistance to maintain the achieved gain. However, very high back resistance values may sharpen the "Q" of the tuned circuit; then bandwidth may have to be restored by a change in value of the coupling condenser or with a compensating choke.

For a series type circuit, such as that shown at *A* in Fig. 1, the forward dynamic resistance of the diode is im-

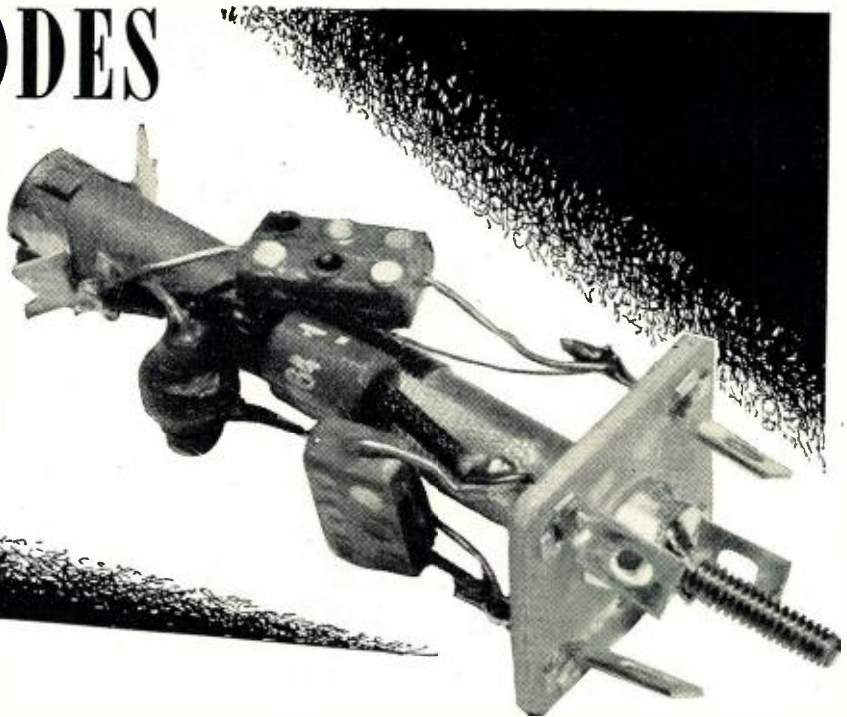

A conventional i.f. transformer assembly using a 1N64 germanium diode. G-E uses this unit in its TV receivers.

Fig. 1. Basic TV detector circuits. (A) A series and (B) a shunt type of circuit.

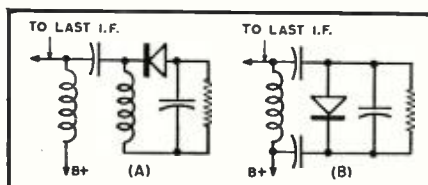

portant since it may be so large in comparison to the load as to form a voltage divider and reduce the output voltage. Because germanium diodes have lower dynamic resistance than vacuum tubes, additional gain may be realized in the crystal type video detector circuit. The "Q," or the sharpness of the resonance of the tuned circuit, will be broader as a result of the lower resistance of a germanium diode compared to that of a vacuum tube. While this may reduce the gain of the last i.f. stage, it can be restored by increasing the load resistance.

For both the series and the shunt circuit the load impedances are determined primarily by the video bandwidth requirements; therefore, these load impedances must necessarily be low values. The load condenser should be small enough to present a reasonably high impedance to the highest video frequency of 4 mc. and at the same time be sufficiently large to hold the charge from one peak to the next with a 24 mc. or 44 mc. i.f. signal. The load resistor must be large enough so as not to lower the impedance of the condenser and small enough to permit the condenser to discharge at video frequencies. Typical values are 5 to 10 μ fd. capacitance and 1500 to 5000 ohms resistance.

It should be realized that there are wider variations in the dynamic resistance of germanium diodes than there are in vacuum tubes. For this reason detector type germanium diodes are selected in the manufacturing process by test in an actual video detector circuit, see Fig. 2. This helps assure uniformity in actual performance. The design engineer attempts to select circuit values that minimize individual diode variations.

As a video second detector the germanium diode must convert an i.f. of 20 to 50 mc. into d.c., with the video signal and synchronizing pulses being passed on to the amplifier while the i.f. is rejected. This requires crystals capable of withstanding voltages higher than 1 or 2 volts; hence types like the 1N60 and 1N64 are used because these crystals are able to withstand voltages on the order of 5.0 to 10.0 volts.

Because both the dynamic resistance and the crystal capacitance of the germanium diode are very low, the crystal provides excellent demodulation in video detection circuits. The crystal provides exceptional linearity at low signal levels and is free from any undesirable contact potential effects. The excellent linearity characteristic of germanium diodes at low voltages and the absence of contact potential effects help achieve improved video output with reduction of distortion factors in low modulation regions. Hence the quality of the signal representing white is improved and the over-all picture presents more natural rendition of various shades from white to gray to black.

Since the picture carrier is amplitude modulated, a TV detector circuit

is similar to the detector circuit found in AM receivers. In both instances the chief function of the detector is to demodulate the picture carrier. Crystals perform the detection function remarkably well at the AM broadcast frequency and crystals will perform the detection function better in TV since crystals operate better at higher frequency. The reason for this is that the efficiency of germanium diodes does not fall off as rapidly as the efficiency of tubes with an increase in frequency at which the circuit is operating. But a video detector imposes more severe requirements on the detector diode than an AM broadcast type detector or an FM receiver type detector is called upon to meet.

The trend in video detector design has been from the 6H6 to the 6AL5 to the germanium diodes. The input signal to the detector is such that current flows through the diode when the diode plate is positive with respect to the cathode. While the polarity of the picture signal is essentially a design problem and not a service problem, it must be remembered that whenever a germanium diode is replaced in a TV receiver the original polarity must be maintained, otherwise white and black objects will be reversed and synchronization will become extremely critical.

In general, picture phasing considerations are the same for a vacuum tube diode. It is necessary to achieve correct polarity of the crystal diode according to whether the blanking pulses are negative or positive and whether the signal injected to the CRT is to the grid or to the cathode. When the signal is to the grid it must end up with sync negative; when the signal is to the cathode, it must end up with sync positive. Whether the sync will be positive or negative depends upon the number of video amplifiers and the polarity of output of the detector; there is a phase shift of 180 degrees for each video amplifier.

Detector Circuit Considerations

Many modern TV receivers use a germanium diode as the video detector

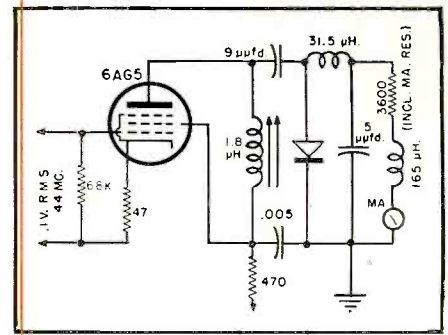

Fig. 2. The special test circuit for the 1N64 as used by General Electric Company.

for various reasons as listed below:

1. Simplicity of design,
2. Ability to handle a large dynamic signal range,
3. Minimum amplitude distortion (not too important, but worth mentioning),
4. High degree of linearity,
5. Ability to shield the detector by mounting inside shield can.

One important requirement of a video detector is that the output level be approximately flat for frequencies from 30 cps to 4.0 mc.; the video amplifier should be designed to pass this range of signal without attenuation. Therefore, the value of each component in the detector circuit is usually the result of careful selection by the design engineer; if replacement of any component is necessary, a technician should be careful to use resistors, condensers, and coils of the same value. The coupling network may be of the peaking coil resistor type, or it may be a low pass filter type. Many receivers are now using a low pass filter type. It is worthy of note that no d.c. restoration is necessary with direct coupling from the video detector to the video amplifier because the d.c. component is preserved with direct coupling. But there must be direct coupling all the way from the detector circuit to the picture tube.

The signal at the output of a video detector is not quite strong enough to drive a picture tube. In this respect it

Fig. 3. Possible applications of germanium diodes in modern television receivers.

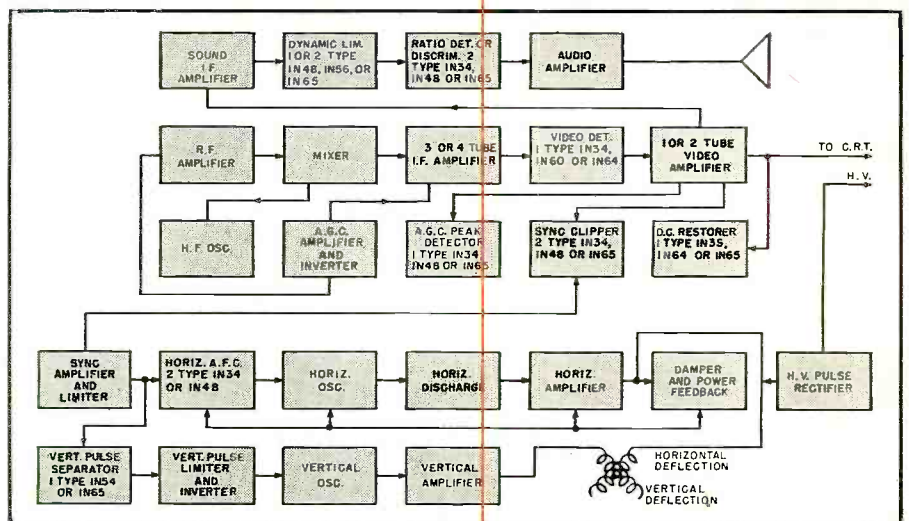

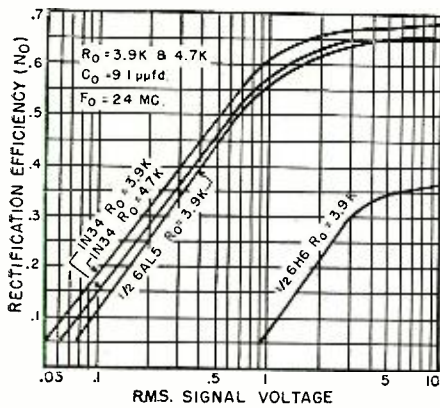

Fig. 4. Rectification efficiency vs. signal level. The curve for the 1N34 may be considered representative of the 1N60. These measurements were made with a fixed driving impedance and voltage which is not exactly the case in a video detector. In that particular instance the loading on the last i.f. coil is of most importance.

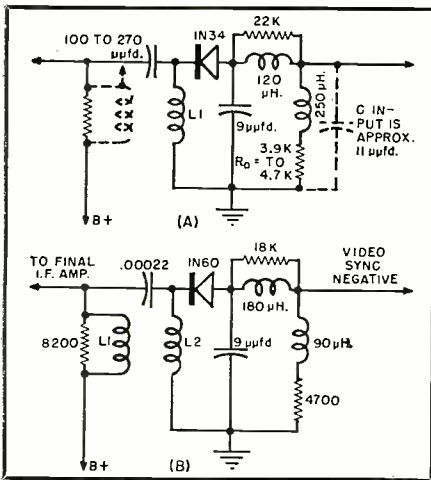
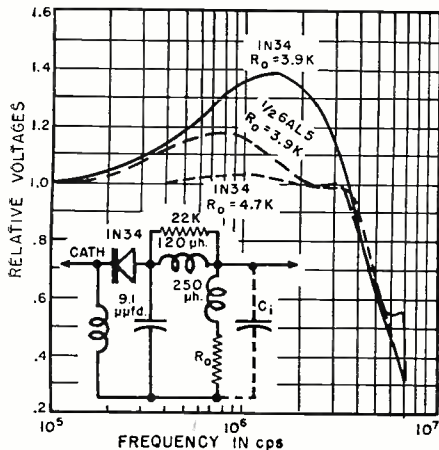

Fig. 5. Series type video detectors. (A) Using the 1N34. The inductance, L_1 , is tuned to the i.f. frequency with the total shunt capacitance. If the tuning coil is on the plate side of the circuit, L_1 is a 10 μ hy. r.f. choke. (B) Using a 1N60. Either L_1 or L_2 may be the tuning inductance. The value should be about .3 μ hy. When tuning inductance L_1 is on plate side of tube, L_2 should be a 10 μ hy. r.f. choke.

Fig. 6. Video bandpass curves. The curve for the 1N60 would be the same as that shown for the 1N34. The shape of the bandpass curves is more dependent on the load circuit values than on tube or diode used.



is similar to AM receiver detectors which require one or two stages of audio amplification for satisfactory sound. Video amplifiers following the detector are usually RC amplifiers similar to those found in AM receivers.

Signal amplification following the detector is generally small because most of the receiver video gain is obtained in the i.f. strip. While it is possible to have two stages of video amplification after the detector, it is common practice to simplify the circuit by using just one stage of d.c. coupled video amplification. This means that a detector must cover a wide range of signal amplitudes from 0.5 to 5.0 volts.

The 44 mc. i.f. frequencies may involve some reduction in pre-detection gain (although with tubes like the 6BC5 and the 6CB6, the gain at the higher frequencies is greater than was thought possible); thus, the detector may be called upon to work efficiently at low signal levels and high frequencies. The video detector for such a circuit would have to provide good linearity at low signal levels so that correct over-all highlight gamma (a numerical indication of the degree of contrast in a received television picture) may be maintained.

The video detector may be any of the usual types such as half-wave, full-wave, plate circuit, grid leak, or infinite impedance type. By virtue of simplicity the diode detector is so common that it is used almost exclusively; practically all are of the half-wave type. The additional circuit complication for full-wave detection does not warrant the expense involved.

Detector rectification efficiency of a typical half-wave diode tube type video detector circuit might be on the order of 35-40%, that is, with an i.f. input voltage of 1.4 r.m.s. to the diode the video output is on the order of about 1.5 volts peak-to-peak, or from maximum white to synchronizing pulse tip. The detection efficiency of a germanium diode type video detector circuit may approach about 52%. Small time constant load circuits involving small capacitances and low values of load resistance are necessary in order to preserve the high frequency video components in the detector output; these affect rectification and account for some loss in over-all efficiency.

Because these remarks may seem misleading to some engineers it should be understood that they are made with the following considerations in mind. The term "rectification efficiency" does not indicate whether or not more useful video output will be obtained by germanium diodes than by tubes. It is necessary to design the circuit specifically for crystals or tubes in order to maintain proper bandwidth as well as a.c. output. If two optimum circuits are compared there is likely to be little difference in output for crystals over tubes.

There seems to be no disagreement that the germanium diode has decided advantages over a vacuum tube where the detector is required to operate with

signal levels on the order of 0.5 volt peak or less. For a bandwidth of 4.0 mc. the germanium crystal 1N34 shows a 5.5 db gain over a 6H6 and approximately a 0.5 db gain over a 6AL5 at a signal level of 5 volts. See Fig. 4. A 1N60 will show slightly better gain. Small signal rectification of the crystal diode for low values of load resistance is much better than for the 6AL5.

Fig. 5A shows a video detector circuit using a 1N34 type crystal. The resistor in series with the 250 μ hy. coil and ground may vary from 3900 to 4700 ohms. The performance of the circuit is better when the resistor is 4700, as shown in the comparative sets of curves in Figs. 4 and 6. These curves are more dependent upon load circuit values than upon tubes or crystal diodes.

Because of the great interest in the use of germanium diodes in modern television circuits newer and better types of crystals are being designed and manufactured. Fig. 5B illustrates a Sylvania type video detector circuit designed especially for television applications. The type 1N60 was specifically designed and is tested for this type of service in the circuit shown in Fig. 8. This germanium diode provides high circuit efficiency and exceptionally good linearity at low signal levels. Low interelectrode and stray circuit capacitances make for improved video response. Increased over-all gain is obtained by virtue of reduced capacitive loading of the detector input circuit. When a circuit is designed with the component values specified, a full 4 mc. video bandwidth may be maintained at the output of the detector. This circuit has high dynamic efficiency, low shunt capacitance, and excellent linearity at low signal levels of 0.5 volt peak or even less signal voltage.

For preservation of the high frequency video components in the demodulated picture carrier envelope the time constant of the vacuum tube detector load circuit should not exceed approximately 0.08 microsecond. This time constant should be observed even with elaborate types of high frequency compensation networks. To achieve this time constant the diode load resistance is generally 4000 ohms or less, and the load capacitances are correspondingly small. It is for these reasons that the efficiency of a vacuum tube detector circuit is generally low.

The dynamic impedance of the diode is an appreciable portion of the total circuit impedance. With the 1N60 germanium diode there is a substantial improvement in detection efficiency because the dynamic impedance of the crystal is materially lower than that of an equivalent vacuum tube diode of the 6H6 or 6AL5 type. Since with a crystal the shunting capacitance is substantially less it is possible to increase the effective load resistance without sacrificing bandwidth.

Increasing the diode load resistance results in material improvement of the
(Continued on page 120)

A Sharply Tuned A. F. AMPLIFIER

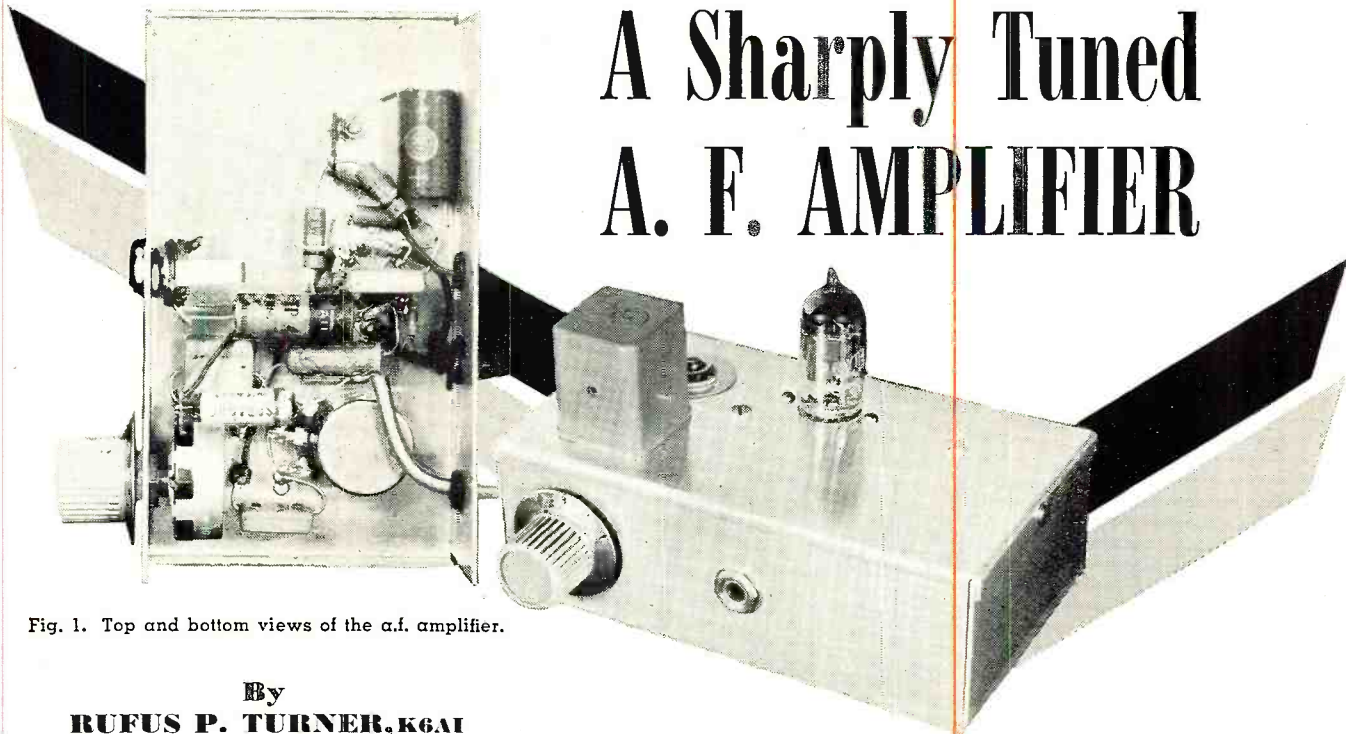

Fig. 1. Top and bottom views of the a.f. amplifier.

By
RUFUS P. TURNER, K6AI

A single-frequency amplifier of the bandpass type, having better than 50 decibel rejection at the second harmonic of the resonant frequency. At 1000 cycles, bandwidth is approximately 10 cycles.

SEVERAL feedback audio amplifier circuits of the resistance-capacitance tuned, bandpass type are in common use. These circuits find use where a selective amplifier is required. Common applications are bridge null detectors, peaked amplifiers for code reception, and tuned amplifiers for instrumentation and control.

RC-tuned amplifiers are not capable of providing large amounts of selectivity within a few stages. This is because of the relatively poor "Q" of RC circuits. It is common, for example, in a 2-stage RC-tuned amplifier for the output at half or twice the resonant frequency to be as much as 1/10 of the resonant output. In a 4-stage RC-tuned amplifier employing conventional components, the 2nd harmonic response rarely is better than 40 db (output voltage 1/100 of that at resonance). Thus, unless continuous tuning is a requirement, LC networks are more desirable.

The amplifier shown in the accompanying illustrations employs an LC-type bridged-T network (CH_1 , C_4 , C_5 , R_7 ; in Fig. 2) in its feedback circuit, and in two stages (one tube envelope) achieves a 2nd harmonic discrimination of more than 50 db. Components C_4 , C_5 , and R_7 have been selected for 1000 cycle operation, since the amplifier originally was designed for use as a null detector for a 1 kc. impedance bridge. Maximum voltage gain is 30; maximum output voltage 10 volts r. m. s. Sharpness of the amplifier is revealed by the following response figures: 1000 cycle output 10 volts, 500 cycle output 0.025 v., 2000 cycle output 0.025. At 7 volts' output

(70% of maximum resonant output at 1000 cycles), bandwidth is 10 cycles (995 to 1005 cycles). Amplifier operating voltages are 300 volts a.c. or d.c. at 2.8 milliamperes and 6.3 volts a.c. or d.c. at 0.3 ampere. These light power requirements enable the amplifier to be operated by the power supply of some other unit into which it may be built.

The first triode of the 12AX7 is used as an isolating input amplifier with degeneration obtained from the unby-passed cathode resistor, R_2 . The second

triode incorporates degeneration through the bridged-T network which effectively cancels the stage gain on all frequencies except the network null frequency. The latter accordingly is transmitted readily. For best selectivity choke CH_1 must have good "Q." This requirement, plus ability to tune the inductor closely to the desired frequency, has been met by employing a UTC Type VI-C tunable inductor.

Adjustment of the circuit is simple: (1) Feed a ¼-volt signal at 1000 cycles into the signal input terminals. (2) Connect an a.c. vacuum-tube voltmeter (set to its 10 volt range) to output jack J_1 . (3) With an 8-32 Allen wrench, adjust the inductance of choke CH_1 for peak deflection of the meter. (4) Adjust network rheostat R_7 for further increase in the peak deflection of the meter. (5) Adjust gain control R_1 as may be required for meter reading near full scale. The amplifier may be tuned to frequencies other than 1000 cycles by changing the values of C_4 , C_5 , and R_7 . Condensers C_4 and C_5 must be identical, each having twice the calculated capacitance for tuning choke CH_1 to resonance at the desired frequency. For the Type VI-C15 (CH_1) choke shown, rheostat should be 100,000 ohms maximum for frequencies between 20 and 800 cycles, 500,000 ohms from 800 to 3000 cycles, and 2 megohms from 3000 to 20,000 cycles.

High-impedance output is shown. This arrangement is entirely satisfactory for coupling into the high-impedance circuits of oscilloscopes, v. t. voltmeters, amplifiers, and the like. If low-impedance loads, such as headphones, normally will be employed; a cathode follower stage should be provided, in order to avoid adversely affecting the frequency and "Q" of the bridged-T network.

Fig. 2. Complete circuit diagram and parts list for the tuned a.f. amplifier unit.

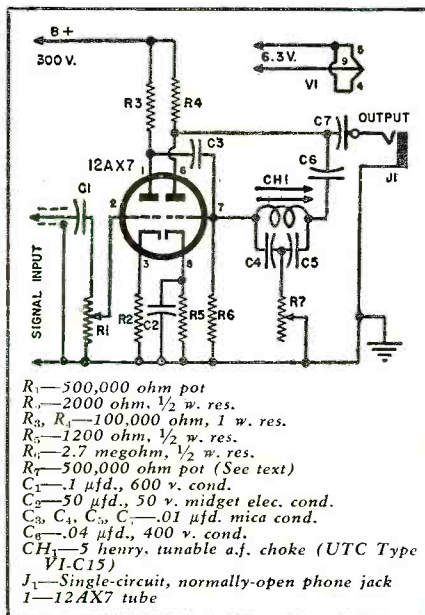

BUILD THIS MIXER-EQUALIZER

By
LLOYD B. HUST



Over-all view of the mixer-equalizer shown with both high and low impedance mikes.

Features dual (high and low impedance) inputs and a built-in low frequency boost equalizer. The design is flexible in that it can be easily changed to meet your specific requirements.

THE versatility of many audio amplifiers now in use can be enhanced by providing additional input channels. Rarely will the single microphone input of many amplifiers be adequate for the different uses to which the owner desires to put his equipment, and even with the more modern amplifiers with multi-channel inputs, one can often find use for an extra input or two. Although most amplifiers have high-impedance microphone input circuits, it is often desirable to use these amplifiers with a low impedance source. Also, it is often the case that although two microphones are available, one may be of the high impedance type while the other is a low impedance microphone. In addition, it is often desirable to be able to equalize the output from certain microphones to compensate for certain acoustic conditions. This is often the case with crystal microphones, many of which have an extended high frequency characteristic. Such a set of conditions brought about the design of the unit to be described here.

This mixer-equalizer can be built for little more than the cost of a good input transformer and a couple of volume controls, but its usefulness makes it a most valuable addition to the audio system. It was particularly designed for use with an auditorium amplifier which had but one microphone input. Several instances occurred in which the usefulness of this amplifier was limited because of the fact that only one microphone input was available. It was not feasible to make actual cir-

cuit changes in the amplifier and for that reason this mixer was designed so that it could be plugged into the existing microphone channel without any other connections to the amplifier itself. Both high and low impedance microphones were available for use with this amplifier and it was decided that it would be a definite advantage to have the mixer handle a microphone of each type. Since its construction, this mixer has been used successfully with a low impedance RCA velocity mike and with a high impedance American dynamic mike as well as with a high impedance Astatic crystal mike. All microphones worked well with this unit and the mixing action was smooth and efficient.

Because an equalizer circuit is built into the device, the low impedance channel can accommodate the output from a modern low-impedance magnetic type phono pickup. A low impedance tape playback head can also be used satisfactorily in this channel, while a high impedance tape head can be used in the high impedance channel if desired.

The unit was built on a chassis taken from a war surplus relay box, but any chassis about 4" x 4" x 2" will do very nicely. The chassis used has a bottom plate which makes the unit entirely self-shielding. The input jacks used were standard single circuit jacks, chosen because the microphones on hand were equipped with plugs to fit jacks of this type. Naturally, the builder will want to use jacks to fit the equipment he possesses. Likewise, the

output plug should be of the type to fit the amplifier with which this unit is to be used.

The actual construction of the mixer-equalizer presents few problems. The circuit is simple—the low impedance input is fed through the transformer and its volume control to R_2 . Likewise, the high impedance input is fed from its control to R_1 . These two resistors isolate the two controls of the separate circuits so that they will not short-circuit each other. The signal is then fed from the junction of these two resistors into the equalizing network and thence to the output which feeds the amplifier. It will be noted that when the switch S_1 is in position D , the equalizing network is switched out of the circuit entirely so that the unequalized output of the two microphones can be fed into the amplifier if desired.

Curves A , B , C , and D indicate the action of the equalizer for corresponding switch positions. The curve for position D , of course, shows no equalization, but it indicates the degree of output available when the equalizer has been switched out of the circuit. The various degrees of equalization indicated by curves A , B , and C were found to be satisfactory to compensate for acoustic conditions as well as to give various degrees of low boost when phono or tape pickups were fed through the device. If the builder wishes he can add other switch positions and can achieve other equalization curves to suit his own individual set of conditions. It will be seen from an examination of the circuit, as well as from the frequency response curves indicated in Fig. 2, that the equalizer gives low boost only. High boost equalizers were not added for several reasons. First, any equalizing circuit introduces

losses and it was felt that a high boost circuit in addition to the low boost circuit would bring the losses to a point which would greatly limit the degree of usefulness of the mixer. Second, practically all the equalization desired—the limiting of the extended high range of a crystal mike, the playback of tape recordings, and the use of a low impedance magnetic phonograph pickup—would be in the nature of bass boost.

In the construction of any apparatus which is to be used in connection with the input of a high gain amplifier, it is necessary that precautions be taken against the introduction of hum. The steps taken to eliminate the possibility of introducing hum into the amplifier by the use of this mixer are few, but important. First, and probably most important was the selection of the input transformer. The *Chicago BI-7* unit was chosen, both for its hum rejection characteristic and for its excellent frequency response. When one considers that the hum rejection of this transformer is 70 db, and that its frequency response is flat within a fraction of one db from 30 to 20,000 cycles, he can be sure that here is one link in his chain of audio components which will be strong. He should take this into consideration when he is tempted to substitute an inferior unit. It should be noted that this transformer is rated as 50, 150, 250, or 600 ohms to grid, and in connecting it the builder should use those terminals which will suit the equipment he is to use. In the author's model, the 50 ohm input was used, and this will be found right for most applications unless one is planning to feed a line into the mixer.

Other steps that were taken to eliminate any possibility of hum were the connection of all grounds except those at the input jacks to one point on the chassis, the arrangement of the parts to assure short leads, and the placing of leads close to the chassis whenever possible. At first it had been planned to insulate the input jacks from the chassis so that the ground side could

be connected to the common one-point chassis ground, but experiment showed that this was not necessary. The use of a bottom plate completes the shielding of the chassis proper, but experiments showed that fairly good results could be had in some instances without this bottom plate. Although no shielded wire was used within the chassis itself, it was, of course, necessary to use a shielded lead to the amplifier. The photographs of the unit show this lead to be of ordinary braid shielding, but it was found that the use of shielded wire of this type would, under certain conditions, cause hum if the shielding were allowed to touch the chassis or case of the amplifier. For that reason, the shielded lead as shown in the photographs was replaced with a length of high impedance microphone cable which is rubber covered. This change cleared up the only hum problem encountered with this unit.

It can easily be seen from an examination of the schematic diagram that a mixer of this type need not be limited to two channels. The same design can be used and as many channels as desired, either high or low impedance, can be used. Also, it should be apparent that the device will work very well without the use of equalizing circuits. However, since the components comprising the equalizer are low in price and readily obtainable, it would seem unwise to destroy the versatility of the unit by eliminating the equalizer. This is especially true inasmuch as the switching arrangement allows immediate switching out of the equalizer if desired.

It should be realized that when one uses any mixing and equalizing device in the input circuit of an amplifier, he cannot expect the output of that device to be equal in amplitude to that of a microphone plugged directly into the amplifier. However, this mixer was tried out with three different amplifiers—an *RCA* amplifier of such ancient vintage that the model number could not be determined, a relatively new *Bell and Howell* amplifier—the one used with the "Filmo" arc projec-

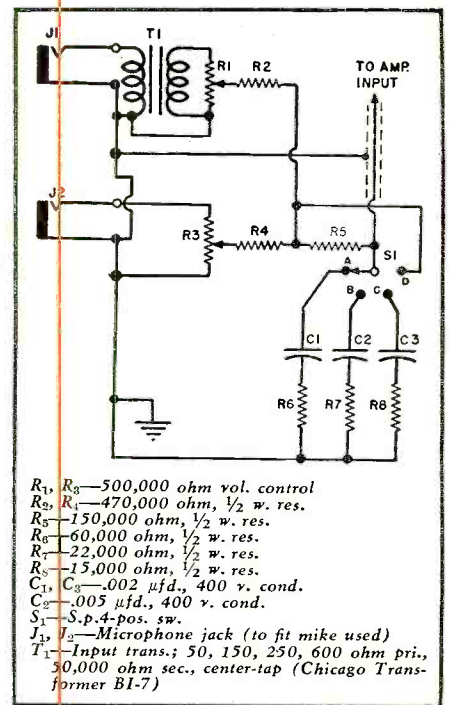

Fig. 1. The two-channel mixer-equalizer.

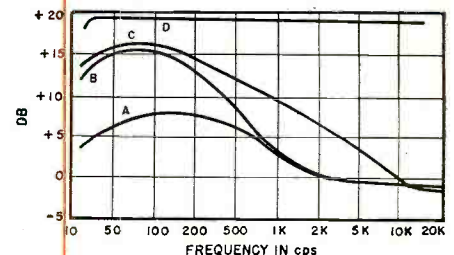
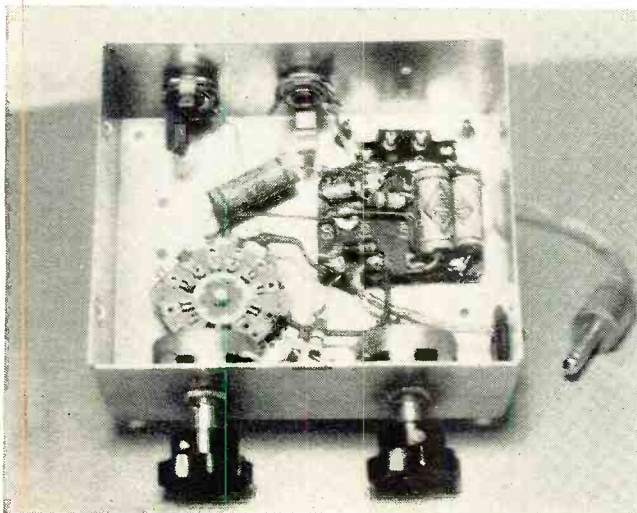

Fig. 2. Equalizer curves for various switch positions of the mixer-equalizer unit.

tor, and a home-made amplifier. In each case good results were obtained, and each amplifier had sufficient gain to more than make up for any losses within the mixing unit. The audio enthusiast or public address man will find that such a unit added to his equipment will do much to increase its usability.

Underchassis view of the home-built mixer-equalizer unit.



Over-all view of the compact (4" x 4" x 2") low-cost unit.

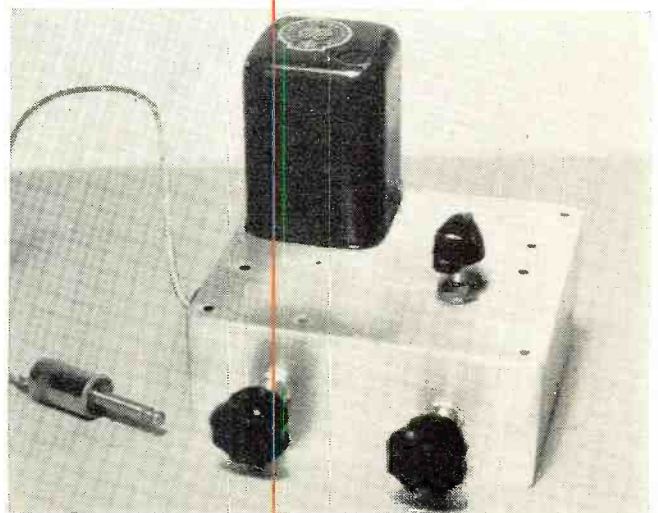

Mac's RADIO SERVICE SHOP

By JOHN T. FRYE



CARBON-TET CAN KILL

“HEY, Barney,” Mac’s muffled voice came from behind the closed door of the chassis-cleaning closet, “step outside and see if you can smell any carbon-tet fumes at this exhaust-fan port.”

The apprentice technician of Mac’s Radio Service Shop went out into the alley and sniffed cautiously at the strong current of air being pushed out by the fan. “Sure can,” he called; “where’s it coming from?”

“Come on back in here and see,” Mac invited.

When Barney opened the door of the cleaning closet, he immediately noticed some changes. For one thing, a sort of metal funnel was mounted with its large opening pointing directly toward the exhaust fan and only a couple of inches away from it. From the smaller end of the funnel a piece of downspouting went down along the wall and terminated in a ninety-degree elbow that rested on the floor. In front of the open mouth of this elbow was a piece of gauze that had been soaked in carbon tetrachloride. Replying to the boy’s questioning look Mac explained:

“Carbon-tet fumes are five times as heavy as air; so I cooked up this arrangement to pull them right off the floor without interfering too much with the sucking out of dust from the top of the room. That fact that you could detect the carbon-tet vapor outside while I could smell none of it in here shows that the system is working.”

“And that’s good?”

“I’ll say it’s good. Just recently I’ve had my eyes opened to just how dangerous breathing carbon-tet fumes can be; and when I think of how carelessly we have been using the stuff in the past, I feel like a man who has just

found out that the make-shift poker he has been using to stir the fire is really a stick of dynamite.”

“How did you get hep to all this?”

“I had a little ‘hint’ published in RADIO & TELEVISION NEWS that involved the use of the cleaning fluid. That brought me a letter from an instructor at the Coast Guard Institute asking if I was aware of the very real danger that lurked in the improper use of the chemical—a danger that he had seen demonstrated very tragically. Naturally, I asked him for more information; and at the same time I wrote to the American Medical Association and to one of the country’s largest manufacturers of carbon-tetrachloride for their opinions. I also mentioned what I was doing to Dick Rider, the operator down at the State Theater, and he promptly came up with some back issues of a trade magazine called *“International Projectionist”* that discussed the use of the cleaning agent in the operating booth. From all these sources came warnings that say substantially the same thing: carbon-tetrachloride can and will cause serious illness and death if proper precautions are not observed in its use.”

“I’ve noticed that bottles of the stuff always carry warning labels saying you should not breathe the vapor,” Barney mused; “but I never paid much attention to them. How does it get you?”

“It can do serious harm if the vapor is inhaled, if it is taken internally, if it is splashed into the eyes, or even if it is permitted to come into contact with the skin.”

“Sounds like a lot of stuff to me,” Barney said skeptically. “While I’ve never tried drinking it or splashed it into my eyes, I’ve inhaled a lot of vapor and have had it all over my

hands lots of times, and I’m still kicking.”

“You’ve been mighty lucky,” Mac said. “One thing that has helped is that you have usually used the carbon-tet in here with the exhaust fan going, and that has kept the vapor concentration down. However, it does not take a heavy concentration to be dangerous. Doctors used to think that anything under 100 parts per million was safe, but now they think it is desirable to keep the vapor below 50 parts per million. You can get an idea of just how little this is when I tell you that a normal nose just begins to detect the odor at 79 parts per million.”

“Maybe some people can take more of it than others can.”

“That’s quite true. In one case I read about, four men were working together using carbon-tet for cleaning purposes. The next day one of the men developed symptoms of carbon-tetrachloride poisoning. Three days later, since he was still not feeling well, he entered a hospital. Ten days later, in spite of proper medical care, he died. None of the other three men showed any ill effects.”

“Then poisoning doesn’t always show up right away,” Barney observed.

“That’s one of the treacherous things about it,” Mac replied. “It is not unusual for symptoms to show up from two to eight days after exposure, and because of this the connection between the poisoning and the use of the chemical is often overlooked. But to get back to the subject of the varying reaction of people to carbon-tet, it has been discovered that certain groups of people are especially susceptible to poisoning. These groups include fat people, undernourished people, alcohol addicts, and people who suffer from diabetes, liver or kidney diseases, jaundice, pulmonary and heart disease, or peptic ulcers.”

“So alcohol and carbon-tet don’t mix, eh?” Barney said thoughtfully. “Boss, you had better clean the sets this afternoon. Mom hasn’t noticed it yet, but her sweet cider is beginning to taste more interesting every day now, and I hit it up pretty hard after dinner. I know you wouldn’t want me to take any chances.”

“Well, you have already had a whiff of the vapor; so let’s see if you have any of the typical symptoms of vapor-poisoning,” Mac said with a grin. “The symptoms depend somewhat upon the concentration of the vapor and the duration of the exposure; but in general they are a feeling of fullness in the head, mental confusion, and headache; and then this is followed by nausea, stupor, and loss of consciousness. In severe cases there may be trouble with the vision and the coughing up of bloody mucus. If the person is not removed to a safe area promptly, death may occur because the person simply stops breathing.”

“Suppose you should topple over while you were using the stuff here at the bench. What ought I to do?”

(Continued on page 139)



International SHORT-WAVE

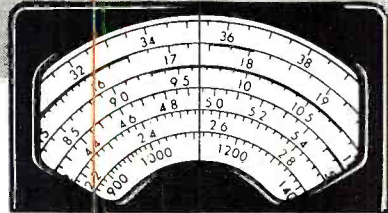

Compiled by **KENNETH R. BOORD**

IT IS a pleasure this month to dedicate the *ISW DEPARTMENT* to *Radio Monserrat*, HROW, in Tegucigalpa, capital of Honduras, Central America. Thanks go to David Dary, Kansas, for the following interesting data he received direct from the station:

Radio Monserrat, HROW, was founded May 22, 1949, and operates on a medium-wave channel of 850 kc.; short-wave frequencies are 6.020 and 6.675; schedule is 6:30 a.m. to 11 p.m. local time (0730-2130 *EST*). HROW is a commercial station owned and managed by Alfredo Leon Gomez. It employs *Western Electric* transmitters.

Sr. Gomez sent along this data about Honduras—population is 1,500,000; the capital city, Tegucigalpa, has 80,000 inhabitants; other principal cities are San Pedro Sula, La Ceiba, Tela, Puerto Cortez, Santa Rosa de Copan, and Yucatan; is known for the famous ruins of Copan; products include bananas, gold and silver, timber, cotton, cereals, and cattle; the national tree is the pine.

Best wishes go to HROW for the future!

* * *

Club Notes

England—The International Short Wave League is no longer associated with *Short Wave News* published in London. It now is an independent organization with headquarters at 123, Sturla Road, Chatham, Kent, England, and is producing its own magazine called "Monitor." Membership fee for USA DX-ers will remain at 40 cents a year; the publication "Monitor" will cost \$1.20 a year, according to Frank Baldwin, manager of ISWL. (Oskay, N. J.)

Information concerning the World Friendship Society of Radio Amateurs may be had by writing headquarters of this organization at 35, Bellwood Road, Waverley Park, Peckham Rye, London, S.E. 15, England. The club's publication, "Skywire," is currently carrying a series of articles written by members on such subjects as the elementary theory of radio; a reliable superhet receiver; design of a reliable frequency meter, and so on.

New Zealand—The New Zealand Radio DX League has chosen these new officers for the coming year—Arthur T. Cushen, president; Merv Branks, vice-president; Jim Martin, vice-president; Des Lynn, secretary. The "Times" Committee is composed of Merv

Branks, editor; Arthur T. Cushen, short-wave editor; Keith Robinson, assistant broadcast editor; Bill Milne, assistant short-wave editor, and Alex Allen, circulation manager.

USA—Membership in the Minnesota Short Wave Listeners Association, recently organized club, is open to anyone anywhere; for details write to Meck Clark, 702 Cloquet Ave., Cloquet, Minnesota, who is secretary-treasurer of the group; Malfred Harnish is president of the club.

* * *

This Month's Schedules

Afghanistan—*Radio Kabul* was tuned 1140 when had request records in progress; announced "This is Kabul calling; we operate on 445.1 meters, 674 kc., and on 30 meters short-wave on a frequency of 9.975;" deteriorated badly around 1200, appeared to close down 1210A. (Pearce, England)

Andorra—*Radio Andorra*, 5.990, noted around 0700 with Latin American music, announcements in French and Spanish. (Catch, England)

Anglo-Egyptian Sudan—*Radio Om-*

durman, 9.740A, noted recently with schedule extended to 1530 sign-off; uses no signature tune for native broadcasts. (Pearce, England) Bluman, Israel, says Omdurman has recently adjusted its 31-m. outlet to 9.737, presumably to get clear of Leopoldville on 9.745; still is badly QRM'd afternoons (*EST*) by Lisbon on 9.740, Bluman explains.

Omdurman, 17.94, now has "morning" Arabic session (heard Sundays) at 0345 to 0430A closedown. (Ridgeway, South Africa)

Angola—Pearce, England, recently has heard *Radio Clube de Angola*, Luanda, on 11.865A at 1515 and closing 1530; also heard by Bellington, N. Y., and by Ridgeway, South Africa. Ridgeway says the 11.865A channel closes 1530 but programs continue to 1630 over 9.64, 7.14.

Radio Clube do Huambo, 9.705, noted 1430-1500 with orchestral records, then varied popular music to 1530. (Pearce, England) *Radio Sweden* says CR6RJ, *Radio Clube de Huila*, Sa da Banderia, broadcasts on 9.755, with 1 kw., weekdays 0600-0700, 1300-1500, Sundays 0630-0745, 1230-1330, according to verification. Bluman, Israel, reports this one heard from 1300 onwards.

A new Angolan is noted on 7.790 at 1445-1525 when signs off with "A Portuguesa." (Radio Sweden)

Argentina—The SIRA programs from
(Continued on page 124)

(Note: Unless otherwise indicated, all time is expressed in American *EST*; add 5 hours for *GCT*. "News" refers to newscasts in the English language. In order to avoid confusion, the 24 hour clock has been used in designating the times of broadcasts. The hours from midnight until noon are shown as 0000 to 1200 while from 1 p.m. to midnight are shown as 1300 to 2400.) The symbol "V," following a listed frequency indicates "varying." The station may operate either above or below the frequency given. "A" means frequency is approximate.

David Dary, *ISW Monitor*, uses an RME-45 receiver and an RME DB-22A preselector.



AUDIO Simplified

By

DAVID FIDELMAN



Fig. 1. Commercial amplifier using the phase-inverter amplifier driver unit (shown in Fig. 7) to couple output of voltage amplifier to the push-pull power amplifier.

THE design and construction of voltage amplifiers has been discussed in previous articles of this series. The important characteristics of voltage amplifiers are: (1) overall gain, (2) input and output impedance, (3) input and output voltages, (4) frequency response, and (5) distortion. The gain, terminal impedances, and signal voltage levels are the amplifier design specifications, while the distortion and frequency response characteristics should always be the best that can be reasonably attained.

The required gain and output voltage can be obtained by using a sufficient number of amplifier stages, while the correct impedances can be obtained by resistance or transformer matching. However, it is more difficult to obtain the required good frequency response and distortion characteristics simply by use of basic, straightforward amplifier techniques. Bad frequency response can be corrected to a certain extent by equalizer circuits, but once distortion is present in the audio signal there is no way of removing it. The best method of obtaining good frequency response and low distortion is by using *negative feedback*.

Negative Feedback

A feedback amplifier is one in which a certain amount of voltage or current from the output is introduced back into a previous stage of the amplifier. The basic circuits for feedback in an amplifier are shown in the diagrams of Fig. 2. The arrangement in A shows the circuit for voltage feedback in which the amount of signal that is fed back is proportional to the voltage across the output load by means of the high resistance voltage divider. The arrangement in B shows the circuit for current feedback, in which the amount of signal that is fed back is proportional to the current through the output load by means of the resistor placed in series with the output load resistance.

The diagrams of Fig. 2 show that the voltage fed back from the output will add or subtract from the input signal, depending upon whether the two volt-

ages are in-phase or out-of-phase. Suppose, for example, that the voltage fed back is in-phase so that it adds to the input signal to increase it. This has the effect of applying a greater signal to the input of the amplifier, and increasing the output voltage effectively increases the gain of the system. However, if the voltage which is fed back is out-of-phase so that it decreases the input signal, the output voltage is decreased and the gain of the system is effectively reduced. A feedback connection of the type in which the voltages add together is known as *positive feedback*, while the type of connection in which the voltages subtract is known as *negative feedback*.

The actual gain of an amplifier with feedback can be calculated if the feedback factor and the gain without feedback are known. If the fraction of the output voltage which is fed back is β , and the amplifier gain without feedback is A , then the output voltage with feedback is $A \times (E_{input} + \beta E_{output})$ and the gain of the amplifier with feedback is:

$$Gain_{feedback} = A' = \frac{E_{output}}{E_{input}} = \frac{A}{1 - \beta A}$$

The action of positive and negative feedback can be seen in more detail from the above formula by noting that when A is negative the gain with feedback is less than without feedback, and when A is positive the gain is greater than without feedback.

In a previous article it was shown that the gain of a single stage of amplification is negative, that is, the voltage in the plate circuit is 180° out-of-phase with the voltage in the grid circuit. Therefore, for any odd number of stages the output is out-of-phase with the input and can give negative feedback, while for an even number of

stages the output is in-phase with the input and will give positive feedback.

The feedback equation also shows that if the amplification and feedback are such that the value of βA is equal to +1 then the gain will be infinite and the circuit will oscillate. This condition is extremely important in the construction of oscillators, since a stable oscillator is obtained by the application of positive feedback at the desired frequency. Negative feedback reduces the amplification, and therefore also reduces the noise and distortions introduced within the feedback loop by the same amount. The percentage of distortion is decreased, and the frequency response curve is made more flat. In general, the following desirable effects are obtained by the use of negative feedback.

(1) Greater stability. The circuit characteristics will remain constant for wide changes in tube characteristics and applied voltages.

(2) Reduction of harmonic distortion and intermodulation distortion.

(3) Reduction of phase distortion.

(4) Improvement in the frequency response characteristics.

(5) Reduction of noise.

(6) Modification of the input and output impedances. In applying negative feedback to audio amplifiers, great care must be taken to apply the feedback in such a manner that phase shift does not cause it to become positive feedback at any frequency, because such positive feedback will tend to produce instability and increase distortion at these frequencies, and may even cause oscillation.

Transformer Coupling

In setting up audio systems it is often necessary to perform the functions of impedance transformation and phase

inversion. Impedance transformation is required whenever it is necessary to couple between circuits of different impedances, such as the plate of an amplifier stage to a transmission line or other low impedance load. Some type of circuit must be used which will match the two impedances properly. Phase inversion is required whenever it is necessary to couple from a single-ended to a push-pull circuit.

The simplest method of performing these functions is by the use of transformers, as shown in Fig. 3. Some transformer applications have already been shown, without further explanations, in previous articles in this series. A transformer consists of one or more windings placed on a single iron core, in such a manner that the electromagnetic field of the primary winding induces a signal in the secondary winding. If the two windings have different numbers of turns, then there will be an increase or a decrease in the voltage from one winding to the other, proportional to the ratio of the number of turns in each winding. When the secondary winding is loaded with a resistance, then this resistance appears in the primary circuit multiplied by the square of the turns ratio between the two windings. These basic characteristics of transformers are indicated by the formulas included in the diagram of Fig. 3.

For increased flexibility, the windings in a single transformer will often have taps brought out at various numbers of turns in order to give a wide variety of turns ratios. Different numbers of turns of the same winding can also be used as a transformer, as shown in B of Fig. 3, and such a transformer is called an auto-transformer.

Transformer coupling is used mainly between impedances ranging from a few ohms up to about 50,000 ohms, and is most useful in applications such as:

(1) Input coupling from low impedance sources to high impedance grid circuits,

(2) Interstage coupling from plate to grid circuits,

(3) Output coupling from plate circuits to low impedance lines or loudspeaker voice coils,

(4) Impedance matching between low impedance lines or from line to loudspeaker voice coil, as well as numerous other applications which will become evident upon further consideration of various audio systems.

One of the other important characteristics of transformers which can be seen from Fig. 3 is that the various windings are isolated from each other, since there is no direct connection between them, and transformers can, therefore, be used for d.c. and ground isolation between circuits. In coupling from the plate circuits of amplifiers, transformers are used mainly with general purpose triodes and pentode power amplifiers, since other types of tubes require too high an impedance.

Although they have a number of desirable features which make them

quite convenient for use in audio circuits, transformers also have certain disadvantages which often make their use undesirable. One of the main disadvantages is their cost. A good quality transformer will cost considerably more than a single amplifier stage. Thus, if a tube can be made to perform the same function, it is obviously less expensive to use the tube instead of the transformer. The frequency range of transformers is limited by the practical considerations of maximum obtainable primary inductance and distributed capacity across the windings, so that when extremely wide frequency bands are required, transformers cannot always be used. The frequency response is very important when the feedback loop includes the transformer, since phase shift may cause the feedback to become positive at some frequency and cause instability. Care must also be taken that too large an unbalanced direct current does not flow through the windings—since such currents may saturate the iron core and cause distortion in the audio signal. One other factor which may make transformers undesirable for certain applications is their size, since the shielding or the size of the core may often cause high-quality transformers to be too large for applications where small size and compactness are required.

Considering the relative advantages and disadvantages of using transformers in audio circuits, it is evident that they should be used mainly in applications where their particular advantages are of value. A few typical examples are:

(1) To obtain high output voltage for limited supply voltage,

(2) To match to low impedance lines, particularly where isolation is required between primary and secondary circuits, and

(3) When a low d.c. resistance is essential in the grid circuit of the following stage, as well as other cases which may occur in the design and setup of specific audio systems.

Cathode Followers and Phase Inverters

In many applications where it is not convenient or practical to use transformers, the functions of impedance transformation and of phase inversion can be performed by vacuum tubes. By using current feedback of the type shown in Fig. 2B, these functions can be performed by the *cathode follower* amplifier.

The cathode follower is a single-stage negative current feedback amplifier in which the output voltage is taken from across a load resistance in the cathode circuit. Typical circuits of cathode follower amplifiers are shown in Fig. 4. In these circuits the signal plate current flows through the load resistor as in the conventional amplifier stage, but this resistor is placed between cathode and ground instead of between plate and "B+." Since the input grid voltage is applied between

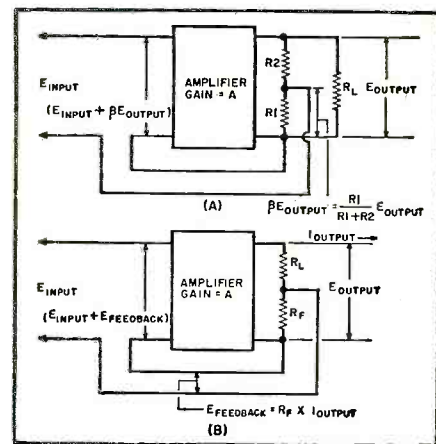

Fig. 2. Functional representation of the basic methods of voltage and current feedback. (A) Basic circuit for the application of voltage feedback to an amplifier by feeding a fraction of the output voltage back to the input. (B) Circuit for the application of current feedback to an amplifier by feeding back to the input a voltage proportional to output current.

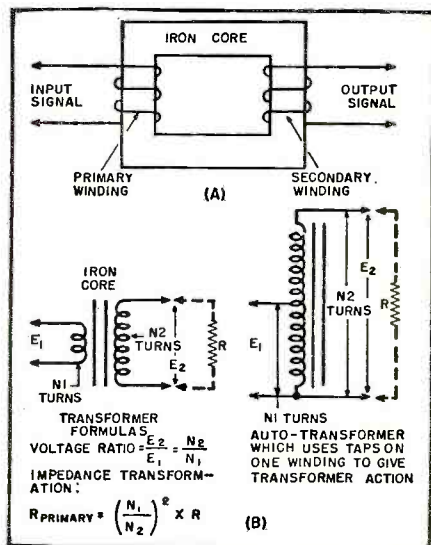
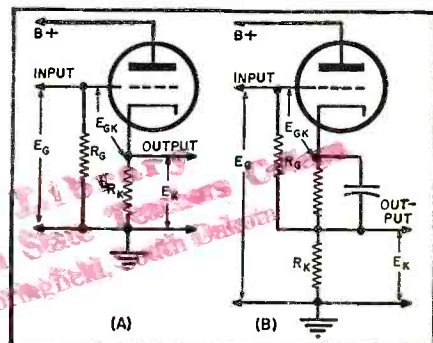

Fig. 3. Basic characteristics of transformers. (A) Basic physical construction of transformer. (B) Electrical representation.

grid and ground, while the control signal is the grid-cathode voltage, the grid-cathode signal is the output voltage subtracted from the input voltage.

The result of this type of connection is a considerable amount of negative

Fig. 4. Two often-used cathode-follower circuits. The output voltage is developed across the resistor in the cathode circuit.



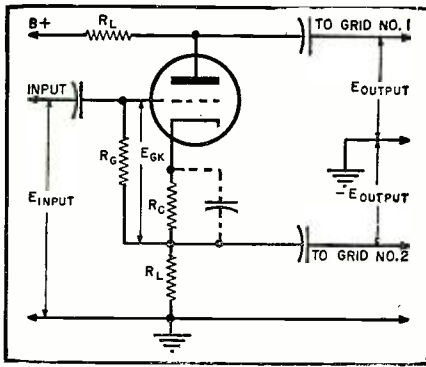

Fig. 5. How equal resistances are used in the cathode and plate circuits of a cathode follower to give a push-pull output from a single-ended input signal.

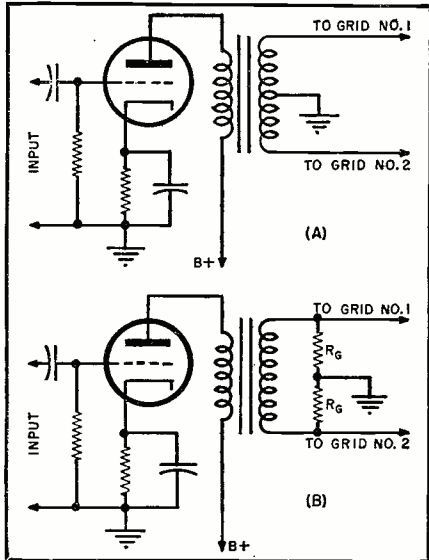

Fig. 6. Use of a transformer to give push-pull output from single-ended input signal.

feedback over the one stage, and the output signal across the cathode resistor must always be less than the input signal between grid and ground, since otherwise the tube would have to have an infinite amplification factor. The gain of the stage from the input grid signal voltage to the output cathode signal voltage is:

$$A' = \frac{E_k}{E_g} = \frac{\mu R_k}{(\mu + 1) R_k + R_p} = \frac{1}{1 + \frac{R_k}{\mu R_k}}$$

which is always less than one.

The cathode-follower amplifier connected in this manner has certain characteristics which are often very useful. The output impedance across the cathode resistor is very low because of the large amount of feedback, and is approximately equal to $1/g_m$ in parallel with R_k , which will almost always be well under 1000 ohms. The low output impedance is one of the most important characteristics of the cathode-follower, since it can be used to give a transformation from a high to a low impedance with no loss in signal level, over a very wide frequency band, without the use of a transformer. This circuit is particularly useful in feeding a

low-impedance line from a high-impedance amplifier circuit. The input impedance is higher than for the same tube used in a conventional amplifier stage, and is equal to:

$$R_{input} = \frac{R_g}{1 - A'}$$

so that the closer the gain is to one, the higher is the input impedance. This high impedance is important in many cases where it is desirable to have the minimum amount of loading across some high impedance source, for example, in the preamplifier of a condenser microphone to obtain adequate bass response.

Because the cathode-follower has so much negative feedback, it introduces very little amplitude distortion, and is capable of handling a high input voltage without overloading.

Consideration of the basic cathode-follower circuit in Fig. 4 shows another extremely important characteristic. Suppose a positive voltage is applied to the grid—then the plate current increases and the cathode becomes more positive. This means that the output taken across the cathode load is in phase with the input signal applied to the grid. However, in a conventional amplifier stage the output signal in the plate circuit is exactly opposite in phase with the grid input signal. Therefore the cathode output signal in a cathode-follower amplifier is exactly opposite in phase with the signal in the plate circuit, and this factor can be used to construct a phase inverter. The manner in which this can be done is shown in the circuit in Fig. 5. Equal resistances are placed in the cathode and in the plate circuit, and one output is taken from the cathode circuit and the other from the plate circuit. This gives two equal signals opposite in phase, which can then be applied to the two grids of a push-pull amplifier.

Driver Amplifiers

The driver amplifier couples the output of the voltage amplifier section to the input of the power amplifier. It must be able to supply enough voltage and power to the power amplifier grid to drive it to full output without overloading. When a push-pull power am-

plifier is used, the driver section should also contain a phase inverter to couple the output of a single-ended voltage amplifier to the push-pull grids of the power amplifier. Special techniques may also be used in the driver to minimize the effects of grid current in the power amplifier.

Because the amount of voltage required from the driver is determined by the power amplifier requirements, different circuits may often be required for different power amplifier tubes. Triodes in general are less sensitive and require higher grid signal voltages than pentodes and beam power tubes. Normally a general-purpose triode will furnish sufficient output voltage to drive most of the power tubes used in all except the very high power sound reproducing systems.

The circuits of several different driver amplifiers which are suitable for coupling the output of a single-ended voltage amplifier to a push-pull power amplifier are shown in Figs. 5, 6 and 7. The circuit of Fig. 6A shows the simplest and best known method of performing this function, i.e., by use of a transformer having a center-tapped secondary winding. Since this provides two equal voltages 180 degrees out-of-phase, perfectly satisfactory results are obtained with properly designed transformers. If the transformer secondary is not center-tapped, it can still be used for push-pull operation by connecting a resistance voltage divider with its center grounded, as shown in Fig. 6B. The center-tapped winding is preferable because it introduces low resistance into the power amplifier grid circuit so that there is less distortion when grid current is drawn, and because it does not reflect any resistive load into the driver circuit on the primary side. However, because good transformers are expensive, they are not too widely used in most of the average-size sound reproducing systems.

For most applications, good results are obtained with the use of resistance-coupled amplifier stages. The simplest circuit which can be used for this purpose is the cathode-follower phase splitter circuit shown in Fig. 5. With equal load resistors in the plate and cathode circuits, two equal output voltages, opposite in phase, are obtained which are then applied to the two power amplifier grids. Since the gain to each side is approximately that of the cathode-follower with a maximum of 1, the total grid-to-grid output voltage gain of the phase inverter has a maximum value of 2. With this low gain, the tube does very little amplification, but takes the place of the transformer in coupling from the single-ended to the push-pull stages.

Another type of circuit which can be used for phase inversion is shown in Fig. 7. In this circuit the voltage amplifier drives one of the push-pull grids directly, while an additional amplifier stage is used to amplify a small part of this voltage with a 180-degree phase

(Continued on page 154)

Fig. 7. Practical phase-inverter amplifier.

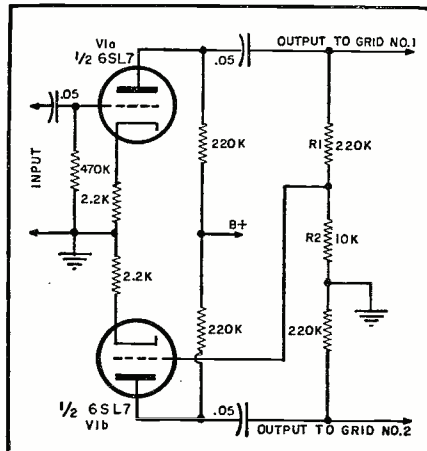

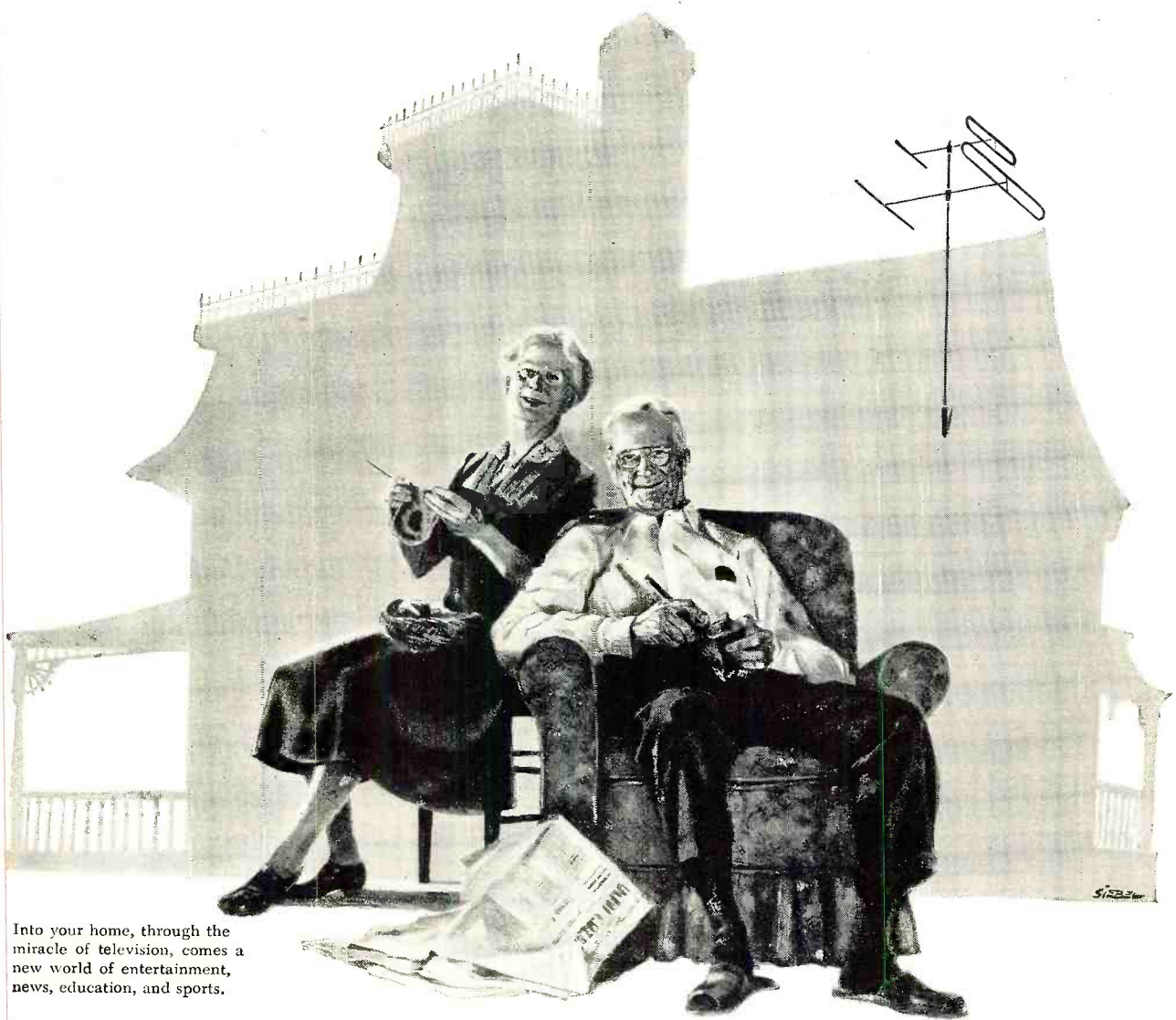

Into your home, through the miracle of television, comes a new world of entertainment, news, education, and sports.

They can still go out while staying home

Now "homebodies" who seldom leave their neighborhoods can view programs from distant cities—with all the comforts of home. Drama, comedy and variety shows are brought into the living room. Sports, news events as they happen can be viewed by all. Now television is open coast to coast . . . Those in the East may look in on the West, and the West may look in on the East. Television is enjoyed in more than

15 million homes, as a result of research at the David Sarnoff Research Center of RCA at Princeton, N. J. Today's image orthicon TV camera was perfected there. Dr. V. K. Zworykin of RCA developed the *kinescope*—which is the screen of television receivers. And RCA scientists have also perfected electron tubes, circuits, sound systems, phosphors, and antennas to make television part of everyday life.

The development of all-electronic television is only one example of RCA research. This leadership assures you high quality performance from any product or service of RCA and RCA Victor.

* * *

See the latest wonders of radio, television, and electronics at RCA Exhibition Hall, 36 West 49th St., New York. Admission is free. Radio Corporation of America, Radio City, New York 20, New York.



RADIO CORPORATION of AMERICA
World Leader in Radio — First in Television

Features OF THE NEW 1952



PROOF OF THE NEW O-7 OSCILLOSCOPE'S OUTSTANDING PERFORMANCE

Below are actual, unretouched photographs showing the outstanding frequency response characteristics of the NEW 1952 HEATHKIT OSCILLOSCOPE, MODEL O-7. To the left is a 10 KC square wave — to the right a 4 MC sine wave as they actually appear on the screen. Two highly severe tests to make on any

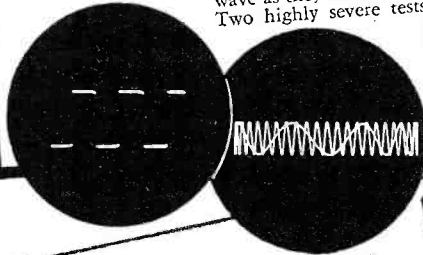

scope (only the best of scopes will show traces like these) — and the O-7 really comes through.

COMPANION VACUUM TUBE VOLTMETERS

Here are the two NEW 1952 VACUUM TUBE VOLTMETER COMPANION PIECES. Matched instruments of new design to open up the whole field of DC, AC, and resistance measurements for you. The new greatly reduced size combines style, beauty, and compactness — The V-5 and AV-1 have the new panel and cabinet construction as shown on the right. A tremendous pair of voltmeters. Small in size but virtual giants in the range of measurements they make.

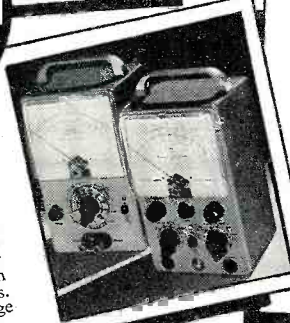

NEW STYLE AND BEAUTY

Style that's modern, yet functional — that's the trend of today — and Heathkits are right up to the minute. Note the cut showing the new V-5 and AV-1 cabinet and panel construction. The front panel and rear cover slide right over the recessed flange of the case thereby eliminating sharp edges and pointed corners. The voltmeter kits aren't "shelf" or "mounted" instruments — they're moved about on the bench a lot and thus the new compact size and specially designed cabinets — Another 1952 Heathkit feature.

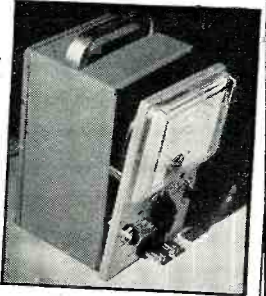

A STATEMENT FROM SIMPSON ELECTRIC CO.

In choosing Simpson Meters for their Heathkit VTVM, the Heath Co. has set a new high standard of kit meter quality. The same high quality of material, workmanship and design that has given Simpson the reputation for building "Instruments That Stay Accurate" is found in the Heathkit Meter Movement.

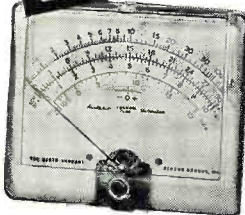

SIGNED
SIMPSON ELECTRIC CO.

A STATEMENT FROM CHICAGO TRANSFORMER

It is indeed gratifying to note the outstanding sales records you are building with your Heathkits.

This sales success is readily understandable, since we are cognizant of the high quality standards you have established for your component suppliers.

We at Chicago Transformer are proud that our product has contributed to the recognized quality and increasing popularity of Heathkits.

CHICAGO TRANSFORMER DIVISION
Essex Wire Corporation

L. S. RACINE
Vice-President and Sales Manager

HEATHKIT PRECISION RESISTORS

Where exact resistance values are required for instrument accuracy, the Heath Co. has spared no effort in supplying the finest resistors available. Precision resistors as manufactured by Continental Carbon Inc., and Wilcor Corp., meet the rigorous JAN (Joint Army-Navy) specifications and are small in size, extremely non-inductive, highly stable, have a low temperature coefficient, and can be held to great accuracy. You'll find quality components in Heathkits.

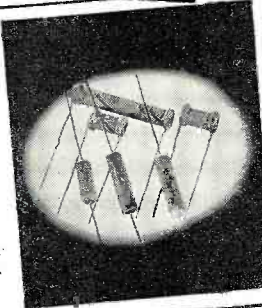

COLLEGES USE HEATHKITS

Colleges and Universities throughout the country are using Heathkits in their electrical engineering, radio, and physics laboratories — Heathkits are the answer to good test equipment at low cost, plus rugged, dependable, and accurate. Trade schools are having their students build Heathkits to obtain a first hand working knowledge of test equipment and to get the practical experience gained by construction. Heathkits fill school needs.

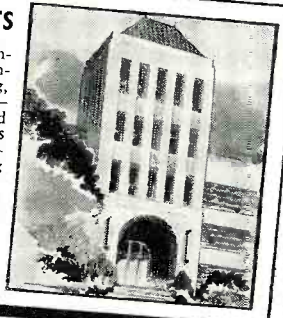

YOU SAVE BY ORDERING DIRECT FROM MANUFACTURER—USE ORDER BLANK ON LAST PAGE

EXPORT AGENT
ROCKE INTERNATIONAL CORP.
13 E. 40th ST.
NEW YORK CITY (16)
CABLE: ARLENY, N.Y.

The HEATH COMPANY

... BENTON HARBOR 15, MICHIGAN

New LABORATORY LINE HEATHKITS



MODEL AV-1
Shipping weight 5 lbs.

\$29.50

NEW *Heathkit* A.C. VACUUM TUBE VOLTMETER KIT

Now — as a Heathkit — at a price anyone can afford, an AC VTVM. A new kit to make possible those sensitive AC measurements required by audio enthusiasts, laboratories, and experimentors. Here is the kit that the audio men have been looking for. Its tremendous range of coverage makes possible measurements of audio amplifier frequency response — gain or loss of audio stages — characteristics of audio filters and attenuators — hum investigation — and literally a multitude of others. Ten ranges consisting of full scale .01, .03, .1, .3, 1, 3, 10, 30, 100, 300 volts RMS assure easy and more accurate readings. Ten ranges on DB provide for measurements from -52 to +52 DB. Frequency response within 1 DB from 20 cycles to 50 KC.

The ingenious circuitry incorporates precision multiplier resistors for accuracy. Two amplifier stages using miniature tubes, a unique bridge rectifier meter circuit, quality Simpson meter with 200 microampere movement, and a clean layout of parts for easy wiring. A high degree of inverse feedback provides for stability and linearity.

Simple operation is accomplished by the use of only one control, a range switch which changes the voltage ranges in multiples of 1 and 3, and DB ranges in steps of 10.

The instrument is extremely compact, cabinet size — 4 1/8" deep x 4-11/16" wide x 7 3/8" high, and the newly designed cabinet makes this the companion piece to the VTVM. For audio work, this kit is a natural.

NEW *Heathkit* AUDIO FREQUENCY METER KIT

MODEL AF-1
Shipping weight 12 lbs.



\$34.50

A NEW Heathkit Audio Frequency Meter — the ideal instrument for determining frequencies from 20 cycles to 100 KC. Set the selector switch to the proper range — feed the signal into the input terminals — and read the frequency from the meter — completely simple to operate, and yet dependable results.

Quality Simpson 200 microampere meter has two plainly marked scales (0-100 0-300). These scales, read in conjunction with the seven position selector switch, give full scale readings of 100, 300, 1000, 3000, 10,000, 30,000, and 100,000 cycles. Convenient ranges for fast and easy readings.

For greatest accuracy, the 1-3-10 ratio of ranges is maintained and each range has individual calibrating control.

Input impedance is high (1 megohm) for negligible circuit loading. A signal and a change in signal voltage between these limits will not affect the meter reading. In addition, input wave shape is not critical (the unit will read the frequency of either sine wave or square wave input).

The tube complement consists of a 6SJ7 amplifier and clipper, 6V6 amplifier and clipper, 6H6 meter pulse rectifier, 6X5 power supply rectifier, and OD3/VR150 voltage regulator.

Construction is simple, and quality components are used throughout.

NEW *Heathkit* INTERMODULATION ANALYZER KIT

Intermodulation testing of audio equipment is rapidly being accepted by more and more engineers and audio experts as the best way to determine the characteristics of audio amplifiers, recording systems, networks, etc. — shows up those undesirable characteristics which contribute to listening fatigue when all other methods fail.

The Heathkit Intermodulation Analyzer supplies a choice of two high frequencies (3000 cycles and a higher frequency (60 quency) and one low frequency (60 cycles). Both 1:1 or 4:1 ratios of low frequencies can be set up for to high frequencies can be easily set IM testing, and the ratios are easily set by means of a panel control and the instrument's own VTVM. An output level control supplies the mixed impedance of desired level with an output impedance of two thousand ohms. The Analyzer section has input level control and proper filter means feeding the instrument's VTVM to read intermodulation directly on full scale ranges of 30%, 10% and 3%. Built-in power supply furnishes all necessary voltages for operating the instrument.

You won't want to be without this new and efficient means of testing



MODEL IM-1
Shipping wt. 18 lbs.

\$39.50

NEW *Heathkit* SQUARE WAVE GENERATOR KIT

The new Heathkit Square Wave Generator Kit with its 100 KC square wave opens an entirely new field of audio testing. Square wave testing over this wide range will quickly show high and low frequency response characteristics of circuits — permit easy adjustment of high frequency compensating networks used in video amplifiers — identify ringing in circuits — demonstrate transformer characteristics, etc.

The circuitry consists of a multivibrator stage, a clipping and squaring stage, and a cathode follower output stage. The power supply is transformer operated and utilizes a full wave rectifier tube with 2 sections of LC filtering.

As a multivibrator cannot be accurately calibrated, a provision is provided to allow the instrument to be accurately synchronized with an accurate external source when extreme accuracy is required.

The low impedance output is continuously variable between 0 and 25 volts and operation is simple. You'll really appreciate the wide range of this instrument, 10 cycles to 100 kilocycles — continuously variable. Kit is complete with all parts and instruction manual, and is easy to build.

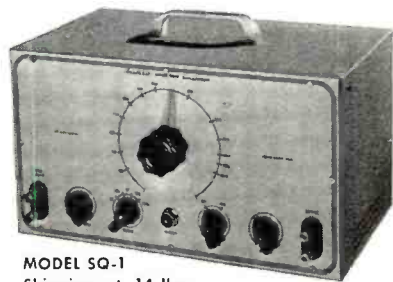

MODEL SQ-1
Shipping wt. 14 lbs.

\$29.50

YOU SAVE BY ORDERING DIRECT FROM MANUFACTURER—USE ORDER BLANK ON LAST PAGE

EXPORT AGENT
ROCKE INTERNATIONAL CORP.
13 E. 40th ST.
NEW YORK CITY (16)
CABLE: ARLAB-N.Y.

The **HEATH COMPANY**

... BENTON HARBOR 15, MICHIGAN

THE *New* 1952
Heathkit
**OSCILLOSCOPE
 KIT**

MODEL O-7
 SHIPPING WEIGHT 24 LBS.

\$43⁵⁰

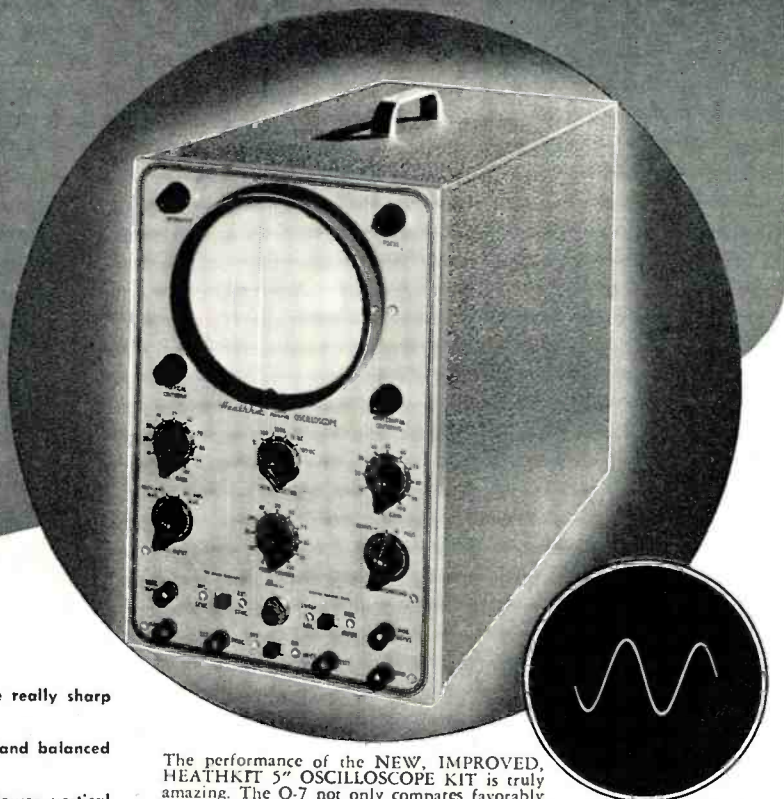

Features

- New "spot shape" control for spot adjustment — to give really sharp focusing.
- A total of ten tubes including CR tube and five miniatures.
- Cascaded vertical amplifiers followed by phase splitter and balanced push-pull deflection amplifiers.
- Greatly reduced retrace time.
- Step attenuated — frequency compensated — cathode follower vertical input.
- Low impedance vertical gain control for minimum distortion.
- New mounting of phase splitter and deflection amplifier tubes near CR tube base.
- Greatly simplified wiring layout.
- Increased frequency response — useful to 5 Mc.
- Tremendous sensitivity .03V RMS per inch Vertical — .6V RMS per inch Horizontal.
- Dual control in vernier sweep frequency circuit — smoother acting.
- Positive or negative peak internal synchronization.

The performance of the NEW, IMPROVED, HEATHKIT 5" OSCILLOSCOPE KIT is truly amazing. The O-7 not only compares favorably with equipment costing 4 and 5 times as much, but in many cases literally surpasses the really expensive equipment. The new, and carefully engineered circuit incorporates the best in electronic design — and a multitude of excellent features all contribute to the outstanding performance of the new scope.

The VERTICAL CHANNEL has a step attenuated, frequency compensated vertical input which feeds a cathode follower stage — this accomplishes improved frequency response, presents a high impedance input, and places the vertical gain control in a low impedance circuit for minimum distortion. Following the cathode follower stage is a twin triode — cascaded amplifiers to contribute to the scope's extremely high sensitivity. Next comes a phase splitter stage which properly drives the push-pull, hi-gain, deflection amplifiers (whose plates are directly coupled to the vertical deflection plates). This fine tube lineup and circuitry give a sensitivity of .03V per inch RMS vertical and useful frequency response to 5 Mc.

The HORIZONTAL CHANNEL consists of a triode phase splitter with a dual potentiometer (horizontal gain control) in its plate and cathode circuits for smooth, proper driving of the push-pull horizontal deflection amplifiers. As in the vertical channel, horizontal deflection amplifier plates are direct coupled to the CR tube horizontal deflection plates (for improved frequency response).

The WIDE-RANGE SWEEP GENERATOR circuit incorporates a twin triode multivibrator stage for producing a good saw-tooth sweep frequency (with faster retrace time). Has both coarse and vernier sweep frequency controls.

And the scope has internal synchronization which operates on either positive or negative peaks of the input signal — both high and low voltage rectifiers — Z axis modulation (intensity modulation) — new spot shape (astigmatism) control for spot adjustment — provisions for external synchronization — vertical centering and horizontal centering controls, wide range focus control — and an intensity control for giving plenty of trace brilliance.

The Model O-7 EVEN HAS GREAT NEW MECHANICAL FEATURES — A special extra-wide CR tube mounting bracket is provided so that the vertical cascade amplifier, vertical phase splitter, vertical deflection amplifier, and horizontal deflection amplifier can mount near the base of the CR tube. This permits close connection between the above stages and to the deflection plates; distributed wiring capacity is greatly reduced, thereby affording increased high frequency response.

The power transformer is specially designed so as to keep its electrostatic and electromagnetic fields to a minimum — also has an internal shield with external ground lead. You'll like the complete instructions showing all details for easily building the kit — includes pictorials, step-by-step construction procedure, numerous sketches, schematic, circuit description. All necessary components included — transformer, cabinet, all tubes (including CR tube), completely punched and formed chassis — nothing else to buy.

NEW INEXPENSIVE *Heathkit*
ELECTRONIC SWITCH KIT

The companion piece to a scope — Feed two different signals into the switch, connect its output to a scope, and you can observe both signals — each as an individual trace. Gain of each input is easily set (gain A and gain B controls), the switching frequency is simple to adjust (coarse and fine frequency controls) and the traces can be superimposed for comparison or separated for individual study (position control).

Use the switch to see distortion, phase shift, clipping due to improper bias, both the input and output traces of an amplifier — as a square wave generator over limited range.

The kit is complete: all tubes, switches, cabinet, power transformer and all other parts, plus a clear detailed construction manual.

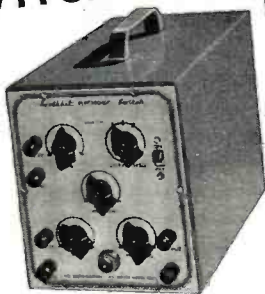

Model 5-2
 Shipping Wt. 11 lbs.

Only
\$19⁵⁰

YOU SAVE BY ORDERING DIRECT FROM MANUFACTURER—USE ORDER BLANK ON LAST PAGE

EXPORT AGENT
ROCKE INTERNATIONAL CORP.
 13 E. 40th ST.
 NEW YORK CITY (16)
 CABLE: AREAB-N.Y.

The **HEATH COMPANY**

... BE TON HARBOR 15, MICHIGAN

THE *New* 1952

Heathkit VTVM KIT

MODEL V-5
SHIPPING WT. 5 LBS.

\$24.50

Features

- New styling, — formed case for beauty.
- New truly compact size. Cabinet 4 1/8" deep by 4-11/16" wide by 7 3/8" high.
- Quality 200 microamp meter.
- New ohms battery holding clamp and spring clip — assurance of good electrical contact.
- Highest quality precision resistors in multiplier circuit.
- Calibrates on both AC and DC for maximum accuracy.
- Terrific coverage — reads from 1/2V to 1000V AC, 1/2V to 1000V DC, and .1 to over 1 billion ohms resistance.
- Large, clearly marked meter scales indicate ohms, AC Volts, DC Volts, and DB — has zero set mark for FM alignment.
- New styling presents attractive and professional appearance.

A real beauty — you'll have only highest praise for this NEW MODEL VACUUM TUBE VOLTMETER. Truly a beautiful little instrument — and it's more compact than any of our previous models. Note the new rounded edges on the front panel and rear cover. The size is greatly reduced to occupy a minimum of space on your workbench — yet the meter remains the same large size with plainly marked scales.

A set of specially designed control mounting brackets permit calibration to be performed with greatest ease — also makes for ease in wiring. New battery mounting clamp holds ohms battery tightly into place, and base spring clip insures a good connection to the ohms string of resistors.

The circuitry employs two vacuum tubes — A duo diode operating when AC voltage measurements are taken, and a twin triode in the circuit at all times. The cathode balancing circuit of the twin triode assures sensitive measurements, and yet offers complete protection to the meter movement. Makes the meter burn-out proof in a properly constructed instrument.

Quality components are used throughout — 1% precision resistors in the multiplier circuit — conservatively rated power transformer — Simpson meter movement — excellent positive detent, smooth acting switches — sturdy cabinet, etc.

And you can make a tremendous range of measurements — 1/2V to 1000V AC, 1/2V to 1000V DC, .1 to over 1 billion ohms, and DB. Has mid-scale zero level marking for quick FM alignment. DB scale in red for easy identification — all other scales a sharp, crisp black for easy reading.

A four position selector switch allows operator to rapidly set the instrument for type or reading desired — positions include ACV, DC+V, DC-V, and Ohms. DC- position allows negative voltage to be rapidly taken. Zero adjust and ohms adjust controls are conveniently located on front panel.

Enjoy the numerous advantages of using a VTVM. Its high input impedance doesn't "load" circuits under test — therefore, assures more accurate and dependable readings in high impedance circuits such as resistance coupled amplifiers, AVC circuits, etc. Note the 30,000 VDC probe kit and the RF probe kit — available at low extra cost and specially designed for use with this instrument. With these two probes, you can make DC voltage measurements up to 30,000V, or make RF measurements — added usefulness to an already highly useful instrument.

The instruction manual is absolutely complete — contains a host of figures, pictorials, schematic, detailed step-by-step instructions, and circuit description. These clear, detailed instructions make assembly a cinch.

And every part is included — meter, all controls, pilot light, switches, test leads, cabinet, instruction manual, etc.



Heathkit 30,000V DC PROBE KIT
A new 30,000 V DC Probe Kit to handle high voltages with safety. For TV service work and all other high voltage applications. Sleek looking — two color molded plastic — Red body and guard — jet black handle — Comes with connector, cable, and PL55 type plug. Plugs into Heathkit VTVM so that 300V scale is conveniently multiplied by 100. Can be used with any standard 11 megohm VTVM.

\$550
No. 336 High Voltage Probe Kit
Shipping Wt. 2 lbs.



Heathkit RF PROBE KIT
This RF Probe Kit comes complete with probe housing, crystal diode detector, connector, lead and plug and all other parts plus clear assembly instructions. Extends range of Heathkit VTVM to 250 Mc. ± 10%. Works on any 11 megohm input VTVM. Specify No. 309 RF Probe Kit.

\$550
Ship. Wt. 1 lb.

YOU SAVE BY ORDERING DIRECT FROM MANUFACTURER—USE ORDER BLANK ON LAST PAGE

EXPORT AGENT
ROCKE INTERNATIONAL CORP.
12 E. 40th ST.
NEW YORK CITY (16)
CABLE: ARAB-N.Y.

The HEATH COMPANY
... BENTON HARBOR 15, MICHIGAN

Heathkit SIGNAL GENERATOR KIT

Model SG-6
Shipping Wt. 7 lbs.

The new Heathkit Signal Generator Kit has dozens of improvements. Covers the extended range of 160 Kc to 50 megacycles on fundamentals and up to 150 megacycles on useful calibrated harmonics; makes this Heathkit ideal as a marker oscillator for TV. Output level can be conveniently set by means of both step attenuator and continuously variable output controls. Instrument has new miniature H_F tubes to easily handle the high frequencies covered.

Uses 6C4 master oscillator and 6C4 sine wave audio oscillator. The kit is transformer operated and a husky selenium rectifier is used in the power supply. All coils are precision wound and checked for calibration making only one adjustment necessary for all bands.

New sine wave audio oscillator provides internal modulation and is also available for external audio testing. Switch provided allows the oscillator to be modulated by an external audio oscillator for fidelity testing of receivers. Comes complete, all tubes, cabinet, test leads, every part. The instruction manual has step-by-step instructions and pictorials. It's easy and fun to build a Heathkit Model SG-6 Signal Generator.



Heathkit CONDENSER CHECKER KIT

Only
\$19.50

Model C-2
Shipping Wt. 6 lbs.

Checks all types of condensers — paper — mica — ceramic — electrolytic. All condenser scales are direct reading and require no charts or multipliers. Covers range of .00001 MFD to 1000 MFD. A Condenser Checker that anyone can read. A leakage test and polarizing voltage for 20 to 500 V provided. Measures power factor of electrolytics between 0% and 50% and reads resistance from 100 ohms to 5 megohms. The magic eye indicator makes testing easy.

The kit is 110V 60 cycle transformer operated and comes complete with rectifier tube, magic eye tube, cabinet, calibrated panel and all other parts. Has clear detailed instructions for assembly and use.

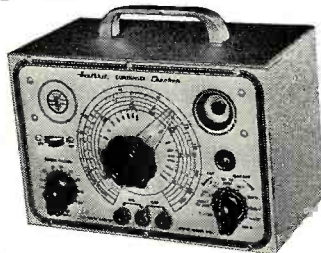

NEW Heathkit SIGNAL TRACER AND UNIVERSAL TEST SPEAKER KIT

\$19.50

Model T-2
Shipping Wt. 7 lbs.

The popular Heathkit Signal Tracer has now been combined with a universal test speaker at no increase in price. The same high quality tracer follows signal from antenna to speaker — locates intermittents — finds defective parts quicker — saves valuable service time — gives greater income per service hour. Works equally well on broadcast, FM, or TV receivers. The test speaker has an assortment of switching ranges to match either push-pull or single output impedances. Also tests microphones, pickups and PA systems. Comes complete: cabinet, 110V 60 cycle power transformer, tubes, test probe, all necessary parts, and detailed instructions for assembly and use.

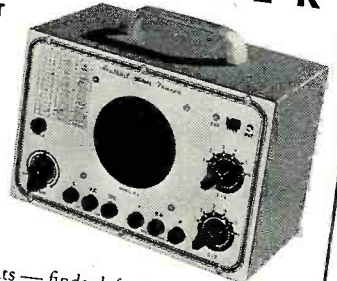

Model TC-1
Shipping Wt. 12 lbs.

\$29.50

Heathkit TUBE CHECKER KIT

The Tube Checker is a MUST for radio repair men. Often customers want to SEE tubes checked, and a checker like this builds customer confidence. In your repairing, you will have a multitude of tubes to check — quickly. The Heathkit tube checker will serve all these functions — it's good looking (with a polished birch cabinet and an attractive two color panel) — checks 4, 5, 6, 7 prong Octals, Locals, 7 prong miniatures, 9 prong miniatures, pilot lights, and the Hytron 5 prong types. AND IT'S FAST TO OPERATE — the gear driven, free-running roll chart lists hundreds of tubes, and the smooth acting, simplified switching arrangement gives really rapid set-ups.

The testing arrangement is designed so that you will be able to test new tubes of the future — without even waiting for factory data — protection against obsolescence.

You can give tubes a thorough testing — checks for opens, shorts, each element individually, emission, and for filament continuity. A large BAD-?-GOOD meter scale is in three colors for easy reading and also has a "line-set" mark.

You'll find this tube checker kit a good investment — and it's only \$29.50.

YOU SAVE BY ORDERING DIRECT FROM MANUFACTURER—USE ORDER BLANK ON LAST PAGE

EXPORT AGENT
ROCKE INTERNATIONAL CORP.
13 E. 40th ST.
NEW YORK CITY (16)
CABLE: ARAB-N.Y.

The HEATH COMPANY

... BE TON HARBOR 15, MICHIGAN

NEW 1952 *Heathkit* BATTERY ELIMINATOR KIT



Model BE-3
Shipping Wt. 17 lbs.

- Can be used as battery charger.
- Continuously variable output 0 - 8 Volts — not switch type.
- Heavy duty Mallory 17 disk type magnesium copper sulfide rectifier.
- Automatic overload relay for maximum protection. Self-resetting type.
- Ideal for battery, aircraft and marine radios.
- Dual Volt and Ammeters read both voltage and amperage continually — no switching.

The new Heathkit Model BE-2 incorporates the best. Continuously variable output control is of the variable transformer type with smooth wiper type contacts. There are no switches or steps and voltage between 0 and 8 Volts is available at 10 Amperes continuous and 15 Amperes intermittent. Maximum safety from overloads and shorts provided by automatic overload relay which resets itself when overload is removed.

The new rectifier is a 17 plate Mallory magnesium copper sulfide type. This is the most rugged type available for long trouble-free use.

Output is continuously metered by both a 0 - 10 Volt Voltmeter and a 0 - 15 Amp Ammeter. Shorted vibrators indicated instantly by ammeter.

Equip now for all types of service — aircraft — marine — auto and battery radios — this inexpensive instrument vastly increases service possibilities — better be ready when the customer walks in.

NEW *Heathkit* SINE AND SQUARE WAVE AUDIO GENERATOR KIT

Designed with versatility, usefulness, and dependability in mind, the AG-7 gives you the two most needed wave shapes right at your fingertips — the sine wave and the square wave.

The range switch and plainly calibrated frequency scale give rapid and easy frequency selection, and the output control permits setting the output to any desired level.

A high-low impedance switch sets the instrument for either high or low impedance output — on high to connect a high impedance load, and on low to work into a low impedance transformer with negligible DC resistance.

Coverage is from 20 to 20,000 cycles, and distortion is at a minimum — you can really trust the output wave shape.

Six tubes, quality 4 gang tuning condenser, power transformer, metal cased filter condenser, 1% precision resistors in the frequency determining circuit, and all other parts come with the kit — plus, a complete construction manual — A tremendous kit, and the price is truly low.



Model AG-7
Shipping Wt. 15 lbs.

\$34.50

THE NEW *Heathkit* HANDITESTER KIT

A precision portable volt-ohm milliammeter. Uses only high quality parts — All precision 1% resistors, three deck switch for trouble-free mounting of parts, specially designed battery mounting bracket, smooth acting ohm adjust control, beautiful molded bakelite case, 400 micro-amp meter movement, etc.

DC and AC voltage ranges 10 - 30 - 300 - 1000 - 5000V. Ohms range 0 - 3000 and 0 - 300,000. Range Milliampères 0 - 10 Ma, 0 - 100 Ma. Easily assembled from complete instructions and pictorial diagrams.



\$13.50

Model M-1
Shipping Wt. 3 lbs.

NEW *Heathkit*

T.V. ALIGNMENT GENERATOR KIT

Here is an excellent TV Alignment Generator designed to do TV service work quickly, easily, and properly. The Model TS-2 when used in conjunction with an oscilloscope provides a means of correctly aligning television receivers.

The instrument provides a frequency modulated signal covering, in two bands, the range of 10 to 90 Mc. and 150 to 230 Mc. — ALL ALLOCATED TV CHANNELS AS WELL AS IF FREQUENCIES ARE COVERED.

An absorption type frequency marker covers from 20 to 75 Mc. in two ranges — therefore, you have a simple, convenient means of frequency checking of IF's, independent of oscillator calibration.

Sweep width is controlled from the front panel and covers a sweep deviation of 0-12 Mc. — all the sweep you could possibly need or want.

And still other excellent features are: Horizontal sweep voltage available at the front panel (and controlled with a phasing control — both step and continuously variable attenuation for setting the output signal to the desired level — a convenient instrument stand-by position — vernier drive of both oscillator and marker tuning condensers — and blanking for establishing a single trace with base reference level. Make your work easier, save time, and repair with confidence — order your Heathkit TV Alignment Generator now!

Model TS-2
Shipping Wt. 20 lbs.

\$39.50

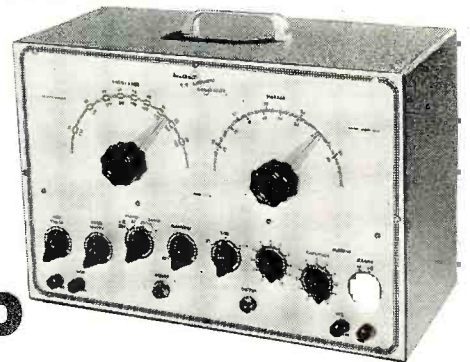

YOU SAVE BY ORDERING DIRECT FROM MANUFACTURER — USE ORDER BLANK ON LAST PAGE

EXPORT AGENT
ROCKE INTERNATIONAL CORP.
13 E. 40th ST.
NEW YORK CITY (10)

The HEATH COMPANY

... BENTON HARBOR 15, MICHIGAN

Heathkit IMPEDANCE BRIDGE KIT



Model 1B-1B
Shipping Wt. 15 lbs.

\$69⁵⁰

This Impedance Bridge Kit is really a favorite with schools, industrial laboratories, and serious experimenters. An invaluable instrument for those doing electrical measurements work. Reads resistance from .01 Ohms to 10 meg., capacitance from .00001 to 100 MFD, inductance from 10 microhenries to 100 henries, dissipation factor from .002 to 1, and storage factor from 1 to 1000. And you don't have to worry about selecting the proper bridge circuit for the various measurements—the instrument automatically makes the correct circuit when you set up for taking the measurement you want. Bridge utilizes Wheatstone, Hay, Maxwell, and capacitance comparison circuits for the wide range and types of measurements possible. And it's self powered—has internal battery and 1000 cycle hummer. No external generator required—has provisions for external generator if measurements at other than 1000 cycles are desired. Kit utilizes only highest quality parts, General Radio main calibrated control.

Mallory ceramic switches, excellent 200 microamp zero center galvanometer, laboratory type binding posts with standard 3/4 inch centers, 1% precision ceramic-body type multiplier resistors, beautiful birch cabinet and ready calibrated panel. (Headphones not included.)

Take the guesswork out of electrical measurements—order your Heathkit Impedance Bridge kit today—you'll like it.

Heathkit LABORATORY RESISTANCE DECADE KIT



\$9⁵⁰

Shipping Wt. 4 lbs.

An indispensable piece of laboratory equipment—the Heathkit Resistance Decade Kit gives you resistance settings from 1 to 99,999 ohms IN ONE OHM STEPS. For greatest accuracy, 1% precision ceramic-body type resistors and highest quality ceramic wafer switches are used.

Designed to match the Impedance Bridge above, the Resistance Decade Kit has a beautiful birch cabinet and attractive panel. It's easy to build, and comes complete with all parts and construction manual.

Heathkit LABORATORY POWER SUPPLY KITS

Limits:

No load.....	Variable 150-400V DC
25 MA.....	Variable 30-310V DC
50 MA.....	Variable 25-250V DC

Higher loads: Voltage drops off proportionally

Every experimenter needs a good power supply for electronic setups of all kinds. This unit has been expressly designed to act as a HV supply and a 6.3 V filament voltage source. Voltage control allows selection of HV output desired (continuously variable within limits outlined), and a Volts-Ma meter scale indicates either DC voltage output (Range of meter 0-500V D.C., 0-200 Ma. D.C.). Instrument has convenient stand-by position and pilot light.

Comes with power transformer, filament transformer, meter, 5Y3 rectifier, two 1619 control tubes, completely punched and formed chassis, panel, cabinet, detailed construction manual, and all other parts to make the kit complete.



\$29⁵⁰

Model PS-1.....Ship. Wt. 20 lbs.

Heathkit ECONOMY... 6 WATT AMPLIFIER KIT



Model A-4
Ship. Wt. 8 lbs.

\$12⁵⁰

No. 304 12 inch speaker... **\$6.95**

This fine Heathkit Amplifier was designed to give quality reproduction and yet remain low in price. Has two preamp stages, phase inverter stage, and push-pull beam power output. Comes complete with six tubes, quality output transformer (to 3-4 ohm voice coil), husky cased power transformer and all other parts. Has tone and volume controls. Instruction manual has pictorial for easy assembly. Six watts output with response flat $\pm 1\frac{1}{2}$ db from 50 to 15,000 cycles. A quality amplifier kit at a low price. Better build one.

Heathkit HIGH FIDELITY... 20 WATT AMPLIFIER KIT

Our latest and finest amplifier—the model A-6 (or A-6A) is capable of a full 20 Watts of high fidelity output—good faithful reproduction made possible through careful circuit design and the use of only highest quality components. Frequency response within ± 1 db from 20-20,000 cycles. Distortion at 3 db below maximum power output (at 1000 cycles) is only .8%. The power transformer is rugged and conservatively rated and will deliver full plate and filament supply with ease. The output transformer was selected because of its exceptionally good frequency response and wide range of output impedances (4-8-16-150-600 ohms). Both are Chicago Transformers in drawn steel case for shielding and maximum protection to windings. The unit has dual tone controls to set the output for the tonal quality desired—treble control attenuates up to 15 db at 10,000 cycles—bass control gives bass boost up to 10 db at 50 cycles.

Tube complement consists of 5U4G rectifier, 6SJ7 voltage amplifier, 6SN7 amplifier and phase splitter, and two 6L6's in push-pull output. Comes complete with all parts and detailed construction manual. (Speaker not included.)

MODEL A-6: For tuner and crystal phono inputs. Has two position selector switch for convenient switching to type of input desired.

MODEL A-6A: Features an added 6SJ7 stage (preamplifier) for operating from variable reluctance cartridge phono pickup, mike input, and either tuner or standard crystal phono pickup. A three position selector switch provides flexible switching.

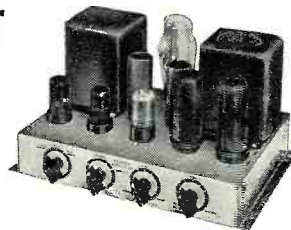

\$33⁵⁰

Shipping Wt. 18 lbs.

\$35.50

Shipping Wt. 18 lbs.

YOU SAVE BY ORDERING DIRECT FROM MANUFACTURER—USE ORDER BLANK ON LAST PAGE

REPORT AGENT
ROCKE INTERNATIONAL CORP.
13 E. 40th ST.
NEW YORK CITY (16)
CABLE: AREAR-N.Y.

The **HEATH COMPANY**

... BENTON HARBOR 15, MICHIGAN

Heathkit RECEIVER & TUNER KITS for AM and FM



\$19⁵⁰

Model BR-1 Broadcast Model Kit covers 550 to 1600 Kc. Shipping Wt. 10 lbs.

Model AR-1 3 Band Receiver Kit covers 550 Kc. to over 20 Mc. continuous. Extremely high sensitivity. Shipping Wt. 10 lbs.

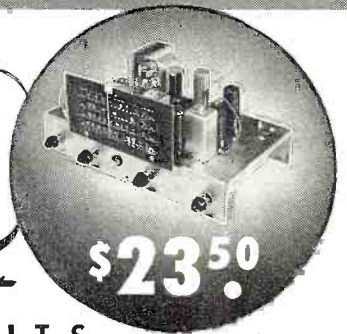

\$23⁵⁰

TWO HIGH QUALITY Heathkit SUPERHETERODYNE RECEIVER KITS

Two excellent Heathkits. Ideal for schools, replacement of worn out receivers, amateur and custom installations.

Both are transformer operated quality units. The best of materials used throughout—six inch calibrated slide rule dial—quality power output transformers—dual iron core shielded. I.F. coils—metal cased filter condenser. The chassis has phono input jacks. 110 Volt output for phono motor and there is a phono-radio switch on panel. A large metal panel simplifying installation in used console cabinets is included. Comes complete with tubes and instruction manual incorporating pictorials and step-by-step instructions (less speaker and cabinet). The three band model has simple coil turret which is assembled separately for ease of construction.



Model FM-2
Ship. Wt. 9 lbs.

\$22⁵⁰

TRUE FM FROM Heathkit FM TUNER KIT

The Heathkit FM Tuner Model FM-2 was designed for best tonal reproduction. The circuit incorporates the most desirable FM features—true FM.

Utilizes 8 tubes: 7E5 Oscillator, 6SH7 mixer, two 6SH7 IF amplifiers, 6SH7 limiter, two 7C4 diodes as discriminator, and 6X5 rectifier.

The instrument is transformer operated making it safe for connection to any type receiver or amplifier. Has ready wound and adjusted RF coils, and 2 stages of 10.7 Mc IF (including limiter). A calibrated six inch slide rule dial has vernier drive for easy tuning. All parts and complete construction manual furnished.



MAIL TO THE
HEATH COMPANY
BENTON HARBOR 15,
MICHIGAN

ORDER BLANK

From _____

SHIP VIA

- Parcel Post
 Express
 Freight
 Best Way

Quantity	Item	Price	Quantity	Item	Price
	Heathkit Oscilloscope Kit — Model O-7			Heathkit H.V. Probe Kit — No. 336	
	Heathkit VTVM Kit — Model V-5			Heathkit R.F. Signal Gen. Kit — Model SG-6	
	Heathkit FM Tuner Kit — FM-2			Heathkit Condenser Checker Kit — Model C-2	
	Heathkit Broadcast Receiver Kit — Model BR-1			Heathkit Handitester Kit — Model M-1	
	Heathkit Three Band Receiver Kit—Model AR-1			Heathkit Power Supply Kit — Model PS-1	
	Heathkit Amplifier Kit — Model A-4			Heathkit Resistance Decade Kit — Model RD-1	
	Heathkit Amplifier Kit — Model A-6 (or A-6A)			Heathkit Impedance Bridge Kit — Model IB-1B	
	Heathkit Tube Checker Kit — Model TC-1			Heathkit A.C. VTVM-KIT — Model AV-1	
	Heathkit Audio Generator Kit — Model AG-7			Heathkit Intermodul. Analyzer Kit—Model IM-1	
	Heathkit Battery Eliminator Kit — Model BE-2			Heathkit Audio Freq. Meter Kit — Model AF-1	
	Heathkit Electronic Switch Kit — Model S-2			Heathkit Square Wave Gen. Kit — Model SQ-1	
	Heathkit T.V. Alignment Gen. Kit — TS-2				
	Heathkit Signal Tracer Kit — Model T-2				
	Heathkit R.F. Probe Kit — No. 309				

On Parcel Post Orders, include postage for weight shown and insurance. (We insure all shipments.)

On Express Orders, do not include transportation charges — they will be collected by the Express Agency at time of delivery.

Enclosed find Check Money Order for _____

Please ship C.O.D. Postage enclosed for _____ lbs.

ALL PRICES SUBJECT TO CHANGE WITHOUT NOTICE

EXPORT AGENT
ROCKE INTERNATIONAL CORP.
13 E. 40th ST.
NEW YORK CITY (16)
CABLE: ARLAB-N.Y.

The **HEATH COMPANY**

... BENTON HARBOR 15, MICHIGAN

HORIZONTAL And VERTICAL SUPPRESSION CIRCUITS And THEIR USE

By
DAN LERNER

Supervisor, Television Service, Philco Corporation

One of the most difficult of all TV servicing problems. Here is how one group handles it.

RECENTLY a tough customer problem in a Midwestern city was represented by numerous complaints of a white line or rope on the left hand side of the picture tube. This so-called rope occurred only on one particular channel and its cause baffled many a technician. After numerous engineering checks it was found that the white rope was caused by a sync overshoot somewhere in the transmitter system. See Fig. 1. Many attempts at clearing up the trouble produced no results. Finally it was decided that perhaps some expedient would be found in the receiver which

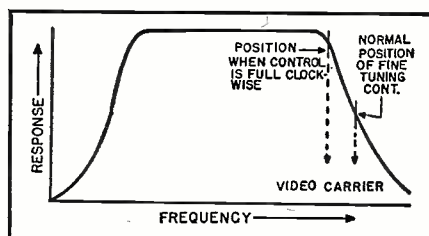
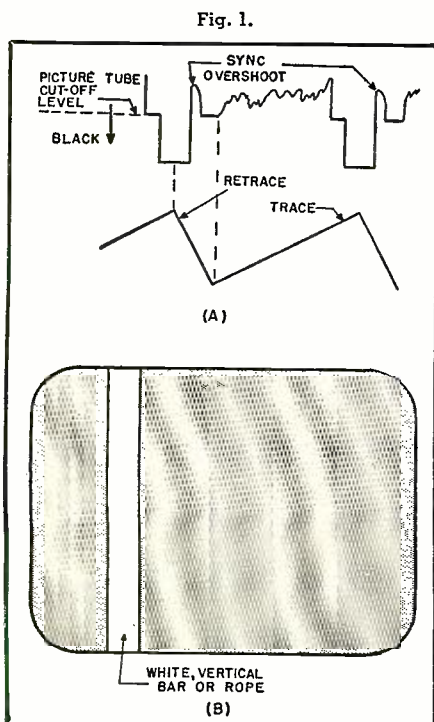

Fig. 2.

would solve the problem. Examination of the overshoot with an oscilloscope of a wide video bandpass revealed the overshoot to be of a relatively high frequency (approximately 3.6 mc.). It was also noticed that only on certain receivers would this white line appear. These particular receivers were those with a relatively wide video i.f. and video amplifier bandpass, 3.8 to 4.0 mc. On these receivers of the intercarrier sound type it was possible to tune the fine tuning controls so that the white line disappeared. However, picture definition was affected at the point the white line disappeared. The reason for this can be seen from Fig. 2. Notice that when the fine tuning control is rotated clockwise the video carrier is moved up on the response curve. As the carrier moves up on the curve, the high frequency response of the receiver is gradually reduced. In a receiver using a conventional sound i.f. system if the receiver is correctly aligned sound will be lost as the picture starts to lose definition; however, in an intercarrier receiver the sound is not lost since the sound depends upon the beat between the sound and video i.f. carriers.

The first fix that was tried in order to get rid of the white line was to purposely degrade the high frequency picture information by increasing the

value of the plate load resistor in the video output stage. See Fig. 3. However, this so-called fix not only removed the white line but also much of the high frequency picture detail. Since it was in the video section it degraded the picture quality on all the received television channels.

Horizontal Suppression

Finally it was decided to try some sort of horizontal suppression circuit. Since the overshoot occurred right after the horizontal sync pulse it was reasoned that the white line was caused by successive line CRT unblanking during horizontal retrace time. If this were so then a heavy negative or positive pulse to keep the picture tube from conducting during retrace time would do the trick.

At first the circuit shown in Fig. 7A was tried. This circuit used a heavy negative spike from the horizontal damper which was applied to the picture tube accelerating anode. The 47,000 ohm load resistor was used as the load across which the spike was applied to the accelerating anode. This circuit worked up to a point. That is, the high voltage involved, about 1500 volts, required the use of a high voltage condenser. The lead from the damper circuit to the anode produced some amount of harmful sweep radiation. Some of the left hand side of the picture was lost.

The next circuit that was tried is

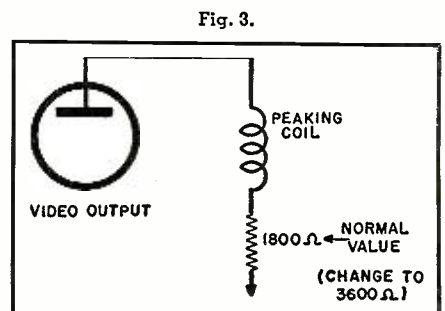
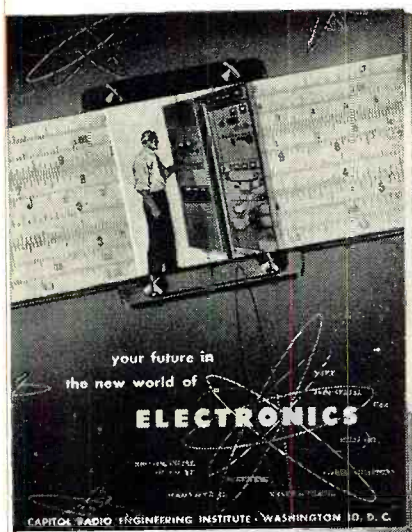

Fig. 3.



← The data that Launched Thousands
of Careers is yours FREE . . .
to show

HOW YOU CAN BE SUCCESSFUL IN RADIO-TV-ELECTRONICS

YOU CAN plod along for years, getting a paltry increase now and then, enjoying little security, finding your work dull and drab.

Then something happens. Things look up. You become more confident. Your earnings rise. You feel more important.

"Luck," some may say.

"Contacts," others may suggest.

But in your heart, you will know the answer: "Training." And it all may have started the moment you filled out a coupon requesting a copy of a free booklet named "Your Future in the New World of Electronics." From this data you get knowledge of where you stand in Electronics. Tremendous expansion leaves this gigantic industry pleading for trained men. In the defense build-up alone, more than \$7 billion in electronics contracts have been awarded. Top manufacturers sold about \$3 billion worth of electronic merchandise in 1951. By 1960, the radio-electronics industry should do no less than 10 billion dollars per year, not counting military orders.

Today there are over 50,000 radio-equipped police cars; an even larger number of taxis are radio equipped (at least 65,000); 28,000 civilian planes have radio; 27,000 American ships have radio; there are 9,200 industrial radio network installations.

Within 5 years, says the Chairman of the FCC, there will be 1,500 TV stations, and in 10 years, 2,500 in operation. There are 14,496,000 TV sets and over 100,000,000 radios in operation. How these figures will increase in the next few years the most daring of experts are reluctant to predict. Countless positions must be filled—in development, research, design, production, testing and inspection, manufacture, broadcasting, telecasting and servicing. To fill these posts, trained men are needed—men who somewhere along the line take time to improve their knowledge, their skills. Men who, today, perhaps, take two minutes to send for a booklet.

"Your Future in the New World of Electronics" shows you how CREI Home Study leads the way to greater earnings through the inviting opportunities described above.

However, CREI does not promise you a "snap." With an accredited technical school such as this, you must study to convert your ambition into technical knowledge you can sell in the fabulous Electronics market.

Since its founding in 1927, CREI has provided thousands of professional radio men with technical educations. During World War II CREI trained thousands for the Armed Services. Leading firms choose CREI courses for group training in electronics at company expense, among them United Air Lines, Canadian Broadcasting Corporation, Trans Canada Airlines, Sears, Roebuck and Co., Bendix Products Division, All-American Cables and Radio, Inc., and RCA Victor Division.

CREI courses are prepared by recognized experts, in a practical, easily understood manner. You get the benefit of time-tested materials, under the personal supervision of a CREI Staff Instructor, who *knows* and *teaches* you what industry wants. This is accomplished on your own time, during hours selected by you, and controlled by your own will power. This complete training is the reason that graduates find their CREI diplomas keys-to-success in Radio, TV and Electronics. CREI alumni hold top positions in America's leading firms. At your service is the CREI Placement Bureau, which finds positions for advanced students and graduates. Although CREI does not guarantee jobs, requests for personnel far exceed current supply.

Now is the time of decision for you. Luck will not propel you forward unless it finds you trained. Contacts won't budge you an inch unless you have the skill to back them up. The answer is: Technical Training . . . and willingness to learn. Together they will bring you increased earnings in this new Age of Electronics. Fill out the coupon and mail it now. We'll promptly send you your free copy of "Your Future in the New World of Electronics." The rest—your future—is up to you.

MAIL COUPON FOR FREE BOOKLET

CAPITOL RADIO ENGINEERING INSTITUTE

Dept. 112D, 16th & Park Rd., N.W., Washington 10, D. C.

Send booklet "Your Future in the New World of Electronics" and course outline.

CHECK TV, FM & Advanced AM Servicing Aeronautical Radio
FIELD OF Practical Television Engineering Engineering
GREATEST Broadcast Radio Engineering (AM, FM, TV)
INTEREST Practical Radio Engineering

Name

Street

City Zone State

If residence school in Wash., D. C., preferred, check here



FREE LICENSE FOR HAM!

Absolutely! No strings attached! Every ham in the U. S. has a FREE LICENSE to write us immediately and tell us what new or used radio or electronics gear you want to sell. We pay sizzling high prices. Tell us what you have—TODAY—and see the color of our dough—FAST!

NEW TRANSFORMERS 110 V. 60 CYCLES
Look at these sensational buys!

13 V. @ amp.	\$1.89
STANCOR P4079, 700 V. Center tap, 90 ma. 6.3 V. @ 3.5 amps & 5 V. @ 3 amps.	3.25
THORDARSON TV Filter Choke. T-1704, 1500 h. 3 ma, 12K insulation	1.79
THORDARSON T-13R08, 700 V. Center tap, 90 ma.; 2.5 V. Center tap @ 6 amp.; 6.3 V. Center tap @ 3.5 amp.	3.25
THORDARSON 15A68 CHT audio xfmr. Dynamic mike or line-to-grid. Pri.: 60/38/30/22/15/ 10/5.5/2.2 ohms. Sec.: 60,000, 15,000 ohms	2.95

CONDENSER SPECIALS

.1 mfd. @ 400 VDC. Ea. 10c. 10 for 69c	
16 mfd. @ 400 VDC. Paper electrolytic. Ea. 30c. 5 for \$1.00	
.05 mfd. @ 5000 VDC. Paper. Ea. 39c. 3 for 1.00	

4 V. BATTERY PACK
For TBY Walkie-Talkie. New, in original
boxes

PE-103 DYNAMOTOR
With filter base and cords. 6 or 12 V. input; 500 V.
output. Excel. cond. Limited quantity. ...

VHF ARC-5 R-28 RECEIVER
10-tube, superhet with 4-channel xtal controlled
freq. range of 100-156 mc. Makes a dream
fixed or mobile unit. Brand new. \$32.50.

VHF ARC-5 T-23 TRANSMITTER
Companion to above receiver. Uses plate modulation.
1625 osc., 1625 and 832-A triplers, 832-A
final. This VHF set can be converted to 6 or 10
meters easy as pie. Excel. cond. \$42.50.

SPECIAL
Both of above units are terrific for 2 meters, ham,
novice, CAP or CD. Special price for the combo:
ONLY \$71.95.
INCLUDES FREE GIFT OF CONVERSION BOOK
COVERING WORLD OF INFORMATION.

5 W. MARINE RADIO TELEPHONE
Jefferson-Travis Emerson Radio Corp. Freq. 2-3 mc.
2-channel, x-tal control. Complete with mike, speaker,
110 V. charging unit, all tubes and instructions.
6 V. input or will run 8-10 hrs. on own battery pack.
BRAND NEW, BOXED (Less xtals & batteries) ONLY
\$79.50.

CIRCUIT BREAKER: 15 amp 110 VAC. New. \$1.59
20 amp 110 VAC. New. \$1.79

BC-728-A PORTABLE RECEIVER
This item is harder to find than square eggs. But YOU
asked for 'em so here they are. 4 adjustable push-
button controlled frequencies in the 2-mc. band.
Wonderful for marine, police and ham use. Uses a
2 V. wet cell for power. Can be held in one hand.
Complete with tubes, speaker AND NEW BATTERY.
Good cond. For our hams ONLY \$28.95.

ARC-5 OR 274-N TRANSMITTERS

2.1-3 mcs. New	\$19.95
1-4 mcs. Used, excel. cond.	14.95
4-5.3 mcs. Used, good cond.	6.25
4-5.7 mcs.	6.20
7-9.1	12.50

ARC-5 OR 274-N RECEIVERS

3.5-1.5 mcs. Brand new	\$49.50
1.5-3 mcs. Brand new	24.50
1.5-3 mcs. Used	7.95
8-9.1 mcs. Brand new	11.95

28 V. RECEIVER DYNAMOTOR 1.00
14 V. RECEIVER DYNAMOTOR 9.95
RACK FOR DUAL TRANSMITTER 2.95
TRIPLE RECEIVER RACK 5.00
BC-442-A ANTENNA RELAY with 50
mmfd. condenser. Excel. cond. 3.95

METERS! OUR BARGAIN SPECIALS!

0-100 VDC movement with 20-0-20 scale. 2 in. sq. Simpson. Used.	\$2.25
0-20 kilovolt DC 3 in. rd. Westinghouse. FS equals 1 ma. Use external multiplier. Only	4.95
0-25 MADC 2 in. rd. Weston.	2.99
0-2 amp. R.F. 3 in. square Westinghouse.	3.95
0-9 amp. RF 2 in. rd. Westinghouse.	2.99

All orders F.O.B. Los Angeles. 25% deposit required.
All items subject to prior sale.

COLUMBIA ELECTRONIC SALES
522 South San Pedro Street
LOS ANGELES 13, CALIFORNIA

shown in Fig. 7B. In this case a positive pulse was applied from the last "Sync Amp." plate which, connected to the cathode, caused the tube to cut off during horizontal retrace. This circuit looked like it would be the answer for awhile, however other problems presented themselves. Tapping off from the plate of the "Sync Amp." would cause loading of the plate circuit and thus insufficient sync on some signals. On very weak stations bursts of noise amplified in the "Sync Amp." would cause black streaks and dots to appear on the screen.

The next circuit tried is shown in Fig. 7C. Again a positive pulse is applied to the picture tube cathode. However the pulse is obtained from the "Horizontal Output" plate by means of a gimmick coupler. This circuit also worked well up to a point, for any ringing in the horizontal system would be applied to the CRT cathode which would modulate the tube as shown in Fig. 5. Finally the circuit shown in Fig. 6 was used successfully. The 1N34 crystal allowed only the positive pulse to pass and thus the negative ringing excursions were eliminated.

Vertical Suppression

Many manufacturers use some kind of vertical retrace suppression circuit. All of them, in one way or another, prevent the picture tube from conducting during vertical retrace time. Such circuits have perhaps limited use to the average television consumer, however they are just another television refinement. Most present day television receivers have no d.c. restorer. Thus in scenes where very little studio lighting is used the white vertical retrace lines show through. Also in very weak signal areas the receiver contrast is usually insufficient to eliminate the white lines.

The circuit shown in Fig. 4 was used successfully to give vertical retrace suppression. To prevent any chance of loading, a series .003 μ fd. condenser and 180,000 ohm resistor is used to tap off the positive vertical signal from the vertical output plate. This signal is applied to the picture tube cathode across a 47,000 ohm load resistor.

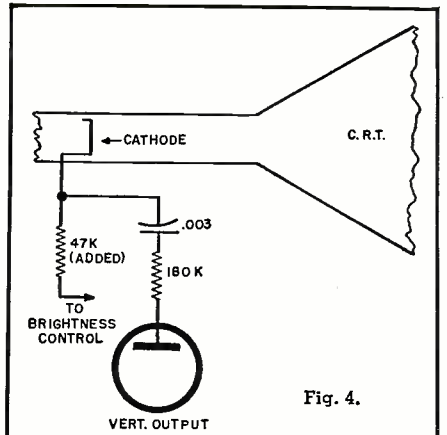

Fig. 4.

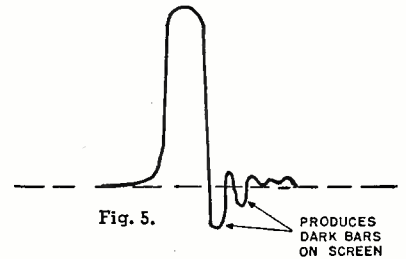

Fig. 5.

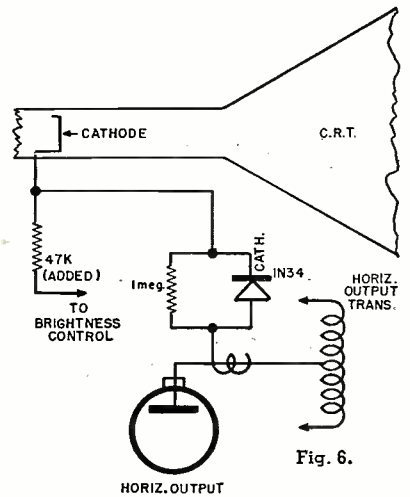

Fig. 6.

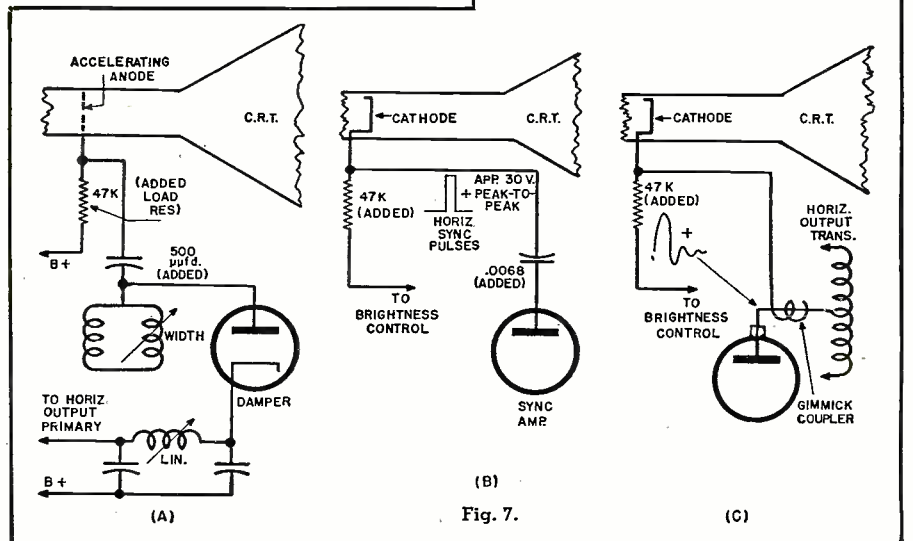

Fig. 7.

THE NEW "630" 30-TUBE CHASSIS WITH THE AMAZING CASCODE TUNER

**BRINGS IN RECEPTION
... UP TO 200 MILES**

4 Microvolt Sensitivity

This amazing new Super DX handles all tubes from 10" to 24" will bring in better reception up to 200 miles without the use of boosters and will work where other sets have failed. The NEW STANDARD COIL CASCODE tuner gives you greater sensitivity with less snow. This tuner utilizes the newly developed 6BK7 tube with the gold plated grid... is fully shielded against radiation and has a newly designed converter circuit. Has new improved Mark flyback with built in Keyed AGC for better picture control; 15 KV output; 3 stage sync separator; 5 hour minimum heat run at factory. Moulded plastic condensers; synchro lock; improved new Ferrite core with coil for greater range of width. Armstrong FM sound system; improved linearity control. Factory wired, aligned & tested before shipment. Phono connection and switch on chassis. Complete with RCA Hi-Fi 12" speaker. DIRECTLY ADAPTABLE FOR COLOR AND UHF STATIONS. Speaker. **RMA GUAR.**

CHASSIS MTG. BRACKETS...\$6.50

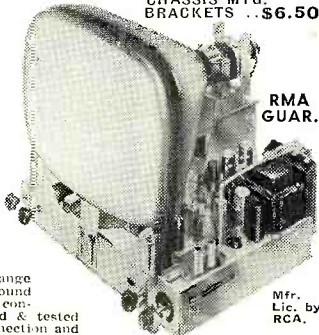

\$149⁹⁵

Complete with Fed. Tax. Less Picture Tube.

SENSATIONAL INTRODUCTORY OFFER OF AIREX SUPER DX TV SETS.
... The finest complete set value in its price class ...

These outstanding sets were specially designed to meet our rigid specifications to assure you many pleasant hours of trouble free TV at an unequalled price. The mfr. is licensed by RCA. RMA guarantee. All you have to do is plug in and play.

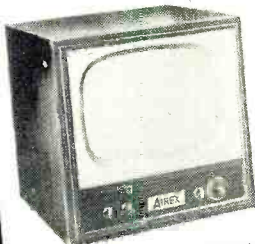

17" \$154.95
20" \$179.95

24" CONSOLE
1 YEAR WARRANTY ON TUBES AND PARTS **\$299⁹⁵**



17" \$174.95
20" \$199.95

CHECK THESE FEATURES

- Has standard coil Cascode tuner that brings in reception up to 200 miles • 22 tubes • Large HI-FI speaker • Hand rubbed, satin finished genuine mahogany cabinet • A3C • Moulded plastic condensers
- Black, glareless picture tube, guaranteed for 6 months • Adaptable for UHF and color • Synchronized FM audio system • 5 hour heat run at factory
- Factory wired, aligned and tested.

TV TUBE EXTRA

Standard Brands
Factory New—1st Quality

12 1/2" Round	\$22.50
14" Rectangular	23.95
16" Rectangular	29.95
17" Rectangular	29.95
20" Rectangular	32.95
24" Round	42.95
Ring & sleeve for 24"	74.95
	7.50

RESISTORS

100 assorted
1/2 to 2 watts.....\$2.29

ESPEY FM-AM RADIO

12 TUBES Push Pull Output **\$74.95**

300 OHM TV WIRE

1000 ft. spool **\$17.95**
100 ft. spool **\$2.00**

"630" KITS

Includes all parts & all small tubes
Loose Cathode Ray Tube. **\$129.95**

SPECIAL VALUES

- STANDARD COIL TUNER.....\$22.95
 - TV MASKS—16&17" —\$4.95; 20" —\$7.95; 24" —\$14.95
 - REGENCY BOOSTER ADEL DB410.....\$19.11
 - BELL AMPLIFIER, extended control.....\$4.95
- We carry a complete line of 630 component parts.
We have a full line of RADIO TUBES.
FROM 40% TO 60% OFF LIST

All merchandise is brand new, factory fresh & fully guaranteed. Mail & phone orders filled upon receipt of certified check or money order for \$25 as deposit on TV chassis. 20% on other items. Balance C.O.D. F.O.R. N.Y. Prices subject to change without notice. No Fed. taxes to pay. Prices lower than OPS Regs.

AIREX RADIO CORP.

171 WASHINGTON ST., N. Y. C. 7, N. Y.
PHONE WOrth 2-4029

PRICE SMASHING VALUES IN CABINETS FOR THE "630" CHASSIS

Beautiful, richly finished, hand rubbed mahogany cabinets to suit every taste. They are designed to house the "630" chassis, 12" speaker and up to 20" TV tube. The combination cabinets will hold up to a 20" TV tube, radio and Webster record changer, with ample record space. All cabinets are equipped with mask and mounting brackets. The perfect chassis deserves a perfect cabinet. It will be a focal point of beauty in your home. Other models in stock. When ordering chassis and cabinet, no chassis mounting brackets needed. Send for FREE circular.

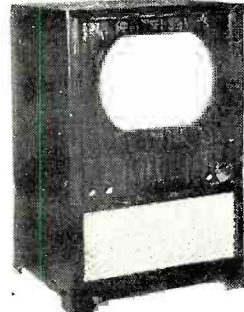

"ECONOMY"

38x22x22—16" & 17".....\$49.95
41x25x23—16" to 20".....59.95
45x28x25—24" tube.....74.95
Blonde \$10 additional.



"STRATFORD"

40x28 1/2 x 23 1/2. Genuine croch Mahogany doors.....\$89.95

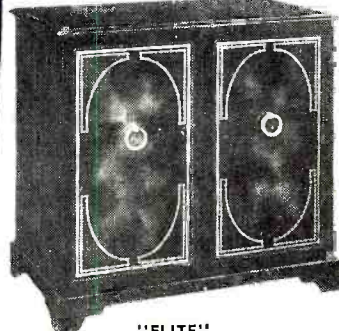

"ELITE"

Combination—38x40x23 1/2. Red antique genuine leather. Gold leaf hand tooling.....\$149.95
In lined oak, gold colored leather.....159.95

SEND POSTCARD TO BE PUT ON FREE MAILING LIST

BIG VALUES AT OLSON'S

Stock No.	Description	Olson's Price
T-80	TV Focus Coil. Replaces RCA 202D1. For magnetically deflected 55" Kinescopes...	\$1.79
T-90	TV Focus Coil, EM-PM Type. Used on 16"-70" and 19"-66" Kinescopes...	\$2.98
T-91	Ion Trap with 2 powerful Alnico 5 magnets. Bronze clamp keeps it firm...	.98
X-263	Ion Trap single magnet type. Most popular in use. Order plenty...	.49
T-94	GE Type Universal Flyback Trans. similar RTO-985, 77J1 for all 65"-70" Kinescopes. Ferrite core, supplies 14,000 volts. Single ea. \$3.99. Lots of 3, each.	\$3.49
T-93	70" TV Yoke. Similar to RCA 209D1. For use on Kinescopes up to 19" single ea. \$3.49. Lots of 3, each.	\$2.99
T-82	55" TV Flyback Trans. Similar to RCA 211T1. For all 10" and 12" Kinescopes. Single ea. \$2.99. Lots of 3, each.	\$1.99
T-84	55" TV Yoke. Similar to RCA 208D1. For 10", 12" and 16" Kinescopes. Single ea. \$2.79. Lots of 3, each.	\$1.99
G-256	500 MMFD 10KV Ceramic TV Condenser. With threaded terminals. Single, ea. 79c. Lots of 10, each.	.49
G-399	500 MMFD 20KV Ceramic TV Condenser with threaded terminals. single, ea. 89c. Lots of 10, each.	.85
R-14	TV Carbofilm Resistor. 2 mcg. For practically all TV sets.	.59
W-75	TV Anode Connector. Phosphor Bronze plug, rubber shield and polyethylene cord	.49
X-197	JFD Lightning Arrestor. UL approved. For all 300 ohm TV lines.	\$1.32
X-207	TV Antenna Chimney Mount. Attaches to any chimney. Takes mast 3/8" to 1 1/2" diameter.	\$1.79
X-165	Recording Wire. Stainless Steel. Excellent frequency response, 1/2 hr. spool.	\$1.98
X-166	Recording Wire. Stainless Steel. Excellent frequency response, 1 hr. spool.	\$2.98
Y-41	Recording Discs. 6" size Aluminum base, smooth coating. Pkg. of 5 discs.	\$1.20
Y-42	Recording Discs. 8" size Aluminum base, smooth coating. Pkg. of 5 discs.	\$1.50
Y-43	Recording Discs. 10" size Aluminum base, smooth coating. Pkg. of 5 discs.	\$2.40
W-53	AC Lamp Cord. Zips apart. 2 conductor copper tough insulation. 250' spool.	\$4.99
K-14	Speaker Baffle. For 5" and 6" speakers. Sloping front. Fine walnut finish.	\$3.45
K-15	Speaker Baffle. For 8" speakers. Sloping front. Fine walnut finish.	\$3.95
K-16	Speaker Baffle. For 10" speakers. Sloping front. Fine walnut finish.	\$4.45
K-17	Speaker Baffle. For 12" speakers. Sloping front. Fine walnut finish.	\$5.45
XG-46	Astatic QD Cartridge. Turnover type with 2 needles for LP and 78 RPM Discs	\$3.99
AS-44	Volume Control Kit. Contains 10 popular single and dual controls. Many with switch.	\$2.99
AS-45	Condenser Kit. Contains between 40 and 50 electrolytic and By-pass condensers.	\$3.95
X-191	Service Call Tags. In 3 sections, claim check, identify and Billing form, with wires. Per 100.	\$1.19

BY-PASS KIT IN STEEL CABINET LIMITED QUANTITY ONLY

Positively no more of these kits will be available when we run out of 4 drawer steel cabinets. **THIS IS REAL VALUE** — Kits contain the famous Olson Akrad "Super Sealed" By-Pass condensers. Cabinet size 4 1/4 x 6 3/8 x 6". Choice of 2 kits.

42 CONDENSER KIT
AS-36 ONLY
\$6.95

Qty.	Cap.	Volts
2	.002	600
2	.002	600
5	.01	600
5	.02	600
10	.05	600
10	.1	600
2	.005	1600
2	.008	1600
2	.01	1600

Regular list \$18.38

100 CONDENSER KIT
AS-37 ONLY
\$11.95

Qty.	Cap.	Volts
2	.001	600
5	.002	600
5	.003	600
10	.01	600
10	.02	600
10	.05	600
10	.1	600
5	.005	1600
5	.008	1600
5	.01	1600

Regular list \$41.48

FOR SALE BY OLSON—SOLID CARLOAD OF WIRE

Once a year Olson goes through his wire stock and closes out at cut prices millions of feet of brand new clean wire. Close-out time is here—and at a particularly good time for you. Right now while copper wire is tight you can buy yourself a good assortment of various types as listed below at CUT PRICES. All wire is number 20 or 22 unless otherwise shown. In addition you get at no cost an all steel forged pair of electrician pliers with serrated jaw and wire cutting edges. If you order 10 rolls of wire.

PACKED ON 50 FT. COILS

Stock No.	Number of Conductors	Type of Insulation	Suggested Uses	Close-out Price 50 Ft. Coil
W-80	1	Plastic	Hook-up, easy stripping	\$.49
W-81	1	Lacquered Braid	Hook-up or ground wire	.49
W-82	1	Waxed Cotton	Pushback hook-up	.59
W-83	1	Heavy Rubber	General use, extremely good	.65
W-84	1	Rubber and Lacquer Braid	Heavy duty, for rough use	.79
W-85	1	Rubber and Lacquer Braid	No. 16 wire for auto ignition and filaments	.99
W-86	2	Plastic	Twisted for extension speakers, intercoms	.89
W-87	3	Plastic	Twisted for intercoms & Telephones	1.29
W-91	4	Plastic & Cotton	For intercoms & speakers	1.59
W-92	5	Plastic & Cotton	For intercoms & Spec. Purpose	1.89
W-93	6	Plastic & Cotton	For intercoms & Spec. Purpose	2.19
W-96	7	Plastic & Cotton	For intercoms & Spec. Purpose	2.49
W-97	8	Plastic & Cotton	For intercoms & Spec. Purpose	2.89
W-95	9	Plastic & Cotton	For intercoms & Spec. Purpose	3.19
W-94	10	Plastic & Cotton	For intercoms & Spec. Purpose	3.49

Here's a bargain: Stock up on the multiple conductor cables shown above. The individual conductors or wire come apart easily. Thus, for instance, a 50 ft. coil of 10 conductor wire will give you actually 500 ft. of high grade wire!

SHIELDED WIRE

W-98	1	Plastic	For phono and amplifiers. Bare Shield	\$1.39
W-88	1	Plastic	Has insulating cover over shield	1.49
W-89	2	Plastic	For intercoms—Bare Shield	1.69
W-90	2	Plastic	For intercoms, cotton cover over shield	1.89



FREE THESE PLIERS ARE YOURS AT NO EXTRA COST FROM OLSON'S.

PLIERS GIVEN FREE WITH EVERY ORDER FOR 10 ROLLS OF WIRE, SAME OR ASSORTED. GET TWO PAIRS OF PLIERS WITH 20 COILS, ETC.

Pliers are all steel, forged and have serrated gripping jaw as well as sharp wire cutting edges. Handles are fully insulated.

COMPLETE TV CONICAL ANTENNA KIT

Nothing More to Buy
STOCK NO. AU-67
\$17.99

Latest model Genuine Aircraft Aluminum Tubing. Everything you need to erect a high gain 20 element two-bay antenna with high frequency stubs; 2 5-ft. steel mast sections; 1 UL approved twinline lightning arrester; 1 steel chimney mounting assembly with necessary strapping; 75-ft. 300 ohm twinline; 6 insulated screw-eye standoffs; and 2 insulated mast stand-off insulators. The antenna has a conical pattern providing high gain on ALL channels. All the necessary installation parts are packed with the antenna. Here's the economical way to buy. Have everything at hand for that installation. Order these kits NOW. This is real Olson Value. Shpg. wt. 25 lbs.

TWIN LINE
300 Ohm Poly Twinline
High quality, low loss. For all TV and FM installations. Shpg. wt. 2 lbs.
Stock No. W-73. 100 ft. coil... \$2.99

OPEN WIRE TV LINE
★ Use in Place of 300 Ohm Line
Ideal for fringe area installations. Not affected by moisture or sun. Made of #18 copperweld wire with genuine polystyrene insulators spaced 3" apart. Tensile strength 400 lbs.
Stock No. W-78. 100ft. coil. Shpg. wt. 4 lbs. \$5.95

COMPLETE TV CONICAL ANTENNA KIT
FULL 20 ELEMENT
IN LOTS OF 3, EACH \$8.66
With matching Q bars and High Frequency Stubbs Genuine Aircraft Aluminum elements. High gain stacked conical. Will pull in those stations in "Fringe Areas." Works on set or portable.
THIS IS A TERRIFIC VALUE!
Each Antenna consists of two conical bays plus a pair of matching Q bars. Less mast. Packed—3 Antennas to a carton. This gives you six bays and 3 pairs of Q bars.
Sold Only in Boxes of 3 Antennas AU-66. Carton of 3. Weight 25 lbs.
\$25.98

BUILD YOUR OWN RECORD PLAYER

★ Kits available now from Olson.
★ Choose from 2 Models.
Each Kit contains a rim drive motor with velvet finish turntable, crystal pickup, all purpose needle, 4" PM speaker, matching output transformer, 2 tube AC-DC amplifier complete with tubes (35W4 and 50B5).
Single Speed Model 78 RPM
Complete Stock Kit as described above. Shpg. wt. 8 lb. **\$8.95**

Build a Receiver Set of Basic Components

Kit of 5 AS-38 parts... \$1.89
You get this kit of 5 basic parts to build an AC-DC set or portable.
Parts: Loop \$0.95
R. F. Coil 1.10
I.F. Transformer (456 KC) Input 1.60
Output 1.60
Oscillator Coil 75
List Price of Set 6.00
Use any 365 mfd. variable for tuning. Covers 535-1625 KC.



OLSON RADIO WAREHOUSE • 275 E. Market St., Akron 8, Ohio

PEAK VALUES

Power Transformer Bargain
115 Volt, 60 Cy. Primary, 800 Volts CT. @ 250 MA., 6.3V @ 4A, 6.3V @ 4A, 6.3V @ 2A, 5V @ 2A, 5V @ 2A. Fully Cased. **\$7.89** ea.
BRAND NEW, Wt. 14 Lbs. Only

CARTER MOBILE DYNAMOTOR
6 Volt DC Input, 400 Volts at 375 MA. Output, Model No. 4037AS. 7" Long, 4" Wide, 3 1/2" High, 10 lbs. (List Price, \$70.00) **\$24.95**
BRAND NEW Only

SENSITIVE RELAY
Personal moving coil type, mounted in meter case. Adj. 700 microamps to 1 ma. Made by Triplet. ea. **\$5.75**

6 VOLT DC RELAY
Small Size. Ideal for Mobile Use, SPDT **\$0.99**

PANEL METERS

NEW GOV'T SURPLUS STANDARD BRANDS *Special Scale

2" METERS	
0-5 MA	2.45
0-30 MA	2.75
0-50 MA	2.75
0-100 MA	2.45
0-200 MA	2.95
0-10 MA AC	2.95
0-2 AMP RF	2.95
0-50 AMP AC	3.25
0-30 AMP DC	2.95
3" METERS	
0-1 MA	3.95
0-1 MA	4.95
0-2 MA	4.95
0-50 AMP AC	4.95
0-2.5 AMP RF	5.95
0-100 VDC (1 MA)	5.95
0-150 VDC (1 MA)	5.95
0-200 VDC (1 MA)	5.95
0-250 VDC (1 MA)	5.95
0-750 VDC (1 MA)	5.95
0-150 VAC	6.95
0-300 VAC	6.95

FILTER CHOKES

10 Hy 175 MA	\$2.25
10 Hy 250 MA	2.75
10 Hy 350 MA	3.95
6 Hy 500 MA	4.95
6 Hy 400 MA (Rusty)	2.95

PIGTAIL MICAS

MMP: 5, 20, 50, 60, 100, 250, 300, 400, 500, 750, 800, 1000, 2000, 3000, 4000, 5000, 6000, 10000	\$0.09 ea.
--	------------

Silver Mica Capacitors

MMP: 10, 50, 60, 340, 750, 780, 1000	\$0.12 ea.
--------------------------------------	------------

Non-Inductive Resistors
Ohms: 500, 12,500, 100 watts \$0.75

FILAMENT TRANSFORMER
6.3 Volts at 10 Amps plus 2.5 Volts CT at 12 Amps. 3500 Volt Insulation. Primary 115 Volt, 60 Cy. Fully shielded. \$2.99 ea.

BAKELITE CASED MICAS

MFD	VDC	Price	MFD	VDC	Price	MFD	VDC	Price
.001	600	\$1.18	.024	1500	\$0.65	5	5 KV	\$1.60
.002	600	.24	.033	1500	.75	.002	5 KV	1.60
.01	600	.26	.02	2 KV	.90	.003	5 KV	1.90
.02	600	.26	.002	2500	.45	.005	5 KV	2.50
.01	1 KV	.45	.004	2500	.50	.001	6 KV	2.50
.002	1200	.35	.001	5 KV	.70	.002	6 KV	2.90

WIRE WOUND RESISTORS

5 watt ohms: 25-50-84-200-2500	\$.09 ea.
10 watt ohms: 25-40-1325-2K-4K	.15 ea.
20 watt ohms: 150-300-750-1K-1.5K, 2.5K-2.7K-10K-20K	.20 ea.
30 watt ohms: 100-2500-5300-18K	.22 ea.
100 watt ohms: 100-3750-1500-2K, 10K, 15K, 20K, 100K	.59 ea.

POWER SUPPLY KIT
1-UTC Power Transformer 700 VCT @ 60 ma, 5V @ 2A, 6.3V @ 1.2A.
2-UTC 60 ma chokes. Transformer and chokes fully cased. Transf. and 2 Chokes, SPECIAL \$3.95

ADJUSTABLE SLIDER RESISTORS

20 Watt: 1, 5 Ohms	\$.025
50 Watt: 500 Ohms	.35
75 Watt: 100, 50, 200 Ohms	.39
100 Watt: 50, 3750	.69

MISCELLANEOUS BARGAINS

Ceramics .0005 mfd	12 for \$0.49
.05 600V Oil Tubular	.17 for .99
10K, 15K Pots	4 for .99
Air Follower 10 MMP, APC50	.39
.01 MFD, Moulded Paper Cond.	20 for .99

PEAK ELECTRONICS CO.

188 WASHINGTON ST., NEW YORK 7, N. Y.
Phone Cortlandt 7-6443-4

WHAT'S New in Radio

For additional information on any of the items described herein, readers are asked to write direct to the manufacturer. By mentioning RADIO & TELEVISION NEWS, the page, and the issue number, delay will be avoided.

OUTPUT TRANSFORMERS

Quam-Nichols Company, 522 East 33rd Place, Chicago 16, Illinois has recently added a complete companion line of "Tru Match" output transformers designed to insure maximum tone quality of loudspeakers by exactly matching the voice coils of the original equipment.

The new line consists of twenty-five output transformers and is intended to provide the distributor with a single source for both speaker and its component transformer.

The transformers are being individually packaged with complete information on the matching characteristics of all units in the line and suggestions on the selection of units for specific applications enclosed in each box.

comes in colorful plastic and is small enough to fit in a tool box or be fastened to the work bench.

HEADPHONE RECEIVER

The Brush Development Company, 3405 Perkins Avenue, Cleveland 14, Ohio, is now in production on a new



headphone receiver that features high fidelity and smooth frequency response.

The new unit, which is available in three styles, is equipped with a "Metal-seal Crystal" element to provide a new freedom from the problems caused by high or low humidity.

The double headset has been designated the BA-206, the single unit the BA-207, and the Lorgnette style the BA-208.

CRYSTAL OSCILLATOR

Crest Laboratories, Whitehall Bldg., Far Rockaway, Long Island, New York has just announced a new multi-frequency high output signal generator.

The Model 50 is compact in size and

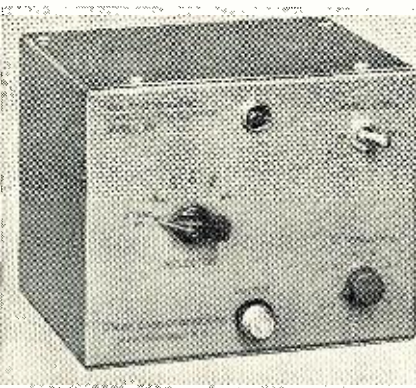

provides a convenient and inexpensive means of obtaining multiple outputs for spot frequency alignment of television and military receivers. It is available in a crystal-controlled range of 4.5 to 50 mc.

Additional details on this unit are available on request.

PIN STRAIGHTENER

General Cement Manufacturing Company, 919 Taylor Avenue, Rockford, Illinois, is currently introducing a duplex tube pin straightener, the No. 8655.

This handy combination for straightening both miniature and jumbo miniatures of the 7 and 9 pin types, saves tubes that would otherwise be discarded because of bent pins.

When the tube is inserted in the proper receptacle, the precision steel die aligns and straightens the pins, making the tube reusable. The unit

withstand the unusually high temperature developed.

Elements and tips in the new iron are replaceable.



INSTRUMENT RECTIFIERS

The Precision Rectifier Division of Electronic Devices, Inc., 429 12th Street, Brooklyn, New York, has developed a new instrument rectifier which is unique in that it uses selenium rectifiers in its construction.

This feature is possible because of a
(Continued on page 112)

What's inside a *Radio-Relay* station?

Because microwaves travel in straight lines and the earth is round, there are 123 stations on the transcontinental television route between Boston and Los Angeles. This view of a typical unattended station shows the arrangement of the apparatus which amplifies the signal and sends it on.

ON THE ROOF are the lens antennas, each with its horn tapering into a waveguide which leads down to equipment

ON THE TOP FLOOR, where the signal is amplified, changed to a different carrier-channel and sent back to another antenna on the roof. Here are testing and switching facilities. Normally unattended, the station is visited periodically for maintenance.

ON THE THIRD FLOOR are the plate voltage power supplies for several score electron tubes.

ON THE SECOND FLOOR are filament power supplies. Storage batteries on both floors will operate the station in an emergency for several hours, but

ON THE GROUND FLOOR is an engine-driven generator which starts on anything more than a brief power failure.

Anything that happens—even an opened door—is reported to the nearest attended station instantly.

Coast-to-coast *Radio-Relay* shows again how scientists at Bell Telephone Laboratories help your telephone service to grow steadily in value to you and to the nation.



BELL TELEPHONE LABORATORIES

Improving telephone service for America provides careers for creative men in scientific and technical fields.

February, 1952

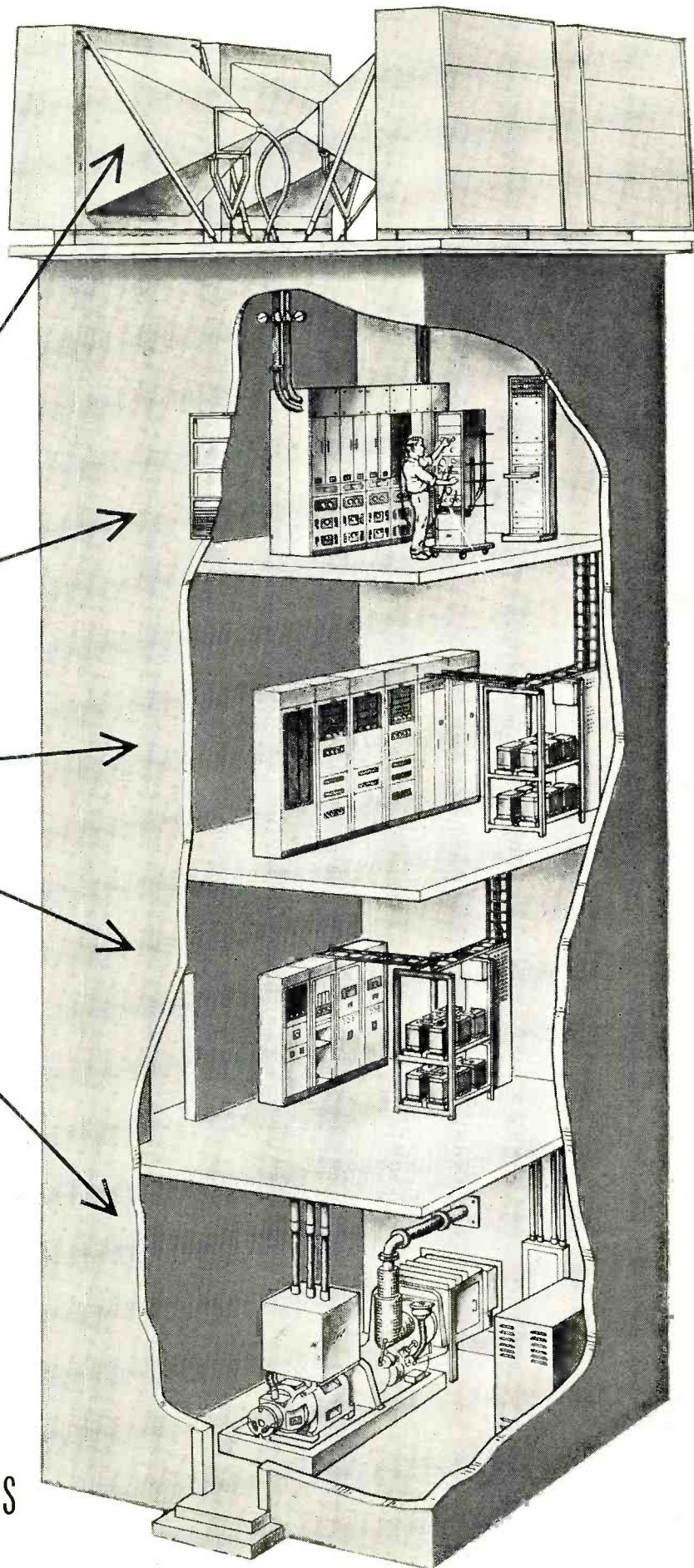

IT'S HERE! McGee New 1952 Model 12 Inch Coaxial Speaker for \$12⁹⁵

BUY YOUR WIDE-RANGE COAXIAL SPEAKER AT MCGEE

**NEW 1952 MODEL
12" COAXIAL P.M.
\$12⁹⁵
WHY PAY
MORE?**

**15"
COAXIAL
P.M.
SPEAKER
\$19⁹⁵**

McGee offers its new 1952 model 12" coaxial PM speaker. The finest that we have ever offered. Quality you would put in your finest sets if you were a manufacturer. Genuine Alnico V magnet 6.8 oz. in the 12" woofer. The tweeter is coaxially suspended inside the 12" and has a metal diffuser attached. The high pass filter is concealed under the pot cover, leaving only two wires to connect to your radio or amplifier. Why buy an ordinary speaker, when you can have a 12" coaxial PM for only \$12.95? Input 8 ohms with 18 watt peak and 10 watts average. Shipping weight 8 lbs. Response from 30 to 17,500 cps. McGee's finest speaker value. Stock No. CU-147. Sale price, \$12.95 each.

Only \$19.95 buys a full 15" 20 watt coaxial PM speaker, with built-in high pass filter. Hook to any 8 ohm output on radio or amplifier. Response below 20 to above 17,500 cps. Good bass response. A lucky purchase makes this price possible. Full 32 oz. magnet in the woofer, 5" tweeter, Model P15-9. Ship. wt. 11 lbs. Sale price, \$19.95.

100 Molded Plastic Bypasses \$9⁹⁵

100 molded plastic tubular bypass condensers. All 600 volt. And all by the same nationally known mfr. Regular dealers' net is over two and one-half times our 200% off sale price. You'll chuckle when you look these over. Here's what you'll get: .001, 10-.002, 20-.005, 20-.01, 20-.02, 10-.05 and 10-.1. Our big deal No. RN-202 100 plastic tubulars. Shipping weight 2 lbs. Net price, \$9.95.

100 600 VOLT TUBULARS \$6⁹⁵

100 top quality 600 volt tubular by-pass condensers. Made this year by a famous condenser factory. Don't confuse these with grab-bag surplus. McGee's deals are guaranteed to please you. Here's what you get: 10-.001, 10-.002, 20-.005, 20-.01, 10-.02, 20-.05 and 10-.1 600 volt condensers. Our big deal No. RN-203. Shipping weight 2 lbs. Net price, \$6.95.

20 50 x 30 150 V. ELECTROLYTICS \$9⁷⁵

Here's a red hot value. 20 of our XX quality replacement electrolytics. The most popular condensers in use today. Takes care of 90% of your AC-DC radio filter needs. Compact construction 1950 production. 1-year guarantee. 50-30 mfd. 150 volt housed in a card-flexible tube. 20th Anniversary, big deal No. RN-204. Sale price \$9.75.

SELENIUM RECTIFIERS

65 mil Selenium Rectifier, net59c each
100 mil Selenium Rectifier, net69c each
150 mil Selenium Rectifier, net79c each
200 mil Selenium Rectifier, net89c each
250 mil Selenium Rectifier, net1.19 each
350 mil Selenium Rectifier, net1.59 each
450 mil Selenium Rectifier, net1.79 each
McGee offers you the finest in Selenium rectifiers. All standard 130 volt.

GENERAL ELECTRIC 2-SPEED CHANGER SCOOP!
WITH VARIABLE RELUCTANCE CARTRIDGES

P-12 \$19.95 General Electric, 2 speed automatic record changer. Plays 10" and 12" records of either 33 1/3 or 78 rpm. Pickup arm equipped with separate plug-in heads. RPX-041 with 1 mil sapphire stylus for 33 1/3 rpm records. The two cartridges purchased separately are worth \$1.70 alone. However, they are standard equipment with this deluxe changer. Changer base size 10 3/4" x 12 1/2". Shipping weight 13 lbs. General Electric catalog No. P-12. A \$60.00 list changer, on sale at terrific saving at McGee. Scoop price, with both General Electric, plug-in variable reluctance cartridges, for the low price of \$19.95.

EG-2 \$8.95 AC self-powered preamplifier for General Electric variable reluctance pickup cartridges. This preamp is necessary if you use variable reluctance cartridges with an ordinary radio-phonograph connection. Some amplifiers are already equipped with the necessary gain for this type of pickup. Simply plug in any of the changers and plug preamp into the radio phono input. Stock No. EG-2 preamp. Net price \$8.95.

P-13 \$19.95 General Electric, 2 speed automatic record changer. Plays 10" and 12" records of either 33 1/3 or 78 rpm. Pickup arm equipped with a simple twist of the knob selects the proper needle. The new cost of the cartridges purchased separately is \$8.20. This fine changer comes ready equipped with the cartridge. Changer base is 12x12 1/2". General Electric catalog No. P-13 automatic record changer. Shipping weight 13 lbs. Brand new, factory cartoned. Offered at the low price of \$19.95. (A self powered pre-amp for use with low gain inputs. Net price \$8.95 extra.)

3-SPEED CHANGERS ON SALE AT MCGEE

WEBSTER CHICAGO 3-SPEED \$24⁹⁵
Regular \$47.50 List Only

Webster Chicago Model 100-16 3 speed automatic record changer with crystal cartridge and all speed sapphire needle. (1 needle plays all records). Base size 12x12 3/4". Shipping weight 14 lbs. This offer good only as long as our stock lasts. A special purchase makes this offer possible. Webster Chicago 3 speed changer, Model 100-16, Sale price \$24.95.

WEBSTER CHICAGO MODEL 100-2 ONLY \$26.95

For the first time we offer the world famous Webster-Chicago, model 100-2. Features a newly designed spindle, that drops the records flat; air-cushioned to the turntable. Pickup arm sets down after the last record plays. Plays all records automatically, 33 1/3, 78 and 45 rpm. New balanced tone arm with Electro-Tilt-A-Matic cartridge with dual needles. Ordinarily cost over \$37.00. McGee offers them for only \$26.95 each. Base size 12" x 12 3/4". Shipping weight 14 lbs.

V.M. 3-SPEED MODEL 406 \$22.95

VM model 406, deluxe 3 speed automatic record changer. Plays them all. Intermixes records of the same speed. Equipped with a flip over crystal pickup with twin needles. Base size, 12 1/4" x 13". Shipping weight 12 lbs. VM-406. Net price \$22.95.

GENERAL INSTRUMENT 3-SPEED \$19.95

Another tremendous McGee record changer scoop. Only 500 to sell. General Instrument, 3 speed automatic record changer with standard crystal cartridge and all purpose sapphire needle. Brand spanking new. Our first offering of a 3 speed changer at less than \$20.00. We purchased a large quantity and pass our saving on to you. Stock No. GI-3384. Sale price \$19.95 each. Price to the small manufacturer in lots of 48 or more, \$19.50 each.

New Versatile Espy 12-TUBE FM-AM CHASSIS \$64.50

★ BUILT IN PRE-AMPLIFIER FOR G.E. VARIABLE RELUCTANCE PICKUP
★ WIDE RANGE AUDIO
★ MAY BE USED WITH A CRYSTAL MIKE AS A HOME P.A. SYSTEM

McGee's new 1951 model 12 tube FM/AM chassis. Latest design with phono inputs for all types of record players, crystal or G.E. variable reluctance. Receives standard broadcast 550 to 1700 KC and FM 88 to 108 MC. Wide range audio response (push-button 550 to 1700 KC and FM 88 to 108 MC). Loop antenna for broadcast and 300 ohm line type antenna, may be stapled in cabinet. Attractive lighted slide rule dial. Chassis size, 13 1/2" x 8 1/2" high and 5" deep. Shipping weight 20 lbs. Stock No. 7-CX. Made to sell at a much higher price. McGee's sale price is \$64.50, less speaker (output matches 8 ohms). 7-CX chassis with our 12" coaxial PM, CU-14X, both \$74.50. Espy 7-C chassis, 12" coaxial PM speaker and 3 speed VM changer with G.E. variable reluctance cartridge, \$104.95.

TERRIFIC RADIO-PHONO SALE

12-TUBE ESPEY CHASSIS 2-12" P.M. SPEAKERS \$200.00 VALUE WALNUT CABINET G-2-SPEED CHANGER \$179⁹⁵

Buy this combination offer and have a fine radio-phonograph combination for less than the value of the cabinet alone. This beautiful walnut cabinet was intended for a Capehart \$800.00 combination and is the finest possible, furniture quality cabinet. Hinged top lifts in two sections. 25 1/2" lid covers the changer compartment and 14 1/2" covers the radio compartment. Changer mounting panel is furnished blank. Radio panel is shipped ready cut to fit the Espy 7-C chassis. Twin heavy duty 12" FM speakers are furnished. Espy 7-C chassis and a General Electric 33 1/3 and 78 rpm, 2 speed automatic changer with two plug-in G.E. variable reluctance cartridges. Stock No. MED-37.5 cabinet. Espy 7-C chassis, 3 speed G.E. changer and 2 12" speakers. Sale price, \$179.95. 3 speed VM automatic changer with G.E. variable reluctance turnabout cartridge furnished for \$15.00 extra. Shipping weight 200 lbs. Shipped via truck, rail or express only \$78.95. Capehart cabinet described above, furnished cut to fit the Espy 7-C chassis, cabinet only \$78.95.

RED HOT SPEAKER VALUES

McGee has a tremendous stock of 100,000 speakers to \$7.95. Every speaker is fully guaranteed. Order your speakers now.

4 inch, square.....	1 oz. magnet	\$1.39
5 inch, pin cushion.....	1 oz. magnet	1.39
6 inch, pin cushion.....	1.47 oz. magnet	2.09
5 x 6 inch, oval.....	1.69 oz. magnet	1.69
5 x 6 inch, oval.....	1.47 oz. magnet	2.19
7 inch, pin cushion.....	2.15 oz. magnet	3.19
8 inch, pin cushion.....	2.15 oz. magnet	3.29
8 x 9 inch, oval.....	2.15 oz. magnet	3.09

All cond. guaranteed one year.

50-W. OUTPUT TRANS. ONLY \$7⁵⁰ WHY PAY MORE

50-watt super quality high fidelity output transformer. Matches push-pull parallel or push-pull 6L6 tubes to 4/8/16-ohm voice coil, also 60 and 250 ohm line. Very efficient winding construction only 140 ohms, total resistance primary, and 8 ohm voice coil tap only .2 of an ohm. This output transformer wastes a minimum amount of audio power due to heat loss within the transformer. Very ideal for public address applications. Stock No. 50-JB, net weight 5 1/2 lbs. Bargain price \$7.50 ea., for \$13.95.

McGee's Super High Fidelity Best Value in U. S. A. OUTPUT TRANS. \$7⁹⁵ 20-20,000 CPS.

Model A-403 High fidelity output transformer. Why pay \$20 or \$30 for an output, when our A-403 is available at \$7.95? Impedance, 6000 ohms plate to plate (for PP 6L6 or 6V6), 100% feedback winding, 4-15-250 and 500 ohm secondary housed in a potted case. Net weight 6 lbs. Recommended for all amplifiers up to 34 watts.

SPEAKER AND BAFFLE SALE

8" SPEAKER AND BAFFLE \$4.95
Stock No. 818, Tan leatherette covered, plywood slant type wall baffle plus an 8" Oxford, 2.15 oz. Alnico V magnet PM speaker. A red hot McGee special for only \$4.95 each, or \$4.70 each in lots of 3 or more.

10" SPEAKER AND BAFFLE \$6.95
Stock No. CA-10, Tan leatherette covered plywood slant type wall baffle, plus a 12" Permdux, 3.16 oz. Alnico V PM speaker. Only a few hundred to sell at \$6.50 each, or \$6.25 each in lots of 3 or more.

12" SPEAKER AND BAFFLE \$6.95
Stock No. CA-12, Tan leatherette covered plywood slant type wall baffle, plus a 12" Quam, 4.64 oz. Alnico V magnet PM speaker. (Popular Adjustacone model). A terrific McGee value for only \$6.95 each, or \$6.60 each in lots of 3 or more.

50-WATT BOOSTER AMPLIFIER—\$39.95

25-Watt Horn \$28.95 50-Watt Booster \$39.95

50-WATT BOOSTER A sensational value, 50 watt booster amplifier with push-pull parallel 6L6 output tubes. Connect to your present amplifier as a booster or use with the PE-2X Preamp to add the use of 2 mikes and one low level input. The booster amplifier has one input jack and with 1 volt input gives 30 watts of audio. Booster has a 6 lb. potted case high fidelity output transformer, matches speaker with 4-8-16 ohm voice coil, also 60 ohm and 250 ohm line. Booster has a 2.5 mil power supply with 5U4 rectifier. Price includes tubes: 4 6L6, 7N7 and 5U4. The two variable controls are for master volume control and base boost tone control. Size 8 x 6 1/2 x 14 1/2". Stock No. PA-55X. Shipping weight 26 lbs. Sale price \$39.95 ea.

2-MIKE PRE-AMP. Pre-amplifier plugs in directly to the PA-55X Booster amplifier. It enables use of 2. Crystal or Dynamic Mikes plus one low level input. Furnished with 4 foot cables and plugs. Stock No. PR-2X, with tubes 7F7 and 7N7. Net price \$10.00 ea.

25-WATT HORN 25-Watt Driver and 3 1/2-foot air column re-entrant Trumpet. The standard type trumpet and driver you see the most. Drivers are 100% weatherproof, horn is spun aluminum, offered to you at a considerable savings. Stock No. MA-33. Shipping weight 20 lbs. Net price \$28.95.

McGEE OFFERS T.V. TUNERS — RADIO AND T.V. KITS

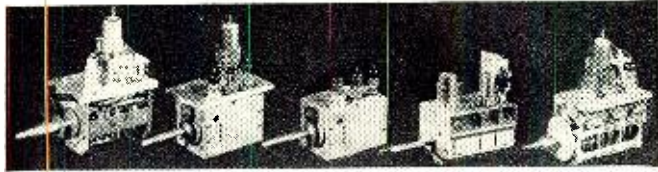

R.C.A. Type 3 Sarkes-Tarzian \$9.95 Type 2 Sarkes-Tarzian \$7.95 R.C.A. Printed Circuit \$14.95 General Inst. \$2.95

RCA TV FRONT END WITH TUBES \$9.95

Terrific buy on this RCA TV tuner. We have a limited quantity of the famous original 201E1, 13 channel completely wired and tested TV front end tuners. Ready to connect to your TV video I.F. strip. Offered at a sacrifice. Price was originally \$44.00. Now only \$9.95 each, with tubes. You'll save plenty on this item. No. RCA-13 TV front end tuner. Shaft length 3 3/8" from base of tuner. Converter coil type for separate sound as used in the famous 430 chassis. Net price \$9.95 each, two for \$19.00, complete with 3-616 tubes.

SARKES-TARZIAN TYPE 3-TUNER WITH TUBES \$9.95

This popular Sarkes-Tarzian TV front end is widely used today. 13 channel rotary type switch with individually tuned coils. Price includes a schematic diagram and 3 tubes: 6C4 osc., 6B16 RF and 6AG5 mixer. Regular factory cost is twice our price. Each tuner and its own tube sockets are wired, ready to hook up to a video and sound I.F. strip. May be used with either inter-carrier or separate sound I.F. circuits. Built in fine frequency control. Shipping weight 3 lbs. Type 3 Sarkes-Tarzian TV tuner with tubes. Net price \$9.95. Type 3 tuner and 205-XX video coil kit, both for \$16.95.

SARKES-TARZIAN TYPE 2-TUNER WITH TUBES \$7.95

Type 2 Sarkes-Tarzian TV tuner, same as Type 3 listed above, except does not have input I.F. coil built on. Complete with 3 tubes. Net price \$7.95. Type 2 tuner and 205-XX video coil kit, both for \$14.95.

RCA 12-CHANNEL PRINTED CIRCUIT TV TUNER \$19.95

Latest design RCA 12 channel printed circuit TV tuner. Rotary switch with snap-in printed circuit strip principle. This popular tuner used by Hallicrafters in inter-carrier circuit sets. Shaft length 3 3/8". Built in fine frequency control. Price includes tubes: 6J6 and 6CB6. A terrific value at \$19.95 each.

GENERAL INSTRUMENT TV TUNER, LESS TUBES \$2.95

Completely wired, 13 channel selector incorporating fixed inductance and variable capacitance. Converter output transformer is attached. To be coupled direct to separate sound and video I.F.s, 3 616 tubes are required. Shaft length 2 3/4". Built in fine frequency control. Original cost over \$20.00. Weight 4 lbs. Have been in sets, but guaranteed to be a good value. Stock No. GI-13PX, General Instrument TV tuner, less tubes. Net price \$2.95 each.

2-TUBE SARKES-TARZIAN TUNER LESS TUBES \$7.95

Sarkes-Tarzian new two tube model, type TT-3A, 12 channel television tuner. This is the new 2 tube model requiring a 6J6 plus 6AK5, or 6AG5, or 6C16 or 6AU6 RF tube. Pre-aligned by trained factory personnel. Input feeds 21 mc broad band. Fine tuning control is over the channel selector shaft. Power requirements: 120 to 140 volts DC at 17 mills, plus 6.3 volts filament. This tuner is offered at a terrific saving to you. Stock No. TT-3A. Net price \$7.95, two for \$15.00, less tubes. Available with 2 3/4", 5 1/2" or 7 1/2" shaft. Specify shaft length desired. 6J6 and 6AU6 tubes for above tuner, both for \$2.39 extra.

COMPLETE 17" TO 20" T.V. KIT

- ★ AC-TRANS-TYPE **\$59.95** LESS TUBES
- ★ CONVENTIONAL CIRCUIT
- ★ READY WIRED 12 CHANNEL T.V. FRONT END
- ★ 70° DEFLECTION
- ★ CERAMIC FLYBACK
- ★ KIT OF TUBES EXCEPT KINE \$16.95
- ★ 17BP4A \$21.95 EXTRA



A complete kit of parts to build an AC transformer operated television chassis for use with a 16, 17 or 20 inch rectangular picture tube. The 12 channel Sarkes Tarzian tuner is ready wired. The 4 tube video I.F. strip is also wired. Circuit is of the conventional accepted design, with latest ceramic type flyback high voltage supply. Chassis is ready punched. Warning: Do not buy this kit unless you understand Television and electronics. It is difficult to wire. We furnish schematic and photos. Kit model WH 20 ship weight 40 lbs., less all tubes \$59.95. Kit of 19 tubes but less picture tube \$16.95 extra. 17 inch 17BP4A \$21.95 extra. 20CP4 inch rect. tube \$39.95 extra.

CONVERT YOUR T.V. TO A LARGER PICTURE TUBE

LOOK—16" RECTANGULAR CONVERSION KIT \$28.95

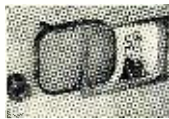

With each conversion kit you get a plastic mask, 70 degree deflection yoke, 40 dov guaranteed black face picture tube, plus our new 77J1-X 14,000 Volt Universal fly-back and horizontal output transformer that works on any output tube and any single rectifier (1B3 or 1X2). A suggested diagram is furnished for use of the transformer with several different output tubes and rectifiers. We think this is the finest and best priced conversion kit in the country. Shipped Truck or Express, only.

- Kit No. TCK-14, with 14BP4A 14" rectangular tube, Net price..... \$27.95
- Kit No. TCK-16, with 16RP4A 16" rectangular tube, Net price..... 28.95
- Kit No. TCK-17, with 17BP4A 17" rectangular tube, Net price..... 28.95
- Kit No. TCK-20, with 20CP4A 20" rectangular tube, Net price..... 49.95

REGENCY T.V. BOOSTER \$19.10

McGee has the famous Regency DB-410 TV booster. Order yours from McGee. Shipping weight 6 lbs. Sale price, \$19.10 each.



Video Coil Kit \$7.95
20 matched TV video and sound I.F. coils, intended for use with the RCA circuit. You get 6 peaking coils—2-7.5 mc picture I.F.'s, 2-21.25 mc sound I.F.'s, discriminator and converter coil and 3 filament chokes. Stock No. 205-XX, weight 3 lbs. Net price, \$7.95. \$6.95 if purchased with ANY TV tuner; all coils identified.

T.V. FRINGE AREA DEALERS—ATTENTION

FM AND TELEVISION BOOSTER SALE

ANOTHER McGEE 600P TWO FOR \$20.00
WHY PAY MORE? NOT A KIT BUT A FACTORY-BUILT BOOSTER
Sensational value. Continuously variable inductance type tuner, from channel 2, including the FM band, through channel 13. This booster is self powered for 110 volts AC operation. Incorporates a 6J6 tube. Input for 300 ohm TV line and 300 ohm output to the TV set. Single knob tuning. Attractive plastic case. McGee-Silver Super Set TV-FM booster, Stock No. GB-6B. Shipping weight 5 lbs. McGee's terrific sale price, \$10.95 each, two for \$20.00.



SENSATIONAL NEW 2-BAND RADIO KIT ONLY \$14.95

10-WATT HIGH FIDELITY AMPLIFIER KIT \$14.95

- ★ MIKE INPUT
- ★ PHONO INPUT
- ★ BASE AND TREBLE BOOSTER

A complete kit of parts, including tubes, diagram and instructions, to build a 10 watt high fidelity twin tone control audio amplifier, with bass and treble boost. Inputs for radio tuner, crystal mike and crystal phono pickup. Output transformer matches 4-8-250 ohms. Use with our 12" coaxial PM speaker, or any good PM and have a beautiful sounding, yet low cost amplifier. Response from 50 to 15,000 cps. Chassis is ready punched and a ventilated cover is furnished. A straight forward circuit with twin triode gain stages and 2-50L6 tubes in push-pull. New twin 150 ma. selenium rectifier voltage doubler; television type power supply. Price includes tubes: 12AX7, 12AU7 and 2-50L6, plus rectifiers. A good quality kit with matched parts. Size, 5 1/4" x 10" x 5 3/4" high, including cover. Stock No. AP-10R, shipping weight 8 lbs. Sale price \$14.95 each. 12" coaxial PM speaker, \$12.95 extra.



MODEL ME6-2 \$14.95

NEW MODEL 6-TUBE, 2-BAND RADIO KIT
A FULL 2-GANG SUPERHET KIT
RECEIVES 550-1600 KC PLUS 6-18 M.C.

McGee's new 1951, 6 tube AC-DC 2 band radio kit. Receives broadcast, 550 to 1600 kc and short wave, 6 to 18 mc. A straight forward superhet circuit with 2 gang tuning condenser, 456 kc I.F. transformers, etc. 5" speaker illuminated slide rule dial. Everything furnished, including tubes, 12SK7, R.F., 12K8 mixer, 12SK7 I.F., 12SQ7 detector, 1st audio, 35L6 output, 35Z5 rectifier, diagram and a photo showing view of underside of completely wired chassis. The chassis pan and dial parts are factory production. With this kit, you can build a commercial looking and quality 2 band radio, housed in a streamlined plastic cabinet. Size: 13 x 6 3/4 x 6 3/4". Stock No. ME6-2, shipping weight 10 lbs. Net \$14.95.



SELF POWERED AC Broadcast Tuner Kit, 3-Gang Tuning, Complete Kit, \$12.95

A self-powered, 3-gang superhet tuner kit with R.F. stage. When wired according to diagram will make a top quality broadcast tuner (550 to 1650 kc.) for use with any amplifier. Don't class this with ordinary tuners; this has its own power transformer. This complete kit is furnished with a diagram, photos and tubes. 6AG6 R.F., 6BE6 oscillator R.F., 6AL6 I.F. detector, 6AL5 diode, AVC, plus rectifier. Connect to any audio amplifier. Ideal for use with our S-2020, TM-16 or 7X3 amplifier kits. Chassis size, 9 1/2 x 4 1/2 inch. Shipping weight, 7 lbs. Broadcast tuner kit Model BT-38X. Net price, \$12.95.



8-TUBE 22 WATT Wide Range Amp. Model Tx5 Kit Only \$37.95

A complete kit, including tubes (3-7E5, 2-7F7, 2-6A3, plus rectifier), diagram and photos. All triode circuit makes for minimum harmonic distortion. Inputs for radio tuner any kind of phono pickup (crystal or G.E. variable reluctance) and either crystal or dynamic mike. Output transformer matches 8 ohm voice coil. Twin electronic tone controls, bass and treble with range selector switch for either juke box quality with heavy bass response or brilliant symphonic range. The best quality amplifier kit we know how to make. Has a very wide range output and heavy power transformer. Response 18 to 20,000 cps. 8 tube all triode amplifier kit, complete with tubes. Weight 25 lbs. Net \$37.95.

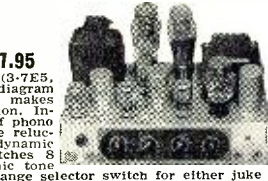

10-TUBE RADIO KIT \$29.95

3-GANG TUNING MIKE INPUT 12 WATT HI-FI AUDIO BASS-TREBLE BOOST

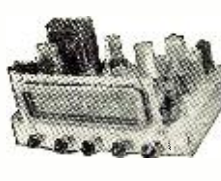

A NEW 1951 ALL-PURPOSE RADIO KIT

10-Tube Broadcast (550 to 1700 kc) Radio Kit for custom builders. Features 3-gang superhet circuit with A.V.C., high gain IF circuit, 8" slide rule dial. Chassis size 12 1/2" long, 10" front to back, 6 1/2" high. Audio inputs for a crystal or dynamic mike, and record changer or player. Tone compensation for standard crystal pick-up or General Electric variable reluctance. Push-pull 6V6 output tubes, shielded high fidelity output transformer matches 8 ohm PM speaker, heavy power transformer, 2 tone controls for separate bass and treble boost. A complete kit, including tubes 6SK7 R.F., 6SA7 mixer, 6SK7 I.F., 6H6 detector, AVC, 6SQ7 1st audio, 12AX7 variable reluctance and mike amplifier, 12AX7 phase inverter, 2-6V3 outputs, plus rectifier, diagram and instructions. Shipping weight 18 lbs. Stock No. BK-R10. Net price \$29.95. 10" PM speaker, \$6.95 extra. Crystal mike and desk stand, \$4.95 extra. 12" coaxial speaker \$12.95 extra.

5-Tube Broadcast SUPERHET RADIO KIT \$12.95

Model RS-5 tube AC-DC superheterodyne radio kit. Has loop antenna and 2 gang condenser, with lighted slide rule dial broadcast, 550 to 1650 kc. Full size dynamic speaker, matched 456 I.F.'s, automatic volume control. This is a complete radio kit. Everything furnished, including diagram, photos and tubes: 12K8 mixer, 12SK7 I.F., 12SQ7 detector, 1st audio, 50L6 output, 35Z5 rectifier. Shipping weight 7 lbs. Stock No. RS-5. Net price \$12.95.



Build Your Own \$7.95 Phono-Mike Broadcaster

Kit Model DE-6R. With this simple kit, you can build a 3-tube phono oscillator that also has a mike input. Will broadcast over any radio within your home (about 75 feet) from 1000 to 1500 kc. Inputs for crystal mike or crystal phono pickup. Fader control fades from mike to record. Ideal for a home P.A. system, baby lister and home entertainment. A complete kit of parts including tubes. Kit Model DE-6R. Net price, \$7.95. DE-6RWT, wired and tested. Net price, \$9.95. Crystal mike and desk stand, \$4.95 extra. Concealed microphone unit, only 1 1/2" in diameter and 1/2" thick. Specify hidden mike when ordering. Stock No. T-001. Net \$3.95 extra.



McGEE HAS EICO TEST EQUIPMENT KITS

- Model 145-K Multi-Signal tracer, Net \$19.95
- Model 221-K Vacuum Tube Volt meter, Net 25.95
- Model 315-K Signal Generator, Net 39.95
- Model 320-K Signal Generator, Net 19.95
- Model 425-K 5" Oscilloscope, Net 44.95
- Model 625-K Tube Tester Kit, Net 34.95
- Model 380-K Sweep Generator, Net 34.95
- Model 950-R Cond. Res. Comp. Bridge Kit, Net 19.95
- Model 1040-K Battery Eliminator, Net 25.95

McGEE RADIO COMPANY Price: F.O.B. K.C. Send 25% Deposit with Order, Balance Sent C.O.D. With Parcel Post Orders, include Postage **TELEPHONE VICTOR 9045. WRITE FOR FLYER 1422 GRAND AVE., KANSAS CITY, MISSOURI**

Safety ALL WAYS

with **AMPHENOL**

INLINE ANTENNA

Because your TV antenna is continually being exposed to the rigors of Mother Nature—wind, ice and storm—choosing an antenna that is structurally strong is very important. The Amphenol Inline Antenna is engineered to repeatedly withstand winds of 70 miles per hour and one-half inch annular ice loadings. It is clean in design and presents no surface unduly exposed to wind. Its aluminum construction is strong and light in weight. In addition, the aluminum is rust and corrosion resistant and is especially suited for use in sea coast areas and other places where salt or other corrosive conditions are encountered.

LIGHTNING ARRESTOR

The National Electric Code states that every unshielded outdoor antenna lead-in should have an approved lightning arrester. The Amphenol Lightning Arrester is approved for this purpose and also carries the Underwriters' Laboratories seal of approval. It eliminates the danger of lightning causing damage to your TV set or home and also carries off the minor static discharges that interfere with good picture reception.

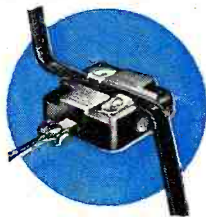

AMERICAN PHENOLIC CORPORATION
1830 SOUTH 54th AVENUE • CHICAGO, ILLINOIS



See your regular Amphenol Distributor now for your copy of this 20-page book containing all the factors which determine Better TV Picture Quality and safe antenna installation.

Technical BOOKS

"FOUNDATIONS OF WIRELESS" by M. G. Scroggie. Published by *Illiffe & Sons, Ltd.*, Dorset House, Stamford Street, London, S.E. 1, England. 320 pages. Price 12 s./6d. (postage 8d.) Fifth Edition.

The fifth edition of this popular basic text has been completely rewritten to bring it up-to-date and in line with recent radio developments.

The text material covers the basic theory of radio, beginning with the most elementary concepts. The author has not assumed that the user of this text has had any previous experience with radio or radio terminology nor that he is familiar with mathematical manipulation.

The book is divided into twenty chapters and four appendices and covers elementary electrical concepts, capacitance, inductance, a.c. and d.c. circuits, tuned circuits, tubes, antennas, simple receivers, the superheterodyne, power supplies, CR tubes, transmission lines, a.f. circuits, etc. The appendices include a table of alternative technical terms (including American terminology for British terms used in the text), symbols and abbreviations, circuit symbols, and a decibel table.

The author's style is refreshingly simple and his use of analogies is unhackneyed. Aside from the vast amount of information to be gleaned from this book, the text makes interesting and lively reading.

* * *

"RECEIVING TUBE SUBSTITUTION GUIDE BOOK"

by H. A. Middleton. Published by *John F. Rider Publisher, Inc.*, New York. 44 pages. Price \$0.99. Paper bound. First Supplement.

In order to keep up with new tube developments, this first supplement to the "Receiving Tube Substitution Guide Book" has been published.

Included in this handy, paper bound book are nearly 750 new substitutions, among them older tube types that were omitted in the original publication. Most of the listings given apply to tubes used in television receiver circuits and, in addition, data on making such substitutions has been incorporated to facilitate servicing.

Like the original book, this supplement presents the required information in easy-to-use form. Television receivers are listed by make and model number and the proper substitutes and circuit changes given in tabular form.

In the case of receiving tubes, the tubes are listed by number, the substitute is given, performance of the substitute is evaluated, and the necessary circuit changes are explained.

Technicians will find this guide book a valuable addition to their service data shelves.

* * *

"TV AND ELECTRONICS AS A CAREER" by Ira Kamen & Richard H. Dorf. Published by *John F. Rider Publisher, Inc.*, New York. 319 pages. Price \$4.95.

This book is an authoritative, graphically presented account of the workings of a greatly expanding field—electronics. Besides Mr. Kamen and Mr. Dorf, the other contributing authors are: W. Hollander Bohlke of the *RCA Service Co., Inc.*, who writes on "Television Servicing"; Raymond W. Peterson of *Admiral Corporation*, who writes on "Radio and Television Manufacturing" and "Electronic Engineering"; and J. R. Poppele of *WOR-TV*, who contributed the section on "Television Broadcasting." These men, who have gained their knowledge and experience directly from their work in radio and television broadcasting, communications, manufacturing, engineering, sales, and servicing, provide young people planning a career and those already in electronics, with factual information and guidance.

The chapters are clear and well-written, and give extensive descriptions of what various jobs in the industry consist, the work they entail, how to prepare for them, and how to go about getting them. The different salary scales are also given.

-50-

130,000 qualified TV servicemen needed

Here is how you can be one of them

INDUSTRY EXPERTS HAVE ESTIMATED over 130,000 qualified TV technicians will be needed for the installation, trouble-shooting and repairing of the television receivers in use by 1955.

There are far fewer than 50,000 fully trained TV technicians available today. This means more jobs, unrivaled future for security, greater earning power for thousands and thousands of additional TRAINED and EXPERIENCED TV Servicemen. Will you be one of them?

OUTSTANDING FUTURE FOR QUALIFIED TV SERVICEMEN

Men now in radio servicing as well as men in the radio-electronics industry with no experience in TV servicing . . . here is your opportunity. The RCA Institutes Home Study Course in Television Servicing makes it possible for you to convert your skill in radio servicing, or interest in radio-electronics, to the important money-making field of TV servicing.

The RCA Institutes Course gives you a sound knowledge of television fundamentals . . . intensive practical instruction in the proper maintenance and servicing of complex TV receiver circuits—including color TV and UHF . . . teaches you the "short cuts" on TV installation and trouble-shooting, saving you many hours of on-the-job labor.

TRAINING MEETS MODERN REQUIREMENTS

This course is in step with the progress of the television industry. It is backed by RCA—pioneer in television development. It is based on the actual experience of the RCA Service Company in servicing thousands of home television receivers. The

course is constantly being revised, improved and kept up-to-the-minute. It will help you to a more profitable and productive future in these ways:

PREPARE YOU to take the required technical examination with confidence, in those areas that require a license or permit to engage in TV servicing.

TRAIN YOU, if you are a serviceman in a non-TV area, to become a qualified TV technician by the time TV comes to your area. In TV areas, TV servicing has substantially replaced radio servicing as the chief source of income.

IF YOU ARE A QUALIFIED TV SERVICEMAN, it will keep you in step with the latest industry developments including color TV and UHF.

IT DEVELOPS the latent talents of installers into skilled trouble-shooting TV technicians.

TRAINS MEN in radio-electronics with no previous servicing experience to fill jobs as TV technicians, to win promotions and better pay.

RCA INSTITUTES HOME STUDY COURSE PLANNED TO YOUR NEEDS

You keep your present job in radio—television—electronics. In your spare time, you study at home. You learn "How-to-do-it" techniques with "How-it-works" information in easy-to-study lessons prepared in ten units. Cost of RCA Home Study Course in Television Servicing has been cut to a minimum—as a service to the industry. You pay for the course on a "pay-as-you-learn" unit lesson basis. You receive an RCA Institutes certificate upon completion of the course. The RCA Institutes Home Study Course in Television Servicing is approved by leading servicemen's associations.

RCA Institutes conducts a resident school in New York City offering day and evening courses in Radio and TV Servicing, Radio Code and Radio Operating, Radio Broadcasting, Advanced Technology. Write for free catalog on resident courses.

Send for FREE BOOKLET

Mail the coupon—today. Get complete information on the RCA INSTITUTES Home Study Course in Television Servicing. Booklet gives you a general outline of the course by units. See how this practical home study course trains you quickly, easily. Mail coupon in envelope or paste on postal card.



MAIL COUPON NOW!

RCA INSTITUTES, INC.
Home Study Department, RN-252
350 West Fourth Street, New York 14, N.Y.

Without obligation on my part, please send me copy of booklet "RCA INSTITUTES Home Study Course in TELEVISION SERVICING." (No salesman will call.)

Name _____
Address _____ (Please Print)
City _____ Zone _____ State _____



RCA INSTITUTE, INC.
A SERVICE OF RADIO CORPORATION of AMERICA
350 WEST FOURTH STREET, NEW YORK 14, N.Y.

February, 1952

Now you can believe everything you hear!



the
CRAFTSMEN 500
ULTRA FIDELITY
audio amplifier

Even we were amazed when we tested this remarkable amplifier. Never before, in our experience (or yours) has such remarkable performance been recorded. The C-500 is 99.99+ % distortion-free. We had to think of a new word to describe it. The word is ULTRA-FIDELITY. Hear the "500" and you'll know why.

C500 Amplifier Features

- **FAMOUS WILLIAMSON** all-triode circuit.
- **FREQ. RESPONSE:** ±0.1 db., 20 cps to 20,000 cps; ±2 db., 5 cps to 100,000 cps.
- **POWER RESPONSE:** 12 watts ±2 db., 10 cps to 50,000 cps.
- **TOTAL H DISTORTION:** Less than 0.1% at 10 watts, at mid-freqs.
*0.01% at av. listening level below 1 watt.
- **TUBE COMPLEMENT:** (2) 6SN-7GTA; (2) KT66 power output; 5V4G rectifier.

Sold by leading radio parts distributors everywhere or write to

THE RADIO
craftsmen INC.
Dept. R2, 4401 N. Ravenswood Ave.
Chicago 40, Ill.

Within the Industry
(Continued from page 30)

Forces . . . **JACK C. KEITH** has been elected vice-president in charge of sales for *Howard W. Sams & Co., Inc.* He has been with the firm since its inception . . . The Television Picture Tube Division of *Sylvania Electric Products Inc.* has appointed **RALPH R. SHIELDS**, former engineer for the company's test equipment merchandising, to the post of merchandising supervisor . . . **WARREN W. FREBEL** has been named vice-president in charge of purchasing by *Majestic Radio & Television Division* . . . **JOSEPH H. LANCOR, JR.** is the new director of the Transducer Division of *Consolidated Engineering Corporation* . . . **FRED H. GARCELON** has taken over the post of eastern sales manager for *Hytron Radio & Electronics Co.* . . . **BROOKS A. KAFKA** of Schenectady has been appointed supervisor of purchasing for the *General Electric Company's* cathode-ray tube operations . . . The Electrical Textile Sales Division of *Owens-Corning Fiberglas Corporation* is now being managed by **GEORGE H. SHERRARD** . . . **GEORGE I. LONG** has been named vice-president and general manager of *Ampex Electric Corporation* . . . *Sangamo Electric Company* of Springfield, Illinois has appointed **JOHN G. TWIST** to the post of sales manager of the company's Capacitor Division in Marion, Ill. . . . **LEIGH A. BRITE** is the new director of research and development for the *Transmitter Equipment Mfg. Co., Inc.* He was formerly chief electronics engineer of the U.S. Air Force Security Service at Brooks Field, Texas.

MILTON R. BENJAMIN has been appointed general sales manager of *Jewel Radio Corporation* of New York.



He was formerly vice-president and national sales manager of *Majestic Radio & Television*. In this capacity, he directed the sales of television and radio receivers as well as *Wilcox-Gay* recording equipment.

Prior to joining *Majestic*, he was associated with several outstanding companies in the radio industry in both sales and managerial capacities.

ANDREW CALIFORNIA CORPORATION has been set up in Simi to handle the California business of **ANDREW CORPORATION** of Chicago . . . The **CROSLEY DIVISION** has purchased the physical assets of **BRAND AND MILLEN LIMITED**, radio and television manufacturing firm of Long Branch, Ontario. The Canadian firm will be operated as a wholly-owned subsidiary and renamed **CROSLEY RADIO & TELEVISION, LIMITED** . . . **ARCO ELECTRONICS, INC.**, has opened a branch office, **ARCO CAPACITORS, INC.**, at 5281 W. Pico Blvd. in

WINTER SALE
PRICES SLASHED

Don't Buy Tubes until you get our prices. Quantities Limited. Prices Subject to Change Without Notice. Low Prices.

RADIO & TELEVISION TUBES

These prices apply only on orders for 12 or more tubes. Orders for less than 12, write for quotation.

1B3—\$.88	6BA6—\$.63	6X4—\$.48
1L4—.68	6BA7—.85	12AT6—.53
1R5—.70	6BE6—.63	12AU7—.99
1S5—.70	6BG6—1.18	12AU6—.88
1T4—.70	6BH6—.70	12AU7—.78
1U4—.68	6BO6—1.10	12AX7—.85
1U5—.60	6CB6—.70	12BA6—.78
3Q4—.78	6CD6—1.65	12BE6—.62
3S4—.78	6C4—.66	19BG6—1.78
3V4—.78	6S4—.72	19T8—.99
6AK5—1.38	6SD7—.98	25BQ6—1.10
6AL5—.68	6SK7—.70	25L6—.68
6AQ5—.68	6SN7—.78	35C5—.68
6AT6—.58	6T8—1.08	50C5—.68
6AU6—.68	6V6—.68	117Z3—.58
6AV6—.58	6W4—.64	50B5—.71

All Other Types at Vast Reductions

Westinghouse Kuprox Rectifier 0.64 Amp. 28 Volts. Reg. \$11.00 ea. Special	\$1.95
TUBE SALE—2A7-55-27-85-31-56-57, No Mixed Ass't. 6 of Any Type	\$2.25
12 BRAND NEW 10" PHONO RECORDS—Ass't. Jazz—Popular. Please Specify	\$1.79
Single Pole—10 Pos. 2 Gang Switch	29c

FRESH EVEREADY BATTERIES IN STOCK FOR PORTABLES, ETC.

457 'B'—'A' 'B' Batts.	\$1.75	717 'A' Batts.	.70c
467	1.75	720	.39c
482	1.58	724	.42c
490	2.28	726	.49c
753	3.96	730	.60c
755	3.68	742	.64c
950 Flash Cells. 48 for	4.03	746	.63c
			\$3.90

3 Ft. 5 Wire Shielded Cable with Amphenol Connector	8 for \$1.00
Signal Corps Phones—2 M. Ohms (8 M. Ohms Imp.)	\$1.25
2 Ft. Ext. Cord (and Plug)	.40c
2 MFD—1000 V Upright Bottom Lug Oil Cond.	.89c

TOBE TUBULAR ELECTROLYTICS

20-20 MFD. 150 V. .49c	30-30 MFD. 150 V. .57c
40-40 MFD. 150 V. .59c	

Low-Loss Short Wave Lock Type Air Trimmer Variable Condensers	3 GANG T.R.F. VARIABLE CONDENSERS .000365 Con. 65c
3 Pl.—12-15 Mmfd. .12c	D.P.D.T. SLIDE TOGGLE SWITCH .15c
7 Pl.—25-30 Mmfd. .15c	
8 Pl.—30-35 Mmfd. .16c	
14 Pl.—56 Mmfd. .24c	

4 PR. WAFER SOCKETS \$1.49 per C. each	.3c
5-6 PRONG WAFER SOCKETS	\$2.50 per C
100 ASS'T. SOCKETS—4-5-6-7	\$3.50 per C
1,000 OHM WIRE WOUND POTENTIOMETER	.15c
30 W. FILTER CHOKE SHIELDED	for \$1.25
UNSHIELDED	.3 for \$1.00
2,000 ohm Wire Wound Rheostats	\$.1 per doz.
CARTER WIRE WOUND C.T. VARIABLE 20 OHM RESISTORS	.85c per doz.

PIEZO CRYSTAL HOLDERS	12 for \$1.00—\$6.00 per hundred—\$50.00 per 1,000
-----------------------	--

RCA Band Switches—3 gang, 3 pos. 3 band. 30c 6 gang, 4 pos. 4-5 band. 40c	
Trimmer-Padder Ass't.—all isolantite—singles, dual, triples—100 ass't. pieces.	\$.25

Philco push button Rotary Switch Double Pole.	.35c
---	------

ATTENTION: Prospectors, Explorers for Hidden Treasures! Construct a U.S. Army Type of Metallic Mine Detector Amplifier with cables, headphones and Jack. Army wiring diagram. Type AN/PRS-1. \$1.95

RCA Ass't Mica By-Pass Cond. .001. 100 for	.95c
8 or 9 Gang Push Button Switch	.49c

DRILLED CHASSIS FOR 5-6 tubes 5"x10"x1 1/2"	.25c
PHONE JACKS—OPEN & CLOSED AUTO.	.18c
EBY SPEAKER VOL. CONTROL—00 OHMS	.15c
SALE—PHONO RECORD ALBUMS—12"—3 comp. 15c; 10"—3 comp.—15c; 4 comp. 20c; 12 comp. 69c	

6 Prong Amphenol Sockets	.54.00 per C
--------------------------	--------------

AMERTRAN FILAMENT TRANSFORMER—6.3 V. 1 Amp. Encased Isolantite Terminal Posts.	\$.150
--	--------

VULCAN HEAVY DUTY 100 WATT SOLDERING IRON. Built for U.S.N.—Brand New—Eonly, sells for \$8.50.	OUR PRICE \$2.99
--	------------------

AMERTRAN AUDIO OUTPUT XFORMER—Pri. 10,000 @ 15 MA: Sec. 300. 6-1 Ratio.	\$.149
---	--------

AMERTRAN MIXER AUDIO XFORMER—Pri. 600-10,000 Ohms	\$.100
---	--------

156-1 RATIO VERNIER DIALS—4 in. 3/4 in. Hub.	.35c
--	------

LINE VOLTAGE NOISE ELIMINATOR—Plugs In Between Radio and Elec. Socket.	.35c
--	------

HEARING AID COROS—Assortment of 12 for	\$.100
--	--------

BY-PASS COND. ASS'T.—25 Cans. Bake. Paper, etc.	\$.100
---	--------

MINIMUM ORDER \$3.00—NO C.O.D. SHIPMENTS—PLEASE INCLUDE POSTAGE

NEWARK

SURPLUS MATERIALS CO.

Dept. FE

324 Plane Street NEWARK 1, N. J.

RADIO & TELEVISION NEWS

Become an Electrical Engineer



MAJOR IN ELECTRONICS



- B. S. Degree in 36 Months
- Radio-Television Technician Certificate in 18 Months

By 1954 there will be at least two positions for every engineering and technician graduate. This College offers a tested plan that permits you to enter these vast employment opportunities at an early date. First—you save a valuable year through optional year-round study. Second—you can receive advanced credit for prior training gained in the armed forces, other schools or field experience.

Enter Both Radio and Television Through This Plan

12 months or one-third of the B. S. degree course (Electronics major) — also brings you the Radio Technician's certificate. An added 6-month course qualifies you for the Radio-TV Technician's Certificate.

The Proven "UNIT CHASSIS SYSTEM"



of teaching was developed here. It "breaks down" the TV set by stages. You learn every component of all types and makes — and are prepared for future design changes, including the advent of color.

SPECIAL! Television Clinics

Ambitious Radio and TV Servicemen can enroll now in special one-month spring or summer clinics—to handle latest field service problems. Combine education and vacation.

Over 48,000 former students from all states and 23 overseas countries. Faculty of trained specialists. Modern laboratories and equipment. Nonprofit technical institute and college 49th year.

MILWAUKEE

SCHOOL OF ENGINEERING
Founded 1903—Milwaukee, Wis.

Terms open April, July, October, January

FREE — Write for "Occupational Guidance Bulletin," "Your Career" booklet, and Catalog.

Milwaukee School of Engineering
Dept. RN 252, 1025 N. Milwaukee
Milwaukee, Wisconsin

Without obligation send Catalog for Electrical Engineering, B. S. Degree, major in Electronics; Power; "Your Career"; Occupational Guidance Bulletin on: Radio-TV; Electrical Power; Welding; Heating, Refrigeration Air Conditioning; TV Service Clinic.

Name _____ Age _____

Address _____

City _____ Zone _____ State _____

If veteran, indicate date of discharge _____

The quickest analysis of an amplifier's operation with respect to its stability is accomplished by plotting the gain and phase response *without feedback* at all frequencies on a polar diagram. The resulting chart (see Fig. 3) is known as a Nyquist Diagram. The graphical measurement of the margin of stability then appears as the distance from the curve to a -20 db point (the amount of inverse feedback) at 180° phase shift. Oscillations would occur with the application of this amount of feedback, if the curve were to enclose this point. As shown in the graph (Fig. 3), both the low and high frequency stability margins are unusually wide.

Speaker Damping

One extremely important characteristic, resulting from the use of a triode output stage along with a large degree of inverse feedback, is a very low output source impedance. In the case of the *Craftsmen 500* amplifier, this impedance, as seen by a speaker connected to the 16 ohm tap, is only 0.5 ohm. The amplifier can, therefore, be considered to have a 16/0.5 or 32:1 damping factor. Of even greater importance is the fact that this impedance is maintained near this value (see Fig. 4) throughout the audio range. The usefulness of such excellent speaker damping at very low frequencies has been readily demonstrated in reducing speaker "muddiness" and "one-note-boom." At higher frequencies, the effect of damping transient distortions in the speaker is often conveyed to the listener as a fresh sensation of clarity in reproduction.

Distortion

As can be seen by referring to the distortion vs power output diagram, both the harmonic and intermodulation distortions are remarkably low in this amplifier. At one watt, the intermodulation distortion (measured with 40 and 12,000 cps:4/1) is below 0.04%,

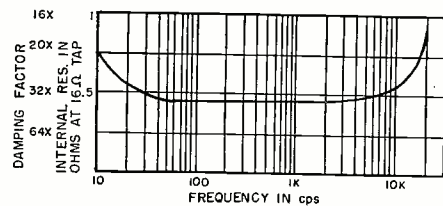

Fig. 4. Graph showing the output source impedance-frequency characteristic of unit.

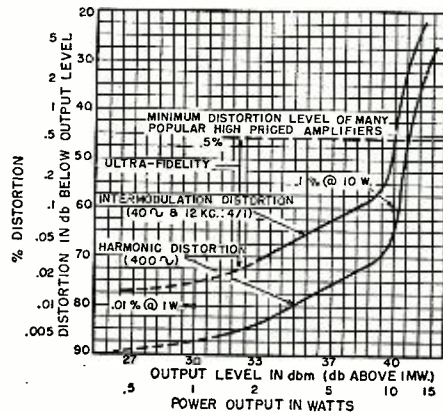

Fig. 5. Harmonic and intermodulation distortion vs power output of unit.

while the harmonic distortion is even less than 0.01%.

Because these very low magnitudes of distortion are maintained throughout the audio range, this amplifier has been described as being not only a high-fidelity amplifier but also capable of *ultra-fidelity*.

BIBLIOGRAPHY

1. Williamson, D.T.N.: "Design for a High-Quality Amplifier," *Wireless World*, April & May, 1947.
2. Williamson, D.T.N.: "The New Version," *Wireless World*, August, 1949.
3. Sarser, D and Sprinkle, M.C.: "Musician's Amplifier," *Audio Engineering*, November, 1949.
4. Cooper, G.F.: "Audio Feedback Design—Part 3—Analysis of the Williamson Amplifier," *Radio-Electronics*, December, 1950.
5. Keroes, H.I.: "Building the 'Williamson' Amplifier," *RADIO & TELEVISION NEWS*, December, 1950.

Under chassis view of the *Craftsmen 500* amplifier using the Williamson principle.

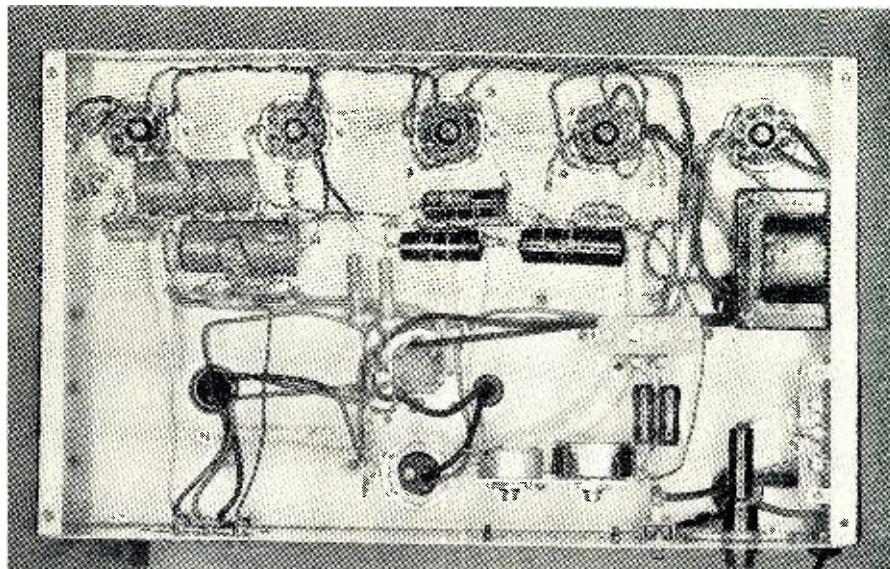

B-19 MK11 TRANS-RECEIVER
 Less Power Pack \$32.50
 B-19 Power Pack \$8.95

ID-24 ARN-9
 Dual 0-200 Mil-gram, Movement 10 3/4" Case, ILS Equipment \$6.95



ARC5 MODULATOR
 MD7/ARC5 Plate Modulator w/4-pin motor complete w/Tubes 1-12J5, 2-1625, 1-VR50. Good cond. Price.....\$7.95



\$4.95

BEAM BOOM!!

\$4.95



AUDIO TRANSFORMERS

AT501 HI-FI Special: PRI: 3000 ohms P-P/Sec: 4/16/12/50/2000 hms 60-10,000 CY.—1 db 50W. \$3.49

AT152 HI-FI Driver PRI: 10,000 ohms Sec: 40,000 ohms PP Grids 50-15 KC/1 db. \$1.49

AT083 Output to H.S. or line PRI: 14,200 ohms SEC: 8000/600 ohms. \$1.19

AT449 HI-FI Driver (5000 ohms) to P.P. output grids (4,000 ohms) 100-10,000 CY. 10 W. 6V6 to PP 805's \$2.39

AT666 Intersom Input: Spkr (-4-8 ohms) to grid (250,000 ohms). \$9.69

AT415 Plate (18,000 ohms C.T.) to line (125 ohms) 175 W.—500-600 CY. \$1.95

AT858 Plate (10,000 ohms C.T.) to line V.C. (500/125/30 ohms) HI-FI—50 W. \$6.95

AT070 Mike-or-Line (250 ohms) to grid (250,000 ohms C.T.). \$1.29

AT765 Mike-or-Line (600 ohms) to grid (50,000 ohms C.T.). \$0.89

MOBILE MODULATION KITS

T-103 Mike to 615 grid.
 T-102 G5J to Modulators, PP 6V6 or PP 6L6.
 T-104 Mod. Trans. PP 6V6 or PP 6L6 to 829, 832, or 2E26.

All components miniature, ruggedized, and hermetically sealed.
COMPLETE KIT & DIAGRAM.....\$3.50

HI-FI UNIVERSAL OUTPUT TRANSFORMER
 Amertran Silcor. PRI: 20,000/16,000/5000/4000 ohms. Sect. 500/15/7.5/5/3.75/1.25 ohms. 30 db. contin. Plat to 20,000 CY. w/Diag. \$4.75

SELENIUM RECTIFIERS

UP TO 18 VAC IN—UP TO 14 VDC OUT

2A.....	\$ 2.50
4A.....	4.00
6A.....	6.00
10A.....	7.50
12A.....	9.00
24A.....	9.00

UP TO 36 VAC IN—UP TO 28 VDC OUT

1A.....	\$ 3.00
2A.....	4.00
4A.....	6.00
10A.....	14.50
12A.....	18.00
24A.....	36.00

UP TO 54 VAC IN—UP TO 42 VDC OUT

2A.....	\$6.50
4A.....	12.00

UP TO 120 VAC IN—UP TO 100 VDC OUT

2A.....	\$11.00
10A.....	48.00
12A.....	60.00

Special Rectifiers On Request

Hi-Current Chokes
 1 HY—12 Amp—46 Ohms.....\$14.95
 .01 HY—2.5 Amp—4 Ohms.....\$2.25

LO-VOLT. XFMR'S

Primaries 115v, 60 Cycle

30V-40V at 3.5 amps.....	\$3.75
24V-1.5A.....	1.95
8V-1.5A.....	.98
18V-6A.....	3.75
12V-6A.....	3.75

HI CAP. FILTER CONDENSERS

Cap. WVDC Price	
800 15	\$1.35
2000 20	1.85
500 200	2.00
250 150	1.45

PRECISION RESISTORS

OHMS	OHMS	OHMS
5	150	7,500
5.05	250	10,000
10	430	12,000
18	468	17,000
82	800	20,000
120	920	30,000
125	1100	35,000
128	4300	84,000
30c EACH.....	10 FOR \$2.50	
100K 120K 150K 220K	40c EACH.....	10 FOR \$3.50
1 MEGOHM.....	EACH \$7c	

MAGNETRONS

Tube	2J62
2J27	3J31
2J31	5J30
2J21-A	720A
2J22	718DY
2J26	720BY
2J32	725-A
2J38 Pkg.	730-A
2J49 1kg.	QK 62
2J61	QK 61
2J61	QK 60

700 A, B, C, D

UNIVERSAL POWER TRANSFORMER

Pri: Vibrator Input @ 6/12/24/110 VDC. AC Input: 110/220 V. @ 60 CY.
 Sec: 230-0-230 V—40 MA.
 6.3 V—1.8A. \$1.49

DYNAMOTORS

Type	Volts	Amps.	Output Volts	Amps.	Radio Set
PE86	28	1.25	250	.060	RC 36
DM416	14	6.2	330	.170	RU 19
DM33A	28	7	540	.250	BC 456
PE101C	13/26	12.6	400	.135	SCR 515
3D AR 93	28	3.25	375	.150	
23356	27	1.75	285	.075	APN-1
35C0458	28	1.2	250	.060	
ZA-085	12/24	4/2	500	.050	
ZA-056	12/24	8/4	12/275	3/110	
B-19 pack	12	9.4	275		Mark II
D-104	12		500	.050	
			225	.100	
			440	.200	
DA-3A	28	10	300	.060	SCR 522
			150	.010	
			14.5	.5	
5053	28	1.4	250	.060	APN-1
PE73CM	28	19	1000	.350	BC 375
CW21AAX	13	12.6	400	.135	
	26	6.3	800	.020	
		9	12		
PE94	28	10	300	.200	SCR 522
			150	.010	
			14.5	.5	

SPECIAL CONVERTER
 IN: 115VDC, OUT 12/26VDC, 500W
 BRAND NEW.....\$99.50

INVERTERS

PE 218-E: Input: 25 28 vdc. 92 amp. Output: 115 v. 350-500 cy. 1500 volt-ampere. Dim: 17"x6 1/2"x10". \$49.50
 New \$49.50

PE 218-H Same as above except size: 16 1/2"x6"x10". \$49.50
 New \$49.50

PE 206: Input: 28 vdc. 38 amps. Output: 80 v. 800 cy. 500 volt-amp. Dim: 13"x5 1/2"x10 1/2". New \$25.50

RACK-PANEL TYPEWRITER DESK

Heavy duty standard panel, 19"x10 1/2"Wx3 1/2"H, tough steel, supporting metal desk well 20"x15" wide x 4 1/2" deep. Ideal for that new, compact rig. Space saving panel may be used to support extra equipment. Attractive Gray finish. New. Only a few left! \$4.95



A NATURAL FOR THAT NEW 2—OR—3 ELEMENT PLUMBERS DELIGHT. 9 FT. LONG. OF TUBULAR STEEL CONSTRUCTION. END BRACKET'S FOR MOUNTING ELEMENTS. MAST MTG. CUP 3" DIAMETER. ONLY 20 LBS., NET WEIGHT.
TAKE 'EM AWAY FOR ONLY \$4.95

SR-9 SONAR MOBILE RECEIVERS*

27-30 MC	
30-40 MC	
40-54 MC	
108-132 MC	Ⓞ
144-149 MC	
152-163 MC	

MB-26 SONAR MOBILE XMTRS.

27-30 MC	
30-40 MC	
40-54 MC	
108-132 MC	Ⓞ
144-149 MC	
152-163 MC	

*Available in either AM or FM models
 Ⓞ Models available for either 6, 12, 24 VDC.
 Price: SR-9 or MB-26.....\$72.45

Send for Tech. Data

OIL CONDENSERS

Mfd.	Volt.	Price
5	50	\$0.45
650	80	1.95
15	220AC	2.20
0.5	750AC	1.59
0.5	1000	.69
2x0.5	1000	.70
1	1000	.75
1.5	1000	.85
2	1000	.90
4	1000	1.75
3x.01	1200	1.35
1	1500	1.30
1	1500	1.40
1	1500	1.45
0.15	4000	1.20
2x0.1	4800	1.20
0.1	6000	2.39
0.15	6000	1.50
2x0.1	7000	2.95
.015	16000	3.95
.0016	15000	5.95
.25	20000	
1	25000	
.5	25000	
1	7500	

MOTOR START. COND.

CAP	VAC.	PRICE
13-15	220	\$1.20
20-24	110	1.00
26-30	220	1.35
43-65	110	1.25
43-48	110	1.25
50-75	110	1.25
53-60	220	1.50
61-69	320	1.60
64-72	110	1.25
72-87	110	1.25
75-84	110	1.25
83-106	110	1.50
107-129	110	1.65
130-157	110	1.75
130-150	70	1.50
130-180	110	1.85
158-191	110	1.85
161-180	110	1.75
189-210	110	1.95
200-220	110	2.10
270-300	110	2.10
324-360	110	2.40
378-420	110	3.00
432-480	110	2.75
485-540	110	2.85

MANY OTHERS

SPECIALS

Time Delay Relay—45 Sec. 115VAC-DC 10A.....\$2.29

Carbon Pile Reg. 18V—5V 35X025.....7.50

AT-13 Driver Trans. 6V6 to P-21 815.....1.75

DM 34 Dynamotor, 14V In, 220V, 80 MA out.....1.29

Sens. Relay: 3.5MA, 13K ohms, 2PST, 2A.....1.29

Klixon Breaker: Thermal, 35A......69

T-30 Carbon Mikes—New......89

Screen Mod. Trans. for 807's.....1.19

3-4 MC coils for ARC-5 Trans. #0029, #7247, Set 2.79

LINE FILTERS

LINE FILTER, GE 100 Amp Filter w/2x5 Mfd 50V oil cond.
 Operates on 110VAC DC.....\$1.39

1KW LINE FILTER, clean up BC1 & TV1. Easy to Mount.....\$3.95

Noise Filter. Jx51E, 10 Amp.....\$1.29

Noise Filtr. Jx55D, 4 Amp......35c

932 PHOTO TUBE

Gas Photo-tube having S1 response, particularly sensitive to Red and Near Infrared Radiation. Can be used with incandescent light source. Send for Data. Price.....75c



FILTER CHOKES

Stock	Description	Price
CH-250	SWING. 2.5-24H/4-.05A 10KV Test	\$7.95
CH-8-19	SWING. 0.006H/5A-.035H/5A .032 ohms DCR, 1KV TEST.....	3.95
CH-776	1.28 H/130 MA/75 ohms.....	2.25
CH-344	1.5 H/145 MA/1200V Test.....	2.35
CH-854	1 H/80 MA.....	1.29
CH-43A	10 HY/15 MA—850 ohms DCR.....	1.95
CH-999	15 HY/15 MA—400 ohms DCR.....	1.95
CH-511	6 H/80 MA—310 ohms DCR.....	2.45
CH-3-501	2x.5H/100 MA.....	2.79
CH-188M	5 HY 200 MA.....	1.79
CH-488	10 HY .030A.....	1.19
CH-791	Dual 1.75-125 HY 100 MA.....	1.27

BC605 INTERPHONE AMPLIFIER

Easily converted to an ideal Inter-communications set for office—home—factory. Complete w/conversion diagram for 110V operation. Brand New \$4.75



TRANSFORMERS ALL PRIMARIES 117V, 60 CYCLES COMBINATION TRANSFORMERS

Stock No.	Rating	Price
CT-77B 5500V	.002 2.5V/2A, 12KV TEST, 6.3VCT/6A, 4600V TEST.....	\$12.95
CT-75B 1200VCT	600MA 2x.5VCT/6.2A, 6.3VCT/3A, 6.3V/3A.....	14.95
CT-J5-2 600VCT	200MA 5V/6A.....	4.95
CT-825 360VCT	.340 6.3VCT/3.6, 6.3VCT/3A.....	3.95
CT-626 1500V	.160 2.5/12.30/100.....	9.95
CT-15A 330VCT	.070 6.3/1A, 2.5VCT/2.....	2.95
CT-071 110V	.200 33/200, 5V/10, 2.5/10.....	4.95
CT-378 2300V	4MA 2.5/2.....	6.95
CT-367 580VCT	.050 5VCT/3A.....	2.25
CT-721 550VCT	100 6.3/1, 2.5VCT/2.....	2.95
CT-95A 2x10VCT	.010 6.3/1A, 2.5VCT/7A.....	3.25
CT-403 350VCT	.026MA 5V/3A.....	2.75
CT-610 1250	.002MA 2.5V/2.1A, 2.5V/1.75A.....	4.95
CT-137 350VCT	.026MA 5V/3A.....	2.75
CT-456 300VCT	30MA 6.3V/1.3A, 5V/3A.....	3.45
CT-69 800VCT	100MA 6.3/1.2A, 5V/3A.....	4.95
CT-319 600VCT	.085A 5V/2A, 6.3/7.5A, 6.3/3A.....	3.25
CT-441 50-46V	200MA 110VCT/2A.....	2.75
CT-442 525VCT	75MA 5V/2A, 10VCT/2A, 50V/200MA.....	3.85

KLYSTRON TRANSFORMER

PRI: 115V, 60 CY
 SEC: 1050V/10MA, MINUS 625V/5MA, 26.3V/4.5MA, 2x2.5V/3A, 6.3V, 3A.
 Stock No. CT-341. Only a few left at \$22.45

FILAMENT TRANSFORMERS

Stock	Rating	Price
FT-924	5.25V/21A, 2x7.75V/6.5A, 2x26V/2.5A.....	17.95
FT-824	16V/1A, 7.2V/7A, 6.4V/10A, 6.4V/2A, 2x26V/2.5A.....	12.95
FT-357	9VCT/45A.....	14.75
FT-781	866 Trans. 2x2.5/5A.....	2.25
FT-154	6.3V/1.5A.....	1.10
FT-157	4V/16A, 2.5V/1.75A.....	2.95
FT-101	6V/.25A.....	.79
FT-55-2	7.2V/21.5A, 6.5V/6.85A, 5V/6A, 5V/3A.....	8.95
FT-986	16V @ 4.5A or 12V @ 4.5A.....	3.75
FT-38A	6.3V/2.5A, 2x2.5V/7A.....	4.19
FT-A27	2.5V/2.5A, 7V/7A, TAP 2.5V/2.5A, 16KV TEST.....	18.95
FT-340	2x2.5V/3A, 7V/7A—23KV TEST.....	24.95
FT-038	6.3V/500A, WELD.....	29.45
FT-364	6.3V/2A, 6.3V/4.5A.....	2.29

PLATE TRANSFORMERS

Item	Rating	Each
PT-614	4730VCT/500MA, 12KV INS.....	\$29.95
PT-976	Auto: 120VCT/10MA.....	.69
PT-31A	2 x 300V/5 MA.....	.79
PT-033	4150V/400 MA 1 1/2 x 9 1/2 W x 9" D 70 lbs.....	49.95
PT-403	Auto: 70V/1A.....	2.29
PT-160	1120VCT/770 MA, 590VCT/82 MA, 25 lbs.....	24.95
PT-170	Auto: 156/146/137/128—71A.....	3.29
PT-31A	2 x 300V 5 MA.....	.79
PT-976	120VCT/10MA.....	.79
PT-12A	280VCT/12A.....	2.95
PT-919	1200-0-1200 200 MA.....	8.95

RACK-PANEL DESK

Tough, 3/4" steel panel with reinforced members. Supports heavy duty metal desk 22x22". Standard panel 19"x10 1/2" H. Ideal space saver for Freq-Meter, AFO or Receiver. Brand New White Type Last. \$4.95



All merchandise guaranteed. All prices F.O.B. N.Y.C. Send M.O. or Check. Only shipping charges sent C.O.D. Rated concerns send P. O.

COMMUNICATIONS EQUIPMENT CO.

131 Liberty St., New York, N. Y., Dept. N-2 CHAS. ROSEN Phone: Digby 9-4124



Special Offer On This Complete RADIO ENGINEERING LIBRARY

New, Up-To-Date Edition of Famous Library Covers Whole Field of Radio Engineering. Places Latest Facts, Standards, Data, Practice, and Theory At Your Fingertips.

THE five big volumes of the new edition of the Radio Engineering Library now include the very latest facts, standards, data, and practice. This Library will help solve hundreds of problems for designers, researchers, engineers, and students in any field based on radio.

Written by leading radio engineers, these books cover circuit phenomena, networks, tube theory, vacuum tubes, amplification, measurements, etc.—give specialized treatment of all fields of practical design and application. They provide you with a complete and dependable encyclopedia of facts.

5 Volumes • 3872 Pages • 2770 Illustrations

- Eastman's FUNDAMENTALS OF VACUUM TUBES, 3rd Edition.
- Terman's RADIO ENGINEERING, 3rd Edition.
- Everitt's COMMUNICATION ENGINEERING, 2nd Edition.
- Hund's HIGH FREQUENCY MEASUREMENTS, 2nd Edition.
- Henney's RADIO ENGINEERING HANDBOOK, 4th Edition.

SEND NO MONEY

Special Low Price • Easy Terms

On this special offer you get this Library for \$34.50, instead of \$39.00. You save \$4.50 and may pay on easy terms. Mail coupon below to examine the Library FREE for 10 days. No obligation. These books are recognized as standard works; you are bound to need them. So take advantage of this special money saving offer. *Mail coupon at once!* McGraw-Hill Book Co., Dept. RTN-2-52, 327 W. 41st Street, New York City.

McGraw-Hill Book Co., Dept. RTN-2-52
327 West 41st St., New York 18, N. Y.

Send for 10 days' FREE trial, the RADIO ENGINEERING LIBRARY. If not satisfied I will return books. Otherwise I will send \$4.50, plus delivery charges, then; and \$5 a month for 6 months (Reg. price \$39.00; you save \$4.50).

Name.....

Home Address..... RTN-2-52

City & State.....

WE'LL PAY DELIVERY CHARGES if you enclose \$4.50 first payment WITH coupon. Same return privilege for full refund.

Tube Substitutions for TV Receivers

As the tube situation gets tighter, technicians will be forced to improvise to keep TV sets in operation.

By
MEYER CHERTOCK

Delehanty Institute

THE necessity for developing substitutes for television components in short supply has already become acute. When prompt repairs are required to keep sets in operation, available materials must be used.

Since the shortage of tubes is one of the technician's greatest headaches at present, the techniques for substituting available types for hard-to-get numbers will be considered here.

R.F., I.F., and Video Amplifiers

In the r.f., i.f., and video amplifier family, we have such tubes as the 6AC7, 6AU6, 6BH6, 6AK5, 6AG5, 6CB6, 6BC5, and 6BA6. If the heater voltage is drawn from the 6.3 volt winding of the power transformer rather than a series filament connection, the differences in heater current may be disregarded. A small increase or decrease in heater current will not damage the power transformer. Aside from some differences in G_m , R_p , and interelectrode capacity, most 7 pin miniature triple grid amplifiers can be interchanged and will provide adequate operation if certain factors are taken into consideration.

In Fig. 1A, the plate, screen, grid, and heater pins are numbers 5, 6, 1, 3, and 4. These tubes differ only in the heater, suppressor, and cathode pin

connections. A jumper may be connected from suppressor to cathode, between pins 7 and 2, if the grounding connection is removed from the suppressor. With this small change, it is now possible to insert any of the following tubes and, in most cases, reception will be possible. These tubes may operate in such a socket: 6AU6, 6AG5, 6CB6, 6AH6, 6BJ6, 6BA6, 6AK5, 6BC5, 6BH6, and 6AS6.

Since each of these tubes have slightly different characteristics, the i.f. or r.f. response curve may have to be altered. However, if the substitution provides the desired end result—a fair picture on the screen—the substitution may be considered successful.

To touch up the i.f. response curve, an r.f. sweep generator will have to be connected to the mixer grid, and an oscilloscope connected to the video detector load resistor. A slight adjustment of the i.f. transformers will then have to be made to correct any serious distortion of the response curve.

Audio Circuits

In the second section of TV receivers, we may find 6SH7 or 6SJ7 tubes and these may be interchanged. The 6SH7 has the suppressor connected to the cathode internally, and has two cathode leads. They function as FM limiters or sync clippers. Audio amplifiers such as 6AT6 and 6AV6 have similar characteristics. Newer additions to the duo-diode and triode family are the 6AQ6, 6BF6, 6BU6, and

Fig. 1.

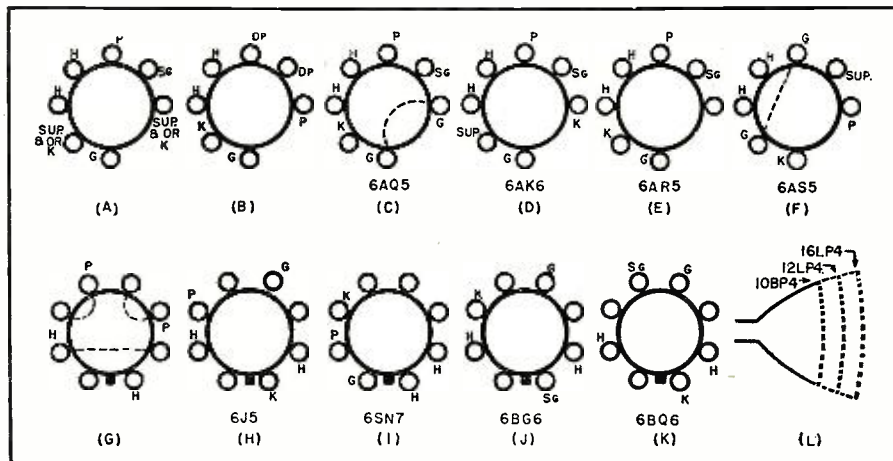

6BK6. These tubes differ only in mu for the triodes, and rectification efficiency for the diodes.

In most cases, any of the duo-diodes or triodes listed will provide reception of audio signals. In Fig. 1B, the socket pin numbers are common to a large family of tubes—6AT6, 6AV6, 6AQ6, 6BU6, 6BF6, and 6BK6.

Audio power amplifiers provide a wealth of possibilities for interchanging. The 6V6, 6K6, 6F6, 6U6, and 6Y6 have similar base connections. Where the output circuit is not a push-pull, substitution of any of these tubes will, in most cases, provide reception. In push-pull circuits, identical tubes must be used, as the plate current unbalance will accentuate power supply hum. The plate current may be adjusted to the tube manufacturer's recommendations by changing the cathode bias resistor to provide more or less bias.

The miniature audio power amplifier family seems to suffer from a lack of uniformity as far as base pin connections are concerned. Reception of audio signals may be obtained by substituting any of the tubes shown in Figs. 1C, 1D, 1E, and 1F, if the tube socket is rewired. Adapters may be made permitting the use of octal base tubes in place of 7 pin miniatures, or, more easily, 7 pin miniatures in place of octals or loctals.

To use a miniature tube in place of a loctal or octal base tube, it is necessary to have a miniature socket and an octal or loctal tube base. Wires are connected to the miniature socket and pulled through the corresponding element pin of the octal tube base.

Some miniature tubes which can be interchanged with the octal or loctal type tubes are listed for audio only. In addition, a miniature for a 6 prong tube has been added:

6AT6 6AT6 6AT6 6AQ5 6AR5 6BF6
6SQ7 6Q7 75 6V6 6K6 6SR7
6BF6 6AT6 6AT6
6R7 7B6 7C6

Rectifiers (Low Voltage)

The 5U4 may be substituted for the 5Y3 low voltage rectifiers. A 5T4 or 5V4 may be substituted for the 5U4. A rectifier socket may be made to handle 5X4, 5U4, 5V4, and 5T4 by connecting the jumpers as shown in Fig. 1G. These same jumpers make it possible to substitute a 5Y3 for a 5Y4, or *vice versa*. A 5Y3 may be substituted for a 5W4 or 5Z4 without any rewiring.

By the use of adapters, various base type rectifiers may be interchanged. A four prong base rectifier may be used for either an octal or a loctal base. A miniature may be used for an octal or a five prong base tube. All that is necessary is the wiring of the same elements together between different bases. Some combinations are:

5V4 5Z3 80 6X4 6X4
5A24 5U4 5Y3 6X5 84

Single Triodes

A 6J5 vertical oscillator may be replaced by one-half of a 6SN7 if the socket is rewired for the 6SN7 triode

February, 1952

Gives a
CLEARER PICTURE
of Your
BUSINESS FUTURE

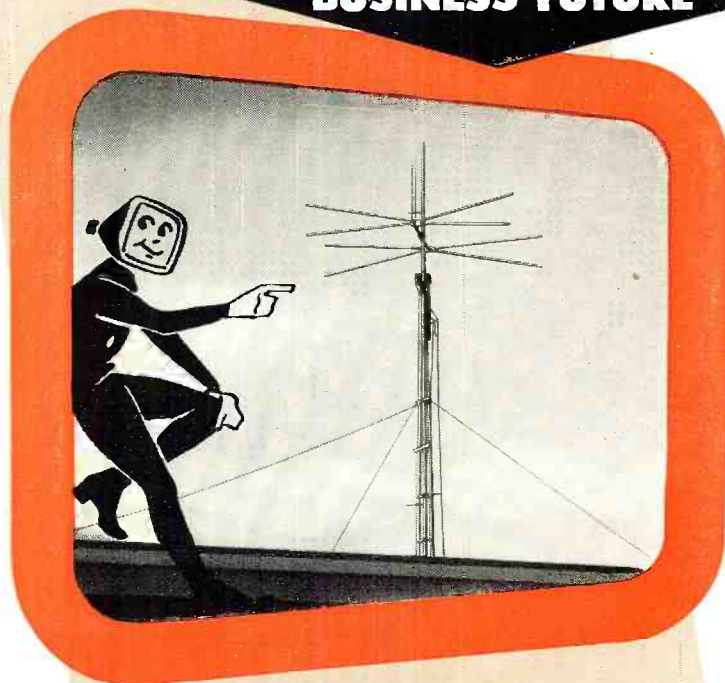

PRODUCT DEVELOPMENT ENGINEERING by **PENN Teletower**

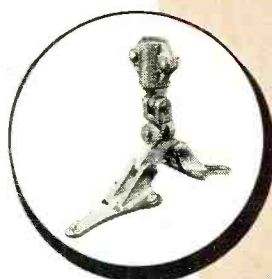

POLE BASE MOUNT-PBM5. Construction permits mounting on peak of ridge so erection can be made from either ridge or side.

To know what tomorrow's developments in tower engineering and merchandising may be . . . keep posted on what's happening today at Teletower! Almost since T-V came out of the laboratories and into the living rooms, Teletower has been first with the important product developments. The Teletower itself . . . the improved T-X section . . . the adjustable roof mount . . . the built in base . . . these were simply forecasts of even bigger "firsts" to come.

Stay tuned in with Teletower! Watch this publication for our advertising . . . the advertising of the tower that tops all others in sales.

CANADIAN REPRESENTATIVE: Atlas Radio Corp., Ltd., 560 King Street, W. Toronto, Canada.

PENN

Teletowers
Lifttowers
enna-Mast
Hardware

PENN BOILER & BURNER MFG. CORP., LANCASTER, PA.

TUNG-SOL[®]

for
Uniformity
and
Dependability

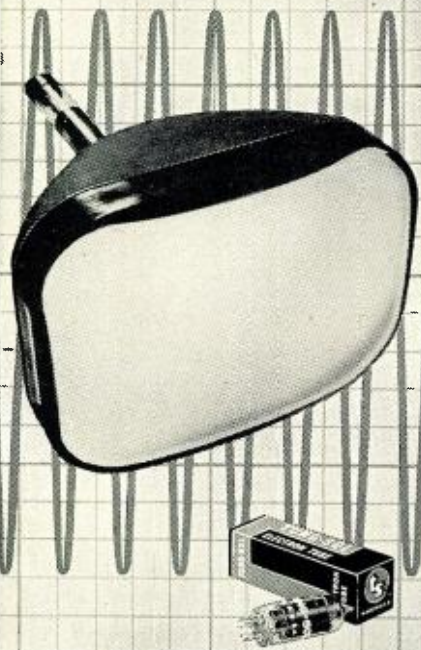

REPLACEMENT:

Tung-Sol tubes keep service standards up to set manufacturers' specifications.

INITIAL EQUIPMENT:

Tung-Sol tubes meet the highest performance requirements of set manufacturers.

TUNG-SOL
RADIO, TV TUBES, DIAL LAMPS

TUNG-SOL ELECTRIC INC., NEWARK 4, N. J.
Sales Offices: Atlanta • Chicago • Dallas • Denver
Detroit • Los Angeles • Newark

ALSO AUTO LAMPS, ALL-GLASS SEALED
BEAM LAMPS AND SIGNAL FLASHERS

section, as in Figs. 1H and 1I. A 6C4 may be used in place of a 6J5 if a miniature-to-an-octal adapter is employed connecting the 6C4 elements to the proper octal pins. In some cases, 6AU6's have been rewired as triodes to replace some miniature triodes, and good results have been obtained.

Horizontal Dampers

The 5V4 damper may be replaced temporarily by a 5Y3 with some change in horizontal linearity, or the octal socket may be rewired for a 6W4. 6W4 and 6U4 have identical electrical characteristics and pin numbers. They serve primarily as horizontal dampers.

Readjustment of the horizontal drive and the horizontal linearity slug may correct the linearity to some degree. Expansion of the left half of the pattern may be corrected by a reduction in size of the damper resistor. If the 5V4 is replaced with a 6W4 in the Philco 48-1000, the socket is rewired, and the series resistor to the 5V4 heater may be shorted out.

Horizontal Amplifiers

A 6CD6 may be interchanged with a 6BG6 as a horizontal amplifier. The slight difference in bias is easily overcome by additional bias obtained from the rectification of the saw-tooth wave pulses in the grid circuit. Either of the above may be rewired to accommodate a 6BQ6 (see Figs. 1J and 1K).

The new 6BD5 as well as the old 807 offer some possibilities which the author has not as yet tried.

Vertical Amplifiers

A number of substitutions may be made in the vertical amplifier family. 6V6 and 6K6 may be interchanged. Parallel triodes of 6SN7 may be re-

wired for 6V6, or *vice versa*. Any of these may be replaced with a 6S4 with a 9-pin miniature socket, or *vice versa*.

Sync, Sweep, Etc.

A miniature, such as 12AU7, may be interchanged with an octal such as the 6SN7. A 12AU7 and 12BH7 may be interchanged in many applications.

A 6SN7 multivibrator whose cathodes are connected may be rewired for a 6N7. A 6SN7 may be rewired to accommodate a 6F8, since both are identical in characteristics. The 6SN7 is the modern single-ended edition of the 6F8, and the 12AU7 is the more modern 9-pin version of the 6SN7.

The 6SL7 is the modernized single-ended version of the 6C8, and the 12AX7 is the 9-pin version of the 6SL7.

CR Picture Tubes

Picture tubes are quite an expensive item. When there is doubt as to whether the picture tube or some component in the chassis is at fault, a temporary substitution of some other picture tube may be possible. A very simple substitution can be made by interchanging 10BP4, 12LP4, or 16LP4. The deflection angle of each of these tubes is the same. A receiver which provides a full size picture on a 10BP4 face will also provide a full size picture on a 12LP4 or 16LP4 face, and *vice versa*, as shown in Fig. 1L.

A simple precaution worthy of some note concerns the 16LP4. The neck surrounding the cathode-ray gun of the 16LP4 is one inch shorter than the neck surrounding the 10BP4. The bulky, old electromagnetic type of ion trap will not fit in this space. Either a single or a double permanent magnet type of ion trap beam bender must be employed with the 16LP4.

From Leonard J. D'Airo comes another conversion diagram of considerable interest to television technicians. Mr. D'Airo has used this technique in converting Tele-King receivers to accommodate 16" and 19" CR tubes.

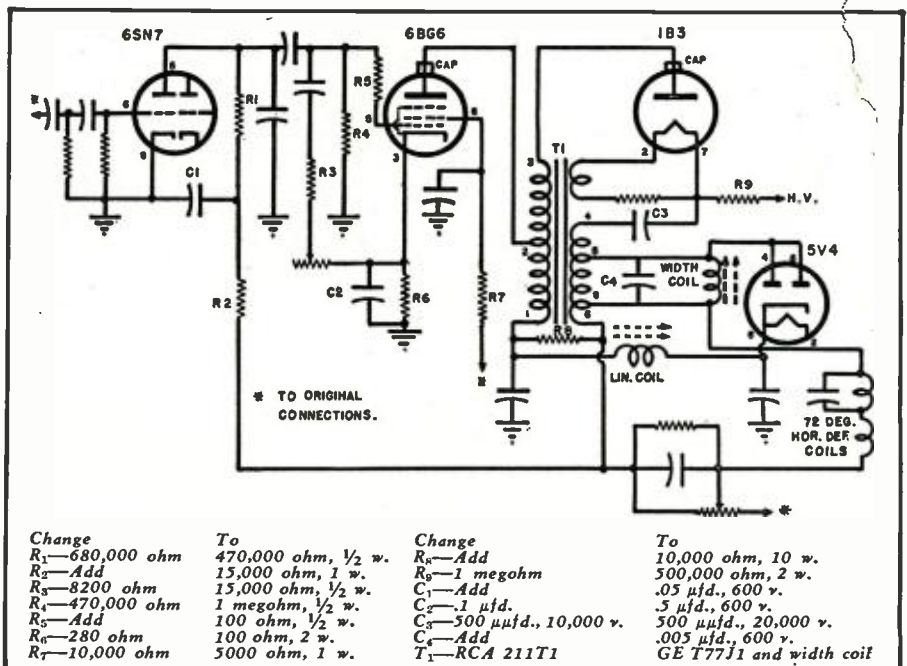

OUTSTANDING VALUES NOW AVAILABLE

RPC SUPER CHIEF ANTENNA KIT

The finest in all-around reception.

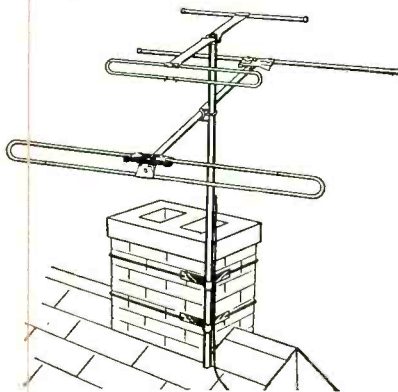

Separate high band and low band antennas. Constructed of high tensile aluminum. Complete with:

- 60 ft. 300 ohm line.
- 5 ft. 1 1/4" rustproof steel mast.
- Double strength chimney mount.
- 2—mast std. off.
- 1—7" std. off.
- 3—3 1/2" std. off.
- 1—RCA lightning arrestor.

COMPARE THIS PRICE! \$7.95

TUBE SPECIALS

6CB6.....	59c
6BC5.....	59c
6BN6.....	99c
6AU6.....	59c
6AK5.....	\$1.15
1X2.....	79c

70° Deflection Yoke

WITH CONDENSER AND RESISTOR

NETWORK \$2³⁹

FINEST MADE

SUPER SALE ITEM ELECTRIC SOLDERING GUN

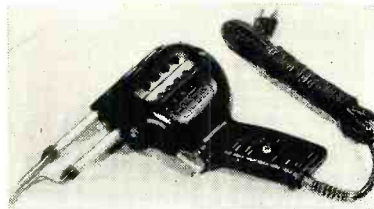

Best Made. 250 watt capacity. Heats in less than five seconds. Operates on 60 cy. 120V, AC. Trigger switch. No current or time wasted. **Lightweight.** Gives perfect balance and soldering ease. **Built-in Spotlight.** Compare this gun to any other on the market.

\$9⁹⁹

Complete with nickel and brass tip.
Extra tips..... 15c

AMAZING SPEAKER BUYS

4" PM 1 oz. Mag.	Each \$1.19
5" PM 1 oz. Mag.	Each \$1.19
6" PM 1 oz. Mag.	Each \$1.55
7" PM 2.15 oz. Mag.	Each \$2.15
6x9" PM 2.15 oz. Mag.	Each \$2.25
10" PM 3.15 oz. Mag.	Each \$3.39

300 OHM LINE

7 Strands #20 heavy, pure polyethylene web.
1000 ft.....\$16.95

TWO UNHEARD OF VALUES!

14" and 20" CONVERSION KITS AT NEW LOW PRICES!



Simple conversions to larger screen television.

14" Kit—14BP4 CR tube, 70° Deflection yoke. Attractive Lucite mask.

NOW ONLY \$25⁹⁵

20" Kit—20CP4 CR tube, matched ram, 70° yoke and 20" HV flyback transformer. Attractive gilt-edged Lucite mask.

NOW ONLY \$49⁹⁵

SUPER SALES ITEM!

20CP4 CR TUBE. FIRST LINE.
STANDARD GUARANTEE.

Limited Supply • Each \$31.00

★ ★ ★

PHONO CRYSTAL CARTRIDGES

REPLACE ALL
STANDARD CARTRIDGES

1 volt.....	Each \$1.49
3 volt.....	Each \$1.59

Radio Parts Company, 614 RANDOLPH ST., CHICAGO 6, ILL.

AT LAST! TV RECEPTION UP TO 200 MILES

ON ACTUAL FIELD TESTS WITH

NEW DX630 CHASSIS

will operate in fringe areas or in localities remote from TV broadcast stations up to 200 miles.

HAS 4 MICROVOLT SENSITIVITY—10 times any other TV receiver. Will pick up distant stations without use of boosters or special antenna arrays—and with less noise. Will operate any tube including 24", greater brilliance, improved keyed AGC circuit, (eliminating flickering and fading). Uses the best materials with a high factor of safety, to insure trouble-free operation. STD. RTMA GUARANTEE free replacement of defective parts or tubes for 90 days. Completely factory wired chassis ready to operate with 12" P.M. Speaker.
Price including excise tax..... **\$148.95**

TELEVISION PICTURE TUBES

Standard makes, 6 months guarantee, all prices include 10% excise tax. (See ad for prices.)

TELEVISION CABINETS

We have a large variety of table model, consoles and combination cabinets DESIGNED TO PLEASE the most discriminating tastes. Beautifully finished, mostly handrubbed available in mahogany, walnut, blond colors. Table model (outside dimensions 23 3/4" x 24" x 24") price in mahogany for all sizes up to 20", including **\$34.95** mask, and 10% excise tax.....
Extra for glass.....\$2.75

Console cabinet of beautiful design made of the finest veneers and good finish. Size 39" high x 24" wide x 22 3/4" deep finished. In mahogany or walnut. Cut for 630 chassis with 12" speaker will take either 16, 17, or 20" tube. Price including mask and excise tax. **\$43.95**
Extra for glass.....\$2.75

For the various other cabinets in our large selection we will furnish photos and other NECESSARY INFORMATION, ON REQUEST. New Dumont conversion kit. Send for Free Catalog.

TELEVISION COMPONENTS

Television 630 chassis pan all socket, transformer, etc. holes punched made of sturdy cadmium plated steel. Size—16" x 17" x 3 1/2". **\$3.95**

TELEVISION PICTURE TUBES

Standard Brands
SIX-MONTH GUARANTEE

12 1/2" (Black or White).....	Glass 16" Round (Black).....	\$23.95	\$34.50
Glass 14" Rectangular (Blk.).....	Glass 16" Rectangular (Blk.).....	\$23.50	\$34.50
17" Rectangular (Blk.).....		\$31.95	
19" Round (Blk.).....		\$39.95	
20" Rectangular (Blk.).....		\$39.95	
21" Rectangular (Blk.).....		\$42.95	
24" Metal.....		\$69.95	

New—Dumont True Focus Conversion Kit

Convert your old set for even focus over entire screen!
Dumont 70" Yoke, Model Y2A1—distributed winding.....\$6.57
Dumont 70" Flyback Transformer Model H1A1.....6.57
Dumont L-nearity control—for above units......75
Dumont Width Coil for above units......75

TELEVISION COMPONENT SPECIALS

"Faster Than Hotcakes!"

New Dumont 3c Tuners Sound Center I.F. 21.25 or 21.75.....	\$23.40
Plus your old Tuner	
NEW DEFLECTION YOKE RCA 201DI, with network, only.....	\$1.95
NEW FOCUS COIL 240 Ohms, RCA type 202DI only.....	\$1.25
NEW PM/EM FOCUS COIL, 1200 ohm winding only.....	\$.89

All Merchandise Subject to Prior Sale. All Prices Subject to Change without Notice.

WRITE FOR COMPLETE CATALOG N-2

EDLIE ELECTRONICS INC.

154 Greenwich St. New York 6, New York

BLINKING LIGHTS

Construction details on a simple relaxation oscillator circuit for use with neon lamps.

By

STANLEY SIENKIEWICZ

Industrial Electronics Dept.
DeForest's Training, Inc.

PROBABLY the oldest and most commonly used eye-catching device is the blinking light. Whether for ornamental purposes, for advertising, or in toys, flashing lights can always be counted upon to hold the center of attention. The manner in which the flashing of the light is achieved is very important, however, and flashing incandescent lamps fall considerably short of the best effect; they flash too slowly. This article will describe the use of neon bulbs in a simple relaxation oscillator circuit for the purposes mentioned above, or, for that matter, any other purpose suggested by the reader's own imagination.

The circuit, shown in Fig. 1A, is a relaxation oscillator of the simplest type operated from the a.c. line and shows the arrangement for two lights. The flashing rate will be determined by the values of resistance and capacity used in each branch. With values as shown, the neon bulbs will flash about five times per second. Increasing the resistance will cause them to flash more slowly and will also cut down the brightness of each flash. Since the brightness of the flash depends upon the current passed by the neon bulb, increasing capacity will also increase brightness besides increasing the time between flashes. The size of the electrolytic condenser in the power supply will determine how long the bulbs will continue to flash after the a.c. line has been disconnected. If the electrolytic condenser is made larger than 8 μ fd., a small resistance should be connected in series with the selenium rectifier. This rectifier is of the 75 ma. type, although, since the cur-

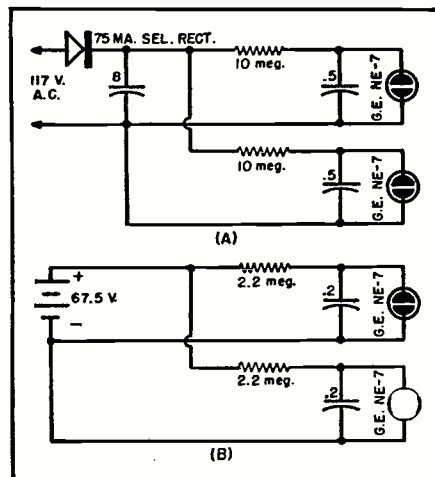
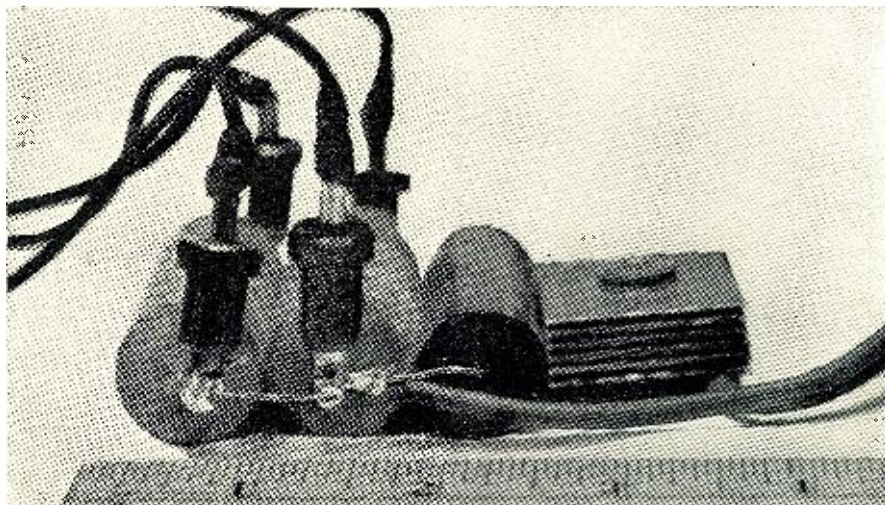

Fig. 1. (A) Simple relaxation oscillator operated from a.c. line and using two neon lamps. (B) Same circuit battery-operated.

rent requirements of the device are very small, other types can be used. Fig. 1B shows the circuit diagram for the same setup using a dry cell battery. Ionization potential of the General Electric NE-7 is about 60 volts, and since the current drain is very small, it is possible to operate the device on the smallest types of 67 1/2 volt battery, such as the Burgess G-45. The writer used this device to provide blinking eyes in a stuffed Easter bunny. Although this device has been

Fig. 2. Oscillator unit is compact enough to be used inside fairly small toys, etc.



in operation since Easter of 1950, the bunny's eyes have been blinking continuously until the time of this writing and have not as yet decreased their flashing rate.

The writer found that the G-E NE-7 is the type best adapted for use as eyes. The elements consist of a circular wire and a solid metal piece in the center. If the bulb is connected into the circuit with the circular wire as cathode, the glow will appear as a red circle; if connected so that the center element is the cathode, it will glow as a red dot. Either effect is interesting.

In one application of this gadget the author installed the neons to serve as eyes for a plastic pig. With proper insulation of parts, the pig can still be used as a bank, which was its original purpose, besides which it is rather ornamental and is extremely intriguing to children and grownups alike. If the parts are installed in something that is relatively small, construction can be made fairly compact since none of the parts is large, as shown in Fig. 2. If the device is to be used as a toy, it is recommended that a battery be used to supply power.

The parts, whether for the a.c. or d.c. version, can easily be installed in any type of stuffed animal. The writer leans toward blinking eyes, but other imaginations may suggest other effects. One variation is to keep one light constant and allow the other to blink, producing the effect of winking. Operated from the a.c. line, any number of bulb circuits can be connected in parallel. The effect of a dozen or so on a Christmas tree is that of fireflies on the tree branches. For this application, the smallest types of neon bulbs can be used.

Variations of this device have been successfully used in seasonal advertising displays in retail store windows, where the blinking bulbs have been invaluable as an eye-catcher. The medium can be varied depending upon the season for which the display is made.

-30-



"Testing-n-ng, One, Two, Three!"



\$10.00

FOR YOUR CARTOON IDEA

Have a pet peeve about service customers and their peculiarities? Help us keep the above "SERVICEMAN'S DIARY" cartoon series going by sending in your idea. No need to draw it—just write it out. Sprague will pay \$10.00 for every idea that is used.

Unequaled Dependability

Actual service records prove that Sprague Twist-Lok dry electrolytic capacitors are tops for keeping you out of trouble with service customers—by keeping their TV sets working right!

And Sprague has the *most* complete listing of *every type* of television electrolytic. Ask your Sprague distributor for a catalog or write to: SPRAGUE PRODUCTS COMPANY, 51 Marshall St., North Adams, Mass.



TWIST-LOK* 'LYTICS

The easiest to use, most reliable electrolytics for television replacement use

* T.M.

(Sprague Products Co. is the Distributors' Division of the Sprague Electric Co.)



What Do You Want to Trade In on a New hallicrafters?

I have a complete stock of Hallicrafters receivers and transmitters. We will give you the best doggone trade-in in the world because we need used receivers badly for our trade. What do you have? Write me about it. I give you prompt delivery, 90-day FREE service and the world's lowest credit terms. Write, wire, phone, or visit either store today for the best deal. Export orders solicited.

Bob Henry
WPARA



Popular Double-IF Model SX-71

A double superheterodyne circuit receiver at modest cost. Built-in narrow band FM reception. Temperature compensated, voltage regulated. 5 position band selector for 538-1650 kc, 1600-4800 kc, 4.6-13.5 mc, 12.5-35 mc, 46-56 mc. 11 tubes plus voltage regulator and rectifier. Only \$199.50



All-Wave Receiver Model SX-62

Covers 540 kc to 109 mc—including AM, FM, and SW broadcasts. Six bands: 540-1620 kc, 1620 kc-4.9mc, 4.9 mc-15 mc, 15-32 mc, 27-56 mc (AM-FM), 54-109 mc (AM-FM). Only \$289.50. Other popular Hallicrafters models: S-76, \$169.50; S-40B, \$99.95; S-72, \$109.95; S-72L, \$119.95; S-81, \$49.50; S-82, \$49.50.

HENRY RADIO STORES 11749 Olympic Blvd. LOS ANGELES 25 CALIF.
"WORLD'S LARGEST DISTRIBUTORS OF SHORT WAVE RECEIVERS"

A Message TO THE Musically SENSITIVE LISTENER

It is possible to reproduce your great favorites... classics or popular... in your own home, reflecting original concert-hall performance.

ASSEMBLE YOUR HIGH-QUALITY MUSIC SYSTEM AROUND

THE BROOK

ALL TRIODE HIGH QUALITY AUDIO AMPLIFIER

Detailed information and free booklet, "Better Listening," available on request. Dept. RB-2

BROOK ELECTRONICS, INC.
34 DeHART PLACE, ELIZABETH 2, N.J.

HEY, MAC!

Send a penny postcard TODAY for our giant bargain catalog already mailed to many thousands of regular customers. Your chance to save big money on TV and radio items for servicemen and builders. Everything in stock! Quick shipment and fair dealing always.

WEBSTER-CHICAGO 3-SPEED CHANGER

\$23.95

Famous Model 100

Plays 7", 10" and 12" records at 33 1/3, 45 and 78 RPM. Brand new and fully guaranteed. Don't wait—buy now at less than 1/2 regular list price! Modernize that old record player while these fine changers are available at our record low price!

SUPER V-BEAM
\$2.95 each
in Lots of 10
Only \$3.25 Each, Singly

Pre-assembled V-Beam for one-man quick-up. High gain and excellent directivity on all channels. Shipped less mast. Wonderful for fringe areas. Approved by TV installation men everywhere. Unbeatable value!

BIG SAVING! 300-OHM TWIN-LEAD!
Standard 300-ohm twin-lead recommended for outdoor use. Will withstand severest weather conditions. Buy in quantity and save at our record low price. Per 1000 ft. **\$1.995**

STAR ELECTRONIC DISTRIBUTORS, INC.
Dept. RN-2 7736 S. Halsted, Chicago 20, Ill.

Low Cost Exciter (Continued from page 42)

are used for the 80 and 40 meter inter-stage tanks when output is on 40 or 20. These coils are low-C circuits and quite broad enough to give plenty of grid excitation to their associated grid circuits without retuning over the entire bands. To adjust these coils, the exciter is switched to 20 meters and with a flashlight bulb load, the panel controlled trimmer is peaked for maximum brilliance. The two slugs are now adjusted for maximum brilliance of the light bulb and the adjustment is complete. On each band the panel trimmer, C₂₃, is peaked for maximum output near the center of each band. No retuning is necessary if working into a 50 ohm resistive load with this adjustment, except when changing frequency from one end of the 80 meter band to the other.

The three output coils are grouped around the bandswitch for short leads. From the photograph it is obvious that there is plenty of room left under the chassis and the unit is not difficult to wire.

Although keying the v.f.o. is not recommended, the 6AK6 cathode circuit may be satisfactorily keyed. Cathode bias on the following stages will prevent excessive plate current to the doublers in the key-up position. The keying leads should be well bypassed and an r.f. choke may be used to prevent feedback into the chassis via the key leads. Since keying provision was made in the 150 watt amplifier used with the exciter, no keying jack was provided.

A further refinement that could be added would be provision for switching of different tuning condensers across the oscillator tank to give complete bandspread on the three bands. This has not been tried, however, and is offered only as a suggestion for experiment.

Power consumption of the entire exciter is 55 ma. at 210 volts on 20 meters with slightly less plate current on 40 and 80. A measured output of slightly over 1 watt is obtained on each band into a 50 ohm resistive load. The total filament current drain is approximately 3/4 ampere so that a power cable several feet long may be used without excessive filament voltage drop. This cable should preferably be shielded to prevent possible harmonic radiation and a two-wire shielded lead is quite satisfactory, using the two leads for the hot filament and "B-plus" conductors. Two VR-105's are used to regulate the plate voltage in the power supply.

A five inch National dial is inexpensive, smooth, and easy to install. This simple exciter is giving entirely satisfactory service for c.w., phone, and SSSC, using a 150 watt amplifier and an SSSC adapter to be described in later issues.



TUBES

FROM **Niagara Radio Supply**
AT **50%** TO **90%** OFF

RECEIVING		RECEIVING		RECEIVING		RECEIVING		RECEIVING	
00A	1.60	5W4GT	1.00	6R7GT	.84	12AX7	1.20	36	.78
002	1.54	5X4G	.88	6R8	1.60	12AY7	3.00	37	.78
0A3/V75	1.25	5Y3GT	.82	6S4	.88	12B7	1.10	38	.59
0A4G	1.19	3Y4GT	.72	6S7	.97	12BA6	.94	39/44	.25
0B2	1.64	5Z3	.88	6SA7GT	.84	12BA7	1.19	40	1.10
0B3/V80	2.40	5Z4	.88	6SB7	1.00	12BD6	1.00	41	.74
0Y4	.74	6A3	1.24	6SC7	1.20	12BE6	.86	42	.74
01A	.72	6A4/LA	1.34	6SD7GT	.97	12BF6	.83	43	.74
IA3	.72	6A5G	1.95	6SN7GT	.88	12BH7	1.20	45	.88
IA4P	1.29	6A7	.98	6SF5GT	.88	12BJ6	1.20	45	.88
IA5GT	.77	6A8GT	1.04	6SF7	.97	12BK6	.75	47	.79
IA6	.84	6A84	1.00	6SG7	.97	12BT6	.75	47	.79
IA7GT	.94	6AB5/6N5	1.33	6SH7GT	.72	12BU6	.75	48	2.40
IA85	.79	6AB7/1853	1.04	6SI7GT	.88	12C8	.78	49	.94
IA85	.79	6AC5GT	1.19	6SQ7GT	.74	12F5GT	.78	50	2.48
IA85	.79	6AC7/1852	1.14	6SR7GT	.84	12H6	.90	50A5	.94
IA85	.79	6AD7G	1.34	6SS7GT	.94	12I6GT	.94	50B5	.94
IA85	.79	6AE6G	.88	6ST7	1.09	12J7GT	1.00	50C5	.94
IA85	.79	6AF6G	.94	6SV7	1.24	12K7GT	.78	50C6G	1.45
IA85	.79	6AG5	.88	6SZ7	1.10	12K8GT	.88	50L6GT	.84
IA85	.79	6AG7	1.54	6T7G	1.19	12K9GT	.88	50P6GT	.88
IA85	.79	6AH6	1.39	6T8	1.17	12L6GT	.90	50V6GT	1.00
IA85	.79	6AK5	1.49	6U4	1.20	12S7GT	.92	50Z7G	.90
IA85	.79	6AK6	1.11	6U5	.94	12SC7	.98	50Z7G	.90
IA85	.79	6AL5	.81	6U6GT	.97	12SF5GT	.88	50Z7G	.90
IA85	.79	6AL7GT	1.33	6U7G	.45	12SF7GT	.88	50Z7G	.90
IA85	.79	6AQ5	.91	6V5GT	1.95	12SG6T	.62	50Z7G	.90
IA85	.79	6AR5	.93	6V6	1.54	12SH7GT	.72	50Z7G	.90
IA85	.79	6AS5	.99	6V6GT	.88	12SK7GT	.94	50Z7G	.90
IA85	.79	6AT6	.72	6V7G	.90	12SL7GT	1.04	50Z7G	.90
IA85	.79	6AU5GT	1.24	6W4GT	.84	12SN7GT	.97	50Z7G	.90
IA85	.79	6AV5GT	1.33	6W5G	1.33	12SO7GT	.83	50Z7G	.90
IA85	.79	6AV6	.72	6W6GT	1.00	12SR7GT	.84	50Z7G	.90
IA85	.79	6AW6	1.33	6W7G	1.04	12T3	.84	50Z7G	.90
IA85	.79	6AX5GT	.83	6X5	1.33	12U4	.97	50Z7G	.90
IA85	.79	6B4G	1.60	6X5GT	.74	14A5	1.95	50Z7G	.90
IA85	.79	6B5	1.60	6Y3G	1.95	14A7	.94	50Z7G	.90
IA85	.79	6B6	.87	6Y5G	.88	14AF7	1.20	50Z7G	.90
IA85	.79	6B7	.97	7A4	.78	14B6	.94	50Z7G	.90
IA85	.79	6B8G	.84	7A5	.88	14B8	1.10	50Z7G	.90
IA85	.79	6BA6	.84	7A6	.84	14C5	1.33	50Z7G	.90
IA85	.79	6BA7	1.14	7A7	.84	14C7	1.20	50Z7G	.90
IA85	.79	6BC5	.97	7A8	.88	14E6	1.10	50Z7G	.90
IA85	.79	6BD5	1.33	7A8	.88	14F7	1.33	50Z7G	.90
IA85	.79	6BD6	1.60	7AD7	1.60	14G7	.94	50Z7G	.90
IA85	.79	6BE6	.84	7AF7	.90	14H7	.94	50Z7G	.90
IA85	.79	6BF6	.78	7AG7	1.04	14I7	.94	50Z7G	.90
IA85	.79	6BG6G	1.18	7AH7	1.10	14J7	.94	50Z7G	.90
IA85	.79	6BH6	.96	7AW7	1.33	14K7	.94	50Z7G	.90
IA85	.79	6BI6	.96	7B4	.84	14L7	.94	50Z7G	.90
IA85	.79	6BK6	.75	7B5	.84	14M7	.94	50Z7G	.90
IA85	.79	6BL7	1.45	7B6	.84	14N7	.94	50Z7G	.90
IA85	.79	6BN6	1.52	7B7	.84	14O7	.94	50Z7G	.90
IA85	.79	6BQ6GT	1.34	7B8	.84	14P7	.94	50Z7G	.90
IA85	.79	6BT6	.75	7C4	.84	14Q7	.94	50Z7G	.90
IA85	.79	6BY5	1.33	7C5	.84	14R7	.94	50Z7G	.90
IA85	.79	6C4	.78	7C6	.84	14S7	.94	50Z7G	.90
IA85	.79	6C5GT	.78	7C7	.84	14T7	.94	50Z7G	.90
IA85	.79	6C6	.78	7C8	1.33	14U7	.94	50Z7G	.90
IA85	.79	6C8G	.97	7E5	.54	14V7	.94	50Z7G	.90
IA85	.79	6CB6	.97	7E7	.88	14W7	.94	50Z7G	.90
IA85	.79	6CD6	2.94	7F7	.84	14X7	1.33	50Z7G	.90
IA85	.79	6D6	.84	7F8	1.33	14Y4	1.20	50Z7G	.90
IA85	.79	6D8	.88	7G7	1.33	15	.35	50Z7G	.90
IA85	.79	6E5	1.10	7H7	.84	18	.35	50Z7G	.90
IA85	.79	6E6	1.33	7I7	1.33	19	.35	50Z7G	.90
IA85	.79	6F5GT	.78	7L7	1.19	19B6G	2.34	50Z7G	.90
IA85	.79	6F6	.94	7M7	.97	19C8	1.60	50Z7G	.90
IA85	.79	6F6GT	.83	7N7	.97	19J6	1.60	50Z7G	.90
IA85	.79	6F7	.88	7O7	.82	19T8	1.45	50Z7G	.90
IA85	.79	6F8	.94	7P7	.94	20	.35	50Z7G	.90
IA85	.79	6G6	1.14	7S7	.97	21A	.35	50Z7G	.90
IA85	.79	6H6GT	1.33	7T7	.97	24A	.35	50Z7G	.90
IA85	.79	6J5GT	.68	7W7	1.04	25A6GT	1.60	50Z7G	.90
IA85	.79	6J6	1.19	7X6	1.10	25A7GT	3.70	50Z7G	.90
IA85	.79	6J7GT	.81	7X7	1.09	25AC5GT	1.43	50Z7G	.90
IA85	.79	6K5GT	1.60	7Y4	.74	25B5	1.95	50Z7G	.90
IA85	.79	6K6GT	.78	7Z4	.84	25B6G	1.33	50Z7G	.90
IA85	.79	6K7GT	.72	8A	1.05	25B6GT	1.60	50Z7G	.90
IA85	.79	6K8GT	.72	8B	.88	25C6	3.60	50Z7G	.90
IA85	.79	6L5	.86	8C	.64	25L6	1.60	50Z7G	.90
IA85	.79	6L6G	1.74	8D	.88	25L6GT	.84	50Z7G	.90
IA85	.79	6L6GA	1.74	8E	.64	25N6G	1.95	50Z7G	.90
IA85	.79	6L7	.97	8F	.88	25S	1.60	50Z7G	.90
IA85	.79	6N5	1.33	8G	.88	25W4GT	1.00	50Z7G	.90
IA85	.79	6N6	1.95	8H	.88	25Y5	1.45	50Z7G	.90
IA85	.79	6N7GT	.88	8I	.88	25Z5	.78	50Z7G	.90
IA85	.79	6P5GT	1.20	8J	.88	25Z6	1.10	50Z7G	.90
IA85	.79	6P7G	1.60	8K	.88	26	.49	50Z7G	.90
IA85	.79	6Q6G	1.60	8L	.88	26BK6	.83	50Z7G	.90
IA85	.79	6Q7GT	1.00	8M	.88	27	.30	50Z7G	.90
IA85	.79			8N	.88	30	.25	50Z7G	.90
IA85	.79			8O	.88	31	.84	50Z7G	.90
IA85	.79			8P	.88	32	.94	50Z7G	.90
IA85	.79			8Q	.88	32L7GT	.88	50Z7G	.90
IA85	.79			8R	.88	33	.92	50Z7G	.90
IA85	.79			8S	.88	34	.92	50Z7G	.90
IA85	.79			8T	.88	35/51	.82	50Z7G	.90
IA85	.79			8U	.88	35A5	.88	50Z7G	.90
IA85	.79			8V	.88	35B5	.88	50Z7G	.90
IA85	.79			8W	.88	35C5	.97	50Z7G	.90
IA85	.79			8X	.88	35L6GT	.84	50Z7G	.90
IA85	.79			8Y	.88	35M6	.90	50Z7G	.90
IA85	.79			8Z	.88	35W4	.84	50Z7G	.90
IA85	.79			8A	.88	35Z4GT	.72	50Z7G	.90
IA85	.79			8B	.88	35Z6GT	.68	50Z7G	.90
IA85	.79			8C	.88	35Z6G	1.33	50Z7G	.90

ONE OF AMERICA'S GREAT RADIO STORES

Niagara

RADIO SUPPLY CORP.

160 Greenwich Street, New York 6, N.Y.

WRITE DEPT. R-2-2

Minimum order \$5. 20% deposit with orders unless rated. F.O.B. N.Y.C. Prices subject to change without notice. * SURPLUS

free

send for it

212-PAGE

ALLIED Catalog



the only complete up-to-date catalog for Everything in Radio, Television & Industrial Electronics

Send for the Buying Guide that's used daily by thousands of service technicians, engineers, Amateurs, sound men, builders and experimenters. Make your selections from the world's largest stocks of quality equipment—at lowest money-saving prices. Get every buying advantage at ALLIED—speedy delivery, expert personal help, and complete satisfaction on every order. Make ALLIED your single, dependable source for electronic supplies.

SEND FOR FREE CATALOG

ALLIED RADIO

ALLIED RADIO CORP., Dept. 1-BB-2
833 W. Jackson Blvd., Chicago 7, Ill.

Send FREE 212-Page ALLIED Catalog

Name _____

Address _____

City _____

Zone _____ State _____

RADIO-TV Service Industry News

AS REPORTED BY THE TELEVISION TECHNICIANS LECTURE BUREAU

THE Federal Communications Commission's "freeze lifting" timetable for the renewal of television broadcasting station construction calls for the release of the new channel assignment tables for both u.h.f. and the revised v.h.f. television allocations to occur early in the year. Immediately following the release of the new tables, hearings will get underway on applications for channel assignments and it is expected that the first of the construction permits will be granted by April first. The areas that will receive priority for stations will be those that do not have telecasting stations and in which the applications for stations do not exceed the number of channels allocated to the area.

While attention has been focused primarily on u.h.f. television in connection with the lifting of the freeze, it is interesting to note that construction permits will be granted for a large number of new v.h.f. television stations. There still are a lot of v.h.f. channels available. It has been reported that there are a number of v.h.f. transmitters and towers already completed and stored in warehouses. With this equipment immediately available, it is probable that a number of new v.h.f. stations will be on the air with television programs by summer.

While it is impossible to foretell the probable speed of telecasting expansion after the freeze has been lifted because of the many unpredictable factors that have a vitally important bearing on the quantity of essential materials that will be available, there probably will be rapid progress made in the development of u.h.f. telecasting. Transmitter manufacturers have been working diligently for many months on production models of their successful experimental u.h.f. transmitting units. It is quite possible that u.h.f. transmitting equipment will become available rapidly which will pave the way for TV in many smaller communities that are now either completely outside of present television service areas or in the far fringe of their coverage.

New Service Opportunities

Since the first stations to be built after CP's are granted will be in areas that do not now have television broad-

casting facilities, the first effect of the renewal of station construction will be to provide opportunities for many new TV installation and service businesses. Whenever a television transmitter goes on the air in a new area there is, of course, an immediate boom in receiver sales. Receiver manufacturers have developed special sales programs for the stimulation of consumer interest in the ownership of television receivers in new telecast areas. These sales programs are timed to reach their peak of effectiveness during the period commencing when the new station starts to put its test pattern on the air to the official opening of the station with its first regular television program.

Set retailers, as a rule, want to concentrate their entire facilities on the sale of receivers and they are content to assign the necessary installation, adjustment, maintenance, and servicing functions to an independent television servicing organization. The volume of service business that is immediately created in a new television area usually taxes the facilities of all of the radio and television service shops in the area that make a bid for the business.

An interesting development in television service started during the second year of television broadcasting which was stopped by the station construction freeze. As new television areas opened up, many men who had gained their practical experience in installing and servicing television receivers, in operating TV service businesses, and by working for TV installation and service contractors in the major cities moved in to the newly created television areas to establish their own installation and service businesses. These men held many decided advantages over the local radio service operators without practical TV experience who desired to expand their businesses to handle television servicing. Among these advantages were: 1. The "know-how" gained from practical experience regarding the best practices in installing and maintaining television receivers. 2. An understanding of the financial requirements necessary to set up and maintain an adequately equipped and staffed service organization. 3. Experience in organizing and directing the work of

RADIO & TELEVISION NEWS

installation and service technicians to get the best possible returns from their labor. 4. Knowledge of the normal replacement tube and parts stock requirements and exercise of caution to avoid over-buying. 5. A practical understanding of how to develop and maintain cooperative contacts with TV receiver retailers and thus maintain a satisfactory volume of installation and service work.

Experience has shown that the initial boom in television receiver sales in a new TV area lasts about six months. After that there is a continuing drop of receiver sales until it levels off to a norm for that particular section. After that it appears to follow a sales cycle similar to that of radio receivers.

It is during this "boom" period that properly financed and capably managed service businesses become firmly entrenched and thus develop a decided competitive advantage over less efficient shops after the days of easy-to-get business are over.

The local radio service operator in a new TV area who has had no previous television installation and servicing experience faces several serious problems in trying to get established in television servicing. In the first place, the television receiver sales boom moves too fast and does not allow him the necessary time to acquire wide practical experience through working with TV and to expand his facilities and personnel at the same time. He is faced with major problems in business management: (a) To secure additional capital to invest in the necessary equipment and supplies that even a minimum-sized TV service business requires, (b) to hire, train, and supervise the work of at least a few technicians, (c) maintaining constant dealer contacts in order to continue to receive the installation and service work on the receivers they sell.

The many service business failures that occur about a year after telecasting gets underway in a new area are usually due to the lack of adequate finances. Most of these service operators attempted to finance practically all of their capital equipment out of service income and they were unable to meet their obligations after the "boom" subsided and service revenue fell off.

It must be pointed out, however, that hundreds of experienced radio service shop operators have become very successful TV installation and service contractors. These men possessed unusual management skill and acumen which enabled them to build sound, financially successful businesses in television service.

Capital Requirements

A television installation and service business is not just a larger radio service business. It is an entirely new kind of a business. It has always been possible for a man who possessed both an exceptional ability to repair radios and a pleasant sales personality to



YEARS AHEAD



360° ELECTRONICALLY SWITCHED BEAM

GIVES SAME CLEAR PIX AS MOTOR DRIVEN AERIALS AT 1/3 THE COST

SIMPLE FLICK OF SWITCH CLEARS PICTURE *INSTANTLY NO WAITING*

OPENS BIGGEST REPLACEMENT MARKET IN TV HISTORY

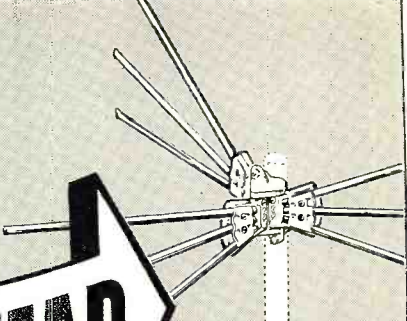

NO MOTORS OR MOVING PARTS



NO ROOF ORIENTATION



NO ELECTRIC POWER



NO GHOSTS

FREE

T

TENNA TIPS

PRICE 50¢

MAIL THIS COUPON TO-DAY!

SNYDER MFG. CO.
22nd & Ontario Sts., Phila. 40, Pa.

Please send me free copy of authoritative booklet **TENNA TIPS** on Directronic and all other types of aerials, plus catalogs.

NAME _____

ADDRESS _____

CITY _____ ZONE _____ STATE _____

SAVE \$\$\$ at PLATT

20 POUNDS OF ASSORTED RADIO PARTS

You won't want to pass up this buy—SO HURRY!—order now while it lasts!

ONLY \$2.79



TRANSMITTER-RECEIVER

Navy Model ABA-1 (CG-43AAG)

Army Model SCR-515A, known as the BC-645

450 MC
15 Tubes

BRAND NEW—ORIGINAL CARTON

Can be easily converted for phone or CW 2-way communication. Covering for the following bands: 420-450 MC low band, 450-460 MC for fixed or mobile, 460-470 MC for citizens, 470-500 MC television experimental. Size 10 1/2 x 13 1/2 x 4 3/4. Contains 15 tubes: 4—7F7, 4—7H7, 2—7E6, 2—6F6, 2—955, 1—WE-316A door knob. Complete as shown above.

ONLY \$24.95

SHIP-TO-SHORE BC-223 TRANSMITTER



A 30 watt Transmitter, ideal for ship-to-shore or Ham Rig. Crystal or MO control on four pre-selected channels, 2000 to 5250 KC. Use of 3 plug-in coils, five tubes: 2—801 and 3—46, and TU 17-18-25 tuning units. TRANSMITTER \$39.95 TUBES 5.95

TUNING UNITS

PE-125 VIBRATOR POWER SUPPLY FOR BC-223 18.95



Field Telephones

Army surplus, completely reconditioned and electrically tested using 2 flashlight cells and a pair of interconnecting wires. GUARANTEED—like new.

\$20.95

DUAL PURPOSE EMERGENCY UNIT

Made by leading Detroit Auto Mfr. Especially recommended for oil cans and electrical fires. Guaranteed by mfr. against defects. Order two—one for your home; one for your car in case of flats or fires.

ONLY \$2.29 each

SPECIAL! \$179.50

BC-348 RECONDITIONED GUARANTEED LIKE NEW All letters. Freq. range 200 to 500 KC. 1/2 to 18 meg. Old reliable of World War II.

HEADSETS

HS-33 low impedance with cord and plug used, fine condition \$1.89
HS-23 high impedance, BRAND NEW with ear pads, 4.25
HS-33 low impedance, BRAND NEW with ear pads, cord and PL54 plug 4.95
HS-30 with ear plugs, low impedance, used, good condition 1.69
CD-307A Cords, 6 ft. NEW 1.89
H-16/U, High Impedance. \$3.95



SCR-27N

COMMAND and ARC-5 Equipment



RECEIVERS

	USED	NEW
BC-453—190 to 350 KC.	\$17.95	\$37.50
BC-453—3 to 6 MC.	11.95	18.95
BC-455—6 to 9 MC.	8.95	11.95

TRANSMITTERS

BC-457—4 to 5.3 MC.	7.95	12.95
BC-458—5.3 to 7 MC.	6.95	13.95
BC-494—low to 4 MC.	16.95	29.95
BC-459—7 to 9.1 MC.	16.95	27.50

ADDITIONAL EQUIPMENT

BC-456 Modulator	3.95	6.95
BC-450 Control Box (3 Receiver)	1.49	2.95
BC-451 Control Box (Transmitter)	1.29	2.49
BC-442 Relay Unit (ANT)	2.95	3.95
Plugs: PL-147, 148, 151, 152, 153, 154, 156—EACH	1.25	
Flexible Shafting with gear to fit Receivers		1.69
3 Receiver Rack	2.25	
2 Transmitter Rack	1.69	

BC-221 Frequency Meter

Real Value! They are just like new, with original calibration charts. Range 125-20,000 KC with crystal check points in all ranges. Complete with crystal and tubes.

ONLY \$119.50

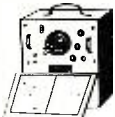

MINIMUM ORDER \$2.00

Immediate Delivery—Send 25% deposit on C.O.D. orders. All shipments F.O.B. N.Y.C. (N.Y.C. residents add sales tax to your remittance.)

PLATT ELECTRONICS CORP.

Dept. A, 489 Broome St., N. Y. 13, N. Y.

PHONES: WO 4-0827 and WO 4-0828

make a fair living out of a one-man radio service business. It would be possible, of course, for a good TV technician to operate a one-man television service shop. But it would be extremely difficult to get a fair return on his investment in the business and to take out an income for himself that would be comparable to the income his experience and abilities would provide him if he worked for a larger TV service business.

A study of successful television service businesses indicates that there is a certain minimum in personnel necessary for them to be profitable under normal conditions. The type of area in which the business is located will, of course, have an important bearing on the minimum personnel required for a successful business. This will vary from six to nine people in addition to the owner of the business.

These studies indicate that the capital requirement for a minimum-sized television installation and service business is about ten thousand dollars. This amount of capital would provide for the investment of \$6500 in equipment, supplies, tools, etc., and allow \$3500 as operating capital. More would be desirable.

The investment in equipment would include: Office furniture and mechanical equipment, \$500; Shop furniture and tools, \$1000; Shop test equipment, \$1000; Technicians' equipment (for 4 men) \$400; Installation equipment (for 1 truck) \$200; truck and automobile (technicians use their own autos) \$3400.

It should also be pointed out that u.h.f. television will probably demand a larger investment in shop test equipment for the efficient servicing of u.h.f. receivers and in particular, u.h.f. front end alignment. Since the investment mentioned is for but one test instrument position in the shop, it can readily be seen how capital requirements expand in order to handle a larger service business.

An important lesson that has been learned by TV installation and service contractors is that accurate financial and accounting records are indispensable. The editors of this department have interviewed a number of TV service contractors who were able to discount their bills during the serious business slump of last summer. In every case these service businessmen attributed their good financial positions to the fact that they followed the advice of the accountants and drastically curtailed purchasing and expenses while business was still good last Spring. The accountants' advice was based upon a knowledge of trends as indicated by accurate accounting reports.

NATESA Annual Convention

The National Alliance of Television and Electronic Service Associations held its first annual convention at the Conrad Hilton Hotel in Chicago recently. Organized about a year ago in Washington, D. C., NATESA now numbers sixteen member associations.

Associations which affiliated with NATESA during the convention included the following: Associated Radio & Television Service Dealers of Columbus, Ohio, represented by J. P. Graham; Television Service Engineers, Inc., of Kansas City, Mo., represented by Wade Williams, president, J. B. McDowell, secretary, Ray Crawford, treasurer, and members Donald Day, M. Thomason, Mac Metoyer, and Walter Niswonger; California TV Service Dealers Association, Inc., of Hollywood, Cal., represented by Joseph M. Robin, general manager; Certified Television Electronics Association of Baltimore, Md., represented by Selman M. Kremer, vice-president; Radio Service Dealers Association of Kansas, Inc., of Wichita, Kas., represented by Bill Nichols, chairman of the board, Ted Combs, president of the Wichita Chapter, and W. A. Rosenberg, executive state secretary; and the Radio Television Service Association of Minneapolis, Minn., represented by John W. Hemack.

In selecting their officers for the coming year, the Associations' delegates re-elected Frank J. Moch, president, James O. Hustad, secretary, and Bertram L. Lewis, treasurer. Regional officers elected included the following: Russell J. Cummings, eastern vice-president; Milton Klarsfield, eastern secretary; Joe McMillian, central vice-president; J. B. McDowell, central secretary, and Joseph M. Robin, western vice-president.

The following were selected by their own associations to serve as directors of NATESA: Arthur Rhine, New York, N. Y.; Joseph Lauinger, Brooklyn, N. Y.; Walter Ferry, East Orange, N. J.; J. Palmer Murphy, Paterson, N. J.; Don Kresge, Baltimore, Md.; William Nichols, Wichita, Kan.; John W. Hemack, Minneapolis, Minn.; J. P. Graham, Columbus, Ohio.

National headquarters for the National Alliance of Television and Electronic Service Associations is in Chicago, Ill. Information concerning its program may be obtained by writing to Frank J. Moch, President, NATESA, 5908 Troy Street, Chicago 29, Ill.

Progress of Philadelphia Committee

The Joint Electronics and Radio Committee on Service in Philadelphia—better known as the JERCS Committee—recently announced the formation of the sub-committee that is to study and recommend a technical educational program that will fulfill the requirements outlined by the sub-committee comprised of members of the Philadelphia radio and television service associations.

In its report, the service sub-committee made the following recommendation: "Prepare and make generally available a technical education program for the service industry, without regard to brand names, seeking only that all technicians, contractors, and servicing dealers have every opportunity to keep abreast of the new tech-

Six Months from Today Which will YOU hold?



ADD TECHNICAL TRAINING TO YOUR PRACTICAL EXPERIENCE

GET YOUR FCC LICENSE IN A HURRY!

Then use our Amazingly Effective
JOB-FINDING SERVICE

Get this Valuable Booklet **FREE**



TELLS HOW YOU CAN GET A
FREE TELEVISION
ENGINEERING
COURSE

TELLS HOW —

WE GUARANTEE

TO TRAIN AND COACH YOU AT HOME
IN SPARE TIME UNTIL YOU GET

YOUR FCC LICENSE

If you have had any practical experience—Amateur, Army,
Navy, Radio repair, or experimenting.

TELLS HOW —

Employers make

JOB OFFERS Like These to Our Graduates Every Month

Letter, October 11, 1951, from Chief Engineer, Broadcast Station, North Carolina, "Need men with radiotelephone 1st class licenses, no experience necessary. Will learn more than at average station for we are equipped with Diesel Electric power, transmitting and studio equipment."

Telegram, October 2, 1951, from Chief Engineer, Broadcast Station, Wyoming. "Please send latest list available first class operators. Have November 10th opening for two combo men."

These are just a few samples of the job offers that come to our office periodically. Some licensed radioman filled each of these jobs . . . it might have been you!

HERE'S PROOF FCC LICENSES ARE OFTEN SECURED IN A FEW HOURS OF STUDY with OUR Coaching AT HOME in Spare Time.

Name and Address	License	Lessons
Lee Worthy 22 0 1/2 Wilshire St., Bakersfield, California	..2nd Phone..	..16
Clifford E. Vogt Box 1018, Dania, Florida	..1st Phone..	..20
Francis X. Forch 38 Beuler Pl., Bergenfield, New Jersey	..1st Phone..	..38
Sgt. Ben H. Davis 317 North Roosevelt, Lebanon, Illinois	..1st Phone..	..38
Albert Schoell 110 West 11th St., Escondido, California	..2nd Phone..	..23

CLEVELAND INSTITUTE OF RADIO ELECTRONICS

Desk RN-38, 4900 Euclid Bldg., Cleveland 3, Ohio

February, 1952

TELLS HOW —

Our Amazingly Effective JOB-FINDING SERVICE

Helps CIRE Students Get Better Jobs

Here are a few recent examples of Job-Finding results:

GETS CIVIL SERVICE JOB

"Thanks to your course I obtained my 2nd phone license, and am now employed by Civil Service at Great Lakes Naval Training Station as an Equipment Specialist."

Kenneth R. Leiser, Fair Oaks, Mtd. Del., McHenry, 111.

GETS STATE POLICE JOB

"I have obtained my 1st class ticket (thanks to your school) and since receiving same I have held good jobs at all times. I am now Chief Radio Operator with the Kentucky State Police."

Edwin P. Healy, 264 E. 3rd St., London, Ky.

GETS BROADCAST JOB

"I wish to thank your Job-Finding Service for the help in securing for me the position of transmitter operator here at WCAE, in Pittsburgh."

Walter Koschik, 1442 Ridge Ave., N. Braddock, Pa.

GETS AIRLINES JOB

"Due to your Job-Finding Service, I have been getting many offers from all over the country, and I have taken a job with Capital Airlines in Chicago, as a Radio Mechanic."

Harry Clare, 4537 S. Drexel Blvd., Chicago, Ill.

Your FCC Ticket is recognized in all radio fields
as proof of your technical ability

OURS IS THE ONLY
HOME STUDY
COURSE WHICH
SUPPLIES FCC-
TYPE EXAMINA-
TIONS WITH ALL
LESSONS AND
FINAL TESTS.

Get All 3 FREE

MAIL COUPON NOW

CLEVELAND INSTITUTE OF RADIO ELECTRONICS
Desk RN-38 — 4900 Euclid Bldg., Cleveland 3, Ohio
(Address to Desk No. to avoid delay)

I want to know how I can get my FCC ticket in a minimum of time. Send me your FREE booklet, "How to Pass FCC License Examinations" (does not cover exams for Amateur License), as well as a sample FCC-type exam and the valuable booklet, "Money-Making FCC License Information."

Tell me how I can get your Free Television Course.

NAME

ADDRESS

CITY..... ZONE..... STATE.....

Paste on penny postcard or send air mail

SAVE UP TO 95% SENSATIONAL SURPLUS VALUES!

274-N & ARC-5 EQUIPMENT RECEIVERS

BC-946B. 550 to 1600 KC New **\$35.00**
 3-6 MC. Used. Originally \$30. NOW **\$19.95**
 6-9 MC. Used... **\$19.95**
 1.5-3 Megs. New **\$34.95**



TRANSMITTERS

T-22 ARC-5, 7-9 Megs Used xint. **\$14.95**
 M07-ARC5 Modulator Plate and Screen for T23ARC5 with Dynamotor **\$15.00**
 T-21 ARC-5, 7-9 MC. New. Orig. \$40. Now **\$8.95**
 5-7 MC. Used **\$5.95**
 4-5 MC. Used. Orig. \$30.00. Now **\$5.95**
 T-19 ARC-5, 3 to 4 Megs. Now **\$16.95**
 R-23 ARC-5, 190 to 550 KC, Loop or Straight wire antenna input **\$19.95**
SPECIAL: For any Receiver purchased with any Transmitter, Discount \$1.00.

HI-VOLTAGE OIL CONDENSERS

1 Mfd 25 KV	\$49.50
1 Mfd 10 KV	4.00
1 Mfd 6 KV	1.95
.65 Mfd. 12.5 KV	12.50
.25 Mfd. 20 KV	25.00
.3X.3 Mfd. 7.5 KV	5.00

TEST EQUIPMENT

TS-3	APR-1
TS-10	A-58
TS-12	A-60
TS-13	
TS-16	ASD or AIA Watt & Wavemeter
TS-19	CS-60ABW, SWR Unit, CS-60 ABS
TS-34	Oscilloscope CS-60ABX
TS-45	BC-376 IE-56
TS-51	BC-725 LS-1
TS-57	BC-90 LU
TS-69	BC-906 20A-1
TS-74	GR-P496 BC-221AK
TS-75	I-124 BC-1016
TS-127	I-144 Triplett 1183 Tube Tester
TS-170	I-198 Espy 105 Tube Tester
TS-202	RC-252
TS-226	I-223 LZ

VHF SETS

- ARC-5, complete with control boxes. Price on Request.
- ARC-4 with tubes less dynamotor. Xint. condition **\$30.00**
- SCR-222, complete. Price on request.

APN-4 ACCESSORIES. Consists of cables assembled to plugs, antenna switch, FT446 and FT447. Now **\$15.95**

EXPORT INQUIRIES INVITED!

We carry an unusually large stock of Airline Equipment, Test Equipment, Radar Sets, etc. Write for our low prices and complete information. Complete shop facilities for testing, repairing and overhauling.

IMPORTANT!
 Send 30% deposit. All merchandise and prices subject to prior sale or change at any time.

WANTED! BC-611 HANDIE-TALKIES, ART-13

Also Any Surplus Electronic Gear, Test Equip., Parts or Assoc. Equip. Prompt Replies—Top Prices Paid!

FM EQUIPMENT

• **TRANSMITTERS**
 924 4-Channel 27-39 megs. 25 watts ECHO oscillator 40 KC swing. 12 dy **\$25.00**

BC-684 27-39 megs. 25 watts 10-Channel Xtal controlled with DM-35 Dynamotor for 12 V. **\$39.00**

• **TRANSCEIVERS**
 Portable FM. Operates on 6V DC. 34MC. Alum. case with antenna relay. Xmt. uses 1073, 125 KC xtal in osc stage (1C7), 4 abibs & 1 fin. amp. (HY65) Revr is superhet, xtal controlled, osc. at 8060. Transmitter power furnished by Carter 400 V. @ 200 MA. Gene-

motor. Receiver powered by Vibropack. Includes control box, French phone hand set, 8" speaker, extra mike. Complete **\$45.00**
25 WATT FM TRANSCEIVER
 30-40 megs. xtal controlled. Superhet. recvr. built-in squeelch circuit. Uses 815 tube in final 6D2K input. Uses 2 dynamotors: one for revr (250V @ 90 MA) and one for transmitter (300 V 100 MA). Uses 19 tubes, all metering jacks & tuning adjustments for final amp. on front panel. Made by REL. Model 565A. Used. Less crystal & bottom cover, but with all tubes **\$55.00**

Visors 1-152. New **\$2.00**
 FL-30 AUDIO FILTERS. Newly mfgd. (quantities avail.). **\$17.50**
BC-620 FM TRANSCEIVER & PE 120 VIBROPACK
 20 to 27 Megacycles. Xtal Controlled. Part of SCR-509. Includes PE-120 Vibrator Power Supply Battery Case, Shock Mounting. For 6V or 12V operation. Used, but in excellent condition **\$29.50**

NEW STANDARD BRAND CHOKES

SWINGING CHOKES		SMOOTHING CHOKES			
HY MILS	OHMS	PRICE	VOLTAGE	CASE	WT.
8-10	175	100	2.75	3KV	Closed 3.5
8-30	200	80	1.25	3KV	Closed 4.5
5-25	200	100	4.50	2KV	Closed 5
5-25	300	90	1.15	5KV	Closed 18
8-25	300	80	5.95	5KV	Open 8 1/2
3-25	500	60	12.95	7KV	Closed 28
8-40	1 amp	50	39.95	10KV	Closed 58

HY MILS	OHMS	PRICE	VOLTAGE	CASE	WT.
5	500	600	4.55	2KV	Closed 4
7	150	200	1.25	2KV	Open 2
10	500	60	12.55	7KV	Closed 28
12	300	80	5.15	5KV	Closed 9
12	400	400	6.55	2KV	Closed 15
15	200	120	2.45	3KV	Open 4.5 lbs.
20	400	80	5.55	4KV	Closed 9 lbs.
20	400	85	6.55	5KV	Closed 11 lbs.
1 1/2 Series	175	95	5.95	2.5K	Closed 15
4 Paral.	350	24			
26 Series	200	112	6.95	3.5K	Closed 15
6.25 Parallel	400	28			

VHF RADIO & ELECTRONICS SUPPLY

DEPT-R-30, 2033-37 W. VENICE BLVD. LOS ANGELES 6, CALIFORNIA

nical developments and employers are adequately supplied with trained personnel."

Members of the Technical Education Advisory Panel include the following: Bernard Bycer, of *Perfect TV Service*; J. C. Campbell, of *Edmar Communications*; Gene Castroville, of *Raymond Rosen & Co.*; Alvin H. Fisher, of *Motorola-Philadelphia*; Edwin T. Stark, of *Fairhill Products*; Herbert Carson, of *ABC Appliance Co.*; Sol Cutler, of *Sentinel Laboratories*; George Rincoe, of *Emerson Radio of Penna.*; Joseph Whalen, of *Inter-State Television*; Harry White, of *Louis J. Smith Co.*; William C. Hart, of *Ogontz Service Co.*; T. W. Hopson, of *Don Havens TV Service*; Thomas Jones, of *Bergdoll's, Inc.*; Joseph Margusity, of *Phillips Service*; and Albert Wilensky, of *Gewurtz-Stern Co.*

Detroit TCSA to Sponsor Program

The Television Contractors Service Association of Detroit, Michigan, has invited radio and television service groups throughout Michigan to join with them in initiating a program of industry cooperation along the lines of the JERCS plan in Philadelphia, according to J. J. Barton, President of the Detroit Association.

TV IN TURIN

By R. ZAMBRANO
 Torino, Italy

WITHOUT fanfare, television transmissions have been going forward on an experimental basis at Turin, Italy during most of 1951.

The standard adopted, after the pattern set by the European C.N.T.T. Council, is 625 lines, 25 frames-per-second, interlaced, and with negative modulation. A slightly modified 6th channel was used with a video carrier frequency of 82.25 mc. and a sound carrier of 87.75 mc. The video bandwidth is 5 mc. The transmitter is a General Electric 5 kw. unit which has been installed on a hill in Turin. The superturnstile antenna is mounted atop a 240-foot steel tower which is 2000 feet above sea level.

Studios for RAI are located in Turin and are linked to the transmitter site by a u.h.f. relay operating at 2000 mc. The photograph, Fig. 1, shows one of the pictures received on a Motorola "F" receiver. The picture was taken during an RAI transmission with a 35 mm camera, with an f 3.5 lens, at an exposure of 1/5 second.

Fig. 1.



SENSATIONAL VALUE!

#630 SUPER 30 TUBE CHASSIS
 Mfr. Licensed under R. C. A. Patents

Complete with 20" first quality tube AND Beautiful hand-rubbed Mahogany Console Cabinet. COMPLETE PRICE **\$259.95** slightly higher with full doors



the latest 1952 model with all the newest electronic improvements...
 • peak sensitivity for fringe areas
 • synchrolock tuning
 • keyed A G C
 • 15,000 volts under load
 • 12-inch RCA speaker
 • can be adapted to color & UHF
 • high quality parts

A set—NOT A KIT
 Completely wired, Factory Engineered, aligned and tested. RMA Guaranteed

1 YEAR GUARANTEE ON TUBE
 A half-hour to mount; ready for operation. Saves up to \$150.

Compare this anywhere for high quality—low price!
 Write Dept. F for further information. Phone and mail orders filled on receipt of money order for 25% as deposit... the balance C.O.D., f.o.b. N. Y.

NEW ENGLAND TELEVISION CORP.
 75 CHURCH STREET NEW YORK, N. Y.

Attractive Low Cost Easily Installed



For Multiple Apartment, Homes, Hospitals

Here's a low-cost intercom louvre, complete with pushbutton, that will satisfy the most exacting customer, yet keep your installation time and costs down to a minimum!

The Lowell Model C3 is a flush-mounting louvre stamped from 16-gauge steel equipped with pushbutton, and finished in white. Dimensions: 7" x 4 1/2".
 The Lowell Model CB3X is a heavy steel box with 3/4" knockouts, used with the C3 louvre for protection of the speaker. All hardware furnished, for mounting plate to box. Dimensions: 4" wide x 6" high x 2" deep. Finished in Zinc Chromate.

LOWELL MANUFACTURING CO.
 Mfrs. of Lowell Speaker Baffles—"Heard Everywhere"
 3030 Laclede Station Road Maplewood 17, Missouri
 Canadian Representative: ATLAS RADIO CORPORATION LIMITED
 560 King Street W., Toronto, Ontario

Aluminum Foil Beam
(Continued from page 55)

measure a little over 16 feet so that by picking out the longer ones they will be long enough for the driven element and the reflector. If they cannot be bought they may be made out of good 2 x 2 pine stock, rounding the corners with a draw knife and finishing up with a plane. Square elements might work just as well although this was not tried. There was very little sag in the elements as shown in the photograph.

After determining the exact spacing the poles may be nailed to the edge of the 1 x 4 supports. As an additional precaution they should also be tied to the supports with a piece of strong wire. Cross bracing between the 1 x 4 supports would give more rigidity to the structure but didn't seem to be needed in the writer's case. The braces, if used, should be 2½ feet apart.

There was some concern at first whether this type of construction would stand up in a strong wind but it has weathered one severe storm and came through without a mishap.

The 1 x 4 supports were nailed to a piece of 1 x 6, 2½ feet long, using 20 penny nails. Another piece of 1 x 6 the same length was beveled on the ends and nailed to the first piece at a 90 degree angle as shown in the diagram.

A piece of ¾ inch pipe was fastened to the beveled 1 x 6 by drilling holes in the pipe and running ¼ inch bolts through them. The end of the pipe fits in a hole in the top piece of 1 x 6. A metal brace made of ½ inch strap iron held the two pieces of 1 x 6 rigidly at right angles. In this way the pipe was very rigidly secured to the beam. All of the wood was painted with wood filler to make it waterproof.

A "T" match was made of the same pole material and covered with aluminum foil. It was about 2 feet long and lay between the 1 x 4 supports. Soft aluminum straps about 1½ inches wide were made to connect it to the driven element and keep the units about two inches apart. These straps may be moved to give a better impedance match and reduce the standing wave ratio. Two other straps of the same material were fastened near the center of the "T" match and spring type binding posts were mounted on them for connecting to the 300 ohm line.

Any of the conventional systems for supporting and turning the beam may, of course, be used. I happened to have a chimney that was no longer in use so the pipe was run down through the inside of it and turned in the fireplace. Sometimes the simplest method is to run the pipe through the roof of the shack.

With the present day scarcity of aluminum this aluminum foil beam may be able to solve your problem as it did mine, and if the XYL has a couple of rolls on hand in the kitchen and no ducks to bake you will not even need to make a trip to the dime store. —30—

TEK-FILE

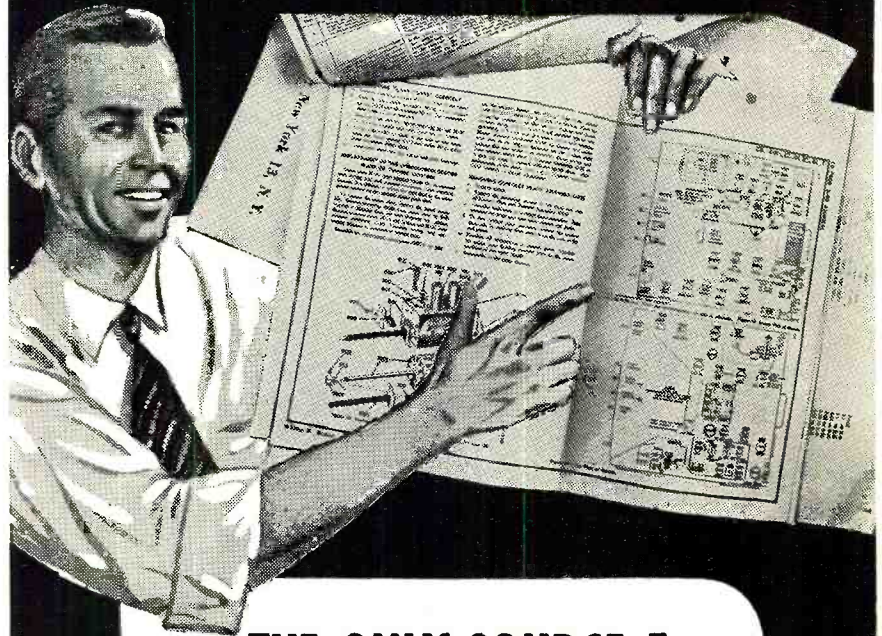

THE ONLY SOURCE For *Exact* SERVICING DATA

Make your servicing job faster — easier — and more profitable by using the new Tek-File: The only monthly service that gives you complete, factory-authorized data which exactly matches the set you're working on.

You buy only what you need — when you need it. Each Tek-File pack has at least 128, 8½ x 11" pages bound in one or more file folders — containing *complete* servicing data for the manufacturer's sets you specify. Easy to file, easy to use in shop or field.

THE MAN WHO USES
RIDER TEK-FILE — MANUALS
MAKES MORE MONEY.

See your jobber today.



JOHN F. RIDER

PUBLISHER, INC.
480 Canal St., N. Y. 13, N. Y.

METER BARGAINS

3" RD 0-20 ua dc.	\$14.95	3" RD 0-300MA dc.	\$4.50
4" SQ 0-50 ua dc.	12.95	3" RD 0-500 MA dc.	4.50
3" RD 0-1 MA dc.	4.90	3" RD 1000MA dc.	4.50
3" RD 0-5MASpScale	2.25	2" Aircraft 0-30 A.	1.98
3" SQ 0-50MASpSc'e	4.50	3" RD 30-0-30 Adc.	5.50
3" RD 0-100MA dc.	4.50	2" RD 0-150 VAC.	4.95
3" RD 0-200MA dc.	4.50	3" SQ -10+6DB	14.50
2" SQ 0-3 VDC&2"SQ 0-100 ADC with shunt.	both 1.99		
3" RD JBT Freq. meter 30F,	48-52&58-62 cycles.		14.50

TUBE BARGAINS

5U4G\$.65	6AU6\$.62
5Y3GT49	6BC567
5Z490	12AU667
6AL555	12AU782
6AK585	12BE660

All tubes standard brands, guaranteed.
Write for prices on other types.

MULTIMETER

5000 ohms per volt. 3" meter, 24 ranges, only 5 7/8" x 3 1/16" x 2 1/4"
4 DC MIL RANGES 0/0.3/6/30/150.
4 DC VOLT RANGES 0/6/150/300/1500.
4 ohms ranges 0/2K/20K/200K/2 meg.
4 AC VOLT RANGES 0/6/30/150/600.
4 OUTPUT RANGES 0/6/30/150/600.
4 DB RANGES -6/+10/+8/+24,+22/+38,+34/+50.



Complete with battery, test leads & 90 DAY GUARANTEE

\$15.95

OIL CAPACITORS

3mf 330VAC4/31.00	8mf 1KVDC\$2.50
14mf 330VAC3.45	8mf 1KVDC3.95
2mf 600VDC75	4mf 1.5KVDC2.95
4mf 600VDC89	16mf 1.5KVDC6.95
8x8mf 600VDC2.75	2mf 2KVDC1.95
10mf 600VDC1.95	2mf 3KVDC3.95
50mf 600VDC9.95	4mf 4KVDC10.50
2mf 1.5KVDC1.85	1mf 7.5KVDC99
2mf 1KVDC1.25	300MFD 3V Elect.39

CHOKES

9 HY 90 MA, 100 Ohm.\$.99
7 HY 125 MA, Cased.1.49
10 HY 150 MA, 140 Ohm.1.69
6 HY 200 MA, Cased.3.15
4-18 HY 200 MA, 140 Ohm, Cased.1.95
15 HY 250 MA, 65 Ohm, Cased.3.49
5-25 HY 300 MA, 120 Ohm, SW. Ch., Cased.6.50
8 HY 300 MA, Cased, 85 Ohms.5.00
6 HY 450 MA, 30 Ohm, Cased, Hermet. Seal.8.50
6 HY 500 MA, Cased.5.95
7 HY 700 MA, 15 Ohm, Cased.11.50
3-90 HY 500 MA, SW. Ch., Cased.7.95
3.5 HY 950 MA, 25 Ohm, Cased.11.50
7 HY 1 Amp, Cased.29.50
2-16 HY 1 AMP, SW. 45 Ohm.37.50
6 HY 1.5 A, Cased.42.50

115V FILAMENT TRANSFORMERS 60 CY

2.5 VCT 10A, Cased.\$1.49
2.5 VCT 10A, 10 KV Insulation, Cased.4.50
2.5 V @ 6A, 2.5 V @ 6A, Cased.3.45
5 V @ 3A, 2.5 KV Insulation2.95
5 V @ 3A, 6.3 VCT @ 3.5A2.95
5 VCT 12A, 2.5 KV Insulation.5.95
5 VCT 20A, 2.5 KV Insulation.6.85
2.3 VCT 1A, 2 KV Insulation.1.99
6.3 VCT 3A, 2.5 KV Insulation.1.99
6.3 V @ 4A, 6.3 V @ 4A, Cased.2.50
6.3 V @ 6A, 6.3 V @ 6A2.50
6.3 VCT @ 6A, 2.5 KV Insulation.3.00
6.3 V @ 10A, Cased.2.95
10 VCT 10A, 2.5 KV Insulation3.95
24 V 1A, 2 KV Insulation3.95
32 V 1Amp, 2 KV Insulation.1.95

115V POWER TRANSFORMERS 60 CY

68 to 83 V Half Wave, 1.5A.\$1.25
300 V 20 MA (Half Wave)\$1.25 ea.; 2/ 1.75
435 VCT 145 MA, 6.3 V 3A, 5 V 3A2.49
680 VCT 250 MA, 6.3 V 3A, 5 V 3A2.75
700 VCT 90 MA, 6.3V 3A, 5 V 3A2.75
740 VCT 185 MA, 6.3 V 4A, 5 V 3A5.95
800 VCT 200 MA, 6.3 V 3A, 5 V 3A5.95
800 VCT 300 MA, 6.3 V 10A, 5 V 6A, 5 V 2A.9.50
750-600-0-600-750 VDC, 225 MA.9.95
5400, 3800, 6200 VCT 110 MA.9.50
2500 VDC 1A, Pr. 230 V 3ph 60 Cy.125.00

COMPONENT BARGAINS

Cramer Time Delay Relay, TD-120S\$14.95
SCR522 XMTR-RCV60.00
Plug in Relay 2000 ohm 2 MA SPDT2.95
5 Screw terminal strip (6/32 Screw)10/ 1.20
Barrier Strip, Yellow Bakelite, 6 term.10/ 1.50
9 pin min. wafer socket10/ .60
7 pin min. molded socket10/ .75
7 pin min. molded sock. base shield10/ .99
7 pin min. statite sock. base shield10/ 2.50
4 prong statite socket10/ 1.00
Octal sock. mica filled or Statite10/ 1.00
6 prong. MIP 6 socket10/ .85
1CA Phono Plug & Jack #2383-238510/ 1.50
1 1/2" Panel Binding10/ 1.50
7 ft. rubber line cord & mold. plug10/ 1.50
1" green 110V Pilot Light assembly35
SPST 6A 125V. H & H Bat Handle Togg. Sw.39
C-H Luminous tip bat handle Aircraft Togg. Sw.25
SPST 5A 125V.25
SPDT as above35
SPST as above, neutral only35
SPDT as above, neutral center49
SPST Rotary Switch, wafer type2/ .25
6 nos., Ceramic Rotary Switch5.99
Millen Flex. coup (39002)10/ 1.50
JK34 Jack (PL55) 18, JK33 (PL68)20
2 cell penlite bulbs (#222), 3V V.A.05
Grain of Wheat 3V bulb 5c, GE #57, 12V.05
Mazda S-6 115V 6W bulb10
STAFITE Plate Caps-807 17c, #4621
Johnson 210 sock. #5c, #11 sock.85
4" Sq. 0-100 ua DC10.95

POLY-TECH

919 Dawson St., New York 59, N. Y.
Tel. Murray Hill 6-2650

What's New in Radio

(Continued from page 88)

special plate stabilizing process and because the individual cells are matched to give uniformity within and between units. Tradenamed "Minisel," the new units are manufactured in all standard configurations, i.e., half-wave, center-tap, doubler, three-quarter bridge, and bridge. The individual cells are rated at 10 volts a.c. input and 5 ma. d.c. output but can be obtained with input ratings up to 26 volts a.c. and output current ratings up to 10 ma. d.c. for special applications.

NEW V.T.V.M.

The Electronic Measurements Company of Red Bank, New Jersey, has come out with a new vacuum tube voltmeter, the Model 161-A.

This new test instrument incorporates seven d.c. voltage ranges, six a.c. voltage ranges, resistance coverage from .1 ohm to 1000 megohms, and a single power level scale which covers from -10 db to +10 db.

The unit is housed in a metal cabinet

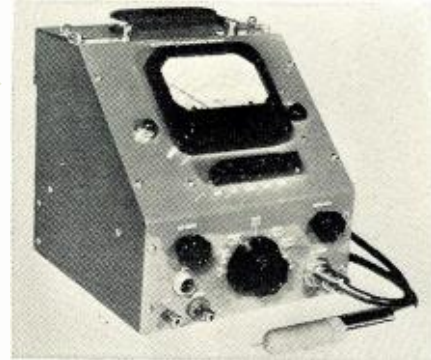

finished in dark grey wrinkle. It measures approximately 8 1/2" x 8" x 8", which includes a storage compartment for accessories. The Model 161-A weighs about 8 1/2 pounds with accessories.

SERVICE LIGHT

Columbia Wire & Supply Company of 2850 W. Irving Park Road, Chicago 18, Illinois is now marketing a new TV service light which has been especially designed with the technician's needs in mind.

The unit features a 7 watt, 110 volt bulb, a non-breakable reflector, a 6 foot cord with plug, and a rubber suction cup which holds firmly on any flat surface.

The light takes very little room inside the TV cabinet and throws the light where needed, leaving both hands free to work.

Each light comes boxed in a lightweight and durable container which can be used to carry the unit on service calls.

Additional information on this unit is available from the company.

SOLDERING GUN

Wen Products Co., 5806 Northwest Highway, Chicago 31, Illinois, has announced

the availability of a new low-cost soldering gun which has been designed to meet the needs of a wide range of users.

This transformer-type soldering device heats instantly when the trigger is pressed and cools when the trigger is released. A built-in spotlight illu-



minates the work, while a long tip permits reaching spots which would otherwise be inaccessible.

The unit is said to have ample reserve power for heavy duty or intermittent work in factories, repair shops, radio and television service establishments, or in home workshops.

INDUSTRIAL VIBRATORS

A complete new line of aircraft and industrial vibrator types has been recently introduced by the James Vibrapow Company of 4036 North Rockwell Street, Chicago 18, Illinois.

The new line is said to cover most aircraft and industrial replacement requirements. These components will supplement the company's line of communications vibrators.

Specifications on these new units are given in a new supplement catalogue, Form F529. Further information and a copy of the new catalogue are obtainable from the company on request.

REVERSIBLE STYLUS

In response to the demand by record collectors, the engineers at General Electric Company's Syracuse laboratory have designed a dual reversible sapphire and diamond stylus to permit

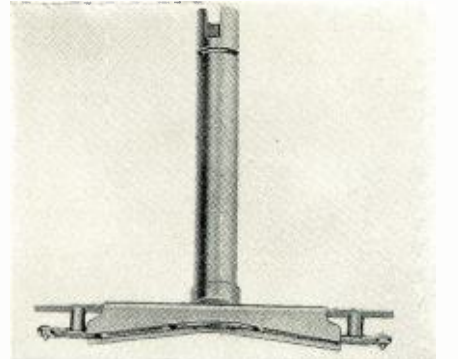

the playing of all three record speeds with equal fidelity and without the necessity of changing cartridges.

Designated the Model RPJ 013, the new stylus employs the sapphire for standard and the diamond for 33 1/3 and 45 rpm records. A simple twist of



We're Chopping Prices Way Down With "Surprise" Trade-In Allowances On Your Used Test and Communication Equipment.

hallicrafters

RECEIVERS



HALLICRAFTERS S-38B
Shpg. wt. 14 lbs.
Only \$49.50



HALLICRAFTERS S-76
Shpg. wt. 44 lbs.
Only \$169.50

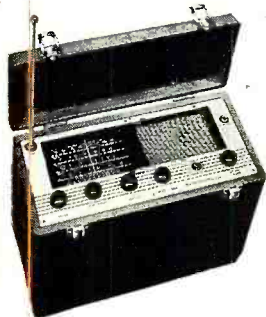

HALLICRAFTERS S-72
Shpg. wt. 16 lbs.
Only \$109.95



HALLICRAFTERS SX-71
Shpg. wt. 51 lbs. Only \$199.50

HALLICRAFTERS S-40B
Shpg. wt. 32 lbs.
Only \$99.95

Constantly hacking away at high prices, Walter Ashe gives you bigger-than-ever "Surprise" Trade-In Allowances on your used (factory-built) test and communication equipment. This is your chance to save on that new equipment you've been wanting. Get your trade-in deal working right now. Wire, write, phone or use the handy coupon today.

FREE CATALOG!

164 value-crammed pages of everything in Radio and Electronics for Industry, Schools, Laboratories, Radio Stations, Service Technicians and Amateurs.

All prices F.O.B. St. Louis
Phone: Chestnut 1125

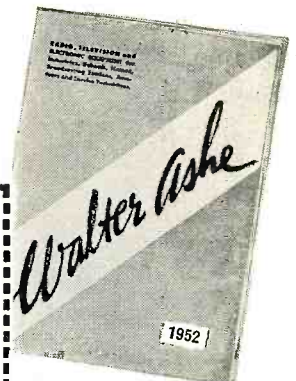

Walter Ashe Radio Co. RN-52-2
1125 Pine St., St. Louis 1, Mo.

O. K. Walter, Rush "Surprise" Trade-in-offer on my

for _____
(show make and model No. of new equipment desired)

Rush Free Copy of your new Catalog.

NAME _____ ADDRESS _____

CITY _____ Zone _____ STATE _____

Walter Ashe
RADIO CO.
1125 PINE ST. • ST. LOUIS 1. MO.

for dependable sound, I DUST Y relies on ATLAS



DR Double-Reentrant Projectors



Paging & Talk-Back Speakers



ALNICO-V-PLUS Driver Units



Dual Speakers



FULL-GRIP, VELVET-ACTION Mike Stands



Radial Driver Unit Projectors



Super-Power Driver Units



Loud Speaker Support Stands



the readily-accessible positioning knob will place either the diamond or sapphire in playing position without moving the cartridge or arm.

The new unit is designed to be used with the G-E RPX 047 and RPX 050 variable reluctance cartridges. No weight adjustment or compensation is needed and the tracking pressure is constant at from six to eight grams.

MINIATURE CONDENSERS

Erie Resistor Corporation of Erie, Pennsylvania, has introduced a new

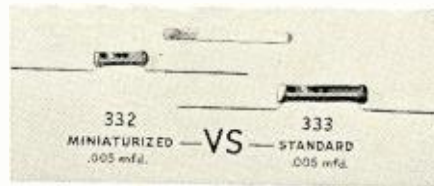

line of miniaturized ceramic condensers which have been tradenamed "GP3 ceramicons."

These units employ a high dielectric constant ceramic material which permits capacitance values as high as .002 μ fd. on a basic $\frac{1}{8}$ " x $\frac{3}{8}$ " long tube and .005 μ fd. on a $\frac{1}{8}$ " x $\frac{5}{8}$ " long tube. Baked enamel, clear lacquer, dipped phenolic insulation, or low-loss molded phenolic insulation are available.

A data sheet giving complete information on these units may be obtained from the company.

R.F. ATTENUATOR

A new r.f. attenuator which is suitable for use by radio and television engineers, technicians, and service personnel has been introduced by *Jerrold Electronics Corporation*, 26th and Dickinson Streets, Philadelphia 46, Pa.

The new unit, designed for 72 ohm input and output matching over the 0-250 mc. range, provides attenuation in any value from 0 to 82 db by a simple "in" and "out" switching arrangement. The attenuator is accurate within 1% at the maximum attenuation, according to the company. The feed-through insertion loss is less than .5 db at 250 mc.

The instrument is currently available in two models, the A-72 for use with RG-59/U cable and the A-72X for use with RG-11/U cable. Both models are supplied with appropriate chassis connectors and two male cable connectors.

BINDING POST

Kings Electronics Company, Inc., 40 Marbledale Road, Tuckahoe, New York, is marketing a new and improved binding post, the Model K952.

The unit utilizes the quick-discon-

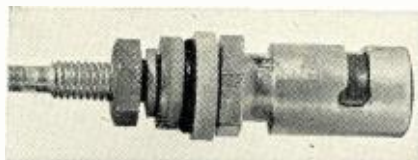

nect principle with spring loaded action and stainless steel locking jaws. "Teflon" insulation throughout provides low dielectric loss, no moisture absorbance, no carbon tracking, and

SURPLUS

FEBRUARY SPECIALS

DUAL VARIABLE MIDGET CON-DENSER, 35 mmfd. per section... **\$1.49**
50 watt Birnback tube sockets... 95c each
3" round Weston A.C. volt meters; Model 476, 0 to 150... \$5.95 each
Removed from new surplus equipment.
PL 68 covers only. NEW... 5c each
6 ft. cord with PL 55 plug. NEW... 59c
Head phones, high impedance (Used. Good condition.) HS23, etc. \$1.69
250 ft. rolls phosphorus bronze ship-type antenna wire. Seven strands #18. NEW... \$6.95 roll
2 MFD 600 volt D.C., G.E. 23 F 47 Pry-nol. NEW... \$7.95
90 MFD 120 volt A.C., 3 phase G.E. 26 F 68; Pry-nol. NEW... \$7.95
Edwards Lung Buzzers, Type O. #15, 12 volt. Works on 6 V D.C. NEW... 69c each
VERTICAL ANTENNA MASTKIT fully adjustable to 35 ft. Easy to setup for Fringe Area FM, Television or Rotary Mast Beam. NEW. \$12.95
WESTON #476-3" RD-0-150 V-A.C. Removed FM New Surplus. Guar. \$5.95 each

30 amp plug fuse, house type. All new. **A WONDERFUL BUY. 100 for \$3.00**

15 amp 3AG fuses.....	100 for \$2.00
50 amp 5AG type HBR.....	100 for 2.95
40 amp 5AG type HBR.....	100 for 2.95
40 amp 4AG type.....	100 for 2.95
35 amp 4AG type.....	100 for 2.95
20 amp 4AG type.....	100 for 2.95
15 amp 4AG type.....	100 for 2.95
10 amp 4AG type.....	100 for 2.95
1 amp 4AG type.....	100 for 2.95
4 amp 3AG type.....	100 for 2.00
1 amp 3AG type.....	100 for 2.00
1/2 amp 3AG type.....	100 for 2.00
275 amp HJR type.....	100 for 2.95
70 amp HBR type.....	100 for 2.95
70 amp ACL type.....	100 for 2.95

ANTENNA INSULATOR

A specially designed insulator that provides great tensile strength. NEW..... 10 for 60c

Open circuit jacks.....	10 for \$1.50
JK 26 and PL 54.....	per set 49c
3 AG fuse post.....	25c each
4 AG fuse post.....	25c each
3 AG type HJM.....	25c each
30 ft. hook-up wire.....	10c

1000 ft. of 2 cond. twisted stranded wire. \$4.50

2 MFD 600 volt oil condensers, rnd. can. 89c ea.

LUMINOUS PAINT KIT. For Dusting, Painting or Mixing. GLOWS IN THE DARK. 79c ea.



MUELLER CLIP JUMPER

Complete, ready to use. Two No. 21-A clips and 14" of insulated wire. Packed 10 in a box. BRAND NEW..... 19c each; lots of 10, \$1.50

J41A Telegraph Keys. NEW.....	\$0.89 each
J5A Telegraph Keys. NEW.....	.95 each
J38 Telegraph Keys. NEW.....	1.25 each

8 x 8 x 8 MFD, 4 x 8 MFD 600 V., D.C. SPRAGUE CONDENSER. Bargain. New. \$4.95

FILAMENT TRANSFORMERS, 110 V., 60 cycle input, output 9, to 13. V. in 1 V. steps. Output rated 3 amps. New..... \$1.89

G.E. SOLENOIDS, 14 V., D.C., 25 ohms. Mycalex arm, many applications. New..... \$.98

NEW TUBES BOXED

304TL Tubes. NEW	837	1.55 ea.
Eimac	8N17	.89c ea.
3BP1 Tubes. Guaranteed	6W4GT	.69c ea.
	12A6	.89c ea.
	12SN7GT	.89c ea.
6SN7GT New. 79c; 4/ 3.00	6AL5	.79c ea.; 4/ \$3.00
6AK5 .. \$1.19 ea.; 5/ 5.00	11D5	\$.109 ea.; 4/ 4.00
201E .. 1.19 ea.; 5/ 5.00	3HP7	.39c ea.
1629 .. .35c ea.	1625	.59c ea.; 4/ 2.00
471A .. .29c ea.; 4/ 1.00	1626	.59c ea.; 4/ 2.00
HY615 .. .29c ea.; 4/ 1.00	1629	.39c ea.; 4/ 1.20
803 .. .39c ea.	1K873	\$.25 ea.; 4/ 4.00
2121A .. 8.95 ea.	15E	1.49 ea.; 4/ 4.00
15E .. 1.49 ea.	861	\$.19.95 ea.
860 .. .49c ea.		

POWER RHEOSTATS

Standard Brands: 5 Ohms; 100 Watt; 4.48 amps
100 Ohms; 100 Watt; 1.0 amp.

Boxed, Brand New with Knob \$2.50 each—or \$25.00 per Dozen.

Write us for your meter wants. Over 3,000 in stock. Write for Our 16-Page Bulletin.

DOW RADIO, INC.

1759 E. Colorado St. Pasadena 4, Calif.
PHONE: SYcamore 3-1196
\$1.50 min. order. 25% deposit with orders
Send full remittance to save C.O.D. charges
All merchandise fully guaranteed. Subject to prior sale.

the maintenance of mechanical properties in the binding post temperature application range of 67 to 149 degrees F.

Complete moisture sealing is effected on the chassis itself by a special "Teflon" and rubber combination. Color coded removable rubber caps can be provided for identification and personnel protection. The unit is silver plated to the base, which is a chessman type for easy soldering.

R.F. PROBE

Precise Development Corporation, Oceanside, Long Island, New York, is now offering a new low-cost r.f. probe to the trade.

The Model 912 incorporates a time-tested circuit which is housed in a specially constructed, non-porous case and uses a germanium crystal rectifier for measurements through 250 mc. The probe handle is terminated in an Am-



phenol connector while the other end of the RG-59/U shielded cable may be ordered with an *Amphenol*, phone plug, or phone tip type of fitting.

Complete information on this new probe is available from the company direct.

TRAINING AID

Of interest to schools and organizations concerned with radio-electronic instruction is the new electronic visual training aid recently introduced by the *United Radio-Television Institute*, 237 Washington Street, Newark 2, New Jersey.

Known as the Model 101, the unit features a 17 x 22 inch display board on which a completely operating receiver is wired in such a way as to provide easy measurement of voltages, tracing of circuits, etc. It also incorporates a basic signal generator, condenser checker, test speaker, etc. to aid in the repair and troubleshooting of defective radio receivers.

The unit is available in kit form and comes complete with an illustrated instruction manual and a cable containing most connecting wires—color coded for easy assembly. The training aid is also available factory-wired at additional cost.

PORTABLE MIXER

Developed to meet the need for a quality broadcast mixer for field use in AM, FM, and TV remote pickup, the new Model 220A portable mixer just released by *Altec Lansing Corporation*, 9356 Santa Monica Boulevard, Beverly Hills, California, is also suitable for use with public address systems.

Designed for high fidelity mixing,

the world's toughest transformers

wear these exclusive one-piece drawn-steel cases



THE ONLY COMPLETE*, VERSATILE LINE WITH TOUGH SEALED-IN-STEEL CONSTRUCTION**

When tougher transformers are made, CHICAGO makes them—in rugged, streamlined drawn-steel cases that provide the fullest enclosure and protection, that look well with other modern electronic components and enhance the appearance of the equipment. The exclusive CHICAGO one-piece drawn-steel case (no seams or spot welds) is the strongest, toughest type of mechanical construction. Further, the one-piece design provides a continuous electrical and magnetic path which means better electrostatic and magnetic shielding. Seamless construction assures maximum protection against adverse atmospheric conditions—means longer, more dependable transformer life.

Whether your transformers must pass the most rigid MIL-T-27 specifications or are intended simply for average, normal applications, it's wise to choose CHICAGO "Sealed-in-Steel" Transformers (the world's toughest) for that extra margin of dependability under all operating conditions.

***COMPLETE.** There's so CHICAGO "Sealed-in-Steel" unit for every application: Power, Bias, Filament, Filter Reactor, Audio, MIL-T-27, Stepdown, Isolation—all in one-piece, drawn-steel cases.

****VERSATILE.** Available in 3 constructions to meet most requirements—a type for every application.

H-Type. Steel base cover is deep-seal soldered into case. Terminals hermetically sealed. Ceramic bushings. Stud-mounted unit. Meets all MIL-T-27 specs.

S-Type. Steel base cover fitted with phenolic terminal board. Convenient numbered solder lug terminals. Flange-mounted unit.

C-Type. With 10" color-coded stripped and tinned leads brought out through fibre board base cover. Flange-mounted unit.



SEND FOR "NEW EQUIPMENT" TRANSFORMER CATALOG

Have the full details at your fingertips on CHICAGO'S New Equipment Line—covering "Sealed-in-Steel" transformers designed for every application and geared to today's circuit requirements. Write for your copy of this important catalog today, or get it from your electronic parts distributor.

CHICAGO TRANSFORMER

DIVISION OF ESSEX WIRE CORPORATION

3501 ADDISON STREET • CHICAGO 18, ILLINOIS

WORLD'S FASTEST SELLING VOLT-OHM MILLIAMMETER

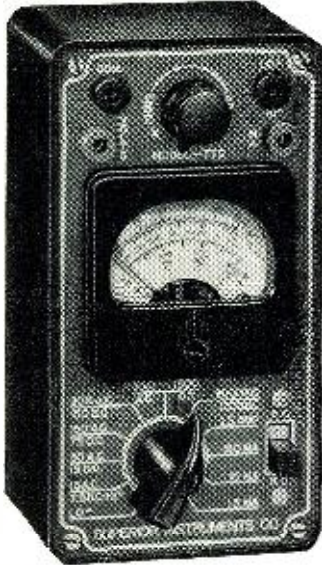

Model 770
is an accurate pocket-size V.O.M.
Measures only 3 1/2" x 5 1/2" x 2 1/4"

Write Dept. RN-2 for catalog of complete line.



Manufactured and Guaranteed by
SUPERIOR INSTRUMENTS CO.
227 Fulton Street • New York 7, N. Y.

Sensitivity
1000 ohms per volt

- ★ Uses latest design 2% accurate 1 Mil. D'Arsonval type meter.
- ★ Same zero adjustment holds for both resistance ranges. It is not necessary to readjust when switching from one resistance range to another. This is an important time-saving feature never before included in a V.O.M. in this price range.
- ★ Housed in round-cornered, molded case.
- ★ Beautiful black etched panel. Depressed letters filled with permanent white, insures long-life even with constant use.

The Model 770 comes complete with self-contained batteries, test leads and all operating instructions. **\$14.90 NET**

- Specifications:**
- 6 A.C. VOLTAGE RANGES: 0-15/30/150/300/1500/3000 Volts.
 - 6 D.C. VOLTAGE RANGES: 0-7.5/15/75/150/750/1500 Volts.
 - 4 D.C. CURRENT RANGES: 0-1.5/15/150 MA., 0-1.5 Amps.
 - 2 RESISTANCE RANGES: 0-500 Ohms 0-1 Megohm.

AT YOUR PARTS JOBBER

this compact unit incorporates two 1410A dual preamplifiers with individual volume controls for four microphone inputs, a 1440A line amplifier, a master volume control, a 30A power supply, and a large 4" vu meter.

It can be operated from a.c. power or external battery supply. Available in-

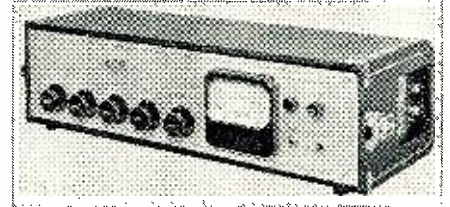

put impedances are 30, 150/250, or 500/600 ohms, and a selection of output impedances of either 125 or 600 ohms is provided through a selector switch. The gain of the system is 80 db, with a maximum output level of +18 dbm at less than 1% harmonic distortion.

The mixer is housed in a black luggage-type case which measures approximately 23" long, 6" wide, and 12" high and weighs 27 pounds.

TEST LEADS

Insuline Corporation of America, 3602 35th Avenue, Long Island City 1, New York, is in production on a new set of extra long-handled test leads which have been especially designed to speed up and simplify circuit probing in complicated radio and television chassis.

Eight inches long and made of polished hard rubber, the handles are fitted with short, sharp-pointed tips which minimize the possibility of short-circuiting adjacent connections. The flexible leads are of kinkless wire 48

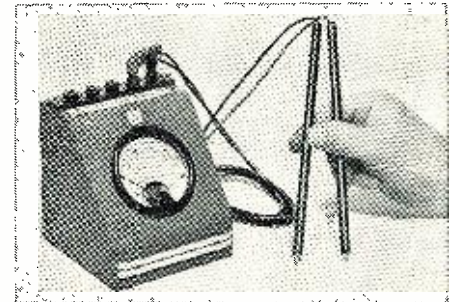

inches long, have standard phone tips, and can be used with practically all types of test instruments.

Distribution of these leads, Catalogue Number 329, is being handled by regular jobbers.

PORTABLE TAPE RECORDER

Full-scale production is underway at Amplifier Corp. of America, 398 Broadway, New York 13, New York, on the company's new "Magnemite" battery-operated portable tape recorder-playback unit.

Weighing only 9 3/4 pounds and measuring 1 1/2 x 8 1/2 x 5 1/2 inches, the new unit incorporates a high gain amplifier which requires no preliminary warm-up and will pick up a normal speaking voice 100 feet from the microphone.

The recorder operates from self-con-

It's...
KESTER
FLUX-CORE
SOLDER



IN DEMAND

IN DEMAND and used by the manufacturers of original equipment... Best for you, what could be better... Kester Rosin-Core, "Resin-Five" and "Specialized" Solders!

KESTER SOLDER COMPANY
4235 Wrightwood Ave., Chicago 39
Newark 5, N. J. • Branford, Can.



"ALNICO MAGNET SPECIAL" . . . Round Bar . . . \$.49
134x8
ALNICO CHIP MAGNETS (approx. 30/20) . . . 1.50
Irregular shapes; each a permanent magnet -
15 per ounce.lb.
ALNICO MAGNET KIT 1.98
"U", Rod, etc. 10 assorted 1.98

Leotone RADIO HARDWARE

TREASURES 2.95
LB. of Nuts, Screws, Lugs, Washers, etc. 69c

GUN SYNC. CONTROL BOX (Fairchild Mk3) 2.95
A "Gold Mine" of new Toggle, Relay, Fuses.

PORTABLE METAL UTILITY BOX, 6x6x6 3/4"69
Hinged lid

"CABINET SPECIALS" Sturdy wood; slide dials
Type "A" - Ivory. Inside: 10 1/4 x 6 5/8 x 5 1/2. Dial: 1.49
Type "B" - Mahog. Inside: 17 x 8 1/4 x 10 1/4. Dial: 2.49
Type "C" - Mahog. Inside: 14 1/4 x 6 3/4. Dial: 1.95
Type "D" - MIDGET CABINET & CHASSIS, Pol Walnut, Ideal for Radio, Amplif, Osc. Inter-com. Test Eqpt, etc. Inside: 7" x 5 1/2" x 4" 1.49
Fused 4 mini-tube chassis. Set

!!SWITCH SPECIALS!! DPDT BAT TOGGLES (AHH) . . . 6A/125V. Sgls. hole mtg. Lug terms. 49c 12/5.49
ROTARY SWITCHES 5A/125V. 6 pos. 1/2" shaft 3 pos. Dp or 6 pos. Sp either 39c 6/1.98
DPDT FLUSH PLATE BAT TOGGLE (C-H8715K2) . . . Lum. tip, screw lugs. 1 3/4" mtg. holes 59c 6/3.25

HEARING AID PARTS MIDGET OUTPUTS for 50B5, 35B5, etc. to V.C. (3/4" x 1 1/2") 49c 6/2.49
MIDGET AUDIO CHOKES (3/4" x 1 1/2") 4500 ohms DC 49c 6/2.49
HEARING AID AMPLIFIER (2 tube) 49c 6/2.49
A REAL VEST POCKET RADIO adding simple tuner, (1/2" x 2 1/2" x 3 1/2"). WITH SCHEMATIC FOR 2 OR 2 TUBE SET! 2.49
HEARING AID TUBES set of 2 for above 2.98
HEARING AID BONE CONDUCTION RECEIVER 1/2" x 3/4" x 1 1/2" Exc. MUSICAL CONTACT MIKE, DETECTORPHONE, MINI. SPIR. low impd. 2.49

VARIABLE CONDENSERS four 250 mmf sects. 7 1/2" x 3" x 2 3/4". Silver plated, 1/2" shaft 1.29
3 GANG SUPERHET VARIABLE 3 1/4" x 1 3/4" x 1 1/2"98
220V/110V STEP-DOWN BALLAST 60 watt. Plugs in std. line receptacle. 5 1/4" x 1 7/8" 1.39
MIDGET PLUG & JACK PL-291/JK-48. 39c 6/1.98
H5-33 HEADSET 10-imped; 5 ft. cord & PL-55 2.49
"POLYSTYRENE" 12" lgtbs. ROD: 1/4" 10c; 3/8" 20c; 5/8" 36c; 3/4" 52c; 7/8" 79c; 1" 106c
TUBING (OD): 1/4" 10c; 3/4" 12c; 1/2" 17c; 5/8" 23c; 3/4" 27c; 1" 36c; 1 1/2" rubber eye-pieces79
#20 PUSH-BACK WIRE Red, Yel, Blue or Blk. 100 ft.89
1" AMBER JEWEL ASS'LY DC. buy base 39c 6/1.98
H.F. FIDELITY CRYSTAL HAND MIKE hi-impd. Moulded bakelite case & 6 ft. cable 3.95
RADIO GRILLE CLOTH Beautiful patterns & colors Sizes 9x9 to 12x24. 10 asstd. 2.95
JK PLUG & JACK PL-291/JK-48. 39c 6/1.98
8 WATT POTENTIOMETER 2000 ohms. Mould, bakelite, w.w. O.D. 3" x 1 3/8" 5.00
DIRECT FACTORY SPEAKER 4" AIR Write for FREE "SPEAKER PARTS MANUAL" Min. Order \$3.00. Only 20% deposit req. on all C.O.D.'s. Full remittance with foreign orders. Please add sufficient postage-excess refunded.

EGTONE RADIO CORP.
67 Day Street
New York 7, N. Y.

BE AN EXPERT

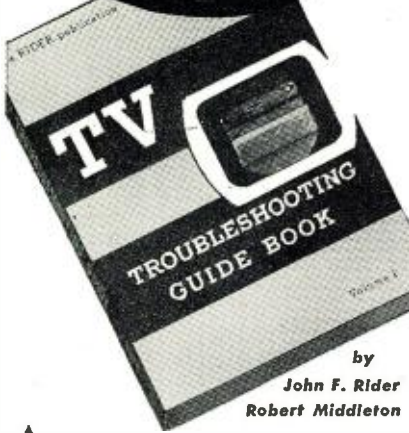

by
John F. Rider
Robert Middleton

A new, practical, easy-to-use book for the TV service technician. It tells you how to spot receiver troubles and correct them. Contains factual information right from the manufacturer, things you must know to be a TV troubleshooting and repair expert. The contents include: explanation of split-circuit and intercarrier receivers, circuit variations and how they affect operating waveforms, simplified TV receiver troubleshooting by scope and picture tube screen display analysis, remedies for circuit troubles, rapid methods of alignment and recognition of alignment problems. Not a theory book—but a practical, down-to-earth troubleshooting and repair guide.
200 pages, 8½" x 11", durably bound.....\$3.90

ENCYCLOPEDIA ON CATHODE-RAY OSCILLOSCOPES AND THEIR USES

By John F. Rider and Seymour D. Uslan



This practical book tells you everything you should know about an oscilloscope! WHAT it is — what it can do... and HOW to use it properly! They say — "Invaluable," S. F. Patton, General Mgr. Allen B. DuMont Labs., Inc. "... most elaborate treatment..." F. E. Smolek, Service Mgr., Zenith Radio Corp. "... most complete..." Radio Television Service Dealers.
992 pp., 8½" x 11", durably bound, \$9.00

FIRST SUPPLEMENT RECEIVING TUBE SUBSTITUTION GUIDE BOOK

By H. A. Middleton



An indispensable addition to your service library. Illustrates 650 completely new AM-FM-TV tube substitutions with socket wiring instructions.
48 pp., 8½" x 11"\$3.99
FIRST EDITION — 225 pp., 8½" x 11".....\$2.40

MAIL THIS COUPON — TODAY!

JOHN F. RIDER, Publisher, Inc. Dept. RN 2
480 Canal St., New York 13, N. Y.

Please send me book(s) checked. I understand, if not satisfied, I may return them within 10 days and receive full refund.

TV TROUBLE SHOOTING GUIDE BOOK, \$3.90
 ENCY. ON C-R SCOPES AND USES, \$9.00
 RECEIVING TUBE SUB. GUIDE, \$2.40
 1st SUPPLEMENT, \$3.99

NAME..... (PLEASE PRINT)
ADDRESS.....
CITY.....ZONE.....STATE.....



tained dry batteries which last 100 hours without replacement at an operating cost of less than 2½ cents an hour. At a tape speed of 1½ inches per second with a frequency response to 3000 cycles, two full hours of re-



ording time can be accommodated on a single 5 inch reel of standard ¼ inch sound recording tape.

Playback is accomplished through crystal earphones. An external power amplifier and speaker may also be connected to the output terminal. An auxiliary playback unit, complete with amplifier and speaker, is available separately.

TEST INSTRUMENT

Electronic Measurements Corp., 280 Lafayette St., New York 12, New York, has added a new test unit to its line of such instruments.

The Model 106 vacuum tube voltmeter is specially designed for field alignment of radio and television sets. It is completely electronic on all functions and ranges and has five a.c.-d.c. and ohms ranges. Featuring a 1½ volt range for both a.c.-d.c. volts, this instrument is housed in a molded bakelite case that measures 7¼ x 5¼ x 2½ inches, which weighs three pounds.

FM RECEIVERS

The Hallicrafters Company, Fifth and Kostner Avenues, Chicago 24, Illinois, has recently introduced two new civic patrol FM receivers, the Models S-81 and S-82.

Designed to cover police, fire, bus, truck, private telephone, forestry, and



other industrial bands operating either in the 30 to 50 mc. or the 152 to 173 mc. range, the new sets use a selenium rectifier and six tubes in a superheterodyne circuit. Both units can be operated either from 105 to 125 volt d.c.

QUALITY TESTED TUBES

New and guaranteed in stock now; many others not listed—complete line of receiving tubes at low prices. In ordering tubes listed below, you may also order types not listed, at about same prices. Submit your requirements on any types for our quotation. Call us on Westinghouse and other types of industrial and special-purpose tubes.

OA2 . . . \$1.15	6BH6 . . . \$.80	12AV6 . . . \$.55
OB2 . . . 1.25	6BQ6GT90	12AY7 . . . 2.75
OZ465	6C465	12BA670
1A7GT95	6CB670	12BA790
1B3GT85	6CB685	12BE670
1N2180	6CD6G . . . 1.75	12BH7 . . . 1.00
1N21B . . . 3.50	6F798	12SH795
1N2385	6FG98	12X1775
1N23A . . . 2.50	6HG75	12SK775
1N23B . . . 3.75	6J5GT55	12SL775
1N3468	6J6 . . . 1.00	12SQ775
1R565	6J795	25BQ6GT . . .98
1U465	6K6GT79	25L6GT65
2B775	6K775	35C560
3A485	6K880	35Z6GT55
3A5 . . . 1.10	6L798	50C560
3D655	6R890	50L6GT60
3Q455	6SA775	8060
35490	6SF585	304TL . . . 11.50
5FP7 . . . 1.95	6SG798	304TH . . . 11.50
5U4G59	6SH770	403-A75
5V4G . . . 1.00	6SK775	90W.E.) 1.75
5X4G85	6SL7GT75	717-A98
5Z395	6SN7GT70	8071.65
6AB475	6SQ775	8137.75
6AC798	6T8 . . . 1.25	866-A . . . 1.65
6AJ5 . . . 1.65	6U4GT80	95545
6AK595	6V6GT60	95637
6AK6 . . . 1.00	6V6M . . . 1.50	161675
6AL555	6W4GT80	1524 . . . 1.40
6AG585	6X445	162540
6AH6 . . . 1.50	6X5GT45	162640
6AN5 . . . 4.95	7A680	162930
6AU665	7H780	5686 . . . 3.95
6AV655	12A675	591075
6B4G . . . 1.25	12C885	900444
6B670	12CB75	9005 . . . 1.50
6BE670	12AT7 . . . 1.00	900644
6BG6G . . 1.20	12AU775	VR-105 . . 1.25

SELENIUM RECTIFIERS

Current (cont.)	FULL-WAVE BRIDGE TYPES			
	18/14 Volts	36/28 Volts	54/40 Volts	130/100 Volts
1 Amp.	\$1.98	\$1.98	\$1.98	\$1.98
2 Amps.	\$2.40	3.75	\$6.95	\$10.50
4 Amps.	3.85	7.00	9.00	11.00
6 Amps.	5.65	9.00	11.00	13.00
10 Amps.	8.95	10.95	11.00	14.00
12 Amps.	7.50	14.00	11.00	15.00
20 Amps.	13.25	20.50	11.00	16.00
24 Amps.	14.00	26.00	11.00	17.00
30 Amps.	19.00	30.00	11.00	18.00
36 Amps.	25.50	35.00	11.00	19.00

All our Rectifiers are new & Guaranteed one year. We manufacture special types of rectifiers and rectifier supplies to your specs. . . . FAST DELIVERY.

- Selenium Rectifier Specials
110 V., ½ Wave 65 ma. . . . only 59c each
110 V., ½ Wave 450 ma. . . . only \$1.65 each
- New, Selenium Rectifier Transformers
PRI: 110V, 60 cycle in. } 4 Amps. . . \$ 7.75
SEC: 18, 24, and 36 } 12 Amps. . . 14.75
Volts } 24 Amps. . . 33.75
Designed for Bridge or Center-Tap use—Not Surplus.
- 110 V. PRI.—36 V. @ 50 Amp. SEC. \$39.95
• 110 V. PRI.—5 V. @ 190 Amp. SEC. 85.00

3"	4"	5"	6"	8"	10"
PM Speakers—New, Boxed.	Imported English Hi-Fi Speakers				
\$1.60	\$1.65	\$1.75	\$3.50	\$4.50	\$5.50
12"	5.95 (RCA)	10"			

Electrolytic Condensers

All Guaranteed Fresh Stock		Lots of 10	
20 x 20—150 v.	50 x 50—150 v.	20 x 20—150 v.	50 x 50—150 v.
\$3.39	\$3.70	\$3.39	\$3.70
\$3.70	\$4.00	\$3.70	\$4.00
\$4.00	\$4.30	\$4.00	\$4.30
\$4.30	\$4.60	\$4.30	\$4.60
\$4.60	\$4.90	\$4.60	\$4.90
\$4.90	\$5.20	\$4.90	\$5.20
\$5.20	\$5.50	\$5.20	\$5.50
\$5.50	\$5.80	\$5.50	\$5.80
\$5.80	\$6.10	\$5.80	\$6.10
\$6.10	\$6.40	\$6.10	\$6.40
\$6.40	\$6.70	\$6.40	\$6.70
\$6.70	\$7.00	\$6.70	\$7.00
\$7.00	\$7.30	\$7.00	\$7.30
\$7.30	\$7.60	\$7.30	\$7.60
\$7.60	\$7.90	\$7.60	\$7.90
\$7.90	\$8.20	\$7.90	\$8.20
\$8.20	\$8.50	\$8.20	\$8.50
\$8.50	\$8.80	\$8.50	\$8.80
\$8.80	\$9.10	\$8.80	\$9.10
\$9.10	\$9.40	\$9.10	\$9.40
\$9.40	\$9.70	\$9.40	\$9.70
\$9.70	\$10.00	\$9.70	\$10.00

- CARTER 6 Volt Dynamotors Brand New—400 VDC @ 375 ma. List Price \$71.40. Your Cost—Special. . . . \$28.00
Also 500 VDC @ 250 MA.—6V Dynamotor @ 33.00
- TV "Cheater" Cord—6 Ft. Complete. U.L. App'd. Reg. net 59c. Special.39c
- ART-1—75 meter DeLuxe Mobile AM XMTR. Complete. (Built-in Pwr Supply). New @ \$25.00
- AR-II—Complete Radio Station in a Suitcase! Superhet RCVR and 35 watt CW XMTR. 110 and/or 220 VAC Supply Built-in. 4 thru 16 Mcs. New. Write for Details.
- 300 ohm quality Twinlead. Pure Poly. 55 Ga. #20 wire. All tinned strands. New. 1,000 Ft. Roll \$20.00
- RG 59/U—73 ohm CO-AX Cable. New. 1,000 Ft. Roll \$55.00

BARRY ELECTRONICS CORP.
136 Liberty Street, N. Y. & N. Y. REctor 2-2563
Terms: 25% with order, balance C.O.D.—Send a few cents for postage—All merchandise guaranteed, F.O.B. N.Y.C.

or 50-60 cycle a.c. The dial is calibrated in frequency and type of service.

The S-81 operates in the 152 to 173 mc. range while the S-82 covers the 30 to 50 mc. band. —30—

Square-Wave Generator

(Continued from page 48)

somewhat unexpectedly if the wiring is carelessly arranged to include feedback loops between grid and plate, screen and plate, or grid and screen. This parasitic oscillation will be evidenced by a general instability of operation, and the tube output signal may change drastically, for example, if any of the tube socket terminals are touched by hand. Small resistors placed in series with the grid, screen, or plate circuits are generally sufficient to prevent such parasitics. The theory is simply that oscillation can occur only if the tube presents a negative resistance to its circuit as a result of regenerative feedback; the insertion of a positive resistance in series with the input circuit will cancel this effect. It should be borne in mind that this feedback may occur in the v.h.f. or u.h.f. region, where a small loop of wire together with tube inter-electrode capacitances may constitute an LC tank circuit of an oscillator.

Power Supply

The arrangement of tube circuits with respect to the power supply is perhaps somewhat unconventional. It was desired to operate all of the tubes at low voltage—on the order of 150 volts—in order to diminish the heat dissipation in the unit and to minimize the size requirements of the components. This consideration, together with the requirement of d.c. coupling between stages, led to a series arrangement of tubes across the power supply. The "B" supply furnishes approximately 325 volts at 55 ma. The two 6AG7's, in series with the supply, provide 175 volts drop to the regulated 150 volt portion of the supply, which operates the remainder of the tubes. A d.c. current flows through the 6AG7's, since each carries full current half the time. It will also be noted that the push-pull arrangement is used in all circuits of the generator, which prevents modulation of any part of the power supply by the square-wave.

The positive output terminal of the power supply is grounded in preference to the conventional "B—" connection, since the generator output is taken from the 6AG7 plates and it was desired to avoid the use of large blocking condensers to keep hot "B+" off the output terminals. It will also be seen that the 6.3 volt heater winding of the power transformer is returned through its center-tap to a voltage divider across the 0A2 regulator tube. The purpose of this connection is to set the d.c. heater-to-cathode voltage on all tubes to less than 90 volts, which is the maximum rating specified in the tube handbook. —30—

February, 1952

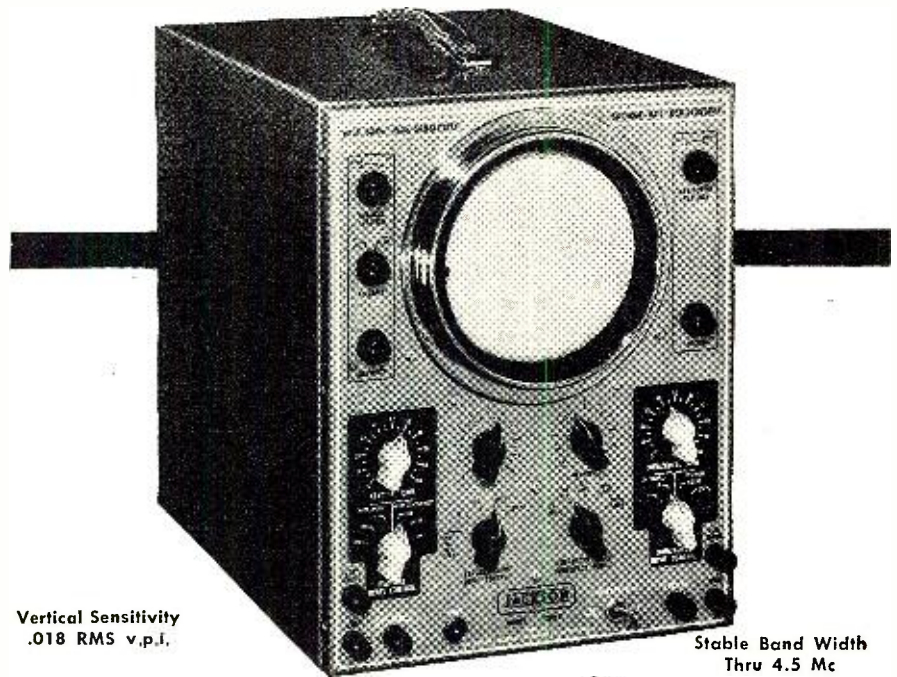

Vertical Sensitivity
.018 RMS v.p.i.

Stable Band Width
Thru 4.5 Mc

JACKSON Oscilloscope gives you "dual service"

This is a high-quality, laboratory-grade 5" Oscilloscope that provides the "dual service" of both high sensitivity and wide band width.

s p e c i f i c a t i o n s

Vertical Amplifier—Video-type frequency compensation provides flat response within 1.5 db from 20 cycles thru 4.5 Mc, dropping smoothly to a still useful value at 6 Mc.

Sensitivity Ranges—With a band width of 20 cycles thru 100 Kc, the sensitivity ranges are .018, .18, 1.8 RMS volts-per-inch. The wide band position 20 cycles thru 4.5 Mc has sensitivity ranges of .25, 2.5, 25 RMS volts-per-inch.

Horizontal Amplifier—Push-pull with sensitivity of .55 RMS volts-per-inch.

Input Impedances—Vertical: 1.5 megohms shunted by 20 mmfd. Direct to plates, balanced 6 megohms shunted by 11 mmfd. Horizontal: 1.1 megohms.

Linear Sweep Oscillator—Saw tooth wave, 20 cycles to 50 Kc in 5 steps. 60 cycle sine wave also available, as well as provision for using external sweep.

Input Voltage Calibration—Provides a standard voltage against which to measure

voltages of signal applied to vertical input.

Vertical Polarity Reversal—For reversing polarity of voltage being checked or for choosing either positive or negative sync. voltages.

Return Trace Blanking—Electronic blanking provides clear, sharp trace to prevent confusion in waveform analysis.

Synchronizing Input Control—To choose among INTERNAL, EXTERNAL, 60 CYCLE, or 120 CYCLE positions.

Intensity Modulation—60 cycle internal or provision for external voltage for intensity modulation uses.

Additional Features—Removable calibration screen—Accessory Model CR-P Demodulation Probe for Signal Tracing—All-steel, gray Ham-R-Tex cabinet. Total net weight only 26 pounds. Same height as other Jackson TV instruments: 13" H x 10 1/4" W x 15 1/8" D.

Prices: Model CR-2, Users' Net \$197.50. Model CR-P Probe, Users' Net \$9.95.

TWO OTHER FINE JACKSON INSTRUMENTS

Model 655 Audio Oscillator



Sine-wave 20 cycles to 200,000 cycles. Less than 3% harmonic distortion between 30 cycles and 15,000 cycles. Frequency calibration accurate within 3% or 1 cycle. Hum level down more than 60 db of maximum power output. Output impedances of 10, 250, 500, 5000 ohms or HI Z resistive output.

Model TVG-2 TV Generator



Sweep Oscillator in three ranges from 2 Mc thru 216 Mc, all on fundamentals. Reversible sweep direction. Sweep width variable .1 Mc thru 18 Mc. Marker covers 4 Mc thru 216 Mc. Crystal Oscillator to use as Marker or Calibrator. Video Modulation, from external source for using actual video signal for check, or for use with Audio Oscillator to produce bars for linearity checks.

See your electronics distributor for more information, or write

JACKSON ELECTRICAL INSTRUMENT CO. • DAYTON 2, OHIO

"Service Engineered" Test Equipment
IN CANADA: THE CANADIAN MARCONI CO.

Special Purchase FM Radio Chassis

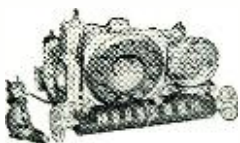

88-108 MC
Complete with 6 tubes. Built-in Antenna and Speaker. Product of Famous Radio & TV Manufacturer whose name we promised not to mention.

TUBE LINEUP
1-12BA7 1-1258
2-12BA6 1-35W4
1-35B5

Regularly \$29.95
Brand New

May also be used as an FM Tuner by picking signal off detector.

\$16.95

SPECIAL PURCHASE Record Changer Gen. Instruments 3-Speed Automatic

Reg. \$34.95
Brand New

\$19.97

With flip-over dual cartridge. Plays 33 $\frac{1}{3}$ -45 and 78 RPM records automatically.



NOTE: Do not send money for postage on above items—we ship best way—charges collect.

JUST ARRIVED!

EW LOT OF SURPLUS

BC 306A Ant Tuning units....	\$ 1.95
BC 706D Switch Boxes.....	.69
CD 716 Cords with PI-55 & JK-56	1.29
RL 42B Ant Reels.....	3.95
1-82A Radio Compass Indicator	3.95
12 GP7 Cathode Ray Tubes....	12.95
BC-347 Interphone Amp. Less Tube	2.95
BC-221T Freq. meters—brand new	125.00
26 MMF VAR Cond. 10 Space..	.99

LOW FREQ. XTALS-FT 241A

For SSB, lattice filter, etc. $\frac{1}{2}$ " spc. 54th or 72nd harmonic channels listed by fundamentals. Fractions omitted.

372 404 435 506	400 462	5910	2030 2442
374 405 436 507	440 463	6370	2045 2532
375 406 437 508	441 464	6450	2105 2545
377 407 438 509	442 466	6470	2125 2557
379 408 481 511	444 468	6497	2145 3202
380 409 483 512	446 469	6522	2155 3215
381 411 484 514	447 470	6547	2220 3237
383 412 485 515	448 472	6560	2258 3250
384 413 487 516	450 474	6610	2280 3322
385 414 488 518	451 475	7480	2282 3510
386 415 490 519	452 476	7580	2290 3520
387 416 491 520	455 477	7810	2300 3550
388 418 492 522	457 479	7930	2305 3570
390 419 493 525	459 480		2320 3580
391 420 494 526	461		2360 3945
392 422 495 530			2390 3955
393 423 496 531			2415 3995
394 424 497 533			2435
395 425 498 537			
396 426 503 538			
397 427 504			
398 429			
401 431			
402 433			
403 434			

SCR 522

Xtals
 $\frac{1}{2}$ " pins
 $\frac{1}{2}$ " spc.

5910	2030 2442
6370	2045 2532
6450	2105 2545
6470	2125 2557
6497	2145 3202
6522	2155 3215
6547	2220 3237
6560	2258 3250
6610	2280 3322
7480	2282 3510
7580	2290 3520
7810	2300 3550
7930	2305 3570
	2320 3580
	2360 3945
	2390 3955
	2415 3995
	2435

99c ea.
10 for \$9.00

SPECIAL
:00 Kc xtals
without holders
69c Each
for \$2.00

BC-610

Xtals
2 banana
pins
 $\frac{1}{2}$ " spc.

5910	2030 2442
6370	2045 2532
6450	2105 2545
6470	2125 2557
6497	2145 3202
6522	2155 3215
6547	2220 3237
6560	2258 3250
6610	2280 3322
7480	2282 3510
7580	2290 3520
7810	2300 3550
7930	2305 3570
	2320 3580
	2360 3945
	2390 3955
	2415 3995
	2435

99c ea.
10 for \$9.00

SPECIAL
:00 Kc xtals
without holders
69c Each
for \$2.00

HAM XTALS-FT 243 HOLDERS— $\frac{1}{2}$ " pin spc.

4190 6773 7840	1015 5773 6273 6540 7440 7650
5030 6873 7873	1129 5800 6306 6573 7473 7673
5485 6906 7906	2045 5806 6325 6575 7506 7706
6040 6973 7840	3735 5825 6340 6500 7540 7806
6073 7740 7973	5305 5840 6373 6606 7573 8240
6106 7773 8273	5677 5850 6406 6625 7606 8340
6125 7806 8306	5706 5873 6440 6640 7640 8400
6140	5725 5875 6450 6673
6173	5740 5906 6473 6706
6175	5750 5940 6475 6740
6206	5760 5973 6506 7340

49c Ea.
10 for \$4.50

99c Ea.
10 for \$9.00

Add 20c for each 10 xtals or less for postage and handling.

TERMS: All items F. O. B., Washington, D. C. All orders \$30.00 or less, cash with order. Above \$30.00, 25 per cent with order, balance C. O. D. Foreign orders cash with orders, plus exchange rate.

SUN RADIO
OF WASHINGTON, D. C.
938 F STREET, N. W. WASH. 4, D. C.

Crystal Diodes (Continued from page 64)

over-all detection efficiency. The circuit in Fig. 5B has been carefully designed to provide a bandwidth of not less than 4.0 mc. The component values have been chosen to work into an effective load capacitance of about 11 μmfd . The 9 to 10 μmfd . condenser should be a low tolerance component, or the tolerance should be on the low side rather than the high side so that the capacitance does not exceed 10 μmfd .; the additional 1 or 2 μmfd . is the shunt capacitance of the germanium crystal.

In this circuit the detector polarity is such that the demodulated video signal at the grid of the video amplifier is sync negative. There are good reasons for recommending this type circuit:

1. There is some noise limiting in the video amplifier by virtue of driving the tube to cut-off on the noise peaks.

2. The use of a d.c. coupled video amplifier between the detector and the picture tube preserves the d.c. component and eliminates the necessity for d.c. restoration. It is better to retain the d.c. than to block it with a condenser and then attempt to restore it.

3. This circuit presents a high quality picture with receiver simplification.

4. The use of the 1N60 provides improved response in the direction of white, better background illumination levels, excellent highlight detail, and improvement in the over-all gamma of the video system.

Fig. 7 shows static characteristics for the 6AL5, 1N34, and the 1N64 over a small voltage range near the origin of the curves. The following aspects of this graph are noteworthy:

1. The linear portion of the crystal curves extends to considerably lower voltage signal levels than the 6AL5 is able to achieve.

2. This improvement in linearity at low signal levels has the over-all effect of improving highlight detail.

3. The better the linearity the more

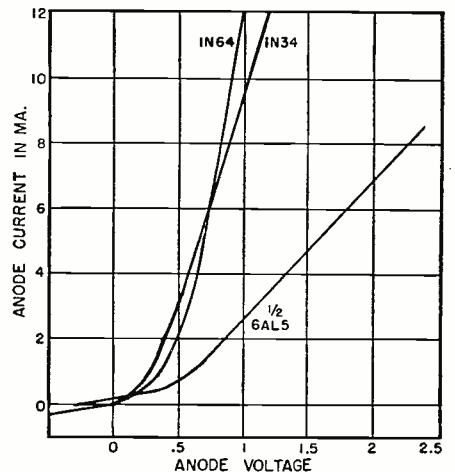

Fig. 7. Static diode characteristics graph. Note that the curve for the 1N34 and the one for the 1N64 go through the zero point for voltage and current on the graph and that the 6AL5 draws some current at the point of zero volts applied potential.

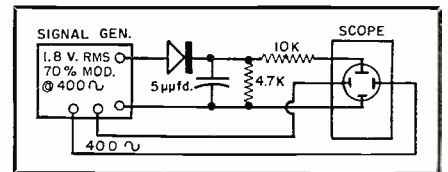

Fig. 8. Sylvania's test circuit for the 1N60.

reduction of amplitude compression in the direction of a white signal.

4. For small value signals, rectification efficiency of crystals is better with low values of load resistance than with any comparable 6AL5; it is possible to use higher load resistances with the crystal without sacrificing any element of picture quality.

Circuit Applications of the 1N64

General Electric has developed a special second detector diode, the 1N64. This was designed specifically for use as a second detector in television receivers. The physical characteristics of this diode are identical to those of the general purpose types. It is pri-

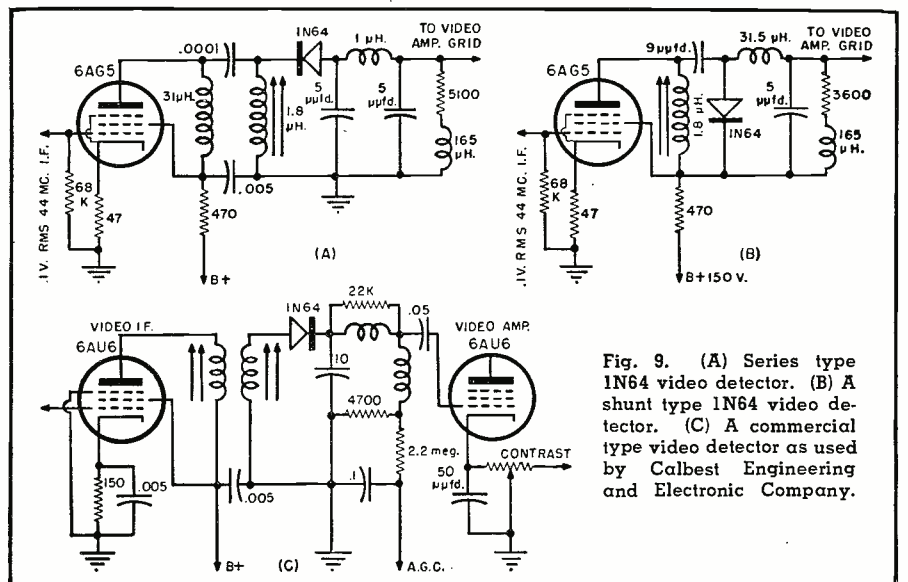
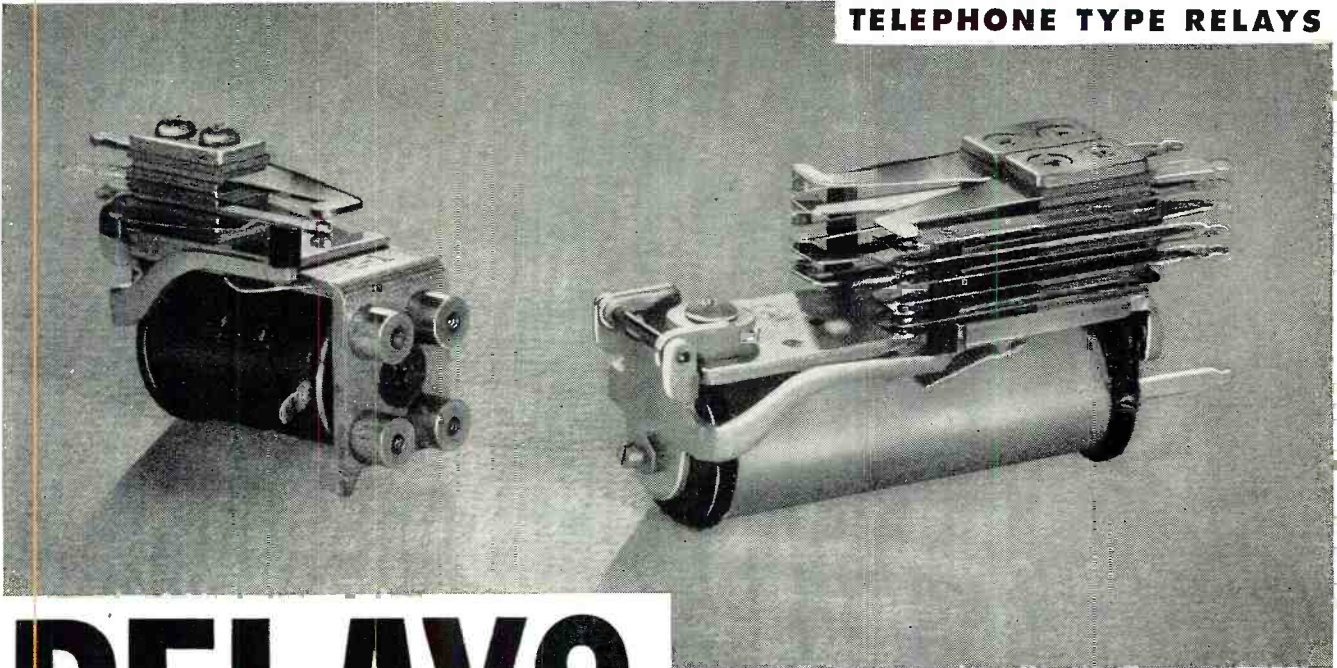

Fig. 9. (A) Series type 1N64 video detector. (B) A shunt type 1N64 video detector. (C) A commercial type video detector as used by Calbest Engineering and Electronic Company.

TELEPHONE TYPE RELAYS



RELAYS

This list represents only a small part of more than a million relays in our stock—one of the world's largest. All relays are standard, brand new in original packing, and fully guaranteed by Relay Sales. Send us your relay requirements. If the items are in stock we can make immediate delivery at substantial savings in cost to you.

SHORT TELEPHONE RELAYS

STK. NO.	VOLTAGE	OHMAGE	CONTACTS	UNIT PRICE
R-635	12 VDC	100	1C&1B	\$1.35
R-308	12 VDC	100	2C @ 4 Amps	1.85
R-343	12 VDC	100	1C	2.00
R-826	12 VDC	150	2C, 1B	1.55
R-770	24 VDC	150	1A/10 Amps	1.45
R-368	8/12 VDC	200	1B	1.40
R-771	24 VDC	200	1A/10 Amps	1.45
R-603	18/24 VDC	400	2A	1.55
R-575	24 VDC	500	2C	2.40
R-764	48 VDC	1000	1C&2A	2.00
R-417	5.5 ma	5800	2C	2.50
R-563	60/120 VDC	7500	1A	2/3.10
R-213	5/8 VAC 60 Cy.	2A	2.50
R-801	115 VAC	NONE	1.45
R-589	12 VDC	125	2A	1.30
R-113	12 VDC	150	4A	1.55
R-689	12/24 VDC	255	1C	1.55
R-799	24 VDC	500	NONE	1.00
R-115	24 VDC	500	1C	1.70
R-110	24/32 VDC	3500	1C	2/3.45
R-121	150 VDC	5000	2A&1C	2.05
R-122	150 VDC	5000	2C/Octal Base	2.50
R-634	150/250 VDC	6000	1A&1B	2.45
R-369	8/12 VDC	150	2A, 2B	1.60
R-908	6 VDC	15	4A @ 4 Amps	1.50
R-800	12 VDC	150	2C&1A	1.55
R-537	12/24 VDC	150	2C&1B	2.00
R-750	24 VDC	400	1A	1.60
R-367	10/16 VDC	195	2C	2.50
R-335	20/30 VDC	700	2A, 1C	2.00
R-366	30/120 VDC	4850	1C	2.50

STANDARD TELEPHONE RELAYS

STK. NO.	VOLTAGE	OHMAGE	CONTACTS	UNIT PRICE
R-806	115 VAC	900	1A	\$2.05
R-161	6 VDC	10	2B&1A	1.10
R-873	6 VDC	12	3C-3A MICALEX	3.00
R-305	12 VDC	50	2A Split Cerm.	1.35
R-360	24 VDC	200	1C	1.50
R-484	24 VDC	200	2A, 1C	1.35
R-337	24/48 VDC	1200	1A, 2B Split	2.65
R-101	24 VDC	1300	2A	2.50
R-868	30/162 VDC	3300	1C	1.90
R-365	52/162 VDC	3300	4C	3.95
R-518	85/125 VDC	6500	1C	3.60
R-918	52/228 VDC	6500	1C	3.60
R-852	52/228 VDC	6500	1C, 1A	3.00
R-341	75/228 VDC	6500	4C @ 4 Amps	3.65
R-633	180/350 VDC	10,000	1C @ 5 Amps	2.90
R-344	72/300 VDC	11,300	3A, 1B	2.45
R-332	100/350 VDC	40,000	2A	3.50
R-664	110 VAC	2B&1A/OCT. SOCKET	2.45
R-667	6 VDC	.75	1B/10AMP. 1A/3AMP.	1.45
R-632	6 VDC	12	5A&1C	3.25
R-154	6/12 VDC	200	1A	1.50
R-517	12 VDC	250	2A	1.50
R-116	85 VDC	3000	1B	3.05
R-631	100/125 VDC	3300	2A	1.90
R-545	110/250 VDC	7000	1C	2.40
R-124	300 VDC	12,000	1A	1.55
R-511	24 VDC	200	W/MICRO N.O.	3.05
R-160	6 VDC	12	3C&3A	3.00
R-851	52/228 VDC	6500	1C, 1A	3.00
R-591	6 VDC	40	1B&1C	1.35
R-155	12 VDC	100	4A&4B	1.45
R-520	200/300 VDC	14,000	2C	3.45
R-159	6 VDC	50	2A	1.35
R-158	6 VDC	50	4A Cerm.	1.85
R-381	6/8 VDC	100	1A Split	2.50
R-382	6/12 VDC	200	1B Split	2.50
R-153	12 VDC	200	1C&1A	1.55
R-304	12 VDC	200	4A Split Cerm.	2.50
R-383	6/12 VDC	500	1A Split	2.50
R-385	6/12 VDC	500	1B Split	2.50
R-384	6/12 VDC	500	3A Split	3.00
R-576	12 VDC	200	2A	2.50
R-316	24 VDC	200	1C	1.50

OTHER RELAY TYPES IN STOCK

- Keying Relays
- Rotary Relays
- Contactors
- Midget Relays
- Voltage Regulators
- Differential Relays
- Sealed Relays
- Special Relays

WRITE FOR CONTACT DATA

Manufacturers and Distributors:
Write for the new Relay Sales Catalog.

Telephone

Seeley 8-4146

833 W. CHICAGO AVE., DEPT. R, CHICAGO 22, ILL.



MATTISON SILVER ROCKET 630 CHASSIS With • TUNEABLE • BUILT-IN BOOSTER for Better DX Reception

Featuring **NEW Standard Coil Tuner** and **70° COSINE YOKE** for edge to edge focus!

Tube Complement:
28 tubes
3 rectifiers
1 CRT

32

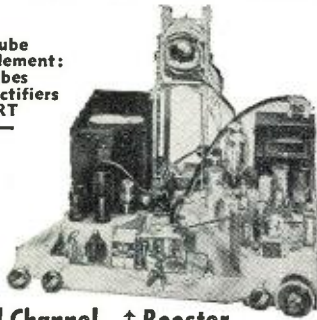

All Channel Booster

- Broad band—single knob control pre-amplifier built-in to eliminate long leads which may cause regeneration and attenuation of signal.
- **ONLY THE MATTISON 630 CHASSIS HAS AN ALL CHANNEL TUNEABLE BUILT-IN BOOSTER THAT INCREASES SIGNAL STRENGTH UP TO 10 TIMES. THE SILVER ROCKET WILL OUT-PERFORM ANY CHASSIS MADE AND IS PRICED RIGHT TO SELL FAST WITH AN EXTRAORDINARY MARGIN OF PROFIT FOR YOU. WRITE FOR CONFIDENTIAL PRICE SCHEDULE.**

ALL
CABINETS
MADE IN
MATTISON'S
OWN
CABINET
FACTORY!



The "Chinese Quadrille" is only one of 36 breathtaking cabinets.

FREE! Write for MATTISON'S merchandising portfolio explaining:
"THE MATTISON UNASSEMBLED PLAN"
and
"THE MATTISON \$1,000,000 FLOOR PLAN"



Write for the name of your MATTISON distributor nearest you. **NO OBLIGATION!**

Manufactured with integrity

Mattison Television & Radio Corp.
893 Broadway, New York 3, N. Y.

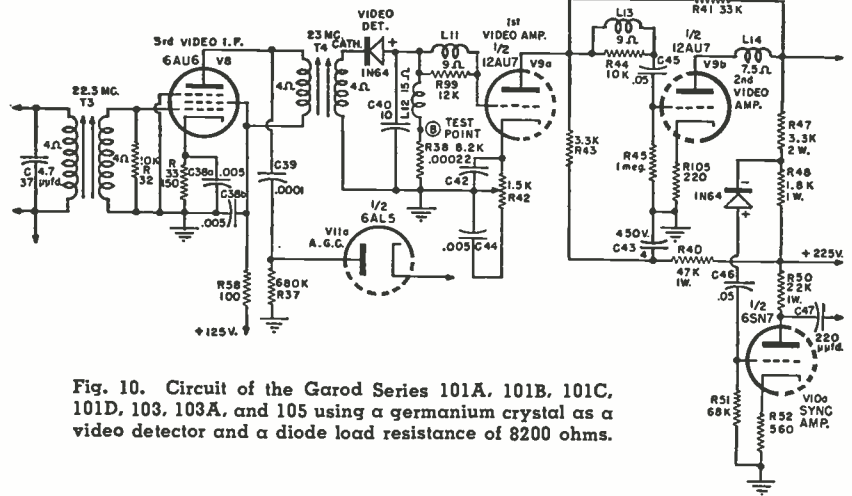

Fig. 10. Circuit of the Garod Series 101A, 101B, 101C, 101D, 103, 103A, and 105 using a germanium crystal as a video detector and a diode load resistance of 8200 ohms.

marily selected for maximum efficiency as a detector at high frequencies because only in this way can proper detection and uniformity be assured. The minimum d.c. output current in the circuit of Fig. 9B is 100 microamps, the peak inverse voltage is 20 volts, and the maximum shunt capacity is 2.0 μ fd. In addition, to assure uniformity of bandwidth, the diode is tested to have more than 50,000 ohms resistance at -1 volt and less than 4000 ohms resistance at +0.25 volt.

The schematic shown in Fig. 9B was designed to use a 1N64 germanium diode with the 44 mc. i.f., and this is the circuit used in most G-E model television receivers. The small size of the diode makes it possible to mount it inside the last i.f. can for maximum shielding. The 1N64 provides optimum efficiency in this shunt type detector circuit. The circuit components, 9 μ fd. condenser and the 31.5 microhenry coil, may be varied if it is desired to change the bandpass characteristic. Similarly, variations of the 5 μ fd. condenser and the 3600 ohm resistor will affect the video output as a function of the video frequencies.

Fig. 9A shows a series type detector circuit in which the low forward dynamic resistance of the 1N64 enables it

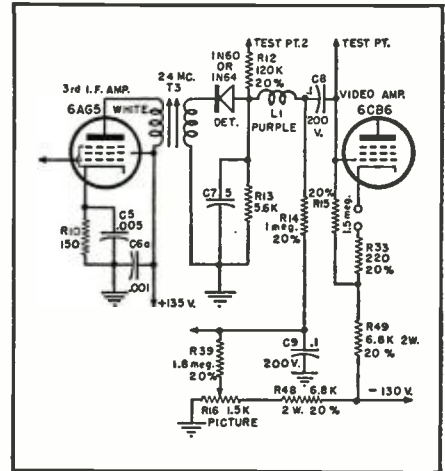

Fig. 11. The Teletone TAP-2-UL chassis.

to perform exceptionally well. Since any variation of the forward resistance of the diode will effect changes in the bandpass characteristic of the detector stage, the load resistance should be maintained relatively high with respect to the dynamic forward resistance of the diode for the purpose of minimizing variations in the bandpass. For this reason the components should be chosen with great care. Low tolerance

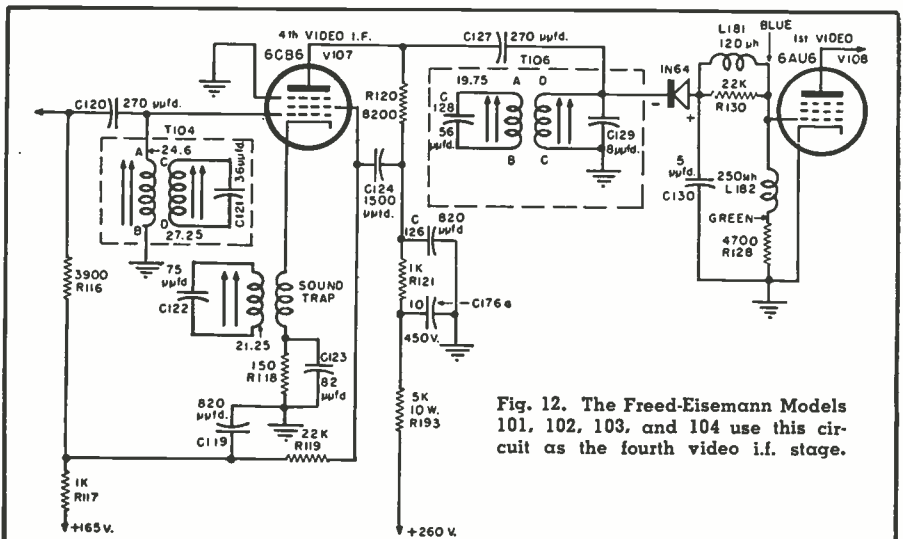

Fig. 12. The Freed-Eisemann Models 101, 102, 103, and 104 use this circuit as the fourth video i.f. stage.

values will stabilize any crystal diode detector circuit.

Because of the great interest in the use of germanium crystals as video detectors a number of commercial applications of the basic circuits discussed have been illustrated. Fig. 9C is an application of the 1N64 to a TV receiver by the *Calbest Engineering and Electronics Company*. For convenience, the associated circuitry, involving a.g.c., contrast, and a video amplifier is presented.

Teletone has been interested in TV receiver simplification because they are designing and manufacturing low price budget sets for a mass market. Fig. 11 shows a *Teletone* circuit using a crystal with an absolute minimum of associated components. The use of a resistor with a value of 5600 ohms would not be possible with a 6H6 or a 6AL5 because the bandpass would be unduly affected.

Gerod makes excellent use of a germanium crystal with a relatively high value diode load resistance of 8200 ohms. This is one of the highest values found in any of the commercial circuits available. This is also an excellent example of a video detector feeding a two-stage video amplifier with a single tube, see Fig. 10. Note also the use of the 1N64 between the second video amplifier stage and the picture tube. The 1N64 was selected for specific d.c. characteristics for this circuit; it helps eliminate hash in the sync circuit.

In the *Freed-Eisemann* circuit of Fig. 12 there is a complete schematic for the fourth picture i.f., the crystal video detector, and the first video amplifier. This is a quality circuit and it follows the standard recommendations for the choice of the component values, as indicated elsewhere in this article. While this circuit uses the 24 mc. i.f., it will work equally well with the 44 mc. i.f. and with a signal input voltage of 0.1 r.m.s.

(To be continued)

SOLDERING TO POLYSTYRENE

By OTTO WOOLLEY, WØSGG

SOLDERING to polystyrene coil forms and sockets presents a problem if damage to the unit is to be avoided. One method is to solder quickly, being careful to avoid overheating the socket or form. However this often results in an electrically poor joint.

In the case of coil forms, one thoroly satisfactory method is to use a holder for the form consisting of an inexpensive wafer type socket. Plug the coil form into the socket and the prongs extend through the bottom leaving plenty of room for soldering. Even though the form may be overheated the socket will maintain the prongs in the form in alignment and no damage will be done.

Soldering to sockets uses the same method in reverse, i.e., plugging a discarded tube into the socket. The tube prongs will not only hold the socket prongs in alignment but will also carry off excess heat that might damage the polystyrene.

-30-

High-Fidelity • TV • Radio
Phonographs • P.A. • Parts
Test Equipment • Tools • Books
Ham Gear • Electronic Tubes



31st year

New Lafayette e Catalog

NOW
READY!

IMMEDIATE
SHIPMENTS
★
COMPLETE STOCKS
★
TECHNICAL SERVICE
★
30-DAY MONEY BACK
GUARANTEE
★

A practical encyclopedia used by economy-minded servicemen, hams and technicians throughout the world because they know they have a complete "one-source" guide. For quality equipment, for hard-to-get items, for nationally-advertised merchandise, for low prices, it's Lafayette.

Lafayette

RADIO &
TELEVISION

DIV. RADIO, WIRE, TELEVISION, INC.

RUSH THIS COUPON AT ONCE

VISIT LAFAYETTE
SHOPPING CENTERS
at

100 Sixth Ave.
New York 13, N. Y.

•
110 Federal St.
Boston 10, Mass.

•
24 Central Ave.
Newark 2, N. J.

•
542 E. Fordham Rd.
Bronx 58, N. Y.

Lafayette Radio, Dept. RB
100 Sixth Avenue
New York 13, N. Y.

FREE!

I need the 1952 catalog. Please rush!

Name.....

Address.....

City.....Zone.....State.....

PASTE ON POSTCARD

For Replacements

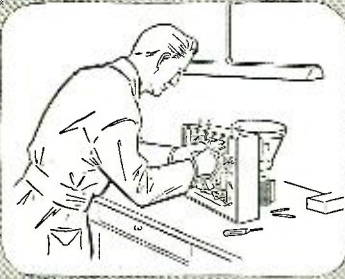

Get the CORRECT
Temperature Compensating
Ceramic Capacitor . . .

use **ERIE**

IN addition to the standard replacement line of ERIE Ceramicons, a complete line of temperature compensating ceramic capacitors is available in the following ranges.

Temp. Coeff.	Range	Temp. Coeff.	Range
P100	1 MMF-212 MMF	N220	1 MMF-600 MMF
PO30	1 MMF-226 MMF	N330	1 MMF-665 MMF
NPO	1 MMF-400 MMF	N470	1 MMF-800 MMF
NO30	1 MMF-420 MMF	N750	1 MMF-1100 MMF
NO80	1 MMF-480 MMF	N1400	1 MMF-1380 MMF
N150	1 MMF-545 MMF	Hi-K	100 MMF-.016 MFD

Be sure . . . order CORRECT parts when replacements are necessary. Erie Temperature Compensating Ceramic Capacitors have wide application for Front End, IF, Oscillator and other Critical Circuits.

Your local distributor can order all the above capacitors for you from one source . . . ERIE.

Electronics Division
ERIE RESISTOR CORP., ERIE, PA.
LONDON, ENGLAND . . . TORONTO, CANADA



International Short-Wave

(Continued from page 69)

Buenos Aires continue to be heard well evenings (EST) over the 9.69 and 9.450 channels (carry separate programs in English). (Eccles, Minn.) LRS, 11.88, fine level 2215. (Niblack, Ind.) Serrano, Brazil, reports that SIRA now lists a new and at present inactive frequency 15.345. (ISWC, London) SIRA has reverted to individual calls; for a while was using LRA as call for all SIRA transmission; now uses LRU for 15.290; LRS, 11.880; LRA, 9.690; LRY, 9.450. (Cushen, N. Z.)

Australia—Perth, 9.610, noted with good signal around 0510-1030; Brisbane, 9.660, heard at good level 0600-0900. (Boggs, Mo.) VLI6, 6.09, Sydney, signs on 0215, at least weekdays. (Bellington, N. Y.)

Austria—Blue Danube Network, 9.617, Salzburg, noted 0400 with headline news, 0600 with newscast; sent QSL card listing s.w. channels of 6.055, 5.080, 9.617. Radio Wien, Vienna, noted with recordings 0150 in parallel on 7.245, 9.664; call 0200; news in German 0215, followed by orchestral music. (Pearce, England)

Azores—Ponta Delgada broadcasts daily on CSA93 at 1700-1900 using 4.845; the same program usually is repeated the following day over CSA92, 11.090, at 1500-1600 beamed to Portugal. The 4.845 broadcast is for the Azores. (WRH Bulletin)

Bechuanaland—ZNB, 8.242, Mafeking, heard 1200-1430 closedown by Swedes. (Nattugglan)

Belgian Congo—OTM, 9.38, noted with 18-note drum interval signal prior to opening 0000. (Bellington, N. Y.) This one heard afternoons to 1500 when closes with National Anthem after giving resumé (in French) of programs to be heard the following day. (Pearce, England) OTM2, 9.38, opens 1100, high level in South Africa; plays much music; in native from 1300; OTM1, 6.295, noted 1430 in French, closes 1500; OTH, 9.21, also opens now 1100 in French and Flemish and is not in parallel with OTM2; not certain of closing time on 9.21. (Ridgeway, South Africa)

Brazil—Radio Ministerio de Educacao, PRL4, 9.766, Rio de Janeiro, noted at fair level 1600 improves by 1615; Portuguese announcements, music. (Ridgeway, South Africa) Recife, 9.565, is heard with good level when presenting "Brazil Calling" (English) weekdays 2005-2030, Sundays 1725-1800. (Boggs, Mo.) PRB25, 15.135, Sao Paulo, Radio Record, is heard Sundays to 0100. (Cushen, N. Z.) ZYC8, 9.610, Rio de Janeiro, noted 1815 in Portuguese. (Patterson, Ga.) PRF6, 4.895.2, Manaus, Radio Bares, noted in language around 2000. (Russell, Calif.)

British Guiana—ZFY, 5.980, Georgetown, noted opening 0443 with music; fair level and no QRM. (Bellington, N. Y.)

British Honduras—Belize is reported by overseas sources as operating now

FOR THE "GOLDEN EAR" THE PFAN-TONE STRAIN-SENSITIVE PICKUP

Here's why this truly faithful reproducer appeals to people gifted with the "Golden Ear" . . . why the PFAN-TONE STRAIN-SENSITIVE PICKUP brings out the brilliance of great voices and orchestras . . . the latent music on your records that other pickups leave untouched.

- The PFAN-TONE STRAIN-SENSITIVE PICKUP is an amplitude transducer with a CONSTANT RESISTANCE of about 250,000 ohms.
- Signal output is at a practically CONSTANT IMPEDANCE LEVEL.
- Excellent Transient Response.
- NO DISTORTION, phase shift or evidence of intermodulation is audible.
- LINEAR RESPONSE, free from peaks or resonances.

Cartridges are available for both standard and micro-groove, and can be had with Famous PFANSTIEHL M47B Precious Metal Alloy or diamond tipped styli.

A special preamplifier is necessary to provide the correct D.C. voltage for the pickup element and to provide the first stages of signal gain. Four styles are ready, or, if you prefer, you can build your own from the circuit in the literature.

Ask your radio supply man, or write today for complete FREE INFORMATION.

PFANSTIEHL
CHEMICAL COMPANY

101 Lake View Avenue, Waukegan, Illinois



**MANUFACTURERS!
EXPORTERS!
PURCHASING AGENTS!**
• HONESTY • INTEGRITY
• QUALITY OF
PRODUCT

- Radio and Receiving Tubes
- Transmitting & Special Purpose Tubes
- Radio and Electronics Parts and Equipment
- All Types of Electrical Wire, Magnet Wire, and Cable

Write — Wire — Phone
For Your Special Needs

We are also bonafide
General Purchasing Agents.
CAN WE HELP YOU?
References: Dun & Bradstreet.

Electronic Expeditors

225 N. Wabash Ave., Dept. R, Chicago 7, Ill.
Phone ANdover 3-0841

BRANCH OFFICES

9015 Wilshire Blvd., Beverly Hills, Cal., CR 4-6237
507 Fifth Ave., New York 17, New York, MU 7-0084

WANTED! WANTED!

MILITARY TEST SETS & EQUIPMENT

TS-12, 13, 35, 14, 15, 146, 174, 175, 263, 268, etc. APR, ARC, ART, APS, APA, SCR, BC equipment and parts. Also TUBES, any quantity. WRITE, WIRE OR CALL.



Coaxial Relay K-101 SPDT-24V DC5	\$ 4.95
Set of 83-15P Coax Connectors for Above	1.35
1500 KC Vacuum Tube	1.25
VS-2 Vacuum Switch	6.95
Sigma Plate Relay 8000 ohm SPDT	2.49
RG39/U Coaxial Cable-7.7 ohm	22.50
150' roll 800 V 300' roll	84.95
3" Scope Shield	1.29
2000-0-2000 V @ 800 MA xformer	24.95
15 HY @ 300V Choke	5.95
2 mfd 300V Condenser	4.25

TUBES!! BRAND NEW! STANDARD BRANDS! NO SECONDS! COMPARE! TUBES!!

0A3	V7R5	\$1.69	3C24	\$2.25	217C	\$8.95	812H	\$6.90	8008	\$7.95	WL616	\$37.50	5Y4G	\$0.73	6SL7GT	\$0.98	12SL7	\$4.05	
0B3	VR90	1.49	3C27	4.95	227A/5C27	5.95	813	8.95	8011	1.75	WL619	18.95	5Z3	.99	6SN7GT	.98	12SN7	.98	
0C3	VR105	1.29	3C31	3.49	249C	3.95	814	3.95	8012	3.95	WL677	34.50	5Z4	.99	6SR7	.75	12SR7	.85	
0D3	VR180	1.29	3C45	19.25	250R	12.95	815	2.95	8013	2.95	WL681	22.50	6A3	1.25	6SR7GT	.85	12SR7	.85	
1B22			3C45	19.25	250TH	22.50	816	1.30	8014	29.95	0A3	1.55	6A4LA	1.35	6S8T	.95	12Z3	.85	
1B23		12.50	3CP1S1	2.95	250TL	21.50	826	.98	8020	1.29	0A4G	1.20	6A6	.92	6S8T	1.20	14A4	.98	
1B24		19.95	3DP1	4.95	274A	5.50	828	12.95	8025	5.95	0B2	1.63	6A8	1.05	6S7	1.25	14B6	.95	
1B26		3.95	3EPIA	14.95	274B	2.65	829	12.95	8061	2.25	0A4	.75	6A7	1.39	6S7GT	1.20	14E7	.95	
1B27		24.50	3DPI-S2A	8.95	276A	9.95	829B	14.95	9002	2.25	01A	.75	6AB	1.05	6V7	1.25	14E8	.95	
1B29		2.75	3DPIA	1.98	293A	2.98	830B	3.95	9003	2.25	1A4P	1.20	6AC7	1.15	6U5G	.95	14H7	.95	
1B32		8.95	3EPIA	14.95	294A	2.75	832A	12.95	9004	2.25	1A4P	1.20	6AD7GT	1.35	6U6GT	.98	14I7	.95	
1B36		24.96	3FP7	3.95	300B	9.95	832A	12.95	9005	2.95	1A5GT	.78	6AG7	.95	6V6	1.55	14J7	.95	
1B38		32.50	3GP1	4.75	304TH	14.95	833A	41.50	9006	.49	1A6	.85	6AG6G	.95	6V6	1.55	14J7	.95	
1N21	Xtal	2.25	3HBT	3.95	304TH	14.95	834	1.98	9007	2.25	1A7	.75	6AG5	.89	6V6GT	.89	14K7	.69	
1N21B		4.25	4-12SA	26.95	310A	5.95	838	2.95	9008	2.25	1B3/8016	1.25	6AH6	1.40	6W7	1.05	24A	.75	
1N22		1.35	4-250A	29.95	310A	5.95	839	3.25	9009	2.95	1C4	.75	6AJ3	1.15	6X4	.73	25LEGT	.75	
1N23		1.35	4-250A	29.95	316A	12.95	843	.98	9010	1.49	1B5/25S	.55	6AK3	1.10	6Y3GT	.98	25LEGT	.75	
1N24		1.35	4-250A	29.95	323A/B	24.50	845	4.95	9011	1.49	1B5/25S	.55	6AK3	1.10	6Y6G	.98	25Z6GT	1.05	
1N26		6.95	4B24/EL3C	7.95	327A/5C37	4.95	849	4.95	9012	1.49	1C7G	.73	6AO2	.87	7A4/XXI	.79	28D7	1.95	
1N27		1.69	4B26/2000	8.95	331A	12.95	851	2.95	9013	1.49	1C7G	.73	6AR5	.79	7A5	.89	30	.45	
1N34A		1.40	4B28	4.95	350A	8.95	860	2.95	9014	1.49	1D8GT	.73	6AT6	1.25	7A6	.85	32	.95	
1P23		1.79	4C27/CV92	9.95	368AS	7.95	865	1.45	9015	1.49	1E5GT	1.19	6AV6	.93	7A7	.85	32	.95	
1P36		2.95	4C35	34.50	371A	1.49	865	1.45	9016	1.49	1F4	.73	6AV6	.93	7A7	.85	32	.95	
2C17		7.50	5B1P	4.95	371A	1.49	865	1.45	9017	1.49	1F5G	.73	6AV6	.93	7A7	.85	32	.95	
2C21	RRK33	.69	5AP4	3.69	388A	2.75	866JR	1.23	9018	1.49	1F5G	.73	6AV6	.93	7A7	.85	32	.95	
2C22	7193	.49	5B1P	4.95	393A	6.95	869B	49.50	9019	1.49	1F5G	.73	6AV6	.93	7A7	.85	32	.95	
2C26	7193	.49	5B1P	4.95	417A	12.95	874	1.49	9020	1.49	1G6GT	.73	6B7	.85	7B3	.85	35	.51	
2C34	RRK44	.89	5CP7	4.95	434A	4.95	876	2.59	9021	1.49	1G6GT	.73	6B7	.85	7B3	.85	35	.51	
2C39		24.50	5CP7	4.95	446A	4.95	876	2.59	9022	1.49	1G6GT	.73	6B7	.85	7B3	.85	35	.51	
2C46		14.95	5D21	24.50	450TH	47.50	885	1.85	9023	1.49	1G6GT	.73	6B7	.85	7B3	.85	35	.51	
2C44		1.49	5F7P	3.25	450TH	47.50	885	1.85	9024	1.49	1G6GT	.73	6B7	.85	7B3	.85	35	.51	
2C46		1.49	5F7P	3.25	450TH	47.50	885	1.85	9025	1.49	1G6GT	.73	6B7	.85	7B3	.85	35	.51	
2C51		6.95	5J1P	1.39	503	1.39	903	3.59	9026	1.49	1G6GT	.73	6B7	.85	7B3	.85	35	.51	
2D21		1.79	5J2P	24.45	562	97.50	908	12.95	9027	1.49	1G6GT	.73	6B7	.85	7B3	.85	35	.51	
2E22		4.89	5J23	12.95	562	97.50	908	12.95	9028	1.49	1G6GT	.73	6B7	.85	7B3	.85	35	.51	
2E26		3.69	5J30	12.95	702A	3.95	918	1.89	9029	1.49	1G6GT	.73	6B7	.85	7B3	.85	35	.51	
2E30		2.29	5J30	43.50	703A	1.35	918	1.89	9030	1.49	1G6GT	.73	6B7	.85	7B3	.85	35	.51	
2J21A		4.95	5J32	99.50	704A	1.05	927	1.59	9031	1.49	1G6GT	.73	6B7	.85	7B3	.85	35	.51	
2J22		8.45	5L1P	15.95	705A	2.95	930	1.20	9032	1.49	1G6GT	.73	6B7	.85	7B3	.85	35	.51	
2J26		29.50	5N1P	39.50	706A	3.95	934	1.39	9033	1.49	1G6GT	.73	6B7	.85	7B3	.85	35	.51	
2J27		7.95	5N1P	39.50	706A	3.95	934	1.39	9034	1.49	1G6GT	.73	6B7	.85	7B3	.85	35	.51	
2J30		99.50	6C21	24.50	706Y	42.50	935	1.45	9035	1.49	1G6GT	.73	6B7	.85	7B3	.85	35	.51	
2J31		39.50	6F4	8.95	706Y	42.50	935	1.45	9036	1.49	1G6GT	.73	6B7	.85	7B3	.85	35	.51	
2J32		39.50	6F4	8.95	707B	17.95	936	1.45	9037	1.49	1G6GT	.73	6B7	.85	7B3	.85	35	.51	
2J33		39.50	7B7P	8.95	708A	4.95	938	1.45	9038	1.49	1G6GT	.73	6B7	.85	7B3	.85	35	.51	
2J34		39.50	7D4P	17.95	709A	3.95	939	1.45	9039	1.49	1G6GT	.73	6B7	.85	7B3	.85	35	.51	
2J38		97.50	9J1P	14.95	711A	8011	1.45	941	1.45	9040	1.49	1G6GT	.73	6B7	.85	7B3	.85	35	.51
2J37		7.95	9J1P	14.95	713	1.45	941	1.45	9041	1.49	1G6GT	.73	6B7	.85	7B3	.85	35	.51	
2J38		12.75	9L1P	19.95	714AY	6.95	941	1.45	9042	1.49	1G6GT	.73	6B7	.85	7B3	.85	35	.51	
2J39		39.50	9L1P	19.95	715B	9.75	941	1.45	9043	1.49	1G6GT	.73	6B7	.85	7B3	.85	35	.51	
2J40		39.50	10BPA	22.50	715B	9.75	941	1.45	9044	1.49	1G6GT	.73	6B7	.85	7B3	.85	35	.51	
2J46		39.50	10D7	49	715C	29.95	941	1.45	9045	1.49	1G6GT	.73	6B7	.85	7B3	.85	35	.51	
2J48		29.50	12DP7	16.95	717C	9.95	941	1.45	9046	1.49	1G6GT	.73	6B7	.85	7B3	.85	35	.51	
2J49		29.50	12HP7	16.95	721A	2.95	941	1.45	9047	1.49	1G6GT	.73	6B7	.85	7B3	.85	35	.51	
2J50		22.50	12HP7	16.95	722A	2.95	941	1.45	9048	1.49	1G6GT	.73	6B7	.85	7B3	.85	35	.51	
2J54B		39.50	12LPA	22.50	722A	2.95	941	1.45	9049	1.49	1G6GT	.73	6B7	.85	7B3	.85	35	.51	
2J55		39.50	15R	4.95	723A/B	22.50	941	1.45	9050	1.49	1G6GT	.73	6B7	.85	7B3	.85	35	.51	
2J61		49.50	15R	4.95	723B	3.89	941	1.45	9051	1.49	1G6GT	.73	6B7	.85	7B3	.85	35	.51	
2J62		49.50	16AP4	42.50	725A	7.95	941	1.45	9052	1.49	1G6GT	.73	6B7	.85	7B3	.85	35	.51	
2K25	3AB	29.50	19T8	2.90	725B	7.95	941	1.45	9053	1.49	1G6GT	.73	6B7	.85	7B3	.85	35	.51	
2K28		36.25	23D4	.45	730A	30.50	941	1.45	9054	1.49	1G6GT	.73	6B7	.85	7B3	.85	35	.51	
2K30		24.50	23D4	.45	730A	30.50	941	1.45	9055	1.49	1G6GT	.73	6B7	.85	7B3	.85	35	.51	
2K34		30.50	30 Special	.59	730A	30.50	941	1.45	9056	1.49	1G6GT	.73	6B7	.85	7B3	.85	35	.51	
3AP1		12.95	35TG	4.95</															

BARGAINS OF THE MONTH

NOVICE CW TRANSMITTER

Here's a neat and compact surplus item which converts very simply to 3700-3750 KC crystal controlled. Condition? Guaranteed suitable. Instructions? Yes, we furnish them. Complete comprehensive, step-by-step; nothing left to guesswork. This is BC-438, the command transmitter which has been such a favorite with old-timers. By the time this ad appears, the BC-457, described in November QST, will be all gone, so we worked out the conversion on BC-458. Now don't wait until these are all gone! ONLY...\$7.95

APN-1 WOBBLULATOR

(See Dec. Radio & TV News)
Now you can build that "VERSATILE SWEEP FREQUENCY GENERATOR!" We've managed to acquire only 100 of the APN-1 magnetic units. So HURRY!\$6.95

BROADCAST BAND & AERO

MN-26-C Remote Controlled navigational direction finder and communications receiver. Manual DF in any one of three freq. bands, 150 to 1500 KC. 24 V. Self contained dynamotor supply. Complete installation, including receiver, control box, loop, azimuth control, Left-Right Indicator, plugs, loop transmission line, and flex. shafts. **BRAND NEW, ORIG. PACK. \$69.50**
MN-26-C alone, New.....\$39.50

MN-20-E BENDIX LOOP

Here is a dandy! Use as a remote-controlled loop with MC-124 flexible shaft, or mount a lightweight beam on the loop and use the slip-rings to feed it. Inside gears are 15:1 ratio. Originally used with MN-26 or RA-10-DB. BRAND NEW and CLEAN. **Special. ONLY \$6.95**
MC-124 flexshaft, will ship length closest to your specs.....\$3.00
MN-20-E drive with azimuth scale, for above loop, 15:1 ratio.....\$2.50

MARINE RADIOMEN

Send now for our latest Marine Catalogue describing and pricing the famous "G.L. MARINER" transmitters, receivers, and Direction Finding.

4 USES—4 DOLLARS

The most versatile dynamotor in surplus! The best dynamotor for conversion to 6 v. Multiple windings! After conversion you get choice of 120 or 350 v at 50 MA or 250 v at 100 MA. No brushes to shift around, no mechanical work. Or use it as a 2:1 or 1:2 step-up or step-down transformer for DC voltage! Changes 6 to 12, or 12 to 24, or vice versa, up to 3 A. Or use it as a GENERATOR. Turn with motor, get 12 v DC at 12.8 A or 24 v DC at 6.3 A, plus high voltage. Includes easily removable self-contained 800:1 sealed-in oil gear reduction unit. Complete dope sheet furnished. **BRAND NEW.....\$4.00**

BC-223 ACCESSORIES

1. VB-5 VIBRATOR, 12 volt sync. This is the part that wears out first in PE-125-AX, so better stock up while you can! NEW, only.....\$1.19
2. 10-FOOT CORD with plugs all wired up, ready to go, to connect PE-125, PE-123, or PE-123 to BC-223. NEW, only.....\$1.50
3. TU-25 plug-in tuning unit, ON NEW NOVICE BAND! Tunes 350-250 KC. NEW, \$3.50
4. PE-55 12v Dynamotor with starting relay, fuse, etc., checked perfect. Output 500 v, 400 ma. \$17.50
5. CRYSTAL HOLDER Part 471-B. Each.....\$1.29
6. SCHEMATIC of BC-223, with any order of above items, if you ask for it.....FREE

NEW CARBON MIKE

A little gem! Same impedance as T-17, but hold in the palm of your hand! Flexible cord with standard 3-circuit plug. Press-to-talk switch. New shipment. **BRAND NEW.....\$2.79**

COMMAND EQUIPMENT

With free dope sheets and schematics

- RECEIVERS**
BC-455, 6-9 mc. NEW.....\$24.95
- TRANSMITTERS**
BC-696, 3-4 mc. NEW.....\$24.95
BC-457 or T-20/ARC-5, 4.5-3 mc. Like new.....\$24.95
BC-458 or T-21/ARC-5, 5.3-7 mc. Excellent used 7.95
T-23/ARC-5, VHF, 100-150 mc. Excellent used 24.95
Good used, less tube.....\$1.29
- MOD BC-456, Brand new \$5.95. Excellent used 2.49
As is for parts.....1.29
- 274N PLUG.** 7-pin command plug to connect command revrs. and mtrs. This is the same plug as used in the packs. NEW, each 21c; five for \$1.00
Local Control Adapter Part 471-B. Each.....\$1.29
Exact pot, switch, knobs, etched plate, and instruction data. Ready to mount.....\$1.29
SPINE TUNING KNOB.......79c

9 TO 13 VOLT TRANSFORMER OR LINE VOLTAGE BOOSTER

Tapped transformer. Input 115 v 60 cy. 9 to 13 volts out in 1 volt steps at 1 amp. Our free schematic shows lots of uses. **NEW.....\$1.89**

HI-FI DYNAMIC HEADSET!

A lucky purchase from Uncle! This is the DYNAMIC set, using waterproof fiber cones, which gives absolutely best music reproduction, flat from almost nothing to beyond 25,000 CPS. Permoflux net price new is \$49.95 per set! These have large chamois cushion ear muffs, and headband pad snaps off and on with dot fasteners for cleaning. 105-ohm impedance. 10:2 makes no difference with these babies. Bass notes come out like a 15" speaker. Don't miss these! 400 ohms impedance. Checked out.....\$3.50

FREE! NEW CATALOGUE!

Interesting, Descriptive, Nothing but Bargains! Send for It Now!

AUDIO SUPER-SPECIALS

SUPER HI-Q cut-off tone control choke. 0.65 H, 55 ohms DC. ONLY.....98c
TWIN to above, cuts 5 lows. 5 H.....98c
use as 50 ma power supply choke. ONLY.....98c
QUINCY Transformers, one for mike to push-pull grids, flat 30 to 15,000 CPS; other for push-pull output, tapped sec., turns 14:1. In unit with resistors, condensers, etc. **RIGHT FOR ONLY.....\$1.29**
PHASE SPLITTER for ONLY.....98c
or push-pull unit. Has 3 windings, each exactly 1:1 to any other; essentially flat 100-15,000 CPS.
BRAND NEW, ONLY.....69c
ONE OF EACH OF ABOVE, ALL FOR.....\$3.69

G.L. ELECTRONICS

905 S. Vermont Ave., Los Angeles 6, Calif.
All Prices F.O.B. Los Angeles. Calif. Buyers Add Sales Tax

in the 60-meter band (probably around 4.960) daily 1300-1400, 1900-2000. However, has not been found there recently by USA DX-ers. Formerly operated as ZIK2 on listed 10.600.

Bulgaria—Radio Sofia, 9.705, noted ending its *English* broadcast 2030 and asking for reports and comments. (Maurice, N. Y.) Carries own *English* programs 2000-2030, 2300-2315 on this channel and at other times during the evening (EST) takes relay of *Radio Moscow's (English)* North American beam. Measured 9.7043 at 2000 by Oskay N. J.

Noted 1500 with *English* for Europe on 6.070 and announced further *English* for same channel 1600-1630. (Pearce, England) Heard on this frequency 1645 in French news session. (Rodger, Scotland)

Canada—VED, 7.32, Edmonton, Alberta, noted daily 0100 with news. (Bellington, N. Y.) Confirmed move to this frequency. (Russell, Calif., others) CBFY, 11.704, Montreal, noted from 0700. (Ferguson, N. C.) Has religious service 0815, at least weekdays.

CBC's International Service is scheduled — *European Service* — 0905-1130, CKNC, CKCS; 1130-1330, CKNC, CKCS; 1330-1345, CKCS; 1345-1400, CKCS, CHOL; 1400-1420, CHOL; 1420-1545, CHOL, CHLR; 1545-1600, CHLR; 1600-1700, CHLR, CKRZ; 1700-1830, CKLO, CKRZ. *Australasian Service* — Sun. and Wed. only 0340-0450, CHOL, CKLO. *Caribbean and Latin American Service* — 1850-2240, CHOL, CKLO; *English* remains 2105-2135. *North West Territories Service* (Northern Messenger) — Sundays only 2315-0005 (approx.). Channels are CKNC, 17.82; CKCS, 15.32; CKCX, 15.19; CHOL, 11.72; CHLR, 9.71 (new); CKLO, 9.63; CKOB, 6.09; CKRZ, 6.06.

Canary Islands—Radio Clube de Tenerife, 7.518, noted on Sundays with varied recordings from 1330. (Pearce, England) Heard recently at good level 1700-1800 sign-off. (Saylor, Va.)

Cape Verde Islands—CR4AA, 5.8535 (measured by Oskay, N. J.), Praia, noted in Portuguese to closing with "A Portuguesa" at 1700; nice signal in New York. (Bellington)

Ceylon—Radio Ceylon noted in parallel on 9.52 and 11.975 at 1116; closed 1147. (Pearce, England) Also noted by Rosenauer, Calif.

The 15.120 outlet noted after 2130, fading badly by 2215 some days. (Balbi, Calif.) Carries BBC news relay 2100.

Chile—CE1174, 11.742, Santiago, noted with strong signal 2240 and announcing for "El Nuevo Mundo"; signed off 0001. CE960, 9.593, Santiago, noted 2130 to after 2230 in Spanish, mostly recordings. (Ferguson, N. C.)

China—Radio Peking heard on 10.360A at 0400-0445; has news 0400 followed 0415A by POW messages; announces 6.100, 10.260 (actually now 10.360A), 11.690, 15.060, and 15.170 in parallel; announces POW messages for all three English transmissions (has different POW's on each session) at 0400, 0830, 1700 (which would make POW schedule 0415A, 0845A, 1715A).



FOR FRINGE AREA & DX the New DAVIS SUPER-VISION ANTENNA

Built to the same Davis High-Quality Reception Standards which have made Davis Electronics Products so popular with users and the trade. Backed by over a quarter of a century of electronic experience.

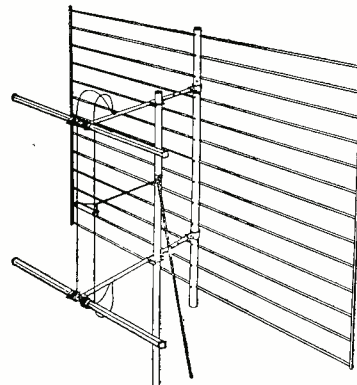

MANY OUTSTANDING FEATURES:

- Broad-Band Receiving — Channels 2 to 13.
- Eliminates or Greatly Reduces "Ghosting" Problems.
- Provides 10 DB or More Gain on High Channels — where gain is most needed.
- Excellent Front-to-Back — on all channels.
- Minimizes Interference: Airplane Flutter — Diathermy and Ignition — F. M. — Neon Signs — X-Ray — Industrial — Etc.
- Can Be Tipped WITHOUT Tilting Mast. Features exclusive 15% tilt to take advantage of horizontal wave length.
- Jiffy Assembly. Light-weight rugged construction.

AT YOUR JOBBERS, OR WRITE TO:

DAVIS ELECTRONICS 1-3

3047 W. Olympic Blvd., Los Angeles 6, California

SIRS: RUSH INFORMATION TO ME AS CHECKED BELOW:

Send Free Technical Data on new SUPER-VISION ANTENNA.

Send Name and Address of NEAREST JOBBER.

Name _____

Street _____

City _____ State _____

(Rosenauer, Calif., others) The 10.360A channel varies greatly at times; was measured recently 0625 as 10.3565 by Oskay, N. J.

When this was compiled, *Radio Peking* in its 1700-1730 *English* session was being heard widely with best signal on 10.36A (Home Service outlet) in parallel with 11.685A and 15.060A (Overseas Service outlets); the 11.685A and 15.060A channels remain in parallel to around 2130 closedown, while 10.36A carries a separate program to after 2200 (some say to 2400).

Colombia—HJBB, 4.815, Cucuta, is good level around 2100. (Catch, England) HJDE, 6.1455, Medellin, noted with native program 2000; HJFB, 6.2255, Manizales, heard signing off 2305. (Russell, Calif.)

Costa Rica—San Jose, 11.970V, noted 2230-2240 with Spanish commentary and Latin American music. (Lane, Wyo.)

Cuba—COBL seems to have settled down again on 9.833 where battles with Budapest evenings (*EST*). (Leary, Ind., others)

Curacao—PJC2, 5.010, noted 1825 with light QRM; had commercial in *English* 1915; QRA is "Curom," P.O. Box 31, Willemstad, Curacao. (Kroll, N. Y.) Commercials in both *English* and Spanish noted by Ferguson, N. C.

Cyprus—Limassol, 6.117A, noted with stringed instrument interval signal around 2254 prior to opening day's transmission. (Bellington, N. Y.) Heard signing on 2154 on 6.790. (Oskay, N. J.)

Czechoslovakia—Prague, 11.875, noted at nice level around 1935 when giving news; 9.550 is in parallel; both have strong signals at times. (Niblack, Ind.) Prague, 6.010, noted 0000-0030 with a program from Yugoslavia. (Krejny, Ohio)

Denmark—OZF, 9.52, Copenhagen, is good level in North American transmissions 2030-2130, 2200-2300. (Golden, Mass.)

Dutch New Guinea—D. Van Os, Program Director, Radio Omroep Nieuw Guinea, Hollandia, Dutch New Guinea, has advised Paul Dilg, Calif., that the station would appreciate any phonograph records (presumably music) that anyone can send; used but yet serviceable records will be welcomed. Present record library is quite limited. Hopes to have a new 3.5-to-5-kw. transmitter in operation soon; present output on 7.126 is 400 watts; schedule is 0430-0630 with an additional broadcast Saturdays 2100-2300. QSL cards and schedules are being printed. *Return postage is welcomed with reports.* New installations are still under construction; hopes to extend broadcasting hours when new transmitter is put on the air.

Ecuador—Hoffman, N. Y., says the big diesel motors and generators for the high-powered transmitter project of HCJB are now in Ecuador and that concrete bases for the power plant have been placed.

Officials of HCJB have informed me of recent changes made in the European Service. The two former releases for Britain in *English* have been

RADIO and TELEVISION RECEIVER TROUBLESHOOTING and REPAIR

by A. A. Ghirardi and J. R. Johnson
820 pages, 417 illustrations, 6 x 9, price \$6.75

The complete know-how of service procedure by the most modern time-saving professional methods.

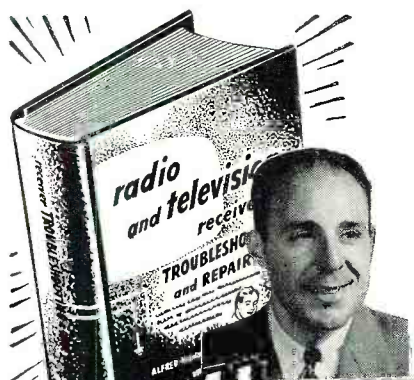

NOW! GHIRARDI'S Complete New Service Training Course

Helps you lick the toughest service problems!
Paves your way to the big-money jobs!

22 COURSES IN ONE!

Here is what this big book covers:

- 1—Receiver Components and Their Troubles; 2—How to Develop a Systematic Troubleshooting Procedure; 3—Basic Methods: Preliminary Questions and Checks; 4—Static Tests; 5—Dynamic Testing; 6—Practical Direct-Approach Troubleshooting; 7—Special Problems in AC/DC and 3-Way Portables; 8—Special Battery Set Problems; 9—Servicing Communications Receivers; 10—Troubleshooting Television Receivers; 11—Taking Performance Data; 12—Re-aligning AM Receivers; 13—Re-aligning FM; 14—Re-aligning TV; 15—Replacing Defective Resistors; 16—Replacement and Repair of R-F and I-F Inductors and Transformers; 17—Power, A-F and Deflection-Frequency Inductors and Transformers; 18—Defective Capacitors; 19—Servicing Tuning-Drive Mechanisms, Station-Selector and Band Switches; 20—Testing, Replacing and Repairing Loudspeakers; 21—Servicing Record-Playing Equipment; 22—Servicing Home Recorders.



Make your service library complete—save money in the bargain. Get the above great new Ghirardi book PLUS the new Ghirardi **RADIO AND TELEVISION RECEIVER CIRCUITRY AND OPERATION** (issued only a few months ago) at the special price of only \$12.00 for the two. (Regular price for the two books is \$12.75.)

Ghirardi's **RECEIVER CIRCUITRY & OPERATION** brings you complete, easy training on the basic circuits and operating principles of all radios, TV sets, record players, etc. Makes you far less dependent on service manuals, mfr.'s data—helps you go right to the seat of troubles in 1/2 the usual time!

SEE COMBINATION OFFER IN COUPON

BRAND NEW! . . . JUST OFF PRESS

Here's the big book you've been waiting for . . . the new Ghirardi guide to modern Radio-TV servicing by professional methods . . . a book that can help give your earning power a big boost by teaching you to work faster, more efficiently on every receiver service job!

RADIO AND TV RECEIVER TROUBLESHOOTING AND REPAIR starts with a full analysis of radio-TV components and why they fail. Next you learn how to work by the most modern service methods—from quick analyses to static tests of electrical characteristics to dynamic signal tracing and signal injection. Special problems in ac/dc, battery sets and others are clearly explained.

MAKES TV TROUBLES EASY TO REPAIR

A big TV service section is arranged so that you can find answers to specific problems in a jiffy. Complete chapters greatly simplify alignment procedure for each type of receiver. Six chapters cover every phase of component replacement, testing, tuning problems, speaker troubles, etc. Over 400 illustrations make things doubly easy to understand—including dozens of unique step-by-step charts that explain complicated details of the work almost at a glance.

Nowhere else will you find servicing explained so clearly or in such handy form for either home study or on-the-job reference. Read this great book for 10 full days at our risk. MAIL COUPON TODAY!

FLASH! SHOULD SERVICEMEN BE LICENSED?

No matter how any of us may feel about it, the fact remains that many cities and states are now preparing laws requiring servicemen to undergo rigid licensing tests. Let these two Ghirardi books help prepare you today for any such test you might have to pass!

10-DAY EXAMINATION

Dept. RN-22, Rinehart Books, Inc., Technical Division,
232 Madison Ave., New York 16, N. Y.

- Send the new Ghirardi **RADIO & TELEVISION RECEIVER TROUBLESHOOTING & REPAIR** for 10-day examination. If I like book, I will then promptly send \$6.75 in full payment. If not, I will return book postpaid in good condition and owe you nothing.
- RADIO-TV SERVICE COMBINATION OFFER**—Send above book PLUS **RADIO & TV RECEIVER CIRCUITRY AND OPERATION** on same examination basis. Special price for both books only \$12.00 (to be paid in 10 days, or books returned).

Name _____

Address _____

City, Zone, State _____

Employer's name & address _____

Sensational TV BARGAINS.

Rocket YAGI

5 ELEMENT TV ANTENNA

Excellent Pictures in Fringe Areas

HIGH GAIN. Clearer, sharper, steadier pictures. **PERFECT PICTURES IN FRINGE AREAS.** Minimum interference from ghosts and noise due to a precise pattern. Five elements include one folded dipole, three directors, and one reflector. Supplied less mast. **MATCHES 300 OHMS IMPEDANCE.** Mated insulator provides additional strength. Exclusive design mast clamp prevents antenna turning or canting under any conditions. **STURDY.** TROUBLE-FREE CONSTRUCTION. No return calls. No broken elements. Stands the test of severest weather. Elements of extra heavy aluminum-clamped top and bottom. **QUICK FIT.** Completely pre-assembled. Just swing elements into line and tighten wing nuts. Simple, quick, easy. Available for any channel, high or low band.

Channels 2 and 3 **\$7.95** each
Channels 4, 5, and 6 **\$6.95** each
Channels 7 to 13 **\$3.95** each

EACH CHANNEL requires a DIFFERENT Yagi. When Ordering specify exact channel number desired.
SOLD ONLY BY MAIL BY NATIONAL ELECTRONICS

Rocket DIRECTRONIC MOTORLESS TV ANTENNA

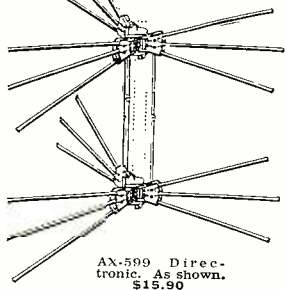

360° Electronically Switched Beam

- No Motors
- No Roof Orientation
- No Electric Power
- No Ghosts

The Directronic 18 element, 360° antenna is the finest for ultrafringe or metropolitan reception. The HI-T-A-C molded insulator is a masterpiece of extreme tensile strength not affected by weather or temperature, either mechanically or electrically. Included in the AX-599 "Servicemen's Array" are:

- 18 hi-tensile aluminum alloy elements
 - 1 set of connecting stubs (3)
 - Universal U Clamps for masts to 1 1/2" Diameter Beam Selector
 - 75 feet of Tri-X Cable
 - 1 stacked array per carton
- AX-56 Directronic, 6 element Single.....\$ 9.05
AX-56B Directronic, 12 element Stacked..... 14.25
AX-59 Directronic, 9 element Single..... 9.95
All above antenna prices include Tri-X Cable and Switch.

SOLD ONLY BY MAIL BY NATIONAL ELECTRONICS

Rocket ALL CHANNEL CONICALS

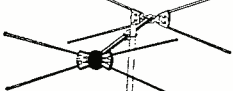

This sturdy, all-aluminum constructed TV antenna designed for broad-band reception on all TV channels, plus FM. High Gain, 4 to 1 front to back ratio. All channels 2-13. Use Directronic Beam Selector. Maximum signal to noise ratio. For use with 72-150-300 ohm lines. Low interception angle. Complete with all hardware—less mast.

Stacked Array with Tie Rods...\$8.20 each
Single Bay...\$3.75 each
SOLD ONLY BY MAIL BY NATIONAL ELECTRONICS

- 1 1/4" O.D.
Mast Steel (Dualcoated) 5' crimped.....\$1.05
Mast Steel (Dualcoated) 10'.....\$1.95
Mast Steel (Zinc plated) 10'.....\$1.59
Mast Connectors for 1 1/4" O.D. Mast—10" long...49c
3 Conductor Motor Wire.....3c ft.
4 Conductor Motor Wire.....4c ft.
Peak Roof Saddles (Will take up to 1 1/2" O.D.)\$1.49
Twin Lead 300 Ohm—70 Mil—Solid...2 1/2c ft.
Twin Lead 300 Ohm—60 Mil—7/28 Stranded.3c ft.
Double Stacking Assembly for stacking 2-XX Arrays.....\$1.70 set
Aluminum Guy Line 7/18—Stranded—300 ft.coil.\$4.95
Arrestors (TV-Lighting)......69c
Chimney Mount—Complete with Straps.....\$1.19
Coax—72 Ohm.....6 1/2c ft.
Guy Wire—Galvanized—4 strand #20.....1/2c ft.
Guy Wire—Galvanized—6 strand #20.....1/4c ft.
Guy Wire—Galvanized—11 strand #20.....20c ft.
Boosters—Anchor—101-75.....\$22.50
Tee—S-505.....\$26.97
Stand-off Screw Insulators—7" for 300 Ohm...\$2.75
Stand-off Screw Insulators—7" for 300 Ohm...\$5.50 C
Strap Clamp Stand-off Insulators—3".....\$8.50 C

PRICES SUBJECT TO CHANGE WITHOUT NOTICE
ALL PRICES F. O. B. CLEVELAND, OHIO
Do not remit more than complete purchase price. Pay shipping charges on receipt of goods. 25% Deposit on C.O.D. orders, please. Money Back guarantee
For Faster Service, Address Desk RN-2

National Electronics
OF CLEVELAND
THE HOUSE OF TV VALUES
Delco Building • Cleveland 3, Ohio

merged into a single period at 1600-1730 over 17.89, 15.115, 12.455; German, on these channels, has been changed to 1430 daily; French to 1500 daily; Portuguese has been added on Wed., Fri., and Sun. at 1830; this brings the total number of languages to ten.

Egypt—SUV, 9.985, Cairo, now has news 1130-1140 when closes; plays one request record each day. (Ridgeway, South Africa) SUX, 7.862, Cairo, heard with Arabic program around 1645. (Sanderson, Australia)

Several overseas sources report that The Egyptian Broadcasting Service is transmitting test programs from Cairo daily on 9.55 at 1345-1600; ISWC, London, says opens with the "Triumphal March" from *Aida* (Verdi), and that broadcasts in *English* and French—with news in *English* 1345 and in French 1400; announces "This is Cairo calling on an experimental short-wave-length of 9.555 megacycles" (in French as "Ici Le Cairo"). Reception reports and suggestions are requested to Egyptian Broadcasting Service, Cairo, Egypt.

El Salvador—Noted a San Salvador outlet testing recently on 11.95A around 1836 tune-in; played mostly Latin American music; good level but some fade and at times had bad CWQRM; call letters were given frequently by male announcer and sounded like YSAX; new station? (Bellington, N. Y.)

Ethiopia—Radio Addis Ababa, ETAA, 15.047, was heard on a recent Saturday until 1300 with a special program in native (Amharic). (Bluman, Israel) *May be used further irregularly; watch for it!*

Fiji—ISWC, London, and other overseas sources say a 500-watt transmitter will start operations from Suva some time this year.

Finland—Helsinki still has news weekdays 0715 and 2200 on 15.190, 17.800, 9.550. Heard on 6.120 with music at 1140 tune-in. (Pearce, England)

France—Paris, 5.954 (*measured*) noted in Portuguese when tuned 1640; announced in Portuguese and French 1645 and left the air. (Ferguson, N. C.) Paris heard on 9.680 with news in French 1500. (Rodger, Scotland) Heard on 15.24 signing off in French 1630; used "La Marseillaise" to close transmission. (Niblack, Ind.) Heard in Calif. on 7.24 at 0300-0315 in French; 0315-0330 in *English*. (Winch, Rosenauer) This outlet noted in Portuguese 1640 and signing off at 1645. (Ferguson, N. C.)

French Equatorial Africa—Radio Brazzaville, 11.970, noted 1745 on a recent Sunday with a special (*English*) program called "Africa Today" instead of the usual *English* newscast. (Ferguson, N. C.; Rosenauer, Calif.) Noted signing off in French daily 1800 on 11.970, 9.440. (Golden, Mass.) Heard on these channels with news 0015. (Hoffman, N. Y.)

French Morocco—Radio Maroc, 6.006, Rabat, is fair from 0200 sign-on but has QRM from RIAS, 6.005, Berlin. (Saylor, Va.) Heard on this *measured* frequency in England 1800-1825 with

NEW KLIPZONS with Well Known SELF HOLDING points

The miniature TEST PROD, THAT'S A CLIP too!



TYPE L Price 35c ea.

The Longie Adaptor is especially designed for test work in miniaturized or deep, close packed chassis. The extra long, slender points have the unique self-holding jaw and a needle-sharp point for piercing insulation. The Longie fits over R.T.M.A. standard test points directly, and over phonograph needle type with special insert supplied.



TYPE S Price \$2.95

KLIPZON Type S Shielded Leads provide a reliable means of piping audio or radio frequencies in lab or service work. Total capacity only 25 mmf. for 3 ft. length. Complete shielding of leads eliminates stray pickups, feed-back, etc.



TYPE H Price \$2.50

KLIPZON Type H Jumbo Heavy Duty Test Prods and Leads bring the self-holding feature to conductors as large as #4 B & S Ga. Points are needle-sharp, and protected with insulating sleeves. Provided with 4 ft. stranded copper poly-ethylene rayon leads, equivalent to 18 B & S Ga.

- AT YOUR RADIO PARTS DISTRIBUTOR
- Write for FREE FOLDER #18

UNITED TECHNICAL LABORATORIES
Engineers • MORRISTOWN, N. J. • Manufacturers

PANEL METERS
LARGE STOCK—WESTON—SIMPSON
CHECK AMERICAN FIRST
For Speedy Delivery and Low Prices
Special Scales, Special Calibration
Large Stock Meters on Hand ALL Times
Prompt Replies All Inquiries
AMERICAN ELECTRONICS
29 S. Park Av. Rockville Center, N. Y. RO 6-0207

LEARN TELEVISION
ELECTRONICS and RADIO
Engineering Laboratory and Classroom
Training. Day and Evening Classes.
FOR ILLUSTRATED CATALOG
ELECTRONICS INSTITUTE, Inc.
21 HENRY, DETROIT 1, MICH.

RADIO & TELEVISION NEWS

dance music, then short newscast in French to 1830 when closed with "La Marseillaise." (Catch)

French West Africa—Radio Dakar, 15.342, noted parallel with 11.896 at 1530 in French. (Ridgeway, South Africa)

Germany—RIAS, 6.005, Berlin, has nice signal to 0300 sign-off. (Saylor, Va.) **OZF,** 9.52, Copenhagen, in recent DX session said RIAS would move to another channel soon; no other details. (Bellington, N. Y.) In verifying, listed power of 20 kw., schedule as 2245-0245, 0400-2005 (Sat.-Sun. 2245-2045). (Cushen, N. Z.)

A station heard on 6.090 at 0145-0215 in European language with horn interval signal is believed to be *Radio Free Europe*; fair signal in Calif. (Balbi) Leipzig, 9.728, noted 0015 with news in German. (Sanderson, Australia)

Greece—Radio Athens noted on 7.300 (recently measured by Oskay, N. J., as 7.2985) with music around 2355 and 0000 with news. (Bellington, N. Y.) Greek Forces Station, 7.050, noted regularly afternoons (EST). Athens heard on 7.300 with news in *English* 1430, followed 1445 by news in French. (Pearce, England) The North American beam 2000-2100 appears to be on 7.300 now; news noted in progress 2043. (Bellington, N. Y.)

Larissa, 6.745, is good some days around 0100-0200 sign-off with Greek program. (Saylor, Va.) **Edho Janina,** 6.23, is still heard from after 0000, fair signal some days; plays all kinds of music; should sign on 0000 with Greek musical notes. (Bellington, N. Y.)

Greenland—Godthaabs Radio, 7.572, heard 1700-1845 closedown. (*Nattuglan*, Sweden) Noted by Oskay, N. J., on measured 7.5834 opening 1745.

Still heard on 7.09A to 1845 sign-off with march followed by Danish Anthem; has bad CWQRM at times. (Bellington, N. Y.)

Guatemala—TGLA, 6.29A, noted in Spanish around 1910 announcing as "La Voz de Centro America." (Bellington, N. Y.)

Haiti—4VRW at press time seemed to have settled down around 9.96. (Bellington, N. Y., others) Recently measured as 9.953 at 1745 when announced as *Radio Haiti* (in French); still good level 1934. (Ferguson, N. C.)

Honduras—HRP1, approximately 6.345, noted testing evenings to around 2300 or 2315; announces in both Spanish and *English* and asks for reports to Radio Station HRP1, San Pedro Sula, Honduras. (Bellington, N. Y.) This one has been noted also by de Leon, Mexico, announcing "El Eco de Honduras," and asking for reports on test transmissions.

Hong Kong—ZBW3, 9.525, heard with *English* from 0230 onwards; Chinese after 0500 when is weak and often with QRM. (Balbi, Calif.)

Hungary—English programs for North America are now beamed from Budapest over 6.247A, 9.833, 7.220 at 1700-1730, 1930-1950, 2330-0030. (ISWC, London)

Iceland—TFJ was recently measured

February, 1952

JUST WHAT TV SCHOOLS AND BUILDERS OF #630 TV KITS WERE WAITING FOR! ONE SET OF #630 BUILDER'S INSTRUCTIONS THAT COVER ALL #630'S.

It's the new "Brooks LIFE-SIZE Edition" featuring 4-GIANT LAYOUT CHARTS showing chassis and components in actual LIFE size, EASY TO FOLLOW STEP BY STEP INSTRUCTIONS are right alongside diagrams INCLUDING A TV FOLDER with schematics, code charts, alignment procedure, etc.

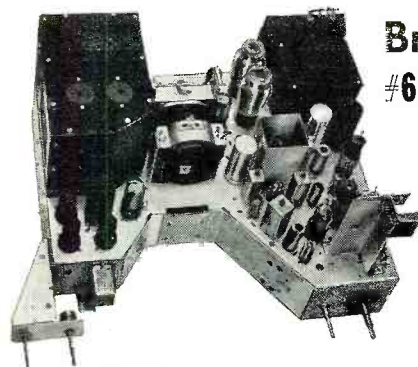

Brooks LIFE-SIZE Edition #630 TV-BUILDER—INSTRUCTIONS

Instructions.....by WALTER H. BUCHSBAUM
Layouts and Artwork.....by GEORGE MILLER
Practical Applications.....by IGNAZIO MERCANTE
Compiled and Edited.....by MORRIS BROOKS

Complete construction details for the original RCA (10") and the latest SUPER DELUXE operating all 16" to 24" CRT's.

Popular priced at only **\$2.49**
POSTPAID

STANDARD TURRET TUNER, com. w/tubes...\$22.49
VARIABLE CONTROL KIT, 9 controls..... 5.83
VIDEO AND I.F. KIT, 19 items..... 7.84
ELECTROLYTIC CONDENSER KIT, 6..... 7.37
CARBON RESISTOR KIT, 107 resistors..... 6.98
BRACKET AND SHIELD KIT, 18 items..... 8.63
Universal Mtg. Bracket Set, 12 1/2" to 20"..... 6.97

POWER TRANSFORMER, 295ma. 201T6...\$9.97
VERTICAL OUTPUT TRANS. 204T2.... 2.69
HORIZONTAL OUTPUT TRANS. 211T5.... 3.98
FOCUS COIL, 470 ohms. 202D2.... 3.42
DEFLECTION YOKE, 60° 201D1.... 2.97
DEFLECTION YOKE, 70° 206D1.... 3.98
PUNCHED CHASSIS PAN, cadmium plated... 4.87

The Manhattan

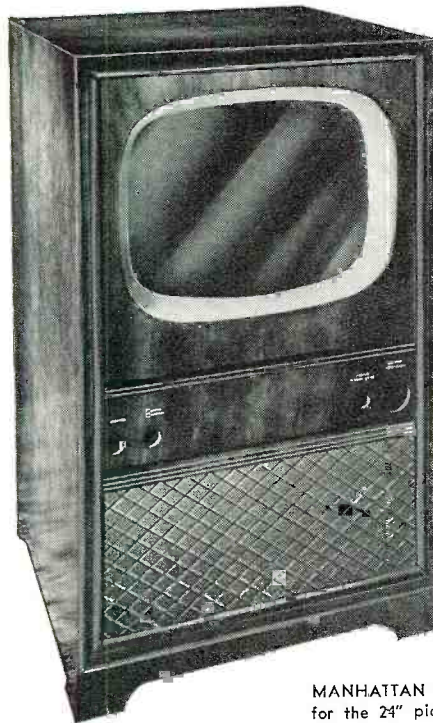

CUSTOM-BUILT CABINET For #630 AND ALL OTHER TV SETS

From Factory — To You

The MANHATTAN has everything
STYLE . . . QUALITY . . . PRICE

STYLED—to blend with any furniture setting,
it's a best seller.

QUALITY—constructed of genuine mahogany or walnut, handrubbed to a fine piano finish.

LOW PRICE—made possible by our huge commitments and a special deal to ship directly from factory to you.

THE MANHATTAN—takes any TV set. The knob-panel and shelf are either drilled for a #630 chassis, or left blank for any other TV set. The picture tube cutout is any size you order (12 1/2" to 24") and the mask and safety glass are included.

EVERYTHING NECESSARY—for an easy, perfect installation is included— assembling instructions, picture tube mounting brackets, hardware, backboard, and as a finishing touch we even include a backup for recessing the picture tube neck.

EACH CABINET—is carefully packed in an air cushioned carton & shipped F.O.B. factory, N. Y.
\$59.37 cab., size H-41", W-25", D-24", wt. 56 lbs.
86.22 cab., size H-46", W-27", D-24", wt. 78 lbs.

MANHATTAN to fit any size CRT **\$59.37**
12 1/2", 14", 16", 17", 19" or 20"

MANHATTAN also available **\$86.22** Blonde 10% extra
for the 24" picture tube.....

FINEST STANDARD GUARANTEED PICTURE TUBES

Most desirable 3 sizes. Choice of DUMONT 6-mos. guaranty or SHELDON blue label 1-yr. guaranty.

17" Rect. **\$34.63**

20" Rect. **\$49.74**

24" Round **\$79.49**

#630 STANDARD TV KIT

COMPLETE SET OF PARTS
for the FAMOUS ORIGINAL RCA #630
29-TUBE 10" TO 12 1/2" CHASSIS

Complete with all tubes, hardware and instructions, (less CRT & wire). **\$99.99**
First time ever offered at only....

#630 SUPER DE LUXE TV KIT

COMPLETE SET OF PARTS
for the 31-TUBE 16" to 24" CHASSIS
Including AGC and other features

Complete with all tubes, hardware and instructions, (less CRT & wire). **\$119.44**
First time ever offered for.....

#630 SUPER DE LUXE TV CHASSIS Complete ready to play with all tubes, hardware, knobs, etc. (less CRT) **\$167.97**

BROOKS RADIO & TV CORP., 84 VESEY ST., Dept. B, N.Y. 7, N.Y.



EVERYTHING you buy from KEY is fully guaranteed. If you are not satisfied you may return your purchase for credit or refund as you prefer. NO questions asked. All merchandise offered subject to prior sale. Minimum order \$2.00. All prices are FOB Baltimore, Maryland. Shipment will be made by Registered Express Collect unless otherwise specified. Include 25% with all COD orders.

AUDIO OUTPUT TRANSFORMERS

Stock No.	Primary Impedance	Price Ea.
900	2,000 ohms	\$0.49
957	2,400 ohms; with bucking winding	.69
775	2,500 ohms	.49
247	2,500 ohms; with bucking winding	.69
178	3,000 ohms	.49
656	5,000 ohms	.49
576	6,000 ohms	.49
858	8,000 ohms	.49
430	1,100 ohms; with bucking winding	.69

HORIZONTAL OUTPUT (FLYBACK) TRANSFORMER. Equivalent to RCA 211T3. .269 ea.

Capacity	Voltage	Price ea.
2 mfd	1,000 V.D.C.	\$1.49
3.5 mfd	220 V.A.C.	.69
4 mfd	3,000 V.D.C.	5.95
6 mfd	1,000 V.D.C.	2.29
7 mfd	220 V.A.C.	1.39
7 mfd	600 V.D.C.	2.69
8 mfd	1,000 V.D.C.	3.69
8 mfd	330 V.A.C.	2.75
10 mfd	1,000 V.D.C.	3.89
12 mfd	600 V.D.C.	3.50
16 mfd	330 V.A.C.	3.98

PAPER CAPACITORS, TYPE TTR

Capacity	Voltage	Price Ea.
.005 mfd.	50 V.D.C.	.39
.01 mfd.	100 V.D.C.	.49
.02 mfd.	100 V.D.C.	.59
1.0 mfd	400 V.D.C., C-D RM4100	.39
2.0 mfd	400 V.D.C., C-D RM4200	.49
4.0 mfd	400 V.D.C., C-D RM4400	.89

BLOWERS, A. G. REDMOND TYPE L

Approx. 100 cfm \$7.50 ea.

POWER TRANSFORMERS, 117 V., 50/60 C. Primaries

Stock No.	Description	Price
*1159	Sec #1-650 V.C.T. @ 150A; Sec #2-6.3V @ 2.1A; Sec #3-3V @ 3A Jefferson	\$4.95
*1160	Sec #1-1450 V.C.T. @ 100A; Sec #2-6.3V @ 1.2A; Sec #3-3V @ 3A Jefferson	5.95
102	Sec #1 700 V.C.T. @ .090A; Sec #2-6.3 V.C.T. @ 4A; Sec #3-3V @ 3A SNC	3.89
*8398	Sec #1-6.3V @ 10.0A; Sec #2-6.3V @ 1.5A; Sec #3-3V @ 3A.C.T.; Sec #4-860V @ 1.41 A.C.T. Westinghouse, Tuffernell Insulated	5.95

HIGH VOLTAGE TRANSFORMER, 117V 50/60 C Primary

*1158	Pri-117V., 50/60C; Sec 4000V @ .025A Jefferson	8.95
*1157	Sec #1 4V @ 16.0A; Sec #2.5V @ 1.75A Jefferson	5.75
239	Sec #1 5V @ 3.25A; Sec #2 5V @ 3.25A can deliver 5V @ 6.5A; 10V.C.T. @ 3.25A SNC	2.50

FILTER CHOKE

*1161 Dual 30 henry. .020A Jefferson 1.00
 * Current ratings for these items are conservative. They are Government equipment and are underrated. High-voltage insulation.

Stock No.	Description	Price Ea.
647	5.6 Henries, .085A, 900V. ins.	\$0.89
794	5.0 Henries, .090A, 900V. ins.95
*8350	10.0 Henries, .225A, 500V ins. Westinghouse, Tuffernell Insulated.	3.98

TANK CIRCUIT, 150-200 Mc, Uses 2-826's

In Metal Shield Box, complete w/tubes. . . \$7.95 ea.
 CONTROL STRIP, ANTENNA LINE, Uses 2-9006, 1-9002. Has 6VAC DPST relay. Complete w/tubes and relay 2.50 ea.

KNOB ASSORTMENT 20 for \$1.00

SARKES TARZIAN TUNERS, Uses 1-6C4.
 2-GAGS, Good condition. As is, less tubes 2.98 ea.
 Panel light socket assembly assortment. 10 for \$0.95

RECEIVER LOOP ANTENNA ASSORTMENT 10 for \$2.39

AC LINE CORDS, MOULDED RUBBER PLUGS ASSORTED 10 for 1.95

ATTENTION INDUSTRIAL USERS!!!!

We have large stocks of the following items:
 Amphenol Connectors
 Allen Bradley Potentiometers
 P & B "Stak-kon" Terminals
 Tube Sockets
 High-vacuum and Gas-filled Condensers
 Compression Type Trimmer Capacitors
 Magnet Wire
 AMP Terminals
 Bundry Hyluxes
 Fiberglass Yarn
 We invite your inquiries. We will reply the same day your query is received.
 Write, wire, or phone—Phone No. Wilkens 8300.

Key Electronics Division

1801 N. LONGWOOD ST.

BALTIMORE 16, MARYLAND

IT'S A SALES NATURAL

Because It's

T P-PROOF



Tip-Proof

Model No. TA 135

INDOOR TV ANTENNA

Complete with twin lead.

Closes TV set sales on-the-spot. One reason why over 1,000,000 have already been sold!

See Your Jobber or Write for Brochure No. 16



MANUFACTURING CO., INC.

6129 16th Ave. Brooklyn 4, New York

FIRST in Television Antennas and Accessories

TUBE SPECIALS

(MINIMUM ORDER \$15.00)

GUARANTEED!!

1A5 gt	5.65	6L6G	1.50
1B24 syl.	12.50	6L6 GA	1.35
1C645	6L7G85
1G6 gt57	6R7 gt83
1J6C75	6S27	9.00
1LH89	6SF565
1NS72	6SH775
1N5 gt72	6SL7 gt70
1L455	6SN7 gt70
1R572	6S0763
1R472	6V6	1.65
17A	1.50	6V6Y	1.95
2A1P	7.95	6X463
2C26A	1.17	6X5 gt49
2D2	4.90	6Y6G65
2J22	1.95	6Z5	6.55
2J31	17.50	7C575
2J32	17.50	7C775
2K41	27.50	7E570
211-VT4C49	707B	11.00
3AP1	10.00	714AY	4.50
3BP1	4.45	720BY	4.50
3B26	2.75	723A/B	9.50
3BP7	4.95	735A	6.50
3DP1	2.95	807	1.35
3DP1-52	3.95	807	3.75
3H7	1.50	817	2.95
35465	830B	2.95
307A	2.95	866A	1.35
310A	5.95	925	1.35
311A	5.95	931A	3.95
394A	3.95	954	1.19
397	1.50	955	1.19
5B21	14.00	10V35
5FP7	1.65	1935
5T4	1.50	35Z135
5U4C55	39/4429
5Y3C49	VT-5245
5Y3GT45	161665
5Z360	161929
6AC7	1.75	164240
6AG	1.65	RL-21	2.00
6C560	125C785
6C639	12S1765
6CG659	CR 00555
6F675	CK1006	2.25
6H659	HY65	2.95
6H6 gt59	VT155	135.00
6J555	VR10590
6J5 gt55	VR15085
6K770	205185
6K8G70	8020	1.00
6K8 gt75	24G	1.45

HAMS!! NOVICES!!

Here is a compact 25 to 40 Transmitter-Exciter kit that has a commercial appearance and packs a real wallop! Check these features: (1) 80 thru 10 meters; (2) Crystal or V.F.O. operation; (3) 3 stages, all metered, GAG7 xtal/E.C.O., 6L6 Buf. & 807 Amp.; (4) Front panel band change (plug-in units); (5) Only 3 controls to adjust; (6) 25 to 40 watts phone or CW; (7) Relay rack mounting; (8) Keying provisions in amplifier and buffer stages; (9) Simple assembly with complete manual; (10) No coils to wind, size: 5 3/4" x 19" x 13" deep. Limited quantity! Get yours now! FC-40 transmitter kit complete with tubes, meter, manual, coil set for one band (please specify band desired), etc. ONLY \$31.50
 Material subject to prior sale. 25% dep. with all orders. Balance C.O.D. Orders received less postage, shipped express.

FOREST SALES CO., INC.

702 MADISON ST. EU. 6-1663 OAK PARK, ILL.

12.175V at 1120 on a Sunday; is scheduled Sundays *only* 1115-1145; previous measurement was 12.1798. (Oskay, N. J.)

India—AIR noted 0300 with news on 17.740, 15.190; at 0615 on 15.16 signing on in *English* on 15.16 with program for Burma (native); heard on 4.940 closing 1100, then reopening 1130 in native and running to 1330 closedown; on 3.495 at 1030 native music, at 1100 talk in *English*. VUC2, 4.880, Calcutta, noted with news 1030, off 1200; VUB2, 4.840, Bombay, at 1030 in native music; VUM2, 4.920, Madras, news 1030. The Delhi 4.940 outlet noted closing native program 1330; Arabic program near 7.123 closes 1430. Delhi noted on 5.990 (with severe QRM from *Radio Andorra*), 7.170, 7.190 in broadcast for Europe (*English*) 1400-1515. (Pearce, England) Madras has been heard on 3.490A around 0900-0930; Calcutta, 7.210, noted with news 0730. (Rosenauer, Calif.)

WRH says AIR is broadcasting Home News in *English* at 1030-1045 on Delhi channels of 3.435, 4.940, 5.970, 6.010, 9.590, 11.760, and over Bombay, 7.240; Calcutta, 4.880; Madras, 4.920, 6.085, and Mysore, 6.065.

Delhi, 11.85, noted 1930-1945 with news; 11.79 heard 2130-2145 with news. (Boggs, Mo.) The 11.85 outlet noted signing on 1830. (Russell, Calif.) I note India with news 0730 and 0830 on a frequency of 15.380; at 0730 is parallel on 17.760, 9.590.

Indo-China (Vietnam)—“*La Voix de Vietnam*” noted near 7.090 at 1759 tune-in; Eastern-type music; at 1800 call was repeated several times in French by woman followed by news in French. (Pearce, England) This channel noted in Calif. around 0400-0500 with poor to fair signal. (Winch) Has *English* news 0845-0905. (Cushen, N. Z.)

Radio France-Asie, Saigon, noted on 9.754 around 0800. (Bluman, Israel) The 11.83 channel is now heard as early as 0400. (Balbi, Calif.) Has news 0500. (Sanderson, Australia)

Radio Dalat has a daily program in Vietnamese on 7.265 with 1 kw. at 0515-0630 and a program in French is aired each Sat. 0630-0700. *Radio Hanoi* operates on 6.165, 1 kw., 1830-1930, 2300-0030, 0500-0830 in Vietnamese, French, *English*, and Chinese; news in *English* 0530-0545; news in French 1805-1820, 2345-2400, 0730-0755. (*WRH Bulletin*)

Iran—Radio Tabriz noted around 2315 in Persian or Arabic language on 6.085A; good signal but bad fade and QRM. (Bellington, N. Y.) *Nattugglan*, Sweden, says *Radio Tabriz* is scheduled 2130-2300, 0330-0600, 1030-1345; heard best in Sweden 1200-1300.

OTC, Belgian Congo, says *Radio Teheran* is now using 9.680 instead of 15.100 for news in Persian 1400; in German 1430; in French 1445; in *English* 1500, and in Russian 1515. (Robertson, Mass.)

Iraq—HNG, measured 11.724, Baghdad, heard 2325 in Arabic. Verification listed call of HNG for *Marconi* Type S.W.B. 10 Short-wave transmitter, 16

14 DYNAMIC ARTICLES IN THE BIG MARCH ISSUE!

Including:

A MIDGET V. F. O.

AUDIO SIMPLIFIED

HIGH-QUALITY 50-WATT AMPLIFIER

A 150-WATT UNIVERSAL R. F. AMPLIFIER

RADIO CONTROL ON THE CITIZENS BAND

CRYSTAL DIODES IN MODERN ELECTRONICS

ELECTROSTATIC FOCUS FOR PICTURE TUBES

THE LOUDNESS CONTROL—AID TO HIGHER FIDELITY

PLUS

SIX OTHERS!

ALL

REGULAR DEPARTMENTS

SPECIAL FEATURES

SUBSCRIBE TODAY

(Subscription Rates Save You Money)

**USE HANDY
ORDER CARD
FACING
THIS PAGE**



RADIO & TELEVISION NEWS

EVERY ISSUE VITAL TO YOU

ZIFF-DAVIS PUBLISHING COMPANY • 366 Madison Avenue • New York 17, N.Y.
Publishers also of: RADIO-ELECTRONIC ENGINEERING Edition of RADIO & TELEVISION
NEWS • PHOTOGRAPHY • PHOTOGRAPHY ANNUAL • MODERN BRIDE • FLYING
AMAZING STORIES • FANTASTIC ADVENTURES • ZIFF-DAVIS COMICS

Be precise!
BUY PRECISE you'll save with these top quality kits

The New **PRECISE** Vacuum Tube Voltmeter with the famous PRECISE Reflex Circuit for increased stability and greater accuracy.

By comparison, your best value! 1% Ceramic resistors; Etched panel; Amphenol connectors; Separate 5 V., AC scale; Tubes: 6AL5, 6X5, 6SN7; True zero adjust; 4 1/2" Meter; Three-color rapid construction book explains each step. Complete with btry. & test lead.

Ranges: +DC: 0-5-25-250-500-1000 V.
 -DC: 0-5-25-250-500-1000 V.
 AC: 0-5-25-250-500-1000 V.
 Ohms: Rxl, Rxl0, Rxl100, Rxl10,000, Rxl1,000,000 ohms.
 DB: From -20 to +55 DB.

PRECISE Kit Model \$2598*
 909-K
 Factory wired, Model 909. \$44.98*

NO OTHER PROBE OFFERS SO MUCH... all **PRECISE** exclusives... make it the most practical, foolproof and sturdy High Voltage Probe in the industry today.

Multiple insulation; Mechanically shockproof construction; Interchangeable tips; Swivel Lead connection; Interchangeable resistors; Triple flash guards; Sturdy, non-porous shell construction.

PRECISE Model 909 \$698*
 (Wired only) Complete

PRECISE DeLuxe V.T.V.M.... Build it horizontally or vertically to fit your own bench requirements. Large 7 1/2" meter for better visibility—greater accuracy.

All the unusual features and ranges of the **PRECISE** Model 909 V.T.V.M. in a DeLuxe version. Complete with btry. & test lead.

PRECISE Kit Model \$3898*
 907-K
 Factory Wired, Model 907\$57.98*

New R.F. PROBE Lowest Price in the field! Leads in Value!

Time-tested circuit; Special non-porous case; Uses germanium crystal rectifier up thru 250 mcs. Probe handle terminated in an amphenol connector—other end of shielded cable available in either amphenol, phone plug or phone tip type fitting at no added charge.

PRECISE Model 912 \$425*
 (Wired only)

All instruments carry the **PRECISE** Guarantee, components protected by the RMA Warranty. Write for FREE Catalog N-3! SEE THE COMPLETE **PRECISE** LINE AT YOUR JOBBER NOW! *Prices slightly higher in the West.

EXPORT DEPT.: 15 Moore St., New York, N. Y., Cable "Minthorne."



PRECISE PRECISE DEVELOPMENT CORP.
 An Engineered Product Oceanside, L. I., New York

FINGER STOCK

Electrical Weather-Stripping by Eimac —
 Now Available!

Silver-plated, spring alloy, pre-formed finger stock especially suited for electrical "weather-stripping" for TVI-proofing cabinet access doors, etc. Also ideal for making coaxially constructed tube connections and many other uses. Available in 17/32", 31/32", and 1/8" widths.

• Write for new Eimac Catalogue Summary showing Eimac tubes and other accessories.

Eimac

EITEL - McCULLOUGH, INC.
 San Bruno, California

TEVCO

SINGLE REFLECTOR CONICALS

1259—Single Bay 3/8" elements. 3.19
1256—Single Bay 1/2" elements. 3.89
1254—Double Bay 3/8" elements. 6.68
1258—Double Bay 1/2" elements. 7.89
1257—Four Bay 3/8" elements. 14.89
1253—Four Bay 1/2" elements. 17.19

FIVE ELEMENT YAGI BEAMS

2002 to 2006—any lo channel. 8.69
2007 to 2013—any hi channel. 3.19
1236—Single Bay Twin-V. 3.76
1237—Double Bay Twin-V. 7.49
1231—Four Bay Conical. 16.99
1230—Double Bay Conical. 7.89
1243—Swift Rig Folded Hi Folded Low. 3.89
1240—Single section conical—lots of 6. 1.69
1244—Swift Rig Folded Hi Straight Low. 3.49
2113—Deluxe Indoor Antenna. 1.99
1860—Chimney Mount. Dozen Lots 1.19
1905—3/2" Mast Snap-On Standoff. Per 100 3.60
1873—3/2" Mast Standoff Insulator. Per 100 5.50
1872—4" Nail-In Insulator. Lots of 50 .02
1870—3/2" Wood Screw-Eye Insulator. Lots of 50 .02
1229—Single Bay Conical. 3.75
1861—5 Ft. 1/4" Diam. Galv. Steel Mast. .82

Send for quantity prices and complete list

TELEVISION SUPPLY CO.
 Box 13 Greenpoint Station Brooklyn, N. Y.

kw., high-level Class B modulation; aerials omni-directional; program times 2330-0100 (actually opens normally 2300), 0430-0600, and 0830-1500; Arabic and occasional European languages, music, and talks; interval signal is bird call; time signal is clock striking. (Ferguson, N. C.)

Ireland—Athlone, 17.84, noted yet with daily newscast around 1330-1345A. (Ferguson, N. C.)

Israel—Kol-Israel on 9.010 and 6.830 noted with news 1430; on 9.010 with "Voice of Zion" (*English*) program starting 1630 and closing down 1716A. (Pearce, England)

Bluman, Israel, says press reports say the new 50 kw. transmitter is not yet ready to go into operation but that the "Voice of Zion" hopes to have a second 7.5 kw. transmitter on the air shortly. Sent this winter schedule for Kol-Israel:

On 6.830, 1205 kc., 737 kc., 575 kc., 1330-1445 (also on 9.010); weekdays (Sun.-Thurs.) 2330-0130, 0300-0815, 0900-1605; Saturday 0030-0815, 0900-1605, and Saturday (Israel's Sunday) at 2330-0130 (Sun.), 0300-1605; *English* 0700, 1430; French 0800. Tel-Aviv II, 9.010 and 652 kc., scheduled 1130-1330, French at 1130-1215; "Voice of Zion" on 9.010 at 1445-1715 (*English* at 1630; French 1530). Forces Station (Galei-Zahal), 6.725, is scheduled 1130-1500 and is parallel on m.w. 1275 kc., 1304 kc., 1393 kc., and 1336 kc.

Italy—Rome noted again on 15.405 in broadcast (*English*) to Far East 0315; noted ending *English* 0615 recently on 11.905, followed by French for Middle East. Heard signing on 1150 in Serbo-Croat on 11.905 in parallel with 9.57; and signing on in *English* for British Isles 1350 on 6.010 (announced 11.81, 9.57 as parallel). Noted 1440 with anthem and call, followed by foreign language broadcast near 7.105; heard mornings (*EST*) on this channel also; heard in *English* 1505-1530 for South Africa on 9.630, 11.81. (Pearce, England) Rome noted on 9.575 in *English* news 1900 and 2145; transmission runs 1900-2200. (Robertson, Mass.) Heard opening 0400 on 11.905 in Italian at dictation speed. (Fargo, Ga.) Ridgeway, South Africa, reports Rome on 5.26 at 1415 in Spanish to 1445, then interval to 1500 when has further session.

Italian Somaliland—Bluman, Israel, says that a station in Italian Somaliland has been carrying out tests on 7.420 daily 1200-1300; programs consist of Italian light music (recordings), with news in Italian 1230.

Jamaica—Radio Jamaica, 4.950, has news 0730. (Saylor, Va.)

Japan—According to press reports from Tokyo, the Radio Corporation of Japan by this time should have resumed Overseas Service in various languages including *English*. Latest NHK schedules are JKH, 7.2575, 5 kw., 1530-0900; JKI, 4.910, 5 kw., 1530-1725; JKI-2, 9.655, 5 kw., 1725-0245; JKJ, 7.285, 5 kw., 1530-0900; JKM, 4.940, 5 kw., 1530-1715, 0310-0900; JKM-2, 9.695, 5 kw., 1725-0300; JBD, 9.505, 7.5 kw.,

1530-1905, 0255-1000; JBD-2, 5 kw., 0255-1000; JBD-3, 15,225, 7.5 kw., 1915-0245; JBD-4, 15,235, 5 kw., 2200-0245; JKI-4, 11,800; 5 kw., 1530-2145.

AFRS, Tokyo, 11,825, noted with strong signal when closing with *English* announcement 2159. (Winch, Calif.) BCOF, 6,105, Kure, noted with news 0400. (Sanderson, Australia)

Kenya Colony—Nairobi, 4,855A, noted 1320 with talk; 1330 classical records. (Pearce, England) *Measured* 4.8535 at 1500 closedown when played "God Save the King." (Catch, England)

Lebanon—Beirut, 8,026A, is heard some nights from around 2330 in Arabic. (Bellington, N. Y.) Noted 1000 opening hour's program in *English*. (Pearce, England)

Liberia—ELBC, Monrovia, is still operating on 6.023 (*measured*) daily to 1845 closedown, but now has bad QRM. (Oskay, N. J.)

Mauritius—Ridgeway, South Africa, finds that V3USE, Forest Side, has been wandering around the 19-m. band lately; at last report, Ridgeway found it on 15.100 to 1230 when closes with "God Save the King."

Mexico—XEMC-XESC sent letter verification and picture postcard views of Mexico, via airmail; listed XEMC, 1590 kc., m.w., 5 kw.; XESC, s.w., 15,205, 5 kw. Gave no schedules. (Pearce, England) Verification from XEWW, Mexico City, lists s.w. channels of 15.160 and 9.500 with 10 kw. output and XEW, m.w., on 900 kc. with 250 kw.; QRA is Cadena Radiodifusora Mexicana, S.A., Radiodifusora XEW, La Voz de La America Latina Desde Mexico, Calle Ayuntamiento 54, Apartado Postal 2516, Mexico, D.F. (Hoffman, N. Y.)

Monaco—Monte Carlo, 6,035, 9,785, now broadcasts an *English* program each Friday 1730-1800. (Radio Sweden) Bellington, N. Y., recently heard *English* religious program from Monte Carlo on a Friday evening 1803.

Noted on 9.785 in Texas to 0900 or later. (Stark)

(Continued on page 141)



Ungar's little Angels

STILL HARPING ON THE SAME SWEET SONG

From minor repairs to high-speed production soldering, 8 talented muses to remember are

Ungar's Little Angels. Each versatile, job-designed tip fits the trim, slim Ungar

Pencil to strum a tune in perfect harmony with most soldering requirements. Ask your supplier for the lyrics to this merry melody.

No. 540 COMBINATION KNIFE

Primarily recommended for cutting and stripping vinyl plastic insulation from specialty wire. Also ideal for cutting and marking various plastics and wood, cutting and sealing woven plastic materials. Consists of Part No. 122 which threads onto Heating Unit No. 267.

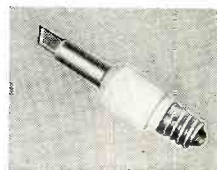

Write for Catalog No. 400

Ungar ELECTRIC TOOLS, INC., Los Angeles 54, Calif.

LEARN Practical RADIO AT HOME



COMPLETE ONLY . . .

\$19⁹⁵

BUILD 15 RADIOS

ABSOLUTELY NO PREVIOUS TRAINING NEEDED
EXCELLENT BACKGROUND FOR TELEVISION

10-DAY MONEY-BACK GUARANTEE

WHAT THE 1952 PROGRESSIVE RADIO "EDU-KIT" OFFERS YOU:

This is a practical home radio course. You learn theory, construction, operation, trouble shooting, code. You build RECEIVERS, TRANSMITTERS, AMPLIFIERS, CODE OSCILLATOR, SIGNAL TRACER.

You start with a simple radio circuit, and gradually advance to more complex circuits. No previous background is required. No instructor is needed. All parts and instructions are included and every single step is clearly explained.

All parts are guaranteed, individually packaged, identified, and explained.

There is nothing extra to buy. You receive all parts, tools and instructions at once. You keep everything; there is absolutely nothing you return to us.

You can easily pay for the kit in a short time by repairing radios. Use the tester and signal tracer for servicing. The signal tracer alone is worth more than the price of the entire kit.

USED BY RADIO SCHOOLS AND GOVERNMENT AGENCIES!

Progressive Radio "Edu-Kit" includes tubes, paper condensers, mica condensers, electrolytic condensers, variable condensers, selenium rectifiers, chassis, hardware, tie strips, tube sockets, solder, wire, soldering iron, tubing, coils, instruction book, radio trouble-shooting guide, radio tester, television trouble-shooting manual, etc.; in brief, everything you need in a practical radio course.

Order your "Edu-Kit" today, or send for further information.

Postage prepaid on Cash orders—C.O.D. orders accepted in U.S.A.

PROGRESSIVE ELECTRONICS CO.
497 UNION AVE. DEPT. RN-2 BROOKLYN, NEW YORK

FREE RADIO TESTER & SOLDERING IRON

GET A WELL-PAYING JOB



GO INTO A PROFITABLE BUSINESS AND PLAN FOR A FUTURE



HARVEY

Features the Finest Brands
At Most Reasonable Prices!

WILLIAMSON HR-15 AMPLIFIER KIT

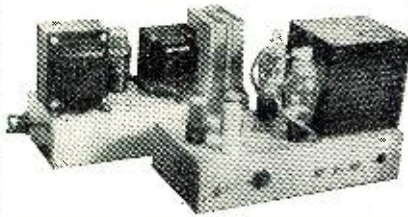

The famous Williamson HR-15 amplifier circuit now available with the original Partridge transformers built to Williamson's specifications. Build this kit in 3 hours or less, and enjoy sound of a quality you never heard before. The HR-15 is a 2-Chassis power amplifier for use with tuners or other front ends having own volume and tone controls. All American triodes, 2-6SN7GT, 2-807 or 6BG6G in PP output, 5V4G rectifier. Response ± 5 db. 10-100,000 cycles. Output impedances 1.7 to 109 ohms in 8 steps. Absolute gain 70.8 db. 20 db. of feedback around 4 stages and the output transformers. Kit is Complete with Tubes, Punched Chassis, Pre-wired Resistor Board, Sockets, Genuine Partridge Output Transformer, and All Necessary Parts.....\$76.50

As Above, with CFB Transformer.....\$90.00
PARTRIDGE Output Transformers available separately WWFB, as used in above kit.....\$26.00
CFB Transformer, Hermetically sealed.....\$40.00

HR-15T A Williamson Kit with all TRIAD TRANSFORMERS... including power transformer, chokes and specially designed output transformer which is completely sealed in tar. ± 2 db. 10-100,000 cps. Harmonic Distortion less than .1% - 10 watts output. Output impedances 4-8-16 ohms.....\$69.50
Both HR-15 and HR-15T Kits available with KT-66 tubes for \$3.00 extra.

★ ★ ★ ★ ★

IN STOCK...
THE COMPLETE LINE OF



(Exclusive with HARVEY in the N. Y. area)

Transformers for all applications - Military and Civilian - High Fidelity Audio Components, "Trijets" - Hermetically Sealed Midgets, Power Transformers, Replacements, Filters, Reactors, etc. for the laboratory, industrial, servicing, public address and radio amateur fields. Complete stocks of all components are on hand for immediate delivery.

The TRIAD "HS" series of transformers incorporates hum-bucking coils and nickel-alloy multiple shielding for minimum pickup. They are small in size, light in weight, rigidly supported and hermetically sealed. Note actual appearance

of the "HS" case, on left, and the telescopic view on the right which illustrates the construction of this particular type.



Write for latest catalog.



NOTE: In view of the rapidly changing market conditions, all prices shown are subject to change without notice and are net, F.O.B., N.Y.C.

Telephone **hrc** LUXEMBURG 2-1500

HARVEY
RADIO COMPANY, INC.
103 West 43rd St., New York 18, N. Y.

Spot Radio News (Continued from page 22)

maximum rate of change not to exceed $\frac{1}{2}$ cycle per second, and the horizontal scanning frequency will be $\frac{2}{495}$ times the color subcarrier frequency, which corresponds to 15,750 cps. The bandwidth assigned to the modulated color subcarrier will extend to at least 1 mc. at 6 db attenuation below the color subcarrier frequency and to at least .4 mc. at 6 db above the color subcarrier frequency. Signals outside the assigned channel, it was said, would be attenuated at least 60 db below the peak visual signal amplitude.

As in standard telecasting, sound will be frequency modulated, with a maximum deviation of ± 25 kilocycles, and with preemphasis in accordance with a 75 microsecond time constant. In the main, slides are being used during the tests and color pickup will be on specially-built receivers located in the labs and, in some instances, in the homes of the engineers and management headmen involved in the tests. Of course, it will be possible to pick up the black and white images of these colored views on any standard receivers, in view of the compatible system employed. Everyone is being asked to report their findings on this portion of the test. Since the telecasts are experimental, they are being run during the morning or other off-periods when commercial broadcasting is not in progress.

CABLES FOR TELEPHONY AND TELEGRAPHY, always assumed to be a mainstay requirement, now have a mighty competitor to contend with: the very-high bands of radio.

In the Hawaiian Islands, the telephone company has found that submarine cables are very impractical since the heavy surf pounds the lines against the coral reefs and causes constant breaks. Accordingly, it has been decided to employ a radio system and the frequencies used for TV (Channels 5 and 6 or 76 to 88 mc.) and FM (channels 251-300 in the 98 to 108-megacycle bands).

In tests with the higher frequencies, normally used for this type of communications (3700, 4200, 5925-6425 and 10,700-11,700 megacycles), it was found that the long water paths between the many islands linked in the communications systems, interfered with transmission. Over water paths of 60 miles or more, signals on the higher channels were very unreliable, tests revealed.

Transmitters are expected to be located at sites about 42 to 92 miles apart.

The extensive repairs required for another cable system, connecting this country and the Far East, and the reliable services afforded by the easily-maintained radio systems, has also spelled doom for an oldtimer in the telegraph world. In this instance, the cables were laid in 1902 and 1906 and

LOW FREQUENCY CRYSTALS

FT-241A (Brown) Holders. Channel spacing, 1.388 kcs. All frequencies in kilocycles.89c ea.					
375	402.777	430.555	458.333	486.111	513.888
376.388	404.166	431.944	459.722	487.500	515.277
377.777	405.555	433.333	461.111	488.888	516.666
379.166	406.944	434.722	462.490	490.277	518.055
380.555	408.333	436.111	463.878	491.666	519.444
381.944	409.722	437.5	465.277	493.055	520.833
383.333	411.111	438.888	466.666	494.444	522.222
384.722	412.5	440.277	468.055	495.833	523.611
386.111	413.888	441.666	469.444	497.222	525.000
387.5	415.277	443.055	470.833	498.611	526.388
388.888	416.666	444.444	472.222	500.000	527.777
390.277	418.055	445.833	473.611	501.388	529.166
391.666	419.444	447.222	475.000	502.777	530.555
393.055	420.833	448.611	476.388	504.166	531.944
394.444	422.222	450.000	477.777	505.555	533.333
395.833	423.611	451.388	479.166	506.944	534.722
397.222	425.000	452.777	480.555	508.333	536.111
398.611	426.388	454.166	481.943	509.722	537.5
400.000	427.777	455.555	483.333	511.111	538.888
401.388	429.166	456.944	484.722	512.5	540.277

Power Supply for Any 274-N Receiver



Just plug it into the rear of your 274-N RECEIVER... any model. Complete kit and black metal case, with ALL parts and diagrams. Simple and easy to build in a HFT. Delivers 24 volts plus B voltage. No wiring changes to be made. Designed especially for the 274-N receiver. All necessary parts for conversion of rest of receiver also included. ONLY \$8.95.

CONDENSER TESTER

One of our best sellers! Useful, versatile laboratory item, in kit form. Simple and easy to build in less than an hour. Checks condenser leakage and continuity up to 8 megs. Will test any paper, electrolytic, mica or oil capacitor from 50 mmf. to 50 mfd. Self-contained power supply and neon bulb indicator with sock and bezel. Dilled metal cabinet. Complete instructions and diagrams included with each kit. Only \$5.00.



U-V LIGHT SOURCE

8 watt ultra-violet light source. In kit form including Sylvania black-light tube, (for U-V light in the 3660 Angstrom unit region) ballast, starter, mounting panel, reflector, line cord/plug, hardware, instructions. An invaluable device for schools, labs, service shops, home workshop, etc. Here is a genuine value. Complete kit, (less outer housing)... only \$4.95

TU-10B Tuning units. This is the hi-freq. tuning unit with the excellent variable condensers as well as loads of micas, coils, worm drive, etc. Only \$1.75 ea.

LOOK! NO HANDS!



This mike leaves both hands free for mobile QSO's. Fastens to operator by simple snap strap. Adjustable. Double action sw. operates push-to-talk or holds on. Only \$2.00 ea. POSTPAID in U.S.A. and CANADA.

NEW PHONE PATCH

Now redesigned into more compact and convenient housing, the # 60008 phone patch retains all of its excellent characteristics. Provides you with exactly what you need to patch your phone into transmitter or receiver. Features include hi-impedance input suitable for xt1 mike and both hi and low impedance inputs to insure proper match to your particular receiver. Unit is complete... "Sure-fire" ready to go to work for you. Only \$4.95 ea.

TRANSFORMERS-CHOKES:

5V, 25A. Pri. 115V, 60 cy. AC. A real rugged job excellent for 804TL-4-250A etc. Limited quantity. Only \$4.50 ea.

10H, 200 ma choke. Hermetically-sealed steel case. Also has hum-bucking tap. A beautiful item only \$1.98.

Power Transf. 350-0-350 @ 70 ma. 5V @ 3A. 6.3 @ 3A. Pri. 110V, 60 cy. AC. Upright mtg.\$3.25 ea.

Power transf. Pri. 115V, AC, 60 cy. Sec. 520-0-520 @ 200 ma.\$5.25 ea.

350-0-350 @ 300 ma. 6.3 @ 4A. 6.3 @ 5A. 5V @ 3A. Pri. 115V, 60 cy. AC...only \$7.95 ea.

450-0-450 @ 200 ma. Pri. 115V, 60 cy. AC. 5V @ 3A, 6.3 @ 5 amp. In shielded case. Only \$8.90 ea.

350-0-350 @ 350 ma. 6.3 @ 10A. 5V @ 6A. Pri. 115V, 60 cycle. Only \$8.95 ea.

Minimum order \$2.00. All items subject to prior sale. All prices subject to change without notice. 20% deposit must accompany all orders, balance C.O.D.

**OFFENBACH &
REIMUS CO.**

1564 MARKET ST.
SAN FRANCISCO, CALIF.

have since broken down innumerable times. The damage in one line is so bad, company representatives have reported, that about \$500,000 would have to be spent for repair. In addition, it was said, it would be necessary to purchase a new cable-repair ship to replace an antiquated vessel recently sold, which might cost over 1 million dollars. It would be wiser, the cable owners told the Commission recently, to discontinue completely the cable service and transfer operations to existing companies using radiotelephone circuits over the same routes.

It wasn't too long ago that cablemen had announced that radio circuits could never supplement or complement a wired service. Those views now appear to have become items for the pages of history, recording the progress of electronics.

IN AUSTRALIA, there is in operation a radio-communications system which has been described as one of the most unique in the world—a flying-doctor service relying on a network which links this sparsely settled land from coast to coast.

In that country, whose size is about the same as ours, there are many hundreds-of-thousands of square miles which have a population of less than two persons to the square mile. In these remote areas are sheep and cattle ranches which, in some instances, sprawl over 1000 square miles of land. The need to serve these large areas was always important, but impossible to meet, until radio came along. Today, there are eight bases at which are located transmitters, operators, and suitable aircraft with pilots and doctors. There are also outpost stations which use smaller transmitters and can contact the base posts. Through the facilities of this net, it has become possible to not only provide medical aid, but air ambulance service too, and over 1000-odd mile routes.

Describing this unusual communications setup in the *Proceedings of the Institution of Radio Engineers, Australia*, L. N. Schultz noted that the base transmitters use powers of from 20 to 300 watts, depending on the area to be served. In one instance, there are two 300-watt transmitters, operating on the 2, 4, or 6-megacycle bands. It is possible to adjust these transmitters so that they can operate simultaneously on a pair of frequencies modulated by one operator, or alternatively, the transmitters can operate on separate frequencies modulated by different ops. Pedal-driven generator power transceivers are used at the outpost stations, which have a power of about 3 watts. Many models use vibrators. All have three fixed crystal-controlled transmitting and receiving frequencies. Also provided is a variable tuning range to cover high-frequency bands. At the station, which uses a trio of frequencies on high power, horizontal doublets are used in the antenna system, arranged to be a quarter wavelength in height above ground.



- NO SEPARATE BOOSTER TUNING
- UNIFORMLY HIGH USABLE GAIN
- LESS "SNOW"—BETTER PICTURES
- EXCLUSIVE 4-STAGE BROADBAND CIRCUIT
- EASILY CONCEALED—HIGHLY STABLE

Tenna-Top

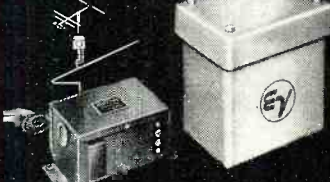

First all-channel, low-noise, antenna-mounted, self-tuning TV booster! Mounts on antenna mast ahead of the lead-in. Automatically boosts the signal—not any local noise picked up by the lead-in. Clearly brings in telecasts you could never get before. Finest booster for tough fringe areas or noisy locations in primary areas.

Model 3010 TENNA-TOP.
List Price\$89.50

**Send for
FREE BULLETIN TODAY!**

AUTOMATIC SELF-TUNING

SUPER Tune-O-Matic TV BOOSTER

Connect it...and forget it! Anyone... even a child...can get his favorite programs with a clarity of picture and sound like never before...on any channel...automatically...without any booster tuning!

Exclusive E-V all-electronic broadband circuit gives superb low-noise performance...provides higher effective gain on all channels...works where others have failed, even in tough fringe areas. Furthermore, the booster can be easily concealed. Installation is quick and simple. Plugs into 50-60 cycle a.c. outlet. Thousands of installations have proved it completely trouble-free. There's nothing like it!

Model 3000 TUNE-O-MATIC. List...\$59.50

Electro-Voice

TV BOOSTERS • MICROPHONES • HI-FI SPEAKERS • PHONO-PICKUPS

Patent Pending

Electro-Voice, Inc., Dept. N2-2
410 Carroll St., Buchanan, Michigan
Send Free Bulletin No. 163

Name _____
(PLEASE PRINT)

Address _____

City _____ Zone _____ State _____

Serviceman Installer Dealer TV Fan

MERIT

TV full-line* Components For
Improvement, Replacement, Conversion



SELL IMPROVED RECEPTION

MERIT "TV" Kit #1000 for edge to edge focus—contains MDF-70 Cosine Yoke, HVO-7 Universal Flyback and MWC-1 Width Linearity Control. Keep a Kit handy — you'll get plus business and a reputation for "know-how."



MDF-70 . . . original of the "cosine" series—low horz, high vert inductance. Used by such famous sets as Radio Craftsman. Cosine Yokes will improve 10,000,000 sets now in use!

MERIT... HQ for TV Service Aids

MERIT's 1952 Catalog #5211 now available . . . introducing MERIT IF-RF Coils, includes Coil & Transformer data, listings. Other MERIT service aids: TV Repl Guide #404, Sept. '51 issue—covers 3000 models, chassis of 82 mfrs; Cross Ref Data on IF-RF Coils, Form #14. Write: Merit Coil and Transformer Corporation, 4425 North Clark Street, Chicago 40.

These three MERIT extras help you:

- Exclusive: Tape-marked with specs and hook-up data
- Full technical data packed with every item
- Listed in Howard Sams Photo-facts



*Merit is meeting the TV improvement, replacement and conversion demand with a line as complete as our advance information warrants!

BURTON BROWNE ADVERTISING

According to Schultz, there are 600 outpost stations which are from 50 to 600 miles from the base posts. All are tied into a net which provides a continuing, reliable medical-aid service.

THE MORAL POWER OF TV which has been of deep concern to those in Congress, in government bureaus, and in industry, too, has rallied many to discuss its effect on our present and future living patterns.

During a dinner, tendered to Dr. Allen B. Du Mont recently, celebrating the pioneer's twentieth year in television, the important subject was sharply analyzed. The picture-tube specialist declared that TV has already affected the political fortunes of many. "Already the politicians, high and low . . . are wondering what television is going to do to them or for them next year," he declared.

Noting that the roving eye of the camera could distinguish the demagogue from the statesman, the eminent tube man declared that the politicians are planning to avoid or make use of this unerring ability.

Looking into the future, Dr. Du Mont said: "I cannot help but wonder what is in store for us next year and in succeeding years when the honesty of television is put to work in earnest, in the cause of good, clean, honest government. . . . It is conceivable . . . that in the working of that accomplishment, television at its efficient best could fill the halls of Congress with statesmen, and our state and local offices with men whose greatest desire is to serve the public interest and welfare by means of the application of honesty and sincerity. . . . If that dream could become a reality, television could move forward, unhampered, for fulfillment of its destiny in the full and complete service of mankind."

The dynamic code adopted by the broadcasters has also provoked discourse on the moral force of television. Commenting on the new code, during a meeting of the American Television Society, James L. Caddigan, director of programming and production of the *Du Mont* TV net, said that these standards represent . . . "television's declaration of independence . . . a declaration that points up the fact that the television industry is completely capable of handling its responsibilities to the community, the television audience."

IN '52, the famous Olympic games will be held, this time in Helsinki, Finland. And as in '48, broadcasting will play quite a role in covering this international event.

According to present plans, disclosed in the *EBU* bulletin, permanent trunk programs will be established between Helsinki and other areas in Western and Central Europe, and these will be extended as required from their distant terminals by cable or radiotelephone. In the trunk link the following cities will be connected: Stockholm, Oslo, Copenhagen, Berlin, Frankfurt, Co-



CARTER DYNAMOTOR

Stock No. 4037AS

DC input 6VDC; output 400V @ 375 mils DC. Perfect for mobile communications in car, plane or boat.

BRAND NEW—List \$26.95
\$71.40. Our Price

6-TUBE AC-DC KIT 550-1700 KC

Complete with Rubbed Walnut Cabinet and 5" SPEAKER—Slug Tuning—Components mounted, ready for wiring. Tube complement:

2—12SK7
1—12SQ7
1—35Z5

1—12SA7
1—35L6



8½" high, 12" wide, 6½" deep. Less tubes \$7.95



GE 120D 12" SPEAKER

Alnico V Magnet—14.5 oz. Extended Range 50-15,000 cy. 25 watt, 8 ohm V.C. \$16.95

RCA 12" P.C. SPEAKER

Alnico V Magnet 3.2 ohm V.C. \$3.95

VACUUM TUBE VOLTMETER

EMC Model 106

Meter Cannot Burn Out!

Uses dual triode balanced bridge circuit. All ranges completely electronic. Zero center for FM discriminator alignment. 1% precision resistors throughout. 5 db ranges; 5 AC ranges; 5 DC ranges. Full scale deflection of 1.5v AC-DC. Resistance in 5 ranges from 2 ohm to 1000 megohms. Housed in compact, portable bakelite case; 4½" x 5½" x 2½" \$35.90



Model 106 in kit form \$23.90
Model RFP—Hi-frequency probe 6.95
Model HVP—30,000 volt probe 8.75

Complete EMC Catalog of Test Equipment Available Upon Request

GE OUNCER TRANSFORMERS

Same as UTC, 01, Mike, pick-up, or line to 1 grid. Pri. impedance 50, 200/250, 500/600. Sec. impedance 50,000 ohms. High fidelity 40-15,000 cycles \$3.95

EXTENDED RANGE OUTPUT TRANSFORMER

9000 ohms pri. impedance; 8 ohm sec. 6L6's class AB-1. Certified laboratory frequency run with 20 db; feedback ±1 db. 20 cy.-15 kc. 4¼" high, 3½" deep, 3¼" wide. Mtg. centers 2½" x 3¾". VERY SPECIAL \$4.89

OIL FILLED CONDENSERS

Made by Sprague and C-D. 10 mfd, 600 VDC, 220 VAC, ea. 99c
—Write for Quantity Prices—
Mounting Brackets (shown), ea. 15c



TERMS: 20% cash with order, balance C.O.D. unless rated. Prices F.O.B. our warehouse in N. Y. C. Minimum order \$3. NOTE: Due to conditions beyond our control, prices are subject to change.

Phone WOrth 4-3270

ACORN ELECTRONICS CORP.

76 Vesey St., Dept. N-2, New York 7, N. Y.

WALKIE TALKIE \$4.99 Complete Set of 2

POCKET SIZE —ELECTRONIC VOICE POWERED
No tubes, batteries, adjustments, license or permit needed!
Guaranteed to work anywhere up to ½ mile with extra wire. Swell for garage to house, etc. Your own private, talk-listen phone. Not war surplus. Brand new. Solid Aluminum Case. Two complete units with wire—READY TO USE! SEND ONLY \$1.00 deposit and pay postman \$3.99 C.O.D. or send \$4.99 for PP delivery. Limited supply. MIDWAY COMPANY, Dept. WRT-2, KEARNEY, NEBRASKA.

LEARN CODE

No matter how difficult it has been for you to learn code before, I guarantee that you will memorize the Morse International Code in two hours or return method within 5 days and I will refund your money. Get in on the fun of 'easy license' civilian radio. Send one dollar for complete method. NOTHING ELSE TO BUY!

OTTO LUTHER, NEW PRESTON, CONN.

RADIO & TELEVISION NEWS

logne, Hilversum, Brussels, and Hamburg.

As in previous years, a broadcast center will be provided to coordinate the technical arrangements for all broadcasts, particularly those required by observers from other lands. This center will be located beneath one of the grandstands at the stadium, and will contain the control rooms, recording booths, studios, switching panels, results-announcement units, and maintenance facilities. A magnetic-tape recorder will be used exclusively.

A staff of about 250 is expected to be provided, many of which will be assigned to technical matters. A number of interpreters will also be on hand. No arrangements have as yet been made for television coverage. The possibilities of microwave circuits have been discussed and telecasts may be made through such facilities to receivers in Germany, France, and elsewhere. Undoubtedly there will be pools for TV film coverage and eventual distribution to our TV nets via a transoceanic plane-ferrying service.

RADIO'S FIVE DECADES of progress were celebrated, as '51 came to a close, with scores of unique programs in Washington and New York. In the nation's capital, the FCC issued a review which noted that the first radio signal was flashed across the Atlantic on December 12, 1901 by Marconi. Today, FCC said, there are 700,000 authorizations to individuals to operate transmitting equipment... quite a record of progress.

Commenting on the new era of TV, the Commission said that it is looking toward... "resolving the remaining problems which will permit removal of the freeze and blueprint operation of a nation-wide TV service for years to come." A bright promise for the years to come! L.W.

POSITIONS OPEN

THE Signal Corps has announced that there is an urgent need for electronic equipment installer-repairmen for duty in the Army Communication Center at the Pentagon in Washington, D. C.

These Civil Service positions, paying from \$1.47 to \$2.27 an hour, require rotating shift duty.

No written test is required. Applicants are rated on the basis of their training and experience, as described in their applications. A certain amount of credit is allowed for advanced amateur radio operation.

Persons interested in these positions should file Application Form 57, Supplemental Experience Form CSC-206, and Card Form 5001 ABC with the Executive Secretary, Board of U. S. Civil Service Examiners, Military District of Washington, Room 2E-1030, Concourse, The Pentagon, Washington 25, D. C.

Complete information may be obtained from the Executive Secretary of the Board of Civil Service Examiners at the address given above or from the U. S. Civil Service Commission, Washington 25, D. C.



FREE DIVIDENDS
EXTRA 10% OFF ON 100 TUBES
OR MORE . . . EXTRA 5% OFF
ON 25 TUBES OR MORE

BRAND NEW STANDARD BRAND TUBES—
Individually Boxed and Guaranteed

0Z4	.59	6BN6	1.32	717	1.19
1A3	.89	6BQ6	1.44	7K7	1.19
1A6	.98	6C4	.76	7L7	1.09
1B3	1.02	6C5	.79	7N7	.89
1B5/2SS.	1.09	6CB6	.85	7Q7	1.19
1H5	.89	6CD6	2.39	7T7	.84
1J6	.74	6D6	1.09	7Z4	.86
1L4	1.12	6D8	1.39	12A6	.79
1LA4	1.12	6F6	.88	12A8	.86
1LA6	1.12	6F8	1.49	12A15	.65
1LC5	1.12	6H6	.76	12A16	1.09
1LC6	1.12	6J5	.59	12A17	.89
1LD5	1.12	6J7	.81	12A18	.96
1LN5	.87	6K6	.66	12A19	.79
1N5	.82	6K7	.74	12A20	1.24
1S5	.79	6L5	1.39	12A21	.99
1T4	.83	6L6GA	1.69	12BA6	.79
1U4	.78	6N7	1.19	12BE6	.89
1U5	.69	6Q7	.88	12J5	.79
1X2A	.96	6S4	.76	12Q7	.77
2A4G	.84	6SA7	.76	12SA7	.78
2A5	.84	6SF7	.99	12SK7	.77
3A4	.89	6SH7	.89	12SL7	1.09
3Q4	.99	6SH7	.89	12SN7	1.09
3Q5	1.02	6S17	.76	12SQ7	.68
3S4	.88	6S17	.79	12TA7	1.03
3V4	.99	6SL7	1.19	14B6	1.03
5U4	.65	6SN7	.89	14B8	1.03
5V4	1.10	6SR7	.86	14N7	1.07
5W4	.85	6S7	.72	14N7	1.02
5Y3	.47	6T8	1.19	14W7	1.09
5Z3	.75	6V6	1.69	14B6	1.34
5Z4	.89	6V6GT	.86	18T6	1.09
6A3	1.12	6W4	.89	25BQ6	1.49
6A3	1.59	6W6	.74	25L6	.85
6AB7	1.21	6X5	.74	25W4	.88
6AF6	1.18	6Y6	.96	26Z6	.74
6AG5	.86	7A4	.89	32L7	1.49
6AG7	1.59	7A5	.86	35W4	.86
6AH6	1.49	7A6	.86	35Y4	.58
6AK5	1.49	7AD7	1.92	35Z5	.87
6AL5	.72	7AF7	.89	47	1.34
6AQ5	.67	7AG7	1.05	50A5	.96
6AR5	.99	7B5	1.05	50B5	.86
6AS5	.99	7B6	.89	50C5	.86
6AS7	5.39	7B8	.99	50L6	.72
6AT6	.68	7C5	.79	50Y6	.99
6AU5	1.59	7C5	.89	56	.66
6AU6	.67	7C6	.99	70L7	1.69
6AV6	.69	7E5	.99	77	.89
6BA6	1.16	7E6	.99	80	.79
6BA7	.86	7E7	.99	117Z3	.78
6BC5	.82	7F7	.99	2081	1.22
6BE6	1.76	7H7	.96	117N7	1.79
6BG6	.86	7G7	1.21		
6BH6					



the famous
630 TV Chassis
World's Finest
TV RECEIVER

The New and Improved Super Famous "630" T.V. Chassis, is a 30 tube high quality television receiver (including 3 rectifiers) manufactured under license by the Radio Corporation of America. This chassis is the standard by which all other T.V. chassis are measured. Standard R.M.A. Guarantee! FREE replacement on all defective tubes and parts.

- FEATURES:**
- Full channel coverage.
 - Discriminator-type FM sound system.
 - Improved picture brilliance.
 - AFC horizontal hold.
 - Keyst AGC.
 - Stabilized vertical hold.
 - 3 stage sync. separator and clipper.
 - Automatic brightness control.
 - 4 Mc band width.
 - Highest quality parts used.
 - All standard tubes.
 - For all Cathode Ray tube sizes and types, 16", 17", 19", 20", 24" Tubes. Perfect for Fringe Area Reception.—Will work where most sets fail to operate.

With HiGain standard coil tuner and R.C.A. Hi-Fi 12" Speaker, complete with knobs and hardware. Complete with Fed. Taxes Paid.

Less Cathode Ray Tube. **\$141.50**

630 DX Chassis—Extra power for fringe areas. Can be operated without booster or complicated antenna. Complete with Fed. Taxes Paid. Less Cathode **\$151.50**

Ray Tube **\$4.95**

Chassis Mounting Brackets when ordered with chassis. **\$4.95**

TV PICTURE TUBES

All black faced—non glare. **SHELDON, ZETKA, and other famous makes. All Guaranteed.**

10BP4A	\$21.95	17BP4	\$22.90
12LP4A	22.95	17HP4	24.95
14BP4	21.95	19AP4	32.95
16HP4	28.95	19EP4	32.95
16KP4	28.95	19DP4	39.50
16GP4	30.95	20CP4	32.95
16LP4	32.95	24AP4	65.50

FREE CATALOG OF TV ANTENNAS, CABINETS, PARTS, ACCESSORIES.

Terms: 20% cash with order, balance C.O.D. Prices F.O.B. N. Y. City Warehouse. Min. order \$5. (Allow for postage). Prices in this ad supercede all others published.

WORLD FAMOUS AUTOMATIC RECORD CHANGER Series 100

Plays 12, 10 or 7 inch records at 33 1/3, 45 or 78 R.P.M. New spindle carefully lowers unplayed record stack. Balanced arm assures light needle pressure and long wear. Needle-tip (included) for standard or micro-groove records. Inside-out records played without any adjustment. Pickup arm comes to rest position after last record has played. Complete factory packed and sealed record changers.

List Price **\$47.50** LIMITED QUANTITIES **\$24.79** OUR PRICE

STEVE-EL ELECTRONICS CORP VISIT OUR NEW STORE
Dept. N-2 61 Reade St. New York 7, N. Y. COrtlandt 7-0086

SURP US

COAXIAL CONNECTORS

83-1AC	\$.42	83-1R	\$.40	83-22AP	\$1.40
83-1AP	\$.30	83-1RT	\$.68	83-22R	1.15
83-1F	1.30	83-1SP	.50	83-20SP	1.15
83-1H	.80	83-1T	1.30	83-168	1.15
83-1J	.80	83-1T	1.30	83-185	.15

FULL LINE OF JAN APPROVED COAXIAL CONNECTORS IN STOCK

UHF	N	SN	BNC
UG-12	UG-27A	UG-87	UG-166
UG-18	UG-29	UG-89	UG-171
UG-19	UG-30	UG-98	UG-175
UG-21	UG-34	UG-102	UG-176
UG-21B	UG-36	UG-103	UG-185
UG-22	UG-37	UG-104	MX-195
UG-22B	UG-37	UG-106	UG-197
UG-23	UG-58	UG-108	UG-201
UG-24	UG-85	UG-109	UG-206
UG-25	UG-86	UG-146	UG-236
M-358	MC-270	PL-259A	PL-325
M-359	MC-320	PL-274	SO-239
M-359A	PL-258	PL-284	SO-264
	PL-259	PL-293	TM-201
93-C	49120	D-163950	ES-888172-1
93-M	49121A	D-166132	

SOUND POWERED TELEPHONES

U. S. NAVY TYPE M HEAD AND CHEST SETS
U.S.I. A-260 W.E. D-173013

ANY TYPE—\$14.88 EACH

TS-10 Type Handsets.....\$8.92 ea.
RCA SOUND POWERED UNITS—Use as microphone or receiver.....Pair \$4.95

F. W. BRIDGE SELENIUM RECTIFIERS

AC Volts Input.....18	AC Volts Input.....40
DC Volts Out.....3.85	DC Volts Out.....7.95
1.3 Amps.....3.85	0.6 Amps.....4.60
2.4 Amps.....4.95	1.2.....5.95
6.6 Amps.....12.75	6.0.....15.50
13.0.....15.75	9.0.....17.50
26.2.....22.75	4.95.....9.95
35.50.....32.50	18.....42.50
72.....49.50	36.....55.50

GENERATORS

Eclipse-Pioneer type 716-3A (Navy Model NEA-3A) Output—AC 115V 10.4A 800 to 1400 cy. 10; DC 30 Volts 60 Amps. Brand New.....\$38.50
Eclipse-Pioneer type 1235-1A, Output—30 Volts 15 Amps. Brand New—Original Packing \$15.50

CATHODE RAY TUBES

2AP1	\$ 9.75	SAP1	\$ 3.75	7BP1	\$ 8.75
2AP5	10.25	SAP4	5.75	7BP7	7.95
3AP1	10.25	SBP1	5.75	7BP14	14.95
3AP4	10.25	SBP4	5.75	9GP7	12.85
3BP1	7.95	SOP1	4.95	9HP7	9.95
3CP1	4.85	SOP7	5.50	10BP4	18.50
3DP1A	4.85	SPP7	2.85	10FP4	24.50
3EP1A	6.75	SPP4	5.75	12DP7	16.50
3FP7	2.95	SJP2	26.50	12HP7	16.50
3GP1	4.95	SJP4	26.50	90P1	9.95
3HP7	4.95	SLP1	19.50	90S	4.45
4AP10	4.75	SMP1	10.65		

METERS

3 MA DC 2 1/2" R—Simpson black scale.....\$3.35
500 Microamps, DC—2 1/2" round—Sun.....4.30
1 ma. DC Fan type—4 1/2" scale (rem. from equip.).....3.95
500 ma. DC 2 1/2" R—General Electric.....3.15
2 amp. RF 2 1/2" R—Simpson.....4.12
2 amp. AC 4 1/2" R—JBT.....4.12
30 V DC 2 1/2" R—General Electric.....3.95
3 amp. RF 3 1/2" R—Boston.....6.00

OIL FILLED CONDENSERS

MFD	VDC	PRICE	MFD	VDC	PRICE
4	400	\$0.55	2	2000	\$1.50
5-5	400	1.65	.3	2000	1.30
1	600	.55	1	2000	1.95
2	600	.69	12	2000	8.95
4	600 R'd	.69	1.1	2500	3.85
4	600	1.65	32	2500	15.80
4	600 R'd	1.65	5	3000	2.40
6	600	1.75	.03	4000	1.25
8	600	1.85	3x.2	4000	2.95
8-8	600 R'd	1.85	5	5000	1.95
4-4-4	600	2.50	1	5000	2.50
4x3	600	2.50	.01-.03	5000	4.88
2	1000	.65	1	7500	1.65
2	1000 R'd	.95	1	7500 R'd	1.79
3.5-5	1000	1.85	1	7500	2.85
4	1000	1.95	.045	12KV	8.95
6	1000	2.50	.05	16KV	4.70
1	1200	.85	3	16KV	4.95
1	1200	.85	.075	20KV	8.95
1-1-1	1200	1.85	10	20KV	19.95
1	1500	1.25	5	330VAC	3.95
4	1500	2.95	7	440VAC	4.10
1-1.5	2000	.95	5	660VAC	4.25
			5	660VAC	4.50

HIGH VOLTAGE TRANSFORMERS

G.E.—Pri. 115V 60 cy
Sec. 6250V 80 MA—12.5 KV Ins.....\$18.50
G.E.—Pri. 115V 60 cy. Sec. 6250/3850/2600V 56 MA
12.5 KV Ins.....\$18.50
Raytheon—Pri. 115V 60 cy. Sec. 8500/6450V CT 43
Ma Hermetically sealed.....\$22.50

CRYSTAL DIODES

1N21	\$1.19	1N23	\$1.49	1N34	\$0.79
1N21A	1.30	1N23A	2.25	1N41	1.95
1N21B	4.00	1N23B	5.25	1N45	.94
1N22	1.09	1N27	1.79	1N52	1.05

SYNCHROS

Size 1, 3, 5, 6, 7 and 8 generators, motors, control transformers, differential generators, and differential motors in stock.

AY-101D	5G	N	C-69406-1
AY-120D	5H		C-77740
AY-130D	6DG	2J1F1	C-78248
1F	6G	2J1G1	C-78249
5B	7DG	2J1H1	C-78241
5C	7G	C-44968-6	C-79331
5D	A	C-56701	C-78254
5DG	B	C-56771	C-78670
5F	M	C-69409-2	C-78668

SEND FOR COMPLETE LISTING
SYNCHRO CAPACITORS IN STOCK

LECTRONIC RESEARCH LABS.

715-R Arch St., Philadelphia 6, Pa.

Phones—Market 7-6771-2-3
All prices F.O.B. Phila.
Terms—Net 10 Days to well rated accounts or cash with order. Minimum order—\$3.00.

A TAPE RECORDER TAKEUP CLUTCH ASSEMBLY

By LLOYD B. HUST

ONE of the problems encountered in designing a tape recorder is that of obtaining a smooth variable speed for the takeup reel. This reel turns rapidly at first, but must turn progressively slower as the diameter of the roll of tape builds up. This problem is solved in many tape recorders by the use of a spring belt, similar to those used in 16 mm moving picture projectors.

This solution is satisfactory in many instances, but unless the pulleys are machined very smoothly, and unless the belt has exactly the right tension, the takeup reel may move in a series of small jerks. This is of little moment in the case of a movie projector, but in the case of a tape recorder, these small jerks are transmitted to the tape with a resulting annoying "flutter." Even with a spring belt which is perfectly adjusted, time will cause a misadjustment which will cause noisy operation of the machine as well as the flutter.

The clutch diagrammed below solves the problem of variable takeup speed without these annoying complications. Furthermore, it is simple enough for the experimenter to build without trouble and with the tools ordinarily found in the home workshop. Although the sketch shows the complete spindle-clutch arrangement, existing spindle shafts can have the clutch added to them if they are of sufficient length.

The clutch consists, primarily, of a free running pulley which is attached to a sheet metal disc 1 3/4" in diameter; a second similar disc is attached to a collar which is locked to the main shaft by means of a set-screw; a disc of 1/8" inch cork—available as gasket material from any auto supply store—and a compression type spring about 1 inch long and large enough in diameter to slip easily over the shaft. The spindle itself is made up of two pieces of shafting—a 5/16" piece, 1 inch long, and a 1/4" piece about 4 1/2" long. The 5/16" piece is drilled for most of its length to take the 1/4" shaft. A small hole is drilled in the other end of the 1/4" piece and drilled and tapped to take a 6-32 screw. These two pieces are assembled as shown in the

drawing, and are held together by the 6-32 screw. A heavy sheet metal disc about 1 1/4" in diameter and having a 1/4" center hole is slipped over the 1/4" shaft and fit up snug to the 5/16" piece and soldered in place. A small hole is drilled in this piece and a pin made from a small brad is soldered in place. This much of the assembly provides a riding surface and drive pin for the roll of tape. The clutch itself is then assembled. One of the 1 3/4" discs is centered with and soldered to the pulley. The other disc is soldered to one of the collars. The spindle is placed through the panel bearing, then the collar with the disc is fastened in place underneath the panel. The cork disc is coated on both sides with graphite (rubbing with a soft lead pencil will do the trick) and slipped over the shaft next to the disc which is in place. A drop of oil is placed inside the pulley and it is pushed up against the pulley and the spring is then slipped on and the retaining collar fastened in place.

Adjustment of the unit is extremely simple. A takeup pull, exerted on the tape after it has left the capstan, should be between 3 and 9 ounces. However, this pull will vary as the build-up of the reel varies. Usually, correct tension on the tape is that which assures positive pull on the tape when the takeup reel is full. Any greater tension may have a tendency to stretch the tape. The tension is adjusted by adjusting the lower collar on the shaft. Pushing it up tightens tension on the spring and, hence, gives more pull to the spindle. Lowering the collar loosens the tension.

The pulley used may take a round or flat belt—even a spring belt will do as the belt is not required to slip. Belt tension should be sufficient to assure positive pull of the pulley at all times. The pulley should be lubricated lightly through the oil hole provided, but the hole should then be packed with felt so that oil will not run onto the surfaces of the clutch. A little care taken in the construction of this clutch will assure smoother operation of many types of tape recorders.

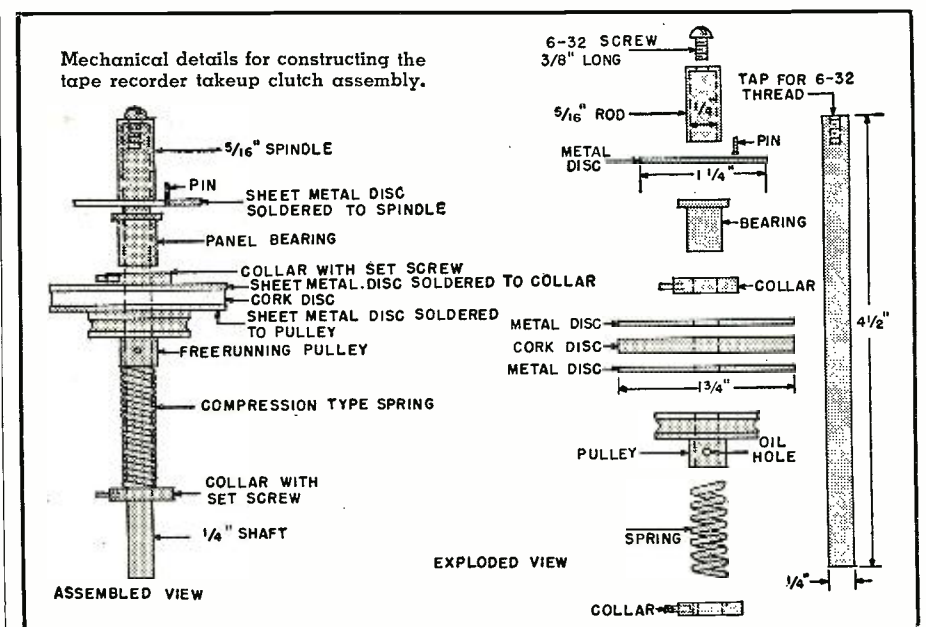

Mae's Service Shop
(Continued from page 68)

"Drag me outside into the fresh air. If I quit breathing, administer artificial respiration at once and keep at it until I start to breathe naturally again. Keep me lying down and warm. After I regain consciousness, you can give me some hot tea or coffee to drink. Of course, a doctor should be summoned at the first opportunity and the treatment turned over to him."

"Is there anything I should be careful not to do?"

"Yes; never give alcohol, fats, oils, or epinephrine to a person who has been exposed to carbon tetrachloride."

"What's the best thing to do if you accidentally get some of it in your eyes?"

"Wash them at once with large quantities of water for a period of at least fifteen minutes."

"What would you do for a person who accidentally drank some of the liquid?"

"That would be particularly dangerous, for drinking only 3 or 4 cc of carbon-tetrachloride may cause death. The first thing to do is to cause vomiting by making the victim drink a glass of lukewarm salty or soapy water. This unpleasant but necessary procedure should be repeated at least three times to insure that all poison possible is removed from the stomach. Then a teaspoon of Epsom salts in water can be given. That is about all the layman can do outside of seeing to it that the victim is placed in the hands of a competent doctor as quickly as possible."

"What does it hurt to get carbon-tet on the skin?"

"For one thing it washes away the natural oil of the skin and results in redness, roughness, and chapping. This, in turn, impairs the skin's ability to keep out germs and microbes, and infection is likely to develop. It is especially important to keep the chemical away from cuts and burned areas on the skin, for, while it has not been definitely established, there is some evidence that the poison may be absorbed into the system through such places. Finally, some individuals display an allergy to the cleaning agent."

"If you do get some of it on the skin," Mae continued, "you should immediately wash with a mild soap and warm water. Then an ointment containing petrolatum or lanolin should be applied."

"You know, you're beginning to scare me," Barney admitted.

"You should be scared," Mac said emphatically. "Carbon-tet fumes are said to be more poisonous than chloroform. If the poisoning does not cause immediate death, it may result in permanent damage to the liver, kidneys, heart, adrenal glands, lungs, or digestive and nervous systems. There is an added danger when carbon tetrachloride is exposed to an open flame or intense heat, for then it decomposes and forms

**MORE TV
OUTLETS
PER
DOLLAR!**

AMPLIFIED, ALL-CHANNEL MASTER ANTENNA SYSTEMS

FOR 2 TO 2000 TV SETS

NO Special connectors
NO Matching transformers
NO Engineers
NO Individual channel equipment

**INSTALLED WITH THE
TURN OF
A SCREW**



BLONDER-TONGUE systems are based on the use of "no loss" Distribution Amplifiers which split the signal from the antenna into the desired number of outlets... all having the same signal level and picture quality as though each TV set used the antenna alone.

The B-T Automatic, All-Channel systems, using three basic units in any desired number and combination, can be easily installed by any TV service man.



DISTRIBUTION AMPLIFIER, MODEL DA8-1-M
8 TV Outlets
Amplified and Isolated
List Price \$87.50

Combine these B-T units to serve up to **2,000** sets from 1 antenna.



Model #CA-1-M
Commercial Antensifier
(30 Times Gain)
Use As Pre-Amplifier, Line
Amplifier or de-luxe Booster
List Price \$77.50



MODEL #DA2-1-M
Distribution Amplifier
2 TV Set Outlets
List Price \$39.50

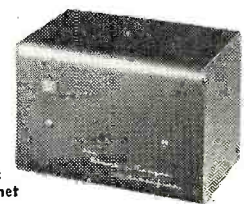

Finest All-Channel
TV Booster. Fully
Automatic, 16 Times
Gain. In Metal Cabinet
List Price \$57.50

B-T HOME ANTENSIFIER MODEL HA-2-M

FREE INSTRUCTION BROCHURE ON MASTER ANTENNA SYSTEMS...Write Today. Dept. E-2

Blonder-Tongue Labs., Inc. Mt. Vernon, N. Y.

WHAT DO YOU NEED?

RADCOM deals in radar, sonar, high and low power transmitters; navigational aids; all types of marine and airborne equipment.
Inquiries Invited!
Complete Export Facilities!

WANTED

RADCOM pays highest prices for surplus equipment, parts and tubes. We need TCS-7 and up; SCR 274-N; SCR 399 equipment; BC 312, 342 and 348 Receivers; SCR 522 equipment; SCR 211 frequency meters, RA-34 rectifiers, hand gen. GN-45.

RADCOM ENGINEERING Co. 8 Livingston St. Newark 3, N. J.

WE CHALLENGE COMPARISON!

The
**Phillips
DX-er**

HAS NO EQUAL

The only Rhombic Type antenna actually field tested and proven in extreme fringe areas to have higher gain than any other type of television antenna on the market today.

**NON-RESONANT...14 DB GAIN
SEE AND HEAR THE DIFFERENCE**

FOR HIGH AND LOW BANDS (2-13)

MODEL 102P

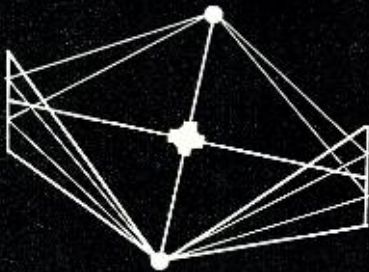

**HIGH GAIN • DIRECTIONAL
COMPLETE COVERAGE 2-13
PRE-ASSEMBLED • WIND RESISTANT
LIGHTWEIGHT • QUICK ASSEMBLY**

HIGH BAND ONLY (7-13)

MODEL 104P

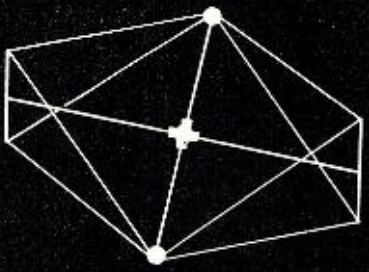

WRITE DIRECT OR CONTACT YOUR JOBBER
TODAY FOR LITERATURE AND INFORMATION
ON THE PHILLIPS DX-er RHOMBIC ANTENNA.

**Roger-Phillips
RESEARCH LABORATORIES**

717-RD North Lake Avenue, Pasadena 6, Calif.

the deadly phosgene gas of warfare.”
“What kind of safety rules would you recommend?”

“Always keep carbon tetrachloride in tightly-stoppered bottles and keep the stoppers in those bottles except when you are actually extracting some of the liquid. Never use the chemical except out of doors or in a well-ventilated place, preferably one with down-draft ventilation. Never allow pads or cloths soaked with the liquid to lie around, but place them outside as soon as you are through with them. Take precautions to prevent getting the cleaner in your eyes. Avoid having the skin in contact with it for a prolonged length of time, such as would occur when carbon tetrachloride-soaked gloves are worn. Never place carbon-tet on an open flame or a hot surface. And, of course, never keep it in a medicine cabinet or with any other bottles whose contents are taken internally.”

“Whew!” Barney gasped. “In view of all that, maybe it would be better just to quit using it altogether.”

“Not at all,” Mac denied. “Gasoline is dangerous, too, but that does not cause us to give up our automobiles and go back to the horse and buggy. Carbon-tet does a lot of jobs around a radio shop better than any other chemical agent. It is an excellent dry-cleaning fluid, metal degreaser, and rubber solvent. You can’t beat it for cleaning turntable rims, wire and tape recorder heads, tuning condenser wiping contacts, or volume controls. It evaporates quickly and leaves practically no residue. Many manufacturers of turntables, recorders, TV tuners, etc., recommend its use; and there is no reason why their recommendations should not be followed; but just remember to observe common sense precautions when you are using it.”

“I’ll remember, Boss,” Barney promised. “From now on, while I’ve got the cork out of that carbon-tet bottle, I’m only going to breathe out!”

TV SERVICE TIP

ELECTRONICS Corporation have come up with a worthwhile tip for technicians which may help to solve a bothersome TV service problem.

The use of low-grade rubber anode caps on picture tubes, which gradually become conductive due to chemical decomposition of the rubber, are causing technicians to believe that the picture tube itself is defective.

The suggested cure is to remove the rubber cap and replace it with a new one of plastic or synthetic rubber which does not contain lamp black as a vulcanizing agent. If such a cap is not available, the elimination of the cap will not harm the set or the picture tube.

Cleaning the tube can be accomplished if ordinary water and a scouring compound are used along with a little “elbow grease.” The area around the anode button should be so cleaned and then thoroughly dried and polished with a clean, dry cloth so that no residue remains.

Giant Thirteenth Edition
RADIO HANDBOOK
THE NEW, GREAT ONE-VOLUME LIBRARY OF RADIO INFORMATION
734 PAGES!

How to design, construct and operate standard types of radio transmitting and receiving equipment... both at standard frequencies and in the v-h range. Information you must have where you can find it quickly... now in a complete one-volume library, the RADIO HANDBOOK!

Reference data galore, the latest in theory and practice, and a wealth of information on the operation of vacuum tubes as amplifiers in all frequency ranges. Profusely indexed for easy finding, clearly illustrated and described for easy reading, all within easy reach for owners of this one-volume RADIO HANDBOOK!

\$6.00 AND WORTH IT!
BY MAIL, \$6.25; FOREIGN, \$6.50
AT YOUR FAVORITE DEALER
OR DIRECT BY MAIL FROM
Editors and Engineers
1262 KENWOOD ROAD, SANTA BARBARA, CALIFORNIA

LOW FACTORY PRICES

Sensationally New for 1952!
MIDWEST TELEVISION
and 5 Wave Band RADIOS

Mammoth **20-inch** Rectangular PICTURE

FACTORY TO YOU **EASY TERMS**

A sensational new 1952 line of beautiful consoles and complete chassis. Mammoth 20-inch Television and popular 5 Wave Band Radios—at Low Factory Prices.

30 DAYS TRIAL

MIDWEST RADIOS AM-FM

WE PAY TRANSPORTATION CHARGES.

Special Bonus Gift!
Illuminated TELEVISION CLOCK
Given With Every Purchase of a MIDWEST RADIO or TELEVISION
LIMITED TIME ONLY!

Phone For **FREE 1952 MIDWEST CATALOG**
IN NEW YORK MURRAY Hill 2-6810 IN CHICAGO STate 2-5600
IN CLEVELAND Prospect 1-7450 IN PITTSBURGH GRant 1-0609
IN DETROIT WOODward 3-1233 IN ST. LOUIS GRand 1161
IN PHILADELPHIA LOCust 4-1035 ... or send coupon below

SEND THIS COUPON For FREE MIDWEST 1952 Catalog

MIDWEST RADIO & TELEVISION CORP.
Dept. 377 909 Broadway, Cincinnati 2, Ohio

NAME _____
ADDRESS _____
CITY _____ ZONE _____ STATE _____

RADIO & TELEVISION NEWS

International Short-Wave

(Continued from page 133)

Mozambique—Lourenco Marques noted on approximately 15.27 signing on in Portuguese 1100; swamped 1115 by VOA Relay Base at Tangiers which signs on then. (Pearce, England) Bluman, Israel, lists this as CR7BG on 15.273, good from 1100 onwards. Ridgeway, South Africa, says is parallel with 4.82 with all-Portuguese program. Noted in Calif. by Balbi signing off 1500.

New Zealand—Wellington noted with good signal in parallel around 0000-0030 on 15.280, 11.780. (Foerster, Ill.) Heard on 11.78 and 9.54 (weaker) around 0500-0545 sign-off. (Boggs, Mo.)

Nicaragua—YNVP, 6.76, noted with Spanish announcement 2030, giving slogan "La Voz de Nicaragua." Had popular Latin American tunes around 2020. (Bellington, N. Y.)

Nigeria—At the time this was compiled, Bellington, N. Y., received a letter from **Radio Nigeria**, Lagos, 7.255, that would shortly use a new wavelength; did not state what channel would be put into use, however. Bellington says the 7.255 outlet has readable signal some days around 1630 but with bad slop-over from Munich, 7.250; also is heard some days from 2330 sign-on, parallel with London, 6.110. Verified for Bellington and for Oskay, N. J.

Northern Rhodesia—The Northern Rhodesia Broadcasting System, Lusaka, heard on 7.220A at 1040-1130 fade-out recently; musical program including some American popular selections; announcements were in an African dialect; weak signal in Calif. (Rosenauer)

Norway—**Radio Norway**, LLG, 9.610, noted signing on 0600 for New Zealand-Australia-Far East; announced as operating in the 13-, 19-, 25-, and 31-m. bands; very weak in parallel on 15.17. On Sundays has "Norway This Week" (English) 0700-0715; other days closes 0700. (Pearce, England) Oslo noted opening 0800 on 15.170 with good level in Georgia. (Fargo) LLH, 9.645, noted in English at 1500. (Ridgeway, South Africa) The 11.735 channel is fine strength opening 2000 to North America. (Niblack, Ind.)

Pakistan—**Radio Pakistan**, 11.675, noted yet opening with good level 0830 with Burmese program for Burma. (Bellington, N. Y.) General Overseas Service noted lately near 9.480 signing on 1210 with news at dictation speed to 1230; news still heard 1015-1030 on 11.675; at 0200-0210 on 15.620 (for Bengal). Noted on 4.805 (Lahore?) at 1015-1030 in parallel with 11.675; news 1015; confirmed this channel as Karachi but may be Lahore. (Pearce, England) Rosenauer, Calif., others, have recently heard the 4.805A channel around 0900 onwards; had news 0330-0945; no location was given; signal fair.

Panama—HOLA, 9.504, Colon, signs off weekdays 2300 but on Saturdays

ANTENNA EQUIPMENT

MAST BASE—INSULATED

MP-132 BASE—as illustrated at left, 1 heavy coil spring, 2" insulator. Overall length: 11½". Weight: 2½ lbs. Price \$3.95

MAST SECTIONS FOR ABOVE

BASE—Tubular steel, copper coated, painted, in 3 foot sections, screw-in type. MS-53 can be used to make any length, with MS-52-51-50-49 for taper. Price for any section 50c Ea.

AN-104A Antenna—100-156 MC.	\$2.00
AN-117 Whip Steel—6 Ft. length.....	1.50
AN-109A Whip Steel, 5 Ft. w/Base.....	1.50
AS-27/ARN-5 Ram's Horn, 110 MC.—USED..	5.95
LP-21-A Loop for ADF equip.—Used, tested..	9.95
AT-37/APT Stub—113-150 MC.....	6.95
AT-32/APT-3 or APT-1 Stub—113-150 MC....	6.95
AN-97/ARQ-8 Spike with coaxial lead in base.	4.95
AS-61/ARN-3 Half-Wave Dipole—335 MC.....	3.95

DYNAMOTORS:



DYNAMOTOR And BLOWER
9 Volts DC input, output 450 Volts 60 MA., 4500 RPM. At 6 Volts DC input, output 260 Volts 65 MA., 3000 RPM. Price \$4.95

INPUT:	OUTPUT:	STOCK NO.:	PRICE:
12 V. DC	220 V. 70 MA.	DM-24	\$6.95
12 V. DC	220 V. 100 MA.	DM-18	4.95
12 or 24 V. DC	440 V. 200 MA. &		
	220 V. 100 MA.	D-104	9.95
14 V. DC	375 V. 150 MA.	DM-375	8.95
14 V. DC	330 V. 135 MA.	DM-330	7.95
14 V. DC	500 V. 50 MA.	PE-50	14.95
12 or 24 V. DC	275 V. 110 MA.	USA/0516	3.95

Tell Us Your Dynamotor, Inverter, & Motor Needs!

TRANSFORMERS AND CHOKES:

TRANSFORMERS

110 VOLT 60 CYCLE PRIMARIES	Sec. 6.3 V. 1 Amp.	\$1.25
	Sec. 24 V. ½ Amp.	1.50
	Sec. 24 V. 1 Amp.	1.95

CHOKES

H-115 8 Henries 500 MA Filter, 5000 V.Ins..	\$10.95
H-121 13 Hy. 250 MA Filter, 1500 V. Ins...	4.95
II-412 4-12 Hy. Swinging, 300MA, 2500V.Ins.	4.95

What'll You Have?

BC-230 Transmitter, with Tubes.....	\$ 4.95
R-1/ARR-1 Receiver f/conversion to 220 MC.	4.95
FL-3 Filter, 1020 cycle Audio Filter..USED.	1.50
Leg & Seat Assembly for Hand Generators...	3.50
CD-501 Cord for GN-45 Generator.....	2.00
C-37/ART-13 Control Box f/ART-13 Trans.	NEW: \$6.95 USED: 4.95
CD-318 Cord f/Throat or Lip Mikes.....	.59
CD-307 Cords 65" w/PL-55 & JK-26.....	.99
CD-604 Cord w/C-410 Trans. & PL-54 Plug..	.89
Head & Chest Set w/Plug for EP-8...USED:	2.95
Microphone & Headset, Dynamic type f/MARK II:	NEW: \$2.95 USED: 1.95
TUNING UNITS for BC-375-191: TU-5, 7, 8, 9, 10, or 26.....Each:	3.95
TA-12B Transmitter w/Tubes.....USED:	29.50
RA-10 CA or DA Receiver w/Tubes...USED:	17.95
MR9-C Control Box f/RA-10 Rec.—with Mtg.	12.95
BC-605 Amplifier..NEW: \$ 5.95 USED:	3.95
BC-347 Amplifier w/Tube.	NEW: 2.95 USED: 1.95
BC-709 Amplifier..NEW: 4.95 USED:	3.95
BC-434 Control Box.	NEW: 8.95 USED: 5.95
BC-732 Localizer Control Box.	NEW: \$2.95 USED: 1.95
MC-211 Right Angle Adapter f/MC-215.....	.50
MC-215 Tuning Shaft for 274 N-96.....	2.00
MC-124 Tuning Shaft f/Radio Compass—12 ft.	3.95
PL-112 Plug for LP-21 Loop.....	1.25
CD-365 Cord—for LP-21 Loop.....	1.75
PL-P-103 Plug for BC-348 Receiver.....	1.50
FT-154 Mounting—for BC-348 Receiver.....	2.50
FA-10 Fairlead.....	1.00
BC-455 Comm. Receiver, 6-9.1 MC...USED:	7.95
BC-457 Comm. Transmitter, 4-5.3 MC.Used:	5.95
BC-458 Comm. Transmitter, 5.3-7 MC.Used:	5.95

BC-223 TRANSMITTER

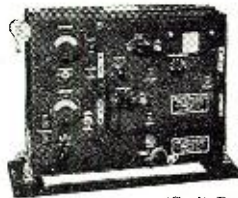

30 Watt transmitter with Crystal or MO control on four pre-selected channels. CW, MCW cover frequency range 2000-5200 KC. by use of plug-in coils. Complete with tubes and choice of one Tuning Unit (listed below). Less Mtg.—Prices: NEW: \$32.50

USED \$26.50

(Gov't. Reconditioned)

CABLE—Trans. to Power Supply.....	\$2.00
TUNING UNITS: TU-17—2000-3000 KC.; TU-18—3000-4500 KC.; TU-25—3500-5250 KC..	\$3.50 EACH
SPARE VIBRATOR & TUBE KIT f/PE-125HX.....	\$ 5.95
PE-125HX POWER SUPPLY f/BC-223—12/24 Volt input; output 475 Volts 150 MA.	NEW: 14.95
SPARE TUBE KIT in metal box. f/BC-223:	5.95
OPERATING MANUAL for BC-223AX.....	2.50
SHOCK MOUNTING for PE-125.....	1.50
FT-173 MOUNTING for BC-223.....	2.50
BC-223 TRANSMITTER—Incomplete, for parts. No front panel or meters. Price—As is:.....	\$4.95

GUY CABLE

Regular Aircraft Control Cable, 3/32"—7x7—49 Strands galvanized weatherproof. 920 lb. Test. Ideal for television or radio mast guying. Non preformed. Prices:

2¼¢ per Ft.—1000 Ft. or more: 2½¢ per Ft.

BLOWERS:

115 Volt 60 cycle BLOWER (pictured), approx. 100 CFM Dis. 2¼" intake; 2" outlet. Quiet running. Motor size: 2½"x3¾". NEW—not Gov't surplus.



\$7.99

Order No. RN-520..

DUAL BLOWER—Same as RN-520 above, except has blower assembly on each side of motor. Order No. RN-800..... \$12.95

AERIAL WIRE

Aerial Wire—Phosphorous Bronze #16 Stranded, 200 lb. test. Weatherproof. 150 feet on Reel. RL-3 with Clips ... \$1.50

WIRE—HEAVY DUTY RUBBER COVERED

2/±16—20 Ft. Length.....\$1.25
2/±12—10 Ft. Length 1.00
1/±8—Shielded, 15 Ft. 1.50
1/±6—Shielded, 7½ Ft.75
1/±2—Shielded, 8 Ft. 1.00
1/±8—Cotton covered—Per Foot06
500 Ft. ±20 Cotton covered stranded and tinned, in 3/2" lengths. 500 Ft. (Ass't. colors).....\$3.95

METERS:

0-150 Volt, 400 cycle, 2½" Rd.....	\$3.95
0-5 Amp. AC, 3" Rd., 0-75A Scale.....	3.95
0-5 Milliamp DC, 2½" Sq., 0-5 Scale.....	3.95
0-1 Milliamp DC, 2½" Rd., 0-150 Scale.....	3.95
0-500 Microamp, 2½" Rd., 0-15 & 0-600 DC Volt Scale.....	3.95
TUNING METER I-70B Reverse Scale, Weston #606 for Compass Control Boxes.....	3.95

3/4 RPM ANTENNA ROTATOR MOTOR

High torque, reversible motor—operates directly from 110 Volt 60 cycle by use of condenser. Light weight, quiet running. Ruggedly built, positive stop, easily mounted. Normally operates from 110 Volt 400 cycle. Complete—with instructions. NEW....

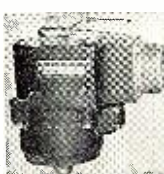

\$4.95

10 MFD 400 Volt Cond., \$1.00. SPDT Switch: 35c

6-VOLT POWER SUPPLY

VIBRATOR TYPE—6 Volt DC input; output 230 Volt DC 50 MA. filtered w/tube. Size: 6½"x4"x5½". Price \$6.95

VIBRATOR TYPE—6 Volt DC input; output 230 Volt DC 50 MA.—not filtered—w/tube. Ideal for Command Receiver operation as receiver is filtered internally. Size: 4½"x4"x3½". \$4.95

SEND IN YOUR ORDER TODAY!

Address Dept. RN • Minimum Order \$2.00
Prices F.O.B., Lima • 25% Deposit on C.O.D. Orders

FAIR RADIO SALES

132 SOUTH MAIN ST.
LIMA, OHIO

READ RADIO & TELEVISION NEWS EVERY MONTH

WELCOME, BROTHER 'VARI'!
Many Servicemen want your New Micrometer Adjustment and Snap-in Mount!

GLAD TO JOIN THE CAUSE, BROTHER 'FERRI'!
You've done a wonderful job for 100,000 sets in only 5 months!

the world's most sensitive, compact and efficient Small Radio Antennas at Low Cost!

shown actual size

GRAYBURNE CORPORATION, 103 Lafayette St., New York 13, N. Y.

GRAYBURNE
Grayburne means Quality Electronic Components

NOW THERE ARE 2 GRAYBURNE Loopsticks!

FERRI-LOOPSTICK and VARI-LOOPSTICK

Grayburne Loopsticks, with magic Ferrite cores, obsolete conventional radio loops, improve reception amazingly over entire broadcast band, and pull in hard-to-get stations that normally can't be heard with ordinary loops.

Highest Sensitivity: Average Q is 250, unaffected by adjacent metallic or inductive elements.

Omni-Directional: Equally sensitive and efficient at every angle. No more turning or moving receivers to get better reception.

Greater Receiving Range: Greater, more uniform amplification over a wider frequency range—all at higher signal-to-noise ratio.

Performance-Proved: After comparative tests, service dealers coast to coast have bought 100,000 Loopsticks in only 5 months!

FERRI-LOOPSTICK: Just set and forget! For permanent installations, new or replacement, where user desires to make no further changes once Loopstick has been set for maximum overall efficiency. **List 75¢.**

VARI-LOOPSTICK: Has advantages of Micrometer Adjustment and one-hole Snap-in Mount! For peaking efficiency on several stations consecutively, station jumpers and DX tuners. Peak resonance for any station is quickly obtained. **List \$1.00.**

Write for name of your nearest Grayburne distributor and free booklet "Ferrites and Their Applications."

runs to 0200 (Sun.). (Bellington, N. Y.)
Noted in *English* 2130. (Ferguson, N. C.)

Paraguay—Ridgeway, South Africa, says *Radio Encarnacion*, XPA5, 11.946, is noted with frequent relays of *Radio Belgrano* programs, around 1500 to well after 1630; has woman announcer on its own sessions; good level in South Africa.

Peru—*Radio Colonial*, 9.33, noted 0054 with music. (Bellington, N. Y.) OAX4Z (announced), 15.105, Lima, noted 2218 announcing for *Radio Nacional del Peru*. (Ferguson, N. C.) OAX4W, 9.405, Lima, continues to be heard in England around 1900, but at poor level. (Catch) OAX4X, *Radio El Sol*, Lima, is now heard on 15.105 until 0100. (Cushen, N. Z.)

Philippines—DZH9, 11.855, Manila, noted mornings (*EST*) but at times is covered by a VOA outlet on 11.86. (Balbi, Calif.) DZH8, 15.300, noted R5 at 1000. (Pearce, England) Heard opening with *English* announcement 1555; had program of religious music 1600-1630; good signal in Calif. (Rose-nauer) Heard well in South Africa from around 0830 to 1200 closedown on DZH7, 9.73; DZH9, 11.855, and DZH8, 15.300; DZH6, 6.030, is also announced but not heard. (Ridgeway)

Radio Free Asia, 6.110, Manila, noted 1000 signing off with announcement is using DZI4, Manila, 10 kw. (Pearce, England) DYH3, 6.140, Cebu, noted 0340-0400, mostly in Filipino but with *English* identification 0400. (Rose-nauer, Calif.)

Poland—Warsaw sent winter schedule for *English* broadcasts for Europe—1230-1300, 6.220, 7.205; 1315-1345, 6.115, 9.525; 1350-1420, 6.220; 1545-1615, 7.205; 1615-1645, 6.115, 9.525. (Pearce, England) Warsaw, 6.15, noted with *English* 2320; bad heterodyne but strong signal; talk closed 2335 and station signed off *English* at 2342 and continued in foreign language. Announced that this channel is being used four times daily for *English* broadcasts to North America. (Niblack, Ind.) These *English* sessions are 1700-1730, 1730-1800, 2315-2345, 0030-0100. (Bellington, N. Y.)

Portugal—*Radio Free Europe* noted over the Lisbon 9.604 relay outlet with interval 1057 and then signing on 1100 in Czech. (Pearce, England) Lisbon noted on 6.360 to 1900 when signed off with "A Portuguesa" after the Lisbon clock sequence. (Stark, Texas) CSA21, 6.374, Lisbon, heard at good level from 1315 onwards; announces in Portuguese as Home Service; music and talks. (Ridgeway, South Africa) This outlet noted signing off 1900. (Saylor, Va.)

Lisbon, 11.963A, noted 1730-1800 sign-off, good level; 9.745 is better in parallel. (Niblack, Ind.) Bishop, Ohio, reports Lisbon signing on 1330 on 11.996 with strong signal. Lisbon heard on *measured* 15.124 around 0700 to close down 1130; all-Portuguese. (Catch, England)

Reunion Island—*Radio Saint-Denis* gives this schedule in letter—2145-2245,

STOP

those costly TV service calls with ...

ELECTRO CHEMICALS

• ANTENNA KOTE • CORONA-X
• CONTACT CLEANER

ANTENNA KOTE—Our newly developed chemical compound for safely coating all exposed exterior television connections. Non-electric conductor. Eliminates use of tape. Non-corrosive, weatherproof and oil-proof. Brush attached to cap of bottle.

CONTACT CLEANER—A fast drying combination of special solvents that offers a great cleaning solution. Recommended for treating volume controls, band switches, tuning condensers, etc. Leaves a non-corrosive film on contacts after drying. Brush attached to cap of bottle.

CORONA-X—The new and superior product used to control and prevent corona arc discharge on high voltage circuits in television. Has excellent high voltage insulating qualities. Easy to apply. Air dries. Brush attached to cap of bottle.

A Complete Line of Electronic Chemicals
Exclusive territories for sales representatives
Write for circular "R-1"

DAKOLINE CHEMICAL CO., INC.
ELECTRONIC CHEMICALS DIVISION
357 ATLANTIC AVE., BROOKLYN 2, N. Y.

NEW LABCO TV CABINET

**Ideal for Conversions
Custom Chassis—Kits**

Only
\$49⁵⁰

Model 800
H—40"
W—24"
D—24"
Immediate Delivery

A masterpiece of fine cabinet making—mahogany veneers hand-rubbed to a high satin luster. Has no equal for conversions, custom chassis, and kits. Ideal for 630 RCA-type chassis. Blank front panel easily removed for cutting to any shape CR tube to 20" size. Complete with adjustable CR tube cradle, adjustable yoke assembly shelf, masonite ventilated back. Handsome console at an exceptional price.

20% with Order, Balance C.O.D.
F.O.B. Factory

LABCO ELECTRONICS, INC.
2216 MARKET ST. - PHILA. 3, PA.

0315-0410, 0900-1000 (Sat. to 1400) on 4.797, 7.170. (Radio Sweden)

Sao Tome—CR5SC, 4.808, noted regularly 1500-1600 closedown; has three-note gong; CR5SB, 17.698, heard Sundays 0700-0800. (Ridgeway, South Africa)

Saudi-Arabia—D j e d d a, measured 5.976, noted recently 2243 with interval prior to opening broadcast 2245 and to closedown 2331; must have changed schedule as formerly was heard 2300-2345A. (Ferguson, N. C.) Noted around 1150 on 11.95, 11.85, 5.975. (Pearce, England) Bluman, Israel, says the 5.975 outlet is now on the air also at 0600-0645.

South Africa—SABC calling Africa noted on 11.937 at 1200-1505 closedown; has news 1500, some days in *English*, others in Afrikaans; usually has news 1200 followed with weather report (*English*) at 1215. (Pearce, England)

Southern Rhodesia—Salisbury, 3.320, noted 1325 with recordings; call 1330. (Pearce, England)

Spain—Radio Juventud Escuela No. 17, 7.200, noted around 1726 with varied recordings. Sends fine QSL card promptly; QRA is Radio Juventud, Buenos Aires 4, Cadiz, Spain; gives frequency as 7.200 but sent no schedules. At 1500 note good signal from FED, Valladolid, 7.005, Radio Nacional de Espana en Malaga, 7.025, Radio Mediterraneo, 7.037, Valencia, all of which take Spanish news relay from Madrid at 1545. Spanish-speaking station noted near 7.105 at 1430 announcing "Radio Tullento Murcia." (Pearce, England)

Bluman, Israel, says Madrid's Radio SEU, EDV-10, seems to have settled down now on 7.140 where it has a clear channel between Radio Africa, 7.128, Tangiers, and Berlin, 7.150, after having roamed the 42-m. band for quite some time.

Madrid, 9.363, continues to have strong signal during its "repeat" session for North America (*English*) 2215-2245. (Mesard, D. C.)

Spanish Morocco—Radio Tetuan, EA9AH, measured 6.0625, was logged recently 1745 with poor level; signed off 1802. (Oskay, N. J.)

Sweden—SDB2, 10.78, Stockholm, heard regularly from 1300; *English* 1345-1400; bad QRM at times. (Ridgeway, South Africa) This one usually is poor for *English* in North American session 2000-2015; 15.155 in parallel is much better signal in Ohio. (Bishop) Heard over SBP, 11.705, daily 0815 in *English* ("Sweden Today"). (Rodger, Scotland) The 15.155 channel is parallel.

Syria—Maurice, N. Y., recently received this schedule from Damascus—665 kc. and 719 kc., m.w., 50 kw., Arabic program 2330-0200, 0630-0800, 1000-1700; on 6.165, 20 kw., dipole antenna, Arabic 2330-0200, 0630-0800, 1000-1700; 7.145, 2 kw., dipole antenna, 0200-0230 Arabic; 0230-0430 French; 0830-0930 Arabic, 0500-0600 *English*; 11.915, 20 kw., rhombic antenna, 1530-1630 French, and 1630-1730 *English*; 17.865, 20 kw., rhombic antenna, 0945-1045 Arabic and *English* for India-Pakistan;

**"I'm tough and rugged.
but the SWEETEST mike you ever owned!"**



TOUGH?

Yes, the Turner Model 99 Dynamic is the greatest mike in the world for taking hard knocks... yet retains the perfect response and sensitivity that make the 99 an outstanding microphone value.

Indoors or outdoors — for ham rig, broadcast remotes, sound installations — the Turner 99 is completely dependable. For mobile public address systems, paging systems, communications or recording machines, the 99 delivers crisp, clear results. Its smooth response is not affected by heat, cold or humidity.

Specify the Turner Model 99 Dynamic microphone with confidence. Use it with pride. Order from your Turner dealer or representative, or write direct for complete microphone literature.

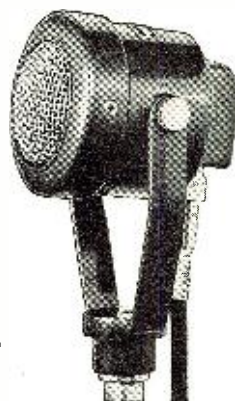

**TURNER
Model 99**

Response: 60 — 9000 c.p.s.
Level: 52 db below 1 volt/dyne/
sq. cm. at high impedance
Impedance: 50, 200, 500 ohms
or high impedance
List Price -----\$36.00

THE TURNER COMPANY

IN CANADA:

Canadian Marconi Co., Ltd.
Toronto, Ont., & Branches

EXPORT:

Ad. Auriema, 89 Broad Street
New York 4, N. Y.



900 17th Street N.E.
Cedar Rapids, Iowa

PEN-OSCIL-LITE

Extremely convenient test oscillator for all radio servicing; alignment • Small as a pen • Self powered • Range from 700 cycles audio to over 600 megacycles u.h.f. • Output from zero to 125 v. • Low in cost • Used by Signal Corps • Write for information.

GENERAL TEST EQUIPMENT
38 Argyle Buffalo 22, N. Y.

**SCHEMATICS—CONVERSIONS
FOR SURPLUS GEAR**

NEW LIST! MANY ADDITIONS!
Send stamped, self addressed envelope for List B. Add 25c for chart explaining AN nomenclature.
R. E. BOX 1220
GOODHEART BEVERLY HILLS, CAL.

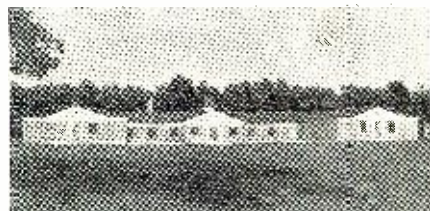

**RADIO ENGINEERING
TELEVISION
ELECTRONICS**

Thorough training in all phases of radio and electronics, open to high school and junior college graduates. Old established school specializing in Radio training exclusively. Modern laboratories and courses. Enrollments limited. Approved veteran training.

VALPARAISO TECHNICAL INSTITUTE
Dept. RD Valparaiso, Ind.

USE PHOTOFAC

the world's best Radio and TV Service Data ...



WE'LL PROVE YOU'LL SAVE TIME and EARN MORE WITH PHOTOFAC

FREE Service Technicians: We'll send you any Photofact Folder listed in the "PF INDEX and Technical Digest." If you haven't an Index, get a free copy from your local Photofact distributor or write for it today. To obtain Free Folder, be sure to state Photofact Set and Folder Number as shown in the Index.

NOW—learn for yourself how PHOTOFAC makes your Radio and TV work quicker, easier, more profitable! Just get and use an actual PHOTOFAC Folder. Discover why over 35,000 successful service technicians count on this invaluable data daily. No other service gives you PHOTOFAC'S completeness, accuracy, uniformity and lowest cost. PHOTOFAC is the only Radio-TV service data prepared from laboratory analysis on the actual equipment. Get your FREE Folder now. Examine, use, compare. See why you can't afford to be without PHOTOFAC!

NOTE: Our FREE Folder offer is limited to Service Technicians only. Attach coupon below to your letterhead and mention your jobber's name. Experimenters and others may obtain the Photofact Folder by remitting amount shown below.

HOWARD W. SAMS & CO., INC.

HOWARD W. SAMS & CO., INC.
2201 E. 46th St., Indianapolis 5, Ind.

I am a Service Technician. Send me Free Folder No. which appears in Photofact Set No. (as listed in the PF Index).

I am an Experimenter. Enclosed \$..... Send me Folder No. which appears in Photofact Set No. (TV—\$1.00. AM/FM—50c. Record Changer or Communication Receiver—75c)

Name.....

Address.....

City.....Zone.....State.....

EASY PAY PLAN! PAY AS YOU EARN! Ask your distributor about this amazing plan. Only \$18.39 puts the entire profit-boosting Photofact library in your shop now!

QRA is General Administration of the Syrian Broadcast, Victory Street, Damascus, Syria.

Tahiti—Radio Tahiti, 6.135, Papeete, noted 0034 in French. (Winch, Calif.) With native music 2345-2355; French 0000; weak to fair level in Wyoming. (Lane) English announcement noted 0125. (Russell, Calif.)

Taiwan—Taipeh, 15.235, noted opening 2300 with news and commentaries in English; announced 11.735 in parallel; good on 15.235, very weak (barely readable) on 11.735; has Chinese after 2400, and is better level then. (Rosebauer, Calif.) Noted opening 0530 on 7.135A. (Bellington, N. Y.) "Voice of Free China," Taipeh, noted on 11.800 with English 1415 good strength; has Chinese after 1515. BED26 has moved to 10.050A where is well heard at 0500 and noted again 0900. (Cushen, N. Z.) The 6.095 and 7.02 Taipeh outlets sign on 0500, former is best level. (Balbi, Calif.)

Tangiers—Radio Africa, 7.125, noted with Spanish music afternoons (EST). (Pearce, England) Heard with announcement in French by male announcer at 1813 recently. (Bellington, N. Y.)

Thailand—HS8PD, 15.918, Bangkok, has a good signal (in native) in South Africa 0845; music 0900; signal deteriorates at 1015. (Ridgeway) The 6.24 outlet is heard faintly most days after 0500. (Balbi, Calif.)

Trinidad—VP4RD, 9.625, Port-of-Spain, noted 0700 and around 1700 at fair level; according to verification received, station has a 3.275 channel. (Gates, Conn.)

Turkey—ISWC, London, and other overseas sources, report a new station announcing as "Burasi Ismir Radyosu,"

operating irregularly on 6.500A; is likely to be on the air Wed. and Sun. only around 1200 to approximately 1535; programs are relayed from the long-wave station of Radio Ankara.

TAS, 7.285, Ankara, good signal with English 1600-1645. (Foerster, Ill.) Often heard from 1330. (Simonian, Mass.) Announces TAP. 9.465, is parallel at 1600.

TAT, 9.515, noted recently 1100 in native language; TAP, 9.465, noted on the air at 1110 to tune-out 1135. TAV, 17.820, noted signing on in English 0730 for Australia-Far East with news, recorded music, Mail Bag. (Pearce, England) This one noted in Georgia with news 0730. (Fargo) TAP, 9.465, noted with news 1600. (Rodger, Scotland) TAT, 9.515, continues with "local-like" level in its 1815-1900 beam to North America (English). (Clapp, N. J.)

Uruguay—CSA21, 6.1612, Montevideo, noted at good level 2030. (Russell, Calif.)

USI—Padang, 7.24, noted from around 0440 to 0600 sign-off. Indonesian noted lately on 11.935A very weak with QRM at 1000; heard signing on 0430 on this channel announcing as Radio Indonesia in Djakarta. (Balbi, Calif.) YDC, 15.15, Djakarta, heard 1010. (Pearce, England) The Indonesian on 11.082 with Dutch announcements, music—heard 0800 to closing 0930 with Hawaiian tune—is believed YDQ3, Makassar, Celebes. (Ridgeway, South Africa) Overseas sources say the new 100 kw. transmitter at Kebajoran, Java, will use YDF6, 9.585, instead of YDF7, 11.770, for programs 1100-1500 daily beamed to Europe.

The Djakarta Forces transmitter has verified its 7.165 outlet for Cushen, N. Z. Transmitter is a new 7.5 kw. job

CONDENSER TIME DELAY RELAY

By JOSEPH HOULE

TIME delays between 1 and 10 seconds are easily obtained using parts that inhabit most junk-boxes—d.c. relays and electrolytic condensers. The circuit shown, Fig. 1, can be adapted to door openers, lamp flashers, voice-controlled transmitter switching, or whatever need may turn up. It has been used in a circuit for holding a magnetic door latch open for 5 seconds after a push-button is pressed.

Momentary closing of the switch or push-button, S₁ will charge up the condenser from the d.c. source. After the switch is released, the condenser will discharge through the relay coil, holding it closed for a time depending on the coil resistance, the relay adjustment, the supply voltage, and the capacitance. The relay drop-out current and the capacitance are the most important factors. To get the longest hold-down time, adjust the relay for light spring pressure and a small gap between armature and pole face when the relay is closed. If the relay contacts will have to handle more than 1 or 2 amperes, don't make the spring pressure too light or the contacts will stick together. If necessary, use a second heavier relay, controlled by the sensitive relay, for handling heavy loads.

A selenium rectifier working off the

115-volt line makes a good d.c. source. If this voltage is too high for the relays on hand, it is OK to insert some resistance in series with the coil to limit the initial current; this will lengthen the hold-down time somewhat, too.

A relay with a pair of back contacts (normally closed contacts), and a condenser across the coil, will close and release continuously when the back contacts are connected in series with the d.c. line—making, in effect, a low-frequency square-wave generator. The frequencies obtainable are in the right range for sign flashers.

A good combination for a 5 to 6-second hold-down time is a 2000-ohm sensitive relay with about 5000 ohms in series with the coil, a 110-volt selenium rectifier supply, and a 160-μfd. condenser.

Fig. 1. Wiring diagram. With a 50 μfd. condenser, 2000 ohm relay, and 110 volt d.c. source, delay is about 2 seconds. Up to 10 seconds is obtainable with larger condensers or with higher resistance relays.

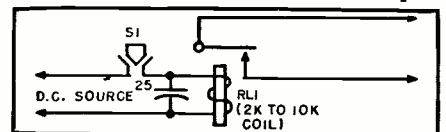

and is directed towards Western Java and the Celebes; however, is currently using 11.940 (replacing 7.165) at 0430-0630 daily. (Radio Australia)

USSR—Station on 7.10 noted around 1740 with classical music, off 1757 with Russian Anthem; woman announcer; fair signal but CWQRM'd at times. (Bellington, N. Y.) Soviet on 6.825 noted 2300 with usual bells. (Leary, Ind.) Soviet noted in native 0745 on 7.175. (Stark, Texas) *Radio Tashkent*, 6.825, heard with *English* for India-Pakistan 1000. (Pearce, England) Moscow heard on 7.340 with talk and news around 1650-1700. (Rodger, Scotland) Ridgeway, South Africa, notes Tashkent, 6.825, also in *English* 1115-1130; begins language session 1130, sometimes has bad CWQRM.

Moscow, 15.36, noted with news 0930-0945 for India-Pakistan; good level in Calif. (Rosenauer) Noted on 7.245 with *English* 0045 and at 0245. (Hoffman, N. Y.) Komsomolsk, 9.7257, noted in *English* 0050. (Russell, Calif.)

Vatican—HVJ, 15.120, heard with *English* 1000-1010, then in Polish. (Pearce, England) Noted 1315-1330 in *English* on 9.644; often spoiled by bad jamming. (Ridgeway, South Africa).

Venezuela—YDKF, 4.880, noted with good level to 2300 sign-off. (Foerster, Ill.) YVMI, 3.370, Maracaibo, noted 1730-2200; QRA is YVMI, *La Voz de La Fe*, Maracaibo, Venezuela. (Kroll, N. Y.) YVMC, 3.350, noted at good level to 2200 sign-off. (Lane, Wyo.)

Western Samoa—Overseas sources say ZM2AP, Apia, is on the air 0030-0330 on Sat., Sun., Tues., Thurs.; 0103-0230 Mon., and 1500-1600 Mon., Tues., Wed., Fri.; test channels are 3.410, 6.040; has not been reported as heard in USA.

Yugoslavia—*Radio Yugoslavia* noted with call 0930 on 6.100. (Pearce, England) By this time, *Radio Yugoslavia* should have started an *English* session; no further details were available when this was compiled. A detailed list of programs beamed by this station can be had by writing to Yukovich George, 6 Mose Pijade, Belgrade 2, Yugoslavia. (*WRH Bulletin*)

* * *

Press Time Flashes

When this was compiled, Bellington, N. Y., was hearing a station in Arabic around 2330 on 6.165 which seemed to have same program as Beirut, Lebanon, on 8.026A.

The Yugoslav Emigrant Radio, 6.887, noted around 0030-0045 in European language. (Leary, Ind.) Noted in Britain on *measured* 6.888 at 1620 and closing 1635. (Catch)

The Forces Station, Djakarta, USI, is now on 11.940A until 0630 closedown; program is quite similar to that heard formerly on 7.165. (Radio Australia)

Ridgeway, South Africa, notes an Angolan station on 7.800 closing 1430 with "A Portuguesa" which he believes to be Radio Clube de Benguela; other channel used by Benguela is 7.080, closing 1430.

Congratulations go to John J. Oskay, New Jersey, who won the recent DX

February, 1952

NEW Automatic Radio

CUSTOM-BUILT AUTO RADIOS

RECORD SMASHING VALUES!

1949-1950-1951

CUSTOM-BUILT AUTO RADIOS



Ford, Chevrolet, Plymouth, Dodge, Henry J, Hudson, Studebaker. List Price \$59.95. Each radio is a six tube superheterodyne six volt battery operation—three gang tuning condenser and tuned RF stage PM speaker Alnico No. 5., wt. 10 lbs.—easy installation.

ATTRACTIVE DISCOUNTS TO DEALERS

SPECIAL

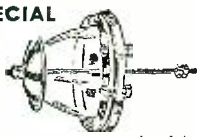

Navy entering type insulator. Porcelain flanged bowl with brass rod and fittings and aluminum shield. Dimensions: 4 3/8" high, 6-5/8" O.D. base. NEW with Spare Bowl...\$4.50

TUBES Prices Slashed

2C34	\$.80	6AL5	\$.66
2X2/879	\$.65	6AQ5	\$.77
3C24	\$.75	6AR5	\$.79
7C4/1203A	\$.75	6AT6	\$.59
10Y	\$.45	6AU6	\$.99
15R	\$.85	6BD6	\$.69
30 SPEC	\$.55	6AV6	\$.75
39/44	\$.40	6BA6	\$.69
45 SPEC	\$.35	6BE6	\$.73
WE 303A	8.80	6B6GT	\$.99
316A	\$.65	6B06GT	1.29
WL531	1.00	6J3GT	1.29
713A	1.00	6K5	\$.85
801A	1.00	6J7	\$.85
803	1.00	6L7	\$.90
826	1.00	6SD7GT	\$.90
931A	1.00	6SN7GT	\$.79
864	1.00	6U6	\$.95
CK1007	1.20	6V6GT	\$.88
CK1007	1.20	6W4GT	\$.66
1626	1.00	6X4	\$.75
2051	1.15	7C6	\$.90
7193	1.00	7Z4	\$.85
8011	1.70	12AU6	\$.59
9006	1.50	12AT6	\$.75
C5B	9.75	12AV6	\$.73
CE072	1.30	12BE6	\$.89
CR70	1.30	12BD6	\$.89
CRP-2	1.30	12SN7	\$.99
E-1148	1.35	12SQ7	\$.85
HY-615	1.25	25Z5	1.35
HR-72	1.30	33	\$.90
RK-73	1.65	35W4	\$.90
3BP4	1.95	50B5	\$.96
5P7	1.95	50C5	\$.96
1J6G	1.75	50L6GT	\$.89
1B3GT	1.60	50L6GT	\$.89
5U4G	1.50	75	1.15
5W4	1.90	85	1.85

MICROWAVE EQUIPMENT

- 10CM Echo Box Frequency Range 2890MC-3170MC. Direct Reading Micrometer Head. Ring Prediction Scale Plus 9% to Minus 9%. Type "N" Input. Resonance Indicator Meter with Accessories and 10CM Directional Coupler and Spares—Brand New.
- 50 Radar, 10CM Rotating Antenna 24" Parabola in Turret 360° Span—Brand New 50-3 Bearing Control.

PRICES UPON REQUEST

All Sizes of Crystal Electrodes.

LINEAR POTENTIOMETERS WW

Ohms	Watts	Ea.	Ten
500	2	\$0.45	\$0.40
1000	2	.50	.45
3000	2	.55	.50
10,000	2	.55	.50
5000	3	.50	.45
7500 Dual	3	.85	.80
15,000	3	.55	.50
20,000	3	.65	.60
50,000	4	.90	.85
15	25	.95	.90
20	25	.95	.90
25	25	.90	.85
50	25	.95	.90
100	25	.95	.90
200	25	1.20	1.10
500	25	1.20	1.10
1000	25	1.30	1.25
25	25	1.40	1.35
15,000	25	1.70	1.60
20,000	25	2.00	1.95
150/switch	50	2.15	2.00
200/W switch	50	2.15	2.00
800	50	2.65	2.50
10,000	50	2.95	2.75
15	60	2.95	2.75
15	75	2.95	2.75

RELAYS

12VDC DPST Allied Box 32	\$1.25
24VDC 3PDT 8 amp.	1.50
24VDC DPDT Allied D66326	1.45
24VDC Solenoid operates 2 switches	1.75
40VDC DPST-SPDT 1000 OHM	1.25
110VAC DPST 1 amp contacts	3.65
110VAC DPDT 25 AM contacts	3.65
115VAC DPST Str's Dunn	3.95
CXA-2097	3.65
220VDC DPDT Str's Dunn	4.50
CX-2122	4.50

HIL-VOLTAGE FILTER CHOKES

.4 HY 4.5 Amp DC 3 Ohms 1230 RMS to ground GE 69G351	NEW
1.7 HY 2 Amp DC 9000VDC GE YB464A	NEW
.25 HY 4 Amp .5 Ohm 20,000 Test 4	NEW
1 HY 3.2 Amp DC 3.5 Ohm GE 69G459	NEW

TIME DELAY SWITCHES

1 Minute 115 VAC 60 Cy Enc. in Waterproof Metal Case.	\$5.25
3 Micro Switches Make Contact at 40-41.4 Sec. Time Delay 110 VAC Motor.	4.50
Thermo Switch 50° to 300° F. 115 VAC @ 5A. 230 VAC @ 5A Breaks Contact with Increase of Temperature.	1.35
30-40 Second Mercury Time Delay Relay 110 VAC AD-Lake.	7.50

SPECIALS

80.86KC Crystal with Holder	\$2.50
GN-45	2.50
CD-501A Cord for BC-654 to Balloon with Hydrogen Gen.	1.95
300-Ft. Aerial Wire	2.00
Box Kite 17'x17'x36"	2.25
93-440 MMF Variable Condenser	1.10
7-190 MMF Variable Condenser	.95
24-750 MMF Tapered Rotor Plates	1.25

SPECIALS

BC-357 Marker Beacon Rec.	55.95
BC-224 Receiver . . . Used	79.00
BC-603 Receiver . . . Used	24.95
BC-222 Walkie Talkie 28-52MC less crystal tube—ant. Used	19.95
BC-684 Transmitter . . . Used	24.95
BC-AG-229 Rec. only w/ tubes	15.95
BC-AL-429 Rec. only w/ tubes	15.95
BC-659 Transceiver w/ supply	59.95
Exciter . . . Used	42.50
TU-17A 2000-3000KC	4.95
CAY-47151 800-1500KC	4.95
BC-709 Interphone Amplifier	7.95
BC-709 Interphone Amplifier	4.00

CAPACITORS

BATH TUB	EA.	TEN
4 MFD 600 VDC	.45	.40
2 MFD 400 VDC	.60	.60
.25 MFD 600 VDC	.40	.35
3 MFD 600 VDC	.40	.35
2X1 MFD 600 VDC	.65	.65

OIL-FILLED AND GE PYRANOL

1 MFD 600 VDC	.85	.80
2 MFD 600 VDC	.95	.95
4 MFD 600 VDC	1.40	1.40
5 MFD 600 VDC	1.65	1.60
1.8 MFD 600 VDC	2.50	2.35
2 MFD 1000 VDC	1.65	1.60
3 MFD 2000 VDC	2.00	1.90
.25 MFD 2000 VDC	1.40	1.30
1 MFD 7500 VDC	7.50	7.00
1 MFD 7500 VDC	12.50	12.00
1 MFD 15000 VDC	14.95	14.90
.008MFD 15000 VDC	12.50	11.75
.045 MFD 16000 VDC	12.95	12.50

PAPER

8-8 MFD 600 VDC	2.25	2.15
Tobe Filtermite 600 VDC	2.55	2.40
8-8-4 MFD 600 VDC	2.55	2.25

ELECTROLYTIC

2500 MFD 3 VDC	.40	.40
500 MFD 12 VDC	.50	.45
25 MFD 25 VDC	.40	.35
40 MFD 25 VDC	.60	.55
50 MFD 50 VDC	.60	.55
100 MFD 25 VDC	1.25	1.15
150 MFD 50 VDC	.50	.45
160-160MFD 150 VDC	1.50	1.25

TOGGLE-ROTOR SWITCHES

Pole	Position	Section	Shaft	Price
1	3	1	1 1/16"	\$0.35
1	4	2	7/8"	.50
*1	3	6	7/8"	.60
*2	4	4	1"	.60
*2	8	2	2 1/4"	.95

*Ceramic DPST 3A 250 Volt W/Hard-ware \$0.35
DPDT Center "OFF" 1 Throw Momentary 20A 125VAC 1.15
3PDT 10A-250 VAC 1.20
DPDT 5A 250VAC 1.30
DPST C-H AN3023-2 0.90

TERMS:

Minimum order \$5.00—Mail orders promptly filled—All prices F.O.B. Boston, Mass. Send M.O. or check. Shipping charges sent C.O.D. 25% deposit required with all C.O.D. orders.

Prices Subject to Change without Notice

SEND FOR OUR CATALOGUE

Inquiries from Dealers, Schools and Industrial Firms Invited

COMET ELECTRONIC SALES CO.

22 Washington St. • Beacon 2-7863 • Brighton 35, Mass.

Unlimited Opportunities in RADIO ENGINEERING

DEGREE IN 27 MONTHS

Complete Radio Engineering course, including Telev., U.H.F. and F.M. Bachelor of Science Degree, also in Mech., Civil, Elect., Chem., and Aero. Eng.; Bus. Adm., Acct., Extensive campus, modern buildings, well equipped labs. Low cost. Prep courses. Personalized, practical instruction. Founded 1884. Placement service. Growing shortage of engineers. Prepare now for unlimited opportunities ahead. Enter September, January, March, June. Write for catalog.



TRI-STATE COLLEGE

1622 College Ave. ANGOLA, INDIANA

EASY MONEY!!

If you don't get our postcards telling the cash we'll pay for that surplus gear you bought when the buying was good, then YOU ARE LOSING MONEY! So send us your name and address NOW and GET ON OUR MAILING LIST!

G. L. ELECTRONICS

905 S. VERMONT AVE., LOS ANGELES 6

145

www.americanradiohistory.com

FREE!

BIG NEW 1952

CONCORD CATALOG



Send for it NOW!

YOUR COMPLETE BUYING GUIDE for every need in— TV • RADIO • ELECTRONICS

You save time and money—with this bigger, better 1952 Buying Guide! Here is page-after-page full of the latest and greatest values in Television, Radio and Electronics. It brings right to your finger tips one of the world's largest stocks of nationally-known guaranteed quality parts and equipment—High Fidelity, TV, and Radios, Phonos, and Recorders, Sound Systems, Ham Gear, Test Equipment, Electronic Tubes, Parts, Books, Kits, and Tools. You find it quick and easy to get whatever you need—at the very lowest prices. Send for your FREE Concord Catalog today! Have it handy for quick reference.

FREE! New 2nd Edition HIGH FIDELITY GUIDEBOOK



Send for your FREE copy today

TELLS ALL you want to know about High Fidelity. How to bring concert hall realism into your home. What makes a real Hi-Fi Music System. How to select custom components or complete ensembles at modest cost. Shows various installations and a complete range of famous guaranteed Hi-Fi units.

CONCORD RADIO CORPORATION
901 W. JACKSON BLVD. • CHICAGO 7

CONCORD RADIO CORP., Dept. RB-52
901 W. Jackson Blvd., Chicago 7, Ill.

- Rush FREE Big, New CONCORD Catalog
- Rush FREE High Fidelity Guidebook

Name.....
Address.....
City..... Zone..... State.....

contest sponsored by the International Short Wave League, London. John logged 98 countries during the brief period of the competition.

A station on 4.330 heard around 0830-0900 with oriental language may be *Radio Pyongyang*, North Korea. (Rosenauer, Calif.)

The new schedule for the "Voice of America's" Amateur Program is—Latin American Service on Saturday 2130 on 6.040, 6.060, 9.650, 11.890, 15.210, 15.350; Far Eastern and Pacific Service on Sundays 0745 and 0945 over 6.060, 6.075, 6.125, 6.185, 6.195, 9.515, 11.890, 15.245; European and Near Eastern Service on Sunday 1415 over 6.040, 6.170, 9.700, 11.775, 11.830, 15.270. (Graybill, Wash. State)

Guentzler, Ohio, has received these schedules from *Radio Moscow* for English periods—*North American Service* 0800-0830, 17.83, 15.12, 11.96, 11.91; 1820-1930, 15.23, 15.11, 9.70, 9.67, 9.57, 9.55, 7.24, 7.20; 1930-2030, 15.23, 15.11, 9.67, 7.24, 7.20; 2030-2300, 15.23, 15.11, 9.70, 9.67, 9.57, 9.55, 7.24, 7.20; 2300-0100, 11.88, 9.56, 7.24, 7.20. *To Far East and Europe*—0300-0330, 11.78, 11.75, 11.72; 0400-0500, 15.36, 11.82, 11.78, 11.75, 11.72, 9.68, 9.64; 0530-0600, 15.41, 15.36, 11.82, 11.78, 11.75, 11.72, 9.68.

YDG2, 2.310, Sourakarta, Java, USI, is heard in New Zealand with news in Indonesian to 0945 when closes down. (Cushen)

Bluman, Israel, says ZNR, Aden, 2 kw., reported operating on 6.085, 6.760, 12.115, is a radio telephone transmitter but at times may be used for special relays. At present there is no regular radio station at Aden. (WRH Bulletin)

QRA for the "Voice of Free China" outlet on 11.800 is New Park, Taipeh, Taiwan; is heard from 1400; asks for reports to Near East and European Division; appears to be American-operated (?); has Russian 1400-1420, then English 1420-1440 when fades out. (Cushen, N. Z.)

Radio Sweden says the Chinese station reported heard on 6.430 around 1900-2000 may be *Radio Hsin-Hua*, Harbin, Manchuria; that Istanbul, Turkey, has been heard 1430-1457 on 7.970 and on 7.775; Rome can be heard now on 9.780 from 1220 onwards; *Radio Africa*, 7.126, Tangiers, broadcasts a short financial bulletin in English 1630; a Swedish firm has just published "Dux DX-bok," containing a list of long-, medium-, and short-wave stations; DX-ers can get a copy by sending eight IRC's to DX Editor, Radio Sweden, Stockholm 7, Sweden.

Lisbon, 11.963, is fairly good signal 1700-1800. (Kessel, Canada) LRA, 9.69, Buenos Aires, is a fine signal in Seattle, Washington, evenings, regularly. (Oestreich) *Radio Indonesia*, 7.270, Djakarta, noted 0700-0730 with popular American recordings, announcements in Dutch; *Radio Nacional*, 15.145, Lima, Peru, noted 1845-2030; BED32, "Voice of the Chinese Air Force," 9.775, Taipeh, Taiwan, heard 0530-0600. (Rosenauer, Calif.) CR4AA, 5.900V, Cape Verde Islands, still noted 1530-1700 in Newfoundland. (Puddle) Prague, Czechoslovakia, noted around

STAN-BURN EDARKE

ANTENNAE SPECIALS

DOUBLE V 1/2" Dowel.....	\$2.98	1-11	12
DOUBLE V 3/4" Dowel.....	3.45		Or More
DOUBLE V 1" Dowel.....	3.95		\$2.20
10 Element Conical 1/2" Dowel.....	3.55		2.45
Folded Hi Straight Low Quick Rig 1/2" elements.....	4.25		2.95
WINDOW CONICALS.....	4.95		3.55
MASTS			
5 FOOT SWEGGED.....	.89		.69
10 FOOT PLAIN.....	1.59		1.29
TV WIRE			
42 Mil. 300 OHM.....	\$15.95	M Ft.	
55 Mil. 300 OHM.....	17.95	M Ft.	
72 OHM COAXIAL.....	52.50	M Ft.	

CATHODE RAY TUBE SPECIALS

7JP4.....	\$15.00	16RP4/KP4 N.U.....	23.00
10BP4.....	14.95	16RP4A.....	26.00
10BP4 N.U.....	19.95	17BP4A.....	27.00
10BP4A N.U.....	19.95	20CP4.....	39.95
12LP4.....	19.95	20CP4 Sheldon.....	37.00
12LP4A.....	19.95	19AP4.....	47.95
14BP4.....	19.95	19DP4A.....	47.95
16DP4A.....	26.00	24AP4A.....	73.00
16GP4.....	33.00	Single ion traps.....	.39
16AP4A.....	39.00	Double ion traps.....	.59
CHASSIS 630 K38 VIDEO.....	\$139.50		
OPEN FACE CABINET.....	39.00		

TRANSFORMERS

Nationally Advertised

RCA type for 16" to 24"..... \$3.85

X032..... \$3.85

G.E. type for 16" to 24"..... \$3.85

X045..... \$3.85

These are very special prices while they last!

DEFLECTION YOKES

COSINE FERRITE

TODD YOKE 70°..... \$4.20

REGULAR 70°

YOKE..... 3.85

CONDENSER SPECIALS

BY PASS—ALL GUARANTEED

20x20-150 Stan Burn.....	\$0.41
50x30-150 Stan Burn.....	.49
20x150 Stan Burn.....	.32
8-450 Stan Burn.....	.41
16-450 Stan Burn.....	.49

4 Prong Vibrators each \$1.29

Lots of 12 or more..... 1.19

Standard TV Tuners..... \$18.95

RCA Guaranteed Tuners (with tubes).....

SPECIAL! While they last..... \$12.00

SPEAKER SPECIALS

ALL GUARANTEED

4" P.M.....	\$1.64
5" P.M.....	1.75
6" P.M.....	2.41
8" P.M.....	3.43
12" P.M.....	5.33
4x6 P.M.....	2.19
6x9.....	3.73
5x7.....	3.43
10" P.M.....	5.48

Authorized Distributors for: General Electric, Kenrad, National Union, Jewel, De Wald, Regal, Automatic and Satchel Carlson.

We carry a complete line of popular makes of Radio and TV tubes, at 50% discount. Also many other special purpose and transmitting types, and all electronic parts and equipment at lowest prices. Send us a list of your requests for quantities and prices.

20¢ with order. Balance C.O.D. All prices FOB, NEW YORK Warehouse. Minimum order \$5.00.

Write for our latest price list to Dept. RN-2

STAN-BURN RADIO and ELECTRONICS CO.
(C.B.S. THEATRE BLDG.)
1697 BROADWAY • NEW YORK 19, N.Y.

EVERY RADIOMAN Can Use These SERVICE HINTS!

Valuable Manual Yours—FREE!

Every page of "How to Simplify Radio Repairs" is packed with on-the-bench, practical ideas. Contains photos, charts, diagrams—no fluff—no vague theory. In plain every-day language it gives you priceless suggestions—new servicing ideas. You'll use and benefit from the experience of experts. Partial list of contents: How to Localize Trouble; How to Service Amplifiers; How to Test for Distortion; How to Test Audio Circuits; How to Test Speakers; How to Find Faults in Oscillators; How to Test Radio Parts—and it's all yours—FREE! No obligation.

FEILER SEND COUPON OR PENNY POSTCARD FOR YOUR FREE COPY TODAY!

FEILER ENGINEERING CO., Dept. 2M2
8026 N. Monticello Ave., Skokie, Ill. (Suburb of Chicago)

Please RUSH my FREE copy of "How to Simplify Radio Repairs."

Name.....
Address.....
City..... Zone..... State.....

6:200 relaying Moscow after 1430; had own program 1400-1430.

Copenhagen Radio reports Radio Yugoslavia on a new outlet of 7.235 at 2000-2145 and 2300. (Golden, Mass.) Copenhagen, 9.52, is good level in Iowa 2030-2130. (Lund) Radio Ceylon has replaced 3.400 with 9.520 used parallel with 7.190, 11.975 at 0630-1145 (English from 0830); the "All-African Service" of SABC is now on "summer" schedule of 17.748 at 0330-0700, 0900-1045, and 11.927 at 1100-1510. (WRH) Haiti's 4VN, 6.013, is coming in well now 1800-2135 sign-off; 4VPL, 8.984, Petionville, is heard around 1600 but has had CWQRM; 4V2S, 4.951, is heard 1500-1545 sign-off; all have French. (Saylor, Va.)

FBS, 7.220, Fayid, Suez Canal Zone, is heard 1630 with Arabic program of world news and native music; BED22, 7.010, Taipei, Taiwan, noted 0600 with Western music; BED26, 10.080A, noted 0500 with Chinese news; BED7, 11.735, has news now 0700; Bangkok, 11.910, noted 0445 with news; North Shensi, 9.024, China, noted 0445 with Western music. (Sanderson, Australia)

4VEH, 9.71, Cap-Haitien, Haiti, has been off the air for about two months; two of its transformers have burned out and it is necessary to rebuild the transmitter; hopes to return to the air shortly with three times as much power as before. (Hoffman, N. Y.; Golden, Mass., others)

Port Moresby, Brt. New Guinea, is scheduled over VLT7, 7.280, Mon.-Fri., 0815-0745, 1545-1745; Sat. 0315-0800, 1545-1730; Sun. 0315-1200, 1645-2000. VLT9, 9.52, is on the air Sun.-Thur. 2100-2245, 0100-0300; Fri. 2100-0300, Sat. 2100-2300, 0100-0300. (Radio Australia)

Short Wave News, London, says by this time Radio Goa, Portuguese India, should again be using its 10 kw. transmitter on 9.260. The Newark News Radio Club reports a test was heard some time ago from Stockholm's new high-powered transmitter on 21.730 at 0500-0559; the new Stockholm super-powered jobs should now be in regular operation.

A flash from officials of HCJB, Quito, Ecuador, says HCJB will be going to 100 kw. shortly; more than 100 tons of new equipment have already arrived in Quito; new land has been purchased at a better site in the valley to take HCJB out of the shadow of Pichincha which should permit signals to get out across the Pacific better; new site is in direct line with old one and an FM link will be utilized from studios to transmitters; present plans call for two 50 kw. transmitters which can be sub-divided into four 25 kw. transmitters to be used for four frequencies or two—depending on the language being used and the time of day; new studios will be built, and already new curtain beam antennas are being erected.

Acknowledgement

Thanks for the splendid reports. Keep them coming to Kenneth R. Board, 948 Stewartstown Road, Morgantown, West Virginia, USA...KRB

February, 1952

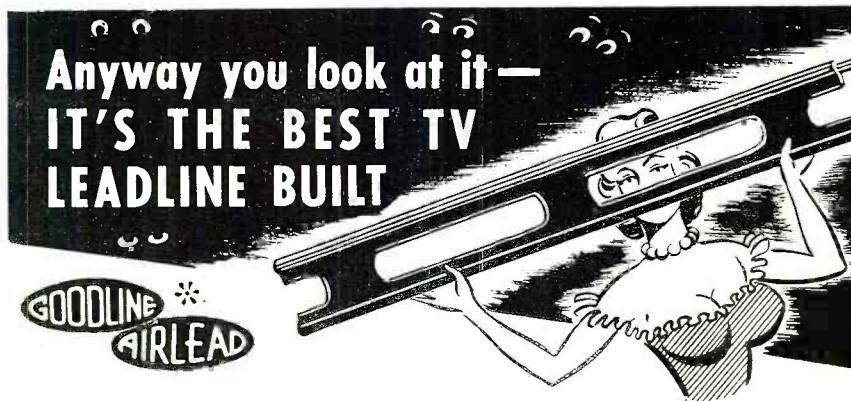

ONE OUTSTANDING FEATURE:

**LOWER IN COST THAN OTHER LEADLINES
PURPORTED TO GIVE YOU THE SAME RESULTS
OTHERS EQUALLY IMPORTANT—**

- Sharp, clean "snow-free" pictures.
- Correct impedance for "ghost-free" reception. Nominal 300 ohms.
- Correct spacing for minimum radiation loss. Less than 1% of operating wave length.
- Fully insulated—approved by safety experts.
- Pure, unadulterated polyethylene insulation—specially treated by our chemists for extreme weather.
- High-efficiency conductors: Flexible, stranded—to insure long life.
- Easily installed—with standard insulators.
- Packaged in convenient lengths: 100', 250', 500', 1,000', 2,500'.
- AT YOUR DEALERS, or Write For Free Samples and Literature.

*Patent Pending *Trade Mark U.S. and Foreign Patents Pending
EXCLUSIVE LICENSEE AND SOLE MANUFACTURER

Don Good, INC.

1014 FAIR OAKS AVENUE
SOUTH PASADENA, CALIFORNIA

OTHER OUTSTANDING GOODLINE PRODUCTS:

VARIABLE TELETRAPS—2: Highly effective for *eliminating interference* from FM STATIONS, and DIATHERMY and AMATEUR SIGNALS within its tuning range.

HI-PASS FILTER: *Eliminates or greatly reduces interference* picked up by I. F. AMPLIFIER or TV RECEIVER—interference arising from strong, local low-frequency fields: X-Ray, Diathermy Equipment, Neon Lights, Etc., Etc.

RADIO and TELEVISION ELECTRONICS
Thorough training for men and women in all Technical phases
Enroll NOW for New Classes (Day & Eve.) which start 1st of Mar., June, Sept. & Dec.
Free Placement Service For Graduates
For Free Catalog write Dept. RN-52
RCA INSTITUTES, INC.
A Service of Radio Corporation of America
350 West 4th St., New York 14, N. Y.

QUALITY · SERVICE · DEPENDABILITY
DUMONT PERFECTLY CENTERED
COMPLETELY MOLDED **CAPACITORS**
Sold and Preferred Everywhere
DUMONT Electric Corp.
308 Dyckman Street, New York 34, N. Y.

No Experience Needed To
**PRINT YOUR OWN
POST CARDS**

The GEM STENCIL DUPLICATOR saves money... gets results quickly! Hundreds of uses for every type of business and organization. We ship the GEM complete with all supplies, Guide Board for accurate printing and 60-page Book of Ideas at the special low price of only **\$8.50** (a \$15.00 value)

FREE TRIAL OFFER

Use the GEM FREE at our expense. SEND NO MONEY. Write and complete GEM outfit will be sent you postpaid. After ten days, send us only **\$8.50** or return the GEM. You must be satisfied! WRITE TODAY.

BOND EQUIPMENT CO. Dept. 52
6633 Enright • St. Louis 5, Mo.

NEW a "must" book
for every
TV Service Technician

**"Servicing TV
in the
Customer's Home"**



**SAVES TIME
SAVES WORK
EQUIS MORE
for You
on Outside
Service Calls**

**shows how
to diagnose trouble using
capacitor probe and VTVM**

Here's the book you've been asking for—practical, proved help to make your outside TV servicing really effective and profitable. Saves time, work and chassis hauling... shows you how to make successful repairs on the spot. You learn the following: 1. A simple, effective method for tracing down trouble, using your VTVM and a simple capacitor probe. 2. Methods for finding your way around a strange circuit—shows you how to "pull tubes" and diagnose trouble by observing audio and picture effects. 3. How to judge TV set performance by analysis of the test pattern. 4. Methods for making adjustments in the field. You'll want this essential, profit-building book. Handy pocket size; sturdy cover. **\$1.50**

ORDER TC-1. Only.....
Pays for itself on the very first job.

HOWARD W. SAMS & CO., INC.

Order from your Parts
Jobber, or write direct to
HOWARD W. SAMS & CO.,
2201 E. 46th St., Indianapolis 5, Ind.

**ORDER
TODAY**

Send... copy(ies) of "SERVICING TV IN THE
CUSTOMER'S HOME," \$1.50 per copy.

(Check) (money order) for \$..... enclosed

Name.....

Address.....

City..... State.....

An "Extra" Superhet
(Continued from page 45)

denser. Starting with T_3 , align the tuned circuits of both i.f. transformers for maximum output meter response, making sure that the receiver volume control is on full and that the signal generator output is kept reduced to the point where the output signal is clearly audible but not loud.

Remove the oscillator short circuit and connect the signal generator through a dummy antenna of 200 μf . to the antenna connection. It now becomes necessary to experimentally track the oscillator with the antenna circuit, using a systematic procedure. In following the steps given below, the antenna coil inductance and trimming capacity must be adjusted at the appropriate frequencies (600 kc. for the inductance, 1400 kc. for the trimmer) each time a change is made in the oscillator conditions.

Adjust the padding condenser to its minimum capacity setting. Set the receiver dial and signal generator to 600 kc. and adjust the oscillator inductance until a signal is heard. If no signal is heard within the range of the oscillator inductance adjustment, screw the inductance in as far as possible and increase the padding capacity until a signal is heard. Attempt to align the oscillator trimmer condenser to agree with the dial at 1400 kc. If the adjustment cannot be made, again increase the capacity of the padding condenser and reduce the oscillator inductance (by turning the screw out)

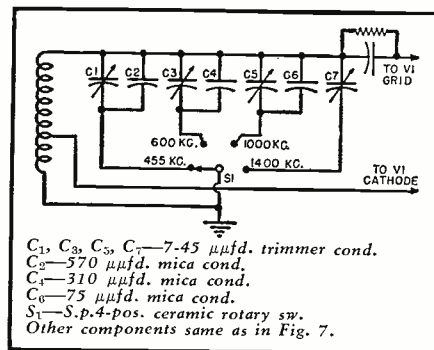

C_1, C_3, C_5, C_7 —7-45 μf . trimmer cond.
 C_2 —570 μf . mica cond.
 C_4 —310 μf . mica cond.
 C_6 —75 μf . mica cond.
 S_1 —S.p.4-pos. ceramic rotary sw.
Other components same as in Fig. 7.

Fig. 6. The optional signal generator tank circuit for spot frequency use.

to obtain a new setting at 600 kc. Continue this process until both 600 and 1400 kc. are correctly indicated. Now tune the receiver and generator to 1000 kc. and make a sensitivity measurement, which should be written down. Increase the padding condenser capacity slightly, decrease the inductance to give a 600 kc. signal, align at 1400 kc., and again measure sensitivity at 1000 kc. If the sensitivity is better than it was before, repeat the last operation until the measurements show greatest sensitivity and then start falling off again. Return to the adjustment giving maximum 1000 kc. sensitivity. Throughout the alignment process it is important to obtain a definite peak in adjusting the antenna and oscillator trimmers.

Fig. 7 shows the circuit of a simple but highly practical signal generator that may be easily constructed at low cost from "junk box" parts, if access to a regular generator is inconvenient. Using the values specified for C_1 and

Fig. 7. Complete schematic diagram of a simple broadcast-band signal generator.

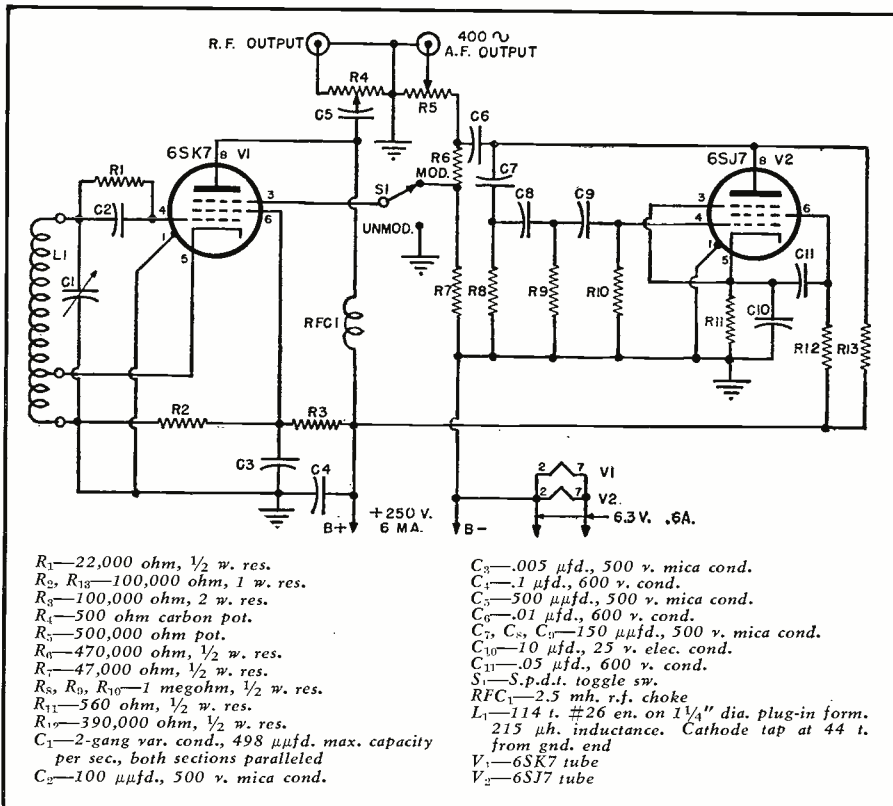

- R_1 —22,000 ohm, $\frac{1}{2}$ w. res.
- R_2, R_3 —100,000 ohm, 1 w. res.
- R_4 —100,000 ohm, 2 w. res.
- R_5 —500 ohm carbon pot.
- R_6 —500,000 ohm pot.
- R_7 —470,000 ohm, $\frac{1}{2}$ w. res.
- R_8 —47,000 ohm, $\frac{1}{2}$ w. res.
- R_9, R_{10} —1 megohm, $\frac{1}{2}$ w. res.
- R_{11} —560 ohm, $\frac{1}{2}$ w. res.
- R_{12} —390,000 ohm, $\frac{1}{2}$ w. res.
- R_{13} —2-gang var. cond., 498 μf . max. capacity per sec., both sections paralleled
- C_1 —100 μf ., 500 v. mica cond.

- C_2 —005 μf ., 500 v. mica cond.
- C_3 —1 μf ., 600 v. cond.
- C_4 —500 μf ., 500 v. mica cond.
- C_5 —01 μf ., 600 v. cond.
- C_6, C_7, C_8, C_9 —150 μf ., 500 v. mica cond.
- C_{10} —10 μf ., 25 v. elec. cond.
- C_{11} —05 μf ., 600 v. cond.
- S_1 —S.p.d.t. toggle sw.
- RFC—2.5 mh. r.f. choke
- L_1 —114 t. #26 en. on 1 $\frac{1}{4}$ " dia. plug-in form. 215 μh . inductance. Cathode tap at 44 t. from gnd. end
- V_1 —6SK7 tube
- V_2 —6SJ7 tube

Let the generator will tune continuously from about 344 kc. to 2100 kc., a more than ample range for broadcast receiver alignment. If desired, the continuously variable frequency tank circuit may be replaced by the one shown in Fig. 6, in which case the spot frequencies of 455, 600, 1000, and 1400 kc. are available at the turn of a switch. This system is convenient and desirable for the experimental alignment process just described, as generator frequency reset errors are avoided. The signal generator r.f. output voltage may be modulated by the 400 cycle phase shift oscillator, V_2 . The very pure sine wave voltage output of this oscillator is also available for audio test purposes, the output level being controlled by R_5 .

The signal generator is quickly and accurately calibrated by zero-beating, in another receiver, standard broadcast stations of the desired frequencies. The 455 kc. frequency is calibrated by beating the second harmonic of the generator against a broadcast station operating on 910 kc. The generator may be powered temporarily directly from the receiver described in this article by removing the ground connection from the generator tube filament circuit. The receiver filament circuit is already center-tapped to ground.

Tracer-Amplifier

(Continued from page 51)

ever, the volume control and associated components should be located as close as possible to the 6SF5 tube socket. The power supply should be located on the rear of the chassis and removed as far as possible from the grid circuit of the 6SF5 to reduce the possibility of hum pick-up. Further insurance against hum is provided by using shielded wire for grid circuit leads more than an inch or two long or where they may pass close to heater leads.

Fig. 2 shows the comparative response at audio frequencies of the probe (curve A) and the microphone/phone input (curve B). While the curves are far from what the high-fidelity man calls "flat" still they are good enough—and the results prove it—to provide good quality when the amplifier is used with a record player or when checking for distortion in receivers. It should be remembered that the tracer was designed with maximum gain as the primary consideration. Average gain with the probe is better than 70 db, more than adequate to detect a weak signal at the front end of a receiver in even the remotest locations (North and South Poles excepted)! Average gain at the microphone/phone input J_1 is better than 40 db, sufficient to handle crystal or dynamic microphones and phono pickups.

As mentioned before the probe produces only slight loading effect to tuned circuits. It can actually be made to produce none at all. In receiver cir-

Sam's Surplus Sells For Less

COMMAND AND/OR ARCS TRANSMITTERS and RECEIVERS

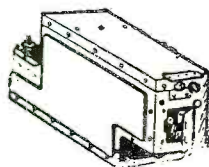

3-6 MC Receiver. Used \$ 6.95 New 17.95
6-9.1 Receiver. Used \$ 6.95 New 12.95
Triple Receiver Rack.....\$1.95
V.H.F. ARC5 Transmitter or Receiver, Complete w/tubes Used \$24.95 New

2.1-3 MC Transmitter with tubes 14.95
4-5.3 MC Transmitter with tubes 6.95
5.3-7 MC Transmitter with tubes 6.95
7-9.1 MC Transmitter with tubes 9.95 \$19.95
3-4 MC Transmitter with tubes 18.95
28V Receiver Command Dynamotors \$0.97

MODULATORS

BC-456 with Tubes, less dyn..... 2.95
MD-7/ARC5 Plate Modulator..... 8.95
MD-7 Modulator Dynamotor, 28V 2.95
BC-433 Receiver—with tubes.....\$24.95
MN-26C Compass Receiver..... 24.95 \$39.50
MN-26Y Compass Receiver..... 24.95 39.50
BC-357 Marker Beacon Rec. W.O. Tube 5.95



BC-223 Transmitter. 30 watt. Ideal for Ship-to-Shore or Ham Rig. Crystal or MO control on four pre-selected channels. 2000 to 5250 KC. Use of 3 plug-in coils. Five tubes: 2-801, and 3-36, and TU 17-18-25 tuning units.

Transmitter—\$39.95. Tubes—5.75. Tuning Units—\$2.25. Amp Meter. No. 60-0-60. New—1.29.

CIVIL AIR DEFENSE or 2 METERS

ARC-4. W/tubes. Good, used.....\$29.95
522 Trans.-Receiver. W/tubes. Good, used 69.50
Modulation Transformer. BC-375. New..... 2.49
BC-375 Trans. 100 Watt Voice, CW, MCW, freq. range 200 kc to 12 mc, uses Plug-in Tuning Units listed complete with tubes, less Tuning Units..... \$29.95

Tuning Units for BC-375 or 191 Trans:

TU- 7 4500-6200 kc.....\$2.49
TU- 8 6200-7700 kc..... 2.49
TU- 9 7700-10000..... 2.49
TU- 10 10000-12500..... 2.49
TU- 22 & TU-26 200-500 kc.....each 4.50
FT-151 Shock Mounting for BC-375 or 191.... 2.95
BC-306 Antenna Loading..... 1.95
GP-7 Navy Transmitter: 100 watt master os. Can use on any freq. from 350-9050 kc. by using proper plug-in. With 1 tuning unit.....\$13.33

LOOP ANTENNAS



DU-1 2 tube amplifier. New \$25.95
MM-20-E.....New 7.95
LP-21 A.....New 16.95
Rotatable Loop Unit—Type MN-20E. 8" diameter—used with MN-26 Compass and RA 10 DB. By Bendix. Only.....\$7.95

FL8 Filters—A's, B's, C's.....New 1.95
FL5 Filters.....New .95
Hand Keys—J-38.....New 1.19

TSC Transmitter & Receiver with 12V Power Supply and Cables. Good—used.....\$179.50

Heineman Circuit 115 V., 20 amp. 1.39
Breakers 115 V., 5 amp. .97
Prop Pitch Transformer, only.....new 6.95
RT-7PN-1 Transceiver w/o tubes. Used 9.95

Cash with order. Prices subject to change without notice. California orders please include 3 1/2% Sales Tax. Please include approximate postage—Excess will be refunded. What Have You in Surplus? Submit

ESEGE SALES COMPANY INC. 1306 BOND STREET, at PICO LOS ANGELES 15, CALIFORNIA

"S" METER



"S" METER

"S" METER — SAM'S SPECIAL. Illuminated face (supplied with miniature lamp). Full scale reading of 5 ma. A standard value for most "S" Meter Circuits. Dia. across face — 2 3/8". Black bakelite face. Reverse-set pointer..... New \$2.49
Vibrators—Mallory. For use on 12 V battery.....New \$0.97

TRANSFORMERS

12V 24V 2am 110V primary.....\$2.95
ARC-4 2 Meter Transceiver, tubes good, used \$29.95
BC-434 Control.....Used—\$1.95 New 2.95
Code Tapes for TG-10 15 rolls. New..... 7.95
BC-906 Absorption Type Freq. Meter Range 150-225 mc. 0.500 DC Microm. Used \$11.50
Field Phones E-E 8's.....Used \$19.95 pr. New \$34.50 pr.
Relay. SP-ST. Leach 6 V or 12 V.....New 1.49

CRYSTALS—CR IA / AR

8150.000—8036.25—8001.43 \$1.19 ea. 3 for \$2.95

DYNAMOTORS

PE103 New Case \$29.95
PE-103 New, Less Base..... 19.95
DM-32A Input 28V. Output 250 DC. .06 amps. Used 1.95
PE-73 29V @ 20 amps. output 1000V @ .350 amps. New 8.95
PE-77 14V @ 40 amps output 1000V @ .350 amps.....New 19.95
SPEC. 27V @ 400V 7.50 mil 750V 350 mil.....New 12.95
PE-94 or SCR-522 24V. Used—\$5.95 New 14.95
PE-94 Dynamotor only..... 4.95
DM-34 12V @ 2.8 amps. Output 220V @ 160 amps.....New 9.95
SPEC. 9V @ 450V output @ 80 ma. New 5.95
SPEC. 12V @ 320V output @ 80 ma. New 4.95
SPEC. 6V @ 250V output @ 80 ma. New 6.95
SPEC. 12V @ 440V output @ 200 ma. New 12.95
ARC-1 DY-9/ARC-1.....Used 11.50
14 Volt Input—425 Volt Output at 163 mils. Starting Filter and Relays in base. Like New 3.95
RL-42B Antenna Reel Ass. Less wire. New 9.95



OIL CONDENSERS

Standard Makes—New
2 mfd 600V.....\$0.49
4 mfd 600V..... 1.39
1 mfd 1000V..... .69
3 mfd 1000V..... 7.95
.5 mfd 2500V..... 1.49
10 mfd 600V..... 7.95
2 mfd 2500V..... 3.95
2 mfd 5000V \$ 8.95 2 mfd 7500V 29.59
T-30 Throat Mikes.....Used—3 for \$0.50
CD-307 Head Set Extension Cord..... 1.19



HEAD SETS

HS-30.....New \$1.95
HS-23.....Used—\$1.95; New 2.95
Matching Transformer for HS-30..... .69
BC-348 Mounting Base..... 2.49
RG-7U Coax Cable, 97.5 ohms.....foot .08
MIKE CHEST SET "F-1" button.....New 2.95



DECK INSULATORS

Bowl & Flange type. Heavy galv. metal flange—10 1/2" dia. Porc. bowl set in rubber gaskets. Top bell—7 3/8" dia. Brass feed thru rod L insul. dist. between top bell and flange—6 1/2". New \$2.95

Say You Saw It In RADIO & TELEVISION NEWS

CODE SENDING AND RECEIVING SPEED

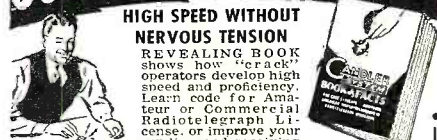

HIGH SPEED WITHOUT NERVOUS TENSION

REVEALING BOOK shows how "crack" operators develop high speed and proficiency. Learn code for Amateur or Commercial Radiotelegraph License, or improve your sending and receiving

with the Candler System which develops radio-telegraph experts and code champions. CANDLER SYSTEM CO. FREE BOOK
Box 928, Dept. 2-B, Denver, Colo.

Enjoy the best!

GARRARD Outplays the rest!



World's Finest 3-speed Record Changer with Automatic stop. Quiet motor. Heavy turntable. Prevents disturbing resonance, wows, rumble.
GARRARD SALES CORP., Dept. 2N
164 DUANE ST., N. Y. 13
Gentlemen:
I am interested in learning what to look for when purchasing a 3-speed record changer. Please send me, without obligation, your FACT SHEET.
NAME _____
ADDRESS _____
CITY _____ ZONE _____ STATE _____

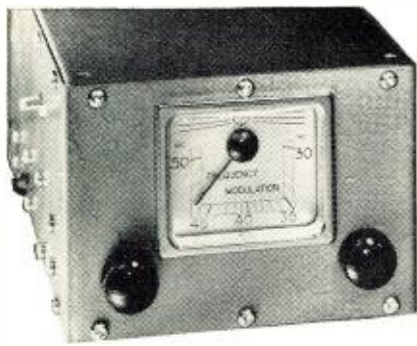

Model M-51

for emergency communications

USED BY HUNDREDS OF MUNICIPALITIES FROM BOSTON, MASS., TO ALHAMBRA, CAL.

POLICALARM MONITORADIO

Says S. L. Grant, City Manager, Winchester, Virginia . . .

"I think you have a receiver that is well built, and I see no reason why it should not be in demand by all public works departments that have a transmitter available."

Users of FM 2-Way Radio Communications equipment throughout the entire nation, find Policalarm and Monitoradio a welcome innovation to low-cost mobile communications radio .

For Complete Information: See Your Jobber—Or Write Us Today

RADIO APPARATUS CORPORATION

55 N. NEW JERSEY ST., INDIANAPOLIS 4, IND., PHONE: ATLANTIC 1624

5 Models For All Systems

6 VOLT MOBILE

M-51

Tuneable 30-50 MC

M-101

Tuneable 152-163 MC

115 VOLT AC-DC

PR-31

Tuneable 30-50 MC

PR-8

Tuneable 152-163 MC

AIRCRAFT

AR-1

AM Tuneable 108-132 MC

115 Volt AC-DC



CRONAME TV CONVERSION KIT

Be Proud of Your
Big Tube
Conversion
or Custom
Installation
3
Professional
Quality
Components

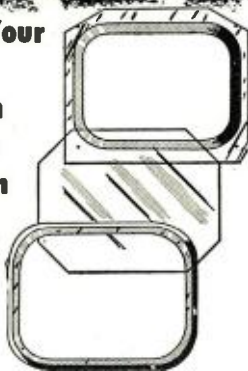

1. Metal Mask Tailored for Perfect Fit.
2. Heavy 1/4" Tempered Safety Glass.
3. Beautiful Gold Finished Metal Escutcheon.

All Popular Sizes: 14", 16", 17" and 20"

Easy Installation Instructions Included

Order CRONAME TV CONVERSION KITS;
CRONAME TUNING DIALS, KNOBS and
ACCESSORIES from Your Parts Jobber.

Send for New CRONAME Catalog.

WALDOM

ELECTRONICS, INC.

911 N. Larrabee St., Chicago 10, Ill.

Mfrs. of Replacement Speaker Cone Assemblies

150

PHOTOCON SALES

1062 N. Allen Ave. SYcamore 4-7156
Pasadena 7, Calif. RYan 1-8271

WRITE FOR OUR WINTER SURPLUS SALES CATALOGUE

WE WILL BUY YOUR NEW OR CLEAN USED
ELECTRONIC SURPLUS: ARC-1, ARC-3, BC-
224, BC-348, BC-312, BC-342, ATC, ART-
13, APS-13, BC-221, LM's, TS-12, TS-13,
TS-23, TS-34, TS-35, IE-19A, I-222, SCR-
522, TS-100, or any BC, I, IE, TS, APR.

WRITE FOR PRICES:

APR4, APR5A, APR7, TS-34, 804CS2, APA-
33, BC-348, ART-13, TS-12, APN-9, ARC-1,
BC-610, TCS.

DuMont 208 5" Oscilloscope	EXCELLENT	\$225.00
804B General Radio Signal Generator	EXCELLENT	300.00
8-330 mc.	EXCELLENT	
APN-1 Altimeter Indicator 0-1 ma.		2.95
shunt, 250" dial	NEW	
LM & BC-221 Frequency Meter with cal.		99.50
book, crystal, and tubes	EXCELLENT	69.50
SCR-625 Mine Detector	NEW	39.50
	USED	150.00
AN/APN4B Complete	EXCELLENT	29.50
PE-218 Inverter 400N	NEW	17.50
Weston Model 545 Tachometer Meter	NEW	3.50
HS-33 600 ohm Headsets	USED	5.95
	NEW	
400 cycle Inverters—G.E. 5D21NJ3A		24.50
Input 24V. DC. Output 115V. AC.		
400 cycles 485 V.A.	NEW	300.00
DuMont 241 Oscilloscope	EXCELLENT	225.00
G.E. Oscilloscope CRO5Y	EXCELLENT	

TS-148/UP, Large quantity BC-348's, TS-12,
TS-13, TS-100, 1059/APA-11 Indicator, APR-4
Tuning units. Write for Prices.

Receiver-Indicator R-65/APN9 complete	\$400.00
Drafting Machine single scale 16" Fulcrum	
less scale. Exc.	35.00
CRT-3 Two-Channel Gibson Girl	NEW 75.00
DuMont 224 Oscilloscope less front	
cover	EXCELLENT 125.00
8R9R Tubes	100.00
TS-174/U Frequency Meter. EXC. COND.	400.00

NOTE: One of the largest and most complete electronic surplus stocks in the country. We have thousands of tubes, capacitors, plugs, accessories, transmitters, receivers, test equipment, etc. Send us your requirements.

TERMS: Prices F.O.B. Pasadena, California. 25% on all C.O.D. orders. Californians add 3% Sales Tax. Prices subject to change without notice.

circuits following the first stage, where some amplification has been given the signal, it is unnecessary to even touch the probe tip to the circuit under test. Response can be obtained merely by bringing the probe close to the circuit connection. Strong response can also be obtained by placing the probe tip on top of glass envelopes of tubes in the i.f. and audio stages.

It will be noted that with the gain control full on a slight hum can be heard from the tracer speaker. This hum originates entirely from free a.c. pickup by the short probe tip and can be eliminated by poking the probe inside a grounded metal can. The hum is of no consequence since under normal operation the volume control is seldom more than half on, and at this setting no hum whatsoever will be noticed.

One precaution should be observed in the construction of this instrument. All high voltage wiring in the plate circuit of the 6F6 power stage should be of the high voltage type or at least provided with adequate insulation to prevent breakdown under certain conditions of high frequency audio input. Actual measurements at 5000 cycles input to the probe have indicated an output voltage at this frequency of more than 600 volts developed at the plate of the 6F6. This is practically the overload point of the output stage and is obtained with the volume control full on. Since the control is seldom more than half on no trouble should be experienced from insulation breakdown. The point is mentioned only to acquaint the reader with the fact and perhaps prevent him from being knocked on his dorsal posterior if he should happen to accidentally become a part of the output circuit under the above conditions.

An interesting experiment to demonstrate the tracer's sensitivity may be performed by operating the signal tracer as a "wide-band" receiver. This may be done by connecting an ordinary 2.5 mhy. r.f. choke between a receiving antenna and ground. The ground side of the choke is connected to the tracer chassis and the probe touched to the antenna side of the choke. The result will be a bedlam of broadcast stations, police, hams, airlines, beacons, and everything else all bursting forth from the speaker at the same time. —30—

CONDENSER TESTERS

By C. D. CHANDLER, W4BO

HERE'S a kink on the use of condenser testers that I have found very useful in the measurement of small values in critical circuits (FM transmitter pulse, TV receivers, and equalizers) where two condensers must be of equal value.

Using a v.t.v.m., measure the voltage across the grid to cathode of the "eye" tube, use this voltage as the balance indicator rather than the "eye." In this manner the values can be measured very closely. I have been able to restore a circuit to normal with ease by "culling" my stock of condensers.

I hope that this hint will be of some use to fellow sufferers. —30—

RADIO & TELEVISION NEWS

Franklin Oscillator

(Continued from page 58)

that shielded cable be used to minimize possible radiation which might cause interference to television sets in the vicinity.

Construction

If the accompanying photographs are carefully studied, there is little that can be said regarding construction of this exciter. It is assembled in the conventional manner.

The v.f.o. unit may be mounted in the three-compartment war-surplus cast-aluminum box formerly housing the multi-gang tuning condensers for the RAK/RAL Navy receivers. With this arrangement it is possible to use the left-hand condenser and its worm-gear drive after the two unneeded sections of the condenser have been removed from the box. This particular arrangement for mounting the v.f.o. is not necessary, however, for any conventional means of v.f.o. assembly may be used. One point should be borne in mind. The tank circuit of the oscillator, as shown within the broken lines in Fig. 6, should be mounted in a compartment of its own, or at least mounted away from the vacuum tubes. This is to insure isolation from heat and attendant mechanical changes.

The v.f.o. is bolted directly to the front panel. The HRO type dial is specified to provide extremely accurate calibration facilities.

The frequency multiplier cascade is built on a standard 17 x 4 x 3 inch steel or aluminum chassis. This chassis is very easily mounted in the exciter cabinet by means of a pair of chassis mounting brackets modified as shown in Fig. 9. The bottoms of these brackets are bent up at right angles to the body of the bracket presenting a shelf-like support for the ends of the chassis. One 6-32 hole is drilled and tapped in each bracket and at either end of the chassis on the lip. As the unit is very light in weight, only one 6-32 screw is needed at each end of the chassis to secure it in place.

The power supply chassis is secured to the bottom rear of the cabinet by small angle brackets.

Fig. 9. Chassis bracket modifications to provide a secure and serviceable mounting for the frequency doubler cascade circuit.

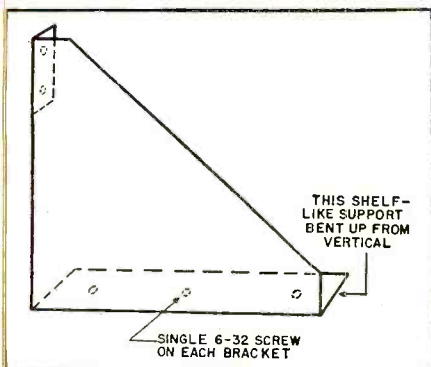

February, 1952

"CONICAL-V-BEAMS"

REGISTERED TRADE MARK



-first CHOICE everywhere!

-for SUPERIOR PICTURE QUALITY
...FULL RANGE AUDIO AND VIDEO
...ALL-WEATHER CONSTRUCTION

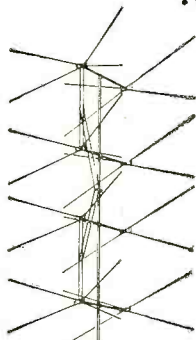

MODEL 8X-TV

- WILL OUTPERFORM ANY OTHER ANTENNA OR COMBINATION THEREOF!

— 90% of all Television Antennas being produced today are genuine TELREX "Conical-V-Beams" or imitations thereof!

Because TELREX TV antennas are designed, engineered and field-tested by experts to produce results! You can depend on famous "Conical-V-Beams" for cleaner, sharper pictures, finer sound reception and rugged, weather-durable fabrication that means a lasting antenna installation! Check on the famous TELREX line, today!

THE ULTIMATE IN HIGH GAIN ALL CHANNEL TV ANTENNAS

The TELREX 8X-TV illustrated is the 4 bay stacked array that outperforms all others at remote-from-transmitter locations. "IF THE 8X-TV DOES NOT PROVIDE A USABLE SIGNAL, RECEPTION IS IMPRACTICAL."

"CONICAL-V-BEAMS" are produced under Re-issue Patent No. 23,346

CANADIAN AND FOREIGN PATENTS PENDING

THE SKILL TO DESIGN... THE FACILITIES TO PRODUCE... THE ABILITY TO DELIVER

telrex inc.

AMERICA'S STANDARD OF COMPARISON

CONICAL-V-BEAMS

ASBURY PARK 7, NEW JERSEY

WANTED!

ALL TYPES AIRCRAFT, RADAR, RADIO SETS, COMPONENTS, DYNAMOTORS AND ASSOCIATED EQUIPMENT. Such as ART-13, BC-611, Test Equipment, ARC-1, ARN-6, ARN-7, RTA-1B, Etc.

WE PAY TOP DOLLAR!

WEST REGION ELECTRONICS, Dept. RW
1437 South Norton Ave., Los Angeles 19, California



Another Outstanding Jobber
THE LUKKO SALES CORP.

5024 IRVING PARK RD, CHICAGO 41, ILL.

has all 17 KITS & INSTRUMENTS in stock!

425K 5" SCOPE KIT \$44.95

See EICO ad on Page 171

RADIO ENGINEERING 27 MONTHS DEGREE IN

Radio engineering is a big field. There's room for you in it—if you're good. Get first-class training at Indiana Tech. Intensive specialized course, including strong basis in mathematics and electrical engineering, advanced radio theory and design, television. Modern laboratory. Low tuition. Also 27-month courses in Aeronautical, Chemical, Civil, Electrical and Mechanical Engineering. Approved for G.I.'s. Enter March, June, September, December. You can earn part of your expenses right here in Fort Wayne while you are studying.

INDIANA TECHNICAL COLLEGE

922 E. Washington Blvd., Fort Wayne 2, Indiana
Please send me free information on B.S. Engineering Degree in 27 months as checked.

- Radio-Television Aeronautical
 Civil Mechanical Electrical

Name.....
Address.....

ATR

AUTO RADIO VIBRATORS

have Ceramic Stack Spacers



A COMPLETE LINE OF VIBRATORS . . .

Designed for Use in Standard Vibrator-Operated Auto Radio Receivers. Built with Precision Construction, featuring Ceramic Stack Spacers for Longer Lasting Life. Backed by more than 20 years of experience in Vibrator Design, Development, and Manufacturing.

NEW MODELS

NEW DESIGNS

NEW LITERATURE

"A" Battery Eliminators, DC-AC Inverters
Auto Radio Vibrators

See your folder or write factory

AMERICAN TELEVISION & RADIO CO.
Quality Products Since 1931
SAINT PAUL 1, MINNESOTA-U.S.A.

A 72-ohm coaxial cable, such as RG-59/U, is used for feeding r.f. from the v.f.o. to the frequency multiplier cascade, and from the final doubler or multiplier stage to the succeeding amplifier stage of the transmitter.

Tuning and Operation

This exciter was designed with facility of operation and ease of construction foremost. Therefore, no complicated metering circuits were specified, as it was felt that they were not needed in equipment of this type. All that is actually needed to "tune up" is a screwdriver and an accurately calibrated wavemeter with a sensitive r.f. indicator, such as a meter with germanium rectifier circuit. Once initial tuning operations have been performed, the stages may be "peaked" with a ¼-watt neon lamp.

Having made certain that all connections have been properly made, plate voltage may be applied to the v.f.o. and the frequency doubler cascade. The wavemeter should be set at approximately 1.7 megacycles and placed near the output of the 6SN7GT/G oscillator tube (V_1 in Fig. 6). Then, the v.f.o. should be tuned until an indication is noted on the wavemeter r.f. indicating device. The wavemeter should then be tuned to 3.55 megacycles and placed near L_2 and C_{11} (Fig. 6) tuned for maximum output as indicated on the meter. The 6AG5 buffer/doubler (V_3 , Fig. 6) is now tuned to 3.55 mega-

cycles and is operating as a frequency doubler.

Before proceeding with the adjustment of the frequency doubler cascade, the interstage coupling condensers C_9 , C_{11} , C_{16} (Fig. 3) should be adjusted for approximately half capacity. Now, with appropriate coils in their sockets, the frequency multiplier cascade may be tuned, progressing from one stage to the next, in a conventional manner. With the wavemeter tuned to 3.55 megacycles and placed near L_1 - L_2 , tune C_1 (Fig. 3) with a screwdriver until a maximum meter reading is noted on the wavemeter; with the wavemeter tuned to approximately 7.1 megacycles and placed near L_3 - L_4 , tune C_{10} for maximum meter reading; with the wavemeter tuned to approximately 14.2 megacycles and placed near L_5 - L_6 , tune C_{15} for maximum meter reading; with the wavemeter tuned to approximately 28.4 and placed near L_7 - L_8 , tune C_{19} for maximum meter reading.

If 21 mc. output is desired (when this frequency band is opened for amateur operation) V_3 (Fig. 3) may be used as a frequency tripler. In this case the wavemeter would be tuned to approximately 21.300 megacycles and placed near L_5 - L_6 . A commercially wound coil for 21 megacycles (such as the "B & W JEL 15") should then be substituted for the 14.0 megacycle coil. Then C_{15} should be tuned for a maximum meter reading on the wavemeter.

For 50 megacycle output from V_4 and

Fig. 10. Complete circuit details and parts list for the power supply section.

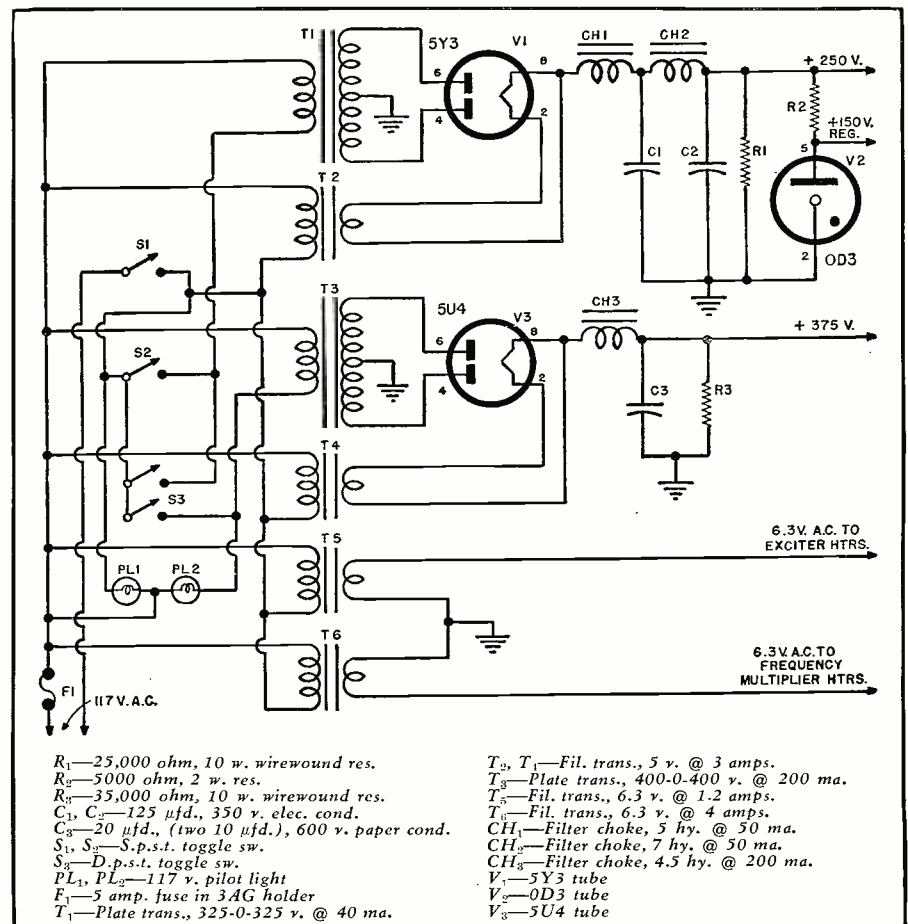

J_2 it will be necessary to use different coils than those specified in the parts list of Fig. 3. Coils should be substituted as follows: L_1-L_2 should be replaced by a 7.0 megacycle coil, L_2-L_3 should be replaced by a 14.0 megacycle coil, L_3-L_4 should be replaced by a 28.0 megacycle coil and L_4-L_5 should be replaced by a 50 megacycle coil. These coils may be the commercially wound variety; their exchange in this setup does not necessitate technical changes in the coils, or the circuit. In tuning the stages for 50 megacycles output, the v.f.o. should be tuned to approximately 1.6 megacycles with V_2 tuned to approximately 3.25 megacycles. Then V_1 (Fig. 3) should be tuned to 6.5 megacycles, V_2 to 13 megacycles, V_3 to 26 megacycles and finally V_4 to 52 megacycles. Great care should be exercised that output is not taken from any coaxial socket but that of V_4 (J_2). The 50 megacycle amateur band is not harmonically related to any other amateur band and therefore out-of-band operation will result if the foregoing suggestions are not followed.

It should be noted that 1.7 megacycle operation may be obtained by replacing L_2 (Fig. 6) and L_1-L_2 (Fig. 3) with appropriate 1.7 megacycle inductances. In this case V_2 (Fig. 6) and V_1 (Fig. 3) would act as r.f. amplifiers with 1.7 megacycle output obtained from J_2 .

To take advantage of the extreme accuracy and stability of this exciter, it should be calibrated with the aid of a very accurate signal generator in conjunction with the station receiver. However, a "dial scale versus frequency" curve may be effectively plotted by obtaining frequency reports from stations contacted across each amateur band. If this procedure is used, the unit should only be operated well within the band edges to avoid receiving the not so welcome QSL from the FCC. An accurate frequency meter will allow operation close to the band edges, and relieve the operator of much mental strain.

Conclusion

Although many types of variable frequency oscillators have been introduced to the amateur world in the past few years, they all may be improved upon. In these days of congestion with the few hundred kilocycles allotted to the amateur service, it is more important than ever that we keep our signals "put" and to insure that our keying characteristics are the best that we are able to provide. This exciter embodying the Franklin oscillator provides a simple, clean, and dependable frequency control. When properly built, it is surpassed in stability only by a temperature-controlled crystal oscillator.

No effort has been made to keep the exciter down to "miniature" size, but there is no reason why the frequency doublers as well as the power supply could not be converted for miniature tubes. Then one would have extreme compactness in addition to the very desirable features already outlined.

SEE LEO FIRST FOR . . . hallicrafters

I can SAVE you money . . . Liberal Trade-ins



Leo I. Meyerson
WØGFQ



\$169.50

New S-76 RECEIVER

Extra selectivity with double superheterodyne circuit. One RF, two conversion and 3 IF stages. Range 550-1550 Kc, 1.7-34 Mc in four bands. 8 tubes plus voltage regulator and rectifier. Complete with tubes, less speaker.

R-46 SPEAKER \$19.95



\$199.50

SX-71 RECEIVER

Double Conversion sharp selectivity, plus built-in NBFM at moderate cost. 11 tubes plus voltage regulator and rectifier. Low down payment.

R-46 Speaker \$19.95

NAME YOUR TERMS • LOW DOWN PAYMENTS • PERSONALIZED SERVICE

HALLICRAFTERS RECEIVERS AVAILABLE FOR IMMEDIATE SHIPMENT

S-38B	\$49.50	S-72 Portable	\$109.95
S-40B	\$99.95	SX-62	\$289.50
S-81	\$49.50	S-78A	\$89.50
S-82	\$49.50	S-76	\$169.50
		R-46 Speaker	\$19.95

Famous WRL RADIO REFERENCE MAP 25c JUST OFF THE PRESS!



CU on 10-20 & 75 Meters

NEW LOG BOOK 25c

For mobile or fixed station. Spiral binding. Full column log listing all FCC required info. Will accommodate 1,525 stations. "Q" signals, phonetic alphabet, amateur international prefixes.



PHONE 7795

WRITE—WIRE

WRL 1952 CATALOG

Send for your copy today. Contains everything new in radio and television. Jam-packed with bargains. Leo I. Meyerson, WØGFQ



FREE

WORLD RADIO LABORATORIES RN-2

744 West Broadway

Council Bluffs, Iowa

Please send me:

- Radio Map
- New Catalog
- Used Equipment List
- SR-75 Info
- SX-71 Info
- New Log Book

Name

Address

City

State

BRAND NEW TUBES

0A4G . . . \$ 1.49	1B22 . . . 3.25	1B23 . . . 8.95	1B24 . . . 8.50	1N22 . . . 1.25	1N23 . . . 1.49	1N23B . . . 4.50	3B24 . . . 4.50	3E29 . . . 13.95	4E27 . . . 16.50	4X150A . . . 35.00	5D21 . . . 22.50	6AN5 . . . 5.50	6J4 . . . 6.50	15E98	250R . . . 8.95	304TL . . . 9.95	307A . . . 3.95	703A . . . 4.95	715B . . . 8.95	715C . . . 22.50	813 . . . \$ 8.50	829 . . . 9.95	832 . . . 5.50	832A . . . 9.95	836 . . . 3.75	837 . . . 1.49	838 . . . 2.99	860 . . . 3.95	872A . . . 2.75	884 . . . 1.75	931A . . . 5.95	1616 . . . 90	1624 . . . 1.50	1625 . . . 45	1632 . . . 89	1644 . . . 80	2050 . . . 1.75	2051 . . . 1.50	8025 . . . 4.95	9003 . . . 1.75
--------------------	-----------------	-----------------	-----------------	-----------------	-----------------	------------------	-----------------	------------------	------------------	--------------------	------------------	-----------------	----------------	---------------	-----------------	------------------	-----------------	-----------------	-----------------	------------------	-------------------	----------------	----------------	-----------------	----------------	----------------	----------------	----------------	-----------------	----------------	-----------------	---------------	-----------------	---------------	---------------	---------------	-----------------	-----------------	-----------------	-----------------

YOUR SURPLUS WANTED!
We Pay Highest Prices!

Vacuum Capacitors

Complete Line of Transmitting & Receiving Tubes.

J. S. H. SALES CO.

Dept. R-9, 7552 Melrose Ave., Los Angeles 46, Calif.

SELL Jensen PHONO NEEDLES For Any Type Record Player

Please send me FREE Jenselector. Picks the proper replacement needle.

Name

Address

City

State

Jensen Industries, Inc., 336 S. Wood St., Chicago 12

NEW.... by **Cabinart**

KITS

**FOR
CORNER
FOLDED
HORN
ENCLOSURES**

Assemble your own folded horn from a Cabinart Kit. All material included. Gain a full octave of clean bass that is never reproduced by ordinary cabinets.

MODEL 61
12" Speaker

\$19.95

MODEL 63
15" Speaker

\$23.95

SOLD ONLY THROUGH
RADIO PARTS DISTRIBUTORS

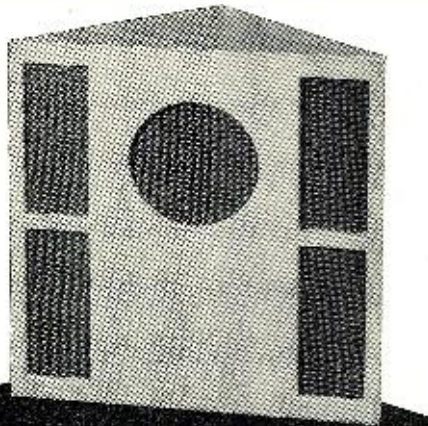

Your radio parts distributor can obtain this kit from:

G & H WOOD PRODUCTS COMPANY

75 NORTH 11th STREET • BROOKLYN 11, N. Y. • EVERgreen 8-3058

The Kit includes:

- LUMBER CUT TO SIZE
- BAFFLE PRE-CUT FOR 12" OR 15" SPEAKER
- GRILL CLOTH
- HARDWARE
- PLASTIC WOOD
- GLUE
- KIMSUL ACOUSTIC INSULATION
- ASSEMBLY INSTRUCTIONS
- FINISHING INSTRUCTIONS

Audio Simplified
(Continued from page 72)

reversal to drive the second push-pull grid with the proper voltage and phase. The driving voltage for this phase-inverter-amplifier tube is obtained from the voltage divider formed by the two resistors in the first push-pull grid. The resistances should be chosen so that

$$A = \frac{R_1 + R_2}{R_2}$$

where A is the gain of the phase inverter tube. The exact value of the resistor (now shown as 10,000 ohms) must be selected very carefully for satisfactory balance of the push-pull amplifier. A disadvantage of this circuit is that as the tubes age, the gain of the phase inverter stage may change and cause unbalance in the push-pull amplifier. Cathode degeneration by use of an unbypassed cathode resistor can help to stabilize the gain to reduce this effect, or the use of a variable instead of a fixed resistor for the 10,000 ohm unit permits periodic readjustment to maintain accurate balance.

Practical Circuits

All of the sound reproducing systems in use at the present time are based upon the circuits which have been described in this article. Push-pull power amplifiers are almost always used when good reproduction is required, and one of the various phase inverter circuits is used to couple a single-ended voltage amplifier to the power amplifier grids. Good amplifiers almost invariably use negative feedback to improve the distortion, frequency response, and stability, according to the negative feedback design equations which have been given in this article.

The circuits which have been described previously in this article are redrawn, with practical component values, in Fig. 8 for the benefit of those who may want to use one of these circuits in the construction of an amplifier. The tubes and components suggested in these schematics are suitable for most applications, and their specific

Fig. 8. Practical component values for circuits described herein. (A) Practical cathode-follower circuit based on Fig. 4B. (B) Cathode-follower phase inverter (Fig. 5).

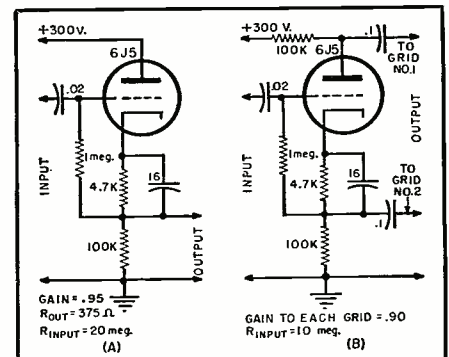

New! Up-to-date!

**TELEVISION
SERVICING**

by **Walter H. Buchsbaum**



340 pages
170 illustrations



Symptoms of defective operation easily recognized, quickly corrected by illustrations, diagrams and how-to-do-it facts in this new book.

USE IT 10 DAYS FREE

Coupon below brings you "Television Servicing" on FREE trial for 10 days, without obligation. Mail it NOW.

PRENTICE-HALL, Inc., Dept. M-RN-252
70 Fifth Ave., New York 11, N. Y.

Send me, for 10 DAYS' FREE TRIAL, "Television Servicing." I will return it in ten days and pay nothing—or keep it and send \$1.35 down (plus postage) and \$2 monthly for 2 months.

NAME

ADDRESS

CITY..... STATE.....

SAVE! Send \$5.35 with this coupon, and we'll pay postage and packing.

Concertone
MAGNETIC TAPE
RECORDERS



NETWORK
RECORDER
NWR-1

"just like being there"

THE ONLY low cost high fidelity tape recorders delivering professional performance. Professional users' net prices begin at

\$345.00

Write for Bulletin #102

Manufactured By

Berlant Associates

4917 W. Jefferson Boulevard
Los Angeles 16, California

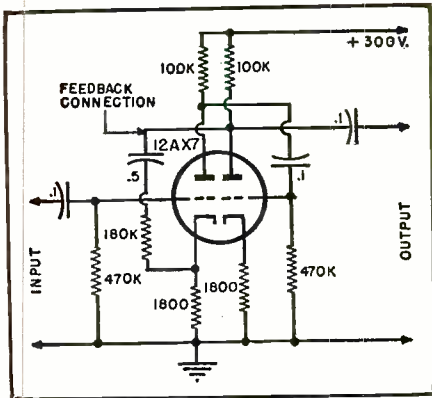

Fig. 9. Application of negative feedback to a two-stage dual-triode amplifier to provide a stable gain of 40 decibels.

requirements will be discussed in further detail in connection with power amplifiers in a later article in this series.

A typical use of negative feedback is shown in the schematic of Fig. 9, which shows the application of negative feedback to a two-stage dual-triode amplifier to give a stable amplifier with a fixed gain. The amplifier without feedback would have an amplification of about 70 db, but the application of feedback from the second plate to the first cathode reduces this gain to 40 db. The total amount of feedback is 30 db, and with this amount of feedback the gain will remain quite stable with aging of the tubes until they fail completely. In most audio amplifiers, the negative feedback is generally applied over the entire amplifier from the secondary of the output transformer to one of the first stages in the voltage amplifier. The manner in which this is accomplished, as well as the connection of the various circuits to form a complete audio amplifier, will be discussed later in this series.

(To be continued)

AMATEUR EXTRA CLASS LICENSE

THE FCC is currently considering a proposal to recognize amateurs of long experience by modifying the requirements for the Amateur Extra Class license in such cases.

Any applicant for Amateur Extra Class license will be given credit for examination elements 1(C) and 4(B) if he so requests and submits evidence of having held a valid amateur radio station or operator license issued by any agency of the United States Government during or prior to April, 1917.

-30-

TECHNICIANS NEEDED

MITCHELL Air Force Base, N. Y. has sent out a call for trained communications technicians to take part in its reserve training program.

Training takes place one weekend a month for which members are paid for four days inactive duty, according to grade.

Complete data on this program may be obtained by writing: Commanding Officer, 914th Air Reserve Training Wing, Mitchell Air Force Base, N. Y., Att: Recruiting Information. -30-

February, 1952

There's a **Newcomb quality** amplifier for every sound need, from the low cost STANDARD E SERIES, through the superb DELUXE H SERIES, to the incomparable CUSTOM K SERIES illustrated.

Write for literature

NEWCOMB AUDIO PRODUCTS COMPANY
 DEPT. 6824 LEXINGTON AVE.
 HOLLYWOOD 38, CALIFORNIA

For GREATER TV ENJOYMENT...

Install a MOSLEY 3-WAY ANTENNA SWITCH

Here's convenience! MOSLEY TV Antenna Switches give instant, easy selection of any one of three antennas. Special rotary type switch, making silver-to-silver contact, assures low-loss, constant impedance.

Cat. No. F-10 is Flush Mounted Switch and Lead-in Socket combination for neat, concealed-in-wall installation in standard electrical box. Cat. No. F-20 is enclosed in attractive plastic case for mounting on wall or back of set. Both models available in brown or ivory.

MOSLEY Low-Loss TV Antenna Accessories Provide BETTER TV PICTURES Through More Efficient Installation!

At leading Radio Parts Jobbers everywhere

MOSLEY ELECTRONICS 2125 Lackland Road
 Overland, Missouri

Cat. No. F-20
List \$3.75

Cat. No. F-10
List \$3.75

The New

Mandl's Television Servicing

gives you detailed, illustrated trouble-shooting procedures for every flaw or failure you're likely to encounter.

A COMPLETE MASTER INDEX and separate lists of trouble symptoms for each circuit defect make it easy to locate any particular trouble and the exact procedures for correcting it. Unusual, hard-to-find flaws as well as all common trouble are dealt with.

THE LATEST CIRCUITS are explained and illustrated, including servicing techniques for UHF and VHF.

ORIGINAL PHOTOGRAPHS show actual symptoms that appear on the TV screen when defects occur. Hundreds of circuit diagrams, illustrations of station defects, scope patterns, and other illustrations aid in the identification and location of circuit faults

and these are only a few of the features that make this the most helpful, practical, and complete service manual yet to be published...

Are these outstanding radio & TV aids on your working reference shelf?

Radio and TV Mathematics

by Fischer. Step-by-step solutions for hundreds of typical problems, arranged under radio and electronic headings for quick reference. Shows what formulas to use, what numerical values to substitute, how to solve each

Television for Radiomen

by Noll. Very clear, non-mathematical explanation of all principles and full instruction on installation, alignment, adjustment, and trouble-shooting.

Television & FM Antenna Guide

by Noll & Mandl. A basic course on theory plus a complete handbook on all types of antennas and installation procedures.

Movies for TV

by Battison. Practical information on all equipment and experienced advice on the do's and don'ts of making newsreels, commercials, features, titles, special effects, cartoons, etc

SEE THEM ON APPROVAL

The Macmillan Co., 60 5th Ave., N. Y. 11

Please send me copies of the books checked. I will either remit in full or return the books in 10 days.

- | | |
|--|---------------|
| <input type="checkbox"/> Mandl's TV Servicing \$5. (prob.) | Signed |
| <input type="checkbox"/> Radio & TV Math. \$6.75 | |
| <input type="checkbox"/> TV for Radiomen \$7.75 | Address |
| <input type="checkbox"/> TV & FM Antenna Guide \$6.25 | |
| <input type="checkbox"/> Movies for TV \$5.00 | |

NEW TV PRODUCTS on the Market.....

SOUND AMPLIFIER

Vidaire Television Company, 576 W. Merrick Road, Lynbrook, New York has introduced a new push-pull sound amplifier for use with television receivers having a single tube for sound output.

In cases where the receiver has been designed without consideration being given to sound tone quality, by removing the 6K6, 6V6, or 6Y6 sound output tube and plugging in the company's A-130 amplifier, the over-all frequency response of the sound system is increased. The amplifier is flat within 1.5 db between 80 and 20,000 cycles.

TV BOOSTER

Blonder-Tongue Laboratories of 38 N. Second Avenue, Mt. Vernon, N. Y. is in production on an improved version of the company's "Home Antensifier".

Designated the Model HA-2-M, this unit covers all channels and is fully automatic. It has no knobs or controls and turns on and off with the TV set operation by means of an automatic, silent thermo-relay power switch.

Featuring an improved 4-tube chassis with 4-stage cascaded amplification

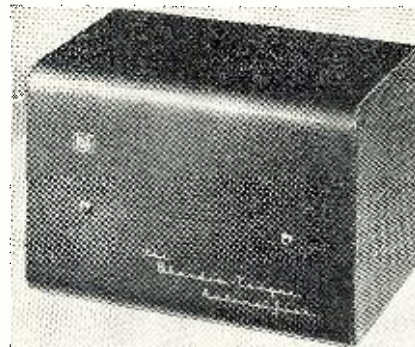

and a push-pull circuit, the new model has an average gain of 16 times (24 db) over all channels.

The unit is housed in a compact metal cabinet finished in mahogany hammertone. It may be installed in less than 1 minute, concealed or displayed.

TV CHASSIS

Regal Electronics Corporation of 605 W. 130th Street, New York, New York has just released a new television chassis which has been designed especially for fringe area applications.

The powerful 22-tube chassis, capable of driving 16", 17", 19", and 20" cathode-ray tubes, has a horizontal automatic frequency control which has been tradenamed "Regalok". It has a 70 degree yoke with ample sweep to cover a 20" television picture tube without shadows.

The set also includes a turret type tuner, a high gain video amplifier, four stages of i.f. amplification, a power line

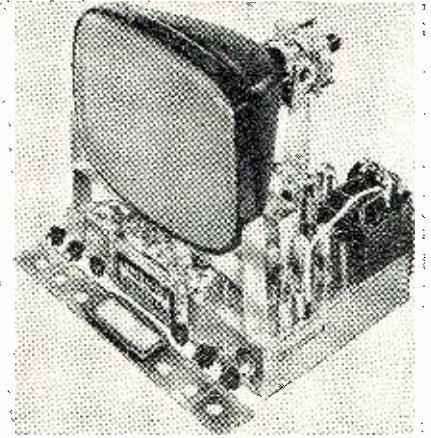

filter, and sync clamping to insure absolute sync hold.

The new chassis are now available at parts jobbers and distributors.

CR TUBE EXTENSION

General Cement Manufacturing Company, 919 Taylor Avenue, Rockford, Illinois, has devised a new picture tube extension which is said to speed servicing work and facilitate custom installations.

The No. 8689 permits the chassis to be removed without disturbing the picture tube, as the picture tube can be mounted away from the chassis, thus allowing flexibility in custom-built TV cabinets.

The extension measures four feet in length and is heavily insulated with positive contact receptacles.

OPEN LINE ARRESTER

JFD Manufacturing Company, Inc. 6101 Sixteenth Avenue, Brooklyn 4, N. Y., has developed an open line lightning arrester, the Model AT107.

The new arrester is constructed of high dielectric porcelain. Under its

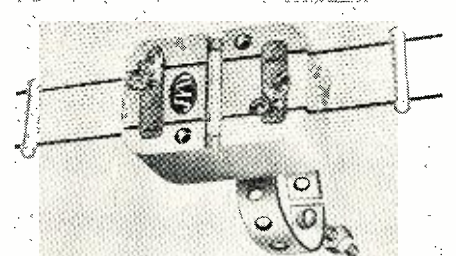

clear polystyrene cover positive contact can actually be seen when in use. The unit is permanently sealed against temperature and humidity changes. Its nickel-plated brass hardware provides lasting corrosion resistance.

RADIO & TELEVISION NEWS

Packaged with four feet of ductile aluminum ground wire, the arrester is equipped with a perforated steel strap for wall, window sill, or grounded pipe mounting.

TV ATTENUATOR

International Resistance Company, 401 North Broad Street, Philadelphia 8, Pa., has announced the availability of a new television attenuator which permits the quick reduction of undesirable effects on picture and sound caused by excessively strong signals.

Known as the QJ-3, the new unit provides signal attenuation from approximately 0 to 70 db. Easily installed, the attenuator permits the adjustment of signal level to overcome such undesirable effects as adjacent channel interference, background picture on weaker stations, horizontal or vertical patterns in picture, poor picture definition, annoying hum or buzz, and picture and sound breakover, when caused by excessive signal strength.

The unit may also be used in service work to duplicate fringe area signals when the shop is located near a strong local station.

MALLORY U.H.F. CONVERTER

A u.h.f. converter which is ready to be put on the market as soon as channels have been assigned for commercial telecasting in the u.h.f. region has



been announced by *P. R. Mallory & Co., Inc.*, Indianapolis 6, Indiana.

The new unit is entirely self-contained including the built-in u.h.f. antenna. No changes need be made in any part of the television receiver with which the converter is to operate. The converter cabinet design and slide-rule dial make it suitable for use with any v.h.f. receiver.

Two designs will be available, one having an i.f. of 127 mc. for use with v.h.f. receivers employing a *Mallory* six-turn "Inductuner," the second incorporating an i.f. output at v.h.f. Channel 5 or 6 for use with v.h.f. receivers employing switch-type tuners.

TUBE REACTIVATOR

Transvision Inc. of New Rochelle, N. Y., has just released a new cathode-ray tube reactivator which is portable, self-powered, and completely self-contained.

Because the unit weighs only 3 pounds, the reactivation of the CR tube can be performed in the customer's

ARROW "The Home of Values!"

SCR 508 EQUIPMENT

BC 603 Receiver L/dyn.....	\$24.95	Exc. Used
BC 604 Transmitter L/dyn.....	12.95	Exc. Used
BC 605 Amplifier L/dyn.....	4.95	New
BC 606 Control Box.....	.95	Exc. Used
FT 237 Mounting.....	9.95	Exc. Used
MP 48 Mast Base.....	2.95	Exc. Used
DM 34, Dynamotor.....	10.95	Exc. Used
DM 36, Dynamotor.....	10.95	Exc. Used
DM 37, Dynamotor.....	14.95	Exc. Used
TM 11-600 Tech Manual.....	1.95	
Crystals, Set of 80.....	19.95	

COMMAND (SCR 274 N) EQUIPMENT

BC-453, with tubes.....	\$19.95	Used
BC-454.....	9.95	New
BC-455 6-9 mc receiver.....	7.95	\$14.95
BC-457 4-5.3 mc transmitter.....	6.95	
BC-458.....	6.95	
T-19 ARC 5, 3-4 mc transmitter.....	10.95	
T-21 ARC 5, 5.3-7 mc transmitter.....	7.95	11.95
T-23 ARC 5, 100-156 mc xmtr.....		49.50
BC-496, 2 position Rec. Control Box.....	1.95	
MC-215 Mechanical Drive Shaft, per length.....	2.45	
BC-450 3 Receiver Remote Control.....	2.95	
BC-451 Transmitter Control Box.....	.69	1.50
BC-442 Antenna Relay, complete.....		3.95
3 Receiver Rack.....	1.95	

MIKES and HEADSETS

HS 23 High Impedance Headset.....	new \$4.95
HS 30 Miniature Headset.....	used .98
CD-307 Ext. cord for HS 23-33.....	like new .95
T-32 Desk Microphone.....	Good \$2.95
used cond.....	.98c
Throat Mike—T 30—New.....	.98c
Lip Mike—Navy Type—New.....	.98c
Extension Cord and Switch Assembly for lip and throat Mikes—New.....	.98c
CW 49505 High impedance headset complete with leather headband and rubber cushions.....	Used 98c
RS-38, Microphone.....	new 4.95
TS 10 sound powered HAND SET.....	new \$9.95 ea. used \$5.95 ea.
HS-38.....	new \$2.29

WOBULATOR

See page 43—December "Radio News" \$5.95 ea.

CONDENSERS. 19c each.....	6 for \$1.00
1 mfd.—800 VDC.....	1 mfd.—400 VDC
1 mfd.—1200 VDC.....	1-2-4 mfd.—400 VDC
1 mfd.—1200 VDC.....	1-1—2000 VDC
.39c each.....	3 for \$1.00
.25 mfd.—1500 VDC.....	1 mfd.—1000 VDC
2 mfd.—220VAC.....	

CATHODE RAY TUBES

3FP7 ---	1.95	4AP10 ---	\$.95
5FP7 ---	1.95	5CP1 ---	3.95
5BP4 ---	3.95		
16JP4 ---	\$19.95		
16DP4 ---	\$19.95		
90 DAY GUARANTEE			
Tubes—304TH.....	\$8.95		
304TL.....	8.95		
830B.....	2.95		
9001.....	1.39		
9002.....	.98		
9003.....	1.49		

MISCELLANEOUS

SPECIALS!

BC 442 Less Condenser.....	Used \$1.49	New \$1.95
APS 13 UHF Antenna, Pair.....		.98
I-97 Bias Meter.....	3.95	4.95
RL 42 Antenna Gearbox Motor and Reel.....	4.95	7.50
Circuit Breaker 40 Amps.....		.59
I 82 F Five Inch 360 degree compass indicator and Selsyn receiver.....		7.50
A-81-2 Transmitters Selsyn for I82 indicator.....		4.95
(both I82F & Trans. Selsyn for \$11.00)		
PE-101 Dynamotor.....		2.75
Model 507, Thermal-converter Weston Type D, range .12 amp.....		.59
BC-1023 Marker Beacon Receiver, complete with tubes, shock mount and instruction manual.....		9.95
BC-924 27-38 MC. FM Transmitter, complete with tubes.....	19.95	
BC-684 27-38 MC. FM Transmitter, less dynamotor.....	19.95	
SCR-183 complete 12 volt set with all coils, tubes, dynamotor and control units.....		49.50
ARB Control Box.....		1.95
BC 1206 Receiver, new.....		7.95
BC-375, transmitter only.....	19.95	
TA-12, transmitter.....	22.50	
110 volt, 60 cycle blower.....		7.95
A27 Phantom antenna.....		1.95
PE 206 Inverter.....	4.95	
Scott Hi-Fi output transformer.....		1.49
PE-218 Inverter.....		19.95
BC-604, as is.....		7.95
SCR-522, transceiver, less tubes.....		39.50
LP 21A ADF Loop.....		6.95
BC-709, battery operated, h. wt., inter-phone amplifier, complete with tube, shock mount and manual, brand new ea.....		\$3.95

MONTHLY SPECIAL!

BC770 KEYS P/O RC 100
Standard 19-inch panel chassis containing many valuable parts such as 10 amp 110V 60 cps circuit breaker, 10mfd. 600VDC condenser, 6.3 fil. transformer, etc.
\$2.45
new less tubes

VIBRATORS

2 Volt—7 Prong Synchronous... 69c 10 for \$6.00
6 Volt—4 Prong Non-synchronous 98c 10 for 9.00

I. D. 6B/APN4 LORAN INDICATOR SCOPE

less tubes, like new. \$29.95
ONLY.....
R9/APN4, complete with tubes, like new. \$17.95

SCR 625 Famous Army Mine-Detector

For Prospectors, Miners, Oil Companies, Plumbers, etc.

This unit is being offered now at a considerable reduction in price. Recently advertised at \$79.50 it is now available in the same brand new wrappings in suitcase style carrying case (less batteries) at **\$59.50** WHILE THEY LAST! Used, like new, \$39.50

CPR-46 ACJ Receiver (ASB7)—509 to 556 mc, new with tubes..... \$29.50
CJP-20 ABX Power unit, (ASB7) new with tubes..... 4.95
used with tubes... 3.95

Shipments FOB warehouse. 20% Deposit on orders. Minimum order \$5.00. Illinois residents, add regular sales tax to remittance. Prices subject to change without notice.

ARROW SALES, Inc. Dept. N, 1712-14 S. Michigan Ave., Chicago 16, Ill. PHONE: Harrison 7-9374

ELECTRONIC CIRCUIT KIT

Form your own electronic circuits with amazing kit. Contains resistor and carrier pigments, insulator and instructions—complete. Experiment, develop, miniaturize.

Prepaid—\$5.50. \$5.50 plus C.O.D.

ALDEN ELECTRO CO. 6760 Stony Island Ave. Chicago 49, Ill.

ON-THE-SPOT BATTERY RECORDER

WALKIE-RECORDALL 8 lb. miniature BATTERY RECORDER-PLAYBACK
Continuous, permanent, accurate, indexed recording at only 3c per hr. Instantaneous, permanent playback. Picks up sound up to 60 ft. Records conferences, lectures, dictation, 2-way phone & sales talks; while walking, riding or flying. Records in closed briefcase with "hidden mks"! Write for Detailed Literature.

MILES REPRODUCER CO., INC. 812 BROADWAY Dep't RN-3 NEW YORK 3, N. Y.

EASY TO LEARN CODE

It is easy to learn or increase speed with an Instructograph Code Teacher. Affords the quickest and most practical method yet developed. For beginners or advanced students. Available tapes from beginner's alphabet to typical messages on all subjects. Speed range 5 to 40 WPM. Always ready—no QRM.



ENDORSED BY THOUSANDS!

The Instructograph Code Teacher literally takes the place of an operator-instructor and enables anyone to learn and master code without further assistance. Thousands of successful operators have "acquired the code" with the Instructograph System. Write today for convenient rental and purchase plans.

INSTRUCTOGRAPH COMPANY

4711 SHERIDAN ROAD, CHICAGO 40, ILLINOIS

Something worth thinking about—

**ARE DAILY
ADJUSTMENTS**



There's a big showing up in the tape recording world . . . it's the tragedy of *High Maintenance Costs*. Many radio stations are confronted with the daily ritual of recorder checking and adjusting. Added to the time cost of such inspections is the cost of frequent parts replacements and loss of program time.

In contrast, Ampex users find their equipment will operate continuously eighteen hours a day with but infrequent inspection. Upkeep and replacements are almost nil; heads have remarkably long life. Ampex performance is constant over long periods of continuous operation. Long life with low maintenance is assured in each Ampex recorder by high manufacturing standards and complete test of each machine before shipment. It all adds up to one sure fact—Ampex quickly pays for itself out of savings from lower operating costs and added dependability.

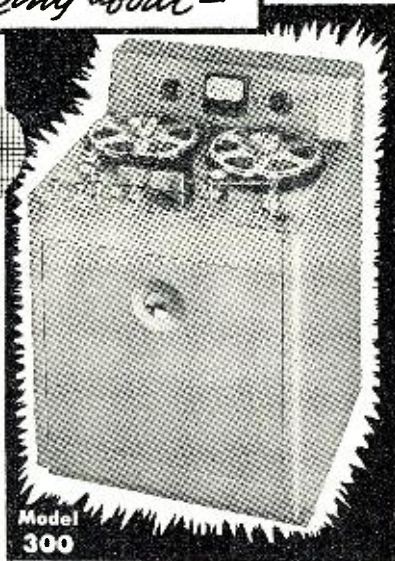

Model 300

Complete Specifications on Request

Shown is the time proven Model 300 Console. Throughout the field of professional audio recording this machine is the recognized leader.

home, if necessary, without removing the picture tube from the television set. In the majority of cases the re-activation is complete and permanent, amounting to a virtual rejuvenation.



The unit will not work on broken filaments, broken glass, or shorted components.

Further information on this unit is obtainable from Dept. DG of the company.

NEW 21" TUBES

The Cathode-Ray Tube Division of *Allen B. Du Mont Laboratories, Inc.*, Clifton, New Jersey has made available to the trade two new all-glass 21" rectangular TV picture tubes.

Designated the Types 21EP4A & 21KP4A, the new tubes employ the same all-glass bulb which results in a picture area of 242 square inches, larger than the previous metal-cone 21" tubes. The screen face is made of filter-glass for minimizing reflections and improving contrast.

The 21EP4A uses the company's bent gun for electromagnetic focusing. A single magnet ion trap is used. The 21KP4A is one of the new "Selfocus Teletrons" requiring no focus controls or circuitry. It provides absolute focus at all times. This tube may be used as a replacement for either electromagnetic or electrostatic focusing type tubes.

FRINGE-POWER AMPLIFIER

Raytheon Manufacturing Company, Newton, Massachusetts, has developed a new fringe-power amplifier which has been designed to improve TV reception up to 38 per cent in rural areas. The new amplifier unit may be in-

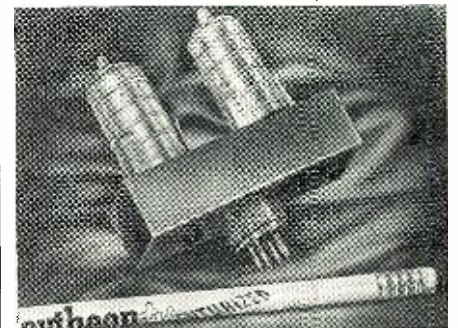

stalled by simply plugging it in. It is designed to provide added sound amplification where picture performance has outdistanced the receiver's ability to pick up the accompanying sound.

DEFLECTION YOKES

Standard Transformer Corporation, 3580 Elston Avenue, Chicago, Illinois,

STANDARD OF THE GREAT RADIO SHOWS



AMPEX ELECTRIC CORP.
Redwood City, California
Dealers in Principal Cities

AMPEX

Magnetic Tape Recorders

**STAY ON THE AIR
WHEN POWER FAILS...with
an ONAN Electric Plant**



Model 10EL, 10KW A.C.

When storms, floods, or fires interrupt electricity and force you off the air, you lose listeners and income. Guard against loss, assure vital public service during emergencies by installing an Onan Electric Plant. Onan Standby Electric plants serve many network and private stations. Automatic models to 35,000 watts.

**AUTOMATIC
START & STOP**

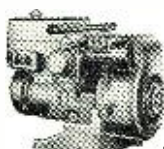

**PORTABLE ELECTRIC PLANTS
FOR MOBILE RADIO USES**
Supply A.C. power for broadcasting at scene of events. Light in weight. Can be carried by hand or in trunk of car. A.C. models: 400 to 3,000 watts.

Write for FREE Folder



D. W. ONAN & SONS INC.
4816 University Avenue
Minneapolis 14, Minneapolis

WANTED WE NEED YOUR
Surplus
Electronic Equipment
WE PAY TOP \$\$\$ FOR:
Radio Receivers An Connectors
Transmitters Clamps
ARC-1 Plugs
ARC-3 Cords
ART-13 Relays
Control Boxes Telephone Materials
Indicators WE BUY ANYTHING!!
WRITE, WIRE TODAY!
TELL US WHAT YOU HAVE
TALLEN COMPANY, INC.
Dept. RN, 159 Carlton Ave.
Brooklyn 5, N. Y.

LEARN CODE NOW!!!
BE A RADIOMAN . . . Code ability recognized by all Service Branches. Here is an Electronic Code Trainer complete with Army Key-Tube-Phone-Variable Note. Simply plug in A.C. or D.C. and use. Instructions and simplified code training course included. Factory Guaranteed . . . Complete as advertised. Nothing else to buy. We pay postage. Send \$5.95 Check, Money Order . . . \$5.95 For Group Training, Deluxe model with 3" Speaker, \$7.75. Additional Keys, for either unit, each \$1.00.
MISCELLANEOUS SPECIALS AT GREENWICH
SURPLUS XMTR—BC180—Freq. 6.2-7.7 MC—Forerunner of ARC-5 less tubes and meter—with shock mts.—good cond. only \$ 2.95
SURPLUS AIRCRAFT RCVR—ABK-9—good shape only \$ 7.95
SPECIAL 1-MFD—1000 VDC—CD 1.00
25 WATT RHEOSTATS—15, 25, 40, 50, 60, 70, 150 or 200 ohms. Fam. makes each .69
BATHTUB—Dual .5MFD—600 VDC—S.T. each 1.55
VARIABLE—Split Stator—100 MMFD . . . ca. sect. 1.95
HIGH VOLTAGE COND.—.001 MFD—75000 VDC. each 74.95
CERAMICON—180 MMFD—CEN. 100 for \$ 9.90
METER for MULTITESTER—(basic 0-1 Mil) 2 1/2" SQ. 1.29
TV TUBE SPECIAL—6CD6—Guaranteed—1st \$6.00. Our Price each 1.29
dozen 12.98
Special—TUBULAR ELECTROLYTIC—Fresh Stock 8 med. 450 VDC. dozen 2.50
GREENWICH SALES CO. 57 CORTLANDT ST. NEW YORK 7, N. Y.

has added two new deflection yokes to its line of TV replacement parts.

The DY-8 and DY-9, with cosine distributed windings designed to provide anti-astigmatic focusing over the entire picture tube area, are both 70 degree ferrite core units with coils wound on nylon bobbins.

The DY-8 has a horizontal inductance



of 8.5 mhy. while the DY-9 has an inductance of 13.5 mhy.

Bulletin 387 describes these new Stancor units in some detail. A copy is available on request.

INDOOR ANTENNA

Insuline Corporation of America, 36-02 35th Avenue, Long Island City 1, New York, is currently distributing a new table-top antenna of simple design, rugged construction, and attractive appearance.

Tradenamed the "Meteor," the new unit has two nickel-plated arms which are adjustable in length from 15 to 38 inches and are hinged so that they can

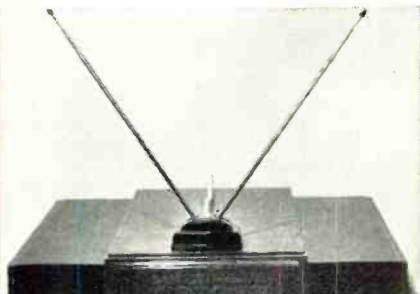

be closed in completely or opened out flat. A weighted base with a padded bottom permits the antenna to be oriented quickly for best reception. A four-foot length of 300 ohm lead, fitted with spade lugs, is included.

SHEDDON TUBE

The Sheldon Electric Company of Irvington, New Jersey has recently announced the availability of a new, all-glass 21" rectangular, low voltage, electrostatic focus TV picture tube which features a special no-glare cylindrical face.

Known as the 21FP4A, the new tube eliminates glare by using a cylindrical face by means of which annoying reflections are thrown below the level of the viewers' eyes by tilting the tube to an almost unnoticeable degree.

Volume production is expected to be reached on these tubes in the very near future.

-50-

February, 1952

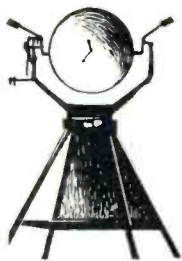

ELECTRONICS TECHNICIANS ELECTRICAL DRAFTSMEN

CONVAIR IN SUNNY SAN DIEGO, CALIFORNIA, INVITES YOU....

—to accept a position now in the modern, progressive Convair Engineering Department . . . and live in beautiful San Diego, California—land of sunny Winters and blanket-cool Summers.

Yes, Convair (Consolidated Vultee Aircraft Corporation) will pay your moving and travel expenses to a good job . . . if you are a trained Electronics Technician or Electrical Draftsman. Aircraft experience a help . . . but not necessary.

WORKING FACTS: You get two holidays a week at Convair—overtime accomplished in 5-day week. Attractive salary ranges. Interesting, challenging, essential, long-range projects of a wide variety, including—commercial aircraft, military aircraft, missiles, engineering research and electronic development. Excellent patent royalty arrangements. Top-notch retirement plan—better-than-average life and health insurance. Complete progress-salary review for each person twice yearly. Opportunity for continuing engineering education.

MAIL THIS COUPON NOW
FOR FREE BROCHURE GIVING
COMPLETE DETAILS
AND APPLICATION FORM.

THANK YOU

Mr. H. T. Brooks, Engineering Department 5000
Convair, 3302 Pacific Hiway, San Diego, California

My name _____
Occupation _____
Address _____
City _____ State _____

Advance with ELECTRONICS CITY

You need firm grasp of fundamentals to keep pace with these complex, fast-growing fields. In thorough 2-year course learn electricity, electronics, physics, mathematics, drafting, etc. Other engineering and technical courses. Coed. Day, evening. 44th year. Write for Catalog.

FRANKLIN TECHNICAL INSTITUTE
46 Berkeley Street Boston 16, Mass.

Another Outstanding Jobber
LIFETIME ELECTRONICS
1501 ADAMS STREET • TOLEDO, OHIO
EICO has all 17 KITS & INSTRUMENTS in stock!
Prices subject to change.
221K VTVM KIT \$25.95 See EICO ad on Page 171

MARK THESE VALUES!

6SN7 .79c	5U4 .59c	6AL5 .59c	12AU7 .84c	6J6 .98c
0Z4 .54	6AB4 \$.89	6AC7 .116	12BE6 \$.84	35Z5 \$.54
1B4 .89	6AG5 .85	6AG6 .85	12BH7 1.07	50A5 1.09
1L4 .73	6AK5 1.48	6AK6 1.37	12SA7 .79	50L6 .67
1R5 .79	6AU6 .64	6B6E \$.77	12SK7 .72	95T .29
1S5 .78	6B6G 1.89	6B6H 1.29	65J7 \$.79	6W4 \$.65
1X2A .95	6B6J .78	6B6K .78	65K7 .79	7FB 1.49
5V4G 1.09	6B6L .67	6B6M .67	65L7 .99	12AT7 1.05
5Y3 .46	6B6N .78	6B6P .78	65T6 1.09	12BA6 .77

1000 Kc. CRYSTALS—Laboratory Precision 1.35
Cut. New. Uncased. Each
WRITE FOR YOUR FREE BARGAIN LIST NOW.

TOP STANDARD BRANDS ONLY—100% GUARANTEED
RCA—GE—SYLVANIA—HYTRON—PHILCO—KENRAD—NU—
TUNGSO—WESTINGHOUSE—WESTERN ELECTRIC

MARK electronics 1888 Randall Ave.
New York 72, N. Y.

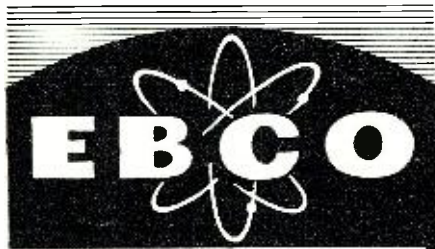

**Mfrs. of
PICTURE
TUBES
and
Electronic
Equipment**

Sold only thru Radio Parts Jobbers

17" Rectangular C.R.T.net **\$21⁹⁵**

20" Rectangular C.R.T.net **\$32⁹⁵**

Prices include tax

EIGHTEEN MONTHS GUARANTEE!

EBCO offers you a complete line of custom-quality picture tubes, manufactured to the highest standards, and guaranteed for 18 months. ASK YOUR JOBBER. If he cannot supply, send us his name and we will arrange to ship through him.

**"EBCO" Dual-Purpose
CHECKER-REACTIVATOR
for TV Picture Tubes**

Check picture tubes for shorts, cathode emission, leakage, etc., without removing tube from TV set. Also PUT NEW LIFE into weak tubes with the REACTIVATING power of this instrument. (Will not work on tubes with mechanical defects). Lightweight, portable; 110V-60 cycles. Factory-guaranteed. ASK YOUR JOBBER.



Model 10
net **\$19⁹⁵**

FIELD STRENGTH METER

Want better antenna orientation? Better TV performance? Want to save time and money? Then use the NEW "EBCO" FIELD STRENGTH METER. Measures field strength from 50 to 50,000 microvolts at the 300 ohm input terminals. Many other great features. net **\$64⁹⁵**

2-SET CONNECTOR

with

**"VISUAL-PROOF"
LIGHTNING
ARRESTOR**



Operate 2 TV sets from 1 antenna with this connector. As lightning arrester, electronic discharge is indicated by glow of two neon lights. You see it work! net **\$4⁹⁵**

ASK YOUR JOBBER!

ELECTRONIC BEAM CORP.

923 Old Nepperhan Ave.
YONKERS, N. Y.
Phone: YOnkers 3-3514



Geiger Counter
(Continued from page 37)

mounting hole of the carrying handle also secures the bottom of the lucite block and the meter. One other screw at the top of the meter provides adequate fastening.

Condensers C_6 and C_7 are mounted in the top end of the case, adjacent to the meter, with their mounting strips spot soldered to the case. Flexible leads are first attached to the condensers to permit wiring them into the circuit at final assembly. Two condensers are used in parallel here to obtain sufficient capacity in the available space.

After all the metal work is completed, the finished case is spray painted with automobile enamel or hammertone lacquer and the result is an exceptionally sturdy and finished-appearing product.

All other components, except the phone jack, are mounted on a small sub-chassis, $2\frac{1}{2}$ inches wide by $3\frac{3}{4}$ inches long, with a $\frac{1}{2}$ -inch lip at the rear and a $1\frac{1}{2}$ -inch lip at the front. The sub-chassis is held to the case by three holes in the front lip, through which pass the mounting bushings of the two toggle switches and the voltage-adjusting potentiometer. This potentiometer shaft is fitted with a small knob and is prevented from accidental turning by the guard formed by the upper end of the carrying handle and a piece of $\frac{1}{4}$ -inch diameter metal rod. The rod is located so that it just clears the knob and is mounted to the handle by a machine screw, after first drilling and tapping one end of the rod.

Looking at the rear of the sub-chassis, Fig. 4, the three tubes are mounted in line across the rear, with V_4 at the top, V_1 in the center, and V_2 at the bottom. The three high voltage condensers, C_4 , C_5 , and C_6 , are mounted in line between the tubes and the rear of the meter case. The particular condensers specified are conveniently mounted to the chassis by use of the screw terminals provided at either end of the units. It is necessary to use insulating washers when mounting C_5 , as one end of it does not go directly to ground.

The transformer, T_1 , and reactors, CH_1 and CH_2 , are mounted in line on the bottom of the sub-chassis, as observed in the photographs. In Fig. 4, T_1 is at the extreme bottom, and is mounted on an insulating disc of lucite, 1-inch in diameter and $\frac{3}{8}$ -inch long. The method is to attach the disc to the transformer by two holes drilled through the disc and deeply countersunk for flathead machine screws, to provide electrical clearance from the screws to the chassis. The disc and transformer assembly is then held to the chassis by a hole drilled halfway through the disc and tapping the hole for a machine screw. The transformer operates with high peak voltages and the windings will break down to the case if it is not insulated from the

chassis. The proper connections for T_1 are indicated in Fig. 2 by the encircled numerals, which refer to the numbered terminals on the actual transformer.

It is most important that well insulated hook-up wire be used when wiring the instrument. If the insulation is not adequate, undue leakages and voltage breakdowns will certainly occur. A plastic-insulated wire, such as Belden Type 8913, is recommended.

BIBLIOGRAPHY

1. U. S. Atomic Energy Commission; "Prospecting For Uranium," United States Government Printing Office. (Available from the Superintendent of Documents, price 30c.)
2. Ives, R. L.; "A Compact Geiger Counter," RADIO & TELEVISION NEWS, Radio-Electronic Engineering Edition, July 1950, p. 10.
3. Norman, L. M.; "The Era of Geiger Counters," RADIO & TELEVISION NEWS, July 1950, p. 34.
4. Kaufman, A. B.; "Radioactivity 'Sniffer,'" RADIO & TELEVISION NEWS, April 1950, p. 46.
5. Ford, W. B.; "Build Your Own Geiger Counter," RADIO & TELEVISION NEWS, July 1949, p. 34.
6. Dees, B. C.; "Geiger-Mueller Counters," RADIO & TELEVISION NEWS, Radio-Electronic Engineering Edition, September 1946, p. 3.
7. Ives, R. L.; "Geiger Counter for Lectures," Electronics, July 1950, p. 105.
8. Thomas, A.; "High-Voltage Supplies For G-M Counters," Electronics, December 1948, p. 100.
9. Graves, A.; "Modern Geiger-Mueller Counters," Electronics, January 1947, p. 80.
10. Freedman, S.; "Prospecting for Uranium Ore Using G-M Counters," Radio-Electronics, July 1949, p. 36.
11. Dorf, R. H.; "Counters For Prospectors," Radio-Electronics, October 1949, p. 37.
12. Scott, R. F.; "Prospecting for Uranium," Radio-Electronics, September 1949, p. 20.
13. Leslie, E.; "The Geiger Counter—How Does it Work," Radio-Electronics, September 1949, p. 22.

DRILLING LARGE HOLES

By RUFUS P. TURNER, K6AI

THE technician who must get along with a small electric drill will be interested to learn that clean, "drill press-type" large holes can be cut easily with counterbores operated in the electric drill. Counterbores require small pilot holes which keep them running true while doing the cutting. They never give egg-shaped or triangular holes, the woe of electric drill users, whether the stock is a thin chassis or $\frac{1}{4}$ -inch panel.

The high-speed type counterbore should be used. Essential sizes for radio work are $\frac{3}{8}$ " for volume controls, rotary switches, pilot lights, and socket punches; $\frac{1}{2}$ " for toggle switches and binding post plates; and $\frac{3}{4}$ " for 9-pin miniature sockets and large pilot lights.

-30-

Using a counterbore in an electric drill. A clean, $\frac{3}{8}$ " hole is being cut. A $\frac{3}{4}$ " counterbore is shown at right of the chassis.

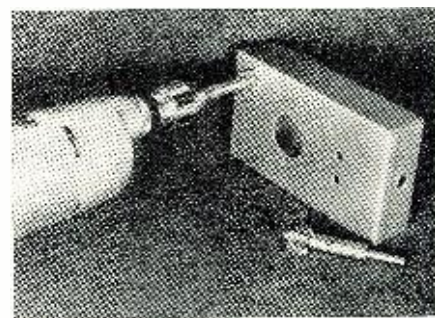

RADIO & TELEVISION NEWS

Manufacturers' Literature

Readers are asked to write directly to the manufacturer for the literature. By mentioning RADIO & TELEVISION NEWS, the issue and page, and enclosing the proper amount, when indicated, delay will be prevented.

CLAROSTAT CATALOGUE

Clarostat Mfg. Co., Inc., Dover, New Hampshire has issued a concise technical catalogue which has been designated No. 51.

Most of the space in the publication is devoted to extensive listings of types and values of resistors and controls. Items listed are standard and include carbon and wirewound controls of various types and sizes, attachable shafts and switches, rotary switches, constant-impedance controls and sound system attenuators, tube-type resistors and ballasts, line voltage regulators, fixed and adjustable power resistors, power rheostats, glass-insulated flexible resistors, TV beam benders, and the company's resistor decade box.

Copies are available from Clarostat distributors or from the company direct.

SERVICE HINTS

Readers of this magazine are being offered a free copy of a newly published booklet "How to Simplify Radio and TV Repairs" by Feiler Engineering Co., 8026 N. Monticello Avenue, Skokie, Illinois.

The booklet, which normally sells for 25 cents a copy, contains helpful data on radio and TV servicing and outlines the advantages of signal tracing techniques.

When requesting copies of this publication, readers are asked to mention RADIO & TELEVISION NEWS.

RELAY CATALOGUE

Advance Electric & Relay Co., 2435 North Naomi Street, Burbank, California is currently offering a copy of its new relay catalogue to interested persons.

This two-color catalogue illustrates and describes the company's complete line of standard and special relays and includes detail data, dimensions, contact combinations, circuitry, and prices.

Among the units covered are circuit controls, radio and h.f. keying, midget, aircraft, coaxial, hermetically-sealed, and special purpose types.

RECTIFIER DATA

A booklet containing a reprint of the article "Metallic Rectifier Design and Application" is being offered by Radio Receptor Company, Inc., Seletron Rectifier Division, 251 W. 19th Street, New York 11, N. Y. to interested persons.

February, 1952

Be "ECONOMY-WISE" with

GREYLOCK TERRIFIC TUBE BUYS!

All tubes listed below carry 6 month Guarantee—excepting only burnouts and breakages. At these sensationally low prices, these tubes must be ordered in quantities of AT LEAST 10 ASSORTED TYPES—add 10% for orders under 10 tubes. All individually boxed in attractive Greylock Cartons.

1L4	6AT6	6J5GT	12AU6
1S5	6AU6	6J7GT	12A8GT
1U4	6AV6	6S4	12BA6
1U5	6BA6	6SK7GT	12F5GT
3Q4	6BE6	6V6GT	12BE6
3V4	6C4	6W4GT	25Z5
5Y3GT	6C5GT	6X4	35W4
6AL5	6C6	6X5GT	35Z5GT
6AQ5	6CB6	12AT6	11Z73

YOUR NET COST EACH **49¢**

0Z4M	6AR5	12AU7	35B5
1R5	6R7GT	12AV6	35C5
1T4	6SQ7GT	12AX7	50C5
354	6SN7GT	12SK7GT	50L6GT
5X4G	6U4GT	25L6GT	

YOUR NET COST EACH **59¢**

1LC5	6BQ6	7N7	12SN7GT
6AG5	6T8	7X7	25BQ6GT
6AK5	6Y6G	12K8GT	35L6GT
6AK6	7A7	12SA7GT	
6BA7	7E5		

YOUR NET COST EACH **79¢**

12BH7	6AC7	14C5	7C7
19T8	32L7GT	1A7GT	

YOUR NET COST EACH **99¢**

1V2	6BC5	12AX4GT	12SQ7GT
5U4G	6SA7GT	12BA7	25Z6GT
6AB4	6SL7GT	12J5GT	35Y4
6AS5	12AL5	12Q7GT	50B5
6AQ6	12AV7	12S8GT	80

YOUR NET COST EACH **69¢**

1LA4	1X2	6BJ6	6SG7
1LN5	6BH6	6J6	7A8
1NSGT			12AT7

YOUR NET COST EACH **89¢**

6BG6G	\$1.09	12AZ7	\$1.29
19BG6G	1.09	6AH6	1.29
1B3GT	1.19	6BQ7	1.49
6AG7M	1.19	6V3	1.59
6CD6G	1.29	807	1.79
6BL7GT	1.29	7JP4 CRT	16.50

SPECIAL—6AR6\$2.49



SPEAKER SPECIALS

Permanent Magnet—Alnico No. 5 Slugs	
3" PM .68 oz.	\$1.09
4" or 5" PM .68 oz.	1.29
6" PM 1.0 oz.	1.59
6x3" PM 3.16 oz.	3.49
8" PM 2.15 oz.	3.69
10" PM 6.3 oz.	6.99
12" PM 8.2 oz.	4.95

AUTO SPEAKERS

7 1/2" 4-ohm dynamic less output	\$2.19
7 1/2" PM less output	4.95

4 ELEMENT CONICAL ANTENNAS

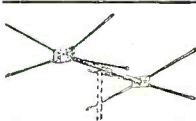

Constructed of reinforced butt seam aluminum elements and strong steel cross bars; ruggedized insulators.

SINGLE Order #P-003 **\$3.99**

STACKED Order #P-004 **\$8.29**

Extra elements for conicals to make fan-flector type.

P-009—Low Band Elements, each.....49c

P-010—High Band Elements, each.....35c

CHIMNEY MOUNTS #E-1585.....Only 99c

TERMS: Net C.O.D., F.O.B. New York City. 25% Deposit on all C.O.D. orders.

GREYLOCK "BONDED" ELECTROLYTIC CONDENSERS

Guaranteed Fresh Stock



Lots of 10—Your Assortment			
Mfd.	W.V.DC Net each	Mfd.	W.V.DC Net each
16	150 \$0.29	40 x 40	150 .45
24	150 .35	50 x 30	150 .45
30	150 .35	8	450 .29
40	150 .39	8 x 8	450 .49
20 x 20	150 .39	16	450 .39
20 x 40	150 .39	30	450 .44
30 x 30	150 .44	40	450 .49

Above prices are for minimum quantities of 10 assorted condensers. Deduct additional 10% discount in lots of 100 assorted condensers.

FAMOUS MAKE TV BOOSTER

Regular List \$32.50.

No. 0-001—WHILE THEY LAST! **\$16.95**

FOR ADDITIONAL VALUES:

Radio Hams, Radio & TV Servicemen, Electronics Experimenters—write for Greylock's Great New Catalog N-2, crammed full of money-saving values for you!

"A Trusted Name in Radio!"

GREYLOCK ELECTRONICS SUPPLY CO.

115 Liberty Street - New York 6, N. Y.

MAKE THIS YOUR HOME FOR IMPORTANT WORK UNDER IDEAL CONDITIONS!

- TEST & INSPECTION ENGINEERS
- ELECTRONIC ENGINEERS
- FIELD ENGINEERS
- LAB. TECHNICIANS
- TV RECEIVER DESIGN ENGINEERS

NEEDED TO WORK ON: YOU BENEFIT FROM high wages, a modern, air-conditioned plant, paid vacations and holidays, group insurance and a good chance for advancement. Housing immediately available in the beautiful suburban and country areas that surround the Bendix Radio plant.

Write, Phone or Wire Mr. E. O. COLE, Dept. O



Bendix Radio

DIVISION OF BENDIX AVIATION CORPORATION
BALTIMORE 4, MARYLAND

ELECTRONICS MADE EASY WITH THE ELECTRONIC TRAINING UNIT

it's New!..

Model 101

for

- Experimenters
- Servicemen
- Hobbyists
- Students
- Schools

RADIO RECEIVER
SIGNAL GENERATOR
CONDENSER TESTER
SUB. TUBE TESTER

in one unit!

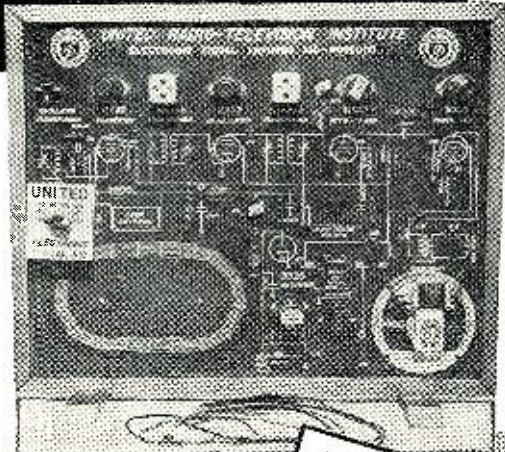

AVAILABLE IN EASY TO ASSEMBLE KIT FORM complete with ILLUSTRATED instruction manual—Wired and assembled only 12.50 additional. Please send 25% plus postage with C.O.D. Postage prepaid with check or money order

\$39.50



UNITED RADIO TELEVISION INSTITUTE

237 Washington Street

Newark 2, N. J.

SHOOT TV TROUBLE FAST!

With H. G. Cisin's Copyrighted RAPID "TV TROUBLE SHOOTING METHOD"

Without experience or knowledge, this guaranteed new method of servicing TV sets enables you to DIAGNOSE TV troubles as rapidly as an expert. NO THEORY—NO MATH—you can locate all faults in record-breaking time, regardless of make or model.

"TV TROUBLE SHOOTING METHOD" is the most valuable aid to TV servicing ever written. Be a TV Trouble Diagnostician. Increase your present earnings. Open your own profitable business or get a high-paying skilled job.

It's all in this book . . .

Nothing more to Pay—Nothing else to Buy Alphabetically listed, there are 85 picture troubles, over 58 raster and 17 sound troubles and by this unique copyrighted method you know EXACTLY WHERE the trouble is; plus step-by-step instructions, including 69 RAPID CHECKS, enabling you to find the faulty part.

13 IMPORTANT PRELIMINARY CHECKS NEED NO INSTRUMENTS! Of the 69 Rapid Checks, OVER 65 ALSO REQUIRE NO INSTRUMENTS! Rapid checks include emergency checks for distorted pictures, defective tubes including PIX tube, plus 57 others. ALL EXPLAINED IN SIMPLE LANGUAGE, PERFORMED WITHOUT INSTRUMENTS, MANY CHECKS USE THE PICTURE TUBE AS A GUIDE.

H. G. Cisin, the author, is the inventor of the AC/DC midset radio. He licenses RCA, APTC, etc. He has also trained thousands of technicians now owning their own prosperous TV service organizations or holding highly paid TV positions. His years of experience are embodied in this remarkable new TV TROUBLE SHOOTING METHOD.

Guaranteed. Money Back in 5 Days if Not Satisfied! Send your name and address today with \$1 for your post-paid copy; you'll say it's worth hundreds!

H. G. CISIN—CONSULTING ENGINEER (Dept. N-4), 200 Clinton St., Brooklyn 2, N. Y.

Name.....
Address.....
City..... Zone..... State.....

The March Issue of
RADIO & TELEVISION NEWS
Will Be on Sale February 29

TWIN-TRAX TAPE RECORDERS

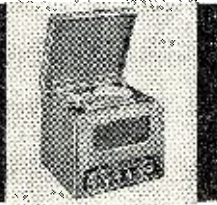

...give you more

MORE MODELS
the most complete variety of recorders for professional, semi-professional and experimenter use.

MORE FEATURES
for better quality, smoother performance and easier operation.

MORE VALUE
because our direct sales policy saves you dealer markups.

Send today for our catalog 5109 which lists complete technical specifications and performance ratings for all recorder models and accessories. *Trademark Reg.

AMPLIFIER CORP. OF AMERICA
398 Broadway New York 13, N. Y.

BARGAIN HUNTING? RADIO SERVICEMEN!
Write for SENSATIONAL CATALOG
HENSHAW RADIO SUPPLY
3619 TROOST KANSAS CITY, MO.

Written by Julian Loebenstein, the article is thoroughly illustrated with application photographs, drawings, diagrams, and charts. It reviews the background of metallic rectifiers and clarifies the various factors in their application to electronic circuits.

Copies will be forwarded without charge to persons making their requests direct to the company.

TV-RADIO CATALOGUE

Star Electronics Distributors, Inc., 7736 S. Halsted Street, Chicago 20, Illinois, has announced a new 52-page "Winter-Spring Bargain Catalogue."

Designated Catalogue No. 12, the new publication lists a complete line of both standard and bargain merchandise. Thousands of items for service technicians, manufacturers, experimenters, amateurs, and engineers are listed.

Included are speakers, baffles, antennas and accessories, TV components, receivers, cabinets, record changers, and many other items.

TRANSFORMER CATALOGUE

The Halldorson Company, 4500 N. Ravenswood Avenue, Chicago 40, Illinois has issued a new and comprehensive catalogue-manual which includes not only a complete television and auto replacement guide but also other useful information to make it handy sales manual as well as a catalogue.

Items have been renumbered for quick selection and easy use. The publication features the latest developments, including an up-to-date listing of television replacements such as flyback transformers, deflection yokes, focus coils, and other components.

A copy of the new catalogue may be obtained from any of the company's authorized distributors or from the company direct.

TV SERVICE GUIDE

General Electric Company's new and comprehensive television service guide is currently available to service technicians, dealers, and distributors.

This 80-page publication is designed for easy "on-the-bench" reference, each page opening flat, the paper dirt and fingerprint-resistant.

The new guide contains schematic diagrams with circuit symbol numbers, tube locations, top and bottom chassis views and cabling diagrams on combination sets, accurate information on 102 G-E chassis, plus 10 r.f. tuners used in 86 TV chassis. A picture section identifies every postwar G-E television set made from 1945 through present production models including the 24 inch chassis, plus color code charts for resistors and condensers.

The guide is priced at \$1.00 and is available from the company's distributors or from the company at Syracuse, New York.

COLOR CODE CHART

The first color chart to include all the color-coding requirements of the entire electronic industry has been

RADIO & TELEVISION NEWS

prepared by *Centralab Division of Globe-Union Inc.*, Milwaukee, Wisconsin.

Printed in eleven colors with over 3300 color dots or marks, the new color code chart is especially suited for use by electronic engineers, in research and educational laboratories, by purchasing and production men, by radio and TV service engineers, and by distributors of electronic equipment.

Color coding outlined on the new chart includes that of transformers, battery cables, antenna and ground leads, telephone switchboard cable, RTMA and JAN mica, paper, and ceramic condensers, standard values of fixed composition resistors, miscellaneous condensers and resistors, electrodynamic speakers, and radio and television chassis.

Initially, distribution will be made through the company's representatives and jobbers. Later it will be made available to anyone at a nominal charge. The chart measures 36 inches high and 30 inches wide.

RECTIFIER HANDBOOK

The Rectifier Division of *Sarkes Tarzian, Inc.*, Bloomington, Indiana has compiled a new "Selenium Rectifier Handbook" which has been designed for engineers, service technicians, hams, and experimenters.

The handbook contains 48 pages which cover radio-television type rectifiers, and schematic diagrams on how to use these units. Seven pages are devoted to replacement information, while 25 pages cover power and high voltage selenium rectifiers with isothermal, frequency, and reverse characteristics.

The booklet will be sent free to engineers but service technicians, amateurs, and experimenters may obtain a copy by sending in 50 cents with their requests.

ALLIED CATALOGUE

Of interest to service technicians and custom builders is the new special supplement No. 128 recently released by *Allied Radio* of 833 W. Jackson Blvd., Chicago 7, Illinois.

This 16-page booklet lists latest television and radio releases and includes tuners, boosters, tape recorders, converters, a.c.-d.c. receivers, record changers, phonograph components, television accessories, TV antennas, TV chassis, test equipment, communications equipment, tools, and cabinets.

POCKET REFERENCE BOOK

The Tube Department of *Radio Corporation of America* has again published its "Pocket Reference Book" which is issued annually for the benefit of dealers, service technicians, and industrial users.

Available at all *RCA* distributors, the new book has been completely revised and expanded to include information on *RCA* products introduced during the current year. The booklet also contains complete product listings and comprehensive data on the char-

February, 1952

THE JUNIOR SUPER-METER THE MOST COMPLETE AND COMPACT MULTI-SERVICE INSTRUMENT EVER DESIGNED!

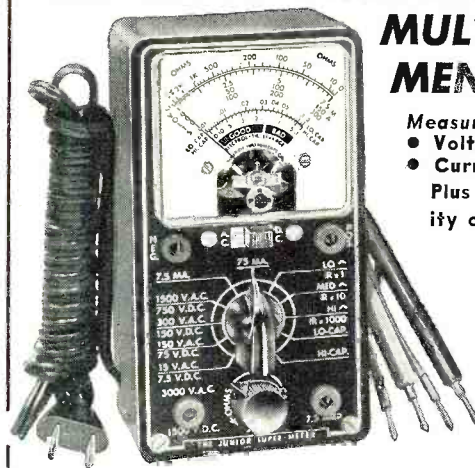

- Measures:
- Voltage
 - Current
 - Resistance
 - Capacity
 - Reactance
 - Inductance
 - Decibels

Plus Good-Bad scale for checking the quality of electrolytic condensers.

Specifications:

- D.C. Volts: 0-7.5/75/150/750/1500 Volts.
- A.C. Volts: 0-15/150/300/1500/3000 Volts
- Resistance:
 - 0-10,000/100,000 ohms. 0-10 Megohms.
- D.C. Current: 0-7.5/75 Ma. 0-7.5 amperes.
- Capacity: .001 Mfd. - .2 Mfd. - 1 Mfd. - 20 Mfd.
- Electrolytic Leakage: Reads quality of electrolytics at 150 Volt test potential.
- Decibels: -10 Db. to +18 Db. +10 Db. to +38 Db. +38 Db. to +58 Db.
- Reactance: 15 ohms - 25 K ohms 15 K ohms - 2.5 Megohms.
- Inductance: .5 Henry - 50 Henries 30 Henries - 10 K Henries.

Handsome round cornered molded bakelite case 3 1/8" x 5 7/8" x 2 1/4" complete with all test leads and instructions.

\$21.40

SOLD ON EASY PAYMENTS AT THE NET CASH PRICE

No interest or carrying charges added. Simply remit \$5.40 with order, pay balance \$4.00 per month for four months.

MOSS ELECTRONIC DIST. CO., INC.

Dept. B-11, 38 Murray St., New York 7, N.Y.

NOW!

The Sensational New
**WEATHERS One-Gram
Capacitance Pick-Up**
(Cartridge Form)



AT LONG LAST! — REALISM without noise
20 TO 20,000 CYCLES

Adjudged Sensation at November New York Audio Show.

Will Improve and Replace Any Modern Phonograph Pickup

- ✓ One gram stylus pressure with ideal tone arm
- ✓ Two grams pressure on modern Webster changers
- ✓ Very low pressures with other players, including RCA 45 changer
- ✓ Will operate properly with most good quality tone arms

Constant Amplitude Response, 20 to 20,000 cps. 1 volt into 1/2 megohm at 1000 cps. AES Response Equalization from separate output connection, for LP records.

Replaceable 1-mil sapphire stylus (choice of 1-mil or 3-mil sapphire stylus on request). Records last thousands of plays. One sapphire plays thousands of records.

**WEATHERS CARTRIDGE
AT A NEW LOW PRICE**

WEATHERS power supply, complete with power cord, for 117 volts, 60 cps. net \$14.50

Complete with ultra-flexible cable, oscillator unit, tube, installation hardware and instructions. net

\$37.50

Oscillator requires 6.3 volts ac at 0.3 amp, and 250 volts dc at 2ma. Available from most amplifiers.

Check or Money Order. No. C.O.D.'s Please
Shipments postpaid in U.S.

WEATHERS INDUSTRIES
510 RICHEY AVE., W. COLLINGSWOOD 6, N. J.

BUILD YOUR OWN RADIO with these **ALLIED** quality **easy-to-assemble kits**
latest circuits • finest parts



"RANGER" SUPERHET

Complete with Cabinet
 Learn radio while you build and enjoy this sensitive AC-DC broadcast receiver. Tunes 535-1620 kc; includes built-in antenna, 5" PM dynamic speaker, automatic volume control, handsome walnut plastic cabinet. Easy to assemble from detailed instruction manual. Complete kit includes

punched chassis, all parts, tubes and cabinet—quality components throughout. Shpg. wt., 8 lbs. 83-275. "Ranger" Kit, only.....\$17.85

FAMOUS RADIO LAB KIT

10 RADIO KITS IN 1

Here's the most instructive Experimenters' kit you can buy. With it, you can build a broadcast receiver, phono amplifier, phono oscillator, signal tracer, electronic timer, photo cell relay, home broadcaster, electronic switch, etc. Fascinating, instructive. Complete with all parts, tubes, microphone and

12-page manual. Shpg. wt., 10 lbs. 83-265. Radio Lab Kit, only.....\$14.25

"SKY-ROVER" PORTABLE

With Carrying Case

Build this powerful 3-way superhet portable for AC, DC or battery operation. Covers 535-1650 kc AM broadcast; has built-in antenna, PM speaker, automatic volume control, handsome carrying case. Easy to assemble from 8-page illustrated manual. High-quality kit includes all parts, tubes and case (less

batteries). Shpg. wt., 6 lbs. 83-276. "Sky-Rover" Portable Kit, only.....\$17.95 80-596. Battery Kit for above set, only.....\$ 2.11

FREE 212-Page 1952 Catalog

For everything in Radio, TV and Industrial Electronics at lowest money-saving prices, see ALLIED's complete Buying Guide. Write for your FREE copy today.



ALLIED RADIO
 ALLIED RADIO CORP., Dept. 1-R-2
 833 W. Jackson Blvd., Chicago 7, Ill.

Send Kit No. 83-275 } \$.....
 Send Kit No. 83-265 } enclosed
 Send Kit No. 83-276 } prices FOB Chicago
 Send FREE 212-Page Catalog

Name.....
 Address.....
 City.....Zone.....State.....

acteristics, interchangeability, and socket requirements of more than 450 RCA receiving tubes, including kinescopes. It provides similar data on 75 dry batteries.

Fundamentals of television and some helpful hints on television troubleshooting, compiled by John Meagher, are also included along with a 56-page daily diary for 1952, calendars for 1952 and 1953, and 16 pages of full-color maps.

WIRING DEVICES

Over 1000 individual electrical wiring devices are listed and described in the new 40-page catalogue just issued by Rodale Manufacturing Co. of Emmaus, Pa.

Known as "General Catalogue No. 51-1952," the new publication includes hundreds of items that are of particular interest to the radio and electronics industries.

A copy of the catalogue may be obtained from the company without charge.

"HIGH FIDELITY GUIDE"

Lafayette Radio, 100 Sixth Avenue, New York 13, New York is currently offering copies of its new 1951-1952 "High Fidelity Guide."

This new, fully-illustrated, 32-page manual and catalogue is one of the most complete publications of its kind. It lists high fidelity components of all the leading manufacturers, complete radio-phonograph and television systems, home installations, and finished cabinets. The booklet also carries a complete explanation of the term "high fidelity," the requirements of a high fidelity system and its components, and

details on how to plan such a system for the home.

REPLACEMENT MANUAL

Sprague Products Company, North Adams, Massachusetts now has available for distribution the 4th edition of its "TV Replacement Capacitor Manual."

Containing accurate, up-to-the-minute condenser replacement data on a total of 1561 receiver models made by 63 companies, the new book is printed in dark brown ink to distinguish it from earlier editions.

The publication gives complete, set-by-set listings of original equipment condensers and their recommended *Sprague* replacements. Rating data and manufacturer's part numbers are listed for the original unit while the *Sprague* catalogue numbers and electrical specifications are given for the replacement unit.

Free copies of the new manual, publication M-481, are available from local *Sprague* distributors or may be obtained from the company direct upon receipt of 10 cents to cover mailing and handling.

ANTENNA MOUNTS

South River Metal Products Co., Inc. of South River, New Jersey has published a comprehensive catalogue covering its line of antenna mounts and accessories.

Designed especially for dealers, service technicians, and jobbers, the new catalogue lists chimney mounts, wall brackets, adjustable wall brackets, a combination wall bracket, and a duo-pipe mount. Other types of hardware are also featured.

Microwaves, in a vast communications system, span the rugged terrain of the Pacific Northwest for the Bonneville Power Administration. At the present time they have 200 miles of microwave circuits in operation and expect to have at least 1400 miles during the next five years. Workmen in the picture are shown completing installation of a giant parabolic antenna on microwave tower near Squak Mountain in north-west Washington. Like TV, microwaves are reflected and beamed from station to station.

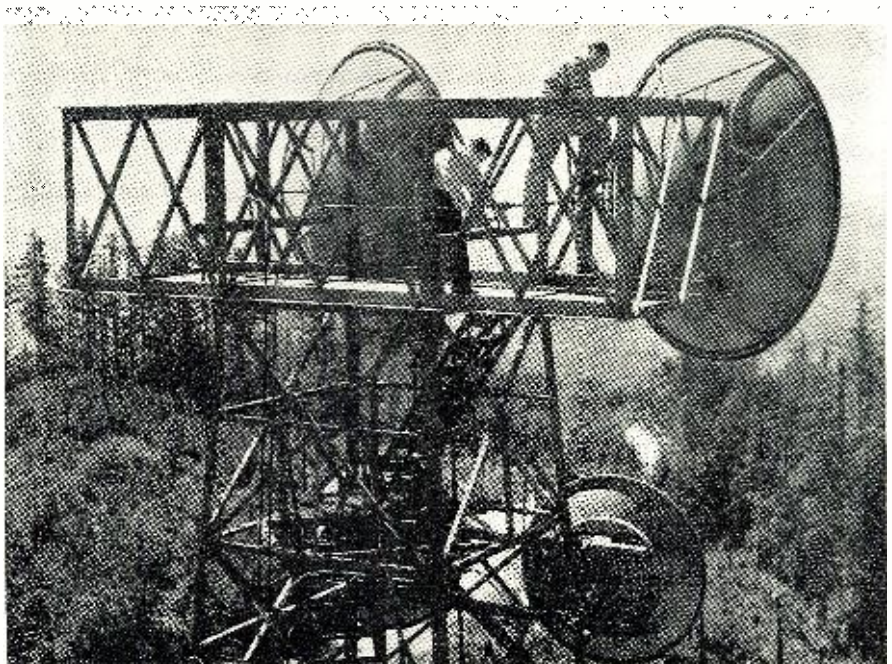

Quality Control
(Continued from page 49)

The new electrostatic focus, magnetic deflection tubes can be tested fully in this test set. An Indian-head pattern generator supplies a uniform video picture for making quick resolution tests. Since electrostatic focus tubes such as the 17HP4A, 20HP4A, and 21FP4A, vary in focus voltage with the ion trap position, a uniform method of testing these tubes must be established. The procedure is to first set the brightness at a low level and adjust the ion trap for maximum light output. This operation assures the tester that the beam is clearing the gun apertures. If the ion trap is not adjusted for the maximum light condition, there is a possibility that the electron beam will actually melt a new "aperture" into the electron gun parts. When the ion trap has been set up, the focus anode voltage is then varied to achieve the best line structure (vertical resolution) and the best horizontal resolution as evidenced by the vertical wedge in the Indian-head pattern. The voltage for best over-all focus should occur within the limits specified. Focus voltage also varies slightly with grid No. 2 voltage and with anode voltage. In order that a complete engineering analysis can be made on the various types of electron guns, a variable width pulse generator and synchronizing unit are available.

Besides its use in development work, production recorded readings, and life test data, the engineering test set is also used to analyze all test rejects. Data on these rejects is supplied to the engineer concerned so that he may take immediate steps to correct the process or material at fault.

The use of such an engineering test set by engineers and production men results in an over-all increase of the product quality level. Every attempt is made to ensure its full use, and low scrap rates are proof of its benefits.

-30-

PHOTO CREDITS

Page 88, 96.....	The Radio Craftmen	Credit
49.....	Raytheon Manufacturing Company	
52, 59 (right).....	Radio Corporation of America	
59 (left).....	Argosie Radio & Television	
59 (center).....	Argos Products Co.	
62.....	General Electric Company	
70.....	David Bogren, Inc.	

ERRATA

In the International Short-Wave Department appearing in the December, 1951 issue an error was made in the item "Stability of BBC Outlets." Mr. H. F. Smith, editor of "Wireless World," has pointed out that the BBC transmissions are maintained to within one part in one million (10⁻⁶) of their nominal values instead of the one part in ten as stated in the column. Our apologies to BBC and our thanks to Mr. Smith for calling this error to our attention.

In Fig. 3 (Page 49, November, 1951 issue) of the article "An Audio Amplifier with 'Presence,'" the pin numbers for the 6SD7 tube have been inadvertently interchanged. Pin 4 should be numbered 6 and vice versa.

In the article "A Combination Phonograph-Tape Recorder," the diagram of Fig. 3 appearing on Page 46 of the November, 1951 issue shows resistor R₂ connected to ground. It should, of course, be connected to "B+."

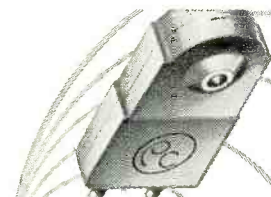

for flawless reproduction
NO OTHER CARTRIDGE CAN PERFORM LIKE A PICKERING

Pickering patented design
provides **DYNAMIC COUPLING***
throughout the entire audible range

*** DYNAMIC COUPLING ASSURES**

- constant stylus contact with the record grooves over the entire audio spectrum (20-20,000 cps)
- full frequency response
- full transient response

**NO RESONANCES
NO MISTRACKING
NO GRINDING OF GROOVE WALLS**

Pickering Cartridges transmit all of the sounds in the musical spectrum, without loss of definition, just as a fine optical lens passes all of the colors in the rainbow.

For literature address Dept. C

Well-informed engineers and technicians, schooled in the science of electro-mechanics, know that only wide-range frequency response provides full transient response; the electronic phenomena which enables the reproduction of orchestral music with all the subtle sounds that give each musical instrument its individual character.

Pickering engineers and designers have but one objective . . . to produce products that will please the music lovers' insatiable appetite for the flawless recreation of recorded music . . . for the utmost in quality insist upon Pickering Audio Components.



OCEANSIDE, NEW YORK

PERFORMANCE Not Size IS WHAT COUNTS

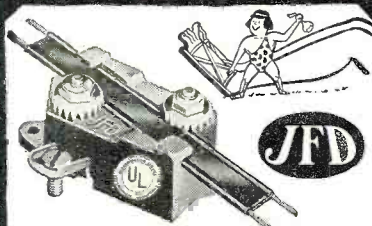

"LITTLE GIANT" LIGHTNING ARRESTER



PROTECTS Against Lightning Hazards

No. AT 105 \$1.25 LIST
For ribbon-type and oval jumbo twin lead.

ONLY JFD Lightning Arresters offer you these exclusive patented features . . .

1. Strain-relief Retaining Lip prevents pulling or straining of lead against contact points.
2. You actually see positive contact made with lead-in wire.
3. No wire stripping or cutting.

Write for Form No. 84 showing the damage lightning can do to a Television Installation.



JFD MANUFACTURING CO., Inc.
6127th Avenue, Brooklyn 4, N. Y.
FIRST in Television Antennas and Accessories

LEARN

Television-Radio Electricity
REFRIGERATION-ELECTRONICS
IN THE GREAT SHOPS OF **COYNE**

TRAIN QUICKLY! OLDEST, BEST EQUIPPED SCHOOL of ITS KIND in U.S. Young and Older Men . . .

Come to the Great Shops of Coyne in Chicago. Get practical training in TELEVISION-RADIO or ELECTRICITY—vital in Defense Program. Prepare now for a better job or better service rating.

START NOW—PAY LATER

You can finance most of your tuition, pay for it later in easy monthly payments. Special plan for men of Draft Age. Part time employment service available.

FREE BOOK Clip coupon for Big Free Illustrated Book. Indicate below, course that interests you. No salesman will call. Act NOW.



B. W. Cooke, President
A TECHNICAL TRADE INSTITUTE CHARTERED NOT FOR PROFIT
Established 1899
500 S. Paulina, Chicago

ELECTRICITY ★ TELEVISION RADIO ★ REFRIGERATION ★ ELECTRONICS

B. W. COOKE, Pres. COYNE School
500 S. Paulina St., Chicago 12, Ill. Dept. 22-85H

Send FREE BOOK and full details on:

TELEVISION-RADIO ELECTRICITY

NAME

ADDRESS

CITY

STATE

Replace Your Old TV Aerial
With Snyder's Amazing New

360° MOTORLESS TV AERIAL

Same Clear Pix
As Motor Rotating
Aerial Systems
Costing Triple
This Price

FOR ULTRA FRINGE
Only \$15.95

Complete with beam
selector switch and
75 ft. 3 conductor
cable.

Electronically beams in complete 360° rotation to give clear picture on all channels. You choose direction with Directronic selector switch mounted on or near TV set. Complete double-stacked arrays with 18 hi-tensil double-alloy aluminum elements.

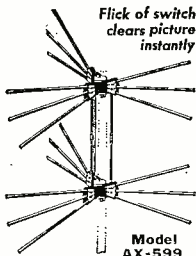

Flick of switch
clears picture
instantly

Model
AX-599

Snyder's Powerful 5 Element

YAGI TELEVISION ARRAYS

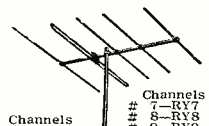

For Fringe &
Ultra Fringe

Highly directional and closely tuned to each channel. Cuts interference and noise to a minimum. Five elements; one folded dipole, three directors and one reflector. Individual array for each channel. Specify model desired.

Channels
7-RY7
8-RY8
9-RY9
10-RY10
11-RY11
12-RY12
13-RY13

Channels
3-HY3
4-HY4
5-HY5
6-HY6

\$7.95

\$4.95

TIE RODS for stacking 2 Yagi arrays. Specify HI or Lo Band. pair \$85c

TV ANTENNA ACCESSORIES

- STEEL EXTENSION POLES. Weather treated. 10 ft. long. 1 1/4" dia. \$2.19
- 5 ft. long. 1 1/4" dia. Crimped End. 1.35
- 3 1/2 ft. long. 1 1/4" dia. Crimped End. 1.19
- CHIMNEY MOUNT BRACKETS. Complete with strap. CM-1. 1.59
- HEAVY DUTY MAST BRACKETS WB-2. Adj. to 18" from wall. 3.75
- ANTENNA SWIVEL BASE. Aluminum. Fits 1 1/4" O.D. mast section. 4.5

Get Full 70° Focus!

Latest Design DEFLECTION YOKE
For TV Replacement and Conversion!



Anastigmatically corrected coils are used in all units to provide sharp focus over entire picture area. The high deflection sensitivity makes conversions in most cases without further changes in deflection circuits. Designed for all round and rect. tubes with app. 70° deflection angle. Hor. DC resistance—13.5 ohms. Vert. DC resistance—65 ohms. Hor. inductance—3.3 mh. Vertical inductance—50 mh. Instructions included. \$4.50

Special!

FLYBACK
TRANSFORMER

For 10"-12" tubes. Type 211T3, similar to RCA type. 211T1. \$2.95

Replacement
for 10-12"
Tubes

FOCUS 1.49
COIL

FREE!
LATEST FYI BULLETIN

Write for
Yours Now

Special Values

New Equipment

WHOLESALE
RADIO PARTS CO., Inc.
311 W. Baltimore St.
BALTIMORE 1, MD.

Classified

Rate 50c per word. Minimum 10 words

RADIO ENGINEERING

RADIO Engineering Broadcasting, Aviation and Police Radio, Servicing, Marine Operating and Electronics taught thoroughly. Expenses low. Write for catalog. Valparaiso Technical Institute, Dept. N, Valparaiso, Ind.

SALE

WIRE recorder foundation mechanism, Webster Chicago 78. \$30.00. Wurlitzer Jute Box 16, record mechanism, \$15.00. Henry H. Jensen, UGD, Ogden, Utah.

TOWERS: 100-foot galvanized steel, bolted, sectional, 12-foot square base, pyramidal. Ideal for long distance TV and FM antenna mounting, Penn Albert Hotel, Greensburg, Pa.

DIAGRAMS Radio, Record Changers, Recorders, 75c; Television with Service Data, \$1.25 up. State manufacturer and model number. Kramer's Radio Service, Dept. N8, 36 Columbus Ave., New York 23, N. Y.

HOTTEST surplus list in the country. Electronics-Hydraulics, Aircraft-Gadgets. Dick Rose, Everett, Wash.

HEARING aids, used. Zeniths, less accessories, \$7. One-piece Nationals, \$10. One-piece overhauled, with accessories, \$20.00. Shelby Instrument, 321 W. 7th St., Long Beach, Calif.

TUBES, surplus, bought-sold. Free list. Betz, 73 Caroline Ave., Yonkers, N. Y.

AMERICA'S favorite, "The Tuffy Tower," 20' television tower, easy to erect and safe to climb. May be made 40' by telescoping pipe through tower. Complete with peak roof saddle hinged mount. F.O.B. \$25 net. Youngstown Steel Towers Co., 1825 Wilson Ave., Youngstown 8, Ohio.

TV and FM Antennas. Yagi, Conical, Bow-Tie. Mounts, accessories. Lowest prices. Wholesale Supply Co., Dept. H, Lunenburg, Mass.

WANTED

RG-8-U, RG-11-U or RG-59-U coaxial Cable, any lengths, any quantities. Write: Television Service Co., 249 N. 48th St., Lincoln, Nebr.

AN/APR-4, other "APR-," "ARR-," "TS-," "IE-," ARC-1, ARC-3, ART-13, everything surplus; Tubes, Manuals, Laboratory equipment. Describe, price in first letter. Littell, Farhills Box 26, Dayton 9, Ohio.

WANTED: The following sets, parts or equipment associated with: BC-611 handie-talkies; ARC-1; ARC-3; ARN-7; BC-342, 312; R-89B/ARN-5; T-47, 47A/ART-13 & dynamotor; F-21/ARA-9 audio filter; RT-7A/APN-1; APN-2; APN-9; BC-348; MG-149; BC-735D; BC-966A; DM-32A; BC-453B; CRT-3; SCR-322; plus all types test equipment. Top Dollar paid. Write: Robert Sanett, Dept. WC, 4668 Dockweiler, Los Angeles, Calif.

WANTED: ARC-1, ART-13, TCS-12, BC-348, BC-342, BC-312, BC-221, BC-654A, RA-34, PE-103A, PE-104A, manuals, Radar, tubes, test equipment. Arrow Appliance, 525 Union, Lynn, Mass.

HELP WANTED

RADIO Officers, \$7,200-\$10,000 annual earnings, top union conditions, 6 months Radio Operating experience U.S. Merchant ships on FCC License since Jan., 1935, can get emergency FCC License to sail at once. Also experienced U.S.N. Radiomen with 2nd class Radiotelegraph license & 6 months sea Radio time. Phone, write, wire American Radio Association, CIO, 5 Beekman St., New York. CO 7-6397.

CORRESPONDENCE COURSE

USED Correspondence Courses and Books sold and rented. Money back guarantee. Catalog free. (Courses bought.) Lee Mountain, Pisgah, Ala.

RADIO Servicing Course shows latest short cut methods. Lessons easy to follow. Only \$3.00, postpaid in U.S.A. Buyers Syndicate, 30 Taylor St., Springfield, Mass.

MISCELLANEOUS

SPEAKERS repaired, wholesale prices, guaranteed workmanship. Amprite Speaker Service, 70 Vesey St., New York City 7.

RADIO Television, Trade Gazette; stamp please. Trowbridge, 655 W. 81st St., Chicago.

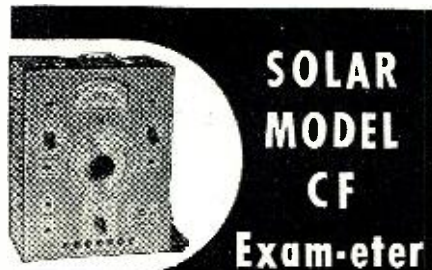

SOLAR
MODEL
CF
Exam-eter

The most complete of all capacitor analyzers, Solar's famous Model CF is a sturdily constructed, reliable instrument designed to simplify electronic servicing.

- Has exclusive patented Quick-Check circuit for qualitative tests and intermittent checks without unsoldering capacitors
- Capacitance bridge—10 mmf to 2000 mf in 4 ranges
- Power factor—0 to 50 percent
- Insulation resistance—3 to 10,000 megohms
- Electrolytic leakage current reads directly on 4 1/2" meter
- Built-in d-c power supply continuously adjustable from 0-550 volts for electrolytic tests under rated voltage
- 100 ohms to 7.0 megohm A-C resistance bridge
- 0-600 volt, D-C vacuum-tube voltmeter
- 10-50 volt A-C vacuum-tube voltmeter
- Quality Components for Long, Trouble-free Service
- 115 V., 50-60cy
- Capacities with test leads
- Instruction manual

\$69.95

Ready to operate Price: F.O.B. N.Y.
20¢ deposit with order. Balance C.O.D. Jobbers—
Write for discounts.

ARCEE ELECTRONICS CO.
95 WARREN ST., N.Y. 7, N.Y.—Dept. A

NEW • ELECTRONIC MATERIALS • GUARANTEED

Type	Coil	Contacts	Features	Price
Sigma #5	65 (2)	SPDT	2-24 VDC	\$2.45
Sigma #5	65 (2)	SPDT	CASED	3.45
Sigma #5	5000 (2)	SPDT	1 1/2 ma plate	4.75
Leach 1077BF	160	DPDT	CERAMIC	2.45
G. E.	2000	SPDT	4 ma plug-in	2.95
Clare SK-5032	32	DPDT	6VDC plug-in	3.45
W. E. KS-9665	2000	1A, 1B, 1C	9 ma	4.45
A-B B5	100	SP solenoid	50 A 24 V	1.85
A-B B6	65	SPST	100 A 24 V	2.95
Ref B5	100	SP solenoid	50 A 12-24 V	1.95
Allied 80D35	200	4PDT	10 A cont.	3.25
Allied D09D 28	14	3PDT	6 VDC	2.15
GM 13016	200	4PDT	10 A cont.	3.75
GM	5000 (2)	4PDT	8 ma plate	5.75
Allied BL	42	SPNO	6 VDC mini	.85
1 RPM 110 V 60 cy MOTOR HI GEAR RATIO				1.85
5 Amp 110 VAC, Kw hr meter				4.95

OIL CAPACITORS			
2 uf bathtub	\$.85	1 uf/1000 VDC	\$1.65
4 uf/ 50 VDC	.65	5 uf/ 600 VDC	1.85
4 uf/600 VDC	1.45	8 uf/ 600 VDC	2.45
20 uf/600 VDC	5.95	15 uf/ 100 VDC	3.75

COMPONENT KITS OF QUALITY	
100 INSULATED CARBON RESISTORS	\$2.75
100 NON-INSUL. CARBON RESISTORS	1.75
50 RF CHOKE COILS all useful types	1.75
50 MICA CONDENSERS—over 20 values	1.95
25 PRECISION WIRE WOUND RESISTORS	2.95
POTENTIOMETER KIT—15 types	2.25
50 CERAMIC CONDENSERS—over 25 values	2.45
50 BYPASS CONDENSERS—tubular	.75
20 ELECTROLYTIC CONDENSERS	2.95
40 TUBE SOCKETS—4-6-6-7-8 prong	1.95
50 TIE POINTS STRIPS—2-3-4-5-6-7-8 term.	1.45
20 BATHTUB CONDENSER—assortment	1.95
HOOKUP WIRE ASSORTMENTS—cut lengths	1.00
EXTRA LOW—10% OFF ON 5 ASSORTED KITS	

ELECTRONIC SPECIALTY SUPPLY CO.
56-A Lispenard St. Barclay 7-2684 New York 13, N. Y.



Communication Problems Solved
with ARMY FIELD
TELEPHONES and
TELEPHONE WIRE

All-purpose—all-weather
This is genuine W110B Army Field Wire on original steel reels. Insulated, 2-conductor, copper-steel strands. Excellent for all types of communication. Used extensively per \$36.50 by telephone companies, industry, engineering projects, ranches, public address systems.

- Reconditioned L I K E N E W E E - B Phones, per \$36.50
- GRADE 1—Unused, excellent condition. Mile reels (wt. 160 lbs.) \$22.50
- Half-mile reels (wt. 80 lbs.) 12.50
- 500 ft. reels (wt. approx. 18 lbs.) 4.95
- W-130—Lightweight Assault Wire—2 Conductor. Excellent inter-com wire. Unused, excellent condition. 10,500 ft. reels. 57.50
- Approx. 3,300 ft. reels. 19.50

Send for FREE FOLDER
All prices F.O.B., Sacramento. No C.O.D. (Calif. residents add 3% for sales tax.) Prices subject to change without notice. Send check or money order.
LORIS SALES, P. O. Box 1896 M-2, Sacramento, Calif.

FEBRUARY 1952

INDEX OF Advertisers

While every precaution is taken to insure accuracy, we cannot guarantee against the possibility of an occasional change or omission in the preparation of this index.

NAME	PAGE
Acorn Electronics Corp.	136
Airex Radio Corp.	85
Alden Electro Company	157
Allied Radio Corporation	9, 106, 164
American Electronics	128
American Phenolic Corporation	92
American Television & Radio Co.	152
Ampex Electronic Corporation	158
Amplifier Corporation of America	162, 168
Arcex Electronics Co.	166
Arrow Sales, Inc.	157
Ashe Radio Co., Walter	113
Astastic Corporation	30
Atlas Sound Corp.	111
Barry Electronics	118
Belden Mfg. Co.	21
Bell Telephone Laboratories, Inc.	89
Bendix Radio	161
Berlant Associates	154
Blonder-Tongue Laboratories	139
Bond Equipment Company	147
Brook Electronics, Inc.	104
Brooks Radio & Television Corp.	129
Burstein-Applebee Company	167
Candler System Co.	149
Capitol Radio Engineering Institute	83
Centralab Inc.	26-27
Channel Master Corp.	19
Chicago Transformer Company	115
Cisin, H. G.	162
Cleveland Institute of Radio Electronics	109
Collins Audio Products	18
Columbia Electronic Sales	81
Comet Electronics Sales Co.	145
Communications Equipment Company	97
Convain	159
Coyne Electrical School	165
DeForest's Training Inc.	5
Dakoline Chemical Co., Inc., The	142
Davis Electronics	126
Daw Radio Inc.	114
Dull's Electrical Translation	168
DuMont Laboratories, Allen B.	24
Dumont Electric Corporation	147
Editors & Engineers, Ltd.	140
Eddie Electronics, Inc.	102
Eitel-McCullough, Inc.	132
Electronic Beam Corporation	160
Electronic Expeditors, Inc.	124
Electronic Instrument Co., Inc.	151, 159, 3rd Cover
Electronics Institute, Inc.	128
Electronic Specialty Supply	166
Electro Voice, Inc.	135
Eric Resistor Corporation	121
Esego Sales	149
Fair Radio Sales	141
Feiler Engineering Co.	146
Finnegan, H.	168
Forest Sales	130
Franklin Technical Institute	159
G & H Wood Products	151
G. L. Electronics	126, 145
Garrard Sales	149
Gem Radio & Television Corp.	16
General Cement Manufacturing	22
General Electric Company	13, 31
General Test Equipment	143
Good, Don, Inc.	147
Goodhart, R. E.	143
Grayburn Corporation	142
Greenlee Tool Co.	167
Greenwich Sales Company	158
Greylock Electronics Supply Co.	161
Hallcrafters Company, The	32
Harvey Radio Company, Inc.	134
Heath Company, The	74 thru 81
Henry Radio Stores	164
Henshaw Radio Supply	162
Hytron Radio & Electronics Co.	17
Indiana Technical College	151
Instructograph Co.	157
J.F.D. Manufacturing Company	130, 165
J. S. H. Sales Company	153
Jackson Electrical Instrument Co.	119
Jensen Industries, Inc.	153
Kaar Engineering Company	126
Kester Solder	116
Key Electronics Division	130
Labco Electronics, Inc.	142
Lafayette Radio Corporation	123
La-Pointe Plasmoid Corporation	25
Leetronic Research Labs.	138
Leotone Radio Co.	116
Loris Sales	166
Lowell Metal Products Corp.	110
Luthier, Otto	136
MacMillen Company	156
McConnell's	168
McGee Radio Company	90, 91
McGraw-Hill Book Co.	98
Mallory & Co., P. R.	4th Cover
Mark Electronics	159
Martin Mfg. Co.	168
Mattison Television Co.	122

Let MILTON S. KIVER Help You Prepare For U.H.F.-TV And...

TELEVISION SERVICING

Easy to TRAIN AT HOME This Practical Way!

Men with the right training in Television Servicing are in big demand... pull down big pay. T.C.I. TRAINS YOU RIGHT with easy-to-follow technical training designed by servicemen, for servicemen! You learn practical, professional type Television Servicing without leaving your present job. Included are money-making extras such as set conversion, master antenna installation, U.H.F.-TV and field servicing short cuts. You can start earning Television money after the first few lessons. You learn to test, trouble shoot and repair all types of TV sets the proven, practical way!

HERE'S HOW YOU GET EXPERIENCE!

You train on your own large screen modern television receiver, furnished as part of your course. This set is yours to keep! As an optional feature you can get two weeks of actual field experience out on service jobs and on the repair bench for Chicago's largest independent servicing organization. You learn Television Servicing by actually doing Television Servicing... you get the practical know-how you need to qualify for BIG MONEY in this fast-growing field! Age is no barrier. Many TCI students are over 40!

ACT NOW! Fill out and mail coupon for FREE Catalog and SAMPLE LESSON. Write TODAY!

TELEVISION COMMUNICATIONS INSTITUTE
205 W. Wacker Dr., Dept. 1-T, Chicago 6, Ill.

CUT HOLES 1/2" to 3 1/2" IN RADIO CHASSIS



WITH A GREENLEE RADIO CHASSIS PUNCH

• Save hours of work... no reaming or tedious filing. Punch cuts through chassis quickly... makes accurate, clean holes for sockets, plugs, and other receptacles. Just turn with an ordinary wrench. There's a GREENLEE Punch in each of these sizes: 1/2", 5/8", 3/4", 7/8", 1", 1 1/8", 1 1/4", 1 1/2", 1 3/4", 1 7/8", 1 5/8", 1 3/4", 2 1/4". Write for complete facts. Also get information on Knockout Punches and Cutters for conduit and meter holes up to 3 1/2". Greenlee Tool Co. 1882 Columbia Avenue, Rockford, Illinois.

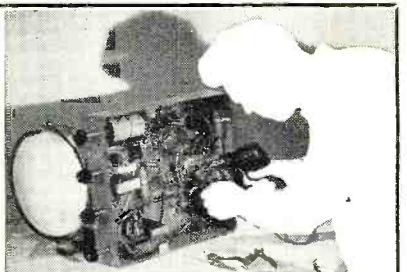

YOU GET and keep modern large screen Television receiver.

YOU DO actual testing, servicing, trouble shooting and repairing

TV BROADCASTING COURSE READY NOW!
Train at home for these big pay studio jobs! Video engineers, camera men, microwave engineers, etc. Easy non-mathematical training covers all phases. Write!

MAIL NOW FOR FREE BOOKLET

MILTON S. KIVER, President
TELEVISION COMMUNICATIONS INSTITUTE
205 W. Wacker Dr., Dept. 1-T, Chicago 6, Ill.
Rush full facts on the course checked below. I am not obligated. Salesman will not call.
() TV Servicing () TV Broadcasting
Name..... Age.....
Address.....
City..... Zone..... State.....
() BEGINNERS check here for information on Pre-Tel Radio Course.

DID YOU GET IT? IF NOT SEND NOW FOR B-A's 136 BIG PAGE FREE CATALOG

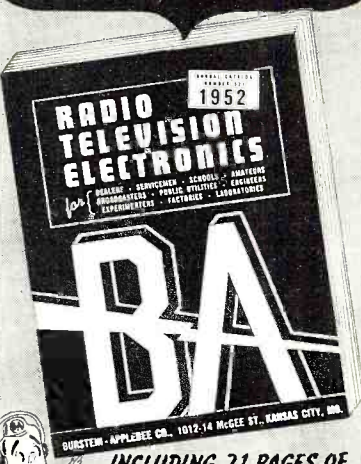

INCLUDING 21 PAGES OF DOLLAR-SAVING BARGAINS!

BURSTEIN-APPLEBEE CO.
1012-14 McGee St.
Kansas City 6, Mo.
Send your 1952 catalog to:
Name.....
Address.....
City..... State.....

BURSTEIN-APPLEBEE CO.

FREE

COMPARE THIS NEW 10-POUND PORTABLE TAPE RECORDER



The MAGNEMITE* MIGHTY MIDGET BATTERY-OPERATED TAPE RECORDER

Compare the Magnemite* with other so-called portable recorders. Self-powered by inexpensive batteries that last and last. Always ready for instantaneous use—in or away from home, office or studio. Yes, the Magnemite* is America's first truly portable tape recorder.

Net Factory Price \$189.50

Supplied with tubes; batteries; microphone; crystal earphones; reel of tape; takeup reel; instructions.

*Trade Mark Reg. Order today, or write for additional literature to:

AMPLIFIER CORP. of AMERICA • 398 Broadway • New York 13, N. Y.

Will buy all ART13/T47A \$220.00, ART13/T47, \$150.00, BC348's (not B's or C's) \$65.00, ARC-3 complete \$750.00, R77 Receivers only \$400.00, ARC-1's \$600.00, BC312's \$65.00, BC342's \$60.00. SHIP VIA EXPRESS C.O.D. SUBJECT TO INSPECTION—to:

H. FINNEGAN

49-57 Washington Ave., Little Ferry, N. J.

Compare the Weight.

Pounds lighter than any other tape recorder.

Compare the Size.

Measuring only 11½ x 8½ x 5½ inches it's actually the world's smallest tape recorder.

Compare the Motor Drive.

Driven by a constant-speed spring-wound motor that runs 15 minutes per winding. A tremendous advantage over DC motors with varying speeds.

Compare the Battery-Operation.

100 operating hours per set of inexpensive dry cell batteries. No wet cells to recharge daily.

Compare the Playback.

Yes, a playback preamplifier actually built-in. Listen through earphones or external amplifier.

Compare the Price.

More features than other portable recorders, yet a far lower price. Reason? Our direct selling policy and expanded production facilities.

BENDIX 4-CHANNEL E.C.O.

Channel 1 1050-1700 KC | Channel 3 3000-4800 KC
Channel 2 2000-3400 KC | Channel 4 4370-7000 KC

Unit is front end of TA-12B transmitter by band switching each channel is a complete oscillator uses a 6SK7 or 12SK7. In each channel by adding an 807 driver and a pair of 807's for a final you have a 50 watt trans. each osc. section is completely shielded and mounted on an aluminum chassis with var. cond. shafts extended ready to add voltage. GOVT. COST OVER \$150.00 NEW. WHILE THEY LAST. For That New Ham Band 2700 KC...\$5.95

3834 Germantown Ave. Phila., Penna. RA 5-6033

McCONNELL'S

OAK RIDGE CRT TESTER



"CATHETTE"

is the ONLY CRT Tester*

that checks ALL the following:

- HIGH VOLTAGE BREAKDOWN
- BEAM CURRENT MEASUREMENT
- ELECTRON GUN CONDUCTANCE
- SHORTS BETWEEN ANY ELEMENTS

Ask to see this INDISPENSABLE new tool at your nearest jobber. You'll agree that it's a MUST for every TV Serviceman today! MODEL 106 "CATHETTE" CRT Tester, net **\$29.95**

* Pat. Applied for.

Check these additional features:

MODEL 108 POWER SUPPLY (Pocket Size, same as above), used in conjunction with Cathette CRT Tester, permits testing of Picture Tubes in carton! net, **\$19.95**

- Checks gas between elements in Electron Gun
- Checks gas between High Voltage Anode and Electron Gun
- Checks conductance between Cathode, Control Grid, and Screen Grid
- Checks filament continuity
- Checks high voltage on Anode
- Checks Screen to Control Grid voltage from set
- Checks Control Grid to Cathode voltage from set
- Checks leakage
- Tests and positions Ion Trap
- Checks brightness control voltage
- Easy-to-read calibrated DC Voltage scales (0-500V, 0-15KV)
- Easy-to-read tube test scales
- Supplied with duo-decal plug and socket. (Special adaptors available as accessories)
- Pocket size: 5½ x 3¾ x 2¼". Shpg. wt. 3 lbs.



Send NOW for your copy of our complete new catalog, illustrating and describing the above equipment, as well as all other OAK RIDGE TV Test Instruments. Cable Address: "UNIONTEX" N. Y.

OAK RIDGE PRODUCTS

37-01 Vernon Blv' Long Island City 1, N. Y.
Mfg. Division of VIDEO TELEVISION, INC.

OAK RIDGE PRODUCTS, Dept. N
37-01 Vernon Blvd., Long Island City 1, N. Y.
Please send your complete new OAK RIDGE Catalog at once, to:

Name

Address

City..... State.....

NAME	PAGE
Merit Coil & Transformer Corp.	136
Midway Company	136
Midwest Radio & Television Corp.	140
Miles Reproducer Company, Inc.	157
Milwaukee School of Engineering	96
Mosley Electronics	155
Moss Electronics Distr.	163
National Electronics	128
National Radio Institute	3
National Schools	11
Newark Surplus Materials	94
Newcomb Audio Products	155
New England Television Corp.	110
Niagara Radio Supply Corporation	105
Oak Ridge Products Company	168
Offenbach & Reimus Company	134
Ohmite Mfg. Company	33
Olson Radio Warehouse	86-87
Onan & Sons, D. W.	158
Peak Electronics Company	88
Pen Boiler & Burner Mfg. Corp.	99
Pfanstiel Chemical Company	124
Photocon Sales	150
Pickering and Company, Inc.	165
Platt Electronics	108
Poly-Tech Company	112
Precise Development Company	132
Premier Radio Tube Co.	117
Prentice-Hall, Inc.	163
Progressive Electronics Company	133
Pyramid Electric Company	28, 34
RCA Institutes, Inc.	93, 147
Radcom Engineering Co.	139
Radio Apparatus Corp.	150
Radio Corporation of America	73, Second Cover
Radio Craftsmen, Inc., The	94
Radio and Television News	131
Radio Ham Shack, Inc.	125
Radio Parts Co.	101
Rauland Corporation	10
Raytheon Manufacturing Company	15
Relay Sales	121
Rider, Publishers Inc., John F.	111, 118
Rinehart Books, Inc.	127
Roger-Phillips Research Labs.	140
Sams & Company, Howard W.	144, 148
Simpson Electric Co.	20
Snyder Manufacturing Company	107
Sprague Products	103
Sprayberry Academy of Radio	29
Stan Burn Radio & Electronics	146
Star Electronics Distr., Inc.	104
Stev El Electronics	137
Sun Radio of Washington, D. C.	130
Superior Instrument	116
Sylvania Electric Products	7
Tab	169, 170
Tallen Company	158
Television Communications Institute	167
Television Supply Company	132
Telrex, Inc.	151
Thompson Products	12
Transvision, Inc.	95
Trio Manufacturing Co.	23
Triplet Electrical Instrument Co.	6
Tri-State College	145
Tung-Sol Electric Inc.	100
Turner Company	143
Ungar Electric Tool Company, Inc.	133
United Radio Television Labs.	162
United Technical Laboratories	128
V & H Radio & Electronics	110
Valparaiso Technical Institute	143
Waldom Electronics Inc.	150
Ward Products Corp.	14
Weathers Industries	163
Weller Electric Company	8
West Region Electronics	151
Wholesale Radio Parts, Inc.	166
World Radio Laboratories, Inc.	153

Amaze Yourself and Your Friends!

By Adding Pipe-Organ-Type Bass

to your present Amp. and Spkr. without muffling highs & middle

REVOLUTIONARY CIRCUIT INVENTION only 4-resistors & 4-condensers

No. A25 Schematic & Data \$2.00

DULL'S ELECTRICAL TRANSLATIONS
702 N. Brancroft Wilmington, Del.

EASY WAY to PRACTICE RADIO CODE



NEW amazing Telegraph Code Practice Set. Light touch of DUPLEX PRACTICODE telegraph key produces LOUD PROFESSIONAL "BEE" thru its large 4-inch Permanent Magnet Speaker. Works 6 months on only one 1 1/2-volt cell—no parts to burn out! SELF-COMPLETED WITH REAL PROFESSIONAL TELEGRAPH KEY AND BATTERY—Nothing else needed! As many as 6 sets can operate on one line! Colorful Wood Cabinet, 3 1/2 x 5 x 10 1/2" in red, green, yellow or blue pastels. One-year factory guarantee.

For full details and prices, write NOW for FREE Catalog 2-N
MARTIN MFG. CO., Dept. 2-RN, South Road Poughkeepsie, N. Y.

RADIO & TELEVISION NEWS

TRANSFORMERS

115 V 60 Cyc Input TV & CR Pwr Xfmr for 2A to 20KV (w/quadrupler ckt). ALL Tubes, PL & CSD Windings dly. \$1.00 VDC/27.5A dly.

Full-Wave, 6.4V/10.3A, 5.4/8A, 2.5V/3A
 Hypersol Core, Oil Impreg. \$1.25
 1500V FOR CRT, 3V/6A, 2.5V/1.75A CSD KENYON HVINS 4/BC412

1320V & 375VCT/110MA, 5V/3A, 5V/3A/2.5A, 6.3V/2.75A HSLD HV, 9.98
 1100VCT/200MA, 6.3VCT/4A, 5V/3A, 9.98
 1000VCT/200MA, 1.8V/5.5A, 6.3V/5A, 5V/6A, 6.98
 1000VCT/150MA, 300V BIAS, 6.3V/5A, 5V/3A, 2.6V/1.6V/1.25A HSLD HV, 9.98
 1000VCT/125MA, 500VCT/100MA, 2X5V/2A, 1.8V/1A, 6.3V/8A U.T.C., 5.98
 360VCT/55MA, 3X5V/3A, 6.3VCT/1A, 6.3VCT/3A CSD HVINS CAN BE USED 2X RATING RAYTHEON USN, 4.98
 900V/35MA, 2X2.5/2.5XCLNT 1800 VDB TWO 2X2.5 FIL WNDGS HSLD, 3.49
 900V/35MA, CRT, 3V/6A, 2.5V/1.840VCT/110MA, & 530VCT/21MA, 2.5V/3A, 6.3V/1A, 6.3V/3A CSD, 4.98
 720VCT/85MA, 5V/2A, 6.3V/1.25A, 770V/2.5MA, 2.5V/3A HVINS HMSLD, 3.69
 760VCT/120MA, 2.5VCT/10A & 6.3VCT/2A, 5V/3A, 10V/5A, 6.98
 720V/85MA, 5V/3A, 6.3V/3.5A, 2.98
 700VCT/125MA, 6.3VCT/4A, 5V/3A, 3.98
 800VCT/80MA, 6.3VCT/4A, 3.98
 700VCT/85MA, 6.3V/3A, 6.3V/7.5A, 5V/2A, 3.25
 650VCT/150MA, 5V/3A, 6.3V/2.1A, 2.5V/1.25A, 2V/1.4A HSLD, 4.49
 550VCT/275MA, 5V/4A, 6.3V/6A, 4.49
 550VCT/60MA, 6.3V/4A HSLD, 4.49
 480VCT/80MA, 6.3V/4A, 3.98
 420VCT/90MA, 6.3V/1.9A W/INPUTS 6, 12, 24, 115VDC & 115V, 5.98
 550VCT/150MADC, 5V/3A, 6.3V/3A, 3.49
 220V/50MA, 6.3V/2A, 6.3V/1A, 5V/3.5A, 1.89

I-F TRANSFORMER

456 Mc Double Slug Tuned, Shielded, 10 to 14Mc FM&TV Double Slug Tuned, Shielded, 2 for \$1; 5 for \$2

PULSE TRANSFORMERS

7.5 KV Pulse, Pri 4KV, 50-1000 ohm imp. Permallyon core, Weco. 4.98
 Pulse Blocking Osc. 30V, Video Interstage, 1:1 ratio, 32 mh wndgs, H'Sld, HVINS, GE, 5.98
 Pulse Blocking Osc. 30V, Video Interstage, 1 mh wndgs, GE, H'Sld, HVINS, 52.98
 Pulse Blocking Osc. Video Interstage, 3 wndgs, 1-1 ratio, 32 mh wndgs, H'Sld, HVINS, 1 s rise time, 52.98

FILAMENT TRANS.

2.5V/2A @ 9c, 10 for \$1.49, 10 for \$6.98
 2.5VCT/10A, 10KVINS, 4.98
 2.5VCT/20A/12KV INSUL. G.D. HSLD, 7.98
 5VCT/10A/12KV INSUL. G.D. HSLD, 7.98
 5VCT/10A/12KV INSUL. G.D., 6.98
 5V/60A HVINS KENYON, 13.98
 6.3V/15A, CSD HVINS KENYON, 13.98
 6.3VCT/6A/1KV INS. CSD HVINS, 1.98
 6.3VCT/7A VARY HSLD HVINS, 1.98
 6.3VCT/1A HVINS CSD, 1.98
 6.3V/2A @ 1.39, 2 for 2.69
 6.3VCT/4A USN USABLE 6.5A HVINS, 2.69
 7.5VCT/12A CSD HVINS, 1.98
 12.6VCT/1.25A CSD HMSLD, 1.98
 24V/2A CSD @ \$1.98, 2 for 3.49
 42V/2A CSD @ \$1.98, 2 for 3.49
 42.5V/2A SEL RECT TRANS., 5.98
 2X5V/10A GE 1.25 KVINS, 10.98
 2X5V/10A, 2X5V/10A HSLD, 8.49
 2X2.5VCT/6A, 2.5VCT/1A/12KVINS, 8.49
 6.4V/12A, 6.4V/10.6A, 8X5V/3A, 5.98
 2X6.3V/3A, 5V/6A, 5V/3A, 7V/14A, 147 KVA, 55.98; Two/4 11.49

PLATE TRANS.

2X350VCT/25MA or 60AVCT CSD, 5.98
 750VCT/650MA 500V, 11.98
 1100VCT/2120V PRI 1.5 or 230V CSD Collins Trans, 6.50
 300V/10MA CSD WE D161913, 6.98
 550VCT/60MA 210V H'SLD, 69.98
 1500V AS VDBLR WE, SIG, 19.98
 3H5629/750V/35MA, 12.98
 550V/3.2KVA, 12.98

STEP UP OR STEP DOWN

110V to 220V or 440V 185 Watt, 4.98
 110V to 220V/200 Watt \$5.98; 2 for 10.98
 Isolation 1150V/185Watts, 3.98
 90, 95, 100, 115, 120, 19.98
 220V 2KW, 19.98
 220V to 440V/250W Amer Trans, 5.98

MODULATION AND AUDIO XFMRs

MODUL/240 Watts Peak Pwr Par 807's to PR70's RF/2000 ohm Load STANGOR, 15.98
 LSN HSLD, 1.98
 UNIV OUTPUT/12 Watts Any Tube Any Voice Coil UTAH 5099, \$1.29; 2 for 2.98
 Line Auto Forming 210V U.T.C. 1.5, 5.98
 Mike or Line to Grid "ouncer" UTC 0.14
 50-1200 ohms to 1/2 meg \$15 List, \$1.98
 OUTPUT/300V HT PWR 5 to 8 ohm C.N. Weco H'Sld HVINS, 52.98

400 Cyc/115V Inpt Xfmr's

G-E 3140, 3030, 2920, 2810V/35MA, \$4.98
 Weco 123Vct/350MA, 1140Vct/70MA, 6.98
 G-E 785V/200MA, 210V/135V, 5V/2A, 4.98
 G-E 6.3V/3A, 6.7V/9A, 6.3V/2A, 3.98
 Weco 6.3V/4.63A, 6.3V/3A, 3.49
 Weco 6.3V/1.25A, 6.3V/1.25A, 1.98
 Weco 6.3V/3A, 5V/2A, 2.49
 Weco 6.3V/1A \$1.95; 6.3V/1.6A, 1.49
 FREED 5V/10A \$4.98; Weco 4A, 9.98
 FREED 2.5VCT/10A csd, 4.95
 Mfgs. tell us your needs. Give Mfgs. & Sig Corp. Stock Numbers.

CHOKES

DUAL 30HY/60MA CSD, \$0.98
 1HY/40MA W/9 CSD 2 for .98
 15HY/40MA AC/DC SETS, 2.98
 12HY/80MA CSD, 3 FOR, 2.98
 10HY 85MA @ 98c; 2 FOR, 1.79
 5HY 100MA HMSLD, 1.39
 DUAL 12HY/150V/100MA/160 OHMS CSD/H'SLD/2KVINS USN, 1.49
 10HY/100MA CSD-U.T.C HSLD, 1.69
 19HY/100MA CSD, 1.98
 DUAL 5HY/120MA/200VTEST, 2.89
 50HY/125MA CSD/HSLD, 2.89
 DUAL 12HY/150V/100MA/160 OHMS CSD, 1.49
 8HY/200MA U.T.C CRK/BKPL, 2.25
 12HY/300MA CSD/3KVINS HSLD, 3.25
 12HY/200MA CSD, 3.25
 DUAL 22HY/300MA, 3.98
 8HY/2HY/THORDASON, 3.98
 DUAL 2HY/300MA HMSLD USN, 2 for 1.98
 20HY/300MA, or 15HY/400MA/12 KVINS, 8.95
 3 HY 400 MA 15 KVINS HMSLD, 1.33
 10HY/135MA, 1.33

MERCURY THERMO REGULATOR

DUAL CRT 325V Extremely sensitive & accurate for most exacting requirements—Research, Fire, Prew. Freeze, etc. Control, Control, Control, Control, Brand New, Individ. Boxed w/data & ext. SPECIAL, Ea. 98c; 12 for \$10.00

HIGH CURRENT MICA CNDRS.

CYLINDRICAL SIMILAR TYPE C

Mfd.	KV	Amps	Mc	Each
.09	1.5	35	1	\$14.98
2X-003	1.5	7	3	2.98
.01	1.5	7	1	49.50
.0005	1.5	7	1	49.50
.001	1.5	7	1	45.00
.0025	1.5	7	1	48.00
.005	1.5	7	1	28.98

TELL US WHAT YOU NEED

LINE FILTERS

10Amp/130vacdc 0.1 to 1000 Mc's, \$1.98
 10Amp/250vacdc 1 to 1000 Mc's, 3.98
 50Amp/60vacdc/250vac, "Elim" 0's, 2.98
 100Amp/usable 110 vacdc GE, 2 for \$1.98

"TAB"

THAT'S A BUY

INSULATORS

Type A, B, C, D are glazed. Length of others as stated. Height in inches, then base diam. or width if square. Ball-end type (not shown) is screw mid. STANDOFF & PILLAR TYPES all tapped both ends (Type E has mtg. flange & 2-clamp screw taps). Type S has 4 thd. holes on 5/8" rad. ca. end. Type F is ridged hi-voltage hollow type. LEAD-IN & THRU PANEL TYPES—size of 2-section types is top section only. Type D is single cup with metal mtg. flange & hardware. Type P is ridged single cup with 3-hole mtg. SPACER, BUSHING & COUPLER TYPES have shoulders. Type G is coax "fish-spine" bead type. Type Q ("Receiver") is 4-hole mid. 1/4" I.D. Type E has 2 thd. holes on each of 4 wings.

Type	Size	Each	Typel	Size	Each
Stand-Off	Pillar	N	4 3/4 x 7/8	35¢	
E	3x1	89c	N	6 1/2 x 1	45¢
F	18 1/2 x 2 1/2	2.98	S	1 1/4 x 1/4	12¢
F	19 1/2 x 2 1/2	3.49	Strain Types		
F	20 1/2 x 3	3.98	A	3 1/4 x 7/8	10¢
K	1x1	12¢	Ball End	3x1 1/4	10¢
M	1x 1/2	9¢	Lead-In, Thru Panel		
M	1 1/4 x 3/4	12¢	C	2 1/2 x 1 1/2	12¢
N	1 1/2 x 3/4	4¢	D	1 1/2 x 2 1/2	49¢
N	1 3/4 x 3/4	4¢	L	1 1/4 x 1 1/2 hole	7¢
N	1 3/4 x 3/4	5¢	L	1 1/4 x 1 1/2 hole	7¢
N	1 3/4 x 3/4	5¢	L	1 1/4 x 1 1/2 hole	7¢
N	1 3/4 x 3/4	9¢	T	1 1/4 x 3/4 hole	20¢
N	1 3/4 x 3/4	9¢	U	1 1/4 x 3/4 hole	20¢
N	1 3/4 x 3/4	10¢	V	1 1/4 x 3/4 hole	20¢
N	1 3/4 x 3/4	11¢	W	1 1/4 x 1 1/2	25¢
N	1 3/4 x 3/4	12¢	X	1 1/2 x 2 1/2	49¢
N	1 1/2 x 1 1/4	15¢	Spacers, Coupling		
N	2 1/2 x 1	18¢	H	1 1/4 x 3/4	4¢
N	2 1/2 x 1	23¢	I	3/8 x 3/4	4¢
N	2x1	25¢	J	3/8 x 3/4	4¢
N	3x3	25¢	Q	1/2 x 3/4	10¢
N	4x4	25¢	Q	1/2 x 3/4	10¢
N	4x1 1/4	35¢	R	1 1/2 x 2 1/2	10¢

OIL CAPACITORS

Mfd	Each	Mfd	Each
25wvdc	2	1.6¢	330vac
50 wvdc	10	3.98	1250
4 150wvdc	15	4.98	1250
1-1.3-5	.69	.25	1.29
2x 150wvdc	.25	1.39	165
1.2	300wvdc	.5	1.59
1	400wvdc	.75	1.69
.1	.49	3.29	.0015
.5	.59	3.49	.98
1	.59	3.49	wvdc
1	.05	.79	.00025
1	1.29	2000wvdc	9.49
6	2.49	2x1	1.75
8	2.49	2x1	1.98
10	2.49	2x1.5	2.49
2x1	.94	3	3.98
2x1.5	.94	3	4.49
3x1.25	.99	4	4.49
600wvdc	9.49	2500wvdc	2.29
.034	.64	3000wvdc	2.29
.25	.71	4000wvdc	2.98
.5	.79	5000wvdc	2.98
1	.99	6000wvdc	3.49
2	1.29	7000wvdc	3.49
3	1.49	8000wvdc	3.49
4	1.69	9000wvdc	3.49
5	1.89	10000wvdc	3.49
6	2.09	11000wvdc	3.49
7	2.29	12000wvdc	3.49
8	2.49	13000wvdc	3.49
9	2.69	14000wvdc	3.49
10	2.89	15000wvdc	3.49
11	3.09	16000wvdc	3.49
12	3.29	17000wvdc	3.49
13	3.49	18000wvdc	3.49
14	3.69	19000wvdc	3.49
15	3.89	20000wvdc	3.49
16	4.09	21000wvdc	3.49
17	4.29	22000wvdc	3.49
18	4.49	23000wvdc	3.49
19	4.69	24000wvdc	3.49
20	4.89	25000wvdc	3.49

ELECTROLYTIC CNDRS SPECIALS!

50 mf/350vacd FP,3 for 98c
 30-15-10mf/250vacd3 for 98c
 40-20mf/250-25vacd4 for 98c
 30-2x20mf/450-25vacd FP,2 for 98c
 10-2X20mf/450-25vacd FP,3 for 98c
 4mf/450vacd "Tynee-Dry",2 for 98c
 6000mf/15vac SPECIAL, \$1.98

ATTENUATORS—TOP MFGS.

DUAL 5000 ohm 20 step Bridged, \$4.98
 7470 & 1063 ohm 12 step W. W., 3.98
 DUAL 25000 ohm 20 step, 3.98
 DUAL 1300 ohm 20 step, 3.98
 100,000 ohm 20 step 3DB/Step, 4.98

SWITCHES AND MICROSWITCHES

SPNC/10A/WZ-RQ11 Plunger, \$0.69
 SPNC/10A/YZ-TK/Pln Plunger, 3
 DUAL 1300 ohm 20 step, 3.98
 SPNC/30A/B-1/Hi-Alt/Cased, 1.25
 6 AMP/125V Removed from Equip. Bklt. CSD CLEAN SPST, 4/51; DPST, 5/51

PRECISION RESISTORS

Over 2 1/2 Million in Stock

"TAB"—Specialists in Precision Resistors

No Mfrs. Choice—We Ship Types in Stock

0.116	271	1225	2332	6500	11000
0.42	472	1372	2512	6800	11500
0.625	280	1240	3500	7000	11666
0.607	286	1330	3508	7200	11833
1.03	299	1355	3700	7400	12000
1.3	300	1400	3730	7600	12167
1.5	314	1445	3900	7800	12333
1.5	315	1445	3900	8000	12500
1.83	320	1500	4090	8200	12667
2.0	330	1515	4200	8400	12833
4.35	340	1600	4220	8600	13000
4.4	325	1645	4280	8800	13167
5.025	360	1645	4300	9000	13333
6.25	366.6	1650	4440	9200	13500
7.5	370	1670	4440	9400	13667
7.8	390	1710	4500	9600	13833
8.5	390	1710	4500	9800	14000
9.3	390	1740	4720	23000	18600
10.38	400	1770	4750	23200	18800
11.25	414.3	1818	4885	23325	19000
13.52	418.8	1830	4900	23400	19200
14.2	425	1845	5000	24000	20100
14.25	426.9	1865	5100	24200	20500
14.5	427	1892	5210	24400	20900
14.7	432	1925	5300	24600	21300
16	440	1895	5270	25000	22000
17	450	1895	5300	26000	22800
17.5	450	1925	5400	26200	23000
19.2	460	1895	5600	26500	23500
20	470	1895	5730	27000	24000
21.4	475	1910	5910	27500	24500
23	478	1910	5910	28000	25000
24	480	1925	6000	28500	25500
26	500	1904	6125	28800	25800
28	520	1905	6300	29000	26000
31.5	525	1905	6300	29500	26500
37	540	1910	6400	30000	27000
44	560	1910	6400	31000	27500
49	560	1910	6400	31500	27800
51.78	560	1912	6990	32000	28000
55	588	1913	7000	35000	31600
60					

EICO

TEST INSTRUMENTS

guards

Majestic
HIGH STANDARDS OF
TELEVISION PRODUCTION QUALITY

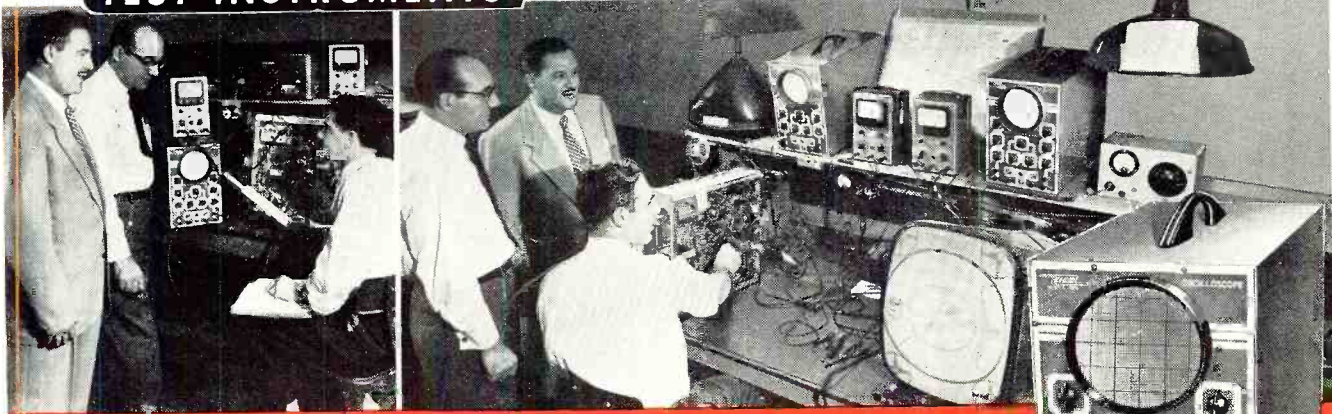

In the Majestic design laboratories, Frank J. Dieli and assistant, Paul Smith, discuss with Harry R. Ashley, some important prototype-circuit measurements just taken with the 425 Oscilloscope, #221 VTVM and #HVP-1 HV Probe.

Frank J. Dieli, Majestic's Chief Engineer, and Harry R. Ashley, President of EICO, inspecting the use of the EICO Model 425 5" Push-Pull Oscilloscope, Model 221 Vacuum Tube Voltmeter and Model HVP-1 High Voltage Probe at the important Final Test Position on the Majestic Television production lines.

KITS - Wired Instruments

For Laboratory Precision at Lowest Cost -
the Leaders Look to **EICO!**

WHY does The Majestic TV Division of The Wilcox-Gay Corp., another one of America's leading TV manufacturers, specify EICO Test Instruments on both its production lines and in its design laboratories?

BECAUSE -like Emerson, Tele-King, Tele-Tone, CBS-Columbia, and many another famous TV manufacturer coast to coast, Majestic knows that

- ONLY **EICO** TEST EQUIPMENT DELIVERS ALL 10 **EICONOMICAL** FEATURES
1. Laboratory Precision
 2. Lowest Cost
 3. Lifetime Dependability
 4. Speedy Operation
 5. Rugged Construction
 6. Quality Components
 7. Latest Engineering
 8. Super-Simplified Assembly and Use Instructions
 9. Laboratory-Styled Appearance
 10. Exclusive EICO Make-Good Guarantee

Before You buy any higher-priced equipment, be sure You look at the **EICO** line - in **Wired** as well as **Kit** form! Each **EICO** product is jam-packed with unbelievable value. **YOU** be the judge - compare, see **EICO** instruments today - in stock at your local jobber - and **SAVE!** Write NOW for **FREE** newest Catalog 2-R.

FOLLOW THE LEADERS... INSIST ON EICO!



NEW 555K MULTIMETER
KIT \$29.95 WIRE \$34.95
20,000 ohms/volt



NEW 950K R-C BRIDGE &
R-C-L COMP. KIT \$19.95
WIRED \$29.95



320K SIG. GEN.
KIT \$19.95 WIRE \$29.95

NEW 322K SIG. GEN.
KIT \$23.95 WIRE \$34.95



NEW 1040K BATTERY ELIM.
KIT \$25.95 WIRE \$34.95



511K VOM
KIT \$14.95
WIRED \$17.95



NEW 526K MULTI METER
KIT \$13.90 WIRE \$16.90
1000 ohms/volt

NEW 1171K
RES. DECADE BOX
KIT \$19.95 WIRE \$24.95



NEW 625K
TUBE TESTER KIT \$34.95
WIRED \$49.95

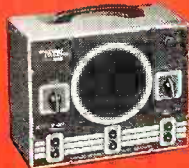

145K SIG. TRACER KIT
\$19.95
WIRED \$28.95



NEW 315K DELUXE SIG.
GEN. KIT \$39.95
WIRED \$59.95

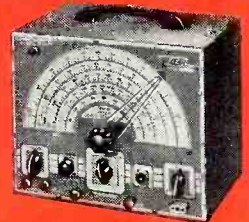

360K SWEEP GEN. KIT \$34.95
WIRED \$49.95



NEW 425K 5" PUSH-PULL
SCOPE KIT \$44.95 WIRE \$79.95

NEW 221K VTVM
KIT \$25.95 WIRE \$49.95



**HIGH VOLTAGE
PROBE** \$6.95



ELECTRONIC INSTRUMENT CO., Inc.
276 NEWPORT STREET, BROOKLYN 12, NEW YORK

©1951

Prices 5% higher on West Coast. Due to unstable conditions, prices and specifications are subject to change without notice.

Why take a chance?

Some people make their living by taking chances. But you must make your living by earning customer satisfaction—so why take chances by ordering capacitors by rating only? Order by rating *and* brand!



Make Sure! Make it Mallory!

Customer satisfaction with your service pays off in repeat business . . . word-of-mouth advertising . . . cash in the bank. You can build it by using Mallory capacitors on all your service work.



Top-notch TV and radio set makers accept Mallory FP's as *the* standard of capacitor quality. You get longer life even with higher temperatures and greater ripple current . . . dependable operation even at 185° F. (85° C.).



Mallory Plascaps* leave ordinary plastic tubulars far behind! Dependable performance . . . no leaks . . . no premature "shorts" . . . no off-center cartridges . . . and no unsoldered leads. It will pay you to use Mallory Plascaps—the first completely engineered plastic tubular!

Back of every Mallory capacitor is the knowledge and experience gained in 25 years of research and development work. Mallory produced the first dry electrolytic capacitor...pioneered in making smaller, longer-lasting capacitors with outstanding heat-resistant qualities. There's just no sense in taking chances on capacitor performance. Always be sure . . . always order Mallory capacitors for all your service work.

Depend on your Mallory Distributor for quality products at competitive prices.

P. R. MALLORY & CO. Inc.
MALLORY

CAPACITORS • CONTROLS • VIBRATORS • SWITCHES • RESISTORS
• RECTIFIERS • VIBRAPACK* POWER SUPPLIES • FILTERS

*Reg. U.S. Pat. Off.

APPROVED PRECISION PRODUCTS

P. R. MALLORY & CO., Inc., INDIANAPOLIS 6, INDIANA