

# RADIO & TELEVISION NEWS

NOVEMBER

1951

35¢

In Canada 40¢

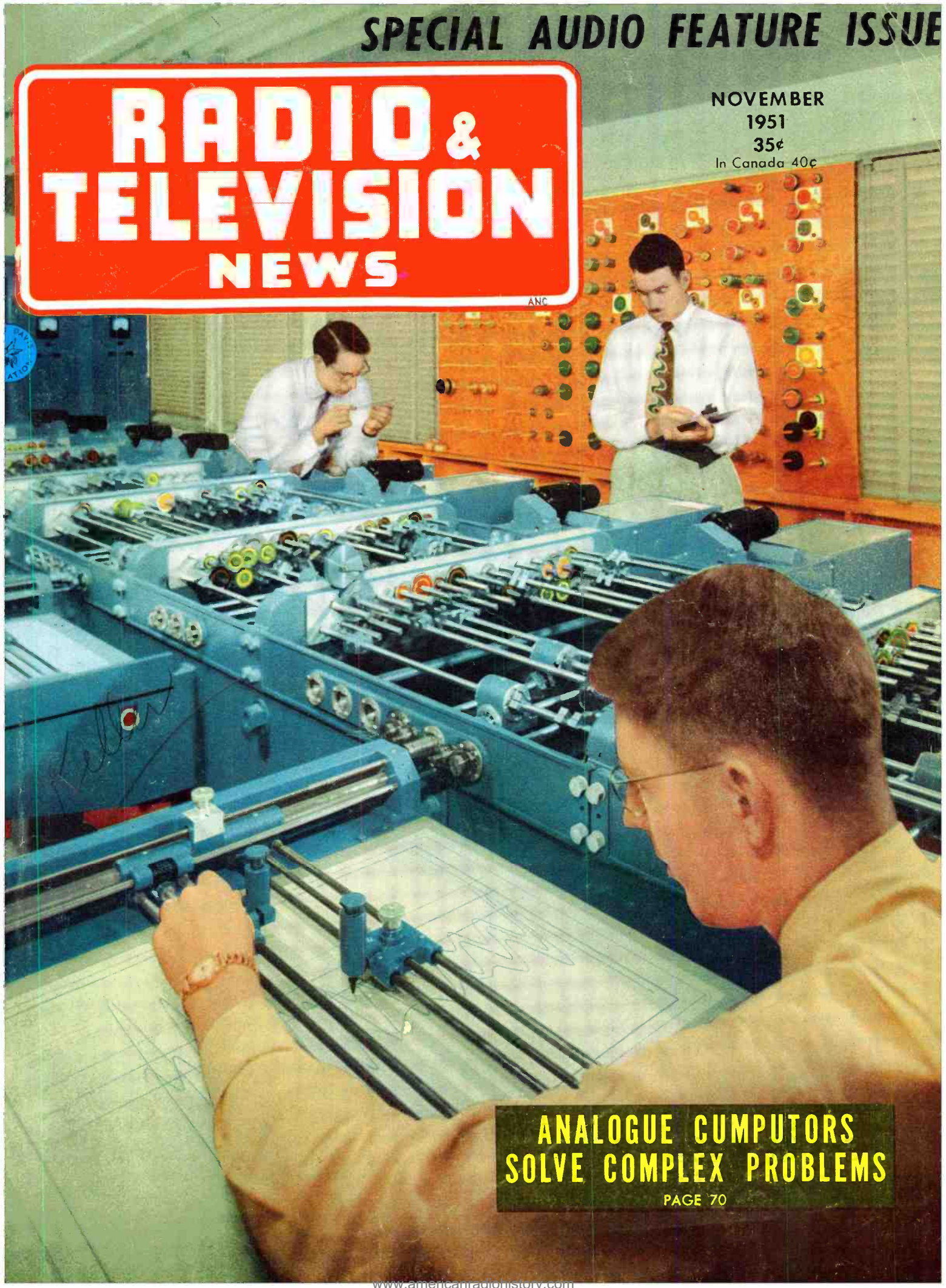

**ANALOGUE COMPUTERS  
SOLVE COMPLEX PROBLEMS**

PAGE 70



# Now Stake out your claim for the Giant RCA "TREASURE CHEST"

... to help you do a better job in less time and  
in the "professional" manner that inspires respect

You get all these valuable servicing aids for  
only **10 RCA golden "TREASURE TOKENS"**



- ✓ Handsome, sturdy Tube and Tool Carrying Case ... holds over 100 tubes to meet every normal service call.
- ✓ Big 48" Red-and-White Drop Cloth ... a magic carpet to "customer confidence."
- ✓ Handy 6-Piece Ratchet-type Screwdriver Kit ... all the sizes you need for everyday service work.
- ✓ New Improved RCA Tube Movement and Inventory Guide ... a yearly record of your business.
- ✓ New "RCA Kinescopes" Booklet ... complete conversion, interchangeability and characteristics data.
- ✓ 5 Leatherette TV Program Holders ... ideal souvenir gifts for your service calls.
- ✓ Plus an extra dividend of the 24-page bulletin "Receiving Tubes for AM, FM, and Television Broadcast"—Form 1275-E—together with latest tube price lists.

## Here's all you do

With every purchase of an RCA kinescope, of any type, you will receive a golden RCA "Treasure Token." *Save these coins* on the key chain provided. When you have collected 10 coins, present them to the RCA Tube Distributor from whom you obtained them, and receive, *without cost*, the complete RCA "Treasure Chest" of outstanding service aids.

The RCA "Treasure Chest" is *not for sale*. You can earn it *only* by presenting 10 RCA "Treasure Tokens" to your regular RCA Tube Distributor.

Start prospecting for your golden coins *right now!* This offer expires on November 16, 1951. Your RCA Tube Distributor has a sample RCA "Treasure Chest" for your inspection. See him today!

### Extra Bonus!

With every 2 RCA kinescopes you buy, you will receive, along with your "Treasure Tokens," a bonus copy of a new book, "TV Servicing" ... a compilation of the famous "Radio Service News" articles, together with brand-new material by RCA Television Specialists.



**RADIO CORPORATION of AMERICA**  
ELECTRON TUBES  
HARRISON, N. J.





# VARIABLE RELUCTANCE CARTRIDGE

**"OUTSELLS ALL OTHER  
MAKES COMBINED!"**

**Reports ARNOLD DEUTSCHMANN**  
Vice President, RADIO SHACK Corporation  
Boston, Mass.

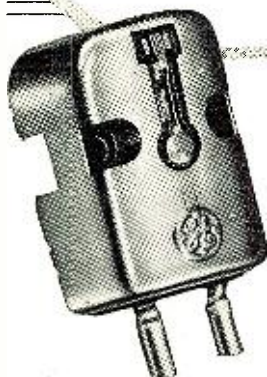

**M**ORE customers ask us for G-E than for all other cartridge brands combined. In our business that's an important tip-off because people who come to us usually know exactly what they want in audio performance. They demand that we stock the best. We handle every commercial cartridge—and G-E Variable Reluctance units outsell them all by at least 4 to 1!

Famous the world over as a "quality" store for audio accessories, Radio Shack on Boston's Washington Street is typical of finer dealers everywhere in its

support of General Electric parts and components.

Every stylus in every G-E cartridge is double-damped to absorb virtually all mechanical noise. Diamond or synthetic sapphire tips are available for standard or microgroove records.

**A Sales Point to Remember**—Replace with a G-E stylus and you get the equivalent of a whole new pickup! Here's why:—General Electric's single-package stylus assembly contains stylus, cantilever, and damping blocks—the only parts of your pickup that are affected by time and use. No other cartridge gives you this advantage.



**SPEAKER PERFORMANCE THAT SELLS**—and stays sold! Lew Kornfeld and Arnold Deutschmann, Radio Shack experts, agree that G.E.'s 27 sizes of speakers bring quality sound within the range of every taste and budget.

**SEND FOR THIS  
NEW BOOKLET!**



General Electric Company, Section 9111  
Electronics Park, Syracuse, New York

Yes—send me new booklet with complete information on General Electric diamond styli.

NAME .....  
ADDRESS .....  
CITY..... STATE.....

*You can put your confidence in—*

**GENERAL  ELECTRIC**



Editor  
**OLIVER READ, D.Sc., D.Litt.**  
 Managing Editor  
**W.M. A. STOCKLIN, B.S.**  
 Technical Editor  
**H. S. RENNE, M.S.**  
 Associate Editor  
**HAROLD BECKER**  
 Midwest Editor  
**RAY FRANK, W9JU**  
 Assistant Editor  
**P. B. HOEFER**  
 Television Consultant  
**MILTON S. KIVER**  
 Short-Wave Editor  
**KENNETH R. BOORD**  
 Staff Artist  
**R. S. KUPJACK**  
 Chief Draftsman  
**B. L. NEWMAN, W9ROB**  
 Associate Advertising Director  
**M. J. CULLIGAN**  
 Advertising Manager  
**L. L. OSTEN**  
 Midwest Adv. Manager  
**JOHN A. RONAN, JR.**  
 Western Adv. Manager  
**JOHN E. PAYNE**  
 Art Director  
**HERMAN R. BOLLIN**

# RADIO & TELEVISION NEWS

Reg. U.S. Pat. Off.

Radio News Trademark Reg. U. S. Pat. Office • Television News Trademark Reg. U.S. Pat. Office.

## CONTENTS

## NOVEMBER, 1951

Custom Audio-TV Systems.....	Irv Rose	35
A 2-Tube Portable Receiver.....	Serge L. Krauss	38
Wide Range Capacity Phonograph Pickup.....	Paul Weathers	40
A Corner Labyrinth Transducer.....	Norman C. Fulmer	42
A Combination Phonograph-Tape Recorder.....	Lloyd B. Hust	43
A Simulated Echo Chamber.....	Herbert Michels	47
An Audio Amplifier with "Presence".....	Glen Southworth	48
Selecting Your Amplifier.....	Robert Newcomb	51
The RCA Tricolor Tube.....	Walter H. Buchsbaum	52
X-rays in Industry.....	Ed Bukstein	55
Universal Design Curves for Tone Control Circuits.....	M. B. Knight	56
Audio Simplified (Part 3).....	David Fidelman	59
The "Ham-Lim".....	Ed Miller	64
Crystal Diodes in Modern Electronics (Part 2).....	David T. Armstrong	66
Mac's Radio Service Shop.....	John T. Frye	69
Analog Computers Solve Complex Problems.....	Louis L. Grandi and Don Lebell	70
Practical Sound Engineering (Part 9).....	H. M. Tremaine	72
Summary of TV Situation Round-the-World.....		90
Radio-TV Service Industry News.....		160



COVER PHOTO: Over-all view of the mechanical differential analyzer in use at the University of California at Los Angeles. This analog equipment was the first in the West Coast area. (Ektachrome by J. Dale Healy)

Chairman of the Board and Publisher  
**WILLIAM B. ZIFF**

President  
**B. G. DAVIS**

Secretary-Treasurer  
**G. E. CARNEY**

Vice-Presidents  
**MICHAEL H. FROELICH**  
 Dir. Eastern Div.

**H. J. MORGANROTH**  
 Production Director

**LYNN PHILLIPS, Jr.**  
 Advertising Director

**H. G. STRONG**  
 Circulation Director

**LOUIS ZARA**  
 Associate Editorial Director

### BRANCH OFFICES

CHICAGO (11)  
 185 N. Wabash, AN 3-3220

LOS ANGELES (14)  
 875 S. Hill St., TR 6-9213

### DEPARTMENTS

For the Record.....	The Editor	8	What's New in Radio.....	84
Spot Radio News.....		20	Manufacturers' Literature.....	94
Within the Industry.....		28	Technical Books.....	116
Short-Wave.....	K. R. Boord	63	New TV Products.....	148



COPYRIGHT 1951  
 ZIFF-DAVIS PUBLISHING COMPANY  
 366 Madison Ave., New York 17, N. Y.  
 VOLUME 46 • NUMBER 5



Member  
 Audit Bureau of  
 Circulations

RADIO & TELEVISION NEWS is published monthly by the Ziff-Davis Publishing Company at 366 Madison Ave., New York 17, N. Y. Copyright under International copyright convention. All rights reserved. Entered as second-class matter July 21, 1948, at the Post Office, Chicago, Ill., under the act of March 3, 1879. Entered as second-class matter at the Post Office Department, Ottawa, Canada. Postmaster—Please return undeliverable copies under Form 3539 to 135 N. Wabash Ave., Chicago 1, Ill. SUBSCRIPTION RATES: in U. S., Canada, Mexico, South and Central America and U. S. Possessions, Chicago 1, Ill. \$4.00 for twelve issues; in British Empire, \$5.00; all other foreign countries, \$5.00 for twelve issues. U. S. Possessions, \$6.00 for twelve issues; in British Empire, \$7.00; all other foreign countries, \$7.00 for twelve issues. Subscribers should allow at least two weeks for change of address. All communications about subscriptions should be addressed to the Director of Circulation, 185 N. Wabash Ave., Chicago 1, Ill. CONTRIBUTIONS: Contributors are advised to retain a copy of their manuscripts and illustrations. Contributions must be accompanied by return postage and they will be handled with reasonable care, but this magazine assumes no responsibility for their safety. Any copy accepted is subject to whatever adaptations and revisions are necessary to meet the requirements of this publication. Payment covers all author's, contributor's and contestant's rights, title, and interest in and to the material accepted and will be made at our current rates upon acceptance. All photos and drawings will be considered as part of the material purchased.

RADIO & TELEVISION NEWS



**NOW... GET EVERYTHING YOU  
NEED TO LEARN AND MASTER**

# TELEVISION

## RADIO-ELECTRONICS .AT HOME!

Use **REAL** commercial-type equipment to get practical experience

Your future deserves and needs every advantage you can give it! That's why you owe it to yourself to find out about one of the most **COMPLETE**, practical and effective ways now available to prepare **AT HOME** for America's billion dollar opportunity field of **TELEVISION-RADIO-ELECTRONICS**. See how you may get and keep the same type of basic training equipment used in one of the nation's finest training laboratories... how you may get real **STARTING HELP** toward a good job or your own business in Television-Radio-Electronics. Mail the coupon today for complete facts — including 89 ways to earn money in this thrilling, newer field.

**D.T.I., ALONE, INCLUDES BOTH MOVIES and HOME LABORATORY** In addition to easy-to-read lessons, you get the use of **HOME MOVIES** — an outstanding training advantage — plus 16 big shipments of Electronic parts. Perform over 300 fascinating experiments for

practical experience. Build and keep real commercial-type test equipment shown at right

**Get BOTH of these information packed publications FREE!**

**MODERN LABORATORIES**

If you prefer, get all your preparation in our new Chicago Training Laboratories—one of the finest of its kind. Ample instructors, modern equipment. Write for details!

**MILITARY SERVICE!**

If you're subject to military service, the information we have for you should prove very helpful. Mail coupon today.

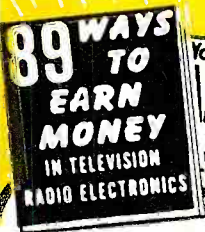

**ACT NOW! MAIL COUPON TODAY!**

DE FOREST'S TRAINING, INC., Dept. RN-11-H  
2533 N. Ashland Ave., Chicago 14, Ill.

Without obligation, I would like your Opportunity News Bulletin showing "89 Ways to Earn Money in Television-Radio-Electronics"; also, the folder showing how I may prepare to get started in this thrilling field.

Name.....Age.....  
Address.....Apt.....  
City.....Zone.....State.....



ABOVE: Build and keep a real 16 INCH commercial TV receiver. Optional after completing regular training at moderate added cost.

**Here's the REAL THING!**

**SET UP YOUR OWN HOME LABORATORY**

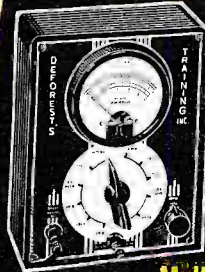

Multimeter



Oscilloscope

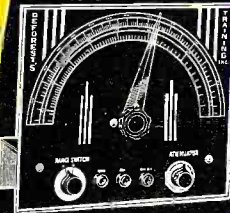

R-F Signal Generator

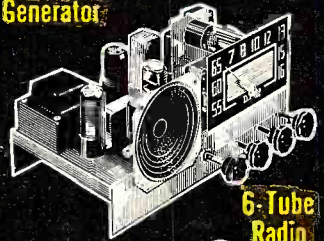

6-Tube Radio

**HOME MOVIES**

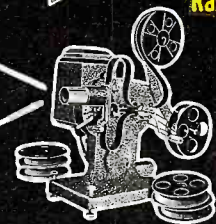

**De FOREST'S TRAINING, INC.**  
CHICAGO 14, ILLINOIS  
A De VRY INSTITUTION



For accurate  
flexible and  
quick tube  
testing at  
low cost...  
model 3413-A

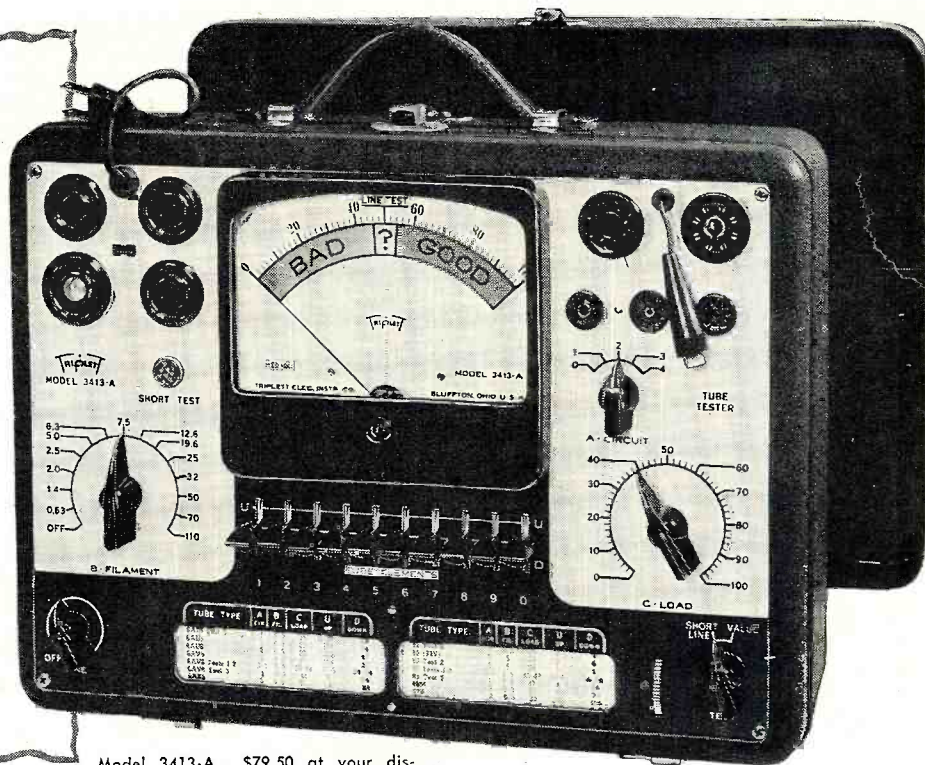

Model 3413-A...\$79.50 at your distributor. (Price subject to change.) BV Adapter, \$7.90 Add'l.

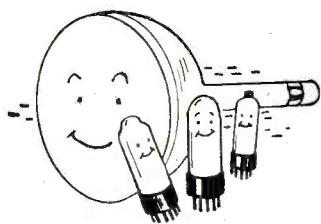

1. YOU CAN TEST MORE TYPES of tubes, also appliances for shorts and open circuits.

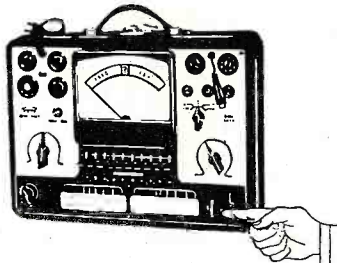

2. JUST SPIN THE KNOB—for correct, last-minute data, on the speed roll chart. Lists 700 tubes.

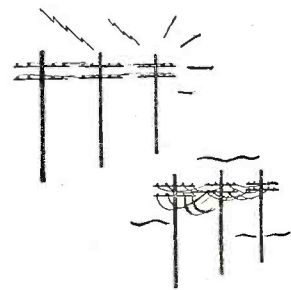

3. YOU CAN COMPENSATE for line voltage—just throw snap-action switch.

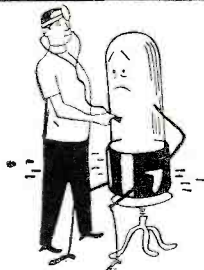

4. YOU CAN TEST EACH ELEMENT in each tube—by a simple flip of the switch.



5. YOU CAN TEST THE NEW TUBES—including those with low cathode current.



6. YOU GET NEW TUBE DATA—immediately, while it is still news. No waiting.

*Nearly Half a Century of Service to the Service Man*

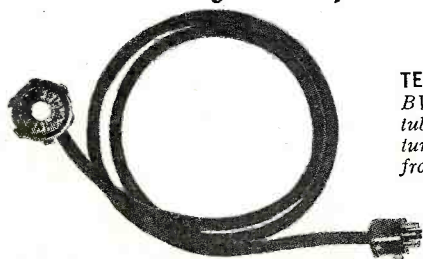

TESTS PICTURE TUBES, TOO! With this BV Adapter, Model 3413-A tests every tube in a TV receiver, including the Picture Tube—without even removing tube from receiver or carton! Saves time!

FOR THE MAN WHO TAKES PRIDE IN HIS WORK

**Triplet**

TRIPLET ELECTRICAL INSTRUMENT CO. BLUFFTON, OHIO U.S.A.

RADIO & TELEVISION NEWS



THOUSANDS OF RADIO & TV SERVICE DEALERS  
ARE ON THE

*Right side  
of the Fence!*

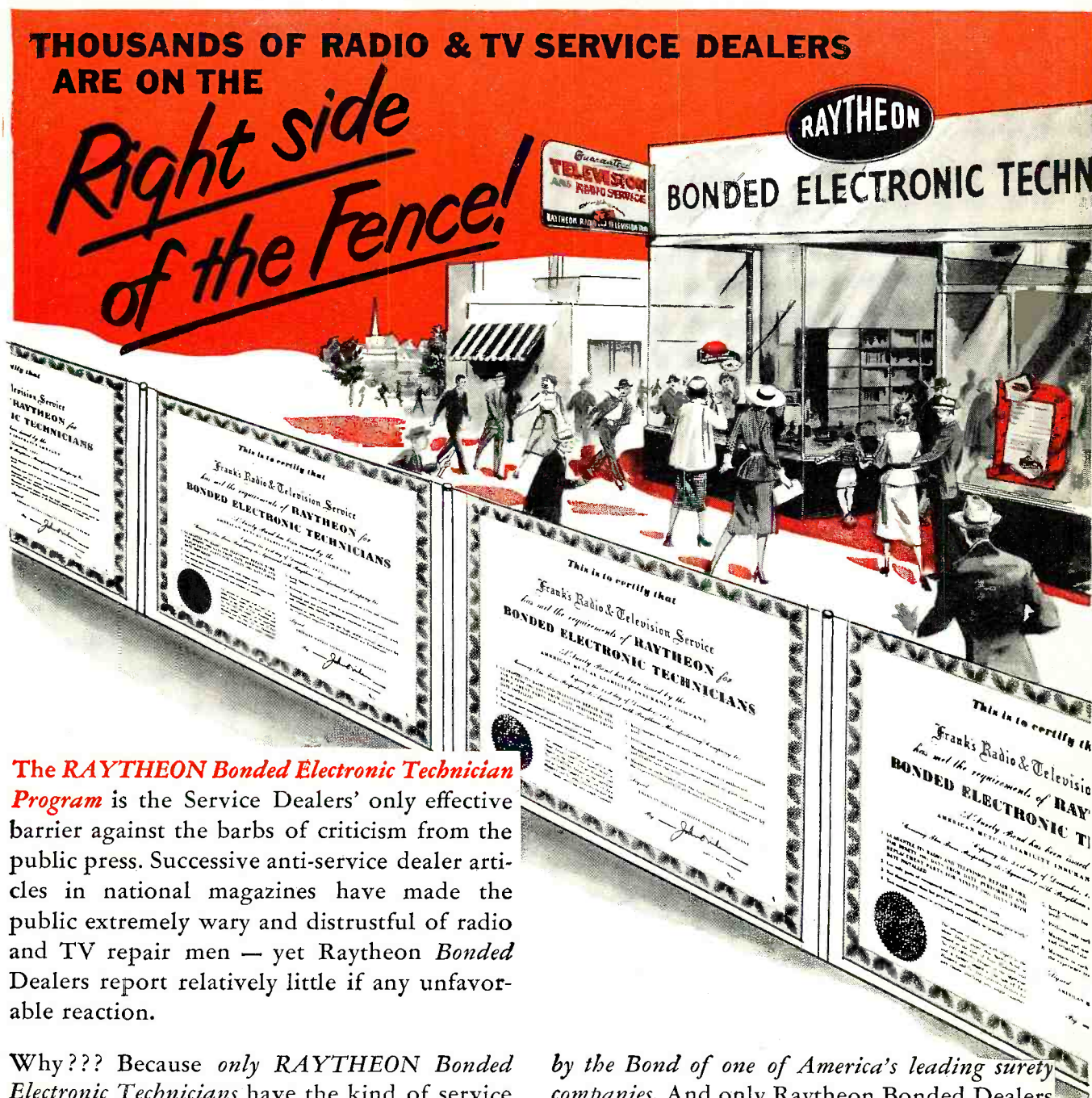

The **RAYTHEON Bonded Electronic Technician Program** is the Service Dealers' only effective barrier against the barbs of criticism from the public press. Successive anti-service dealer articles in national magazines have made the public extremely wary and distrustful of radio and TV repair men — yet Raytheon *Bonded* Dealers report relatively little if any unfavorable reaction.

Why??? Because *only RAYTHEON Bonded Electronic Technicians* have the kind of service in which the customer can have complete confidence — *cash-protected, guaranteed service backed*

*by the Bond of one of America's leading surety companies.* And only Raytheon Bonded Dealers operate to a "Raytheon Code of Ethics" which completely satisfies their customers and protects themselves.



*This tremendous business asset—The Raytheon Bond—costs service dealers nothing if they can qualify for it. Better ask your Raytheon Tube Distributor if you can join the ever increasing number of Service Dealers who are reaping the benefits of this priceless Bond.*

RIGHT...FOR SOUND AND SIGHT®



**RAYTHEON MANUFACTURING COMPANY**

Receiving Tube Division

Newton, Mass., Chicago, Ill., Atlanta, Ga., Los Angeles, Calif.

RADIO AND TELEVISION RECEIVING TUBES, CATHODE RAY TUBES, SPECIAL PURPOSE TUBES, SUBMINIATURE TUBES, MICROWAVE TUBES

*Excellence in Electronics*



**NO SHADOWS**

with new

**DUAL SPOTLIGHT  
Soldering Gun**

Pull the trigger of your new light-duty Weller Soldering Gun, and instantly twin spotlights focus on the job—banish every shadow. Five seconds later the tip is at soldering heat! No waiting. No wasted current. This streamlined 135-watter—newest of the famous Weller line—is fast!

Built compactly for working in crowded chassis, too. And the time and power you save pays for your Weller Gun in a few months.

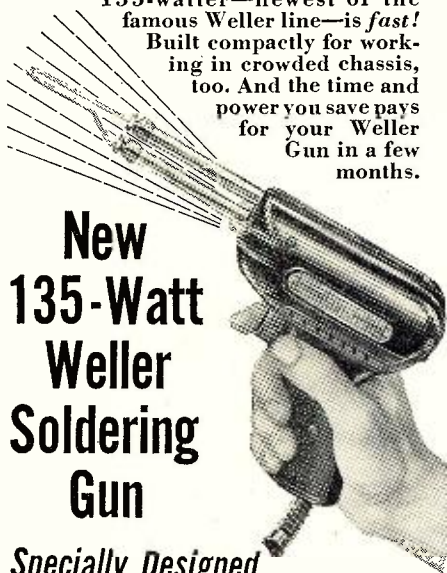

**New  
135-Watt  
Weller  
Soldering  
Gun**

*Specially Designed  
for TV and Radio Work*

- **DUAL SOLDERLITE**—Two prefocused spotlights completely eliminate shadows.
- **OVER/UNDER DESIGN**—Tube construction braces tip and improves visibility.
- **5-SECOND HEATING**—Pull the trigger and you solder!
- **LONGER REACH**—Slides easily into deep chassis; reaches the tightest corners.
- **GREATER CAPACITY**—Smaller, lighter, with greater soldering capacity.
- **TRIGGER-SWITCH CONTROL**—Adjusts heat to the job. No need to unplug gun between jobs.
- **DUAL HEAT**—Single heat 100 watts; dual heat 100/135 watts; 120 volts; 60 cycles. Handles all light-duty soldering.

See new Models WS-100 and WD-135 at your distributor, or write for bulletin direct.

• **SOLDERING GUIDE**—Get your new copy of "Soldering Tips"—revised, up-to-date, fully illustrated 20-page booklet of practical soldering suggestions. Price 10¢ at your distributor, or order direct.

**WELLER**  
ELECTRIC CORP.

810 Packer Street, Easton, Pa.

8

*For the* **RECORD.**

BY THE EDITOR

**ON THE PSYCHOLOGY OF SOUND**

**T**HAT which we choose to call "electronics" embraces many subjects in the field of radio, television, and audio. Broken down into various categories, the list becomes longer with each passing month. New terms like "super-sonics" suddenly appear in everyday conversations, and we absorb them as matter-of-fact in such an expanding field. We wonder sometimes if there is any real practical limit to the applications for electronics.

If the present pace is maintained or increased because of electronic military requirements, we can expect fantastic developments to take shape in the near future. It was only a few years ago that television, FM, and radar emerged from their infancy and developed into an important part of our ever-expanding industry. And it was well after D-Day that engineers and the public became "audio-conscious" to the extent of recognizing the term "audio" as a separate topic, and to divide the radio receiver into two components instead of one—the tuner and the audio amplifier.

Educating the public towards more realistic sound systems for the home became a real challenge to the engineer, manufacturer, salesman, and audio technician. That much has been accomplished is now generally conceded. However, millions of people that can both enjoy and afford to have quality reproducing equipment, have never heard an honest-to-goodness comparison between "quality and quantity" either at home or in the sound department of a dealer.

We use the term "quantity" intentionally, after experiencing the shattering effects to the ears and nerves of routine audio demonstrations at various conventions and in demonstration rooms of a few jobbers of audio gear. We doubt if many of them appreciate the "psychology of sound" as it applies to the human ear. Many of these characters seem to delight in their ability to pump so much audio into a speaker that even outside traffic noise, police sirens, etc., can't even approach the apparent efficiency of their products.

Webster defines sound as follows: "Sensation due to stimulation of the auditory nerves and auditory centers of the brain, usually by vibrations transmitted in a material medium (commonly air) affecting the organ of hearing-vibration energy which occasions such a sensation. Sound is propagated by progressive longitudinal vibratory disturbances (sound waves)."

Thus, it becomes apparent that the source of sound lies in the realm of

physics, while the effect of sound is a physiological consideration. The engineering of sound consists of controlling the cause so as to produce the desired effect.

Now, what is this "desired effect"? Is it to torture the prospect? Sometimes it appears to be. Or is it intended to provide relaxation and enjoyment to the prospective listener or purchaser?

It is ridiculous to assume that the prospect wants a reproduction facsimile of the *Cities Service Band* as it would be heard if he or she were sitting at the point of microphone pick-up. It is more intelligent to assume that the listener, if he were purchasing a ticket in an auditorium for a band concert, would choose one at least half-way back from the stage of the original sound source, or at a point where his hearing would distinguish all of the instruments at a comfortable audio level.

If those engaged in audio demonstrations would use a bit of common sense, they would soon learn to make every effort to please their prospective customers—not to antagonize them or irritate them with excessive volume levels, in many cases approaching the threshold of pain.

It is one of the routine tests of manufacturers of loudspeakers to purposely overload their reproducers in order to determine at what particular level the speaker cone will disintegrate. But this test should not be attempted (and it often is) when demonstrating the reproducing features of a music system.

We hear a lot these days about intermodulation distortion—or should we say lack of—in reproducing systems, and yet when it comes to demonstration, many step up the audio output to the point where considerable mechanical distortion is produced which, in turn, creates the illusion that there is, within the equipment, a high percentage of other types of distortion, such as harmonic or intermodulation. Generally speaking, a sound is said to be distorted when the waveform is altered in transmission or the intensity of any frequency is suppressed or exaggerated out of its natural proportions.

It is suggested, accordingly, that a real attempt be made by the demonstrator to consider that the source of sound lies in the realm of physics, and while the effect of sound is a physiological consideration, to repeat: "the engineering of sound consists of controlling the cause so as to produce the desired effect." . . . . . O.R.

**RADIO & TELEVISION NEWS**



the only complete catalog  
for everything in Radio,  
TV & Industrial Electronics

your 1952 **free!**  
**ALLIED** 212-page  
value-packed catalog



**Send for it today!**

Here's the *one* authoritative, complete, up-to-date Buying Guide to TV, Radio and Industrial Electronics. Make your selections from the world's largest stocks of quality equipment at lowest, money-saving prices. See the latest and most complete presentation of electronic apparatus: new TV, AM and FM receivers; High-Fidelity Custom Sound components; latest P.A. Systems and accessories; recorders; fullest selections of Amateur receivers and station gear; specialized industrial electronic equipment; test instruments; builders' kits; huge listings of parts, tubes, tools, books—the world's *most complete stocks* of quality equipment.

ALLIED gives you *every* buying advantage: speedy delivery, expert personal help, lowest prices, liberal time payment terms, assured satisfaction. Get the latest 1952 ALLIED Catalog. Keep it handy—and save time and money. Send for your FREE copy today!

the world's  
largest stocks

- Radio Parts Unlimited
- Test Instruments
- Television & Home Radios
- P.A. and Hi-Fi Equipment
- Amateur Station Gear
- Builders' Supplies
- Equipment for Industry

quick, expert service



**ALLIED IS YOUR TV and HI-FI HEADQUARTERS**



Count on ALLIED for the latest in TV! If it's made—we have it for quick delivery. We specialize, too, in High-Fidelity sound components—everything in amplifiers, speakers, tuners, phono gear and accessories. For TV or Hi-Fi—think of ALLIED!



**ALLIED RADIO**  
the World's Largest Radio Supply House  
EVERYTHING IN ELECTRONICS

**free**

SEND TODAY FOR RADIO'S  
LEADING BUYING GUIDE

ALLIED RADIO CORP., Dept. T-L-1  
833 W. Jackson Blvd., Chicago 7, Illinois

Send FREE 212-page 1952 ALLIED Catalog No. 127.

Name \_\_\_\_\_

Address \_\_\_\_\_

City \_\_\_\_\_ Zone \_\_\_\_\_ State \_\_\_\_\_



# Sell Satisfaction... Sell TRIO TV Products

Yes, complete satisfaction all the way around results when TRIO TV products are sold. Jobbers know their dealers recognize quality of product — dealers know TRIO products mean satisfied customers. That's why TRIO products are the most wanted TV products on the market today.



Watch For  
Important TRIO  
Announcement In  
Trade Publications  
Soon

## TRIO YAGIS LEAD THE FIELD

### TRIO 2-CHANNEL YAGIS

Models 445 & 479

Rapidly becoming the most popular — most wanted TV antenna in America. Available for channels 4 and 5, and channels 7 and 9. Provides gain on two channels equal to any two conventional 4-element yagis!

#### Features

- Full 10 db Gain On 2 Channels!
- One Bay Replaces Bulky Stacked Array!
- One Lead Replaces Old-Style 2-Lead Systems!
- Less Weight Per Gain Than Any Other TV Antenna!

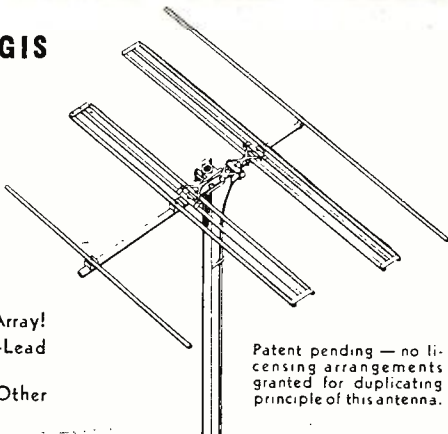

Patent pending — no licensing arrangements granted for duplicating principle of this antenna.

### TRIO DOUBLE FOLDED DIPOLE

(Model 304)

Here is the popular TRIO Double Dipole TV Antenna. With 10 db forward gain and a front-to-back ratio of 25 db, it is unexcelled for extreme fringe areas. Available for each of 12 TV channels. Easily stacked for additional gain. Reinforced fittings for extra strength — extra rigidity!

#### Features

- Outperforms Conventional Large Arrays!
- Exact Impedance Match To 300 Ohm Line!
- Sturdy Construction — Light Weight!
- Partially Assembled!
- Gain Flat Over Entire Channel!

### TRIO PHASITRON

Now Available  
Separately  
(Model No. PC-600)

The TRIO PHASITRON, originally sold only as part of the TRIO Controlled Pattern TV Antenna System, is now available separately for TV set owners who want to get the very best results from their sets and antennas, or to hams and other experimenters.



PHASITRON acts as a continuously variable tuning stub and will provide an exact impedance match between line and booster and helpful in matching output impedance of booster to set input impedance. Due to exact matching, losses in line become negligible and set performance greatly improved.

May also be used to coordinate input from two or more antennas to provide added balanced output to set. Write for full details.

### NEW TRIO TV ACCESSORY CONTROL UNIT

Model No. RY-1

A handy control unit that hides away inside or in back of the TV set and provides an automatic line switch for booster, rotator, TV lamp or other accessories. By plugging the line cords from these accessories into the TRIO Control Relay Unit, all accessories are turned on with the one switch controlling the TV set. Quickly installed without making any wiring changes in set.



### New TRIO TV ROTATOR AND DIRECTION INDICATOR

Two heavy-duty 24 volt motors — instead of one — provide a reliability of operation that makes this rotator outstanding.

One motor turns antenna clockwise — the other counter-clockwise. Even if left on continuously, a motor cannot burn out since load on a single motor is never on more than 50% of the time!

The new TRIO TV Rotator provides the ultimate in trouble-free, dependable operation. Supports heaviest arrays, even in 80 M.P.H. winds.

Positive acting electrical stops at both ends of 360° turn eliminates lead damage.



#### Rotator Features

- Cast TENSALLOY aluminum mast holder, 11/16" steel shaft. Withstands 4500 lbs. bending movement.
- Automatic Electro-Mechanical Brake — reduces coasting to minimum.
- All-aluminum case — no cast zinc!
- Turns 1 RPM, lifetime lubricated.
- Ball-bearing end thrusts on shafts.
- Ideal for 10, 6 and 2 meter amateur use.

#### "TELEVISION TOPICS"

Write today for your free copy of "TELEVISION TOPICS" by G. N. Carmichael. It discusses items of interest to TV distributors, dealers and users, includes information on Antenna Types and Height, Lead-Ins, TV Signal Propagation, Interference, TV Set Limitations, Rotators, Mast and Towers and Future Trends in TV.



*TRIO*

MANUFACTURING COMPANY  
GRIGGSVILLE, ILLINOIS



# TRAIN

# for Security! Good-Paying Jobs!

## MAKE THE MONEY YOU'VE ALWAYS DREAMED OF!



# LEARN RADIO -TELEVISION

## AND ELECTRONICS BY EASY SHOP METHOD TRAINING AT HOME!

**You get  
all the parts—even tubes!—**  
for this modern Superheterodyne Receiver. You learn to build it step by step. And you keep it! Get all the facts. Mail coupon now.

Let **NATIONAL SCHOOLS**—a resident-training school for nearly 50 years—train you at home for today's unlimited opportunities in Radio-Television-Electronics. National Schools is one of the largest schools of its kind. It is located in Los Angeles—the center of Radio and TV world! It has four large buildings of modern shops and labs. Its faculty is considered tops in the business.



You learn from lessons prepared by experienced instructors and engineers. Men who are successful Radio and Television technicians. Men who have trained 1000's of men like YOU!



### Only National Schools Gives You This Professional Multi-Tester!

You get this amazing, new testing instrument—factory-made and tested—complete—ready to use! Simple to operate. Accurate and dependable. An instrument every Radio-TV man needs. Light enough to carry around—so you can use it at home or on service calls. You'll be proud to own this valuable equipment.

### Here are only a Few of the Good-Paying Jobs You Can Choose

Radio Station Engineer, District Service Manager, Aircraft Radio Inspector, Own Your Own Repair Shop, Inspector Technician, Service Specialist, Special Government Jobs, Complete TV Service, Sound Truck Operator. Many more! National Schools graduates have secure, good-paying jobs like these! So don't wait—mail the coupon today. Now—while you're thinking about it!

### Attention! Men Going into Service Soon!

National Schools' course quickly prepares you for many important jobs in the Armed Services. With National Schools Training you have an opportunity to get into special service classifications—with higher pay and grade—immediately!

### FREE SERVICE FOR GRADUATES

National Schools uses its great influence and prestige to help you find your place in the field of your choice. Don't put it off! Start yourself toward a skilled trade! Get the big pay you've always wanted!

## NATIONAL SCHOOLS

LOS ANGELES 37, CALIFORNIA • ESTABLISHED 1905

### MAIL THIS COUPON TODAY—WITHOUT FAIL!

NATIONAL SCHOOLS, Dept. HR-111  
4000 South Figueroa Street  
Los Angeles 37, California

Mail in envelope  
or paste on  
penny post card.

Mail me FREE the book mentioned in this ad. Also a free sample lesson. I understand no salesman will call on me.

NAME \_\_\_\_\_ AGE \_\_\_\_\_

ADDRESS \_\_\_\_\_

CITY \_\_\_\_\_ ZONE \_\_\_\_\_ STATE \_\_\_\_\_

Check here if you were released from the Service less than 4 years ago.

### You Train At Home—In Your Spare Time

National Schools Shop Method Home Training gives you basic and advanced instruction in all phases of Radio-TV-Electronics. And remember—your training is based on resident school training principles. You learn fast from hundreds of diagrams and pictures. All instructions are written by experienced technicians who work in Radio and TV every day. All instructions have been developed and tested in National Schools' own labs and studios, which are equipped with the latest RCA equipment. No wonder this National Schools course is so up-to-date, practical, interesting. And so easy to learn! And no wonder it is held in such high regard by leaders of American industry! Approved for eligible Veterans.

### We Teach You How To Make Welcome Extra Money—While You Learn!

Many National Schools students—men like you—make plenty of extra dollars each week in spare time! Fixing neighbors' radios, appliances—and other ways we teach you. You start learning and earning from the day you enroll. From the very first lesson!

### WE SEND YOU LOTS OF PARTS LIKE THIS!

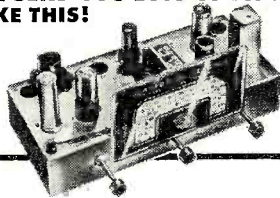

With National Schools Shop Method Home Training, you get basic principles and plenty of practical training. You learn by doing. No wonder you learn so fast! We send you many parts—all of professional, modern quality. You do lots of practical experiments. You advance day by day, step by step. Until you can even build the modern Superheterodyne Receiver you see above—plus other important testing units. The free book tells you all about it. The free sample lesson shows how easy the training is. Use the coupon. Send today—without fail!

**DON'T PUT  
IT OFF!  
GET THE  
BIG SALARY  
YOU HAVE  
ALWAYS  
WANTED!**

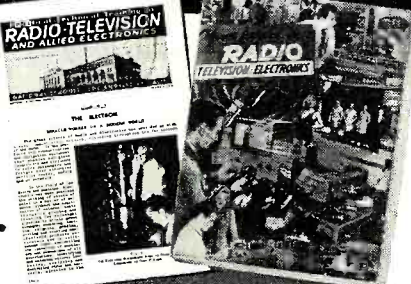

## FREE BOOK TELLS YOU HOW!

Page after page—In color—tells you everything you want to know. Mail the coupon. Get this valuable book today. And if you hurry—YOU GET A FREE SAMPLE LESSON, TOO! Shows how easy National Schools Home Training is. Mail the coupon today.

### Today's Shortage of Trained Technicians Creates Chance of a Lifetime For You!

Think of it! With guided missiles, radar, and other electronic devices so important to national defense! With big, new developments in TV. With over 90,000,000 home and auto radios, over 12,000,000 TV sets. With more than 3100 radio stations...over 100 TV stations—and more building every day...yes, imagine the great opportunity you have today!

YOU are wanted in Radio-Television-Electronics! America's fastest-growing field. High-pay jobs—the kind you've always wanted—are waiting for YOU!

### Job Security! Big Money! For YOU! in Today's Expanding Industries!

Trained Radio and Television technicians really make important money these days. Thousands of National Schools graduates—men just like you—are earning good money all over the country. Why not you? And—National Schools graduates get the personal satisfaction of being highly-skilled technicians. Men people respect. Men who enjoy their work—rather than having to drag along in just any old job.

### National Schools Has Trained 1000's of Successful Men! Why Not YOU?

In almost every state—and many foreign countries—National Schools graduates are filling big jobs with famous companies. Or running their own successful businesses. What are YOU waiting for? National Schools training is complete training. So when you graduate you can take advantage of today's big opportunities in Radio-Television-Electronics—fast.



# Know "WHY" Ceramic Capacitors...

Here are the facts about Ceramic Capacitors — why they are the most permanent capacitors . . . why they do a better job . . . give a better performance . . .

Up until a few years ago, capacitor design was based on one idea — "the bigger the better." Paper and mica, etc., were cheap, readily available materials, and their use was the only known art for making commercial capacitors (or "condensers" as they used to be called).

Now don't misunderstand us . . . those old condensers were really OK as far as they went. *But today there's something more to talk about . . . CERAMIC CAPACITORS.*

Actually, the idea of ceramic capacitors isn't new. They've been used as electronic components for more than 20 years. We call them new because it's only in the last few years that service-engineers have paid any attention to them . . . and because some of these modern ceramic capacitors really are new . . . with *new* higher voltages, *new* and better physical characteristics. So if ceramic capacitors were overlooked by service-engineers during the last few years . . . we feel it's because you didn't know about just how *good* they really are—or because what you needed wasn't available.

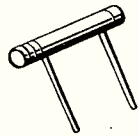

Let's take a look at modern ceramic capacitors and the story behind them. It was in the early 1900's when German scientists discovered the dielectric properties of ceramic materials. In the U.S.A., we had an abundant supply of mica and other materials, so U.S. research men never bothered with ceramics. Then came World War I, and ceramics became mighty important in European radio manufacture. Ceramics were a long way from perfected but they did the job . . . and continual improvement made them increasingly important in the electronic field. Meanwhile, at Centralab, we had started to investigate these new materials. It was soon found that U.S.A. had a bigger source of raw ceramic materials and that our stocks were of vastly superior physical and electrical characteristics.

Then one of our foreign representatives supplied us with a complete set of foreign-made ceramic components. Result — Centralab developed a ceramic research program. The program was big and thorough . . . and it's still going on.



In a few years, Centralab put on the market its first ceramic capacitors. With World War II, came tremendous developments in electronics. Radio, radar and other electronic equipment demanded the finest in component parts . . . and ceramic capacitors came into their own.

*In fact, independent research has shown that during World War II, in some classes of military equipment, there was not a single known instance of a failure of a ceramic capacitor!*

Thus, through the lessons learned over a period of 20 years of intensive research — Centralab Ceramic Capacitors have today become the best capacitor buy for safe guaranteed servicing. For when you use CRL ceramic capacitors, you're using the benefits of hundreds of thousands of man-hours of research—experiments with over 20,000 different ceramic compounds!

That's why any ceramic isn't the best ceramic for the job. Each of those 20,000 ceramic mixes had definite physical and electrical characteristics . . . and when we say that Centralab today uses only 250 of those 20,000 tested compounds, you can be sure that those discarded did not perform to the exacting requirements of sensitive electronic circuits.



Yes, and if you compare the old-style paper and mica capacitors with modern ceramic capacitors . . . point for point, based on your own technical experience, you'll see why ceramics are vastly better . . . the safe, dependable way to assure a good service job.

For example, every serviceman is aware of the moisture absorbing quality of paper condensers . . . and how moisture can seep in along the leads on mica units. Compare these old designs with modern ceramic tubular and disc types . . . Centralab's Ceramic-X capacitor bodies are nonhygroscopic . . . moisture absorption being only .007% or less! That fact alone means Centralab Capacitors give you and your service customer the ultimate in reliability—even under severe tropically humid conditions.

Old-timers in the service field . . . yes, and young ones, too, will recall the bulky size . . . the difficulty of handling old-fashioned large size capacitors . . . when size seemed to be an important factor in design. Now, look at modern ceramic capacitors. They're less than 1/4 the size . . . you can fit them anywhere!

When you look at this chart of the development of capacitors using various materials . . . the tremendous improvement of the dielectric con-

stant "K" with the entry of ceramics into the field is dramatically evident.

One of the most serious problems with old-time capacitors was that they broke down under high temperatures. Here again, ceramics have more than proven their superiority. 85° C. will not harm the modern ceramic capacitor. In fact, the ceramic body itself can easily withstand any temperature encountered in electrical apparatus. High capacity is

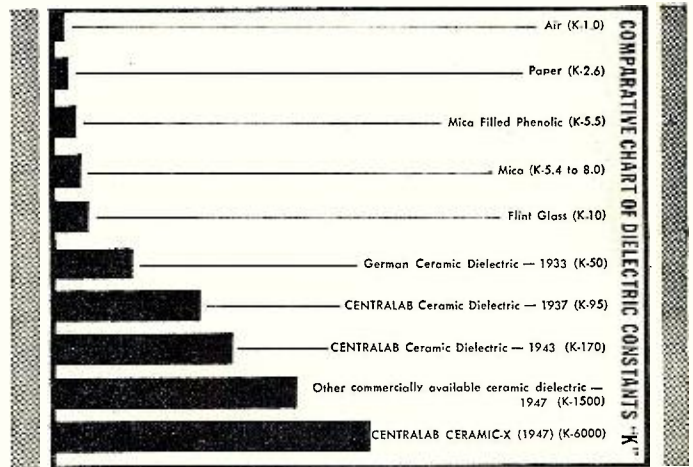

well maintained under wide temperature variation. What's more, the copper-silver electrodes are electro-bonded to the ceramic with a tensile strength of 30,000 lbs. per square inch — thus preventing any possible change of the relative position of the electrodes.

A typical example of the high degree of perfection and performance offered by ceramic capacitors is contained in CRL Hi-Vo-Kaps. These units are rated at 10 — 20 and 30 KV and are intended exclusively for TV. You'll find that practically the entire TV industry has standardized on these CRL units as original equipment for this most exacting application.

When it comes to low power factors—check ceramics against all others. With ceramics, initially it's .1% to .6%. After 100 hours at 95% humidity, it's .5% to 3% and they'll return to normal! That's ceramic high efficiency! If it's accuracy you want, ceramic capacitors can give you unusually close tolerances in wide range of values.

In r.f. circuits, where drift is critical, one of the likely causes is temperature change. Stabilization can be effected by capacitors which compensate for temperature variations. Centralab pioneered ceramic capacitors for this purpose. This important research resulted in Centralab's famous TC-Hi-Kaps Zero Temperature and Negative Temperature Compensating units. These are a Centralab exclusive "First". For service-engineers they are the industry's last word in accurate stabilizing capacitors.

Service-engineers today are called upon for more exacting work—more downright customer satisfaction. Every job that comes into your shop is a challenge to your reputation. Regardless of the care in workmanship, no service job is better than the components you put into it. To stay in business tomorrow — you can't take chances today.

Field research shows that smart service-engineers everywhere are replacing all old-fashioned or dangerously old capacitors with ceramic capacitors, within the capacity ranges available. Particularly if there is any indication of possible failure within a reasonably short period. For by-pass and coupling applications . . . they're using Centralab BC Hi-Kaps. For tuning applications, they're using temperature compensating TC Hi-Kaps. It's their own assurance of a good job well done . . . and their customer's insurance of complete satisfaction. What's more, to the serviceman and customer alike . . . *there's little or no premium in price.*

\* \* \*

You'll find Centralab ceramic capacitors are available in a wide variety of capacities from any recognized better radio parts distributor. Ask him. And remember, Centralab is the pioneer in the field of electronic ceramics. That fact alone is your best assurance of engineering know-how, production know-how, and performance know-how that permits no compromise with quality.



# and you'll Buy Ceramic Capacitors

Choose the exact capacitors you need from the world's widest line of ceramic capacitors — for jobs that demand the best in guaranteed TV-AM-FM servicing . . .

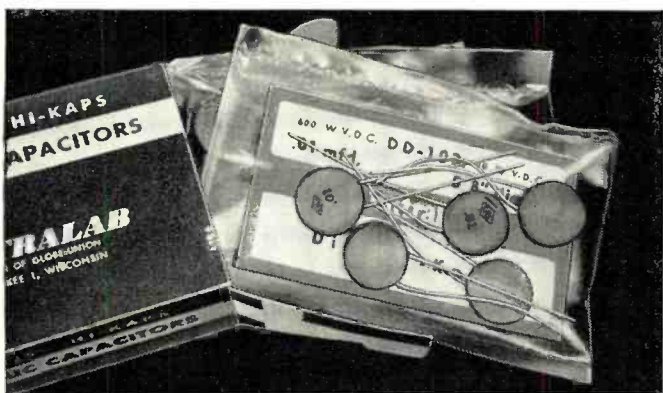

CERAMIC DISC HI-KAP CAPACITORS — provide very high capacity in extremely small size, with minimum thickness. For by-pass, coupling and general applications. Superior power factor and low inductance.

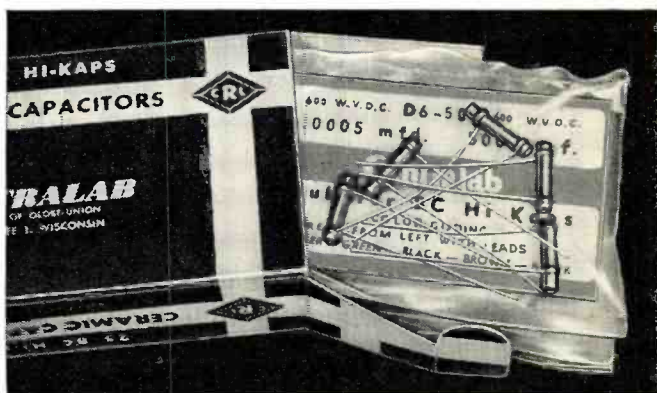

CERAMIC BC TUBULAR HI-KAP CAPACITORS — for by-pass or coupling applications and most general circuit work. Smallest size on the market. Remarkable stability under high temperatures or humidity.

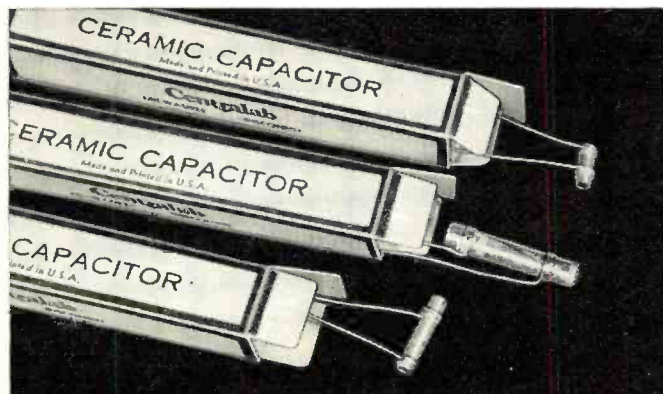

TC TEMPERATURE COMPENSATING CERAMIC CAPACITORS — stable units that do not change in capacity under wide temperature variations—or may be selected to correct for frequency drift in resonant circuits caused by temperature changes. Also superior replacement for close tolerance micas.



CAPACITOR KITS — several are available. Illustrated is assortment of 200 units of most generally used values, supplied in a four-drawer metal cabinet. Often assures required values will be on hand when needed in labs or for service. No charge for cabinet.

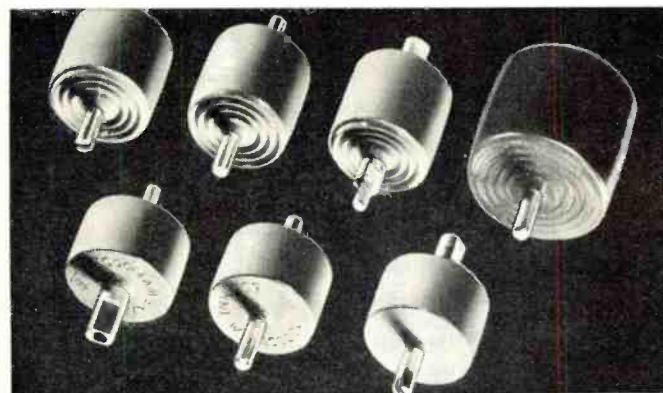

TELEVISION HIGH VOLTAGE CAPACITORS—are the accepted standard for the TV industry. Used for filter and by-pass in TV high voltage power supply and pulse filter for cathode ray tubes. Ask for Centralab Hi-Vo-kaps.

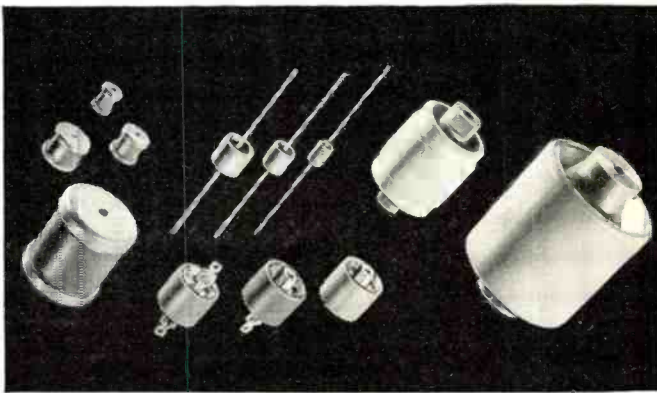

TRANSMITTING AND HIGH ACCURACY CERAMIC CAPACITORS — for applications involving rigid frequency control. Used for holding oscillator frequencies to close limits. Excellent as secondary Standards.

Yes, for the safest, quickest guaranteed servicing . . . standardize on Centralab Ceramic capacitors. You'll have the world's widest line to select from — as made by Centralab, *America's pioneer builder of ceramic capacitors*. You can get complete information on all the capacitors described here — plus other valuable service information from Centralab's Catalog 27 . . . available at your distributor's.

## Centralab

Division of Globe-Union Inc.  
910 E. Keefe Avenue • Milwaukee 1, Wis.



# AVOID RESISTOR BREAKDOWNS



## OHMITE LITTLE DEVIL RESISTORS

### Provide EXTRA MARGIN of SAFETY

Where dependability is of the utmost importance, play safe with Ohmite Little Devil molded composition resistors. While they are tiny in size, these units have exceptional ruggedness, stability, and current carrying capacity. Little Devils are completely sealed and insulated by molded plastic. Under continuous full load for 1000 hours, their resistance change is less than 5%.

Ohmite Little Devils are available in 1/2, 1, and 2-watt sizes, in  $\pm 5\%$  or  $\pm 10\%$  tolerance. Standard RTMA values, 10 ohms to 22 megohms are furnished. In the 1-watt size,  $\pm 10\%$  tolerance, values as low as 2.7 ohms are provided.

AVAILABLE ONLY FROM YOUR DISTRIBUTOR

**OHMITE MANUFACTURING CO.**

4884 Flournoy Street, Chicago 44, Ill.

- **RATED AT 70C**—Little Devils have a wide margin of safety—being rated at 70C instead of 40C.
- **WITHSTAND TEMPERATURE, HUMIDITY**—Meet all JAN-R-11 requirements, including salt water immersion and humidity tests.
- **RESISTANCE AND WATTAGE CLEARLY MARKED**—In addition to color coding, the resistance value and wattage are marked on every unit.
- **TEMPERED LEADS**—Tinned copper leads are differentially tempered to prevent sharp bends.

*Be Right with*

**OHMITE**®

**RHEOSTATS  
RESISTORS  
TAP SWITCHES**

**RADIO & TELEVISION NEWS**



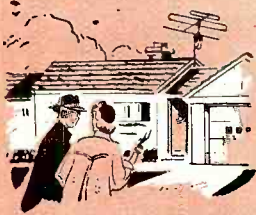

... Seen the Most in hundreds of thousands of TV homes — Alliance Tenna-Rotor is the universal favorite everywhere!

TAKE A DRIVE AROUND ANY TV TOWN—SEE FOR YOURSELF! AND, THAT'S WHY THE ALLIANCE BOOSTER'S SO POPULAR TOO!



... Seen the Most because they're demonstrated right in the homes of 35 million television viewers! Both the Alliance Booster, Tenna-Scope, and Alliance Tenna-Rotor film Commercials deliver an impact that's terrific — repetitive — continuous! And, they deliver that impulse to buy!

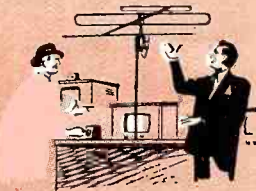

... Seen the Most on the sales counters of smart dealers! IT PAYS TO DISPLAY ALLIANCE PRODUCTS BECAUSE THEY'RE SEEN THE MOST AND SOLD THE MOST!

NOTE: Alliance Tenna-Rotor is a TV Antenna Rotator. Alliance Tenna-Scope is a TV Booster.

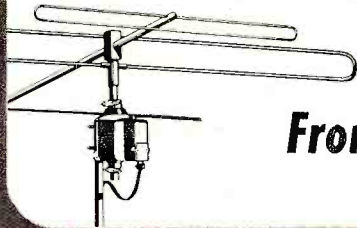

**From Coast-to-Coast**

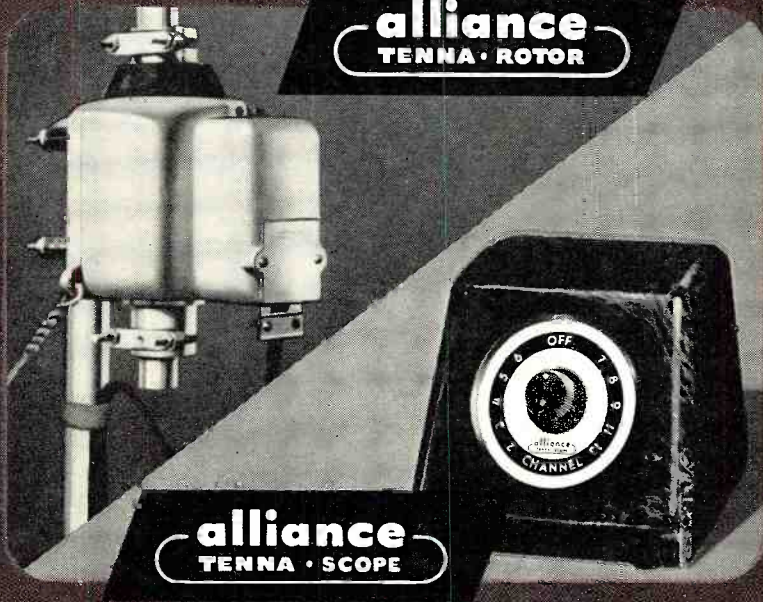

**Sold the Most**

**BECAUSE THEY'RE**

**Seen the Most**

Millions of free home demonstrations make sales! Thirty-five million viewers see Alliance TV Films in 12 million homes every week! Both Tenna-Scope, the Alliance Booster, and the famous Alliance Tenna-Rotor enjoy unequalled exposure to viewers in the major TV markets where you sell!

**ALLIANCE MANUFACTURING COMPANY • Alliance, Ohio**



# HOW TO STACK YAGIS WITH 100% EFFICIENCY

New System Eliminates Mismatch; Provides Higher Gain For Yagis

Acting on the complaint of installers of all makes of Yagi antennas that only a small additional gain was achieved in stacking, Channel Master Laboratories engaged in a thorough research project during the past summer. The engineers came up with the new Z-MATCH system, and, like all important discoveries, it is relatively simple.

They noted that although all single Yagis claim to match 300 ohm line, they are stacked one-half-wave with  $\frac{3}{8}$ " connecting rod transformers spaced about 3" apart, with an impedance of 325 ohms. Each Yagi's impedance, therefore, was stepped up to 350 ohms, with the two in parallel totaling only 175 ohms. This meant a mismatch of almost 2:1 when used with 300 ohm line. (Fig. 1 lower right)

Channel Master engineers reasoned that in stacking, the impedance of each single 300 ohm Yagi must be reduced in order for the total stacked Yagi to match a 300 ohm line, as follows:

1. Let the single Yagi match 300 ohm line perfectly when used alone.
2. Reduce Z (impedance) of each Yagi to 200 ohms for stacking.
3. Use  $\frac{3}{8}$ " half-wave connecting rod transformers spaced at  $3\frac{1}{8}$ ".
4. These connecting rod transformers have an impedance of 350 ohms.
5. These 350 ohm connecting rods transform each 200 ohm impedance to 600 ohms.
6. The two 600 ohm impedances in parallel equal 300 ohms.
7. **Therefore a perfect match is achieved in both single and stacked antennas!** (Fig. 2)

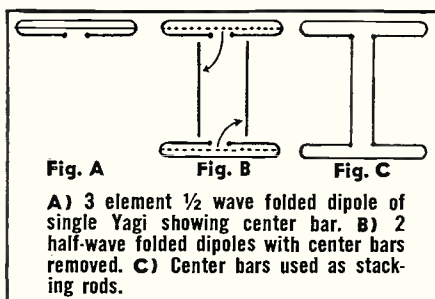

The new Z-MATCH system automatically provides for lowering the impedance of each Yagi when preparing it for stacking. A 600 ohm, 3 conductor folded dipole (Fig. A) is used on the single Yagi to provide a perfect 300 ohm impedance. In stacking, the center bar is taken out of the folded dipole which lowers the impedance to 200 ohms and leaves a pair of  $\frac{3}{8}$ " rods one-half-wave long (Fig. B). These are then used as connecting rods and the result is a stacked Yagi which perfectly matches a 300 ohm line (Fig. C). In order to provide a perfect 300 ohm impedance for the single Yagi, the crossarm had to be lengthened, resulting in higher gain for the Z-MATCH single Yagi. The antenna is wider spaced than most other commercial Yagis which use a half-wave crossarm. Furthermore, the cost of extra connecting rods is completely eliminated. Z-Match is an exclusive feature of Channel Master Yagi antennas. Completely pre-assembled,

# Tests Reveal Serious Mismatch in Stacked Yagis

## New Z-Match Yagi Achieves 100% Perfect Match To 300 Ohm Line, Single or Stacked.

## Higher Gain On All Yagi Installations Accomplished By Adjustable Impedance And Wider Spaced Elements.

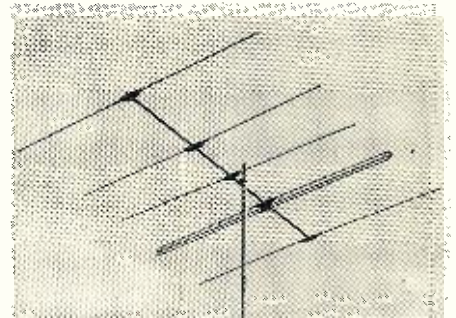

**Now! Stack Yagis without extra stacking bars!**

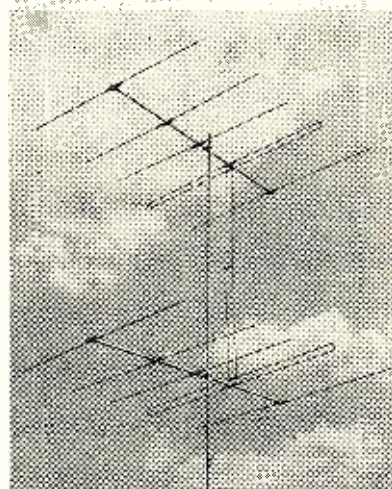

Mismatch eliminated! Now Channel Master proudly introduces the Z-Match Yagi—a new antenna that guarantees 100% perfect match in both single and stacked Yagi installations.

Single bay Yagi perfectly matches 300 ohms because of wider spaced elements. When Yagis are stacked, the center bars of the folded dipoles are removed and used as half-wave connecting rods. This reduces the impedance of each antenna, and automatically creates a perfect 300 ohm match for the complete stacked Yagi array. The Z-Match system, PLUS wide spacing, provide higher gain for Channel Master Yagis, single or stacked. No extra stacking bars result in lower cost.

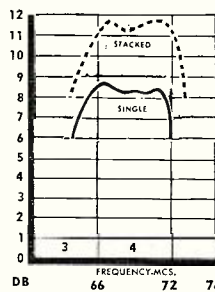

Gain of Z-Match Yagi on Channel 4

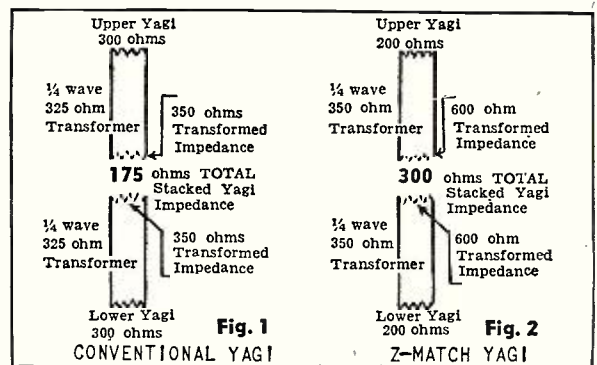

# CHANNEL MASTER CORP.

NAPANOCH ROAD, ELLENVILLE, N. Y.

Write for complete technical literature.

RADIO & TELEVISION NEWS







# NOW-Be a Fully Trained, Qualified RADIO TELEVISION TECHNICIAN IN JUST 10 MONTHS OR LESS

**I Send You  
18 BIG  
KITS  
OF RADIO-  
TELEVISION  
EQUIPMENT**

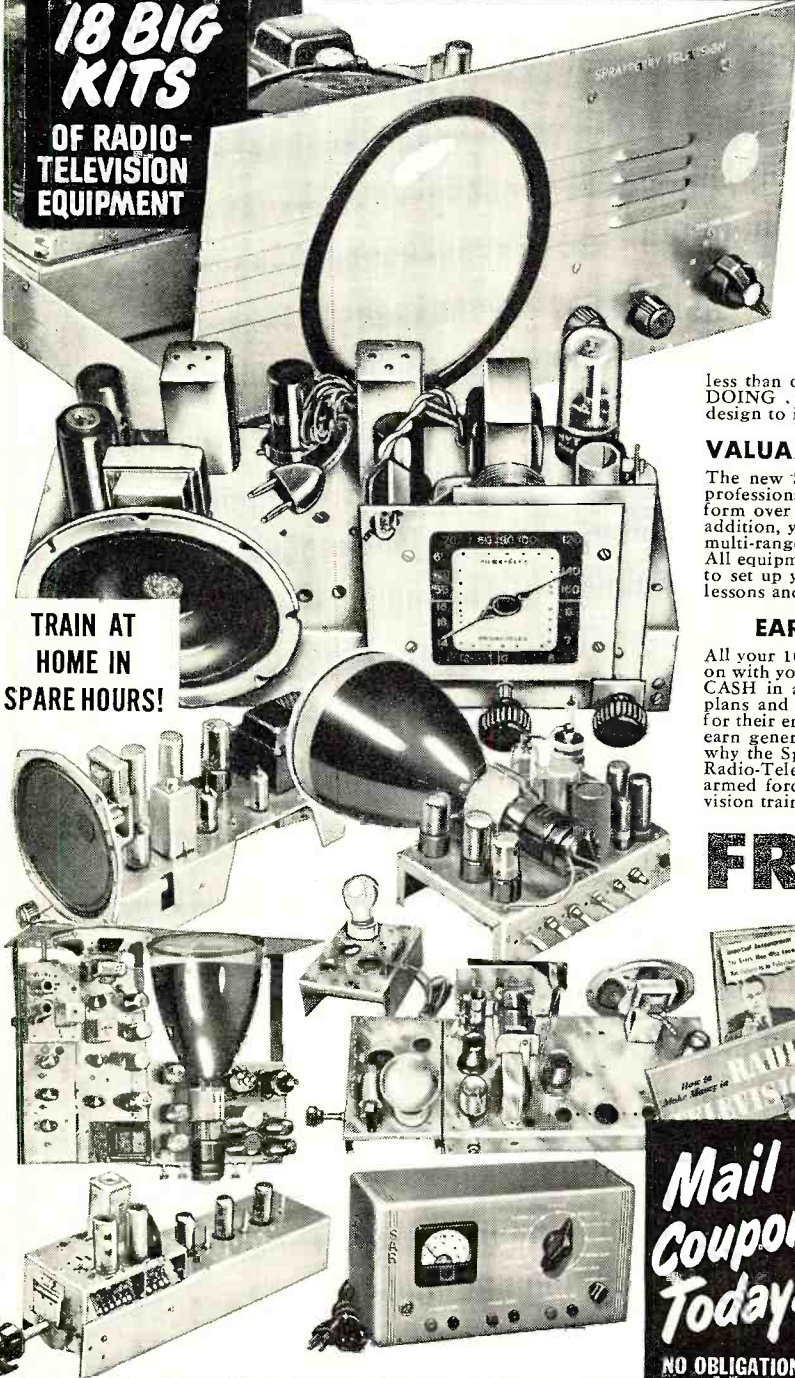

**TRAIN AT  
HOME IN  
SPARE HOURS!**

**New "Package" Unit Training Plan  
PAY AS YOU LEARN—YOU SET THE PACE!**

**No Monthly Payment Contract to Sign!**

Now . . . be ready for Radio-Television's big pay opportunities in a few short MONTHS! Frank L. Sprayberry's completely new "Package" training unit plan prepares you in just 10 MONTHS . . . or even less! Equally important, there is NO monthly payment contract to sign . . . thus NO RISK to you! This is America's finest, most complete, practical training—gets you ready to handle any practical job in the booming Radio-Television industry. In just 10 months you may start your own profitable Radio-Television shop . . . or accept a good paying job in this fascinating expanding field at work you've always wanted to do. Mr. Sprayberry has trained hundreds of successful Radio-Television technicians—and stands ready to train you in less than one year, even if you have no previous experience. You learn by DOING . . . actually working with your hands with equipment of special design to illustrate basic theory instead of relying on books alone.

**VALUABLE EQUIPMENT INCLUDED WITH TRAINING**

The new Sprayberry "package" plan includes many big kits of genuine, professional Radio-Television equipment. While training you actually perform over 300 demonstrations, experiments and construction projects. In addition, you build a powerful 6-tube standard and short wave radio set, a multi-range test meter, a signal generator, signal tracer, many other projects. All equipment is yours to keep . . . you have practically everything you need to set up your own service shop. The interesting Sprayberry book-bound lessons and other training materials . . . all are yours to keep.

**EARN EXTRA MONEY WHILE YOU LEARN!**

All your 10 months of training is AT YOUR HOME in spare hours. Keep on with your present job and income while learning . . . and earn EXTRA CASH in addition. With each training "package" unit, you receive extra plans and ideas for spare time Radio-Television jobs. Many students pay for their entire training this way. You get priceless practical experience and earn generous service fees from grateful customers. Just one more reason why the Sprayberry new 10 MONTH-OR-LESS training plan is the best Radio-Television training in America today. If you expect to be in the armed forces later, there is no better preparation than good Radio-Television training.

**FREE 3 BIG RADIO TELEVISION BOOKS**

I want you to have ALL the facts about my new 10-MONTH Radio-Television Training—without cost! Act now! Rush the coupon for my three big Radio-Television books: "How to Make Money in Radio-Television," PLUS my new illustrated Television Bulletin PLUS an actual sample Sprayberry Lesson—all FREE with my compliments. No obligation and no salesman will call on you. Send the coupon in an envelope or paste on back of post card. I will rush all three books at once!

**SPRAYBERRY ACADEMY OF RADIO**  
Dept. 25-C, 111 North Canal St., Chicago 6, Ill.

**Mail  
Coupon  
Today!**  
NO OBLIGATION  
No Salesman  
Will Call

**SPRAYBERRY ACADEMY OF RADIO, Dept. 25-C**  
111 North Canal St., Chicago 6, Ill.

Please rush to me all information on your 10-MONTH Radio-Television Training Plan. I understand this does not obligate me and that no salesman will call upon me.

Name.....Age.....

Address.....

City.....Zone.....State.....

Please check Below About Your Experience  
 Are You Experienced?  No Experience

**IF YOU ARE  
EXPERIENCED IN RADIO**

Men already in Radio who seek a short intensive 100% TELEVISION Training with FULL EQUIPMENT INCLUDED are invited to check and mail the coupon at the right.



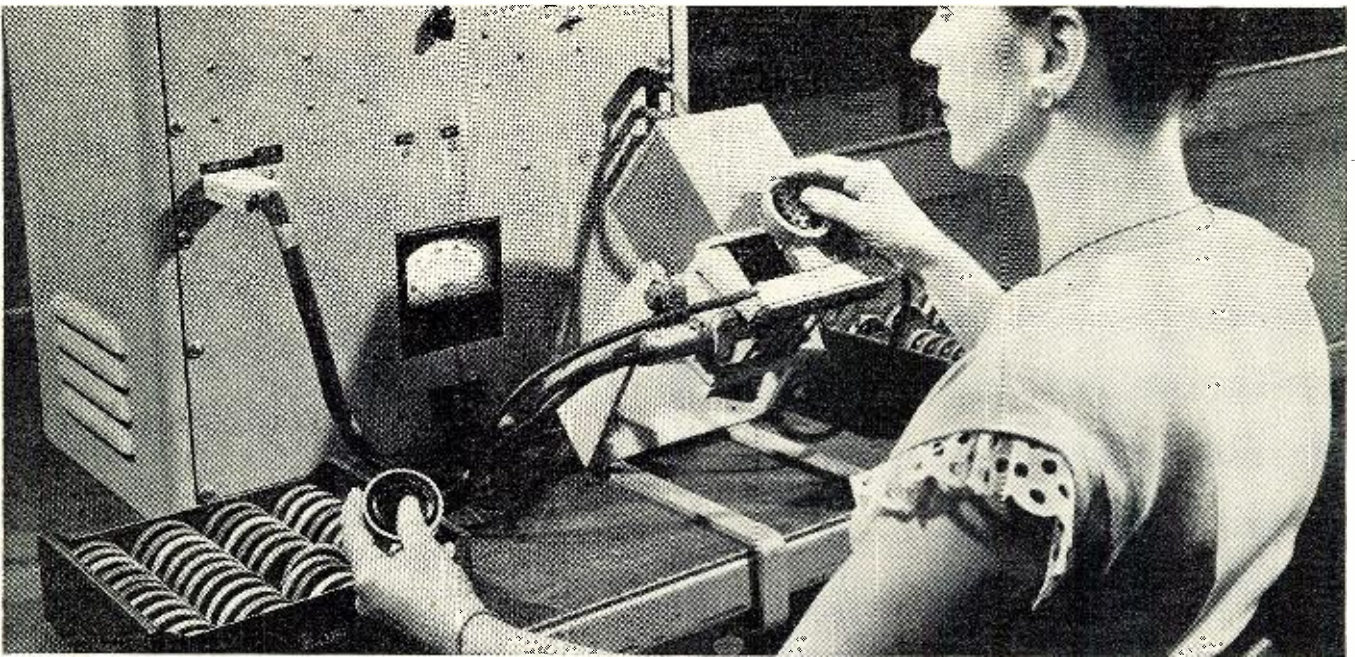

*This Western Electric employee mounts a transmitter in the test fixture which is swung down to face an artificial mouth at 45-degree angle, just as transmitters are held in use. More than a million transmitters are tested each year.*

## **T**his mouth speaks to millions

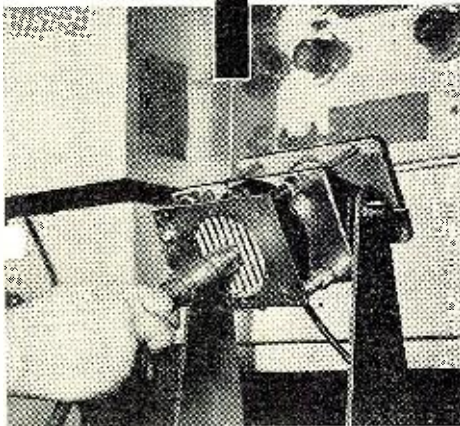

*At Bell Laboratories a scientist employs a condenser microphone to check the sound level from another type of artificial mouth, used in transmitter research.*

To serve the changing needs of telephone subscribers millions of telephone sets have to be moved each year. Before being put back into service most of them are returned to the Western Electric Company's Distributing Houses where they receive a thorough checkup.

Western Electric engineers needed a rapid method of testing transmitters over a range of frequencies. At Bell Telephone Laboratories, scientists had just the thing—a technique they had devised for fundamental research on transmitters. In co-operation with these

scientists, Western Electric engineers developed the practical tester in the illustration.

The transmitter is removed from the handset and put in front of an artificial mouth which emits a tone that swings several times per second over a band of frequencies. A signal lamp tells whether the transmitter is good. Each test takes 5 seconds.

This new tester illustrates how Bell Laboratories research and Western Electric manufacturing skill team up to maintain your telephone service high in quality yet low in cost.



## **BELL TELEPHONE LABORATORIES**

• EXPLORING AND INVENTING, DEVISING AND PERFECTING, FOR CONTINUED IMPROVEMENTS AND ECONOMIES IN TELEPHONE SERVICE

**RADIO & TELEVISION NEWS**



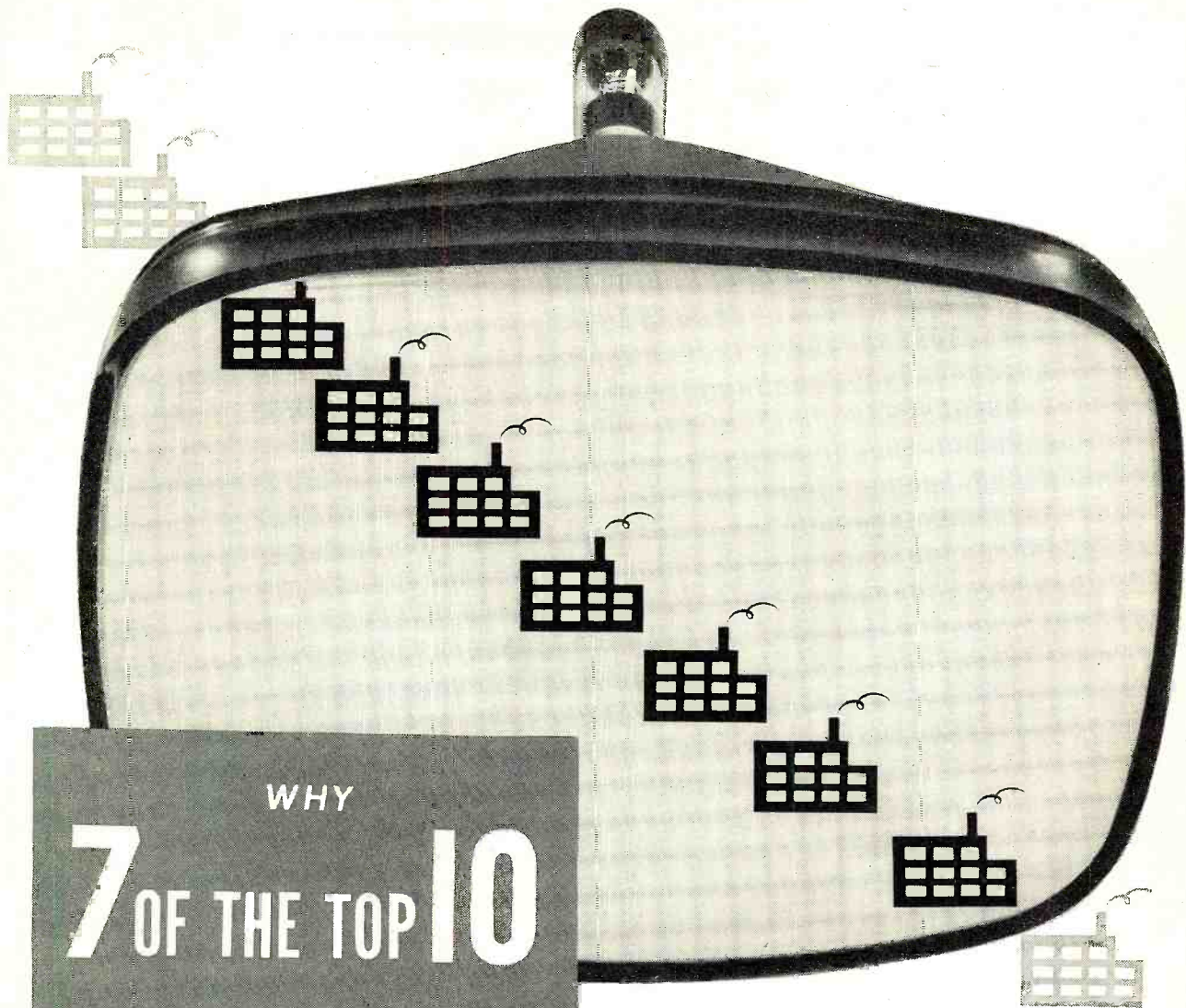

WHY  
**7 OF THE TOP 10**  
 TELEVISION SET  
 MANUFACTURERS USE  
**SYLVANIA**  
 PICTURE TUBES

A Sylvania tube engineer, for example, invented the famous Ion Trap now generally adopted, under special Sylvania license, by other leading picture tube makers.

Sylvania's 25 years of lighting research, including advances in phosphors and filamentary wire techniques and coatings, has also contributed to the outstanding clarity and long life of Sylvania picture tubes.

**Popular TV show tells millions**

Set owners are being kept informed of Sylvania's leadership by the big, popular television show, "Beat the Clock," on CBS-TV. Every week this program emphasizes Sylvania's unique background and the fine quality of all Sylvania products, thus assuring you of an enthusiastic acceptance of Sylvania Tubes used as replacements in the sets you service.

To help you choose the right Sylvania Tube for each service job see your Sylvania Distributor now for your free SYLVANIA TV TUBE SELECTOR, a handy wallet folder which explains the differences between more than 100 types of picture tubes. Sylvania Electric Products Inc., Dept. R-2111, Emporium, Pa.

The important reasons behind the steadily increasing demand for Sylvania TV Picture Tubes are: (1) high quality performance, (2) broad national recognition.

Sylvania's picture tube experience includes leadership in 4 specialized fields... all basic to TV picture tube production. These are *radio, electronics, lighting, and phosphors.*



**SYLVANIA**



RADIO TUBES; TELEVISION PICTURE TUBES; ELECTRONIC PRODUCTS; ELECTRONIC TEST EQUIPMENT; FLUORESCENT TUBES, FIXTURES, SIGN TUBING, WIRING DEVICES; LIGHT BULBS; PHOTOLAMPS; TELEVISION SETS

November, 1951



SOMETHING TO  
**REMEMBER**  
ABOUT  
**SPRAGUE**  
TWIST-LOK™ TV  
CAPACITORS



• **M**ore twist-prong electrolytic capacitors are made by Sprague than by any other manufacturer . . . And Sprague naturally lists the largest, most complete line for exact TV replacement applications.

• And when you use a Sprague Twist-Lok TV Capacitor, you can be sure it's dependable. No costly call-backs will jeopardize your profit or your reputation. Your business judgment will tell you to *accept no substitutes.*

★Trademark

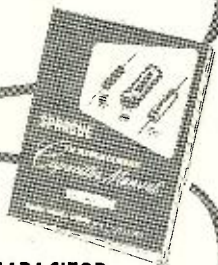

GET YOUR  
**NEW**  
SPRAGUE TV CAPACITOR  
REPLACEMENT MANUAL TODAY!

Just off press, this NEW 3rd edition of the famous Sprague Manual is jam-packed with up-to-the-minute replacement recommendations for critical capacitors in practically every TV set on the market today! FREE from your Sprague parts distributor or send 10¢ directly to Sprague to cover handling and mailing costs.



51 Marshall St.  
NORTH ADAMS, MASSACHUSETTS  
(Distributors' Division of the Sprague Electric Company)

# Spot Radio News

★ Presenting latest information on the Radio Industry.

By RADIO & TELEVISION NEWS'  
WASHINGTON EDITOR

**COLOR TV**, which streaked across the front pages in the spring, faded away to an item of casual interest during the summer, has returned to its exalted position in the news, and it appears may bask in the limelight for quite awhile now, thanks to the rousing interest of industry from coast to coast. Two factors have been particularly responsible for the throbbing enthusiasm; the long-promised public demonstrations of compatible color and the intensely active panels of the National Television Systems Committee, who have been holding continuing sessions probing standards, surveying practical solutions to sending and looking problems, and studying actual results in the field.

In New York City, at the "Center Theatre," color interest has been keen. Hundreds have seen and thousands will see electronic color with programs originating both from studio and remote sites, all being telecast over experimental facilities, over Channel 4 and coax. The remote programs have served to demonstrate very effectively the merits of the tube system, with colors of swiftly moving objects such as swimmers and paraders, waving flags and divers, appearing very faithfully on direct-view 16 and 19-inch receivers.

According to many observers, the dot-sequential technique now employed can be described as a foolproof method capable of providing pictures which would be acceptable to everyone, including the experts on the Commission's staff, who incidentally have been on the viewing grounds in New York and Washington. The latter have been particularly interested in the work of the NTSC groups and during one series of sessions, which involved lectures and demonstrations in Philadelphia, Syracuse, Princeton, and Little Neck, Long Island, viewed the striking progress which industry had achieved in compatible color. They were extremely impressed with the new procedures evolved, such as oscillating color sequence, a flip-flop or color-phase alternation technique, that has been found to reduce the visibility of phase (timing) errors in the subcarrier (sampling) channel of the system, by reversing the phase sequence (timing order) of the color subcarrier information after each scanning field, so that opposite types

of color errors result on adjacent lines in space. The major advantage of the plan was said to lie in the fact that vestigial sideband transmission of the color subcarrier information can be made practical, thus improving both compatibility and the reproduced color pictures. By using this attack, a first order correction can be obtained for chromatic errors that would normally result, due to phase errors in the color-subcarrier channel.

It was noted that while the *ocs* principle can be applied to an unmodified dot-sequential system, the approach provides best results when used with a constant-luminance system using quadrature sampling or demodulation. It was learned, while the *ocs* system was being analyzed, that phase errors in the dot-sequential system can produce brightness as well as chromatic errors, but as a first order approximation only chromatic errors are produced in the constant-luminance system. That is why, it was explained, *ocs* is so effective for the latter method.

In a debate on *ocs* during a NTSC panel meeting, it was brought out, that allowing single-sideband operation of the color subcarrier reduces the need for uniformity of the amplitude and delay characteristics of the receiver in the vicinity of the color subcarrier frequency. This, it was said, simplifies the conversion of present black and white sets to color, and likewise simplifies the design of i.f. amplifiers for color chassis. In addition, it was pointed out, the effect permits a higher color subcarrier frequency which, in turn, permits the transmission of wider color bandwidth, and for the same subcarrier visibility permits the subcarrier to be transmitted at a higher amplitude, because of increased attenuation on existing monochrome receivers. This higher amplitude improves the signal-to-noise ratio and decreases the probability of *c.w.* interference. Furthermore, tests showed that *ocs* permits greater tolerance in the phase of the reinserted subcarrier at the receiver and improves the probability of obtaining good color under conditions of multipath transmission.

The results achieved by the proponents of compatible color and the investigating committees have been found to be so encouraging that indus-

**RADIO & TELEVISION NEWS**



# 3 Important Rauland Policies

...Are they  
paying off for you?

**1** Did you know that Rauland's Replacement Picture Tube Warranty and Adjustment Policy provides a 6 months warranty from the date of purchase by the consumer? And that all Rauland replacement tubes now carry a triple registration card providing protection for jobber, dealer and consumer?

**2** Did you know that Rauland provides a full 120-day price protection on distributor inventory of replacement picture tubes? That Rauland distributors can carry a stock adequate for their territories without risk of loss through price adjustment?

**3** Did you know that Rauland offers valuable premium points for the prompt return of warranty registration cards? Each card returned promptly entitles dealer and distributor to premium points redeemable in valuable merchandise prizes.

*If you have not received full details on all of the above, write, phone or wire your distributing contact on Rauland tubes. If you have not received your prize merchandise catalog, use the coupon below today.*

## THE RAULAND CORPORATION



*Perfection Through Research*

4245 N. KNOX AVE. • CHICAGO 41, ILLINOIS



The Rauland Corporation  
4245 N. Knox Ave., Chicago 41, Illinois

Please rush premium merchandise catalog and full information on:

Earning Premium Prizes  6 Months Warranty  
 Distributor Price Protection

Name \_\_\_\_\_

Address \_\_\_\_\_

City \_\_\_\_\_ State \_\_\_\_\_



**INLINE**  
ANTENNA

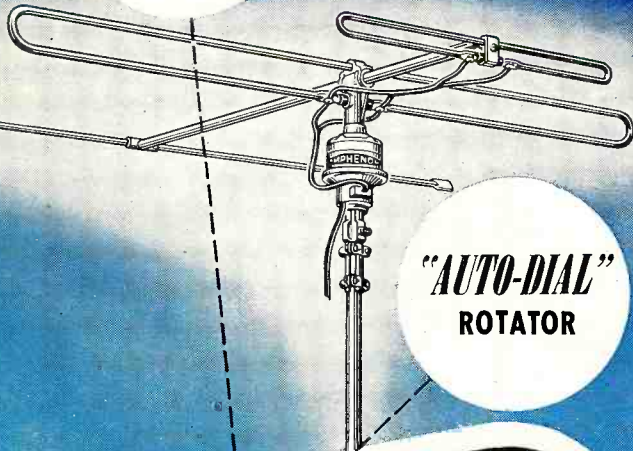

**"AUTO-DIAL"**  
ROTATOR

# Perfect TV Picture COMBINATION



REISSUE  
\* PAT. NO. 12,273

Technical men know that Amphenol's patented "Inline" antenna construction means superior electrical characteristics i.e., a single forward lobe to "pick up" the strongest signal — no minor lobes to receive reflected or spurious radiations. When this single lobe is accurately pointed to the desired signal by Amphenol's "Auto-Dial" antenna rotator, technical men know what any layman can see . . . the picture is the best there is!

For the best TV picture on any channel, from any direction, Amphenol's "Inline" antenna and Auto-Dial rotator . . . the unbeatable combination by **AMPHENOL**

**AMERICAN PHENOLIC CORPORATION**  
1830 SOUTH 54th AVENUE CHICAGO 50, ILLINOIS

try leaders have begun to issue beaming predictions on color's future. According to RCA's board chairman, David Sarnoff, color TV . . . "will add importantly to programming and give extra value to advertising." However, before the potentialities of color . . . "can be fully translated into a satisfactory service to the public" . . . he felt, the FCC must authorize the compatible idea. "If given the opportunity to do so," he added, "the public can and will make that decision . . . (to prefer compatibility)." In his opinion, the present situation . . . "calls for consideration by all concerned of the need for recommending to the FCC, that it authorize the use of dual standards, which would permit the compatible as well as the incompatible system of color TV to operate commercially. Only under such conditions can the public have the opportunity to see both systems in actual operation . . . reach its own decision and make its own choice." It was his view that . . . "only those who fear the public's decision would object to submitting their systems to such a competitive test."

**COLOR TUBES** also bounced back in the headlines as the autumn months appeared, with . . . announcements that the tricolor affair would soon become a production-line possibility; messages discounting the tube's value as a replacement for the color wheel from Columbia's colorman, Dr. Peter C. Goldmark, and a statement that a tube featuring an entirely new concept had been invented by none other than the world-famous scientist, Ernest O. Lawrence, director of the radiation laboratory of the University of California. The tube was said to be adaptable to any system and could be produced for about ten to twenty per-cent more than the present black and white types in various sizes.

According to those sponsoring the tube, *Chromatic Television Laboratories*, a division of *Paramount Pictures*, a silk-screen technique of printing is used to imprint alternating lines of colored phosphors on the picture tube faceplate with an accuracy of a few thousandths of an inch. A wire grid of multiple electronic lenses was said to serve as a means of deflecting electrons to color strips on the viewing plate, at a rate equal to the switching rate use in transmission.

Present plans were said to call for not only the production of tubes and possibly chassis, but the licensing of other manufacturers to process the tube. Industry spokesmen, who revealed that they had heard about the tube's development during the color hearings, questioned the flexibility of its application to mechanical or electronic systems, and felt that only extensive field testing will provide the ultimate answer as to its commercial possibilities.

**THE ULTRA-HIGHS**, described by many as the only means which can be used to open up the telewave bottleneck, and sharply viewed by others as a paper dream which perhaps might come to life in some flatland communities, received a torrential bouquet of orchids from the government's communication's headman, Wayne Coy, during a seminar meeting in Bridgeport recently. He declared that: "I'm so sold on u.h.f. that personally I'd like to see all of television there."

Noting that, in his opinion, there is enough know-how around now to justify the immediate opening of the 470 to 890-megacycle band, the FCC chairman said that we should use . . . "every megacycle of the band." Implying that it was realized that the higher bands have not as yet reached the point where it equals the present bands on all fronts, including general coverage, the Commissioner pointed out that the new band is far from being . . . "the lemon some . . . have been led to believe it is."

Describing reception in New Haven, 20 miles away from Bridgeport, where an *NBC* transmitter is operating on two frequencies, 530 and 850 megacycles, Coy said that the results from the upstairs' stations were as good as those recorded for the local lowband station.

**THE ALLOCATION STUDY**, shifted from the hearing room to the post office, or testimony via the mails, has  
(Continued on page 154)

**RADIO & TELEVISION NEWS**



"For TV servicing —

**ALL OUR G-E TEST EQUIPMENT  
COVERS BOTH VHF AND UHF"**



"Dual Use G-E Units Cut Our Invest-  
ment in Half and Double Our Output,"  
reports Pennsylvania serviceman.

"BECAUSE they will perform in VHF and UHF bands, we bought a General Electric Scope, Variable Permeability Sweep and Crystal Controlled Marker Generator. We count this the best investment we ever made. Easy to operate, these units minimize our training problems and increase our work output per man. For trouble-shooting and alignment work you can't beat them."

That's the word from Warren Herbicek and John Mathews, television service engineers of Newton Square, Pennsylvania. You save almost half of your test equipment cost when you use these General Electric units that deliver complete TV service coverage.

With servicemen everywhere it's the same story. Your G-E Test Equipment distributor will be happy to demonstrate. Meanwhile, mail the coupon below for new descriptive bulletins. *General Electric Company, Electronics Park, Syracuse, New York.*

Let Your G-E Equipment Pay Its Way... convenient credit terms can be arranged through your General Electric distributor.

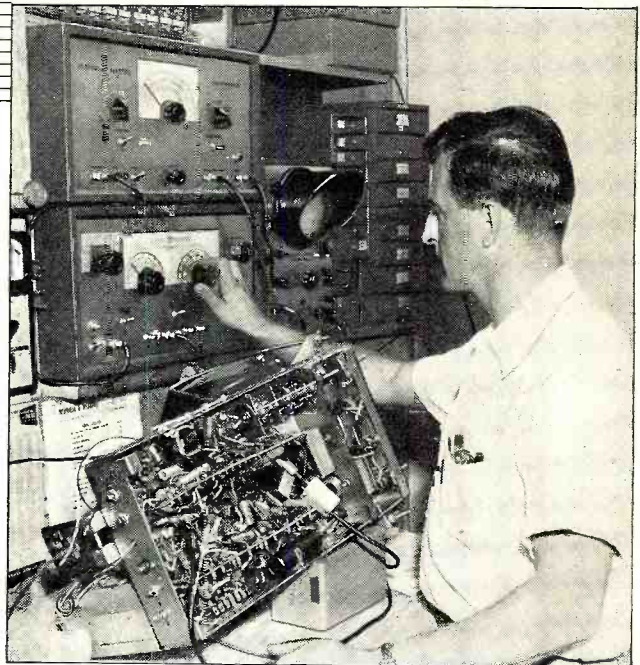

"No equipment does as many jobs so well," agrees partner Herbicek. "It's mighty accurate, too. We've checked our own alignment jobs 6 months later and the instruments show identical patterns."

**SEND FOR  
THESE FREE  
BULLETINS...**



*You can put your confidence in —*

**GENERAL  ELECTRIC**

General Electric Company, Section 9111  
Electronics Park, Syracuse, New York

Yes—send me bulletins with complete information on  
General Electric TV Test Equipment.

NAME.....

ADDRESS.....

CITY.....STATE.....





At

EVERY YEAR A "BANNER" YEAR IN

← 1949

**PENN TOOK THE LEAD  
with Teletower . . .  
World's Best Seller!**

In 1949, Penn got the jump because of engineering and construction advances offered by Teletower. Among these are universal motor mount easily adaptable to *all* antenna rotors . . . exclusive long-life Telecote finish . . . built-in climbing rungs . . . semi-automatic pilot-hole alignment . . . improved T-X section.

**BUILT-IN BASE. Permits  
Raising Tower on Slope  
After Fastening Base to Roof.**

1950



Big boon to installers . . . Penn's introduction in 1950 of a new type built-in base. Heavy plate takes thrust of tower welded to section of pipe. Tower can be raised on severest slope *after* base is fastened to roof. Installation time is saved . . . hazards reduced. Base is permanently attached and non-removable. Protected by Telecote.

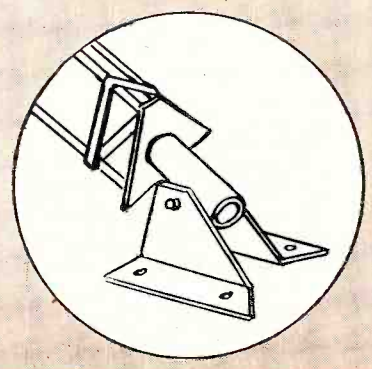

**PENN** Teletowers  
Whiftowers  
enna-Mast

PENN BOILER & BURNER MFG. CORP.  
LANCASTER, PENNSA

"STAY TUNED IN

[www.americanradiohistory.com](http://www.americanradiohistory.com)



*Penn*  
**PRODUCT DEVELOPMENT ENGINEERING**



**NEW TOWER. Supports  
250-lb. Head Load  
Without Guying**

**1951** →

A truly revolutionary development in antenna supports... Penn's new tower that maintains 250-lb. head load without requiring a single strand of guy wire. Erection time: 30 minutes! Sensation of the recent RTMA convention at which it was exhibited. Get the facts on this one while it's "hot"... write Teletowers.

**1950**  
↓

**COMPLETE LINE of Tested  
Tenna-Mast Hardware**

In 1950, Penn introduced its popular Tenna-Mast Hardware. Pole-base mount illustrated is made of durable aluminum. Special construction permits mounting on peak of roof so that erection can be made from either ridge or side. Penn various models of Base mounts accommodate pipe or tubing from 1" to 2".

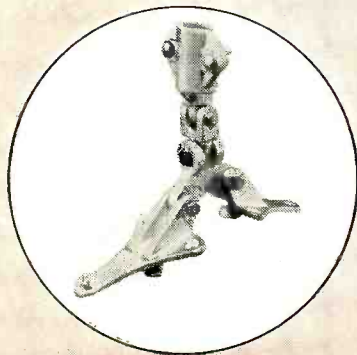

Canadian representative:  
**Atlas Radio Corp., Ltd.**  
560 King St. W.,  
Toronto, Canada.

**WITH TELETOWERS"**

**PENN** Teletowers  
Whiftowers  
enna-Mast

**PENN BOILER & BURNER MFG. CORP.**  
LANCASTER, PENNA.



# A New Idea in Radio Tuners— COLLINS "PRE-FABS" SAVES YOU MONEY

Now you can have a high quality Collins FM Tuner at about half the cost. You buy the basic units which have all been prewired, aligned and factory tested. All you do is assemble these into the punched chassis and wire up the power supply. Yes, it's that easy the Pre-Fab way.

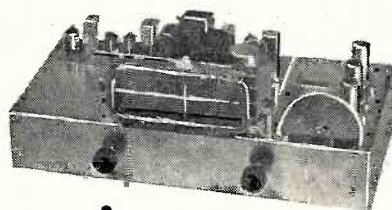

The Collins "Pre-Fab"  
Tuner Assembled.

Here's a combination designed for the pocket as well as the ear... High in quality—low in cost.

**\$3375**

There's no finer tuner available than this Collins Deluxe Combination. Engineered for high quality and yet priced right.

**\$4650**

All Prices Shown Include Tubes

## Choose Any Combination

They are priced for your pocketbook from \$33.75 to \$46.50

**ALL YOU BUY IS** a tuning unit, an IF Amplifier and the universal chassis Kit, which is standard for all combinations. Check the "Pre-Fabs" listed below and make your selection.

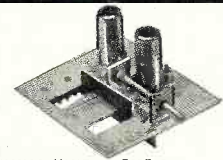

**TUNING UNIT FMF-2**  
Permeability Tuned . . . has two tuned stages using a 6AK5 converter and 6C4 local oscillator **\$1150**

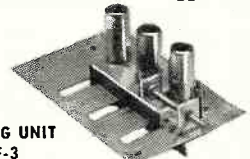

**TUNING UNIT FMF-3**  
Permeability Tuned...has three tuned stages including a 6J6 RF amplifier, 6AK5 converter, and 6C4 oscillator **\$1450**



**IF AMPLIFIER IF-3**  
Employs three tubes terminating in a new type ratio detector circuit **\$875**



**IF AMPLIFIER IF-4**  
Also employs a ratio detector... extra IF stage gives it added gain **\$1225**



**IF AMPLIFIER IF-6**  
Deluxe model . . . has three IF stages, two limiters, and a discriminator type of detector. Superior to any such amplifier on the market in gain and sensitivity. **\$1850**



**UNIVERSAL CHASSIS KIT UC-1**  
Includes a punched chassis, handsome slide rule tuning dial, oversize power transformer, filter condenser, rectifier tube and socket, hardware, volume control and switch, knobs, terminal strips, AC line cord and plug. **\$1350**

Mail—  
Order Coupon  
TODAY!

Collins Audio Products Company, Inc.  
P. O. Box 368, Westfield, N. J.

Enclosed find  check  money order for \_\_\_\_\_

Send me the following "Pre-Fab" Units:

- |  |   |
|--|---|
| <input type="checkbox"/> Tuning Unit FMF-2 | <input type="checkbox"/> IF Amplifier IF-4          |
| <input type="checkbox"/> Tuning Unit FMF-3 | <input type="checkbox"/> IF Amplifier IF-6          |
| <input type="checkbox"/> IF Amplifier IF-3 | <input type="checkbox"/> Universal Chassis Kit UC-1 |

Name \_\_\_\_\_

Address \_\_\_\_\_

City & State \_\_\_\_\_



# Golden Opportunity to prepare for better pay jobs in Television Servicing

for men in  
radio-electronics



### YOU STUDY AT HOME

In your spare time, you learn pre-tested "How-to-do-it" techniques with "How-it-works" information in easy-to-study lessons. The course is based on the experience of the RCA Service Company in servicing thousands of home television receivers.

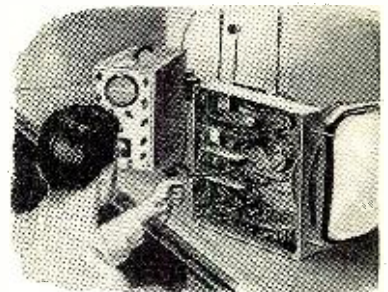

### YOU KEEP WORKING ON YOUR JOB

Because you work in the radio-television-electronics industry, your job provides the laboratory work of the course. There are no kits, parts or equipment to buy. Self-employed independent radio and television servicemen are eligible for enrollment.

No vocational field offers more opportunities for "career" jobs and good pay than television—America's fastest growing industry. The demand for TRAINED and EXPERIENCED TV SERVICEMEN is growing. There is a big shortage of such men now and will be for several years to come.

### PLENTY OF GOOD JOBS OPEN TODAY

Radio-Television jobbers, dealers and service companies offer lifelong opportunities with excellent salaries for qualified service technicians. Manufacturers of television receivers are looking for men with good service training as inspectors, testers and troubleshooters. Many experienced servicemen go into business for themselves. Others hold their regular jobs and earn extra money servicing TV receivers in their spare time.

Radio-electronics manufacturers busy with defense equipment contracts offer excellent job opportunities for men with a television technician background. Servicemen called into military service are further reducing the supply of skilled TV servicemen available for civilian activities. Think what television servicing offers *you* in terms of a lifetime career and financial security.

### RCA INSTITUTES Home Study Course in TELEVISION SERVICING—

#### A Service to the Industry

Because of the critical shortage of TRAINED and EXPERIENCED TV SERVICEMEN, RCA Institutes is offering this highly specialized and practical home study course as a service to the working members of the radio-television-electronics industry. Its object is to train more *good* servicemen and to help make good servicemen *better*.

Never before has this course been available to anyone outside of RCA. It is now offered to *you*, through RCA Institutes, one of America's oldest and most respected technical training schools. The course covers most major makes and types of TV receivers. Available exclusively to men in the radio-television-electronics field. Not offered to the general public, or under G.I. Bill.

The cost is low . . . only \$9 a unit for 10 units or \$90 total, on an easy pay-as-you-learn plan. At successful completion of the course you earn an RCA Institutes certificate that can lead straight to a better job at higher pay.

RCA Institutes conducts a resident school in New York City offering day and evening courses in Radio and TV Servicing, Radio Code and Radio Operating, Radio Broadcasting, Advanced Technology. Write for free catalog on resident courses.

**SEND FOR FREE BOOKLET.** Find out complete details of the RCA INSTITUTES Home Study Course in TELEVISION SERVICING. Don't pass up this opportunity to prepare yourself for a money-making career in the television industry. Illustrated booklet explains all the features of the course. Mail coupon in an envelope or paste on a penny postcard—NOW!

## MAIL COUPON NOW!

RCA INSTITUTES, INC.  
Home Study Department, RN-1151  
350 West Fourth Street, New York 14, N.Y.

Without obligation on my part, please send me copy of booklet "RCA INSTITUTES Home Study Course in TELEVISION SERVICING." (No salesman will call.)

Name \_\_\_\_\_ (Please Print)

Address \_\_\_\_\_

City \_\_\_\_\_ Zone \_\_\_\_\_ State \_\_\_\_\_



**RCA INSTITUTES, INC.**  
A SERVICE OF RADIO CORPORATION of AMERICA  
350 WEST FOURTH STREET, NEW YORK 14, N.Y.



# new!



ACTUAL SIZE

## PYRAMID TINY TYPE 85LPT TUBULAR PAPER CAPACITORS

Fit anywhere!

Suitable for  
85°C. operation!

CAPACITANCE RANGE:  
.0001 TO .5 MFD.

VOLTAGE RANGE:  
200 TO 600 V., INCLUSIVE

Sturdily built in phenolic-impregnated tubes. Ends are plastic-sealed.

WRITE FOR COMPLETE LITERATURE  
Representatives and Distributors  
Throughout the U.S.A. and Canada



## PYRAMID

### PYRAMID ELECTRIC COMPANY

1445 Hudson Boulevard.  
North Bergen, N. J., U. S. A.

TELEGRAMS: WUX North Bergen, N. J.  
CABLE ADDRESS: Pyramidusa

# Within the INDUSTRY

**EDWARD M. TUFT** has been named to the newly created post of vice-president in charge of organizational development for the *RCA Victor Division of Radio Corporation of America*.



Mr. Tuft will coordinate a company-wide program designed to develop the resources of qualified manpower required for the continued expansion and development of the activities of the division.

He has served as director of personnel for the division since 1947 and as a vice-president of the organization since last October.

\* \* \*

**HOFFMAN RADIO CORP.**, operator of seven plants in Los Angeles and Pasadena, has opened warehouses in New York and Chicago. The New York offices are at 30 Church Street while Chicago facilities are at 219 E. North Water Street... **HI-LO ANTENNA CORPORATION** has completed a new plant adjacent to the company's plant at 3540 N. Ravenswood Avenue in Chicago. The additional space will enable the firm to triple its production of antennas... Limited defense production has started at the new **WESTINGHOUSE ELECTRIC CORPORATION** Television-Radio Division plant near New Brunswick, New Jersey... **NEOMATIC, INC.**, has doubled its capacity for the production of electronic components by moving into larger quarters at 11632 San Vicente Blvd., Los Angeles 49, California... A new wing providing approximately 7000 square feet of floor space is being added to the dry type air-cooled transformer plant of **ACME ELECTRIC CORPORATION** at Cuba, New York... **VERIBEST ELECTRONICS COMPANY** is now in production at its new plant located at 655 Main Street, Westbury, Long Island, New York.

\* \* \*

**NARDA**, the National Appliance & Radio Dealers Association, was recently honored by the American Trade Association for outstanding services rendered to the public by a trade association.

The "Award of Merit" was "For its excellent services to its industry and the public and especially for its aggressive campaign to protect the buying public and assure it the best installation and maintenance service possible for television sets. The Association set up high standards, clearly phrased so that both dealers and the public could understand them. They

were designed to eliminate certain unhealthy conditions within the industry and to promote a sound public relations policy."

A jury headed by Charles Sawyer, Secretary of Commerce, made the selection.

\* \* \*

**RADIO & ELECTRONICS SOCIETY OF INDIA** is making plans to hold an International Exhibition in Bombay, February 9 to 29, 1952.

The Society hopes that this exhibition will provide radio and electronic equipment manufacturers throughout the world with an opportunity to study the requirements of the Indian and Asian markets and thus establish new and profitable contacts.

Major exhibits will include radio and television receivers, component parts, facilities for servicing and training, x-ray and other medical equipment, aviation radio devices, etc.

Complete details on the exhibition are obtainable from the Consulate General of India, 3 East 64th Street, New York 21, New York.

\* \* \*

**WILLIAM M. NAVE** of Owensboro has been named works manager of the



*General Electric Company's* new electronic tube plant now under construction near Anniston, Alabama.

He will be in charge of the more than 2000 workers who will produce

miniature receiving tubes at the new \$6,000,000 plant.

Mr. Nave began his employment with the *Ken-Rad Tube and Lamp Company* in Owensboro in 1938. When the company was purchased by *General Electric* he became assistant superintendent of the Tell City, Indiana, tube works of the company in 1945, later becoming superintendent.

He will take up his duties in Anniston soon after the first of the year. The plant is expected to be finished by February, 1952, and production will start approximately one month later.

\* \* \*

**RTMA** has inaugurated a new program designed to assist small manufacturers in the radio-television industry, especially in the procurement of sub-contracts for military production.

The Small Business Survey Committee, headed by A. D. Plamondon, Jr., president of *Indiana Steel Products Co.*, has made a survey of the production facilities of RTMA member-companies available for defense work. This data will be forwarded to

**RADIO & TELEVISION NEWS**





# Service Clinic!

Engineering information to help you better service Raytheon

**Gated automatic gain control** has been specially designed for use in TV receivers. This type of A. G. C. is superior because it utilizes a gating horz.-pulse plate supply that eliminates approx. 87% of the noise admittance into the A. G. C. system. Note that the local noise interference shown in Fig. 2 can only be effective during the gated  $I_p$  conduction area shown in Fig. 1 and here the station sync. tips are noise clipped by the 1st video amplifier grid cut-off.

**Gated or keyed A. G. C.** also has another important operating characteristic. The plate gating pulse, being of a time interval corresponding to the station horz. sync. pulse, gates out the station vertical sync. pulse. This greatly reduces the amount of 60 cy component which would normally be injected into the A. G. C. filter. Thus a filter of faster time-constant may be used to reduce airplane flutter.

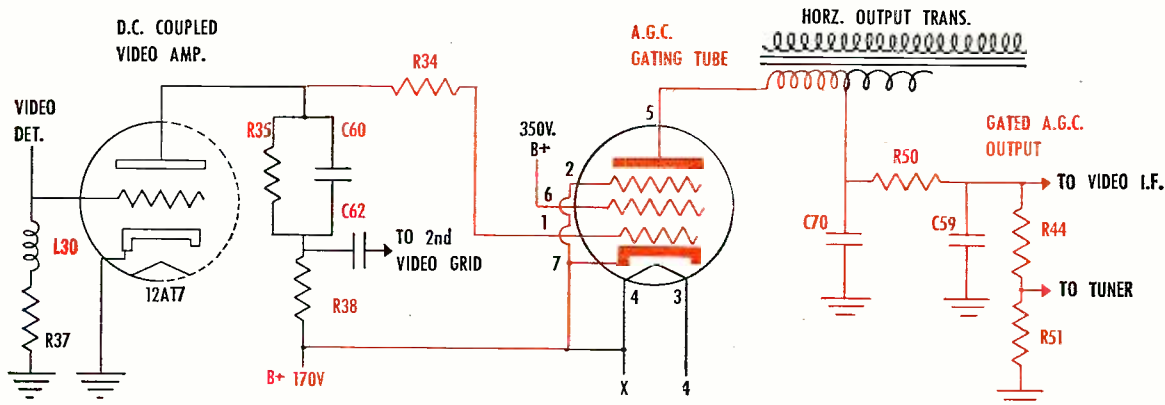

Raytheon's gated A. G. C. circuit above uses a 6AU6 gating tube that is D. C. coupled to the video detector through the 1st video amplifier. The only plate supply is the pulse furnished by the horz. output transformer as shown in Fig. 1. Note that the cathode of the gating tube is tied to B+ (170 volts) and that the grid is directly coupled to the plate of the 12AT7 through R34 (R34 reduces grid loading effects on video response). The input signal and D. C. voltage drop (bias), in Fig. 2, developed across the 12AT7 plate load (R35, C60 and R38) are applied between the grid and cathode of the gating tube. The plate current supplied by the horz. output transformer passes through the A. G. C. filter (C70, R50 and C59) developing the negative A. G. C. output voltage across R44 and R51.

**Improved circuitry** such as this is one of many reasons why you can feel free to recommend Raytheon TV to a friend or a customer.

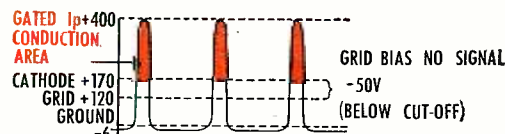

FIG. 1—INSTANTANEOUS PLATE VOLTAGE

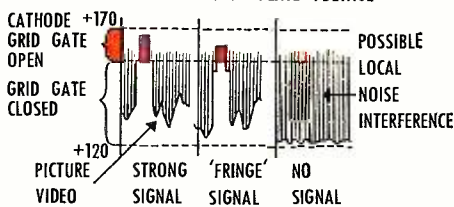
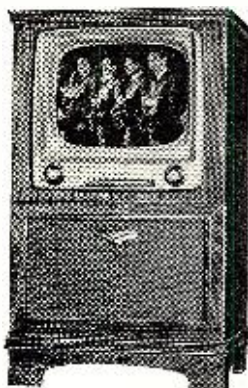

FIG. 2—INSTANTANEOUS GRID VOLTAGE



Dependably Built for Dependable Performance



Belmont Radio Corp., 5921 W. Dickens Ave., Chicago 39, Ill.  
Subsidiary of Raytheon Manufacturing Co.

Raytheon TV Presents  
**JOHN CAMERON SWAYZE**  
Sundays on NBC. See local  
paper for time and station.

THE STARLIGHT—Model RC-1720





**NO. BO-11**

The new CHICAGO No. BO-11 output transformer is now being used effectively in 40 to 60 watt high-fidelity amplifiers with outstanding success. Designed particularly for use with 807's, 3C33's (dual triode), WE300's, 6AR6's and similar tubes. Frequency response is essentially flat—with in .5 db—from 20 to 20,000 cycles.

**NEW CHICAGO**

**40-60 WATT  
FULL FREQUENCY  
Output Transformer**

**.5 db 20-20,000 CPS**  
for use with 807's,  
3C33's, WE300's, 6AR6's  
and similar type tubes

**SPECIFICATIONS**

Primary\*—3000/2500 ohms CT  
Secondary\*—600/16/8 ohms CT and  
150/4 ohms

\*Split and balanced windings

Operating level—40 to 60 watts. Mounted in one-piece drawn steel case, 4 3/8" x 4 1/2" x 5 5/8" high; with mounting studs and convenient pin-type terminals. Weighs 9 1/2" pounds.

**There's a CHICAGO Output Transformer for Every Full Frequency Use**

Cat. No.	Application	Impedance	Max. Power
BO-1	Single Plate to line	Pri.—15,000 ohms at 0 to 10 ma d-c *Sec.—600/150 ohms CT.....	+20 dbm
†BO-4	P.P. Plates to line	Pri.—7,500 ohms CT *Sec.—600/150 ohms CT.....	+43 dbm
BO-5	P.P. Plates to line	Pri.—10,000 ohms CT *Sec.—600/150 ohms CT; 16/8/4 ohms.....	+37 dbm
†BO-6	P.P. Plates to voice coil	Pri.—7,500 ohms CT *Sec.—8/20 ohms.....	+43 dbm
BO-9	P.P. Plates to line or voice coil	Pri.—5,000/3,000 ohms CT *Sec.—600/16/8 ohms CT; 150/4 ohms.....	+42 dbm

†Tertiary winding provides 15% inverse feedback. \*Split and balanced windings

**HIGH Q  
CHOKES  
for Dynamic  
Noise Suppression Circuits**



Two precision-built chokes with inductance values of .8 and 2.4 henrys respectively—accurate to within  $\pm 5\%$  with up to 15 ma d-c. Units have a minimum Q of 20. Remarkably compact, 1 1/8" x 2 3/8" x 1 1/8".

No.	Inductance
NSI-1	.8 h
NSI-2	2.4 h

**Famous "Sealed in Steel"  
New Equipment Line**

The units described above are typical of CT's New Equipment Line featuring transformer engineering that's ahead of the trends in circuit design. Get the full facts on the complete line now. Check the features, and you'll see why CT is called the "Engineer's Transformer." Check the prices; see how little more these advanced units cost over ordinary transformers.

Write for Complete "New Equipment" Catalog Today



**CHICAGO TRANSFORMER**

DIVISION OF ESSEX WIRE CORPORATION

3501 ADDISON STREET • CHICAGO 18, ILLINOIS



prime contractors and subcontractors who have indicated their need for suppliers of specific types.

RTMA is the first trade association to undertake a program of this type for its membership.

\* \* \*

**RICARDO MUNIZ**, formerly with the Allen B. Du Mont Laboratories, Inc.,



has been appointed vice-president in charge of operations of Trad Television Corporation of Asbury Park, New Jersey.

As general manager of Du Mont's television receiver manufacturing division, he had full responsibility for the production of all television equipment as well as the engineering on television receivers and military equipment.

In his new position he will be in complete charge of engineering and production functions, including government contracts, domestic television production, and the company's theater television set.

\* \* \*

**RADIO PARTS & ELECTRONIC SHOWS, INC.** board of directors, meeting in a three-day session in Asheville, North Carolina, named Charles A. Hansen of Jensen Mfg. Co., president; Sam L. Baraf, United Transformer Co., vice-president; W. D. Jenkins, Radio Supply Co., secretary; and Lew W. Howard, Triad Transformer Mfg. Co., treasurer.

Dates for the four-day 1952 Show to be held in Chicago were set for the week of May 18th. The board also voted to increase its membership from nine to fourteen members.

\* \* \*

**BARTON K. WICKSTRUM** has been elected to the post of vice-president and director of sales of Sylvania Electric Products Inc.



He was formerly general sales manager of the company's Lighting Division and succeeds Robert H. Bishop who resigned to become a vice-president of E. F. Drew & Co., Inc.

Mr. Wickstrum has been associated with the company since 1939 and prior to that time was with Libby, McNeill & Libby and Hearst Enterprises, Inc.

\* \* \*

**BERNARD HECHT** has been appointed general manager of Starrett Television Corporation of New York . . . The new vice-president and treasurer of Motorola Inc., is **E. P. VANDERWICKEN**. He succeeds **GEORGE R. MACDONALD** who is retiring as of December 31st . . . **HOWARD ROWLAND** has been named chief research engineer of The Workshop Associates. He was formerly chief electrical engineer for

(Continued on page 157)

**RADIO & TELEVISION NEWS**



# NEW PARA-CON ANTENNA COMBINES PARABOLIC & CONICAL PRINCIPLES



Barbara Lee—Wining TV Star, WEWS Cleveland

## Sight Sells It

After all, people buy TV sets to enjoy the picture. It just makes sense that the antenna bringing in the best picture brings in the best entertainment and the most customer satisfaction. Hook a Para-Con onto any set and you'll agree—it sells on sight.

## Any TV Set Performs Better With a Para-Con Antenna

Every set performs better when conditions are better. Install Para-Con when older sets are starving for a stronger signal. Install a Para-Con when any set is being drowned in a sea of local interference. In the majority of set installations, Para-Con makes both old and new sets perform at their peak. To be on the safe side every time, install the sensationally performing new Para-Con antenna and forestall TV troubles at both the reception and the service end.

## Proved in Thousands Of Installations

Spectacular success has been achieved in practically every installation. Even in locations far removed and in difficult terrain where other more elaborate arrays were tried and failed, PARA-CON aerials not only bring in brighter, clearer pictures but seize and channel in stations where dependable reception has not been possible with an ordinary antenna. Ward's new PARA-CON Antenna has been field tested in thousands of installations . . . proved far and away better.

## Singles Out The Stations

### High Front to Back Ratio

The new Para-Con design achieves an unusual capacity to obtain sharp directivity over all the television spectrum. Para-Con principles afford greater power and less interfering noise on each channel.

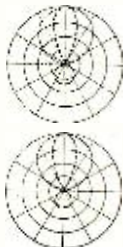

## One Antenna Covers All Channels

The Para-Con antenna reaches out and grasps all channels. The Ward Para-Con has an exceptionally low standing wave ratio combined with a spectacular high gain advantage on all channels.

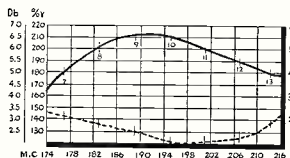
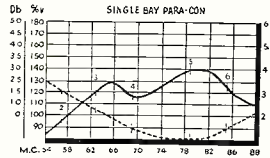

## No Ghost Hunts

No more skeletons in your customer's TV closets. Scientifically determined direct impedance matching characteristics eliminate many ghosts. Para-Con's revolutionary design transfers the maximum power from the antenna to the receiver with a minimum of reflections.

## Profit-Wise Dealers Prefer Para-Con\*

The antenna is one of the most important and critical components of a TV receiver. Nearly 20% of all TV service calls result from faulty antennas. The general all-around, high performance of Ward's Para-Con antenna gives customer satisfaction right from the initial installation. Expensive call-backs due to antennas are slashed. Ruggedly built for long lasting trouble-free service Para-Con withstands winds and weather. Easy to handle and quick to install . . . saves time and expense.

See your distributor for Ward's answer to your antenna problems.

\*Trade Mark

## Solves 9 out of 10 Installation Problems—Challenges Comparison

Two best features are incorporated into one BEST antenna. The praiseworthy features conical type aerials possess for supplying full audio and full video bandwidth reception are used with a parabolic design that gives the Para-Con a concentration of signals. Para-Con is engineered to concentrate the maximum wave energy on the antenna by providing all-around, unmatched performance . . . perfect picture clarity . . . long customer satisfaction.

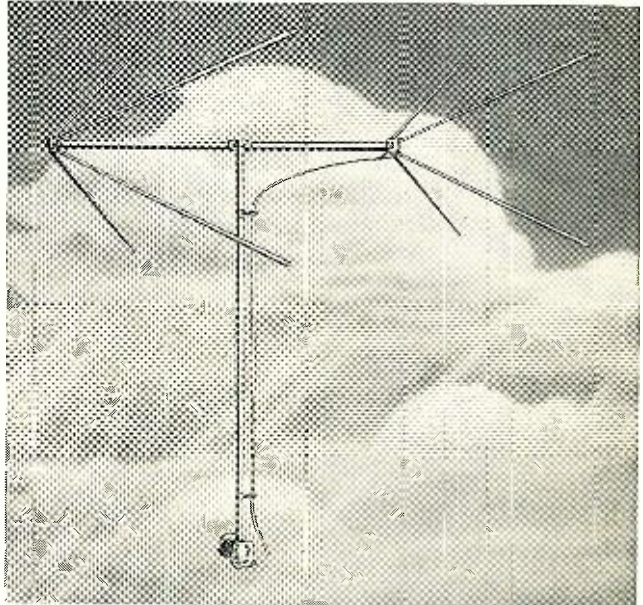

## The First In TV To Use Parabolic Principle

Parabolic antennas have long been used in special applications for concentrating weak signals onto driven elements. The brilliant results of Ward Para-Con are now setting new performance standards on all channels and in most every area. Ward's Para-Con Antenna is different. It's new. Now it is possible for one antenna to meet and solve many of the local problems of installation and reception.

## Ideal For All Band Fringe Areas

In fringe areas where selection of a number of channels is available, Ward's stacked Para-Con models provide the ideal compromise antenna for maximum results on all bands. Stacked in either two or four bay arrays, the Parabolic design reflectors reach out, gather and concentrate maximum energy on the antenna elements.

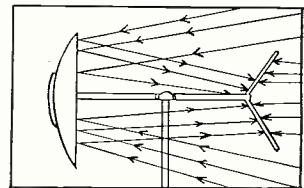

Diagrammatic sketch showing how parabolic reflectors gather in and concentrate energy on conical elements.

# WARD

## PARA-CON

(Combining Parabolic and Conical Principles)

# ANTENNAS

THE WARD PRODUCTS CORPORATION, Division of The Gabriel Co.  
1523 E. 45th Street, Cleveland 3, Ohio  
IN CANADA: ATLAS RADIO CORP., LTD., TORONTO, ONT.



# Want To Double Your Pay?



## How To Pass **FCC** **COMMERCIAL** RADIO OPERATOR **LICENSE** **EXAMINATIONS**

**GET THIS AMAZING NEW BOOKLET FREE!**

**TELLS HOW—**

**WE GUARANTEE**

TO TRAIN AND COACH YOU AT HOME  
IN SPARE TIME UNTIL YOU GET

**YOUR FCC LICENSE**

If you have had any practical experience—Amateur, Army, Navy, radio repair, or experimenting.

**TELLS HOW—**

Employers make

**JOB OFFERS Like These**

**to Our Graduates Every Month!**

Telegram, August 9, 1950, from Chief Engineer, Broadcast Station, Pennsylvania, "Have job opening for one transmitter operator to start immediately, contact me at once."

Letter, August 12, 1950, from Dir. Radio Div. State Highway Patrol, "We have two vacancies in our radio Communication division. Starting pay \$200; \$250 after six months' satisfactory service. Will you recommend graduates of your school?"

Letter, August 24, 1950, from radio-television sales and service company, Ohio, "We are in need of a good television man. The pay will be good, also good surroundings to work in. Please let us hear from you."

These are just a few examples of the job offers that come to our office periodically. Some licensed radioman filled each of these jobs . . . it might have been you!

**HERE'S PROOF FCC LICENSES ARE OFTEN SECURED IN A FEW HOURS OF STUDY WITH OUR COACHING AT HOME IN SPARE TIME**

Name and Address	License	Lessons
Lee Worthy 2210 1/2 Wilshire St., Bakersfield, Calif.	2nd Phone	16
Clifford E. Vogt Box 1016, Dania, Fla.	1st Phone	20
Francis X. Foerch 38 Beuler Pl., Berginfield, N. J.	1st Phone	38
S/Sgt. Ben H. Davis 317 North Roosevelt, Lebanon, Ill.	1st Phone	28
Albert Schoell 110 West 11th St., Escondido, Calif.	2nd Phone	23

**CLEVELAND INSTITUTE OF RADIO ELECTRONICS**  
Desk RN-35, 4900 Euclid Bldg., Cleveland 3, Ohio

**TELLS HOW—**

**Our Amazingly Effective  
JOB-FINDING SERVICE**

**Helps CIRE Students Get Better Jobs**

Here are a few recent examples of Job-Finding results:

**GETS CIVIL SERVICE JOB**

"Thanks to your course I obtained my 2nd phone license, and am now employed by Civil Service at Great Lakes Naval Training Station as an Equipment Specialist."  
Kenneth R. Leiser, Fair Oaks, Mtd. Del., McHenry, Ill.

**GETS STATE POLICE JOB**

"I have obtained my 1st class ticket (thanks to your school) and since receiving same I have held good jobs at all times. I am now Chief Radio Operator with the Kentucky State Police."  
Edwin P. Healy, 264 E. 3rd St., London, Ky.

**GETS BROADCAST JOB**

"I wish to thank your Job-Finding Service for the help in securing for me the position of transmitter operator here at WCAE, in Pittsburgh."  
Walter Koschik, 1442 Ridge Ave., N. Braddock, Pa.

**GETS AIRLINES JOB**

"Due to your Job-Finding Service, I have been getting many offers from all over the country, and I have taken a job with Capital Airlines in Chicago, as a Radio Mechanic."  
Harry Clare, 4537 S. Drexel Blvd., Chicago, Ill.

**OURS IS THE ONLY HOME STUDY COURSE WHICH SUPPLIES FCC-TYPE EXAMINATIONS WITH ALL LESSONS AND FINAL TESTS.**

Your FCC Ticket is always recognized in all radio fields as proof of your technical ability.

**Get All 3 FREE**

**MAIL COUPON NOW**

**CLEVELAND INSTITUTE OF RADIO ELECTRONICS**  
Desk RN-35—4900 Euclid Bldg.  
Cleveland 3, Ohio

(Address to Desk No. to avoid delay.)

I want to know how I can get my FCC ticket in a minimum of time. Send me your FREE booklet, "How to Pass FCC License Examinations" (does not cover exams for Amateur License), as well as a sample FCC-type exam and the amazing new booklet, "Money-Making FCC License Information."

Name .....

Address .....

City ..... Zone ..... State .....

Paste on penny postcard or send air mail.

**RADIO & TELEVISION NEWS**



# YOU ARE HELPING TO BUILD THIS PLANT!

Your increasing demand for Hytron tubes is helping to build this fine, ultra-modern plant. Located at Danvers, Massachusetts, it will be the most modern receiving-tube plant that engineering know-how can build.

And this is more important to you. Its advanced equipment and skilled staff will — we promise — give you the best tubes your money can buy. Because Hytron sincerely believes only the best is good enough for you.

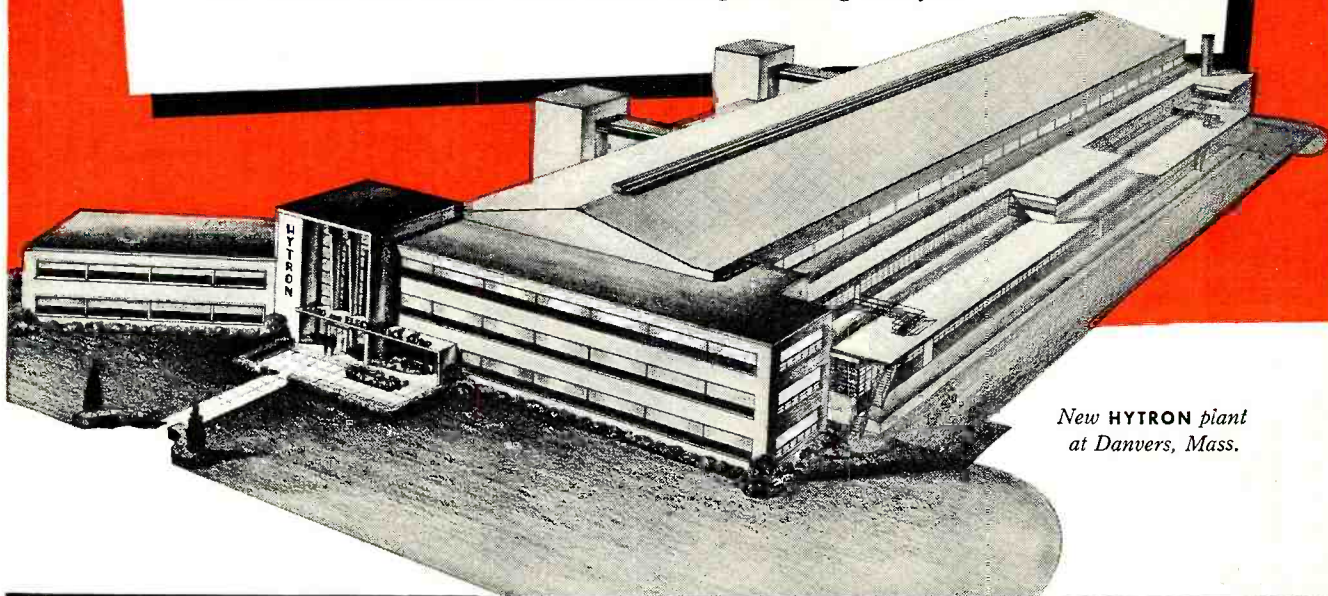

*New HYTRON plant at Danvers, Mass.*



## NEW NAME ADDED

The famous red-white-and-blue Hytron carton has added a famous symbol: CBS. Yes, Hytron is proud to be a division of the Columbia Broadcasting System, Inc. — with greatly expanded opportunities to grow in service to you. Two respected names now guarantee you unsurpassed tube performance. CBS-Hytron is your sign of the very best in electronic tubes. Look for the attractive carton. Be sure to demand the best: CBS-Hytron.



MAIN OFFICE: SALEM, MASSACHUSETTS



# EICO

TEST INSTRUMENTS

# Guard

CBS-Columbia Inc.  
COLOR TELEVISION PRODUCTION QUALITY

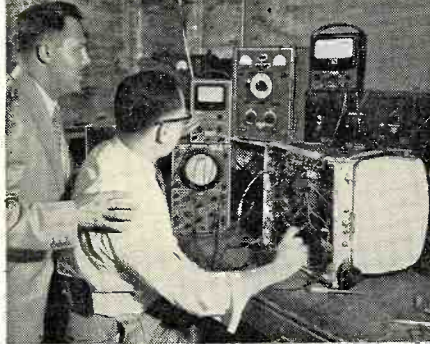

In the CBS-Columbia design laboratories, Al Goldberg takes some important readings with the EICO Model 221 Vacuum Tube Voltmeter and Model 555 Multimeter, as Harry R. Ashley looks on.



Mr. Al Goldberg, Assistant Chief Engineer of CBS-Columbia, and Harry R. Ashley, President of EICO, inspecting the use of the EICO Model 221 Vacuum Tube Voltmeter and Model HVP-1 High Voltage Probe at the Sweep Frequency Troubleshooting Position on the CBS-Columbia Color Television production lines.



**NEW**  
221K VTVM KIT \$25.95  
WIRED \$49.95



HIGH VOLTAGE  
PROBE \$6.95

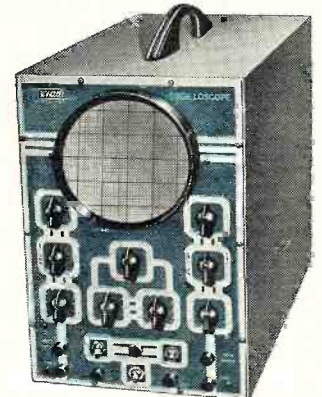

**NEW**  
425K 5" PUSH-PULL  
SCOPE KIT \$44.95. WIRED \$79.95

## KITS WIRED INSTRUMENTS



**NEW** 555K MULTIMETER  
KIT \$29.95. WIRED \$34.95  
20,000 ohms/volt

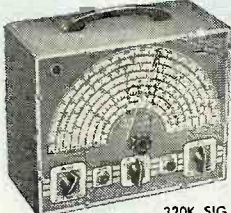

320K SIG.  
GEN. KIT \$19.95. WIRED \$29.95

**NEW** 322K SIG. GEN.  
KIT \$23.95. WIRED \$34.95



**NEW** 950K R-C BRIDGE &  
R-C-L COMP. KIT \$19.95  
WIRED \$29.95



**NEW** 1040K BATTERY ELIM.  
KIT \$25.95. WIRED \$34.95

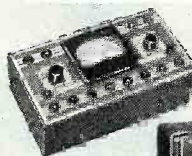

511K VOM  
KIT \$14.95  
WIRED  
\$17.95



**NEW** 526K MULTI-  
METER KIT \$13.90  
WIRED \$16.90  
1000 ohms/volt



**NEW** 1171K RES.  
DECADE BOX KIT  
\$19.95  
WIRED \$24.95

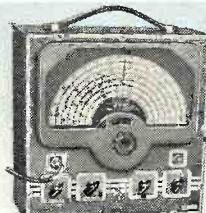

**NEW** 315K DELUXE SIG.  
GEN. KIT \$39.95  
WIRED \$59.95



**NEW** 625K  
TUBE TESTER KIT \$34.95  
WIRED \$49.95

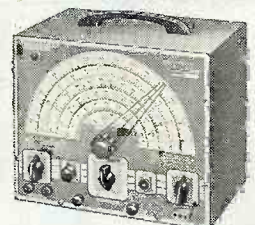

360K SWEEP GEN. KIT \$34.95  
WIRED \$49.95

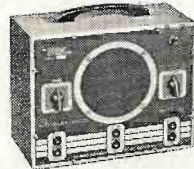

145K SIG.  
TRACER KIT  
\$19.95  
WIRED  
\$28.95

For Laboratory Precision at Lowest Cost—  
the Leaders Look to **EICO!**

**WHY** does CBS-Columbia, Inc., today's headline-maker in Color Television set production, use EICO Test Instruments on its new Color Television production lines and in its design laboratories?

**BECAUSE** — like Emerson, Tele-King, Teletone, and many another famous TV manufacturer coast to coast, CBS-Columbia knows that ...

**Only EICO Test Equipment delivers  
All 10 EICO nomical Features!**

1. Laboratory Precision
2. Lowest Cost
3. Lifetime Dependability
4. Speedy Operation
5. Rugged Construction
6. Quality Components
7. Latest Engineering
8. Super-Simplified Assembly and Use Instructions
9. Laboratory-Styled Appearance
10. Exclusive EICO Make-Good Guarantee

Before You buy any higher-priced equipment, be sure You look at the **EICO** line—in **Wired** as well as **Kit form!** Each EICO product is jam-packed with unbelievable value. **YOU** be the judge—compare, see **EICO instruments today** — in stock at your local jobber — and **SAVE!** Write **NOW** for **FREE** newest Catalog 11-R.

**FOLLOW THE LEADERS . . . INSIST ON EICO!**

# EICO

ELECTRONIC INSTRUMENT CO., Inc.  
276 NEWPORT STREET, BROOKLYN 12, NEW YORK

©1951, Electronic Instrument Co., Inc.  
Prices 5% higher an West Coast. Due to unstable conditions, prices and specifications are subject to change without notice.



**Beautiful designs—yet a major problem with any custom-built installation is to make provision for fast, easy servicing.**

**D**ISCRIMINATING persons who are willing to pay for custom audio-television equipment for their homes demand more of their installations than the buyer of manufactured units—and rightly so.

In most instances those who request the services of custom designers do so because of special architectural problems that must be overcome or because of unusual effects they wish to achieve.

Combining the finest high-fidelity equipment with top quality remote-controlled video components—and then blending the whole system into an architecturally-sound built-in cabinet may sound like a glamorous occupation—but it is, in reality, a fairly complicated operation.

To perform this exacting job, a happy working combination of many talents is essential. First, architectural problems must be solved. How many square feet of floor space can be allotted? Where can the speaker chamber

# Custom AUDIO-TV SYSTEMS

By  
**IRV ROSE**

Voice and Vision, Inc.

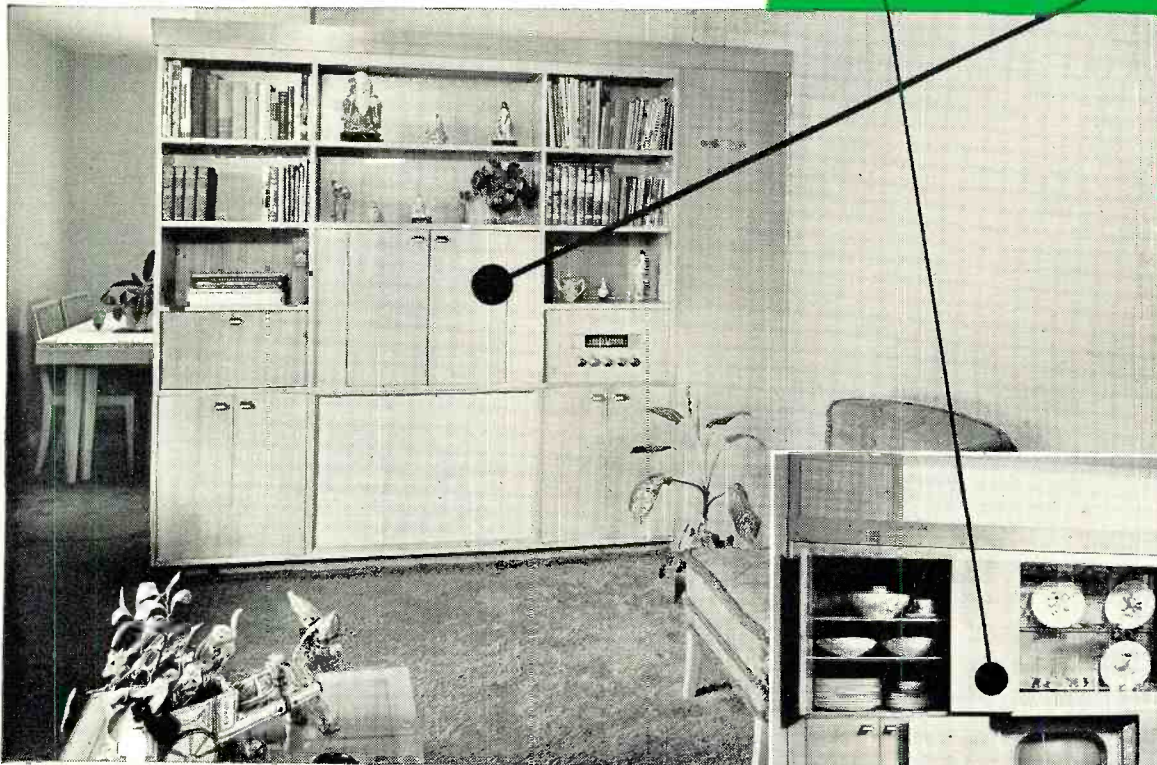

The dining room side of the custom installation is shown below. China, glassware, and silver storage space is provided along with an auxiliary speaker for use when TV set is in this position.



The living room side of the living room-dining room divider storage wall. The cabinet is constructed of bleached mahogany and incorporates a Radio Craftsmen 101 TV tuner chassis with a 17" picture tube mounted in a turntable cabinet. The cabinet turns 180 degrees to provide reception in both the dining and the living rooms. All leads from the TV compartment are fed through the top bearing. The back of the television compartment is of perforated Masonite and is readily removable for servicing. The cabinet also houses a record player on a pull-out drawer which is located behind doors below the radio tuner. The speaker compartment is below the television unit. A bass reflex speaker unit, the baffle is covered with Pandanus. The door to the left of the television set encloses a drop-leaf desk with pigeon holes behind. Below the desk space is a record storage bin. This entire installation replaced an unsightly divider wall which originally housed ordinary kitchen cabinets on dining room side of wall and provided much-needed storage room.



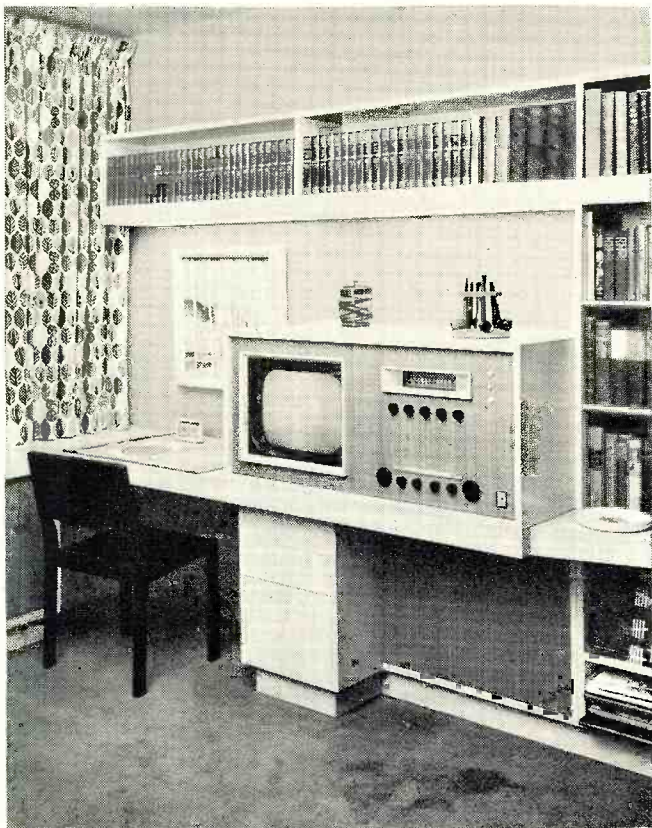

Custom built-in TV and radio system featuring a 16" rectangular picture tube and an AM-FM radio. All electronic units are mounted on special slide-out assemblies to provide maximum accessibility for servicing. The TV panel, loudspeaker grille, and sliding doors under the window are covered with horsehair fabric. Ventilation for the TV-radio unit is provided by a cold air inlet under the desk and a wooden louvered outlet on the top of the cabinet.

A custom installation in which period cabinets flank the living room doorway. The problem here was to design twin breakfronts which would not only add to the decor but would cover unsightly radiators and holes in the wall left by the removal of recessed book shelves. The recess in the wall permitted the use of a 20" tube although the cabinets are only 14" deep. Wire grille doors provide access to the radiators. Heat from the radiators is isolated with steel baffles and asbestos. The system incorporates an Altec-Lansing AM-FM radio and a Radio Craftmen TV tuner with 20" tube. The picture tube is mounted in a swivel compartment while the tuner chassis slides out on ball bearing gliders. The loudspeaker is mounted above the television set and serves the radio-phonograph unit. TV chassis is removable from the front. The cabinet is finished in antique pine.

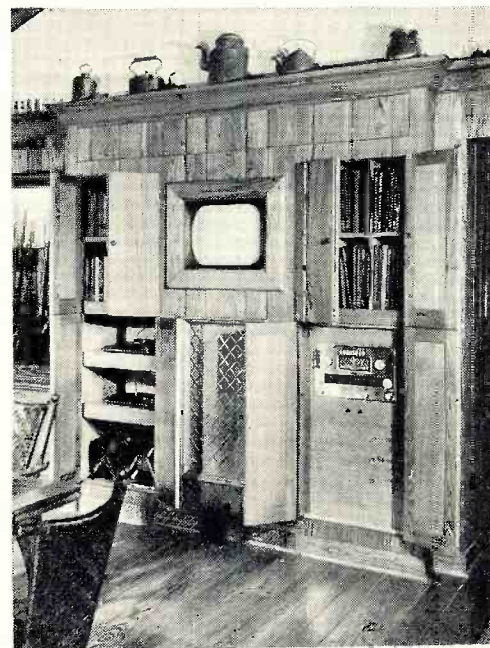

A sportsman's den completely paneled in wormy chestnut. All radio and TV servicing is done through side panel on right near the door. The chassis compartment is vented by flue-action created by holes in ceiling and floor. This complete entertainment center has a Du Mont 20" custom TV chassis, an Altec-Lansing 604B speaker and a movie screen which pulls down from a compartment installed above picture tube.





Bleached mahogany breakfront installation. The doors are covered with cane so that the FM can be received without opening the doors. The unit incorporates a bar while the top drawer of the center section pulls out to form desk. The TV set can be removed from the front for servicing. The Pandanus-covered loudspeaker grille blends with woodwork. The equipment employed in this installation includes a Du Mont 19" TV set with FM, a Webster changer, Pickering cartridges, an Altec-Lansing amplifier, a Scott dynaural preamp, and Altec-Lansing 604B speaker.

A complete home entertainment center built into a remodeled entrance-way alcove. The cabinet work is all of bleached mahogany paneling. The unit incorporates bookcases, magazine racks, photographic equipment storage, a built-in movie screen, which pulls down, a Du Mont 19" TV set with FM, a Webster changer, Pickering cartridges, Altec-Lansing amplifier, a Scott dynaural preamp, and an Altec-Lansing 604B speaker.

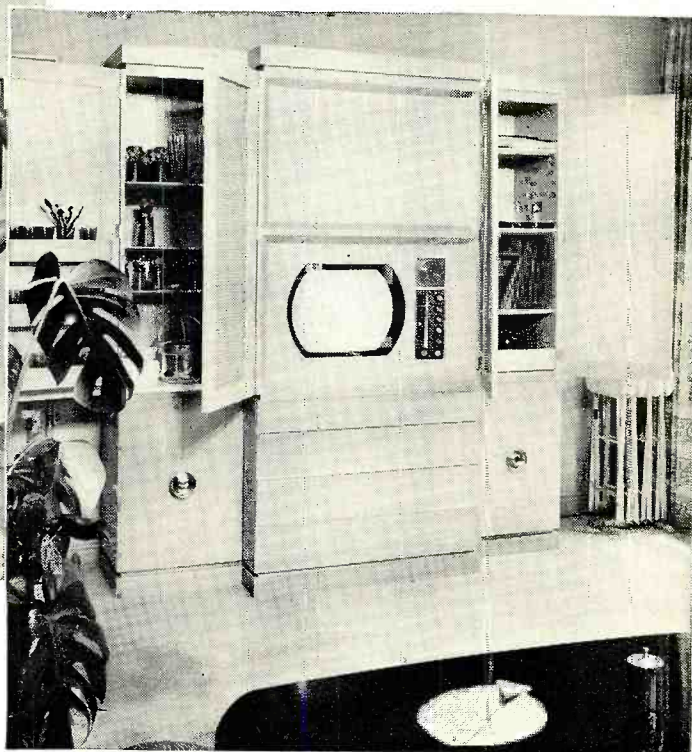

and good. There is no book of rules to follow as each installation is unique. No two custom installations are alike and a highly skilled, highly paid service crew must be maintained to handle service complaints.

Customers who know that their installations will receive immediate attention should anything go wrong are satisfied customers—and these persons are your best advertisement for new custom installation customers.

It takes more than a desire for money to make a success of a custom installation business. In addition to technical know-how of the highest order the custom man must have

great creative ability and the desire to do the job properly; he must have a special flair for all phases of interior design and know furniture styles and architectural types, and above all, he must be prepared to offer service—sometimes beyond the "call of duty."

Speaking realistically, the job is a hard one but it is also a satisfying one. The rewards, other than monetary, to be derived from work of this sort are numerous. To provide an installation that is electronically sound yet esthetically pleasing is a goal worth seeking and achieving.

-30-

This specially-designed living and dining room divider cabinet provides a 16" television-high fidelity radio-phonograph system plus storage on the dining room side for glasses, silver, etc. Sliding doors on the living room side cover the controls for the TV-radio-phonograph unit. Sliding glass doors on dining side conceal that storage space. An inlaid copper planting box runs the entire length of the cabinet. An inclined loudspeaker baffle directs music toward ear level. A Radio Craftsmen TV chassis and AM-FM tuner, an Altec-Lansing amplifier, a Webster changer, and Pickering cartridges are used in this installation.





# A 2-TUBE PORTABLE RECEIVER

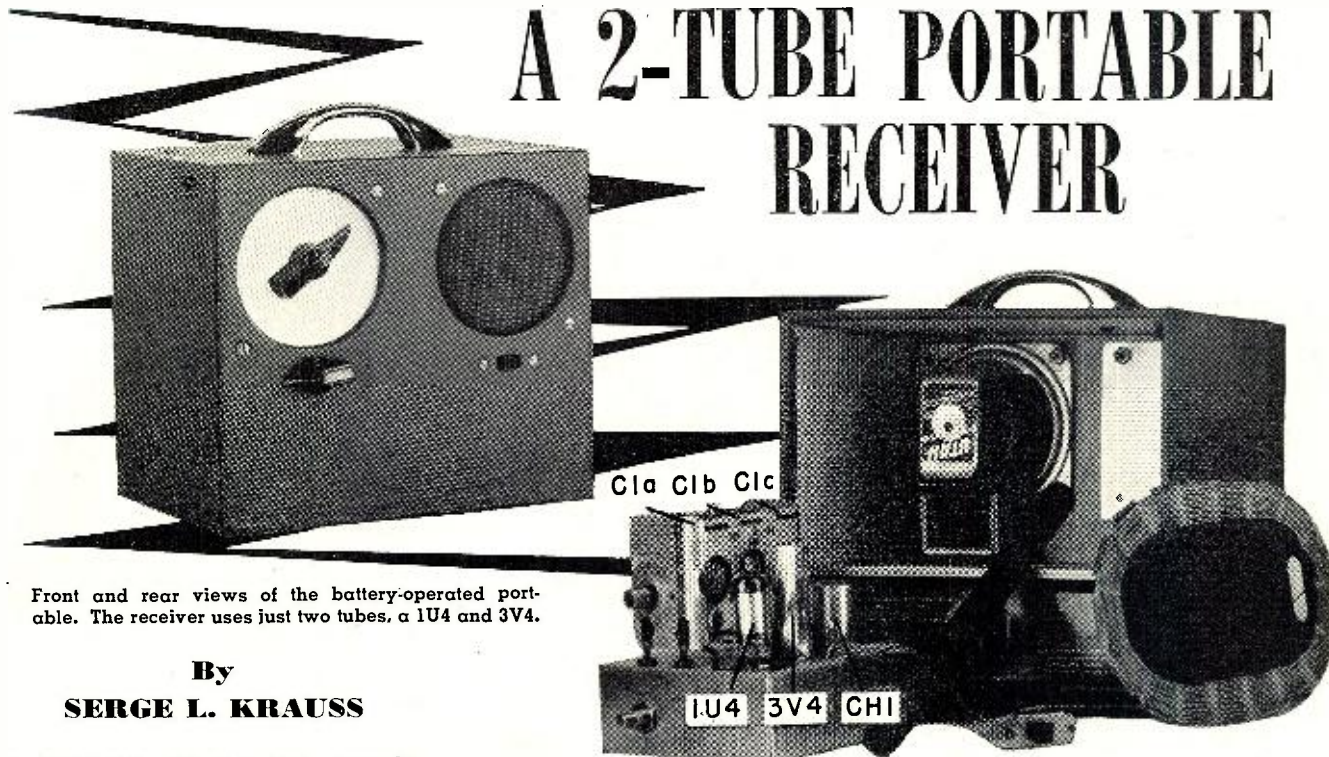

Front and rear views of the battery-operated portable. The receiver uses just two tubes, a 1U4 and 3V4.

By  
**SERGE L. KRAUSS**

THE title, "A Two-Tube Portable Receiver" is reminiscent of the early twenties when tubes were quite expensive and dry batteries were the only source of power. Although today tubes are more reasonably priced, portable receivers still rely upon dry batteries which supply power at many dollars per kilowatt hour so that even now cost of operation is a big factor. One way to reduce battery consumption is to use fewer tubes. The receiver to be described uses but two tubes, a 1U4 and a 3V4, in a circuit that provides daytime loudspeaker reception of Chicago stations one hundred miles distant with a four by six inch loop antenna.

The two tubes provide two stages of radio and two stages of audio amplification. Both of the r.f. stages and the detector are tuned, giving the receiver the selectivity of three tuned circuits.

Reflex circuits have been used for years but seem to have fallen into disuse of late. However, the ease with which modern tubes can be used to provide both radio and audio frequency amplification makes the construction and adjustment of this receiver fairly simple.

The signal progresses through the circuit in the following manner. The r.f. signal intercepted by the antenna passes through coupling condenser  $C_2$  to the grid of the 1U4 where it is amplified and impressed on the primary of coil  $T_1$ . The signal induced in the secondary passes through coupling condenser  $C_3$  to the grid of the 3V4 where it receives its second stage of r.f. amplification and is impressed on the primary of coil  $T_2$ .

The signal induced in the secondary of this coil is demodulated (detected) by the 1N34 germanium diode. The r.f. component is filtered by condensers  $C_7$  and  $C_8$ . The a.f. signal devel-

oped across the volume control,  $R_3$ , is taken from the control arm and fed through resistor  $R_1$  into the 1U4 grid where it receives its first stage of audio frequency amplification. The audio signal current in the 1U4 plate circuit passes through the primary of coil  $T_1$  and the audio reactor  $CH_1$ , where it develops an audio potential.

The r.f. current is bypassed from the audio reactor by condenser  $C_4$ . The audio signal across the reactor is passed through condenser  $C_4$  and resistor  $R_2$  into the 3V4 grid where it receives the second stage of audio amplification. The audio signal current in the 3V4 plate circuit passes through the primary of coil  $T_2$  and the speaker (output) transformer primary. The potential developed across the output transformer is coupled to the speaker voice coil and becomes audible sound. The r.f. current is bypassed from the speaker transformer by condenser  $C_6$ . The coupling condensers,  $C_2$  and  $C_3$ , are small in value, adequate for r.f. currents but high impedance to audio currents so as to avoid undue attenuation by the shunting effect of the r.f. tuned circuits which have a low impedance to the audio currents. The bypass condensers  $C_7$  and  $C_8$  are large enough to insure a low impedance path for r.f. currents without undue loss of the higher frequency audio currents. The values selected for the bypass condensers may possibly be reduced to improve the audio fidelity, the limit of reduction being the point where the receiver becomes unstable.

***With a good loop and speaker, this battery-operated receiver provides good reception up to 100 miles.***

A strong carrier will cause a reflex amplifier to become non-linear and produce an audio component that is heard with the volume control "off". Therefore this receiver performs smoothest in suburban areas (the usual application for portable sets).

The performance of the receiver is largely influenced by the size and quality of the loop antenna, the quality of the r.f. coils, and the efficiency of the speaker. The loop antenna should be as large as practical for the enclosure selected. One of the new powdered iron "rod" type antennas is very effective and compact. The r.f. coils used in this model have a "Q" on the order of 100, which is par for units in 1 3/8" shield cans.

Speaker efficiency is of utmost concern with battery operated receivers. A 3 db gain in speaker sensitivity at milliwatt levels is equivalent in performance to the use of two output tubes. An actual test, using a high grade speaker having a large magnet, gave good results with only one filament of the 3V4. This reduced the "B" consumption from approximately 7.5 ma. to 5 ma.

One of the requisites of a stable receiver is the proper distribution of the components on the chassis in order to avoid interaction. A recommended chassis layout, as used in the model, is shown in the photographs. The tuning gang, audio reactor ( $CH_1$ ), and tubes are above the chassis. The two r.f. coils and the remainder of the parts are mounted below the chassis.

Before mounting the tuning gang

**RADIO & TELEVISION NEWS**



permanently, be sure to provide a pair of leads for each section, one from the stator and the other from the associated rotor wiper. These leads should be connected directly to the r.f. coil secondary terminals so as to keep signal currents from circulating through the chassis.

The secondaries of coils  $T_1$  and  $T_2$  are shown tapped. This is not essential but does improve the performance. Tapping the coil feeding the 3V4 reduces the grid impedance and the tendency to regenerate caused by the grid-to-plate capacity. The basing of the 3V4 and its low grid-to-plate capacity permits its use as a stable r.f. amplifier if the grid impedance is not too large. The tap on the detector coil improves the selectivity by reducing the load on the tuned circuit. Most r.f. coils are wax dipped and to tap them simply chill the coils in the refrigerator, then flake the wax off near the center of the winding with a common pin, pry up a turn, slide a wooden toothpick under the loop, and remove the insulation with fine abrasive paper so that connection can be made. A loop of bus wire through a hole in the terminal end of the coil form twisted tight makes a convenient terminal for the tap.

The audio reactor ( $CH_1$ ) may be the secondary of a mike transformer or the windings of an audio transformer connected series-aiding if a regular reactor is not available. The 3V4 should be shielded, a piece of metal from a food can will do the job inexpensively. Ground it with a pigtail to the chassis.

Lead dress and parts placement are important to insure stable performance in any receiver, particularly if a small chassis is used. The condensers between the r.f. coils and the grids should be of the small type connected with short leads, and dressed near the chassis. The germanium crystal diode should be connected to the coil terminal with a short lead and the lead to the volume control should be run between the coil shields and the chassis to shield it from other circuits.

Run a bus wire between the tube socket center shields and use it for terminating the ground end of the various bypass condensers. Connect this bus to the interstage r.f. coil secondary ground lead.

Whether the receiver is to be strictly battery-operated or not, the use of a power supply is recommended for making the initial tryout and adjustment. The parts are less costly than a set of batteries and more constant power is provided for checking performance. A power supply circuit is included in Fig. 1 and is the one that was used in developing the circuit.

Be sure to check the circuit connections carefully before applying power as battery tubes are easily destroyed or permanently damaged by excessive filament potential or plate current. Several tubes and an hour's work were sacrificed by an error in reading the socket connections during the development of this model.

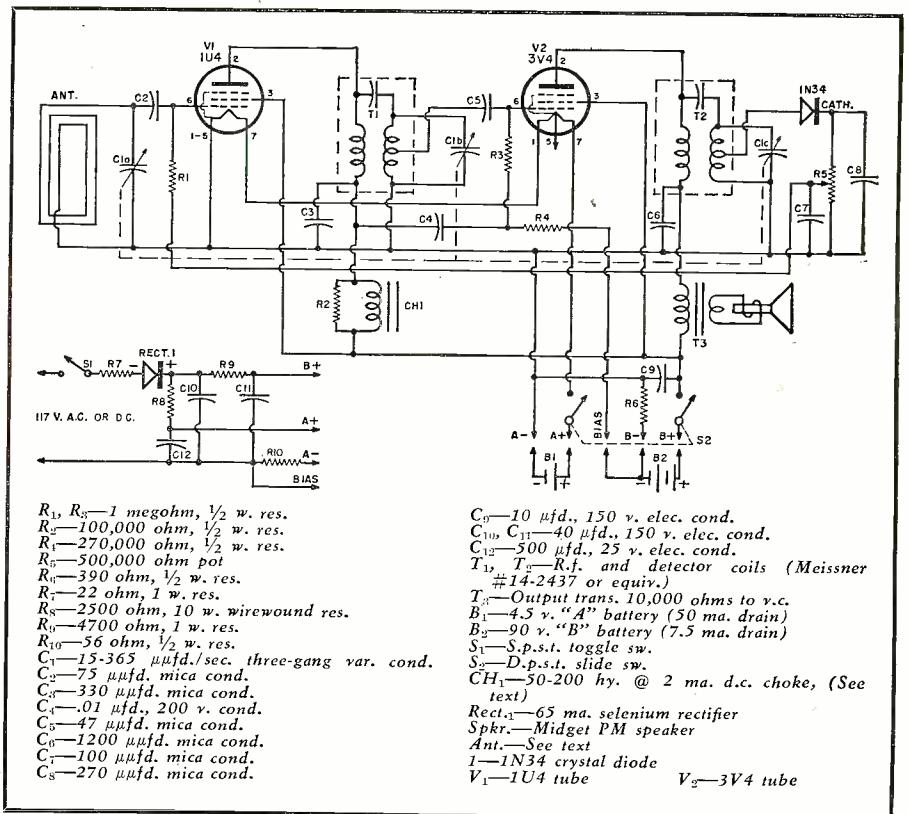

Fig. 1. Schematic of portable. The a.c.-d.c. supply (lower left) can replace batteries.

The rod antenna shown in one illustration was home-built and was used for experimental reasons. Although the unit worked extremely well, the assembly is not readily available from regular retail outlets. It is a new item recently used by RCA in one of their late model portable receivers. It is possible that RCA distributors have this unit available now as a replacement item. Should an antenna of this type be unavailable, it would be possible to resort to the conventional loop type which is shown in one of the photographs. These are readily available and cost in the neighborhood of

50 cents. Most of these loops have additional turns on them and they can be pruned down to the nearest turn for final adjustment.

One last caution, the filter condenser for the filament condenser section of the power supply will build up an excessive potential which will destroy the tubes if the filament circuit should be opened by a loose connection or removal and insertion of a tube with the power on. A feedthrough switch in the line cord is insurance against an accident of this nature when you are experimenting with the receiver.

—30—

Under chassis view of portable receiver showing correct parts layout for compactness.

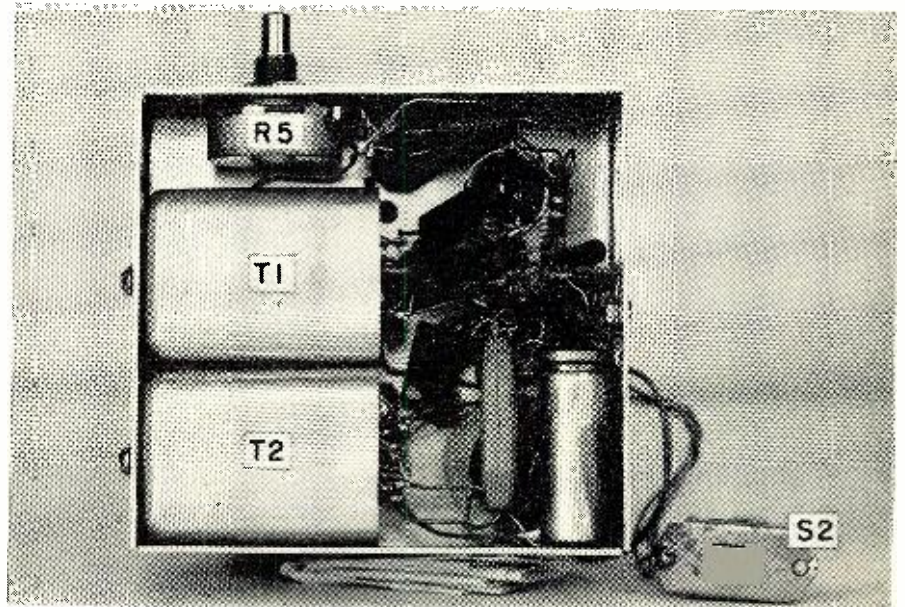





Fig. 1. The capacitance type pickup. Cost of the unit is around \$200.00.

By

**PAUL WEATHERS**

Pres., Weathers Industries  
510 Richey Ave., Collingswood, N. J.

THE intriguing problems of recording and reproducing sound - without introducing disturbing distortion and noise, while extending the frequency spectrum to the limits of audibility in both directions, are never completely solved. That is why engineers continue research year after year, coming closer and closer to the ideal, but always leaving a little more to be done. The more nearly perfect the reproducing system, the more critical our senses become and the more intolerant we are of the imperfections in other systems.

On the other hand, a form of wishful thinking sometimes causes experienced listeners to ignore or blind themselves to imperfections, which to the uninitiated are glaring defects. I am referring specifically to the wide range fanatics who will ignore noise, or even listen for wide-band noise to determine if a system is truly wide range. When records are limited at eight to ten thousand cycles, high frequency noise is the only determinant of the capability of the system.

For those who would condition themselves to interpret wide-band noise nothing is better than the *Cook Laboratories'* record #20. It is significant that the best of existing pickups today modify the recorded noise when reproducing with a conventional micro-groove 1.0 mil stylus point. Part of this modification of the recorded noise is due to flexing of the groove walls

under the force due to acceleration of the jewel and stylus assembly. Further modification of the noise results in most pickups because of resonance in the stylus assembly; the latter fault is readily determined because the noise seems to have a definite pitch.

For those who do not have access to a recorded noise record for testing, the simple expedient of listening to scratches, and other surface noises, tells more about the transient response of the sound system than any other test. A system which has good transient response will not draw attention to noise ticks and surface noise. Listening tests have proven that noise is not so noticeable when it does not assume a definite pitch.

The old practice of limiting the frequency response to reduce noise sometimes produces a disagreeable effect which is more audible than the original noise, though the modified noise measures less with instruments. This result is produced by a response in which the cut-off is sharpened by resonant circuits or resonant loudspeakers. The noise assumes the frequency of cut-off and constantly intrudes itself in an objectionable manner.

A wide range system, free of resonances, will invariably sound more pleasant and draw less attention to ticks and surface noises.

The pickup and the loudspeaker are the two principal offenders for changing the character of noise in a sound system so that it interferes with pleasant listening.

This article deals with a new pickup of startling characteristics which is completely free from undamped resonances. The freedom from intermodulation, combined with ability to track even a wax master without damage, makes this pickup a most useful tool for recording studios, broadcast sta-

**An unusual pickup unit designed specifically for broadcast, recording, and other high quality uses.**

tions, and other high quality applications.

As pickups of the generator type require the record to do the work of generating an e.m.f., it was decided to utilize a modulation type of transducer in which the groove of the record merely has to move the stylus back and forth. The capacitance variation between the stylus and another electrode would change the resonance of an associated electrical circuit so as to modulate an oscillator associated with this tuned circuit.

The idea of modulation by this means is not new and the Patent Office files show much prior art, and patents totaling almost 400. Some of the art is as old as radio and the idea of using the capacitance of a vibrating electrode associated with a phonograph needle or stylus dates back into the middle 1920's. Consequently the author is not claiming to have unearthed a brand new concept never worked on before. Nevertheless, the author has, during the last several years, done much work in this field, which has resulted in several issued patents and applications and which makes this relatively old idea a very practical reality. One form of this development was shown to the Audio Engineering Society in New York on June 12, 1951, at which meeting a wide range system was demonstrated with this new pickup.

Among the modulated energy types of pickups, the variable capacitance type appears to have many advantages over other types of modulated energy pickups.

1. The mass of the pickup structure and arm can be reduced to almost any desired degree within mechanical possibility to match the compliance of the stylus.

2. The resonance of the stylus as-



sembly can be extended to a frequency above audibility, then completely damped.

On the other hand, there are many problems with capacitance type pickups.

Single-ended capacitance pickups are inherently non-linear when the amplitude of motion of the movable capacitance electrode, due to record modulation, becomes large compared to the steady state spacing. This is due to the fact that an incremental movement, when the electrodes are close together, produces a greater capacitance change than the same incremental movement when the electrodes are farther apart. Obviously, if this condition is not corrected, a high amplitude, low frequency signal will modulate a superimposed high frequency signal. Of course this same condition would exist in a magnetic pickup with stationary poles facing only one side of the armature when the amplitude of the armature motion becomes great compared to the gap. The fault can be corrected in the same manner with capacitance pickups as it is corrected in magnetic pickups—by push-pull action.

There are push-pull capacitance circuits which produce low distortion and which have been successfully demonstrated. The other common method for producing a relatively linear modulation of a carrier by single-ended capacitance pickups is to make the electrode spacing many times the maximum displacement of the movable electrode; thus intermodulation effects are minimized.

The circuit described in this article, which utilizes a single-ended capacitance pickup, completely eliminates intermodulation due to non-linear capacitance effects by an entirely new approach so that the peak-to-peak movement can be almost twice the capacitance electrode spacing without introducing intermodulation.

### Circuit Operation

The circuit for producing linear response from a single sided capacitance pickup is shown in Fig. 2. Most frequency modulated pickups previously developed required the oscillator tube to be mounted on or very near the tone arm, due to the microphonic sensitivity of the lead connecting the variable pickup capacitance to the frequency sensitive circuits. It is undesirable to have tubes associated with the tone arm because of the voltage supply leads which would be required, and because of the comparatively large space which would be taken by the tubes and components, and the possibility of hum.

The new circuit has been developed so that the only capacitance sensitive connection is the lead through the center of the aluminum tube which acts as a tone arm. As this lead would be sensitive to mechanical vibration or shock, it is mounted on a wide strip of insulation across the inside diameter of the aluminum tube which permits

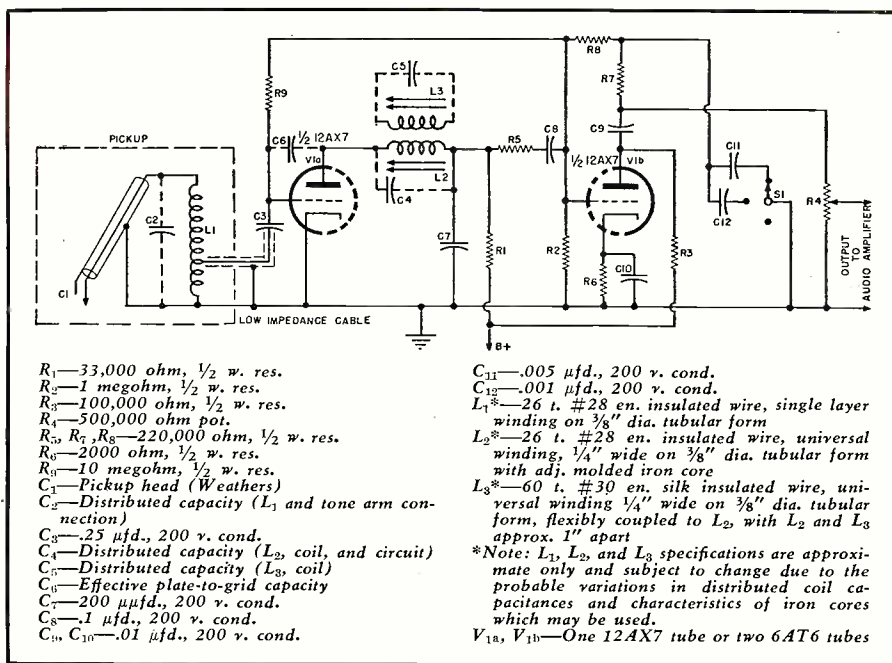

Fig. 2. Circuit for producing linear response from a single-sided capacitance unit.

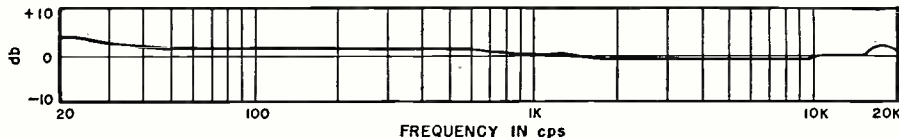

Fig. 3. Frequency response of the Weathers phonograph pickup system.

practically no movement so that microphonic noise is not produced by the tone arm.

This conductor extends through the tone arm to the ungrounded side of a relatively high "Q" coil mounted in the tail housing.

This tone arm coil is tuned to a mean resonant frequency of 16 mc. by the distributed capacitance of the coil plus the capacitance of the conductor through the tone arm ( $C_2$ ) in parallel with the static capacitance of the pickup stylus assembly ( $C_1$ ). This resonant frequency varies about 100 kc. with the maximum variation in pickup capacitance.

A tap is provided at approximately three turns from the grounded end of the tone arm coil. The flexible shielded lead to the oscillator is connected to

this tap, with the lead shield connected to the coil ground. This pickup lead is a standard cable such as commonly used with crystal or magnetic phonograph pickups, and it may be any convenient length up to four feet or so. The oscillator end of the pickup lead is fitted with an ordinary phonograph plug.

Inside the oscillator assembly (shown in Fig. 4), the central conductor of the pickup cable connects to the grid of a high-mu triode  $V_{1a}$  through condenser  $C_3$  and the shield of the cable connects to the chassis and the cathode of  $V_{1a}$ . The grid of  $V_{1a}$  is returned to ground through the two resistors  $R_5$  and  $R_2$ .

The grid of  $V_{1a}$  operates directly from the very low impedance tap on  $L_1$ , and  
 (Continued on page 172)

Fig. 4. Internal view oscillator unit. Operating frequency is 16 megacycles.

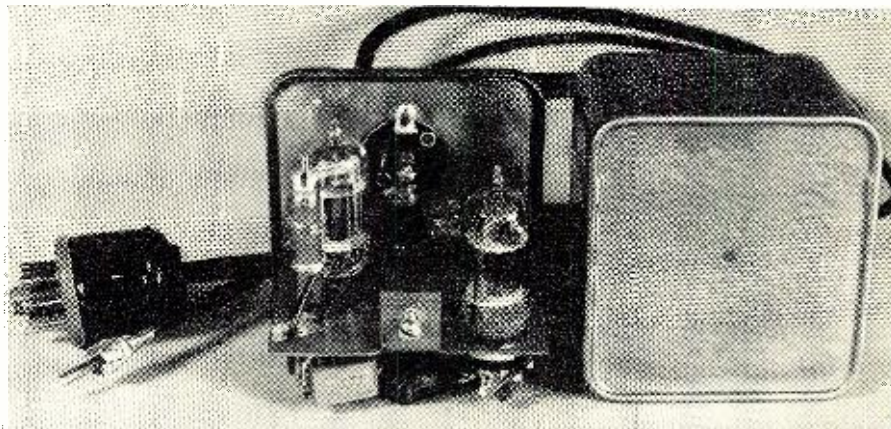



# A CORNER LABYRINTH TRANSDUCER

By  
**NORMAN C. FULMER**

Fig. 1. Over-all view of corner labyrinth transducer. Author used a multicellular, horn-type tweeter (shown on top of cabinet) with a crossover network to obtain better balance of highs and lows.

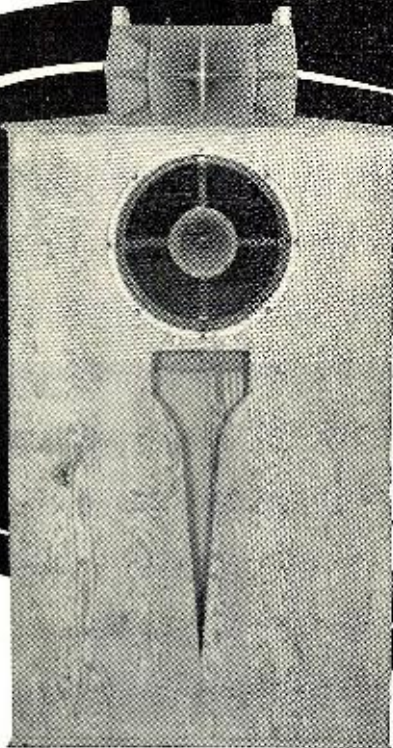

***For corner or wall—transducer will provide good low frequency response. Design is for 15" speaker.***

LABYRINTH loudspeaker housings have achieved a firm place among the various types of transducers used to reproduce the low frequency end of the audio spectrum. "The general conclusion is that the acoustic labyrinth gives better bass than the reflex cabinet . . ." <sup>1</sup> ". . . rock-like steadiness and was considered superior to a similar reflex cabinet . . ." <sup>2</sup> ". . . they sound pretty good. Possibly a bit better than an infinite baffle. At least on a par with them." <sup>3</sup> ". . . accentuated response due to cabinet resonance has been eliminated . . . the low frequency range has been extended." <sup>4</sup>

The labyrinth loudspeaker cabinet to be described is fairly compact and is shaped to fit into a corner of a room; it has a flat back so that it may also be placed against a wall. Its overall dimensions are 30 inches wide, 48 inches high, and 11 inches deep. It is designed for use with a 15-inch loudspeaker which may be of the coaxial type. Unlike most labyrinth cabinet designs, the present cabinet provides balanced loading on the rear side of the speaker cone.

Fig. 1 is a photograph of the cabinet. Fig. 2 shows the path of sound from the rear of the speaker cone through the labyrinth, and Fig. 3 shows construction details.

A labyrinth cabinet employs direct radiation from the front of a loudspeaker cone, and loads the rear of the cone with a length of labyrinth tube or pipe which may be folded to achieve compactness. The labyrinth should have about the same cross-section area as the speaker cone.

Both closed-end and open-end laby-

riths are used; the latter is preferable because it avoids a totally closed enclosure which might tend to cause air pressures to be built up within the enclosure, resulting in distortion and a lack of "liveliness" of response. A totally enclosed cabinet might be referred to, in a derogatory manner, as being a "pressure-box," just as bass reflex cabinets are sometimes referred to as "boom-boxes." It is only fair to acknowledge, however, that a closed speaker cabinet having a sufficiently large volume will overcome the "pressure-box" objection, and a properly designed bass reflex cabinet will minimize the "boom-box" effect.

Types of loudspeaker housings that are not afflicted by "pressure" and "booming" effects are the large open baffle, the exponential horn, and the open-ended labyrinth. Of these, the open-ended labyrinth has the desirable qualities of being relatively compact and easy to construct. As to compactness, the labyrinth cabinet here described has a 6-foot path from front-to-back of the speaker cone, and is thus equivalent to a 12-foot diameter flat baffle in this respect.

The length of an open-ended labyrinth should be equal to one-quarter of a wavelength of the cone resonant frequency; for a speaker having a 50-cycle cone resonance, the labyrinth length should be about five and a half feet. The labyrinth loading will then reduce the "boom"-producing amplitude hump which tends to occur at the cone resonance frequency. The labyrinth loading also is effective to extend

and aid frequencies that are lower than the cone-resonant frequency.

The advantages of placing the loudspeaker in a corner of a room are well known.<sup>5</sup> The presently-described cabinet is shaped with 90-degree sides for easy corner placement. The labyrinth has a maximum length of 6 feet, which is correct for a loudspeaker having a cone resonance frequency of 45 cycles.

The open end of the labyrinth is tapered over a distance of two feet, as shown in the photograph and drawings, in order to have an effective labyrinth length of from 4 to 6 feet; the tapered opening is approximately exponential with its widest end at the longest length of the labyrinth. The exact shape of the tapered opening is not believed critical. The opening, being wider at the longer wavelengths of labyrinth-loaded sound, favors the lower-frequency portions of the loudspeaker response. The broadband effect of the taper is found to provide very good loading over a wide range of cone resonance frequencies. Loudspeakers having cone resonances ranging from 40 cycles to 65 cycles have operated satisfactorily.

By way of comparison, a square opening was tried, instead of the tapered opening, at the end of the labyrinth. The bass response then seemed somewhat "tight" and "confined." After changing to the tapered shape, the lower bass range seemed "free and easy" and more "alive." The tapered labyrinth opening thus provides two beneficial effects: smoother bass re-

*(Continued on page 126)*

**RADIO & TELEVISION NEWS**



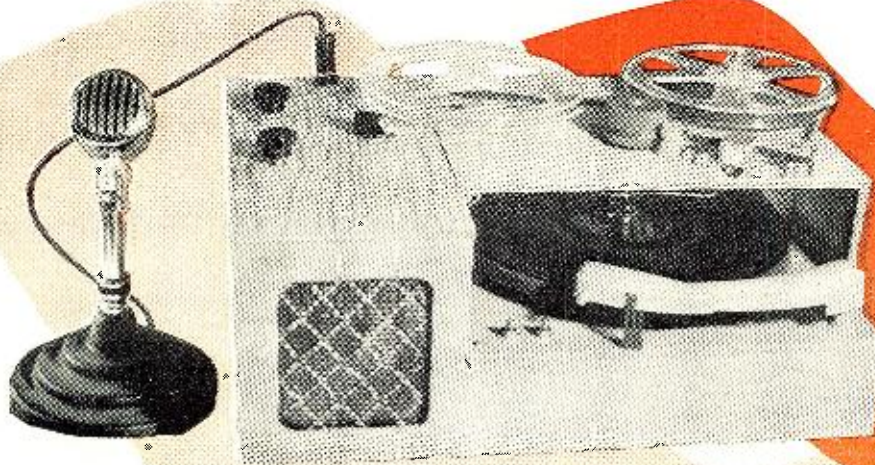

Over-all view of the home built record player and tape recorder combination. The player will handle any standard 78 rpm recording.

By  
**LLOYD B. HUST**

# A Combination Phonograph-Tape Recorder

THE popularity of the magnetic tape recorder continues to increase as new uses for the device unfold and as new developments and improvements in recording equipment are made known. At the same time, the reproduction of music from discs flourishes, and the high sales of phonograph records reflects public approval of this source of musical enjoyment.

With the record-playing tape recorder to be described herewith, the various advantages of both devices are combined, and the entire unit can be constructed for less than the cost of a low priced tape recorder. In fact, the device was designed for the builder who does not care to spend a lot of money for a precision unit, but who would like to have a good usable tape recorder at hand. Special pains were taken in the development of the recorder to eliminate the need for high-cost precision machined parts so that it could be built by the novice at moderate cost. Although a metal turning lathe would make the project easier, it is by no means necessary, and practically all the work can be done with the tools available in any well-equipped radio shop or home workshop.

One of the problems encountered in the construction of a tape recorder is that of pulling the tape steadily past the recording head without any flutter or variation of speed. In most recorders this is done by means of a capstan attached to a heavy machined flywheel. The problem is solved in this recorder by using the phonograph turntable as a flywheel. This is connected through a shaft to a capstan of such size that when the turntable revolves at the speed of 78 rpm, a tape speed of  $7\frac{1}{2}$  inches per second is obtained. A spring belt pulls the takeup spindle so that change of speed of the takeup reel as the reel fills can be taken care of

***All parts are either readily obtainable or can be home built without special tools or equipment.***

easily and smoothly. No rewind mechanism is used as the recorder utilizes two channel recording, and after both channels have been used the tape will be rewound ready for playing back. Of course, if the builder wishes, he can make provision for rewind. One method would be to utilize a small motor attached directly to the feed spindle.

To permit full sized, 1200-foot tape reels to be used, and in order to utilize the effect of a heavy turntable, the phono motor is the *General Industries* heavy duty model RM-4. This is a 78 rpm motor with a heavier-than-usual turntable. Other motors can be used, but if good results are to be obtained, only heavy-duty motors equipped with heavy turntables should be selected. The builder should make sure that the phono spindle of the unit selected will turn as the turntable turns, as it is from this shaft that the power for the capstan is obtained. Also, speeds slower than 78 rpm should not be used, as this will result in the angular velocity of the capstan being too low to give recordings with minimum "wow".

The machine is built on two decks, with the amplifier placed at one end. The cabinet is built of  $\frac{1}{4}$ " plywood which is easy to work besides being inexpensive. The top deck serves as the housing for the tape pulling mechanism, which is mounted in such a way that it can receive its power through

a shaft directly from the phono motor which is mounted below. A flexible coupling makes connection between the shaft driving the tape capstan and the phonograph turntable spindle. Dimensions are shown in the illustrations, but the builder can alter them to suit his own needs. It should be pointed out here that the cabinet arrangement and size as given are just a suggestion and that a more suitable housing for the unit can be worked out by the builder to suit his own needs. It is suggested that no attempt be made to make the machine more compact in order to avoid unnecessary difficulties.

The tape driving capstan is made from a rubber stopper of the type used by chemists. A No. 12 stopper with a center hole can be purchased at any chemistry supply shop, or it may be obtained from some drug stores. The stopper as purchased is beveled, and it must be sanded into the form of a cylinder. This can be done quite easily on any power sander. After it has been sanded to the correct shape, it is forced over the shaft which will serve as the drive shaft. This shaft is then chucked in a small power drill and as the drill rotates the stopper, it should be held against a sander very carefully and sanded to the correct size. The exact size is not important unless the builder is desirous of interchanging



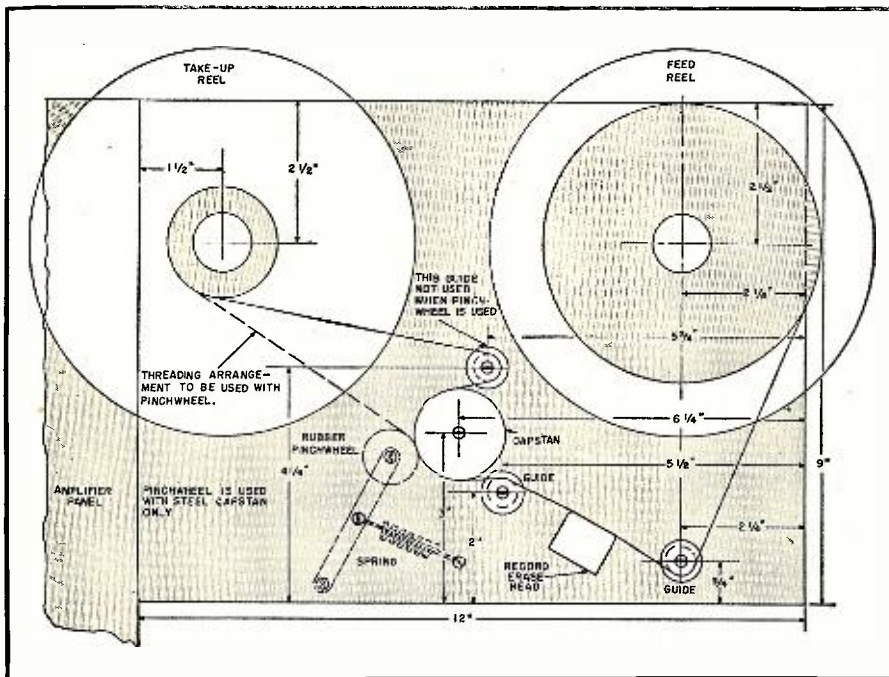

Fig. 1. Top view of recorder deck showing threading arrangement for the tape.

recordings between this machine and a commercial model. If so, the capstan should be sized so that it will give a tape speed of  $7\frac{1}{2}$  inches per second at 78 rpm. The correct capstan diameter for this speed is 1.839". Although the exact size is not important as far as the results of the recorder are concerned, it is *most important* that the capstan be sanded so that it will run true without any wobble. Otherwise, objectionable "wow" will result. More accuracy is needed in this regard if the recorder is to be used for music than if it is to be used for speech. A slight speed variation is not as noticeable when speech is recorded as when music is put on the tape.

The bearings used for the tape spindles and for the capstan shaft are old volume control bearings which are fastened in the top panel in the positions indicated in Fig. 1. Of course, standard panel bearings can be used, or the builder can even use ball bearing races if he wishes. The important thing is that the shafts run true and smoothly in their bearings. A little light lubricating oil in each bearing is

necessary if a free-running assembly is to result. The capstan shaft is held in place by the pulley which is mounted below the panel. The takeup spindle, in a like manner, has a pulley mounted below the panel. The feed spindle has a collar beneath its bearing so that the shaft will not pull out. A washer is placed between the capstan and the top of its bearing and the flexible connector is fastened to the bottom of the capstan shaft. The connector is of the type used to connect a condenser shaft or a control shaft to a shaft in a panel bearing and it is available wherever radio parts are sold. Since the phono spindle is slightly larger than the hole in the connector, the connector must be drilled out so as to slip over this spindle. It can then be held in place with set screws. It is important that the phono spindle and capstan shaft line up with each other as accurately as possible so that the entire mechanism can turn freely and easily.

An alternate method would be to slot the top of the phonograph spindle by means of a hacksaw, and place a pin

across the lower half of the flexible coupling. This pin would then fit in the slot in the turntable spindle when the top was in position, and permit the top to be swung out of the way without the use of tools. For best results this pin should be a good fit in the spindle slot.

Details of the tape spindles are shown in Fig. 2. They are each constructed in four parts: a 1" length of brass tubing  $\frac{1}{4}$ " i.d. by  $\frac{5}{16}$ " o.d.; a  $2\frac{1}{2}$ " length of  $\frac{1}{4}$ " shafting; a  $1\frac{1}{2}$ " disc cut from heavy sheet metal; and a  $\frac{5}{16}$ " disc cut from  $\frac{1}{16}$ " brass.

The  $\frac{5}{16}$ " disc is soldered over the end of the tubing, and a hole to clear a 6-32 screw drilled in the center of the disc. The disc which has a  $\frac{1}{4}$ " hole in the center is then slipped on and is soldered in place. A pin—a small brad cut to  $\frac{1}{4}$ " is about right—is soldered about  $\frac{3}{16}$ " out from the upper shaft. This pin is placed through the disc from the bottom and is soldered lightly there. Excess solder should be removed so that the shaft will not bind in the bearing. A washer should be used between the bearing and the disc. It will be easy to solder the disc in place if a  $\frac{5}{16}$ " hole is first drilled in a piece of wood and the top of the shaft placed in this hole. The disc can then be pulled up snugly against the wood and held in place with a small clamp. A little soldering flux will make it easy to get a good joint here with a minimum of solder.

A piece of felt is cemented to the top panel just beneath the feed spindle. This serves to place a small amount of tension on the tape as it is pulled from this reel. The disc should rest right on this felt, and as the reel is emptied, the friction on the felt becomes less, compensating, to some extent, for the increased tension on the tape because of smaller reel diameter. If this tension is right, it will not be necessary to use a pressure pad to hold the tape against the head, providing the tape guides and head are placed as shown in the illustrations.

As stated before, the takeup reel is pulled by a spring belt from the capstan shaft. It is important that the tension on this belt be correct. If it is too tight, the tape will be pulled too tightly and may break. If it is too

Power supply (right) and amplifier (left) exposed to show layout.

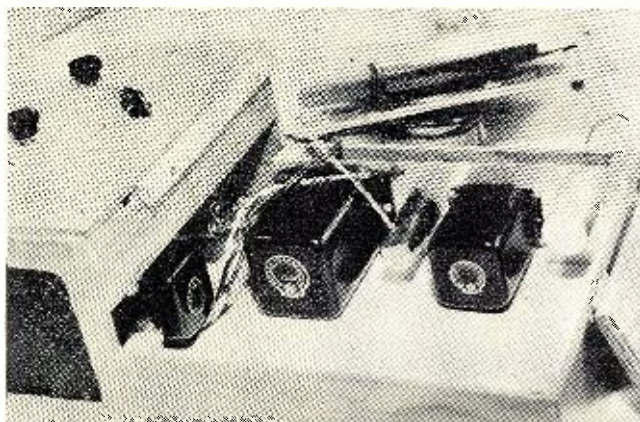

Top of tape deck showing placement of capstan, head, and guides.

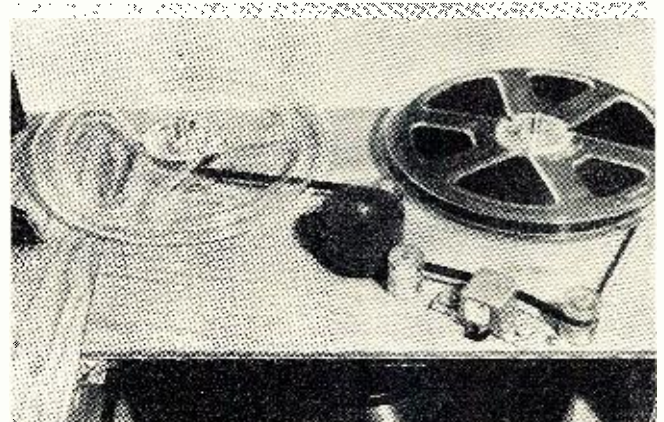



loose, the tape will not be held tightly against the capstan and hence will not be pulled past the head steadily. It is suggested that a length of lightweight belting be prepared a little over-length. Then it can be cut off, bit by bit, until the right tension is obtained.

If the builder has access to a metal turning lathe, he can get somewhat more accurate results if he builds the capstan of steel. This should be made as indicated in Fig. 2. With this capstan it is necessary to have a rubber pinch wheel which is also illustrated in Fig. 2. A little more accuracy and better results can be secured with this capstan and the spring belt tension will not be as critical when this type is used. However, such a capstan can be made only on a lathe, and for this reason it is given as an alternate for the builder who has this piece of equipment.

A word regarding the pulleys is in order here. Although the ones illustrated were machined on a lathe, pulleys from an erector set, war surplus pulleys, or any other of a similar type will do. The one on the capstan shaft should be about  $1\frac{1}{2}$  times the diameter of the one on the takeup shaft. The exact size is not important, but it should approximate the one shown in the illustrations.

The tape guides in the author's model were made from plastic on a lathe, but they can be built from a  $\frac{1}{4}$ " spacer held between two fiber or plastic washers. The correct height of the groove, as measured from the panel, can be obtained by the use of additional washers. It is not necessary for the guides to turn, but they must be accurately placed and should be smooth so that the tape can pass over them easily.

The recording head used is the *Shure* Model 815 which is available at most radio parts jobbers. This head has two sections—an erase section and a record-playback section. The head should be placed as indicated in the illustrations and the tape guides should be adjusted for height so that the top of the tape is even with the top of the erase gap in the head. With this placement, the top half of the tape will receive the recording. When the entire roll of tape has passed the head, the two reels are interchanged. This places what was the lower half of the tape in the upper position and it takes the recording. After the tape has been recorded on both widths, it is then ready for replaying without having to be re-wound. Fig. 1 indicates how the guides and head are placed with respect to the capstan. It will be noted that the tape "wraps around" the capstan to a considerable extent in Fig. 1, and because of this and due to the fact that the capstan is made of rubber which has considerable friction, it is not necessary to have a pinch wheel to keep the tape from slipping. With the steel capstan, it is necessary to have a rubber pinch wheel as shown dotted in Fig. 1. The tape must make positive contact with the face of the head at

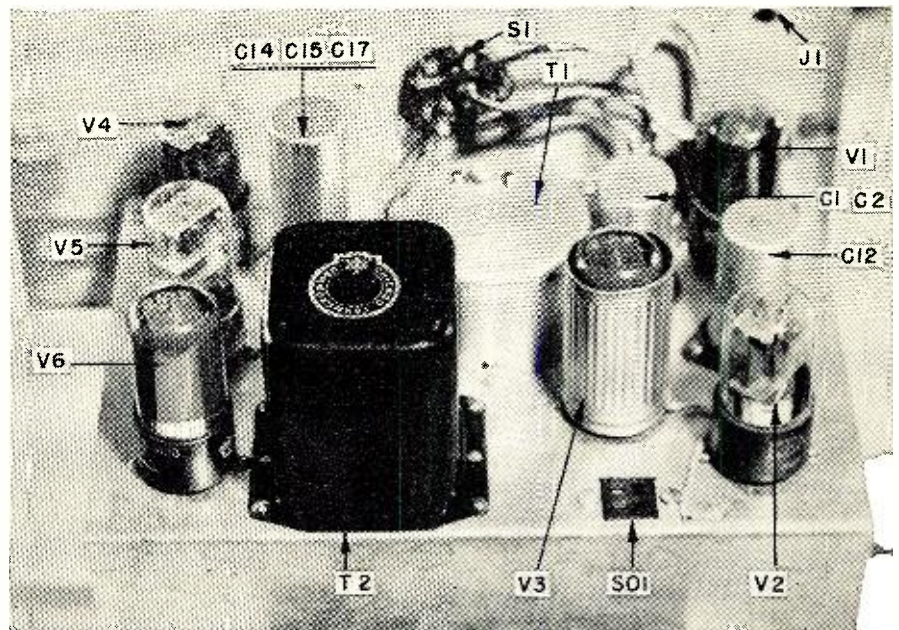

Over-all view of the amplifier chassis with cover removed to show parts layout.

all times, but a slight adjustment of the position of the guides is all that is necessary to assure this, provided that there is sufficient tension on the tape. It is suggested that the builder finish the mechanical part of the recorder and make sure that everything is running smoothly and easily before proceeding with the amplifier. A full reel of tape should be run through the machine to check proper operation.

### The Amplifier

A tape recording amplifier is, necessarily, more complex than the usual phonograph amplifier. This is true because of the necessary equalizing circuits, the high gain necessary for tape recording playback, and because of the necessity for the amplifier to supply some source of ultrasonic voltage which is needed for satisfactory recording on tape. Nevertheless, a little care in the construction of such an amplifier can result in a smooth working, satisfactory unit. The amplifier

designed for this recorder is constructed with a separate channel for recording and playback. The head is switched from one channel to the other depending upon whether it is used for recording or playing back. The *Shure* Model 815 head, which is specified for use with this machine, is actually two heads in one. One section is a record-playback section and the other is an erase section. The amplifier supplies an erase voltage to this section of the head as well as an audio and bias voltage to the recording section.

In order for the amplifier to be mounted conveniently in the space allotted, and in order for the amplifier to be constructed with hum-free operation in mind, the power supply (Fig. 4) is mounted on one chassis and the amplifier proper (Fig. 3) is mounted on another. The power supply chassis is just a sheet of metal which is mounted between two cleats at the back of the phono deck as shown in the photograph of the unit with the

Fig. 2. Construction details on mechanical parts used in phonograph-recorder unit.

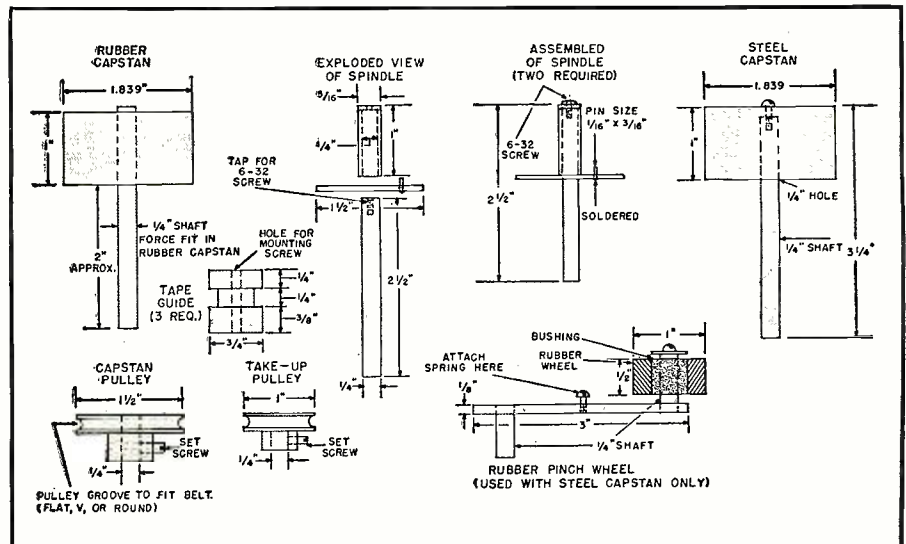



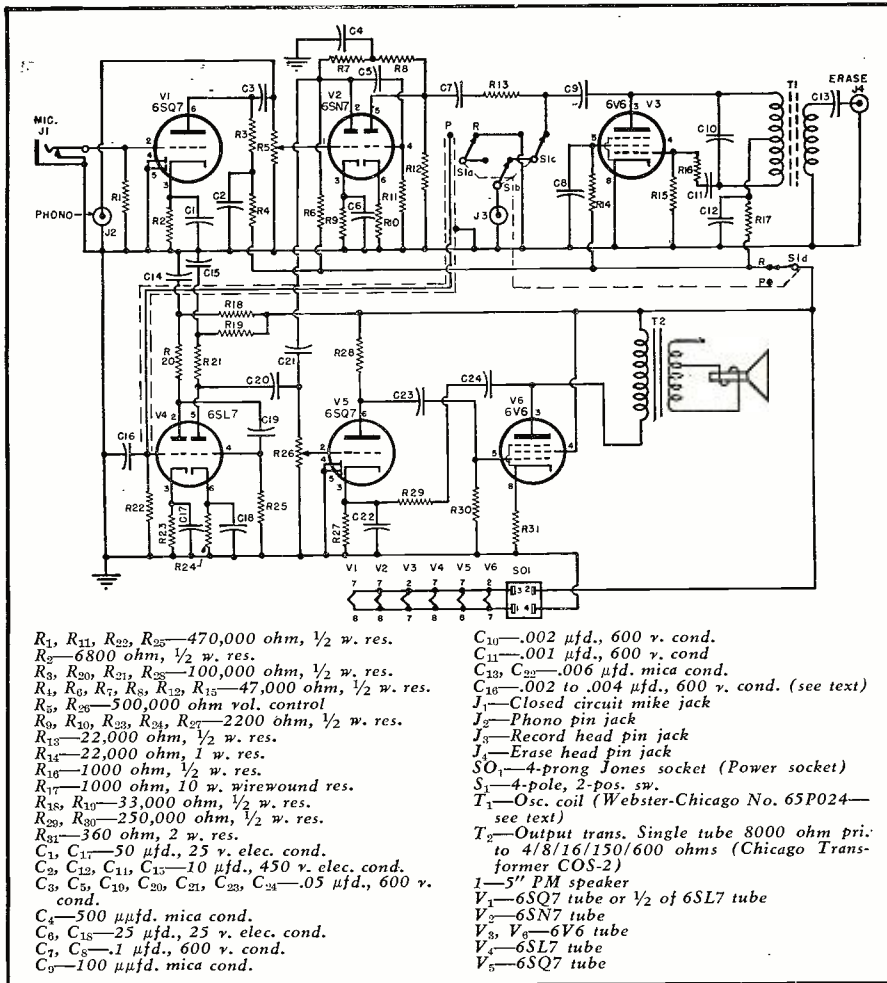
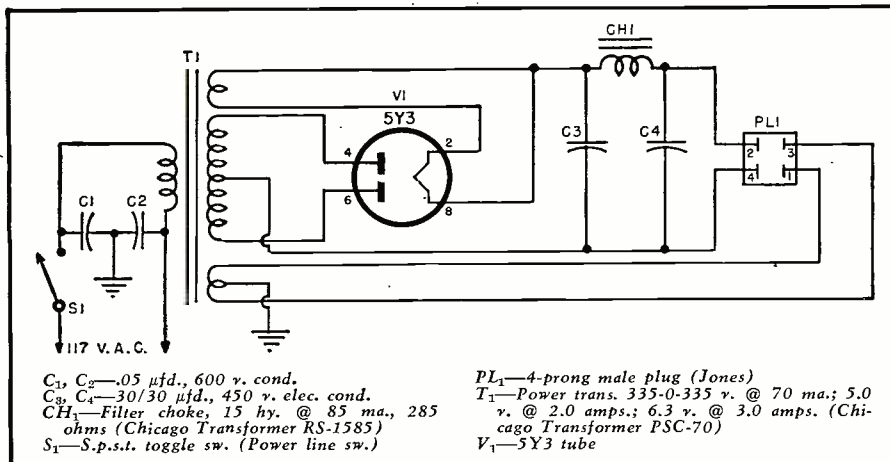

Fig. 3. Diagram of record-playback amplifier, including an ultrasonic bias supply.

phono motor removed. The amplifier is mounted at the extreme left end of the cabinet with the controls on top. Since hum pickup by the playback head is always a problem with any tape recorder, two major precautions were taken to minimize this. First, a high quality, shielded power transformer and choke were used. The sealed-in-steel feature of the Chicago transformers shown here makes them ideally suited for this purpose. Second, the power transformer was positioned as far as possible from the head.

The actual construction of the amplifier is relatively simple. The recording section (Fig. 3) has inputs for a high impedance microphone or a phonograph pickup. It utilizes a 6SQ7 tube. (One section of a 6SL7 may be used here if desired.) The last two stages are taken care of by the two sections of a 6SN7. Equalization is brought about by inverse feedback between the last two stages. For a discussion of the principles involved in this type of equalization, the reader is referred to the article, "A Practical Approach to

Fig. 4. Diagram of power supply used with combination phonograph-tape recorder.



Negative Feedback" by B. E. Parker in the January 1951 issue of RADIO & TELEVISION NEWS. The resistors  $R_7$  and  $R_8$  with the condenser  $C_4$  comprise the equalizing network for this section. The output of the last stage of the recording channel is fed through condenser  $C_7$  and  $R_{13}$  to the record-playback switch, which in turn feeds this signal to the recording head. At the same time the ultrasonic bias taken from the plate of  $V_3$  through condenser  $C_9$  is fed to the head. This gives the proper mixture of audio and high frequency voltage for proper recording on the tape. In the interest of simplicity, no recording level indicator is included, but after a little experimenting with the setting of the recording volume control, the correct level can easily be found. In order that the material being recorded can be monitored if desired, and in order that phonograph records can be heard from the loudspeaker, a connection is made between the recording channel and the playback channel through condenser  $C_{21}$ . Adjustment of the playback control will allow the signal to be heard or not, as desired. It will be noted that one section of the record-playback switch controls the plate voltage to the entire recording channel so that accidental erasure of tape on playback is impossible. This feature also minimizes interaction between the two channels when the playback channel is being used.

The playback channel consists of a 6SL7 tube which performs the function of the first two stages. The condenser,  $C_{16}$ , which is connected from the first grid of this tube, is necessary to get highest output from the head at high frequencies. Its value will be somewhere between .002  $\mu$ fd. and .004  $\mu$ fd. This should be chosen by experiment—the value giving best high frequency response should be used. In addition to the 6SL7 tube the playback channel has a 6SQ7 which feeds the output stage—a single 6V6.

Between the last two stages in this channel, as in the recording channel, we have an equalizing network. However, in this case, the equalizer is chosen to give both high and low frequency boost, or, more properly, middle frequency suppression. The feedback network consists of  $C_{22}, C_{24}$ , and  $R_{29}$ . The amount of feedback, and hence the amount of middle frequency suppression, can be increased by decreasing the value of  $R_{29}$ . However, introducing too much feedback may cause oscillation because of phase shift. The output of the 6V6 is fed to a 5" PM speaker, which, admittedly, will not do justice to the output of the amplifier. However, it is just used as a monitor speaker and leads are taken to the back of the cabinet from the output transformer for the use of an external speaker or to feed a line as desired. The Chicago COS-2 output transformer is admirably suited for use with this amplifier. It should be noted that in some cases it may be necessary to

(Continued on page 102)



# A SIMULATED ECHO CHAMBER

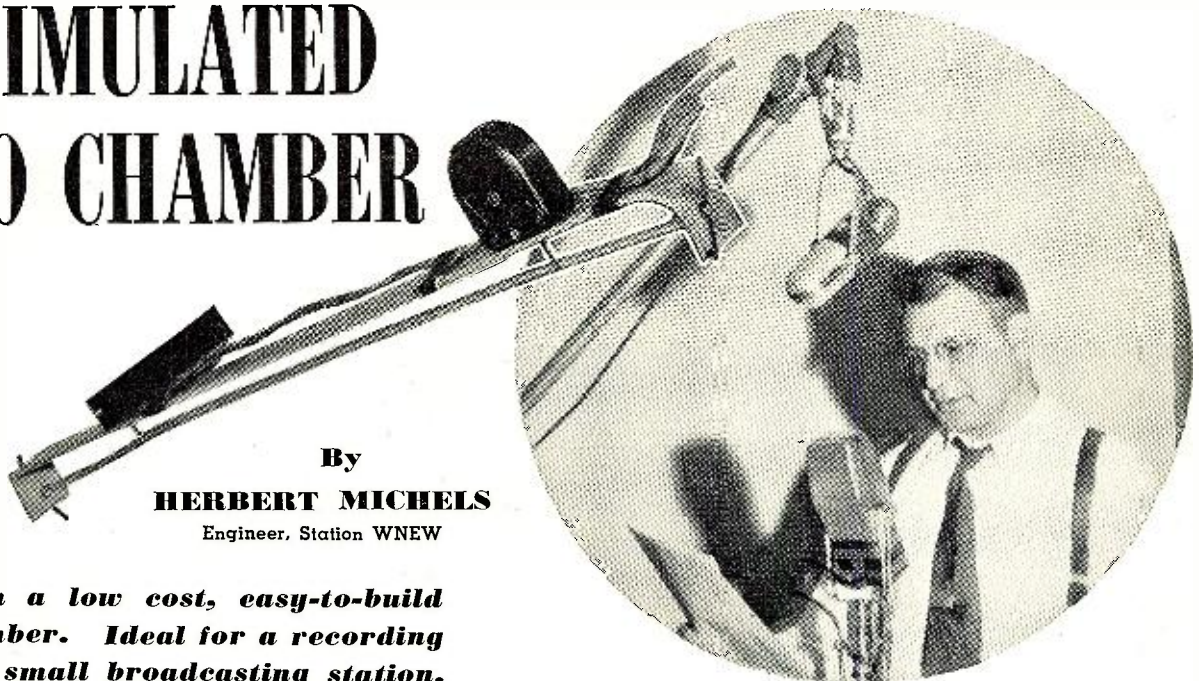

By  
**HERBERT MICHELS**  
Engineer, Station WNEW

**Details on a low cost, easy-to-build echo chamber. Ideal for a recording studio or small broadcasting station.**

AN important but often overlooked accessory for the broadcasting studio, recording studio, or radio acting school is an echo chamber. But in most cases, except for the network key stations, the echo chamber is left out of the studio layout because of the high cost of including an extra room; a long narrow room with a speaker at one end and a microphone at the other.

This problem has been solved by many of the smaller studios with a simple simulated echo chamber. The simulated chamber is inexpensive to construct and does not require more than a few feet of extra space. Its effect in most cases is equal to the real thing; and in some applications actually sounds more realistic.

To construct the chamber, all that is needed is a long steel coil spring, an inexpensive recording cutting head, a phono pickup, and an amplifier with a 70 db gain with a five watt output. The hook-up is as shown on the diagram with the output of the pickup fed into the mike input on the mixing console. The output level of the echo chamber will be roughly -70 db depending on the type of pickup used. The diagram shows a low impedance pickup, however, if a high impedance output is desired, a crystal pickup may be substituted.

As a precaution against any mechanical vibration from an external source affecting the spring, the entire unit, including the heads, is suspended with rubber bands, with plenty of slack given on the leads to the heads. Steel phono needles are soldered directly to the spring before mounting the heads; the heads are then placed in position and the needles set in place. In positioning the heads, it is important that there be no mechanical stress in any direction.

Just as with any other type of studio

Simulated echo chamber (left) and actor shown using device (right). Lower mike is fed directly to mixing board while the boom mike feeds simulated echo chamber.

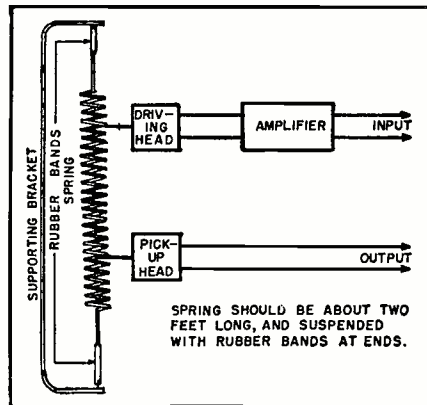

Details of echo chamber construction. When completed it is placed in a vertical position in closet or long box.

equipment, a technique must be developed for the most effective use of the echo chamber. This, of course, is best when developed through experience; but as a guide Table 1 should prove most useful. In almost all instances, the most realistic effects are achieved by using two microphones in front of the person or sound effect to be given the echo. One microphone is fed directly into the mixing panel while the other is fed first through the

echo chamber and then into another position on the mixing panel.

Table 1 shows placement and level settings of the microphones used to provide the various effects.

### Details of Construction

The spring and heads are supported by a bracket 23 inches long, made of 1/8th inch steel to provide a solid and heavy unit. This was especially constructed of heavy gauge steel so that the unit would be less susceptible to external vibration. The bracket, as shown in the illustration, forms a frame for the spring, with the driving and pickup heads mounted on the outside of the frame; the needles feed through 1/4 inch holes. The heads are bolted directly to the metal frame each in their respective positions, 5 inches from the ends of the bracket.

As a driving head, a low priced replacement cartridge was found to work very well. It was a home recorder type magnetic recording head with an 8 ohm impedance. The pickup head is an older type RCA 200 ohm  
(Continued on page 109)

Table 1. Microphone placement and level settings for various sound effects.

EFFECT DESIRED	MIKE PLACEMENT	MIKE LEVEL SETTINGS
Ghostlike or spiritual.	Echo and direct mike placed one foot from subject.	Both mikes set at normal level.
Person in cave.	Direct mike placed one foot in front of subject. Echo mike placed two feet in front and raised above subject.	Direct mike should feed normal level. Echo mike set to peak about 5 db below normal.
Person giving speech in large auditorium.	Echo and direct mike placed two feet in front of subject.	Feed normal level from direct mike. Echo mike should peak about 20 db below normal.
Dream effect.	Both echo and direct mikes placed less than one foot from subject. Subject speaks across mikes to prevent lip noises.	Echo mike should peak at normal level. Direct mike level is down about 5 db below normal.



# An AUDIO AMPLIFIER With "PRESENCE"

By  
GLEN SOUTHWORTH

*Details on an audio amplifier whose performance provides a convincing illusion of naturalness and reality.*

TO SOME extent a recent trend in sound reproduction has been to judge audio equipment on the basis of listening tests rather than technical measurements. "Presence" is a term which appears to be replacing the older expression "high fidelity," and denotes a combination of reproducing elements which is capable of providing a convincing illusion of naturalness and reality even though not precisely duplicating the original performance.

Among the characteristics necessary for "presence" is the ability to accurately reproduce very soft sounds and the ability to handle damped wave trains without introducing an unnaturally rapid decay. To do this it is necessary to consider the linearity of the reproducing system as a characteristic distinct from conventional measurements of distortion such as harmonic and intermodulation. Although variations in linearity are usually associated with these distortions there are exceptions such as the case of resonant circuits, octave band-pass filters, and other specialized cases. Similarly, conventional harmonic and intermodulation measurements seldom indicate what kind of nonlinearity is present.

Fig. 1 illustrates possible linearity curves for five different types of amplifiers. Fig. 1A represents the ideal case of a perfectly linear amplifier with no harmonic or intermodulation distortion, while 1B, 1C, 1D, and 1E represent amplifiers, each of which generates one per-cent total harmonics at the rated output. The amplifiers shown in 1B and 1C will tend to have similar intermodulation percentages, however the amplifier of 1B will tend to discriminate against low intensity sounds, damp the wave trains unnaturally fast, and increase the percentage of any modulations that may be present in the original sound, thus making instruments that are slightly out of tune sound much worse. The amplifier of 1C will tend to produce the opposite effect. Low inten-

sity sounds are emphasized, wave trains are less rapidly damped, and the degree of modulation present in the original signal is decreased, the result being a combination of additional clarity and musical quality known as "presence."

In the case of the amplifier shown in 1D, signals below a certain level are almost entirely suppressed. Harmonic distortion measurements seem to indicate high order harmonics in the output, while the intermodulation distortion percentages may be appreciably greater than in the case of the amplifiers shown in 1B and 1C. At low levels both intermodulation and harmonic distortions may be very high, even though distortion at maximum output levels is on the order of one

per-cent. In all amplifiers inverse feedback usually improves linearity, however, in the case of the amplifier of 1D, feedback operates primarily by reducing the gain of the system so that more drive is required and the cut-off point is at a lower level. Nevertheless, even a very large amount of feedback may fail to make an amplifier with this deficiency satisfactory for low level listening, particularly with a highly efficient speaker system.

The amplifier of 1E represents that rare case in which a step occurs in the linearity curve. This results in increased distortion at certain operating levels and can cause a very unsteady tone in the case of a solo instrument falling within this range.

In designing an audio amplifier for optimum linearity some of the major considerations are the tube curves and stability at low operating levels, as well as the amount of inverse feedback that can be used. Both linearity and stability will be greatly affected by the choice of tubes, grid bias, and filament and plate supply voltages. High plate voltages and filament temperatures should be avoided in order to prevent a gassy condition or grid emission which tends to suppress low level signals. High mu triodes often have a tendency toward grid current flow, even with relatively low plate supply voltages. Multi-grid output tubes, such as the 6L6, show similar tendencies when run with plate and screen voltages at or above maximum ratings,

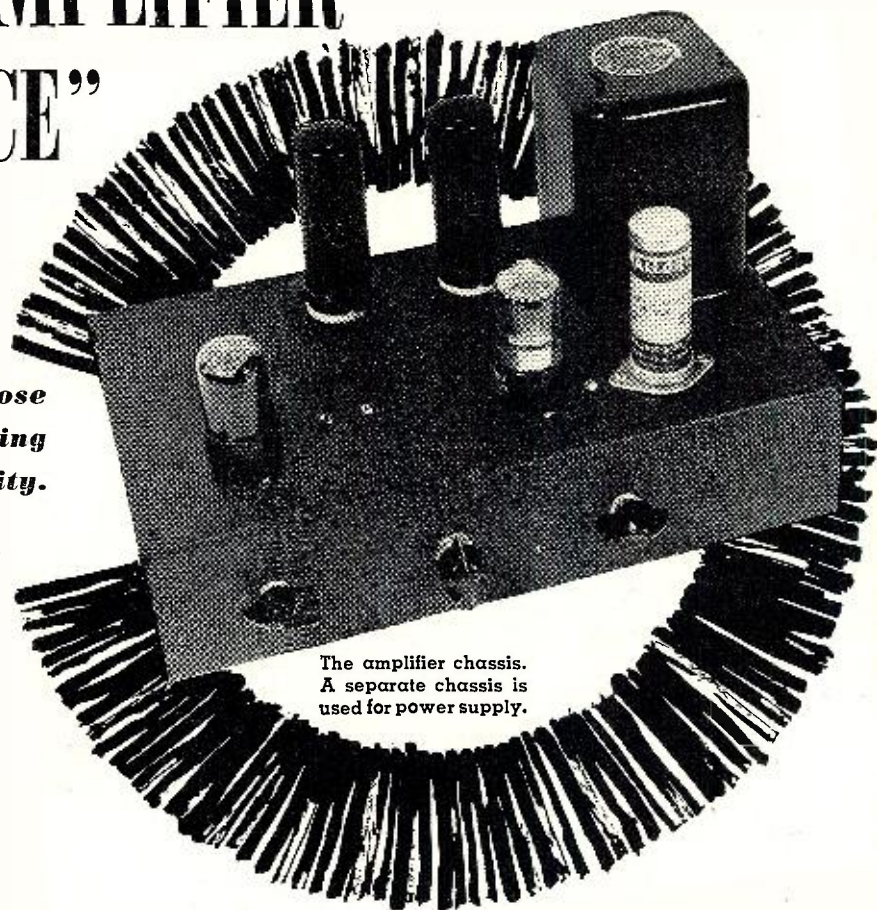

The amplifier chassis. A separate chassis is used for power supply.

Fig. 1. Linearity curves for five different amplifiers. B, C, D, and E all generate 1% total harmonic distortion at rated output. (A) ideal amplifier curve, (B) curve resulting from over-biasing, (C) typical class A amplifier without feedback, (D) class B operation or gaseous tubes produce this curve, (E) produced by paralleled tubes or tube instability, i.e., parasitics.

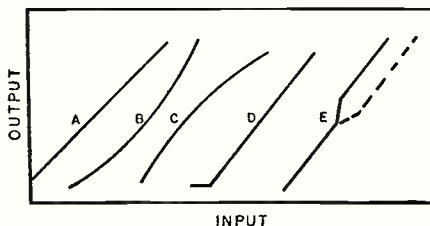



while low mu triodes appear to be stable in performance at either high or low plate voltages. Choice of grid bias, particularly in push-pull stages, also influences the linearity curve as illustrated in Fig. 1.

A specific amplifier design is shown in Fig. 3. Low mu triode driver tubes are used in a conventional phase inverter circuit, while 6L6 tubes with conservative plate and screen voltages are used for push-pull output. In the output stage, low value grid resistors tend to reduce the build-up of grid current, while the use of separate cathode resistors tends to eliminate creeping plate current variations found when a common cathode resistor is used, and provide a convenient means of tube balancing. Frequency response, harmonic distortion, and linearity curves for the driver and output stages under various conditions are shown in Table 1.

The amplifier stage preceding the 6SN7 driver uses a pentode tube and is deliberately designed to introduce a nonlinear curve similar to the one shown in Fig. 1C. It has certain advantages that will be discussed later. A rugged power supply is used with the amplifier; this, together with the conservative tube voltages, provides a piece of equipment that will require a minimum of maintenance.

The primary consideration in the design of the amplifier was to obtain low distortion at low levels, with the result that the completed system is able to reproduce an input range of better than 90 decibels. With a directly measured power input of 400 microwatts to a speaker system of moderate efficiency, a range of 80 cycles to 13 kilocycles is clearly audible at a distance of ten feet. Indirect measurements showed that an equivalent output of one microwatt was sufficient to produce a clearly audible signal over the range from 100 cycles to 8 kilocycles, while the lowest limit checked, 1/100th microwatt, gave an audible sound over the range of 400 to 4000 cycles. Harmonic distortion at the lowest level measured, 40 milliwatts, is virtually nonexistent, even with speaker load. Harmonic distortion rises gradually to a figure of about one-half per-cent at 2 watts and 4 per-cent at 14 watts, both cases being with speaker load. Because of conservative design, momentary overloads do not appear to distress the amplifier by causing temporary gassiness or secondary emission from the tube elements—a very desirable feature when the amplifier is operated near maximum output levels.

A simple inverse feedback loop is used in the amplifier and, with the values given, develops about 10 db of feedback with a 20 ohm load, and approximately 30 db of feedback under no load conditions. More feedback may be employed if desired, however, performance without any feedback is very good, providing the amplifier works into the proper load impedance. Somewhat higher maximum output

powers may be obtained by using a condenser input power supply, however, in this case it is recommended that the 6L6 output tubes be replaced with tubes such as the recently developed 5881, as the plate and screen supply voltages will run about 430 volts and 330 volts—well above the maximum ratings for 6L6's.

In appreciating the importance of the linearity curve of an audio system several related factors must be considered. Probably the most important of these is the character of the listener's auditory response. The perception of loudness is essentially a nonlinear function somewhat similar to the curve shown in Fig. 1C. As a result of this characteristic it is possible to perceive sounds over the enormous range of approximately 120 decibels. Currently available, high quality sound sources are usually limited to a range of 50 to 70 db, and are frequently reproduced at considerably lower levels than the original sound and in acoustic environments with appreciable background noise, with the result that the actual range perceived by the listener is very limited. Furthermore, the hearing vs loudness frequency contours that have led to such devices as the "loudness control" may be misleading in that their chief reference is to steady state signals. In the case of rapidly damped sounds such as produced by instruments at the extremes of the audio spectrum, bass drum, tympani, cymbals, triangle,

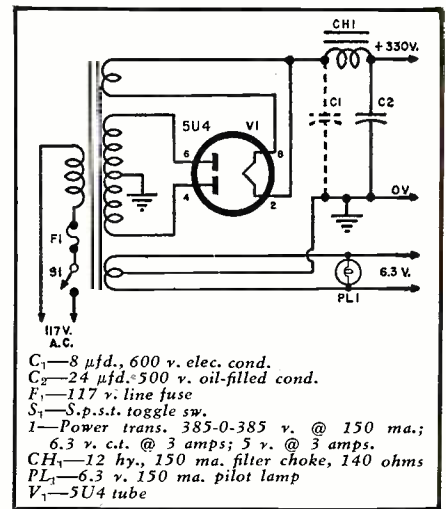
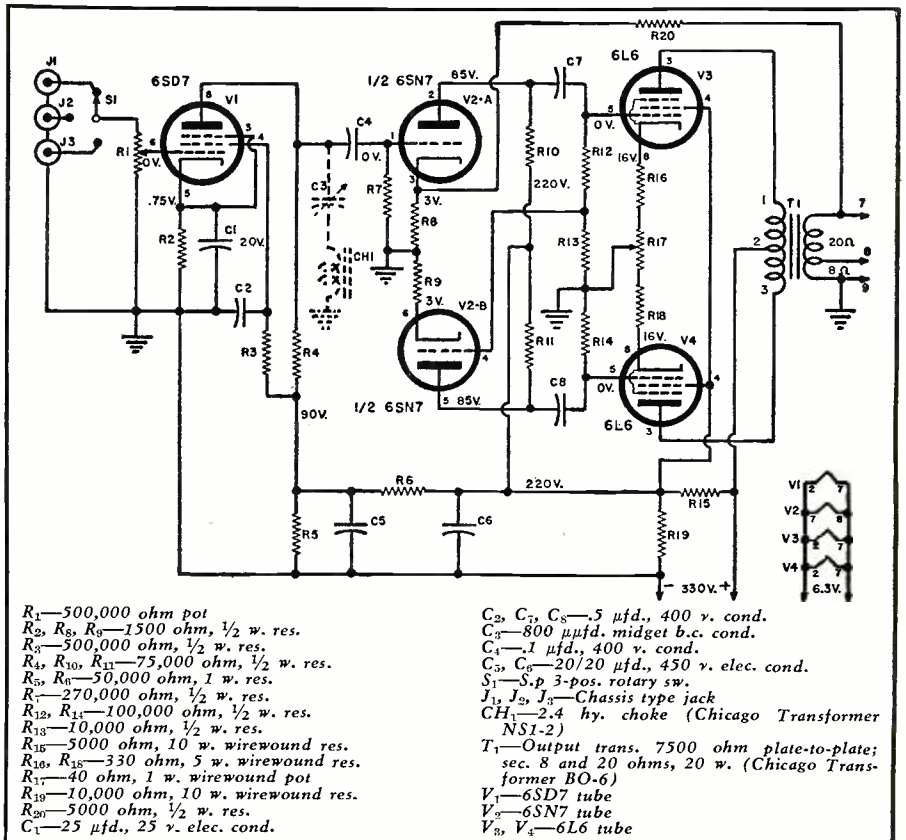

Fig. 2. Circuit diagram of heavy-duty power supply for amplifier. Condenser input may be used to provide additional power at the risk of more frequent tube failures.

etc., the sound may be perceptible for only a brief part of the total duration, with its attendant unnaturalness. If a curve such as shown in Fig. 1C is deliberately introduced in the amplifier design, then several things will occur which may be considered beneficial in low level listening. First, due to the fact that low level sounds are reproduced at a higher relative level than high intensity sounds, less apparent "masking" takes place, making possible the perception of such odd

Fig. 3. Circuit diagram of "Presence" amplifier. No critical matching of parts is required. An optional tunable noise filter which provides attenuation of specific frequencies from 4000 cps up, is included. Plate leads of the 6L6's should be kept as short as practical and should be well shielded from the input circuits of unit.



- R<sub>1</sub>—500,000 ohm pot
- R<sub>2</sub>, R<sub>8</sub>, R<sub>9</sub>—1500 ohm, 1/2 w. res.
- R<sub>3</sub>—500,000 ohm, 1/2 w. res.
- R<sub>4</sub>, R<sub>10</sub>, R<sub>11</sub>—75,000 ohm, 1/2 w. res.
- R<sub>5</sub>, R<sub>6</sub>—50,000 ohm, 1 w. res.
- R<sub>7</sub>—270,000 ohm, 1/2 w. res.
- R<sub>12</sub>, R<sub>13</sub>—100,000 ohm, 1/2 w. res.
- R<sub>14</sub>—10,000 ohm, 1/2 w. res.
- R<sub>15</sub>—5000 ohm, 10 w. wirewound res.
- R<sub>16</sub>, R<sub>17</sub>—330 ohm, 5 w. wirewound res.
- R<sub>18</sub>—40 ohm, 1 w. wirewound pot
- R<sub>19</sub>—10,000 ohm, 10 w. wirewound res.
- R<sub>20</sub>—5000 ohm, 1/2 w. res.
- C<sub>1</sub>—25 μfd., 25 v. elec. cond.

- C<sub>2</sub>, C<sub>3</sub>, C<sub>5</sub>—5 μfd., 400 v. cond.
- C<sub>4</sub>—800 μfd. midget b.c. cond.
- C<sub>6</sub>—1 μfd., 400 v. cond.
- C<sub>7</sub>, C<sub>8</sub>—20/20 μfd., 450 v. elec. cond.
- S<sub>1</sub>—S.p. 3-pos. rotary sw.
- J<sub>1</sub>, J<sub>2</sub>, J<sub>3</sub>—Chassis type jack
- CH<sub>1</sub>—2.4 hy. choke (Chicago Transformer NS1-2)
- T<sub>1</sub>—Output trans. 7500 ohm plate-to-plate; sec. 8 and 20 ohms, 20 w. (Chicago Transformer BO-6)
- V<sub>1</sub>—6SD7 tube
- V<sub>2</sub>, V<sub>3</sub>—6SN7 tube
- V<sub>4</sub>—6L6 tube



**DISTORTION VS OUTPUT LEVEL  
WITH SPEAKER LOAD**

.04 watt	No measurable distortion
1.5 watts	.1% second harmonic, .5% third harmonic
14 watts	.5% second harmonic, 4% third harmonic

**LINEARITY CHARACTERISTICS  
WITH SPEAKER LOAD**

Maximum audible input range 90 db  
Attenuating amplifier input signal 10 db  
causes a drop in amplifier output of 9 to  
9½ db at moderate power levels

**OVER-ALL FREQUENCY RESPONSE WITH SPEAKER LOAD**

Without Feedback	With Feedback
- 4 db at 20 cps	- 2 db at 20 cps
+ 3 db at speaker resonance	+ 1 db at speaker resonance
0 db at 1000 cps	0 db at 1000 cps
+ 9 db at 10 kc.	+ 1 db at 10 kc.
+ 13 db at 23 kc.	0 db at 40 kc.
0 db at 45 kc.	- 2 db at 60 kc.

**TYPICAL RESPONSES FOR OPTIONAL, TUNABLE NOISE FILTER**

4 kc. Rejection	8 kc. Rejection	10 kc. Rejection
- 2 db at 2500 cps	- 3 db at 5000 cps	- 6 db at 8 kc.
- 5 db at 3000 cps	- 7 db at 6000 cps	- 25 db at 10 kc.
- 25 db at 4000 cps	- 25 db at 8000 cps	0 db at 15 kc.
- 2 db at 5500 cps	- 9 db at 10 kc.	
	0 db at 14 kc.	

Table 1. Performance data covering the "Presence" amplifier unit.

musical combinations as a bass drum and triangle playing simultaneously. Secondly, the duration of damped wave trains is longer, making it easier to recognize certain instruments and noises. A rule of thumb, used by the author, is to consider wave trains with durations of less than 1/20th second as essentially noise without easily discernible pitch. Certain sounds, such as jingling coins or keys, are right on the borderline and only a slight additional damping of the wave train is sufficient to destroy the character of the sound. Similarly, modulations or "beats" faster than approximately 20 per-second and with modulation percentages exceeding 50 per-cent may cause a constant tone to be perceived as essentially noise. The linearity curve being discussed tends to bring many sounds out of the classification

of noise due to the increased duration and lowering of modulation percentages it affords, and although this type of curve may introduce intermodulation between two pure tones it should be noted that this is the same general type of intermodulation distortion that the ear itself generates and may not be at all objectionable if the linearity curve is not bent too rapidly.

Probably the linearity curve shown in Fig. 1D is a good example of some of the worst effects of nonlinearity. This curve is characteristic of an amplifier producing high order harmonics, long recognized as undesirable in reproduction. In operation, signals below a certain level will be attenuated or suppressed and due to the fact that high frequencies in orchestral music are generally of much lower amplitude than low frequencies, the result may

be an apparent attenuation of treble. In most cases some low frequency component, such as turntable rumble, noise, etc., will be present with the result that low level components are very heavily modulated rather than attenuated completely, with the result that the high-frequency noise level (needle scratch, tape hiss, etc.) may sound high because not only are noise components negligibly attenuated, but musical components may be perceived as merely additional noise.

Aside from the effects of nonlinearity on the listener's ear, it is desirable to consider the effects upon associated equipment such as loudspeakers. In general, the accentuation of pulses, and the rapid damping of wave trains, such as will occur with a linearity curve like that of Figs. 1B or 1D, will tend to emphasize any transient distortions present in the speaker, the speaker baffle, or associated room acoustics. The extra duration provided by a curve such as shown in Fig. 1C makes transient wave trains easier to reproduce, is less likely to stimulate spurious resonances, and provides better "masking" of such resonances when they occur, and, in the author's opinion, is a considerably more important factor than low impedance amplifier outputs for speaker damping, inasmuch as it affects not only the speaker performance but baffle and room acoustics as well.

Although it is conventional to confine comments on the listening quality of audio amplifiers to generalities, the author will take the risk of detailing some of the specific listening characteristics of the amplifier described. The first thing to be noted is the wide variation of quality perceivable from different program sources such as tape, individual records, radio reception, and from the use of various types of associated equipment such as pickups and loudspeakers. Both speakers and pickups may possess definite linearity distortions similar to those encountered in audio amplifiers. Frequently, however, linearity distortion may be predominant at certain frequency ranges. In both speakers and pickups this often occurs at high frequencies due to the relatively small mechanical motion required, one speaker tested showing a relative attenuation of 6 kc. response of 25 decibels by decreasing the input from 1 watt to 1 milliwatt.

With a good speaker system selected particularly for superior linearity, the "presence" amplifier performs very well at either high or low output levels. In the case of good tape recordings, the reproduction is actually equivalent to the original sound, while in the case of disc recordings excellent clarity and the ability to recognize the acoustics of the original recording location are obtainable. Both a more musical sound and lower "listening fatigue" occur, due to the increased intelligibility produced by the adequate reproduction of low level sounds

(Continued on page 142)

The power supply chassis. A four-wire cable is used to connect the two chassis. Six-wire cable may be used if the a.c. switch is installed on the audio chassis.

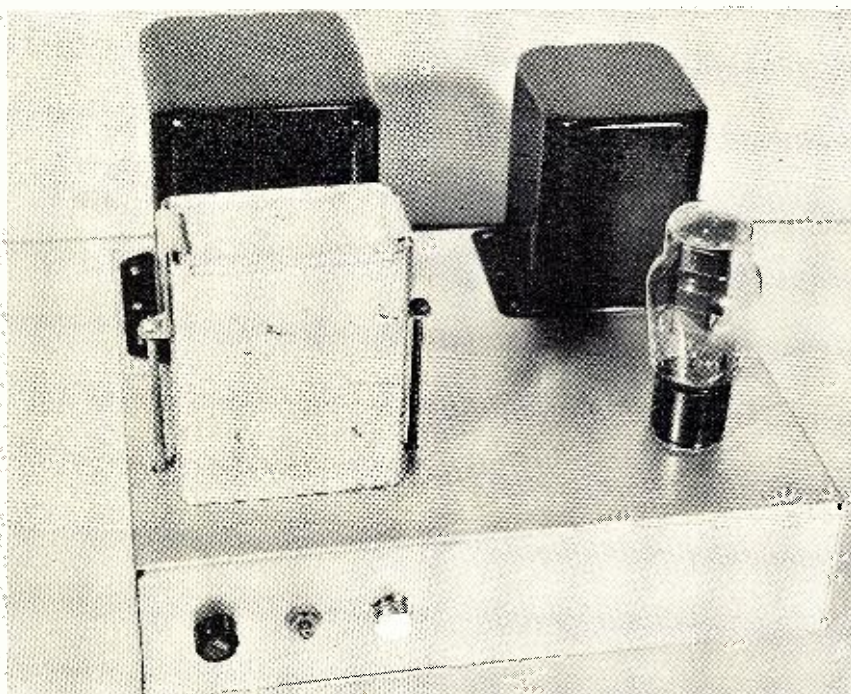



# Selecting Your AMPLIFIER

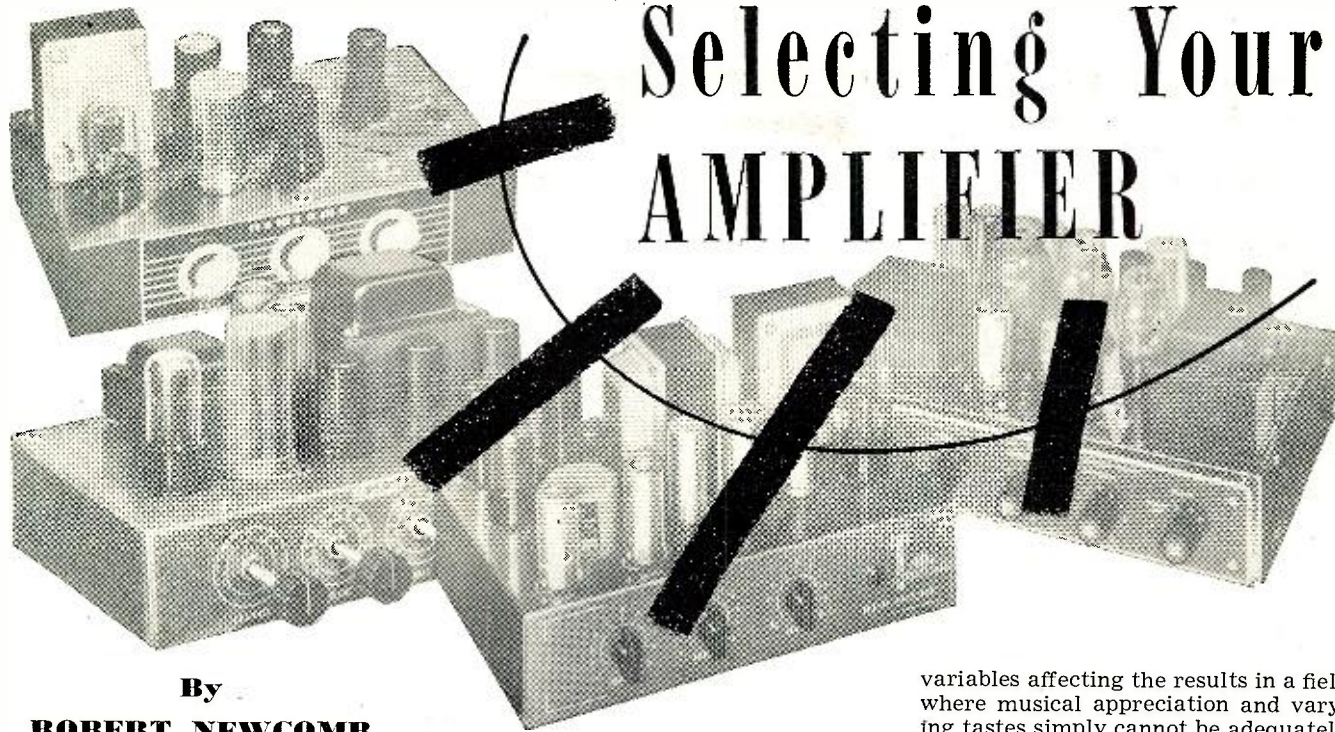

By

**ROBERT NEWCOMB**

President, Newcomb Audio Products Co.

***There is no such thing as a perfect amplifier. Any given design or system is a series of compromises. Do you select your amplifier from design data or by listening test? Here are some timely tips on how to choose your audio equipment.***

THE problem of determining which amplifier to buy has become more and more confusing to the layman in recent years. Primarily, this is because the increasingly aggressive advertising on the part of manufacturers and sellers has degenerated to a technical battle as to who can draw the straightest lines on graph paper. Advertisers have exhausted every means to put forth every conceivable technical measurement which might be interpreted as being an advantage for their product. It is natural that advertising men should seek to draw all available data from the engineers. It is unfortunate that most data which the engineer can offer, in any form that is easily publishable, is that obtained from instruments. Since instrument measurements so frequently bear little or no relationship to the resulting sound one hears, it is no wonder that confusion reigns. Not that instrument measurements serve no purpose, for they most definitely *are* important, but they should be considered only as a means to an end—not the end itself. They are particularly valuable to the design engineer during the design of a particular amplifier. His instrument readings have meaning to him only as guides to note variations resulting from changes. The final judge of results *must* inevitably be his ears. Particularly is this so in attempting to compare amplifiers of different design and manufacture. There is no way for one engineer to know the mind of the engineer of an-

other company. Thus, even he cannot always interpret properly the instrument measurements on another's amplifier. Unfortunately, all too often engineers do attempt to evaluate the work of others in terms of measurements on their own products. While such evaluation may occasionally be soundly carried out, in most cases it can only lead to confusion and is meaningless as far as the consumer is concerned, for, all that really matters is "how it sounds." There is absolutely nothing to take the place of the human ear, and, irrespective of the measurements one can make, they simply do not explain the differences one hears between amplifiers. Measurements can indicate electrical changes but they do not necessarily promise that the ear will like the change. The tendency of consumer agencies to report opinions as facts and to quote measurements as complete proof of audio quality can, under these circumstances, do little but add further confusion. Such "recommendations" are undoubtedly made in good faith. It's just simply not possible for another's opinion on sound to be exactly like your own, and it is even more unlikely that response curves quoted as supporting the view can have any practical value to the consumer who must be the one who is to be satisfied. Many a play panned by the critic has been tremendously successful. Many a sound system claimed to be perfect by the engineer has left music lovers absolutely cold. With so many

variables affecting the results in a field where musical appreciation and varying tastes simply cannot be adequately evaluated by cold instruments, the potential buyer must accept all advice by well meaning agencies or individuals strictly for what it is—an opinion. Be guided by the company's reputation and experience and perhaps the recommendations of those upon whom you can depend to have knowledge of such matters as regards the construction and dependability. *But*, let no one but yourself determine the resulting tonal quality!

The owner of a custom phonograph installation should realize there is no such thing as perfection and that the best solution to any problem is generally the result of a series of compromises. The variations to be found in the original recording pickup technique, recording process, playback pickup, recording and reproducing amplifiers, the room acoustics for both record and playback, the loudspeaker and its location in the room, the volume level at which the system is played and the individual's ears all combine to produce such variables as to make the final sound one hears far, far different than would be expected by reading published technical data. These are but a few of the many reasons for the potential buyer of a phonograph amplifier to save himself much trouble and just listen to the equipment offered. If he likes it, he should buy it. If he does not like its sound, it simply is no good for him no matter how fine the performance curves may be, or it may be that the associated equipment offered with it is at fault—resulting in an incompatible combination insofar as the individual's taste is concerned. If your system is for record reproduction, use records for your tests.

A discussion of certain features of amplifier design may be helpful to the prospective purchaser. There are so many features offered and so much fine

*(Continued on page 105)*



# The RCA TRICOLOR TUBE

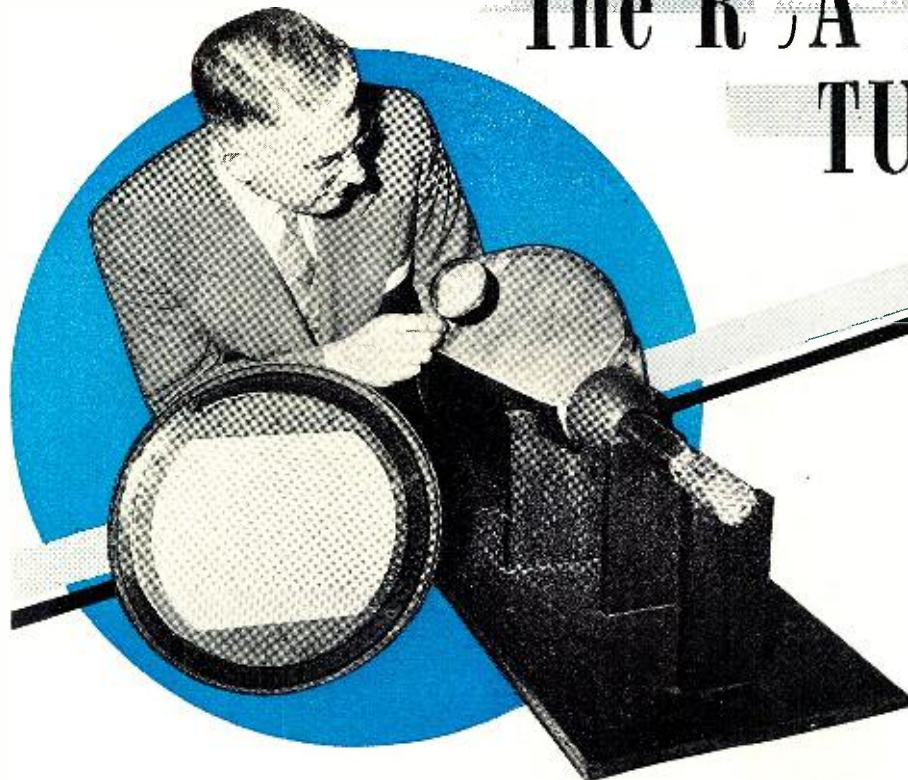

Fig. 1. C. N. Hoyler of RCA Laboratories examines a cutaway section of an RCA tricolor picture tube while the viewing screen of a complete tube is shown at left.

***This new tube, which is suitable for the CBS and RCA systems, will have a tremendous influence on the future of the entire color television industry. Although only pilot models have been produced thus far, the many problems which must be solved before quantity production can start are not unsurmountable.***

AS REVOLUTIONARY as the first cathode-ray tube, the new tricolor kinescope opens up new fields in television. Before going into the details of this device it should be clearly understood that the model discussed here is the RCA experimental number C-73293-C, an *experimental* rather than a standard tube. At the time of writing only a pilot production run is being made and these tubes are intended for experimental rather than commercial use at this date.

In this article we cover mainly the technical aspects of the tricolor tube and neglect its use for either the CBS or an all-electronic color TV system. The tube itself could be used for either system, but the circuits and components supplied with the tricolor tube are usable only for the all-electronic, compatible system using the same sweep frequencies as the present black and white TV standards. At the conclusion of this article a possible color receiver is discussed and this will be based on an all-electronic system such as the one now being proposed by the TV industry itself.

The tricolor tube shown in the lower left of Fig. 1 is a 21" sample, but the one being examined and the one

now in pilot production is basically a metal envelope 16" picture tube. In fact, the metal shell is the same as used in the 16GP4 with an additional flange and a longer and thicker glass neck. The total tube length is almost 26 inches and the neck diameter is 2 inches. Although the face plate has a diameter of 15 $\frac{1}{8}$  inches, the actual picture size is only 11 $\frac{1}{4}$  by 8 $\frac{3}{8}$  inches with rounded corners. Because of the complex internal structure the total weight of the tricolor tube is approximately 25 lbs., considerably more than the 16GP4

Fig. 2. Cutaway of screen, aperture mask, and spacer. Holes and color dots are shown much larger than they are on tube screen.

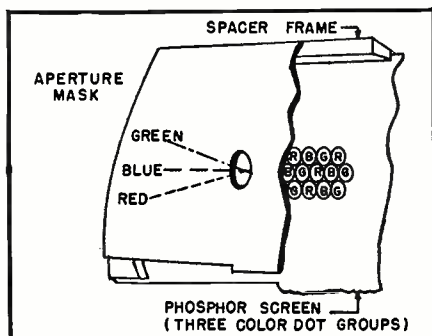

By

**WALTER H. BUCHSBAUM**  
Author, "Television Servicing"

which it approaches in size. Another outstanding difference in appearance is the kinescope socket. The tricolor tube uses a 14-prong diheptal socket, just like the electrostatic deflection picture tubes in small screen TV sets.

## Operating Principles

All color TV systems are based on the principle that with a suitable set of three basic colors most other colors can be reproduced. The same principle is utilized in color photography, color printing, and can even be used in painting. The basic colors giving the widest range of mixed colors lie in the red, blue, and green regions of the spectrum and are called the primary colors. In the tricolor tube, three different phosphors are used, giving red, blue, and green light when struck by a stream of electrons. These three phosphors are deposited on a flat glass plate in the form of tiny dots next to each other in such a manner that they form equilateral triangles with a different color at each apex. Three separate electron guns are mounted in the neck of the tube, one shooting a stream of electrons at the red dots only, the second at the blue, and the third at the green dots. When one of these guns is turned off the brightness adjustment of the other two will determine the color on the screen. For example, if the green gun is shut off and the brightness of the red and blue are varied, different shades of purple will appear. When looking at the screen very closely it may be possible to distinguish between individual red and blue dots, but from the proper viewing distance various shades of lavender, purple, and cerise red will be seen. Similarly, cutting off the red gun will produce shades of bluish green and greenish blue. Mixtures of red and green will give the yellow and orange shades. When all three electron guns are operating the resultant colors will be more like pastel shades and the predominant color will be the one having the greatest brightness. To get white or gray a balance must be struck between all three primary colors, but the amounts of brightness from each electron gun will not be equal.

As we shall see, a color picture is

**RADIO & TELEVISION NEWS**



produced on the screen by modulating each of the three electron guns with a picture signal which corresponds to the amount of primary color present in the picture at the camera. Thus, while the three electron beams scan the picture of a green tree against a blue sky, the red gun will contribute little brightness, the blue gun will predominate during the time the sky is scanned and the green gun will supply the main brightness for the tree.

To produce as much detail as possible the size of the color dots should be a minimum, just as in black and white where the thickness of each line should be minimum. In the RCA tube using a 16 inch envelope, the total number of dots is approximately 585,000, each having a diameter of approximately 0.009 inch. Since they are deposited in exact geometric groups of three, the total number of color dot groups is 195,000.

Fig. 2 shows a greatly enlarged detail of the arrangement used in the RCA tricolor tube. Between the electron guns and the color dot screen an aperture mask is located in such a way that the electron beam from each gun can only strike the proper color dot. The aperture mask is a thin metal plate, stretched over the spacer frame and lined up with the color dot screen. It contains about 195,000 holes, arranged exactly as shown in Fig. 3. To get so many holes with such a small diameter and exact location on a metal plate, the latest techniques of fine photo engraving are used and special precision machinery had to be designed to align the aperture mask correctly with the color dot screen. Once this is done, the spacer frame keeps the aperture plate and the color dot screen as a complete assembly which is mounted to the flanges of the metal envelope. The sketch of Fig. 2 illustrates the importance of the angle at which each electron beam passes through the aperture plate. If that angle is slightly off, the electron beam will strike not only the correct dot, but also part of the adjoining color dot, resulting in color impurities. Naturally it is essential that all three electron beams converge in a fine stream of electrons at the aperture mask. If one of the beams were thicker, electrons would strike the edge of the hole and in a short while this hole would be enlarged and proper coloring would become impossible.

The internal construction of the tricolor tube is shown in Fig. 4A. In addition to the metal envelope a special shield is used inside the tube. This shield is made of Mumetal and has the property of shielding against magnetic flux lines. A magnetic field from a power or audio transformer on the TV chassis could influence the path of the electron beams sufficiently to cause wrong colors. The Mumetal shield affords some protection against such magnetic fields, but it is still best to keep the tricolor tube as far away from all magnetic fields as practical. Also shown in Fig. 4A is the assembly of the

aperture mask, color dot screen and the metal envelope of the tube. The glass face plate is a specially ground and polished piece to give minimum light loss and reflections. In addition to the glass face plate a safety glass is required, just as in present TV picture tubes.

### The Tricolor Tube at Work

Each of the three electron guns in the tricolor tube has the same basic elements as are found in present TV picture tubes. Filaments, cathodes, grids, accelerating anodes, sometimes called "G2," or "1st anode," are all used in the tricolor tube. A glance at Fig. 5 will show that these familiar tube elements are present in each of the three electron guns. In addition we find that these guns contain another element which is used for electrostatic focusing. The action of the focusing element is the same as in the recently-announced electrostatic focus picture tubes for black and white TV. A d.c. potential of approximately 3 kv. is used to focus the electron beam and this is adjusted separately for each gun. Thus, the receiver would have a red, blue, and green focus control. The next element is something never before found in TV picture tubes, the convergence element. The function of this element is, as the name implies, to converge all three electron beams at the holes in the aperture mask. Again use is made of the principles of electrostatic lenses to focus all three beams to the correct hole. The voltage on the convergence electrode is approximately three times as high as the focus voltage and it acts on all three electron beams at the same time. The convergence element is made up of three separate cylinders over each electron gun, connected together internally and also connected to a cup-shaped piece which extends to all three guns. The individual focus element insures that each electron beam comes to a fine point at the color dot screen and the convergence element makes sure that all three beams come to-

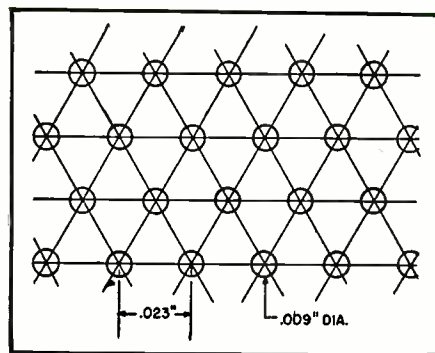

Fig. 3. Aperture mask detail. Each aperture covers one group of three-color dots.

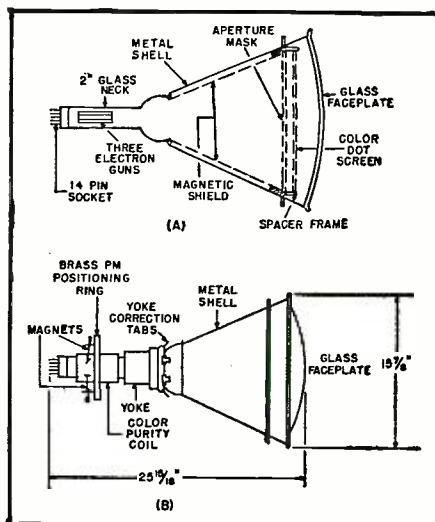
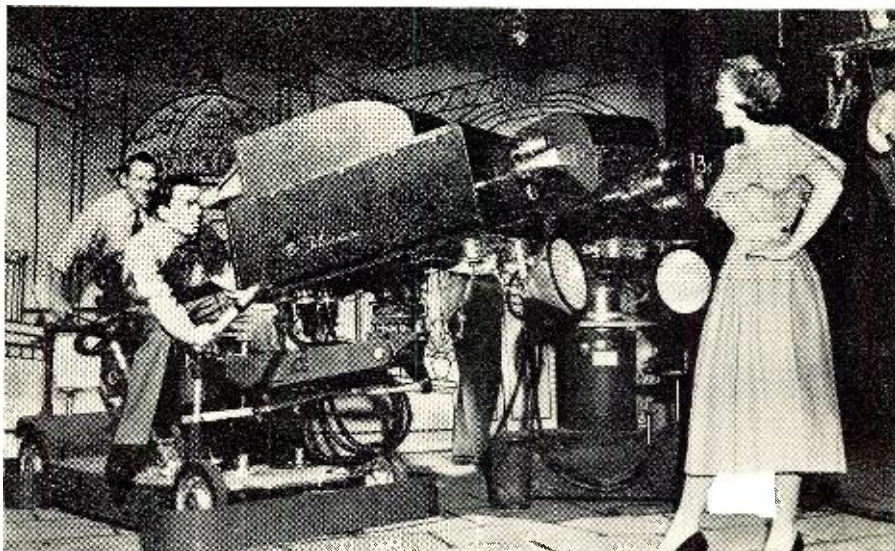

Fig. 4. (A) Internal construction of the RCA #C-73293-C. (B) Component arrangement of the RCA tricolor television picture tube.

gether in the proper holes on the aperture plate.

The second anode of the tricolor tube is the metal shell, just as in any metal envelope picture tube. In the tricolor tube, as shown in Fig. 4A, a magnetic shield surrounds the inside of the metal shell. This shield is at the same potential as the outside shell and electrons which might pass back from the aper-

Color television cameras get a close-up of Ann Schaefer, one of the entertainers who appeared on the field tests of the RCA all-electronic compatible color system.





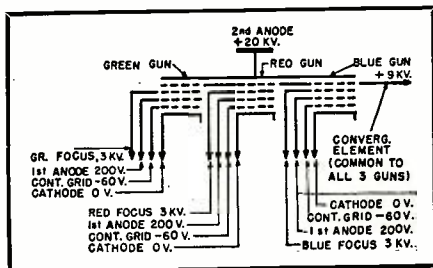

Fig. 5. Electrical arrangement of the RCA tricolor tube. Heaters are in parallel.

ture plate will strike the shield and through it return to the high voltage supply. The aperture plate itself is bolted to the metal shell and therefore also acts as second anode. Electrons bouncing off the color dot screen usually fall back to the aperture plate and from there find their way back into the high voltage supply. As shown in Fig. 5, the correct second anode voltage for a tricolor tube is approximately 20 kv. In present experimental arrangements this voltage is obtained from an r.f. oscillator type high voltage power supply keyed by the horizontal sweep and having an electronic voltage control circuit. It is important that the anode voltage remain stable despite changes in beam current since otherwise variations in brightness of one color electron gun would influence the brightness, focus, and convergence of the other two. That is why a regulated r.f. power supply is used.

The RCA tricolor tube uses magnetic deflection just like other large screen picture tubes, but since the neck diameter is so large and three electron beams must be deflected, a very special deflection yoke is required. The horizontal and vertical coils are positioned just like in a regular yoke, but their size and construction is different. The deflection power required is at least

twice that of present day black and white TV sets, and special insulation is used in the yoke to prevent arcing. Because of the very critical linearity the deflection yoke is designed to give as uniform deflection as possible. If, as happens in black and white TV, the pattern is slightly stretched in any direction, wrong colors will appear wherever such distortion occurs. In addition to a very exact deflection yoke design and linear sweep circuits, special metal tabs are mounted on the rim of the yoke facing towards the screen. These tabs are made of Mumetal which has the property of reducing magnetic flux. Mounted on brass clips, six or eight such tabs are adjusted in various spots around the rim of the deflection yoke to correct for any non-uniformity in the magnetic field from the yoke. Adjustment of these tabs is quite critical and once they are located correctly, care should be taken that they are not moved again.

No ion traps are used in the tricolor tube, mainly because the color screen itself is aluminized, a process which reduces the chances for ion burns. But mounted on the neck of the tube we find another fairly large coil called the color purity coil. This coil consists of loops laid alongside the neck of the tube and looks similar to a long, thin deflection yoke. A variable d.c. current of about 10 ma. sets up a constant field along the neck of the tube. The purpose of the color purity coil is to adjust the axis of all three electron beams so that they fall on their correct colors. By positioning and varying the current it is possible to have the purity coil twist and bend all three electron beams sufficiently to let the red beam, for instance, hit the green or blue dot as well, giving impure colors on the screen. The color purity coil is adjusted

as one of the last items and its setting is done by cutting off two color guns and then adjusting the purity coil until the remaining color appears pure and correct over the entire screen.

Mounted on the cardboard envelope of the purity coil is a brass ring assembly which contains three arms, each of which holds a small permanent magnet. The construction of the ring assembly and the brass arms is such that it is possible to move the magnets over a relatively large area in all directions. This magnet assembly is used to position each of the three electron beams right at the electron gun, and therefore is called the positioning magnet assembly. In adjusting a tricolor tube set-up, the positioning is done first because it determines the location of the three beams with respect to each other. This procedure is very tricky at first, but as more experience is obtained it becomes no more difficult than adjusting the ion magnet on a present TV picture tube. Each positioning magnet must be rotated to find the most suitable polarity, moved closer and further away from the gun, moved up and down along the gun structure, and the best location must be determined. The feature making it really tricky is the fact that the adjustment of one electron beam will materially affect its neighbor, requiring several repeat adjustments.

Fig. 4B shows all the external components mounted on the RCA tricolor tube. Beginning at the faceplate, we know that the aperture plate and color dot screen are located between the front rim and the flange inside the tube with a special magnetic shield extending from the flange towards the neck of the tube. The deflection yoke fits on the neck of the tube just as in any black and white set and the correcting tabs are mounted on little brass clips which rotate on the plastic rim of the yoke, as shown in Fig. 4B. The color purity coil is mounted back of the deflection yoke. It follows the contours of the neck tightly and the brass ring for the positioning magnets is mounted on its cardboard container. The brass structure for these relatively small magnets is quite elaborate to permit adjusting each individual magnet to almost any position without affecting the position of the others. The interaction of magnetic fields cannot be avoided, but the physical arrangement prevents jarring or shaking any of the magnets while other adjustments are made. The 14-pin diheptal socket for the RCA tricolor tube is identical to the type used on all electrostatic 7-inch picture tubes.

#### Dynamic Operating Conditions

Up to now we have discussed only the basic principles of the tricolor tube operation. Special conditions exist in this tube which require a number of additional circuits and devices not ordinarily found in TV picture tubes. As mentioned in the first few paragraphs, the color dot screen is deposited on a

(Continued on page 120)

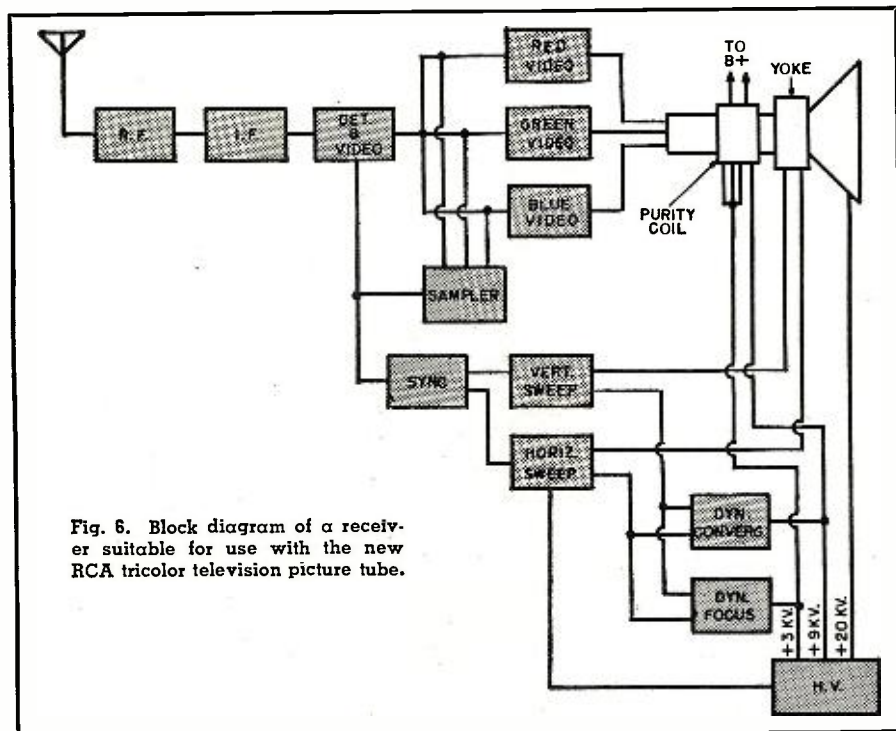

Fig. 6. Block diagram of a receiver suitable for use with the new RCA tricolor television picture tube.



By  
**ED BUKSTEIN**  
Northwestern Vocational Institute,  
St. Paul, Minn.

# X-RAYS In INDUSTRY

**W**HILE the medical uses of x-rays are common knowledge, its equally impressive and vitally important industrial applications are less well known. X-ray inspection has become industry's number one method of nondestructive testing. Just as a doctor uses x-rays to locate a bone fracture, the foundryman uses them to detect air bubbles or other internal flaws in metal castings. Just as a physician uses them to locate spots on the lungs, food processors use them to detect foreign particles in packaged foods.

Discovered by Wilhelm Roentgen in 1895, x-rays have contributed much to mankind's progress. The hot cathode x-ray tube developed by Dr. William Coolidge in 1913 pointed the way towards greater commercial use of x-ray equipment.

A modern x-ray tube is comparatively simple in structure. It consists basically of an evacuated *Pyrex* glass tube with a heated filament at one end and a tungsten target at the other. Electrons emitted from the filament travel down the length of the tube and strike the tungsten target (Fig. 1). Tungsten is used because of its heat resistant properties. The target is operated at a high positive potential with respect to the filament. When the high velocity electrons strike this target, an interchange of energy occurs and x-rays are emitted. X-rays are electromagnetic radiations. They are similar to light and radio waves except for wavelength. The x-ray spectrum extends from .000006 to .012 microns. The micron is equal to one one-millionth of a meter. These extremely short waves are able to penetrate wood, steel, and other materials opaque to visible light.

The penetrating power of the x-rays is determined by the target voltage. When the voltage is relatively low, 5000 to 15,000 volts, the radiations produced are referred to as *soft* x-rays and are used for penetrating bone,

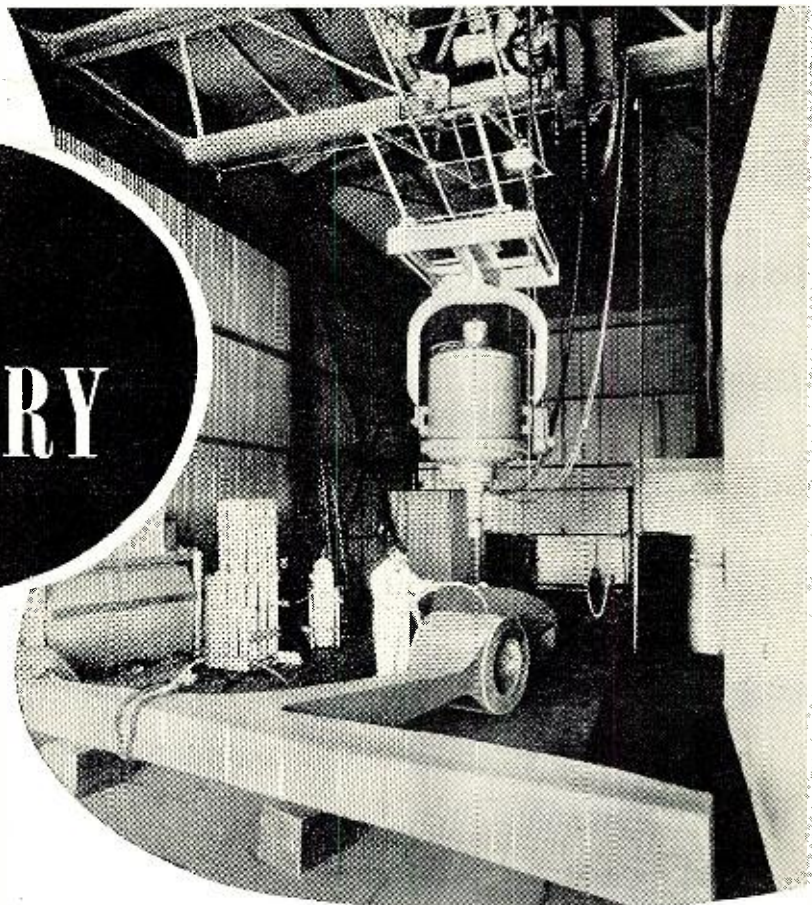

Positioning casting for x-raying with million volt x-ray unit.

## ***Specialized x-ray equipment has given industry a new and important nondestructive test technique***

muscle, citrus fruits, and other low density materials. *Hard* x-rays are produced when the target voltage is high, 50,000 to 1,000,000 volts. These are used to penetrate thicknesses of steel.

### **Radiography**

After passing through the object to be examined, the x-rays strike a photographic film. In passing through the human body, for instance, the x-rays easily penetrate the flesh and muscle but are partially obstructed by bone structures. When developed, the film shows a shadow picture of the bones. This process of obtaining an x-ray photograph is referred to as *radiography*.

Radiography is used extensively to detect internal flaws in metal castings, thus avoiding expensive and time-consuming machining operations on sub-standard parts. The quality of welded joints is similarly determined. Radiography unerringly reveals such defects as lack of fusion, porosity, cracks, etc. Industry has learned a thousand variations on this basic theme. X-rays are used to check concentricity of golf ball centers, internal decay in telephone poles, pulpiness of citrus fruits, alignment of the elements in electron tubes, and centering of the conductor in insulated wires. The x-ray machine is

as much at home in the factory as in the medical clinic.

### **Fluoroscopy**

When rapid x-ray inspection is desired, radiography has a serious limitation, namely, the time delay incurred by the necessity of processing the film. In these cases, a system known as fluoroscopy is employed. In this system, a fluorescent screen is substituted for the photographic film. This screen glows in proportion to the intensity of the x-rays striking it, thus producing an immediately visible image. Fluoroscopic inspection is standard procedure in the packaged foods industry. Pack-  
(Continued on page 140)

Fig. 1. The x-ray tube. When high velocity electrons strike the tungsten target, the x-rays are emitted from the x-ray tube.

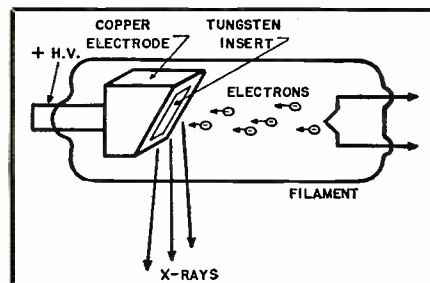



# UNIVERSAL DESIGN CURVES

## For Tone Control Circuits

By  
**M. B. KNIGHT**

Tube Dept., Radio Corporation  
of America

**Eliminate tedious "cut-and-try" methods by  
using these design and evaluation curves.**

THE experimenter who likes to work out his own amplifier designs frequently faces the problem of designing tone-control and compensating networks. Although a cut-and-try technique is successful, the average basement is not stocked with the necessary measuring equipment to carry out that method. Furthermore, that method can be laborious if the designer is not sure what circuit arrangement he should use. This article will give the frequency-response curves obtained with some practical RC filter arrangements, and will also explain how these curves can be used in solving design problems.

Mathematical analysis of even the simpler circuits yields such complicated formulas that cumbersome numerical computations are required to determine the frequency response. We decided, therefore, it would be a saving in the long run to struggle through the computations and make the results available as frequency-response curves applicable to any design problem. These curves also permit quick evaluation of a circuit for its ability to fulfill the designer's requirements. The results for two of the simplest circuits are presented in this article.

Before we get into the subject too

Fig. 1. (A) The most popular of all tone control circuits. (B) Equivalent circuit.

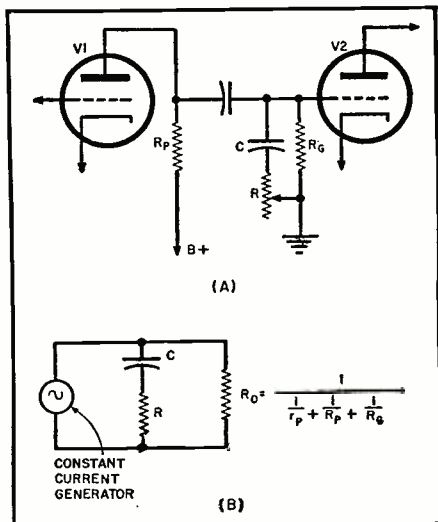

deeply, perhaps we should have a short session on the meaning of the terms boost and attenuation, particularly as used in this article. Some people may object to a term such as "treble boost" because "treble boost" is actually obtained by attenuating the lower frequencies. In fixed-compensating circuits a "treble-boost" circuit has the same form as a "bass-attenuating" circuit; any distinction lies only in the frequencies affected. The two terms are useful in expressing the effect on the ear, nevertheless, but they can be no more precise than the terms "bass" and "treble" themselves. The circuit configuration for a treble-boosting tone control, however, is preferably not the same as a bass-attenuating tone control. In order to have minimum effect on volume, the treble tone control should have little effect on the middle and low frequencies; a bass tone control should have little effect on the middle and high frequencies. But we must not forget that any boost of lows or highs is obtained at the expense of middle-frequency gain so it is not desirable to design for more boost than is needed.

### Treble Attenuating or Bass Boosting

Fig. 1A shows the usual form of a popular tone-control circuit. It is most successfully used as a treble attenuating circuit with the resistor,  $R$ , fixed or variable, or as a bass-boosting circuit with  $R$  fixed. Neglecting the effects of the coupling condenser and of stray and tube capacitances we may use the a.c. equivalent circuit for the arrangement of Fig. 1A as shown in Fig. 1B. The constant-current equivalent circuit is used for convenience of analysis.  $R_o$  is the effective parallel value of the grid resistor,  $R_g$ , the plate load resistor,  $R_p$  and the plate resistance,  $r_p$ , of  $V_1$ . When this tone control is inserted after an audio mixer stage in which other tubes are operated in parallel with  $V_1$ , their plate load resistors and plate resistances must be included in determining  $R_o$ .

The voltage output of the equivalent circuit of Fig. 1B is proportional to the absolute value of the impedance seen by the constant-current generator. To

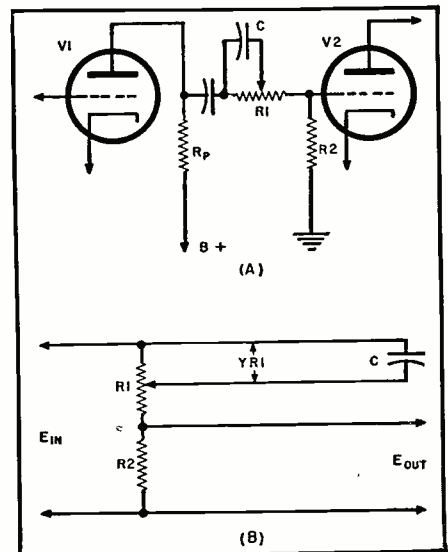

Fig. 2. (A) A tone control circuit suitable for fixed or variable treble boost or bass attenuation. (B) Equivalent circuit.

obtain the universal design curves of Fig. 3, the absolute value of the impedance is divided by  $R_o$ , and the voltage output is expressed as a decimal fraction of the voltage output obtained if  $X_c$  or  $R$  were infinite. Of course, twenty times the logarithm of this fraction converts the voltage output into decibels.

### Universal Design Curves

We shall illustrate the use of these curves by an example. The usual design problem requires that circuit values be chosen to give a desired boost or attenuation at some given frequency. Suppose we want about 10 db of fixed boost at approximately 50 cycles. The circuit values of the preceding amplifier stage are known, except possibly the plate resistance,  $r_p$ , of  $V_1$  (which is usually not the value found with the typical operating conditions shown in the published data for the tube type). But we'll tackle that  $r_p$  problem a little later. For this example, let's assume we are using a pentode, because its plate resistance is so high that it may be neglected. The plate load resistor,  $R_p$ , is 220,000 ohms and the grid resistor is 1 megohm.



First, we find  $R_o$  which is as follows:

$$R_o = \frac{1}{\frac{1}{R_p} + \frac{1}{r_p} + \frac{1}{0.22} + \frac{1}{1}} = 0.180 \text{ megohm}$$

Next, we examine Fig. 3 for the curve which will give us the 10 db boost. The curve for  $R/R_o = 0.4$  would give a difference in voltage output of 10.9 db between very low frequencies and very high frequencies. If we place 50 cycles at the  $-0.9$  db ordinate, we accomplish the desired 10 db of boost at 50 cycles. The abscissa for  $-0.9$  db on the curve  $R/R_o = 0.4$  is 0.36. We may now solve for  $C$ .

$$2\pi f C R_o = 0.36$$

$$C = \frac{0.36}{2\pi f R_o} = \frac{0.36}{2\pi(50)(.18 \times 10^6)}$$

$$C = 6.38 \times 10^{-9}$$

$$C = 0.00638 \mu\text{fd.}$$

We would choose the nearest available value of  $0.006 \mu\text{fd.}$  for  $C$ . Since  $R$  should equal  $0.4 R_o$ , which is 72,000 ohms, we would select a 68,000-ohm resistor. The error incurred by rounding off the numbers to standard values is seldom of significance, but can be evaluated by working the problem in reverse.

This circuit is preferably used in low-level stages, particularly when designed for fixed bass boosting. If it is used in high-level stages care must be taken to avoid distortion due to the small a.c. load impedance at high frequencies. Careful choice of grid bias for  $V_1$  is required if maximum undistorted output voltage is to be obtained, but, in any event, the maximum output voltage is appreciably less than that which can be obtained from a conventional resistance-coupled amplifier.

This circuit has one disadvantage when used as a variable tone-control circuit. The maximum value of  $R$  must be fairly large compared to  $R_o$  in order to achieve a fairly flat response at some setting of the control. As a result, the curves show that the effects of the tone control are not particularly noticeable until the value of  $R$  is a small fraction of the total value and, therefore, the tone adjustment is not gradual over the range of the potentiometer. Moreover, the conventional wiring of the control causes increasing attenuation with clockwise rotation; the use of an "audio taper" pot aggravates the effect. The use of a logarithmic taper pot is recommended, but the taper should be opposite that of the usual audio taper. An audio taper pot, however, may be connected in such a manner that attenuation increases with counter-clockwise rotation.

#### Determining the Plate Resistance

We mentioned previously that the plate resistance of a pentode is usually so high that it may be neglected. The  $r_p$  of a triode in a resistance-coupled amplifier, however, is usually less than the plate load resistor (but larger than the value given in the published tube data which is for typical operation in

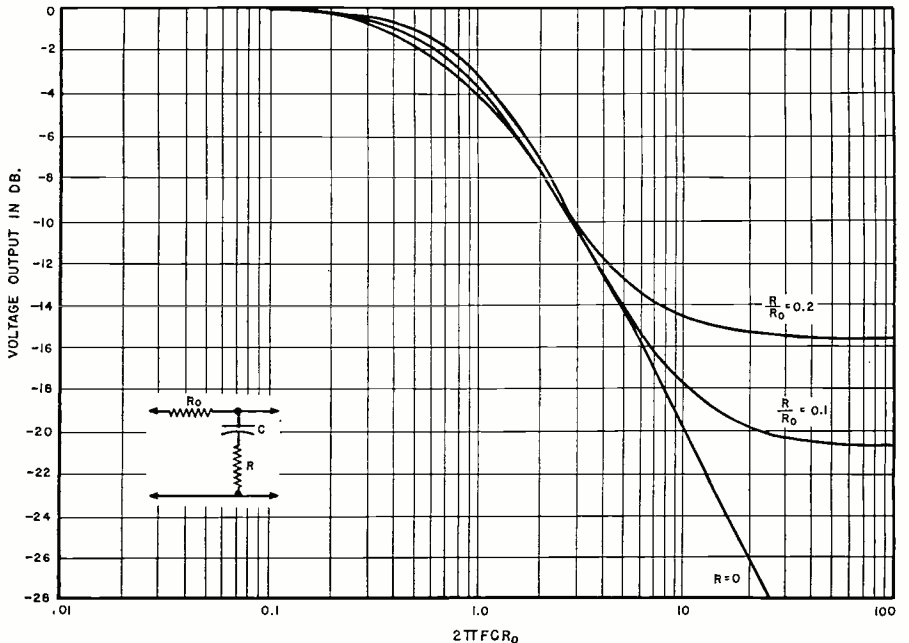
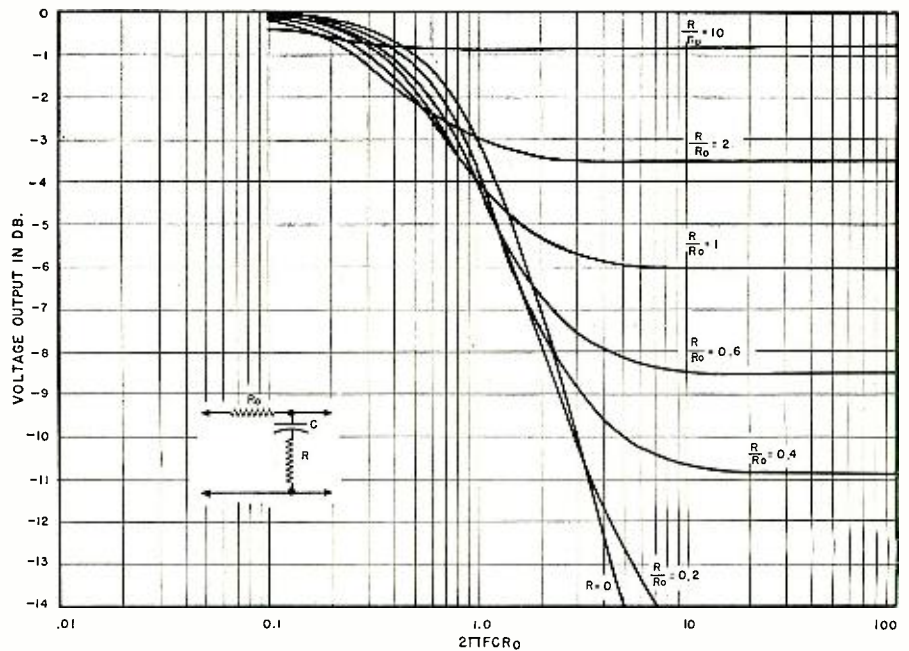
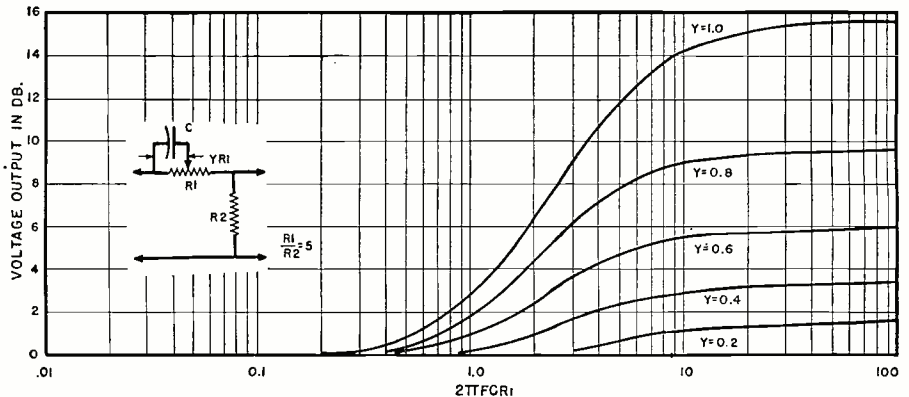

Fig. 3. Universal design curves for determining  $C$  of circuit shown in inset.

Fig. 4. Design curves for determining  $C$  of circuit shown when  $R_1/R_2$  equals 5.



transformer or impedance coupled circuits). Two methods are suggested for finding the  $r_p$ . First, it may be determined quite accurately from the tube characteristic curves. Or, as a

simpler alternative, we have worked out an empirical formula which is usually satisfactory for the operating conditions given in the resistance-coupled amplifier charts found in handbooks.



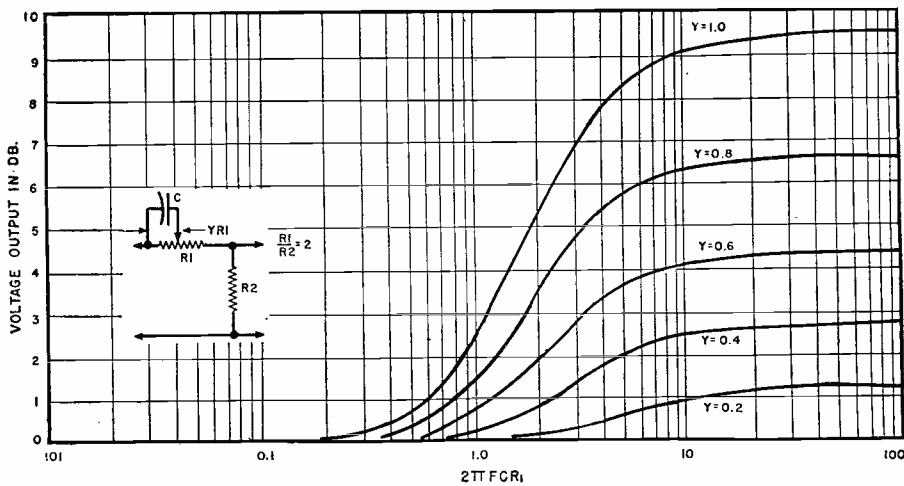

Fig. 5. Curves used to determine C of circuit shown when  $R_1/R_2$  equals 2.

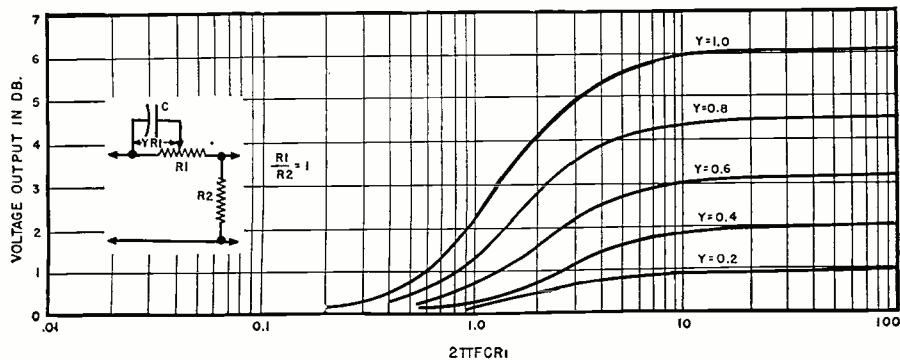

Fig. 6. When  $R_1/R_2$  equals 1, use these curves to determine the C of circuit.

A complete explanation of the method of determining  $r_p$  from characteristic curves may be found in many textbooks, but we shall review the procedure briefly. First, the static operating voltages must be found. The d.c. load line should be drawn on the plate-voltage, plate-current curves and the operating bias placed on this line. If only the cathode resistor is known, the bias may be determined by successive approximations until the point on the load line is found at which the plate current, grid bias, and cathode resistor are consistent. The plate resistance is the slope of the constant grid-voltage

line as it intersects this point on the load line. Of course, it is not likely that the desired grid-voltage line will be plotted on the curves and some interpolation will be necessary. Greater accuracy may be obtained by determining the plate resistance for several values of grid-bias on the load line. These values of  $r_p$  may be plotted for the various values of grid bias and the desired value of  $r_p$  taken from this curve at the operating bias.

Curves of plate resistance *versus* grid bias at several values of plate voltage are available for some tube types. These curves simplify the pro-

Fig. 7. Design curves for determining C of circuit shown when  $R_1/R_2$  equals 10.

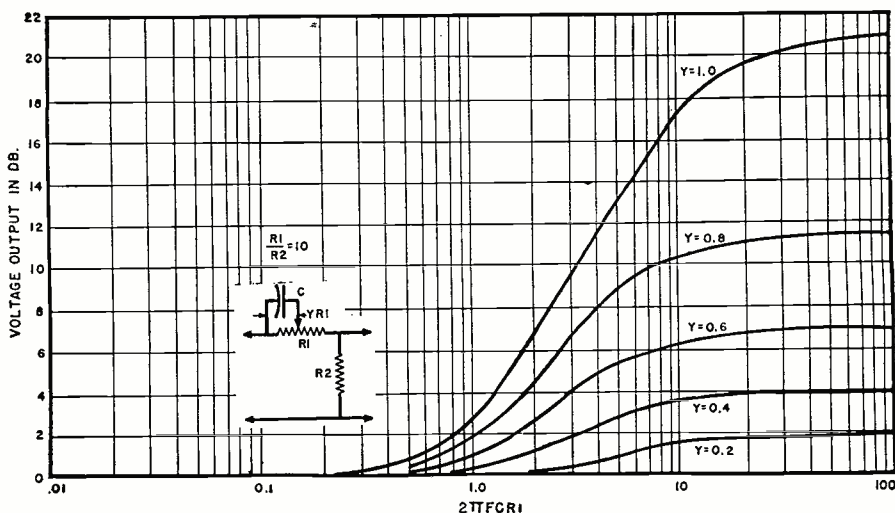

cedure, because the  $r_p$  value may be found by interpolation of these curves after the d.c. operating voltages have been determined.

Because the operating conditions suggested in the resistance-coupled amplifier charts were determined systematically, it could be expected that some relationship might be found between  $r_p$  and some value which could be obtained from those charts. After much trial and error, we found one formula which gives  $R_o$  directly with fair accuracy.

$$R_o = 0.17 \mu R_p + 5000 \text{ (ohms)}$$

The value of  $\mu$  to be used is that found in the tube data for the typical operating conditions. The value of  $R_o$  calculated from this formula is usually well within 10 per-cent of the correct value. The only important discrepancies found were with the highest value of load resistor for types 6SN7GT and 6SL7GT, in which cases the formula gives a value 10 per-cent to 25 per-cent too high, the 25 per-cent error being associated with the highest value of next stage grid resistor. The formula is satisfactory, however, for the lower values of load resistor with these types. It must be emphasized that this formula is empirical; it applies only to triodes operated in accordance with the values given in the resistance-coupled amplifier charts.

### Treble Boosting or Bass Attenuating

Fig. 2A shows another tone-control circuit. It is best applied for fixed or variable treble boosting or for fixed bass attenuating. The equivalent circuit used for analysis is shown in Fig. 2B. For convenience a constant voltage source ( $E_{in}$ ) is assumed. When these curves are used, therefore, the impedance of the tone-control circuit should be made large compared to the source impedance, a condition which is usually easy to meet.

The curves expressing the output voltage of this circuit are shown in Figs. 4, 5, 6, and 7. The zero db reference level is the low-frequency output voltage as attenuated by the voltage divider formed by  $R_1$  and  $R_2$ . The symbol "y" denotes the setting of the tone control and is defined to mean the fraction of the total resistance of  $R_1$  included across the condenser C.

### Use of Curves

The first step in a design problem with this circuit is to choose the ratio of  $R_1$  to  $R_2$  to accomplish the required boost or attenuation, so as to narrow the problem to one set of curves. The rest of the solution is similar to the example with the first circuit.

As an example, suppose we want a variable treble boost tone control effective mainly above 3000 cycles and giving about 10 db maximum boost. Let us assume that we are using a medium- $\mu$  triode for  $V_1$ , so that the source impedance will be sufficiently low for any reasonable values in the tone-control circuit. The curves for

(Continued on page 101)



## Simplified

### Part 3. Complete details on the design and construction of microphones and phono cartridges, including preamp requirements.

By  
**DAVID FIDELMAN**



RCA "Starmaker," a streamlined mike designed for TV and public appearance work.

ALL systems for the recording or reproduction of sound must start with some device for picking up the signal which represents the sound to be reproduced. This signal may be either sound in the air, a disc or magnetic medium containing a sound recording, or an electromagnetic signal representing a radio broadcast of a sound signal. The pickup devices which convert these various signals into audio-frequency electrical signals to be introduced into the reproduction channel are microphones, phonograph pickups, and radio receivers. A proper understanding of the functioning of the sound reproducing system must begin with these various pickup devices.

#### Microphones

No sound reproducing system of any sort would be possible without the use of microphones, since they are used to convert the original sound into an electrical signal that represents the sound pressure variations in the air. Microphones may best be divided into two groups: (a) low impedance microphones, and (b) high impedance microphones, since this grouping determines the type of preamplifier and circuit techniques which must be used with them.

The first group includes the various types of carbon, velocity (or ribbon), and dynamic microphones. The operation of these types is illustrated in Fig. 1, which shows their internal construction in simplified form.

The carbon microphone depends for its operation upon the resistance of the contacts between carbon granules. It consists essentially of a carbon button—which is a cylindrical cavity filled with carbon granules—and a diaphragm coupled to this carbon button in such a manner that pressure variations in the air cause proportional variations in pressure across the carbon granules. This pressure variation causes a change in the resistance be-

tween the plates which are in contact with opposite sides of the carbon button. An audio-frequency electrical signal is obtained by using the microphone resistance as one arm of a series voltage divider and measuring either the voltage variation across the microphone due to its resistance variation, or the current variation in the circuit by means of a transformer. The resistance of this type of microphone is generally of the order of about 100 ohms. It has high electrical output and good enough frequency response and distortion characteristics for voice reproduction, but is not suitable for high-quality reproduction of music.

In the velocity (or ribbon) microphone, a thin corrugated aluminum ribbon is suspended in the air gap between the pole pieces of two parallel sections of a permanent magnet. The difference in air pressure between the

front and back of the ribbon, due to the sound waves in the air, causes it to move in the magnetic field and generate a voltage proportional to the air-particle velocity in the sound wave. The ribbon, which is a thin strip, can move forward and backward, but not sideways or up and down—therefore it is most sensitive to sounds which approach it perpendicularly, and has no response to sound waves which move in a direction parallel to its plane. Its directional response is, therefore, that of the "figure-eight" shown in Fig. 2A. The ribbon is extremely light and is loosely stretched between its supports so that its natural resonant frequency of vibration is below the audible range, therefore its response is uniform over the entire audio-frequency range. Good velocity microphones are capable of high electrical output level and uniform frequency response from 40

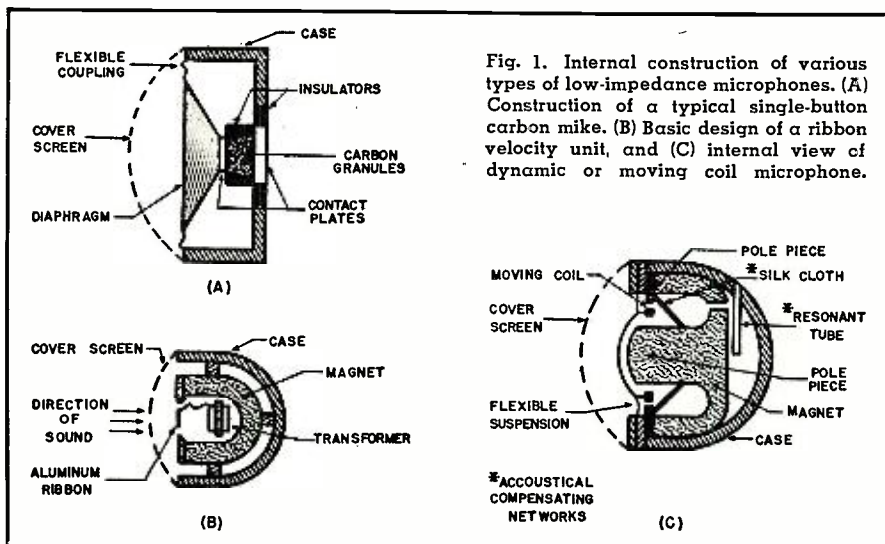

Fig. 1. Internal construction of various types of low-impedance microphones. (A) Construction of a typical single-button carbon mike. (B) Basic design of a ribbon velocity unit, and (C) internal view of dynamic or moving coil microphone.



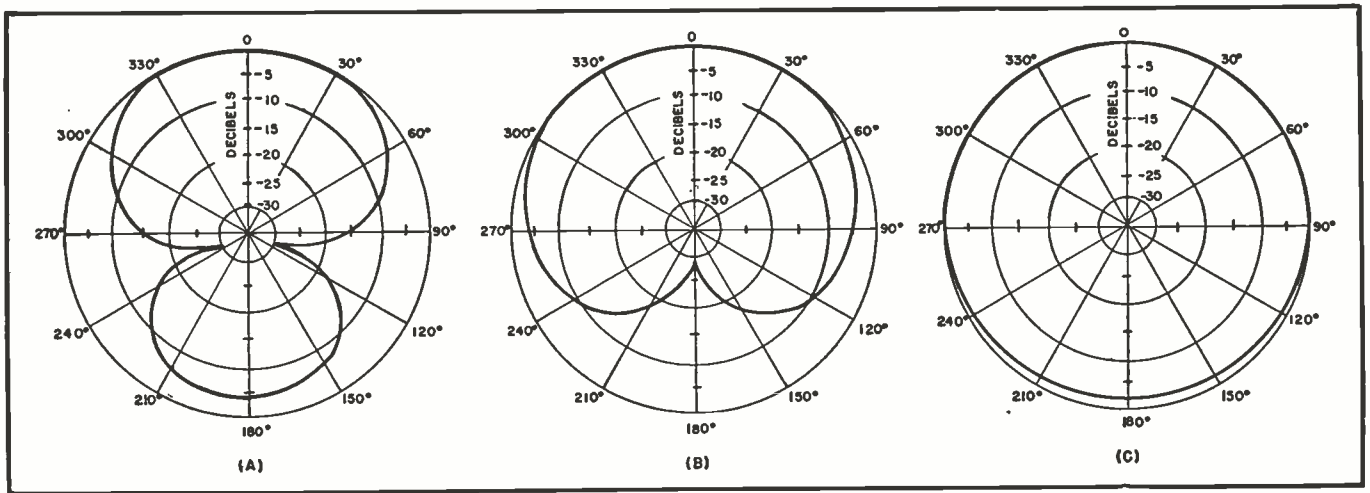

Fig. 2. Various types of microphone directional characteristics. (A) Figure-8 directional response of ribbon velocity unit. (B) Cardioid response. (C) Non-directional pressure response.

to over 10,000 cps, and are perhaps the most widely used studio microphones in high-quality commercial radio broadcasting and sound reproduction.

The dynamic (or moving-coil) microphone consists of a coil which is placed in a magnetic field and coupled to the air by means of a diaphragm. The sound pressure vibrations in the air cause the coil to move in the magnetic field and cut the magnetic lines of force, thus generating a voltage in the coil. The details of construction, given in Fig. 1C, show how the circular coil is mounted in the movable diaphragm so that it is suspended in the radial field between the two poles of a cylindrical magnet and can move into and out of the field according to the sound pressure variations in the air.

The basic construction is extremely simple, and the principle of operation is essentially that of a loudspeaker in reverse. (This is why loudspeakers can be also used as microphones in low-cost intercommunication systems.) In microphones for high-quality sound reproduction, acoustic and mechanical compensating networks are added to the basic microphone design to improve the frequency response and directional characteristics. Moving-coil microphones with such compensating systems are capable of giving a frequency response which is flat from about 40 to 10,000 cps with a non-directional spatial response. Because of its construction, the moving-coil microphone is more rugged than the velocity microphone, is less easily damaged by rough handling, less sensi-

tive to overloading, and not adversely affected by wind—therefore it is well suited to public address work and broadcasting of outdoor events as well as for studio and indoor sound pickup.

A cardioid type of directional response illustrated in Fig. 2B is obtained by combining the bidirectional velocity response of Fig. 2A with the non-directional pressure response of Fig. 2C. In one microphone of this type, shown in Fig. 3A, the "figure-eight" response of a ribbon velocity section is added to the pressure response of a moving-coil section. When the sound originates behind the microphone, the velocity section is moving out-of-phase with the pressure section, therefore the addition and cancellation of the signals from the two sections results in the cardioid directional pattern. A two-section ribbon microphone can also be arranged to give this type of directional characteristic, as shown in Fig. 3B, by enclosing one section of the ribbon in a metal housing terminated in an infinite impedance so that it has a nondirectional pressure response.

The high impedance microphones are the crystal and the condenser microphones. Their construction and principles of operation are illustrated in simplified form in Fig. 4.

Crystal microphones depend for their operation upon the fact that a piezoelectric crystal generates an electrical voltage when it is distorted by a mechanical force. Therefore, if a crystal is arranged so that the sound pressure variations in the air cause it to be mechanically distorted, then it can be used as a microphone to give an electrical voltage proportional to the sound pressure. There are two different types of mechanical arrangements which are used for crystal microphones—the diaphragm-actuated crystal, and the "sound cell."

The diaphragm-actuated crystal is set up as shown in Fig. 4A. The diaphragm moves back and forth according to the sound pressure in the air, and is attached to one or two corners of a bender or a twister bimorph Rochelle salt crystal. The crystal is thus

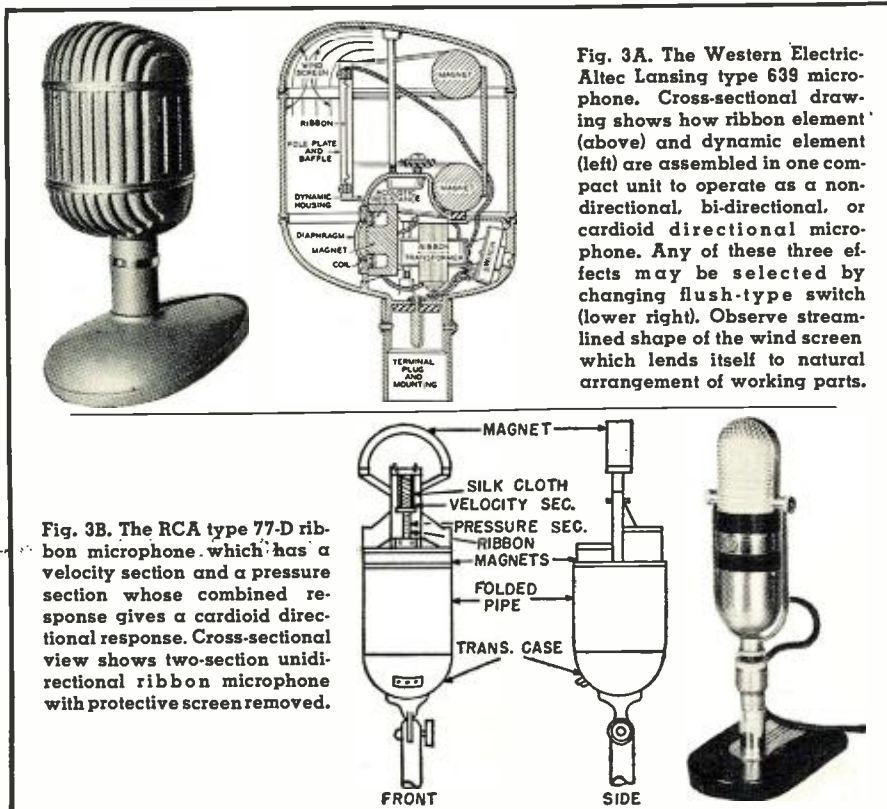

Fig. 3A. The Western Electric-Altec Lansing type 639 microphone. Cross-sectional drawing shows how ribbon element (above) and dynamic element (left) are assembled in one compact unit to operate as a non-directional, bi-directional, or cardioid directional microphone. Any of these three effects may be selected by changing flush-type switch (lower right). Observe streamlined shape of the wind screen which lends itself to natural arrangement of working parts.

Fig. 3B. The RCA type 77-D ribbon microphone which has a velocity section and a pressure section whose combined response gives a cardioid directional response. Cross-sectional view shows two-section unidirectional ribbon microphone with protective screen removed.



distorted according to the pressure of the sound waves, and produces an audio frequency voltage of the same wave pattern as the incident sound wave.

The "sound cell" consists of two bimorph crystals assembled as shown in Fig. 4B, with a completely enclosed cavity between them. If the instantaneous external air pressure is greater than the pressure in the enclosed space the crystals will tend to be bent inwards, whereas a lower external than internal air pressure will cause the crystals to bend outwards. In one case a positive voltage will be generated, and in the other a negative. If sound pressure variations occur in the air outside the sound cell, a proportional audio-frequency voltage will, therefore, be produced by the cell. No diaphragm is required since sound pressure acts on the crystal elements directly. The output impedance of a single sound cell is quite high, therefore a lower output impedance is often obtained by the use of multiple sound cells stacked in parallel (see Fig. 4C).

Crystal microphones give good frequency response to over 10,000 cps and are well suited to high quality sound reproduction. They must operate into a high impedance load, but with special coupling transformers they can be operated into low impedance lines. Sound cells discriminate against mechanical shock and vibration, since the cell responds only to changes in air pressure and generates no voltage when it moves as a unit.

The condenser microphone is one whose operation depends upon variations in electrical capacitance between two electrodes. The basic construction and principle of operation of the condenser microphone is shown in the diagram in Fig. 4D. It consists essentially of a thin stretched diaphragm which is separated by a small distance from a parallel rigid plate. Variations in the pressure of the air on the diaphragm cause it to move toward or away from the plate, changing the electrical capacity between them. Thus an electrical capacity variation is produced which is proportional to the sound pressure variations in the air. Good condenser microphones have uniform frequency response over an extremely wide frequency range (from 0 cps to well over 10,000 cps) and have very stable characteristics, and at the same time are small and compact physically. For this reason they are often used as a standard in acoustic measurements. However, they do not give very large capacity variations for variations in air pressure, resulting in a very low output signal. When used in a conventional series-dropping resistor circuit they give a very low output voltage at high impedance, but can be used in frequency-modulated oscillator circuits to overcome this limitation. Because of the inconvenience involved in their use, condenser microphones until very recently were not widely used in sound reproduction and broadcasting work in this country.

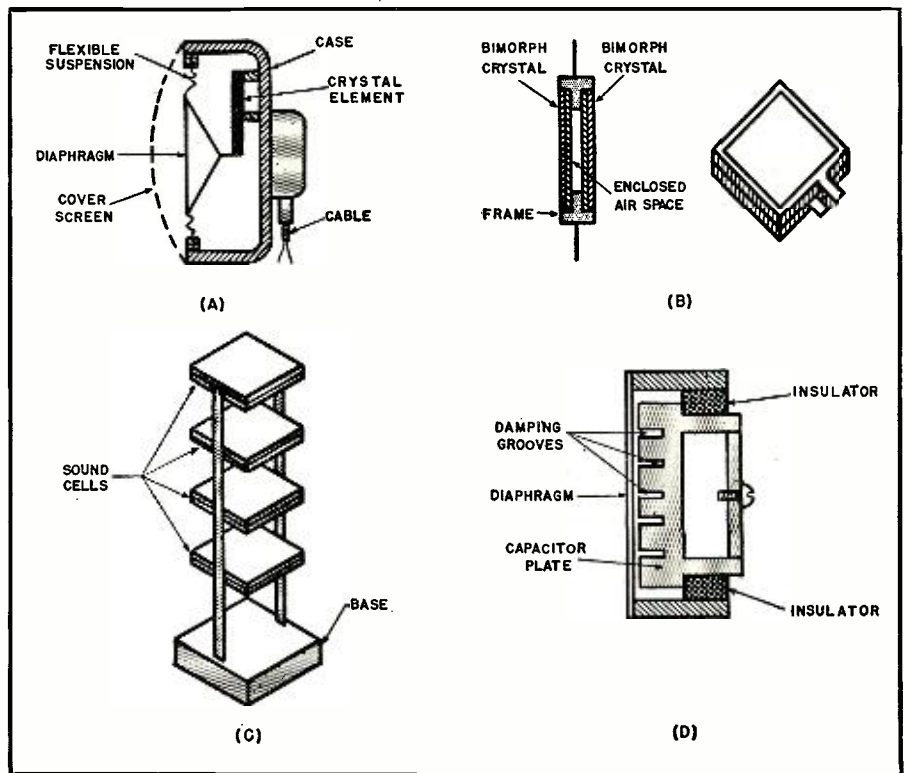

Fig. 4. Construction of high impedance microphones. (A) Diaphragm-actuated crystal unit. (B) Crystal sound cell. (C) Four-element sound cell. (D) Condenser mike.

The important characteristics of the various types of microphones—frequency range, output voltage and output impedance, directional characteristics, and other important features—are summarized in Table 1 for convenient reference.

### Phonograph Pickups

The phonograph pickup converts the sound signal which has been recorded on a disc into an audio-frequency electrical signal. As with microphones, the various types of pickups may be considered in the two categories: (a) low impedance pickups, and (b) high impedance pickups, because this grouping determines the type of preamplifier and circuit techniques which must be used.

The high impedance crystal pickup is, at the present time, the most widely used of any type of pickup for the re-

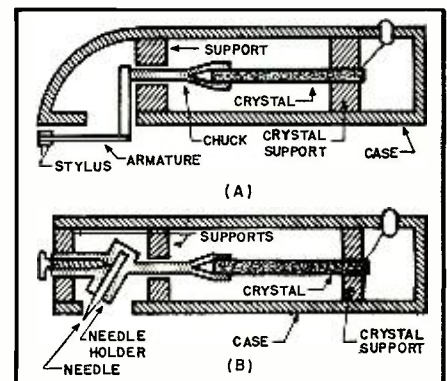

Fig. 5. Construction of two common types of crystal phono pickups. (A) Low-noise type, and (B) removable-needle crystal pickup.

production of phonograph records. The basic construction of low-noise pickup is shown in the diagram of Fig. 5A. It

Table 1. Performance characteristics of the various types of microphones.

TYPE OF MICROPHONE	DIRECTIONAL CHARACTERISTICS	OUTPUT IMPEDANCE	OUTPUT LEVEL	FREQUENCY RANGE	MAJOR APPLICATIONS
Velocity (ribbon)	Bidirectional	50/250 ohms	-55 dbm	30-15,000 cps	High quality and studio pickup
Dynamic (moving coil)	Nondirectional	50/250 ohms	-55 dbm	40-10,000 cps	Studio pickup, remote and outdoor uses
Cardioid	Unidirectional (usually adjustable to bidirectional and nondirectional)	50/250 ohms	-57 dbm	40-10,000 cps or better	High quality studio pickup
Crystal	Nondirectional	1 megohm (approx.)	-51 dbm	40-10,000 cps at best	Amateur, home and p.a.
Condenser	Nondirectional	About 10 megohms (requires special preamplifier)	Approx. -55 to -80 dbm after pre-amp	30-15,000 cps or better	High quality studio pickup and as sound measurement standard
Carbon	Nondirectional	100 ohms	Approx. -45 dbm	Voice frequencies	Voice reproduction and talk-back



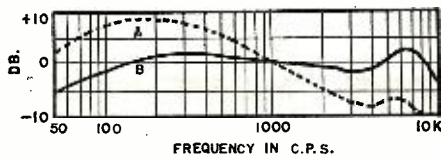

Fig. 6. Frequency response of a low-noise crystal pickup of type shown in Fig. 5A.

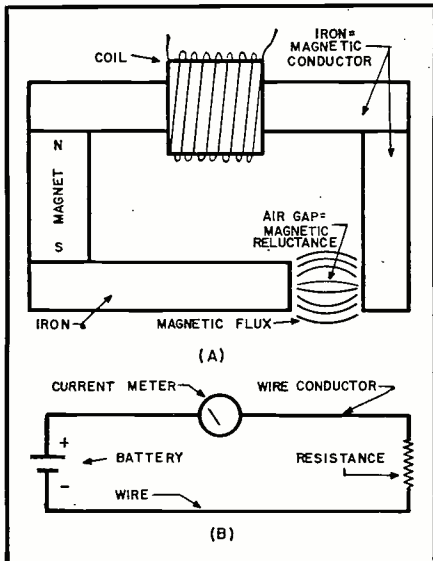

Fig. 7. (A) A simple magnetic circuit and its analogous electrical circuit (B).

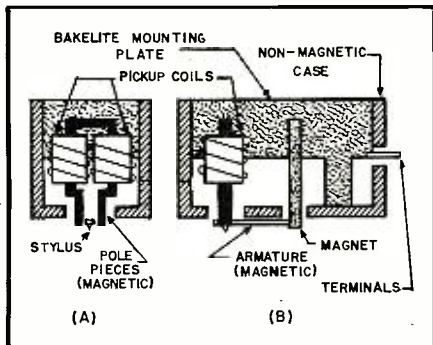

Fig. 8. Simplified diagram showing construction of variable reluctance magnetic pickup.

consists of a torsional Rochelle salt crystal element which is caused to twist by the modulation of the groove in the record, and thus produce an electrical signal whose amplitude and frequency are proportional to the groove modulation. The crystal is supported in the tone arm so that one end is held securely in place, while the other end is coupled to the needle and is supported flexibly so that it can be twisted by the modulation of the groove. The frequency response of such

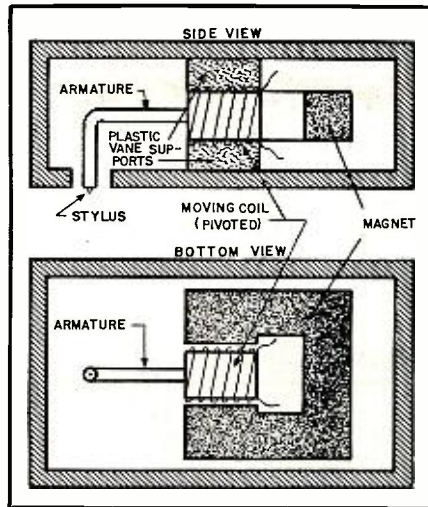

Fig. 9. Simplified diagram showing construction of moving coil dynamic pickup.

a pickup to a constant-velocity (500 cps crossover) test record is shown in curve A of Fig. 6, and the resulting response to the standard NAB recording frequency-response characteristic is given in curve B. (In recording sound on discs, the high frequencies are pre-emphasized in recording and de-emphasized in playback for better signal-to-noise ratio, while the low frequencies are attenuated in recording and boosted in playback to avoid over-modulation of the groove. These recording and reproduction frequency response curves will be discussed in greater detail in a later article of this series.)

Another type of construction of crystal pickup is that shown in Fig. 5B, in which the needle is mounted in a chuck from which it is removable. The needle chuck may be connected to the crystal either by a rigid direct mechanical coupling, or through a rubber coupling, or by means of a lever type of coupling which acts as a mechanical transformer.

Most of the low impedance pickups which are in current use are magnetic pickups, in which variations in the magnetic field or in the magnetic induction generate an electrical signal proportional in magnitude to the amount of motion of the needle in the groove. The two most important types of magnetic pickups at the present time are the *variable reluctance* pickup and the *moving coil* pickup.

The basic principle of operation of the variable reluctance pickup can be understood by reference to Fig. 7. The magnetic lines of force are concentrated in the iron and in the air gap as

shown in the diagram. For the magnetic field, this may be thought of as a "magnetic circuit" analogous to an electrical circuit in which the iron or steel is a conductor and the air gap a resistance. If the length of the air gap changes, the "reluctance" of the magnetic circuit changes, resulting in an increase or a decrease in the number of magnetic lines of force. If a coil is wound around the iron in the magnetic circuit, a voltage is generated in the coil due to the change in the number of magnetic lines of force through the coil.

The construction of a variable reluctance pickup is shown in detail in Fig. 8. The stylus is mounted on an armature of magnetic material which is fixed at one end and can be moved at the stylus end toward either of two coils by the modulation of the record groove. The fixed end of the armature is close to a small bar magnet, while a Mumetal pole piece through the two coils is solid at the top and split at the lower end near the stylus armature. Thus the magnetic circuit is from the bar magnet through the air into the coil yoke at the top, through the two sections of the yoke and into the armature equally from each piece when the stylus is in the undeflected position, and back through the armature to the bar magnet. When the armature is deflected by the stylus toward either one of the sections of the yoke, the magnetic field through that coil is increased and the field through the other coil decreased. The windings are in series, so that a push-pull action results. Since vertical motion of the armature does not cause the magnetic field in one coil to be greater than in the other, no voltage is generated due to vertical components of the motion, and the output voltage due to record scratch is, therefore, reduced. The armature is the only moving component in this pickup, and since this mass is extremely small the high frequency response is excellent.

In the dynamic pickup, the voltage is generated by the motion of a coil in a constant magnetic field. (The principle of operation of this type of pickup is the same as that of the dynamic microphone, although the physical construction is of course different.) The construction of a typical moving-coil pickup is shown in the diagram of Fig. 9. The stylus is mounted in one end of an armature, around whose other end is wound a small coil on a thin sleeve of silicon steel. This coil is supported in the magnetic field between the two poles of a magnet, and is mounted so that lateral motion of the stylus causes it to pivot in the magnetic field about its own center. This motion in the magnetic field generates a voltage in the coil proportional to the velocity of motion. Because the moving system is very light and pivots about a small radius, good high-frequency response is obtained; and because of the design of the coil in respect to the magnetic field, vertical

(Continued on page 158)

Table 2. Characteristics of various commercial-type phonograph pickup units.

TYPE OF PICKUP	OUTPUT IMPEDANCE	OUTPUT LEVEL	FREQUENCY RANGE
Crystal	Approx. 1 megohm	Approx. 1 volt	50-8000 cps
Variable Reluctance	Approx. 300 ohms	.011 volt	40-10,000 cps
Pickering	Approx. 100 ohms	.011 volt	40-11,000 cps
Dynamic (moving coil)	50-100 ohms	Approx. .01 volt	30-10,000 cps
Strain gauge	Approx. 100 ohms	Approx. .005 volt	30-10,000 cps
"Radionic"	Uses special preamp	Approx. 1 volt after preamp	40-9000 cps
(Zenith Cobra)			
Frequency modulation	About 10 megohms, requires special preamp	Approx. 1 volt after preamp	30-12,000 cps





# International SHORT-WAVE

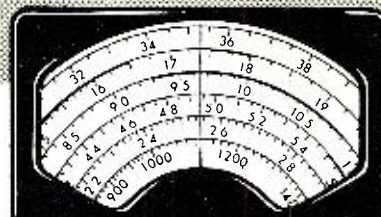

Compiled by **KENNETH R. BOORD**

IT IS A pleasure this month to dedicate the *ISW DEPARTMENT* to *Radio Free Europe*—operated by the *Crusade for Freedom*, and *Radio Free Asia*—operated by the *Committee for a Free Asia, Inc.*

Briefly, this is the story of *Radio Free Europe* and *Radio Free Asia* as cited by officials of the respective organizations:

*Radio Free Europe* began its broadcasting operations to the Iron Curtain countries on American Independence Day, July 4, 1950, with a single station located in the Frankfurt area of Western Germany. The schedule included programs to Bulgaria, Czechoslovakia, Hungary, Poland, and Rumania. Its method of waging psychological warfare was experimental. No American group had yet succeeded in matching the scope, intensity, or effectiveness of the Kremlin in its Cold War offensive against America and the forces of world freedom. But the goal of *Radio Free Europe* was clear from the start (1) to fight the Big Lies of Communism with the Truth, making clear that the basic struggle is *world freedom versus world tyranny*; (2) to undermine Soviet and native Communist influence in the satellite countries by every available means, and, in doing so, to win the allegiance of the captive peoples of these countries; (3) to foster among the prisoner peoples the desire for freedom and to kindle an active spirit of liberation; (4) to tell them of America's earnest desire for their liberation and for the establishment of free governments of their own choice. This was to be a tough, slugging weapon of propaganda that would counter-attack the loud voice of the Kremlin. Although launched with only one low-powered short-wave transmitter, evidence of *Radio Free Europe's* effectiveness quickly became apparent.

*RFE* correspondents, located in almost every European country, reported that large numbers of satellite peoples were listening to *RFE* broadcasts, advertising them by word-of-mouth. Escapees through the Iron Curtain also verified that *RFE* was being listened to and was developing resistance to the Communist overlords. A stream of letters smuggled through the Iron Curtain likewise corroborated these facts. The *Communist Radio* in East Germany attacked *Radio Free Europe* viciously. *Radio Moscow*, its "stooge" stations in the captive countries, and the Communist press in Russia and

Eastern Europe added to the diatribes. Communist radio stations began to "copy" *RFE* programs and techniques. And the Communists issued shrill rebuttals to many *RFE* broadcasts which exposed Communist actions.

Because of the mounting evidence that *Radio Free Europe* was reaching its audience behind the Iron Curtain, proving itself a vitally needed weapon in the Cold War against Kremlin tyranny, plans were laid for a second station in Western Germany. A single, low-powered station obviously could only scratch the surface.

To secure moral and financial support for these expansion plans, General Lucius D. Clay, leader of the Berlin Airlift, formed and headed the *Crusade*

for *Freedom* last fall. This seven-week campaign—which started on Sept. 4, 1950, with a four-network radio address by General Eisenhower, and ended with the dedication of the World Freedom Bell in Berlin on *United Nations Day*, October 24—enlisted the support of 16 million Americans, who contributed \$1,317,000 to help build up *Radio Free Europe*. The tangible results of the *Crusade for Freedom* became known to people on both sides of the Iron Curtain on May 1, 1951. On this day—the day the Kremlin sets aside each year to tell the workers of the world of the "benefits" of Communism—*Radio Free Europe* inaugurated its second station, in the American zone of Western Germany, made possible by American contributions.

The transmitter of this *new* station is located in the village of Holzkirchen; about 15 miles southeast of Munich; its signal power of 135 kw. makes it almost three times stronger than the largest m.w. broadcasting stations in (Continued on page 127)

(Note: Unless otherwise indicated, all time is expressed in American EST; add 5 hours for GCT. "News" refers to newscasts in the English language. In order to avoid confusion, the 24 hour clock has been used in designating the times of broadcasts. The hours from midnight until noon are shown as 0000 to 1200 while from 1 p.m. to midnight are shown as 1300 to 2400.) The symbol "V" following a listed frequency indicates "varying." The station may operate either above or below the frequency given. "A" means frequency is approximate.

### SCHEDULES FOR RFE, RFA

*Radio Free Europe* is scheduled presently as follows—Munich, Germany, with m.w. transmitter at Lampertheim, 135 kw., broadcasts on 719 kc. (417.2 m.) all-Czech or Slovak, 2300-0115, 0600-0815, 1200-1855; Lampertheim, Germany (usually identified as in the "Frankfurt area"), short-wave, 10 kw., 6.130 (48.9 m.), Hungarian 1000-1030, 1230-1300, 1500-1530, 1730-1800; Rumanian 1030-1100, 1315-1345, 1530-1600; Bulgarian 1100-1130, 1345-1415, 1600-1630; Czech 1130-1200, 1415-1430, 1630-1700; Polish 1200-1230, 1430-1500, 1700-1730; Albanian 1300-1315. Biblis, Germany (usually identified as in the "Frankfurt area"), short-wave, 10 kw., 6.020 (49.8 m.), rebroadcasts Czech programs of the Munich (Lampertheim) m.w. transmitter, 1200-1800; Lisbon, Portugal, short-wave, 7.5 kw., 9.605 (31.2 m.), rebroadcasts taped portions of Munich broadcasts at 1200-1800.

*Radio Free Asia*, when this was compiled, was radiating daily from Manila on 6.110 (49 m.) with directional antenna beamed to mainland of China 0830-1000 with half-hour periods in Mandarin, Cantonese, and English.

Four principals active in *Radio Free Asia*. From left to right are: James Day, executive assistant to the director of *Radio Free Asia*; Richard Bertrandias, program director who helped plan and produce RFA's first broadcast to areas behind the Iron Curtain of communist-dominated China; Lian Light, one of the voices on the first broadcast; and John W. Elwood, director of *Radio Free Asia Committee for a Free Asia, Inc.*, 245 California Street, San Francisco, Cal.





# The "HAM-LIM"

By  
**ED MILLER**

Chief Radio Eng., N.R.C.S.

***This simple, two-tube volume limiter can be adjusted with any low voltage d.c. voltmeter. It is easy to build.***

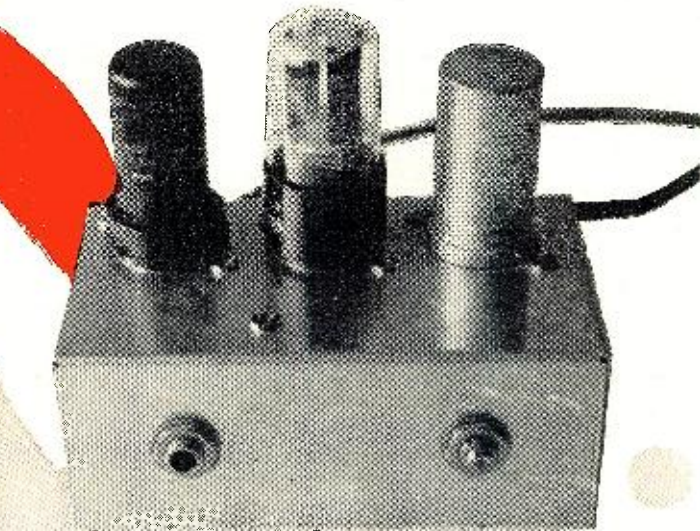

Fig. 1. The "Ham-Lim." This unit can be incorporated in existing equipment or used separately.

FOR many years amateurs have eyed commercial volume compressors with longing, but for many, if not most of them, the expense of such an item prohibited its purchase. True, there were those who bought or built five to ten tube volume compressors or limiters, but for most hams this represents as many or more tubes than are used in the rest of the transmitter. The requirements for a limiter for amateur use are much less stringent than for those used in broadcasting or recording. The frequency response for amateur use is anything but hi-fi, in fact, trimming off the edges at 200 and 2500 cycles is not only considerate use of a channel, but also a help in piercing QRN.

The author's idea of what the ultimate limiter for ham use would be like can be illustrated by the following points: 1. Simple circuit involving only one or two tubes; 2. No expensive or non-standard components; 3. Easy to adjust with the test equipment found

in most ham shacks; and 4. Insignificant current consumption so that it can be operated from the amplifier or modulator with which it is used.

Enter the "Ham-Lim," which meets all the above prerequisites by: (1) using only two tubes with (2) only a handful of resistors and condensers and *no* transformers. It (3) can be adjusted with only a voltmeter, and (4) it draws only two mils plate current and less than an amp at 6.3 volts. The heart of the "Ham-Lim" is the 6SL7GT forward-acting limiter developed by N.R.C.S. and described in the article "An Electronic Loss Compressor" appearing in the November 1950 issue of RADIO & TELEVISION NEWS. Preceding the 6SL7GT is a single stage of pre-amplification (a 6SJ7).

Fig. 2 shows the underchassis wiring which is simple and straightforward. No special precautions need be taken other than those usually taken in building a low-level amplifier. If the unit is to be used with an amplifier or mod-

ulator whose power supply is free from r.f., the decoupling resistor ( $R_{10}$ ) may be omitted, but it is cheap and small and its inclusion may save wiring it in later. As can be seen from the parts list and schematic diagram, most of the parts can be found in the junk-box or obtained very easily. The one exception is the control potentiometer ( $R_7$ ), which is 25,000 ohms, wirewound. Because the taper is unimportant, its procurement should not be difficult.

To realize the effectiveness of the "Ham-Lim," one needs only to look at the compression curves of Fig. 5. Here are shown the curves obtained with three settings of  $R_7$ . The settings are not measured in degrees or ohms, but in volts at point  $x$  in Fig. 3, with no audio applied to the input while heater and plate voltages are on. The approximate curve desired can be duplicated by adjusting  $R_7$  to provide the voltage shown opposite that curve in Fig. 5. There is a certain amount of variance between different tubes, but the difference is not enough to appreciably affect the operation. If a scope and audio oscillator are available, adjustment can be made without using the reference voltage, but where these luxuries are not readily attainable, adjusting the control to the voltage desired is simple and sure.

As mentioned in the outline of the ideal limiter, frequency response outside the 200 to 2500 cps range is not necessary or desirable. A glance at Fig. 4 shows that the response of the "Ham-Lim" is flat from 100 cycles up, from zero compression right up to 15 db of compression. In fact, the response of the compressor is more nearly flat than most high-impedance dynamic and crystal microphones used in amateur transmitters and public address systems.

One distinct advantage of the "Ham-Lim" is that it is forward-acting. This allows almost instantaneous compres-

Fig. 2. Underchassis view of the limiter. Relatively few components are required.

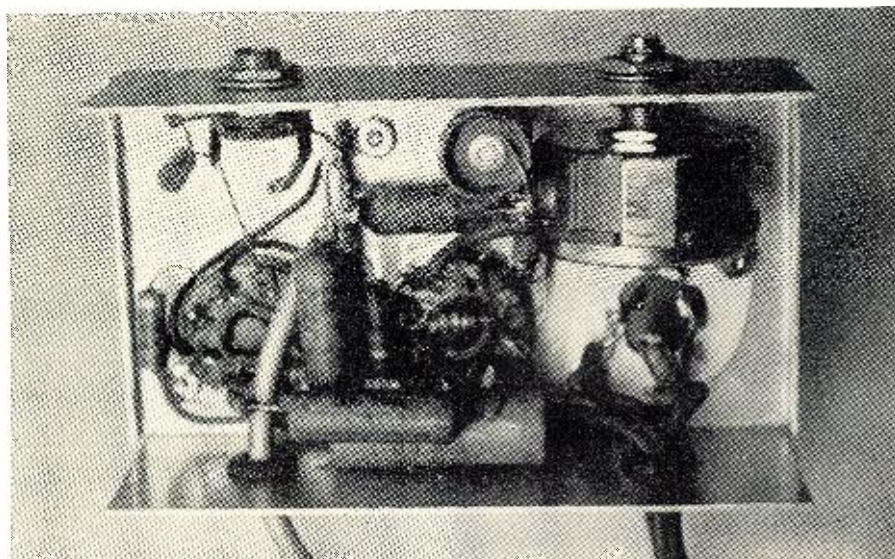



sion to take place even though the tubes are operated in cascade. This is because there is no regenerative path for the applied audio as there is in the backward-acting circuits.

In any article involving audio circuitry, the question of distortion is sure to arise. There is a little distortion of the applied signal when the intensity jumps considerably, but it is insignificant above 200 cycles, and barely noticeable on a scope below this frequency. Reports from listeners indicate that the quality of the speech is unchanged with or without the "Ham-Lim" inserted. As was explained in the previous article (RADIO & TELEVISION NEWS, November 1950), this type of compressor can easily be built into equipment when it is being designed, but there are many instances where the individual is very well satisfied with the audio equipment presently in use, with perhaps the desire to have compression. It is for this latter group that the "Ham-Lim" was designed. It is built with an adapter plug on the power cord that allows the voltages used by the amplifier to be used by the two-tube circuit. If it is desired that the power cable be permanently wired into the speech equipment or if a Jones plug or terminal strip on the audio chassis is preferred, the plug can be omitted.

If a voltmeter is the only instrument available when the unit is first adjusted, the positive d. c. voltage measured at the arm of  $R_7$  with respect to ground can be set by  $R_7$  to 1.2 volts with the microphone unplugged. This will provide satisfactory compression with no further adjustment necessary. If an audio generator and scope are available,  $R_7$  can be set to provide the curve desired with the audio applied to the plate pin of  $V_1$  socket with that tube removed.

The plate voltage that can be used with this limiter can run the range normally encountered in speech equipment, up to about 400 volts. The settings of  $R_7$  corresponding to the desired compression curve do vary with different plate voltages, but the compressor section can be adjusted satisfactorily with only 150 volts on the plates. Naturally, the gain of the pre-amplifier tube is affected by plate voltage to quite an extent, but even the low voltage will usually be sufficient to allow most high-impedance ham microphones to utilize the compressor action.

As with all but the most elaborate units of this type, occasional peaks of audio, that is one or two cycles, will get through at higher than the desired level. For this reason, even when the "Ham-Lim" is used, a transmitter should incorporate some protection from overmodulation, such as negative peak clipping. But irrespective of the transmitter circuitry, incorporation of the "Ham-Lim" will allow more nearly complete usage of the carrier by the modulating source, and a louder-sounding signal at the receiving end.

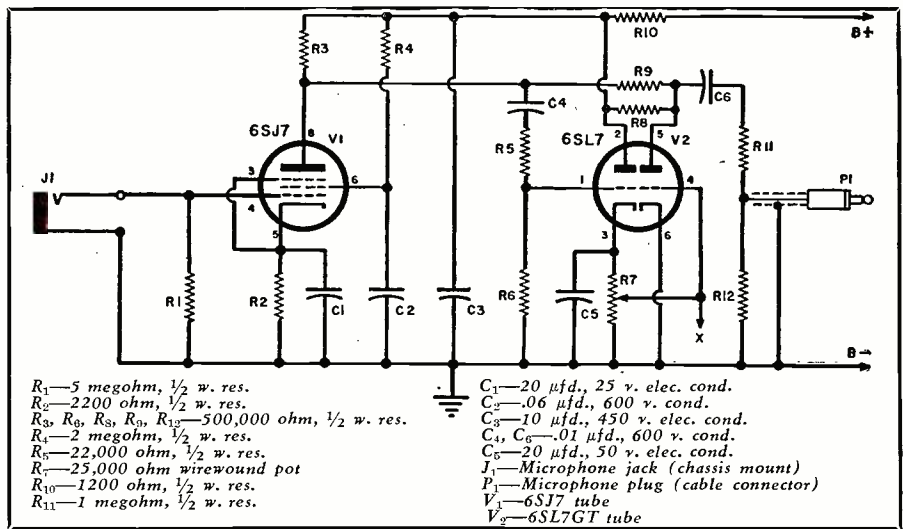

Fig. 3. Complete schematic diagram of the limiter. A separate power supply is required.

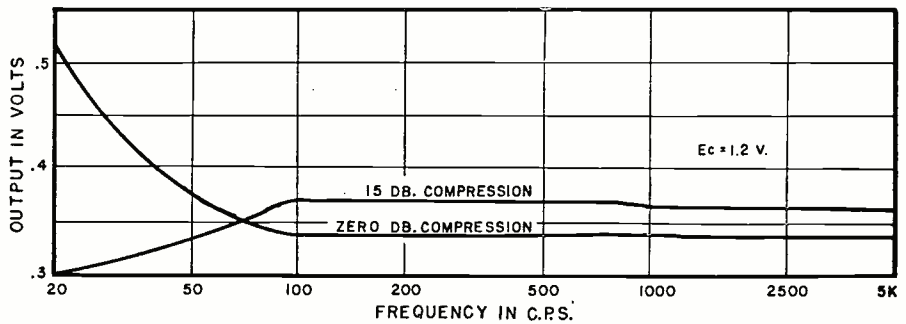
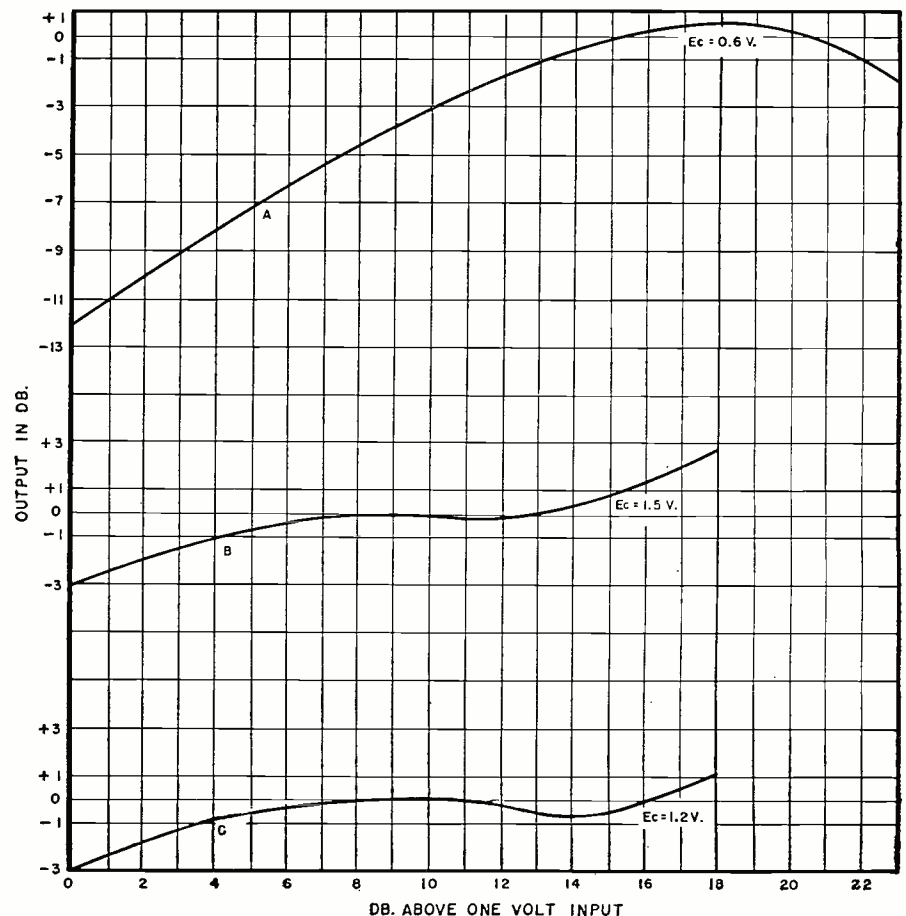

Fig. 4. The frequency response of the "Ham-Lim" is relatively flat between 100 cycles and 5000 cycles anywhere within its operating range of zero to 15 db of compression.

Fig. 5. Compression curves for three different settings of potentiometer ( $R_7$  in Fig. 3).





# CRYSTAL DIODES In Modern Electronics



By  
**DAVID T. ARMSTRONG**

Bank of whisker machines at G-E's germanium products plant in Clyde, N. Y. Operators use microscopes during welding process. Machines form and weld .003" dia. whiskers to pin and lead assemblies of diodes.

## ***Part 2. A review of the various uses of germanium crystal diodes in power and rectifier applications.***

THE applications of germanium diodes, shown in the accompanying circuits, are believed to be of general interest. While they are not the only actual uses, they are indicative of the variety of possible applications. Each crystal type presents its own special requirements which determine circuit design as well as values of associated condensers, resistors, and coils.

### **Large Variety of Possible Uses**

In order to capture the interest and stimulate the imagination of a large number of readers the applications of germanium diodes are covered here in the following groups: power and rectifier supplies, AM (broadcast) receivers, FM receivers, television, amateur, instruments, and miscellaneous applications. This will make a relatively complete discussion of general applications of germanium diodes to modern electronics, and it seems desirable to cover the material in this way so that reference may be made to previous

sections as the series of articles progresses.

The circuit diagrams will be as complete as it is possible to make them, and, wherever practical, maximum and minimum limits will be indicated, for voltage and current limitations determine the success or failure of the diode crystal in a given circuit. In general, maximum frequency limitations on diodes do not apply since the upper frequency limit of 100 mc. for germanium crystals is well within the frequencies encountered beyond the front end, even with the new 44 mc. i.f. Diodes perform well at AM and FM i.f., but they contribute the least noise to a circuit above 30 mc. On the basis of much experimental work germanium diodes are believed to be useful up to frequencies as high as 500 mc.

### **Rectifier Applications**

The circuits in Fig. 1 are variations of low impedance series diode rectifiers. These are general circuits ap-

plicable to power frequencies, as well as the radio frequencies encountered in AM, FM, and TV. These are substantially the same circuits that would be used with tube type diode rectifiers. All the circuits in A, B, and C of Fig. 1 are low impedance load circuits.

With a 1N56 type high conductance diode these low impedance circuits are useful up to 40 volts peak and are capable of delivering at least 30 ma. short-circuit current to the load at 2 volts rms applied. By virtue of its exceptionally low dynamic impedance a 1N56 will provide high current efficiency with load impedances of 1000 ohms or less.

In B is shown parallel operation of two or more crystals to permit greater currents to be handled, or to increase the current delivered to the load at low input voltage levels.

Whenever possible, use a germanium diode to operate into very low impedance loads because they are well suited for such circuitry by virtue of their extremely low forward resistance. The 1N56 has an average forward resistance of less than 60 ohms with +1 volt applied across its terminals. This enables it to pass comparatively large currents with relatively low signal voltages and gives it ideal characteristics for driving low impedance networks.

Fig. 3A shows a rectifier application for high impedance loads. Consider a load impedance of .5 megohm or greater. Because the reverse dynamic impedance of the 1N54 reaches a maximum of over 2 megohms at approximately -10 volts (see Fig. 3 in Part 1 of this series), this circuit will function exceptionally well with input levels on the order of 20 volts rms. The effects of diode reverse conductance upon the efficiency of rectification are substantially reduced by designing the circuit with two high reverse resistance type crystals, like the 1N54, in series.

The 1N54 has unusually high reverse resistance and it is a useful element in circuits involving high values of load resistance. The magnitude of the reverse resistance will vary with the amount of voltage impressed across



the diode. Therefore, for proper use of crystals it is important to keep these two considerations in mind:

1. What is the average signal level at which the diode will be called upon to work?
  2. What is the approximate resistance value of a given diode for this average signal level region?
- Thus, the higher the value of the load resistance in ordinary circuits of a series type, the more important it is to use a germanium diode with high reverse resistance, and to use it where its reverse resistance is maximal.

When operating with low signal level into high impedance networks it is extremely important to increase the signal level to that voltage which will permit use of the diode at the point where the reverse resistance is at a maximum. The resistance of most germanium diodes increases rapidly as back voltage is increased from zero to -10 volts; for the 1N54 the resistance at -10 volts is approximately 2 to 2.5 megohms.

For high signal levels on the order of 20 volts rms or more, it is desirable to design a circuit with the diodes in series, as shown in Fig. 3A. By splitting the signal voltage the diodes present their maximum resistance to the circuit. Because they are in series the resistances are additive. This produces a composite back resistance which is relatively high, even for loads in the megohm range. Keep in mind that the forward resistance will be increased somewhat, but this will have no appreciable effect because of the high value of the load resistance.

Fig. 3B shows a high voltage level rectifier which is a basic circuit for all crystal types. In applications with a meter for a.c. measurements up to 1000 volts 1N34 or 1N48 type crystals are generally used in this series shunt arrangement. Note that the peak inverse voltage is removed from the series rectifier. The 20,000 ohm series input limiting resistor acts in conjunction with the shunt crystal to clip the inverse half of the cycle. This permits the application of input voltages of

Fig. 3. (A) High impedance series diode rectifier circuit. Use of resistors about equal in value to back resistance of the diodes insures nearly equal voltage distribution between diodes. (B) A high voltage rectifier circuit using any type diode.

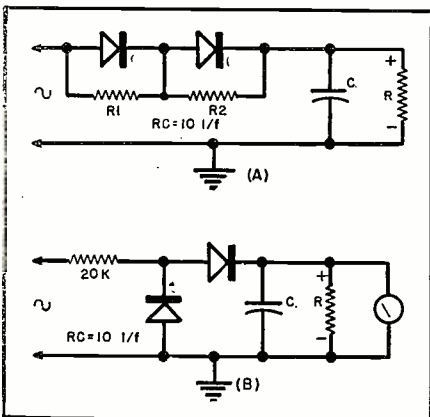

peak value up to several times the rating of the crystal and provides a useful circuit in which a wide range of input voltages may be accommodated. The shunt resistor may be eliminated in meter applications.

A shunt diode rectifier circuit is shown in Fig. 4. This is also a basic clipper circuit. For convenience and comparison both tube and crystal are shown. These circuits function extremely well at frequencies from d.c. up to 100 mc. Recent investigations into the matter have revealed data which indicate that germanium diode crystals will be useful up to frequencies of 500 mc. The condenser  $C_1$  in Fig. 4C prevents d.c. feedback and the resistor  $R$  is the shunt load resistor. Note that in these circuits the cathode is connected to the positive d.c. terminal output.

Fig. 2 shows a comparative set of curves for a crystal diode at 60 cps and 30 mc. Over the voltage range at which most crystals operate the curves are for the most part linear and parallel.

### Bias Applications

A crystal diode will supply from -1 to -3 volts of bias, and makes an excellent fixed bias supply for a class A audio amplifier. Fig. 5A shows a simple and typical low voltage bias supply taken from the 6.3 volt secondary of a power transformer. The 1N34 or 1N48 performs the function of a rectifying crystal and the condenser input filter smooths out a.c. ripple in the d.c. output. Negative bias is taken from the lead connected to the anode of the crystal, while the cathode is grounded through the transformer secondary. Note again that the cathode is the positive d.c. output terminal. This is a simple half-wave circuit and much more economical than the one shown in Fig. 5B, but it is not quite as good. It would be hard to beat the circuit in Fig. 5B for fixed bias that will be satisfactory and trouble free.

This circuit is a bridge type fixed bias supply which will supply about -3 volts of negative bias. The negative d.c. output, you will note, has the

Fig. 4. (A and B) Basic shunt diode rectifier or clipper circuits. (C) Shunt diode rectifier circuit which may be used with any type of crystal. The capacity of C depends on frequency and permissible current surge through the crystal employed. R is the shunt load resistor. (D) Shunt diode rectifier and filter circuit which may be used with any type of crystal. The Type 1N60 and 1N64 are better suited for high frequency i.f. detection than general purpose types such as the 1N34 or 1N48.

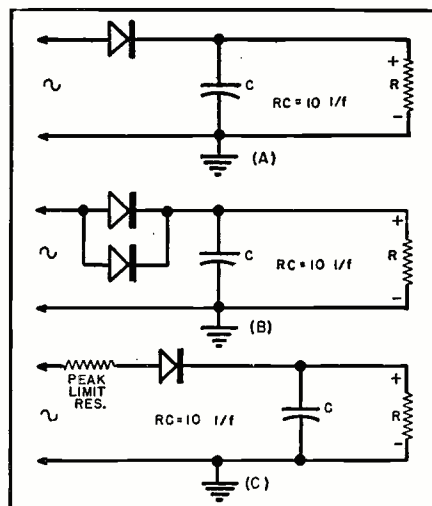
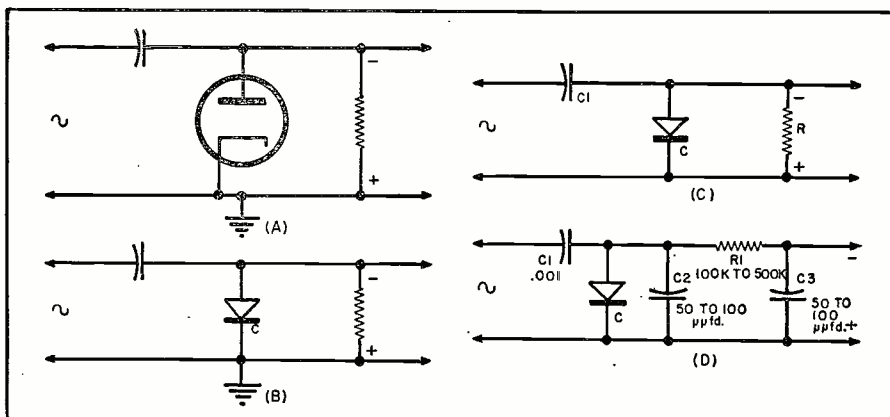

Fig. 1. Series diode rectifiers used in low impedance circuits. (A) Circuit useful over a range of frequencies from d.c. to 100 mc. (B) Method of increasing current in a series diode rectifier. The crystal can be of any type. (C) Peak limiting resistor acts as protection for the crystal.

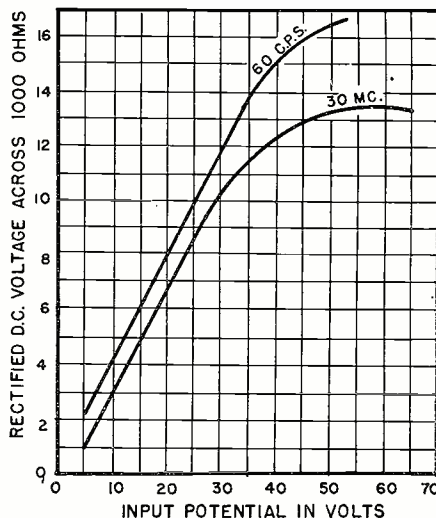

Fig. 2. Comparison of the performance of a crystal diode at 60 cps and at 30 mc. Over the voltage range at which most crystals operate, the curves are, to all intents and purposes, linear and parallel.



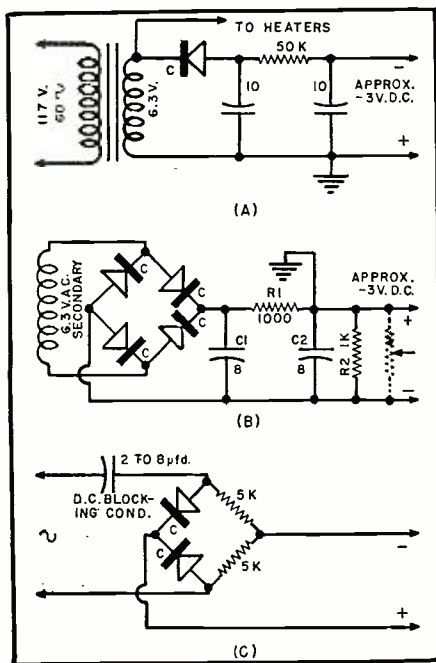
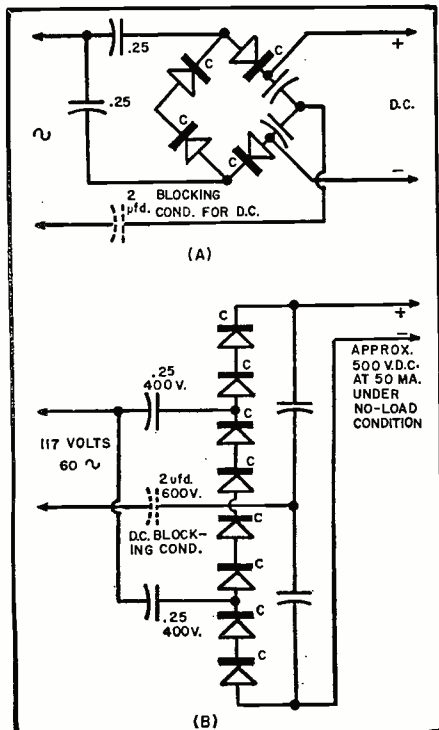

Fig. 5. (A) A simple fixed bias circuit using either a 1N34 or a 1N48. (B) a bridge type fixed bias supply using same crystals. (C) A simplified bridge type bias supply which utilizes 1N34's or 1N48's. This is a less expensive variation of the standard bridge type bias supply of (B).

anodes in parallel. For this type circuit a germanium quad (or varistor) of the octal socket type may be used because it will make a compact assembly involving a minimum of circuit

Fig. 6. (A) A simplified voltage quadrupler which uses either a 1N34 or a 1N48. Value of the condensers depends on frequency at which quadrupler is operated. (B) An improved version of quadrupler shown in (A). Diodes may be either 1N34's or 1N48's. Two diodes in series in each leg are desirable in order to withstand peak inverse voltages present in circuit.



connections, but such a component would be more expensive than four 1N34 or 1N48 crystals.

The filter resistor,  $R_1$ , is 1000 ohms and, since the current drain in a bias supply is negligible, a  $\frac{1}{2}$  watt size is ample. The value of the load resistor  $R_2$  is determined by the negative output voltage desired. As the value of  $R_2$  increases the output voltage increases. At 1000 ohms approximately 3 volts of negative output bias voltage is available. The d.c. negative output may be varied from about  $-1$  to  $-3$  volts by using a potentiometer in place of the shunt load resistor; the suggested potentiometer is shown on the diagram as a dotted line. The arm varies the amount of negative bias in the circuit.

Fig. 5C shows a simplified bridge type circuit. It is better than the one shown in Fig. 5A, and less expensive than the one shown in Fig. 5B.

### Voltage Multipliers

All types of circuits possible with vacuum tubes or selenium rectifiers may be used with crystal rectifiers providing suitable modification of the other circuit components is made to permit the use of the crystals within their rated values. Fig. 7 shows a half-wave and a full-wave voltage doubler which may use either *Sylvania* type 1N34 or *G-E* type 1N48 crystals.

One of the chief values of these circuits is that they may be used at a variety of frequencies, from the power line frequency through the audio frequencies, and on up into the radio frequency ranges. From 60 to 10 kc. it is suggested that the values of the condensers be approximately  $8 \mu\text{fd.}$ ; from 10 kc. to 10 mc. something like  $.25$  to  $.02$  would be satisfactory; and above 10 mc.,  $1000 \mu\text{fd.}$  down to  $47 \mu\text{fd.}$  is suggested. A doubler circuit will deliver about twice the input volts at low output current drain.

Fig. 7B shows a full-wave doubler in a modified bridge circuit. This contains the same components as the half-

Fig. 7. (A) Half-wave doubler circuit using a 1N34 or 1N48.  $R_1$  is a peak limiting resistor. The values of  $C_1$  and  $C_2$  depend on frequency at which voltage is to be doubled. Although this is a conventional power supply rectifier application, it may be used for other general or special purposes. (B) A full-wave doubler, modified bridge circuit using 1N34's or 1N48's.  $R$  is the peak limiting resistor. Capacity of condensers may vary from  $10 \mu\text{fd.}$  at 60 cps to  $47 \mu\text{fd.}$  for 44 mc. i.f. use.

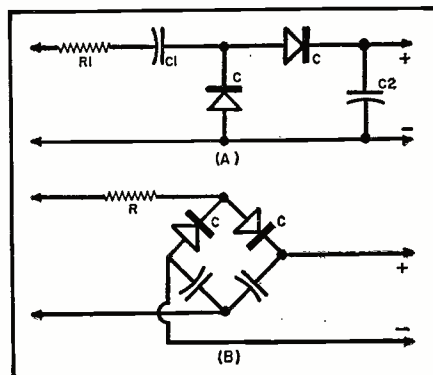

wave doubler shown in Fig. 7A but they are arranged to perform their functions in a simplified bridge circuit. This will deliver full-wave voltage at about twice the input a.c. for low load current drains.

It is important to design any diode circuit so that the load current drain will not exceed the maximum limit indicated by the characteristics of the diode used.

In power rectifier circuits, it is extremely important to stay within the peak inverse voltage rating, even more than within the maximum current rating. When germanium diodes are subject to continuous voltage overrating they literally explode. No one would appreciate having this happen.

Fig. 6A shows a simplified voltage quadrupler. Observe the similarity of such a circuit to what one finds when using seleniums. But note also the polarity connections to the anode whisker and the cathode germanium slab. This quadrupler circuit will provide approximately 500 volts of d.c. from the typical 115 volt, 60 cycle a.c. input supply, or about four times the input voltage.

The maximum current that may be drawn is about 40 ma., depending upon the diode crystal used. In Fig. 6B note that each of the four legs of this quadrupler system works better with two diodes series-connected in order that the crystals may withstand the peak inverse voltage impressed upon the components. The *G-E* type 1N48 and the *Sylvania* type 1N34 will perform quite satisfactorily in this circuit. The condensers should have a value of  $.25 \mu\text{fd.}$  and be rated from 400 to 600 volts; 400 volts may do the trick in many cases, but the safety factor with 600 volts is much better.

Note the addition of the blocking condenser rated at  $2 \mu\text{fd.}$ , 600 to 1000 volts, to prevent d.c. feedback through the line. If two quadruplers are connected in series it is possible to obtain 1000 volts, but this approaches the fantastic. There are simpler and less expensive methods of achieving 1000 volts of d.c. at 50 ma.

### Rectification and Frequency

Rectification efficiency decreases with an increase in frequency and a crystal with a large capacitance shows a greater and faster drop in rectification efficiency than a crystal with a small capacity. In general the lower the contact capacitance the better the high frequency performance of the crystal. Therefore a crystal which performs well at low frequency will perform well or better at a higher frequency, up to the limit of 100 to 500 mc.

Crystals with very high back resistance usually perform best at low frequencies. However, the mobility of electrons in such a crystal is low at high frequencies. Therefore, rectification efficiency is increased at high frequency by doping the germanium and lowering the back resistance. These crystals are then relatively poor at low frequencies.

(To be continued)



THE warm, soft air blowing through the open door of Mac's Radio Service Shop and gently rustling the pages of the calendar on the wall seemed to be mocking the month of November displayed. Of course, a pessimistic observer could, if he tried, pick out signs that summer had almost run its pleasant course: there was a sharp odor of burning leaves on the lazy air; the slanting shafts of light piercing the shop windows came from a sun already far south of the equator; a little boy strutted up and down the alley behind the shop with his head thrown far back so that he could see through the eye-openings of the grotesque, ill-fitting Halloween mask he wore—but who was so foolish as to look ahead from the midst of a wonderful Indian summer? The wise man lived each golden day for itself alone, nor spoiled its enjoyment with morbid thoughts on the winter to come.

Certainly the two wise men inside the shop were entirely taken up with the present. Barney was sweating and mumbling to himself as he tried to get a TV chassis out of its cabinet, and Mac was watching him with an amused grin.

"What's your trouble, Little Chum?" Mac finally asked. "You're mumbling in your chin-fuzz like an old maid catching her first glimpse of a modeled Bikini swim suit."

"Aw, it's this alleged conversion job. Just look at it! The deflection yoke is nailed to a fence-board that, in turn, is nailed to the sides of the cabinet. The tube is held in by an iron ring that is nailed to the front of the cabinet. Getting the works out all in one piece is about as easy as trying to carry a two-bay conical through a revolving door."

"Sounds like you're 'agin' converted receivers."

"Just some of 'em. The ones that are well-planned, both mechanically and electronically, are all OK; but I certainly don't go for cobbled-up affairs like this one. Why, the service charge will have to be double what it would have been if the set were easy to take out and put back. Personally, if I had a smoothly-operating, well-designed, easily-serviced ten- or twelve-inch set, I'd think a long time before turning it over to a nail-happy wood-butcher like the joker who perpetrated this mess. It convinces me that the words 'bigger' and 'better' don't always go together."

"Ah, so young to be so bitter!" Mac murmured mockingly; "and while you're rationalizing, don't forget that your small-screen set will be just the ticket for a color-wheel conversion. I'll grant you, though, that some of the converted jobs that have been trickling in here are pretty awful. I think the main trouble is that we technicians are so wrapped up in the electronic problems involved in a change-over that we are impatient with the mechanical demands of the operation. Being eager to see if we are going to have

# Mac's RADIO SERVICE SHOP

By JOHN T. FRYE

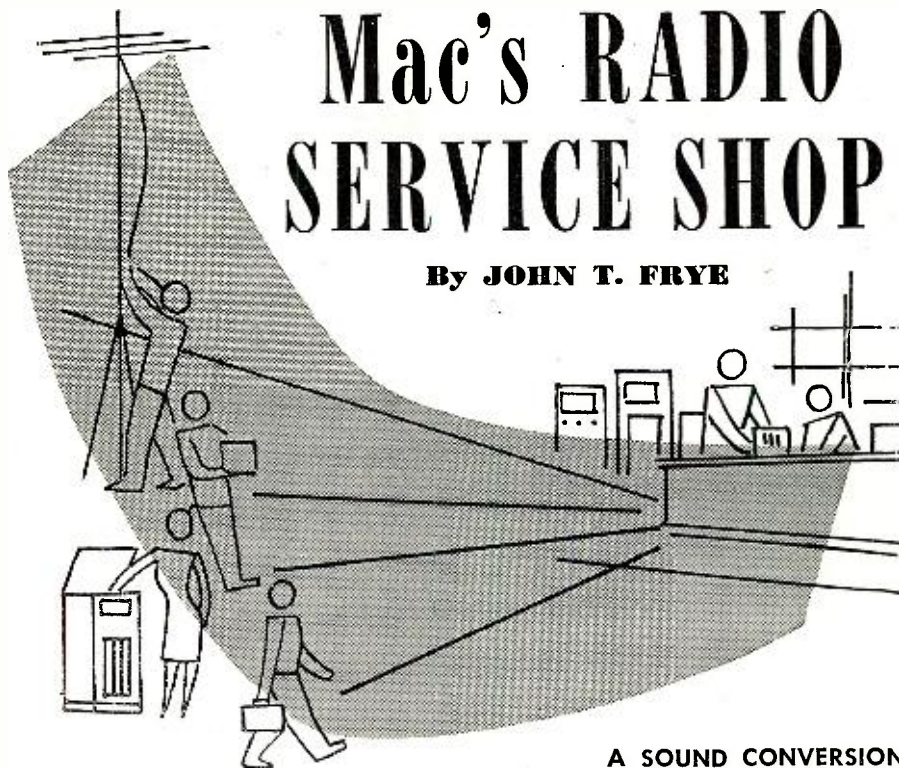

## A SOUND CONVERSION

sufficient linear sweep, etc., we do not give enough thought and planning to make the project mechanically strong and easily-serviced. This short-sighted attitude, carried to an extreme, breeds cases like the one you are admiring there.

"It is rather a coincidence, though, that just a couple of nights ago I talked my friend, Ed Beck, out of a big-tube conversion. That twelve-inch table model of his has always put out a mighty fine, linear picture; it is soundly engineered; and it has never given him a moment's trouble. The tubes at the plant where he works, however, have been feeding him a line about a twelve-inch getting only the center portion of a televised scene, while a seventeen- or twenty-inch tube gets it all.

"It is surprising how many people wonder about this," Mac went on. "I remembered that Ed is a 'shutter-bug,' though; so I explained to him that using different-sized kinescopes was exactly the same proposition as making different-sized projection enlargements from the same identical negative. Each size of tube shows exactly the same scene as the other, but the bigger tubes just 'blow up' the picture to greater dimensions. When Ed grasped this idea, he promptly lost interest in getting a bigger tube, for he knows that the greater the enlargement the greater must be the viewing distance for a pleasing appearance; and his home will not permit the screen to be watched from much more than a dozen feet. So-o-o-o, I talked him into a sound conversion instead."

"What do you mean, 'sound conversion'?" came Barney's muffled inquiry from inside the TV cabinet.

"Just what I said. The sound on Ed's set is as poor as the picture is

good. A single pentode drives a six-inch speaker mounted right in the top of the cabinet—and incidentally that cabinet has a nasty resonant peak at around three or four hundred cycles. When the Philharmonic is playing on the picture screen, you'd swear it was the Corn-Juice Trio down at the Dutchman's if you judged by the sound alone."

"What do you intend to do about it?"

"Already done it. I sold him a good but reasonably-priced coaxial speaker mounted in a reflex cabinet that sits right beside the stand that holds the TV set. A ten-watt hi-fi amplifier rests on a small shelf on the back of the speaker cabinet, and a switch at the rear of the TV set permits the output of the sound detector to be sent through a short shielded cable to the amplifier or to be passed through the set's audio system to its own speaker."

"Why that arrangement? Surely Ed won't want to listen to that six-inch speaker after he hears the coaxial."

"Two reasons: first, I want him to hear the difference between the two reproducing systems, and I want him to be able to demonstrate—as I know he will—this difference to his friends and so win other sound conversion prospects for us. Secondly, if the need arises, the TV set is still a complete unit and can be used by itself, in say a sickroom, where there would not be room for the speaker cabinet; or, if the speaker and amplifier are in use somewhere else, the TV set will not be put out of commission."

"How would the amplifier be in use somewhere else?"

"Well, I showed his daughter, Mary, how she could plug the pickup of her little three-speed table-model record-

*(Continued on page 141)*



$$R \frac{dy}{dt} + y = 0$$

$x=0, y=1$        $dy=0$

By  
**LOUIS L. GRANDI and  
DON LEBELL**

University of California, Dept. of Eng.,  
Los Angeles

# ANALOG COMPUTERS SOLVE COMPLEX PROBLEMS

*The University of California has within the last few years added four new analog computers to its facilities. It is the first time in West Coast history that such an elaborate array of equipment has been made available to students, staff members, and industry.*

THE complex-looking piece of equipment pictured on this month's cover is one of the four analog computers operated by the Engineering Department of the University of California on its Los Angeles campus.

Although such equipment is in operation at other locations throughout the country, this installation is the first on the West Coast. This means that not only can students receive thorough practical training on this increasingly-important equipment, but manufacturers in the West Coast area have such facilities immediately available for the most expeditious handling of their research problems.

The analog facilities include a thermal analyzer, a mechanical differential analyzer, an electrical differential

View of University of California differential analyzer.



Presenting a problem to network analyzer equipment.

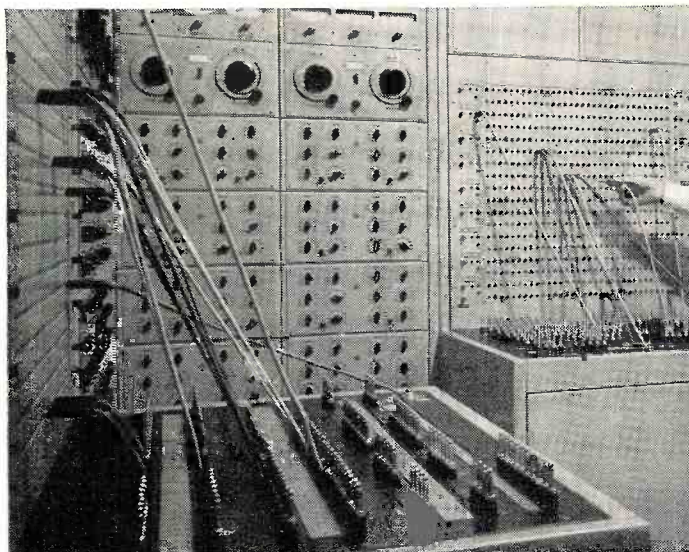



analyzer, and a network analyzer. These four units comprise a formidable battery of research weapons in widely diversified fields of endeavor.

In over-simplified terms, an analog computer is nothing more nor less than a piece of equipment which can be manipulated in such a way that it duplicates mathematically the physical problems under study.

### Differential Analyzers

The University has two types of differential analyzers—mechanical and electrical. Basically, both differential analyzers are the same—the function of each varying only slightly to handle the different requirements.

The electrical differential analyzer is interconnected in accordance with a carefully prepared schematic diagram. The resulting system thus becomes a physical counterpart of the mathematical equations being analyzed. Where it is desired to set up a physical reproduction of an electrical circuit for analysis and study, voltages are used to represent the terms of the original equation. By varying the voltages, the mathematical functions of addition, multiplication, integration, and differentiation may be performed in the circuit. In addition, the analyzer can be used to generate particular functions within the machine. Components are available in the equipment to supply special "engineering functions." Output information is obtained from the screen of an oscilloscope.

This particular unit has been used in primary research on transformer equivalent circuits, to obtain data on relay servomechanisms, and to determine structural characteristics of critically loaded beams.

In general, the electrical differential analyzer can handle mathematical problems involving simultaneous, nonlinear differential equations with variable coefficients. In the realm of physical sciences, the analyzer will handle systems containing nonlinear, lumped parameters.

The mechanical counterpart of the electrical differential analyzer solves problems involving physical properties reduced to mathematical equations. This is accomplished by interconnecting the basic units (integrators, adders, multipliers, etc.) in accordance with the equations being studied. Unlike the electrical differential analyzer, the circuit variables are mechanical, thus the actual variables correspond to the angular displacement of the shafts in the machine.

The equipment features a flexible system whereby the units that perform the basic operations of addition, subtraction, multiplication, division, and integration can be interconnected to meet the particular requirements of the

*(Continued on page 138)*

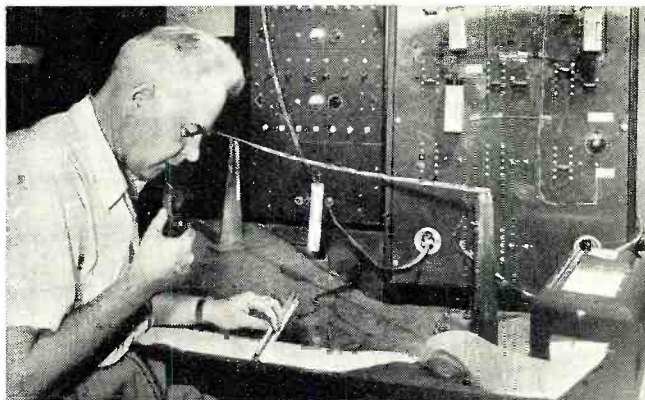

Electronic analog simulating equipment. This is part of the one-hundred amplifier installation and demonstrates the solution of a simple beam problem. Equipment was built at University.



Output table of differential analyzer. "Solutions" appear on graph paper in the form of curves.

★

Wheel disc integrator of the mechanical differential analyzer. A polarized light beam transmits integrator wheel motion directly to the torque amplifier unit.

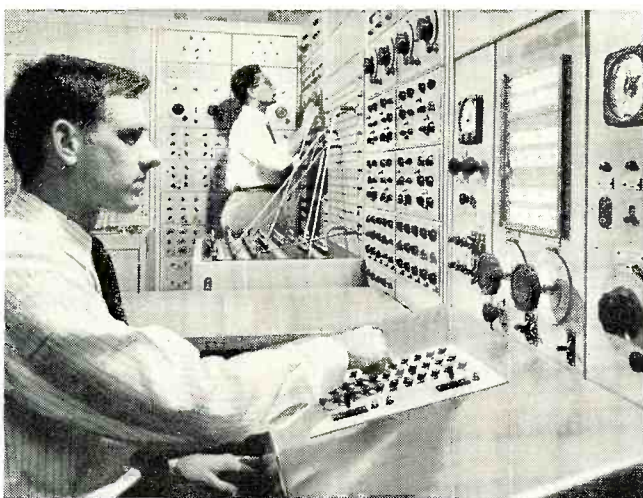
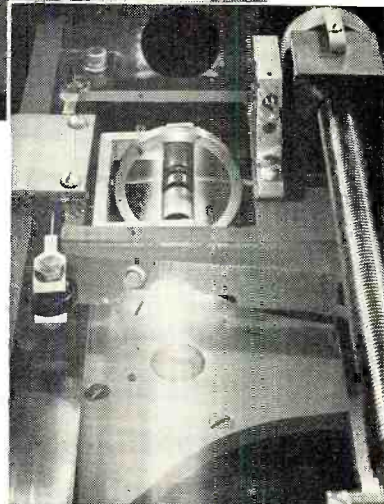

Working a problem on network analyzer.

★

Measuring the output data obtained from the mechanical differential analyzer.

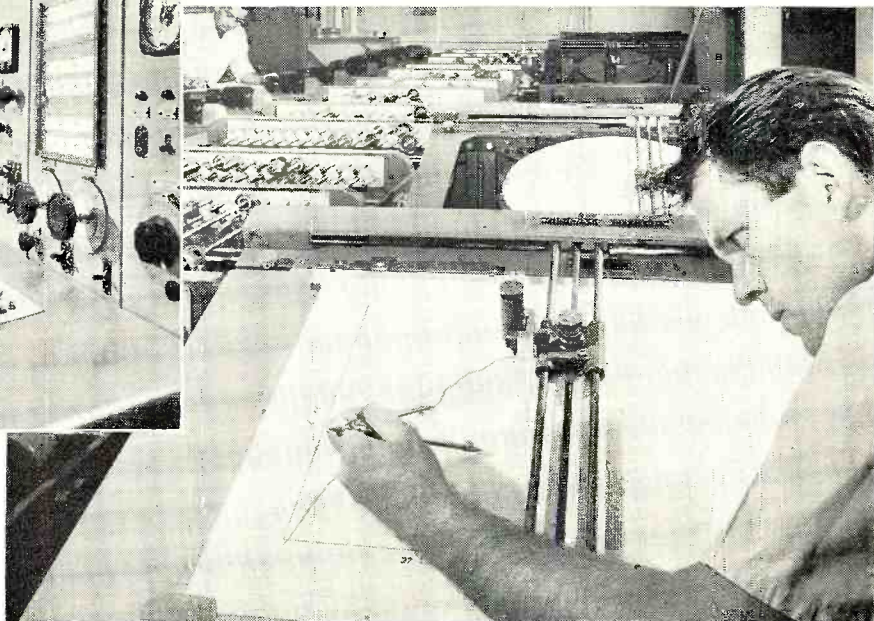





Fig. 1. Front view of a professional-type mixer console by Langevin.

# SOUND ENGINEERING

By  
**H. M. TREMAINE, D.Sc.**  
 Audio Consultant

## Part 9. Continuing the discussion of different types of mixers used in motion picture recording.

**S**OUND mixers used for the recording of motion pictures require special consideration because of the many problems involved in production. This is particularly true when large choral and orchestral groups are to be recorded. It is highly desirable (but not compulsory) that the two musical groups be separated physically if possible. The choir should be placed on a separate stage or in a room adjacent to the music stage with a glass panel between, to allow the musical directors of both groups to observe each other. Headphones are provided

for cueing purposes; also, a loudspeaker for playbacks. When recording groups of the above nature, it is much more convenient to simultaneously record each group on a separate recording channel, with a common monitor system. This allows the best balance to be obtained from each group with the additional advantage of separation for control of levels and simplifying the "cutting" of the sound tracks later. After editing, the sound tracks are re-recorded and any sound effects or dialogue added at that time. The equipment that will be re-

quired for this type of recording includes a "split mixer," two recording channels, combined monitoring system, a disc or magnetic tape playback, and a projection system for cueing the picture. A block diagram of a two-channel system is shown in Fig. 3.

At the left of the block diagram is a ten-position (or more) split mixer with four orchestra microphones feeding the upper section, and four choral microphones feeding the lower section. The mixer network configuration is similar to that of Fig. 8, Part 8 of this series.

Connected to the output of the combining network of the upper mixer section is the usual booster amplifier, master gain control, filters, line and limiter amplifiers, and a ceiling control which feeds the bridging bus. Across the bridging bus is connected a film recorder, noise reduction amplifier, monitor voltage amplifier, and v meter. Volume indicator meters used for film recording are generally peak reading instruments. An example of this type instrument is the RCA "Neon Volume Indicator" especially designed for film recording. The frequency response of each unit is shown above the block. The lower half of the mixer panel feeds a second recording channel similar to channel one.

The combined monitoring system takes its signal from bridging bus-2, through monitor voltage-amplifier-2, to one side,  $Z_1$  of a "Y" type combining network. The other side of the combining network,  $Z_2$ , is connected to the output of monitor voltage-amplifier-1, which receives its input signal from bridging bus-1 through a monitor relay. The other side of the relay con-

Fig. 2. Correct method of connecting the normal jacks in a mixer designed for re-recording. Jacks are used at both the input and output of each mixer pot.

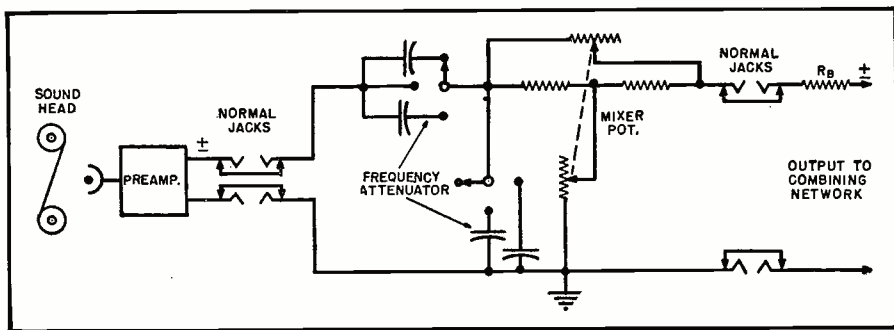



nects to the output of a playback circuit. The output of the monitor combining network  $Z_3$  is carried to a low-pass filter, then to a 100 watt monitor amplifier, and a wide range two-way loudspeaker system.

Bridging the output of the combining network  $Z_3$  is the input to a disc or magnetic tape recorder used for playbacks. The playback circuit connects to the lower side of the monitor relay. When this relay is in the downward position it receives the playback signal and feeds it to the monitor system. The monitor relay also feeds the playback signal to the projection speaker system behind the picture screen during playbacks to allow the musical directors to check the music cues with the action. During the actual recording operations, the picture is projected without sound.

The normal position of the monitor relay is up, which allows the mixer to hear the signal across the bridging bus of the two recording channels simultaneously. Headphones for both musical directors and the choral group, are fed from channel number-1. The playback loudspeaker for the choral group

is paralleled with the input to the projection amplifier.

For re-recording an entirely different setup is required. Fig. 5 shows a typical re-recording setup, employing an 8-position split mixer, which is connected to seven film or magnetic tape sound heads. Re-recording may, at times, become quite involved, as certain sound tracks require both equalization and compression, plus the insertion of music, dialogue, and sound effects. Therefore, each mixer position will require "normal jacks" at both the input and output of each mixer pot to allow them to be removed from the combining networks and connected elsewhere.

Terminating resistors must be patched in to any position of the networks where a mixer pot has been removed, if the position is not used. This is necessary to maintain the correct impedance match for the balance of the network in use. Fig. 2 illustrates how the normal jacks are connected.

Again referring to the block diagram of Fig. 5, at the upper left are several magnetic or film "sound-heads" with their normal preamplifier and equal-

izer. A second preamplifier has been added to compensate for the insertion loss of the equalizer. Equalizers are generally a permanent part of a re-recording channel, as it is seldom that some frequency correction is not required.

After the signal leaves the second preamplifier of the second input number-2 circuit, it is fed into a mixer pot which has been "lifted" from the mixer combining network and connected to the input of a compressor amplifier. At the output of the compressor is a ceiling control which is returned to the combining network of the lower half of the mixer. The reasons for connecting the compressor in this manner were explained in Part 7 of this series. Although most dialogue sound tracks are compressed at the time of original recording, some tracks may require additional compression; also, the compressor permits the compression of un-compressed sound tracks. The first, third, and fourth inputs of the upper section are normalised directly to the mixer inputs. The three inputs to the lower section are conventional.

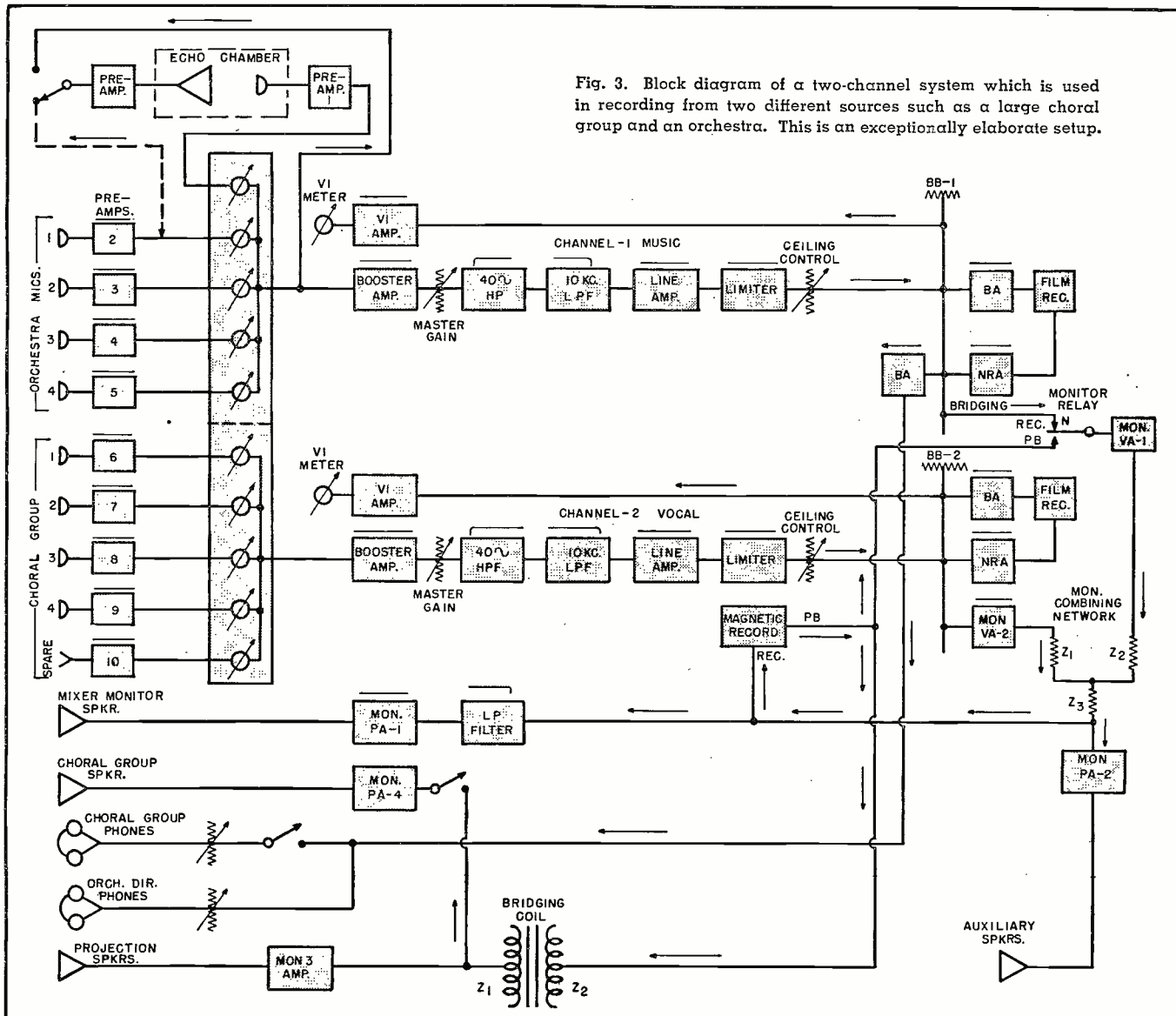

Fig. 3. Block diagram of a two-channel system which is used in recording from two different sources such as a large choral group and an orchestra. This is an exceptionally elaborate setup.



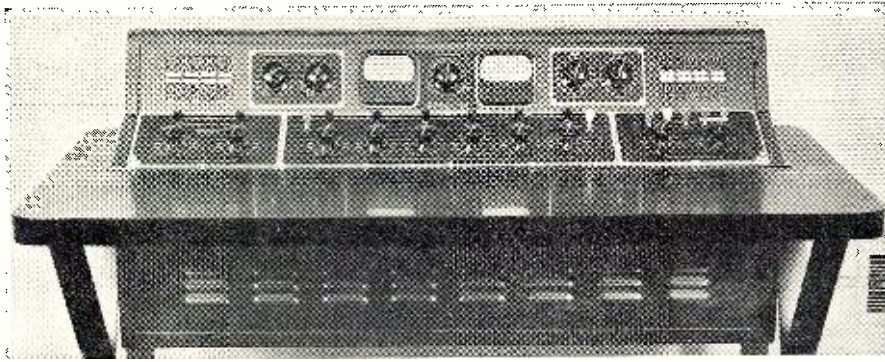

Fig. 4. Front view of a commercial mixer console made by The Langevin Company.

The output of the two mixer networks are combined in a "hybrid" coil. A hybrid coil is a transformer consisting of three windings, constructed in such a manner that the primaries both feed a third winding. The geometrics of the coil are such that no interaction may take place between the primaries; therefore, the signal is transformed to only the output winding of the coil.

Two booster amplifiers are inserted between the output of each network and the sub-master gain controls to compensate for the loss of the sub-master controls, which are generally set to carry about 10 db of loss in their normal positions. An "over-all master" gain control is connected at the output of the hybrid coil. Following the over-all master are the conventional filters, amplifiers, and bridging bus. Equipment to the right of the bridging bus was discussed in Part 8.

The monitoring system is driven in the usual manner from the bridging bus, through a "re-recording low-pass filter." This filter has a characteristic

that is comparable to the average theater listening response. With this type frequency characteristic in the monitor system, the mixer hears what the patron hears in the average theater. At the input of the filter is a bridging coil, to allow it to be connected across the bridging bus without disturbing the bridging bus impedance. The monitor loudspeaker is a conventional theater type speaker system.

The recording machines, playback, and motion picture projector are all driven from a synchronous motor distributor system, similar to that described in Part 5.

Sound mixer circuits and their mechanical construction may become quite complicated; an example is shown in Fig. 4. This console was especially constructed for magnetic tape and disc recording purposes. Contained in the console, starting at the left, are several jackstrips. Below are two controls for adjusting the level of incoming remote lines. At the right of the jacks are two controls, one for adjusting the sig-

nal level sent into a "reverberation chamber," and the second to control the level of an announce microphone (not shown).

Two meters are provided, a standard vu meter, and a milliammeter for reading the plate currents of the various amplifiers mounted in the lower part of the console. A rotary switch between the meters connects the milliammeter to the proper circuits for measurement.

In reality the milliammeter does not measure the plate current but is used as a voltmeter across the cathode of each tube. If the bias is correct, then it goes without saying the plate and screen currents are correct. The series multipliers used with the meter are of such values that the meter is deflected to about 80% of its scale when the tubes are operating normally. At this point on the scale the meter is calibrated to read 100%.

In the center of the console is a six-position mixer for controlling the levels of microphones or other incoming program material. Between the second meter and the right-hand jack strips are two more controls. One adjusts the output level of the monitor amplifier; the other is an "over-all master" control for the mixer panel. As this mixer was designed to operate as a split mixer if desired, two "sub-master" controls are supplied at the extreme right. One controls the output level of the three left-hand pots and the other the three right-hand pots. The circuit may also be patched for a single master control when used as a six-position mixer.

To facilitate servicing, the mixer (Continued on page 110)

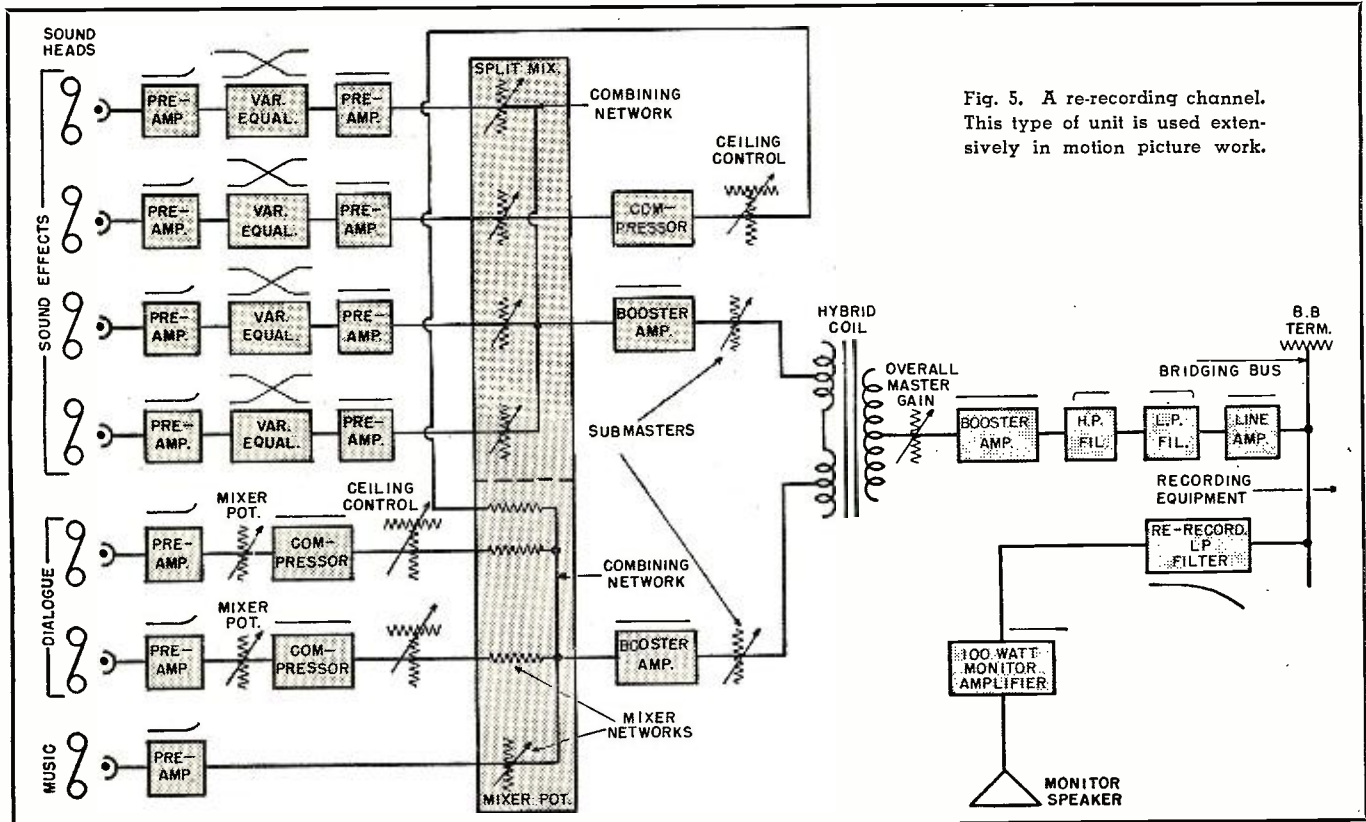

Fig. 5. A re-recording channel. This type of unit is used extensively in motion picture work.





Electron tubes are the nerve ends of military intelligence—in systems set up and maintained by RCA Service Company field engineers.

## *Electron Tube with a military mind*

With the rapid advance of airplanes, tanks, fast ships, and mechanized weapons of war, a swift, sure means of *communication* and *detection* is as important as are the new weapons themselves. It is provided—by electron tubes and electronics.

So important is this area of military intelligence that RCA Service field engineers—here and abroad—have lifted their efforts to new peaks. Working with our Armed Forces, they install and maintain such *communications systems* as short-wave radio and portable radiotelephones

They work with systems of *detection*, such as radar. They help ships and planes *navigate* with loran and shoran. These engineers are the link between research developments made at RCA Laboratories—and America's military strength.

The number of RCA field engineers has *tripled* since World War II. And they serve where needed, wherever an electron tube's "military mind" can be of military use.

\* \* \*

See the latest wonders of radio, television, and electronics at RCA Exhibition Hall, 36 West 49th Street, N.Y. Admission is free. Radio Corporation of America, RCA Building, Radio City, N.Y. 20, N.Y.

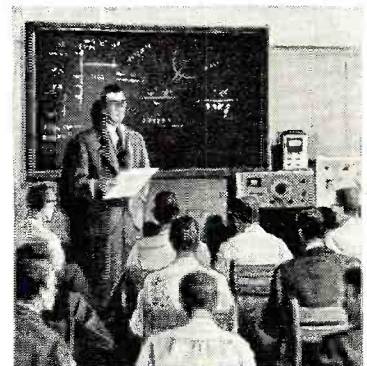

Practical training of military personnel—in classes, factory, and the field—is a basic part of RCA Service Company's work with our Armed Forces.



**RADIO CORPORATION of AMERICA**

*World Leader in Radio—First in Television*



# Features OF THE NEW 1952



## PROOF OF THE NEW O-7 OSCILLOSCOPE'S OUTSTANDING PERFORMANCE

Below are actual, unretouched photographs showing the outstanding frequency response characteristics of the NEW 1952 HEATHKIT OSCILLOSCOPE, MODEL O-7. To the left is a 10 KC sine wave — to the right a 4 MC sine square wave — as they actually appear on the screen. Two highly severe tests to make on any scope (only the best of scopes will show traces like these) — and the O-7 really comes through.

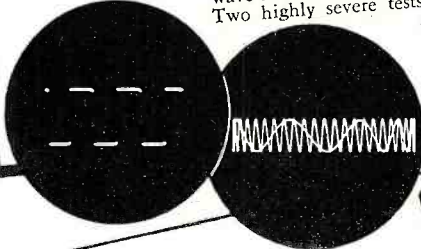

## COMPANION VACUUM TUBE VOLTMETERS

Here are the two NEW 1952 VACUUM TUBE VOLTMETER COMPANION PIECES. Matched instruments of new design to open up the whole field of DC, AC, and resistance measurements for you. The new greatly reduced size combines style, beauty, and compactness — The V-5 and AV-1 have the new panel and cabinet construction as shown on the right. A tremendous pair of voltmeters. Small in size but virtual giants in the range of measurements they make.

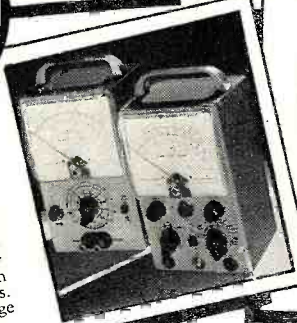

## NEW STYLE AND BEAUTY

Style that's modern, yet functional — that's the trend of today — and Heathkits are right up to the minute. Note the cut showing the new V-5 and AV-1 cabinet and panel construction. The front panel and rear cover slide right over the recessed flange of the case thereby eliminating sharp edges and pointed corners. The voltmeter kits aren't "shelf" or "mounted" instruments — they're moved about on the bench a lot and thus the new compact size and specially designed cabinets — Another 1952 Heathkit feature.

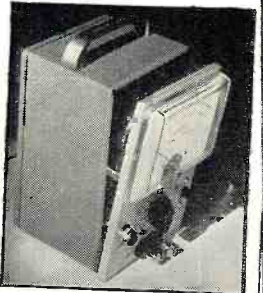

## A STATEMENT FROM SIMPSON ELECTRIC CO.

In choosing Simpson Meters for their Heathkit VTVM, the Heath Co. has set a new high standard of kit meter quality. The same high quality of material, workmanship and design that has given Simpson the reputation for building "Instruments That Stay Accurate" is found in the Heathkit Meter Movement.

SIGNED  
SIMPSON ELECTRIC CO.

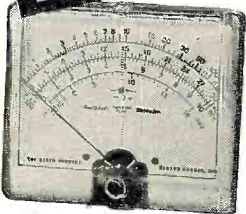

## A STATEMENT FROM CHICAGO TRANSFORMER

It is indeed gratifying to note the outstanding sales records you are building with you Heathkits.

This sales success is readily understandable, since we are cognizant of the high quality standards you have established for your component suppliers.

We at Chicago Transformer are proud that our product has contributed to the recognized quality and increasing popularity of Heathkits.

CHICAGO TRANSFORMER DIVISION  
Essex Wire Corporation

L. S. RACINE  
Vice-President and Sales Manager



## HEATHKIT PRECISION RESISTORS

Where exact resistance values are required for instrument accuracy, the Heath Co. has spared no effort in supplying the finest resistors available. Precision resistors as manufactured by Continental Carbon Inc., and Wilcor Corp., meet the rigorous JAN (Joint Army-Navy) specifications and are small in size, extremely non-inductive, highly stable, have a low temperature coefficient, and can be held to great accuracy. You'll find quality components in Heathkits.

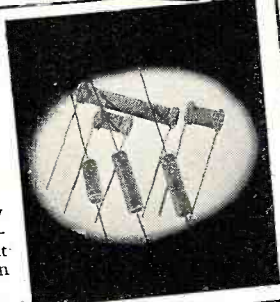

## COLLEGES USE HEATHKITS

Colleges and Universities throughout the country are using Heathkits in their electrical engineering, radio, and physics laboratories — Heathkits are the answer to good test equipment at low cost, plus being rugged, dependable, and accurate. Trade schools are having their students build Heathkits to obtain a first hand working knowledge of test equipment and to get the practical experience gained by construction. Heathkits fill school needs.

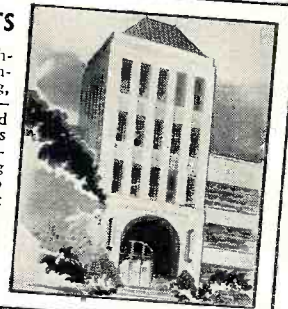

YOU SAVE BY ORDERING DIRECT FROM MANUFACTURER—USE ORDER BLANK ON LAST PAGE

EXPORT AGENT  
ROCKE INTERNATIONAL CORP.  
13 E. 40th ST.  
NEW YORK CITY (16)  
CABLE: ARLAB-N.Y.

# The HEATH COMPANY

... BENTON HARBOR 15, MICHIGAN



# New LABORATORY LINE HEATHKITS



MODEL AV-1  
Shipping weight 5 lbs.

## NEW *Heathkit* A.C. VACUUM TUBE VOLTMETER KIT

Now — as a Heathkit — at a price anyone can afford, an AC VTVM.

A new kit to make possible those sensitive AC measurements required by audio enthusiasts, laboratories, and experimentors. Here is the kit that the audio men have been looking for. Its tremendous range of coverage makes possible measurements of audio amplifier frequency response — gain or loss of audio stages — characteristics of audio filters and attenuators — hum investigation — and literally a multitude of others. Ten ranges consisting of full scale .01, .03, .1, .3, 1, 3, 10, 30, 100, 300 volts RMS assure easy and more accurate readings. Ten ranges on DB provide for measurements from -52 to +52 DB. Frequency response within 1 DB from 20 cycles to 50 KC.

The ingenious circuitry incorporates precision multiplier resistors for accuracy, two amplifier stages using miniature tubes, a unique bridge rectifier meter circuit, quality Simpson meter with 200 microampere movement, and a clean layout of parts for easy wiring. A high degree of inverse feedback provides for stability and linearity.

Simple operation is accomplished by the use of only one control, a range switch which changes the voltage ranges in multiples of 1 and 3, and DB ranges in steps of 10.

The instrument is extremely compact, cabinet size — 4 1/8" deep x 4-11/16" wide x 7 3/8" high, and the newly designed cabinet makes this the companion piece to the VTVM. For audio work, this kit is a natural.

# \$29.50

## NEW *Heathkit* AUDIO FREQUENCY METER KIT

MODEL AF-1  
Shipping weight 12 lbs.

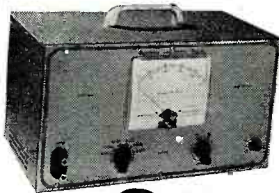

# \$34.50

A NEW Heathkit Audio Frequency Meter — the ideal instrument for determining frequencies from 20 cycles to 100 KC. Set the selector switch to the proper range — feed the signal into the input terminals — and read the frequency from the meter — completely simple to operate, and yet dependable results.

Quality Simpson 200 microampere meter has two plainly marked scales (0-100 0-300). These scales, read in conjunction with the seven position selector switch, give full scale readings of 100, 300, 1000, 3000, 10,000, 30,000, and 100,000 cycles. Convenient ranges for fast and easy readings.

For greatest accuracy, the 1-3-10 ratio of ranges is maintained and each range has individual calibrating control.

Input impedance is high (1 megohm) for negligible circuit loading. A signal and a change in signal voltage between these limits will not affect the meter reading. In addition, input wave shape is not critical (the unit will read the frequency of either sine wave or square wave input).

The tube complement consists of a 6SJ7 amplifier and clipper, 6V6 amplifier and clipper, 6HG meter pulse rectifier, 6X5 power supply rectifier, and OD3/VR150 voltage regulator.

Construction is simple, and quality components are used throughout.

## NEW *Heathkit* INTERMODULATION ANALYZER KIT

Intermodulation testing of audio equipment is rapidly being accepted by more and more engineers and audio experts as the best way to determine the characteristics of audio amplifiers, recording systems, networks, etc. — shows up those undesirable characteristics which contribute to listening fatigue when all other methods fail.

The Heathkit Intermodulation Analyzer supplies a choice of two high frequencies (3000 cycles and a higher frequency) and one low frequency (60 cycles). Both 1:1 or 4:1 ratios of low to high frequencies can be set up for IM testing, and the ratios are easily set by means of a panel control and the instrument's own VTVM. An output level control supplies the mixed signal at the desired level with an output impedance of two thousand ohms. The Analyzer section has input level control and proper filter circuits feeding the instrument's VTVM to read intermodulation directly on full scale ranges of 30%, 10% and 3%. Built-in power supply furnishes all necessary voltages for operating the instrument.

You won't want to be without this new and efficient means of testing



MODEL IM-1  
Shipping wt. 18 lbs.

# \$39.50

## NEW *Heathkit* SQUARE WAVE GENERATOR KIT

The new Heathkit Square Wave Generator Kit with its 100 KC square wave opens an entirely new field of audio testing. Square wave testing over this wide range will quickly show high and low frequency response characteristics of circuits — permit easy adjustment of high frequency compensating networks used in video amplifiers — identify ringing in circuits — demonstrate transformer characteristics, etc.

The circuitry consists of a multivibrator stage, a clipping and squaring stage, and a cathode follower output stage. The power supply is transformer operated and utilizes a full wave rectifier tube with 2 sections of LC filtering.

As a multivibrator cannot be accurately calibrated, a provision is provided to allow the instrument to be accurately synchronized with an accurate external source when extreme accuracy is required.

The low impedance output is continuously variable between 0 and 25 volts and operation is simple. You'll really appreciate the wide range of this instrument, 10 cycles to 100 kilocycles — continuously variable. Kit is complete with all parts and instruction manual, and is easy to build.



MODEL SQ-1  
Shipping wt. 14 lbs.

# \$29.50

YOU SAVE BY ORDERING DIRECT FROM MANUFACTURER—USE ORDER BLANK ON LAST PAGE

EXPORT AGENT  
ROCKE INTERNATIONAL CORP.  
13 E. 40th ST.  
NEW YORK CITY (16)  
CABLE: ARLAB-N.Y.

# The HEATH COMPANY

... BENTON HARBOR 15, MICHIGAN



THE *New* 1952  
*Heathkit*  
**OSCILLOSCOPE  
 KIT**

MODEL O-7  
 SHIPPING WEIGHT 24 LBS.

**\$43<sup>50</sup>**

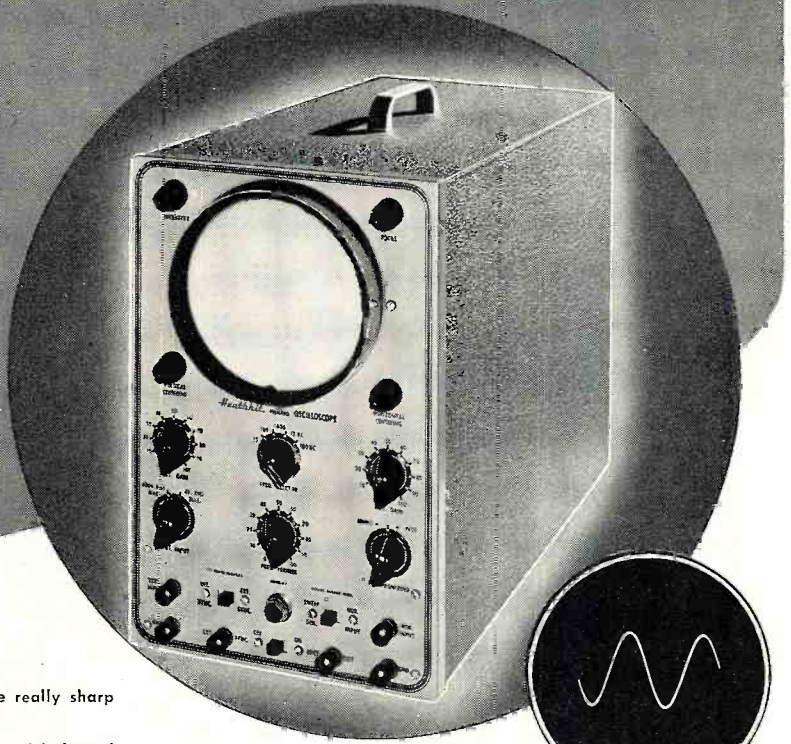

*Features*

- New "spot shape" control for spot adjustment — to give really sharp focusing.
- A total of ten tubes including CR tube and five miniatures.
- Cascaded vertical amplifiers followed by phase splitter and balanced push-pull deflection amplifiers.
- Greatly reduced retrace time.
- Step attenuated — frequency compensated — cathode follower vertical input.
- Low impedance vertical gain control for minimum distortion.
- New mounting of phase splitter and deflection amplifier tubes near CR tube base.
- Greatly simplified wiring layout.
- Increased frequency response — useful to 5 Mc.
- Tremendous sensitivity .03V RMS per inch Vertical — .6V RMS per inch Horizontal.
- Dual control in vernier sweep frequency circuit — smoother acting.
- Positive or negative peak internal synchronization.

The performance of the NEW, IMPROVED, HEATHKIT 5" OSCILLOSCOPE KIT is truly amazing. The O-7 not only compares favorably with equipment costing 4 and 5 times as much, but in many cases literally surpasses the really expensive equipment. The new, and carefully engineered circuit incorporates the best in electronic design — and a multitude of excellent features all contribute to the outstanding performance of the new scope.

The VERTICAL CHANNEL has a step attenuated, frequency compensated vertical input which feeds a cathode follower stage — this accomplishes improved frequency response, presents a high impedance input, and places the vertical gain control in a low impedance circuit for minimum distortion. Following the cathode follower stage is a twin triode — cascaded amplifiers to contribute to the scope's extremely high sensitivity. Next comes a phase splitter stage which properly drives the push-pull, hi-gain, deflection amplifiers (whose plates are directly coupled to the vertical deflection plates). This fine tube lineup and circuitry give a sensitivity of .03V per inch RMS vertical and useful frequency response to 5 Mc.

The HORIZONTAL CHANNEL consists of a triode phase splitter with a dual potentiometer (horizontal gain control) in its plate and cathode circuits for smooth, proper driving of the push-pull horizontal deflection amplifiers. As in the vertical channel, horizontal deflection amplifier plates are direct coupled to the CR tube horizontal deflection plates (for improved frequency response).

The WIDE-RANGE SWEEP GENERATOR circuit incorporates a twin triode multivibrator stage for producing a good saw-tooth sweep frequency (with faster retrace time). Has both coarse and vernier sweep frequency controls.

And the scope has internal synchronization which operates on either positive or negative peaks of the input signal — both high and low voltage rectifiers — Z axis modulation (intensity modulation) — new spot shape (astigmatism) control for spot adjustment — provisions for external synchronization — vertical centering and horizontal centering controls, wide range focus control — and an intensity control for giving plenty of trace brilliance.

The Model O-7 EVEN HAS GREAT NEW MECHANICAL FEATURES — A special extra-wide CR tube mounting bracket is provided so that the vertical cascade amplifier, vertical phase splitter, vertical deflection amplifier, and horizontal deflection amplifier can mount near the base of the CR tube. This permits close connection between the above stages and to the deflection plates; distributed wiring capacity is greatly reduced, thereby affording increased high frequency response.

The power transformer is specially designed so as to keep its electrostatic and electromagnetic fields to a minimum — also has an internal shield with external ground lead.

You'll like the complete instructions showing all details for easily building the kit — includes pictorials, step-by-step construction procedure, numerous sketches, schematic, circuit description. All necessary components included — transformer, cabinet, all tubes (including CR tube), completely punched and formed chassis — nothing else to buy.

NEW INEXPENSIVE *Heathkit*  
**ELECTRONIC SWITCH KIT**

The companion piece to a scope — Feed two different signals into the switch, connect its output to a scope, and you can observe both signals — each as an individual trace. Gain of each input is easily set (gain A and gain B controls), the switching frequency is simple to adjust (coarse and fine frequency controls) and the traces can be superimposed for comparison or separated for individual study (position control).

Use the switch to see distortion, phase shift, clipping due to improper bias, both the input and output traces of an amplifier — as a square wave generator over limited range.

The kit is complete; all tubes, switches, cabinet, power transformer and all other parts, plus a clear detailed construction manual.

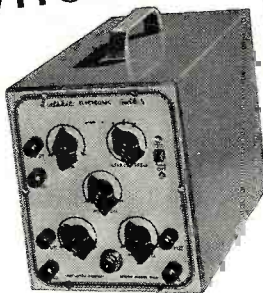

Model S-2  
 Shipping Wt 11 lbs.

*Only*  
**\$19<sup>50</sup>**

**YOU SAVE BY ORDERING DIRECT FROM MANUFACTURER—USE ORDER BLANK ON LAST PAGE**

EXPORT AGENT  
**ROCKE INTERNATIONAL CORP.**  
 13 E. 40th ST.  
 NEW YORK CITY (16)  
 CABLE: ARLAB-N.Y.

*The* **HEATHKIT COMPANY**

**... BENTON HARBOR 15, MICHIGAN**



THE *New* 1952

# Heathkit VTVM KIT

MODEL V-5  
SHIPPING WT. 5 LBS.

# \$24.50

## Features

- New styling, — formed case for beauty.
- New truly compact size. Cabinet 4 1/8" deep by 4-11/16" wide by 7 3/8" high.
- Quality 200 microamp meter.
- New ohms battery holding clamp and spring clip — assurance of good electrical contact.
- Highest quality precision resistors in multiplier circuit.
- Calibrates on both AC and DC for maximum accuracy.
- Terrific coverage — reads from 1/2V to 1000V AC, 1/2V to 1000V DC, and .1 to over 1 billion ohms resistance.
- Large, clearly marked meter scales indicate ohms, AC Volts, DC Volts, and DB — has zero set mark for FM alignment.
- New styling presents attractive and professional appearance.

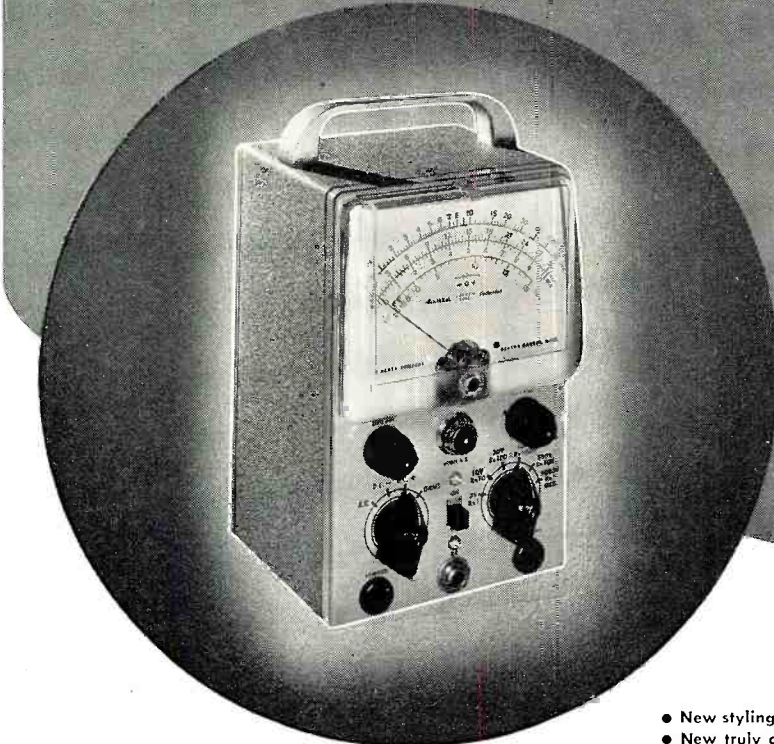

A real beauty — you'll have only highest praise for this NEW MODEL VACUUM TUBE VOLTMETER. Truly a beautiful little instrument — and it's more compact than any of our previous models. Note the new rounded edges on the front panel and rear cover. The size is greatly reduced to occupy a minimum of space on your workbench — yet the meter remains the same large size with plainly marked scales.

A set of specially designed control mounting brackets permit calibration to be performed with greatest ease — also makes for ease in wiring. New battery mounting clamp holds ohms battery tightly into place, and base spring clip insures a good connection to the ohms string of resistors.

The circuitry employs two vacuum tubes — A duo diode operating when AC voltage measurements are taken, and a twin triode in the circuit at all times. The cathode balancing circuit of the twin triode assures sensitive measurements, and yet offers complete protection to the meter movement. Makes the meter burn-out proof in a properly constructed instrument.

Quality components are used throughout — 1% precision resistors in the multiplier circuit — conservatively rated power transformer — Simpson meter movement — excellent positive detent, smooth acting switches — sturdy cabinet, etc.

And you can make a tremendous range of measurements — 1/2 V to 1000V AC, 1/2V to 1000V DC, .1 to over 1 billion ohms, and DB. Has mid-scale zero level marking for quick FM alignment. DB scale in red for easy identification — all other scales a sharp, crisp black for for easy reading.

A four position selector switch allows operator to rapidly set the instrument for type or reading desired — positions include ACV, DC+V, DC-V, and Ohms. DC — position allows negative voltage to be rapidly taken. Zero adjust and ohms adjust controls are conveniently located on front panel.

Enjoy the numerous advantages of using a VTVM. Its high input impedance doesn't "load" circuits under test — therefore, assures more accurate and dependable readings in high impedance circuits such as resistance coupled amplifiers, AVC circuits, etc. Note the 30,000 VDC probe kit and the RF probe kit — available at low extra cost and specially designed for use with this instrument. With these two probes, you can make DC voltage measurements up to 30,000V, or make RF measurements — added usefulness to an already highly useful instrument.

The instruction manual is absolutely complete — contains a host of figures, pictorials, schematic, detailed step-by-step instructions, and circuit description. These clear, detailed instructions make assembly a cinch.

And every part is included — meter, all controls, pilot light, switches, test leads, cabinet, instruction manual, etc.

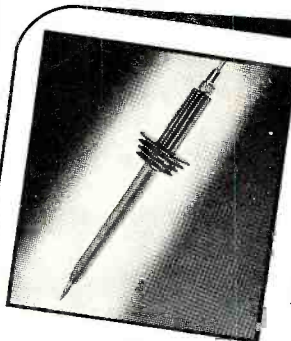

### Heathkit 30,000V DC PROBE KIT

A new 30,000 V DC Probe Kit to handle high voltages with safety. For TV service work and all other high voltage applications. Sleek looking — and guard — jet black plastic — Red body with connector, cable, and PL55 type plug. Plugs into Heathkit VTVM so that 300V scale is conveniently multiplied by 100. Can be used with any standard 11 megohm VTVM.

## \$5.50

No. 336 High Voltage Probe Kit  
Shipping Wt. 2 lbs.

### Heathkit RF PROBE KIT

This RF Probe Kit comes complete with probe housing, crystal diode detector, nector, lead and plug and all other parts range clear assembly instructions. Extends VTVM to 250 Mc. ± 10%. Works on any 11 megohm input VTVM. Specify No. 309 RF Probe Kit.

## \$5.50

Ship. Wt. 1 lb.

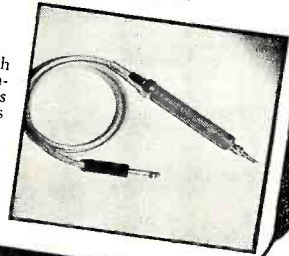

**YOU SAVE BY ORDERING DIRECT FROM MANUFACTURER—USE ORDER BLANK ON LAST PAGE**

EXPORT AGENT  
**ROCKE INTERNATIONAL CORP.**  
13 E. 40th ST.  
NEW YORK CITY (16)  
CABLE: ARCAD-N.Y.

# The HEATH COMPANY

**... BENTON HARBOR 15, MICHIGAN**



# Heathkit SIGNAL GENERATOR KIT

Model SG-6  
Shipping Wt. 7 lbs.

The new Heathkit Signal Generator Kit has dozens of improvements. Covers the extended range of 160 Kc to 50 megacycles on fundamentals and up to 150 megacycles on useful calibrated harmonics; makes this Heathkit ideal as a marker oscillator for TV. Output level can be conveniently set by means of both step attenuator and continuously variable output controls. Instrument has new miniature HF tubes to easily handle the high frequencies covered.

Uses 6C4 master oscillator and 6C4 sine wave audio oscillator. The kit is transformer operated and a husky selenium rectifier is used in the power supply. All coils are precision wound and checked for calibration making only one adjustment necessary for all bands.

New sine wave audio oscillator provides internal modulation and is also available for external audio testing. Switch provided allows the oscillator to be modulated by an external audio oscillator for fidelity testing of receivers. Comes complete, all tubes, cabinet, test leads, every part. The instruction manual has step-by-step instructions and pictorials. It's easy and fun to build a Heathkit Model SG-6 Signal Generator.



**\$19<sup>50</sup>**

## Heathkit CONDENSER CHECKER KIT

Only  
**\$19<sup>50</sup>**

Model C-2  
Shipping Wt. 6 lbs.



Checks all types of condensers — paper — mica — ceramic — electrolytic. All condenser scales are direct reading and require no charts or multipliers. Covers range of .00001 MFD to 1000 MFD. A Condenser Checker that anyone can read. A leakage test and polarizing voltage for 20 to 500 V provided. Measures power factor of electrolytics between 0% and 50% and reads resistance from 100 ohms to 5 megohms. The magic eye indicator makes testing easy.

The kit is 110V 60 cycle transformer operated and comes complete with rectifier tube, magic eye tube, cabinet, calibrated panel and all other parts. Has clear detailed instructions for assembly and use.

## NEW Heathkit SIGNAL TRACER AND UNIVERSAL TEST SPEAKER KIT

**\$19<sup>50</sup>**

Model T-2  
Shipping Wt. 7 lbs.



The popular Heathkit Signal Tracer has now been combined with a universal test speaker at no increase in price. The same high quality tracer follows signal from antenna to speaker — locates intermittents — finds defective parts quicker — saves valuable service time — gives greater income per service hour. Works equally well on broadcast, FM, or TV receivers. The test speaker has an assortment of switching ranges to match either push-pull or single output impedances. Also tests microphones, pickups and PA systems. Comes complete: cabinet, 110V 60 cycle power transformer, tubes, test probe, all necessary parts, and detailed instructions for assembly and use.



Model TC-1  
Shipping Wt. 12 lbs.

**\$29<sup>50</sup>**

## Heathkit TUBE CHECKER KIT

The Tube Checker is a MUST for radio repair men. Often customers want to SEE tubes checked, and a checker like this builds customer confidence. In your repairing, you will have a multitude of tubes to check — quickly. The Heathkit tube checker will serve all these functions — it's good looking (with a polished birch cabinet and an attractive two color panel) — checks 4, 5, 6, 7 prong Octals, Loctals, 7 prong miniatures, 9 prong miniatures, pilot lights, and the Hytron 5 prong types. AND IT'S FAST TO OPERATE — the gear driven, free-running roll chart lists hundreds of tubes, and the smooth, acting, simplified switching arrangement gives really rapid set-ups.

The testing arrangement is designed so that you will be able to test new tubes of the future — without even waiting for factory data — protection against obsolescence.

You can give tubes a thorough testing — checks for opens, shorts, each element individually, emission, and for filament continuity. A large BAD-?-GOOD meter scale is in three colors for easy reading and also has a "line-set" mark.

You'll find this tube checker kit a good investment — and it's only \$29.50.

YOU SAVE BY ORDERING DIRECT FROM MANUFACTURER—USE ORDER BLANK ON LAST PAGE

EXPORT AGENT  
ROCKE INTERNATIONAL CORP.  
13 E. 40th ST.  
NEW YORK CITY (16)  
CABLE: ARLAB-N.Y.

The **HEATH COMPANY**

... BENTON HARBOR 15, MICHIGAN





NEW 1952 *Heathkit*  
**BATTERY ELIMINATOR  
 KIT**

- Can be used as battery charger.
- Continuously variable output 0 - 8 Volts — not switch type.
- Heavy duty Mallory 17 disk type magnesium copper sulfide rectifier.
- Automatic overload relay for maximum protection. Self-resetting type.
- Ideal for battery, aircraft and marine radios.
- Dual Volt and Ammeters read both voltage and amperage continually — no switching.

The new Heathkit Model BE-2 incorporates the best. Continuously variable output control is of the variable transformer type with smooth wiper type contacts. There are no switches or steps and voltage between 0 and 8 Volts is available at 10 Amperes continuous and 15 Amperes intermittent. Maximum safety from overloads and shorts provided by automatic overload relay which resets itself when overload is removed.

The new rectifier is a 17 plate Mallory magnesium copper sulfide type. This is the most rugged type available for long trouble-free use. Output is continuously metered by both a 0 - 10 Volt Voltmeter and a 0 - 15 Amp Ammeter. Shorted vibrators indicated instantly by ammeter. Equip now for all types of service — aircraft — marine — auto and battery radios — this inexpensive instrument vastly increases service possibilities — better be ready when the customer walks in.

**\$24<sup>50</sup>**

Model BE-3  
 Shipping Wt. 17 lbs.

NEW *Heathkit*  
**SINE AND SQUARE WAVE  
 AUDIO GENERATOR KIT**

Designed with versatility, usefulness, and dependability in mind, the AG-7 gives you the two most needed wave shapes right at your fingertips — the sine wave and the square wave. The range switch and plainly calibrated frequency scale give rapid and easy frequency selection, and the output control permits setting the output to any desired level. A high-low impedance switch sets the instrument for either high or low impedance output — on high to connect a high impedance load, and on low to work into a low impedance transformer with negligible DC resistance. Coverage is from 20 to 20,000 cycles, and distortion is at a minimum — you can really trust the output wave shape. Six tubes, quality 4 gang tuning condenser, power transformer, metal cased filter condenser, 1% precision resistors in the frequency determining circuit, and all other parts come with the kit — plus, a complete construction manual — A tremendous kit, and the price is truly low.

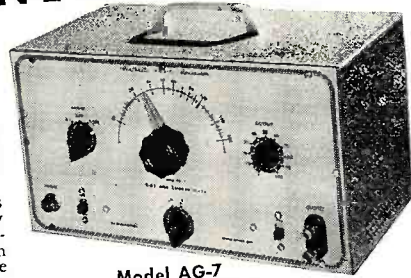

Model AG-7  
 Shipping Wt. 15 lbs.

**\$34<sup>50</sup>**

THE NEW *Heathkit*  
**HANDITESTER KIT**

A precision portable volt-ohm milliammeter. Uses only high quality parts — All precision 1% resistors, three deck switch for trouble-free mounting of parts, specially designed battery mounting bracket, smooth acting ohm adjust control, beautiful molded bakelite case, 400 micro-amp meter movement, etc. DC and AC voltage ranges 10 - 30 - 300 - 1000 - 5000V. Ohms range 0 - 3000 and 0 - 300,000. Range Milliamperes 0 - 10 Ma, 0 - 100 Ma. Easily assembled from complete instructions and pictorial diagrams.

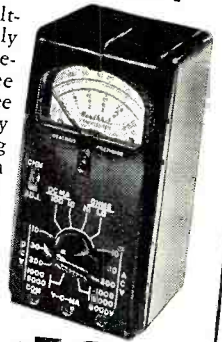

**\$13<sup>50</sup>**

Model M-1  
 Shipping Wt. 3 lbs.

NEW *Heathkit*  
**T.V. ALIGNMENT GENERATOR KIT**

A few auto radio repair jobs will pay for the Heathkit Battery Eliminator Kit. It's fast for service. The voltage can be lowered to find sticky vibrators or raised to ferret out intermittents. Provides variable DC voltage 5 to 7½ Volts at 10 Amps. continuous or 15 Amps. intermittent.

Also serves as storage battery charger. A well filtered, rugged power supply uses heavy duty selenium rectifier, a husky choke, and a 4000 MFD electrolytic condenser for clean DC. 0 - 15V voltmeter indicates output which is variable in eight steps. Better be equipped for all types of service — it means more income.

Model TS-2  
 Shipping Wt. 20 lbs.

**\$39<sup>50</sup>**

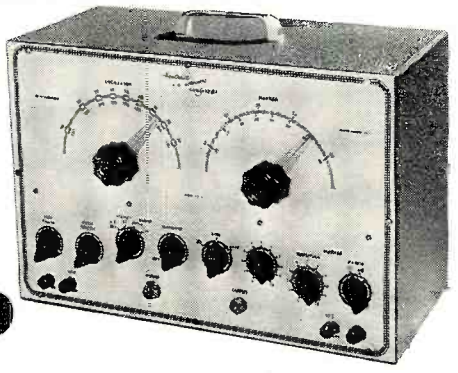

**YOU SAVE BY ORDERING DIRECT FROM MANUFACTURER—USE ORDER BLANK ON LAST PAGE**

EXPORT AGENT  
**ROCKE INTERNATIONAL CORP.**  
 113 E. 40th ST.  
 NEW YORK CITY (16)  
 CABLE: ARLAB-N.Y.

*The* **HEATH COMPANY**  
 ... BENTON HARBOR 15, MICHIGAN





Model 1B-1B  
Shipping Wt. 15 lbs.

# Heathkit IMPEDANCE BRIDGE KIT

This Impedance Bridge Kit is really a favorite with schools, industrial laboratories, and serious experimenters. An invaluable instrument for those doing electrical measurements work. Reads resistance from .01 Ohms to 10 meg., capacitance from .00001 to 100 MFD, inductance from 10 microhenries to 100 henries, dissipation factor from .002 to 1, and storage factor from 1 to 1000. And you don't have to worry about selecting the proper bridge circuit for the various measurements—the instrument automatically makes the correct circuit when you set up for taking the measurement you want. Bridge utilizes Wheatstone, Hay, Maxwell, and capacitance comparison circuits for the wide range and types of measurements possible. And it's self powered—has internal battery and 1000 cycle hummer. No external generator required—has provisions for external generator if measurements at other than 1000 cycles are desired. Kit utilizes only highest quality parts. General Radio main calibrated control. Mallory ceramic switches, excellent 200 microamp zero center galvanometer, laboratory type binding posts with standard 3/4 inch centers. 1% precision ceramic-body type multiplier resistors, beautiful birch cabinet and ready calibrated panel. (Headphones not included.)

**\$69.50**

Take the guesswork out of electrical measurements—order your Heathkit Impedance Bridge kit today—you'll like it.

## Heathkit LABORATORY RESISTANCE DECADE KIT



**\$9.50**

Shipping Wt. 4 lbs.

An indispensable piece of laboratory equipment—the Heathkit Resistance Decade Kit gives you resistance settings from 1 to 99,999 ohms IN ONE OHM STEPS. For greatest accuracy, 1% precision ceramic-body type resistors and highest quality ceramic wafer switches are used.

Designed to match the Impedance Bridge above, the Resistance Decade Kit has a beautiful birch cabinet and attractive panel. It's easy to build, and comes complete with all parts and construction manual.

## Heathkit LABORATORY POWER SUPPLY KITS

*Limits:*

No load.....Variable 150-400V DC  
25 MA.....Variable 30-310V DC  
50 MA.....Variable 25-250V DC  
Higher loads: Voltage drops off proportionally



**\$29.50**

Model PS-1.....Ship. Wt. 20 lbs.

Every experimenter needs a good power supply for electronic setups of all kinds. This unit has been expressly designed to act as a HV supply and a 6.3 V filament voltage source. Voltage control allows selection of HV output desired (continuously variable within limits outlined), and a Volts-Ma meter scale indicates either DC voltage output in Volts or DC current output in Ma. (Range of meter 0-500V D.C., 0-200 Ma. D.C.) Instrument has convenient stand-by position and pilot light.

Comes with power transformer, filament transformer, meter, 5Y3 rectifier, two 1619 control tubes, completely punched and formed chassis, panel, cabinet, detailed construction manual, and all other parts to make the kit complete.

## Heathkit ECONOMY . . . 6 WATT AMPLIFIER KIT



Model A-4  
Ship. Wt. 8 lbs.

**\$12.50**

No. 304 12 inch speaker . . . **\$6.95**

This fine Heathkit Amplifier was designed to give quality reproduction and yet remain low in price. Has two preamp stages, phase inverter stage, and push-pull beam power output. Comes complete with six tubes, quality output transformer (to 3-4 ohm voice coil), husky cased power transformer and all other parts. Has tone and volume controls. Instruction manual has pictorial for easy assembly. Six watts output with response flat  $\pm 1\frac{1}{2}$  db from 50 to 15,000 cycles. A quality amplifier kit at a low price. Better build one.

## Heathkit HIGH FIDELITY . . . 20 WATT AMPLIFIER KIT



**\$33.50**

Shipping Wt. 18 lbs.

Our latest and finest amplifier—the model A-6 (or A-6A) is capable of a full 20 Watts of high fidelity output—good faithful reproduction made possible through careful circuit design and the use of only highest quality components. Frequency response within  $\pm 1$  db from 20-20,000 cycles. Distortion at 3 db below maximum power output (at 1000 cycles) is only .8%. The power transformer is rugged and conservatively rated and will deliver full plate and filament supply with ease. The output transformer was selected because of its exceptionally good frequency response and wide range of output impedances (4-8-16-150-600 ohms). Both are Chicago Transformers in drawn steel case for shielding and maximum protection to windings. The unit has dual tone controls to set the output for the tonal quality desired—treble control attenuates up to 15 db at 10,000 cycles—bass control gives bass boost up to 10 db at 50 cycles.

Tube complement consists of 5U4G rectifier, 6SJ7 voltage amplifier, 6SN7 amplifier and phase splitter, and two 6L6's in push-pull output. Comes complete with all parts and detailed construction manual. (Speaker not included.)

MODEL A-6: For tuner and crystal phono inputs. Has two position selector switch for convenient switching to type of input desired.

MODEL A-6A: Features an added 6SJ7 stage (preamplifier) for operating from variable reluctance cartridge phono pickup, mike input, and either tuner or standard crystal phono pickup. A three position selector switch provides flexible switching. **\$35.50**

Shipping Wt. 18 lbs.

**YOU SAVE BY ORDERING DIRECT FROM MANUFACTURER—USE ORDER BLANK ON LAST PAGE**

EXPORT AGENT  
ROCKE INTERNATIONAL CORP.  
13 E. 40th ST.  
NEW YORK CITY (16)  
CABLE: ARAB-N.Y.

**The HEATH COMPANY**

**. . . BENTON HARBOR 15, MICHIGAN**



# Heathkit RECEIVER & TUNER KITS for AM and FM

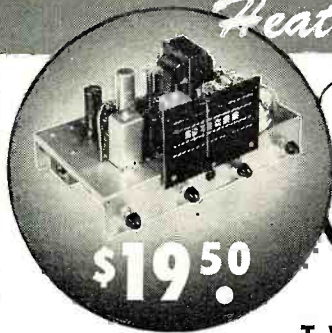

Model BR-1 Broadcast Model Kit covers 550 to 1600 Kc. Shipping Wt. 10 lbs.

**\$19.50**

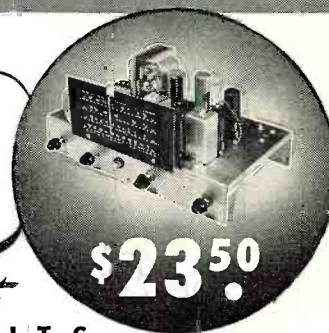

Model AR-1 3 Band Receiver Kit covers 550 Kc. to over 20 Mc. continuous. Extremely high sensitivity. Shipping Wt. 10 lbs.

**\$23.50**

## TWO HIGH QUALITY *Heathkit* SUPERHETERODYNE RECEIVER KITS

Two excellent Heathkits. Ideal for schools, replacement of worn out receivers, amateur and custom installations. Both are transformer operated quality units. The best of materials used throughout—six inch calibrated slide rule dial—quality power output transformers—dual iron core shielded. I.F. coils—metal cased filter condenser. The chassis has phono input jacks, 110 Volt output for phono motor and there is a phono-radio switch on panel. A large metal panel simplifying installation in used console cabinets is included. Comes complete with tubes and instruction manual incorporating pictorials and step-by-step instructions (less speaker and cabinet). The three band model has simple coil turret which is assembled separately for ease of construction.

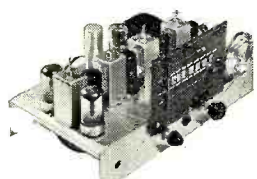

Model FM-2  
Ship. Wt. 9 lbs.

**\$22.50**

## TRUE FM FROM *Heathkit* FM TUNER KIT

The Heathkit FM Tuner Model FM-2 was designed for best tonal reproduction. The circuit incorporates the most desirable FM features—true FM.

Utilizes 8 tubes: 7E5 Oscillator, 6SH7 mixer, two 6SH7 IF amplifiers, 6SH7 limiter, two 7C4 diodes as discriminator, and 6X5 rectifier.

The instrument is transformer operated making it safe for connection to any type receiver or amplifier. Has ready wound and adjusted RF coils, and 2 stages of 10.7 Mc IF (including limiter). A calibrated six inch slide rule dial has vernier drive for easy tuning. All parts and complete construction manual furnished.



MAIL TO THE  
**HEATH COMPANY**  
BENTON HARBOR 15,  
MICHIGAN

## ORDER BLANK

From \_\_\_\_\_  
\_\_\_\_\_

SHIP VIA

- Parcel Post  
 Express  
 Freight  
 Best Way

Quantity	Item	Price	Quantity	Item	Price
	Heathkit Oscilloscope Kit — Model O-7			Heathkit H.V. Probe Kit — No. 336	
	Heathkit VTVM Kit — Model V-5			Heathkit R.F. Signal Gen. Kit — Model SG-6	
	Heathkit FM Tuner Kit — FM-2			Heathkit Condenser Checker Kit — Model C-2	
	Heathkit Broadcast Receiver Kit — Model BR-1			Heathkit Handitester Kit — Model M-1	
	Heathkit Three Band Receiver Kit—Model AR-1			Heathkit Power Supply Kit — Model PS-1	
	Heathkit Amplifier Kit — Model A-4			Heathkit Resistance Decade Kit — Model RD-1	
	Heathkit Amplifier Kit — Model A-6 (or A-6A)			Heathkit Impedance Bridge Kit — Model IB-1B	
	Heathkit Tube Checker Kit — Model TC-1			Heathkit A.C. VTVM-KIT — Model AV-1	
	Heathkit Audio Generator Kit — Model AG-7			Heathkit Intermodul. Analyzer Kit—Model IM-1	
	Heathkit Battery Eliminator Kit — Model BE-2			Heathkit Audio Freq. Meter Kit — Model AF-1	
	Heathkit Electronic Switch Kit — Model S-2			Heathkit Square Wave Gen. Kit — Model SQ-1	
	Heathkit T.V. Alignment Gen. Kit — TS-2				
	Heathkit Signal Tracer Kit — Model T-2				
	Heathkit R.F. Probe Kit — No. 309				

On Parcel Post Orders, include postage for weight shown and insurance. (We insure all shipments.)

On Express Orders, do not include transportation charges — they will be collected by the Express Agency at time of delivery.

Enclosed find  Check  Money Order for \_\_\_\_\_

Please ship C.O.D.  Postage enclosed for \_\_\_\_\_ lbs.

ALL PRICES SUBJECT TO CHANGE WITHOUT NOTICE

EXPORT AGENT  
**ROCKE INTERNATIONAL CORP.**  
13 E. 40th ST.  
NEW YORK CITY (16)  
CABLE: ARLAB-N.Y.

# The HEATH COMPANY

... BENTON HARBOR 15, MICHIGAN



Replace Your Old TV Aerial  
With Snyder's Amazing New

# 360° MOTORLESS TV AERIAL

Same Clear Pix  
As Motor Rotating  
Aerial Systems  
Costing Triple  
This Price  
FOR ULTRA FRINGE  
Only \$1895

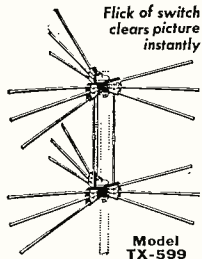

COMPLETE with three  
3 1/2 ft. masts, 75 ft.  
3 cond. cable, beam se-  
lector sw., guy rings,  
mtg. base & U clamp.

Electrically beams in complete 360° rotation to give clear picture on all channels. You choose direction with Directronic selector switch mounted on or near TV set. Complete double-stacked arrays with 18 hi-tensil double-alloy aluminum elements.

**MODEL AX-599 360° ARRAY \$1695**  
Same as above, less masts, guy rings  
and mtg. base.

**360° TV AERIAL FOR CITY AREA**  
Model AX-56—six element array for 360° elec-  
tronic, motorless rotation. Complete with 75 ft.  
3 cond. cable and Directronic beam \$9.50  
selector switch.

## Snyder's Powerful 5 Element YAGI TELEVISION ARRAYS

For Fringe &  
Ultra Fringe

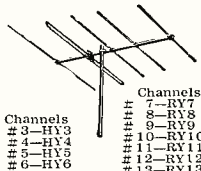

Highly directional and  
closely tuned to each  
channel. Cuts inter-  
ference and noise to  
a minimum. Five ele-  
ments; one folded di-  
pole, three directors  
and one reflector. In-  
dividual array for each  
channel. Specify model  
desired.

Channels  
#3-RY3  
#4-RY4  
#5-RY5  
#6-RY6

Channels  
7-RY7  
8-RY8  
9-RY9  
10-RY10  
11-RY11  
12-RY12  
13-RY13

\$7.95 \$4.95

### TV ANTENNA ACCESSORIES

**STEEL EXTENSION POLES.** Weather treated.  
10 ft. long. 1 1/4" dia. \$2.19  
5 ft. long. 1 1/4" dia. Crimped End. 1.35  
3 1/2 ft. long. 1 1/4" dia. Crimped End. 1.19  
**CHIMNEY MOUNT BRACKETS.**  
Complete with straps, per pair. 1.59  
**HEAVY DUTY MAST BRACKETS WB-2.**  
Adj. to 18" from wall. 3.75  
**ANTENNA SWIVEL BASE.** Aluminum.  
Fits 1 1/4" O.D. mast section. .45

### TV TRANSFORMERS

**57T011—VERTICAL OUTPUT TRANSFORMERS.** Re-  
placement for 204T2, 19,000 ohms pri. imp. \$2.95  
Turns ratio 10:1. Mtg. center 1-19/32 x 1 1/2"  
**43T011—VERTICAL OUTPUT TRANSFORMER.** Same  
as above. Mtg. center— \$1.79  
2-13/16"  
**15T811 VERTICAL BLOCKING OSC. TRANSFORMER.**  
Replacement for 208T2. Mtg. center \$1.49  
1-15/16"  
**21T811 VERTICAL BLOCKING OSC. TRANSFORMER.**  
Same as above. Mtg. center 2" \$1.19

### REPLACEMENT TRANSFORMERS

**2000 OHM OUTPUT TRANSFORMER**  
**210C11A—**To match output tube plate to 3.2 ohm  
V.C. Tubes such as 2516, 35L6, 50L6, 35A5, etc.  
Pri. imp. 2000. Pri. M.A.—30. Audio \$1.69  
Watts—5. 2" MTG. center—  
**UNIVERSAL 8 WATT OUTPUT TRANSFORMER**  
**320Z00—**Matches most tubes 5GL, or P.P. to speaker  
V.C. Pri. imp. 4000, 4500, 5000, 7000, 8000. \$1.19  
10,000. Pri. M.A.—40 Mtg. centers 2 3/8" ...  
**FILTER CHOKE**  
**21CK11—**3 H inductance, D.C. res.—450 ohms .69  
M.A. rating—40. 2" mtg. center—  
**6.3 Volt FILAMENT TRANSFORMER**  
**32FF12—**Pri. 115 V. at 60 cycles. Sec. voltage 6.3  
CT. at 1.0 amp. Insulated for 2500 volts. \$1.09  
Mtg. 2 3/8"  
**70 M.A. POWER TRANSFORMER** Filament  
**63GF12—**Plate voltage 350-550, at 70 M.A. \$3.98  
Filament  
voltage 6.3 CT. at 3 AMPS AND 5 Volts at 3  
Amps. Mtg. centers—2 1/4" x 2-13/16"

WRITE FOR FREE "FY1" BULLETIN  
Address orders to Dept. RN-11  
or Call MUlberry 2134

**WHOLESALE  
RADIO PARTS CO., Inc.**  
311 W. Baltimore St.  
**BALTIMORE 1, MD.**

## WHAT'S

# New in Radio

For additional information on any of the items described herein, readers are asked to write direct to the manufacturer. By mentioning RADIO & TELEVISION NEWS, the page, and the issue number, delay will be avoided.

### PHONO CARTRIDGE

The Astatic Corporation of Con-  
neaut, Ohio has recently brought out

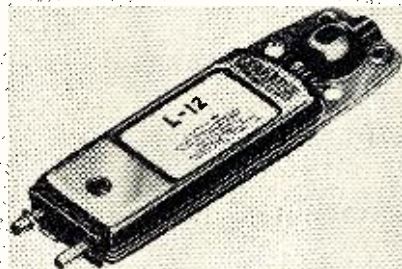

a new phonograph pickup cartridge,  
the Model L-12.

This crystal unit has been designed  
for standard 78 rpm records and fea-  
tures low cost combined with high out-  
put. Output of the L-12 is rated at  
approximately 4 volts at 1000 cycles,  
on the Audiotone 78-1 test record. It  
is designed to operate at a needle pres-  
sure of one ounce and has a total  
weight of 18 grams.

The housing is of stamped steel and  
the terminals are of the quick discon-  
nect pin type. The crystal element is  
coated with a moistureproof material.  
The L-12 is supplied without stylus and  
has a universal chuck to receive all  
standard type needles.

### 3-SPEED RECORDER

Bell Sound Systems, Inc., 555 Marion  
Road, Columbus 7, Ohio has announced  
a new portable, three-speed "Re-Cord-  
O-fone" tape recorder, the Model RT-  
65-B.

The new unit, which measures 8 1/2"



high, 15" wide, and 16" deep, weighs  
33 pounds. By means of direct connec-  
tions to radio, phono, or microphone,  
this equipment records any type of  
sound at any one of three speeds on  
plastic or paper tape, using 5" or 7"  
reels.

The 1 7/8" speed permits four hours  
of continuous recording, the 3 3/4" speed  
provides two hours of recording while

the 7 1/2" speed offers maximum fidelity  
and full frequency range.

Full performance data on the new  
Model RT-65-B can be obtained from  
H. H. Seay, general sales manager of  
the company.

### CUSTOM AUDIO

Newcomb Audio Products Co., 6824  
Lexington Ave., Hollywood 38, Cali-  
fornia is currently offering the basic  
elements for custom, cabinet-type rack  
systems suitable for schools, churches,  
stadiums, etc.

The rack will accommodate all  
standard Newcomb amplifiers as well  
as a record changer, radio, intercom  
amplifier, and other special equipment.

The Model 595-19 cabinet provides  
panel space for 56". Mounting holes  
are RTMA standard 1 1/4" and 1/2" spac-  
ings. Panel mounting holes are tapped



in 1/8" stock. A fully-ventilated rear  
door provides easy accessibility. The  
entire cabinet is a welded assembly  
with dark grey hammertone finish and  
has provision for nine 1/2" conduits.

### ACOUSTIC TAPE

Jensen Industries, Inc., 329 South  
Wood Street, Chicago 12, Illinois has  
developed a new acoustic tape which  
is available with either plastic or pa-  
per base on 150, 600, and 1200 foot  
plastic reels.

The new tape series features im-  
proved output, high fidelity, constant  
output, reduced distortion, and low  
noise. There are twelve different types  
of tape currently available. A data  
sheet listing these types and provid-  
ing physical data on the series is avail-  
able on request.

### NEW V.T.V.M.

Precise Development Corp., Ocean-  
side, Long Island, New York has begun  
delivery on its new vacuum tube volt-  
meter, the Model 909.

Available in kit form or factory  
wired, this new test instrument offers

**RADIO & TELEVISION NEWS**





*Sensationally NEW for 1952!*

# MIDWEST TELEVISION

A Magnificent New Line of Beautiful CONSOLES and Complete CHASSIS featuring This MAMMOTH

## 20-Inch Rectangular PICTURE TUBE

**FACTORY-TO-YOU**

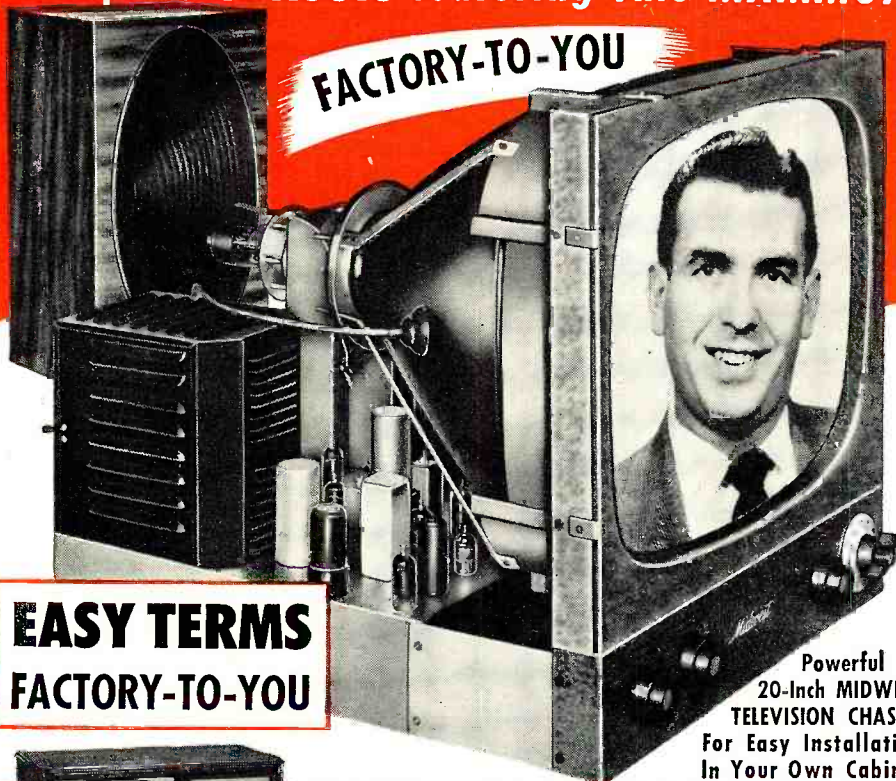

Powerful  
20-Inch MIDWEST  
TELEVISION CHASSIS  
For Easy Installation  
In Your Own Cabinet

**"CONSTELLATION"**  
20-Inch Television Console

**EASY TERMS  
FACTORY-TO-YOU**

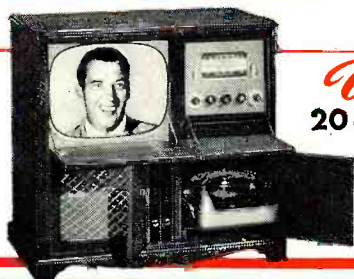

### *Video Grand* 20-Inch TELEVISION-RADIO- PHONOGRAPH CONSOLE

A luxurious instrument that offers the Mammoth 20-Inch Rectangular Picture Television, plus powerful AM-FM Radio, plus 3-Speed Automatic Intermix Record-Changing Phonograph in a beautiful mahogany veneer console.

Also—Powerful New 1952 World-Ranging  
**MIDWEST Series of RADIOS**  
For Beautiful Consoles and Complete Chassis

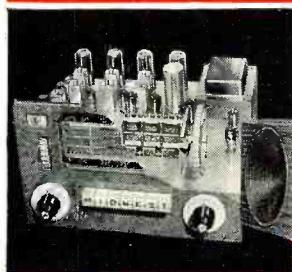

An entirely new line of radios featuring the powerful Series 16 five wave band AM-FM Radio Chassis and the magnificent Symphony Grand Radio-Phonograph with 3-Speed Automatic Intermix Record Player.

*Easy Terms*



**WRITE or PHONE**  
For This NEW 1952

## FREE MIDWEST TELEVISION RADIO CATALOG

If You Live In One of These Cities  
Phone and Ask for Your Catalog

- NEW YORK MURRAY Hill 2-6810
- CHICAGO STate 2-5600
- PITTSBURGH GRant 1-0609
- CLEVELAND PRospect 1-7450
- DETROIT WOODward 3-1233
- ST. LOUIS GRand 1161
- PHILADELPHIA LOcust 4-1035

or Send Coupon Below

• WRITE IN NAME AND ADDRESS (PLEASE PRINT) ON COUPON OR 1c POSTCARD •

MIDWEST RADIO & TELEVISION CORP.  
Dept. 374, 909 BROADWAY • CINCINNATI 2, OHIO  
Please send me your new FREE 1952 Catalog.

NAME \_\_\_\_\_

ADDRESS \_\_\_\_\_

CITY \_\_\_\_\_ ZONE \_\_\_\_\_ STATE \_\_\_\_\_

**MIDWEST RADIO & TELEVISION CORP.**  
DEPT. 374, 909 BROADWAY, CINCINNATI 2, OHIO



# BIG NEWS!!

**PREPARE YOURSELF NOW FOR A WONDERFUL FREE WINTER VACATION IN GLORIOUS, SUNNY FLORIDA!!**

Next month PLATT will celebrate a BIG ANNIVERSARY in business . . . and he invites you to join in the festivities. Yes, PLATT is running another of his famous FREE CONTESTS in DECEMBER. It costs nothing . . . and 1st prize is a vacation in Florida. WATCH FOR PARTICULARS IN PLATT'S DECEMBER AD.

## SCR-27N COMMAND & ARC-5 EQUIPT.

### RECEIVERS

	USED	NEW
BC-453-190 to 550 KC.	\$17.95	\$37.50
BC-454-3 to 6 MC.	11.95	18.95
BC-455-6 to 9 MC.	8.95	11.95

### TRANSMITTERS

BC-457-4 to 3.3 MC.	7.95	12.95
BC-458-5.3 to 7 MC.	8.95	13.95
BC-696-3 to 4 MC.	16.95	29.95
BC-459-7 to 9.1 MC.	16.95	27.50

### ADDITIONAL EQUIPMENT

BC-456 Modulator	3.95	6.95
BC-450 Control Box (3 Receiver)	1.49	2.95
BC-431 Control Box (Transmitter)	1.29	2.49
BC-442 Relay Unit (ANT.)	2.95	3.95
Plugs: PL-147, 148, 151, 152, 153, 154, 155—EACH	1.25	
Flexible Shafting with gear to fit Receivers		1.69
3 Receiver Rack	2.25	
2 Transmitter Rack	1.69	

### Fill Your Battery Only Twice a Year

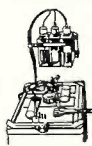

With Automatic Battery Filler. Made by leading Detroit Auto Mfr. Doubles battery life. Fits all cars, instantly installed. ONLY \$1.95

### DUAL PURPOSE EMERGENCY UNIT



- Fire Extinguisher
- Tire Inflator

Made by leading Detroit Auto Mfr. Especially recommended for oil, gas and electrical fires. Tested and stamped in accordance with I.C.C. regulations. ONLY \$2.29 each

### BC-221 Frequency Meter

Real Value! They are just like new, with original calibration charts. Range 125-20,000 KC with crystal check points in all ranges. Complete with crystal and tubes.

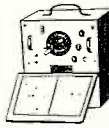

ONLY \$99.50

### PRE-AMPLIFIER MODEL K-1

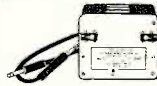

The K-1 is used to amplify output level for microphones and phonographs. Operates on 24-28 VDC, can be converted to 110 AC. Comes complete with PL 55 plug and 2 foot 119-B cord, 2 terminal blocks and instruction book.

BRAND NEW . . . \$4.95

### HEADSETS

HS-33 low impedance with cord and plug, used, fine condition . . . \$1.89  
 HS-23 high impedance, BRAND NEW with ear pads . . . 3.95  
 HS-33 low impedance, BRAND NEW with ear pads, cord and PL54 plug . . . 4.95  
 HS-30 with ear plugs, low impedance, used, good condition . . . 1.69  
 CD-307A Cords, 6 ft., NEW . . . .89



### AIRBORNE EQUIPMENT DESIGNED FOR AIRCRAFT T-85/APT-5 UHF Transmitter

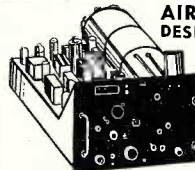

Radar Set AN/APT-5 operates on 80 or 115 volts A.C. at 400 to 3600 cycles requiring 640 volts amperes at 0.90 power factor. Complete with all tubes. Brand new in original packing \$99.50

### Minimum Order \$2.00

Immediate Delivery — Send 25% deposit on C.O.D. orders. All shipments F.O.B., N.Y.C. (N.Y.C. residents add sales tax to your remittance.)

## PLATT ELECTRONICS CORP.

DEPT. A, 489 BROOME ST., NEW YORK 13, N. Y.  
 PHONES: WO 4-0827 and WO 4-0828

MEET THE FINEST audio amplifier ever built, at any price. Its name: the Craftsmen 500, with the famous Williamson all-triode circuit. We had to invent a new word to describe its 99.99%\* distortion-free performance. The word is ULTRA-FIDELITY. Hear the "500" and you'll know why.



### C500 Amplifier Features

- Freq. response:  $\pm 0.1$  db., 20 cps to 20,000 cps;  $\pm 2$  db., 5 cps to 100,000 cps.
- Power response: 12 watts  $\pm 2$  db., 10 cps to 50,000 cps.
- Total H Distortion: Less than 0.1% at 10 watts, at mid-freqs.
- \*0.01% at av. listening level below 1 watt.
- Tube complement: (2) 6SN7GTA; (2) KT66 power output; 5V4G rectifier.

for information, write

THE RADIO

**craftsmen**

INCORPORATED

Dept. R-11, 4401 N. Ravenswood Ave., Chicago 40, Ill.

five plus d.c. ranges, five minus d.c. ranges, and five a.c. ranges in addition, five resistance ranges and a decibel range covering from -20 to +55 db.

When sold in kit form, a special two-color "rapid construction" instruction

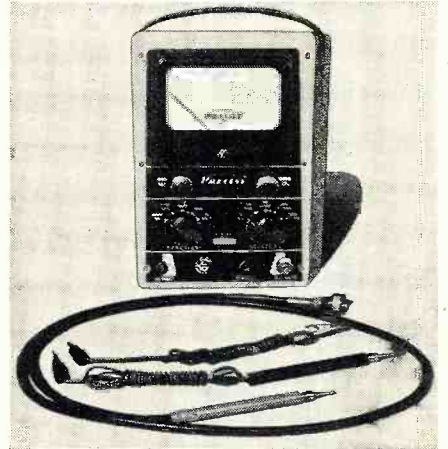

book is included. The complete unit measures 9 1/2" x 6" x 5" and weighs 10 pounds (shipping weight). Test leads, wire, and batteries are included with each unit.

### PORTABLE P. A. SYSTEM

Newcomb Audio Products Co., 6824 Lexington Avenue, Hollywood 38, California is now in production on a portable public address system, the Model H-1512.

The new unit features two heavy-duty 12" loudspeakers in a split case with a 17 watt deluxe amplifier. The system provides inputs for two microphones and one phonograph, the frequency range extends from 20 to 20,000 cycles, has a power output of 17 watts, and 20 watts maximum at less than 5% distortion at any output tap.

The entire system is housed in a plywood carrying case which is covered

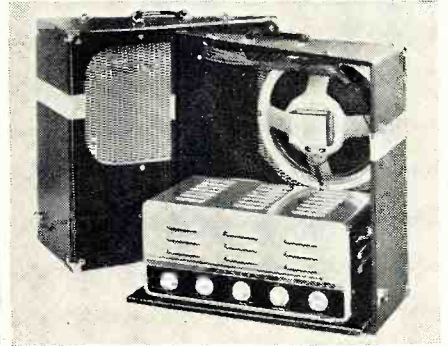

with washable fabricoid material and is equipped with metal fittings and "kickproof" speaker grilles for added protection. Over-all size is 11 1/2" x 20 1/2" x 21" and the unit weighs 44 1/2 pounds.

### REMOTE CONTROL AMPLIFIER

Herman Hosmer Scott, Inc., 385 Putnam Avenue, Cambridge 39, Massachusetts is now in production on a new Type 214-A amplifier which incorporates certain control and compensating features which improve music fi-  
 (Continued on page 165)





*How far ahead can you be  
next year . . .*

**IN TV AND ELECTRONICS?**

← **Send for this free CREI booklet today . . .  
and find out!**

**T**his booklet can mean the difference between small, w-i-d-e-l-y s-p-a-c-e-d salary increases—and rapid advancement. Between routine work—and challenging opportunity. Between constantly defending your job against better-trained men—and dynamic confidence. Between short-circuited hopes—and high-powered ambition.

An exciting new world has opened up with such super-speed that even the most optimistic electronic experts fall short in their predictions of expansion.

Think of the 1,500 TV stations within the next 5 years and the 2,500 stations within 10 years, as predicted by the Chairman of the FCC. Think of the 13,000,000 TV sets now in use. *Remember that we weren't supposed to reach that figure until 1954.* Think of the 100,000,000 radios in current operation. (95% of the nation's homes have one or more sets.) Think of the tremendous defense orders now being placed for electronic equipment and installations.

Think of the thousands of radio-equipped fire and police departments throughout the U.S. Of the many radio-equipped railroads, of the hundreds of cities with 2-way radio service for cars and cabs. Think of the wide-ranging field of aviation communications—radio-controlled aircraft, navigation-and-traffic control, airport stations.

Think of the maritime world with its navigational aids, fathometers, ship-to-shore and ship-to-ship communications and radar. Think of electronic heating, fax and ultra-fax, of electronic medicine, and all the other applications of electronic know-how.

Countless positions must be filled—in development, research, design, production, testing and inspection, manufacture, broadcasting, telecasting and servicing. Who will get those positions? You—if you prepare today—if you are alert and have the ambition to advance your knowledge. You—if you take 2 minutes to send for a free copy of "Your Future in the New World of Electronics."

This helpful book shows you how CREI Home Study leads the way to greater earnings through the inviting opportunities described above.

However, being an accredited technical school, CREI does not promise you a "bed-of-roses." You have to translate your willingness to learn into saleable technical

knowledge—via *study*. Since its founding in 1927, CREI has provided thousands of professional radiomen with technical educations. During World War II, CREI trained thousands for the Armed Services. Leading firms choose CREI courses for group training in electronics at company expense, among them United Air Lines, Canadian Broadcasting Corporation, Trans Canada Airlines, Sears Roebuck & Co., Bendix Products Division, All-American Cables and Radio, Inc., and RCA-Victor Division.

CREI courses are prepared by recognized experts, in a practical, easily-understood manner. You get the benefit of time-tested materials, under the personal supervision of a CREI Staff Instructor. This complete training is the reason why CREI graduates find their diplomas keys-to-success in Radio, TV and Electronics. CREI alumni hold top positions in America's leading firms.

At your service is the CREI Placement Bureau, which finds positions for students and graduates. Although CREI does not guarantee jobs, requests for personnel currently exceed supply by far.

Talk to men in the field and check up on CREI's high standing in electronics instruction. Determine for yourself right now that your earnings are going to rise with your knowledge—and that you get your rightful place in the Age of Electronics. All this CREI can promise you, provided you sincerely want to learn. Fill out the coupon and mail it today. We'll promptly send you your free copy of "Your Future in the New World of Electronics." The rest—the future—is up to you.

**MAIL COUPON FOR FREE BOOKLET**

**CAPITOL RADIO ENGINEERING INSTITUTE**

Dept. 1111C, 16th & Park Rd., N.W., Washington 10, D. C.

Send booklet "Your Future in the New World of Electronics" and course outline.

- CHECK FIELD OF GREATEST INTEREST {  TV, FM & Advanced AM Servicing  Aeronautical Radio Engineering  Practical Television Engineering  Broadcast Radio Engineering (AM, FM, TV)  Practical Radio Engineering

Name.....

Street.....

City..... Zone..... State.....

If residence school in Wash., D. C. preferred, check here



# McGEE'S TREMENDOUS FALL SALE OFFERS TERRIFIC VALUES

## LOOK AT THESE BARGAINS!



### TRAV-LER 3-WAY PORTABLE—\$18.95

A lucky purchase makes this value possible. Model 5022 Traveler 3 way portable. Operates on 125 volts AC or DC, or self-contained batteries. A full 2 volt superhet with Alnico V dynamic speaker. Tube components 1R5, 4U4, 1X3, 3V4 plus rectifier. Has with ivory plastic front panel and Tan or Red leatherette covered case. Compact size 9 x 5 1/2 x 8 1/4. antenna is built in. Receives broadcast 550 to 1600 kc. A powerful set with 6 tube performance. Shipping weight, less batteries, 6 lbs. with batteries. Traveler Model 5022, portable less batteries \$18.95 ea. Lots of 3 \$18.50 ea. Battery kit for Model 5022 \$1.75 extra, (consists of one 67 1/2 volt 'B' and 2 No. 2 flashlight cells).

### VM 3-SPEED AUTOMATIC—\$44.95

Another special purchase offer! VM-975, 3 speed portable automatic record changer. Housed in a deluxe brown leatherette case. 14 1/2" x 17 1/4" x 3 3/4" high. Famous VM Tri-O-Mat changer, plus all 3 speed and all 3 sizes automatically. 10" and 12" records of the same speed can be inter-mixed. Flip crystal cartridge provides the correct needle size for the record you are playing. Has good quality 3 tube amplifier, a tone and volume control and heavy magnet PM speaker. Regular dealer net is \$51.60. Now, a limited number are available at the special sale price of only \$44.95 each. Shipping weight 22 lbs.

### TRAV-LER 3-SPEED PORTABLE—\$18.95

Traveler Model 7033, deluxe 3-speed electric portable record player. Powerful 3 tube amplifier, (2S47, 50L6, and 3Z5 rectifier). Full size Alnico V magnet, dynamic speaker. Plays all records; 7", 10" and 12", 33 1/3, 45 and 78 RPM. Crystal pickup with all purpose lubricated permanent needle. Luggage style case, 12 1/2 x 10 1/2 x 6 1/4", expertly covered with simulated Tan, Green, or Red leatherette. Shipping weight 12 lbs. Traveler or Model 7033, 3-speed portable electric record player. Net price only \$18.95. Lots of 3, \$18.50 each.



## NEW VERSATILE

### 12-TUBE FM-AM CHASSIS

**\$64.50**

- \* BUILT IN PRE-AMPLIFIER FOR G.E.
- \* VARIABLE RELUCTANCE PICKUP
- \* WIDE RANGE AUDIO
- \* MAY BE USED WITH A CRYSTAL MIKE AS A HOME P.A. SYSTEM

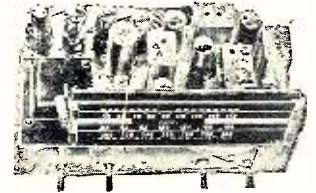

McGee's new 1951 model 12 tube FM/AM chassis. Latest design with phono inputs for all types of record players, crystal or G.E. variable reluctance. Receives standard broadcast 550 to 1700 KC and FM 88 to 108 MC. Wide range audio response (push-pull 7C5) and bass boost tone control. Loop antenna for broadcast and 300 ohm line type antenna, may be stapled in cabinet. Attractive lighted slide rule dial. Chassis size, 13 1/2" x 9" high and 9" deep. Shipping weight 20 lbs. Stock No. 7-CX. Made to sell at a much higher price. McGee's sale price is \$64.50, less speaker output matches 8 ohms). 7-CX chassis with our 12" coaxial PM, CU-14X, both \$74.50. 7-CX chassis with our new 12" coaxial PM, CU-14X and latest model 3 speed record changer with crystal mike or crystal phono pickup, both \$106.65. Same combination deal as above except changer has the G.E. variable reluctance turn-about cartridge. All for only \$106.65.

## LOOK AT THESE VALUES

### RAYTHEON 3-SPEED MOTOR AND T.T. \$4.49

3 speed, 110 volt AC phono motor with turntable and hardware, at less than regular cost. 1951 production, unconditionally guaranteed. Stock No. 345-AB. Shipping weight 3 1/2 lbs. Sale price \$4.49 each, 3 for \$11.95.

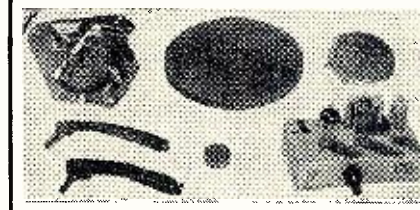

### BEAUTIFUL RADIO PHONO-COMBINATION CABINET

#### MADE FOR CAPEHART ONLY ..... \$99.50

Beautiful hand rubbed mahogany Radio-Phono combination cabinet made for Capehart. Used on the combination setting in the \$600.00 bracket. Cabinet is 37" high, 40" wide and 21" deep. Baffle is cut for two 12" speakers. Hinged top lifts in two sections. Radio Chassis space is 12 1/2" high, 19" deep and 11 1/2" high. The 14" panel can be changed to fit any dial arrangement. Changer compartment is 23 1/2" wide, 14 1/2" high and 18 3/4" deep. Shipping weight 160 lbs. Stock No. MD-CC10. Net price \$99.50 each. Please specify shipment by Express, Truck or Rail Freight.

### RCA 16GP4 \$25.95

Brand new, in original cartons. Genuine RCA 16GP4 metal core tubes at a terrific saving to you. Unconditionally guaranteed for 90 days. Sale price, \$25.95 each, two for only \$50.00.

### QUAM 12" SPEAKERS 3 FOR \$15.00

Quam, 12", 4.64 oz. Alnico V magnet PM speakers, with adjustable cones. Only 200 to sell at this terrific saving. \$5.49 each, 3 for \$15.00.

### 3 TUBE AMPLIFIER KIT \$9.95

Stock No. RA-3M \$9.95. Complete kit of parts, including tubes and diagram; to build a small compact 3 tube AC-DC amplifier. Inputs for crystal mike or crystal phono pickup. Incorporates a dual triode, plus 50B5 and 35W4 rectifier tube. Output is furnished, but no speaker. Use any PM 5" PM speaker, \$1.50 extra. Small 1 1/4" diameter crystal mike element in aluminum shell for hidden use or general purpose. Pictured upper right. Stock No. T-001. Net price, \$3.95 each.

Crystal phono pickup arms for use with 3 speed motors: Deluxe flip-over cartridge arm, with twin needles. For all speed records. Stock No. F0A-1. Net price \$4.88 each. Standard light weight arm with all purpose crystal cartridge and all play needle. Stock No. A-51X. Net price \$2.89 each.

### T.V. BOOSTER REGENCY \$19.10

Regency DB-410 television booster. A real engineered unit, small and compact. Slug tuned, using 1-6J6 tube as neutralized push-pull amplifier. Dollar for dollar, your best booster buy. 5% x 4". For 110 volt AC operation. Weight 6 lbs. Net price \$19.10.



### 50-WATT BOOSTER AMPLIFIER—\$39.95

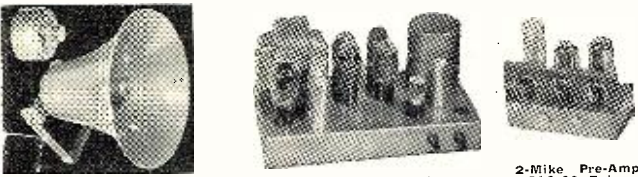

25-Watt Horn \$28.95 50-Watt Booster \$39.95 2-Mike Pre-Amp. \$10.00 Extra. A sensational value, 50 watt booster amplifier with push-pull parallel 6V6 output tubes. Connect to your present amplifier as a booster or use with the PR-2X Pre-amp to add the use of 2 mikes and one low level input. The booster amplifier has one input jack and with 1 volt input gives 5 watts of audio. Booster has a 6 lb. potted case with high fidelity output transformer, matches speaker with 4-8-16 ohm voice coil, also 60 ohm and 250 ohm line. Booster has a 225 mill power supply with 5U4 rectifier. Price includes tubes: 4 6B6, 7N7 and 5Y4. The two variable controls are for master volume control and base boost tone control. Size 8 x 6 1/2 x 14 1/2. Stock No. PA-55X. Shipping weight 26 lbs. Sale price \$39.95 ea.

30-WATT BOOSTER 30 watt Booster Amplifier. Identical in appearance to the PA-55X above, only with 175 mill power transformer and push-pull parallel 6V6 tubes instead of 6B6's. The same wide range output is incorporated. Size this where 30 watts of ADDED audio power is required. If mike input gain is required order our PR-2X Pre-amp. Stock No. PA-30X. Ship. wt. 22 lbs. Price \$32.95 ea.

2-MIKE PRE-AMP. Pre-amplifier plugs in directly to the PA-55X and PA-30X. Enables use of 2 Crystal or Dynamic Mikes plus one low level input. Furnished with 4 foot cables and plugs for remote control of the 55 or 30 watt Booster Amplifier. Small chassis size 5 x 3 1/4 x 4". Stock No. PR-2X. Shipping weight 10 lbs. Net price \$10.00 ea.

25-WATT HORN 25-Watt Driver and 3 1/2-foot air column re-entrant Trumpet. The standard type trumpet and driver you see the most. Drivers are 100% weatherproof, horn is spun aluminum, offered to you at a considerable savings. Stock No. MA-35. Shipping weight 20 lbs. Net price \$28.95.

### 3 SPEED PLAYER ATTACHMENT \$9.95

Stock No. AB-3. Plugs into your television or radio phono jack or use with any audio amplifier. Plays all 3 record styles, 33 1/3, 45 and 78 RPM. Equipped with all purpose crystal pickup and needle. Every radio shop and play room should have one. Operates on 110 volts AC. (No amplifier or speaker is furnished). Shipping weight 7 lbs. Stock No. AB-3. Net price \$9.95.



### SPEAKER AND BAFFLE SALE 8" SPEAKER AND BAFFLE \$4.95

Stock No. 818. Tan leatherette covered, plywood slant type wall baffle; plus an 8" x 6" x 2 1/2" Alnico V magnet PM speaker. A red hot McGee special for only \$4.95 each, or \$4.70 each in lots of 3 or more.



### 10" SPEAKER AND BAFFLE \$6.95

Stock No. CA-12. Tan leatherette covered plywood slant type wall baffle; plus a 12" Quam, 4.64 oz. Alnico V magnet PM speaker. (Popular Adjutacone model). A terrific McGee value for only \$7.95 each, or \$6.60 each in lots of 3 or more.

12" SPEAKER AND BAFFLE \$7.95 Stock No. CA-12. Tan leatherette covered plywood slant type wall baffle; plus a 12" Quam, 4.64 oz. Alnico V magnet PM speaker. (Popular Adjutacone model). A terrific McGee value for only \$7.95 each, or \$7.75 each in lots of 3 or more.

### RED HOT SALE OF AUTOMATIC CHANGERS

WEBSTER CHICAGO 3-SPEED \$24.95 Regular \$47.50 List Only



Webster Chicago Model 100-16 3 speed automatic record changer with crystal cartridge and all speed Sapphire needle. 11 needles plays all records. Base size 12 1/2" x 14 1/2" x 14 lbs. This offer good only as long as our stock lasts. A special purchase makes this offer possible. Webster Chicago 3 speed changer, Model 100-16, Sale price \$24.95.

### SUPER HEAVY DUTY 10" PM \$6.95

We made a special purchase on several hundred 20 watt, 10", 32 oz. Alnico 3 magnet PM speakers. Deep throat and easy moving cone. Ideal for all high fidelity sound systems and radio replacement. The magnet on this speaker is usually used on a 15" size. Very efficient, good high and bass response. You'll appreciate it when you get your hands on this speaker. Attractive copper finish, 3 ohm voice coil. Stock No. 1025PS. Weight 7 lbs. Net price \$6.95 each. Order three of these and use them in a cluster of three. They will take 60 watts of audio and have more cone area than any 15" speaker. For high power, top quality P.A. work. Think this over. 3 No. 1025PS speakers for only \$19.95.

### BUY YOUR WIDE RANGE COAXIAL SPEAKER AT McGEE

#### 12" COAXIAL PM \$12.95

A \$32.50 retail value, 20 watt 12" coaxial PM speaker of quality used on radios to the \$300 to \$500 bracket. Hook up like any PM speaker. High pass filter is built in speaker. Matches 8 ohm output of radio amplifier. Wide range response. 20 to 17,500 CPS. Model No. CU-14X. Ship. wt. 9 lbs. Special sale price, \$12.95.

#### 15" COAXIAL PM \$19.95

Only \$19.95 buys a full 15", 20 watt coaxial PM speaker, with built-in high pass filter. Hook to any 3 ohm output on radio or amplifier. Response below 20 to above 17,500 CPS. Good bass response. A lucky purchase makes this price possible. Full 32 oz magnet in the woofer, 5" tweeter. Model P15-9. Ship. wt. 11 lbs. Sale price, \$19.95.

### GENERAL INSTRUMENT 78 R.P.M.

Record Changer SCOP \$10.95 PRICE TWO FOR \$21.00

General Instrument 78 RPM automatic record changer. Plays 10- or 12-inch records automatically. One of the latest models made. Beautiful golden brown hamper-tone finished base, 12x12 1/2". Equipped with an Astatic L-70 crystal cartridge. Heavily flocced turntable and plastic fittings are deep maroon colored. This may be our last chance to offer a 78 RPM changer at this all purpose price. Comes packed two to a master carton, just like they would be shipped to a set manufacturer. Order 2 changers for an additional saving. Shipping weight for 2 changers, 20 lbs. Stock No. 1T-SG1. Net price, \$10.95 each; two for only \$21.00.

### V.M. 3 SPEED Record Changers \$22.95

VM Model 406 deluxe 3 speed automatic record changer—plays them all—intermixes records of the same speed—equipped with a flip over crystal pickup with twin needles—base size 12 1/2" x 14 1/2" x 14 lbs. VM-406. Net \$22.95. Buy the VM-950 changer with or without base. Choice of G.E. VR or crystal cartridge. We think the VM-950 record changer is the finest in America. It automatically plays all records all speeds and all sizes; 2 10-in., 33 1/3 or 78 rpm, 10 12-in., 33 1/3 or 78 rpm and 12 and 10-in. records of the same speed intermixed. 12 7-in. 33 1/3 or 12 7-in. 45 rpm. Automatically shuts off after the last record. Size 13 1/2" x 16 1/2" x 14 1/2" high. Offered with crystal cartridge, G.E. VR cartridge, or either with a base. VM-950, 3 speed changer with standard crystal cartridge and needles for 1 and 3 mil. (75 rpm) 33 1/3, 45 rpm.) Net \$29.62. VM-950G, 3 speed changer with the new RPX-050 magic, all-in-one variable reluctance cartridge with styli. Net \$32.80. VM-955, 3 speed changer with crystal cartridge on a base. Net \$32.01. VM-955CR, 3 speed changer with RPX-050 VR cartridge with base. Net \$35.19.



# TELEVISION KITS FOR SCHOOLS • STUDENTS • BUILDERS

**COMPLETE 16 TO 20 INCH TELEVISION "SLAVE" KIT**  
**\$39.95**  
 LESS TUBES



Television Slave Kit, Model No. SK-21; for use with 16, 17 or 20 inch rectangular picture tubes, as well as 16 or 19 inch round tubes. It may be connected to your present TV receiver, regardless of screen size, to give you a remote TV slave unit; sometimes referred to as a TV duplicator. You pick up the TV signal as the picture signal from the picture tube grid. The audio is picked up at the high side of the audio gain control. These two connections are all that is necessary on your present set. A two tube cathode follower kit is supplied with the slave kit so that there will be no loading of your present set. The duplicator kit itself is 14 3/4" wide and 21" long. A ready punched chassis and complete hardware kit is furnished. The circuit is a straight forward AC transformer type. The circuit employs the following tubes: (2) 6SN7, horizontal and vertical oscilators, (2) 6AL5 phase detector and DC restorer, 6X6 variable output, 5U4 rectifier, 6K6 audio, 6BD6 horizontal output, 6W4 damper, 1X2 high voltage rectifier, 12AU7 2nd video sync. separator, (2) 6AG5 are used in the cathode follower. (No speaker is furnished). This kit is the same essentially as a full TV kit, except that it has no tuner or video. All resistors, tube sockets, power transformer, etc., are furnished along with a schematic diagram and instructions. **WARNING:** Only those who understand TV, should buy this kit; as television is very complicated and should not be attempted unless you know what you are doing. TV Duplicator Kit, Model SK-21, complete less all tubes, Net price \$39.95. Shipping weight 38 lbs. 8" PM speaker, \$2.95 extra. Kit of 12 receiving tubes for SK-21, \$14.00 extra. 17BP4A 17" blackface picture tube, \$21.95 extra. 20CP4A, 20" blackface picture tube, \$39.95 extra. (Specify when ordering, which picture tube that you intend using.)

**COMPLETE 17" TO 20" T.V. KIT**

- ★ AC-TRANS-TYPE **\$59.95** LESS TUBES
- ★ CONVENTIONAL CIRCUIT
- ★ READY WIRED 12 CHANNEL T.V. FRONT END
- ★ 70° DEFLECTION
- ★ CERAMIC FLYBACK
- ★ KIT OF TUBES EXCEPT KINE \$16.95
- ★ 17BP4A \$22.95 EXTRA

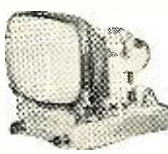

A complete kit of parts to build an AC transformer operated television chassis for use with a 16, 17 or 20 inch rectangular picture tube. The 12 channel Sarkes Tarzian tuner is ready wired. The 4 tube video IF strip is also wired. Circuit is of the conventional accepted design, with latest ceramic type flyback high voltage supply. Chassis is ready punched. **WARNING:** Do not buy this kit unless you understand Television and electronics. It is difficult to wire. We furnish schematic and photos. Kit model WH 20 ship weight 40 lbs.. less all tubes \$59.95. Kit of 19 tubes but less picture tube \$16.95 extra. 17 inch 17BP4A \$22.95 extra. 20CP4 inch rect. tube \$39.95 extra.

**SARKES TARZIAN 3-TUBE T.V. TUNER \$7.95**

This popular Sarkes-Tarzian television front end is widely used today. The 13 channel rotary switch type with individually tuned coils. Price includes a schematic diagram and 3 tubes. 6C4 osc. 6BH6 RF and 6AG5 mixer. Regular factory cost is twice our price. Each tuner and its own tube sockets are wired, ready to hook up to a video and sound IF strip. May be used with either intercarrier or separate sound IF circuits. Built-in fine frequency control. Ship weight 3 lbs. Sarkes-Tarzian Type 3 TV tuner with tubes net. . . . \$7.95  
 Combination deal, Sarkes-Tarzian TV tuner and 207-XX video coil kit, both for. . . . \$14.95  
 Sarkes-Tarzian Type 3-tube kit with Type 2 only has input IF coil built-on. Tapped for sound IF channel. Net. \$9.95  
 Above tuners offered with either 2 1/2 inch or 4 3/8 inch shaft length. 3-tube Sarkes-Tarzian tuner with 2 1/2" shaft but no fine tuning. With tubes 12AT7 and 2-6AG5. Stock No. TX-3T \$7.95 with tubes.

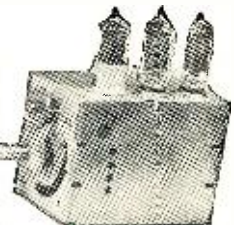

**CONVERT TO A RECTANGULAR PICTURE**



With each conversion kit you get a plastic mask, 70 degree deflection yoke, 90 day guaranteed black face picture tube, plus our new 7711-X 14,000 Volt Universal fly-back and horizontal output transformer that works on any output tube and any single rectifier (1B3 or 1X2). A suggested diagram is furnished for use of the transformer with several different output tubes and rectifiers. We think this is the finest and best priced conversion kit in the country. Shipped Truck or Express, only.

- Kit No. TCK-14, with 14BP4A 14" rectangular tube, Net price. . . . \$27.95
- Kit No. TCK-16, with 16RP4A 16" rectangular tube, Net price. . . . 34.95
- Kit No. TCK-17, with 17BP4A 17" rectangular tube, Net price. . . . 29.95
- Kit No. TCK-20, with 20CP4A 20" rectangular tube, Net price. . . . 49.95

**PICTURE TUBE SALE**

Values like this 12LP4, \$17.95

Look over these picture tube prices and you will see, that for set replacement and conversion use, McGee offers you more for your money. Every picture tube guaranteed full replacement for 90 days. Every tube is a tremendous value. These tubes are not seconds, but 1st quality.

**NOTE: 10MP4 Replaces a 10BP4 Without Any Circuit Changes.**

Tube No.	Defl. Angle	Overall Length	Neck Length	Envelope	Face Type	Ion Trap	Net Price
10M P4	12°	54	17'-9/16"	Glass	Clear	Single	\$16.95
12L P4	12°	50	18 3/4"	Glass	Clear	Double	17.95
12Q P4	12°	55	17 1/2"	Glass	Clear	Single	17.95
14B P4A	(R)	60	16-13/16"	Glass	Filter	Double	19.95
15D P4	15°	60	18 3/4"	Glass	Clear	Double	24.95
16A P4	16°	53	22-5/16"	Glass	Clear	Double	22.95
16I P4	16°	60	20 3/4"	Glass	Clear	Double	29.95
16G P4A	16°	70	17 1/16"	Metall	Filter	Single	24.95
16L P4	16°	52	22 1/4"	Glass	Clear	Double	29.95
16R P4A	16°	58	18 3/4"	Glass	Filter	Single	24.95
17B P4A	17° (R)	70	18 3/4"	Glass	Filter	Single	22.95
19D P4A	19°	60	20 3/4"	Glass	Filter	Double	39.95
20C P4A	20° (R)	70	21 3/4"	Glass	Filter	Double	39.95

Note: (R) Designates a rectangular type tube. 10M P4 perfect for 10B P4.

# SENSATIONAL NEW 2-BAND RADIO KIT ONLY \$14.95

**7-TUBE FM-AM TUNER**

**MODEL RAL-8**

**\$29.95**

- ★ AC SELF POWERED
- ★ 3 GANG TUNING
- ★ A COMPLETE KIT



McGee has ready for delivery, this self powered AC, 7 tube FM and AM superhet tuner kit. Build yourself a professional looking tuner that may be connected to any audio amplifier. Receives broadcast 550 to 1650 kc and FM 88 to 108 mc. A 3 gang tuning condenser is used on both FM and AM. This extra stage of TRF makes a smoother working tuner. 2 IF stages on FM and one IF stage on AM (I.F. frequency 456 and 10.7 mc). Tapped slide rule dial with metal escutcheon plate. Our own lab designed and wired an original tuner using these parts. Chassis is ready punched and painted. Everything furnished including tubes and diagrams. Shipping weight 12 lbs. Stock No. RAL-8, net price \$29.95.

**MODEL ME6-2 \$14.95**

**NEW MODEL 6-TUBE, 2-BAND RADIO KIT**  
**A FULL 2-GANG SUPERHET KIT**  
**RECEIVES 550-1600 KC PLUS 6-18 M.C.**



McGee's new 1951, 6 tube; AC-DC 2 band radio kit. Receives broadcast, 550 to 1600 kc and short wave, 6 to 18 mc. A straight forward superhet circuit with 2 gang tuning condenser, 456 kc. I.F. transformers, etc. 5" speaker illuminated slide rule dial. Everything furnished, including tubes, diagram and a photo showing view of underside of completely wired chassis. The chassis and dial parts are factory production. With this kit, you can build a commercial looking and factory quality 2 band radio, housed in a streamlined plastic cabinet. Size: 13 x 6 1/2 x 6 1/2". Stock No. ME6-2, shipping weight 10 lbs. Net \$14.95.

**SELF POWERED AC**

**Broadcast Tuner Kit, 3-Gang Tuning, Complete Kit, \$12.95**



A self-powered, 3-gang superhet tuner kit with R.F. stage. When wired according to our diagram will make a top quality broadcast tuner (550 to 1650 kc), for use with any amplifier. Don't class this with ordinary tuners; this has its own power transformer. This complete kit is furnished with a diagram, photos and tubes: 6SH7 R.F., 2-7E5 converter-mixer oscillator, 6SR7 I.F. detector and 6X4 rectifier. Connect to any audio amplifier. Deal for use with our 5-204X TM-16 or 7X5 amplifier kits. Chassis size, 9 1/2 x 4 1/2" high. Shipping weight, 7 lbs. Broadcast tuner kit Model TX-3X. Net price, \$12.95.

**8-TUBE 22 WATT**

**Wide Range Amp.**

**Model 7x5 Kit Only \$37.95**

A complete kit, including tubes (3-7E5, 2-7E7, 2-6A3, plus rectifier), diagram and photos. All triode circuit makes for minimum harmonic distortion. Inputs for radio tuner any kind of phono pickup (crystal or G.E. variable reluctance) and either crystal or dynamic mike. Output transformer matches 8 ohm voice coil. Twin electronic tone controls, bass and treble with range selector switch for either juke box quality with heavy bass response or brilliant symphonic range. The best quality amplifier kit we know how to make. Has a very wide range output and heavy power transformer. Response 18 to 20,000 CPS. 8 tube all triode amplifier kit, complete with tubes. Weight 25 lbs. Net \$37.95.



**10-TUBE RADIO KIT \$29.95**

**3-GANG TUNING**  
**MIKE INPUT**  
**12 WATT**  
**HI-FI AUDIO**  
**BASS-TREBLE BOOST**

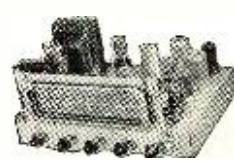

**A NEW 1951 ALL-PURPOSE RADIO KIT**

10-Tube Broadcast (550 to 1700 kc) Radio Kit for custom builders. Features 3-gang superhet circuit with A.V.C., high gain IF circuit, 8" slide rule dial. Chassis size 12 1/2" long, 10" front to back, 6 1/2" high. 5Y3 Chassis size 7" deep, 6" high, 12 1/4" long, 7 1/2" slide rule dial. Very ideal for schools, etc. A straight forward superhet circuit with 456 kc. I.F. transformers, speaker and cabinet. Output transformer is part of radio kit. Stock No. AA-61. Shipping weight 9 1/2 lbs. Net price \$16.95. 6" PM speaker \$2.79 extra. 8" PM \$3.49 extra.

**5-Tube Broadcast SUPERHET RADIO KIT \$12.95**

Model RS-5 tube AC-DC superheterodyne radio kit. Has loop antenna and 2 gang condenser, with lighted slide rule dial and attractive plastic cabinet. Receives broadcast, 550 to 1650 kc. Full size dynamic speaker matched 456 K.C. I.F.'s, automatic volume control. This is a complete radio kit. Everything furnished, including diagram, photos and tubes: 12K8, 12SI17, 2-7E5 and 701.7. Shipping weight 7 lbs. Stock No. RS-5. Net price \$12.95.

**Build Your Own Phono-Mike Broadcaster \$7.95**

Kit Model DE-6R. With this simple kit, you can build a 3-tube phono oscillator that also has broadcast over any radio, within your home, (about 75 feet) from 1000 to 1500 kc. Inputs for crystal phono pickup, microphone, fader control fades from mike to record. Ideal for a home P.A. system, baby siter and home entertainment. A complete kit of parts including tubes. Kit Model DE-6R. Net price, \$7.95. DE-6RWT, wired and tested. Net price, \$9.95. Crystal mike and desk stand, \$4.95 extra. Concealed microphone unit, only 1" in diameter and 1/4" thick. Specify hidden mike when ordering. Stock No. T-001. Net, \$3.95 extra.



**6-TUBE AC-2-BAND KIT \$16.95**

A New 2-band radio chassis kit, features 3-gang tuning, full AC circuit with power transformer, complete with diagram, all parts and tubes, 6SA7, 2-7A7, 7B6, 6K6, and 5Y3. Chassis size 7" deep, 6" high, 12 1/4" long, 7 1/2" slide rule dial. Very ideal for schools, etc. A straight forward superhet circuit with 456 kc. I.F. transformers, speaker and cabinet. Output transformer is part of radio kit. Stock No. AA-61. Shipping weight 9 1/2 lbs. Net price \$16.95. 6" PM speaker \$2.79 extra. 8" PM \$3.49 extra.

**McGEE RADIO COMPANY**

Prices F.O.B. K.C. Send 25¢ Deposit with Order. Balance Sent C.O.D. With Parcel Post Orders, Include Postage

**TELEPHONE VICTOR 9045. WRITE FOR FLYER 1422 GRAND AVE., KANSAS CITY, MISSOURI**



# Federated

announces

THE



## JR. VOLTOHMYST

is back again



with many NEW  
**FEATURES**

- ▼ GREATER VOLTAGE RANGE
- ▼ WIDER FREQUENCY RESPONSE
- ▼ HIGHER OVER-ALL ACCURACY
- ▼ COMPLETE ELECTRONIC OPERATION

**JUNIOR VOLTOHMYST** has high input resistance on all ranges, electronic protection against burnout, durable plastic case, built-in rf shield, negative-feedback bridge circuit, DC polarity switch, zero centering facilities. Measures DC from 50 millivolts to 1200 volts, AC from 100 millivolts to 1200 volts, (rms), and measures resistance from 0.2 ohm to 1-billion ohms. AC and DC Probes supplied.

Model WV-77A is an outstanding buy at **\$47.50**

### ACCESSORIES

WG-264 Probe extends range of Jr. Volt ohmyst up to 250 Mc. Plastic case slips on WG-218 probe.

\$7.75 list

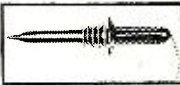

WG-289 High-Voltage Probe and WG-206 Multiplier Resistor extends DC rating of Jr. Volt ohmyst to 50,000 volts and input resistance increased to 1100 megohms.

\$9.95 list

### SR. VOLTOHMYST

Model WV-97A

**SENIOR MODEL** especially designed for TV signal tracing, features high-impedance, full-wave rectifier for direct readings of peak to peak voltage on all scales to 4200 volts. Frequency response is flat to 3 Mc. Reads DC voltages, resistance values, and rms voltages of sine waves. \$67.50

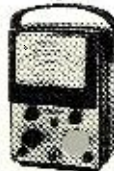

CABLE FEDERPURCH

# Federated

INCORPORATED

## Purchaser

THE ONLY COAST TO COAST  
ELECTRONICS DISTRIBUTOR

New York City 66 Dey St. DI 9-3050

Los Angeles  
911 S. Grand Ave.  
TRinity 7311

Newark, N. J.  
114 Hudson St.  
MARket 3-4005

Allentown, Pa.  
1115 Hamilton St.  
Phone 3-7441

Easton, Pa.  
925 Northampton St.  
Phone 4259

## SUMMARY OF TV SITUATION ROUND-THE-WORLD

As prepared by the Foreign Section of the Department of Commerce.

### WESTERN HEMISPHERE

#### ARGENTINA

1st TV station expected to be ready for operation in fall of 1951 at Buenos Aires. 625 lines, 25 frames, 5 kw. By using an 8-bay triangular loop antenna, the effective radiated power will be approximately 40 kw.

#### BOLIVIA

TV transmission not anticipated for several years.

#### BRAZIL

2 stations: Sao Paulo—PRF3, 525 lines, 30 frames, 5 kw., with 3600 receivers in use as of April, 1951, and Rio de Janeiro, 625 lines, 25 frames, with 3600 receivers in use as of April, 1951. 2 more stations planned, one at Belo Horizonte and one at Porto Alegre.

#### CANADA

2 stations to be completed: Montreal—July, 1952, 525 lines, 30 frames, and Toronto—March, 1952, 525 lines, 30 frames. 1,350,000 receivers in use as of February, 1951. One-way daily microwave service on an 8 consecutive hour basis between Buffalo and the 2 stations will be provided.

#### CHILE

TV not anticipated for some time. Government recently refused foreign exchange to import equipment.

#### COLOMBIA

TV station to be built in Bogota by August, 1952. A contract for the supply of TV equipment has been awarded to two British firms by the municipality of Bogota. The Marconi Co. will supply the transmitter and the complete studio center, while E. K. Cole will supply the receivers.

#### CUBA

2 stations: Havana—CMUR, 525 lines, 30 frames and Havana—CMQ, 525 lines, 30 frames. 18,000 sets in use as of May, 1951. TV chain to be completed before end of 1951.

#### GUATEMALA

In talking stage. No plans for near future.

#### HAITI

No plans for near future.

#### MEXICO

2 stations, 525 lines, 30 frames; Mexico City—XHTV, 5 kw., and Mexico City—XEW. (Matamoros—XELD, to open September, 1951.) 3500 receivers in use as of April, 1951. Government requires all TV receivers entering Mexico to be non-synchronous. Construction permit granted for 11 new stations.

#### PANAMA

No plans.

#### PARAGUAY

No plans.

#### PERU

One Lima radio broadcasting company reportedly interested but no action yet taken.

#### SURINAM

No plans.

#### URUGUAY

1 station at Montevideo planned. Purchase of TV equipment from U.S., British, or other European sources depends on technical studies made by Servicio Oficial de Difusion Radio Electrica (SODRE) engineers, and the result of bids, to be called for soon. Operation expected by end of 1952. A private company formed 2 years ago to build a TV station is withholding action waiting to observe the official installation.

#### VENEZUELA

No development expected for 2 years.

### BELGIUM EUROPE

Under consideration but controversy exists on adoption of 625 or 819 lines.

#### CZECHOSLOVAKIA

1 station—experimental. 625 lines, 25 frames.

#### DENMARK

1 station—experimental. 625 lines, 25 frames, 0.5 kw. 50 receivers in use. 6 more stations planned.

#### EIRE

No definite plans.

#### FINLAND

Closely following developments elsewhere.

### FRANCE

2 stations: Paris—819 and 441 lines, 25 frames. 1 station: Lille—819 lines, 25 frames. 25,000 receivers in use in France as of November, 1950. Network of 8 major transmitters, 819 lines, planned. Before end of 1951 stations in Lyon and Strasbourg will be in operation.

### GERMANY

2 stations—experimental Allied High Command—RIAS; Hamburg—NWDR. 625 lines, 25 frames, 1 kw. 25 receivers in use. 6 more stations planned.

### GREECE

No plans.

### ITALY

2 stations—experimental: Turin—525 lines, 30 frames, 5 kw. Vatican City—819 lines. 1000 receivers in use.

### MONACO

Plans to build 1 station.

### NETHERLANDS

2 stations—experimental. 625 lines, 25 frames, 3 and 5 kw. 1000 receivers in use. Plan 1 or 2 more stations.

### NORWAY

No plans for several years.

### SPAIN

Complete systems ordered for Madrid and Barcelona. 625 lines, 25 frames.

### SWEDEN

1 station—experimental. 625 lines, 25 frames, 1 kw.

### SWITZERLAND

1 station—experimental—Zurich. 625 lines, 25 frames, 0.4 kw. 30 receivers in use. 4 Swiss radio manufacturers formed cartel in 1951 to make TV receivers, and suppress TV receiver imports of foreign manufacture.

### UNITED KINGDOM

2 stations, 405 lines, 30 frames: London (Alexandra Palace) and Midland (Sutton Coldfield). 812,368 receivers in use as of May, 1951. Holme Moss station to be completed in October, 1951. Work proceeding on 2 more—Scotland (Kirk o' Shotts) and for West England and Wales (Wenwoe). Network planned to make TV available to 75% of population by end of 1952, 90% by end of 1954. London-to-Birmingham relay complete.

### USSR

2 stations—experimental. 625 lines, 25 frames. (Understood to be at Moscow, Leningrad.) Stations said to be in preparation: Stalingrad, Kiev, Sverdlovsk. (However, at the Leipzig Fair in Spring of 1951, the Communists displayed only unstyled TV sets with miniature screens and reportedly admitted they did not have a transmitter for broadcasting TV signals, did not broadcast sound with images, did not televise motion—claimed, with demonstration, that they could project still pictures.)

### AUSTRALIA

Bids submitted in 1950 for construction of a national station at Sydney. Operations are expected to begin in 1952. 625 lines, 25 frames. Expect to manufacture domestically all receivers needed.

### INDIA

No present plans. TV will be demonstrated at Intl. Radio & Electronics Exhibition in Bombay in February, 1952.

### IRAN

No plans.

### JAPAN

1 station—experimental. 525 lines, 30 frames, 0.5 kw. 25 receivers in use. 2 TV licenses pending in June, 1951.

### NEW ZEALAND

Investigating technical aspects to determine standards.

### EGYPT

### AFRICA

No plans for near future. TV demonstrations in Cairo in May, 1951, financed by French State TV Agency.

### MOROCCO

1 station, Casablanca—819 lines. Completion expected in 1952. Will include relay to Rabat, later to Meknes and Fes.

### TUNISIA

1 station planned.

### UNION OF SOUTH AFRICA

Under consideration, but no action yet taken.







## FOR GOOD TV INSTALLATIONS ALLIANCE TENNA-ROTORS

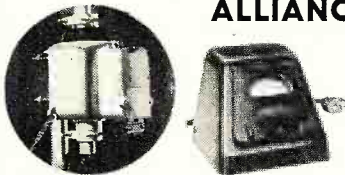

The Alliance Tenna-Rotor makes it possible for you to "beam" or turn your antenna in the direction best suited to pick up any TV station within range. When so turned the signal delivered by the antenna to the TV set is increased by giving you a better, clearer picture. The rotor unit is fully enclosed in a moisture-proof housing, factory lubricated for life. Bearings are stainless steel. Works in any weather. Guaranteed for a full year. Approved by Underwriters' Laboratories. Takes up to a 20 lb. antenna. For heavier antennas also order the Thrust Bearing Bracket shown below. Operates on 115 V. 60 cy AC 30 watts. Rotates clockwise or counter-clockwise full 360° at 1 RPM. Available in 3 models. Shpg. wt. 15 lbs.

**AU-15. MODEL ATR.** Tenna-Rotor with control box which shows end of 360° rotation by means of an indicator lamp on control box. Does not show direction of antenna. Each **\$20.53**

**AU-12. MODEL DIR.** Tenna-Rotor with control box which employs an indicator dial showing direction antenna is beamed. Each **\$26.43**

**AU-21. MODEL HIR.** Tenna-Rotor with automatic control box. You set the pointer for direction desired and antenna turns to that direction and stops automatically. Each **\$26.43**

**4 CONDUCTOR CABLE** For use with all Alliance Tenna-Rotors. **\$4.00**

**W-62, 100 ft. Coil, ea. . . . . \$4.00**

**THRUST BEARING BRACKET** For use with any above Alliance Tenna-Rotors where extremely heavy antenna is to be used. Supports up to 200 lbs. **\$2.91**

**AU-13. each**

### TV-FM ANTENNAS

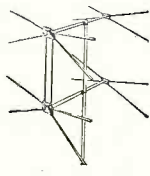

Exceptionally high gain on all channels. Efficient for "fringe" areas. Low standing wave ratio permits use with 72, 150 or 300 ohm lines. Special conical section design minimizes noise, reduces "ghosts" — results in sharp, clear picture. Easily assembled. Double bay with 10 ft. mast. Shpg. wt. 16 lbs. **\$12.99**

**AU-61**

### ALLIANCE TV BOOSTER

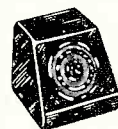

Alliance Booster offers electronic features in design for maximum reception in fringe TV areas. Gives the signal a real boost. One control for all channels. Automatic switch turns Booster on with set. Shpg. wt. 7 lbs. **\$17.97**

**STOCK NO. RA-62**

## WILCOX-GAY TAPE RECORDER

**\$7995**  
Ea.

PRICE SLASHED—Regular Price \$149.95 WHILE THEY LAST Model D10



IT'S A RECORDER . . . a precision tape recorder without equal in the recording field. Makes 1/2 hour continuous recording on a five-inch reel of tape; 1 hour using both channels. Records at 3 3/4" per second. The fidelity, clarity and low-noise reproduction of this fine instrument is remarkable. Makes tape recordings from microphone, built in 78 RPM turntable or any external radio or phonograph. IT'S A PUBLIC ADDRESS . . . jack provided for plugging in any PM speaker permitting use as a PA system. IT'S A PLAY-BACK . . . plays tape back through built-in speaker and records at high speed. Also will play records if a PM speaker is plugged into external speaker jack. OTHER FEATURES . . . two-tone maroon leatherette case, complete with crystal microphone, neon recording level indicator, tone and volume controls, cord and plug and built-in speaker. Size 18 3/4 x 13 x 6 1/2. Operates on 105-120 V 60 cy AC.

Size 18 3/4 x 13 x 6 1/2. Operates on 105-120 V 60 cy AC.

## AMAZING RECORD PLAYER DEAL

\$10 Worth of RCA Discs Included



**\$19.97** Stock No. RA-60

\*Look what the parts would cost if bought separately even at our SPECIAL SALE PRICE.

78 RPM Motor . . . . . \$ 3.79  
Phono arm and cartridge . . . . . 2.99  
Amplifier . . . . . 3.98  
Set of tubes for amplifier . . . . . 1.89  
PM Speaker . . . . . 1.69  
Output Transformer . . . . . .69  
AC Cord . . . . . .29  
Decorated Case . . . . . 4.99  
Set of RCA Victor Non-Breakable Records . . . . . 10.00

**\$30.31**

This is not a kit. The phonograph comes to you completely assembled and factory tested. No troublesome wiring. Just plug in—put on the RCA non-breakable records you get with the outfit and you have dependable entertainment. The amplifier employs 2 tubes, a 50L6 and a 3Z5Z5. Motor is Alliance, the finest. The crystal tone arm is made by Astatic. Sure and Electro-Voice. In addition you get a complete set of RCA Victor non-breakable Children's Records which include such favorites as "Happy the Humburg," "The 50 Hats of Bartholomew Cubbins," "Rapunzel," "Aladdin and His Lamp," etc. Discs are enclosed in beautifully colored albums giving each story so that the child can follow the recording. Cabinet is decorated with gay circus figures and the volume can be regulated by the full range control. Operates on 115 volts AC. Shpg. wt. 15 lbs. Don't delay, order now. The price is low enough so it pays to order even for the parts contained here is a special. You get 3 nationally famous 78 RPM Record Player and \$10.00 worth of genuine RCA Victor non-breakable children's records. **NO MORE WHEN THESE ARE GONE**

### GENERAL INSTRUMENTS—3-SPEED CHANGER

**\$19.99**

A remarkable Olson buy—dual worth twice our price but we got a bargain and Olson is passing the SAVINGS on to you. Will automatically play 10 records. 7", 10", or 12" size. 33 1/3, 45 or 78 RPM. Low pressure cartridge and permanent long life needle. Reject button to reject or skip records. In factory sealed cartons. Size 12" x 12 1/2". Operates on 115 volts AC. 60 Cycles.

### FULL 20 ELEMENT STACKED CONICALS

With matching Q bars and High Frequency Stubs Genuine Aircraft Aluminum elements. High gain stacked conical. Will pull in stations in "Fringe Areas." Works on all channels. Easily assembled.

**THIS IS A TERRIFIC VALUE!**

Each Antenna consists of 20 conical bays plus a pair of matching Q bars. Less mast. Packed—3 Antennas to a carton. This gives you six bays and 3 pairs of Q bars.

Sold only in Boxes of 3 Antennas

**AU-66.** In lots of 3. **\$8.66** Carton of 3. **\$25.98** Weight 25 lbs.

### OLSON'S SPECIAL PICTURE TUBES

**\$24.95**

**RCA 16GP4 Dark Face**

Brand new genuine RCA 16GP4 with the new DARK FACE. Fully guaranteed. Buy these tubes from Olson at less than Jobber Cost. 70° defl. 17 11/16" long, neck 6 7/8" long, metal envelope.

### Build a Receiver Set of Basic Components

Kit of 5 parts **\$1.89**

You get this kit of 5 basic parts to build an AC-DC set or portable:

Parts Reg. List Price  
Loop . . . . . \$0.95  
R. F. Coil . . . . . 1.10  
I. F. Transformer (456 KC) . . . . . 1.60  
Output . . . . . 1.60  
Oscillator Coil . . . . . .75  
List Price of Set . . . . . 6.00

Use any 365 mfd variable for tuning. Covers 535-1625 KC.

### RECORDING TAPE—Famous Mfr's Close-Out!

Get the buy of your life. Save up to 64% on high quality RECORDING TAPE. A large manufacturer had to sell his inventory and he unloaded the whole deal. Olson now offers you this high grade recording tape at prices which defy competition. Standard 1/2" wide, 1200 ft. long. Frequency response 50 to 8,000 cy. Plastic Reel included with each.

**PAPER BASE—**  
1200 ft.  
Stock No. X-248  
Single, each **\$1.49**  
Lots of 10, each

**PLASTIC BASE**  
1200 ft.  
Stock No. X-249  
Single, each **\$1.99**  
Lots of 10, each

### BIGGEST BARGAIN

Special while they last for the combination **\$3.99** RA-91

**PHONO AMPLIFIER RA-19.** **\$3.98**

LESS TUBES

A real high efficiency 3-tube amplifier of modern design. Connect to any crystal phono arm and speaker. Has volume and tone controls 7" x 3 1/4" x 2 1/2". Shpg. wt. 2 lbs.

SET OF TUBES FOR AMPLIFIER 12S07 50L6 35Z5 No. AS-22 . . . . . **\$2.64**

**RIM DRIVE PHONO MOTORS**

**M-63** **\$5.99**

33 1/3, 45, 78 RPM. 3 SPEED. Self starting, complete with turntable. Operates on 115 volt AC 60 cy. Shpg. wt. 5 lbs.

**M-64** **\$4.95**

3 SPEED PICK-UP ARM Cartridge flips by means of a lever. Dual cartridge, one side plays 33 1/3 and 45 and other 78 RPM. Double needle.

**PHONO CARTRIDGE**

Universal replacement for Astatic L-70, L-72, L-82 etc. 3 volts. Fresh Stock XC-30 single each . . . . . **\$1.79**  
Lots of 10, each . . . . . **\$1.59**

**HIGH OUTPUT CARTRIDGE**

Similar, but delivers 9 volts. Can be used on 33 1/3, 45, and 78 RPM discs. XC-47 single each . . . . . **\$2.19**  
Lots of 10, each . . . . . **\$1.99**

### 3-SPEED PHONOGRAPH Special

**\$19.97** Stock No. RA-56

Plays 78-45-33 1/3 RPM Discs

Complete

Finest components in the manufacture of these gorgeously designed phonographs. Features include: 3 speed Alliance motor, heavy floored turntable; level output tone arm with precision-tip needle, volume control, 2 tube built-in amplifier, Alnico 5 PM speaker, leatherette covered case with rounded corners, convenient carrying handle. Order early and order enough. Every phonograph 100% guaranteed. Original factory-sealed cartons. Operates 115 volts AC. Shpg. wt. 15 lbs.

**3 Speed AUTOMATIC CHANGER** Stock No. RA-77 **\$42.95**

WHILE THEY LAST

COMPLETE with VM Model 950 Changer, Amplifier, Speaker and Case. A real Olson value if we ever saw one! Here is the latest VM Model 950 Automatic Changer built into a beautiful carrying case with speaker and fine Amplifier. Plays twelve 7" records (33 1/3 or 45 RPM); twelve 10" or ten 12" (33 1/3 or 78 RPM); 100% automatic in operation. Nothing more to buy when you order this fine player from OLSON. The cartridge is equipped with a long life needle. Heavy shock off after last record. Equipped with a volume control and tone control. Speaker is Alnico V PM. Carrying case is beautifully covered. Size 18" x 12 1/2" x 8". For 115 volts 60 cy. AC. Regular list price \$77.95.







## INDISPENSABLE! PHOTOFACT BOOKS

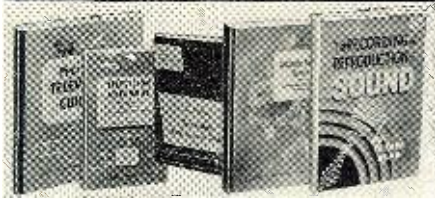

**Photofact Television Course.** Covers TV principles, operation and practice. 216 pages; profusely illustrated; 8½ x 11". Order **TV-1**.....Only **\$3.00**

**Television Antenna. New 2nd edition.** Describes all TV antenna types; tells how to select, install, solve troubles. Saves time; helps you earn more. 200 pages; illustrated. Order **TAG-1**.....Only **\$2.00**

**Television Tube Location Guide. Volume 2.** Accurate diagrams show position and function of all tubes in hundreds of TV sets; helps you diagnose trouble without removing chassis. 224 pages; pocket-size. Order **TGL-2**. Only **\$2.00**

**Television Tube Location Guide. Vol. 1.** Over 200 pages of TV receiver tube position diagrams on hundreds of models. Order **TGL-1**.....Only **\$1.50**

**1949-1950 Record Changer Manual. Vol. 3.** Covers 44 models made in 1949, including multi-speed changers and wire and tape recorders. Original data based on actual analysis of equipment. 286 pages; 8½ x 11"; paper-bound. Order **CM-3**.....Only **\$3.00**

**1948-1949 Changer Manual. Vol. 2.** Covers 45 models made in 1948-49. Paper bound. Order **CM-2**. Only **\$4.95**

**1947-1948 Changer Manual. Vol. 1.** Covers 40 post-war models up to 1948. Order **CM-1**.....Only **\$3.95**

**Recording & Reproduction of Sound.** A complete authoritative treatment of all phases of recording and amplification. 6 x 9". Order **RR-1**.....Only **\$5.00**

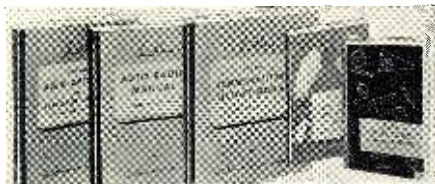

**Audio Amplifiers. Vol. 3.** Clear, uniform, accurate data on 50 important audio amplifiers, plus full coverage of 22 FM and AM tuners, produced during 1950. 362 pages, 8½ x 11". Order **AA-3**.....Only **\$3.95**

**Audio Amplifiers. Vol. 2.** A complete analysis of 104 well-known audio amplifiers and 12 tuners made 1949-50. 368 pages, 8½ x 11". Order **AA-2**.....Only **\$3.95**

**Audio Amplifiers. Vol. 1.** Covers 102 amplifiers and FM tuners made through 1948. 352 pages. Order **AA-1**.....Only **\$3.95**

**Auto Radio Manual.** Complete service data on more than 100 post-war auto radio models. Covers over 24 mfrs. 350 pages, 8½ x 11". Order **AR-1**.....Only **\$4.95**

**Communications Receiver Manual.** Complete analysis of 50 popular communications models. 246 pages, 8½ x 11". Order **CR-1**.....Only **\$3.00**

**Radio Receiver Tube Placement Guide.** Accurate diagrams show where to replace each tube in 5500 radio models, covering 1938-1947 receivers. 192 pages, pocket-size. Order **TP-1**.....Only **\$1.25**

**Dial Cord Stringing Guide. Vol. 2.** Covers receivers made from 1947 through 1949. Shows you the one right way to string a dial cord in thousands of models. Pocket-size. Order **DC-2**.....Only **\$1.00**

**Dial Cord Guide. Vol. 1.** Covers sets produced 1938 through 1946. Order **DC-1**.....Only **\$1.00**

**Making Money in TV Servicing.** Tasted proved methods of operating a profitable TV service business. Covers all important phases. Authoritative, valuable guide to success. Over 130 pages. Order **MM-1**.....Only **\$1.25**

Order from your Parts Jobber or write direct to  
**HOWARD W. SAMS & Co., INC., 2201 E. 46th St., Indianapolis 5, Indiana**  
**HOWARD W. SAMS & CO., INC.**

## Manufacturers' Literature

Readers are asked to write directly to the manufacturer for the literature. By mentioning **RADIO & TELEVISION NEWS**, the issue and page, and enclosing the proper amount, when indicated, delay will be prevented.

### "PACKAGED POWER"

*General Electric Company*, Schenectady 5, New York is currently offering a copy of its new 24-page bulletin on packaged electric power for industry.

Designated as bulletin GEA-5600, the publication outlines the methods of obtaining electric power equipment for quick expansion at low cost and with a minimum of critical materials.

The booklet also explains how the use of "packaged" electrical systems simplifies plant engineering problems, cuts equipment and installation costs, conserves vital materials and manpower, and insures quicker delivery of electrical equipment.

### NEW PLANT BROCHURE

*Columbia Wire and Supply Company*, 2850 Irving Park Road, Chicago 18, Illinois has issued a new brochure describing the facilities and products of the firm.

The illustrated brochure shows the company's planning and layout facilities, rubber capping, attaching of terminals, automatic braiding and shielding, multicutting, automatic cutting and stripping, coiling and winding, etc.

Copies of this brochure and details regarding visits to the new plant may be obtained direct from the company.

### PRODUCTION FACILITIES

*Edwin I. Guthman Co., Inc.*, 15 S. Throop Street, Chicago, Illinois has issued an elaborate booklet showing its production facilities at both its Chicago and Attica, Indiana locations.

The booklet gives a complete history and description of the plants and outlines the various types of jobs the company is equipped to handle.

### MERIT REPLACEMENTS

*Merit Transformer Corp.*, 4427 N. Clark Street, Chicago 40, Illinois has just issued a "TV Replacement Guide and Catalogue" which lists the company's complete line of TV transformers and components.

The new edition, which is available direct from the company, lists all manufacturers and model numbers, and shows the manufacturers' part number and the correct *Merit* replacement unit.

### "EXTRUDED PLASTICS"

*Anchor Plastics Company, Inc.*, 533-5 Canal Street, New York 13, New York has recently released the 1952 edition of its 8-page illustrated brochure "Extruded Plastics."

The publication lists the latest applications for custom-made thermoplastic extrusions and is designed to

help the reader visualize uses in his own field. It has sections describing the facilities and range of extrusions available, applications of extrusions to particular products, and a digest of properties of thermoplastics in tabular form.

Readers who wish copies of this booklet should write their names and addresses on their business letterheads and mail them direct to the company.

### PICTURE TUBE REPLACEMENTS

The Cathode-Ray Tube Division of *Allen B. Du Mont Laboratories, Inc.*, 750 Bloomfield Avenue, Clifton, New Jersey is making available a handy pocket sized TV picture tube replacement selector for TV dealers and technicians.

The new tube selector is a circular cardboard gimmick five and one-half inches in diameter which eliminates the necessity for thumbing through a catalogue or looking up tube characteristics on a wall chart. The replacement selector consists of two circular slotted discs, fastened together at the center and easily rotated, one on the other. At the spin of the discs, conversions are easily figured by checking the technical information showing through the slots.

The company's distributors are handling these selectors and applications for such units should be made through the distributor outlets.

### PICKUP REPLACEMENT MANUAL

The demand for copies of the new "Phonograph Pickup Replacement Manual" has been so great that *Shure Brothers, Inc.* of 225 W. Huron Street, Chicago 10, Illinois has been forced to have additional copies printed.

The new manual lists over 1500 phonographs and radio-TV combinations equipped with or which can effectively use *Shure* crystal or ceramic cartridges. The Manual, No. 66, lists sets made by 123 manufacturers during the years 1938 to 1951.

### ALLIED BUYING GUIDE

*Allied Radio Corporation*, 833 W. Jackson Blvd., Chicago, Illinois has announced that copies of its 1952 catalogue are now available for distribution.

This new 212-page buying guide contains comprehensive listings of radio, television, and electronic parts; test equipment; public address systems; television and radio sets and accessories; TV components, recording equipment and accessories; high fidelity equipment of all types; amateur gear; radio build-



# OUTSTANDING VALUES NOW AVAILABLE

## AMAZING VALUE 3-Way Portable TRAV-LER AC—DC—Battery



- Superhet circuit.
  - Tubes 1S5, 3S4, 1R5, 1U4 and Selenium Rectifier.
  - Alnico V PM Speaker.
  - Attractive airplane dial, luggage type case.
  - Small size. 5 1/4" H x 8 3/8" W x 4 3/4" D.
- Exceptional reception and tone. Nowhere else at this price! **\$17.59**  
Batteries, 1—67 1/2V, 2—1 1/2V flashlight cells. **\$1.85**

## SNYDER DIRECTRONIC MOTORLESS TV AERIAL SYSTEM

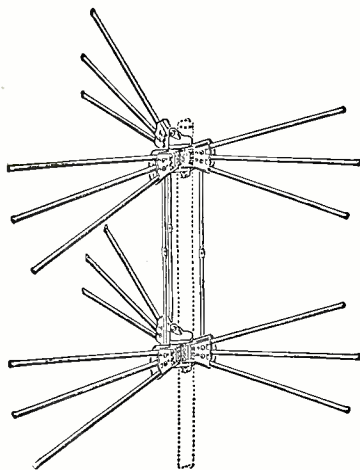

Receive fine signal from all directions. No longer necessary to use Yagi antennas for each band. No longer necessary to use antenna rotors. SWITCH AT SET CONTROLS ELEMENTS IN EFFECT. Simple to install, easy to use.

- All channels for ultra-fringe areas.
- Hi-tensile 3/8" aluminum alloy elements.
- 1 set connecting stubs.
- Universal U clamp for masts up to 1 1/2".
- Directronic Beam Selector.
- 75 feet of TRI-X cable.

COMPLETE.... **\$16.95**

## NOW! LARGE 14" or 16" PICTURE FROM YOUR 10" or 12" TELEVISION SET

Servicemen: Convert customers' sets for extra profits! 90% of all conversions can be made by use of the RAPARCO conversion kit.

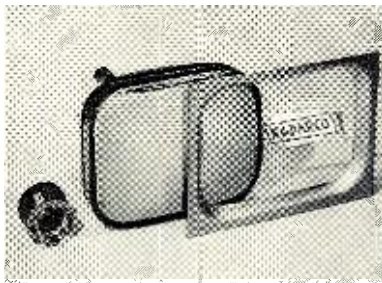

**14" Kit**—14BP4 CR tube, 70° Deflection yoke. Attractive Lucite mask. **\$25.95**

**16" Kit**—16" Rectangular CR tube, 70° Deflection yoke. Attractive Lucite mask, 16" HV Flyback transformer..... **\$39.95**

### TELEVISION MASKS

Attractive, crystal clear lucite, gold trim.

14".....	<b>\$3.95</b>
16".....	<b>\$4.50</b>
17".....	<b>\$4.75</b>
19".....	<b>\$5.25</b>
20".....	<b>\$5.95</b>

## REDUCE YOUR TV RECEPTION TROUBLE

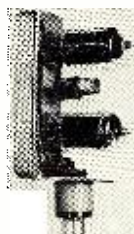

### THE TURRET BOOSTER

- Fully concealed within set.
- Comes on when receiver is turned on.
- No wiring necessary—simple as removing a tube.
- Improves reception—increases video output at least 15%.

Just the thing for fringe area boost or in local areas where antennas are not allowed. PRICE..... **\$9.95**

(Special discount to dealers)

## RPC SUPER CHIEF ANTENNA KIT

The finest in all-around reception.

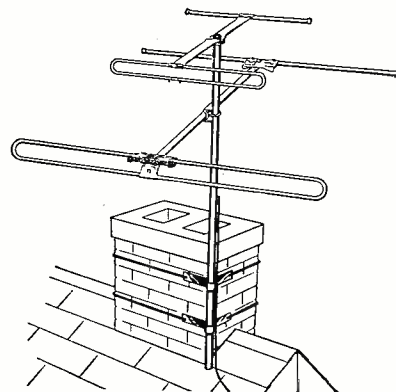

Separate high band and low band antennas. Constructed of high tensile aluminum. Complete with:

60 ft. 300 ohm line.

5 ft. 1 1/4" rustproof steel mast.

Double strength chimney mount.

2—mast std. off.

1—7" std. off.

3—3 1/2" std. off.

1—RCA lightning arrestor.

**COMPARE THIS PRICE! \$7.95**

## G I—13-CHANNEL TELEVISION TUNER

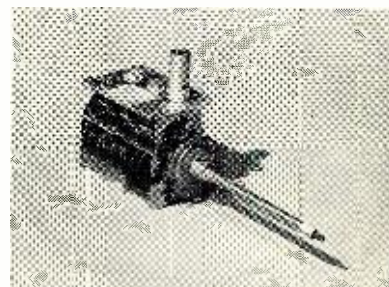

For replacement or construction work. Capacity type tuner with fine tuning control. Using 3—6J6 tubes. Input for 300-ohm line. Size: 3" x 4" x 6". Shaft may be cut to length.

Complete with tubes..... **\$6.95**

Lots of 3..... **\$6.50** each

**Radio Parts Company, 614 RANDOLPH ST., CHICAGO 6, ILL.**



# PARTS-RADIO and TV

## TUBE SPECIALS!

6AU6.....ea. 59c    6BG6G. ea. \$1.29  
12AU7.....ea. 65c    6CD6G. ea. \$1.69

### FILTER CONDENSERS

NEW STOCK . . .  
High Quality

#### 450 Working Volts

8-450V.....ea. 29c  
10-450V.....ea. 35c  
10-10-450V.....ea. 52c  
20-20-450V.....ea. 59c  
40-40-450V.....ea. 74c

#### 150 Working Volts

20-150V.....ea. 30c  
30-150V.....ea. 35c  
40-150V.....ea. 35c  
20-20-150V.....ea. 35c  
30-30-150V.....ea. 47c  
40-20-150V.....ea. 47c  
40-40-150V.....ea. 47c  
50-30-150V.....ea. 47c  
20-20-20-150V.....ea. 47c  
40-40-20-150V.....ea. 47c  
50-50-150V.....ea. 47c

### Pilot Light Special

No. 47. 100 for only \$3.95  
Box of 10 bulbs .45c  
#44 and #51. 100 pilot  
lights for \$4.74  
Box of 10 .59c  
#40, #41, #46. 100 bulbs \$5.88  
Box of 10 bulbs .65c

#### 50 Working Volts

10-50V.....ea. 24c  
25-50V.....ea. 24c  
50-50V.....ea. 24c

### ANTENNAS

"Look at the Prices!"

TV "Perfect  
Balance Antenna"

High-low, 6 element Yagi  
TV antenna, cut for all  
channels, stack it or  
mount in line, complete  
with 8 foot mast, \$6.98  
ind. boxed.....ea.

6 for \$6.49 ea.

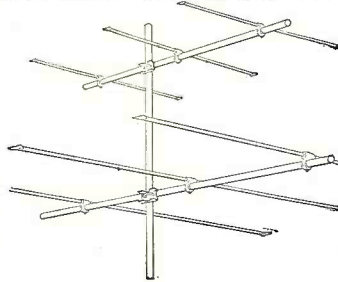

TV INLINE FOLDED DIPOLE ANTENNA. At this  
price we cannot mention manufacturer's name,  
complete with mast, ind. boxed.....

\$7.98  
each

6 for \$7.29 ea.

### FAMOUS MAKE SOLDER GUN

... at this price we cannot mention mfr's. name ...  
4 Rigid interchangeable tips. Instant infinite heat.  
Light weight and well balanced. High intensity  
beamed lighting.  
110 V.AC-300 watts  
2 position switch

\$11.95  
Only

### 14" TV CONVERSION KIT

Convert 10" and 12" sets to 14"-in-  
cludes 14BP4 Tube 70 Degree Def-  
lection Yoke and Attractive Lu-  
cite Mask to eliminate all finish  
work on cabinet. Complete.....

\$29.95

### 17" TV CONVERSION KIT

Consisting of rectangular tube,  
70 Degree Yoke, Beautiful Mask  
and Flyback Trans-  
former. Complete.....

\$37.95



### P. M. SPEAKERS

12" Coaxial PM \$12.95 ea.  
Speakers.  
A high fidelity compact package  
with high pass filter attached to  
frame. 20 watt capacity; 20-  
17500 cps. response; 8 ohm VC.  
A REAL BUY!

Very Best Quality-NATIONAL  
BRANDS Individually Packed

10 or more each	Price each	5x7.....\$2.25 ea.
3".....\$1.14	\$1.26	6x9.....3.25 ea.
4".....1.55	1.65	5" PM with
5".....1.69	1.79	50L6 o.p. \$1.99
6".....1.55	1.67	Xformer..
7".....2.94	3.23	
10".....4.74	5.10	
12".....5.94	6.54	

### OUTPUT TRANSFORMERS Standard Replacement

For 50L6, 35L6, 50A5, 35A5,  
117L7.....49c ea.  
For 6V6, 6F6, 3Q5, 3Q4, 3S4, 3V4,  
41, 42, 6K6, 2A3, 45, 6L6. 59c ea.  
UNIVERSAL OUTPUT TRANSFORMERS  
SPECIAL

Up to 12 watts to any speaker  
(while they last).....ea. 98c

### VOLUME CONTROLS

VERY BEST BRANDS	10 or more each	Price each
1/2 meg. or 1 meg. or 1/10 meg. with switch-long shaft.....	52c	59c
2 meg. for battery sets-switch, long shaft.....	52c	59c
1/2 meg., 1 meg., 1/10 meg., or 2 meg., long shaft, less switch.....	34c	38c

Catalog of tubes and parts included with each order.

NOTICE: we have complete stocks of filter condensers, by-pass condensers, speakers,  
volume controls, output transformers, IF transformers . . . at less than  
standard prices.

**Premier RADIO TUBE CO.** 551 W. Randolph St. Chicago 6, Illinois  
ANdover 3-1590

ers' kits and supplies; tools and hard-  
ware; books, manuals, and diagrams;  
plus thousands of other items pertain-  
ing to the radio-television-electronics  
field.

Requests for this catalogue should  
specify No. 127.

### AMPHENOL CABLES

American Phenolic Corporation, 1830  
South 54th Avenue, Chicago 50, Illi-  
nois has recently issued a compre-  
hensive catalogue covering its line of  
radio frequency cables and connectors.

Known as Catalogue D2, the new  
publication gives complete physical  
data on the company's line of cable fit-  
tings and accessories for all types of  
applications and ratings for the various  
cables made by the company.

The material is presented in compact  
tabular form for easiest handling of  
the required data.

### APPROVED'S CATALOGUE

Approved Electronic Instrument  
Corporation of 142 Liberty Street, New  
York 6, New York is currently offering  
a copy of its 1952 catalogue to inter-  
ested persons.

This two-color publication gives in-  
formation on the company's linearity  
pattern generator, its field strength  
meter for fringe area service, a sweep  
signal generator for both FM and tele-  
vision, an AM-FM high fidelity tuner,  
a 10 watt audio amplifier, a preampli-  
fier for the Williamson amplifier kit, a  
television booster, a broadcast super-  
het tuner, a universal power supply,  
and the company's signal generator  
kit.

Copies of the bulletin are free on  
request when made direct to the com-  
pany.

### INDUSTRIAL TUBES

Milo Radio & Electronics Corp., 200  
Greenwich Street, New York 7, New  
York has just issued a new 28-page  
booklet devoted to industrial electronic  
and special purpose tubes.

Designed for industrial use, this  
booklet furnishes complete technical  
specifications and information on hun-  
dreds of special purpose electronic  
tubes used in various industrial appli-  
cations such as control, processing, pro-  
duction, research, testing, counting,  
sorting, weighing, measuring, detect-  
ing, broadcast and microwave commu-  
nications, radar, etc.

Free copies of this publication may  
be obtained by our readers if they will  
write mentioning RADIO & TELEVISION  
NEWS in their letters of request.

### "SERVICE NEWS"

Telrex, Inc.'s "Service News" is now  
in its second year of publication and  
the company is renewing its offer to  
put interested technicians on the mail-  
ing list to receive this bi-monthly tech-  
nical manual.

This little publication carries instal-  
lation hints, reception data, new prod-  
uct news, and information on such  
current topics as color TV, v.h.f. re-  
ception, etc.



Readers can get their names on the mailing list by writing Dept. T of the company at Asbury Park, N. J.

**HI-FI MANUAL**

Concord Radio Corp., 901 W. Jackson Blvd., Chicago 7, Illinois has issued a new and comprehensive "guide to new musical enjoyment" which is designed for both the average layman and the music lover.

This 48-page handbook devotes 12 pages to a discussion of high fidelity, record reproduction, FM, high fidelity components, selecting the system, and "custom" installations.

The balance of the booklet is devoted to a listing of all types of audio equipment and accessories, including tuners, amplifiers, speakers, speaker cabinets, phono accessories, ensembles, cabinets, tape recorders and accessories, TV chassis, and a new equipment page.

A glossary of high fidelity terms completes the book.

**ACOUSTICAL TERMS**

The American Standards Association, 70 East 45th Street, New York 17, N. Y. has just approved and published a new standard—this one covering acoustical terminology.

Designated standard Z24.1-1951, the new publication provides engineers in the recording and reproducing industry an authoritative dictionary of terms against which they can check their interpretation of terms with those of recognized experts in the acoustical field.

This comprehensive standard was sponsored by the Acoustical Society of America in cooperation with the Institute of Radio Engineers.

Copies of the standard are available from The American Standards Association at \$1.50 per copy.

**G. E. BULLETIN**

General Electric Company, Schenectady 5, New York is currently offering copies of its new induction frequency converter bulletin to interested persons.

This four-page, two-color brochure on the company's "Tri-Clad" induction frequency converters covers three-phase equipment in ratings from ¼ to 100 kw. It describes the fundamentals, operation, and construction features of the high-frequency power apparatus, and includes application information, modifications, and limitations, and complete tables of ratings and frame sizes.

Please specify publication GEA-5637 when ordering copies of this bulletin from the company.

**ELECTRICAL STEELS**

New test data and information on thin electrical steels is included in Armco Steel Corporation's new booklet entitled "Armco Thin Electrical Steels."

The data, which has not been available previously, permits the selection of electrical steels for high frequency

# TUBES - RADIO and TV

5c per Tube extra for less than 50 tubes  
Individually Boxed—All Brands—Standard Factory Guarantee

<b>29c ea.</b> 1L4 1B5 1C7G 1E7 1H6 VT51 VT52 1294 1299 1629	<b>59c ea.</b> 6AU6 6BF6 6C4 6C5GT 6F5GT 6F6GT 6H6 6K6GT 6SF5 6SQ7GT 12BF6 12SQ7GT 25Z5	<b>65c ea.</b> 25L6GT 35A5 35L6GT 35Y4 35Z3 45Z5GT 50L6GT 50Y6GT	<b>79c ea.</b> 1A7 2A5 3Q4 6A8GT 6B6G 6BC7 6BF5 6C6 6D6 6E5 6J7G 6K7GT 6SH7GT 6SN7GT 6U6GT 6U7G 6U6GT 7A5 7E6 7F7 7N7 7R7 7X6 12A8GT 12K7GT 12SC7 12SH7GT 12SN7GT 12SR7GT 14A7 14B6 14B8 14F7 24A 25Z6GT 7A4 7H7 7Q7 12AU6 12SA7GT 12SF5GT 12SF7 12SK7GT 25W4GT 35B5 35C5 41 42 43 45 50B5 50C5 50Y7GT 75 77 78	<b>87c ea.</b> 6Y6G 12AX7 12BA7 12BH7 12SL7GT 14AF7 14C7 71A 117Z6GT 7193	<b>\$1.04 ea.</b> 6AC5GT 6AC7 6J6 6SD7GT 12AT7 19T8 25AC5GT 25Y5 46 47 50C6G
<b>45c ea.</b> 5Y3GT 35W4 80 1619	<b>65c ea.</b> 1A5GT 1H5GT 1U5 5X4G 5Z3 6AQ6 6BA6 6BE6 6H6GT 6Q7GT 6S4 6SF5GT 6SJ7 6S7GT 6SR7GT 6W4GT 7A6 7A7 7A8 7B4 7B5 7B6 7B7 7B8 7C5 7C6 7C7 7Y4 7Z4 12AU7 12BA6 12BE6 12F5GT 12H6 12Q7GT 12SJ7GT	<b>72c ea.</b> 1N5GT 1R5 1S5 1T4 1U4 3S4 3V4 6AL5 6AQ5 6AS5 6BC5 6BH6 6BJ6 6CB6 6SA7GT 6SC7 6SF7 6SK7GT 6SS7 6U5 6V6GT 7A4 7H7 7Q7 12AU6 12SA7GT 12SF5GT 12SF7 12SK7GT 25W4GT 35B5 35C5 41 42 43 45 50B5 50C5 50Y7GT 75 77 78	<b>87c ea.</b> 3Q5GT 5V4G 6AK6 6BA7 6K5GT 6K8GT 6L7 6N7GT 6P5GT 6SL7GT	<b>95c ea.</b> 1B3GT 1J5GT 1LA4 1LA6 1LC5 1LC6 1LD5 1LE3 1LH4 1LN5 1P5GT 1Q5GT 1X2A 3LF4 5Z4 6AB5/6N5 6AG5 6AU5GT 6G6G 6L5G 6R7GT 6S8GT 7E7 7G7 7J7 7K7 7L7 7S7 7V7 7W7 7X7 12AH7GT 12AW6 12S8GT 12Z3 14C5 14X7 35Z6G	<b>\$1.15 ea.</b> 1H6G 2A3 6A3 6AB7 6AG7 6B4G 6B5 6B8GT 6BD5GT 6BN6 6BQ6 6C8G 6D8G 6F8G 6J8G 6S7GT 6T7G 6T8 7C4 7F8 12A7 12AV7 12C8 14F8 25BQ6GT 32L7GT 2051

6BG6G .. ea. \$1.29	6BQ7... ea. \$1.58	6CD6G.. ea. \$1.69
19BG6G ea. \$2.15	807.. ea. \$1.95	813.. ea. \$9.95
		2050 ea. \$2.00

## TUBE KITS

**BEST BRANDS at BEST PRICES**

3Q4, 1T4, 1R5, 1S5. List Value \$8.00. Tube Kit only	<b>\$2<sup>39</sup></b>
3S4, 1T4, 1S5, 1R5. List Value \$7.80. 4 Tube Kit..	<b>\$2<sup>39</sup></b>
1U4, 3S4, 1S5, 1R5. List Value \$7.80. All Four Tubes for	<b>\$2<sup>39</sup></b>
3V4, 1R5, 1S5, 1T4. List Value \$7.80. All for	<b>\$2<sup>39</sup></b>
117Z3, 1U5, 3V4, 1R5, 1T4. AC-DC Portable Kit. All for	<b>\$2<sup>89</sup></b>
12AT6, 12BA6, 12BE6, 35W4, 50B5. 5 Tubes for	<b>\$2<sup>95</sup></b>
50L6GT, 35Z5GT, 12SQ7GT, 12SK7GT, 12SA7GT. 5 Tubes for	<b>\$3<sup>22</sup></b>

## TV PICTURE TUBES

Six month guarantee

10BP4.....	<b>\$1295</b>	16JP4.....	<b>\$2995</b>
12LP4.....	<b>\$1695</b>	16RP4.....	<b>\$2995</b>
12LP4A.....	<b>\$1995</b>	16TP4.....	<b>\$2995</b>
14PB4.....	<b>\$2295</b>	17BP4A.....	<b>\$3195</b>
7JP4.....	<b>\$1795</b>	19AP4A.....	<b>\$3995</b>

Get our catalog of filter condensers, by-pass condensers, speakers, volume controls, output transformers, IF transformers.

TERMS: 20% DEPOSIT with order, balance C.O.D. \$1.00 handling charge for orders less than \$5.00. All shipments F. O. B. Chicago. Our parts and tubes are warranted to be 100% replacements for the prototypes in the listings above. Prices are subject to revision without notice. SATISFACTION GUARANTEED. Illinois residents add 2% sales tax. ORDER TODAY!

**Premier RADIO TUBE CO.** 551 W. Randolph St. Chicago 6, Illinois ANdover 3-1590



# FREE!

## Send Now! FOR NEW HIGH FIDELITY GUIDEBOOK

Full of Solid  
Information!



### Tells All

the things you want to know about High Fidelity! Explains how to bring concert hall realism into the home. Tells what makes a real Hi-Fi Music System. Explains how to select individual components or complete ensembles. Pictures various types of installations - shows how easily you can have your own custom Hi-Fi System at modest cost! Illustrates and describes a complete range of the finest nationally known Hi-Fi units on the market. Prepared for the new enthusiast and for the advanced High Fidelityist. • Send for your FREE Hi-Fi Guidebook today!

For Finest Quality and Value  
SELECT YOUR HI-FI FROM FAMOUS  
GUARANTEED COMPONENTS AT CONCORD

- Altec Lansing • Audak • Bell • Brooks
- Browning • Electro-Voice • Espey • Fairchild
- General Electric • Garrard • Hall
- Hallcrafters • Jensen • Leak • McIntosh
- Meissner • Pickering • Precision
- Radio Craftsmen • Rek-O-Kut • RCA • Stephens
- University • Webster-Chicago • Whartedale

For a Personal Demonstration  
VISIT CONCORD'S HI-FI SALON

## CONCORD RADIO CORPORATION

901 W. JACKSON BLVD. • CHICAGO 7

CONCORD RADIO CORP., Dept. RL2-51  
901 W. Jackson Blvd., Chicago 7, Ill.

- Rush FREE High Fidelity Guidebook
- Rush FREE Big, New 1952 Catalog

Name \_\_\_\_\_

Address \_\_\_\_\_

City \_\_\_\_\_ Zone \_\_\_\_\_ State \_\_\_\_\_

equipment without theoretical determinations, extrapolation of data, or the use of empirical formulas.

Representative test results are given in 21 pages of curves covering the magnetic properties of three iron-silicon alloys, the Tran-Cor T, Tran-Cor T-O, and Tran-Cor T-O-S.

Electrical engineers and designers wishing to secure a copy of this booklet should write to the company at Middletown, Ohio.

### MONTHLY LISTINGS

Radio Surplus Corporation, 732 S. Sherman Avenue, Chicago 5, Illinois is now issuing a monthly listing covering radio, electronic, and television equipment and parts.

Anyone in the industry may obtain

this monthly listing by requesting, on company letterhead, that he be put on the mailing list.

### NEW CONCORD CATALOGUE

Concord Radio Corp., 901 W. Jackson Blvd., Chicago 7, Illinois has just issued its 1952 catalogue covering television, radio, and industrial electronics parts and equipment.

Known as Catalogue 95, the new publication includes high fidelity components and ensembles, television and radio receivers, sound systems, ham gear, test equipment, electronic tubes, parts, tools, books, kits, etc.

Free copies of this new catalogue are available on request from the company.

-30-

## CAKES BAKED IN 90 SECONDS

By GEORGE PETCHEL

Industrial Electronics Dept., DeForest's Training, Inc.

"SOUNDS fantastic, doesn't it?—well, it is!"

So stated a newspaper reporter at the scene of a 90-second cake baking demonstration conducted in the laboratories of DeForest's Training, Inc., 2735 N. Ashland Ave., Chicago, Illinois.

A batter made from a nationally-known cake mix plus plain water was poured into an ordinary Pyrex baking dish. This was placed between two vertical electrodes fastened to a polystyrene base and mounted on top of a kitchen table. The electrodes were connected by means of copper tubing to a radio frequency generator located nearby.

The batter turned into the kind of cake Mother used to make, not in 45 minutes, not in 10 minutes, but in 90 seconds! However, this feat was not accomplished without some measure of research and toil by students and instructors.

Flat aluminum electrodes were first used, but difficulty was encountered in obtaining the correct concentration of electric field and were later supplemented with ordinary aluminum foil. The foil was affixed to two opposite sides of the baking dish and then cut and shaped to form a field which gave best results.

Thickness of the batter also determined the quality of the cake. A thick batter baked more slowly and caused arcing between batter and electrodes. This cake was heavy and had burned spots. A batter which was quite fluid gave fine results and produced a cake that was light and tender with excellent texture and flavor qualities. With this type of batter little or no arcing was encountered and baking time was reduced to a minimum.

The demonstration was performed with a Westinghouse 1 kilowatt radio frequency generator designed especially for schools and laboratories. The unit has two radio frequency outputs. Its low frequency is at 300 kilocycles per second, suitable for experiments in induction heating. Its high frequency output at 10 megacycles per second is for experiment and study in dielectric heating. The latter is the frequency at which the cake baking was done.

Materials suitable for radio frequency heating are determined by their electrical properties. If the material is an

electrical conductor, either magnetic or non-magnetic, it can be heated by means of its own I<sup>2</sup>R losses due to currents induced in the material when it is placed in a varying magnetic field. On the other hand, if the material is nominally insulating, it is placed in a varying electric field and will be heated due to its own dielectric losses generated due to the field.

Dielectric heating, a comparatively new technique, employs higher frequencies than induction heating and is commercially applied to plastics, ceramics, rubber, wood-bonded products such as plywood, and similar non-conducting materials.

The materials available to the student at DeForest's Training, Inc., are limited only by his imagination. Electronics' challenge to convention captures his fancy. Under the stimulation and guidance of the instructors he is encouraged and directed in the development of his ideas. Students who come to the school from far flung sections of the country suggest original applications of this new technique. The drying of hay and corn, curing tobacco, vulcanizing rubber, or cooking and baking various foods are subjects of experimentation.

What has been done in hours can now be done in minutes—even seconds! To the unexpected guest it can now be said, "I didn't know you were coming, but I'll bake a cake anyhow!"

-30-

Test setup used to bake cake with r.f.





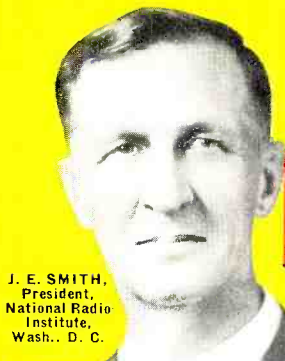

J. E. SMITH,  
President,  
National Radio  
Institute,  
Wash., D. C.

# I Will Show You How to Learn RADIO-TELEVISION

by Practicing at Home in Spare Time



You Practice **SERVICING** with Equipment I Furnish

You build the modern Radio (at left) as part of my Servicing Course. I send you speaker, tubes, chassis, transformer, loop antenna, everything you need. You use it to make many tests, get practical experience you need to make EXTRA money fixing Radios. I send you many other kits of parts with which you build other circuits common to Radio and Television, some of which are pictured on the next page. All equipment is yours to keep. See and read about them in my FREE 64-PAGE BOOK. Mail card below.

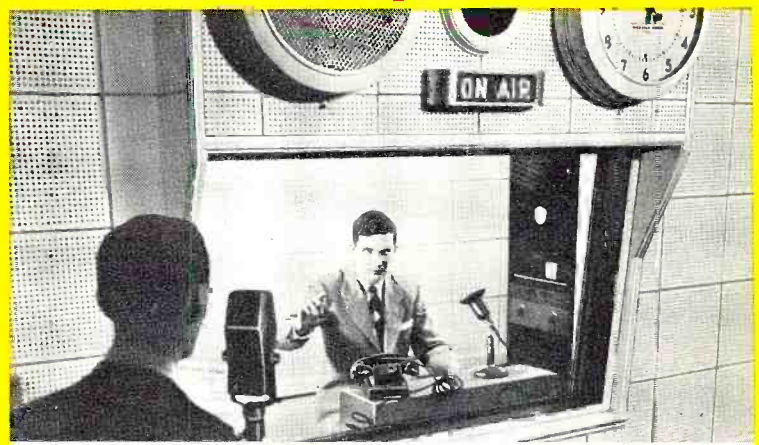
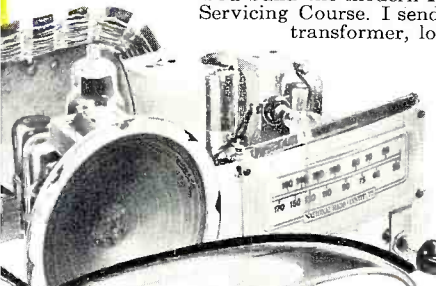

You Practice **COMMUNICATIONS** with Equipment I Furnish

As part of my Communications Course I send you kits of parts to build the low power broadcasting transmitter shown at the right and many other circuits common to Radio and Television. You use this equipment to get practical experience putting a station "on the air," performing procedures demanded of Broadcast Station operators. I train you for your FCC Commercial Operator's License that puts you in line for good pay in Radio or Television Broadcasting. Mail card below.

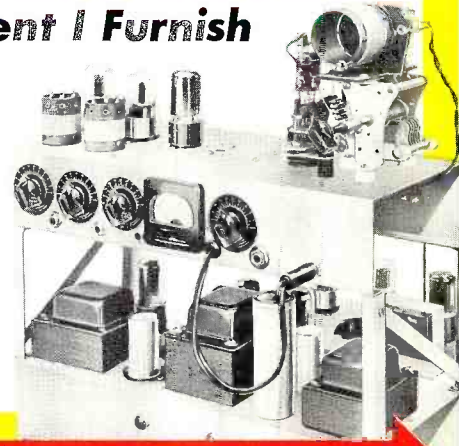

**NEW! Advanced Television Practice!**

New, special TV kits furnished to build high-definition SCOPE . . . RF OSCILLATOR with flyback power supply . . . complete TV SET . . . many other units. You see pulse, trapezoidal, saw-tooth wave forms. Get valuable PRACTICAL EXPERIENCE locating and correcting TV troubles. Mail coupon for facts, pictures and prices!

CUT OUT AND MAIL CARD NOW!

SEE OTHER SIDE THE TESTED WAY TO BETTER PAY

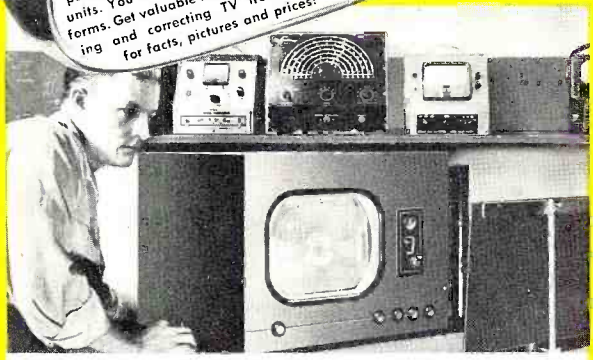

Television Is Today's Good Job Maker

In 1946 only 6,000 TV sets sold. In 1950 over 5,000,000. By 1954, 25,000,000 TV sets estimated. Over 100 TV Stations now operating. Authorities predict 1,000 TV Stations. This means more jobs, good pay for properly trained men. Mail this Postage-Free card NOW for FREE book and sample lesson.

NO POSTAGE NEEDED

**Both FREE**

Sample Lesson & 64-Page Book

ACT NOW! Send for my DOUBLE OFFER FREE. This card entitles you to Sample Lesson on Servicing; shows how you learn Radio-Television at home. You'll receive my 64-page Book, "How To Be a Success in Radio-Television." Mail card now! No postage needed. J. E. SMITH, President, National Radio Institute, Washington 9, D. C. Our 38th year.

Mr. J. E. SMITH, President, Dept. 1R  
National Radio Institute, Washington 9, D. C.

Mail me Sample Lesson and 64-Page Book, "How to Be a Success in Radio-Television." (No Salesman will call. Please write plainly.)

NAME.....AGE.....  
ADDRESS.....  
CITY.....ZONE.....STATE.....

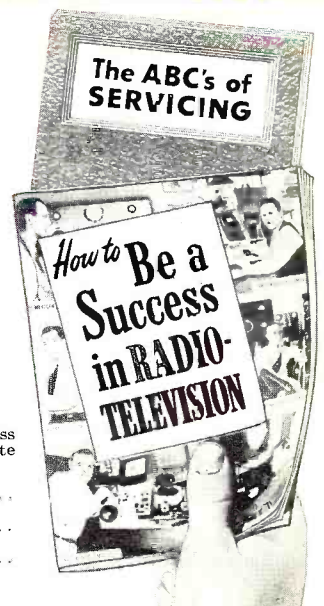



# BE A RADIO-TELEVISION TECHNICIAN

## Train at Home in Spare Time



J. E. SMITH, President,  
National Radio Institute,  
Washington, D. C.

### There's a Bright Future For You In America's Fast Growing Industry

Do you want good pay, a job with a bright future and security? Would you like to have a profitable shop or store of your own? If so, find out how you can realize your ambition in the fast growing RADIO-TELEVISION industry. Even without Television, the industry is bigger than ever before. 90 million home and auto Radios, 3,100 Broadcasting Stations, expanding use of Aviation and Police Radio, Micro-Wave Relay, Two-Way Radio for buses, taxis, etc. are making opportunities for Servicing and Communications Technicians and FCC Licensed Operators.

#### You Learn by Practicing with Kits I Furnish

With both my Servicing Course and my NEW Communications Course I send you many Valuable Kits of Parts. They "bring to life" theory you learn in my

illustrated texts. Some equipment from both courses is shown below and on previous page. All equipment I send is yours to keep. Among equipment you build is a Tester. Use it to make extra money fixing neighbors' sets while training. Special booklets show you how.

#### Training Features Television

Both my Servicing and Communications training include up-to-date lessons on TV principles. Throughout the country my graduates are filling jobs, making good money in both Radio and Television. Remember the way to a successful career in Television is through experience in Radio.

#### Send NOW for 2 Books FREE— Mail Card

Send the Postage-Free card now for my FREE DOUBLE OFFER. You get Sample Servicing Lesson to show you how you learn at home. Also my 64-page book, "How to Be a Success in Radio-Television." Read what my graduates are doing, earning; see equipment you practice with at home. Mail card now. We pay postage. J. E. SMITH, President, National Radio Institute, Washington 9, D. C. Our 38th Year.

**IMPORTANT!**  
**See Other Side**

**Extra Pay in Army,  
Navy, Air Force**

Knowing Radio, TV, Electronics can help you get extra rank, extra pay, more interesting duty at prestige, more interesting times a private's pay up to several times a private's base pay. You are also prepared for good Radio-TV jobs upon leaving service. Mail Coupon NOW.

You Build These and many more for Practical Experience

### Read What Successful NRI Graduates Say:



#### Radio Operator with ABC

"I was a bookkeeper with a hand-to-mouth salary. Now, a Radio Operator." — N. H. Ward, Ridgefield Park, N. J.



#### Can Step Into FM, Television

"When I enrolled with N.R.I., was a laborer. Now I have a position paying over \$10 a day." — R. Ford, Phila., Pa.



#### Is Broadcasting Operator

"Now employed at station WHAW as operator. I have also opened my own Radio business." — R. J. Bailey, Weston, W. Va.



#### \$10 Week In Spare Time

"Before finishing your course, I earned \$10 a week in Radio servicing in my spare time." — S. J. Pet-ruff, Miami, Fla.



#### \$10 to \$15 Week Spare Time

"4 months after enrolling averaged \$10-\$15 a week spare time servicing Radios. Now have business." — W. B. Weyde, Brooklyn, N. Y.



#### Lost Job, Now Has Own Shop

"Got laid off. Best thing that ever happened as I opened a Radio shop." — E. T. Slate, Corsicana, Texas.

### Make Extra Money While Learning

Keep your job while training. Learn Radio-Television principles from illustrated lessons. Get Practical Experience experimenting with circuits common to Radio and Television. Many students make \$5, \$10 a week extra fixing neighbors' Radios in spare time while learning. I send you special booklets that start teaching you the day you enroll.



## MAIL POSTAGE FREE CARD TODAY

### Want Your Own Business?

Let me show you how you can be your own boss. Many N.R.I.-trained men start their own business with capital earned in spare time. Robert Dohmen, New Prague, Minn., whose store is shown at right, says, "Am now tied in with two television outfits and do warranty work for dealers. Often fall back to N. R. I. textbooks for information on installing Television sets."



FIRST CLASS  
Permit No. 20-R  
(Sec. 34.9 PL & R)  
Washington, D. C.

### BUSINESS REPLY CARD

No Postage Stamp Necessary If Mailed In The United States

4c POSTAGE WILL BE PAID BY

NATIONAL RADIO INSTITUTE

16th and U Sts. N. W.

Washington 9, D. C.

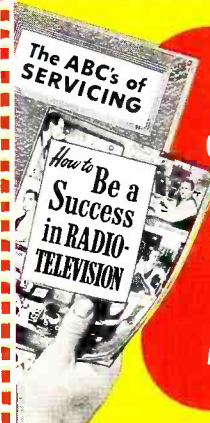

**SAMPLE LESSON  
and 64-PAGE BOOK  
Both FREE**

Cut out and mail  
postage-free card now!



## Universal Design Curves

(Continued from page 58)

$R_1/R_2$  equals 2 (Fig. 5) indicate that almost 10 db of boost can be obtained. One megohm will be a convenient value for  $R_1$ , so our choice for  $R_2$  is 470,000 ohms. At maximum boost setting ( $y$  equals 1.0), a boost of 1 db is obtained at an abscissa value of 0.56. We shall let this value correspond to 3000 cycles and solve for  $C$ .

$$2\pi f C R_1 = 0.56$$

$$C = \frac{0.56}{2\pi f R_1} = \frac{0.56}{2\pi(3000)(10^6)}$$

$$C = 2.97 \times 10^{-11}$$

$$C = 29.7 \mu\text{fd.}$$

The nearest available value for  $C$  would be 33  $\mu\text{fd.}$

One precaution in the use of this circuit is that excessive capacitance across  $R_2$  can reduce the high-frequency response. In the example above, a capacitance of 50  $\mu\text{fd.}$ , which might easily be introduced by the Miller effect if  $V_2$  is a triode, would cause 3 db of attenuation at approximately 10,000 cycles. It is generally advisable, therefore, to use a pentode for  $V_2$  to minimize the Miller effect capacitance. At least, caution must be practised when using a triode.

In the above example, examination of the curves reveals that the desired 9 db of boost is realized only at frequencies higher than about 40,000 cycles. Of course, this is above the audible limits and the circuit is incapable of fully meeting our specifications. We would have achieved almost the same practical result within the limits of our hearing if we had used the curve for  $R_1/R_2$  equals one (Fig. 6). This modification of the design would save more than 3 db of gain because the unusable boost obtained in the original design is obtained only by the reduction of middle-frequency gain, as we pointed out previously.

It must be remembered that a slope of 6 db per octave is the maximum possible with a single  $RC$  filter section. The validity of this statement is apparent when we consider that the reactance of a condenser is inversely proportional to frequency; if the frequency is changed by a factor of two (one octave), the reactance changes by a factor of two, and the voltage across the condenser can change by no more than a factor of two (6 db). If two identical  $RC$  filters are used in cascade with proper isolation between them, a slope of 12 db per octave is possible and the curves are applicable with the ordinate values doubled. Similarly, if unlike circuits are cascaded (again with isolation), the resultant response curve can be obtained by addition of the ordinates. If isolation, such as an amplifier stage, is not provided between filter sections, the mathematical analysis of the circuits is complicated and these curves are not applicable.

-50-

November, 1951

## SURE... you can get TARZIAN Tuners for replacement jobs

And your customers will thank you for it. They'll appreciate it because the overall performance of their receivers will be improved. Tests have shown that you can step up the operation of many receivers by substituting a TARZIAN TUNER. It's the same famous Tuner, which until recently, was available only to original set manufacturers.



### The TARZIAN TUNER, Model TT-5R

- Built for easy conversion
- Adaptable to either split-sound or inter-carrier
- Shaft easily cut to required length
- Available either 21 or 41 megacycles IF
- Top screw adjustments on traps, IF, RF, and mixer circuits.
- Rear terminal connections easily accessible with extra tie points provided.

Contact your distributor, or write direct for instruction sheet for installation in a 630 type chassis.

## SARKES TARZIAN, INC.

TUNER DIVISION  
Bloomington, Indiana





200  
260  
260  
260

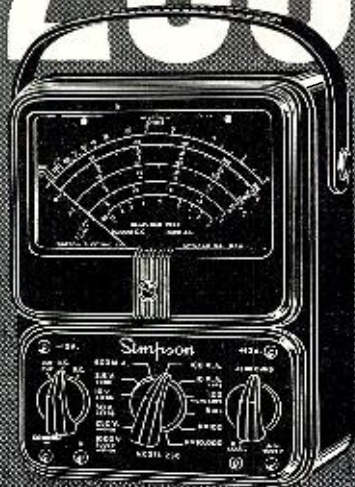

Simpson

volt-ohm-milliammeter that outsells all others combined.

260  
260

## Phono-Recorder Unit

(Continued from page 46)

shield the leads from the output transformer to the speaker or to the terminals at the back of the cabinet. At any rate it will be necessary to isolate them from any input circuits or annoying oscillation will result.

Since both recording and playback channels have relatively high gain, it is important that precautions be taken to guard against instability, motor-boating, and hum. Decoupling is used in the preamplifier stages and high-capacitance condensers are used for filtering. Cathode bypass condensers should be of ample size to minimize hum effects from this source. Since the power supply is mounted on a separate chassis, a.c. gradients in the amplifier chassis are minimized. However, the chassis is grounded at one point only, at the cathode of the preamplifier stage of the playback channel. Indiscriminate grounding of leads can be an annoying source of hum, and care should be taken in this respect. A ground bus mounted on insulated tie points easily solves this problem. All shielded leads should be grounded at one end only. Where these leads are taken through the chassis, rubber grommets are used so that there can be no contact between the chassis and the shielding.

The oscillator stage uses a 6V6 tube in connection with a Webster-Chicago No. 65PO24 oscillator coil. A slight alteration is needed on this coil to make it suitable for this recorder. The secondary coil gives an output of about 12 volts of high frequency current if connected as shown. Since it was desired to use this winding to supply the high frequency voltage for the erase section of the head, and since the Shure head used requires about 40 to 50 volts for the erase section, it was necessary to add some turns to this coil. This can be accomplished as follows: First, the coil should be wrapped with a layer of insulating material, such as waxed paper or varnished cambric. Then a

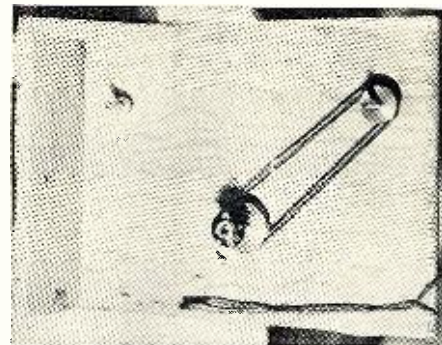

Under chassis view of the tape deck.

- 2 pc.  $\frac{5}{16}$ " o.d.  $\frac{1}{4}$ " i.d. brass tubing, 1' long
- 2 pc.  $\frac{1}{4}$ " steel or brass shafting,  $2\frac{1}{2}$ " long
- 1 pc.  $\frac{1}{4}$ " steel or brass shafting  $3\frac{1}{4}$ " long
- 1 #12 rubber bottle stopper with center hole (see text)
- 3 Tape guides
- 1 Flexible coupling for  $\frac{1}{4}$ " shafts
- 1 Shure Model 815 record-playback-erase tape head
- 1  $1\frac{1}{2}$ " pulley
- 1 1" pulley
- 1 Light spring belt, approximately 1 ft. long. Type used on movie projectors
- 1 pc. felt (disc,  $1\frac{1}{2}$ " diameter)
- 2 Steel discs  $1\frac{1}{2}$ " in diameter (cut from 20 gauge sheet metal)
- 1 General Industries 78 rpm heavy-duty phono motor and turntable
- 1 Crystal pickup
- 1 pr. hinges
- 1 S.p.s.t. toggle switch for phono motor
- 1 Cord and plug for 117 volt supply

Miscellaneous parts required to build unit.

piece of #25 enameled wire should be connected to the *outside* terminal to which the secondary is connected. Then, holding the coil in the left hand, with the terminal strip (bottom of the coil) to the left, 35 turns of wire are random wound over the coil in a clockwise direction. The new secondary then consists of the old secondary with the new winding connected in series. The terminal of the original winding to which *no wire* was connected is one end of the winding and should be grounded. The finish end of the new winding is the other end of the new secondary and it should be connected to the erase head through  $C_{13}$ . The erase coil is mounted on top of the

Fig. 5. Mechanical layout and cabinet specifications for phonograph-recorder unit.

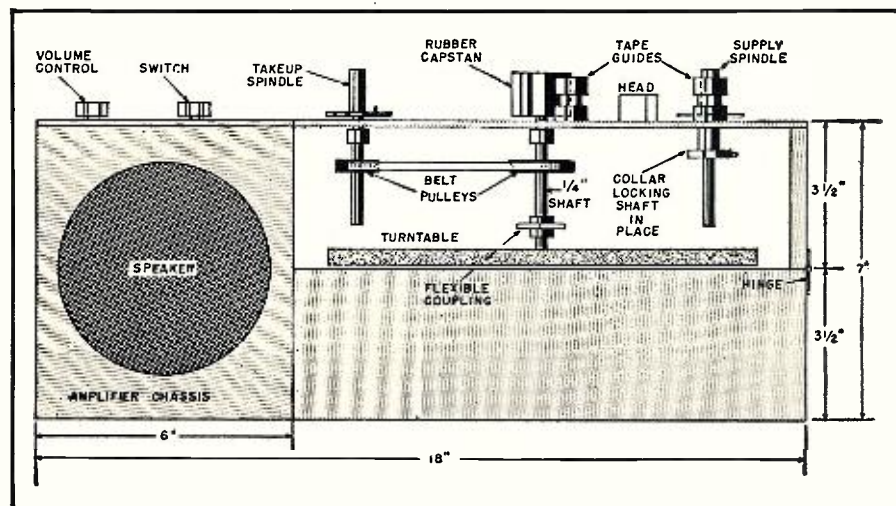



# ARROW "The Home of Values!"

## ASB 7 EQUIPMENT

**CPR-46 ACJ Receiver**—509 to 556 mc, new with tubes... **\$29.50**  
**CAY-52 ACV Transmitter**, new with tubes... **7.95**  
**CJP-55 AER Scope**, new with tubes... **19.95**  
**CJP-20 ABX Power unit**, new with tubes... **4.95**  
 used with tubes... **3.95**  
**CJP-14 AAV Antenna switching unit**, new complete... **4.95**  
**AM 61 Indicator amplifier**—New with blower and all parts except tubes... **\$7.95**  
**BC 709**  
 Battery operated lightweight interphone amplifier. Complete with tube and shock mount, but less battery. New... **\$3.95 ea.**

**AD-1 MOTOR** 24 VDC—1/12 HP 6000 RPM **98c** Intermittent Duty.  
**PE 97 or PE117 Vibrator Power Supply** for BC 620 and BC 659. Used—Less Tubes, **\$2.95** Vibrator and Condenser.  
**PE 120 Vibrator Power Supply** for BC 620 and BC 659 with Tubes, etc.—less vibrator. **\$4.95** Used.  
**PE 218 Inverter**, 24VDC input; output 115 VAC, 400 CPS at 13 amps. (1.5 KVA)... new **\$15.00** like new **12.50**

<b>T</b>	01A	1E7GT	2C26A	33	1619
<b>U</b>	01B	1F4	3B7	34	1625
<b>B</b>	01C	1F5G	3D6/1299	39/44	1626
<b>E</b>	1A6	1G1	10Y	49	
<b>S</b>	1B4P	1G6GT	15R	CRP 72	
	1B5/255	1H4G	19	843	
	1C6	1H6G	30 spec.	954	
	024A	6J7G	6Z7G	12F5	12J5GT 211
	2V3G	6T7G	12A6	12H6	77 957
	CK1005	2X2	6L7G	6ST7	705 A
	1A5GT	6J5GT	6R7GT	6W7G	

## OIL FILLED CONDENSERS

.00025 mfd. 25,000 VDC, oil-filled, new... **\$2.95 ea.**  
 1.75 mfd. 330 VAC, 60 cycle, G. E. Pyranol motor starting condenser with mounting bracket, NEW... **59c ea.**  
 1-1-1 mfd 1200 VDC... **59c** 2 for **\$1.00**  
 .25 mfd 1500 VDC... **39c** 3 for **1.00**  
 .25 mfd 600 VDC B/T... **24c** 5 for **1.00**  
 40 mfd 25 VDC Electrolytic **24c** 5 for **1.00**  
 50 mmfd 5000 VDC vacuum condenser, NEW... **\$1.29**  
 9 mfd. 90 VAC, 400 CPS, 3 phase Delta GE Pyranol... **98c ea.**

## MN 26Y COMPASS RECEIVER

Twelve stage superhet covering frequencies of 150 to 325 KC; 325 to 695 KC; and 3400 to 7000 KC in three bands. These units are brand new but with Dynamotor, Band Switch motor and tubes removed. Schematic Furnished. While they last, ea... **\$4.95**

## PE 206 INVERTER

24 VDC to 80 VAC at 800 CPS 500 VA... Used **\$3.95**

## SCOTT HI-FI OUTPUT TRANSFORMER

Made for Scott Navy Receiver. Fully Potted. Primary 5000 ohms. Secondary: 600 ohms center tapped and 60 ohms center tapped with inverse feedback... New **\$1.49**

## COMMAND (SCR 274 N) EQUIPMENT

	Used	New
<b>ARA</b> (same as command receiver) 1.5 to 3 MC, like new with tubes, less dynamotor, black crackle finish... <b>\$19.95</b>		
<b>ATA</b> 2-3 mc transmitter... <b>17.50</b>		
<b>BC-455</b> 6-9 mc receiver... <b>\$7.95</b>		
<b>BC-457</b> 4-5.3 mc transmitter... <b>4.95</b>		
<b>T-19 ARC 5</b> , 3-4 mc transmitter... <b>10.95</b>		
<b>T-21 ARC 5</b> , 5.3-7 mc transmitter... <b>7.95</b>		
<b>T-23 ARC 5</b> , 100-156 mc xmtr... <b>49.50</b>		
<b>BC-496</b> , 2 position Rec. Control Box... <b>1.95</b>		
<b>MC-215</b> Mechanical Drive Shaft, per length... <b>2.45</b>		
<b>BC-450</b> 3 Receiver Remote Control... <b>1.95</b>		
<b>BC-451</b> Transmitter Control Box... <b>1.50</b>		
<b>BC-442</b> Antenna Relay, complete... <b>2.95</b>		
<b>3 Receiver Rack</b> ... <b>1.95</b>		

## COMPASS INSTALLATION

**MN-26C**—Remotely controlled commercial type navigation receiver. Freq. range 150 to 1500 KC in three bands. Has two 6 volt tubes, 24 V dynamotor and band switch motor, **\$39.95** NEW  
**MN-28C** Control box for above, New... **\$9.95**  
**MN-52** Loop control unit, New... **4.45**  
**MN-20E** Loop (manually rotatable), New... **9.95**  
 Loop transmission cable 168' long, new... **9.95**  
**MC-124** Mechanical cabling, New per lgth. **2.45**  
**IN-4D** Left-right indicator, New... **9.95**  
 Plugs, set of three, New... **3.75**  
 Manual, covering complete set, New... **1.95**

## SCR 508 EQUIPMENT

<b>BC 603</b> Receiver L/dyn...	\$24.95	Exc. Used
<b>BC 604</b> Transmitter L/dyn...	12.95	Exc. Used
<b>BC 605</b> Amplifier L/dyn...	4.95	New
<b>BC 606</b> Control Box...	.95	Exc. Used
<b>FT 237</b> Mounting...	9.95	Exc. Used
<b>MP 48</b> Mast Base...	2.95	Exc. Used
<b>DM 34</b> , Dynamotor...	10.95	Exc. Used
<b>DM 35</b> , Dynamotor...	14.95	Exc. Used
<b>DM 37</b> , Dynamotor...	14.95	Exc. Used
<b>TM 11-600</b> Tech Manual...	1.95	
Crystals, Set of 80...	19.95	

## 89c

1B26	1S4	6AC7	6K8G	717A
1B32	2A4G	6AL5	6SH7	1613
1LD5	3S4	6C4	6V6GT	6W4
1LN5	5W4	6K6GT	VR90	6CB6
<b>\$1.59</b>	100TH... 9.95	805... \$3.29		
6AG5	6L6G	304TH... 10.95	807... 1.59	
6AK5	1624	304TL... 10.95	813... 9.95	
6AK6	1B3	307A... 4.95	866A... 1.69	
		803... 2.89		

## CATHODE RAY TUBES

3FP7... \$1.95	5GP1... \$3.95	16JP4 \$19.95
4AP10... .95	5BP4... 3.95	16DP4 19.95
5FP7... 1.95	5CP1... 4.95	

## CABINET CH-118

Olive drab in color, this cabinet has a full length interlock access door on the rear. The front takes the standard 19" panels with 60 inches of height and 20 inches deep. It is shock mounted on a heavy steel platform and has a two-inch protrusion fully covering one side to accommodate wave trap and wiring. Louvered vents allow air circulation top and bottom.  
 Each F. O. B. Chicago... **\$34.50**  
 A few on hand need paint jobs, or small repair... as is. Only... **\$19.95**

## RA 52-RECTIFIER

A transtat controlled rectifier to produce high voltage DC from 110 VAC 60 cycle source. Up to 11,500 volts DC at 50 watts. Metered high voltage (0-15KV) and current (0-20 MA). **\$74.50** New.  
 Some available with small repair or minor part replacement, less tube. Only... **\$49.50**

**BC 769** Transmitter, P/O RC 100, new less tubes **\$6.95**  
**BC 770** Keyer P/O RC 100, new less tubes... **4.95**

## MONTHLY SPECIAL!

**BC 604 FM Transmitter**—20-27 mc, 10 Channel crystal controlled push-button, excellent for conversion to 10 and 11 meters, small quantity on hand, in good used condition, less dynamotor, some missing side covers, etc. **\$7.95**—otherwise complete, including tubes.

## MIKES and HEADSETS

<b>HS 23</b> High Impedance Headset... new	\$4.95
<b>HS 30</b> Miniature Headset... new	1.50
	used .75
<b>CD-307</b> Ext. cord for HS 23-33... like new	.59
<b>J41</b> Key... new	.98
<b>T-32</b> Desk Stand microphone. Good used cond.	\$2.95
<b>Throat Mike</b> —T 30—New	98c
<b>Lip Mike</b> —Navy Type—New	98c
<b>Extension Cord and Switch Assembly</b> for lip and throat Mikes—New	98c
<b>CW 49505</b> High impedance headset complete with leather headband and rubber cushions.	Used 98c

## SCR 625 Famous Army Mine-Detector

For Prospectors, Miners, Oil Companies, Plumbers, Etc.

This unit is being offered now at a considerable reduction in price. Recently advertised at \$79.50 it is now available in the same brand new wrappings in suitcase style carrying case (less batteries) at

**\$59.50**

WHILE THEY LAST!

Used, like new **\$39.50**



## MISCELLANEOUS SPECIALS!

	Used	New
<b>RA 10 DA</b> Receiver...	\$17.50	\$24.95
<b>BC 442</b> Less Condenser...	1.49	1.95
<b>APS 13</b> UHF Antenna, Pair...		.98
<b>I-97</b> Bias Meter...	3.95	4.95
<b>RL 42</b> Antenna Gearbox Motor and Reel...	4.95	7.50
<b>Circuit Breaker</b> 40 Amps...		.59
<b>Collins VFO Dial</b> —5 calibrated ham bands form 3.2 Mc to 32 Mc; complete with pointer, gears, logging dial and flywheel. Scale 6" on 8" plate, each...		.95
<b>I 82 F</b> Five Inch 360 degree compass indicator and Selsyn receiver...		4.95
<b>A-81-2</b> Transmitters Selsyn for 182 indicator. (both 182F & Trans. Selsyn for \$7.00)		2.45
<b>PE-101</b> Dynamotor...		2.75
<b>Model 507</b> , Thermal-converter Weston Type D, range 12 amp...		.59
<b>BC-1023</b> Marker Beacon Receiver, complete with tubes, shock mount and instruction manual...		9.95
<b>BC-924</b> 27-38 MC. FM Transmitter, complete with tubes...	19.95	
<b>BC-684</b> 27-38 MC. FM Transmitter, less dynamotor...	19.95	
<b>BC-610</b> 10 meter modification kit...		3.95
<b>SCR-183</b> complete 12 volt set with all coils, tubes, dynamotor and control units...		49.50
<b>ARB</b> Control Box...		1.95
<b>ARR2</b> Control Box...		.89
<b>BC 1206C</b> Receiver, new...		7.95

## RECORD PLAYER

Original Government cost \$150.00. Contains husky three tube Amplifier, Large PM Speaker and two speed (33 1/3 & 78 RPM) 110 Volt AC and DC motor. In portable leatherette carrying case. Good operating condition... **\$19.95** each  
 Or with repairs required, as is... **12.95** each  
 Also available straight AC with one speed 33 1/3 RPM motor.  
 Good operating condition... **\$14.95** each  
 Repairs required... **9.95** each

## CHOKES

10 Henry 20 MADC... **29c** 4 for **\$1.00**  
 10 Henry 50 MADC... **39c** 3 for **1.00**

**TS-10** Sound powered phones. Brand New, each... **\$9.95**  
 Used **\$5.95** ea.

## VIBRATORS

2 Volt—7 Prong Synchronous... **69c** 10 for **\$6.00**  
 6 Volt—4 Prong Non-synchronous **98c** 10 for **9.00**

## SURPRISE PACKAGE

20 pounds assorted radio parts. A real value at... **\$1.95**

Shipments FOB warehouse. 20% Deposit on orders. Minimum order \$5.00. Illinois residents, add regular sales tax to remittance. Prices subject to change without notice.

ARROW SALES, Inc. Dept. N, 1712-14 S. Michigan Ave., Chicago 16, Ill. PHONE: HARRISON 7-9374







## Amplifier Selection

(Continued from page 51)

advertising copy that it is well to stop and evaluate them in terms of what is actually accomplished that is of benefit to him. For example: One manufacturer may evolve a splendid circuit which achieves fantastic efficiency (meaning it consumes less power from the power lines in the performance of its job). Such unique efficiency undoubtedly was achieved at higher initial cost which can only be properly evaluated by studying your personal need to reduce power consumption. Most sound equipment draws negligible amounts of power in any event, so further savings here may have little importance to the buyer.

Long arguments can still be started at the drop of a hat on the subject of triode *versus* pentode output systems. Yet, it has been conclusively proven long ago that there need be no actual difference in the results obtainable. Both systems can be equally good, however, it requires much more careful engineering to achieve success with pentodes which may explain why the greatest triode enthusiasts are frequently those who have relatively little equipment and who build only one amplifier now and then. They may simply have had trouble understanding the pentode systems and forever condemn what they will probably never understand. However, pentode amplifiers, as manufactured by top companies and with adequate engineering hours devoted to the original design, can perform as well as triode amplifiers and in some other respects can even surpass designs using triodes. But, as long as satisfactory performance can be obtained using triodes with relatively little work or equipment, home constructors will continue to sing their praises. The buyer of a factory built amplifier, therefore, should not allow himself to become confused by the argument. He should listen and buy what he likes regardless of the output system employed. Any audible differences between really good pentode and triode designs are probably due to other amplifier design factors and not the output system itself. In fact, among the best amplifiers offered, the output systems are all good when compared with the program source, pickups, and loudspeakers, thus other features of the amplifier which will assist in overcoming the many variables referred to previously may rightly determine the amplifier's comparative value to the customer.

Volume expanders are also a confusing feature to most purchasers. In the early years of recording, records did not possess adequate volume range. This condition was further exaggerated by the limited dynamic range of early loudspeakers. The buyer has only to realize how many times his records today must actually be reduced in volume on certain loud passages rather than increased, as would be the result

"I've tried them all, and have found your DUBL-VEE to be tops."

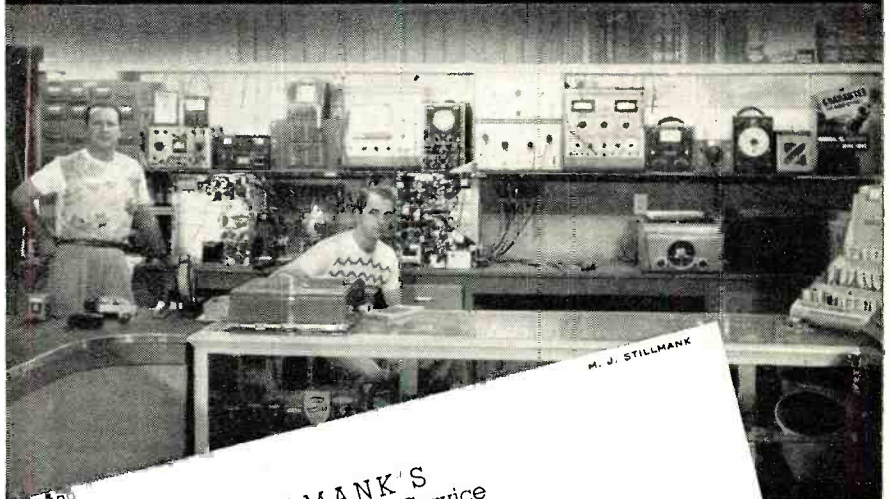

M. J. STILLMANK  
STILLMANK'S  
Radio & Television Service  
"THE ONLY THING WE SELL IS SERVICE"  
2368 NORTH NEVA AVENUE  
CHICAGO 35, ILL.

June 26, 1951

The Workshop Associates  
Division of The Gabriel Company  
135 Crescent Road  
Needham Heights 94, Massachusetts

Gentlemen:

For nearly a year I've been installing your DUBL-VEE antennas which I purchased from Radio Television Supply Company here in Chicago. I wanted to write you this letter to tell you how satisfactory these antennas have been.

In this area, we have Channels 4, 5, 7 and 9. Thus, an all channel antenna is necessary. I've tried them all, and have found your DUBL-VEE to be "tops". We get excellent pictures on all channels with the DUBL-VEE, and, here in the "Windy City", the antennas have stood up wonderfully.

I've always regarded Workshop as the leader in antenna engineering. Your DUBL-VEE has convinced me this is true.

Sincerely yours,

Milton J. Stillmank

We might add that the Workshop DUBL-VEE is the original patented DUBL-VEE antenna. For outstanding TV reception be sure to specify it.

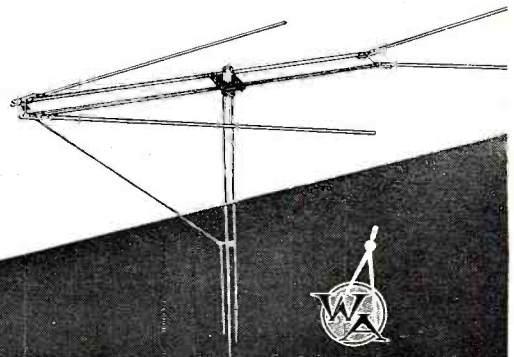

The WORKSHOP ASSOCIATES

DIVISION OF THE GABRIEL COMPANY

Specialists in High-Frequency Antennas

135 Crescent Road, Needham Heights 94, Massachusetts



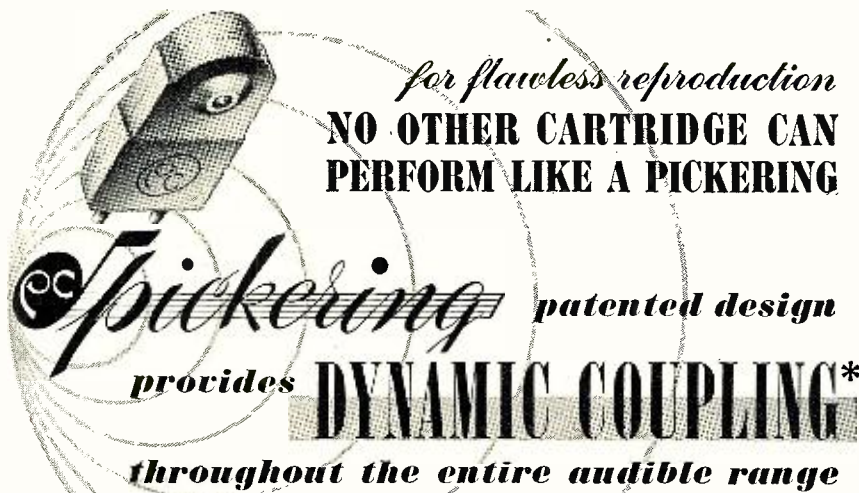

**\* DYNAMIC COUPLING ASSURES**

- constant stylus contact with the record grooves over the entire audio spectrum (20-20,000 cps)
- full frequency response
- full transient response

**NO RESONANCES  
 NO MISTRACKING  
 NO GRINDING OF GROOVE WALLS**

Well-informed engineers and technicians, schooled in the science of electro-mechanics, know that only wide-range frequency response provides full transient response; the electronic phenomena which enables the reproduction of orchestral music with all the subtle sounds that give each musical instrument its individual character.

Pickering engineers and designers have but one objective . . . to produce products that will please the music lovers' insatiable appetite for the flawless recreation of recorded music . . . for the utmost in quality insist upon Pickering Audio Components.



Pickering Cartridges transmit all of the sounds in the musical spectrum, without loss of definition, just as a fine optical lens passes all of the colors in the rainbow.  
 For literature address Dept. C

## WORLD'S FASTEST SELLING VOLT-OHM MILLIAMMETER

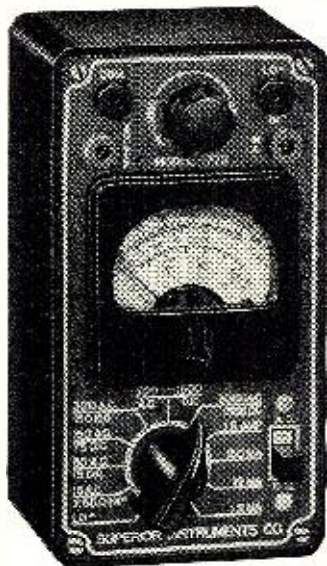

**Model 770**  
 is an accurate pocket-size V.O.M.  
 Measures only 3 1/8" x 5 7/8" x 2 1/4"

**Sensitivity**  
 1000 ohms per volt

- ★ Uses latest design 2% accurate 1 Mil. D'Arsonval type meter.
- ★ Same zero adjustment holds for both resistance ranges. It is not necessary to readjust when switching from one resistance range to another. This is an important time-saving feature never before included in a V.O.M. in this price range.
- ★ Housed in round-cornered, molded case.
- ★ Beautiful black etched panel. Depressed letters filled with permanent white, insures long-life even with constant use.

The Model 770 comes complete with self-contained batteries, test leads and all operating instructions.

**\$14.90**  
 NET

- Specifications:**
- 6 A.C. VOLTAGE RANGES:  
 0-15/30/150/300/1500/3000 Volts.
  - 6 D.C. VOLTAGE RANGES:  
 0-7.5/15/75/150/750/1500 Volts.
  - 4 D.C. CURRENT RANGES:  
 0-1.5/15/150 MA. 0-1.5 Amps.
  - 2 RESISTANCE RANGES:  
 0-500 Ohms 0-1 Megohm.

Write Dept. RN-11 for catalog of complete line.

**SICO** Manufactured and Guaranteed by  
**SUPERIOR INSTRUMENTS CO.**  
 227 Fulton Street • New York 7, N. Y.

**AT YOUR RADIO PARTS JOBBER**

with an expander, and he can quickly cope with the most superbly worded advertising copy on expanders. The improvements in recording and loudspeakers today are more than sufficient to meet volume range demands that are acceptable in the home. Its elimination results in less distortion, less service difficulties, and less expense; thus making room for other more audibly worthwhile features to fit today's needs.

Noise and hum are factors generally expressed in terms unfamiliar to the layman. Furthermore, hum and noise vary. Some types are more audible than others, measurements to the contrary. Thus, much time is saved the buyer by just listening to the product and ignoring the advertising. A little hum can be terribly annoying in a quiet room, especially when large and efficient loudspeakers are used.

The amount of audio power to purchase has resulted in much confusion on the part of consumers, because of the wide diversity of opinion among engineers themselves. The fact is that those who claim 10 watts is enough, and those that speak out for higher powers are both correct under certain conditions. The power needed is not so much a function of the volume at which the listener intends to operate the amplifier as it is the tonal results desired. If one is satisfied with harmonic bass emphasis as a substitute for true bass, a relatively small amount of power is all that's needed. The difficulties arise when one attempts to achieve true fundamental bass emphasis without over-emphasizing the harmonic bass tones. This takes special curve shapes which incidentally are costly to achieve and the consumption of power for comparable bass volume becomes terrific. Just because one has more power available in no way implies that the amplifier will not work as well at low volume. In fact, the tone curves permissible only when ample power is available can result in superior low level performance. This does not imply that all high powered amplifiers utilize their power to the best advantage by including the best tone controls in their designs. Unfortunately, very few of them make proper use of the power available except to permit greater volume. This has only helped lend weight to those who argue for lower powers. However, those who have used higher power combined with tone curves designed to take advantage of the power available, to achieve what could never safely be accomplished with low power systems, know that, properly designed, a twenty to twenty-five watt amplifier cannot be equaled by a 10 watt design.

Tone controls frequently confuse the layman who may easily conclude that merely having the controls is sufficient. Here again one has only to listen to become quickly convinced that there is more to tone controls than the performance specifications indicate. Tone controls are costly, that is, good ones are. Since they can represent a good portion of the cost of an amplifier, good







# New 5 inch Oscilloscope

FOR TELEVISION,  
AM & FM SERVICING

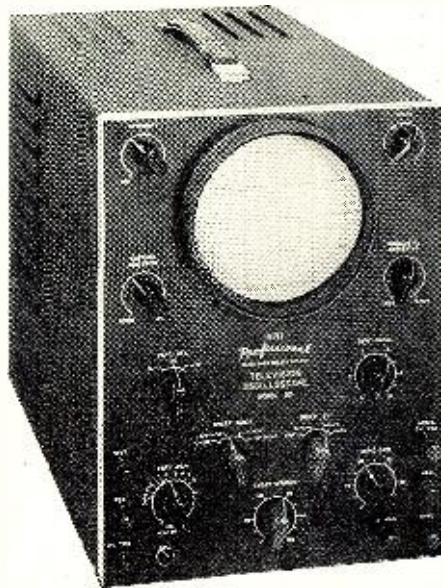

only \$127<sup>50</sup>

Available on monthly terms

PERFORMANCE EQUALS SCOPES  
MUCH HIGHER PRICED

WIDE-BAND VERTICAL AMPLIFIER  $\pm 3$  db from 10 cps to 4.5 mc on any attenuator setting; useful to 7 mc.

VERTICAL SENSITIVITY—.014 volt. (RMS) per inch. CALIBRATED THREE STEP VERTICAL ATTENUATOR (Frequency Compensated)—gives peak-to-peak voltages direct.

BALANCED PUSH-PULL DEFLECTION AMPLIFIERS—used for both horizontal and vertical deflection.

WIDE-RANGE HORIZONTAL SWEEP—10 cps to 100 kc in four overlapping ranges; will sync with 3 mc sine wave.

THIRTEEN TUBES including 5U1 CR Tube.

VOLTAGE REGULATED FUSED POWER SUPPLY.

## DESCRIPTIVE CIRCULAR FREE

Servicemen, investigate this scope before you buy another. Save yourself money, keep down your investment in equipment. Mail coupon or postcard for free descriptive circular giving details regarding its operation, specifications, and terms. You'll agree that this scope is just what you want for TV, AM, and FM servicing jobs—that it is an exceptional value. Send coupon in envelope or paste on penny postal.

## MAIL NOW

NATIONAL RADIO INSTITUTE, DEPT. SD3  
16TH & U STS., N.W., WASHINGTON 9, D. C.

Send me, without obligation, descriptive circular regarding the NRI 5" Professional TV Scope.

NAME.....

ADDRESS.....

CITY.....ZONE.....STATE.....

tone controls are not too common. The mere statement that so much bass boost is available does *not* indicate that the bass tones thus emphasized will be anything like the original tone, nor does it indicate any of the other factors which are important regarding their performance. All that the specifications generally tell one is that the control emphasizes bass by some specified amount. Only your ears can tell whether the emphasis results in excessive harmonic bass tones or retains the original character of the tone while increasing its intensity, and whether an undesirable change of over-all volume occurs when the tone controls are adjusted.

The amount of inverse feedback is another confusing element highly emphasized by advertising copy and frequently treated by engineers, who should know better, on the basis that if "a little feedback is good, more must be better." The layman will do well to leave the amount of feedback used to the manufacturer and determine his acceptance of the product purely by listening to it. Again compromises must be reached between the advantages inverse feedback offers and the disadvantages it brings. Today's loudspeakers were never designed for zero impedance drivers and a point can be easily reached, when increasing the amount of inverse feedback, where these loudspeakers simply do not perform as well. Again the buyer will do well to let his ears be the judge of what pleases him.

Regarding preamplifiers for use with magnetic pickups, the buyer is cautioned that, while there are many excellent separate preamps available to connect to equipment previously purchased, he will be well advised when buying his new amplifier to obtain one with the preamp built in if this feature will be needed. The reason is simply that the buyer can then readily place responsibility for any excess hum or noise and will be assured of full compatibility in every way.

Remote controls, while undoubtedly desirable for some users, must be recognized as substantially increasing the cost for a given performance. In many cases, they can mean higher hum, noise and distortion, poorer response, and greater servicing expense. Yet, they serve a need and the buyer should carefully analyze his needs to be able to evaluate what the remote control can do for him in return for its expense.

In conclusion, it should be emphasized that the best designs are not necessarily the ones that emphasize some one special feature. The best amplifier will most likely be the one whose engineers have understood the complexities and compromises involved in achieving good reproduction in spite of an almost overwhelming number of variables and have intelligently distributed the costs throughout the amplifier so as to achieve a balance of features and performance that will mean the best possible sound under the greatest variety of conditions. Every phase of the design must contribute its share of the

# COLOR

TV now available for all black and white television sets

## Colortone

... makes color conversion a simple matter with the COLORTONE ADAPTER and the COLORTONE CONVERTER. Official specifications.

### STEP No. 1

With an easily installed COLORTONE ADAPTER, color broadcasts will appear on your existing television receivers as a black and white picture. \$19<sup>95</sup> LIST

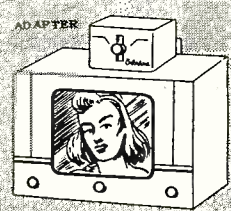

### STEP No. 2

The COLORTONE CONVERTER is a mechanical and electronic assembly for color reception consisting of a color wheel, motor and synchronization unit.

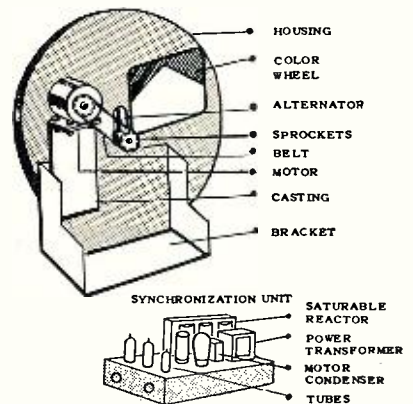

### COLORTONE... FIRST AND FOREMOST IN COLOR TELEVISION

The COLORTONE COLOR CONVERTER ASSEMBLY is available as individual components or in complete kits. Simple to install... complete instructions and easy-to-follow diagrams included with kit.

DISTRIBUTORS—JOBBER—DEALERS: Write for complete data... franchise territories open.

FREE LITERATURE AND PRICE LIST AVAILABLE

## Colortone

TELEVISION CO., INC.  
238 WILLIAM ST., DEPT. N-11, N. Y. 38, N. Y.  
CORlandt 7-5160

### GET OUR PRICE for Your RADIO & AIRCRAFT EQUIPT!

We'll go the limit to buy your parts or equipment. Send us a description of the type and condition of equipment you have—tell us your top dollar asking price—and be pleasantly surprised at the fast action you'll get!

HARJO SALES CO., Suite 533  
341 S. Vermont Ave. Los Angeles 5, Calif.

RADIO & TELEVISION NEWS



results to be obtained. Just as in a chain, an amplifier is no better than its "weakest link." Unless the potential customer bases his purchase on the evidence of his ears, he is in danger of defeating his prime purpose in setting up his custom system—that of achieving a system that really pleases him personally. In the field of custom phono installations, the customer can truly be "King" if he will but realize that the ultimate aim of his system is to satisfy his personal tastes in reproduction. He, and he alone, can determine what is pleasing to him. No cold instruments will ever substitute for his own ears. Just as every phase of an amplifier's design must be most carefully integrated to achieve the finest result, all elements of the complete system must likewise be carefully selected to achieve a balanced system. For the system, too, is no better than its "weakest link." The music lover who selects the products of reputable, well established manufacturers, on the basis of tonal performance from his own actual listening tests, will be repaid many times over for every dollar invested.

-30-

### Simulated Echo Chamber

(Continued from page 47)

magnetic, however, many other pickups were tried and all worked equally well. In the model shown, an extra long phono needle was necessary to reach to the spring from the head positions behind the frame. In testing the unit it was found that in place of the needle, the end of a steel safety pin could be substituted with good results. In any case, the needle should be of tempered steel since a soft needle will tend to damp out the vibrations.

The spring used for the unit is a steel coil made of #18 wire, wound ¼ inch in diameter with 13 turns per inch. Unstretched, the spring is 20 inches long. The correct tension was found by stretching the spring two inches, the ends being hooked to cotter pins on the bracket.

In order to mechanically insulate the unit, the entire assembly is hung vertically with heavy rubber bands from the top, the shielded leads to the heads being given plenty of slack.

-30-

### THE AUDIO FAIR

**R**EADERS are again reminded that The Audio Fair opens at the Hotel New Yorker in New York City on November 1st and will run through the 3rd.

The three-quarter billion dollar audio industry will have its wares on display for the benefit of an estimated 15,000 engineers, students, and audio enthusiasts. This young and growing industry now comprises several hundred equipment makers, manufacturers' representatives, equipment sales organizations, and publications.

As in the past, The Audio Fair will be open to the public.

-30-

November, 1951

# GREAT NEW HEADPHONES

## for Broadcast Monitoring and Laboratory

*by Brush*

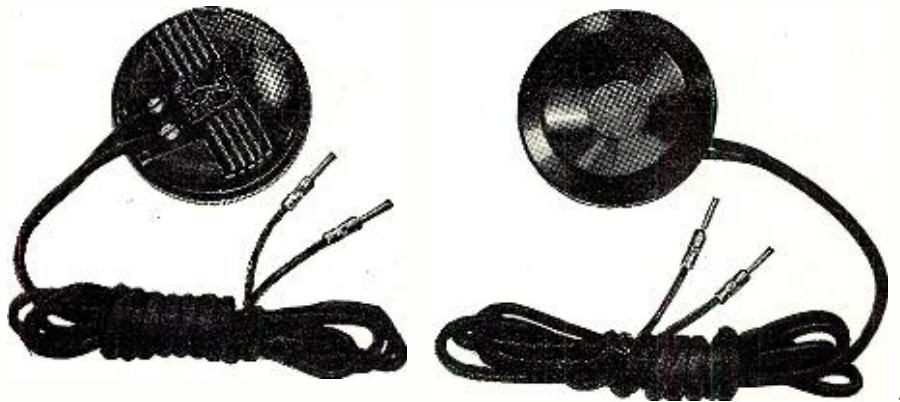

For the first time all the features you have ever wanted are combined in a single headphone, made possible by Brush pioneering and acoustic leadership. *Engineered comfort and smooth sound* will improve work and make life easier for those who use it. Brush's exclusive BIMORPH CRYSTAL\* drive element makes possible these advanced features.

AVAILABLE IN THE FOLLOWING STYLES FROM YOUR LOCAL RADIO PARTS JOBBER:



Double headset  
BA-206



Single headset  
BA-207



Lorgnette Style  
BA-208

- Exceptionally flat frequency response
- Exceptional bass response
- Lightweight - designed for comfortable wear
- Sensitivity is approximately 6.3 dynes/cm<sup>2</sup>/volt at 1000 cps.
- Exclusive METALSEAL CRYSTAL\* for protection against high humidity
- Impedance of 100,000 ohms at 1000 cps.
- No transformer required
- Multiple installations are readily made

\*Trade Mark Registered



THE BRUSH DEVELOPMENT COMPANY

3405 Perkins Avenue, Cleveland 14, Ohio

PIONEERS IN CRYSTAL ACOUSTICS







# IT'S HERE!

## NEW, 164-PAGE CATALOG OF RADIO, ELECTRONICS AND TELEVISION

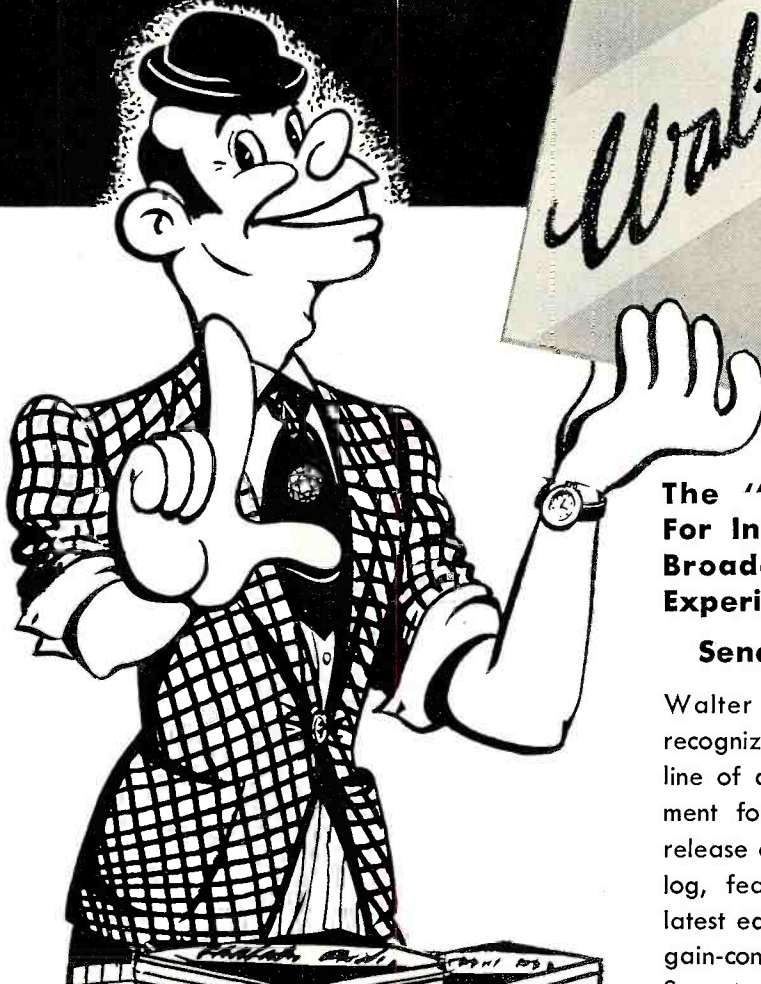

The "Treasure Chest" of Values  
For Industry, Schools, Laboratories,  
Broadcasting Stations, Servicemen,  
Experimenters and Amateurs.

**Send For Your Free Copy Today!**

Walter Ashe Radio Company has long been recognized as the reliable source for a complete line of dependable radio and electronic equipment for every conceivable purpose. With the release of this new, bargain-packed 1952 catalog, featuring bigger-than-ever stocks of the latest equipment, components and parts, no bargain-conscious buyer can afford to be without it. So act now. Mail the coupon today! Your free copy will be sent postpaid by return mail.

- CONVENIENT HANDBOOK SIZE
- CONTENTS ALPHABETIZED FOR EASY REFERENCE

# Walter Ashe

## RADIO CO.

1125 PINE ST. • ST. LOUIS 1, MO.

WALTER ASHE RADIO CO.  
1125 Pine Street, St. Louis 1, Missouri

RN-11-51

Please Rush Free Copy of your new 1952 Catalog.

Name \_\_\_\_\_

Address \_\_\_\_\_

City \_\_\_\_\_ Zone \_\_\_\_\_ State \_\_\_\_\_





**SCR-522 TRANSMITTER & RECEIVER**

2 meters. This is the hottest, most wanted 2-meter rig in ham history! Frequency range 100-156 mcs. If you are a novice or if you have a call—you can stop looking! Want VHF fixed? Want VHF mobile? Want ruggedness, dependability and power with a capital "P"? THE SCR-522 IS YOUR DISH! with ALL tubes, 24 V. dynamotor and control box. Used but excellent condition. A COLUMBIA 4-STAR BUY AT ONLY \$59.50

**SOUND POWERED HEAD AND CHEST SET**

This is the kind of deal that TV men and line-men DREAM ABOUT. These units formerly sold at \$17.95 EACH. Just to see if yer paying attention, we'll let them go—this month only—in good, used condition at just... \$4.95 ea. PAIR ..... 8.95

**TUBES! IF YOU NEED 'EM—WE GOT 'EM!**

5BP4 .....	\$5.95	3A4 .....	\$1.00
902P1 .....	3.50	3A5 .....	1.89
1C5 .....	.89	6K7 .....	.75
1L4 .....	.89	12K8 .....	1.25

**EQUIPMENT WANTED**

Do bill collectors hate you? Does the BW nag you for more dough? When you go to sleep do you keep thinking of money instead of beautiful women? Here, in just 6 words, is the solution to your problem:

**SELL YOUR RADIO GEAR TO COLUMBIA!**

We guarantee to out-bid, out-buy and out-pay any other outfit! Tell us what you have to sell—TODAY!

**PM SPEAKERS 6 OHM ALL BRAND NEW!**

4" square .....	\$1.75	8" round .....	\$4.25
5" round .....	1.99	10" round .....	5.95
6" round .....	2.49	12" round .....	7.95

TD-1 CHEST SET: With F-1 button. NEW. Only \$2.95

**HOPALONG CASSIDY RADIO**

Lookit Columbia make like Santa Claus! This honey of a radio, manufactured by Arvin, makes such a swell Christmas gift that we're letting you in on this deal a month early. It's boxed, brand new and features Hoppy himself! We warn you: whoever gets this set as a gift will hug you to pieces. .... ONLY \$12.50

**20-CONTACT STEPPING RELAY:** Made by Automatic Electric Co. 24 V. coil. New, unused in weathered boxes. .... Ea. \$9.95

**ARC-5 OR 274-N TRANSMITTERS**

2-1-3 mcs. Used	\$14.95
3-4 mcs. Used, excel. cond.	14.95
4-5-3 mcs. Used, good cond.	9.95
5-3-7 mcs. ....	5.50
7-9-1 .....	12.50

**ARC-5 OR 274-N RECEIVERS**

55-1.5 mcs. Brand new	\$49.50
1-3-3 mcs. Brand new	24.50
6-9-1 mcs. Used	7.95
6-9-1 mcs. Brand new	11.95

**MD-7 MODULATOR for ARC-5**

28 V. RECEIVER DYNAMOTOR	\$7.95
14 V. RECEIVER DYNAMOTOR	9.95
RACK FOR DUAL TRANSMITTER	2.95
TRIPLE RECEIVER RACK	3.95

**SUPER-PRO CHASSIS: BC 779-A.** Here's a buy what am terrific! A little Yankee ingenuity can turn this super chassis into a super job! COMES COMPLETE less power and IF transformers, meter, dials and tubes. Fair condition. Only \$12.95 Schematic for Ingenious Yankees. .... 1.00

**WET CELL BATTERIES**

20-2 Type. Brand new	\$1.50
24 V. 11 amp Aircraft Battery. Ideal for all surplus radio gear. BRAND NEW	\$15.50
BC-221 FREQUENCY METER CASE: Wood or metal. Good cond. Ea.	\$2.95
BC-375 TUNING UNIT: NEW! Excluding TU-5. ONLY	\$3.50

**METERS! OUR BARGAIN SPECIALS!**

0-200 amp. AC 4 in. rd. Weston. CT ratio 200:5. Only	\$4.50
0-100 VDC movement with 20-0-20 scale. 2 in. sq. Simpson. Used.	2.25
0-20 kilovolt DC 3 in. rd. Westinghouse. FS equals 1 ma. Use external multiplier. Only	4.95
0-25 MADC 2 in. rd. Weston.	2.99
0-2 amp. RF 2 in. rd. Thermocouple type.	2.99
0-9 amp. RF 2 in. rd. Westinghouse.	2.99

All orders F.O.B. Los Angeles. 25% deposit required. All items subject to prior sale.

**COLUMBIA ELECTRONIC SALES**

522 South San Pedro Street  
LOS ANGELES 13, CALIFORNIA

series with it, which affects the high frequency response and varies with each setting of the control. However, this may be tolerated if a wide frequency response is not important.

Following the combining or mixer tube is a master gain control, connected to a second triode stage, V<sub>4</sub>, which has a degenerative type variable equalizer in its cathode circuit. The output of V<sub>4</sub> may be connected to a phase-inverter tube or transformer for driving a push-pull output stage. The two inputs below the preamplifiers may be used for a radio or phonograph input.

The construction of such an amplifier and mixer requires very careful layout. The input and output leads are very high impedance and must be separated from a.c. circuits and from each other. The resistors R<sub>1</sub>, R<sub>2</sub>, R<sub>3</sub>, and R<sub>4</sub> will require shielding or they may pick up considerable noise. All leads must be kept as short as possible. A single-point ground system, with the ground terminal at the preamplifier cathode circuits, will generally produce the lowest noise level. The metal shields of all wires and tube envelopes must be returned to this point. If practicable, the power supply should be mounted on a separate chassis.

These mixer amplifiers are sometimes referred to as "electronic mixers." Compressor-limiter amplifiers used in the motion picture industry and described in Part 6 of this series are also known as electronic mixers, but these two devices should not be confused.

After a mixer of the low impedance type has been constructed, it must be "phased." Phasing a mixer means that if an instantaneous signal of a given "sign" is applied to the "high" side of each input, the same polarity signal will be obtained at the output of the device on a given terminal. To explain this more clearly, assume the mixer shown in Fig. 8A is to be checked for "phasing." Assuming "T" type attenuator pots have been used and the

Fig. 8. (A) Connections for phasing a mixer, and (B) for phasing an amplifier.

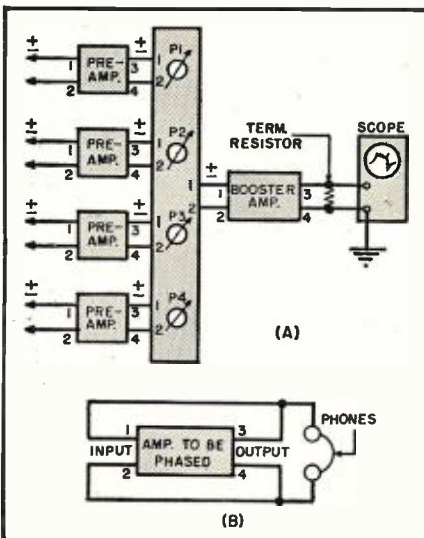

**NEW KLIPZONS** with Well Known SELF HOLDING points

The miniature TEST PROD, THAT'S A CLIP too!



**NOW!** The new LONGIE ADAPTOR



converts old style prods to the new self-holding type

**TYPE L Price 35c ea.**

The Longie Adaptor is especially designed for test work in miniaturized or deep, close packed chassis. The extra long, slender points have the unique self-holding jaw and a needle-sharp point for piercing insulation. The Longie fits over R.T.M.A. standard test points directly, and over phonograph needle type with special insert supplied.



**For A.F. and R. F. TESTING**

**TYPE S Price \$2.95**

KLIPZON Type S Shielded Leads provide a reliable means of piping audio or radio frequencies in lab or service work. Total capacity only 25 mmf. for 3 ft. length. Complete shielding of leads eliminates stray pickups, feed-back, etc.



**TYPE H Price \$2.50**

KLIPZON Type H Jumbo Heavy Duty Test Prods and Leads bring the self-holding feature to conductors as large as #4 B & S Ga. Points are needle-sharp, and protected with insulating sleeves. Provided with 4 ft. stranded copper poly-ethylene rayon leads, equivalent to 18 B & S Ga.

- AT YOUR RADIO PARTS DISTRIBUTOR
- Write for FREE FOLDER #16

**UNITED TECHNICAL LABORATORIES**  
Engineers • MORRISTOWN, N. J. • Manufacturers

**PICTURE TUBE REACTIVATOR**

Reactivates dim picture tube without its removal from cabinet. A real money maker for servicemen or contractors! Supply limited. Reactivator. \$27.50 net

**C. B. S. TYPE COLOR WHEEL**

Special: Color TV wheels. C. B. S. type. Precision made 16" diameter for 7" tube. 22 1/2" diameter for 10" tube. Wheels either size ..... \$17.95

F. O. B. New York—1/4 with order, balance C. O. D.

**ELECTRONIC VISION PROJECTION CO.**  
3492 Kingsland Avenue Bronx, N. Y. C.



mixer has been carefully wired so that the high sides of the mixer pots are all connected to the series building-out resistors, and the shunt arms connected to ground, it should be in-phase. This is best checked with an ohmmeter.

After the wiring has been checked for continuity, the preamplifiers are connected to the mixer inputs. Care must be taken that the output terminals of the amplifiers are connected to the mixer inputs in the same sequence; that is, the same amplifier terminals are connected to the same numbered mixer input terminals.

The "booster" amplifier is next connected to the mixer output and terminated in a load resistor. Across this resistor is connected the vertical input of an oscilloscope, as shown in Fig. 8A and the amplifiers are now "fired up."

The next step is to connect a microphone to the input of the number one preamplifier. A common door buzzer is placed in front of the microphone and set in operation. Number one mixer pot is opened until the buzzer waveform is seen on the scope. Note the pattern of the waveform. Buzzers usually have a very steep "lopsided" waveform. If it does not, the setscrew on the buzzer is adjusted until it does.

After the waveform has been adjusted, the waveform pattern is noted. Now, connect the same microphone to input number two and observe the waveform. It should appear the same; that is, the uneven side should be in the same relative position, either at the top or bottom of the oscilloscope pattern. If it is the same as for number one, position two is in phase with position one. This procedure is followed through for each position, and compared to number one position. If any position shows a "turnover" in the waveform pattern, it is out-of-phase.

Out-of-phase conditions are caused by turnovers in the mixer wiring, or a turnover in the connections to the internal input or output transformer in the preamplifier. Another cause is a reversal of the output transformer winding feeding the mixer input. Under no circumstances should the microphone leads be reversed during the tests, as this will reverse the phase of the microphone.

It is the practice in professional installations to keep all microphones and associated equipment throughout the whole system in phase relative to other parts of the system, and this is extremely important in film recording. Also, all microphones must be in-phase electrically, relative to each other. If not, serious distortion may result when making multiple microphone pickups when the microphones are within 10 feet or less of each other.

To phase two or more microphones, the mixer controls are set to their "off" positions. The microphones to be phased are placed side by side, and as some one speaks into them, the mixer control of the first microphone is opened and the pot adjusted to indicate a normal level, on the mixer vu meter.

November, 1951

# THE Aristocrat

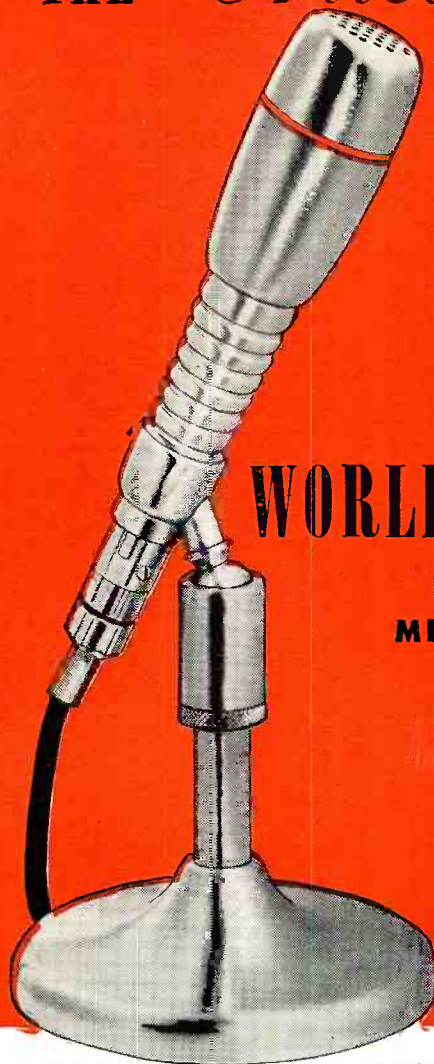

## WORLD'S FINEST

### DYNAMIC MICROPHONE

# THE TURNER COMPANY

900 17th Street N.E., Cedar Rapids, Iowa

IN CANADA:  
Canadian Marconi Co.,  
Toronto, Ont., and Branches

EXPORT:  
Ad. Auriema, Inc.,  
89 Broad Street, New York 4

## WANTED

HIGHEST PRICES PAID FOR SURPLUS EQUIPMENT PARTS AND TUBES. WE ARE ESPECIALLY LOOKING FOR END AND TEST EQUIPMENT SCR 300, 284, 269 COMPASS, SCR 274N. BC 610 COILS, BC 939A ANTENNA TUNING UNITS, BC 654, LOOPS LP21A, RECEIVERS BC 312, BC 342, BC 348, BC 221, RA 34.

**RADCOM ENGINEERING COMPANY**

8 LIVINGSTON STREET

NEWARK 3, N. J.



# the **chicago** V.T.V. . **ELECTRONIC MULTITESTER**

A versatile new Chicago Vacuum Tube Volt Meter with more ranges and greater utility—at the lowest price in the industry!

**\$39<sup>00</sup>**  
net



## RANGES

### DC VOLTS

0-5, 10, 50, 100, 500, 1000, 5000. Input impedance: 20 megohms (including 10 megohms in the DC probe)

### AC VOLTS

0-5, 10, 50, 100, 500, 1000, 5000  
Input impedance: 10 megohms

### OHMS

0 to 1000 megohms in 6 ranges with center scale readings of 10, 100, 1000, 10K, 1Meg., 10Meg.

### CAPACITANCE

50 MMF to 5000 MF in 6 ranges. Low voltage power source enables testing of electrolytic condensers.

### MILLIAMPERES

DC 0-1, 10, 100, 500

(Not electronic) 50 millivolt drop.

Operates on 115 V.A.C. Dimensions: 6 3/4" Wide x 9 1/2" High x 6" Overall Depth

The big 5 1/2" meter is mounted in a handsome brown Hammerloid case slanted for easy reading.

See Your Parts Distributor or Write for Complete Information

**CHICAGO INDUSTRIAL INSTRUMENT CO.**

536 W. ELM ST. • CHICAGO 10, ILL.



## What Do You Want to Trade In on a New hallicrafters?

I have a complete stock of Hallicrafters receivers and transmitters. We will give you the best doggone trade-in in the world because we need used receivers badly for our trade. What do you have? Write me about it. I give you prompt delivery, 90-day FREE service and the world's lowest credit terms. Write, wire, phone, or visit either store today for the best deal. Export orders solicited.

*Bob Henry*  
WPARA

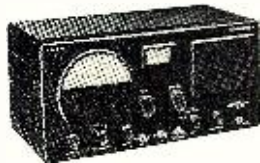

### MEDIUM PRICED HALLICRAFTERS MODEL S-40B

540 kc. to 43 Mc. Temperature compensated. One RF, 2 IF, 3-watt output, 4 bands. 115 V. AC. 7 tubes plus rectifier. Internal speaker. Only \$99.95. Other popular Hallicrafters models: S38-B, only \$49.50; S-72, only \$109.95; SX-62, only \$289.50.

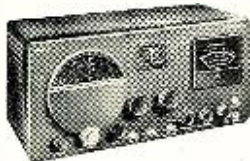

### NEW DUAL-CONVERSION RECEIVER HALLICRAFTERS Model S-76

Note these features: Dual conversion (1650 Kc and 50 Kc)—more usable selectivity than the best crystal. Giant 4-in. "S" Meter—calibrated in microvolts and "S" units. Four bands 538-1580 Kc, 1720 Kc to 32 Mc. Calibrated electrical bandspread. 5 position selectivity. Sensitivity 2 microvolts or better with 5 watt output. 9 tubes plus regulator, rectifier. \$169.50.

Buller 2, Missouri

**HENRY RADIO STORES**

11740 Olympic Blvd.  
LOS ANGELES 25  
CALIF.

"WORLD'S LARGEST DISTRIBUTORS OF SHORT WAVE RECEIVERS"

The output of the second microphone is adjusted in a similar manner, with the mixer pot of the first microphone closed. After obtaining a level for each microphone, both mixer pots are opened to their respective settings. The level indicated by the vu meter should increase. If the level drops, the microphones are out-of-phase with respect to each other. They may be brought into phase electrically by reversing the leads of one microphone. The same procedure is used for either pressure or ribbon types.

If a situation should arise where ribbon microphones are in use, and after going "on-the-air" it is discovered that one microphone is out-of-phase, it may be phased by reversing it mechanically 180 degrees with respect to the position of the other microphone and used in this manner until the program is over, then connected properly.

When two or more microphones are out-of-phase and are placed near each other, regardless of their type, the reproduction will become distorted, taking on a thin and nasal quality. This will also be accompanied by a loss in level. At times the level will approach almost a complete cancellation.

Generally commercial installations employ one of two standard "pin counts," either RCA or Western Electric, for connecting the microphone plugs. After repairs to either the microphone or cables, the phasing and continuity are checked.

Amplifiers, too, require phasing, and may be checked by connecting the input and output terminals in parallel with a set of headphones, as shown in Fig. 8B. If a high-pitched *squeal* or *no* sound is heard, the amplifier input and output are *out-of-phase*. If a low frequency "motorboating" (putt-putt) is heard, the amplifier is *in-phase*. Out-of-phase conditions may be corrected by reversing the internal or external leads to either the input or output transformers, but not both.

If, after correcting the phasing, an unsymmetrical signal is applied to the input, the signal waveform should appear in the same relative position for both the input and output. This method may be used for checking the phase relations throughout the whole system from microphone to recorder.

Manufacturers of equipment designed for recording purposes generally designate the "in-phase" terminals by a plus-minus sign ( $\pm$ ) over the terminal. It is also wise to consult the manufacturer's specification sheets to determine which terminals may be used, when grounding circuits. This is particularly important when applying a ground to the input or output stages of various filters, equalizers, and audio amplifiers.

Next month we will give details on typical recording laboratories found in the picture, disc, and broadcast fields along with information on the type of equipment used by such establishments.

(To be continued)





# TUBES

FROM **Niagara Radio Supply**  
 AT **50% TO 90% OFF**

RECEIVING	ALL NEW	BRANDED	GUARANTEED	2148	\$27.50	282A/B	\$8.25	902P1	\$11.50
00A	5Z3	6S7	12AW6	35V5	\$0.90	283A	9.95	905	3.75
00A2	5Z4	6S8GT	12AX7	35Z3	1.20	284D	7.50	918	1.50
0A3 VR75	6A3	6SA7GT	12AY7	3524GT	.75	286A	9.95	923	.99
0A4G	6A4/LA	6SB7Y	12B7	3525GT	.70	287A	2.75	927	1.25
0B2	6A5	6SD7GT	12BA6	3526GT	1.33	290A	4.95	931A	4.75
0B3 VR90	6A6	6SF5GT	12BA7	36	1.19	291A	4.95	954	.35
0Y4	6A7	6SF7	12B06	37	.84	295A	2.75	955	.40
024G	6A8GT	6SG7	12BE5	38	.64	294A	4.95	956	.40
01A	6AB4	6SG7	12BF6	39/44	.25	301A	5.95	957	.40
IA3	6AB5/6N5	6SH7GT	12BH7	40	1.10	304TH	19.50	958A	.40
IA4P	6AB7/1853	6SK7GT	12BK6	41	.94	304TL	19.50	967	4.95
IA5GP	6AC5GT	6SL7GT	12BN6	42	.78	307A	5.90	975A	12.95
IA6	6AC7/1852	6SN7GT	12B06	43	.78	310A	7.50	981	1.35
IA7GT	6AE6G	6SQ7GT	12BU6	45	1.00	311A	6.75	1603	5.00
IA85	6AF6G	6SR7GT	12C8	45/23	.54	316A	.50	1609	1.95
IA95	6AG5	6SS7GT	12C8	46/25	.88	327A	4.75	1613	.99
IB3GT	6AG7	6ST7	12D6	47	1.34	328A	13.75	1616	1.50
IB4P	6AH6	6SV7	12J6GT	48	2.40	331A	12.50	1619	.35
IB5/25S	6A15	6SZ7	12K7GT	49	2.40	335A	16.20	1620	4.75
IB7GT	6AK6	6T7G	12K8GT	50	2.48	340B	4.75	1621	1.20
IC5GT	6AL5	6U4	12K9GT	50A5	1.10	342B	2.00	1622	3.00
IC6	6AL7GT	6U5	12K06T	50B5	.99	343A	39.50	1623	2.00
IC7G	6A05	6U6GT	12K16T	50C5	1.00	344A	3.25	1624	1.50
IC8	6A05	6U7GT	12K26T	50C6G	1.45	345A	1.25	1625	.39
ID5GP	6A06GT	6V6GT	12K36T	5016GT	1.45	346A	.75	1626	.45
ID7G	6A07GT	6V6GT	12K46T	5016GT	1.10	347A	2.90	1629	3.39
ID8GT	6A08	6V7GT	12K56T	50Y6GT	1.00	348A	5.95	1630	.98
IE5GP	6A09	6V8GT	12K66T	50Y7GT	.90	349A	4.95	1631	.99
IE6GT	6A10	6V9GT	12K76T	50Z7G	.90	349A	6.95	1632	.75
IE7GT	6A11	6W4GT	12SH7GT	52	1.95	349A	2.50	1633	.65
IF4	6A12	6W5GT	12SJ7GT	53	1.33	400A	3.25	1634	.70
IF5G	6A13	6W6GT	12SL7GT	55	1.10	401A	1.95	1635	1.25
IF6	6A14	6W7GT	12SN7GT	56	.68	402A	8.95	1636	3.00
IF7G	6A15	6X5	12SN7GT	57	.98	432	4.75	1638	.50
IG4GT	6A16	6X5GT	12SR7GT	58	.98	446	4.75	1642	.65
IG5G	6A17	6Y3GT	12Z3	59	1.48	464A	12.95	1644	.90
IG6GT	6B5	6Y3GT	12Z3	60A7GT	1.95	527	12.50	1645	1.98
IH4G	6B6G	6Y6GT	14A4	70L7GT	1.95	527	4.95	1646	1.25
IH5GT	6B6G	6Y7GT	14A5	71A	1.88	532A	8.75	1654	2.00
IH6GT	6B8G	6Z4	14A6	75	1.00	532A	3.50	1665	1.25
IJ5G	6BA6	6Z7G	14A7	76	1.45	532A	17.95	1851	1.75
IJ6GT	6BA7	6Z7YG	14A8	77	.63	532A	6.95	1960	.70
IL4	6BC5	7A4	14A9	78	1.00	532A	9.95	2050	1.25
IL6	6BC7	7A5	14C5	79	1.33	532A	22.50	2051	1.30
IL7A	6BD5	7A6	14C7	80	1.20	532A	6.95	2050	1.25
IL8	6BD6	7A7	14E6	81	2.34	532A	4.95	2051	1.30
IL9	6BE8	7A8	14E7	82	1.28	532A	4.95	2051	1.30
ILC5	6BE8	7A9	14E7	83	1.60	532A	4.95	2051	1.30
ILC6	6BF6	7AD7	14F7	83V	1.60	532A	4.95	2051	1.30
ILD5	6BG6G	7AF7	14F8	84	1.10	532A	4.95	2051	1.30
ILE3	6BH6	7AG7	14H7	85	.90	532A	4.95	2051	1.30
ILG5	6BK6	7AH7	14J7	86	1.10	532A	4.95	2051	1.30
ILH4	6BL7	7AJ7	14K7	87	1.33	532A	4.95	2051	1.30
ILN5	6BL7	7AJ7	14L7	88	1.33	532A	4.95	2051	1.30
IN5GT	6BN6	7AU7	14M7	89V	1.60	532A	4.95	2051	1.30
IP5GT	6BQ6GT	7B4	14N7	90	1.33	532A	4.95	2051	1.30
IQ5GT	6BT6	7B5	14S7	91	1.33	532A	4.95	2051	1.30
IR4	6BU6	7B6	14W7	92	1.33	532A	4.95	2051	1.30
IR5	6BY5	7B7	14X7	93	1.33	532A	4.95	2051	1.30
IS4	6C5GT	7B8	14Y4	94	1.20	532A	4.95	2051	1.30
IS5	6C6G	7C4	15	95	.35	532A	4.95	2051	1.30
IS6	6C8G	7C5	18	96	.35	532A	4.95	2051	1.30
IT4	6CB6	7C6	19B6G	2.34	1.60	532A	4.95	2051	1.30
IT5GT	6CD6	7C7	19C8	1.60	1.60	532A	4.95	2051	1.30
IT6	6D6	7E5	19J6	1.60	1.60	532A	4.95	2051	1.30
IU4	6D8	7E6	19T8	1.45	1.45	532A	4.95	2051	1.30
IU5	6E5	7E7	22	1.10	1.10	532A	4.95	2051	1.30
IU6	6E6	7F7	22	.88	.88	532A	4.95	2051	1.30
IU7	6E7	7F8	24A	.85	.85	532A	4.95	2051	1.30
IU8	6E7	7G7	25A6GT	1.60	1.60	532A	4.95	2051	1.30
IU9	6F3GT	7H7	25A7GT	3.70	3.70	532A	4.95	2051	1.30
IW4	6F6GT	7J7	25A8GT	1.43	1.43	532A	4.95	2051	1.30
IW5	6F6GT	7K7	25B3	1.95	1.95	532A	4.95	2051	1.30
IX2	6F7	7L7	25B3	1.33	1.33	532A	4.95	2051	1.30
IX2A	6F8	7M7	25B6GT	1.60	1.60	532A	4.95	2051	1.30
2A3	6G6	7N7	25C6G	1.60	1.60	532A	4.95	2051	1.30
2A4G	6H4GT	7O7	25L6	1.60	1.60	532A	4.95	2051	1.30
2A5	6H6GT	7R7	25L6GT	.86	.86	532A	4.95	2051	1.30
2A6	6H6GT	7S7	25N6G	1.95	1.95	532A	4.95	2051	1.30
2A7	6J6	7V7	25S6	1.60	1.60	532A	4.95	2051	1.30
2B7	6J7GT	7W7	25W4GT	1.00	1.00	532A	4.95	2051	1.30
2E5	6J8	7X7	25Y5	1.45	1.45	532A	4.95	2051	1.30
2X2	6K5GT	7Y4	25Z5	.83	.83	532A	4.95	2051	1.30
2X2A	6K6GT	7Z4	25Z6	1.10	1.10	532A	4.95	2051	1.30
2Z2	6K7GT	10Y	25Z6GT	.75	.75	532A	4.95	2051	1.30
3A5	6K8GT	10Y	26	.49	.49	532A	4.95	2051	1.30
3A8GT	6L5	12A5	26BK6	.83	.83	532A	4.95	2051	1.30
3B7	6L6G	12A5	27	.30	.30	532A	4.95	2051	1.30
3C6/XXB	6L6GA	12A6	27	.25	.25	532A	4.95	2051	1.30
3D6	6L7	12A6GT	27	1.04	1.04	532A	4.95	2051	1.30
3E6	6N5	12A7	32	1.78	1.78	532A	4.95	2051	1.30
3LF4	6N5	12A8GT	32L7GT	1.59	1.59	532A	4.95	2051	1.30
3Q4	6N7GT	12A7GT	33	1.59	1.59	532A	4.95	2051	1.30
3Q5GT	6P5GT	12A5L5	34	1.78	1.78	532A	4.95	2051	1.30
3S4	6P7G	12A76	35/51	1.10	1.10	532A	4.95	2051	1.30
3V4	6Q6G	12A77	35A5	.90	.90	532A	4.95	2051	1.30
3Z4	6Q7GT	12A06	35B5	1.00	1.00	532A	4.95	2051	1.30
5A2A	6R7GT	12A07	35C5	1.00	1.00	532A	4.95	2051	1.30
5U4G	6R8	12A06	35L6GT	.89	.89	532A	4.95	2051	1.30
5V4G	6S4	12A07	35W4	.63	.63	532A	4.95	2051	1.30
5W4GT						532A	4.95	2051	1.30
5X4G						532A	4.95	2051	1.30
5Y3GT						532A	4.95	2051	1.30
5Y4GT						532A	4.95	2051	1.30

**Guarantee**  
 Niagara's Guarantee of Satisfaction  
 All Items must meet with full approval or money refunded.

ONE OF AMERICA'S GREAT RADIO STORES  
**Niagara**  
 RADIO SUPPLY CORP. Dept. R-11-1  
 160 Greenwich Street, New York 6, N.Y.

**NOTICE**  
 Minimum Order \$5.00 F.O.B. our N.Y.C. Whse. 20% Deposit if not rated. Prices Subject to Change Without Notice.



# AT LAST! TV RECEPTION UP TO 200 MILES

ON ACTUAL FIELD TESTS WITH  
**NEW DX630 CHASSIS**

will operate in fringe areas or in localities  
remote from TV broadcast stations  
up to 200 miles.

HAS 4 MICROVOLT SENSITIVITY—10 times any  
other TV receiver. Will pick up distant stations  
without use of boosters or special antenna arrays  
—and with less noise. Will operate any tube in-  
cluding 24", greater brilliance, improved keyed  
AGC circuit, (eliminating flickering and fading).  
Uses the best materials with a high factor of  
safety to insure trouble-free operation, STD.  
RTMA GUARANTEE free replacement of defect-  
ive parts or tubes for 90 days. Completely fac-  
tory wired chassis ready to operate with 12" P.M.  
Speaker.  
Price including excise tax. . . . . \$138.95

## TELEVISION PICTURE TUBES

Standard makes, 6 months guarantee, all prices  
include 10% excise tax. (See ad for prices.)

## TELEVISION CABINETS

We have a large variety of table model, consoles  
and combination cabinets DESIGNED TO PLEASE  
the most discriminating tastes. Beautifully fin-  
ished, mostly handrubbed available in mahogany,  
walnut, and blond colors. Table model (outside  
dimensions 23 3/4" x 24" x 24") price in mahogany  
for all sizes up to 20", including \$34.95  
mask, and 10% excise tax. . . . .

Extra for glass. . . . . \$2.75  
Console cabinet of beautiful design made of  
the finest veneers and good finish. Size 39" high  
x 24" wide x 22 3/4" deep finished. In mahogany  
or walnut. Cut for 630 chassis with 12" speaker  
will take either 16, 17, or 20" tube. \$43.95  
Price including mask and excise tax. . . . .

Extra for glass. . . . . \$2.75  
For the various other cabinets in our large selec-  
tion we will furnish photos and other NECESSARY  
INFORMATION, ON REQUEST. New Dumont  
conversion kit—see copy.

## TELEVISION COMPONENTS

Television 630 chassis pan all socket, transformer,  
etc. holes punched made of sturdy cad-  
mium plated steel. Size—16" x 17" x 3 1/2". \$3.95

## TELEVISION PICTURE TUBES

Standard Brands  
SIX-MONTH GUARANTEE

12 1/2" (Black or White) . . . . .	\$23.95	Glass 16" Round (Black) . . . . .	\$34.50
Glass 14" Rec- tangular (Blk.) . . . . .	\$23.50	Glass 16" Rec- tangular (Blk.) . . . . .	\$34.50
17" Rectangular (Blk.) . . . . .	\$31.95		
19" Round (Blk.) . . . . .	\$39.95		
20" Rectangular (Blk.) . . . . .	\$39.95		
24" Metal . . . . .	\$69.95		

## New—Dumont True Focus Conversion Kit

Convert your old set for even focus over entire screen!  
Dumont 70° Yoke, Model Y2A1—distributed  
winding . . . . . \$6.57  
Dumont 70° Flyback Transformer Model H1A1 . . . . . 6.57  
Dumont Linearity control—for above units . . . . . .75  
Dumont Width Coil for above units . . . . . .75

## TELEVISION COMPONENT SPECIALS

"Faster Than Hotcakes!"

That's how these original 13-channel RCA Tuners  
are selling. Uses 3—6J6 tubes. Sold as \$3.95  
is, less tubes and dial, only. . . . .

NEW DEFLECTION YOKE RCA 201DI,  
with network, only. . . . . \$1.95

NEW FOCUS COIL 240 Ohms, RCA  
type 202DI only. . . . . \$1.25

NEW PM/EM FOCUS COIL, 1200 ohm  
winding only . . . . . \$89

All Merchandise Subject to Prior Sale. All Prices  
Subject to Change without Notice.

WRITE FOR COMPLETE CATALOG EA-1

## EDLIE ELECTRONICS INC.

154 Greenwich St. New York 6, New York

# Technical BOOKS

"MOST - OFTEN - NEEDED 1951  
RADIO DIAGRAMS AND SERV-  
ICING INFORMATION" compiled  
by M. N. Beitman. Published by *Su-  
preme Publications*, Chicago. 192  
pages. Price \$2.50. Paper bound.

This is the eleventh volume in this  
series of handy service data books. Like  
its predecessors, this book contains  
circuit diagrams, alignment data, dial  
stringing information, tube and trim-  
mer location material, and other perti-  
nent facts for quick and easy servicing.

In addition to providing service data  
on 1951 model receivers, this latest  
volume includes a complete index of  
the ten earlier radio manuals as well  
as the company's five television hand-  
books.

\* \* \*

"TELEVISION PRINCIPLES" by  
Robert B. Dome. Published by *Mc-  
Graw-Hill Book Company*, New York.  
281 pages. Price \$5.50.

This is the third book in *McGraw-  
Hill's* television series and is a prac-  
tical exposition of the subject of tele-  
vision at an engineering level.

The material included in the text  
was originally presented as a graduate  
course for engineering students en-  
rolled in the *General Electric* cooper-  
ative educational courses. The same  
pedagogic pattern has been followed  
in committing this material to paper  
so that the text is entirely suitable for  
home study or self-instruction.

The author has pre-supposed a work-  
ing knowledge of a.c.-d.c. theory, radio  
frequency phenomena, circuits, vac-  
uum tubes, and a better-than-speaking  
acquaintance with calculus.

The text material is divided into  
eleven chapters covering the history  
and basic concepts of television, elec-  
tronic methods of scanning and repro-  
duction, video frequency amplifiers, ra-  
dio transmitting equipment, antennas  
for transmission and reception, r.f. in-  
put circuits and noise factors, i.f. am-  
plifiers, video second detectors, the  
scanning system, miscellaneous tele-  
vision circuits, and propagation and  
relays.

This book is ideally suited for the  
radio engineer or the engineering stu-  
dent who wishes to expand his working  
knowledge to include the field of tele-  
vision.

\* \* \*

"THE RADIO AMATEUR'S LI-  
CENSE MANUAL" by the ARRL  
Staff. Published by the *American Ra-  
dio Relay League*, West Hartford,  
Conn. 62 pages plus catalogue section.  
Price \$5.00. Paper bound.

This is the 27th edition of the  
ARRL's complete guide on preparing  
for FCC amateur license examinations.  
Completely revised and expanded, this  
newest edition has a new format.

Ten chapters of the new edition  
cover the six classes of amateur li-

"NO CO E-BACKS"  
when you REPLACE with

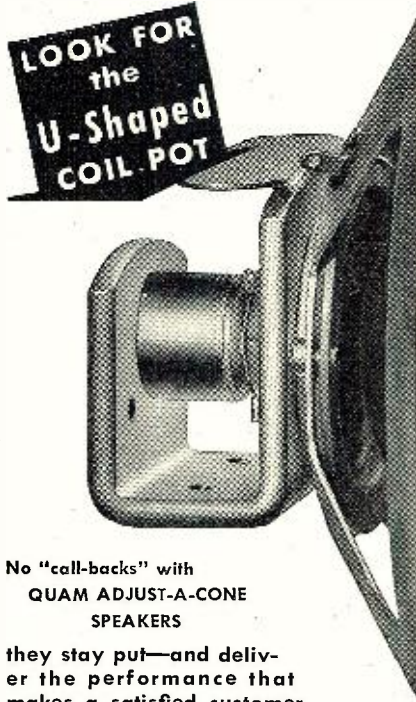

No "call-backs" with  
**QUAM ADJUST-A-CONE  
SPEAKERS**

they stay put—and deliv-  
er the performance that  
makes a satisfied customer.  
Quam Speakers are built right  
and designed right by the  
world's largest speaker manufac-  
turer—builders of the speaker that's  
first for Original Equipment—first in  
the Replacement Field.

Also makers of Quam  
Focalizer Unit & Ion Traps

## QUAM-NICHOLS COMPANY

522 E. 33rd Place, CHICAGO 16, ILL.

MAKERS OF QUALITY SPEAKERS FOR  
27 YEARS, UNDER THE SAME MANAGEMENT



Please send me FREE Jenselector. Picks the proper  
replacement needle.

Name \_\_\_\_\_  
Address \_\_\_\_\_  
City \_\_\_\_\_ State \_\_\_\_\_

Jensen Industries, Inc., 336 S. Wood St., Chicago 12

RADIO & TELEVISION NEWS



censes plus general information on ham licensing, portable and mobile operation, overseas licensing, international and U. S. regulations.

Each chapter which is devoted to a specific class of license has complete data regarding the material covered in the license and a group of typical questions with the acceptable answers.

A particularly valuable feature of the manual is the fact that the full text of the FCC rules governing amateur service has been included, along with editorial discussion of the various points covered.

With the recent changes in license classifications hams will undoubtedly want to avail themselves of the opportunity to secure a copy of this complete and up-to-date source of authoritative information on the subject.

\* \* \*

**"PRACTICAL ELECTRICITY AND MAGNETISM"** by Maurice Rubin. Published by *Chemical Publishing Co., Inc.*, New York. 314 pages. Price \$7.50.

As the title implies, this is a basic treatment of a basic subject. The author starts with a chapter on "electrostatics" which embraces a discussion of the electron, the nature of electricity, conductors and insulators, distribution of charges, condensers, etc.

In the seven succeeding chapters he covers currents, electrical meters and measurements, magnetism, photoelectric and thermionic emission, the electrical conductivity of gases, practical applications of electricity (transmission lines, lighting, communications, radio, television, radar, protective devices and measures in the application of electricity, and miscellaneous applications), and a summary of the recent developments in the electrical field.

While the text material becomes progressively more complex, the author's style remains lucid whether he is discussing the fundamental concepts of electron theory or discussing complex electronic equipment.

In this reviewer's opinion, this book would make an excellent text for classroom work or as a home study manual. With the sort of foundation this text provides the student should experience no difficulty in tackling more advanced concepts and equipment.

\* \* \*

**"BASIC RADIO COURSE"** by John T. Frye. Published by *Radcraft Publications, Inc.*, New York. 171 pages. Price \$2.25.

This text, written by one of *RADIO & TELEVISION NEWS'* most popular contributors, is truly a basic discussion of the why's and wherefore's of radio.

Written in the same breezy and informal style which characterizes Mr. Frye's "Mac's Radio Service Shop," this book is ideal for the student or the tyro technician. Stripped of all technical hocus-pocus, the subject of radio is presented by means of familiar, and sometimes frivolous, analogies. The author has deliberately avoided the mathematical approach to the subject

November, 1951

# In Stock at HARVEY'S

## 2 NEW RCA VOLTOHMYSTS



### NEW WV-77A JUNIOR

**An all-electronic ac-operated vacuum-tube volt-ohmmeter by RCA**

Using the famous Volt-Ohmyst electronic bridge circuit, 200-microampere meter movement, and carbon-film multiplier resistors, the WV-77A incorporates features you would expect to find only in more expensive instruments. Sturdily built and calibrated against laboratory standards.

#### As a DC Voltmeter

It measures dc from 0.05 volt to 1200 volts in five ranges. Uses 1-megohm resistor in isolating probe; probe has less than 2-uuf input capacitance. Has 11-megohm input; useful for measuring high-resistance circuits such as oscillator, discriminator, and avc.

#### As an AC Voltmeter

It measures ac from 0.1 volt to 1200 volts rms in five ranges. Uses high-impedance diode tube as signal rectifier. Frequency range is more than adequate for measurement of power line, audio, and ultrasonic frequencies.

#### As a wide-range Ohmmeter

The WV-77A measures resistance from 0.2 ohm to 1 billion ohms in five ranges. Required only 1.5-volt battery as burn-out protection in measuring such low-power elements as battery-type tube filaments.

The all-new RCA WV-77A Volt-Ohmyst comes completely equipped with probes and cables as illustrated.

LOW PRICED at Only **\$47.50**

### NEW WV-97A SENIOR

**Reads Peak-to-Peak Voltages Directly!**

The WV-97A has a range of usefulness extending beyond that of any other instrument in the field. Its quality, dependability, and accuracy make it a true laboratory instrument; it is exactly what is needed for television in the design laboratory, factory, and service shop.

#### TEN WAYS BETTER!

1. Directly measures complex waves from 0.2 volt to 2000 volts, peak-to-peak.
2. Has an over-all accuracy for dc measurements of  $\pm 3\%$  of full scale.
3. Measures DC voltages from 0.02 volt to 1500 volts.
4. Measures rms values of sine-wave voltages from 0.1 volt to 1500 volts.
5. Has 7 non-skip ranges for both resistance and voltage.
6. All full-scale voltage points increase in a uniform "3-to-1" ratio.
7. Frequency response flat from 30 cps to approximately 3Mc.
8. Negative-feedback circuit provides better over-all stability.
9. Fully enclosed metal case shields sensitive electronic-bridge from rf fields.
10. More convenient to use because of smaller size and new slip-on probes.

Complete with direct probe and cable, dc probe, ohms lead, ground lead, and slip-on alligator clip. ....only **\$67.50**

Telephone **(hr)** LUXEMBERG 2-1500

# HARVEY

## RADIO COMPANY, INC.

103 West 43rd St., New York 18, N. Y.

**VISIT THE AUDITORIUM**  
Come to and visit our new sound department. All these items are in stock and working. Arrive at 11:00 A.M.

**NOTE:** In view of the rapidly changing market conditions, all prices shown are subject to change without notice and are N.Y.C. prices. P.O.B., N.Y.C.



You'll find it  
**FASTER**  
in the  
**MASTER**

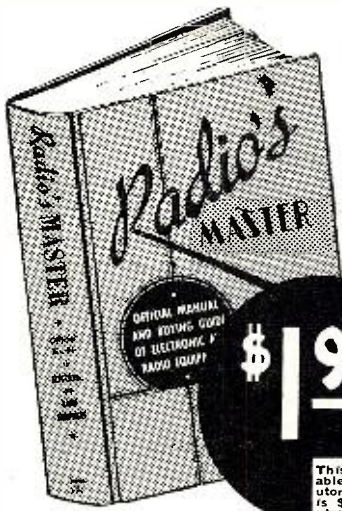

**\$1.95**

This special offer available ONLY thru Distributors (Publisher's price is \$6.50). The Distributors absorb the bulk of the cost for the privilege of printing their ad on the front cover.

No More  
Files of  
Small  
Catalogs and  
Loose  
Literature

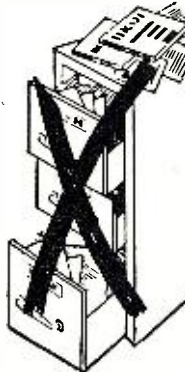

The Industry's OFFICIAL Buying Guide of Radio-Electronic-Television parts and equipment.

- 1100 Pages
- Hard Cover
- Permanently Bound
- Fully Indexed
- Over 75,000 Items
- Over 7000 Illustrations
- Weight—5 lbs.
- Size—8¼ x 10¾"
- Serving the Industry 16 years

When you **BUY--SELL--SPECIFY**  
you must have the **MASTER**

This single volume replaces all other small catalogs  
Over 90% of the products manufactured in the Radio-Electronic-Television Parts and Equipment Industry are catalogued in this BIG 1100 page MASTER Buying Guide. Complete descriptions, with specifications and illustrations are written and compiled by each manufacturer covering such products as: tubes, instruments, TV parts, transformers, capacitors, resistors, test equipment, relays, coils and antenna equipment. Also, recording and PA systems, intercoms, tools, hardware, switches and thousands of associated products. IT'S YOUR "RADIO BIBLE"—SAVES YOU TIME AND MONEY.

**BE MASTER-Minded—GET your copy NOW**  
-from local Distributor

**UNITED CATALOG PUBLISHERS, INC.**  
110 Lafayette St., New York 13, N. Y.

ONLY available thru Distributors at this special \$1.95 price

**LEARN**

**Television**  
**-Radio**  
**OR**  
**Electricity**  
IN THE GREAT SHOPS OF **COYNE**

**COYNE** **TRAIN QUICKLY!**  
**OLDEST, BEST EQUIPPED**  
**SCHOOL of ITS KIND in U.S.**  
*Young and Older Men*

Come to the Great Shops of Coyne in Chicago. Get practical training in TELEVISION-RADIO or ELECTRICITY—vital in Defense Program. Prepare now for a better job or better service rating.

**START NOW—PAY LATER**

You can finance most of your tuition, pay for it later in easy monthly payments. Special plan for men of Draft Age. Part time employment service available. **GI APPROVED**

**FREE BOOK** Clip coupon for Big Free Illustrated Book. Indicate below, course that interests you. No salesman will call. Act NOW.

An Institution not for Profit

**B. W. COOKE, Pres.**  
**COYNE Electrical & Television-Radio School.**  
500 S. Paulina St., Chicago 12, Ill. Dept. 81-85H

Send FREE BOOK and full details on:  
 TELEVISION-RADIO  ELECTRICITY

NAME.....  
ADDRESS.....  
CITY..... STATE.....

**SPECIAL**

1B3 .....	\$.95	6T7 .....	\$.90
6AL5 .....	.65	6T8 .....	1.25
6AU6 .....	.65	6W4 .....	.65
6BQ6 .....	1.20	12AT7 .....	1.10
6J6 .....	1.15	12AU7 .....	.90
6SN7 .....	.85	12BH7 .....	.95

**STANDARD BRANDS**

024 .....	\$.72	6AV6 .....	.70	12AT6 .....	.65
1B5 .....	.85	6BA6 .....	.75	12AV6 .....	.90
1S5 .....	.85	6BC5 .....	.95	12AV6 .....	.70
1U4 .....	.80	6BE6 .....	.80	12BA6 .....	.75
1U5 .....	.80	6BG6 .....	1.90	12BE6 .....	.75
1X2 .....	1.05	6BJ6 .....	.85	12K8 .....	1.00
3Q4 .....	.95	6BN6 .....	1.40	12SJ7 .....	.75
3V4 .....	.90	6CB6 .....	.90	12SA7 .....	.85
5U4 .....	.66	6CD6 .....	2.40	12SK7 .....	.80
5V4 .....	1.10	6HG .....	.85	12SN7 .....	1.00
5Y3 .....	.50	6J5 .....	.80	12SQ7 .....	.75
6AB4 .....	.95	6K6 .....	.80	19BG6 .....	2.40
6AC7 .....	1.16	6S4 .....	.80	25L6 .....	.80
6AG5 .....	1.06	6S47 .....	.80	35W4 .....	.65
6AG7 .....	1.25	6SH7 .....	.65	35Z5 .....	.65
6AH6 .....	1.60	6SK7 .....	.75	47 .....	1.10
6AK5 .....	1.55	6V6GT .....	.80	50B5 .....	.90
6AQ5 .....	.85	6W6 .....	.90	50C5 .....	.90
6AR5 .....	.75	6X5 .....	.60	50L6 .....	.80
6AT6 .....	.70	6Y6 .....	.95		

Order other types not listed, our prices are lower!

**SPEAKERS (Alnico #5)**  
4" PM.....\$1.29 5" PM.....\$1.49

**OUTPUT TRANSFORMERS** 45c ea.  
50L6—6K6—3S4—3V4 .....

**MINIATURE I.F. TRANSFORMER** 59c ea.  
456KC—comp. w/clip. Input—Output .....

**DIAL LAMPS** \$4.95 per 100  
# 47 G.E.—10 to box..... 55c  
1 box .....

**ALLIANCE 3-SPEED PHONO MOTOR** \$5.49  
Complete with turntable (Special) .....

**3-TUBE PHONO AMPLIFIER**  
With tone and volume controls—uses  
128Q7—50L6—35Z5. Less tubes .....

**SELENIUM RECTIFIER (Top Quality)**  
Full Wave Bridge Types  
Up to 18 v. in/up to 28 v. out. Up to 36 v. in/up to 36 v. out.

2 amp. ....	\$2.50	2 amp. ....	\$ 3.25
4 amp. ....	3.75	4 amp. ....	6.00
10 amp. ....	6.00	10 amp. ....	12.00
12 amp. ....	7.75	12 amp. ....	16.00

Power Supplies Built to Order—"FAST SERVICE"

All TV Antenna & Accessories in Stock  
SEND FOR COMPLETE CATALOG  
TERMS: 10% deposit with order. Balance C.O.D.  
F.O.B. N.Y.C.—Minimum order \$5.00.

**ATLAS TEL-RAD PARTS**  
153 CHAMBERS ST., DEPT. RN-11, NEW YORK 7, N.Y.  
Phone HAnover 2-5813

and has rigorously adhered to the practical aspects of the topic.

The book is divided into twenty-six chapters, each of which is a practical exposition of some phase of radio theory or servicing technique. Simple circuit diagrams are included where they are necessary to explain some point under discussion and enough photographs are reproduced to enable the student to become familiar with the various parts he will encounter in radio servicing.

We believe our readers will enjoy this little book and profit from its common-sense approach to the servicing of radio receivers.

\* \* \*

**"TELEVISION TUBE LOCATION GUIDE"** by the Sams Staff. Published by Howard W. Sams & Co., Inc., Indianapolis. Price \$2.00. Paper bound.

This is the second volume of the "Television Tube Location Guide" series and covers receivers produced since the appearance of the first volume and certain earlier receivers that were not included in the original publication.

This volume carries a complete index covering both books. Like the previous volume the receivers are listed by make and model number and then the appropriate diagram is indicated and the company's "Photofact" folder number listed.

The book itself carries over two hundred top chassis diagrams showing the location of the various tubes used in the television receiver circuits. In use, the technician simply looks up the make and model of the receiver he is working on in the index, finds the appropriate diagram for that set, and then proceeds to check the tubes involved in that particular circuit.

-30-

**STOP RECTIFIER HASH**

By SOL DAVIS, W9ZIW

I HAVE found that in any rig using 836's as rectifiers it is virtually impossible to eliminate all of the r.f. hash caused by the ionization of the mercury vapor in the rectifier tubes. Preventative measures ranging all the way from hash filters to complete shielding haven't been too successful.

With my 2000 volt power supply, I decided to change the rectifier tubes to 836's—an almost identical tube to the 866 with the exception that the inverse peak is 5000 volts instead of 10,000 and the 836's are vacuum types. This change eliminated all of my troubles and without making any changes in the original hookup. The 836's are currently available from surplus sources at very low cost.

The filaments of the 836's are rated at 2.5 volts, 10 amperes. Hams working fone exclusively will probably not be bothered by the hash, but for the c.w. boys this is an ideal way of increasing break-in operation efficiency because the "B+" primary does not have to be opened to cut the interference.

One caution, however. The filaments of the 836's should be allowed to heat for at least 40 seconds before the plate voltage is applied.

-30-



## ILLINOIS ELECTROLYTIC CAPACITORS

of "Time Tested Quality"

FOR EVERY ELECTRONIC APPLICATION

Seventeen years of production experience, making millions of quality capacitors, has created this complete, outstanding ILLINOIS CONDENSER line. There's a full Jobber line of capacitors for every TV and radio replacement purpose; capacitors for the entire electronics industry—capacitors that meet the highest standards of dependability.

This engineering and manufacturing experience enables ILLINOIS CONDENSER COMPANY to meet every demand for new capacitor types, whether for peace or defense applications.

Write for catalog or tell us your needs. There is an ILLINOIS ELECTROLYTIC CAPACITOR exactly suited for the job—a capacitor of "Time Tested Quality."



**ILLINOIS CONDENSER CO.**  
1616 NORTH THROOP STREET • CHICAGO 22, ILL.

EXPORT DIVISION:  
15 Moore St., New York 4, N. Y., U.S.A.  
CABLE ADDRESS: "MINTHORNE"

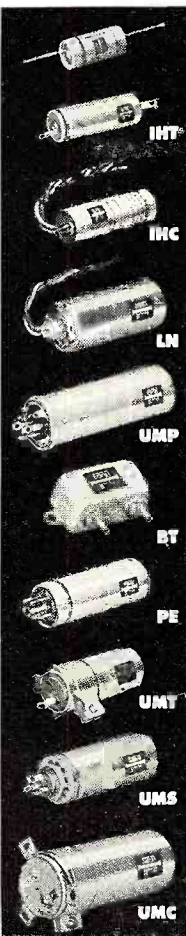

# Magic tools

for that "professional touch"

## WALSCO

TV & radio alignment tools

WALSCO quality-built alignment tools give the technician the most complete line of precision instruments for every receiver. Ask your parts jobber for WALSCO tools. Fully guaranteed.

1. Combination hex stud and small screwdriver for I.F. alignment on Zenith, Hoffman, Belmont, and similar T.V. sets. Molded of toughest, pure nylon. Catalog No. 2526.
2. Tough, extra long (12") front-end aligner for Admiral, Emerson, RCA, etc. Replaceable nylon tip. Catalog No. 2523.
3. Duplex I.F. aligner with recessed blades. One side for #6, other side for #4 studs. Unbreakable plastic. Catalog No. 2519.
4. Short (2") I.F. tool with recessed blade. Perfect for cramped quarters.

WRITE FOR WALSCO CATALOG

**WALSCO** Walter L. Schott Co., Beverly Hills, Calif. • Chicago 6, Ill.

$1 \times \text{BTA} = 12 \times \text{Ord U}^*$

Blonder-Tongue Home Antensifier Model HA-2-M

TV boosters and master antenna systems

\*One Blonder-Tongue antensifier replaces 12 ordinary boosters. Automatically amplifies all channels 16 times

BLOUNDER-TONGUE LABORATORIES • 38 n. second ave., mt. vernon, n. y.





# LEARN Radio-TELEVISION

Through This  
**UNIT CHASSIS SYSTEM**

The exclusive "Unit Chassis System" of teaching television was developed at this 48-year-old College of Electrical Engineering. The TV set is divided into stages on separate chassis. You study one stage at a time, intimately learning the functions of every component of all types and makes of receivers. You are fully prepared to cope with future design changes, including the advent of color television. By enrolling NOW you will be ready for engineering employment opportunities predicted to reach a new high level in 1954.

## You can become a Radio Technician in 12 months

The first third of the College of Electrical Engineering program trains you for such positions as Radio Shop Operator or Serviceman, Supervisor of Service Personnel. The Radio Technician's certificate is awarded. You may then advance immediately or at a future date into courses described below.

## Radio Television Certificate in 6 additional months

Be prepared for such work as Radio TV Service—Audio, Transmitter or Communication Technician—and Broadcast Operator (upon passing FCC examination).

## Also Your Technician Courses are credited toward the B. S. Degree in ELECTRICAL ENGINEERING

The Radio Technician course, while complete in itself, is one-third of the college program (major in electronics). Further, you may select as an elective: design, research, manufacturing and production, or engineering sales and management.



B. S. Degree in 36 months. Military, practical or prior academic, training evaluated for advanced credit. Terms open January, April, July, October.

# MILWAUKEE SCHOOL of ENGINEERING

Technical Institute • College of Electrical Engineering

FREE—Write for "Occupational Guidance Manual" and 1951 Catalog.



MILWAUKEE SCHOOL OF ENGINEERING  
Dept. RN-1151,  
1025 N. Milwaukee  
Milwaukee 1, Wis.

Without obligation, mail  Your Career Bulletin,  1951 Catalog,  Occupational Guidance Manual  Electrical Engineering, B. S. Degree in  Electronics  Electrical Power. Also bulletin on  Electrical Service  Welding  Refrigeration, Heating, Air Conditioning.

Name.....Age.....  
Address.....  
City.....State.....  
IF VETERAN, INDICATE DATE OF DISCHARGE

## Tricolor Tube

(Continued from page 54)

flat glass plate. The aperture mask is likewise a flat metal plate. From present day "flat-face" picture tubes we know that special steps must be taken to obtain good focus over the entire screen since the focal point of the beam describes a circular arc, resulting in good focus either at the center or at the edges. In black and white TV tubes the screen is not quite flat and with a high second anode voltage a fine enough beam can be obtained to give fairly even focus over the greater portion of the screen. The so-called anastigmatic, cosine, or true-focus type deflection yokes provide some correction for this condition. In the tricolor tube this condition is far more serious. The screen as well as the aperture plate is flat and any change in focus or convergence will at once affect the color reproduction. For example, if the three electron beams have different diameters due to mis-focusing, electrons will strike adjacent color dots as well as the correct one. Then when a pure green is desired, a mixture of all three colors will appear. If no correction is provided, color impurities will appear either at the edges or in the center of the screen.

The deflection yoke used for the tricolor tube contains some correction due to its coil design. Additional correction is achieved by superimposing a suitable a.c. voltage on the focusing and convergence elements. This voltage varies with the sweep and will increase the focal length as the electron beams are deflected from the center to the edges. In actual practice this correction voltage is obtained from the horizontal and vertical sweep circuits and is in the form of a parabolic wave, approaching the appearance of a sine wave, except that the valleys are larger than the peaks. To get this type of waveform and apply it in proper amplitude to the focus and convergence elements, separate "dynamic" focus and convergence circuits are used. As shown in the block diagram of Fig. 6, separate sections are used for the focus elements and for the convergence elements. The three focusing elements use a d.c. voltage of about 3 kv., controlled by three separate potentiometers. The dynamic focusing voltage is superimposed on each focusing element through a coupling condenser from the dynamic focusing section. Both vertical and horizontal dynamic focusing transformers are used, fed by an amplifier and wave shaping circuit. Since all three convergence elements are joined together, the dynamic convergence voltage is superimposed by a single coupling condenser. As mentioned before, the d.c. voltage on the convergence element is about 9 kv., therefore a much greater correcting voltage must be supplied than to the focus elements. Again vertical and horizontal dynamic convergence trans-

### SPEAKERS

**12" PM, RCA, Alnico V \$3.95**  
magnet, VERY SPECIAL

6" PM Alnico V magnet. \$1.99  
5" PM Alnico V magnet. 1.79  
4" PM Alnico V magnet. 1.49

**WALL BAFFLES—**  
Hand-Rubbed 8" \$3.69  
Mahogany 10" 3.99  
12" 4.99

### WESTINGHOUSE RCA MULTI-RANGE METER

for RCA Advanced VoltOhmyst or Battery VoltOhmyst  
0-200 MICROAMPS

4 scales—ohms, milliamps, VDC, VAC, 2-color scale, 4 1/2" square meter, calibrated, sealed and made specifically for RCA VTVM.  
BRAND NEW.....

**\$12.95**

**METERS**

7 1/2" 0-200 Microamp Meter made for VTVM, 5 scales—ohms, DCV, ACV, Kilovolts.....	\$17.95
Triplet Milliammeter—Model 327A, 3" square, 0 to 3 mils DC.....	3.95
Simpson 2 1/2" round RF Ammeter, 0 to 8 amps RF, Type 1S-89.....	3.49
Weston Model 507, Thermocouple 0 to 4 amps RF.....	3.95
Weston Model 731, 0 to 5 amps, DC, white face, 3" square.....	5.95
Weston Model 731, 0 to 1 amp, DC, white face, 3" square.....	5.95

### OIL-FILLED CONDENSERS

Made by Nationally Known Manufacturers  
10 mfd, 600VDC, 220 VAC.....ea. 99¢

Write for Quantity Prices

### RELAYS

6VDC—DPDT-SPST, Automatic Electric, 18 ohms.....	\$2.95
12VDC—DPST, LEACH 1054SN, contacts rated at 20 amps.....	2.95
24VDC—DPST, LEACH 1024, 265 ohms.....	2.59
27VDC—DPDT, ALLIED Type B.....	1.89
125VDC—DPST-SPDT, LEACH 1054, 10,000 ohms.....	3.29
Sensitive SPDT, SIGMA, 8000 ohms.....	2.95

### HEADSETS

600 ohm impedance, complete with headband, plug, etc.  
Made by Telephonics.  
Reg. value \$5.95.....

**\$2.95**

### G.E. OUNCER TRANSFORMERS

Same as UTC, O1, Mike, pickup, or line to 1 grid. Pri. impedance 50, 200/250, 500/600. Sec. impedance 50,000 ohms. High fidelity 40-15,000 cycles.....

**\$3.95**

### TRANSFORMERS

Ferranti—pri. 110v, sec. 24v @ 2 amps.....	\$1.79
G.E.—pri. 110v, sec. 10v @ 12 amps.....	4.95
Hermetically sealed, pri. 115V-230V; sec. 1.5v, 30.5, 33.5, 36.5, @ 5 amps.....	3.95

### CARTER DYNAMOTOR

Stock No. 4037A5  
DC input 6VDC; output 400 V @ 375 mils DC. Perfect for mobile communications in car, plane or boat. BRAND NEW.  
List \$71.40. Our Price.....

**\$34.95**

TERMS: 20% cash with order, balance C.O.D. unless rated. Prices F.O.B. our warehouse in N. Y. C. Minimum order \$5. NOTE: Due to conditions beyond our control, prices are subject to change.

Phone WOrth 4-3270  
**ACORN ELECTRONICS CORP.**  
76 Vesey St., Dept. N-11, New York 7, N. Y.

## EASY TO LEARN CODE

It is easy to learn or increase speed with an Instructograph Code Teacher. Affords the quickest and most practical method yet developed. For beginners or advanced students. Available tapes from beginner's alphabet to typical messages on all subjects. Speed range 5 to 40 WPM. Always ready—no QRM.

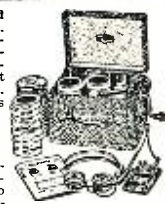

**ENDORSED BY THOUSANDS!**  
The Instructograph Code Teacher literally takes the place of an operator-instructor and enables anyone to learn and master code without further assistance. Thousands of successful operators have "acquired the code" with the Instructograph System. Write today for convenient rental and purchase plans.

**INSTRUCTOGRAPH COMPANY**  
4711 SHERIDAN ROAD, CHICAGO 40, ILLINOIS

**RADIO & TELEVISION NEWS**



formers are used together with wave shaping circuits and suitable amplifiers. While this article is not concerned with actual circuitry we should point out that no radically new principles are involved in either the dynamic focus or convergence sections. RC wave shaping networks are used to change the saw-tooth voltages from the horizontal and vertical sweep sections and regular amplifiers, usually class A1, are used to obtain proper amplitude.

In addition to the problems due to a flat screen, the three cathodes and control grids must be connected in a certain way. Individual brightness and contrast controls must be provided with the understanding that equal amounts of red, green, and blue light do not produce white. White is obtained when *effectively* equal amounts of the three primary colors are present. The effective value, for example, of 1 watt of blue light is not nearly the same as for one watt of green light. To set up the tricolor tube for proper color balance, a black and white signal should be used. Each brightness control is then adjusted until a fairly pure white is obtained. When the d.c. voltages are then measured it will be found that the three electron guns have entirely different bias voltages between their respective grids and cathodes.

The mounting of the tricolor tube also presents something of a problem. A special plastic jacket and ring must be used since the regular ones do not fit this longer shell with the extra flange. The mounting of the deflection yoke must permit free access and movement for the Mumetal correction tabs, while the color purity coil is not supported by any external bracket. Thus it becomes apparent that the only firm grip on the tube can be exercised at the metal shell which is at a high potential and must be insulated. Most plastic insulating material is either quite brittle and cannot take much of a load, or else it is not hard enough to retain its shape under pressure. There is no doubt that by the time tricolor tubes are in commercial TV receivers a good solution will be available for the mounting problem.

Up to now we have discussed the internal structure, the operation, and special problems concerning the RCA tricolor tube. We have omitted one very important point. How does the tricolor tube obtain its color signals? Is it absolutely necessary that the RCA all-electronic system of color TV be used with this tube? Well, it is not. The tricolor tube could be used with the CBS or any other color TV system, but entirely different components would have to be developed for the sweep and dynamic focus and convergence circuits. The full capabilities of the tricolor tube would not be employed in the CBS system, mostly because the resolution detail and color fidelity inherent in the CBS system are not nearly as good as the tricolor tube itself can reproduce. Designed for a 525 line picture, the tricolor tube

November, 1951

# Put across that PERSONALITY WITH AN E-V MIKE

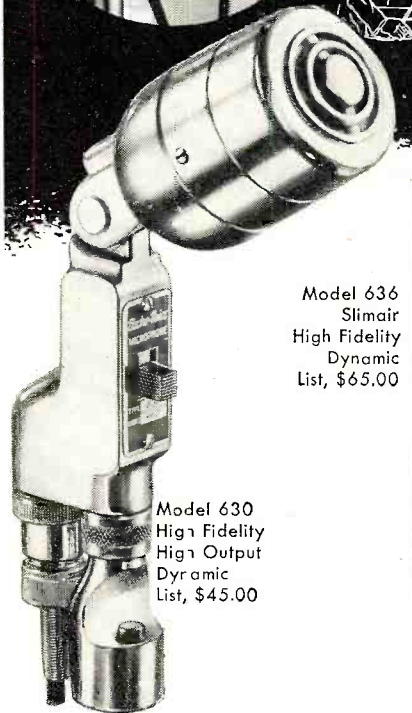

Model 630  
High Fidelity  
High Output  
Dynamic  
List, \$45.00

Model 636  
Slimair  
High Fidelity  
Dynamic  
List, \$65.00

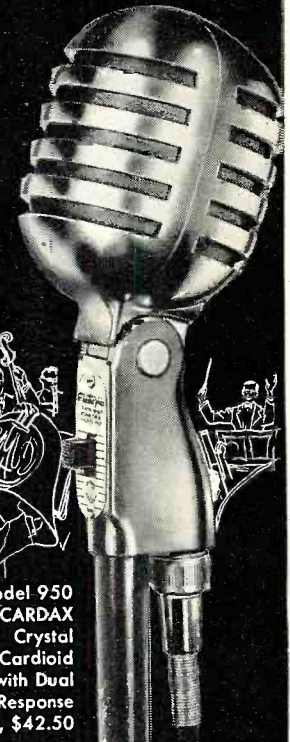

Model 950  
CARDAX  
Crystal  
Cardioid  
with Dual  
Response  
List, \$42.50



Authorized  
Distributors  
Everywhere

## REPRODUCE VOICE AND MUSIC... ACCURATELY!

The microphone makes a difference in the sound you hear! As a radio ham, sound specialist, or home recording fan, you are certain to reproduce the individual quality and personality of speech or song or orchestral music... with a *research-engineered* E-V mike! Send today for illustrated bulletin.

NO FINER CHOICE THAN

# Electro-Voice

410 CARROLL STREET • BUCHANAN, MICHIGAN  
Export: 13 East 40th St., New York 16, N.Y., U.S.A. Cables: Arlab  
MICROPHONES • HI-FI SPEAKERS • TV BOOSTERS • PHONO CARTRIDGES

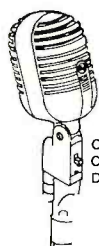

CARDYNE  
CARDIOID  
DYNAMIC

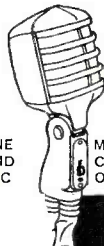

MERCURY  
CRYSTAL  
OR DYNAMIC

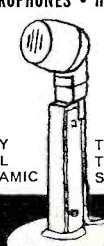

TOUCH-  
TO-TALK  
STAND



MOBIL-MIKE  
CARBON OR  
DYNAMIC

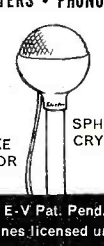

SPHEREX  
CRYSTAL



CENTURY CRYSTAL  
OR DYNAMIC

E-V Pat. Pend.

Crystal microphones licensed under Brush Patents



# 3 New Custom-Built Deluxe TV Chassis by TECH-MASTER

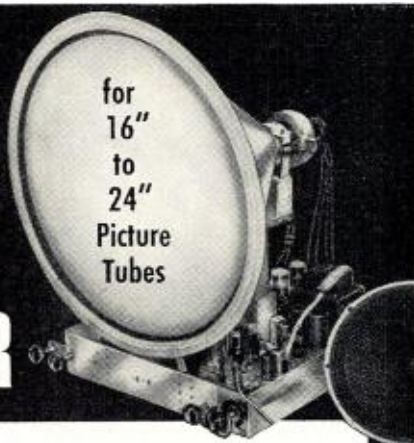

**MODEL 2430**—Designed specifically for all picture tubes requiring from 65 to 70 degrees horizontal deflection, (such as 24AP4, 20CP4, 19AP4, etc.) Supplied with 5X7 speaker and Universal Picture Tube Mounting Brackets. .... \$189.50

**MODEL 2431P**— Similar to model 2430, but with Push-Pull Audio, Phono Jack, 12" PM Speaker and Universal Picture Tube Mounting Brackets. .... \$199.95

**MODEL 2431C**— Basically same as Model 2430 but with Continuous Tuner, Push-Pull Audio, Phono Jack, 12" PM Speaker and Universal Picture Tube Mounting Brackets. Allows complete coverage of both TV and FM bands. .... \$199.95

The new **Gold Medal Series** incorporates all the latest Tech-Master features which have made this improved 630 type chassis the standard by which custom-built TV is measured... performance and service are assured because Tech-Master design and construction are as fine as human hands and brains can produce. All chassis are supplied completely wired, aligned and tested with all tubes (less picture tube).

**LOOK** for your Tech-Master registration and guarantee card attached to each chassis... it is your assurance that you are buying a genuine Tech-Master receiver.

See the Gold Medal Series and other quality Tech-Master products at your favorite Radio Parts Jobber or write direct to Tech-Master Products Co. Dept. RN-11 for complete descriptive literature.



**TECH-MASTER PRODUCTS CO.**  
443-445 Broadway • New York 13, N. Y.

Are You Missing This "Plus" Business?



Sell Extension Speakers, when you install TV in Bars, Cocktail Lounges, Etc.

There are additional profit possibilities in every commercial TV installation, when you sell the advantages of extension speakers—and LOWELL Speaker Baffles! Many Bar and Restaurant owners are now buying larger TV screens, to provide good visibility for more patrons; be sure you emphasize the importance of extending the sound range too!

Lowell Extension Speaker Baffles are ideal for the purpose—easily installed, low in price, attractively designed and finished in any colored lacquer to match surroundings. Lowell Speaker Baffles assure UNIFORM SOUND REPRODUCTION in all directions, give excellent low level response, have "floating conical action." Lowell Baffles are available in all sizes from 6" thru 15", in AL (for low ceilings) and BL (normal ceilings) Models, shown above.

For complete details and prices, write for new catalog covering complete line of Lowell Baffles, for all sound installations.

**Lowell Metal Products Corporation**  
1531 Branch Street, St. Louis 7, Mo.

## THE JUNIOR SUPER-METER

The most complete and compact multi-service instrument ever designed!

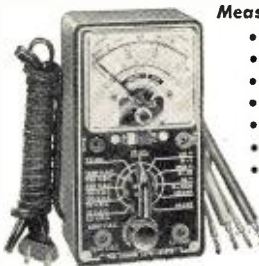

Measures:

- Voltage
  - Current
  - Resistance
  - Capacity
  - Reactance
  - Inductance
  - Decibels
- Plus Good-Bad scale for checking the quality of electrolytic condensers.

**Specifications:**

D.C. Volts: 0-7.5/75/150/750/1500 Volts.  
A.C. Volts: 0-15/150/300/1500/3000 Volts.  
Resistance:  
0-10,000/100,000 ohms. 0-10 Megohms.  
D.C. Current: 0-7.5/75 Ma. 0-7.5 amperes.  
Capacity: .001 Mfd.—.2 Mfd. .1 Mfd.—20 Mfd.  
Electrolytic Leakage: Reads quality of electrolytics at 150 Volt test potential.  
Decibels: -10 Db. to +18 Db. +10 Db. to +38 Db. +38 Db. to +58 Db.  
Reactance: 15 ohms—25 K ohms 15 K ohms—2.5 Megohms.  
Inductance: .5 Henry—50 Henries 30 Henries—10 K Henries.

Handsome round cornered molded bakelite case 3 1/8" x 5 7/8" x 2 1/4" complete \$21.40 with all test leads and instructions.

**SOLD ON EASY PAYMENTS AT THE NET CASH PRICE**

No interest or carrying charges added. Simply remit \$5.40 with order, pay balance \$4.00 per month for four months.

MOSS ELECTRONIC DIST. CO., INC.  
Dept. B-1, 38 Murray St., New York 7, N. Y.

naturally will not give as much detail and clarity when used for only 405 lines of picture information as achieved in the CBS color TV standards. But it is possible to use the tricolor tube in either system of color TV. In the case of the field sequential system, the one now practiced by CBS, only one color gun is in operation during an entire frame. Instead of rotating colored filters in front of the screen, each color electron gun "paints" an entire picture while the other two are cut-off. The same sequence of red-green-blue as used in the color disc will be used in cutting-off the three different electron guns. In any of the all-electronic color TV systems all three colors are scanned at the same time and a sampling device acts as a rotating switch and transmits a small dot of each color in turn. As we know, the tricolor screen is made up of many small dots of the three primary colors and therefore when a "dot sequential" system of color TV is used with it, the best results will be obtained.

### Basic Receiver

At the time of writing no commercial receivers are being made with the tricolor tube. Experimental sets, laboratory samples, and breadboard models are, however, under test in many TV engineering departments. While no definite design has been evolved, certain basic requirements are already known. Depending on the final outcome of the color controversy and the standards agreed upon with the FCC, the receiver outlined in Fig. 6 will give our readers a fair idea of what is involved. This receiver is predicated on some type of dot-sequential system, although it could also be used in the field-sequential CBS system provided the box marked "sampler" contains a field-sequence rate electronic switch.

At first glance the block diagram in Fig. 6 may appear involved and complicated, but actually it contains most of the usual black and white TV sections plus a few special ones for the tricolor tube. The antenna, r.f., and i.f. sections hardly need explanation. They will be identical to those used in present TV sets, with emphasis on good bandwidth to accommodate the color subcarrier (3.58 mc. in the RCA system). The detector and video amplifier will also be very similar to those now used, but again the video frequency response will be quite important. If a dot-sequential system is used with the "mixed highs" feature, a linear response up to 3.8 mc. will be required.

Three separate video amplifiers are required, one for each primary color. Each amplifier must be linear, frequency corrected, and have its own independent gain control. In addition, each amplifier must be controlled by the sampler. This section is keyed by the color synchronizing signal, a burst of 3.58 mc. in the RCA system, which is superimposed on the blanking porch of the regular horizontal synchronizing pulses. It is the job of the sampler unit to permit only one electron gun at





### PRECISION RESISTORS

1.01	12S	2230	30000
3	150	4300	33000
5	200	5000	35000
5.05	230	7500	40000
10.1	300	8500	50000
18	430	10000	55000
43.5	468	12000	57000
50	800	17000	75000
75	920	17300	We ship
82	1000	20000	type in
120	1100	25000	stock
125	1450		
Above Each	30c	Ten for	\$2.50
100000		150000	200000
120000		170000	220000
Above Each	40c	Ten for	\$1.50
1,000,000 ohms			Each 75c

### AUDIO TRANSFORMERS

AT-666	Intercom Input; Spkr. (-4-8 ohms) to Grid (250,000 ohms)	50.69
AT-415	Plate (18,000 ohms C.T.) to Line (125 ohm) 175 Watts—500-600 Cy	1.95
AT-858	Plate (10,000 ohms C.T.) to Line & V.C. (500/125/30 ohms) HI-FI—50W	6.95
AT-070	Mike-or-Line (250 ohms) to Grid (250,000 ohms C.T.)	1.29
AT-765	Mike-or-Line (600 ohms) to Grid (50,000 ohms C.T.)	.89
AT-449	HI-FI Driver (5000 ohms) 100-10,000 Cy. 10 Watts. 6V6 to PPS05's	2.39

### 400 CYCLE TRANSFORMERS

Stock #	Rating	Price
352-7098	2500V/6 MA. 300VCT. 135 MA.	\$5.95
KS-9336	1100V/50 MA. Tapped 625V 2.5V/5A	3.95
KL-7474319	6.3V/2.7A. 6.3V/.66A. 6.3VCT/2A	4.25
KS-8984	27V 4.3A. 6.3V/2.9A. 1.25V/.02A	2.95
52C-080	526VCT/50 MA. 6.3VCT/2A. 5VCT/2A	3.75
32332	400VCT/35 MA. 6.4V/2.5A.	3.85
68G631	6.4V/1.5A	2.75
80G198	1150-0-1150V/3.6 MA	1.75
D-167254	6VCT. 00006 KVA	2.79
302433-A	6.4V/8A. 6.4V/1A	4.85
KS-9445	6.3V/9.1A. 6.3VCT/6.5A. 2.5V/3.5A. 2.5V/3.5A	5.39
KR-0685	592VCT/118 MA. 6.3V/8.1A. 5V/2A	4.79
70G30G1	6.4V/7.5A. 6.4V/3.8A. 6.4V/2.5A ALL CT	2.65
600VCT/36 MA		

MANY OTHERS IN STOCK

### MICROWAVE TUBES

Tube	MAGNETRONS	Frg. Range	Pk. Pwr. Output
2J27	2065-2992 mc.		275 KW
2J31	2820-2860 mc.		265 KW
2J21-A	9345-9405 mc.		50 KW
2J22	3247-3333 mc.		265 KW
2J26	2992-3019 mc.		275 KW
2J32	2780-2820 mc.		285 KW
2J38 Pkg.	3249-3263 mc.		5 KW
2J39 Pkg.	3267-3333 mc.		87 KW
2J49	9000-9160 mc.		58 KW
2J61	3000-3100 mc.		35 KW
2J62	2914-3010 mc.		35 KW
3J31	24,000 mc.		50 KW
5J30			
718DY	2720-2890 mc.		250 KW
720BY	2800 mc.		1000 KW
725-A	9345-9405 mc.		50 KW
730-A	9345-9405 mc.		50 KW

700 A, B, C, D  
706 AY, BY, DY, EY, FY, GY

### KLYSTRONS

723A	723A/B—2K25	726A	707A
------	-------------	------	------

### CW MAGNETRONS

QK 62	3190-3375 mc.	724A
QK 59	2675-2900 mc.	724B
QK 61	2975-3200 mc.	
QK 60	2800-3025 mc.	

New, Guaranteed Each \$87.50

### CR-TR-PULSE TUBES

705A	721	3EP1	724A
3CP1	3EP7	15R	724B
3CP1	3EP1	15R	

MANY OTHER TYPES AVAILABLE. SEND YOUR REQUIREMENTS.

### OIL CONDENSERS

Mfd.	Volt.	Price	SILVER MICA BUTTONS
5	50	50.45	MMF. MMF. MM F.
650	100	1.25	40 175 500
15	220 AC	2.20	50 180 2000
1	500	.40	100 185
0.5	750 AC	1.59	57.50 PER 100
0.5	1000	.69	
2x0.5	1000	.70	
1	1000	.75	
1.5	1000	.85	
2	1000	.90	
4	1000	1.75	
3x.01	1200	1.35	
1	1500	1.30	
1.5	1500	1.40	
2	1500	1.45	
2x0.1	2000	1.10	
2x0.1	4800	1.20	
0.1	6000	2.39	
2x0.1	7000	1.50	
0.1	7500	1.25	
2x0.15	8000	4.75	
.015	16000	8.95	
.0016	15000	5.95	
.25	20000		
1	25000		
1.5	25000		
1	7500		

MANY OTHERS

### TEST SETS

TS 56A/AP	
TS 102/AP	
TS 62/AP	
TS 36/AP	
TS 12 UNIT 2	
TS 69/AP	
TS 33/AP	
CW60-ABM	
LU-1	
LU-3	
TS 159	
TS 226	
TS 250/APN	
TS 89	
I-203-A	
TS 11/AP	
BC 438	
C560-ABW	
I-158	
I-222	
I-185	
TS 268/U	

Send for Further Info. and Price



## WHOLESALE ONLY

Phone or Write for Quantity & Price Digby 9-1124  
**ATT. MR. C. ROSEN**

MICA CONDENSERS	A.C. AND D.C. RELAYS
SILVER MICAS	VIBRATORS
OIL CONDENSERS	UG CONNECTORS
ELECTROLYTICS	HEADSETS
H.V. MICAS	MICROPHONES
PRECISION RESISTORS	INSULATORS
PYRANOLS	BINDING POSTS
TUBE CLAMPS	WAFER SWITCHES
TIN. CABLE CLAMPS	CERAMICONS
DYNAMOTORS	FERRULE RESISTORS
INVERTERS	PL 54 PLUGS
POWER TRANSFORMERS	JK type PLUGS
FILTER CHOKES	BATHUB CONDENSERS
ANTENNAE	CIRCUIT BREAKERS
AUDIO TRANSFORMERS	ARC-3 PARTS
400 cy. TRANSFORMERS	BC 375 PARTS
SHOCK MOUNTS	MK II PARTS
MAGNETRONS	EE-8 PARTS
PULSE TRANSFORMERS	A/C HARDWARE
CONTROL BOXES	A/C FITTINGS
TUBES	

<b>RADAR</b>	<b>RADIO</b>	<b>SONAR</b>
APS-2	APN-4	QBF
APS-4	SCR-518	QBG
APS-10	SCR-545	QCJ
APS-15	FDMK-4	QCL
SA-SC-SN	MK-10	QCO

**MANY OTHER SETS—WRITE**

<b>B-19 MK11 TRANS-RECEIVER</b> Less Power Pack. \$32.50 B-19 Power Pack. 8.95		<b>ARCS MODULATOR</b> MD7/ARC5 Plate Modulator w/dynamotor complete w/Tubes 1-12J5, 2-1625, 1-VR50. Good cond. Price..... \$6.95
--	---	---

<b>VARISTORS</b>	<b>THERMISTORS</b>
D-167176..... \$0.95	D-166288..... \$1.50
D-172155..... 2.25	D-167332 (tube)..... 1.50
D-172307..... 1.75	D-170396 (bead)..... 1.50
D-167208E..... 1.85	D-167613 (button)..... 1.50
D-165687..... .95	D-164699 for MTG..... 2.50
D-174812..... .95	"X" band Guide 2.50
D-171522..... .95	
D-162356 (308A)..... 1.50	

### DYNAMOTORS

Type	Input Volts	Input Amps.	Output Volts	Output Amps.	Radio Set
PE86	28	1.25	250	.060	RC 36
DM416	14	6.2	330	.170	RU 19
DM33A	28	7	540	.250	18C 456
DM42	14	46	.515	.110	SCR 506
			2/8	.050	
PE101C	13/26	12/6	400	.135	SCR 515
			6/3	800	.020
BD AR 93	28	3/25	375	.150	
23356	27	1.75	285	.075	APN-1
35CO458	28	1.2	250	.060	
ZA-085	12/24	4/2	500	.050	
ZA-056	12/24	8/4	12/275	3/110	
B-19 pack	12	9.4	275	.110	Mark II
			500	.050	
D-104	12		225	.100	
			440	.200	
DA-3A	28	10	300	.060	SCR 522
			150	.010	
			14.5	.5	
5053	28	1.4	250	.060	APN-1
PE73CM	28	19	1000	.350	BC 375
CW21AAX	13	12/6	400	.135	
			6/3	800	.020
			9	1.12	
PE94	28	10	300	.200	SCR 522
			150	.010	
			14.5	.5	

### SPECIAL PLATE TRANSFORMERS

Item	Pri.	Output	Price
STP-946	210/220/230	25V/4A 3 1/2" H x 2 1/4" x 2 1/4" D	\$2.39
STP-638	230	5V/9A 5 1/2" H x 4 1/4" x 3 1/2" D	1.25
STP-05A	115/230	2 x 3V/7.57" H x 7" x 5" D	4.25
STP-682	220	30-25-20V/1 MA.	.69
STP-068	230	2.5V/6.5A	1.45
STP-405	230/115	5V 12/9/3A	2.95
STP-370	220/440	3 x 2.5V/57, 2.5V/15A, 5 1/2 x 5 x 4 1/4	5.25
STP-11A	220	2 x 40V/.05/2 x 5V/6A, 12.6/1A	2.95
STP-631	230	2 x 5V/27A 2 x 5V/9A, 100/4H x 5 x 7 30 lbs.	24.95
STP-96B	230	2.5/6.5A	1.95
STP-608	220	24V/600, 5V/2A, 2 x 6.3V/1A	2.25

### INVERTERS

PE 218-E: Input: 25 2nd vdc. 92 amp. Output: 115 v. 350-500 cy 1500 volt-amperes. Dim: 17"x6 1/2"x10". New (as shown)..... \$49.50

PE 218-H: Same as above except size: 16 1/2" x 6" x 10". New..... \$49.50

PE 218H: used, good cond..... 22.00

PE 206: Input: 28 vdc, 38 amps. Output: 80 v. 800 cy. 500 volt-amps. Dim: 13" x 5 1/2" x 10 1/2". New.

### SPECIAL CONVERTER

IN: 115VDC, OUT 12/26VDC, 500W  
BRAND NEW..... \$99.50



**TRANSFORMERS**  
These XFRMRS are Army Spec. All Underrated.

### Comb. Transformers—115V/50-60 cps input.

Item	Amp.	Filament Ratings	Price
CT-825	360VCT .340	6.3VCT/3.6, 6.3VCT/3A	\$3.95
CT-626	1500V .160	2.5/12, 30/100	9.95
CT-15A	350VCT .070	6.3/6, 6.3/1.8, 3 lbs.	2.95
CT-071	110V .200	33/200, 5V/10, 2.5/10	4.95
CT-378	2300V .4	4 MA 2.5/2	6.95
CT-367	580VCT .050	5VCT/3A	2.25
CT-721	550VCT .100	6.3/1, 2.5VCT/2A	2.95
CT-99A	2x110VCT .010	6.3/1A, 2.5VCT/7A	3.25
CT-403	350VCT .026	5V/3A	2.75
CT-93	585VCT .036	5V/3A, 6.3V/6A	4.25
CT-610	1250 .002	MA 2.5V/2.1A, 2.5V/1.75A	4.95
CT-137	350VCT .026	MA 5V/3A	2.75
CT-866	330V .065	6.3V/1.2, 6.3V/600	1.75
CT-456	390VCT .30	MA 6.3V/1.3A, 5V/3A	3.45
CT-160	800VCT .085A	100 MA 6.3V/1.2A, 5V/3A	4.95
CT-319	660VCT .085A	5V/2A, 6.3/7.5A, 6.3/3A	3.25
CT-931	585VCT .86	MA 5V/3A, 6.3V/6A	4.95
CT-442	200	MA 110VCT/2A	2.75
CT-442	525VCT .75	MA 5V/2A, 10VCT/2A, 50V/200 MA	3.85

### Filament Transformers—115V/50-60 cps input.

Item	Rating	Each
FT-781	866 Trans. 2x2.5/5A	\$2.25
FTG-31	2.5V/2.5, 7V/7A (Tape @ 2.5V/2.5A), 16 lbs.	9.95
FT-674	8.1V/1.5A	1.10
FT-157	4V/16A, 2.5V/1.75A	2.95
FT-101	6V/25A	.79
FT-924	3.25V/21A, 2x7.75V/6.5A	17.95
FT-104	6V, 3A	4.79
FT-824	2x26V/2.5A, 16V/1A, 7.2V/7A, 6.4V/10A, 6.4V/2A	12.95
FT-357	9VCT/45A	14.75
FT-463	6.3VCT/1A, 5VCT/3A, 5VCT/3A	5.49

### Plate Transformers—115V/50-60 cps input.

Item	Rating	Each
PT-919	1200-0-1200 200MA	\$8.95
PT-976	Auto: 120VCT/10 MA.	.69
PT-31A	2x300V/5 MA	.79
PT-46A	4080VCT N.L. 3% to 18" Hx6" Wx7" L 20 lbs.	29.95
PT-033	4150V/400 MA 11 1/2"x9 1/4" Wx9" D 70 lbs.	49.95
PT-73-2	3730/3446/3112VCT/77 MA	19.95
PT-28-1	4600VCT/.077	12.95
PT-403	Auto: 70V/1A	2.29
PT-160	1120VCT/770 MA, 590VCT/82 MA, 25 lbs.	24.95
PT-170	Auto: 156/146/137/128—71A	32.95
PT-31A	2x300V/5 MA	.79
PT-976	120VCT/10MA	.79
PT-12A	280VCT/1.2A	2.95

### PRIMARY POWER TRANSFORMER

Stock #	Pri. Ratings	Sec. Ratings	Price
PP-802	115V 60 CY.	128/137/146/156V/.6A	\$9.95

For C.O. Rect.

### SPECIAL PLATE TRANSFORMERS

Item	Pri.	Output	Price
STP-946	210/220/230	25V/4A 3 1/2" H x 2 1/4" x 2 1/4" D	\$2.39
STP-638	230	5V/9A 5 1/2" H x 4 1/4" x 3 1/2" D	1.25
STP-05A	115/230	2 x 3V/7.57" H x 7" x 5" D	4.25
STP-682	220	30-25-20V/1 MA.	.69
STP-068	230	2.5V/6.5A	1.45
STP-405	230/115	5V 12/9/3A	2.95
ST			



# PEAK SURPLUS

## SENSITIVE RELAY

D'Arsonval moving coil type, mounted in meter case. Adj. 700 microamps. 10 Triplett. Made by \$5.75 ea.

MICA CONDENSER .0025 Mfd. 8000 VDC, Low Loss, Bakelite Case, 12 Amps @ 3 MC, 5 Amps @ 200 KC. Type F3L... Each \$4.50

## PANEL METERS

New Surplus Standard Brands  
★—Special Scale  
SQ—Square Case

### 2" METERS

0-1 MA, GR.	\$3.95
0-100 MA, W* LTD.	2.49
0-200 MA, S	2.95
0-2 AMP F, S, SQ.	2.95
0-30 AMP DC, GE.	2.95
0-150 Volt AC, S.	3.95
0-50 Amp AC, GE.	3.95
0-10 MA, AC, GE.	2.95
0-2 MA, GR.	2.95
0-30 MA, S.	2.95
0-50 MA, S.	2.95

### 3" METERS

0-4 KV, DC, RS.	\$7.95
0-2 MA, S	3.95
0-15 MA, WH SQ.	3.95
0-20 MA, WH*	2.95
0-20 MA, S	2.95
0-200 MA, GE.	4.50
0-1MA* Herm. Seal.	4.95
0-150 VDC (1 MA)	5.95
0-250 VDC (1 MA)	5.95
0-1 Amp DC, W.	6.95
0-50 Amp AC, GE.	5.95
0-150 VAC, GE.	5.95
0-300 VAC, W.	6.95
0-21 Amp R.	3.95
0-750 VDC (TMA)WH	5.95

### 4" METERS

0-10 MA DC	\$5.95
0-100 MA DC	3.95
0-250 MA DC	3.95
0-500 MA DC	5.95
0-5 Volt DC (1 MA)	3.95
0-500 Volt DC (1 MA)	7.95

## PIGTAIL MICAS

MMF: 5, 20, 50, 60, 100, 250, 300, 400, 500, 750, 800, 1000, 2000, 3000, 4000, 5000, 6000, 10000.....\$0.09 ea.

Silver Mica Capacitors  
MMF: 10, 50, 60, 340, 750, 780, 1000, 50.12 ca.

Non-Inductive Resistors  
Ohms: 500, 2000, 12,500  
100 watts.....\$0.75

## MOBILE DYNAMOS

Imp.	Output	Price
5.6	400	175 MA \$19.50
5.6	400	300 MA 27.95
5.6	500	300 MA 28.50
5.6	600	150 MA 22.50

## BAKELITE CASED MICAS

MFD	VDC	Price	MFD	VDC	Price
.001	600	\$1.02	1500	5	.65
.002	600	.24	.033	1500	.75
.01	600	.26	.005	2500	.55
.02	600	.26	.002	2500	.45
.01	1 KV	.45	.001	5 KV	.50
.002	1200	.35	.001	5 KV	.70

## WIRE WOUND RESISTORS

5 watt ohms: 25-50-100-200-250	\$ .09 ea.
10 watt ohms: 25-50-100-200-250-325-2K-4K	.15 ea.
20 watt ohms: 50-70-100-300-750-1K-1.5K	.20 ea.
2.5K-2.7K-5K-10K-20K	.22 ea.
30 watt ohms: 100-250-500-1K	.22 ea.
100 watt ohms: 100-3750-1500-2K, 10K, 15K, 20K, 100K	.59 ea.

## GUARDIAN LATCHING RELAY

SPDT, 110 V 60 cy Coil, 15 Amp Contacts...\$1.95

## ADJUSTABLE SLIDER RESISTORS

20 Watt: 1, 50 Ohms	\$0.25
50 Watt: 500 Ohms	.35
75 Watt: 100, 150, 200 Ohms	.39
100 Watt: 50, 3750	.69

## POWER TRANSFORMERS

600 Volt CT, 90Ma, 5 V @ 3A, 6.3V @ 3A	\$4.75
400 Volt CT, 90Ma, 5 V @ 3A	2.50
600 Volt CT, 90Ma, 6.3V @ 3A	3.70
625 Volt CT, 90Ma, 6.3V @ 3A	3.95
800 Volt CT, 200Ma, 5V @ 3A, 2.5V @ 3A, 2.5 @ 1.5A	5.75
800 Volt CT, 250Ma, 6.3V @ 4A, 6.3V @ 4A, 6.3V @ 2A, 5V @ 2A, 5V @ 2A	7.95
768 Volt CT, 305Ma	4.50

## MISCELLANEOUS BARGAINS

50 meg. 35 watt Resistor	\$0.99
4PST Lever Switch Wossman	.89
.05 600V Oil Tubular	.12 for .99
10K, 15K Pots	4 for .99
SPST Push Button Switch	.29
1x1x1 MFD 1200 VDC	.59
Air Padder 50 MMF APC50	.39
Western Electric TS-12 Sound Power Handset	Per Pair 27.95
12" Jensen "Concertone" HiFi Speaker, Model PR12 List Price \$26.50 - Your Cost only	9.95

# PEAK ELECTRONICS CO.

188 WASHINGTON ST., NEW YORK 7, N. Y.  
Phone COrtlandt 7-6443-4

a time to shoot its beam on the proper color dot. In other words, the sampler is a high speed electronic switch operating at 3.58 mc. and cutting off two electron guns while permitting the third to fire. In actual circuitry, the sampler contains a 3.58 mc. oscillator, controlled by an automatic frequency circuit, which compares the incoming color synchronizing signal with the oscillator speed. The output of this oscillator is applied to a three-section delay line in such a manner that 120 degree phase shift exists between the signals as they reach each of the three color channels. Thus during one cycle of the 3.58 mc. sine wave all three electron guns fire, each in its proper turn.

The synchronizing pulses for the horizontal and vertical sweep circuits are removed from the picture signal, clipped, and separated in the same manner as in regular black and white TV sets. The vertical sweep section is identical to those found in present receivers, with special attention being given to perfect linearity. The horizontal sweep is also similar to the set now on your bench, except that the output transformer is not used to generate the high voltage at the same time. A separate high voltage supply is used which will be discussed later. The output of both vertical and horizontal sweeps go to the deflection yoke as in any TV set. Good linearity and sufficient deflection power is a major design problem in these sections.

The horizontal sweep section also keeps the high voltage power supply. This is an r.f. type of supply with voltage regulation in the primary circuit to keep the second anode voltage constant for all colors, regardless of beam current drawn by either one. The recommended second anode voltage is 20 kv., as shown in Fig. 6, and the d.c. potential for the convergence element is 9 kv. The three electrostatic focusing controls are supplied with approximately 3 kv. and all these voltages are obtained from a well filtered bleeder arrangement. Needless to say, the shielding and filtering of the high voltage section is at least as important as in present TV receivers.

Probably the strangest sections in Fig. 6 are the two boxes labeled "Dyn. Converg." and "Dyn. Focus." As was explained before, the flat aperture mask and color dot screen require that some correction be applied to both focusing and convergence elements to keep the three electron beams in proper focus and convergence at the sides as well as in the center of the screen. The dynamic focus section obtains a sawtooth voltage from the horizontal and vertical sweep section which is converted into a sort of parabolic wave shape. Vertical and horizontal correcting voltages are applied through a separate high voltage condenser to each of the three focusing elements to add to the d.c. voltage from the high voltage bleeder. In a similar way the convergence element gets horizontal and vertical correction voltage waves,

# for dependable sound, INDUSTRY relies on ATLAS



DR Double-Reentrant Projectors

## DEPENDABLE QUALITY:

The latest electro-acoustic research and engineering—and over 20 years of manufacturing know-how—are behind every ATLAS product.

## DEPENDABLE SERVICE:

Coast-to-coast and around the world today—in every Industrial, Marine, Railroad, Military, Educational, Civic, U.S. and Foreign Government application—under every kind of climate and noise condition—ATLAS sound equipment is famous for highest efficiency and durability. That's the proof of ATLAS performance dependability.

## DEPENDABLE DELIVERY:

Yes, ATLAS gives our Government highest priority. And yes, we too feel the pinch of material shortages. But our customers will continue to get our usual dependable delivery—because we believe in equitable and dependable distribution to all ATLAS users.

## DEPENDABLE PROFITS:

Completeness of line, excellence of product, dependable delivery, right prices—that's the ATLAS combination that means high, steady Industrial Sound profits for You!

JUDGE for yourself, COMPARE ATLAS at your local Jobber today. See why ATLAS is the preferred line for utmost dependability. Write NOW for FREE latest Catalog 551.



Paging & Talk-Back Speakers



ALNICO-V-PLUS Driver Units



Dual Speakers

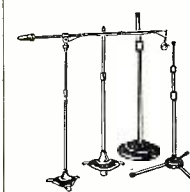

FULL-GRIP, VELVET-ACTION Mike Stands



## ATLAS SOUND CORP.

1446-39th Street, Brooklyn 18, N. Y.  
In Canada: Atlas Radio Corp., Ltd., Toronto, Ont.

## RADIO ENGINEERING IN 27 MONTHS DEGREE

Radio engineering is a big field. There's room for you in it—if you're good. Get first-class training at Indiana Tech. Intensive specialized course, including strong basis in mathematics and electrical engineering, advanced radio theory and design, television. Modern laboratory. Low tuition. Also 27-month courses in Aeronautical, Chemical, Civil, Electrical and Mechanical Engineering. Approved for G.I.'s. Enter December, March, June, September. You can earn part of your expenses right here in Fort Wayne while you are studying.

## INDIANA TECHNICAL COLLEGE

9111 E. Washington Blvd., Fort Wayne 2, Indiana  
Please send me free information on B.S. Engineering Degree in 27 months as checked.

Radio-Television       Aeronautical  
 Civil       Mechanical       Electrical

Name .....

Address .....



again applied through a HV condenser and acting in addition to the fixed d.c. potential. In order to obtain proper waveforms and have them appear in the proper sequence, i.e., when the electron beams sweep from left to right, several tubes are required as well as transformers in both sections. Once minor adjustments are made, both the dynamic focus and convergence section do not usually require much adjustment.

The power supply section delivering filament and "B plus" power to all the other sections in the receiver is no different from any power supply. A larger transformer will be required for a color set than for a black and white set since more tubes are used in the set. Good filtering and regulation are desirable in present TV receivers, but in color sets they will have even greater importance.

### Conclusion

The prospect of a tricolor tube with more than half a million dots of three colors, where each dot must be lit up in the exactly right sequence and intensity, where perfectly linear deflection, focus, and stable high voltage are required may at first frighten the technician. The strange concepts of color purity, color fidelity, convergence, dynamic focus, etc., tend to build up the problems of the tricolor tube to almost insurmountable heights. It is the purpose of this article to clear up these new concepts and explain just how this youngest child in the TV family behaves. We have tried to show that the well-known principles of electricity and magnetism still apply, that electronic circuitry, as we know it today, is used to operate the tricolor tube and that all its problems, corrections, and adjustments can be understood by the alert technician. Just as picture tubes and their operation presented new and apparently staggering problems to the TV service industry a few years ago, so does the prospect of the tricolor tube. But the industry has mastered all the facets of black and white TV in a rather short time and we can safely predict that when commercial sets with tricolor tubes appear on the market, it will not be long before most of the TV technicians will be as adept with these tubes as they are with black and white picture tubes today.

-30-

### NEW TV SERVICE PLAN

GEORGE Fried, president of Authorized Manufacturers Service Co., Inc. of 153 Spencer St., Brooklyn 5, N. Y. has come up with a plan which he hopes will help to counteract the growing tide of TV service complaints.

Membership in the co-op service plan is \$10.00 a year which covers overhead. The members are then entitled to labor at actual cost and a substantial discount on parts, including the picture tube. Surplus accrued through increased membership will be distributed to members in the form of reduced service costs or extended membership.

-30-

November, 1951

# It's fun to be an AUDIO- PHILE!

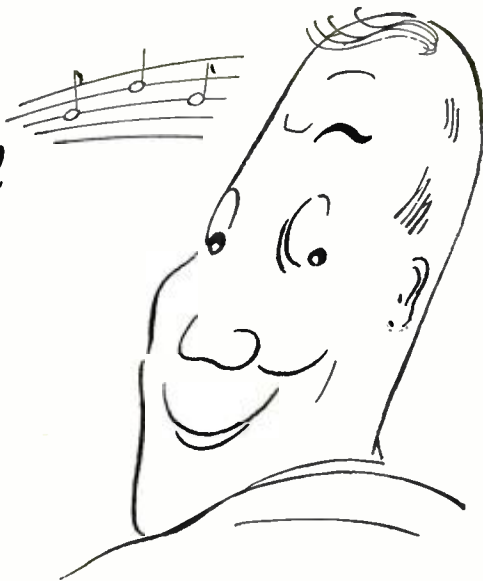

And HIGH-FIDELITY helps to make it more so, for this is the special magazine edited for people who enjoy fine musical entertainment at home.



**MOST FOR YOUR MONEY:** If you are planning your first hi-fi FM-phonograph installation, be sure to read the feature article: "Budget Your High Fidelity." It explains how to make a well-balanced selection in choosing your amplifier, turntable, pickup, and loudspeaker, so as to get maximum performance for whatever amount you plan to spend. (16 pages, 21 illustrations)

**ABOUT TAPE RECORDING:** With the new tape equipment, you can become a recording expert in a single evening. In your own home, you can make amazingly realistic recordings of everything from family conversations to instrumental music and singing, or make your own programs from radio shows (omitting commercials) by connecting the recorder to your radio receiver. (12 pages, 19 illustrations)



**DECORATIVE APPEARANCE:** When you walk in with an armful of hi-fi gear, if your wife greets you with, "Don't take that junk in the living room," get out HIGH-FIDELITY Magazine, and show her all the pictures of attractive installations in fine homes. Win her enthusiastic approval by getting her to help you plan a really beautiful FM-phonograph installation. (16 illustrations)

**CHOOSING RECORDS:** Maybe you like to sweat it out in music-shop listening booths, but you can save time, keep cool, and get a world of help in building your record library from "Schubert on Records," "Tops for the Juke Box," "The Music Between," and "Records in Review," by such leading critics and commentators as C. G. Burke, Carl Eaton, Edward Merritt, Jr., and John Indcox. (18 pages)



HIGH-FIDELITY is a big magazine, 8 3/4 x 11 5/8 inches, handsomely illustrated, with nearly 100 photos and drawings, and beautifully printed on fine paper. It is published quarterly in September, November, February and April.



## High-Fidelity

FOR PEOPLE WHO ENJOY FINE  
MUSICAL ENTERTAINMENT AT HOME

Published by Milton B. Sleeper

Check here if you want your subscription to start with the Summer Issue, a few copies of which are still available.

Mr. Charles Fowler, Editor, High-Fidelity  
11 Audio Bldg., Great Barrington, Mass.  
Please enter my subscription to High-Fidelity:  
 \$6.00 for three years (SAVE \$6.00)  
 \$3.00 for one year (SAVE \$1.00)

Name.....  
Address.....  
Add 50¢ per year in Canada, \$1.00 foreign

125



# 5 Television Scope

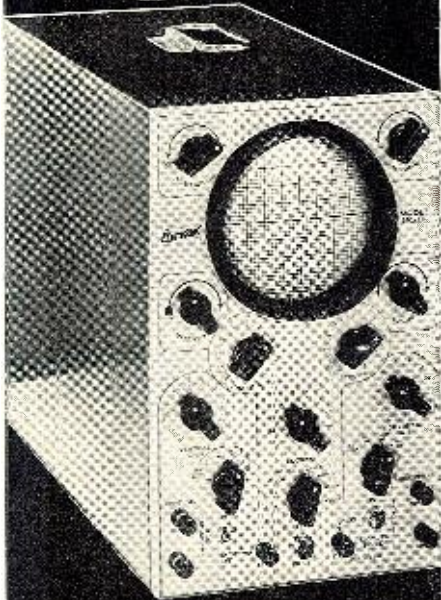

Your biggest value in scopes!

**HIGHEST SENSITIVITY**  
**.015 volts per inch**

- Wide band amplifiers, better than 1 m.c.
- Vertical input impedance 1 megohm, 25 m.m.f.
- 3-range frequency compensated attenuator network
- Demodulator and Modulation circuit
- Synusoidal sweep with phasing control
- Return trace eliminator
- Provision for external sweep and Z axis modulation
- 120-cycle FM sweep

Model 195B. Write for complete information today.

World Famous for Accuracy for 40 Years

**THE HICKOK**

**ELECTRICAL INSTRUMENT CO.**

10524 Dupont Ave., Cleveland 8, Ohio

## Corner Transducer

(Continued from page 42)

sponse with the speaker used, and ability to properly load different speakers having different cone-resonance frequencies.

When assembling the cabinet, it was found advisable to first cut out and assemble the front, back, and sides. The top, bottom, and inserts can then be measured and cut to fit accurately; the dimensions shown in Fig. 3 can serve as a guide. The entire cabinet is constructed of half-inch thick plywood, which is thick enough since there is no appreciable air pressure built up in the cabinet during operation. The inserts, being attached between the front and back pieces, add strength to the structure.

The parts of the cabinet are fastened with glue and wood screws. The bottom, however, is not glued, so that sound-absorbing material may be inserted or removed. It was found that completely lining the inside of the cabinet with one-inch thick rockwool seemed to reduce the "liveliness" of response; best results were obtained throughout the length of the labyrinth.

The loudspeaker is mounted from

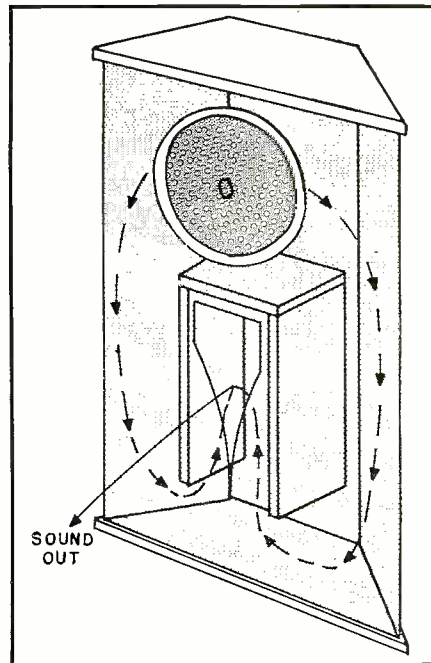
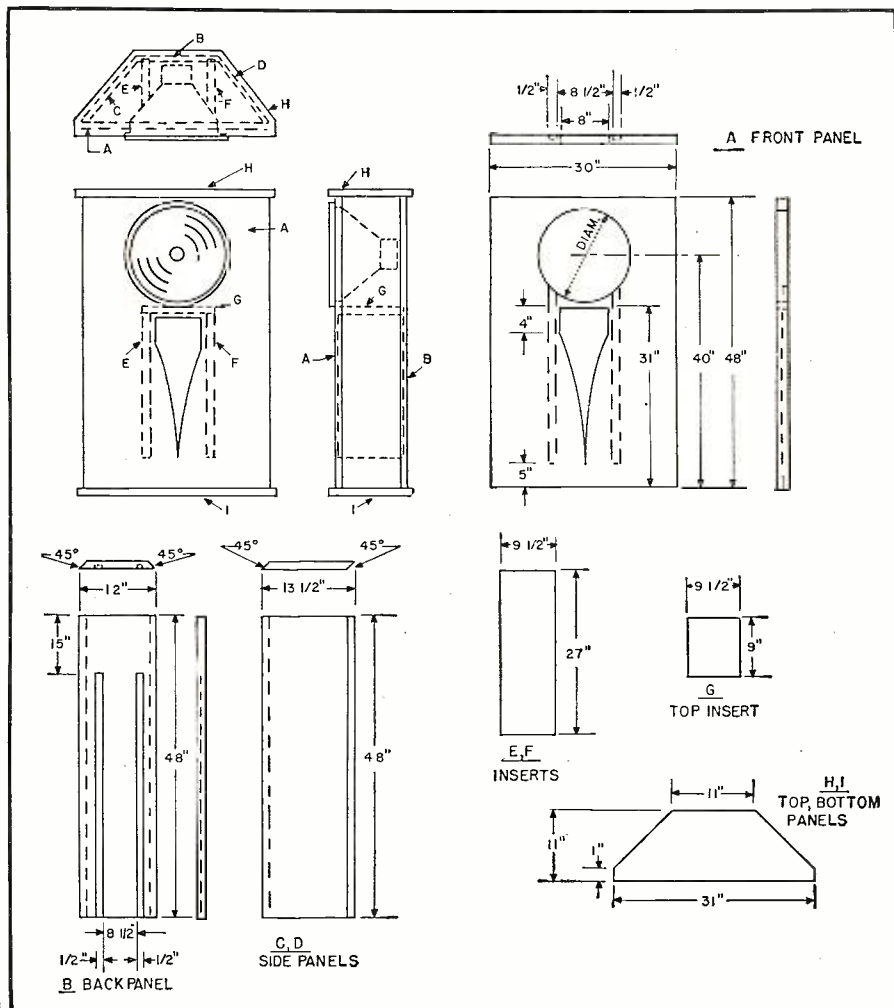

Fig. 2. Sound path from rear of speaker cone.

the front of the cabinet; thus the top can be firmly glued down. In the model constructed corner pieces were attached inside the cabinet at each folding of the labyrinth, in order to

Fig. 3. Construction details on corner labyrinth transducer. Design is for 15" speaker.





provide a constant cross-sectional area through the length of the labyrinth. Considerable effort and cut-and-try was required to do this; the refinement is not believed worthwhile unless one is particularly adept at carpentry. For decorative effect, the front of the cabinet may be covered with a large piece of grille cloth and the top and bottom pieces can be varnished or painted.

**REFERENCES**

- 1, 2. *Brigus, G. A.*; "Loudspeakers." *Wardale Wireless Works, 1948. Pages 50, 78.*
3. *Langham, J. R.*; "High-Fidelity Techniques," *Radcraft Publications, 1950, Page 21.*
4. *Olson, H. F.*; "Elements of Acoustical Engineering," *D. Van Nostrand Company, 1943, Page 133.*
5. *Henney, Keith*; "Radio Engineering Handbook," *Third Edition. McGraw-Hill Book Company, Inc., Page 921.*

-30-

**International Short-Wave**  
(Continued from page 63)

the United States—which are 50 kw. The main studios and administration offices of the station are housed in Munich proper. Programs are on the air 11½ hours a day, seven days a week; they are broadcast exclusively to Czechoslovakia, as this country is presently a particularly vulnerable spot in the Soviet sphere. Because of the transmitter's unusual power, and because all Czech radios can receive its m.w. broadcasts, the RFE programs saturate every city, town, village, and farm area throughout Czechoslovakia in direct competition with Communist-controlled *Radio Prague* and *Radio Bratislava*. In effect, the Holzkirchen m.w. transmitter has a "real" power of 675 kw., RFE engineers point out, or almost 14 times as powerful as America's largest m.w. stations—made possible by an unusual "directional array system." Unlike American broadcasts, which are beamed in all directions, the radio waves of the RFE programs are directed with bullet-like accuracy at a single target—Czechoslovakia, making the RFE transmitter the most powerful m.w. station in the world.

While the new m.w. station concentrates on Czechoslovakia, the Western German short-wave transmitters continue their daily freedom-broadcasts to the other satellite targets—Bulgaria, Hungary, Poland, and Rumania, as well as to Czechoslovakia. Daily programs to Albania, a strategic prisoner state of the Kremlin, went on the air June 1. Tape-recorded broadcasts are also beamed from Lisbon, Portugal.

Thus, RFE, with the help of the American people, has established a beach-head in the battle for the hearts and minds of men behind the Iron Curtain.

RFE is distinct from the "Voice of America" which "projects America abroad." While the "Voice" presents America in the best possible light, *Radio Free Europe's* job is to reveal the Communist regimes in the worst

November, 1951

*Announcing*

**ADVANCED SERIES 400 RECORDERS**

**MODEL 400-A**

with  
Half-Track Head

**MODEL 401-A**

with  
Full-Track Head

15 & 7 1/2  
Inches Per Sec.

**Full REMOTE CONTROL**

Solenoid operated mechanisms for all mechanical motions.

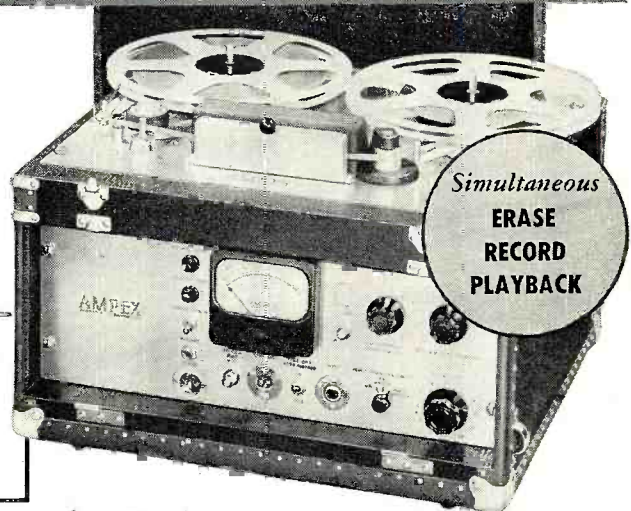

Simultaneous  
**ERASE  
RECORD  
PLAYBACK**

also *Featuring*

- **UNIFORM RESPONSE . . .** to 15,000 cps at 7 1/2 ins. per sec.
- **LOW NOISE & DISTORTION LEVEL . . .** signal-to-noise ratio over 55 db at either tape speed (as defined by NARTB).
- **PUSH BUTTON OPERATION**
- **LONG LIFE . . .** precision built.
- **LOW MAINTENANCE . . .** even with continuous use.



**4 to 1 TAPE SAVING**

The valuable tape saving ability of Series 400 Recorders is clearly illustrated above—the young lady holds four reels which contain the identical program formerly requiring the sixteen reels shown on table. No other recorder can give this remarkable tape saving because no other recorder is capable of 15,000 cycle performance at 7 1/2 ins. per sec.; on but half the width of the tape!

**PORTABLE IN SINGLE CASE or for RACK MOUNTING**

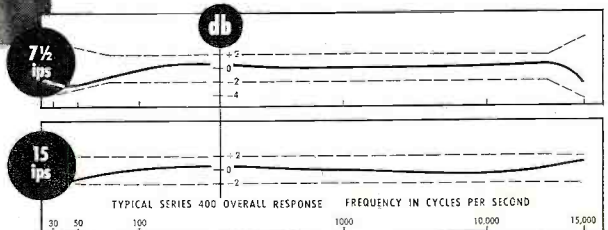
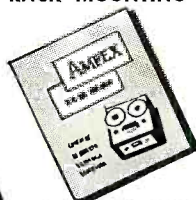

**PERFORMANCE . . . beyond comparison!**

Published specifications of Ampex Recorders are conservative as these typical check-out graphs on Series 400 show. Ampex check-outs always exceed guaranteed performance but even the guaranteed performance is sufficient to make Ampex the world's finest recorder!

**INTERCHANGEABILITY OF TAPES . . .** another unrivalled superiority of Ampex. This means that recordings made on any Ampex can be played back on any other Ampex (of like speed) with identical high fidelity and timing.

ASK FOR BULLETIN  
A-211

... gives complete description and specifications of the Series 400 Ampex Magnetic Tape Recorders.

**AMPEX**  
*Magnetic*



**AMPEX ELECTRIC CORPORATION**  
Redwood City, California

Distributors in Principal Cities

**RECORDERS**



**NEW! Low Voltage  
Selenium Rectifier  
Power Supply**

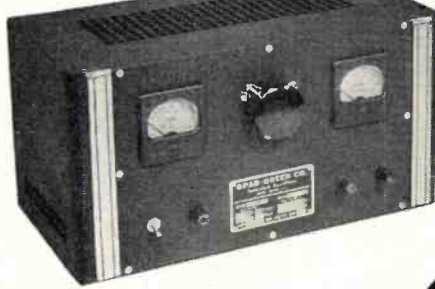

**IN STOCK!  
MODEL GPA2810**

Input: 115 VAC 60 cy.  
Single Phase  
Output: 0-28 VDC 10 Amperes,  
continuous duty.

A reliable source of unfiltered direct current for laboratory and production testing.

**\$115.00 Net  
F.O.B. our N.Y.C.  
Factory.**

Special Selenium Rectifier power supplies available to specifications. Write for Rectifier Equipment Questionnaire. Proposals and recommendations forwarded promptly.

**Opad-Green  
COMPANY**

71-3 Warren St., New York 7, N. Y.

Phone: BEekman 3-7385-6

possible light. *RFE* deals in large measure with what is going on in the target countries, telling the truth about the puppet governments and serving as the free press which their dictators deny them. In effect, it is a "home service from abroad."

Americans and exiles work in harmony to achieve their common goal—the liberation of the prisoner peoples. Experienced, public-spirited Americans administer *RFE*'s activities and head the major departments. But the exiles themselves—most of whom were distinguished journalists, broadcasters, writers, teachers—have the final word as to what is broadcast. They are the ones who know best how to speak to their country. As General Clay says: "*RFE* programs consist of exiles talking to their compatriots in terms that each understands."

On April 26, 1951, America's most distinguished radio honor, the George Foster Peabody Award, was presented to *Radio Free Europe* for the "Promotion of International Understanding."

If present plans materialize, *Radio Free Europe* will be expanded into a "Freedom Network" with individual transmitters for each of the Iron Curtain countries. It is to achieve this goal that General Clay has just asked the American people to take part in a second (1951) *Crusade for Freedom* campaign.

A number of transmitters to blanket the other satellite states will be built with the funds raised in this year's *Crusade*. It is quite possible, *RFE* officials say, that by this time additional transmitters will be in operation.

*Radio Free Asia* has just begun the first privately-operated effort to pierce the Iron Curtain of Communism in Asia, with a one and a half hour program of news and comment beamed to the mainland of China. Broadcasts, on a seven-day-a-week basis, are now being transmitted from San Francisco over leased wire *RCA-C* short-wave to Manila, Philippines, where they are then short-waved on 6.110 with directional antennas beamed on China.

Announcement of the beginning of *RFA* operations was made by Brayton Wilbur, chairman of the *Committee for a Free Asia, Inc.*, of which *Radio Free Asia* is an operating branch under the direction of John W. Elwood, pioneer San Francisco radio executive and former manager of *KNBC* in San Francisco. The original broadcast pattern consists of news and comments divided into three sections—the first in Mandarin, the second in Cantonese, and the third in *English*.

"The fundamental purpose of the broadcasting efforts of *Radio Free Asia*," Wilbur declares, "is to pierce the Iron Curtain of Communism in Asia with factual, accurate, and truthful news. The programming later will be expanded both in terms of hours on the air and types of programs. Eventually, *Radio Free Asia* will beam toward the various parts of Asia programs on agriculture, health, and other topics designed to assist the people of Asia



**HEY, MAC!**

Send a penny postcard TODAY for our giant bargain catalog already mailed to many thousands of regular customers. Your chance to save big money on TV and radio items for servicemen and builders. Everything in stock! Quick shipment and fair dealing always.

**WEBSTER-CHICAGO 3-SPEED CHANGER**

**\$23.95**



**Famous Model 100**

Plays 7", 10" and 12" records at 33 1/3, 45 and 78 RPM. Brand new and fully guaranteed. Don't wait—buy now at less than 1/2 regular list price! Modernize that old record player while these fine changers are available at our record low price!



**SUPER V-BEAM**

**\$2.95** each

in Lots of 10

Only \$3.25 Each, Singly

Pre-assembled V-Beam for one-man quick-up. High gain and excellent directivity on all channels. Shipped less mast. Wonderful for fringe areas. Approved by TV installation men everywhere. Unbeatable value!

**BIG SAVING! 300-OHM TWIN-LEAD!**

Standard 300-ohm twin-lead recommended for outdoor use. Will withstand severest weather conditions. Buy in quantity and save at our record low price. Per 1000 ft. **\$1.995**

**STAR ELECTRONIC  
DISTRIBUTORS, INC.**

Dept. RN-11-7736 S. Halsted, Chicago 20, Ill.

**KITS KITS KITS KITS**

- 5-Variable condensers, 1 to 3 gang. AM, FM & SW types.
- 30-Tube sockets, all types and sizes.
- 50-Knobs, standard types: slip-on.
- 50-Ceramic insulators; various types.
- 50-Iron cores, Ass't.
- 30-Terminal strips, Ass't.
- 15-Output transformers, Ass't. types.
- 50-R. F. chokes, Ass't.

**\$1.95** each

**KITS KITS KITS KITS**

- 40-W. W. Resistors 5-20 W. Ass't.
- 25-W. W. Resistors 25-100 W. Ass't.
- 40-Fraction W. W. Resistors, 1 W. Ass't. values.
- 100-Ceramic condensers, Ass't.
- 100-Mica condensers, Ass't.
- 100-Carbon resistors 1/2 & 1 W. Ass't.
- 100-Paper tubular condensers, 100-1000 DC wkg. v. Ass't. capacities
- 50-Bathub condensers, Ass't.
- 20-Filter condensers, Ass't.
- 12-Relays, telephone and other types, Ass't.

**\$3.95** each

**POWER TRANSFORMERS  
LEADING MFR. BRAND NEW**

- P-1367. 700 V. Ct. @ 90 Ma. 5 V. 3 A. 2.5 Ct. 12.5 A. \$4.50
- P-1352. 700 V. Ct. @ 90 Ma. 5 V. 3 A. 6.3 V. Ct. 3.5 A. \$3.95
- HVPT-6. 700 V. Ct. @ 200 Ma. 5 V. Ct. 3 A. 6.3 V. Ct. 6 A. \$5.50

**FILAMENT TRANSFORMERS**

- GL-856. Prim. 115/250 V. Sec. 4.5 to 34 V. in 4 v. steps at 2 amps. Cased, NEW. \$2.95
- W.E.-T1071. 115/250 50-60 cye. Delivers 11.5 V. @ 8 amps. or 25 V. @ 4 amps. 100 V. A. prim. Completely shielded, NEW. \$3.95

**HERMETICALLY SEALED CHOKE**

- 150 Ohm 7 Hys. 325 Ma. Conservative rating 2000 Volts \$2.95

**AC OR DC SOLENOID**

Pull type. Laminated "U" core, laminated moving pole, in center. Riveted construction. Angle brackets for horizontal mtg. Travel distance of pole, 1 1/4". Winding, 400 turns ± 23 enameled wire, DC resist. 2.8 ohms. For 9 to 12 volts, 60 cycle AC or 7 to 10 volts DC. Two 8" insulated leads, NEW! \$1.19

**5 GANG, INSULATED ROTORS**

15 to 400 mmf. per section. Ceramic shaft isolates rotors. Individual rotor contacts. 3/8" x 7/8" shaft, 1 1/4" winding, 400 turns ± 23 enameled wire, X 33 1/2" x 7". Ideal for Audio Oscillators, Interpolation Bridges, etc. NEW. \$2.95

**ARR-1 RECEIVER**

Attractively built T.R.F. using 4-954 acorn tubes. Originally operated on 234-238 Mc. Can be modified for converter on 6.2 or 1 meters. Ganged permeability tuning. Complete with tubes, NEW. \$6.95

**ASSORTED PARTS PACKAGE**

Approximate 15 lbs. \$1.49  
All prices F.O.B. 25% deposit required with all orders. Prices subject to change without notice.

**WRITE FOR OUR FREE FLYER  
UNITED SURPLUS MATERIALS  
312 South Halsted Street, Chicago 6, Illinois**



and to maintain their courage and will to resist Communism."

Elwood explains that the news programs of *Radio Free Asia* are concentrating on Asian news for the Asians "with the aim of letting the Asians know what actually is going on in their own areas." He points out that all of the media of public communication in the major part of Asia are controlled. "As a result, Asians in those areas now dominated by the Communists have had no access to the truth even about occurrences in their own homelands, let alone truthful reports of world news events. We will tap all existing available sources of accurate and truthful news and will then beam our news reports directly to the people of Asia."

All broadcasts are to be live from San Francisco, conducted in their native language by refugees or exiles from the countries to which the programs may be directed.

Chairman Wilbur points out that the prime objective of the *Committee* is to "build and operate our own transmitting stations as near to the so-called target areas as possible. To accomplish this objective, however, will take at least a year after the actual sites have been chosen. In the meantime, broadcasts from San Francisco will be expanded just as rapidly as *Radio Free Asia* can successfully recruit the trained personnel required for the job."

Elwood sums up like this: "We hope to develop a radio broadcasting program operated by and for the people of Asia, through which the Asians can, themselves, stop and roll back the onslaught of Communist totalitarianism."

*Our best wishes go to both Radio Free Europe and Radio Free Asia in their endeavor to help establish and maintain a "free world!"*

\* \* \*

#### "Big Ben"

Here is some interesting information regarding *Big Ben*, London, from the Director of the BBC's Overseas Services, as received by Art Russell, California:

"In response to request for information regarding hook-up for broadcasting *Big Ben*, our engineers say that it is quite possible that you did hear a pigeon just before *Big Ben* struck. They do perch on the windscreen covering the moving coil microphone and this covering has to be replaced every two or three months. This microphone is placed about 20 feet from *Big Ben* itself, and about the same distance from the four chime bells, just above the public gallery in the tower. It is connected to a medium gain amplifier at the base of the tower which normally operates from the mains supply, but, should this fail, batteries are automatically switched in. Other devices come into operation should this amplifier or line between the Houses of Parliament and Broadcasting House fail.

"Westminster Clock, which is the correct name, is the most accurate and one of the most powerful public clocks in the world. The four dials are each

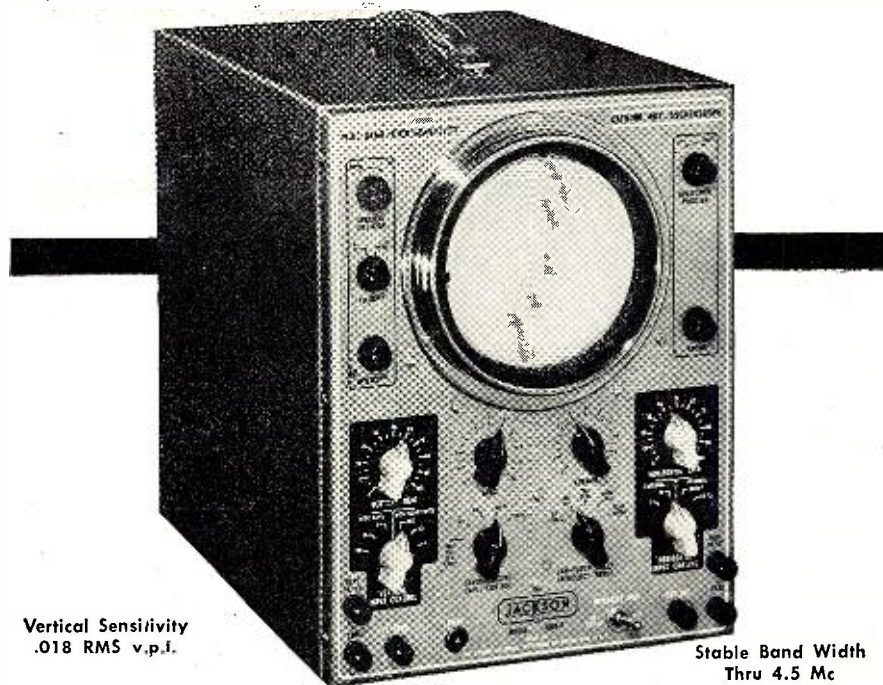

Vertical Sensitivity  
.018 RMS v.p.i.

Stable Band Width  
Thru 4.5 Mc

## JACKSON Oscilloscope gives you "dual service"

This is a high-quality, laboratory-grade 5" Oscilloscope that provides the "dual service" of both high sensitivity and wide band width.

### s p e c i f i c a t i o n s

**Vertical Amplifier**—Video-type frequency compensation provides flat response within 1.5 db from 20 cycles thru 4.5 Mc, dropping smoothly to a still useful value at 6 Mc.

**Sensitivity Ranges**—With a band width of 20 cycles thru 100 Kc, the sensitivity ranges are .018, .18, 1.8 RMS volts-per-inch. The wide band position 20 cycles thru 4.5 Mc has sensitivity ranges of .25, 2.5, 25 RMS volts-per-inch.

**Horizontal Amplifier**—Push-pull with sensitivity of .55 RMS volts-per-inch.

**Input Impedances**—Vertical: 1.5 megohms shunted by 20 mmfd. Direct to plates, balanced 6 megohms shunted by 11 mmfd. Horizontal: 1.1 megohms.

**Linear Sweep Oscillator**—Saw tooth wave, 20 cycles to 50 Kc in 5 steps. 60 cycle sine wave also available, as well as provision for using external sweep.

**Input Voltage Calibration**—Provides a standard voltage against which to measure

voltages of signal applied to vertical input.

**Vertical Polarity Reversal**—For reversing polarity of voltage being checked or for choosing either positive or negative sync. voltages.

**Return Trace Blanking**—Electronic blanking provides clear, sharp trace to prevent confusion in waveform analysis.

**Synchronizing Input Control**—To choose among INTERNAL, EXTERNAL, 60 CYCLE, or 120 CYCLE positions.

**Intensity Modulation**—60 cycle internal or provision for external voltage for intensity modulation uses.

**Additional Features**—Removable calibration screen—Accessory Model CR-P Demodulation Probe for Signal Tracing—All-steel, gray Ham-R-Tex cabinet. Total net weight only 26 pounds. Same height as other Jackson TV instruments: 13" H x 10 1/4" W x 15 1/8" D.

**Prices:** Model CRO-2, Users' Net \$197.50. Model CR-P Probe, Users' Net \$9.95.

#### TWO OTHER FINE JACKSON INSTRUMENTS

##### Model 655 Audio Oscillator

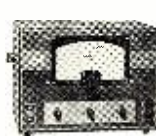

Sine-wave 20 cycles to 200,000 cycles. Less than 5% harmonic distortion between 30 cycles and 15,000 cycles. Frequency calibration accurate within 3% or 1 cycle. Hum level down more than 60 db of maximum power output. Output impedances of 10, 250, 500, 5000 ohms or Hi Z resistive output.

##### Model TVG-2 TV Generator



Sweep Oscillator in three ranges from 2 Mc thru 216 Mc, all on fundamentals. Reversible sweep direction. Sweep width variable 1 Mc thru 18 Mc. Marker covers 4 Mc thru 216 Mc. Crystal Oscillator to use as Marker or Calibrator. Video Modulation, from external source for using actual video signal for check, or for use with Audio Oscillator to produce bars for linearity checks.

See your electronics distributor for more information, or write

**JACKSON ELECTRICAL INSTRUMENT CO. • DAYTON 2, OHIO**  
"Service Engineered" Test Equipment  
IN CANADA: THE CANADIAN MARCONI CO.



# AUTUMN SALE

## ALL PRICES CUT TO BONE

Don't Buy Tubes until you get our prices. Quantities Limited. Prices Subject to Change Without Notice. Low Prices.

### RADIO & TELEVISION TUBES

These Prices apply only on orders for 12 or more tubes. Orders for less than 12, write for quotation.

1B3—\$1.33	6BA6—\$.72	6X4—\$.60
1L4—.80	6BA7—.96	12AT6—.75
1R5—.80	6BE6—.72	12AT7—1.16
1S5—.72	6BG6—.92	12AU6—1.00
1T4—.80	6BH6—.80	12AU7—1.20
1U4—.80	6BQ6—1.28	12AX7—.96
1U5—.72	6CB6—.80	12BA6—.90
3Q4—.88	6CD6—2.75	12BE6—.90
3S4—.80	6C4—.66	19BG6—2.40
3V4—.80	6S4—.72	19T8—1.16
6AK5—1.56	6SD7—1.16	25BQ6—1.28
6AL5—.80	6SK7—.90	25L6—.72
6AQ5—.80	6SN7—1.10	35C5—.80
6AT6—.60	6T8—1.28	50C5—.80
6AV6—1.00	6V6—.90	117Z3—.75
6AV6—.60	6W4—.72	

### All Other Types at Vast Reductions

Westinghouse Kupro Rectifier 0.64 Amp. 28 Volts. Reg. \$11.00 ea. Special \$7.95	
TUBE SALE—27-5-27—11-56-37—11-56-37	
Mixed Ass't. 6 of Any Type.....	2.25
12 BRAND NEW 10" PHONO RECORDS—Ass't. Jazz—Popular. Please specify.....	\$1.79
Single Pole—10 Pos. 2 Gang Switch.....	.29c

### FRESH EVEREADY BATTERIES IN STOCK FOR PORTABLES, ETC.

45' 'B'—'A' 'B' Batts. \$1.75	710	'A' Batts. .70c
467	727	.39c
482	724	.42c
490	726	.49c
753	728	.60c
755	742	.74c
756	746	.63c
950 Flash Cells—48 for.....		\$3.90

3 Ft. 5 Wire Shielded Cable with Amphenol Connector.....	.9 for \$1.00
Signal Corps Phones—2 M. Ohms (8 M. Ohms Imp.).....	\$1.00
2 Ft. Ext. Cord (and Plug).....	.40c
2 MFD—1000 V Upright Bottom Lug Oil Cond. 89c	

### TOBE TUBULAR ELECTROLYTICS

20-20 MFD. 150 V. .49c	30-30 MFD. 150 V. .57c
40-40 MFD. 150 V. .59c	

### Low-Loss Short Wave Lock Type Air Trimmer Variable Condensers

3 Pl.—12-15 Mmfd. .12c	3 GANG T.R.F. VARIABLE CONDENSERS .000365 Con. 65c
7 Pl.—25-30 Mmfd. .15c	D.P.D.T. SLIDE TOGGLE SWITCH .15c
8 Pl.—30-35 Mmfd. .16c	
14 Pl.—56 Mmfd. .24c	

4 PR. WAFER SOCKETS—\$1.49 per C. each.....	.3c
5-6 PRONG WAFER SOCKETS.....	\$2.50 per C
100 ASST. SOCKETS—4-5-6-7.....	\$3.50 per C
1,000 OHM WIRE WOUND POTENTIOMETER.....	.15c
20 HV-FILTER CHOKE SHELVED.....	.3 for \$1.00
UNSHIELDED.....	.3 for 1.00
2,000 ohm Wire Wound Rheostats.....	\$1 per doz.
CARTER WIRE WOUND C.T. VARIABLE 20 OHM RESISTORS.....	.85c per doz.

### PIEZO CRYSTAL HOLDERS.

12 for \$1.00—\$6.00 per hundred—\$50.00 per 1,000
--

RCA Band Switches—3 gang, 3 pos. 3 band. 30c 6 gang, 4 pos. 4-5 band. 40c
---

Trimmer-Padder Ass't.—all isolantite—singles, dual, triples—100 asst. pieces.....	\$2.25
---	--------

Philco push button Rotary Switch Double Pole.....	.35c
---	------

ATTENTION: Prospectors, Explorers for Hidden Treasures! Construct a U.S. Army Type of Metallic Mine Detector Amplifier. Amplifier uses 12 tubes and batteries with cables, headphone cord, and jack. Army wiring diagram. Type AN/PRS-1.....

RCA Ass't Mica By-Pass Cond. .001. 100 for.....	.95c
8 or 9 Gang Push Button Switch.....	.49c

DRILLED CHASSIS FOR 5-6 tubes 5"x10"x1 1/2".....	.25c
PHONE JACKS—OPEN & CLOSED AUTO.....	.18c
8BY SPEAKER VOL. CONTROL—60 OHMS.....	.15c
SALE—PHONO RECORD ALBUMS—12"—3 comp. 15c; 10"—3 comp.—15c; 4 comp. 20c; 12 comp. 69c	

6 Prong Amphenol Sockets.....	\$.40 per C
-------------------------------	-------------

AMERTRAN FILAMENT TRANSFORMER—6.3 V. 1 Amp. Encased Isolantite Terminal Posts.....	\$1.50
--	--------

VULCAN HEAVY DUTY 100 WATT SOLDERING IRON. Built for U.S.N.—Brand New—Ebay sells for \$8.50—OUR PRICE \$2.95
--

AMERTRAN AUDIO OUTPUT XFORMER—Pri. 10.000 @ 15 MA. Sec. 300. 6:1 Ratio.....	\$1.49
---	--------

AMERTRAN MIXER AUDIO XFORMER—Pri. 600-10,000 Ohms.....	\$1.00
--	--------

156-1 RATIO VERNIER DIALS—4 in. 3/8 in. Hub. 35c
--

LINE VOLTAGE NOISE ELIMINATOR—Plugs in Between Radio and Elec. Socket.....	.35c
--	------

HEARING AID CORDS—Assortment of 12 for.....	\$1.00
---	--------

BY-PASS COND. ASST.—25 Cans, Bake. Paper, etc.....	\$1.00
--	--------

MINIMUM ORDER \$3.00—NO C.O.D. SHIPMENTS—PLEASE INCLUDE POSTAGE

**NEWARK SURPLUS MATERIALS CO.**  
Dept. NOV  
324 Plane Street NEWARK 1, N. J.

24 feet in diameter, and the minute hands, which are of copper, travel a distance equal to 100 miles each year. The hour hands, of gun metal, are nine feet long. Big Ben, the bell on which the hours are struck, weighs 13½ tons. Twice a day the performance of the clock is automatically checked at Greenwich Observatory. From the mike hanging in the belfry at Westminster, the chimes are brought by land-line to Broadcasting House, and from there they are passed to our short-wave transmitters and broadcast to the world. At the quarters and half hour the first note of the Westminster chimes gives the correct time, but at the hour it is given by the first stroke of Big Ben. On the other hand, the last pip of the Greenwich Time Signal denotes the exact hour to within 1/20 of a second."

### Club Notes

**Belgium—Radio Sweden** says details on the (new) Belgian Short Wave Club are available from John Gilliams, 147, Rue Franklin, Brussels, Belgium.

**England—An interesting radio club** is the *World Friendship Society of Radio Amateurs*, founded in 1935. It is open to both "hams" and SWL's. Officers now include R. C. Kenny, president; Arthur A. Bird, general secretary; John Beavan, secretary of "Bed-Fast Club"; L. J. Smith, secretary of Junior Section; H. G. Swan, manager of "Pen-Pal Section"; and John Beavan, H. G. Swan, and Syd Poole, executive committee. Carries on some unique services of benefit particularly to "juniors" and to "shut-ins." Further details can be had from Headquarters, 35, Bellwood Rd., Waverley Park, Peckham Rye, London, S.E. 15, England, or from the president, R. C. Kenny, G3AAU, 30, Churchbury Road, Enfield, Middlesex, England.

**USA—The United 49'ers Radio Society** has chosen these officers for the coming year—Edward I. Broome, Vincentown, N. J., president; James J. Zaloudek, Baltimore, Md., first vice-president; Dan C. Ainsworth, Binghamton, N. Y., second vice-president; Julia Boice, New Britain, Conn., secretary; James R. Pickering, Hightstown, N. J., treasurer; Charles E. McCormick, Jr., Baltimore, Md., chaplain; Anson Boice, New Britain, Conn., editor, and James Deegan, Staten Island, N. Y., assistant editor.

### This Month's Schedules

(Note: Some stations are now changing from Summer to Winter schedules, in which cases you may find by this time that schedules are one hour later than listed herein.—KRB)

**Afghanistan—Radio Kabul**, 9.975 (announced) has not been heard weekdays but has been logged Sundays around 1150 with talk in *English*; call 1200, then request program; 1228 announcing "Send requests; if we have them, we will play them"; then, "Until next Sunday, goodnight," and closing abruptly. (Pearce, England)

**Albania—Radio Tirana**, 7.852, still has *English* 1615-1630. (Pearce)

# Compare!

PROVE  
**EMC**  
SUPERIORITY!



**Model 300**  
vacuum tube-volt-ohm-cap. meter

- 4½" Meter • Complete with leads
- Input resistance to 30 Meg. ohms
- 5 AC Volt Ranges to 1,000 volts
- 6 DC Volt Ranges to 1,000 volts
- 4 capacity Ranges • 6 Resistance Ranges to 1,000 Megs.

Model 300—Open Face..... **\$41.50**  
Model 300 in Kit Form..... **\$24.95**  
Model 300P Portable Case with cover..... **\$46.60**



**Model 500**  
r.f. signal generator

Provision for external modulation with 400 cycle internal modulation available. Employs electrostatically shielded transformer for 115 V. 60 cycle operation. Ranges from 150 KC to 36 Megs. on fundamentals—over 100 Megs. on harmonics.

Model 500—Two color gray hammettone. Panel and case..... **\$29.75**  
Model 500 in Kit form..... **\$19.75**



**Model 203**  
tube-ohm-capacity tester

- Tests all tubes including Noval and sub-miniatures!
- Emission testing method gives easy, direct readings
- Tests all tubes from .75V to 117 filament volts.
- Individual sockets for each type tube
- Built-in roll chart.
- Three color hammettone panel.
- Model 203—Portable Oak case, Removable Cover..... **\$49.50**

Dept. RN-11 for Free Complete Catalog of these and other instruments. —See Them at Your Jobbers—



**Electronic Measurements Corp.**  
280 Lafayette St., New York 12, N. Y.  
Export Dept., 303 W. 42nd St., N. Y. C.

## Say You Saw It in RADIO & TELEVISION NEWS

FOR FINEST PHONOGRAPH REPRODUCTION

### PREAMPLIFIER EQUALIZER

**MODEL A100**

- The only pre-amplifier that provides EXACT equalization down to 30 cycles for all makes and types of records.



**EXCLUSIVE FEATURES:**

- Independently adjustable turnover and roll-off.
- 4 turnover frequencies.
- 6 roll-off characteristics.
- Gain control.



**BROCINER**  
ELECTRONICS LABORATORY

1546 Second Ave., New York 28



*Andorra*—Radio Andorra, 5.990 (measured), signs off daily 1900. (Bellington, N. C.; Ferguson, N. C.) Noted in Scotland 1520-1600 with musical program. (Rodger)

*Angola*—Radio Clube Benguela sent card for reception of CR6RB, 9.165, depicting station; verified in *English* this time. (Pearce, England) The 9.705 outlet noted in New York around 1500-1530. (Bellington) Benguela is heard around 1300 on approximately 7.790; *Radio Clube de Huambo*, Nova Lisboa, is noted signing off 1530 on approximately 7.090. (Radio Sweden) *Radio Diamang* has again changed frequency and CR6RG now can be heard on 7.070 at 1330-1430. (Radio Sweden)

*Australia*—VLA11, 11.71, is good level late afternoons in Eastern USA; news 1645, 1745. (Ferguson, N. C.; others)

*Austria*—Vienna, 6.1595, noted with dance music 0001-0030. (Catch, England) Innsbruck is still on 6.000 after 0000, but usually is buried by QRM. (Bellington, N. Y.)

*Azores*—Ponta Delgada, 4.847, noted 1630 with news in Portuguese; signs on 1600. (Pearce, England) When this was compiled, CSA92, 11.090, was still being heard 1400-1500—but by now may be on winter schedule of 1500-1600, (Ferguson, N. C.)

*Barbados*—Cable and Wireless Station ZNX32, 7.547, Bridgetown, was last heard with sports commentaries (races) in August but should be on the air again during *November*, most likely on weekdays (irregularly) around 1100-1658; watch for it particularly on Saturdays, Tuesdays, Thursdays. (Pearce, England)

*Bechuanaland*—Mafeking has not been heard for a long time; *inactive now?* (Ridgeway, South Africa)

*Belgian Congo*—Radio College, Elisabethville, is on the air 1130-1230 weekdays and 0200-0400 Sundays on 3.390, 4.980, 7.200; local news in French 1225. (*WRH Bulletin*)

*Belgium*—Brussels, 21.72, heard calling Leopoldville, Belgian Congo, 1045 and closing 1130. (Ridgeway, South Africa)

*Brazil*—The new station, *Radio Difusora do Guapore*, operates on 4.995 instead of earlier-stated channel of 4.955. Heard under strong QRM from ZYY-2, *Radio Brusil Central*, same frequency, until closedown around 2030; has call ZYY-20 and actual power is 300 watts, to be increased to 1 kw. in December. *Radio Religio Federal* of Rio de Janeiro, Distrito Federal, actually operates on 1490 kc., ZYZ-21, 5 kw., and will soon open on 4.905 with call ZYZ-20 and 5 kw. power (not ZYZ-21 and 1 kw. as stated earlier); transmitters are located at nearby city of Niteroi; offices QRA is P.O. Box 4543, Rio de Janeiro, Brazil. Standard Time Service around the clock, announcing Rio de Janeiro official time every minute, after a gong; also transmits advertisements and weather forecasts, but no music; 60-m. transmitter is to be opened in December; service is in cooperation with and under supervision

# There's a *University* Loudspeaker

**RUGGED!**

**DEPENDABLE!**

**VERSATILE!**

**FOR EVERY COMMERCIAL AND INDUSTRIAL APPLICATION**



**TRUMPETS** Model 7102 exemplifies the rugged construction and progressive engineering behind every University product. Model 7102 is the only loudspeaker ever approved by Underwriters' Labs for Class II Groups E, F, & G hazardous area duty. Features include re-entrant trumpet (pioneered by University) for compactness and greater efficiency, heavy duty 25 watt driver unit with exclusive University "W" shaped Alnico V magnet, and built-in line matching transformer with impedances of 16, 45, 500, 1000, 1500 and 2000 ohms. See general catalog for trumpets of all sizes.

**BREAKDOWN-PROOF DRIVER UNITS** Model PA-30 embodies features developed by University and never successfully imitated. Ratings are conservative, and construction is to well known University standards which have made our drivers famous for their dependable performance. PA-30 is rated at 30 watts, with response 80-10,000 cps, and is the first to have a multi-tap built-in line matching transformer. Exclusive "rim centering" construction of mechanism and use of University "W" shaped Alnico V magnet insures high conversion efficiency, permanent voice coil alignment regardless of shock or vibrations. Weather-proofed throughout.



**PAGING AND INTERCOM SPEAKERS** These feature reflex air columns with hermetically sealed driver units. They are widely used for intercommunication and paging of all types. Efficiency is high and reproduction exceptional at any volume level. Directional, radial, or bi-directional types available. Weather-proof finishes permit use anywhere. Typical of University pace-setting design is the Cobra-12 illustrated, which provides optimum area coverage with minimum power input. Power rating is 12 watts, frequency response 250-10,000 cps, dispersion angle 60° x 120°. Swivel mounting bracket provides full flexibility.

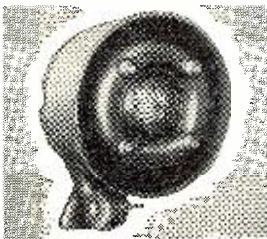

**SUBMERGENCE-PROOF SPEAKERS** These types are designed for use where extreme ruggedness and immunity to spray, gases, live steam or dust are essential. Function even under water, drain automatically, operate continuously regardless of exposure. Models available for directional or radial projection, wall or bulkhead mounting, swivel mount and with or without built-in line matching transformer and attenuator. Design is ideal for railroad use, shipboard, industries, docks, rough mobile work, etc. Model MM-2, illustrated, is rated at 15 watts continuous IPM, frequency 300-6000 cps, impedance 16 ohms.

**FOR ALL HIGH FIDELITY REPRODUCTION REQUIREMENTS**

**WIDE RANGE CONE SPEAKERS** Model 6201 comprises a superb 12" cone speaker with a driver type tweeter mounted coaxially. The cone speaker features a 24 oz. "W" shaped Alnico magnet and edge treated cone for distortion-free low frequency response. Tweeter has wide angle horn. A built-in LC crossover network and external high frequency attenuator are included. Capacity is 25 watts, response 45-15,000 cps, impedance 8 ohms. Other cone speakers for high fidelity, as well as submergence-proof or blastproof service for commercial and military applications.

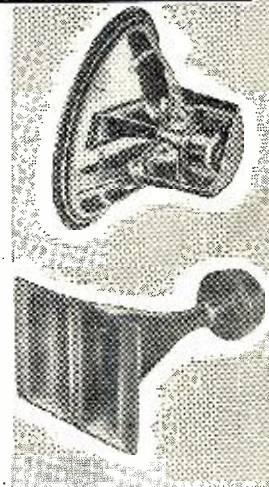

**HIGH-FREQUENCY TWEETERS** University offers a complete line of single and double tweeter units for both 2000 and 600 cycle crossover. Exclusive University "reciprocating flare" horn construction assures uniform wide angle dispersion. A complete line of accessories are included—crossover networks, adapter for mounting tweeter on a standard cone speaker, etc. These tweeters may be added to any standard amplifier and speaker to provide the finest in high fidelity reproduction—and at a very low cost.

WRITE DEPT. 18 TODAY FOR YOUR FREE COPY OF THE NEW 24-PAGE UNIVERSITY TECHNIQUE — A COMBINED TECHNICAL MANUAL AND CATALOG — INVALUABLE FOR YOUR FILES.



**University LOUDSPEAKERS**  
INCORPORATED

80 SOUTH KENSICO AVE., WHITE PLAINS, NEW YORK



BUILD THESE

# NEW PRECISE KITS

Get ASSURANCE of factory ACCURACY and SAVE

The new PRECISE Vacuum Tube Voltmeter with the outstanding PRECISE Reflex Circuit for increased stability and greater accuracy. Your greatest Dollar-for-Dollar value by comparison!



Check, compare these unusual specifications: 1% Ceramic resistors; Etched panel; Amphenol connectors; Separate 5V., AC scale; Tubes: 6AL5, 5X5, 6SN7; True zero adjust; 4 1/2" Meter; Three-color rapid construction books explain each step.

Ranges: +DC: 0-5-25-250-500-1000 Volts; Model 909-K \$2598\*  
 -DC: 0-5-25-250-500-1000 Volts; AC: 0-5-25-250-500-1000 Volts; Ohms: Rx1, Rx10, Rx100, Rx10,000, Rx1,000,000 ohms; DB: From -20 to +35 DB. Model 909, Factory wired... \$44.98\*

Another PRECISE First! NO OTHER PROBE HAS ALL THESE FEATURES! The PRECISE High Voltage Probe is beyond comparison! Feature after feature—all PRECISE exclusives—make it the most practical, foolproof and sturdy H.V. Probe in the industry today.

Multiple insulation; Mechanically shock-proof construction; Interchangeable tips; Swivel Lead connection; Interchangeable resistors; Triple flash guards; Sturdy, non-bourous shell construction. Model 999 \$698\* (Wired only) Complete

PRECISE DeLUXE VACUUM TUBE VOLTMETER FOR VERTICAL OR HORIZONTAL CONSTRUCTION—Large 7 1/2" meter for better visibility and greater accuracy. Build this magnificent V.T.V.M. horizontally or vertically to fit your own bench requirements.

All the unusual features and ranges of the PRECISE Model 909 VTVM in a DeLuxe version. Model 907-K \$3998\* Model 907 \$57.98\* Factory wired... \$49.98\*

PRECISE R.F. PROBE KIT with High Voltage Switch More Versatile Than Any Other R.F. Probe! Model 914-K \$398\* Model 914 \$49.98\* Factory wired... \$4.98\*

Built-in 250 mc., 500 V. switch; Germanium rectifier.

All instruments carry the PRECISE Guarantee. All components protected by the RMA Warranty. Write for FREE Catalog N2! SEE THE COMPLETE PRECISE LINE. SEE YOUR JOBBER NOW! \*Prices slightly higher in the West

EXPORT DEPT.: 15 Moore St., New York, N. Y.; Cable "Minthorne"



PRECISE

PRECISE DEVELOPMENT CORP.

An Engineered Product

Oceanside, L. I., New York

## SHORT-WAVE

in your CAR!

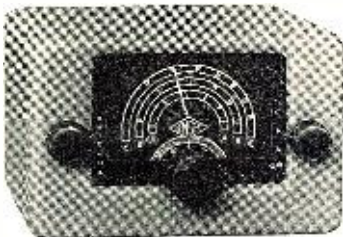
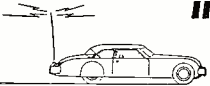

### GONSET "3-30" Converter

- attaches to your automobile radio
- continuous coverage 3 to 30 mc.
- four working (r.f.) tubes
- extremely compact

converter \$44.75 noise silencer \$9.25

OTHER FREQUENCY RANGES (POLICE, MARINE, ETC.) ON SPECIAL ORDER.

see your distributor or write direct

GONSET CO. BURBANK, CALIF.

!!TV. ANTENNA SPECIALS!! 30 ELEMENT CONICAL "X" ALL ALUMINUM \$4.95; 2/58.95 LATEST "DOUBLE-V" HIGH GAIN \$4.95; 2/ 8.95 STACKING BARS aluminum pair .98

## Leotone

- RADIO HARDWARE TREASURE FULL LB. CAN of Nuts, Screws, Lugs, etc.—69¢
- W. E. SINGLE HEADSET Bi-Imm. \$3.95; 2/58.98 INTERCOM TRANSFORMER 3-8/50K 1.29 POWER SWITCH (AHH) SPDT; 15A/125V 1.29 G.E. PYRALOX CONDENSERS Int/500V or .25mf/1000V; bot. lug mtg. \$0.49; 6/ 2.49 PLASTIC CABINET & CHASSIS Handsome Red, Yel. Walnut or Ebony. 1 1/2"x9"x7" 1.79 19 FT. WHIP ANTENNA steel screw sects 2.49 9 1/2 FT. WHIP 3 sects. 1.49
- Radio-Amplifier Steel Cabinet also for Test Eqp., Power Supply, Medical or Industrial Exp. Hinged front. Walnut. 14"x8" sq. \$2.49
- TUBE CARTONS plain white. Prices per 100. Min. (1x1x2 3/4) \$1.20; GT (1 1/4x8x3 1/4) \$1.45; Med. (1 1/2x8x4 1/4) \$1.65; Large (2x2x5) \$1.98
- RUBBER SHOCK MOUNTS 2 1/2" 1 1/2" 49¢; 6/ 2.49 Heavy duty, 100 lb., 2 1/2" mtg. 1.10 49¢; 6/ 2.49
- TANK PERISCOPE Reflector, brand new... 1.69
- OUNCER INPUT XFMR (7x1 1/4) 50 ~ to grid... .98
- 1 1/2 V. FIL TRANSFORMER 1 1/2 Amp. .79
- 3:1 AUDIO TRANSFORMER 2"x1 1/2"x1 1/2" .89
- #20 PUSH-BACK WIRE Red, Yel., Blue, Blk. 100 ft./ 89¢
- W-1108 FIELD WIRE rolls 100-400 ft. only 1/2¢ ft. 74 OHM CO-AX CABLE RG-18/U, 20 ft. lths 1.39
- HIGH FIDELITY CRYSTAL MIKE Rubber shock mtd. Hi-imped. 1 1/4"x1 1/4". Less housing 1.29
- ALUMINUM HOUSING for crystal mike... .15
- HANDY CARBON MIKE (RS-83). Press-to-talk... 1.49
- 5" SPEAKER BAFFLE MOUNT 1 1/4" mesonite... 19¢; 6/ 1.00



- MINI-MIDGET RELAYS!! 34"x24V. DC. SPST, N.O. 280... 3/4"x1 1/4" 79¢ SPST, N.O., 8A, dble brk cont. 230A... 89¢ 1x1 1/2x1 1/2 89¢ SPST, 280... 3/4"x1 1/4" 1.29 SPST, N.O., 280... 3/4"x1 1/4" 1.29
- FARNSTOCK CLIPS .34" brass 100/ 89¢
- TUBE CLAMPS I.D. 1-3/16 or 1-5/16" 8¢; 100/ 56.50

"ALNICO MAGNET SPECIAL" "U" type, pol. 3/4"x3/4"x3/8" ea. 49¢; 6/ 2.49

ALNICO MAGNET KIT Powerful Bar. Block, "U", Rod, etc. 10 asstd. for... 1.98

(WRITE FOR "ALNICO MAGNET" SUPPLEMENT) SPEAKER CONE KIT 4 1/2" to 12" incl. free-edge; Less voice coils. Kit of 12 asst... 1.98

SPEAKER REPAIR KIT Liberal assortment of: V. C. forms, Spiders, Felt, Chamois Leather, Rings, Cement, Shim Kit, Instructions... 2.49

!!SPECIAL!! both CONE & REPAIR KITS for only 3.95

"FACTORY SPEAKER REPAIRS SINCE 1927" Write for FREE Speaker Parts Manual

Min. order \$3.00. 20% deposit req. on all C.O.D.'s. Full remittance with foreign orders. Please add sufficient postage—excess refunded.

EOTONE RADIO CORP. 65 Dey Street New York 7, N.Y.

of the Brazilian National Observatory. PRL4, Radio Ministerio da Educacao e Saude, Rio de Janeiro, has new schedule of 0400-0700, 1000-2100 over 9.77. (Serrano, Brazil)

ZYB8, 11.765, Radio Tupi, Sao Paulo, noted at weak level 1800. (Hoogerheide, Wisc.) Radio Record, 9.505, leaves air 2100. (Bellington, N. Y.)

British Guiana—ZFY, 5.980, Georgetown, noted with recordings 1930 and news 1945. (Ferguson, N. C.)

British New Guinea—VLT7, 9.52, Pt. Moresby, noted 0140 with light classical music; weak level and QSB. (Lane, Wyo.) VLT5, 7.28, heard with ABC news 0600. (Ferguson, N. C.)

Burma—The Burma Broadcasting Service, 9.543, Rangoon, noted recently with news 1000-1015 sign-off; fair level. Announced as operating on 31.44 m. (Rosenauer, Calif.) Is scheduled 2000-2130 (not Sun.) on 9.543; 0030-0230 (not Mon.) on 6.034, 9.543, and 0600-1015 on 6.034. English 2015-2030, 0115-0145, 0915-1015. (WRH Bulletin)

Canary Islands—Radio Clube de Tenerife, EA8AB, has good signal after 1600 on 7.51A. (Pearce, England)

Ceylon—Radio Ceylon, 11.975, noted signing on 2045, good level. (Bellington, N. Y., others) Relays BBC news 2100; announces 7.190 in parallel.

Schedule received from the station lists Commercial Service on 15.120, 7.190, and 11.975 at 2045-1145; all-English except at 0030 and 0630 when lists Hindi programs; lists religious broadcasts in English for 1100 on Sun., Wed., Thur., Fri.; and "VOA" program at 1030. (Dilg, Calif.)

China—Radio Peking was still being heard with English 0430-0500 on 10.260, 11.68A. (Rosenauer, Calif.) Has improved signal on 15.06A during 0830 news period. This outlet noted in Calif. by Russell around 2330 with oriental commentary and singing.

Colombia—Radio Cadena Nacional, Bogota, is now transmitting on a new channel of approximately 5.02 heard regularly around 1930-2045 with fair level in Brazil; announced call is HJKJ. (Serrano) HJCK, 6.018, Bogota, noted signing off 0259 with English announcement by man. (Machwart, Mich.)

Costa Rica—TIPG, San Jose, "La Voz de la Victor," is now heard on 9.615 instead of listed 9.62, closing down 2325, weak signal in Brazil. (Serrano) Officials of TIFC, 9.645, San Jose, inform Russell, Calif., that the short-wave transmitter has been off the air since May 15; a new and "better" transmitter is now under construction and should be on the air within the next month or so.

Cyprus—ZJM5, 6.170, Limassol, has news in Arabic 1330. (DX-Radio, Sweden)

Czechoslovakia—Prague noted with news 1400-1430 on 11.875, 9.550. (Pearce, England)

Denmark—OZH, 15.180, noted with news 0520 during 0430-0530 session in English for Far East on Tue., Thurs., Sat. New schedule to North America is 2030-2130 and 2200-2300 on 9.52; DX



# 630 TS CHASSIS

LICENSED BY RCA

31 Tube with C. R. T. Chassis — World's Most Powerful Set

RECTANGULAR  
**16 or 17"**  
BLACK TUBE  
**\$169.**  
CHASSIS

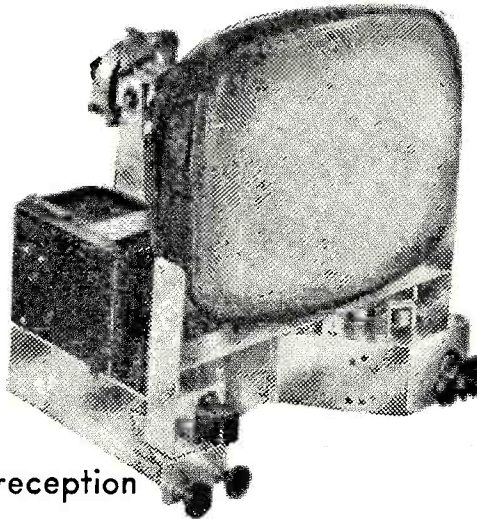

**20"**  
COMPLETE CHASSIS  
**\$189.**  
WITH BLACK  
RECTANGULAR  
TUBE

**24"**  
GENERAL ELECTRIC  
BLACK FACE TUBE  
**\$249.**  
CHASSIS

- Best for fringe area reception
- Improved keyed A. G. C.
- Full 4 megacycles 14000 to 16000 output
- A. F. C. Sync Separator Syncrolok Improved
- 25 Microvolts or better
- Complete chassis with tubes aligned
- Use 70° — 90° deflection yoke-coil
- Standard tuner or Dumont tuner F.M. Radio

NO EXTRA CHARGES \* R. M. A. guarantee on all parts — picture tube replaced free.

**17" Console  
Cabinets**

Mahogany in sealed cartons with doors — \$30. extra  
**\$29.**

**IMMEDIATE  
DELIVERY**

15% DOWN — BAL. C.O.D.

Remit in full — save C.O.D. charges

EXPORT ORDERS FILLED

**20" — 24"  
Cabinets**

CONSOLE — Mahogany or Blond. half or full doors \$30. extra.  
**\$59.**

## UNIVERSAL ELECTRONICS

2380 OCEAN PARKWAY • BROOKLYN, N. Y. • ESPLANADE 6-4842

SETS AVAILABLE AT DISTRIBUTORS LISTED BELOW:

**DENTONES**  
206 BANK OF AMERICA BLDG.  
STOCKTON, CALIFORNIA  
**HOLLIS E. MOUNCE**  
2733 FLORIDA  
LONGVIEW, WASHINGTON  
**M. F. GREEN**  
CASPER, WYOMING  
**ROCKY MOUNTAIN T.V. INC.**  
663 CORONA ST.  
DENVER, COLORADO  
**VINCYS CANADIAN T.V.**  
41 STIRTON ST.  
HAMILTON, ONTARIO, CANADA

**D. S. SERVICE**  
96-98 WEST SECOND ST.  
FOND DULAC, WISCONSIN  
**THE TOWERS T.V.**  
1624 SOUTH DIVISION AVE.  
GRAND RAPIDS, MICHIGAN  
**ILLINOIS VALLEY T.V.**  
117 SOUTH GREENWOOD ST.  
SPRING VALLEY, ILLINOIS  
**CUBAN-AMERICAN EXPORT**  
225 SEYBOLD BUILDING  
MIAMI 32, FLORIDA  
**E. L. BAHNSEN**  
BOX 1858, VINTON, LOUISIANA

**DE GESERE T.V.**  
FORT HUNTER-CURRY ROAD  
SCHENECTADY, NEW YORK  
**HARDY TELEVISION**  
R. D. 3, WARREN, PENNSYLVANIA  
**EDMUND DE LAIN**  
79 LEE AVE.  
JAMESTOWN, NEW YORK  
**GENERAL DISTRIBUTOR**  
204 RIO BRAVO BUILDING  
BROWNSVILLE, TEXAS  
**PIERRE BOURDON CANADIAN T.V.**  
8 RUE BROSSARD  
LA PRAIRIE, CANADA



OIL CAPACITORS		MICA CAPACITORS	
1x1MF 230VAC.	\$.39	.056 MF 1 KV F21	\$.49
5MF 35VDC.	.49	.025 MF 1.5KV F21	.49
14MF 250VAC.	3.95	.024 MF 1.5KV F2L	.49
2MF 600VDC.	.99	.033 MF 1.5KV F2L	.49
7MF 600VDC.	1.99	.025 MF 2 KV F2L	.49
8x8MF 600VDC.	2.75	.02 MF 2 KV F2L	.49
2MF 1000VDC.	1.25	.03 MF 2 KV F2L	.49
10MF 1 KVDC.	4.25	.00075MF 2.5KV F2L	.49
2MF 1.5KVDC.	2.25	.0015 MF 3 KV F2L	.49
2MF 2 KVDC.	2.95	.004 MF 3 KV F2L	.49
2MF 3 KVDC.	2.95	.005 MF 3 KV F2L	.49
2MF 4 KVDC.	2.95	.0024MF 6 KV G1	5.95
2MF 5 KVDC.	5.50	.0008 MF 6 KV G1	6.95
2MF 6 KVDC.	14.95	.0024 MF 8 KV F3	7.50
2MF 12.5KVDC.	59.50	.0013 MF 15 KV G329	50

**CO-AXIAL RELAYS**  
Allied Control Type RA, SPDT, 6 VDC. Uses Standard Co-Ax Connectors. . . . . \$5.95

**NEW STEEL TABLE RACK CABINETS.** 83 1/2" H x 19" W x 13" D, Black Crackle Finish, Hinged Top with Lock, 2 opening in rear for cable connectors. Shipped via Ry. Exp. . . . . \$5.95

**PE-201A Gasoline power plant.** Output—115V 60Cy 70W. 3000 RPM. Used Exw. . . . . \$275.00

**KLEINSCHMIDT PERFORATOR 110-220 VDC.** used excellent condition. . . . . \$250.00

**RCA 12 inch PM Speaker, New.** . . . . \$3.95

**OCTAL PLUG IN BASE AND SHIELD**  
Ideal for Lab, shop, etc., for housing circuits that require frequent changing, capacitors, resistors, tuned circuits, relays, etc.  
2" high x 1 3/8" wide x 1 3/8" deep. . . . . \$0.53  
2" high x 2" wide x 2" deep. . . . . .80  
3" high x 2" wide x 2" deep. . . . . .80  
3 1/2" high x 2" wide x 2" deep. . . . . .83  
Units available in 100 coil forms, or with loss coil forms and slugs. Send for descriptive literature.

**COMPONENT BARGAINS**

1N23B crystals \$4.20, 1N34 xtals.	\$.049
5Y3GT .55, 872A \$2.95, 304TL	9.95
TS-13 Handset \$2.95, National type N dial.	3.25
Dual 10 Amp. 15 60 Cy circuit breaker.	1.00
5 screw terminal strip (6/32 Screw).	1.20
Barrier Strip, Yellow Bakelite, 6 term.	1.50
Milieu terminal strip (1/16" dia).	1.40
9 pin min. water socket.	.85
7 pin min. molded sock. base shield.	1.75
Octal sock. MIP 2.5A.	1.60
4 prong teatite socket.	1.00
6 prong, MIP 6 socket.	1.85
7 prong (small) teatite socket.	1.00
Amph. 61M, 15A 125V plug & 61-61 shell.	.25
Amph. 61F, 15A 125V Recept. & 61-61 shell.	.25
7 ft. rubber line cord & mold. plug.	1.00
7 green 110V Pilot Light assembly.	1.95
SPST 6A 125V. H & H Bat Handle Togg. Sw.	.39
CH Luminous tip bat handle Aircraft Togg. Sw.	.25
SPST 5A 125V.	ea. .35
SPST as above.	ea. .25
SPST as above, momentary only.	ea. .25
SPST as above, neutral loss on circuit break.	ea. .25
SPST Rotary Switch, water type.	2/ .25
6 pos. Ceramic Rotary Switch.	.59
50 or 800 ohm 10W WW Res.	ea. .40
IRC 2000 ohm 50W WW Res.	ea. .75
IRC 10K 50W WW Res Adj.	ea. .55
IRC 10K 100W WW Res Adj.	ea. .75
IRC 50K 100W, 2.5K 100W Adj.	pair 1.25
Rheostats—50 ohm 25W, 100 ohm 25W.	ea. .75
Veeder Root 4 digit counter (A1142).	1.50
Milieu Flex. exp. 100 Ohm. for Hig. Freq. Ant.	10/ 1.50
PL-55 plugs 50c, PL-68 plugs.	.75
JK34 jacks 17c, JK33 jacks.	1.15
3 digit counter dials, for slugs.	1.35
Jack Box 631B (322) used.	.35
Control Box C254AR/ART-13 & plug. New	9.95
Special Mobile 600 Ohm. for Hig. Freq. Ant.	1.50
2 cell penlite bulbs (#222). 3V.	.05
Grain of Wheat 3V bulb 5c, GE #57. 12V.	.05
Mazda S-6 1 1/2" 6V bulb.	.49
3000 MF 3V electrolytic capacitor.	.21
STEATITE Plate Caps.—807 17c, 866.	.85
Johnson 210 sock. 65c, 211 sock.	39.50
AN/PSS-1 mine detector.	ea. 39.50

**CHOKES**

VAR. IND. UTC VLC-14	\$6.50
200 HY 6 MA. Cased	.75
5 HY 50 MA. 200 Ohm	.80
6 HY 70 MA. 215 Ohm	.95
9 HY 90 MA. 250 Ohm	1.10
7 HY 125 MA. Cased	1.49
1.25 HY 130 MA. 57 Ohm. Cased.	1.10
10 HY 150 MA. 140 Ohm. Cased.	1.10
6 HY 200 MA. Cased	3.15
4-16 HY 200 MA. 140 Ohm. Cased.	5.10
3 HY 250 MA. 65 Ohm. Cased.	3.49
15 HY 250 MA. 65 Ohm. Cased.	3.49
5-25 HY 300 MA. 120 Ohm. SW. CH. Cased.	6.50
8 HY 300 MA. Cased.	8.00
6 HY 450 MA. 30 Ohm. Cased. Herm. Seal.	8.50
6 HY 500 MA. 30 Ohm. Cased.	5.95
7 HY 500 MA. Cased.	6.95
7 HY 700 MA. 15 Ohm. Cased.	11.50
5-30 HY 500 MA. SW CH. Cased.	7.95
5-20 HY 500 MA. SW CH. 10 KV. Ins.	12.95
3.5 HY 950 MA. Ohm. Cased.	11.50
7 HY 1 AMP. Cased.	29.50
2-16 HY 1 AMP SW, 45 Ohm	37.50
6 HY 1.5 A. Cased.	42.50

**115V FILAMENT TRANSFORMERS 60 CY**

2.5 VCT 10A, Cased.	\$1.49
2.5 VCT 10A, 10 KV Insulation.	3.15
2.5 V @ 6A, 2.5 V @ 6A, Cased.	3.45
5 VCT 3A, 2.5 KV Insulation.	2.45
5 V @ 3A, 6.3 V @ 3.5A.	2.95
5 VCT 12A, 2.5 KV Insulation.	5.95
5 VCT 20A, 2.5 KV Insulation.	6.85
6.3 VCT 1A, 2.5 KV Insulation.	1.99
6.3 VCT 3A, 2.5 KV Insulation.	1.99
6.3 V @ 4A, 6.3 V @ 4A, Cased.	2.95
6.3 V @ 6A, 5V @ 3A, 5 V @ 2A.	2.95
6.3 VCT 6A, 2.5 KV Insulation.	3.95
6.3 V 10A, Cased.	5.95
6.3 V 12A, 6.3 V 2A Herm. Seal.	3.95
10 VCT 10A, 2.5 KV Insulation.	6.00
24 V 1A, 2 KV Insulation.	3.95

**115V POWER TRANSFORMERS 60 CY**

68 to 83 V Half Wave, 1.5A.	\$1.25
300 V 20 MA (Half Wave).	2.00
435 VCT 145 MA, 6.3 V 3A, 5V 3A.	2.95
630 VCT 40 MA, 6.3 V 2A, 5 V 2A.	3.25
680 VCT 200 MA.	2.95
700 VCT 70 MA, 6.3 V 2.5A, 5 V 3A.	3.50
700 VCT 90 MA, 6.3 V 3A, 5 V 3A.	4.25
740 VCT 185 MA, 6.3 V 4A, 5 V 3A.	5.95
800 VCT 200 MA, 6.3 V 3A, 5 V 3A.	5.95
800 VCT 300 MA, 6.3 V 10A, 5 V 6A, 5 V 2A.	9.95
750-600-600-750 VDC, 225 MA.	9.95
5400, 5800, 6200 VCT 110 MA.	29.50
2500 VDC 1A, Pr. 230 V 3ph 60 Cy.	125.00

**POLY-TECH**  
919 Dawson St., New York 59, N. Y.  
Tel. MUrray Hill 6-2650

session Tuesdays around 2120 and 2250. (Bellington, N. Y., others)

**Dutch New Guinea**—Although Hollandia "claims" 7.160, when this was compiled appeared to be on approximately 7.125, heard 0515-0630 sign-off. (Rosenauer, Calif.; Stark, Texas, others)

**Ecuador**—HC1AC, 6.210, Quito, noted with Latin music 2000-2100; fair signal in Wisconsin but with terrific CWQRM. (Hoogerheide)

**El Salvador**—YSMA, "La Voz Suprema de Occidente," Santa Ana, is still on 6.200. (Stark, Texas)

**Fernando Po**—Santa Isabel broadcasts daily on a frequency of 7.200, with low power, at 0130-0230, 0700-0900, 1200-1400; is *Emisora de Radio-difusion Santa Isabel*, Guinea Espanola. The last broadcast period, 1200-1400, is in Portuguese. There is a special broadcast, "Music in the Air," on the first, 10th, and 20th of each month 1700-1900. Is heard in such African countries as Belgian Congo, Nigeria, Angola, Mozambique, but not reported heard on this side of the Atlantic. A new building is under construction and the new high-powered transmitter is expected to start operations in December of this year, probably around December 5 when there is to be an international meeting of West African colonies. (DeMyer, Mich.)

**Finland**—Helsinki noted 0715 with news on 15.19, 17.800, 9.55; announces repeat for 2200 (to USA) on same channels. (Pearce, England)

**France**—Paris, 6.200, noted 1345-1400 with French-English lesson; announced 48.39 m. and 41.21 m. and said *English* program is daily 1500-1600. (Pearce, England)

**French Guinea**—Radio Guinea, Conakry, reported some weeks ago as broadcasting music around 0700-0730 on 10.230 is not a broadcasting station; Conakry has only radiotelegraph stations for the transmission of telegrams; it does not broadcast musical programs. (WRH Bulletin)

**French Morocco**—Radio Maroc, 6.006, Rabat, noted 1420 with Arabic music. (Pearce, England) And opening 0200, weak and with QRM from RIAS, Berlin (Bellington, N. Y.)

**French West Africa**—Radio Dakar, 15.345, noted 1415 tune-in and signing off 1600 with "La Marseillaise" in transmission directed to France. (Pearce, England)

**Germany**—AFN, "Serving American Forces in Europe," noted near 5.470 around 0930-1200 and another day as early as 0100 when had weather report, morning music; fundamental channel? (Pearce, England) Stuttgart, 6.03, heard recently with news in German, by man, in progress when tuned 2323; good signal and no QRM. (Bellington, N. Y.)

**Gold Coast**—Accra, 15.430, noted on a Sunday recently 1035-1100 with music. (Saylor, Va.)

**Greece**—The Central Broadcasting Station of the Greek Armed Forces, 6.330, noted to closing 1700 (in Greek); on Mondays with special program of

**RADIO Surplus Buys**

**500 KC CRYSTALS**  
500 KC Crystals in FT 241-A holders with 1/2" pin spc.  
ONLY LIMITED QUANTITY AVAILABLE  
**\$1.95 ea.**

**TUNER FROM NAVY "BN" EQUIPMENT**  
Simply modified into 2-meter converter for car or communications receiver. Uses 1-636, 1-6SH7, 1-9006, 1-6J5 (Not Furnished).  
Slugs is tuned from 157 to 187 Mcgacycles. Includes schematic diagram for "BN" equipment.  
Now—A New LOW Price. . . . . **\$4.95**

**BC-605 INTERPHONE AMPLIFIER**  
Ideal for inner-com system in home; office to office, aircraft, boats, etc. Comes complete with tubes, case, and diagram. Easily converted. (See Page 140, April Issue RADIO & TELEVISION NEWS.)  
BRAND NEW IN ORIGINAL CARTONS  
Special Close-Out Price, each. . . . . **\$3.95**

**BLACK LIGHT KITS**  
**ULTRA-VIOLET FLUORESCENCE**  
NOW . . . build your own black light equipment at a new low cost with these easy-to-assemble components. Kit contains: Ultra-violet tube, brackets, ballast, starter, wire, plug and diagrams.  
4-Watt Kit—(5 1/2" tube) . . . . . \$3.00 ppd.  
8-Watt Kit—(12" tube) . . . . . \$4.00 ppd.

**TYPE RL-9 Interphone Amplifier**  
Easily converted to high fidelity phone amplifier or speech amp. Comes complete with tubes. Operates on 24 volt DC. Used, but in good condition. Less dynamotor.  
A money-saving buy at, each. . . . . **\$2.95**

**METERS, AIRCRAFT**  
1-Milliampere, zero center for field strength meters, grid dip or tuning meters.  
BRAND NEW. Postpaid **\$1.95**

ALL EQUIPMENT F.O.B. PASADENA UNLESS OTHERWISE SPECIFIED. PLEASE ENCLOSE FULL AMOUNT WITH ORDER

**C & H SALES CO.**  
BOX 356-NT, East Pasadena Station, Pasadena 8, Calif.

**TELEVISION**  
PREPARE FOR A GOOD JOB!  
BROADCAST ENGINEER  
COMMERCIAL OPERATOR (CODE)  
RADIO SERVICEMAN  
**Television Servicing**  
(Approved for Veterans)  
SEND FOR FREE LITERATURE  
**BALTIMORE TECHNICAL INSTITUTE**  
1425 EUTAW PLACE, BALT. 17, MD.

**BENDIX 4-CHANNEL E.C.O.**  
Channel 1 1050-1700 KC | Channel 3 3000-4800 KC  
Channel 2 2000-3400 KC | Channel 4 4370-7000 KC  
Unit is front end of TA-12B transmitter by band switching each channel is a complete oscillator uses a 6SK7 or 12SK7 in each channel by adding an 807 driver and a pair of 807's for a final you have a 50 watt trans. each osc. section is completely shielded and mounted on an aluminum chassis with var. cond. shafts extended ready to add voltage. GOVT. COST OVER \$300.00 NEW WHILE THEY LAST.  
**McCONNELL'S** 3834 Germantown Ave. Phila., Penna. RA 5-6033



Greek songs, popular music for listeners overseas, and with *English* announcements; said similar broadcast every Monday 1630 and asked for reports to 3 Zalacosta Street, Athens, Greece. (Pearce, England) *Radio Athens*, 11.718, still has *English* 1430-1445. (Pearce, England) Noted signing on around 2330 on 7.300. (Bellington, N. Y.)

**Greenland**—Gronlands Radio, Angmagssalik, broadcasts regularly on 150 kc. and 7.570 and experimentally on 12.300 and 15.4025 according to verification letter; output is 500 watts; on the air 0900-0945. Mail can be received only when the harbor is free from ice—June-Sept. Reception reports are appreciated to the Greenland Department, Vangehusvej 12, Copenhagen Ø, Denmark. (Radio Sweden)

**Guatemala**—By this time, TGNA should be using its new 11.85 channel with *English* around 2200-2230.

**Haiti**—4V2S, *Radio Port-au-Prince*, is operating currently on 5.945 at 0630-0830, 1200-1430, 1800-2100. A new station also located at Port-au-Prince is 4VM on 6.005. Scheduled 1130-1430, 1800-2130. (*WRH Bulletin*) Bellington, N. Y., says this one jumps back and forth around 6.005-6.015.

**Holland**—*Radio Nederland's English* transmissions are now 0530-0610 to Australia, New Zealand, and Pacific Area over 21.48, 17.775, 15.22, 6.025; 1100-1130 to South Asia over 15.22, 11.73; 1500-1540 to Africa, Great Britain, Ireland, and Continental Europe over 11.73, 9.59, 6.025; 2130-2210 to USA and Canada over 11.73, 9.59 (just announced soon would be using 6.025—Bellington, N. Y.). The "*Happy Station Programs*," produced and presented by Eddie Startz, are scheduled Sundays only at 0530-0700 on 21.48, 17.775, 15.22, 6.025 to the Far East, the Pacific Area, and Europe; 1100-1230 over 15.22, 11.73, 6.025 to Near and Middle East and Europe; 1630-1800 over 11.73, 9.59, 6.025 to South and Central America, and 2130-2300 over 11.73, 9.59 to North America.

**Honduras**—HROW, *Radio Monserat*, still noted on 6.67 although some overseas sources report it moved to 6.018. (Bellington, N. Y.) Measured 6.660 at 1955; news in Spanish noted 2000. (Ferguson, N. C.)

**Hong Kong**—ZBW3, 9.524, relays BBC's *Radio Newsreel* 0900. (Russell, Calif.) This one is scheduled on 9.525 with 2 kw. at 2315-0000, 0400-0930; *English* at 2315-2330 (news), 0430-0500, 0700-0930; other programs are in the Chinese dialects. (*WRH Bulletin*)

**Hungary**—*Radio Budapest* noted 1600 in *English* for British Isles on 11.91, 9.833, 7.22, and repeated 1810 on m.w. 556.5 kc. only; at 1710 opening on 11.91, 9.833, 7.220 in *English* for North America. (Pearce, England) Noted signing on 1500 on 11.91. (Leary, Ind.)

**India**—AIR, 15.29 and 11.700A, noted in dual 1045-1100 with news. (Rosenauer, Calif.) Heard with *English* 1400-1500 still on 7.170, 9.720 for Europe; opening 0830 with *English* still on 17.740, 15.290. (Pearce, England)

November, 1951

# TRAIN for TELEVISION

in 3 easy steps!

..at the amazingly low price of...

ONLY \$15.50

for the complete training (all 3 books)

5 Months to Pay!

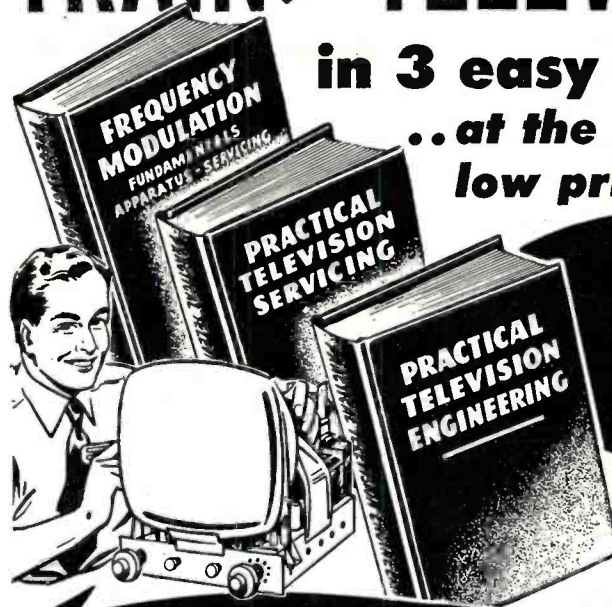

The famous RINEHART TV LIBRARY

## 1—FREQUENCY MODULATION

The "Heart" of Television Sound

Here, for the first time, is a complete, easily understood description of Frequency Modulation (F.M.)—the circuit system by which TV sound is transmitted and on which many other important electronic developments are based. You learn all about basic F.M. theory, control circuits, receivers, transmitters, mobile equipment, detectors, amplitude limiters, antennas and dozens of related subjects. Concise, clear explanations of F.M. test equipment and its use plus specific F.M. service problems are invaluable to busy service men. Price \$5.00 if bought separately.

## 2—PRACTICAL TV SERVICING

Complete "How-to-Do-It" Data

After studying this famous book, you'll find even the most puzzling TV servicing problems greatly simplified. You'll work better, faster—more profitably! Actual service case histories make things amazingly clear. Dozens of illustrations and pattern photos explain details step by step. You learn how TV differs from radio, how receivers operate and, above all, how to service them properly. Other subjects include wiring details, component replacement data, testing tips, fringe area reception hints, improving picture linearity and dozens of other vital TV service subjects. Price \$4.00 if bought separately.

## 3—PRACTICAL TV ENGINEERING

Basic Training for the "Big Money" Field

The "know how" so clearly presented in this big 700-page book can quickly help you forge many steps ahead of the average television student! Starts right at the beginning with an easy explanation of all TV receiving and transmitting components and just how they are combined in the complete television system. Progresses logically through every phase of the work including transmission fundamentals, all about the cathode ray tube and how it works, camera chains, studio work, lenses, oscilloscopes, synchronizing generators, video amplifiers, power supplies, etc. 385 illustrations. Price \$7.50 separately.

...FOR BETTER JOBS!  
...FOR BETTER PAY!

These 3 great books offer you a really outstanding LOW-PRICED OPPORTUNITY to get ahead in the fastest-growing electronics field of them all—TELEVISION!

Already, there are almost 16 million television receivers in U.S. homes. Each TV set uses from 4 to 10 times as many parts as an average radio. Within a few months TV reception will be extended to many parts of the country that never had it before. This famous library helps you get in on the "ground floor" of this giant TV business—paves your way to bigger pay and better jobs!

Read singly, each book is an authentic, easy-to-understand guide to a special phase of Television. Add all 3 together and you have a specialized training that might well spell the turning point in your life toward bigger and better things!

SAVE \$1...pay as you learn

Now—for the first time—this RINEHART TV LIBRARY is offered on 10-DAY FREE EXAMINATION. Read the books for 10 days before you decide—then make a worthwhile cash saving if you buy. Bought singly, these famous books would cost you \$16.50. Under this offer, you save \$1—and you have the privilege of paying in easy monthly installments.

You can't lose on this offer!

10-DAY FREE EXAMINATION

Dept. RN-111, RINEHART BOOKS, INC.  
Technical Division, 232 Madison Ave., New York 16, N. Y.

SAVE \$1—ORDER THE COMPLETE SET!

Send me the famous RINEHART TV LIBRARY (all 3 books) for 10-DAY FREE EXAMINATION. If the books are not what I want, I will return them to you postpaid in good condition at the end of 10 days without any further obligation on my part. If I decide to keep them, I will then send \$3.50 as my first payment and will send you \$3 a month for 4 months until the total special price of \$15.50 is paid.

TO ORDER BOOKS SINGLY

Enclosed find \$... for books checked; or send G.O.D. and I will pay postman. In either case, I may return books in good condition in 10 days and you guarantee to refund my money.

FREQUENCY MODULATION \$5.00 (\$5.50 outside U.S.A.)

PRACTICAL TELEVISION SERVICING \$4.00 (\$4.50 outside U.S.A.)

PRACTICAL TELEVISION ENGINEERING \$7.50 (\$8.00 outside U.S.A.)

Name .....

Address .....

City, Zone, State .....

Your employer .....



## COMMAND PERFORMANCE



*Shelley Winters*

Starring in "THE RAGING TIDE"  
A Universal-International Picture

with the

**American**  
DR 330

Dynamic and Ribbon Cardioid  
**MICROPHONE**

Whenever top performance counts . . . whenever fidelity counts, the American DR 330 Dynamic and Ribbon Microphone will be the first choice for quality by particular sound engineers.

Lovely Universal-International star, Shelley Winters, depends on a microphone with quality tonal reproductions and like many other Hollywood stars she chooses an American.

The American DR 330 is quickly and easily changed from cardioid (ribbon & dynamic) to bi-directional (ribbon) or to omni-directional (dynamic) by simply removing the name plate and changing the linkage bars to the desired pattern. Impedance versatility provides 50 ohms, 150 ohms or 250 ohms, by moving linkage bars.

Attractive gold anodize and black finish this sturdy microphone is the smallest, lightest, most compact microphone of its kind on the market today.

**List Price \$250.00**

Complete with leatherette covered jewel case and 25 foot cable.

**American**  
**MICROPHONE COMPANY**  
370 SOUTH FAIR OAKS AVENUE  
PASADENA 1, CALIFORNIA

*Indo-China (Vietnam)* — Radio France-Asie, Saigon, is now radiating on 7.230 at 1915-1930 and 1815-1845; on 9.524 at 1715-1745; on 9.754 at 1900-1930, 2030-2100, 2345-0000, 0615-0630, 0700-0715, 1015-1030, 1815-1845; on 11.830 at 2030-2045, 0400-0515, 0800-1030 (Sats. to 1100). "French by Radio" is being broadcast on Tuesdays, Fridays at 0515 and 0800 on 11.830; 11.780 channel has been dropped. (Radio Sweden) The 11.83 outlet noted in Brazil 0500-0515 with news by woman announcer, good level. (Serrano) At the time this was compiled, Rosenauer, Calif., noted RFA had moved from 9.750 back to 9.740A, heard around 1015-1057 sign-off; 11.830 in parallel but weaker.

"Voice of Vietnam," 9.62, Saigon, noted with *English* 0830-0900, good level in South Africa. (Ridgeway)

*Iran*—EPB, 15.100, *Radio Teheran*, still noted with news 1330 and 1500. (Pearce, England) Same noted by Guentzler, Ohio, others.

*Iraq*—Radio Baghdad, 11.724, has not been heard with *English* (Western recordings) lately in its morning transmission, around 0100, but has been noted instead in Arabic around 0055-0128 tune-out; noted also in Arabic from around 1000 tune-in and seems to close around 1418 (sometimes runs as late as 1500) with National Anthem; has news in Arabic 1400. (Pearce, England) Noted signing on around 2258 with bird calls. (Bellington, N. Y.)

*Israel* — *Kol-Yisrael*, 9.010A, Tel-Aviv, noted with *English* broadcast of the World Zionist Organization now 1615-1700 sign-off; announces Yiddish for 1430; French 1515; Hebrew 1600; *English* 1615. (Pearce, England) The 6.83 outlet appears to sign on weekdays around 2230. (Bellington, N. Y.) Should have setting-up exercises at start.

*Italy*—Rome noted in *English* for South Africa 1435-1515 on 15.400; at 1420 in *English* for Britain and Ireland on announced 49.92 m., 31.35 m., 25.4 m., heard well on 6.010 and 11.810 but QRM'd on 9.570, off 1500; noted Sundays signing on 0315 with *English* for Pacific on announced 13.91 m., 16.85 m., 16.88 m., and 19.48 m.; at 0600 with *English* for Far East on announced 16.85 m. and 19.48 m. (replacing 19.48 m.). (Pearce, England) Noted on 15.400 and announced 11.897 with *English* 1900; French 2000; Italian 2030, and *English* (repeat) 2145. (Cooley, Pa.) Noted on 5.980 with native program of music 0245; poor level in England. (Catch)

*Japan*—NHK, listed JK12, 9.655, noted 0300-0315 with Japanese-*English* lesson; 7.257 (listed JKH) parallel; excellent signal on both; NHK, 6.175, noted 0330-0345 in parallel with the 7.257 channel, all-Japanese, fair level; NHK, listed JO8G, 6.005, heard recently 0400-0415 in Japanese and did not seem in parallel with any other Japanese outlet. (Rosenauer, Calif.)

*Kenya*—Programs from Nairobi are now radiated on 857 kc. and 4.885 on Sunday 0200-0600, 1000-1400; Wed.

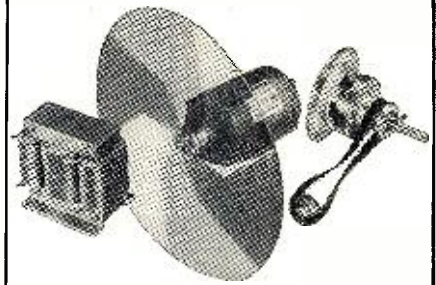

## COLOR CONVERTER KITS

Convert TV set to receive CBS Color



**NEW!**

\* COLOR TIMING GENERATOR

Provides sync pulses for adjusting color wheel control and sweep circuits to new frequencies. . . Eliminates dependence on limited station transmissions.

Write today for complete data

## COLOR SALES CO.

576 W. Merrick Road Lynbrook, L. I., N. Y.  
First Manufacturer of Complete Color Converter Kits

## BRAND NEW TUBES

0A2	\$ 1.58	6BN	\$ 1.09	7V7	\$ 1.20
0B2	1.58	6BA6	.78	7Z4	.69
1A3	1.10	6BC6G	1.48	12A6	1.00
1B3GT	1.16	6H7GT	1.25	12AT7	1.00
1B27	18.50	6CB6	.87	12AU7	.89
1LMS	.79	6C6G	2.40	12C8	1.22
1N23	1.39	6J6	1.29	12CK7	.80
1R4	1.00	6J7	1.00	12J5GT	.69
1R5	.75	6K4	3.39	12K8	.55
1T4	.78	6K6GT	.75	12L7	1.30
1V	.85	6K7	.85	12SF7	1.00
1X2A	1.10	6K8	.98	12SH7	1.00
2C40	6.98	6L6M	2.25	12SK7	.85
3A3	1.59	6L6G	1.55	12SL7GT	.70
3A5GT	1.49	6L6GA	1.59	12SN7GT	.89
7B7	.89	6N7	1.29	12SQ7GT	.84
3E24	4.95	6R4	.90	12SR7	.58
3Q4	.79	6SA7	.89	14F7	1.00
3E4	.79	6SC7	1.00	25L6GT	1.69
4D21	22.50	6SF7	.89	28D7	1.19
5Y3GT	1.45	6SW7GT	1.25	32L7GT	1.00
6A3	1.45	6S7GT	.95	35W4	.48
6AE7	1.19	6S7	.89	35Z5GT	.58
6AC7	1.19	6SK7	.89	39/44	.30
6AH6	1.89	6SL7GT	.90	0B	.79
6AR5	1.89	6SN7GT	.79	50C5	.79
6AK5	1.25	6SQ7	.75	83	1.59
6AK6	1.25	6S97	1.05	VR-90	1.19
6AR5	6.00	6ST7	1.30	VR-105	1.15
6A05	.69	6SU7GT	2.35	VR-150	.98
6AR6	2.00	6T8	1.09	17Z6	1.15
6AS7E	1.50	6V6	1.89	723A/B	14.50
6AS6	3.00	6V6GT	.69	813	8.99
6AT6	.58	6W4GT	.69	832A	10.95
6AV6	.68	7B4	.79	872A	2.75
		6B, 7F7	1.10	9003	1.75

THOUSANDS OF OTHER TYPES. COMPLETE LINE OF TRANSMITTING TUBES. SELL US YOUR OVER-STOCK! WE PAY HIGHEST PRICES!

**J. S. H. SALES CO.**

Dept. R-6, 7552 Melrose Ave., Los Angeles 46, Calif.

## Advance with ELECTRONICS

You need firm grasp of fundamentals to keep pace with these complex, fast-growing fields. In thorough 2-year course learn electricity, electronics, physics, mathematics, drafting, etc. Other engineering and technical courses. Coed. Day, evening. 44th year. Write for Catalog.

**FRANKLIN TECHNICAL INSTITUTE**

46 Berkeley Street

Boston 16, Mass.

**RADIO & TELEVISION NEWS**



0500-0600, 1000-1500; Sat. 0500-0610, 1000-1500, and other days 0500-0600, 1000-1400. (Radio Sweden)

**Lebanon**—A Swedish DX-er reports Beirut on approximately 15.600 to 1505 and not parallel with Beirut on 8.036. (Radio Sweden) Noted with French program 1420 on 8.036. (Catch, England)

**Liberia**—When this was compiled, ELBC, 6.025, Monrovia, was coming through again late afternoons in Eastern USA to closing at 1845; in *English*.

**Luxembourg**—*Radio Luxembourg*, 6.090, noted recently on a Thurs. 1730-1800 with religious program ("Old Fashioned Revival Hour" in *English*). (Rodger, Scotland) Noted recently 1745 with concert music and announcements in French. (Oskay, N. J.)

**Madagascar**—*Radio Sweden* reports *Radio Tananarive* on approximately 3.200 around 1100. Ridgeway, South Africa, reports this one on 3.23 at good level from 1230; French news 1330; QRN.

**Malaya**—Blue Network of *Radio Malaya*, 7.200, Singapore, noted 0900-0915 with news; fair level in Calif. A station on 6.135 heard 0800-0830 sign-off has been identified as Kuala Lumpur; is not parallel with Singapore on 7.250 and must be companion station to Kuala Lumpur on 6.025. (Rosenauer, Calif.) BFEBS, 15.300, Singapore, noted at good strength around 1015 and later. (Guentzler, Ohio)

**Mauritius**—Schedule on 12.121 is French and *English* weekdays 2200-2315, 0300-0430, 0930-1230; Sunday 0115-0300, 0930-1230; Indo-Mauritian program (Hindustani) daily 0800-0930; Sino-Mauritian program (Chinese) Sunday 0300-0345; Tue., Thurs. 0430-0515; Swahili Thurs. 0730-0800. (*WRH Bulletin*)

**Mexico**—XESC, listed 15.205, appears to have moved higher to around 15.220. (Leary, Ind.) Recently measured 15.219 by Ferguson, N. C.

XERQ, 9.610, and XEQH, 6.130 (5 kw. each) are operated by *Cadena Radio Continental* in Mexico City at 0800-0100; all-Spanish broadcasts. (*WRH Bulletin*)

**Monaco**—*Radio Monte Carlo* sent verification and schedule on 9.785 and 6.035 of Mon., Tue., Wed., Fri., Sat. 0100-0300, 0600-0800, 1200-1730; Thurs. 0100-0300, 0600-0820, 1200-1730; Sun. 0100-1730. (Machwart, Mich.) The 9.785 outlet noted at good level with music around 1700-1730 here in West Virginia; identifies 1715.

**Mozambique**—Lourenco Marques noted back on 9.84 from 9.85 for the 0000-0100 beam in Portuguese; also noted on 9.84 signing off 1500. (Bellington, N. Y.) Noted in Calif. on 7.26A with sponsored (*English*) programs to around 1000. (Dilg, others) Heard on 9.76 with *English* 0730; good level in Texas. (Stark)

**Nepal**—*Radio Nepal*, 7.100, has news 0845-0900. (Radio Australia)

**New Caledonia**—*Radio Noumea*, 6.035, still noted signing on 0200 and leaving the air around 0530. (Machwart, Mich.)

November, 1951

**GET YOUR** **BIG, NEW 1952**  
**CONCORD Catalog**  
**FREE!**  
**Send for it NOW!**



**ALL-NEW COMPLETE BUYING GUIDE for Every Need!**

FAMOUS PRODUCTS—VAST STOCKS—LOWEST PRICES

## TV • RADIO • ELECTRONICS

You save time and money—with this bigger, better 1952 Buying Guide! Here is page-after-page full of the latest and greatest values in Television, Radio and Electronics. It brings right to your finger tips one of the world's largest stocks of nationally known guaranteed quality parts and equipment. You find it quick and easy to get whatever you need—at the very lowest prices! Send for your FREE *Concord* Catalog today! Have it handy for quick reference!

*Supplies for Industry, TV and Broadcast Stations, Schools, Servicemen, Hams, Government, Experimenters and Builders*

## CONCORD RADIO

901 W. JACKSON BLVD. • CHICAGO

Over 30 Years of Service to the Radio World

CONCORD RADIO CORP., Dept. RL-51

901 W. Jackson Blvd., Chicago 7, Illinois

Rush FREE Big, New 1952 CONCORD Catalog No. 951

Name \_\_\_\_\_

Address \_\_\_\_\_

City \_\_\_\_\_ Zone \_\_\_\_\_ State \_\_\_\_\_

**FREE**  
**SEND FOR IT TODAY!**



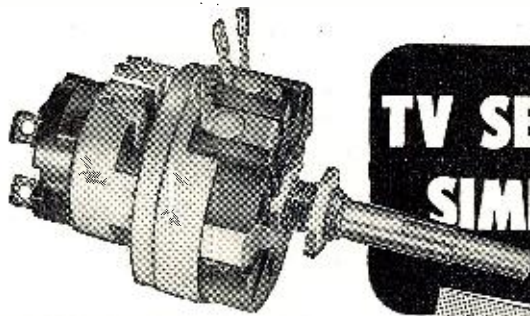

## TV SERVICING SIMPLIFIED

Use this big Clarostat TV Control Replacement Manual! Almost 3000 control listings of all the popular TV set models and chassis. You can spot the correct replacement for any wornout or defective TV control.

Best of all, your Clarostat jobber has that right replacement in stock. No delay. And it fits — electrically and mechanically — without fussing or cussing. Stays put, too, for a profitable job.

### GET THAT TV CONTROL REPLACEMENT MANUAL NOW!

Supply is running out. Send your dollar bill and start saving time, trouble, money, in TV servicing. Or get your copy from your Clarostat jobber.



## Controls and Resistors

CLAROSTAT MFG. CO., INC. • DOVER, NEW HAMPSHIRE

IN CANADA: CANADIAN MARCONI CO. LTD., MONTREAL, P.Q., AND BRANCHES

**New Zealand**—ZL8, 9.62, Wellington, noted 0245 at weak level in Wyoming. (Lane) Heard recently over ZL2, 9.54, at 0540. (Ferguson, N. C.) New schedules received from *Radio New Zealand* list Pacific Islands Service, 1300-1545, ZL3, 11.78; 1600-0145, ZL4, 15.28; 0200 to closedown, ZL3, 11.78. Australian Service, 1300-1545, ZL2, 9.54; 1600-0145, ZL10, 15.22; 0200 to closedown, ZL2, 9.54. Closedown at present is 0545 on Mon.-Fri., 0620 Sat., 0500 Sun.

**Nicaragua**—YNOW, Managua, began using *English* announcements on July 1. (Cushen, N. Z.)

**North Korea**—Pyongyang, 4.590A, noted with usual heterodyne; Russian at dictation speed early mornings; another outlet noted around 4.320.

**Northern Rhodesia**—Lusaka, 9.71, fair level 0500 with news; strong signal in South Africa. (Ridgeway)

**Pakistan**—*Radio Pakistan*, Karachi, has been spotted on approximately 15.700 with a program in *English* to 0330. (Radio Sweden) The 15.335 chan-  
(Continued on page 143)

### Analog Computers

(Continued from page 71)

problem being studied. Functions that cannot be expressed as simple mathematical functions can be handled directly in graphical form by means of special input tables. This feature permits the solution of problems which contain functions capable of being expressed graphically.

Problems involving the flight and stability of aircraft, airfoil de-icing, landing gear design, missile trajectory, missile stability design, and stresses in aerodynamically loaded wings in aeronautics and the field of aerodynamics can be handled by this unit. In the electrical and electronics fields, this equipment can be used in research problems arising in the design of pulse transformers, in electron accelerator studies, in engineering magnetic amplifiers, and in determining electron trajectories. The fields of oceanography, meteorology, servomechanisms, geophysics, and fluid flow can all be served by presenting the basic problems to this analyzer.

### Network Analyzer

The University's a.c. network analyzer differs from the differential analyzers in that it is best suited to the solution of problems by means of physical duplication of the problems rather than by breaking down the problem into a mathematical formula and then feeding the problem to the machine.

This unit consists of banks of resistance, inductance, and capacitance elements which can be varied individually to simulate the circuit conditions of the network under analysis. In addition to these components, the analyzer contains a number of generators, a switchboard-type interconnecting system (patch panel), and all of the meters and testing devices necessary to record the circuit's performance.

**RADIO & TELEVISION NEWS**

## AMPERITE

Studio Microphones  
at P.A. Prices

Ideal for  
BROADCASTING  
RECORDING  
PUBLIC ADDRESS

"The ultimate in microphone quality," says Evan Rushing, sound engineer of the Hotel New Yorker.

• Shout right into the new Amperite Microphone—or stand 2 feet away—reproduction is always perfect.

• Not affected by any climatic conditions.

• Guaranteed to withstand severe "knocking around."

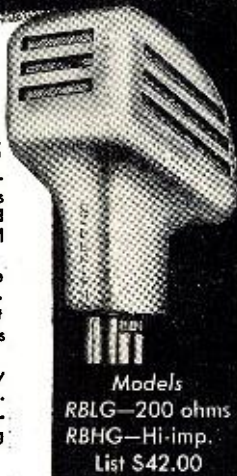

Models  
RBLG—200 ohms  
RBHG—Hi-imp.  
List \$42.00



"Kontak" Mikes  
Model SKH, list \$12.00  
Model KKH, list \$18.00

**Special Offer:** Write for Special Introductory Offer, and 4-page illustrated folder.

AMPERITE Company, Inc.

561 BROADWAY • NEW YORK 12, N. Y.

Canada: Atlas Radio Corp., Ltd., 560 King St. W., Toronto

### LOST!

nights of sleep trying to locate the following equipment:

- BC-611 Handie-Talkies
- ARC-1
- ART-13

We'll pay you more money than you ever dreamed possible! Write:

V & H RADIO  
2033 W. Venice Blvd.  
Los Angeles 6, Calif.



For example, in operation a large power system can be duplicated in a limited space by replacing the various elements of the power system with equivalent electrical circuits. It can also be used to solve problems where the equivalent circuits consist of multiple networks of lumped *R*, *L*, and *C* circuit elements.

The network analyzer has proven to be of particular value in handling such problems as load division, short circuit, and stability in electrical power systems and in providing the analogs of heat transfer, mechanical vibrations, and in intake and exhaust gas systems.

### Thermal Analyzer

The thermal analyzer was designed and completely constructed by the University's Department of Engineering. It is used primarily for the solution of heat conduction problems. Like the network analyzer, it is particularly valuable in cases where the particular problem can be duplicated physically.

The unit consists of sections of resistance-capacitance elements of different values which can be connected into the networks and to various types of voltage and current generators. These generators are used to simulate the heat sources and impose the boundary conditions of the problem.

Each section of these *RC* elements contains two independently variable resistors which are used when two-dimensional heat flow problems are under consideration. The desired solutions appear in the form of oscilloscope traces or as meter readings.

This analyzer has been used to handle such diversified problems as aircraft icing, temperature distribution in gun barrels, forest fire control research, foundry studies, and various phases of melting and freezing processing.

Today the University of California has the research tools required by industry, pure science, and in basic research and foremost among these tools are the analog computers which can be used in man's quest for knowledge.

-50-

## How Bing Crosby's Shavex Speeds up Electric Shaving

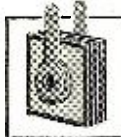
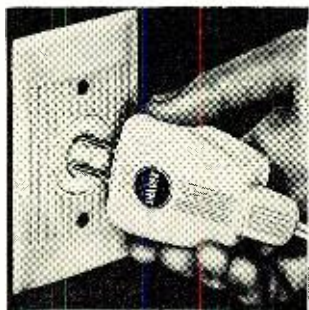

Model 5M4  
Rechargeable  
110V AC  
Current Rating  
1.5A Max.  
Input 120V RMS  
Max. Amp. Voltage  
300V, Size 1 1/2" Square

### ... THANKS TO VERSATILE SELETRON SELENIUM RECTIFIERS

A wonderful boon to faster whisker removal as smooth as Bing's voice is the Crosby Shavex® which changes household alternating current to D.C., thus boosting the power and speed of any electric razor as much as 40% . . . And built into each unit is a miniature SELETRON Selenium Rectifier No. 5M4 for trouble-free operation.

The Shavex is very small, and excessive heating within such a compact enclosure could be a problem. Yet President William H. Burgess of Shavex Division, Electronic Specialty Co., Los Angeles 39, says that extensive temperature tests under full load show SELETRON rectifiers operate much cooler than other rectifiers tested . . . and SELETRON's reliability has been confirmed by successful use of the Shavex under varied conditions of temperature and humidity over a period of several years.

SELETRON builds 'em midget size for radio, TV and other electronic circuits, all the way up to the giant stack assemblies for industrial use. Perhaps the unusual Shavex application may give you an idea for putting these versatile selenium rectifiers to work in some other unique spot . . . If so, SELETRON engineers can be of real assistance. Write us today, and request your copy of bulletin 104-N-11.

Reg. T.M. of Electronic Specialty Co.

SELETRON DIVISION  
**RADIO RECEPTOR COMPANY, INC.**

Since 1922 in Radio and Electronics  
Sales Dept. 251 W. 19th St., New York 11, N. Y. • Factory: 84 N. 9th St., Brooklyn 11, N. Y.



## Ungar's little Angels

### STILL HARPING ON THE SAME SWEET SONG

From minor repairs to high-speed production soldering, 8 talented muses to remember are

Ungar's Little Angels. Each versatile, job-designed tip fits the trim, slim Ungar Pencil to strum a tune in perfect harmony with most soldering requirements. Ask your supplier for the lyrics to this merry melody.

No. 537-S 1/8" PENCIL TIPS, 20 Watts

For Light Duty Work. Recommended for small meters and instruments, small joints and hard-to-reach points on radio and TV, printed circuits, delicate electronic assemblies, aircraft instrument repair, bearing aid assembly and repair.

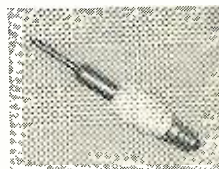

Write for Catalog No. 400

**Ungar** ELECTRIC TOOLS, INC., Los Angeles 54, Calif.

# SAVE

THAT GOOD LOOKING OLD CONSOLE—  
REPLACE YOUR OBSOLETE RADIO

with a modern, easily installed

## ESPEY AM/FM CHASSIS

and your favorite console is "right-up-to-date"

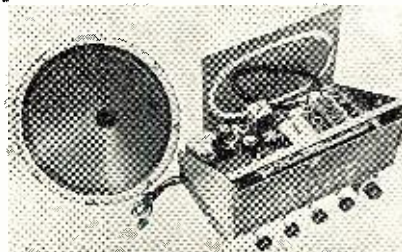

Rated an excellent instrument by America's foremost electronic engineers. Fully licensed under RCA and Hazeltine patents. The photo shows the Espey Model 511-B, supplied ready to play. Equipped with tubes, antenna, speaker, and all necessary hardware for mounting.

**NEW FEATURES**—Improved frequency modulation circuit, drift compensated • 12 tubes plus rectifier, and pre-amplifier pick-up tubes • 4 dual purpose tubes • High quality AM-FM reception • Push-pull beam power audio output 10 watts • Switch for easy changing to crystal or variable reluctance pick-ups • Multi-tap audio output transformer supplying 4—8—500 ohms.

Makers of fine radios since 1928.

Write for literature RN for complete specifications on Model 511-B and others.

**ESPEY**  
MANUFACTURING COMPANY, INC.  
528 EAST 72nd STREET, NEW YORK 21, N. Y.  
TEL. TRafalgar 9-7000



*Build*  
**15 RADIOS AT HOME**  
 With the New Improved 1951  
 Progressive Radio "EDU-KIT"  
**ONLY \$19.95**

**FREE TOOLS WITH KIT**

**ABSOLUTELY NO KNOWLEDGE OF RADIO NECESSARY**

**NO ADDITIONAL PARTS NEEDED**

**EXCELLENT BACKGROUND FOR TELEVISION**

**10-DAY MONEY-BACK GUARANTEE**



**WHAT THE PROGRESSIVE RADIO "EDU-KIT" OFFERS YOU**

The Progressive Radio "Edu-Kit" offers you a home study course at a rock bottom price. Our Kit is designed to train Radio Technicians, with the basic facts of Radio Theory and Construction Practice expressed simply and clearly. You will gain a knowledge of basic Radio Principles involved in Radio Reception, Radio Transmission and Audio Amplification.

You will learn how to identify Radio Symbols and Diagrams; how to build radios, using regular radio circuit schematics; how to mount various radio parts; how to wire and solder in a professional manner. You will learn how to operate Receivers, Transmitters, and Audio Amplifiers. You will learn how to service and trouble-shoot radios. In brief, you will receive a basic education in Radio exactly like the kind you would expect to receive in a Radio Course costing several hundreds of dollars.

**THE KIT FOR EVERYONE**

The Progressive Radio "Edu-Kit" was specifically prepared for any person who has the desire to learn Radio. The Kit has been used successfully by young and old in all parts of the world. It is not necessary that you have even the slightest background in science or radio.

The Progressive Radio "Edu-Kit" is used by many Radio Schools and Clubs in this country and abroad. It is used by the Veterans Administration for Vocational Guidance and Training.

The Progressive Radio "Edu-Kit" requires no instructor. All instructions are included. All parts are individually packaged, and identified by name, photograph and diagram. Every step involved in building these sets is carefully explained. You cannot make a mistake.

**PROGRESSIVE TEACHING METHOD**

The Progressive Radio "Edu-Kit" comes complete with instructions. These instructions are arranged in a clear, simple and progressive manner. The theory of Radio Transmission, Radio Reception and Audio Amplification is clearly explained. Every part is identified by photograph and diagram; you will learn the function and theory of every part used.

The Progressive Radio "Edu-Kit" uses the principle of "Learn By Doing." Therefore you will build radios to illustrate the principles which you learn. These radios are designed in a modern manner, according to the best principles of present-day educational practice. You begin by building a simple radio. The next set that you build is slightly more advanced. Gradually, in a progressive manner, you will find yourself constructing still more advanced radio sets, and doing work like a professional Radio Technician. Altogether you will build fifteen radios, including Receivers, Amplifiers and Transmitters.

**THE PROGRESSIVE RADIO "EDU-KIT" IS COMPLETE**

You will receive every part necessary to build 15 different radio sets. This includes tubes, tube sockets, variable condensers, electrolytic condensers, mica condensers, paper condensers, resistors, tie strips, coils, tubing, hardware, etc. Every part that you need is included. In addition, these parts are individually boxed, so that you can easily identify every item.

**TROUBLE-SHOOTING LESSONS**

Trouble-shooting and servicing lessons are included. You will be taught to recognize and repair troubles. While you are learning in this practical way, you will be able to do many a repair job for your neighbors and friends, and charge fees which will far exceed the cost of the Kit. Here is an opportunity for you to learn radio and have others pay for it.

**FREE EXTRAS IN 1951**

- ELECTRICAL AND RADIO TESTER
- ELECTRIC SOLDERING IRON
- BOOK ON TELEVISION
- RADIO TROUBLE-SHOOTING GUIDE
- MEMBERSHIP IN RADIO TELEVISION CLUB
- CONSULTATION SERVICE
- QUIZZES

Order your Progressive Radio "EDU-KIT" Today, or send for further information.

**PROGRESSIVE ELECTRONICS CO.**

497 UNION AVE.

DEPT. RN-11 BROOKLYN 11, N. Y.

**X-Rays in Industry**

(Continued from page 55)

ages are inspected for proper filling and for foreign particles. Mounted over a conveyer belt, the machine permits fluoroscopic examination with no delay in production time.

**Circuit Considerations**

Figs. 2 and 3 show representative diagrams of x-ray equipment. In Fig. 2, a diode rectifier is employed to convert the available a.c. into d.c. The primary of the step-up transformer receives its voltage from an adjustable autotransformer. This arrangement permits variation of the target voltage and consequent control of the penetrating power of the x-rays produced. A rheostat is included in series with the filament to permit control of the filament temperature. Changing the temperature of the filament will change the number of electrons striking the target and, consequently, the quantity of x-rays produced.

The circuit of Fig. 2 employs a half-wave rectifier, and as a result, the circuit is inoperative during the nega-

tive alternations. In most radiographic and fluoroscopic applications, this periodic interruption of the x-rays is not serious. In those cases where continuous radiation is required, a full-wave rectifier is used. The bridge type rectifier is popular in this application and is shown in Fig. 3. Here again, the autotransformer controls the penetrating power and the filament rheostat varies the quantity of the x-rays.

Lead shielding is used extensively in x-ray installations to protect the operator from excessive exposure. Lead and lead-glass shields and an arrangement of mirrors are commonly used in fluoroscopic installations to permit continuous operation without danger to the operating personnel.

X-rays probe a thousand products daily. They inspect and reveal, they save time and expense, they conserve talent and motion. From the small units which inspect packages of breakfast food, to the million volt giants, the x-ray machine has earned a respected place in industry.

Thus, whether we are aware of the fact or not, x-rays play a vital role in our everyday lives by protecting quality and insuring safe, dependable products.

-30-

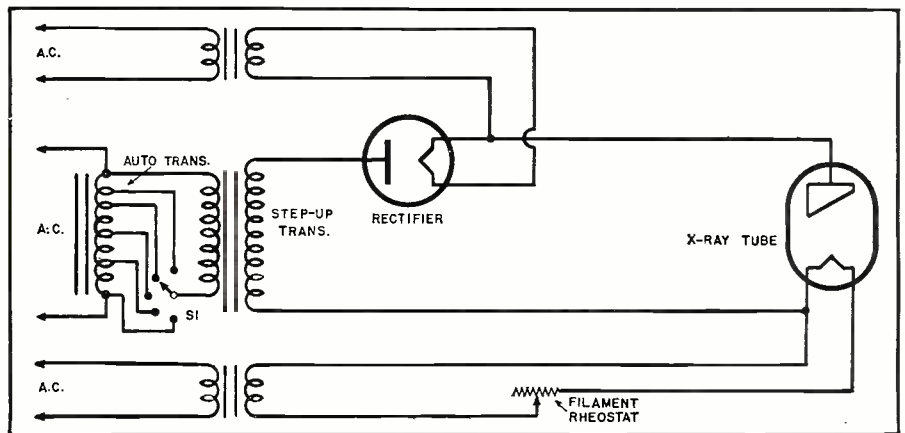
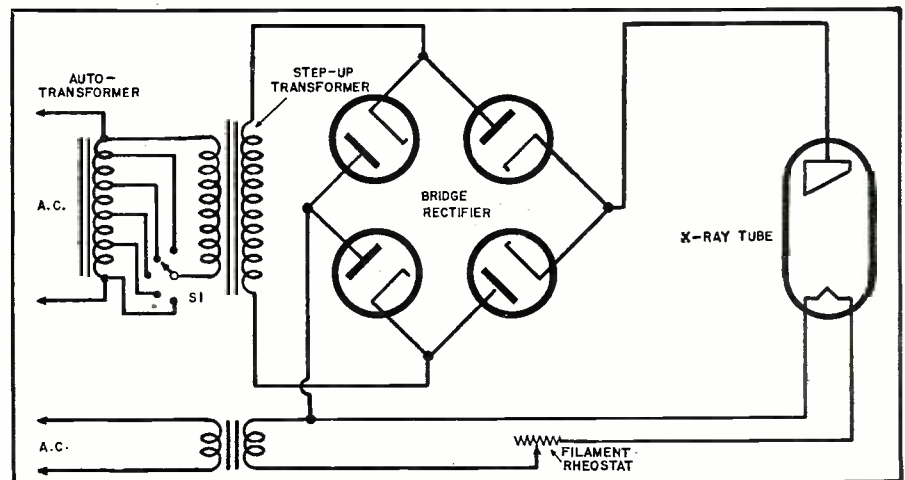

Fig. 2. An industrial x-ray circuit employing a diode rectifier to convert the a.c. into d.c. The primary of the step-up transformer receives its voltage from an adjustable autotransformer thus permitting variation of the target voltage and consequent control of the penetrating power of the x-rays which the unit produces.

Fig. 3. One version of a commercial x-ray circuit in which a bridge type rectifier is used in place of the diode rectifier shown in Fig. 2. The autotransformer controls penetrating power and the filament rheostat varies the quantity of x-rays.





**Mac's Service Shop**  
(Continued from page 69)

player into the amplifier; and she had not heard a dozen bars of her prized Stan Kenton's *September Song* platter coming out of that coaxial speaker until she began making big plans for having a 'platter party' down in the rumpus room so that the kids could hear 'how good SK really was.' Personally, I'm convinced that gal is mad as a hatter. She kept playing records and wanting me to listen for 'that dog house growling' or 'the hot licks of that licorice stick.'

"You're just not hep, Grandpa," Barney said as he pulled his head out of the TV cabinet and turned a very dirty but grinning face up at Mac. "But tell me what other arguments you used to twist the poor man's arm."

"Well, I pointed out that buying a high fidelity sound system was really a fine investment for the future, no matter which way television might turn and twist. Color sets, v.h.f. sets, sets with three-dimensional viewing—no matter what the engineers cook up in the way of receivers, the sound will finally have to be amplified and reproduced; and Ed can be sure the outfit he bought will do a fine job of that, no matter what sound source he feeds into it. Also, he will be able to buy comparatively inexpensive table model sets and still have sound reproduction far better than most expensive consoles would give him. Another less-important consideration is that keeping the speaker away from the chassis will eliminate any microphonic-tube troubles."

Mac stopped for breath and then continued:

"A nice part of buying a sound conversion from the customer's point of view is that he does not lose the money he puts into it when he finally discards the television set to which it was attached. From our point of view, of course, sound conversion has many advantages over tube conversion: it is easier to do, and the results are almost as startling. The cost can be figured exactly in advance, and the customer can see what he is getting for his money. All of the work is *electronic* work and can be done right here in the shop. We neither have to turn ourselves into cabinet-makers to do it or hire a cabinet-maker to finish the job."

"Another great advantage might be termed psychological. In the case of a tube conversion, as we sadly know, the customer sees what looks like very drastic changes made in the set itself, and he is all braced to discover that we have 'messed up' his receiver. He seems to feel that once we have done a tube conversion on his set we are responsible for anything that happens to it from then until eternity. We can explain until we are black in the face that the only changes performed were in the sweep circuits; he still holds us responsible for everything from a dead

NEW for '51  
**Automatic Radio**  
CUSTOM-BUILT  
AUTO RADIOS

1949, 1950 and 1951  
**FORD AUTO RADIOS**



List Price.....\$59.95

1949, 1950 and 1951  
**PLYMOUTH-DODGE RADIOS**

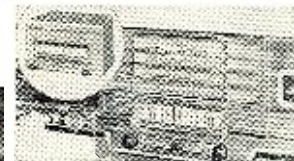

List Price.....\$59.95

**ATTRACTIVE DISCOUNTS TO DEALERS**

1949, 1950 and 1951  
**CHEVROLET RADIOS**



List Price.....\$59.95

**CUSTOM-BUILT RADIOS**

1948-49-50-51 HUDSON  
1951 HENRY J  
1949-50-51 STUDEBAKER  
List Price.....\$59.95

**AUTO RADIO SHORT WAVE CONVERTER**



- Tunes 63 Meters Through 17 Meters
  - Band Spread Tuning
  - Use with any Car Radio
  - Powerful and Sensitive
  - Size 7" x 2 3/4" x 3 3/4"
  - Easy to Install
- PRICE \$34.50**

**CAPACITORS**

UPRIGHT MOUNT		EA	TEN
2X.25 MFD	400 VDC	\$.35	5.30
.5 MFD	500 VDC	.40	.30
1 MFD	600 VDC	.40	.35
2X.05 MFD	600 VDC	.40	.35
.25 MFD	600 VDC	.40	.35
2X.1 MFD	600 VDC	.45	.40
1 MFD	600 VDC	.45	.40
1.5 MFD	600 VDC	.45	.40
1 MFD	600 VDC	.45	.40
BATH TUB			
4 MFD	50 VDC	.45	.40
4 MFD	100 VDC	.55	.50
2X.1 MFD	200 VDC	.40	.35
3X.1 MFD	400 VDC	.40	.35
2 MFD	400 VDC	.55	.55
.05 MFD	600 VDC	.40	.35
.25 MFD	600 VDC	.40	.35
.5 MFD	600 VDC	.40	.35
1 MFD	600 VDC	.40	.35
1 MFD	600 VDC	.50	.45
2 MFD	600 VDC	.65	.60
2X1 MFD	600 VDC	.65	.60
.05 MFD	1000 VDC	1.55	1.50
2X.1 MFD	1000 VDC	.65	.60
OIL FILLED AND GE PYRANOL			
.5-5 MFD	500 VDC	\$.55	\$.60
.1 MFD	500 VDC	.70	.65
1 MFD	500 VDC	.70	.65
1 MFD	600 VDC	.85	.85
2 MFD	600 VDC	1.15	1.10
4 MFD	600 VDC	1.60	1.55
5 MFD	600 VDC	1.60	1.55
1-8 MFD	600 VDC	2.75	2.65
.5 MFD	1000 VDC	.95	.90
2 MFD	1000 VDC	1.60	1.50
5 MFD	2000 VDC	2.00	1.90
.25 MFD	3000 VDC	2.85	2.80
.5 MFD	3000 VDC	2.95	2.90
1 MFD	3000 VDC	7.50	7.00
1 MFD	7500 VDC	12.50	12.00
1 MFD	12000 VDC	14.95	14.90
.0008 MFD	15000 VDC	12.50	11.75
.045 MFD	16000 VDC	12.25	12.50
PAPER			
8-8 MFD	600 VDC	\$2.25	\$2.15
Tobe Filterite			
3X8 MFD	600 VDC	\$2.55	\$2.40
8-8-4 MFD	600 VDC	1.60	1.50
160-160 MFD	150 VDC	1.50	1.25
ELECTROLYTICS			
2500 MFD	6 VDC	\$.40	\$.35
500 MFD	12 VDC	.90	.85
25 MFD	25 VDC	.40	.35
50 MFD	45 VDC	1.10	1.05
1000 MFD	25 VDC	1.25	1.15
1.50 MFD	50 VDC	1.50	1.45

**TIME DELAY SWITCHES**

- 1 Minute 115 VAC 60 Cy Enc. in Waterproof Metal Case. New.....\$5.25
- 3 Micro Switches Make Contact at 40-41.42 Sec. Time Delay 110 VAC Motor. New.....4.50
- Thermo Switch 50° to 300° F. 115 VAC @ 6A. 230VAC @ 1A Breaks Contact with Increase of Temperature. 1.35
- 30-40 Second Mercury Time Delay Relay 110 VAC Adaptors. New.....7.50

**MICROWAVE EQUIPMENT**

- 10CM Echo Box Frequency Range 2890MC-3170MC. Direct Reading Micrometer Head. Ring Prediction Scale Plus 9% to Minus 9%. Type "N" Input. Resonance Indicator Meter with Accessories and 10CM Directional Coupler and Spares—Grand New.
  - SO Radar 10CM Rotating Antenna 24" Parabola in Turret 360° Span—Grand New.
  - SO-3 Bearing Control.
- PRICES UPON REQUEST**  
All Sizes of Crystal Electrodes.

**TUBES**

2C34	.....	\$0.85	1626	.....	\$0.95
3X2/879	.....	1.65	2051	.....	1.15
3C24	.....	.85	7193	.....	.50
7C4/1203A	.....	.85	8011	.....	2.40
15R	.....	.45	8006	.....	.40
39/44	.....	.65	C5B	.....	9.75
3Spec.	.....	.25	CEQ72	.....	1.40
303A	.....	8.80	CK70	.....	1.25
316A	.....	.75	CRP-72	.....	1.40
702B	.....	4.45	E1148	.....	.40
713A	.....	1.45	KKR-72	.....	.75
801A	.....	.55	RT-127A	.....	3.75
826	.....	.95	VT-98	.....	21.00
931A	.....	5.50	5BP4	.....	5.95
100073 MFD	.....	.45	5BP7	.....	2.75
CK1005	.....	.85	1J6G	.....	.95
CK1007	.....	1.20	3AA	.....	1.95
93	.....	.65	6S7	.....	1.45
			6S7J	.....	1.45

**TRANSMITTING MICA**

.065 MFD	1800 VDC	\$0.65
.006 MFD	2000 VDC	.65
.003 MFD	2000 VDC	1.55
.05 MFD	2000 VDC	1.20
.006 MFD	2500 VDC	1.15
.00025 MFD	2500 VDC	2.60
.00073 MFD	3000 VDC	2.75
.001 MFD	6000 VDC	3.50
.0002 MFD	6000 VDC	8.50

**Ceramic Rotary Switches**

Pole Position	Section	Shaft	Price
2	3	6	\$.55
2	3	1 7/8"	\$.60
2	8	2 1/2"	\$.75
4	12	2 3/4"	\$.95
2	8	2 3/4"	1.50
2 Pole 2 Circuit 6 Cont. W/Knob			
DPST Toggle Switch 3A 250V......45			

**RELAYS**

12 VDC DPST Allied Control Box #32	.....	\$1.25
24 VDC 3 PDT 8 Amp	.....	.95
24 VDC Solenoid, Operates 2 Switchettes	.....	1.75
40 VDC DPST-SPDT 1000 Ohm	.....	1.80
110 VAC DPST 1 Amp Cont.acts	.....	3.65
1970 Str'th's Dunn CXA	.....	3.65
110 VAC DPDT 25 Amp Cont.acts Ward Leonard	.....	3.95
115 VAC DPST Str'th's Dunn CNA-2997	.....	3.65
220 VDC DPDT Str'th's Dunn CNA-2122	.....	4.50
PRIMARIES 115V 60CY		
9V @ 750 MA, 6.3C @ 3.9A, 11.5V @ 6A, 240A West. New	.....	\$3.25
660/330V @ .08A CT 5.0/2.5 @ 3A CT	.....	3.25
350-0-350 @ 2.0A 5V @ 3A, 6.3V 4A CT 6.3V	.....	4.25

**VALUES**

- De-Ion Line Starter DPST 115V 60 Cy 15A West. New.....\$6.95
- Genuine Upright Desk Telephone and Ringing Box. New. 4.95
- 1 Relay Line 115V 60 Cy KVA 400 Cy 50 Ohm. New. 24.95

**ROUND PANEL METERS**

LEADING BRANDS			
0-5 RF Amps—Westing	3 1/2"	\$4.50	
0-300 MA DC—Simpson	2 3/4"	3.75	
0-100 Amps DC—Hoyt	3"	5.00	
0-5 Volts DC—Sun	2 1/2"	3.50	
0-15 Volts AC—GE	3 1/2"	4.95	
0-2500 Volts DC—Simpson			
With Multiplier	3 1/2"	5.95	
0-5KV DC 0-10 MA DC	3 1/2"	5.50	
0-150 Volts DC—Hoyt	3 1/2"	4.50	
PORTABLE METERS			
0-10 Amps DC—Weston	489	9.50	
0-3-6-30 Volts DC—Weston	280	19.95	
0-100 Amp DC—Weston			
With 100 Amp—Shunt	269	27.95	
0-25 Amps AC—Weston	433	37.50	
0-1.5-6 Volts AC Output-meter—Weston	571	14.95	

**CARRY-ALL**

TV and RADIO SERVICE CASE \$12.50

**LINEAR POTENTIOMETERS WW**

Ohms	Watts	EA	Ten
200	2	\$0.45	\$0.40
1000	2	2.95	4.45
3000	2	.55	.50
10,000	2	.55	.50
5000	3	.50	.45
7500 Dual	3	.85	.80
10,000	3	.85	.80
25,000	3	.65	.60
50,000	4	.90	.85
15	25	.95	.90
20	25	.95	.90
25	25	.95	.90
50	25	.95	.90
100	25	.95	.90
200	25	1.20	1.10
500	25	1.20	1.10
1000	25	1.30	1.25
3000	25	1.40	1.35
15,000	25	1.70	1.60
20,000	25	2.00	.95
150/W Switch	50 AN 3155-50	2.15	2.00
200/W Switch	50	2.15	2.00
800	50	2.65	2.50
10,000	50	2.95	2.75
15	60	2.95	2.75
15	75	3.95	3.85
750	150	9.50	
20,000	5	8.50	
20,000	5 433AC	1.95	
5000		2.25	
6000		2.25	

**POWER EQUIPMENT**

- Voltage Regulator Raytheon 95/130 V 60 Cy 1.25 Amp Output 115V 60 Watt. New.....\$12.50
- Generator Voltage Regulator 115V 400 Cy GE GBA-20C. New.....19.95
- Vibrapak VPG 369 12 VDC Output 250V @ 70MA Synchronous Mallory. New. 5.95
- ATR Inverter and Regulator 110 VDC to 110 VAC 1.70 60 Cy 150 Watt Model RSB. New.....24.95
- VIBRATOR AT-2110 24 VDC Output 110V 100W. New. 2.50

**SPECIALS**

- 80-801 CA Cord with Holder.....\$2.50
- CD-501A Cord Connects BC-654 Transceiver to GN-45 Gen.....1.95
- Balloon with Hydrogen Gen.....2.50
- Gibson Kit Box Kite 17"x17"x36".....2.25
- 33-140 Mmf Variable Condenser.....1.10
- 7-100 Mmf Variable Condenser......95
- 24-750 Mmf Tapered Rotor Plates with Motor.....1.25
- American Blox with Motor—G.E. 1/8 HP 115V 1 Phase 60 Cy 17.25 RPM. Brand New.....24.95

**TERMS:** Minimum order \$5.00—Mail orders promptly filled—All prices F.O.B. Boston, Mass. Send M.O. or check. Shipping charges sent C.O.D. 25% deposit required with all C.O.D. orders.

Prices Subject to Change without Notice  
**SEND FOR OUR CATALOGUE**  
Inquiries from Dealers, Schools and Industrial Firms Invited

**COMET ELECTRONIC SALES CO.**

22 Washington St. • BEacon 2-7863 • Brighton 35, Mass.



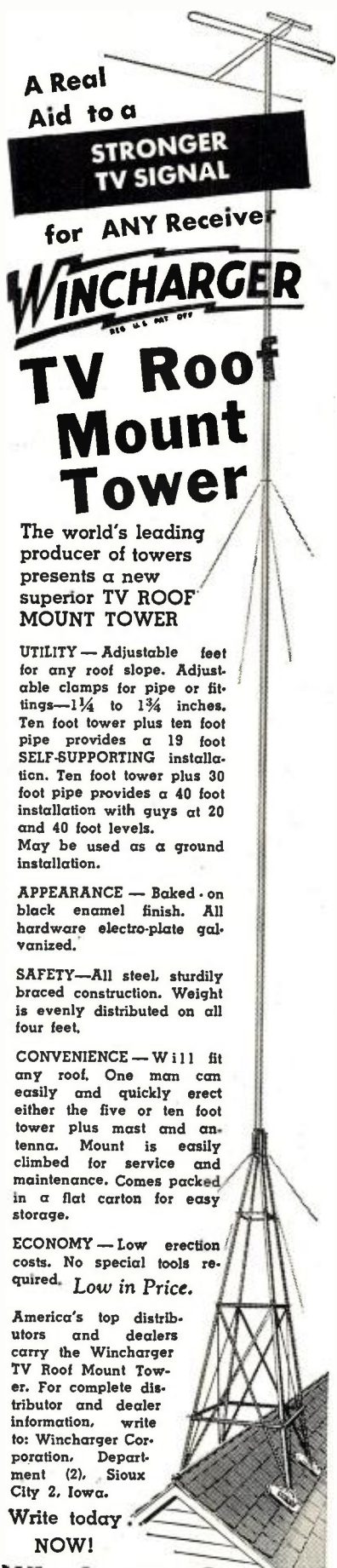

A Real Aid to a

**STRONGER TV SIGNAL**

for ANY Receiver

**WINCHARGER**  
REG. U.S. PAT. OFF.

# TV Roof Mount Tower

The world's leading producer of towers presents a new superior TV ROOF MOUNT TOWER

**UTILITY**—Adjustable feet for any roof slope. Adjustable clamps for pipe or fittings— $1\frac{1}{4}$  to  $1\frac{3}{4}$  inches. Ten foot tower plus ten foot pipe provides a 19 foot SELF-SUPPORTING installation. Ten foot tower plus 30 foot pipe provides a 40 foot installation with guys at 20 and 40 foot levels. May be used as a ground installation.

**APPEARANCE**—Baked on black enamel finish. All hardware electro-plate galvanized.

**SAFETY**—All steel, sturdily braced construction. Weight is evenly distributed on all four feet.

**CONVENIENCE**—Will fit any roof. One man can easily and quickly erect either the five or ten foot tower plus mast and antenna. Mount is easily climbed for service and maintenance. Comes packed in a flat carton for easy storage.

**ECONOMY**—Low erection costs. No special tools required. *Low in Price.*

America's top distributors and dealers carry the Wincharger TV Roof Mount Tower. For complete distributor and dealer information, write to: Wincharger Corporation, Department (2), Sioux City 2, Iowa.

Write today.

NOW!

**Wincharger Corp.**

SIoux CITY, IOWA

r.f. tube to an open voice coil in the speaker.

"This is not true in sound conversion. All that is done to the set is to add the change-over switch and possibly to mount an outlet socket at the rear so that the set switch can also turn the amplifier on and off. The rest of our conversion is clearly separate from the set itself. Only when trouble develops in the speaker or amplifier are we called upon to 'daddy' it. On top of that—"

"Enough! Enough!" Barney shouted, holding up his hand. "That sales talk of yours has more verses than *Made-moiselle From Armentieres*. No wonder poor old Ed gave in.

"And now, if you can descend from the sublime to the ridiculous, how's about getting your gloves, goggles, and crowbar and helping me pry this tube-retaining ring loose from the cabinet. I've fiddled with it until I'm as jittery as though I'd been de-fusing a block-buster." -30-

## "Presence" Amplifier

(Continued from page 50)

and by the lesser percussiveness and lower modulation percentages in the reproduction. Similarly, signal-to-noise ratio appears to be remarkably improved over poorer systems.

In conclusion, a few general comments on sound reproduction might be added. The first of these is that "listening fatigue" is not a factor encountered exclusively in reproducing equipment. People have been gritting their teeth over annoying and painful sounds for centuries before the invention of sound reproduction and an accurate audio system will recreate painful sounds as well as melodious ones. Percussive sounds, highly modulated tones, such as produced by mistuned instruments, and very loud sounds appear to be the most offensive, and certain types of non-linearity frequently found in reproducing systems tend to accent these effects.

A second factor has to do with apparent "balance" between orchestral instruments as well as the effect of the acoustics of the recording environment. With a linearity curve such as the one shown in Fig. 1C, better balance between orchestral instruments will generally be achieved and distortions introduced by acoustics lowered, although the apparent decay period of the recording location will be lengthened. Paradoxically, although a form of actual volume compression is produced by this form of nonlinearity, the instruments with large power reserves such as tympani and percussion, may actually sound louder due to the fact that loudness perceptions are influenced by duration of both the fundamental tones and the high frequency, low level, noises associated with a strongly excited vibrating object. For excellent clarity and musical quality this form of transmission curve is to be recommended. -30-

# MORE LIGHT MORE HEAT

THAN ANY OTHER INSTANT HEAT SOLDERING TOOL



**PHILLIPS VERSA-TOOL**

NOW IMPROVED!

- Same infinite heat capacity at lower wattage (250 watts).
- Cooler operating transformer.

No job too heavy or too delicate for the Phillips Versa-Tool. Compact, 110-115 Volt AC, 250 Watts, the Phillips Versa-Tool was designed for perfect balance and ease of operation.

- Rigid Copper Tips—Four interchangeable tips that absolutely won't sag or bend under pressure.
- Infinite Heat—Heat continues to build up as long as trigger is depressed.
- High Intensity Light—A concentrated light beam focused where it eliminates all shadows.
- Two-Position Switch—Position 1 gives operator light only. Position 2 gives both light and heat.

FOR COMPLETE DETAILS WRITE TODAY

**Phillips Mfg Co.**

2816 Aldrich Ave. S., Minneapolis, Minn.

New! Up-to-date!

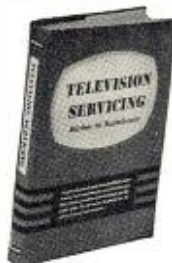

340 pages  
170 illustrations



Symptoms of defective operation easily recognized, quickly corrected by illustrations, diagrams and how-to-do-it facts in this new book.

# TELEVISION SERVICING

by Walter H. Buchsbaum

Get this brand new, complete handbook for sure-fire working knowledge of TV installation, maintenance and troubleshooting. Tells you step-by-step procedures for audio IF alignment, video IF alignment, aligning RF amplifiers, mixers, oscillators, etc. All possible defects classified for ready reference, thoroughly analyzed to show what is wrong and why... and what to do to correct the defect. No mathematical knowledge needed! Practical, authoritative, up-to-the-minute, the perfect handbook for set owners, trainees, and repairmen.

USE IT 10 DAYS FREE

Coupon below brings you "Television Servicing" on FREE trial for 10 days, without obligation. Mail it NOW.

PRENTICE-HALL, Inc., Dept. M-RN-1151  
70 Fifth Ave., New York 11, N. Y.

Send me, for 10 DAYS' FREE TRIAL, "Television Servicing." I will return it in ten days and pay nothing—or keep it and send \$1.35 down (plus postage) and \$2 monthly for 2 months.

NAME .....

ADDRESS .....

CITY..... STATE.....

SAVE! Send \$5.35 with this coupon, and we'll pay postage and packing.

RADIO & TELEVISION NEWS



# International Short-Wave

(Continued from page 138)

nel noted with news 2100, good level in Indiana. (Leary)

**Peru**—OAX4J, 6.330, Lima, *Radio Colonial*, is often heard in Britain to 0200. (Pearce)

**Philippines**—QSL from Far East Broadcasting Co., Inc., Manila, for DZH8, 15.300, stated DZH9, 11.855, is not yet on the air. (Pearce, England) Officials of that organization have informed Russell, Calif., they have begun use of a new eight-element collinear-broadside array for DZH7, 9.731, in services beamed westwards to India before 1000; at 1000 it is pointed to beam on Seattle, Washington, for one-half hour of *English* for USA listeners, and is returned westwards at 1030 for next hour in Indian dialects; asks for reports; Russell says gives a tremendous boost to signals over previous set-up. According to word to Russell, the 11.855 outlet (DZH9) should be on the air by this time. He notes DYH2, 6.14013, Cebu, with organ music 0815, fair level in Calif.

**Poland**—Warsaw noted with *English* 1315-1345 on 9.57, 7.205, and repeated 1350-1420 on 9.525; announced *English* for 1230-1300 on 9.525, 6.115, 1545-1615 on 6.115, 1615-1645 on 9.570, 7.205. And *English* for North America daily on 7.205 at 1700-1730, 1730-1800, 2315-2345, 0030-0100; asks for reports to Polish Radio, English Transmissions to USA, Aleja Stalina 21, Warsaw, Poland. (Pearce, England, others)

**Portugal**—"Servico Ultramarino" of *Emissora Nacional*, Lisbon, is on the air at 1900-2100 on 6.374 and 9.740; at 0700-0900, 0915-1130 on 15.130; at 1230-1530 on 9.740, 11.996, and 1600-1800 on 9.740, 11.962, according to schedule from station. (Radio Sweden)

**Portuguese Guinea**—*Emissora da Guine*, 5.838, Bissau, noted 1640 with music and 1715 with news in Portuguese; signs on 1630. (Pearce, England)

**Reunion Island**—*Radio St. Denis*, 4.807, 7.200, is on the air 2145-2245, 0315-0415, 0900-1200 (Wed. to 1330; Sat. to 1400) on weekdays and 2300-0000, 0200-0430, 0900-1200 Sun.; each channel has a power of 200 watts. (WRH Bulletin)

**Rumania**—Bucharest noted on 9.252 and 6.21 with *English* 1530-1600.

**Sao Tome**—*Radio Clube de Sao Tome e Principe*, CR5SB, 17.6775, noted Sundays 0730-0800 sign-off. (Pearce, England)

**Saudi Arabia**—Djeddah, 11.85 and 11.95, has interval signal of eight notes, with short pause after sixth note. (Bellington, N. Y.) Starts around 2259.

**South Africa**—SABC, 9.87, noted with news 1500. (Pearce, England)

**Southern Rhodesia**—Salisbury, 3.35 and 9.51, is scheduled 1100-1500. (Ridgeway, South Africa)

**Spain**—Alicante is still around 7.940. (Pearce, England) Signs off 1830 with march. (Bellington, N. Y.)

November, 1951

# JUST ARRIVED—CARLOAD ARC-5 EQUIPMENT

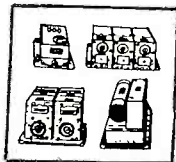

## TRANSMITTERS

- 3 to 4 MCS. . . . \$14.95
- 4 to 5.3 MCS. . . . 8.95
- 5.3 to 7 MCS. . . . 7.95
- 7 to 9.1 MCS. . . . 14.95

All above complete with all tubes and crystal. In excellent condition.

**T-23 ARC-5 VHF TRANSMITTER**—100-156 MCS Chassis, Less Tubes and Crystals. . . . . **\$12.95**

## RECEIVERS

- 190 to 550 KC. \$16.95
- 3 to 6 MCS. . . . 9.95
- 6 to 9 MCS. . . . 9.95

All above Receivers complete with all tubes and dynamotor. In excellent condition.

**R-4/ARR-2 RECEIVER**—234-258 MCS Complete with all tubes and dynamotor. Excellent condition. . . . . **\$19.95**

## COMPONENTS

- MOUNTING RACKS**
- Single . . . . . \$1.00 Ea.
- Double . . . . . 1.75 Ea.
- Triple . . . . . 2.25 Ea.
- RE-2/ARC-5 ANTENNA RELAY UNIT**
- Comp. with Meter and 50 MMFD vac. cond. . . . . **\$4.50**
- MD-7/ARC-5—PUSH PULL MODULATOR UNIT**
- Comp. w./tubes and dynamotor. Exc. cond. . . . . **\$11.50**

## JEEP GENERATORS

12 Volt DC Output @ 60 Amp. Complete with Voltage Regulator and Ammeter. Ideal for Boats, Trucks or Mobile Radio use. Excellent condition. . . . . **\$39.95**

## WALKIE TALKIE BATTERIES

BA 37—1 1/2 volt—A. \$0.50  
BA 38—103 1/2 v.—B 1.29  
Both for . . . . . 1.50

## TCS POWER SUPPLY

2 Motors and 2 Generators mounted on Filter Base Low Voltage Output. 220 V. @ 100 Ma. High Voltage Output 440 V. @ 300 Ma. Specify 24 V. D.C. or 110 V. D.C. Motors. . . . . **\$22.50**

## SOUND POWERED HAND SETS

TS-10 type—Various manufacturers. No batteries needed for operation. Use in pairs with wire. Audible up to 10 miles. Ideal for TV antenna installations, etc. Excellent condition. . . . . **\$17.95**

## SOUND POWERED HEAD AND CHEST SET

Use same way as Hand Set except you have freedom of hands. No Batteries or Power source required for operation. Excellent Condition. . . . . **Pair \$11.95**



## DC GENERATOR

12 Volt DC Output @ 4 Amp. Must be belt-driven @ Approx. 2000 RPM. In good condition. . . . . **\$4.95**

## TANK PERISCOPES

Type M9 Contains 2 glass prisms, one at each end of the periscope. Use them for looking over crowds, at parades, ball games, races, etc., or use prisms separately for optical work. Low priced. All Brand New. . . . . **\$1.95**

## DU-1 LOOP ANT.

Pre Amp. for Direction finder. Contains two tubes. Specify 12 V. D.C. or 24 V. D.C. Exc. Cond. . . . . **\$19.95**

## GO-9 TRANSMITTER

All brand New. 100 Watts CW or MCW emission. Operates from 110 V., 800 Cycle, easily converted to 60 Cycle operation. Low frequency range, 300 KC. to 600 KC. High frequency 3,000 KC. to 18,000 KC. using an E.C.O. We furnish complete conversion data with each transmitter. Complete with . . . . . **\$59.95**

## 2 VOLT VIBRATORS

VB8A Synchronous Type. Used in all portable radios having 2 Volt wet cell supply. . . . . **\$1.50**

## FL-8 FILTER

Range or Voice for 1020 cycles Audio. Switch mounted on Filter. Excellent for C W. . . . . **\$1.25**

## METERS Westinghouse—G.E. Weston

### MILLIAMPERE D.C.

- 2"-0 to 15. . . . \$3.50 Ea.
- 2"-0 to 100. . . . 3.50 Ea.
- 2"-0 to 300. . . . 3.50 Ea.
- 3"-0 to 900. . . . 3.95 Ea.
- 3"-0 to 50. . . . 3.95 Ea.
- 3"-0 to 150. . . . 3.95 Ea.
- 3"-0 to 200. . . . 3.95 Ea.
- 3"-0 to 250. . . . 3.95 Ea.
- 2"-0 to 9RF Amp 3.50 Ea. (with thermocouple)

### VOLT METERS

- 2"-0 to 15 V., A.C. \$2.95
- 3"-0 to 8 AC. . . . 2.95 Ea.
- 3"-0 to 15 AC. . . . 2.95 Ea.
- 2"-0 to 30 DC. . . . 3.95 Ea.
- 3"-0 to 150DC. . . . 3.95 Ea.

### TIME HOUR METERS

- 99999.9 Hrs.
- 10-12 Volts. 60 Cycle 3 Inch. . . . . **\$6.95 Ea.**

### KILOVOLT D.C.

- 3"-0 to 400 DC. \$3.95 Ea.
- 3"-0 to 500 DC. 3.95 Ea.
- 3"-0 to 4. . . . . 3.95 Ea.

(All are 1 1/2 in. full scale; require external multiplier.)

### 2" WESTON SPECIAL

- 0 to 30 V. DC and 0 to 120 Amps. DC \$3.95 Ea.
- 0 to 30 V. DC and 0 to 240 Amps. DC 3.95 Ea.

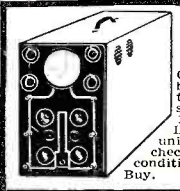

## 3" TRIUMPH OSCILLOGRAPH

Complete Test Scope, with built-in Wobulator, so as to be used on TV or FM servicing. Operates from 110 Volt, 60 Cy. A.C. Limited Supply. All these units have been carefully checked and are in excellent condition. A Real **\$34.95** Ea. Buy.



## PROP PITCH MOTORS

For your Beam Antenna: 20 Volt to 32 Volt, A.C. or D.C. 1/2 H.P. Motor: 1 1/2 RPM Gear Reduction, 7000 to 1. ALL BRAND NEW. Each **\$13.95**

**1/4 H.P. PROP PITCH MOTORS (Small Size)**  
20 to 32 Volt A.C. or D.C. Gear Ratio: 9000 to 1. All Brand New. . . . . **\$16.95**

## CAPACITORS • FIXED OIL FILLED

- Solar, Pyranol, C.D., Etc.
- 2 MFD. 400 V., D.C. \$0.79
- 1 MFD. 600 V., D.C. . . . . .75
- 4 MFD. 600 V., D.C. 1.25
- 8 MFD. 600 V., D.C. 1.95
- 10 MFD. 600 V., D.C. 2.25
- 1 MFD. 1000 V., D.C. 1.00
- 2 MFD. 1000 V., D.C. 1.25
- 4 MFD. 1000 V., D.C. 1.75
- 1 MFD. 1500 V., D.C. 1.50
- 2 MFD. 2000 V., D.C. 1.95
- 3 MFD. 2000 V., D.C. 3.50
- 4 MFD. 2000 V., D.C. 3.95
- 2 MFD. 4000 V., D.C. 5.95

## MIDGET SELSYNS

AY type operates from 6-12 Volts 60 Cycle. Use as both transmitter and receiver. These compact little units draw almost no current and work fine for all remote position indicating applications. OD 2 1/2 x 2 1/2". All New (Approx. wt. 1 lb.) Each **\$2.50**

## 12 VOLT STORAGE

Aircraft Type, 12 Volt, 34 Amp. HR. Made by Exide. Completely inclosed with removable top. Dry Charged. All Brand New. . . . . **\$14.95**

## MISCELLANEOUS SPECIALS

- 9 Channel Push Button Switch, spring back type. . . . \$1.00
- 300 OHM Twin Lead, . . . . Per Ft. 3c
- 67 1/2 V. Radio "B" Batt. . . . Each \$1.00
- 1 Lb. Roll Rosin Core Solder. . . . Roll 95c
- BC606G Interphone Switch Box . . . . . Each 59c
- RG 7U COAX 95 OHM. . . . . Per Ft. 6c
- J-5A Hand Keys, Flameproof. . . . . Each 69c
- RG 59U COAX 52 OHM. . . . . Per Ft. 8c

## CAPACITORS TRANSMITTING VARIABLE

- K 1 MMFD. to 75 MMFD. 1/4" Spacing . . . . \$1.95
- \*D 12 MMFD. to 125 MMFD. 3000 V. Peak . . . . \$3.50
- I 28 MMFD. to 110 MMFD. 5000 V. Peak . . . . \$3.95
- \*F 12 MMFD. to 150 MMFD. 3000 V. Peak . . . . \$3.50
- A 7 MMFD. to 80 MMFD. 1500 V. Peak . . . . \$1.00
- \*With Special "Voice Vernier" Dial. All New, Hammerlund, Goodwell, Etc.

## REVERSIBLE MOTOR

1/40 H.P. Ball-bearing 3450 R.P.M. in Blast-proof case. Needs only a capacitor for starting. All Brand New. 110 V., 60 Cy. . . . . **\$3.95**

## RU 16 RECEIVERS

RU 16 RECEIVERS. \$5.95 Ea. Plug-in Coils, 9 Ranges 100-13570 KC. \$1.50 Ea. RC-130 Transistor. \$5.95 Ea. Plug-in Coils for Trans. 2 MEG-9 MEG. \$1.50 Ea. 12 Volt Dynamotor for above. \$7.95 Ea. RU-19 Control box. \$1.00 Ea.

## BC-1206 BEACON RECEIVERS

Similar to BC-1206. Manufactured by Detroit Radio. 200 to 500 KC. E.P. Direction Finder. Contains 2-25L6, 1-6SA7, 1-6SF7, 1-6SK7. Complete. . . . . **\$7.95**

## BC-357—FREQUENCY RANGE, 60 to 80 MEG.

Operates from 24 Volts D.C. Complete with Tubes. . . . . **\$3.95**

## TUBES

- 8025 . . . . . \$4.95
- 3FP7 . . . . . 1.95
- 5FP7 . . . . . 1.25
- 5BP4 . . . . . 2.50
- 6SJ7 . . . . . 1.00
- 12SR7 . . . . . .90
- 6AG5 . . . . . 1.50
- 6AK5 . . . . . 1.75
- 6AC7 . . . . . 1.50
- 4E27 . . . . . 12.95
- 8020 . . . . . \$2.95
- 6SL7 . . . . . 1.25
- 6V6 . . . . . 1.25
- 6U5 . . . . . .75
- 6B8 . . . . . .75
- 83V . . . . . 1.25
- 6SH7 . . . . . .50
- 7193 . . . . . .50
- 6SN7 . . . . . 1.75

**304TL . . . . . \$7.95**

# TAPE

- CANNED FRICTION TAPE, 3/4", 82 1/2 Ft., 6 Rolls to Can, \$1.25 per Can.
- INDIVIDUAL BOXES
- RUBBER TAPE, 3/4", 15 Ft., 15c Roll. SCOTCH TAPE, 1", 50 Yds., 35c Can.
- FRICTION TAPE, 3/4", 82 1/2 Ft., 15c Roll. MICA TAPE. . . . . 25c Roll.

All Mail Orders Promptly Filled, F.O.B., San Francisco . . . . All California Orders—Add 3% Sales Tax . . . . Do not send postage stamps. Write for our free booklet listing our stock and prices on Radio, Electronics, Tools, Hardware, Motors, Wire, Meters, Batteries, Aluminum Sheets, etc. 20% Dep. on all C.O.D. orders. All items subject to prior sale.

**STANDARD SURPLUS** 1230 Market St., San Francisco 3, Cal. Telephone HEMlock 1-3106



# Performance Plus!

with the Peerless hi-quality 18 watt TRIODE output amplifier kit. Heart of this kit is the Peerless S-240-Q output transformer, conclusively proved superior to all competition in square wave tests. Amplifier's response is flat from 20 to 20,000 cps for radio input. Phono input is equalized for variable reluctance pickup. Simple modification adapts amplifier for use with microphone. Kit contains all basic components and instructions for assembly.

9356 Santa Monica Blvd., Beverly Hills, Calif  
161 Sixth Avenue, New York 13, New York

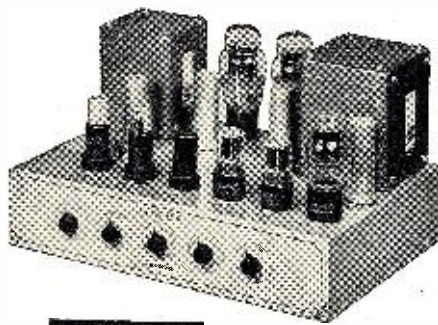

SQUARE WAVE TEST  
PROVES PEERLESS BEST

10722  
Triode  
Amplifier  
Kit



## PEERLESS Electrical Products Division



## STAN-BURN SPARKS

### CONDENSER SPECIALS BY PASS—ALL GUARANTEED

.001-400 Stan Burn..\$0.04	.002-600 Stan Burn.. .08
.01-600 Stan Burn.. .07	.005-600 Stan Burn.. .12
.02-600 Stan Burn.. .09	.005-6000 Stan Burn.. .59
.05-600 Stan Burn.. .10	.1-6000 Stan Burn.. .19
.001-600 Stan Burn.. .07	20x20-150 Stan Burn.. .41
.25-600 Stan Burn.. .15	50x30-150 Stan Burn.. .49
.005-200 Stan Burn.. .07	21-50 Stan Burn.... .32
.004-200 Stan Burn.. .07	

CHASSIS—630—K2—FAMOUS MAKE.....\$139.50

### CATHODE RAY TUBE SPECIALS

10BP4 .....	\$14.95	17BP4A .....	27.00
12LP4 .....	19.95	20CP4 .....	39.95
12LP4A .....	19.95	19AP4A .....	47.95
14BP4 .....	19.95	19DP4A .....	47.95
16DP4A .....	26.00	24AP4A .....	83.20
16GP4 .....	33.00	Single ion traps... .59	
16AP4A .....	39.00	Double ion traps... .39	
16RP4A .....	26.00		

### RAM TRANSFORMERS

RCA type for 16" to 24"  
N032 .....

G.E. type for 16" to 24"  
X045 .....

These are very special prices while they last!

### 70° DEFLECTION YOKES

Todd wired replacement for RCA, G.E., etc.  
Special \$3.85

### ANTENNAS

Conicals, less mast, 10 element.....	\$ 2.98
Circle X, less mast.....	2.98
Double V, less mast.....	2.98
Chimney Mounts—1-12.....	.95
12 or more.....	.89
100 ft. roll strapping.....	2.98
Mast standoffs.....	1.05
10 ft. masts, each.....	1.59
12 or more, each.....	1.49
55 mil. 300 ohm wire white or black, 1000 ft.....	19.97

We carry a complete line of popular makes of Radio and TV tubes, at 50% discount. Also many other special purpose and transmitting types, and all electronic parts and equipment at lowest prices. Send us a list of your requests for quantities and prices.

Terms: 20% with order. Balance COD. All prices FOB. New York Warehouse. Minimum order \$5.00. Write for our latest price list to Dept. RN-11.

**STAN-BURN** RADIO and ELECTRONICS CO.  
(C.B.S. THEATRE BLDG.)  
1697 BROADWAY • NEW YORK 19, N.Y.

## SURPLUS NOVEMBER SPECIALS

### BARGAIN! NEW!

#### CRAMER TIMER ADJUSTABLE TIME DELAY RELAY

RELAY adjustable from 1/30 sec. S.P. D.T. with starting relay for remote control motor and contacts separate. Stock No. R-246. Operating voltage 115V. AC. Coil resistance. Contacts SPST (NO) or (NC) 10 Amps. EACH.....\$9.95



#### VERTICAL ANTENNA MAST KITS

Fully Adjustable 5 to 35 Feet. Easy to Set Up. FOR FM TELEVISION AND ROTARY BEAM Double Antenna Kit used with the famous Hallicrafters BC-610, consisting of 7 steel-alloy mast sections in a handy canvas bag. Each section is 5/8" long, 1 1/2" OD with the last 6" rolled to a smaller OD to telescope into the end of the preceding section. No taper. Assemble into mast up to 35' high or shorter by any multiple of 3'. Finished in weatherproof olive drab. Ideal for erection of FM and Television Beams! Drop your coaxial cable right through the center! Brand new. EACH.....\$12.95

#### TUBE SPECIALS

1626 .....	\$0.49	81 .....	\$0.49	41 .....	\$0.49
1629 .....	.39	919 .....	.99	837 .....	.99
FG104/5561 .....	.29	2X2 .....	.99	2051 .....	1.29
RK73 .....	.99	843 .....	.39	G.E. 211 .....	.98
15R .....	.79	803 .....	2.95	12A6 .....	.69
801 .....	.79	9001 .....	.99	6S7 .....	.69
6AK5 .....	1.49	5BP4 .....	1.95	307ARK75 .....	4.95
250R .....	3.95	1625 .....	.39	1E7G .....	.69
HY615 .....	.49	10Y .....	.39	EF50 .....	.69
1616 .....	.69	12SL7GT .....	.99		

#### MANY OTHERS NOT LISTED

FUSES .03 each. \$1.95 per C  
3AG—1 amp. 4 amp. 15 amp. 4AG—15 amp. 40 amp  
9AG—20 amp. 40. 50. 70 amp

#### GP-7 TRANSMITTER TUNING UNITS

Ideal Basis for E.C.O. Rig  
Tuning units for TCE & GP7 in the following frequencies:  
Kcs. A-350 to 800 kcs.; B-300 to 1500 kcs.; C-1500 to 3000 kcs.; E-4525 to 6500 kcs.; F-6200 to 9050 kcs. Contains all coils, etc. for these frequencies. Used units are in A-1 condition. Units C.P. each.....\$3.95



### Write for Our Bargain Bulletin DOW RADIO, INC.

1759 E. Colorado St. Pasadena 4, Calif.  
PHONE: Sycamore 3-1156  
\$2.00 min. order. 25% deposit with orders. Send full remittance to save C.O.D. charges. All merchandise fully guaranteed. Subject to prior sale.

Madrid noted recently on 7.38 with Spanish music 1915 tune-in; left air 1930 after playing march; bad CWQRM; the Spanish outlet on 7.037 leaves the air now 1830. (Bellington, N. Y.) Madrid noted on 15.636 with news in Spanish for Canary Islands 1145. (Ferguson, N. C.) Madrid's 9.363 definitely has *English* for North America now both 1800, 2215. (Saylor, Va., others)

*Sweden*—"Sweden Calling DX-ers!" now is radiated Saturdays at 0215 on 6.065, 15.155; repeated 1015 on 6.065, 15.155, and 2015 on 10.780, 15.155. Current over-all schedules of *Radio Sweden* are 1900-2030, 10.780, 15.155; 0015-0235, 6.065, 15.155; 0235-1015, 11.705, 15.155; 1015-1300, 10.780, 15.155; 1300-1330, 6.065, 10.780; 1330-1700, 10.780, 6.065. "Sweden Today" (*English*) is 0815-0830 on 11.705, 15.155 and repeated 2000-2015 on 10.780, 15.155. During the 1330-1400 period, separate programs are carried over 6.065, 10.780.

*Switzerland*—Berne has replaced 15.305 with 6.165 for the broadcast to North America 2030-2300. (Bellington, N. Y.) The 6.165 outlet is HER3 and parallels HER4, 9.535, and HER5, 11.865. (Russell, Calif.)

*Syria*—Damascus sent schedule listing Mediterranean Service on 6.157 and 451 m. with *English* 0530-0630; 0730-0830 Arabic; 0830-0930 French; 1100-1630 Arabic. For Europe on 11.915 at 1530-1630 French and 1630-1730 *English*; service for India-Pakistan (at least some *English*) 0945-1045 on 1515-1615. (Pearce, England)

*Tahiti*—*Radio Tahiti*, 6.135, Papeete, noted 0100-0135 sign-off; fair level in Calif. (Rosenauer)

*Taiwan*—Regarding old BCAF, this station is now called BEC32 and is using 9.775; the 11.685 channel not used for some time; they now sign off 0930 on 9.775 instead of 0905 as formerly; have *English* lesson 0700-0730. (Dilg, Calif.) Noted recently 0545-0600 with religious program in *English* and announcing as the Chinese Air Force Station. (Rosenauer, Calif.) Taipeh still noted with news 0630 on 11.735. (Ferguson, N. C.) And parallel on 7.133A. (Saylor, Va.) BED3, 15.236, Taipeh, noted in foreign language 0025. (Russell, Calif.)

*Tanganyika*—Dar-es-Salaam, 3.330, is on the air 0900-1000 on Mon., Wed., Fri, in Swahili.

*Tangiers*—*Pan-American Radio* still noted near 7.525 signing off in Spanish and *English* 1700. (Pearce, England) *Radio Africa*, 7.125, leaves the air 1800. (Bellington, N. Y.)

*Thailand*—The Overseas Broadcasting Station, Bangkok, sent QSL card by registered mail and gave schedule for *English* as 0500-0600 on 6.240, 15.910, 1 kw. (Pearce, England) However, currently seems to have *English* session to around 0625 when changes to native transmission. (Hutchins, Radio Australia) The 6.240 outlet noted in Calif. 0625 with what sounds like church bells ringing. (Rosenauer)

*Turkey*—*Radio Ankara*, 15.165, 9.465, noted with *English* for British Isles



# TRANSVISION

**Sensational Offer!**  
**2 Yr. GUARANTEE**  
**on PICTURE TUBES**



**Pro-Rated**

Transvision is the first and only manufacturer to offer you this amazing 2 year guarantee. Top quality rectangular and round tubes; all sizes.

Write for **NEW LOW PRICES**

**FEED Up to 5 TV SETS**  
**from 1 Antenna with**

**TRANSVISION'S MULTI-SET CONNECTORS**

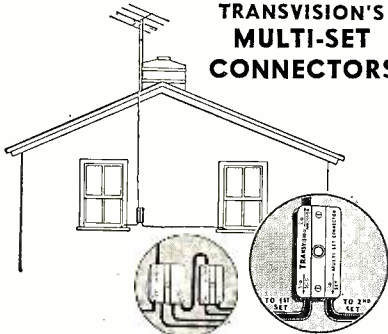

Increase Sales with Multi-Set Connectors. Ideal for homes, garden apartments, TV dealers, bars, etc. Big savings in time and labor. **GUARANTEED.**

PRICES: Multi-Set Con. for 2 sets, \$4.95 list.\* Multi-Set Con. for 3 or 4 sets, \$7.95 list.\* \*Dealers, write for discounts

**CR Tube REACTIVATOR**

**REVIVES DIM TV CR TUBES**



It's profitable—first use often pays for instrument. Reactivates many dim CR Tubes, or tubes with low light output, if there's no mechanical defect. 110V-60 cycles; weighs 3 lbs.

**\$14.95**  
**NET**

**FIELD STRENGTH METER**  
**at NEW LOW PRICE!**

**only \$59 net**

Improves TV Installations; saves half the work. Model FSM-1, complete with tubes, \$59 net.



Write for details on amazing Transvision **FACTORY AGENT PLAN!**

**FREE:** Sample copy of "TV and Electronics Notes." Or send 50c to cover cost of addressograph plate and mailing for **FREE** Subscription. Monthly issues are gold mines of info on color, conversion, sales, service, etc. **WRITE FOR IT TODAY!**

**TRANSVISION, INC.**

Dept. RN NEW ROCHELLE, N. Y.

1500-1545. (Pearce, England) Ankara listed North American schedule over TAT, 9.515, as 1810-1858; Mail Bag on Sundays 1845-1850; news daily 1817-1830. (Chatfield, N. Y.)

Uruguay—CSA14, 11.835, "El Espectador," Montevideo, noted opening 0555 with strong signal in Brazil. (Serrano)

USI—YDC, 15.15, Djakarta, noted around 1400-1500 in English to Europe; news 1410. (Rodger, Scotland) YDQ2, 9.550, Makassar, Celebes, heard with Western popular music around 0915. (Russell, Calif.)

Cushen, N. Z., reports a new RCA 7.5 kw. transmitter is en route to Indonesia for Jogjakarta to replace YDJ, 5.060, and YDJ2, 7.100; the latter channel will be changed to avoid interference from an Indo-Chinese outlet; calls assigned the 100 kw. transmitter now operating at Djakarta are YDF, 6.045; YDF2, 11.785; YDF3, 11.795; YDF4, 17.810; YDF5, 7.220; YDF6, 9.585, and YDF7, 11.770. A new 50 kw. Philips transmitter has arrived at Djakarta and is expected to be in operation in 1952 in the 19-, 25-, and 31-m. bands. (Cushen, N. Z.) Radio Indonesia, Djakarta, broadcasts English at 0600-0700 on 4.910, 15.150; 0930-1030 on 4.910, 11.770, 15.150; 1400-1500 on 11.770, 15.150. (Radio Sweden)

USSR—Moscow noted on 15.36 with news 1130. (Rosenauer, Calif.) And at 1415. (Cooley, Pa.)

Vatican—HVJ, 17.84, noted Tuesdays around 1030-1048 sign-off in English. (Boice, Conn.) \* \* \*

**Press Time Flashes**

Radio Free Europe, Western Germany, noted signing on 0258 near 11.730, heard to 0405 tune-out, and another day with closing calls 0735. Heard on 6.130 around 1700-1730 and later; noted signing on 0950 with Freedom Bell tolling 0950 (on a Sunday). (Pearce, England)

According to press reports, when the new Swedish short-wave station comes on the air (probably in 1952), it will have two 100 kw. short-wave transmitters and 12 short-wave masts; it will be the most powerful station in Northern Europe. There will be directional antennas in seven different directions with two towards North America and the remainder directed towards South America, South Africa, East Africa, India, Australia, and Japan. The new Belgian station, which is under construction, will consist of one 100 kw. short-wave transmitter with one 20 kw. short-wave transmitter in reserve; there also will be two 150 kw. m.w. transmitters with two 20 kw. m.w. transmitters in reserve. The station building will be heated with the cooling water, warmed by the transmitting tubes. It is to be completed in 1952. (Anderson, Calif.)

Dilig, Calif., checked 6.110 for Radio Free Asia, Manila, for me and reports it a powerful signal 0830-0955 daily; same program noted on approximately 8.900, evidently relaying from San Francisco. Radio Free Asia announces QRA of P.O. Box 3161, Manila, Philippines.

**TRANSVISION**  
**SAVE UP TO 50%**  
**on TV Kits, Sets, Chassis**

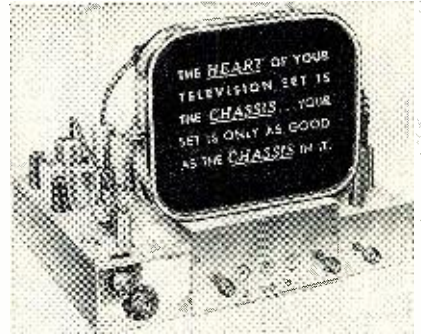

Transvision makes the finest TV KITS, SETS, and WIRED CHASSIS that money can buy. PRICED AMAZINGLY LOW. Kits are easy to assemble. Give top quality picture and sound. Ideal for hobbyists and dealers . . .

. . . and now, new sensational

## COLOR KITS

for converting any TV set to color. Write for complete details.

**\$ 9**

Low prices start from . . .

**FAST SELECTION of Beautiful TV CONSOLES for CUSTOM-BUILDING or for CONVERSION**

from **\$49**



Enjoy **GIANT SCREEN TV**

now. Send for Cabinet Catalog. Conversion instructions come with every cabinet.

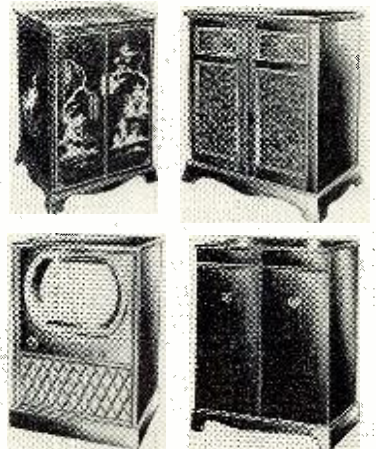

Write for details on amazing Transvision **FACTORY AGENT PLAN!**

**FREE:** Sample copy of "TV and Electronics Notes." Or send 50c to cover cost of addressograph plate and mailing for **FREE** Subscription. Monthly issues are gold mines of info on color, conversion, sales, service, etc.

**TRANSVISION, INC.**

Dept. RN NEW ROCHELLE, N. Y.



# USE PHOTOFAC

the world's best Radio-TV service data—it pays for itself every working day



Try **PHOTOFAC!**

**FREE** We'll send you any Photofact Folder listed in the Photofact Cumulative Index\*

## WE'LL PROVE YOU'LL SAVE TIME and EARN MORE WITH PHOTOFAC

NOW—learn for yourself—at our expense—how PHOTOFAC makes your Radio and TV work *quicker, easier, more profitable!* Examine an actual PHOTOFAC Folder. Use it. You'll learn first-hand why over 35,000 successful service technicians use PHOTOFAC daily. You'll learn that no other service gives you PHOTOFAC's *completeness, accuracy, uniformity, and lowest cost.* PHOTOFAC is the *only* radio and TV service data prepared from laboratory analysis of the actual equipment. Know the facts—get your **FREE** Folder now. Examine, use, compare—learn why no modern service shop can afford to be without PHOTOFAC!

\*Except those followed by asterisk (\*) or letter A.

WRITE FOR **FREE INDEX**

**PAY AS YOU EARN!** Ask your distributor about this amazing plan. Only \$18.39 puts the entire profit-boosting Photofact library in your shop now!

**NOTE:** Our **FREE** Folder offer is limited to Service Technicians only. Attach coupon below to your letterhead and mention your jobber's name. If you have no letterhead, send coupon to your jobber. Experimenters and others may obtain the Photofact Folder by remitting amount shown below.

HOWARD W. SAMS & CO., INC.  
2201 E. 46th St., Indianapolis 5, Ind.

- Send **FREE** Photofact Cumulative Index
- Send Full Easy-Pay Details

I am a Service Technician:

- Send **FREE** Folder for set model.....

I am an Experimenter: Enclosed \$.....

- Send Folder for set model.....
- TV-\$1.00. Record Changer or Comm. Receiver-75c. AM/FM-50c

Name.....

Address.....

City.....Zone...State.....

Saylor, Va., flashes that he had just heard *Radio Tahiti* on 9.053 around 0010-0020 with *English* announcements; bad CWQRM and QRN; *new 24 kw-er?*

Kure, 6.105, Japan, now noted signing off 0815 instead of 0830 as formerly. After Kure signs off, Cebu, 6.100, Philippines, is fairly good level. Pakistan, 11.675, is definitely on this spot now for *English* 1015-1030 and Urdu 1030-1045 sign-off; the 11.675 channel apparently has replaced 11.725 for this period. (Dilg, Calif.)

*Radio Baghdad*, 11.724, noted in Denmark daily with Arabic to 1415, then *English* to 1500 sign-off. Zanzibar is reported signing off on 6.005. (Radio Sweden) *Can anyone confirm Zanzibar?*

*WRH Bulletin* lists schedules of several Haitian stations—4VVA, *Radio Citadelle*, Cap-Haitien, 6.300, 0630-0830, 1200-1430, 1800-2100; 4VCP, Cap-Haitien, 6.310, 1200-1430, 1800-2200; 4VCN, *Radio Fides*, Port-au-Prince, 6.406, 0630-0830, 1800-2100; 4VPL, Pétionville, 8.984, 1500-2000; says output for each is 1 kw.

GTNA, Guatemala City, is now using its *new* 11.85 channel in parallel with 9.668 for *English* at 2200-2230 daily. (Russell, Calif.; Ferguson, N. C., others)

*Radio Free Asia* noted on approximately 10.25 around 0830-0955. (Balbi, Calif.) This is San Francisco point-to-point with Manila which relays *Radio Free Asia* over 6.110.

Pyongyang, 4.59A, North Korea, noted at good level in Russian 0830. (Balbi, Calif.)

News in *English* is broadcast from Nepal, 7.100, at 0845-0900; announcement 0845 is "This is Nepal Radio radiating from Katmandurion, 7.1 mc., in the 40-meter band, and here is the news in English." (Radio Australia)

Here are late tips from Paul Dilg, Calif.—Saigon, 7.087, Indo-China, has a good signal signing off 0900. Jogjakarta, 7.098, Indonesia, is fair level signing off 1030; Bandjarmarin, 5.030, is fair around 0830; Bali, 4.840, is rather erratic, best signal only fair, heard around 0800; Makassar, 9.554A, is fairly good level signing off 1000 with clock striking. A station on 4.805A is parallel with Pakistan, 11.675, around 0800 but at 0845 carries a different program; the 11.675 outlet has *English* 1015-1030 but the 4.805A one is not audible then. Kure, 6.105, Japan, now appears to sign off 0815 instead of former 0830. A station on 8.800A with fair level leaving air 0830 may be Viet Minn, Indo-China. Vladivostok, 5.020A, USSR, is good level relaying Moscow, heard around 0700. (Russell, Calif., measured this one as 5.01524, noted with good signal around 0815.)

Leningrad, 11.63, noted relaying Moscow with *English* 1630-1640, then music. SBT, 15.555, Stockholm, noted good level Saturday 1015 with DX session. ((Harris, Mass.)

The Spanish-speaker on 5.880 at 2030 is *Radio Nacional de Peru*, moved from 5.895; HI8Z, Dominican Republic,

# FOR THE "GOLDEN EAR" CROWD

## THE STRAIN-SENSITIVE PHONOGRAPH PICKUP

Here's why this truly faithful reproducer appeals to people gifted with the "Golden Ear" . . . why the STRAIN-SENSITIVE PICKUP developed by the PFANSTIEHL CHEMICAL COMPANY brings out the brilliance of great voices and orchestras . . . the latent music on your records that other pickups leave untouched.

- The STRAIN-SENSITIVE PICKUP is an amplitude transducer with a **CONSTANT RESISTANCE** of about 250,000 ohms.
- Signal output is at a practically **CONSTANT IMPEDANCE** LEVEL.
- Excellent Transient Response.
- **NO DISTORTION**, phase shift or evidence of intermodulation is audible.
- **LINEAR RESPONSE**, free from peaks or resonances.

Cartridges are available for both standard and micro-groove, and can be had with Famous PFANSTIEHL M47B Precious Metal Alloy or diamond tipped styli.

A special preamplifier is necessary to provide the correct D.C. voltage for the pickup element and to provide the first stages of signal gain. Four styles are ready, or, if you prefer, you can build your own from the circuit in the literature.

Ask your radio supply man, or write today for complete **FREE INFORMATION**.

**PFANSTIEHL**  
CHEMICAL COMPANY

101 Lake View Avenue, Waukegan, Illinois

# TEVCO

## SINGLE REFLECTOR CONICALS

- 1259—Single Bay  $\frac{3}{8}$ " elements. 3.19
- 1256—Single Bay  $\frac{1}{2}$ " elements. 3.89
- 1254—Double Bay  $\frac{3}{8}$ " elements. 6.68
- 1258—Double Bay  $\frac{1}{2}$ " elements. 7.89
- 1257—Four Bay  $\frac{3}{8}$ " elements. 14.89
- 1253—Four Bay  $\frac{1}{2}$ " elements. 17.19

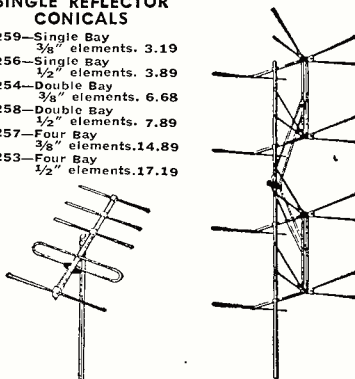

## FIVE ELEMENT YAGI BEAMS

- 2002 to 2006—any lo channel..... 8.69
- 2007 to 2013—any hi channel..... 3.19
- 1236—Single Bay Twin-V..... 3.76
- 1237—Double Bay Twin-V..... 7.49
- 1231—Four Bay Conical..... 16.99
- 1230—Double Bay Conical..... 3.89
- 1243—Swift Rig Folded Hi Folded Low..... 1.69
- 1240—Single section conical—lots of 6..... 3.49
- 1244—Swift Rig Folded Hi Straight Low..... 1.99
- 2113—Deluxe Indoor Antenna..... Dozen Lots 1.19
- 1860—Chimney Mount..... Per 100 3.60
- 1905— $3\frac{1}{2}$ " Mast Snap-On Standoff..... Per 100 5.50
- 1873— $3\frac{1}{2}$ " Mast Standoff Insulator..... Per 100 .02
- 1872— $4\frac{1}{2}$ " Nail-In Insulator..... Lots of 50 .02
- 1870— $3\frac{1}{2}$ " Wood Screw-Eye Insulator..... Lots of 50 .02
- 1229—Single Bay Conical..... 3.75
- 1861— $5\frac{1}{4}$ " Diam. Galv. Steel Mast..... .82

Send for quantity prices and complete list

**TELEVISION SUPPLY CO.**  
Box 13 Greenpoint Station Brooklyn, N. Y.



is now on 5.030, signs off 2130 instead of 2100 as formerly; the 5.028 Colombian signs off 2200; call not known definitely but is another *Radio Cadena Nacional* outlet. (Stark, Texas)

*Radio America*, "La Voz del Nuevo Mundo," 9.405, Havana, Cuba, noted to 0100 sign-off; HC1AC, 6.210, Quito, Ecuador, heard recently testing after 2332 sign-off, called *Radio Ondas Castellanas*, Loja, Ecuador *Radio Sport*, 7.849143, Granada, Nicaragua, noted to 2303 sign-off. (Rastorfer, N. Y.)

Oskay, N. J., has just heard Lagos, Nigeria, on measured 7.2545 with weak signal (in *English*) to 1658 when signed with "God Save the King."

I note *Radio Malaya*, 6.025, Kuala Lumpur coming through well here in the East now 0630 with news; same for Taipei, 7.133A, at that time; Bangkok, 6.24, Thailand, is again audible in *English* around 0615; Pakistan, 7.140A, is good level with news 0700.

At press time, *Radio Eirrean*, 17.84, Dublin, was still being heard with news 1230-1245A, but by now may have changed to winter schedule of 1330-1345A. (Ferguson, N. C.) *Radio Australia* had just confirmed that Hollandia, Dutch New Guinea, had moved to 7.1266 for its daily 0415-0630 transmission, and said is also on the air Saturday 2000-2300, and that Hollandia has plans for expansion from 500 w. to 3 or 5 kw., to use two transmitters, and also may have (*English*) DX session soon, probably on Wednesdays. Japan had just returned to Winter Time (14 hours ahead of EST).

Ridgeway, South Africa, flashes these tips on Angola stations—*Radio Clube de Huambo*, 7.125, Nova Lisboa, opens around 1145 and signal deteriorates by 1430, Portuguese music and announcements; *Radio Clube de Angola*, Luanda, 7.158, good signal from 1345, heard until after 1515; *Radio Clube de Benguela*, 7.085, opens 1300 with march, closes 1430, has gong notes; Loboito, 7.052, CR7AA, gives call-sign often, heard 1430 and closing 1600 with "A Portuguesa"; *Radio Clube de Angola*, 9.64, strong at 1600 and leaves air 1630 with anthem. Other flashes from Ridgeway include—ZOY, 4.915; Accra, Gold Coast, good level in South Africa 1230, *English* commentaries 1245 until leaving air 1300 with "God Save the King"; Tananarive, 9.695, Madagascar, good level but noisy 1200, the 3.23 and 6.17 channels run in parallel and opening 1200, close 1430; Lusaka, 7.22, Northern Rhodesia, is high level 1045 with native program; Salisbury, 9.50, Southern Rhodesia, is good 0400, closes 0615, but is heard later in parallel with 3.35 (9.50 closes 1230 and 3.35 closes 1500); *Radio College*, 4.98, Elisabethville, Belgian Congo, opens 1150 and closes 1233; uses French.

\* \* \*

**Acknowledgement**

Thanks for the FB reports, fellows! Keep them coming during the winter DX season to Kenneth R. Boord, 948 Stewartstown Road, Morgantown, West Virginia, USA. Good listening! KRB.

# Look close... and SAVE

## RECEIVING • SPECIAL PURPOSE • TV TUBES

ONLY THE BEST NATIONALLY KNOWN BRANDS.  
ALL TUBES BRAND NEW—INDIVIDUALLY BOXED. R.M.A. Guarantee

### RECEIVING TUBES

024A	\$.09	6AW6	1.85	6X5GT	.74
1A3	.89	6AX5GT	1.15	6Y6G	.84
1A5GT	.87	6B4G	1.50	6Z5Y5	1.54
1A6	.99	6B6	2.24	7A4	.89
1A4P	1.89	6B7	1.54	7A7	1.06
1A5GT	.87	6B8	1.21	7A6	.86
1A7GT	.98	6B9	1.46	7A7	.86
1B3GT	1.02	6B8	1.21	7A6	.86
1B4P	1.51	6B7	1.16	7A7	2.24
1B5/255	1.51	6B7	1.16	7A7	2.24
1C5GT	1.09	6B8	.86	7A7	.86
1C6	.74	6B6	1.35	7A7	1.54
1C6	.74	6B6	.82	7A7	1.09
1D5GP	.73	6B6	.99	7B4	.86
1D7G	.75	6B6	1.19	7B5	1.26
1D8GT	.75	6B6	.99	7B6	.89
1F4	.74	6B6	.76	7B7	1.26
1F5G	.74	6B6	1.02	7B8	1.26
1G6GT	1.12	6B6	1.22	7C5	1.49
1F7G	.73	6B6GT	1.44	7C5	.89
1G4GT	.74	6B7	1.05	7C6	1.26
1H6GT	1.69	6C5	1.15	7D7	1.26
1H6GT	1.84	6C5	1.15	7E9	.99
1J6G	.74	6CB8	1.55	7F7	1.01
1L4	.74	6CB8	.88	7F8	1.26
1L6	1.12	6D6	1.54	7H7	1.87
1L6A	1.12	6D6	1.54	7H7	1.87
1L8A	1.12	6D8G	1.94	7J7	1.44
1L8A	1.12	6E5	1.14	7K7	1.79
1L6C	1.12	6F5	.75	7L7	1.29
1L6D	1.12	6F5GT	.75	7N7	1.05
1L6E	1.12	6F5	1.29	7Q7	1.09
1L6S	1.12	6F6G	.88	7R7	1.04
1L6H	1.12	6F6GT	.88	7S7	1.19
1H6GT	1.84	6G6	1.32	7T7	1.19
1H6GT	1.25	6H6	.79	7X7	1.85
1G5GT	.74	6J5GT	.59	7Z4	.84
1R5	.82	6J6	1.09	10Y	.65
1S4	1.21	6K7	.82	7A6	1.09
1S5	.79	6J7GT	.81	12A7	1.52
1T4	.83	6J8G	1.49	12A8GT	.86
1T5GT	.74	6K5GT	.78	12A15	1.19
1U5	.78	6K7	.82	12A16	.65
1V2	.75	6K7G	.93	12A17	1.40
1X2A	.96	6K8	1.48	12A17	.96
2A3	1.49	6K8GT	1.48	12A16	1.48
2A4G	1.84	6L6	2.75	12A16	1.59
2A5	.84	6L6	1.98	12A17	.84
2A6	.39	6L6GT	1.28	12A7	.84
3A4	1.72	6L7G	1.19	12B2A7	1.16
3A5	1.55	6N6G	2.73	12B8E	.86
3B3GT	1.84	6N6	1.28	12C7	1.09
3L4	1.85	6N7GT	1.19	12B17	2.03
3L4	1.89	6P5GT	1.68	12C8	.89
3Q5GT	1.47	6P5GT	1.68	12C8GT	1.26
3S4	.78	6Q7G	.88	12H6	.89
3V4	.99	6Q7GT	.88	12J5GT	.79
4A4	.65	6R7	.90	12K8	1.32
5V4G	1.10	6R7GT	1.85	12K8GT	1.24
5W4	.82	6S4	.81	12L7GT	.70
5W4GT	1.25	6S7G	1.94	12S7	.77
5X4G	.89	6S8GT	1.32	12S7GT	.77
5Y3G	1.47	6S7	1.68	12S7	.90
5Y3GT	.75	6S7GT	.68	12S7GT	.99
5Y4G	.75	6S7Y	1.19	12S7	.92
5Z3G	.68	6S7	2.99	12S7	.89
5Z4	1.72	6S7GT	.97	12S7GT	.89
6A3	1.59	6S7	.98	12S7	1.10
6A5	1.08	6S7GT	.98	12S7GT	1.10
6A7	1.84	6S6	.99	12S7	.78
6A8	1.10	6S7	.99	12S7GT	.78
6A8G	1.54	6S7	.84	12S7	.77
6A8GT	1.84	6S7GT	.74	12S7GT	1.20
6A8A	.96	6S7	.76	12S7GT	1.20
6A8T	1.39	6S7GT	.76	12S7GT	1.49
6A8GT	1.44	6S7	1.30	12S7	.68
6A7	1.21	6S7GT	.90	12Q7GT	.78
6A7G	2.24	6S7GT	1.19	12S7	.82
6A7G	1.28	6S7GT	1.19	12S7	.82
6A7S	.86	6S7	.72	14A4	1.19
6A7	1.59	6S7GT	.72	14A7	1.09
6A6	1.49	6S7GT	.86	14B7	1.03
6A6G	1.10	6S7	.98	14B8	1.10
6A6	1.10	6S7	.98	14B8	1.10
6A17GT	1.85	6T7G	1.89	14C7	.99
6A05	.72	6T8	1.19	14E6	1.31
6A06	1.28	6U4GT	1.30	14E7	1.31
6A07GT	1.68	6U5	1.40	14F7	.89
6A08	.67	6U7G	.44	14F8	1.09
6A09	1.59	6V6	1.65	14G7	1.04
6A57	5.39	6V6G	.88	14J7	1.31
6A7G	.76	6V6GT	.86	14N7	1.05
6A05GT	1.59	6W4GT	.84	14R7	.99
6A06	.78	6W6GT	.84	14R7	1.02
6A05GT	1.31	6X4	.74	14S7	1.32
6A06	.62	6X5G	.74	14W7	1.27

14Y4	1.19	35C6	.99	53E	1.85
19B6G/G	2.39	35L6GT	.86	56	.66
19J6	1.59	35W4	.58	58	.99
19T8	1.34	35Z3	.86	58	.59
242E	.87	35Z4GT	1.26	70A7GT	2.73
25AC5/GT	1.42	35Z5	.57	71A	.99
25N6G	1.89	36	.59	75	1.40
25R6	1.49	37	.59	77	.85
25L6GT	.85	38	.59	77	.99
25W4GT	.88	39/44	.79	78	1.40
25Y5	1.15	42	1.40	81	3.36
25Z5	1.15	42	1.40	81	3.36
25Z6GT	.74	43	1.09	82	1.85
26	.48	44	1.26	83	1.85
27	.29	45Z3	1.26	83V	1.24
28D7	1.29	46	1.62	84/0Z4	1.26
30	.76	47	1.44	85	1.99
32L7GT	1.59	50B5	.96	117L/7GT	1.48
33	.98	50C5	.89	117P7GT	1.48
35/51	1.54	50X6	1.54	117Z3	.68
35A5	.96	50Y6GT	1.26	117Z4GT	2.03
35B5	.99	50Y7GT	1.40	117Z6GT	1.54

### SPECIAL PURPOSE TUBES

AE-150	\$2.75	58P1	4.69	811	1.99
CJ	5.85	58P4	4.69	813	7.95
CE-1	.79	5CP1	3.69	814	3.90
CEP-220	1.28	5D1	1.84	815	1.25
CK507AX	1.95	5FP7	6.95	826	2.25
CRP-72	.49	6C21	15.50	828	11.50
D120	4.45	15E	1.09	829B	12.74
EC-1	1.09	829B	1.09	829B	12.74
F123A	7.95	15R	.69	830B	3.69
GL-134	9.95	18C	1.59	831	44.50
HF100	11.95	24R	4.95	832A	12.50
RK34	.59	100TH	7.99	836	3.49
VR90	1.32	211	.79	838	2.45
VR-105	1.22	217A	7.95	841	.44
VR120	1.09	217C	1.29	842	4.49
VR-150	1.09	218	9.95	845	4.49
IB23	5.85	221A	1.44	849	26.75
IB27	6.95	221B	1.10	850	1.59
IB29	6.95	250R	9.75	860	5.90
IB32	7.95	253A	12.95	864	.27
IB38	16.95	254	12.95	865	.99
2A4S	1.84	254C	10.95	866A	1.19
2A1P	8.95	274E	3.50	872A	2.39
2B22	4.44	276A	9.75	876	.27
2C21	1.63	278	12.95	902P1	8.95
2C2	.45	304TH	12.95	913	.89
2C34	.32	304TL	11.95	913	.89
2C36	4.44	307A	4.85	905	2.27
2C40	4.85	371B	9.31	918	1.39
2C43	19.95	393A	5.95	924	1.39
2C5	2.50	417A	1.29	926	2.24
2E22	1.95	446A	4.19	955	.38
2J21A	9.50	469	12.00	956	.36
2J22	1.95	514	12.00	956	.36
2J26	17.95	531	4.95	958A	.95
2J27	19.95	532	7.95	959	1.21
2J31	24.50	702A	2.49	CK1005	.48
2J32	24.95	703A	6.89	1613	.98
2J33	24.95	704A	6.89	1613	1.35
2J34	47.50	705A	1.29	1619	.32
2V36	1.86	707A	12.95	1624	1.38
2K25	2.95	710A	11.11	1625	.38
2K28	29.50	708A	4.69	1626	.38
2K29	21.50	713A	.95	1629	.34
3B279	6.95	715C	18.95	1630	2.24
3C24	1.99	715A	6.95	1632	.75
3B27	3.49	715B	8.95	1633	.62
3C25	1.85	715C	18.95	1633	1.15
3C28	9.50	718AY	48.50	1641	.95
3C34	7.50	718BY	48.00	1642	.69
3B21	4.44	718Y	48.50	1851	1.69
3D23	4.49	720EL	4.99	2050	.99
3E29	12.95	721A	4.89	2051	1.22
3E31	5.29	722A	8.00	8012	1.25
3E31	4.49	722B	14.95	8020	2.95
3D32	6.95	725A	7.49	FG-17	2.95
4A-11	.79	801A	1.69	FG-104	1.70
4B36	15.15	803	2.00	9001	1.39
4A1P10	4.45	804	8.69	9003	1.39
4D23	7.63	805	8.69	9004	.75
4E27	14.95	807	1.74	9004	.75
5A1P1	3.25	808	4.69		



# NEW TV PRODUCTS on the Market.....

## NEW CENTERING DEVICE

Perfection Electric Company, 2635 S. Wabash Avenue, Chicago, Illinois is currently introducing a new picture



centering device designed especially for use with the new electrostatic picture tubes which use no focus coil.

Tradenamed the "Kine-Center", the unit consists of two metal rings which can be rotated independently to adjust the television picture in the tube and center it. The rings are mounted on a special form which is clamped securely to the neck of the tube. The rings are stabilized magnetically.

## TWIN-LEAD TESTER

The *Easy-Up Tower Company*, 427 Romaine Avenue, Racine, Wisconsin has recently introduced a tester for checking twin-lead used in television installations.

Tradenamed the "Twin-Test", the new unit quickly locates breaks in 300 ohm twin-lead and indicates the exact

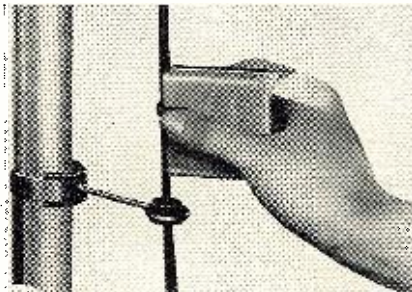

location of the break by means of a light. The unit can be used to test twin-lead while connected to any type of antenna, whether open-circuit or closed-circuit.

## ISOLATION BOX

*Technical Appliance Corporation* of Sherburne, New York has just announced the availability of a new non-powered isolation box for use with the company's antenna distribution system.

The isolation box is housed in a

bakelite box the size of a standard outlet box. It contains a matching network of resistors providing an isolation factor between receivers of at least 30 db, with a minimum signal drop across the outlet. No power is required. Terminals are provided for 300 ohm twin-lead to the receiver.

## TV TUBE CHECKER

*National Union Radio Corporation*, 350 Scotland Road, Orange, New Jersey is now offering a portable checker for television picture tubes which sells in the low-price class.

Rugged and compact, this unit may be used either in the shop or in the customer's home. The checker tests independently of the set so it is not necessary for the receiver to be in operative condition.

It utilizes a beam current test which is proportional to the light output capability of the tube. It also provides

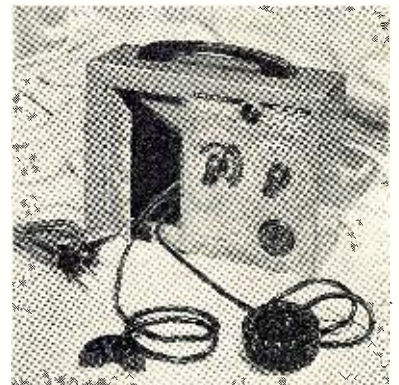

for continuity and short checking of the electron gun.

A catalogue sheet giving a complete description of the new tube checker is available on request.

## SELF-FOCUSING TUBES

*Thomas Electronics, Inc.*, 118 Ninth St., Passaic, New Jersey has developed a new self-focusing electrostatic television picture tube.

The new unit, which operates on a low voltage, is totally unaffected by normal line voltage changes or anode voltage fluctuations and will not drift out of focus, according to the company.

This tube is being marketed for conversion, replacement, and original equipment applications. The 17" size is in production and plans are now under way to bring the tube out in several other sizes.

## REPLACEMENT PART

*Allen B. Du Mont Laboratories, Inc.*, 35 Market Street, East Paterson, New Jersey is now marketing a new horizontal deflection output and high volt-

**RADIO & TELEVISION NEWS**

An Invitation  
to see and hear  
**BRITAIN'S FINEST  
AUDIO PRODUCTS**

AT THE AUDIO FAIR  
Hotel New Yorker Booth 270



## GARRARD

The world's finest automatic record changer. Competitively priced! Plays all speeds. Automatic stop. Heavier turntable. Quieter motor. Muting switch eliminates noise between records. Accurate speed. No wows, wavers, rumbles or disturbing resonance.



## LEAK "POINT ONE"

A new model of Britain's best audio amplifier. Distortion: 0.1%. Triple loop power amplifier and pre-amplifier certified by British Nat'l Physical Lab. (equiv. U. S. Nat'l Bureau of Standards) to exceed manufacturer's performance claims. Pure, undistorted musical reproduction... the ultimate in clarity and frequency response.



## WHARFEDALE

Magnificent speakers, yet inexpensive, with remarkable response. Built by Wharfedale Wireless Works under the direction of world-famous engineer, G. A. Briggs. Brilliant performance approaching living sound. Endorsed by B.B.C.



## BOOKS by G. A. BRIGGS

"Loudspeakers" and "Sound Reproduction" written by renowned authority on sound, G. A. Briggs. The only such books written expressly for the layman. A "must" for those interested in finest musical reproduction.

At your dealer or write to  
**BRITISH INDUSTRIES CORP.**  
164 Duane St., New York 13, N. Y.



age transformer, their Type H1A1.

Designed for conversion or replacement purposes, the new unit features a design which utilizes a ferrite core and special windings. It is capable of

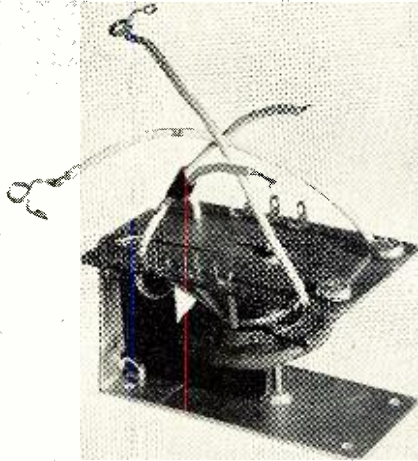

supplying 12 to 13 kv. to a 70 degree tube with ample horizontal size. It is ideally suited for the quick and easy conversion of television receivers using small sized tubes to the larger modern sizes.

**"SUPER RHOMBIC" ANTENNA**

Davis Electronics, 3047 W. Olympic Blvd., Los Angeles 6, California is now marketing a new aluminum alloy antenna which has been specifically designed to eliminate stacked arrays and overcome the problems of fringe and ghost area reception.

Tradenamed the "Super Rhombic Antenna," this new unit gives all-channel coverage. To take full advantage of horizontal wavelengths, the unit has a tilt of 15 degrees. This feature, coupled with its directivity of 12 degrees, makes the antenna extra effective for maximum distances and ghost elimination.

The antenna is lightweight, is shipped preassembled, and may be installed in a matter of minutes.

**DUAL COLOR WHEEL**

Celomat Corporation, 521 W. 23rd Street, New York, New York is now in

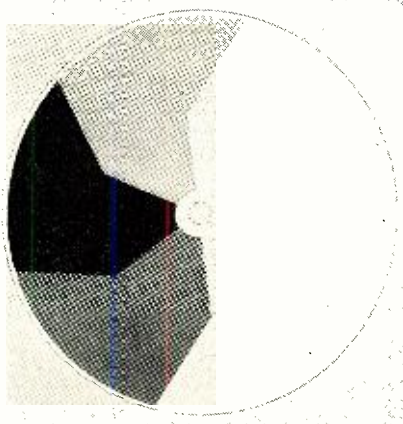

production on its new dual color wheel—an ingenious development that permits color and black and white viewing without elaborate changeovers.

November, 1951



**2000 TV STATIONS SOON TO BLANKET NATION!**

**Get In On The Ground Floor Now! Learn TELEVISION BROADCASTING**

**TAKE T.C.I. PRACTICAL, COMPLETE TRAINING—THE ONLY COURSE ON TECHNICAL & OPERATIONAL PROCEDURES!**

2000 new TV stations will urgently need trained men for video engineers, technical directors, cameramen, micro-wave engineers and other important jobs relating to TV transmitter work. They'll pay BIG MONEY for these men. NOW is the time for YOU to train for big pay, big demand TV station jobs!

**TRAIN AT HOME FOR BIG PAY AND SECURITY IN THIS GROWING, BIG DEMAND FIELD!**

Now you can learn every phase of telecasting—operation, maintenance, installation—at home, in your spare time. And you learn the right way with T.C.I.'s non-mathematical practical training! Here is the only course dealing exclusively with technical and operational instruction. Men now working in TV stations designed this course—are consultants in every phase of your training. You work with schematics, covering RCA, DuMont, General Electric and other circuits in detail. You learn Micro-Wave Relays, COLOR TV, UHF, Industrial TV, FCC Engineering Standards, TV Broadcasting Techniques, network operations and much more. Lessons are written without involved mathematics in language you can understand. You set your own pace; go as fast or as slow as you like.

**TRAIN TODAY FOR BIG PAY TOMORROW!**

Act now for security and top earnings. Take T.C.I. practical training. Unique FREE Employment Service plus FREE Consultation Service. Don't envy the men who pull down the big money in Television. Be one! Mail coupon for full details on T.C.I. Television Broadcasting training AT ONCE!

**TRAINED MEN URGENTLY NEEDED FOR THESE JOBS!**

- Video Engineers
- Technical Directors
- Cameramen
- Micro-Wave Engineers
- Audio Engineers
- Projectionists
- Lighting Engineers
- Remote Engineers
- And Many Others

**Sensational GUARANTEE on FCC LICENSE!**

You will need this license, and TCI positively guarantees to give you all the information you need and until you get your FCC license, no matter how long this may take.

**T.C.I. ALSO OFFERS PRACTICAL TRAINING IN TV SERVICING**

Learn professional type TV Servicing without leaving your present job. Included are set conversion, master antenna installation, COLOR TV and CONVERSION, field servicing short cuts. You learn to test, trouble shoot and repair all types of TV sets.

**HERE'S HOW YOU GET EXPERIENCE!**

You train on your own large screen modern TV receiver, furnished as part of the course. This set is yours to keep! You can also get two weeks actual field experience with

**TELEVISION COMMUNICATIONS INSTITUTE**

Chicago's largest independent servicing organization. You learn TV Servicing by doing TV servicing! Age is no barrier. Many T.C.I. students are over 40! ACT NOW! Get complete information about T.C.I.'s PRACTICAL TELEVISION Servicing Course.

205 W. Wacker Drive  
Dept. 1-Q, Chicago 6, Ill.

**MAIL NOW FOR FREE FACTS!**

**TELEVISION COMMUNICATIONS INSTITUTE**  
205 W. Wacker Dr., Dept. 1-Q, Chicago 6, Ill.

Rush FREE facts on the course checked below! I am under no obligation. No salesman will call.

TV Transmitters     TV Servicing  
 Pre-Television Radio for Beginners

Name .....

Address .....

City..... Zone..... State.....

MILTON S. KIVER, active president of T.C.I., is a registered professional engineer, TV Consultant and internationally known author.



**NEW!**

*filtered D.C.  
power supply*

**CONTINUOUSLY  
VARIABLE,  
0-28 VOLTS  
at 15 AMPERES**

**Test, Service DC  
Equipment from AC Lines  
Faster ... at Less Cost!**

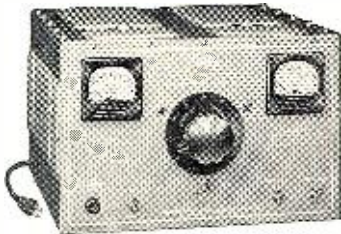

**NEW ELECTRO  
MODEL "N"**

The only moderately priced DC power supply with this output range and dependability. Exclusive "Electro" application of selenium rectifiers increases rectifier power rating and lowers cost per ampere output. One control offers continuous voltage adjustments. Top quality parts and special design withstand high overloads.

Net \$175

**TEST &  
SERVICE**

- Aircraft, tank, marine electronic equipment.
- Relays, solenoids, Phone circuits.
- Laboratory instruments, research, low voltage devices.
- Plating

Send Coupon Today for Detailed Bulletin

**ELECTRO PRODUCTS LABORATORIES**  
4501-RN Ravenswood Ave., Chicago 40, Ill.

Name \_\_\_\_\_

Firm \_\_\_\_\_

Street \_\_\_\_\_

City \_\_\_\_\_ State \_\_\_\_\_

Precision Instruments Since 1944

**Other Models**

Model "B"  
6 Volts, 1-20 Amperes,  
Net \$49.80

Model "BJ"  
6 Volts 1-12.5 Amperes,  
Net \$37.50



SAVE TIME... MONEY with ELECTRO POWER SUPPLIES

The wheel is actually two clear plastic discs with color segments that are balanced and matched in pairs of the same density. These color segments in rotation unite to form a perfect color wheel. For black and white viewing, the wheels are kept stationary—the colored segment sections of the wheels fall below the screen—and the black and white picture is transmitted through the clear plastic upper half of the discs.

TV manufacturers, jobbers, service organizations, and retailers are invited to secure complete details on these new color wheels by writing to Myron J. Greenwald, vice-president of the company, at the New York address.

**DEFLECTION YOKE**

Cleveland Electronics, Inc., 6616 Euclid Avenue, Cleveland 3, Ohio is currently in production on a new "univer-

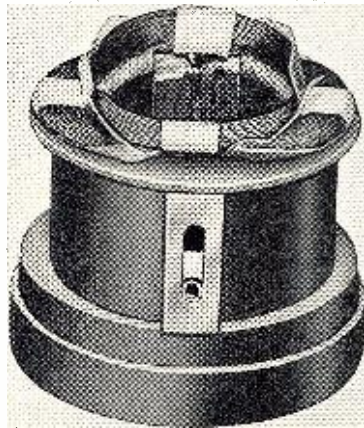

sal" television yoke which is designed with anastigmatically corrected coils to provide a sharper focus over the entire picture area.

Insulated against high temperature throughout with materials suitable for withstanding temperatures up to 90 degrees C., quadruple Formvar wire insulation has been used on all horizontal coils for maximum protection against high voltage.

The unit is easily installed by means of a floating type cage nut which permits rapid and accurate adjustment. The yoke can be used in large picture tube conversions of older sets or as a direct replacement on modern receivers.

**"HI-Q" TV ANTENNAS**

T V Research Labs., 717 N. Lake Avenue, Pasadena, California has extended the distribution of its line of

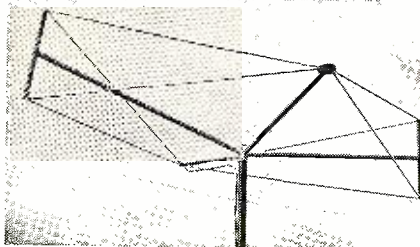

"Hi-Q" television antennas to embrace the entire country.

Designed after a pattern long used by the U. S. Government for DX and

**CARTER DYNAMOTORS**

**BRAND NEW—Original Mfr's Sealed Cartons**  
6V. Inp.—400 VDC out. @ 375 ma. (List \$71.40)  
"Type 4037 AS" Only \$28.00  
6V. Inp.—590 VDC out. @ 250 ma. (List \$73.50)  
"Type 5925 AS" Only \$33.00

**QUALITY, TESTED TUBES**

**NEW & GUARANTEED, In Stock Now;**  
Many Others Not Listed (XMTG, etc.)  
—Write for Low, Low Prices.  
"We can help you on Special Purpose and Industrial Tubes... especially WESTINGHOUSE Types."

0A2	\$.10	6AL5	.40	6Y6G	.75
0B2	.120	6AS5	.75	6X5GT	.45
1N21	.80	6AU6	.55	12AV6	.55
1N21-B	3.00	6AV6	.50	12AU7	.80
1N23	.95	6BA6	.65	12AT7	.95
1N23-A	2.75	6BD6	.50	12BA6	.65
1N23-B	4.00	6BE6	.55	12BE6	.65
1N34	.70	6BD6GT	.85	12BH7	.75
1B3GT	.85	6CD6G	1.50	25L6GT	.50
1R5	.65	6SH7	.60	35C5	.65
1U4	.65	6J5GT	.50	35Z5GT	.50
3A5	.65	6J6	.90	50C5	.60
3DB	.50	6R8	.75	50L6GT	.60
3SA	.90	6S07GT	.75	80	.50
3Q4	.55	6SN7GT	.65	4-12SA	27.50
5U4G	.60	6T8	.80	304TH	11.50
5V4G	1.05	6U4GT	.75	304TL	11.50
5Y3GT	.40	6V6GT	.55	955	.45
6AB4	.75	6W4GT	.50	872A	2.00
6AG5	.65	6X4	.35	813	8.95

**NEW SELENIUM RECTIFIERS**

Current (Cont.)	Full-Wave Bridge Types			
	18/14 Volts	36/28 Volts	54/40 Volts	110/100 Volts
1.		\$1.90		
2.	\$2.40	3.75	\$6.95	\$10.50
4.	3.85	7.00	9.00	
6.	5.65	9.00		
10.	6.95	10.95		48.00
12.	8.50	14.00		58.00
20	13.25	20.50		
24	14.00	26.00		
30	19.00	30.00		
36	25.50	35.00		

"WE CAN MANUFACTURE OTHER RECTIFIERS TO SPECS."

WE HAVE AN INTERESTING INVENTORY OF END-EQUIPMENT—WRITE YOUR NEEDS. "EXTEND YOUR D. O."

**BARRY ELECTRONICS CORP.**

136 Liberty Street N. Y. 6, N. Y.  
Rector 2-2563  
Terms: 25% with order, balance C.O.D.—Send a few cents for postage—All merchandise guaranteed. F. O. B. N.Y.C.

**BOSTON — HUB OF THE UNIVERSE!**

*DeMambro* HUB of HI-FI



Behind these showroom walls lies the world's finest selection of high fidelity equipment. Here discriminating music lovers and discerning radio engineers select superior equipment for incomparable sound reproduction.

**EXCLUSIVE DISTRIBUTORS FOR**

- M-LINTOSH
- STROMBERG-CARLSON
- MAGNECORD
- ELECTRO-STATIC
- ELECTRO-VOICE
- DAVEN

**Complete Selection of**

- Jim Lansing - Altec Lansing - Jensen
- H. H. Scott - Browning - Webster - Craftsman - Brook - Meissner - Scotch - Presto - Avialdisc - Eicar - Ampco

Visit Our Display or Write for Complete Information.

*DeMambro* RADIO SUPPLY CO., INC.

1111 COMMONWEALTH AVE., BOSTON 15, MASS.

Branch Offices  
PROVIDENCE, R.I., 90 Broadway  
WORCESTER, MASS., 222 Summer St.  
MANCHESTER, N.H., 1308 Elm St.

**RADIO & TELEVISION NEWS**



radar reception, the new antenna has a 12 degree directivity, is non-resonant, and is adaptable to any receiver using 72 or 300 ohm input as well as 500 ohm open line. The manufacturer claims that this antenna has a low standing wave ratio.

The unit is preassembled, has special de-icing features, and uses 50 percent wood dowel Douglas fir.

Literature on this new antenna is available on request.

### MINIATURE TV TUBE

The Tube Departments of *General Electric Company* have announced the development of a low-cost miniature television receiver tube which has been designed to reduce snow in fringe area reception.

The new tube, the 6BK7, has a noise factor of only 7 db as a cascade amplifier at 216 mc. Intended primarily for cascade service in v.h.f. reception, the 6BK7 may also be used as a low-noise first i.f. amplifier in u.h.f.

Design features of the tube include

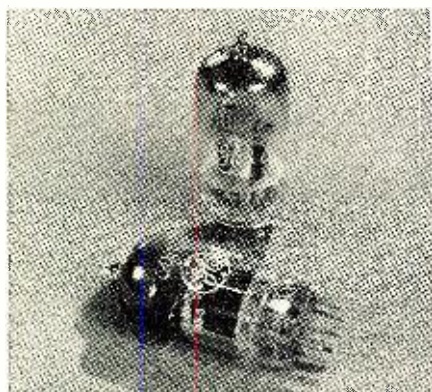

a shield between the triode sections and high transconductance to improve gain and reduce noise level.

Complete performance characteristics on this tube are available from the company at Schenectady 5, New York.

### COLOR TV ADAPTER

The Receiver Sales Division of the *Allen B. Du Mont Laboratories, Inc.*, has just introduced a color television adapter which will make it possible for viewers to see every type color transmission available today, in black and white, on their present sets.

Known as the "Du Matic" switch, the new unit measures 4½" long, 3" wide and 1½" deep. It can be installed on the rear of the set, bolted to the chassis. The switch enables the set owner to change from regular 525 line reception to the 405 lines employed by the CBS systems, to get color pictures in black and white whenever the 405 line color system is on the air.

The new unit will retail under \$20 and can be installed by a local technician in an hour.

### TV SERVICE TOOLS

Two new precision tools which have been designed to simplify and speed up television servicing have been introduced by *Insuline Corporation of Amer-*

## Real values on hard-to-obtain items

### Give These Items a Careful Look!

#### TRANSFORMERS-CHOKES:

5V, 25A. Pri. 115V, 60 cy. AC. A real rugged job excellent for 304TL—4-250A etc. Limited quantity. Only \$4.50 ea.

2.5V, 10A, 10KV insulation. Suitable for 866, 836, etc. Reduced to \$3.39 ea.

10H, 200 ma choke. Hermetically-sealed steel case. Also has hum-bucking tap. A beautiful item only \$1.98.

10H, 50 ma choke. Strap mounting. Handy for dozens of applications. Reg. 98c, reduced to 65c. Charger or fil. trans. Pri. 110V, 60 cycle. Secondary, 9-10-11-12-13 volts @ 1.2 A. Fully cased. A buy at \$1.45.

Fil. trans. Pri. 110V, 60 cy AC. Sec. 24V @ .6A. . . . . only \$1.95 ea.

Power Transf. 350-0-350 @ 70 ma. 5V @ 3A, 6.3 @ 3A. Pri. 110V, 60 cy. AC. Upright mtg. . . . . \$3.25 ea.

Power transf. Pri. 115V, AC, 60 cy. Sec. 520-0-520 @ 200 ma. . . . . \$5.25 ea.

Power transf. Pri. 115V, 60 cy. AC. Sec. 310-0-310 at 50 ma. Cased, upright mounting. . . . . only \$1.95 ea.

Output transf. 50L6 to voice coil. . . . . 79c ea.

Choke, 6 henry, 200 ma. Strap mtg. . . . . \$1.95 ea.

390-0-390 @ 300 ma. Pri. 115V, 60 cy. AC. 5V @ 3A, 5V @ 3A, 6.3V @ 1.6A, 6.3V @ 8A. Completely cased with external copper elect. shield. Made by RCA. Really a beautiful transf. A buy at \$7.95 ea.

450-0-450 @ 200 ma. Pri. 115V, 60 cy. AC. 5V @ 3A, 6.3 @ 5 amp. In shielded case. Only \$8.90 ea.

920-0-920 or 740-0-740 @ 200 ma. Primary 115 or 230V 60 cy. AC. Upright shielded case. Excellent for 807 RP or mod. Only \$10.80 ea.

Scope HV transf. Pri. 115V, 60 cy. AC. Fully cased and insulated. Use with 2X2 rect. Excellent buy at . . . . . \$4.95 ea.

2X2 fil. transf. HV insulation. Fully cased. Also has 4V @ 14A. winding. True O-R value at . . . . . \$1.49 ea.

Double 30 henry choke, 20 ma. Use for low-level speech filter, etc. Fully cased. Hard to beat at . . . . . \$1.49 ea.

#### ENTIRELY NEW! GEIGER COUNTER

Brand new, 1¼ lb., highly sensitive unit housed in strong plastic case. New circuit employs amplifier tube for improved audible signal. This unit more sensitive and dependable than many higher priced instruments. Uses two low cost, long-life batteries. Size approx. 1½" x 3" x 5". Headset, batteries and radioactive ore sample furnished. A tremendous value on an excellent instrument. Price . . . . . \$24.95 ea.

836 hi-vacuum rectifiers, 2 for . . . . . \$1.50

#### FONE PATCH!

Now available, the superior new O-R. #6008 phone patch. Provides you with exactly what you need to patch your phone into transmitter or receiver. Featuring a hi-impedance input suitable for all mikes. Both hi and lo impedance outputs to insure proper match to your particular receiver. Unit is complete—"sure-fire"—ready to go to work for you. Only . . . . . \$4.95 ea.

#### EE89 REPEATERS

See previous ads. Only a few left. NEW! Regularly \$9.95 ea. . . . . now \$6.95 ea.

#### VACUUM TUBE SPECIALS

6SN7 . . . . . \$1.32 net  
6H6 . . . . . .99 net  
8012 . . . UHF triode . . . . . 1.50 ea.  
WE-717A . . . . . 1.00 ea.  
WE-316A . . . Trans. doorknob. . . . . .75 ea.  
WE-388A . . . Large doorknob. . . . . 1.00 ea.  
815 . . . twin-beam tet. . . . . 2.50 ea.  
6L6 . . . metal . . . . . 2.25 ea.  
6L6G . . . . . 1.95 ea.  
6L6GA . . . . . 1.95 ea.  
1636 . . . VHF converter. . . . . 1.00 ea.  
Hytron HY-615 . . . . . .30 ea.

#### LOOK! NO HANDS!

This mike leaves both hands free for mobile QSO's. Fastens to operator by simple snap strap. Adjustable. Double action sw. operates push-to-talk or holds on. BRAND NEW only \$2.00 ea. POSTPAID in U.S.A. and CANADA.



#### POLY RODS & TUBING . . . IN STOCK!

Full stock of high grade polystyrene rod and tubing. Supplied only in 12" lengths. Tubing has .062" wall.

ROD	Price (length)	TUBING	Price (length)
1/8"	\$.03	3/4"	\$.07
3/16"	.06	5/16"	.10
1/4"	.10	3/8"	.13
5/16"	.15	1/2"	.23
3/8"	.20	5/8"	.29
1/2"	.27	3/4"	.38
5/8"	.30		
3/4"	.38		
1"	.45		
1 1/8"	.55		

#### SENSITIVE RELAY

Miniature type (1½" overall) SP-ST contacts. Coil resistance 6500 ohms. (2 ma.) An excellent relay for voice control or model applications. Only \$1.50 ea.

#### Power Supply for Any 274-N Receiver

A shipment of the special transformers has just been received and this popular power supply is now once again available. Just plug it into the rear of your 274-N RECEIVER



. . . any model. Complete kit and black metal case, with ALL parts and diagrams. Simple and easy to build in a jiffy. Delivers 24 volts plus B voltage. No wiring changes to be made. Designed especially for the 271-N receiver. All necessary parts for conversion of rest of receiver also included. ONLY \$8.95.

#### HANDSET HANGER

Beautiful cast aluminum shell finished in black wrinkle. Takes all makes and models. An extremely useful, well-made item. . . . only \$1.95 ea.

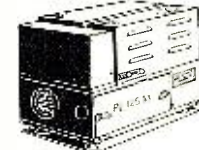

#### HEAVY-DUTY VIBRATOR POWER SUPPLIES

Here are two excellent heavy-duty vibrator power supplies for operation on either 12 or 27 volt D.C. Beautifully built and using only the finest components throughout. Shock mounted. Approx. size, 12" long, 7½" wide, 9½" high. Ideal for portable or mobile applications as amateur, marine, CD, etc.

PE-125AX, 500V D.C. @ 160 ma. Current drain, 12V, 14.5A., 24V, 7.5A.  
PE-125BX, 475V, D.C. @ 200 ma. Current drain, 12V, 15.2A, 24V, 7.2A.  
Spare vibrator furnished with either unit.  
NEW, surplus—either unit. . . . . \$22.95 ea.

#### U-V LIGHT SOURCE

8 watt ultra-violet light source. In kit form including Sylvania black-light tube, (for U-V light in the 3660 Angstrom unit region) ballast, starter, mounting panel, reflector, line cord/plug, hardware, instructions. An invaluable device for schools, labs, service shops, home workshop, etc. Here is a genuine value. Complete kit, (less outer housing) . . . only \$4.95

#### PORTABLE U-V LIGHT SOURCE

Kit same as above except designed for portable operation on 180V B batteries. (Not supplied) Ballast not required . . . uses starting switch and current limiting resistor. Complete kit, (less batteries & outer housing) Only . . . . . \$4.95 ea.

#### HV VACUUM CAPACITORS

VC-50 — 50 MMF . . . . . \$ 3.95 ea.  
VC-150 — 150 MMF . . . . . 10.95 ea.  
VC-200 — 200 MMF . . . . . 13.95 ea.  
All Brand New Merchandise—Excellent Values.

#### 274N/ARC-5 ACCESSORIES

Mounting rack, holds three receivers. Easily modified for single receiver—NEW. . . only \$1.95 ea.  
274N/ARC-5 Spline tuning knobs. . . . . \$9 ea.  
Same as above except with deluxe tuning crank . . . . . \$9 ea.  
Tuning crank. Fits RU 16-17, BC 433 etc. for manual tuning . . . . . \$9 ea.

#### CONDENSER TESTER

• One of our best sellers! Useful, versatile laboratory item. In kit form. Simple, and easy to build in less than an hour. Checks condenser leakage and continuity up to 8 megs. Will test any paper, electrolytic, mica or oil capacitor from 50 mmf. to 50 mfd. Self-contained power supply and neon bulb indicator with socket and bezel. Drilled metal cabinet. Complete instructions and diagrams included with each kit. Only \$5.00.



#### NOTE NEW ADDRESS!

Minimum order \$2.00. All items subject to prior sale. All prices subject to change without notice. 20% deposit must accompany all orders, balance C.O.D.

## OFFENBACH & REIMUS CO.

1564 MARKET ST., SAN FRANCISCO, CALIF.



# Check These TV VALUES!

TRI-X  
CABLE

**DIRECTRONIC MOTORLESS**  
360° Electronically Switched Beam

- No Motors • No Electric Power
- No Roof Orientation • No Ghosts

The Directronic 18 element, 360° antenna is the finest for ultrafringe or metropolitan reception. The HI-PAC molded insulator is a material of extreme tensile strength not affected by weather or temperature, either mechanically or electrically. Included in the AX-500 "Servicemen's Array" are:

- 18 hi-tensile aluminum alloy elements
- 1 set of connecting stubs (3)
- Universal U Clamps for masts to 1 1/2"
- Directronic Beam Selector
- 75 feet of Tri-X Cable
- stacked array per carton

AX-500 Directronic . . . . . \$21.75

AX-56 Directronic, 6 element Single . . . . . 10.50

AX-566 Directronic, 12 element stacked . . . . . 19.75

AX-59 Directronic, 9 element Single . . . . . 12.25

Weight 3 1/2 lbs.

All above antenna prices include Tri-X Cable and Switch.

**S ELEMENT TV ANTENNA**  
Excellent Pictures in Fringe Areas

Here is a highly directive antenna that is the real solution to perfect pictures in fringe areas because it is closely tuned to each channel and cuts interference and noise to the minimum. Five elements include one folded dipole, three directors and one reflector. Supplied less mast. Specify number of channel desired. Channels 2 to 6—\$5.95 Channels 7 to 13—\$3.95 Shipping Weight—5 1/2 lbs. Low Band. Shipping Weight—3 lbs. Hi-Band.

**ALL CHANNEL CONICALS**

This conical TV is designed for broad-band reception on all TV channels plus FM. The conical has proved high signal-to-noise ratio and excellent front-to-back ratio; matches 72, 150 or 300 ohm input impedance. This metropolitan area high quality TV antenna is engineered for super performance. The all-aluminum construction provides maximum strength and eliminates rust and weight problems. The NA44 is built solid and cannot slip or twist on the mast.

Single Bay . . . \$3.75 each  
Shipping Weight 3 1/2 lbs.

Stacked Array with Tie Rods . . . \$6.20 each  
Shipping Weight 7 1/2 lbs.

Lots of 6, single carton. \$21.00 per carton  
Shipping Weight 18 lbs.

Lots of 6, single carton. \$23.10  
Shipping Weight 19 lbs.

1 1/4" O.D. Mast Steel (Duralcoated) 5' Crimped . . . . .	\$ 1.05
Mast Steel (Duralcoated) 10' . . . . .	1.95
Mast Steel (Zinc Plated) 10' . . . . .	1.89
Mast Connectors for 1 1/4" O.D. Mast—	
10" Long . . . . .	.49
Motors—Alliance AT-2 . . . . .	20.53
Alliance DIR . . . . .	26.43
Radiart TR-2 . . . . .	29.70
Walco WRQ-4 . . . . .	28.50
Motor Wire	
3-Conductor (Walco) . . . . .	.03 ft.
4-Conductor (Alliance) . . . . .	.04 ft.
8-Conductor (Radiart) . . . . .	.06 ft.
Peak Roof Saddles (will take up to 1 1/2" O.D.) . . . . .	1.49
Twin Lead 300 Ohm—Solid . . . . .	.02 1/2 ft.
Twin Lead 300 Ohm—7/28 Stranded . . . . .	.03 ft.
Side Wall Mounts—3" Extension . . . . .	.75
Side Wall Mounts—6" Extension . . . . .	1.25
Side Wall Mounts—12" Extension . . . . .	1.75
Side Wall Mounts—18" Adj. . . . .	3.50
Tie Rods for Stacking Antennas . . . . .	3.70 pr.
Double Stacking Assembly—for stacking 2-XX arrays . . . . .	1.70 set
Aluminum Guy Line 7/18—Stranded—	
300' coil . . . . .	4.95
Arrestors (TV—Lighting) . . . . .	.69
Auto Radio (6 tube Universal Underdash) . . . . .	34.97
Chimney Mount—Complete with Straps . . . . .	1.19
Coax—72 Ohm . . . . .	.07 ft.
Elements 3/4" x 45" or 48" . . . . .	.90 pr.
Elements 1/2" x 45" or 48" . . . . .	1.20 pr.
Guy Wire—Galvanized—4 Strand #20 . . . . .	.005 1/2 ft.
Guy Wire—Galvanized—6 Strand #20 . . . . .	.005 1/2 ft.
Guy Wire—Galvanized—11 Strand #20 . . . . .	.01 1/2 ft.
Indoor Antennas (Popular Brands) Rabbit Ears . . . . .	1.75
Boosters—Anchor—101-75 . . . . .	22.50
Astatic—BT-1 . . . . .	19.50
Tec—S-506 . . . . .	22.50
Stand-off Screw Insulators—	
3" for 300 Ohm . . . . .	2.75 C
Stand-off Screw Insulators—	
7" for 300 Ohm . . . . .	5.50 C
Strap Clamp Stand-off Insulators—3" . . . . .	8.50 C

PRICES SUBJECT TO CHANGE WITHOUT NOTICE.  
ALL PRICES F.O.B. CLEVELAND, OHIO

**Chas. E. Freshman & Co.**  
4019 PROSPECT AVENUE  
Cleveland 3, Ohio • Phone EX 1-8723

ica, 36-02 35th Avenue, Long Island City 1, New York.

The No. 6247 is a dual-bladed "Kleer" aligner consisting of a rod of low-loss transparent plastic measur-



ing 4 1/2 inches long and 1/8 inch in diameter and fitted with corrosion-proof steel blades .018 and .025 inch thick, respectively.

The second unit, the No. 6249, is a tuning wand which is a brown phenolic rod 4 3/4 inches long and 1/4 inch diameter. One end contains a molded powdered iron core having a permeability tolerance of 2 per-cent and a "Q" tolerance of 10 per-cent. The other end contains a silverplated brass core.

**WIDE-BAND VIDEO AMPLIFIER**

A new and improved wide-band video amplifier, the Model V-2, has just been introduced by *Polarad Electronics Corporation* of 100 Metropolitan Avenue, Brooklyn 11, New York.

The Model V-2 has a flat amplitude response ± 1.5 db from below 10 cps to 20 mc. It has been designed for use as an oscilloscope deflection amplifier for the measurement and viewing of pulses of extremely short duration and rise time. Designed for laboratory and industrial use, the unit extends the am-



plitude range of vacuum tube voltmeters and signal generators. Its extended low frequency responses permit accurate analysis of television signals.

**"PICBOOST"**

*Electro-Steel Products, Inc.*, 641 Arch Street, Philadelphia 6, Pa. has developed and is marketing a new device that is said to restore brilliance to worn out picture tubes. Tradenamed the "Picboost," the new

**USE**

**KESTER**  
FLUX-CORE  
**SOLDER**

**FOR TV AND RADIO WORK**—Kester Plastic Rosin Core Solder and Kester "Resin-Five" Core Solder. Kester Solders are made from the finest grades of tin and lead commercially available.

**KESTER SOLDER COMPANY**  
4235 Wrightwood Ave.  
Chicago 39  
Newark, N.J. Brantford, Canada

**KESTER SOLDER**

**14 Ram Parts**

**Exact Replacement:**  
You need only 14 Ram parts to cover over 94% of TV sets now in the country—because Ram specifications are identical to those of the original parts!

Flybacks

**cover over 94% of**

**Performance-Proved:**  
Ram makes transformers, yokes, and coils for such leading TV set manufacturers as DuMont, CBS-Columbia, Olympic, Tele-Tone, Majestic, Fada, Silvertone, Starrett, Regal, DeWald, etc.—surpasses their every laboratory, production and field test!

Yokes

**TV replacement**

**Lowest-Priced:**  
for highest profits for you.

width coils  
linearity coils

**needs**

SIMPLIFY your TV parts stock with Ram's complete, universal line! Ask your distributor for Ram components—today! Write NOW for FREE latest TV Replacement & Conversion Guide, #N-11.

**Ram** ELECTRONICS SALES CO.  
50 South Buckhout St.  
Irvington-on-Hudson, N.Y.  
Irvington 9-5700

TEST-PATTERN TESTED COMPONENTS FOR TV



unit is easy to install in the television receiver and restores the brightness that has been lost because of low emission. Since approximately 80 per-cent of tube failures can be traced to low



emission, the use of this new device can save a large percentage of picture tubes, according to the company.

Full details on this unit are available from the company on request.

#### COMMERCIAL TV AMPLIFIER

Blonder-Tongue Laboratories, 38 N. Second Avenue, Mt. Vernon, New York has recently introduced a new type TV amplifier, which has been designed for commercial installations.

The new unit, called the "Commercial Antensifier," is a four-tube, four-stage TV signal amplifier which supplies excellent gain on all channels simultaneously. Operation is automatic, without tuning or adjustment. It can be used with the company's master antenna distribution system, or the systems of other companies, to overcome

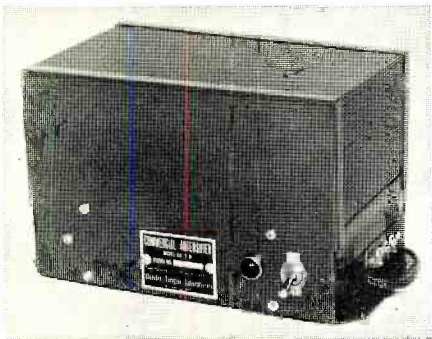

line losses at any point in the system.

The company will supply complete information on the Model #CA-1-M on request.

There's a **NEW SILHOUETTE** on the Microphone Horizon...

## THE NEW ULTRA-CARDIOID DYNAMIC

MODEL **55s**

"THE PERFECT PERFORMER"

# SMALL Unidyne



Model 55s  
List Price \$72.50

The New Small Unidyne is approximately only half as large as the Standard Unidyne.



► Eliminates Feedback Problems

► Permits performer to stand farther from the microphone

THIS MIGHTY, though little, Microphone, is the *only* small-size, uni-directional moving-coil dynamic microphone—all the important directional qualities are retained. The 55s is actually a new Microphone retaining all the highly desirable features that made the Model 55 "Unidyne" world-famous.

Model 55s offers superior performance, featured in a streamlined, small, functionally-designed case. The moving-coil system has a high overall efficiency and smooth frequency response. A large air-gap clearance and a rugged coil construction provide immunity of the moving-coil system to abnormal atmospheric conditions and severe mechanical shocks.

The New Small "Unidynes," Model 55s and 556s, are not replacements for the current Models 55 and 556 "Unidynes." The Standard "Unidynes" are not being discontinued. You now have four outstanding, feedback-killing dynamic microphones from which to choose for the most severe acoustic applications.

Model 556s  
Small  
Broadcast  
Dynamic

Model 55s  
Small  
Unidyne

"not 2  
but 4!"

Model 55s Small Unidyne  
Model 556s Small Broadcast  
Model 55 Standard Unidyne  
Model 556 Standard Broadcast

Code: RUDOT List Price: \$72.50  
Code: RUDOV List Price: 100.00  
Code: RUMUL List Price: 72.50  
Code: RUMUB List Price: 100.00

Patented by Shure Brothers, Inc.



## SHURE BROTHERS, Inc.

★ MANUFACTURERS OF MICROPHONES  
AND ACOUSTIC DEVICES

225 W. Huron St., Chicago 10, Illinois

● Cable Address: SHUREMICRO



### COLOR TONE! TELEVISION!

ON YOUR

Simply attach **TELECOLOR FILTER** to front of set and enjoy programs in glorious color tones instead of dull black and white. **GUARANTEED** to give genuine color tone. Can also be used with any other filter. Once tried, you will never go back to old black and white. Write for **FREE** information. **ORDER BY MAIL. NEW REDUCED PRICES!**

Send check, M.O., cash, COD to Dept. RN-1

10 in.....\$1	16, 17 in.....\$3
12, 14 in. \$2	19, 21 in.....\$5

**HARVARD LAB.** 659 FULTON ST. BROOKLYN, N.Y.

November, 1951

153



**EXTRA!**

**ATR**

**"A" BATTERY ELIMINATORS**

Makes it easy to **DEMONSTRATE AND TEST D.C. APPARATUS FROM A.C. LINES**

**for DEMONSTRATING AND TESTING AUTO RADIOS**

New Models . . . Designed for testing D. C. Electrical Apparatus on Regular A. C. Lines. Equipped with Full-Wave Dry Disc Type Rectifier, Assuring Noise-less, Interference-Free Operation and Extreme Long Life and Reliability.

**NEW MODELS** **NEW DESIGNS**  
**NEW LITERATURE**

"A" Battery Eliminator, DC-AC Inverters  
Auto Radio Vibrators

**ATR** See your folder or write factory

**AMERICAN TELEVISION & RADIO CO.**  
Quality Products Since 1931  
SAINT PAUL 1, MINNESOTA—U. S. A.

**Spot Radio News**  
(Continued from page 22)

jammed the desks of the ether policemen and cluttered the calendar instead of easing the process, as anticipated. Thus far, over 350 proposals have been received by the Commission, many containing bold objections to the plans suggested by Washington. The criticisms were widespread, coming from Pittsburgh, Columbus, Erie, Louisville, Cleveland, New York City, and cities in the far west and south.

The reservation of two channels for the ultra-high band in Pittsburgh was blasted, applicants saying that the hilly terrain would prevent two stations from serving the area. More very-high stations were needed, they said, to do a job. In Cleveland, representatives of broadcasters banded together and sent a request to the Commission urging the setting aside of five channels on the higher bands, instead of two proposed by the FCC. The operators declared that the three stations now operating on the very-high bands could not possibly provide an adequate service for the entire Cleveland area.

From *Columbia*, in New York, came a voluminous complaint, inferring that the allocations program would make it difficult for *CBS* to operate a network effectively, because it lacked owned-and-operated stations in key cities, and thus required channels for stations in major market areas. In their opinion, Boston, Chicago, and San Francisco should be assigned Channels 9, 13 and 11 or 13, respectively. Noting that . . . "for a considerable period, perhaps five years . . . a commercial u.h.f. station cannot compete on anything like an equal basis with a commercial v.h.f. station in the same community" . . . the *CBS* brief recommended that educational institutions operate only in the higher bands to provide more room for the commercial stations in the lower part of the spectrum.

The ultra-high bands were not too welcome either in Philadelphia, and should not be used to complement the present stations, a brief from WIP declared. Surveys conducted by the station were described as disclosing that there was an overwhelming objection to the use of converters which would provide for reception of the higher band stations. In direct contrast, *WELI*, in New Haven, sent the Commission a laudatory statement with an application for the high bands, reporting that their engineers found that not only were the u.h.f. signals interference-free (not subject to noise from auto ignition, diathermy, x-ray, etc.), but they covered a much larger area than expected and could bend around and over obstacles, which it had been assumed would be impossible on these higher bands.

**COAST-TO-COAST TV**, inaugurated by the President in the historic peace-conference telecast over a microwave

THE **BROOK**

*High Quality*

**AUDIO AMPLIFIER . . .**

**ALL TRIODES**

Distortion and intermodulation extremely low

Wide frequency range, flat from 20 to 20,000 cycles within .5 db

Attractive remote-control pre-amplifier

Compensation for various inputs; **Phono, Tuner, Television or Microphone**

Exclusive **BROOK** circuits and transformers

**YES, ALL THESE FEATURES . . . but primarily LISTENING PERFORMANCE heretofore not achieved . . .**

Write for free Technical Bulletin, detailed Distortion Analysis & booklet "Better Listening"

**BROOK ELECTRONICS, INC.** Dept. RL-1  
34 DeHART PLACE, ELIZABETH 2, NEW JERSEY

**STAY ON THE AIR**  
**WHEN POWER FAILS...with an ONAN Electric Plant**



Model 10EL, 10KW A.C.

When storms, floods, or fires interrupt electricity and force you off the air, you lose listeners and income. Guard against loss, assure vital public service during emergencies by installing an Onan Electric Plant. Onan Standby Electric plants serve many network and private stations. Automatic models to 35,000 watts.

**PORTABLE ELECTRIC PLANTS FOR MOBILE RADIO USES**  
Supply A.C. power for broadcasting at scene of events. Light in weight. Can be carried by hand or in trunk of car. A.C. models: 400 to 3,000 watts.

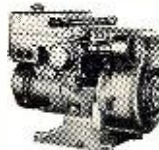

Write for **FREE Folder**

**D. W. ONAN & SONS INC.**  
4815 University Avenue  
Minneapolis 14, Minneapolis

**RADIO & TELEVISION NEWS**



and coax circuit, and hailed by everyone and described as the birth of a new era in TV, has excited everyone with its potentialities. Program departments in the networks have begun thinking about the eventual trek of stars back to Hollywood and the huge movieland-type productions that might be possible from the coast, either live or on film. The technical administrative divisions have begun pondering about the network expansions that will appear as the west-to-east link resolves itself into a daily occurrence. It will be their job to be familiar with all of the towns and cities, en route, which have been tied in to the microwave circuit, although the prime responsibility will be with the A. T. & T. engineers who installed and will operate the chain.

In a review of the system in a recent issue of the *Bell Telephone News*, it was pointed out each of the 107 stations from New York to San Francisco features four ten-foot square horn-shaped antennas, for receiving and transmitting. High-gain amplifiers at each station were noted as being used to boost signals a million-fold. One of the most unusual relay points was cited as being at Creston, Wyoming, where the relay station was located in a gully. The antennas, set to face east, were mounted on a 25-foot tower so as to just peek over a ridge of the Continental Divide, thereby minimizing the troublesome signal reflections from the valley below. A separate 75-foot structure was installed to hold the westward operating antennas high enough to provide a clear line-of-sight to the next relay point at Bitter Creek, Wyoming. In Utah, the review stated, the microwave takes the old Mormon route through Pratts Pass as it approaches the Great Salt Lake. West of Salt Lake City, the engineers adopted an unusual procedure to overcome excess interference caused by radio-wave reflections from the famed Utah salt flats. The technique was to direct the microwave beams from a high station near Salt Lake City to a ground level station 38 miles to the west in the flats. From this point, the signals can take a 20-mile jump to Cedar Mountain, which rises above the flats, then jump 32 miles to a second ground level station and finally back to high ground again in another 32-mile leap to Wendover, just across the Utah-Nevada border. Thus, the path of the beam was said to form a huge W, 122 miles wide.

The East Bay Hills relay station, just outside of Oakland, California, was selected as the point of interconnection with the existing San Francisco-Los Angeles microwave route. A short microwave jump across the bay was noted as serving to carry the signal into San Francisco.

**MOVIELAND's** interest in TV, scheduled for official probing in Washington around Thanksgiving time, has been found to be so keen that a full-house, including many members of the radio



# C-D's Tiny Mike

*takes 30,000 volts with a grin!*

The famous ceramic body made by C-D with an original engineering job inside and out! More dependable, longer lasting than any previous TV high-voltage ceramic capacitor! Can be used at *full rated voltage*, because it's *conservatively* rated for DC flash test up to 2x rated working voltage!

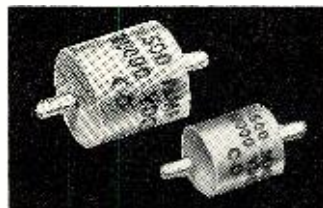

Send for Bulletin 2-614 Department RN-111  
Cornell-Dubilier Electric Corp.,  
South Plainfield, N. J.



## CONSISTENTLY DEPENDABLE CORNELL-DUBILIER CAPACITORS

Plants in South Plainfield, N. J.; New Bedford, Worcester, and Cambridge, Mass.; Providence, R. I.; Indianapolis, Ind.; Fuquay Springs, N. C.; and subsidiary, The Radiart Corp., Cleveland, Ohio

**RADIO COURSES**

- RADIO OPERATING • CODE
- RADIO SERVICING • ELECTRONICS
- F.M. TELEVISION
- PREPARATION FOR CIVILIAN N. MARITIME. ARMY AND NAVY LICENSE REQUIREMENTS.

Write for Catalog T.S.

**YMCA**  
**TRADE & TECH. SCHOOL** 15 W. 63 St., N. Y. 23  
ENR 2-8117

**ON-THE BATTERY RECORDER**

**WALKIE-RECORDALL** 8 lb. miniature BATTERY RECORDER-PLAYBACK

Continuous, permanent, accurate, indexed recording at only 5c per hr. Instantaneous, permanent playback. Picks up sound up to 60 ft. Records conferences, lectures, dictation, 2-way phone & sales talks: while walking, riding or flying. Records in closed briefcase with "hidden mike"! Write for Detailed Literature.

**MILES REPRODUCER CO., INC.**  
312 BROADWAY Dep 1RN-12, NEW YORK 3, N. Y.

**MARK THESE VALUES!** TOP STANDARD BRANDS ONLY—100% GUARANTEED

RCA—GE—SYLVANIA—HYTRON—PHILCO—KENRAD—NU  
RAYTHEON—TUNGSO—WESTINGHOUSE—WESTERN ELECTRIC

6SN7 . . . . .79c	5U4 . . . . .59c	6AL5 . . . . .59c	12AU7 . . . . .89c
0Z4 . . . . .64	6AB4 . . . . .98	6BE6 . . . . .88	35Z5 . . . . .59
1B3 . . . . .96	6AC7 . . . . .119	12BH7 . . . . .1.07	50A5 . . . . .99
1L4 . . . . .89	6AG5 . . . . .1.09	12SA7 . . . . .79	50L6 . . . . .69
1R5 . . . . .79	6AH6 . . . . .1.69	12SK7 . . . . .69	95A . . . . .28
1S5 . . . . .89	6AK5 . . . . .1.55	6BQ6 . . . . .1.59	6J5 . . . . .1.24
1X2A . . . . .96	6AU6 . . . . .65	6BQ6 . . . . .1.29	6K6 . . . . .59
5V4G . . . . .1.09	6BA6 . . . . .69	6CB6 . . . . .79	6N7 . . . . .98
5Y3 . . . . .49	6BC5 . . . . .79	6C86 . . . . .79	6N7 . . . . .98

1000 Kc. CRYSTALS—Laboratory Precision 1.35  
Cut. New. Uncased. . . . . Each  
WRITE FOR YOUR FREE BARGAIN LIST NOW!

**MARK electronics** 335 E. Tremont  
New York 57, N. Y.





## Special Offer On This Complete RADIO ENGINEERING LIBRARY

*New, Up-To-Date Edition of Famous Library Covers Whole Field of Radio Engineering. Places Latest Facts, Standards, Data, Practice, and Theory At Your Fingertips.*

THE five big volumes of the new edition of the Radio Engineering Library now include the very latest facts, standards, data, and practice. This Library will help solve hundreds of problems for designers, researchers, engineers, and students in any field based on radio.

Written by leading radio engineers, these books cover circuit phenomena, networks, tube theory, vacuum tubes, amplification, measurements, etc.—give specialized treatment of all fields of practical design and application. They provide you with a complete and dependable encyclopedia of facts.

5 Volumes • 3872 Pages • 2770 Illustrations

- Eastman's FUNDAMENTALS OF VACUUM TUBES, 3rd Edition.
- Terman's RADIO ENGINEERING, 3rd Edition.
- Everitt's COMMUNICATION ENGINEERING, 2nd Edition.
- Hund's HIGH FREQUENCY MEASUREMENTS, 2nd Edition.
- Henney's RADIO ENGINEERING HANDBOOK, 4th Edition.

**SEND NO MONEY**  
Special Low Price • Easy Terms

On this special offer you get this Library for \$34.50, instead of \$39.00. You save \$4.50 and may pay on easy terms. Mail coupon below to examine the Library FREE for 10 days. No obligation. These books are recognized as standard works; you are bound to need them. So take advantage of this special money saving offer. *Mail coupon at once!* McGraw-Hill Book Co., Dept. RTN-11-51, 327 W. 41st Street, New York City.

**McGraw-Hill Book Co., Dept. RTN-11-51**  
327 West 41st St., New York 18, N. Y.

Send for 10 days' FREE trial, the RADIO ENGINEERING LIBRARY. If not satisfied I will return books. Otherwise I will send \$4.50, plus delivery charges, then; and \$5 a month for 6 months. (Reg. price \$39.00; you save \$4.50).

Name.....

Home Address..... RTN-11-51

City & State.....

**WE'LL PAY DELIVERY CHARGES** if you enclose \$4.50 first payment WITH coupon. Same return privilege for full refund.

and TV industry, is expected to be on hand.

There'll be, at the hearings, over a score of representatives of film organizations, including Consulting Engineers Frank McIntosh and Andrew Inglis (Motion Picture Association of America), and C. M. Jansky and Stuart L. Bailey (Theater Owners of America). The motion-picture interests, which include *Twentieth Century-Fox*, *Paramount*, *Warner Brothers*, and *Fabian Theatres*, will seek six channels, each 10 megacycles wide in the microwave region, below 10,000 mc., to permit transmission of six different theater-TV programs simultaneously to each area.

The use of frequencies now set aside for industrial radio services for theater TV, instead of special frequencies, has been suggested to the Commission. A petition filed by *Twentieth Century-Fox* stated that perhaps the 6425-6575 and the 6575-6875 bands could be used for fixed and mobile-theater TV. Currently, these bands are assigned to the Motion Picture Radio Service on a shared and developmental basis, and employed for *location* communications. It was felt that these frequencies, assigned on a shared basis, would "... effect an ... economy in frequency allocation ... eliminate the problem of using frequencies already allocated to other services ... and would in no way prejudice the other services operating or proposing to operate in the frequency bands specified."

**CAPTIVE AUDIENCES**, available in buses through a tie-in with FM stations, has become the subject of a raging debate in the legal corridors of Washington.

According to a brief filed by anti-transitcasting counsel, forced listening can be dangerous and serve to influence public opinion. In their opinion "... unless the listener ... is completely free to select what he wishes to hear ... in a freely competitive field, the American system of broadcasting is deprived of its vigor and becomes a sinister, formless thing."

The attorneys also advanced the beliefs that freedom of communication by writing or speech, as well as freedom of reflection, can be impaired by transit radio. They felt that the decision "... affirming the inviolable right of the public to select its broadcast programs ..." should be made by the Supreme Court. In the absence of such a ruling, it was said "... it seems likely that transit radio will continue ... and even expand ... operating as a correlated system of broadcasting to captive audiences.

**THE QUALITY OF PROGRAMS**, particularly over TV, described by many Congressmen to be diving lower and lower, may eventually bring about the establishment of a National Citizens Advisory Board, as suggested by Senator William Benton, to "... make a continuing study of programming trends." The move has won the gen-

## CUT HOLES 1/2" to 3 1/2" IN RADIO CHASSIS



WITH A GREENLEE RADIO CHASSIS PUNCH

• Save hours of work ... no reaming or tedious filing. Punch cuts through chassis quickly ... makes accurate, clean holes for sockets, plugs, and other receptacles. Just turn with an ordinary wrench. There's a GREENLEE Punch in each of these sizes: 1/2"; 5/8"; 3/4"; 7/8"; 1"; 1 1/16"; 1 1/8"; 1 1/4"; 1 1/2"; 1 3/4"; 2 1/4". Write for complete facts. Also get information on Knockout Punches and Cutters for conduit and meter holes up to 3 1/2". Greenlee Tool Co. 1891 Columbia Avenue, Rockford, Illinois.

TOOLS FOR CRAFTSMEN

**GREENLEE**



DID YOU GET IT? IF NOT  
**SEND NOW FOR B.A.'s**  
**136 BIG PAGE**  
**FREE CATALOG**

**RADIO TELEVISION ELECTRONICS**  
1952

**B.A.**

INCLUDING 21 PAGES OF DOLLAR-SAVING BARGAINS!

BURSTEIN-APPLEBEE CO.  
1012-14 McGee St.  
Kansas City 6, Mo.

Send your 1952 catalog to:

Name.....  
Address.....  
City.....State.....

**BURSTEIN-APPLEBEE CO.**

**RADIO & TELEVISION NEWS**



eral support of FCC Chairman Coy, who pointed out that he was in favor of a committee, which would "... assess the contributions of radio and TV to the American public and encourage the formation of listener councils."

According to University of California Prexy Dr. Robert G. Sproul, it is doubtful "... that the quality of television or radio programs over commercially-controlled stations can be changed for the better or maintained at any given level by legislation defining more precisely the meaning of public interest, convenience, or necessity." He felt that educational stations offering competition would offer a practical solution and prompt the immediate change for the better in listening and looking. . . . L.W.

### Within the Industry

(Continued from page 30)

the firm . . . **MYER FRIED**, retired U. S. Army colonel with more than 20 years' experience in military and aviation electronics, has been engaged by the *RCA Service Company* as special adviser to the Government Service Division . . . **ROBERT T. BORTH** has been appointed to the newly-created position of manager of employee relations for the *General Electric Company's* Tube Departments . . . *Jerrold Electronics Corporation* has made two new executive appointments. **HENRY J. ARBEITER** has been elevated to the post of vice-president and **DANIEL J. MC CARTHY** has been named assistant secretary-treasurer . . . **DR. CHARLES B. JOLLIFFE** has been elected to the newly-created position of vice-president and technical director of the *Radio Corporation of America*. **DR. E. W. ENGSTROM** was named vice-president in charge of the *RCA Laboratories* Division at the same meeting of the board of directors . . . **FRANK A. D. ANDREA, JR.**, has joined the engineering staff of the *Andrea Radio Corporation* . . . **JAMES GREER** has been appointed sales training manager of *Motorola Inc.* He will direct all sales training activities for the company's distributor salesmen and for retailers . . . The *E. F. Johnson Company* has named **ALBERT M. PICHITINO**, W3NJE/WØ, to the post of chief engineer. He was formerly associated with the Franklin Institute.

**ELECTRONIC DEVICES, INC.**, has purchased **PRECISION RECTIFIER CORPORATION** which will be operated as a division of the parent company. The new division is in production at the main plant of the company at 429 12th Street, Brooklyn 15, New York . . . **WATERS MANUFACTURING, INC.**, has been formed in Waltham, Mass. The firm has negotiated a license agreement with **TECHNOLOGY INSTRUMENT CORPORATION** of Acton, Mass., under which it is manufacturing a line of miniature, precision wirewound trimmer potentiometers.

## OFFICIAL MILITARY 35mm SLIDES



RUSSIAN T-34 TANK

AVAILABLE NOW AT SENSATIONAL LOW COST!

Authentic Army Air Force recognition 35 mm. slides of military equipment of all nations. Gov't. surplus, brand new B. & W. slides, each heavy 4-ply mounted, numbered, and fully identified. Terrific bargain at only 6c each, available in sets of 50 slides in any of three classifications: 1. NAVAL SHIPS, 2. MERCHANT SHIPS, 3. ARMORED VEHICLES. When ordering, please specify which classification is desired. Set of 50 SLIDES, any classification—postpaid **\$3.00**

AERIAL WIRE	WIRE—HEAVY DUTY RUBBER COVERED
Aerial Wire—Phosphorous Bronze #16 Stranded, 200 lb. test, Weather-proof, 150 feet on Reel. RL-3 with Clips <b>\$1.50</b>	2/ #16—20 Ft. Length <b>\$1.25</b> 2/ #12—10 Ft. Length <b>1.00</b> 1/ #6—Shielded, 15 Ft. <b>1.50</b> 1/ #6—Shielded, 7 1/2 Ft. <b>.75</b> 1/ #2—Shielded, 8 Ft. <b>1.00</b> 1/ #8—Cotton covered—Per Foot <b>.06</b> 500 Ft. #20 Cotton covered stranded and tinned, in 9 1/2 Ft. lengths. <b>\$3.95</b> 500 Ft. (Ass't. colors) <b>\$3.95</b>

### BC-223 TRANSMITTER

30 Watt Transmitter with Crystal or MO control on four pre-selected channels. CW, MCW cover frequency range 2000-5200 KC by use of plug-in coils. Complete with tubes and choice of one Tuning Unit (listed below). Less Mtg. Prices: NEW: **\$32.50** **\$26.50** USED (Gov't Reconditioned)

CABLE—Trans. to Power Supply **\$2.00**  
TUNING UNITS: TU-17—2000-3000 KC. TU-18—3000-4500 KC.; TU-25—3500-5250 KC. **\$3.50 EACH**  
SPARE TUBE KIT in metal box, f/BC-223. **\$5.95**  
PE-125 POWER SUPPLY f/BC-223—12/24 Volt input; output 500 Volt 150 MA. **NEW: \$14.95**  
SPARE VIBRATOR & TUBE KIT f/PE-125. **\$5.95**  
SHOCK MOUNTING for PE-125. **\$1.50**  
FT-173 MOUNTING for BC-223. **\$2.50**  
BC-223 TRANSMITTER—Incomlere, for parts. No front panel or meters. Price—As is **\$4.95**

### 3/4 RPM ANTENNA ROTATOR MOTOR

High torque, reversible motor—operates directly from 110 Volt 60 cycle by use of condenser. Light weight, quiet running, ruggedly built, positive stop, easily mounted. Normally operates from 110 Volt 400 cycle. Complete—with instructions. NEW **\$4.95**

10 MFD 400 Volt Cond., **\$1.00**. SPDT Switch: **35c**



### GUY CABLE

Regular Aircraft Control Cable, 3/32" x 7x7—49 Strands galvanized weatherproof, 920 lb. Test. Ideal for television or radio mast ruying. Non preformed. Prices: **2 3/4c per Ft.—1000 Ft. or more: 2 1/2c per Ft.**

### TRANSFORMERS AND CHOKES:

TRANSFORMERS	Sec.	Volts	Amp.	Price
110 VOLT 60 CYCLE PRIMARIES	Sec. 6.3 V.	1 Amp.	<b>\$1.25</b>	
	Sec. 24 V.	1/2 Amp.	<b>1.50</b>	
	Sec. 24 V.	1 Amp.	<b>1.95</b>	
CHOKES				
H-115	8 Henries	500 MA Filter,	5000 V. Ins. <b>\$10.95</b>	
H-121	13 Hy.	250 MA Filter,	1500 V. Ins. <b>4.95</b>	
H-412	4-12 Hy.	Swinging, 300MA,	2500V. Ins. <b>4.95</b>	

### WHIP ANTENNA EQUIPMENT

#### MAST BASE—INSULATED

**MP-132 BASE**—as illustrated at left. 1" heavy coil spring, 2" insulator. Overall length: 11 1/2". Weight: 2 3/4 lbs. Price **\$3.95**

**MAST SECTIONS FOR ABOVE BASE**—Tubular steel, copper coated, painted, in 3 foot sections, screw-in type. MS-53 can be used to make any length, with MS-52-51-50-49 for taper. Price for any section, **50c Ea.**

**WHIP ANTENNA**—9 1/2 Ft. rigid mount. Uses three screw-in sections: MS-49-50-51 and rigid mount w/ antenna connection. **\$2.25**

Address Dept. RN • Minimum Order \$2.00  
Prices F.O.B., Lima • 25% Deposit on C.O.D. Orders

## METERS:

0-150 Volt, 400 cycle, 2 1/2" Rd.	<b>\$3.95</b>
0-5 Amp. AC, 3" Rd., 0-75A Scale	<b>3.95</b>
0-5 Milliamp DC, 2 1/2" Sq., 0-5 Scale	<b>3.95</b>
0-1 Milliamp DC, 2 1/2" Rd., 0-150 Scale	<b>3.95</b>
0-500 Microamp, 2 1/2" Rd., 0-15 & 0-600 DC Volt Scale	<b>3.95</b>
TUNING METER 1-70B Reverse Scale, Weston #606 for Compass Control Boxes.	<b>3.95</b>

## BLOWERS:

115 Volt 60 cycle BLOWER (pictured), approx. 100 CFM Dis. 2 1/4" intake; 2" outlet. Quiet running. Motor size: 2 1/2" x 3 1/4". NEW—not Gov't surplus. Order No. RN-520. **\$7.99**

**DUAL BLOWER**—Same as RN-520 above, except has blower assembly on each side of motor. Order No. RN-800. **\$12.95**



## 6-VOLT POWER SUPPLY

**VIBRATOR TYPE**—6 Volt DC input; output 230 Volt DC 50 MA. filtered w/tube. Size: 6 1/2" x 4 1/2" Price **\$6.95**

**VIBRATOR TYPE**—6 Volt DC input; output 230 Volt DC 50 MA.—not filtered—w/tube. Ideal for Command Receiver operation as receiver is filtered internally. Size: 4 1/2" x 4 1/2" x 3 1/2" **\$4.95**

## DYNAMOTORS:

INPUT:	OUTPUT:	STOCK NO.	PRICE:
12 V. DC	220 V. 70 MA.	DM-24	<b>\$6.95</b>
12 V. DC	220 V. 100 MA.	DM-18	<b>4.95</b>
12 or 24 V. DC	440 V. 200 MA. & 220 V. 100 MA.	D-104	<b>9.95</b>
14 V. DC	500 V. 500 MA.	PE-50	<b>14.95</b>
12 or 24 V. DC	275 V. 110 MA.	USA/0516	<b>3.95</b>

Tell Us Your Dynamotor, Inverter, & Motor Needs!

## What'll You Have?

BC-230 Transmitter, with Tubes	<b>\$ 4.95</b>
R-1/ARR-1 Receiver f/conversion to 220 MC.	<b>4.95</b>
AN-104A Antenna—100-156 MC.	<b>2.00</b>
AN-117 Whip Steel, 6 Ft.	<b>1.50</b>
AN-109A Whip Steel, 5 Ft. w/Base	<b>1.50</b>
AT-37A/APT Stub—113-150 MC.	<b>5.95</b>
AS-27/ARN-5 Rain's Horn, 110 MC. USED:	<b>5.95</b>
FL-8 Filter, 1020 cycle Audio Filter. USED:	<b>1.50</b>
Leg & Seat Assembly for Hand Generators	<b>3.50</b>
CD-501 Cord for GN-45 Generator.	<b>2.00</b>
C-87/ART-13 Control Box f/ART-13 Trans. NEW: <b>\$6.95</b> USED: <b>4.95</b>	
CD-318 Cord f/Throat or Lip Mikes	<b>.59</b>
CD-307 Cords 65" w/PL-55 & JK-26	<b>.99</b>
CD-604 Cord w/C-410 Trans. & PL-54 Plug.	<b>.89</b>
Head & Chest Set w/Plug for EE-8	<b>2.95</b>
Microphone & Headset, Dynamic type f/MARK II. NEW: <b>\$2.95</b> USED: <b>1.95</b>	
TUNING UNITS for BC-375-191: TU-5, 7, 8, 9, 10, or 26. Each:	<b>3.95</b>
TA-12B Transmitter w/Tubes. USED:	<b>29.50</b>
RA-10 CA or DA Receiver w/Tubes. USED:	<b>17.95</b>
RC-605 Amplifier. NEW: <b>\$ 5.95</b> USED: <b>3.95</b>	
BC-347 Amplifier w/Tube. NEW: <b>2.95</b> USED: <b>1.95</b>	
BC-709 Amplifier. NEW: <b>4.95</b> USED: <b>3.95</b>	
BC-434 Control Box. NEW: <b>8.95</b> USED: <b>5.95</b>	
BC-732 Localizer Control Box. NEW: <b>\$2.95</b> USED: <b>1.95</b>	
MC-211 Right Angle Adapter f/MC-215	<b>.50</b>
MC-215 Tuning Shaft for 274 N—96"	<b>2.00</b>
MC-124 Tuning Shaft f/Radio Compass—12 ft.	<b>3.95</b>
FA-10 Fairlead	<b>1.00</b>
BC-455 Comm. Receiver, 6-9.1 MC. USED:	<b>7.95</b>
BC-457 Comm. Transmitter, 4-5.3 MC. USED:	<b>5.95</b>
BC-458 Comm. Transmitter, 5.3-7 MC. USED:	<b>5.95</b>

# FAIR RADIO SALES

132 SOUTH MAIN ST.  
LIMA, OHIO

Say You Saw It In RADIO & TELEVISION NEWS



# BE A HAM!

NOW!— F.C.C.'s new, NOVICE Class regulations make it *much* easier to become a Radio Amateur!

Come on, join in the fun! You can start with as inexpensive a transmitter as the—

## EAGLE PICT-O-GRAPH TRANSMITTER KIT

Foolproof! 6F6 tri-tet oscillator — 6L6 final (doubles for two band operation with one crystal), 30 Watts input on 20, 40, 80, and 160 meter bands. Built in resonance indicator. Pi-network matches random length antennas. Complete kit — all parts, punched metal chassis (no holes to drill!), hardware, and detailed, easy to follow photograph instruction. Model X-30



**\$895**

Plug-in coils (specify band) \$ .99  
Crystal (80 or 40 meter) 2.75  
Professional telegraph key 1.17  
Tubes: 6F6G — \$ .99 6L6G — \$1.88

115V AC POWER SUPPLY, Complete kit with tube PS-30 **\$9.75**

## SW-54 RECEIVER

The World-famous National Co.'s MIGHTY MIDGET! The compact, modern super-heterodyne receiver that is ideal for Ham and SWL! Outstanding features: Tunes everything 540 Kc to 30 Mc — Smooth, vernier bandspread — Five tubes, incl. rectifier — 115V AC-DC — Built-in speaker — Attractive velvet-grey metal cabinet — Headphone switch — etc. **Unsurpassed Value!**



**\$4995**

**"Worked 53 countries — over 1,000 QSO's in less than five weeks . . ."**

thus writes Gerard De Buren, FP8AW, about the results he obtained with his LySCO Model 600 Transmitter! Complete hand-switching all Ham bands 10 thru 160. Stable, direct calibrated VFO. Also crystal controlled (meets Novice regs). 6AG7 temperature compensated oscillator — 6AG7 buffer — 807 final conservatively rated at 35 watts — 5U4G rectifier. Attractive black crackle cabinet only 15" x 9" x 8" deep. FB for portable rig, too! Complete transmitter, with tubes, and operating instructions. **\$131.95**

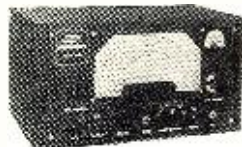

MODEL 600 — Same terrific transmitter as above, but with special filter and features for TVI suppression. **\$143.95**

FOR PHONE OPERATION — Connect any 15-20 watt speech amplifier thru a matching transformer. Or use the LYSCO special Model 401 Clamp Modulator designed for the 500 and 600 Transmitters. Complete with tubes **\$19.95**

### —FLYING CAP?—

For added efficiency and safety use a LySCO CAP phone transmitter in your plane! Up to 25 Watts output, 4" x 4 1/2" x 6" deep — weighs only 5 lbs! 2374 Kc. Uses 300 to 500 Volts at 80 to 125 MA. Completely wired, with tubes **\$33.55**

(With 12 Volt tubes — \$34.30)  
Also available for 10-11, 20, or 75 meter Amateur Bands **\$33.55**

Want to know more about parts and equipment for home and mobile stations — Civil Defense — CAP — Ham Clubs — etc. etc. — **?**

Just mail a postcard, now, for your FREE copy of the Special NOVICE ISSUE of the

HARRISON HAM-A-LUG

**HARRISON**  
NEW YORK 7, N.Y.  
225 GREENWICH STREET  
(10 West Broadway, at Barclay St.)  
BARclay 7-7777

158

## Audio Simplified (Continued from page 62)

motion obviously produces no voltage in the coil. The results obtained with the dynamic pickup are approximately the same as can be obtained with the various forms of variable-reluctance pickups.

The output voltage of a magnetic pickup is proportional to the lateral velocity of the stylus in its deflection by the groove modulation. The basic recording frequency response characteristic is constant amplitude at low frequencies and pre-emphasized above constant velocity at the high frequencies, therefore the pickup output must be equalized to give the correct output frequency response. Since the output voltage is low (approximately 0.01 volt rms at 1000 cps for a standard 78 rpm record) an additional preamplifier with about 40 db gain is required to raise the signal level to compare with the average crystal pickup. Generally this preamplifier includes the equalization so that its output can just be plugged into a flat-frequency-response amplifier.

All the various types of pickups may be used for both LP and standard 78 rpm record reproduction. The differences in pickups for these two types of recording are in the size of the stylus, the fact that LP grooves have half the modulation, and slight differences in the frequency equalization characteristic.

The important characteristics of the various types of phonograph pickups — those which have been described so far, plus a number of different types of pickups which are not as widely used but which also have features which are of merit — are summarized in Table 2 for convenient reference.

### AM and FM Radio Tuners

Radio tuners receive the signal which is broadcast from a radio station and deliver an audio-frequency voltage proportional to the sound being picked up in the studio. The output level from a tuner is generally of the order of 2 volts or more into a high impedance circuit, while some tuners also have a low impedance output of the order of 0 dbm into 600 ohms. The best AM receivers are capable of giving good frequency response to about 10,000 cps, while FM receivers give

Dual-needle variable reluctance pickup for use with standard 78 rpm and LP records.



**Fringe Areas!**

Brach Air General gives more gain than a stacked yagi, on every TV channel!

Tested . . . best performance. Strongest construction. Air General, Brach TA-450 is the only antenna tested to give you highest gain . . . withstand high winds and ice loading. Has non-hygroscopic high-impact insulators; rugged triangular construction; quick rig assembly . . . and other exclusive features. Highest DB gain . . . 9DB on Channels 2-6; 12DB on Channels 7-13. Order today!

**FREE** Send for new booklet, "How to get the most out of fringe area installations" by Ira Kamen, leading TV antenna authority.

**Brach** MANUFACTURING CORP.  
200 Central Ave., Newark 4, N. J.

**SELLS ON DEMONSTRATION**  
**DUKANE**  
**MAGNETIC TAPE RECORDER**

**THE FINEST IN HIGH FIDELITY RECORDING**

*at LOW COST!*

**DEALERSHIPS AVAILABLE NOW!**  
**MAIL COUPON FOR INFORMATION TODAY!**

DUKANE CORP. Dept. RTN -111, St. Charles, Ill.

- Please send information on the Dukane Magnetic Tape Recorder.  
 I am interested in a dealership.

Name \_\_\_\_\_  
Address \_\_\_\_\_  
City \_\_\_\_\_ State \_\_\_\_\_

ESTABLISHED AS "OPERADIO" 1922

**RADIO & TELEVISION NEWS**



response to 15,000 cps with better signal-to-noise ratio and dynamic range than can be obtained from AM broadcasting. Any further or more detailed discussion of radio transmission and reception would be quite out of place in an audio article.

### Preamps for Low-Level Signals

The output impedances and signal level obtainable from the various types of pickup devices and transducers used in the reproduction of sound are listed in reference form in Tables 1 and 2. Consideration of the information contained in these tables shows the types of preamplifiers which should be used with the various units.

There are certain characteristics which all types of preamplifiers for any type of input device must have. The main requirement is, of course, extremely low noise level. Since the signal from the transducer is the lowest level in the entire reproducing channel, any noise which is picked up in this portion of the circuit will have the most serious effect upon the quality of reproduction, and will be most audible in the reproduced sound.

Noise problems almost always originate in the first stages of the preamplifier, where the signal level is lowest. The most serious types of noise problems are hum pickup, thermal noise in resistors, and vacuum tube noise. These can be kept to a minimum by the use of various techniques of design and construction. (These techniques will be described in greater detail in the next article of this series, which will discuss preamplifiers and voltage amplifiers for low level signals.) However, even with the use of the best noise-reducing techniques there are limits to the extent to which the noise in any amplifier can be reduced. Noise considerations impose very important practical limitations on how low a level of signal can still be useful, and on signal-to-noise ratios at low levels. Transducers whose output level is too low cannot be used because too much noise will be introduced in the input stages of the preamplifier. Low level signals from microphones and pickups should be amplified before mixing or attenuation, otherwise the signal level would be too low for satisfactory signal-to-noise ratio.

Another important consideration in the design of preamplifiers is that they must not overload at high signal levels. Since preamplifiers are designed for low-level inputs, they can overload if the input signal is too great. Therefore a high-level and a low-level signal can be amplified by the same preamplifier only if the high-level signal is attenuated so that they are both at the same level.

This article has described the various types of transducers which are used for the reproduction of sound. The output signal of these transducers imposes a number of limitations upon the preamplifiers which must be used to amplify their signals.

*(To be continued)*

November, 1951

*Newcomb*

The sound line  
that quality built...

KX-25

*Write for literature*

NEWCOMB AUDIO PRODUCTS COMPANY  
DEPT. F 6824 LEXINGTON AVE.  
HOLLYWOOD 38, CALIFORNIA

## BMC TRANSCRIPTION PLAYER



16" Synchronous  
Model TP16E \$126.00  
Model TP16D \$84.00  
Model TP12H \$58.50  
(F.O.B. Port Chester, N. Y.)

Export: Rocke International Corporation.  
13 East 40th Street New York 16, N. Y.

### FOR HIGH FIDELITY RECORD REPRODUCTION

Meets the rigid demands of Army-Navy requirements, even Navy salt-spray test. Used by U.S. Signal Corps all around the world. Standard equipment in Veterans' Hospitals, and most radio stations, transcription services, etc., for realistic reproduction of transcription records up to 16 inches, 78 and 33 1/4 r.p.m.

Descriptive Bulletin HS3-1, upon request.  
Available Through Authorized Jobbers.

**RADIO-MUSIC CORPORATION**  
PORT CHESTER • NEW YORK



It's  
Tung-Sol  
for radio  
and tv

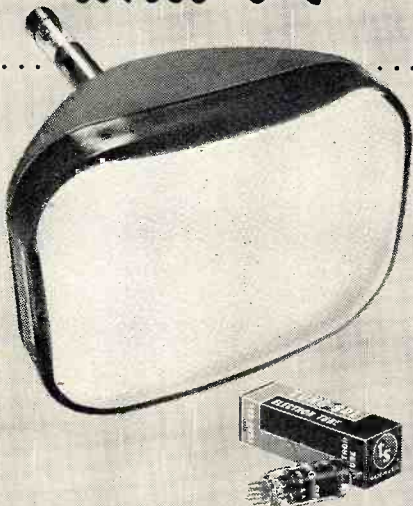

**Quality**

-that keeps pace with the growth of the electronic industry

**Quality**

-that meets fully the performance requirements of all radio and tv set manufacturers

**Quality**

-that safeguards dealer service work

**TUNG-SOL**  
RADIO, TV TUBES, DIAL LAMPS

TUNG-SOL ELECTRIC INC., Newark 4, N. J.  
Sales Offices: Atlanta - Chicago - Dallas - Denver  
Detroit - Los Angeles - Newark

# RADIO-TV Service Industry News

AS REPORTED BY THE

## TELEVISION TECHNICIANS LECTURE BUREAU

**R**ECENT developments in Philadelphia may prove to be the first rosy hues of a new day in replacement parts industry cooperation with relation to independent service business problems.

It all started over a couple of bills intended to set up a system of licensing radio-electronic service businesses and technicians that were thrown in the legislative hopper for consideration by the Pennsylvania State Legislature. The industry generally paid little attention to these bills until the news started to get around that an effort was to be made to present them for a vote without public hearings. Then it developed that all of the organized groups of service businessmen and technicians in the State of Pennsylvania had approved these bills in principle. These were the Federation of Radio Service Associations of Pennsylvania (FRSAP), the Television Contractors Association of Philadelphia (TCA), and the Philadelphia Radio Servicemens Association (PRsMA).

Although subsequent meetings revealed the fact that many of the members of the Associations involved were not familiar with the provisions of the bills and that proponents of approval included many men who had for years bitterly fought any suggestions for the licensing of servicing activities, the very fact that the men who would be most affected by the licensing measures had demonstrated a willingness to accept the shackles of political direction and control of their activities badly jarred other elements of both the set and the replacement parts industries.

It brought several subtle develop-

ments into sharp focus. Legitimate service businesses had been badly hurt by the stream of unfavorable publicity that had stemmed from circumstances over which they had no control.

Sensation writers who live on the "View with Alarm" technique were finding a lush market for articles attacking the TV service business with editors who were either too indolent or incompetent to check the facts on which most of this material is predicated. *Sylvania's* prompt action in canceling its advertising in one of the picture magazines after the appearance of an article which castigated the entire service industry as a "gyp" activity, served to spotlight the irresponsible drivel that has made the independent service businessman's road hard to travel.

The effect of this unfortunate and unfounded publicity has been to make a large segment of the TV-owning public skeptical and fearful of service. This has caused a curtailment of the TV maintenance market, that is, service calls on minor circuit faults that if made in time would allay major service jobs. And where TV set maintenance is neglected the receivers need major service when the technician finally is called in. This means, of course, a larger bill for the service necessary to put the receiver back into top operating condition. The customer who is handed a big bill for the required service work feels that the magazines are right in labeling the radio-TV service businesses as gyp operations.

### Poor Customer Relations

One continuing weakness of the in-

**\$52,000.00  
AVAILABLE**

**TO BUY NEEDED SURPLUS  
ELECTRONIC EQUIPMENT**

Top Dollar Paid! Send description, condition and asking price. Prompt replies!

**URGENT! NEEDED AT ONCE: BC-611  
Handie-Talkies, ARC-1, ART-13, I-152C,  
BC-788C, BC-348. Complete units or  
parts.**

**WEST REGION ELECTRONICS**  
1437 S. Norton Ave., Los Angeles 19, Calif.

**LEARN DAY EVENING CLASSES  
TELEVISION**

**ELECTRONICS-RADIO**  
Modern Laboratory  
Instruction in

- SERVICING
- BROADCAST OPERATING
- ELECTRONIC and TV ENGINEERING

**G.I. APPROVED**

**WRITE FOR CATALOG**

**ELECTRONICS INSTITUTE, Inc.**  
21 HENRY, DETROIT 1, MICH.



how to  
choose a  
high  
fidelity  
loudspeaker



**Jensen**  
WIDE RANGE



G-610  
TRIAXIAL  
3-WAY

SINGLE-UNIT  
DIRECT RADIATOR  
TYPES (5"-15")

"Genuine Jensen Wide Range" means much more than wide frequency range—it means superior performance all the way—in every attribute that makes for enhanced listening pleasure: 1. Wide Frequency Range . . . 2. Balanced Frequency Response . . . 3. Smooth Response . . . 4. Wide Angle Distribution . . . 5. Low distortion . . . 6. Good Efficiency . . . 7. Adequate Power-Handling Capacity.

Whatever the cost or size, a choice from the Genuine Jensen Wide Range series insures a maximum of performance to today's new high fidelity standards.

Write for free booklet—"Let Music Come to Life"—it includes a listing of Genuine Jensen Wide Range loudspeakers.

**Jensen**

MANUFACTURING COMPANY  
Division of the Muter Company  
Export Department at the Factory  
6601 S. Laramie • Chicago 38, Illinois

BURTON BROWNE ADVERTISING

dependent servicing industry is in its "face-to-face" customer relations. The service contractor or dealer who has trained every person on his staff on how to use the doctors' "bedside manner" technique is seldom affected by this bad publicity. But the majority of the independent service contractors and dealers still use the "so what" approach in handling service customers which is irritating with or without a bad publicity background.

Another factor that was strictly a local, transient situation in the Philadelphia area was the large number of temporarily unemployed electronic factory workers who turned to radio and television servicing for some income while the TV-set buying freeze kept the assembly lines closed. Since this occurred during the normally dull season for radio and television service it was competition that hurt the legitimate service businesses.

#### The Philadelphia Plan

These several factors brought about a crystallization of industry interest in the problems of the business of independent radio-TV servicing. Practically every trade association in the industry was represented at an informal meeting called by the Keystone Chapter of NEDA to discuss all facets of the situation. These included RTMA, the Representatives, TCA of Philadelphia, TCA of Detroit, Mich., NARDA, the Electrical Association of Philadelphia, and national as well as Keystone chapter officers of NEDA.

The prime movers in bringing the meeting about were Albert Steinberg, president of the Keystone chapter of NEDA, and Albert Haas, president of TCA of Philadelphia. They both felt that out of such gatherings could come a common understanding of industry problems as they exist in Philadelphia and in Pennsylvania and also provide an approach to their solution.

Officers of the Federation of Radio Servicemen's Associations of Pennsylvania and the Philadelphia Radio Servicemen's Association were officially invited to attend a subsequent meeting. This latter meeting resulted in the formation of the Joint Electronics & Radio Committee on Service in Philadelphia, with local representation from all segments of the industry.

The objectives that it was hoped this newly formed intra-industry group would accomplish were stated as:

1. Develop a consumer education program which will tell the set buyer and user just what can be reasonably expected from his television receiver.
2. Create a means whereby the consumer can recognize the responsible, ethically operating service technician, servicing dealer, and service contractor.
3. Develop an understanding of warranty problems locally and, when possible, throughout the industry. This will tend to bring about an abatement of practices which have been found objectionable by the service industry.
4. Inspire an understanding among

**NEW**

**IMPORTANT BOOK FOR**

- SOUND TECHNICIANS
- AUDIO ENGINEERS
- CUSTOM BUILDERS

**VOLUME 3!**

**HOWARD W. SAMS'**

**"AUDIO AMPLIFIERS"**

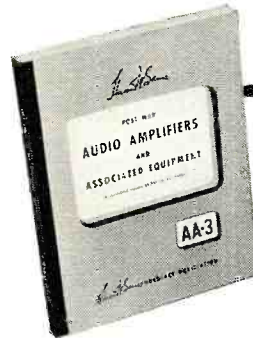

Full Analysis of  
50 Important  
Audio Amplifiers  
and 22 Popular  
FM & AM Tuners  
Based on Actual  
Study of the  
Equipment

#### Covers Latest Audio Equipment

Latest volume in the SAMS' "AUDIO AMPLIFIERS" Library. Provides detailed, clear, uniform analysis of 50 important audio amplifiers, and full coverage of 22 FM and AM tuners, produced during 1950. Each unit is thoroughly analyzed in from 4 to 10 pages; includes circuit diagrams, design data, parts information, full technical coverage described in uniform detail and profusely illustrated by photographs and diagrams. Based on study of the actual equipment. Entirely new material, continuing audio equipment coverage begun in Vols. 1 and 2 (see below). Never before available in a single complete, accurate compilation. Indispensable to public address and sound technicians, custom installers, BC engineers and students—a "must" for everyone in the field of Sound. 362 fact-packed pages; 8½ x 11"; sturdily bound.

ORDER AA-3. Only . . . . . **\$3.95**



**VOLS. 2 and 1**  
**"AUDIO AMPLIFIERS"**

**VOL. 2.** Covers 104 well-known audio amplifiers and 12 important tuners produced during 1949. Includes uniform, detailed circuit and design data based on original lab study of the actual equipment. Profusely illustrated. 368 pages; 8½ x 11"; durably bound.

ORDER AA-2. Only . . . . . **\$3.95**

**VOL. 1.** This is the initial volume covering audio equipment produced after the war, through 1948. Covers 102 audio amplifiers and FM tuners, plus data on important wire and tape recorders. 352 pages; fully illustrated; in sturdy binding, 8½ x 11"

ORDER AA-1. Only . . . . . **\$3.95**

**OWN ALL THREE VOLUMES FOR A COMPLETE, AUTHORITATIVE SOUND LIBRARY**

**HOWARD W. SAMS & CO., INC.**

Order from your Parts Jobber today, or write direct to HOWARD W. SAMS & CO., INC., 2201 East 46th Street, Indianapolis 5, Ind.

My (check) (money order) for \$ . . . . . enclosed. Send the following books:

AA-3.  AA-2.  AA-1. \$3.95 each

Name . . . . .

Address . . . . .

City . . . . . Zone . . . . . State . . . . .



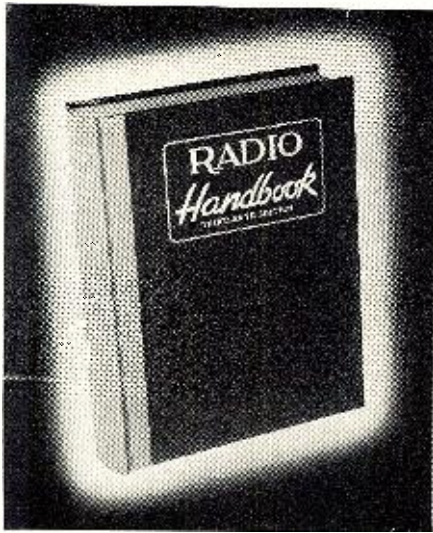

THE THIRTEENTH EDITION  
**RADIO HANDBOOK**  
 HAS EVERY THING YOU NEED  
**IN ONE VOLUME!**

Whatever your position in the radio and electronics field . . . technician, engineer or advanced amateur . . . you'll find the answers you're seeking in the new giant "Thirteenth Edition RADIO HANDBOOK". This great clothbound, gold-stamped one-volume encyclopedia of radio information is the largest "RADIO HANDBOOK" ever published . . . and the best!

Reference data galore, the latest in theory and practice; profusely indexed, clearly illustrated for easy reading; all the information you must have, where you can find it quickly; in addition, new study material to help you obtain your F.C.C. license.

Order your "RADIO HANDBOOK" now from your favorite dealer. You can't afford to be without it . . . 736 pages of vital information . . . at a cost of less than one cent a page!

**\$6.00**

AT YOUR DEALER—By mail from us, \$6.25 in U.S.A.; postpaid. Add tax in California. Foreign orders, \$6.50.



**BETTER TV RECEPTION**

THE "Fringe Area TV" Reference Book By W. W. Smith and R. L. Dawley TV signal propagation, evaluation of TV antenna, making a TV signal survey, types of masts and towers and recommended installation practices. Full data on rhombics, how to use open-wire feed line, how to eliminate ghosts, minimizing fading, TVI, etc.

**\$2.50**

AT YOUR DEALER—On mail orders from us, \$2.60 postpaid. Add sales tax in California.



**ANTENNA MANUAL**

The most practical, comprehensive book on antennas. 300 pages of down-to-earth help on antenna, feed line, radiation and propagation for all frequencies up to 1000 Mc. including FM and TV. Plain language; no need to brush up on math. A necessity for everyone interested in transmission or reception.

**\$3.50**

AT YOUR DEALER—On mail orders from us \$3.60 postpaid. Add tax in Cal. Foreign, \$3.75

OTHER U. S. A. ELECTRONIC BOOKS: You may order from us any such currently advertised book at standard prices; we maintain extensive stocks for prompt shipment. "SURPLUS" DIAGRAMS: We can furnish schematics of many surplus electronic items not included in our Conversion Manuals. Send stamp for list.

**AT YOUR FAVORITE DEALER**  
 OR DIRECT BY MAIL FROM  
*Editors and Engineers*  
 1322 KENWOOD ROAD, SANTA BARBARA, CALIFORNIA

manufacturers that over-selling and over-advertising are not conducive to the best interests of either the purchaser or the industry.

5. Find a suitable method for resolving consumer complaints as quickly as possible and develop means to avoid their undue repetition.

6. To encourage the development of business-managed service outlets, whether among dealers, contractors, or technicians, which will tend to reduce business failures that result in service contract holders being left without service for which they paid in advance.

A sub-committee was formed consisting of representatives of TCA, FRSA, and PRSMA to work out a "Bill of Particulars" for the consideration, acceptance and support of the Joint Electronics & Radio Committee on Service in Philadelphia.

Within a week after it was appointed this sub-committee prepared and presented a "Report on service needs and desires." This report which embraces forty-nine recommendations directed largely to specific segments of the industry, is too lengthy to be completely covered in this department. However, since it details the recommendations of the top service operators in one of the oldest and largest TV areas it should be of keen interest to every man engaged in radio and television service. After the report has been considered and passed on by the entire Joint Electronics & Radio Committee on Service for Philadelphia a complete report will be made available to readers of RADIO & TELEVISION NEWS.

Briefly, the Report opens with the following "General Recommendations":

1. We recommend that the industry, beginning at the manufacturers' level and supported by all other elements, undertake a three-fold public relations program:

(a) Aggressively move to stop the spread of sensational, misleading, and uninformed articles such as have been appearing in national consumer magazines.

(b) Prepare and distribute publicity material to all media which correctly informs the consumer as to what he can expect from his television and/or radio receiver and from the people who are engaged in installing and servicing these instruments.

(c) Prepare and make generally available a technical education program for the service industry, without regard to brand names, seeking only to see that all technicians, contractors, and servicing dealers have every opportunity to keep abreast of new technical developments and employers are adequately supplied with trained personnel.

**More National Companies?**

There have been rumors circulating in the industry that several TV receiver manufacturers are planning to set up their own national servicing organizations patterned somewhat along the lines of the RCA Service Company.

**APPROVED**

"the stamp  
 of unquestioned  
 quality"

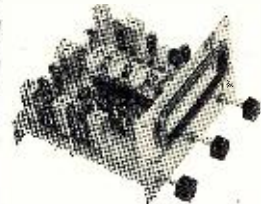

Model  
**A-710**  
 12 Tube  
 Miniature  
**FM-AM**  
**TUNER**

Designed for drift-free realistic high fidelity reception priced right for custom builder, serviceman. Chassis dimension: 8 1/4" x 5 3/4" x 3 1/8". Net weight: 5 1/2 lbs. Power requirements: 170 V DC 20 mils and/or 140 V DC 37 mils. 6.3 V. 4 Amp.



**PRE AMP for  
 Williamson  
 Amplifier Kit**  
 or similar High Fidelity Amplifier.

**MODEL A-800** consists of an amplifier for the reluctance pickup. Separate inputs for radio and crystal cartridge. A 6 position switch used in a compensation circuit for magnetic cartridge of the G.E. and Pickering types. A 3 position switch is used as an input selector. Volume control. High and low tone compensation. Approx. 15 db compensation at various settings. Tubes: 2-7F7. Power: 6.3 Volts AC or DC 1 Amp. 250-300 Volts DC 10 Milliamps at 300 volts.

WRITE FOR FREE 1952 CATALOG

**APPROVED ELECTRONIC  
 INSTRUMENT CORP.**  
 142 Liberty St., New York 6, N. Y.

**OUTSTANDING - TV - VALUES**



**MODEL #300**  
 Folded dipole complete with reflector and high frequency adapter. Covers 13 channels. All alum. construction. Less mast. Shpg. wt. 7 lbs. Price . . . . . \$4.50

**MODEL #200-D**

Stacked array. Consists of 2 complete conicals and connecting bars. Very rigid construction. Covers all 13 channels. Matches 300 Ohm or 72 Ohm. Center impedance 150 Ohm. Ideal for low signal areas. An outstanding buy. Shpg. wt. 12 lbs. **SENSATIONAL OFFER** at less mast. \$7.50

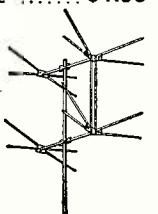

**MODEL #200-S**

Single array. Same construction as above. Shpg. wt. 12 lbs. Price, less mast. . . . . \$3.50

**MODEL #500**

All-band folded dipole antenna. Ideal for rotator use. Maximum gain on any channel. Alum. construction. Less mast. Shpg. wt. 8 lbs. Price . . . . . \$5.25

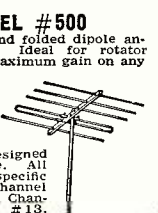

**MODEL #Y-100**

5 element Yagi Hi-Gain beam designed specifically for fringe area use. All alum. construction. Cut to specific channels. Shpg. wt. 4 lbs. Channel #7, \$5.80; Channel #9, \$5.20; Channel #11, \$4.60; and Channel #13, \$4.00. The prices are less mast. "V" type antenna. Price \$4.25

**FULLY AUTOMATIC BOOSTER** automatic on-off, automatic tuning, concealed installation, single or dual input, full band width on all channels, high uniform gain, 19 db on low 2-6, FM and 14 db on high 7-13. Specialty priced.

**ANTENNA ACCESSORIES**

CM-100 Chimney Mount . . . . .	\$ 1.50
WM-104 Wall Mount 4" . . . . .	1.25
WM-107 Wall Mount 7" . . . . .	1.25
U-100 "Universal" Ant. Mtg. Bkt. Offset to 8" . . . . .	3.95
U-200 Same as U-100 but Offset to 12" . . . . .	6.95
3 1/2" 300-ohm stand-off Insulators fit coax cable. Per 100, \$3.00; per 500, \$12.00;	
Best Quality 300-ohm twin lead—Send for prices.	
Folded Dipole Hi-Frequency Adapters . . . . .	1.50
Straight Dipole Hi-Frequency Adapters . . . . .	1.50

**TERMS:** All shipments F.O.B. Newark, New Jersey. 25% deposit with orders, balance C.O.D. Minimum order \$2.00. Include ample postage.

Prices Subject to Change Without Notice  
**EAST COAST ELECTRONICS**  
 39 George St. Dept. 11-N Newark 5, New Jersey



This would be a perfectly natural development and one which would aid rather than harm the independent servicing industry. It is generally recognized by reputable and successful independent TV service contractors that the existence of the *RCA Service Company* during the period of TV's lusty growth—and belt-tightening recession—has been a major factor in maintaining some degree of stability in the television installation and service business. Many service operators feel that if the *RCA Service Company* had not been in the picture there would have been no ceiling on installation and service charges when business was booming and no floor under them when buying tightened up.

There is a great need on the part of both the industry and the TV set users to recognize the importance of competent technical maintenance of a TV receiver for top enjoyment of televised programs—and for proper eye protection. Radios needed maintenance, too, but the average listener's hearing is non-critical so the radio technician is called in only when the set is practically inoperative.

Within a few years the average home will represent a market for about a thousand dollars' worth of radio-electronic and companion equipment per year. As the automobile people have proven, set manufacturers know that they will be able to maintain their competitive positions in that kind of a market only if they are able to provide consistently reliable installation and maintenance service on their products. So it would be a normal economic development for the larger set manufacturers to set up their own repair depots.

Contrary to popular belief, a manufacturer cannot "subsidize" a national servicing department out of receiver sales income in a highly competitive market. He would go broke fast if he tried it. The set manufacturer is faced with the same management problems in the operation of a retail service depot as the independent service contractor, plus—a much bigger non-productive overhead expense. The well-managed independent business can be a more efficient and economical type of operation than any branch of a big concern.

On the other hand, the set manufacturer is "sales-minded." He will develop "service-selling programs" that will bring in maintenance jobs that the "non-sales-minded" independent service contractor doesn't get.

Aggressive independent service operators will study and copy the service-sales campaigns of the big fellows. And they will do all right.

#### Adds New Contract Plans

The *RCA Service Company* now offers several optional contract plans to purchasers of *RCA-Victor* receivers. One of the new plans provides protection on the kinescope alone. It guarantees the set's picture tube for one year from date of purchase. The cost

November, 1951



Thousands read the best-seller! Millions have seen and will see the thrilling movie!

by the makers of professional radio equipment for the greatest adventure of our time!

*Despite 101 days of salt spray and even total immersion, a National transmitter and receiver kept the world-famed Kon-Tiki Expedition in touch with the world! Now the same rugged dependability is yours in the amazing SW-54, the "Mighty Midget" broadcast and shortwave receiver (540 kcs. to 30 mcs.). Measures only 11" x 7" x 7". Write for details and name of nearest supplier!*



**PEN-OSCIL-LITE**  
 Extremely convenient test oscillator for all radio servicing; alignment • Small as a pen • Self powered • Range from 700 cycles audio to over 600 megacycles u.h.f. • Output from zero to 125 v. • Low in cost • Used by Signal Corps • Write for information.  
**GENERAL TEST EQUIPMENT**  
 38 Argyle Buffalo 22, N. Y.

**TV-RADIO TRAINING**  
 APPROVED LEARN-BY-DOING METHODS  
 PRACTICAL SHOP TRAINING QUALIFIES YOU. Learn to service all types radio & television sets the practical way—by actual shop work. This is a "down-to-earth" practical trade course—80% of training devoted to troubleshooting methods & practices. Non-essentials omitted. Concentrate on subjects of practical value. This learn-by-doing course emphasizes on-the-job type training. You make actual repairs on numerous sets in best-equipped TV shops on west coast. Successful placement service. Approved for veterans. Budget terms for non-veterans. Day & Evening classes. Send for free Bulletin 7-A.  
**WESTERN-RADIO TELEVISION INST.**  
 341 W. 18TH ST., LOS ANGELES 15, CALIF.

**No Experience Needed To PRINT YOUR OWN POST CARDS**  
 The GEM STENCIL DUPLICATOR saves money... gets results quickly! Hundreds of uses for every type of business and organization. We ship the GEM complete with all supplies, Guide Board for accurate printing and 60-page Book of Ideas at the special low price of only \$8.50 (a \$15.00 value) *Our 21st Year*  
**FREE TRIAL OFFER**  
 Use the GEM FREE at our expense! SEND NO MONEY. Write and complete GEM outfit will be sent you postpaid. After ten days, send us only \$8.50 or return the GEM. You must be satisfied! WRITE TODAY.  
**BOND EQUIPMENT CO. Dept. 52**  
 6633 Enright • St. Louis 5, Mo.



# PRECISION ELECTRONICS PRESENTS the GROMMES CUSTOM AMPLIFIERS

Designed by Sound Engineers  
for CRITICAL MUSIC LOVERS

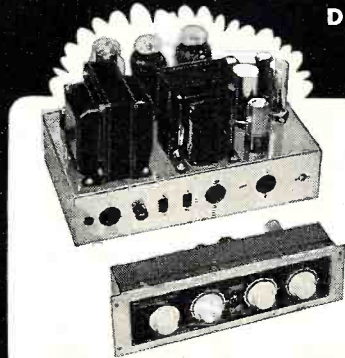

- For those who want the best
- Response 10 to 100,000 CPS  
(±0.1 DB 10 to 50,000 CPS).
- Passes square waves 20 to 10,000 CPS
- Total distortion 0.2% or less at 20 watts.
- Peak power 50 watts.
- 25 DB feedback; Damping factor-11.  
200 PG List \$225.00

- Out-performs larger amplifiers.
  - Response ± 1 DB 20 to 20,000 CPS.
  - Total distortion 1.5% or less at 10 watts.
  - Peak power 20 watts.
  - 10 DB feedback.
- 50 PG List \$73.50

Now! Available  
with Pfanstiehl  
pre amps....



Both models feature the most advanced circuits known to electronics; 4 inputs, feedback pickup pre-amp, calibrated bass and treble controls, hum inaudible, Free technical bulletin.

## PRECISION ELECTRONICS, INC.

641-43 MILWAUKEE AVENUE

CHICAGO 22, ILLINOIS

### The Largest Selling LIGHTNING ARRESTER At Any Price!

NO. AT102



APPROVED



Protects Home and TV  
Set Against Lightning  
Hazards

\$2.25  
LIST

U.S. Patent No. D-4664

- Installs anywhere
- No wire stripping, cutting or splicing

(Complete with strap and ground wire.)

OVER 1,000,000 IN USE TODAY!

See Your Jobber or Write for  
Form No. 34



MANUFACTURING CO., Inc.  
127L 14th AVENUE, BROOKLYN 4, N. Y.  
FIRST in Television Antennas and Accessories

## TUBES VERY LOWEST PRICES Receiving-Transmitting-TV

RMA GUARANTEED—ALL STANDARD BRANDS

Receiving		Transmitting	
0Z4.....\$ .59	6K7.....\$ .59	OB2.....\$1.69	
1A5......69	6SA7......69	OC3/VR105. 1.29	
1A7..... 1.09	6SN7..... 1.09	OD3/VR150. 1.19	
1B3..... 1.19	6V6......89	2X2......59	
1R5......79	7CA......89	3EP1..... 5.39	
1X2A..... 1.19	12AL5......89	3HP7..... 3.49	
5U4......79	12AT7..... 1.19	5FP14.....16.99	
5Y4..... 1.39	12AU7..... 1.19	7BP7..... 7.89	
5Y3......49	12BH7..... 1.19	7CP1.....12.49	
6AB4......99	12SA7......79	79 211......59	
6AC7..... 1.29	12SK7......79	304TH.....12.49	
6AG5..... 1.29	12SQ7......69	GL471A..... 2.75	
6AH6..... 1.89	25BQ6..... 1.29	12A6......69	
6AK5..... 1.89	35/51......89	717A..... 1.19	
6AK6..... 1.19	35A5......98	803..... 2.49	
6AL5......79	35A5......98	805..... 2.99	
6AQ5......89	35L6......89	807..... 1.79	
6AU6......79	35W4......69	809..... 1.79	
6AV6......69	35Y4......89	813..... 7.49	
6BC5......89	35Z5......59	872A..... 2.39	
6BG6..... 1.89	39/44......49	885..... 1.29	
6BN6..... 1.39	50A5......98	905..... 2.29	
6BQ6..... 1.59	50B5......98	954......29	
6CB6......89	50L6......75	1616..... 1.19	
		1624..... 1.49	
		1629......35	
		2051..... 1.19	
		7193......29	
		8020..... 1.25	
		9006......29	

FREE! Write for new catalog including complete listing of tubes, parts and accessories for radio and TV! Also special electronic instruments catalog.  
Minimum Order: \$5.00. 25% deposit with order, balance C.O.D. Include postage with order. All merchandise subject to prior sale, F.O.B., New York City.

### The OS Company

102 Park Place

CO. Rand 7-6195

Dept. R-11, New York 7, N. Y.

of this plan varies with the size of the tube. As an example, the price of the plan on a 17-inch picture tube is \$5.00.

Another of the new service contracts offered is the preferred rate plan. This plan features complete installation, instruction of the customer, full parts and tube coverage (including picture tube) for one year, and one service call during the year. The cost of this plan is \$24.50 for a 17-inch set with a built-in antenna. Additional service during the year will be charged at a flat rate of \$3.95 per job if the set is brought to the RCA Service Company branch, or \$5.95 per home call, regardless of time spent, instead of an hourly charge for labor. With a standard outdoor antenna installation, the cost of this plan for a 17-inch set is \$49.50.

The best-known plan offered by the RCA Service Company is the full-coverage service contract. This contract includes installation, protection of all parts and tubes (including kinescope), and provides unlimited service calls for a full year. The price of this type of contract for a 17-inch set is \$59.95.

### More Shortages Ahead?

Now they say that parts, tubes, and even TV receivers may be in short supply by the first of the year!

There has been a feeling prevalent in the industry that the lifting of the TV station construction freeze would immediately usher in another frenzied boom of receiver sales, installations, and sales of auxiliary equipment.

Although we are in the midst of increased production of defense materiel it has been estimated that the defense program, even when it is in full gear, will require only about twenty per-cent of the productive capacity of the radio-electronics industry. But the fly in the ointment is said to be the shortages of critical materials which will hamper tube and set production on an increasing scale during the next two years.

In a talk presented recently at the NEDA convention, Dr. W. R. G. Baker, of the General Electric Company, made some interesting observations about what may be expected to happen in the way of set production and in new TV stations that will go on the air during the next two years.

Dr. Baker pointed out that if the present pattern of mobilization is followed not more than five million TV sets could be manufactured during 1952 with the quantity of critical materials that will be allocated to the industry for receiver production. He stated further that it might be even less than four million sets if the proposed restrictions on critical materials are adhered to rigidly.

With reference to new TV stations, Dr. Baker estimated that at the end of two years after the freeze is lifted 141 more v.h.f. stations will be put on the air for a total of 248 v.h.f. transmitters operating at that time. And he estimated that during the same period a minimum of 36 u.h.f. stations will be put on the air.

-50-



## What's New in Radio

(Continued from page 86)

delity and simplify operation and installation. The remote control can be placed up to 25 feet from the power amplifier.

The unit has an 8-position record-compensator which adjusts for any recording characteristic. A selector

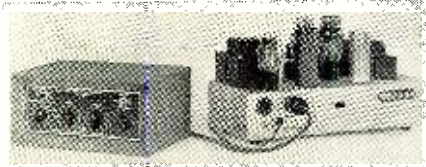

switch changes from phono, tuner, TV, or other high level inputs. The automatic loudness control boosts treble and bass at decreasing volume to compensate for the human ear's insensitivity to high and low frequencies at low volume.

Frequency response is flat from 18 to 22,000 cps and the output is 20 watts. Hum is 84 db below full output with the harmonic distortion less than .5% at full output. The unit is housed in a solid walnut cabinet with etched bronze panel and comes equipped with a 6 foot remote control cable.

### AUDIO AMPLIFIER

The Radio Craftsmen, Inc., 4401 N. Ravenswood Avenue, Chicago 40, Illinois is now marketing the "Craftsmen 500" ultra-fidelity audio amplifier.

This all-triode amplifier, which is based on the Williamson circuit, provides 20 db of inverse feedback around the entire amplifier. Specifications on the unit include a total harmonic distortion of less than .1% at 10 watts



at mid-frequencies; intermodulation distortion of less than .5% at 10 watts; power response of 12 watts  $\pm$  1 db, 10 cps to 50,000 cps; and frequency response of  $\pm$  .1 db at 20 to 20,000 cps,  $\pm$  2 db at 5 to 100,000 cps.

### V.F.O. KIT

E. F. Johnson Company, Waseca, Minnesota has recently announced the availability of a new v.f.o. kit which provides more than adequate v.f.o. output to drive transmitters to full excitation on all bands, 10 through 160 meters.

According to the company, the new v.f.o. unit can be built in an evening

November, 1951



## The Key To Increased Earnings... Is At Your Fingertips

Now, more than ever before, your knowledge of every phase... every detail... of servicing each set in the manufacturer's line really pays off. And there's only one source that gives you all you must know. It's Rider Radio & TV Manuals. The only complete, authoritative service data on television and radio in the world!

Here you'll find the answers to all your servicing questions. From complete unpacking and installation data to complete factory parts lists. With Rider's accurate, factory-authorized information at your fingertips you'll spend less time per call... and do a better job! The result is greater profits. Ask your jobber to show you the latest Rider Manual — today!



**JOHN F. RIDER Publisher, Inc.**  
480 Canal Street, New York 13, N. Y.

### 2-WAY WALKIE TALKIES

POCKET SIZE  
—Electronic  
Voice Powered



No tubes, batteries, adjustments, license or permit needed!

Guaranteed to work anywhere up to 1/2 mile with extra wires. Swell for garage, talk-listen phone. Not war surplus. Brand new. Solid Aluminum Case. Two complete units with wire—READY TO USE! SEND ONLY \$1.00 deposit and pay post-man \$3.99 C.O.D. or send \$4.99 for PP delivery. Limited supply. MIDWAY COMPANY, Dept. WRT-11, KEARNEY, NEBRASKA.

### BC406A REC. SUP HET 2 RF 4 IF'S now tunes 195-210 MC CONVERTS TO 2-5-10 MTR'S and 420 band

15 tubes 19 1/2 MC IF coils 115 VAC pwr. supply self contained complete with 4 6SK7, 2 6SJ7, 1 6N7, 1 6SP5, 1 5T4, 1 6X5, 4 954. Thor. pwr. trans. 70R62 4 Thor. chokes 13C30, 4 dual 8 MFD in oil tames as is 195 to 210 megs check CQ 1945 for hot 10 mtr conversion we give free conversion for 2 meters with ea. unit original print with ea. set brand new original Govt. cost \$292.00 MFG by W. E. WHILE THEY LAST price F.O.B. . . . . \$19.95  
**McCONNEL'S**  
3834 Germantown Ave.  
Phila., Penna. RA 5-6033

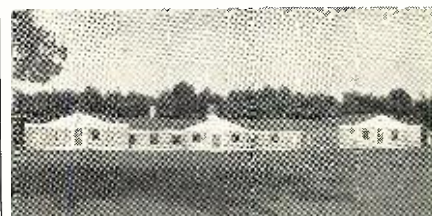

### RADIO ENGINEERING TELEVISION ELECTRONICS

Thorough training in all phases of radio and electronics, open to high school and junior college graduates. Old established school specializing in Radio training exclusively. Modern laboratories and courses. Enrollments limited. Approved veteran training.

**VALPARAISO TECHNICAL INSTITUTE**  
Dept. RD Valparaiso, Ind.





**MOST  
POWERFUL  
COMBINATION  
for  
SINGLE  
CHANNEL  
RECEPTION**

**VEE-D-X**

THE LaPOINTE-PLASCOMOLD CORPORATION  
Windsor Locks, Conn.

and is easily calibrated. Keying can be performed three ways—with the v.f.o. alone, with the transmitter alone, or with both v.f.o. and transmitter simultaneously, the latter method providing perfect "break-in" operation on all bands. Keying is clean due to excellent isolation between the oscillator

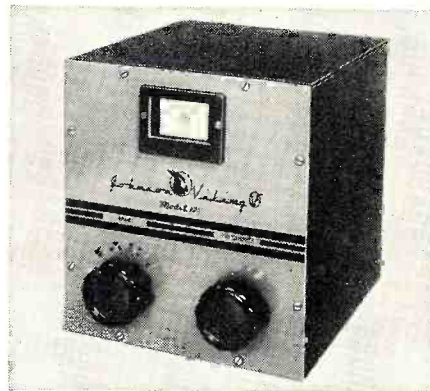

and output circuit and nearly perfect screen grid voltage regulation, according to the manufacturer.

Furnished with a dark maroon finished cabinet and with a 5" dial calibrated directly in frequency, the v.f.o. kit utilizes a 6AU6 electron-coupled oscillator and an 0A2 regulator. Complete details on this kit are included in a data sheet which is available from the company on request.

#### HIGH VOLTAGE PROBE

*Precise Development Corp.* of Ocean-side, Long Island, New York has recently introduced a new high voltage probe which incorporates many new and unique features.

The new unit, known as Model 999, has multiple insulation—two areas of air insulation, plastic inside insulation, and an outside plastic insulation which protects against voltage breakdown. The construction is mechanically shockproof because of its double

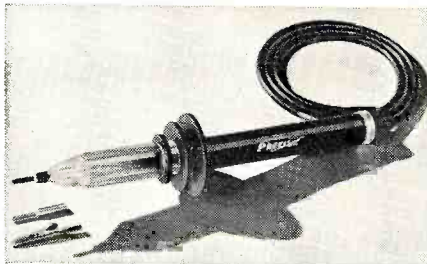

spring suspension system, stainless steel springs, and fiber cushions which have been used in order to maintain vertical and horizontal shock resistant characteristics. Tips are interchangeable and include an alligator clip plus the conventional probing type.

#### NEW CONDENSER

*Dumont Electric Corp.*, 308 Dykman Street, New York 34, New York is in production on a new condenser unit that is said to embody many new design and performance features.

By means of an exclusive manufacturing process the unit is always concentric, the section always being in the exact center of the form. In addition,

# 1<sup>st</sup> choice

## STEPHENS FINE COMPONENTS FOR 2-WAY SYSTEMS

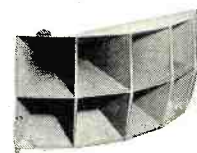

Those who demand the finest in sound reproduction... who want true-to-life tones, specify Stephens Tru-Sonic high fidelity components in their two-way systems. Custom set builders, manufacturers of fine sets and theatres rely on Stephens because there's such a wide selection of components to fit every space requirement and price range. Stephens Tru-Sonic components are available in crossover frequency ranges from 400 to 3500 cps. The low frequency driver, high frequency driver, crossover network and 2x5 horn shown here are only a few representative items available under the Stephens brand.

See you at Room 642  
N. Y. Audio Fair

Write for catalog E-1 and installation instructions.

**STEPHENS** MANUFACTURING CORPORATION  
**TRU-SONIC** Pioneer name in high fidelity reproducing equipment

8538 WARNER DRIVE, CULVER CITY, CALIFORNIA

**MANUFACTURERS!  
EXPORTERS!  
PURCHASING AGENTS!  
ORDER YOUR NEEDS  
FROM THE WORLD'S  
LARGEST SUPPLIERS**

- Radio and Receiving Tubes
- Transmitting & Special Purpose Tubes
- Radio and Electronics Parts and Equipment
- All Types of Electrical Wire, Magnet Wire, and Cable

*Write — Wire — Phone  
For Your Special Needs*

We are also bonafide  
General Purchasing Agents.  
**CAN WE HELP YOU?**  
References: Dun & Bradstreet.

*Electronic Expeditors*

**225 N. Wabash Ave., Dept. R, Chicago 1, Ill.  
Phone ANdover 3-0841**

BRANCH OFFICES

257 S. Spring St., Los Angeles 12, Cal. MA 6-2004  
507 Fifth Ave., New York 17, New York MU 7-008



the company claims that the new unit has excellent over-all insulation, very high humidity resistance, and is easy to work with.

These units are now available in all sizes and two different types. The Standard Type PM with paper dielectric and mineral oil impregnant is recommended for temperatures up to 85 degrees C. The High Temperature Type TM with new thermofilm dielectric is designed for applications where temperatures range up to 150 degrees C.

#### IMPEDANCE BRIDGE

*Brown Electro-Measurement Corporation*, 4635 S. E. Hawthorne Blvd., Portland 15, Oregon has announced two test instruments, the Model 250-C universal impedance bridge and the companion Model 855-A amplifier-oscillator.

The bridge will permit resistance measurements from 1 milliohm to 11 megohms, capacitance from 1  $\mu$ fd. to 1100  $\mu$ fd., and inductance from 1  $\mu$ hy. to 1100 henrys.

Wirewound resistors adjusted to a precision of .05% are used in the

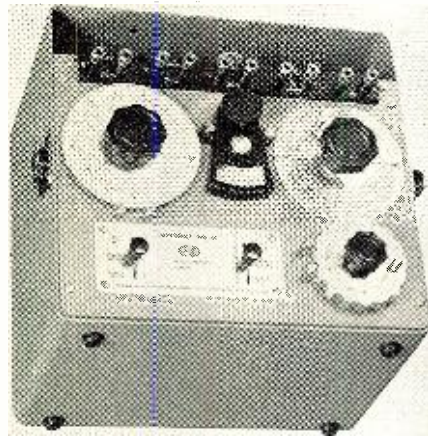

bridge arms. The dial scale has 11,000 effective graduations and controls a precision double-decade and rheostat combination.

The Model 855-A amplifier-oscillator fits into the battery compartment of the bridge and converts the bridge to 115 volt a.c. operation.

Bulletins giving complete specifications on these units are available from Dept. RN-3 of the company.

#### PICKUP CARTRIDGES

*Shure Brothers, Inc.*, 225 W. Huron Street, Chicago 10, Illinois has announced the availability of two new phono pickup cartridges for the replacement market.

The Model W22AB-T turnover cartridge is a high quality, extended range "vertical drive" unit complete with positive turnover mechanism. It may be used as a replacement for single needle, all-purpose cartridges and is also recommended for replacement of other types of turnover and dual needle cartridges.

The Model W42BH dual voltage unit is a low cost "lever-type" cartridge for 78 rpm records. Equipped with a slip-

November, 1951

## Preview

Lic. Under RCA Pat.



Chassis Mounting Brackets \$4.95

RMA Guarantee

Factory Wired, Aligned & Tested Before Shipment

## ... THE NEW 1952 "630" LINE OF TV CHASSIS & CABINETS

### Caveat Emptor Let the buyer beware!

There are many different qualities of 630 chassis & tubes. All our merchandise is 1st quality, factory new—no seconds, no rebuilds & no rejects. You get honest dollar value!

The amazing new, Super "630" 30 tube chassis—perfect for fringe area reception, will handle all tubes from 16" to 24". Thousands of our Super sets are giving new viewing thrills to TV watchers all over the country. Now... the NEW Super extra powerful chassis brings you sharper, clearer pictures than ever before because it is designed with fringe areas in mind. Has improved keyed AGC; 15 KV output; 3 stage Sync separator & clipper; moulded plastic condensers; uses new improved high voltage system; 5 hour minimum heat run at factory; high gain standard coil front end; synchro lock; freedom from arcing & corona leakage. Armstrong FM sound system; improved linearity adjustment & second horizontal linearity control. Phono connection & switch on chassis DIRECTLY ADAPT-ABLE FOR COLOR. Available with Dumont Inputtuner—\$159.95.

\$149.95

With Hi-gain Standard Coil Tuner and RCA Hi-Fi 12" Speaker Complete with Federal Taxes LESS CATHODE TUBE

### PRICE SMASHING VALUES IN TV CABINETS FOR THE 630 CHASSIS

Beautiful, richly finished, hand rubbed mahogany cabinets to suit every taste. They are designed to house the "630" chassis, 12" speaker & up to 20" TV tube. The combination cabinets will hold up to a 20" TV tube, radio & Webster record changer, with ample record space. All cabinets are equipped with mask. The perfect chassis deserves a perfect cabinet. It will be a focal point of beauty in your home. Chassis mounting brackets included with cabinets. Other models in stock. Send for FREE circular.

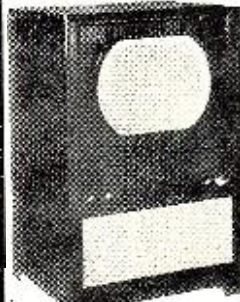

"ECONOMY"

41x25x23. 16" to 20" Tube. Mahogany ..... \$59.95 For 24" ..... \$74.95 Blonde \$10 additional.

SEND POSTCARD TO BE PUT ON FREE MAILING LIST



"STRATFORD"

40x28 1/2 x 23 1/2. Genuine scratch Mahogany doors ..... \$84.95

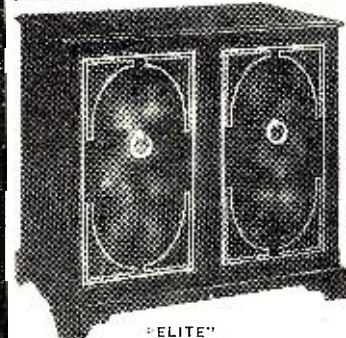

"ELITE"

Combination—39x40x23 1/2. Red antique gen. leather. Gold leaf hand tooling... \$159.95 In lined oak, gold colored leather... \$169.95 Above with selected stained mahog. picture box doors (no leather)... \$139.95 In lined oak... \$149.95

All merchandise is brand new, factory fresh & fully guaranteed. Mail & phone orders filled upon receipt of certified check or money order for \$25 as deposit on TV chassis, 20% on other items. Balance C.O.D., F.O.B. N. Y. Prices subject to change without notice. No Fed. taxes to pay. Prices lower than ODS Resvs.

## AIREX RADIO CORP.

171 WASHINGTON ST., N. Y. C. 7, N. Y. PHONE WORTH 2-4029

### TV TUBE EXTRA

Standard Brands 1st Quality

12 1/2" Round	..... \$22.50
14" Rectangular	..... 23.95
16" Rectangular	..... 29.95
17" Rectangular	..... 32.95
20" Rectangular	..... 42.95
24" Round, metal	..... 74.95
Ring & sleeve for 24"	..... 7.50

All tubes carry full 1 YEAR Manufacturer's guarantee

### RECORD CHANGER

WEBSTER 3 SPEED Series #100 \$29.95

REGENCY BOOSTER Mod DB 410 \$18.95

### SPECIAL VALUES

- Dumont Inputtuner for FM & TV bands..... \$23.85
- Standard Coil Tuner..... 22.95
- TV Masks—16 & 17"—\$4.95; 20"—\$7.95; 24"—14.95
- 300 OHM TV wire, 100 feet..... 2.89
- Standard Coil Booster..... 18.95
- Espey FM-AM Radio, 12 tubes, push-pull output 74.95

We carry a complete line of 630 component parts. We have a full line of RADIO TUBES. FROM 40% TO 60% OFF LIST. WRITE FOR PRICES.

### RCA RADIO and TELEVISION

Thorough training for men and women in all Technical phases WEEKLY RATES DAYS—EVENINGS APPROVED FOR ELIGIBLE VETERANS Free Placement Service For Graduates For Free Catalog write Dept. RN-51 RCA INSTITUTES, INC. A Service of Radio Corporation of America. 350 West 4th St., New York 14, N. Y.

### New Bathtub Condensers Original Pack

2x.1—600v—4 top term.	..... 29¢
2x.01—600v—4 side term.	..... 29¢
.1—600v—2 top term.	..... 27¢
2x.5—400v—3 top term.	..... 25¢
2x.25—400v—3 side term.	..... 25¢

"Shipped prepaid" with cash orders DRILLICK Electronic Sales Co. 5281 W. Pico Blvd. Los Angeles 19, Calif.

### FLASH



### TWO-WAY TALKIES

Manufactured by Dictograph Corp. Brand new Two-Way Intermcom system. Operates on standard flashlight batteries. Two complete stations, ready to operate. More stations may be added. \$16.95 Pair

Send check with order—we pay postage

SHAW'S SURPLUS

2250 McKinley (Dept. T) Fresno, Calif.



Office to Office Room to Room Bldg. to Bldg., etc.



# THE RIGHT ANTENNA

can do wonders for any TV set

## Television & FM Antenna Guide

*Shows you how to get the most out of the antenna system at any location.*



Remember the TV broadcasts from the San Francisco conference in August? *Special antennas made them possible.* To get the most out of any TV receiver at any location, a thorough knowledge of the best type of antenna to use and how to install it is essential. This book gives you that knowledge. It tells you how to determine, quickly and accurately, the best spot and direction for the antenna and what type to use; how to minimize noise from the transmission line; when and why to use booster amplifiers.

### Includes UHF

It explains antennas for the new UHF band and shows how to attach a UHF antenna to a VHF model. Everything you want to know about antennas is here, in the most convenient handbook form for quick on-the-job reference. Get a copy without cost and see for yourself. Use the coupon below.

## FOR THE RIGHT SOLUTIONS TO YOUR PROBLEMS

*use these most helpful books*

## Radio and TV Mathematics

A Handbook of Problems & Solutions



721 sample problems and solutions show you what formulas to use, what numerical values to substitute, and each step in working out any problem you may encounter in radio, television or industrial electronics, conveniently arranged and thoroughly indexed by radio topics so you can quickly find the solution to YOUR problem.

## Television for Radiomen



Clear, non-mathematical explanations of the operating principles and function of every part and circuit in today's TV receivers, with full instruction on installation, alignment, testing, adjusting and trouble shooting.

### SEE THEM ON APPROVAL

The Macmillan Co., 60 Fifth Ave., N. Y. 11

Please send me copies of the books checked below. I will either remit in full or return the books in 10 days.

- Television & FM Antenna Guide \$5.50
- Radio & TV Mathematics \$6.00
- Television for Radiomen \$7.00

Signed .....

Address .....

on condenser harness for dual voltage output, 1.5 volts or 3.75 volts is obtainable in one cartridge.

### PREAMPLIFIER

Approved Electronic Instrument Corporation, 142 Liberty Street, New York 6, New York has recently introduced a new preamplifier, the Model A-800.

The Model A-800 is a four-stage preamp especially designed for quality audio systems such as the Williamson

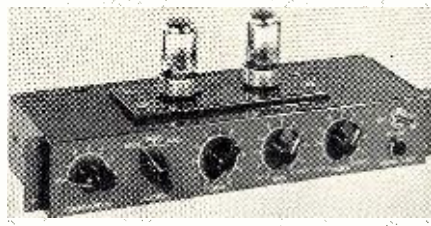

amplifier or units of comparable quality. The preamplifier consists of a two-stage, compensated amplifier for the low gain magnetic type of cartridges and is followed by a two-stage, tone compensating, non-resonant control circuit. Dual triode tubes are used in both stages.

The unit measures approximately 12" wide, 4" deep, and 2" high. Provision has been made for connecting a magnetic type phono pickup, crystal pickup, and radio tuner. A power line cord feeds into the preamplifier through a toggle switch and is terminated in a power outlet. This permits the user to plug in his main amplifier and control all equipment with a single switch.

### TINY PORTABLE

Privat-ear Corporation, 2016 Bronxdale Avenue, New York 60, New York is currently marketing a tiny portable radio designed for personal earphone reception.

Measuring 2 1/4" x 5 1/2" x 7/8" and weighing less than 8 ounces, the set

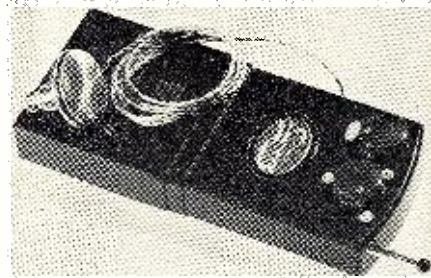

will bring in stations from as far away as 50 miles during the daytime and up to hundreds of miles at night.

The set is housed in a maroon color plastic case and features a built-in telescopic antenna. A small folder giving details on this unit is available from the company on request.

### D.C. POWER SUPPLY

Electro Products Laboratories, Inc., 4501 North Ravenswood Avenue, Chicago 40, Illinois has recently introduced a moderately priced d.c. power supply which provides a continuously

# GET ALL TV CHANNELS WITHOUT ROTATING!

**No Motors  
No Electric  
No Orientation  
No Ghosts!**

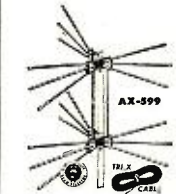
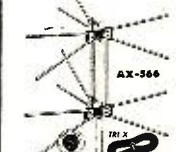

New 360° motorless directronic TV aerial system by Snyder is electronically switch beamed to cover all channels. A flick of the switch clears picture instantly.

**AX-56** All channel. 6 hi-tensile 3/8 aluminum elements. U-clamp. Directronic beam selector. 75 ft. of Tri-X Cable. 1 to 5 \$9.05 6 to 11 \$8.45 12 to 25 \$7.85

**AX-566** All channel. 12 hi-tensile 3/8 aluminum elements. Connecting stubs. U-clamp. Directronic beam selector. 75 ft. of Tri-X Cable. 1 to 5 \$14.25 6 to 11 \$13.20 12 to 25 \$12.25

**AX-59** All channel. 9-3/8 aluminum elements. U-clamp. Directronic beam selector. 75 ft. of Tri-X Cable. 1 to 5 \$9.95 6 to 11 \$13.20 12 to 25 \$8.65

**AX-599** All channel fringe areas. 18-3/8 aluminum elements. Connecting stubs. U-clamp. Directronic beam selector. 75 ft. of Tri-X Cable. 1 to 5 \$15.90 6 to 11 \$14.60 12 to 25 \$13.80

10% Cash with Orders

**ALMO RADIO CO.**

509 Arch St. & 6205 Market St. Philadelphia, Pa.  
6th & Orange Sts., Wilmington, Del.  
440 E. Ventnor Ave., Atlantic City, N. J.  
1133 Haddon Ave., Camden, N. J.

## REK-O-KUT presents a New Continuously Variable-Speed Turntable of Broadcast Quality



*Plays at any speed from 25 to 100 R. P. M., without "wow!"*

*Speed can be varied while in operation to produce sound effects.*

Now for the first time... a continuously variable turntable of Broadcast Quality at a popular price. Ideal for record collectors, musicians, singers, disc jockeys, broadcast stations, music schools, dance studios, skating rinks, gymnasiums, etc. Plays through amplifier, radio, TV set or phonograph. Operates on 50 or 60 cycles.

**Model CVS-12** (illustrated) Chassis, motor and turntable \$84.95 net.  
**Model CVS-12P**, mounted in portable case with 16" dual stylus pickup \$124.95 net.

### 3-Speed 12" Transcription Turntable

Recommended by outstanding music critics. Induction-type motor designed for smooth, quiet, vibration-free operation. 3 speeds, 78, 45 and 33 1/3. **Model LP-743** \$54.95 net.

Write for Illustrated Catalog of REK-O-KUT Line of Hi-Fidelity Recording Instruments, Phonographs, Transcription Tables, Accessories.

**REK-O-KUT CO.**  
38-05 QUEENS BLVD., LONG ISLAND 1, N. Y.

RADIO & TELEVISION NEWS



variable source of filtered d.c. power for operating d.c. equipment from a.c. lines.

The new Model "N" has an output range of 0-28 volts at 15 amperes. An exclusive feature of this new unit is the application of selenium rectifiers

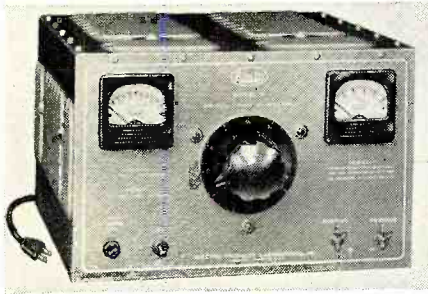

which increases the rectifier power rating and permits lower cost per ampere output. A single control furnishes continuous voltage adjustments for different load conditions over the specified range.

New literature giving full details on the Model "N" is available from the company on request.

#### POWER RESISTORS

Dale Products, Inc. of Columbus, Nebraska has recently released information on its new line of miniature power resistors.

Designated the "Dalohm," the new resistors are said to provide more resistance per watt per cubic inch than any other resistor on the market today.

These new units are available in 2, 5, 10, 25, and 50 watt sizes. A special silicone material completely seals the resistance elements, making them completely impervious to moisture.

The units offer completely welded construction from terminal to terminal. The standard tolerance is one per-cent although tolerances as high as .05 per-cent can be furnished.

The temperature coefficient is substantially flat. Resistance shift is less than .00002 per-cent per degree C.

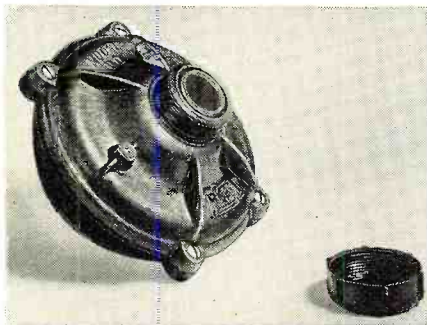

#### DRIVER UNIT

Audicraft Inc., 77 South 5th St., Brooklyn 11, Illinois has introduced the Model DQ driver unit which is the first of its line of p.a. trumpets, driver units, and paging speakers.

The DQ is a heavy-duty unit handling 30 watts of program material and is capable of withstanding peaks of 80% over this figure.

One of the exclusive features of the

SEE LEO FIRST FOR . . .

# hallicrafters

I can SAVE you money . . . Liberal Trade-ins



\$89.95

#### New SR-75 TRANSCEIVER

Receives on 540 Kc through 32 Mc — Transmits on 10, 11, 20, 40, or 80 meter bands. 5 tubes plus regulator. Housed in grey steel cabinet. Shipped with coils, less crystals. Low down payment.



\$199.50

#### SX-71 RECEIVER

Double Conversion sharp selectivity, plus built-in NBFM at moderate cost. 11 tubes plus voltage regulator and rectifier. Low down payment.

R-46 Speaker \$19.95

NAME YOUR TERMS • LOW DOWN PAYMENTS • PERSONALIZED SERVICE

#### HALLICRAFTERS RECEIVERS AVAILABLE FOR IMMEDIATE SHIPMENT

S-38B	.....\$49.50	S-72 Portable	.....\$109.95
S-40B	.....\$99.95	SX-62	.....\$289.50
S-81	.....\$49.50	S-78A	.....\$89.50
S-82	....\$49.50	S-76	....\$169.50
		R-46 Speaker	....\$19.95

#### Famous WRL RADIO REFERENCE MAP 25c



CU on 10-20 & 75 Meters

#### NEW LOG BOOK 25c

For mobile or fixed station. Spiral binding. Full column log listing all FCC required info. Will accommodate 1,825 stations. "Q" signals, phonetic alphabet, amateur international prefixes.



#### JUST OFF THE PRESS!

#### WRL 1952 CATALOG

Send for your copy today. Contains everything new in radio and television. Jam-packed with bargains. Leo I. Meyerson, WØGFO



FREE

WORLD RADIO LABORATORIES RN-11

744 West Broadway Council Bluffs, Iowa

Please send me:

- Radio Map
- New Catalog
- Used Equipment List
- SR-75 Info
- SX-71 Info
- New Log Book

Name .....

Address .....

City..... State.....



COUNCIL BLUFFS, IOWA

#### F. G. C. COMMERCIAL RADIO OPERATORS LICENSE

Critical Shortage of Licensed Operators Exists!!

A wonderful future is yours with an F. C. C. commercial radio telephone or telegraph operators' license leading to top salaried jobs in aviation, broadcasting, transportation and civil service. Sensational new simplified HOME STUDY COURSE teaches you in shortest possible time at lowest possible cost. NO OTHER COURSE LIKE IT! Proven valuable during World War II in speedily training thousands of men; eliminates tedious schooling, exam papers, pouring over books. Each page of text directly related to official F. C. C. exam questions, thus assuring you of all theory requirements.

The entire course, nothing else to buy, containing 230 pages of complete material, diagrams, etc., yours for only \$9.95. Send check or money order; or pay postman \$9.95 upon receipt plus C.O.D. charges. COMPLETE SATISFACTION OR MONEY REFUNDED WITHIN 10 DAYS.

STREAMLINED SELF STUDY COURSES  
509 5th Avenue, New York City

#### EASY MONEY!!

If you don't get our postcards telling the cash we'll pay for that surplus gear you bought when the buying was good, then YOU ARE LOSING MONEY! So send us your name and address NOW and GET ON OUR MAILING LIST!

G. L. ELECTRONICS  
905 S. VERMONT AVE., LOS ANGELES 6



# TESTED AND PROVEN BY HAMS

**World Famed Swiss Cimier**  
Originally made as a military watch.  
NOW, here in America... a Swiss  
import and a real sportsman's  
watch! For time of day or  
split-second stop-watch timing,  
the Cimier holds results indefi-  
nitely, while movement keeps  
going. SEPARATE dials re-  
cord minutes and seconds.  
A true precision time piece.

## GUARANTEED

Guarantee certificate for  
one FULL YEAR with each  
watch. SATISFACTION OR  
MONEY BACK.  
Act NOW while we can hold  
this price. Send check or money-  
order for \$9.95, and we will pay  
postage. (Or we will ship COD,  
and you pay the postman \$9.95  
plus COD charges.)



ONLY  
**9.95**  
Tax  
Included

- A sweep-second stop-  
watch
- Three separate dials
- Tachometer  
(for speed)
- Telemeter (distance)
- A precision wrist-  
watch
- Shatterproof crystal
- Genuine leather strap
- Radium dial and  
hands

A SWISS IMPORT—Separate Minute  
And Hour Recorders—All Chrome Back  
NASSAU COMPANY, Dept. 921 Box 792, G. P. O.  
New York 1, N. Y.

unit is a frequency response to the up-  
per limit of the audio range, achieved  
for the first time in p.a.

To assure long life and service under  
all conditions, to the rugged, water-  
proof construction of the unit is added  
a patented "Self-Instal" diaphragm  
assembly. In this simple compact part  
have been incorporated all elements  
of the vibrating system. Instant re-  
placement of the assembly may be  
made at the point of speaker opera-  
tion.

Terminal corrosion has been elimi-  
nated through use of a completely en-  
closed terminal block integrally mold-  
ed into the high impact phenolic case.  
The head of the unit is a zinc alloy  
casting processed to resist corrosion  
and improve adhesion to the baked  
enamel hammertone finish.

The unit is universal and may be  
coupled to any standard straight or  
re-entrant trumpet.

### WATERPROOF CONTROLS

Clarostat Mfg. Co., Inc. of Dover,  
New Hampshire, has announced the  
availability of a new series of water-  
proof controls.

These new units are being made in a  
wide range of resistances and wattages  
and have been especially designed for  
use in military assemblies.

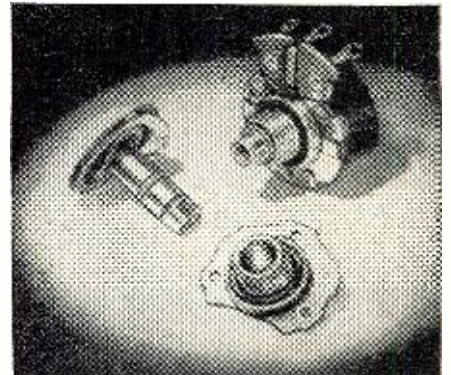

A rubber "O" ring is used on the  
shaft to create a water-tight seal  
which will stand pressure equivalent  
to a six foot head of water. A similar  
rubber "O" ring is used on the mount-  
ing surface of the bushing, performing  
the same function as the shaft "O"  
ring seal.

The rings are of rubber compound of  
special design to meet extreme tem-  
perature requirements and are resis-  
tant to oils and greases.

### AM-FM TUNER

Altec Lansing Corporation, 9356 Santa  
Monica Blvd., Beverly Hills, Cali-  
fornia, has just introduced a new AM-  
FM tuner which includes a built-in  
power supply and multistage audio cir-  
cuit.

Designated the Model 303A, the new  
unit is especially designed for use in  
custom home music installations. It is  
also adaptable for use in industrial  
and broadcast applications.

The AM section of the tuner is of  
the superheterodyne type, designed to  
provide a broadband flat top curve.

The FM circuit employs two grounded

### RADIO & TELEVISION NEWS

## CHECK THESE MONEY-SAVING SURPLUS "BUYS"!



### CONTACT MIKE ASSEMBLY

Postpaid  
in U.S.A. **\$3.95**  
2 miles, on-off switch,  
amplifying trans-  
former, batteries and  
case and connector for  
any radio, AC, DC or  
battery portable.  
Big amplification  
up to full vol.  
output of sound  
system used. 100-  
and-1 other uses!

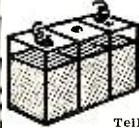

### WILLARD MIDGET 6V BATTERY

3 amp. hr. rating. Trans-  
parent plastic case. 3 3/8"  
x 1 1/2" x 2 3/8". Uses  
standard electrolyte. **\$1.95**

### GRID DIP METER KIT

Tells where your equip. is in the ra-  
dio spectrum. 855 osc. range 3 to  
170 megs. G-3 filament. 150 V. DC.  
With instructions on calibrating coils,  
etc. **\$7.95**

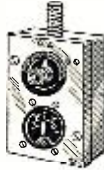

**VIBRATOR TRANSFORMER** for  
that mobile rig. 6 V input. 345  
V. 125 MA output. 15 V. Bias  
Tap. Shpg. wt. 6 lbs. **\$1.49**  
**TRANSFORMER BUY!** 110 V.  
60 cy. input. Output 18 V.  
tapped at 12, 11, 10, 9 at 3  
amps. Shpg. wt. 6 lbs. **.98c**

FULLY STAFFED FOREIGN  
DEPT. FOR ALL EXPORT  
ORDERS

A complete staff of Export Spec-  
ialists for all foreign orders.  
Correspondence and prompt re-  
plies in all languages. Address:  
"Foreign Dept. Alvaradio."

### ORDER DIRECT FROM THIS AD!

Prompt, speedy ship-  
ment. Cash with order.  
Minimum order \$3.00.  
25% deposit on C.O.D.  
orders. Shipments by  
truck or RR. Express  
please, add state sales  
tax. All prices subject  
to change. All merchandise  
subject to prior

### WE PAY TOP \$\$\$ FOR EQUIPMENT!

Especially interested in all types of  
aircraft, radio, test equipment and  
need ARC-1's, ARC-3's, R53/ARN-7's,  
BC-348's, ART-13's, TS-34's. Send  
list of your equipment, present con-  
dition and asking price. Prompt re-  
plies to all correspondence!

# ALVARADIO SUPPLY CO.

DEPT. A-18, 341 S. VERMONT, LOS ANGELES 5, CALIF., DUNKIRK 8-2211

MAKE up to **\$7,500.00** PER YEAR!  
IN

Now! GET YOUR  
**F.C.C. LICENSE**  
AMATEUR OR COMMERCIAL

### TRAIN WITH SHORT-CUT PHOTOSOUND

You Look—You Listen—You Understand

You learn the natural, easy way—by  
SOUND ABSORPTION. While you  
LOOK at simplified diagrams, etc.,  
you HEAR your instructor's voice!  
Repeat to your heart's content—your  
instructor is ALWAYS with you, never  
out of patience! PHOTOSOUND is  
the easiest way ever devised to master  
Electronics—NATURE'S WAY of rep-  
etition, repetition, and repetition.

YOU GET AND KEEP  
OVER 140 RECORDINGS AND 20 VOLUMES

All records and study material become  
your personal property—a valuable  
life-long reference library to help  
you in your career. THE COMPLETE  
COURSE IS YOURS FOR LESS  
THAN THE COST OF THE REC-  
ORDS ALONE!

NO OTHER TRAINING OFFERS  
SO MUCH FOR SO LITTLE!

### HIGH-PAID JOBS NOW OPEN TO GOV'T.-LICENSED RADIO-TV MEN

Average pay reported by F.C.C. nationwide  
survey is \$3,000 to \$7,500 per year for F.C.C.  
ticket holders. Employers want F.C.C. Li-  
censed technicians—an F.C.C. Ticket is  
proof of technical ability. Get YOUR F.C.C.  
License the EASY WAY, with Amazing  
"PHOTO-SOUND" Home Training.

- "YOUR CAREER IN  
COMMUNICATIONS"
- PHOTOSOUND RECORD
- SAMPLE LESSON

Get full  
details NOW!

Mail Coupon

**FREE** ELECTRONIC TECHNICAL INSTITUTE Dept. RN-111  
769 Venice Blvd., Los Angeles 19, Calif.  
Gentlemen: Please send me FREE your booklet, "Your  
Career in Communications," with PHOTOSOUND RECORD,  
and Sample Lesson. I am interested in the F.C.C. AMA-  
TEUR  COMMERCIAL  LICENSES.

NAME..... AGE.....  
ADDRESS.....  
CITY..... ZONE..... STATE.....



grid r.f. stages, a separate oscillator and triode mixer stage, two stages of i.f. amplification, and a ratio detector. Both the AM and FM sections incorporate a.v.c. and a magic eye.

An unusual feature of this unit is a built-in multistage amplifier with a preamplifier for variable reluctance pickup and the following controls: a

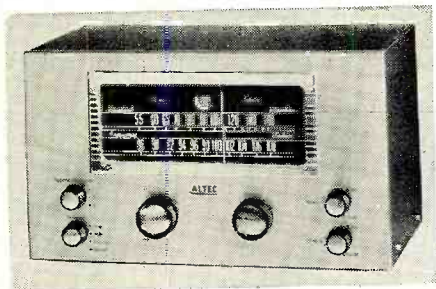

four-channel selector switch for AM, FM, phonograph and a spare; a three-step selection of record crossover frequencies; equalization for variable reluctance pickup; filter for 33 1/3 recording characteristic use; variable control of rise and drop in both treble and bass; and a continuously variable volume control.

Additional information on the 303A is available from the company.

#### MOUNTING BRACKET

Kenwood Engineering Co., Inc., of Kenilworth, New Jersey has developed a new parapet mounting bracket which will accommodate antenna masts up to 1 1/2" in diameter.

Designated the Model 106, the new unit consists of a sturdy frame with four claw-like members which clear the coping and extend to the wall. These claws are made of heavy gauge steel placed on edge to give powerful clamping action. At the lower end of each claw is a hardened cone point set screw which gives positive anchorage

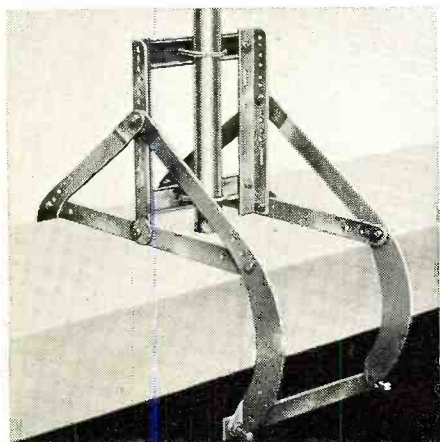

to the wall. A novel eccentric or cam at each side of the frame can be adjusted to give positive vertical support on tile or stone coping.

The mount is shipped completely assembled for quick installation on walls up to 13 1/2" inches thick. Hot dip galvanizing is used to provide permanent rust protection.

-30-

**PROVEN UNDER  
ACTUAL  
TESTS!**

**up to  
200 MILE  
RECEPTION!**

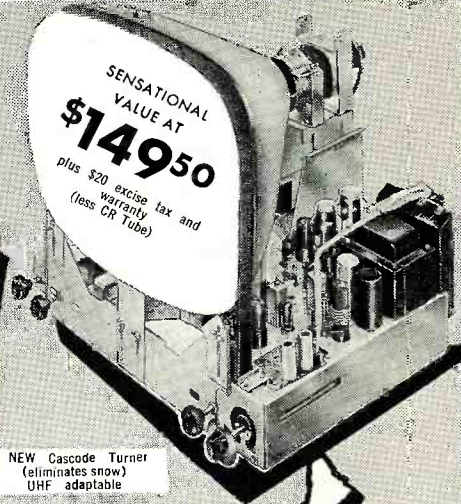

NEW Cascade Turner  
(eliminates snow)  
UHF adaptable

TEN TIMES THE  
SENSITIVITY OF STANDARD SETS  
**THE SUPER VIDEO  
630 DX CHASSIS**

The Country's Most Powerful TV Receiver  
FOUR MICROVOLT SENSITIVITY  
(Per RTMA Measurement Standards)

#### SPECIAL!

Nationally Famous—Standard 630 Chassis **\$13450**  
30 Tubes—Quality Features.....  
Available with DuMont inputuner FM Radio \$10 add.  
Add \$20 excise tax and warranty.

#### IMPORTANT!

IMMINENT SHORTAGES MAY FORCE PRICE  
INCREASES  
ORDER NOW!

Manufactured by the Famous Video Products Corp.

#### Check These High Quality Features

- 30-tube Chassis
- Four Microvolt Sensitivity
- Four Stages of Video IF
- Keyed Automatic Gain Control
- Syncroloc-Automatic Frequency Control
- Limiter-Discriminator FM Sound Circuit
- Standard Coil Turret Tuner
- Separate Circuits for Sound and Video

Will Drive Up To 24" Tube Without Changes

First Quality, Fully Guaranteed Picture Tubes  
at These Amazing Prices

17" .. \$34.75 20" .. \$44.75 24" .. \$82.75

#### Order Your Super Video Long- Range Chassis TODAY!

Terms: 25% Deposit with order, balance  
C.O.D. All prices F.O.B. New York.  
Prices subject to change without  
notice.



**ROYAL**  
TELEVISION SALES

2085 Valentine Ave., New York 58, N. Y.

Immediate  
Delivery of  
**RADIO  
TV**

**SCARCE  
TUBES**

**TUBES  
BOUGHT,  
SOLD and  
TRADED**  
Send Your  
Want and  
Trade List!

Complete Line of  
TELEVISION PICTURE TUBES

Radio and TV service men, experimenters, amateurs, we have many types of scarce tubes ready for immediate shipment. Don't use make-shits or spend valuable time looking for tube sources. Try Electro FIRST and get the tubes you need without delay. Get complete list and Electro's low prices. It's FREE... write today!

**ELECTRO SALES** 425 W. Randolph St.,  
Chicago 6, Ill.

**RADIO  
ENGINEERING**

**B.S. DEGREE IN 27 MONTHS**

Complete Radio Engineering course incl. Telev., U.H.F., and F.M. BS Degree Courses also in Mech., Civil, Elect., Chem. and Aero Eng.; Bus. Adm., Acct. Extensive campus, modern buildings, well equipped labs. Low cost. Prep courses. Personalized instruction. Heavy demand for graduates. Placement service. Founded in 1881. Prepare now for the civil and military opportunities ahead. Enter Jan., March, June, Sept. Write for Catalog.

**TRI-STATE COLLEGE**  
16111 COLLEGE AVE. ANGOLA, INDIANA



**ARMY — NAVY  
AIR FORCE — MARINES  
SERVICEMEN — TECHNICIANS**

**Here's Help!**

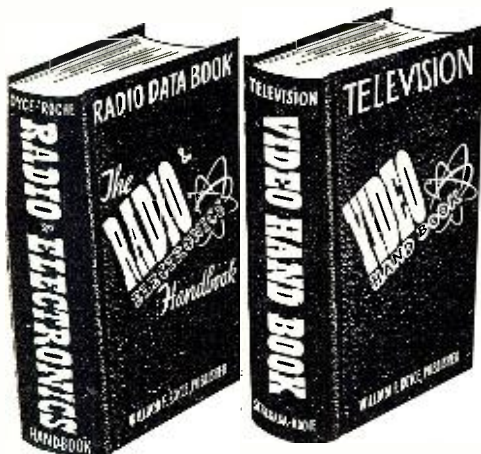

**Now! IN 1800 PAGES**

**THE BASIC KNOWLEDGE AND DATA OF  
RADIO & TELEVISION  
DIGESTED INTO 32 SECTIONS . . . IN A  
COMPLETE, QUICK-TO-FIND, EASY-TO-READ  
HANDBOOK FORM.**

You can plan every operation in TV—Radio and Electronics with the Library Set. These handbooks are your lifelong tools—use them every day on the board, at the bench, or in the field—for construction, production, servicing, installation or operation—for adjusting, trouble-shooting, measuring and testing. Your invaluable aid in service, research, development, design, manufacturing and maintenance. With all data and servicing procedures, these handy books work better, faster and easier.

In addition, you get complete coverage of everything you need in TV, Radio and Electronics—in practical form—everything presented in plain talk, all terms explained; schematics, working diagrams and pictures all clearly illustrated for your quick and easy reference.

These books are works of complete authority prepared by the well known engineers, Joseph J. Roche and Morton Scheraga, under the direction of William F. Boyce, famous for the preparation of hundreds of handbooks and manuals for the U. S. Signal Corps, U. S. Navy, U. S. Air Force, Western Electric Co., General Electric Co., Bell Laboratories, National Radio Co., and many others.

These Handbooks are endorsed by leading schools for instruction and reference. The armed services make them available to their technicians in libraries, schools, and in the field. Engineers, Draftsmen, Laboratory and Production men in every industry have purchased over 50,000 of these books for use in their work.

500 Radio jobbers keep them constantly in stock for the convenience of their service and industrial customers. These are the most commonly used books in Radio and TV.

Whether you use these Handbooks for general reference, scientific instruction or education, one thing is certain; the practical help, the daily usefulness you will derive from them will prove to be worth many times their price.

Contents are too long and complete to describe here, so see the books at your Radio Jobber, your bookstore, or

**SEND FOR TEN DAY  
FREE TRIAL EXAMINATION**

**RADIO ELECTRONICS HANDBOOK.....\$7.00  
VIDEO HANDBOOK ..... 7.00**

**SPECIAL OFFER! SAVE \$2.00**

**The LIBRARY SET.....\$12.00**

**BOYCE ROCHE BOOK CO.  
Caldwell 31, New Jersey**

Send ( ) Library Set (2 books) @ \$12.00  
( ) Radio Electronics Handbook @ \$7.00  
( ) Video Handbook @ \$7.00

In ten days I will send price plus postage, or I will return books postpaid.  
(Offer good in U.S.A. and to men in Armed Services overseas only.)

Name.....

Address.....

Employed by.....

Save postage—we pay postage and packing if you send money NOW. Money back on same return vilege.

**Capacitance Pickup**

(Continued from page 41)

it would appear that such a circuit could not be made to oscillate. However, by inserting a tuned inductance  $L_2$  in series with the anode, the resonance of  $L_2$  being adjusted by a molded iron core to a resonant frequency slightly higher than that of  $L_1$ , oscillation will take place at approximately the resonant frequency of  $L_1$  and associated capacitances.  $L_2$  is tuned by distributed coil capacitance plus associated circuit capacitance. During record reproduction, the operation of the pickup results in frequency modulation of the oscillator. This, in turn, produces a corresponding modulation in the amplitude of oscillation, because of the circuit properties. Simultaneous rectification of this r.f. signal produces an audio voltage across the anode coupling resistor  $R_1$ . This audio voltage corresponds very exactly to the motion of the pickup stylus.

The audio signal is coupled to the grid of audio amplifier  $V_{1b}$  through  $C_8$ , bypass condenser  $C_7$  and series coupling resistor acting to filter out the r.f. voltage.  $V_{1b}$  provides very little gain except at frequencies where the negative feedback is fully or partially removed by  $C_{11}$  or  $C_{12}$ , thus providing conventional equalization for normal record reproduction.

**Oscillator Operation**

As described before, when the circuit associated with  $L_2$  is tuned to a resonant frequency slightly higher than that of  $L_1$ , steady state oscillations are generated, and a voltage drop across  $R_1$ , corresponding to the strength of oscillations, is established.  $L_3$  is mounted so that it is loosely coupled to  $L_2$ .  $L_3$  is tuned by a molded iron core to a resonant frequency which is lower than that of  $L_1$  and adjusted so that the amplitude of r.f. oscillation is reduced but not stopped.

For the sake of simplicity in adjustment,  $L_3$  may be removed with an accompanying reduction of approximately 4 db in audio output. This reduction would be greater except that the apparent "Q" of  $L_2$  is increased by the removal of  $L_3$ , due to resistance losses in the circuit of  $L_2$  and associated distributed coil capacitance  $C_2$ . When  $L_3$  is eliminated, the tuning of  $L_2$  is the only circuit adjustment required for optimum operation.

The exact resonances of  $L_1$ ,  $L_2$ , and  $L_3$  with relation to one another can best be adjusted dynamically.

To understand the sensitive response of this circuit to capacitance variation, let us examine what happens when the electrode spacing of  $C_1$  is varied.

First, note that the actual oscillation frequency corresponds essentially to the resonant frequency of the circuit of  $L_1$  at all times. When the spacing of  $C_1$  is increased or decreased, the oscillation frequency is correspondingly raised or lowered, thus approaching

**A "Sound" INVESTMENT  
IN FINE MUSIC . . .**

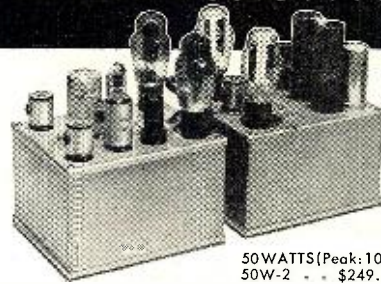

50 WATTS (Peak: 100)  
50W-2 . . . \$249.50

**McIntosh**  
WORLD'S FINEST  
AUDIO AMPLIFIER

**50 WATT AMPLIFIER**

20 WATTS  
(peak: 40)  
20W-2  
\$149.50

Unequaled for quality reproduction of any sound source, the McIntosh is the most advanced amplifier of the day. Its unique, compact design offers: **HIGHEST EFFICIENCY** — over 65%; **LESS THAN 1% DISTORTION AT PEAK POWER**; **DYNAMIC RANGE: OVER 70 db**; **FREQUENCY RESPONSE: 20-20,000 cps.**



AE-2 Amplifier  
Equalizer - \$74.50

SEND FOR **Free** CATALOG Dept. F-3

**McINTOSH Engineering Laboratories, Inc.**  
320 Water Street, Binghamton, N. Y.

**YOUR COPY of  
NEW 1951 COMPLETE  
GREYLOCK  
CATALOG**

IS NOW

**READY!**

SEND FOR IT  
TODAY!

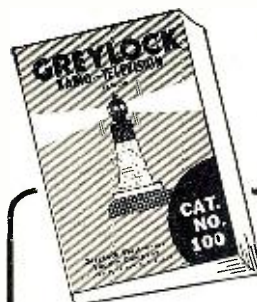

**68 Pages**

crammed full  
of Radio—  
Electronic—  
Television

quality merchandise at terrific savings!  
Many standard lines carried, including:

- BOGEN Challenger Line, Boosters
- JACKSON Instruments
- RIDER Publications
- CORNELL-DUBILIER Vibrators, Converters, Rotators
- SPRAGUE • HYTRON • BURGESS
- REGENCY • ELECTRO-VOICE • JENSEN

High quality Greylock Tubes still available at some of Today's best prices.

If you sell or service Radio, TV or Electronics equipment, you can't afford to be without this **GREAT BUYING GUIDE!** Write NOW for your copy (unless already on our mailing list).  
Dept. N-11

**GREYLOCK ELECTRONICS SUPPLY CO.**  
115 Liberty Street - New York 6, N. Y.

**RADIO & TELEVISION NEWS**



or receding from the higher resonant frequency of the circuit of  $L_2$  in the anode circuit. Consequently, the oscillation amplitude increases or decreases due to the variation in the voltage developed across  $L_2$ , as the circuit approaches or departs from the conditions of an accurately adjusted tuned-plate, tuned-grid oscillator.

Simultaneously with this increase or decrease in the spacing of the electrodes of  $C_1$ , the oscillation frequency is correspondingly shifted away from or toward the resonant frequency of the  $L_2$  absorption circuit, so that the load loss is reduced or increased in like manner, thus compounding the resultant change in oscillation amplitude.

A further compounding of the change in oscillation is produced because of the corresponding increase or decrease in effective grid-to-plate capacitance  $C_6$ , due to the Miller effect. This increase or decrease in the effective value of  $C_6$  causes the resonant frequency of  $L_2$  to decrease or increase as the oscillation frequency is increased or reduced in the same order, while the effect on the grid circuit is of little magnitude due to the low impedance of the immediate connection into the grid.

Since it is not desirable to reproduce frequencies under 20 cycles, inverse feedback is introduced from plate to grid of the oscillator tube by returning the oscillator grid circuit to ground through  $R_0$  and  $R_2$ . This feedback is effective at sub-audible frequencies only, due to the time constant of  $R_0$  and  $C_3$ . This reduces the low frequency response below 20 cycles.

The circuit which has been described produces a distortionless audio output voltage from a single-ended variable capacitance pickup. This result has been developed for a particular type of pickup in which the capacitance variation is inherently non-linear, as a natural consequence of the variable spacing between the electrodes.

The correction of the inherent non-linearity in this pickup is accomplished by establishing the mean frequency of the above described oscillator at a suitable position on the low frequency slope of the anode circuit resonance curve near the knee of the curve. This produces a response to capacitance which is non-linear so that the sum effect of the non-linear capacitance variation in the pickup and non-linear capacitance response of the oscillator is an over-all system which is free of distortion to a remarkable degree.

#### One Gram Vertical Pressure

A goal of one gram of vertical pressure was established for the ideal pickup. One gram seemed impossible enough to achieve unless old techniques were revised or superseded. It was decided to develop the lowest pressure pickup possible irrespective of practical considerations, such as the tripping pressure required by automatic record changers, and fragility under rough handling; then when the successful low pressure pickup was attained, to work back to some practical

# NEW! STANCOR



Here are three of the newest additions to the most complete transformer replacement line in the industry.

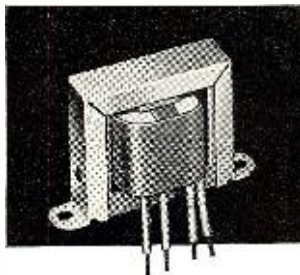

### A-8124, VERTICAL BLOCKING-OSCILLATOR TRANSFORMER

A three winding transformer for replacement in Dumont models RA-103, RA-103D, RA-104A, RA-105, RA-105B, RA-108 and RA-110A. See Stancor Bulletin 384.



### FC-11, FOCUS COIL.

For use with picture tubes up to 24". Equivalent to RCA 202D2. See Stancor Bulletin 383.



### P-8163, TV POWER TRANSFORMER

Equivalent to RCA 75508 (971316-1), used in 28 RCA models. See Stancor Bulletin 388 for a complete list.

Your Stancor distributor has data sheets on these new Stancor TV transformers. Ask him for the latest Stancor Bulletins.

Other new Stancor TV components include **DY-8**, **DY-9**, and **DY-10**, 70° deflection yokes with ferrite cores, nylon coil bobbins and anti-astigmatic focusing (resulting from "cosine" distributed windings) for tubes up to 24". **A-8131**, an air core "flyback" for direct drive circuits, to be used with **DY-10**.

**STANCOR TV TRANSFORMER CATALOG AND REPLACEMENT GUIDE** lists transformer replacements for over 1500 TV models and chassis. Available **FREE** from your Stancor Distributor.



## STANDARD TRANSFORMER CORPORATION

3580 ELSTON AVENUE, CHICAGO 18, ILLINOIS

# Free NEW BIG RADIO CATALOG



Ready now. Complete with everything in radio, television and electronics. Newest parts, as well as old, standard lines. Paste coupon on penny postcard and mail today!

*Lafayette Radio*

DIVISION: RADIO WIRE TELEVISION, INC.

NEW YORK 13 100 Sixth Ave. NEWARK 2 24 Central Ave. BOSTON 10 110 Federal St. BRONX 58 542 E. Fordham Rd.

**LAFAYETTE RADIO,**  
Dept. RK-1  
100 Sixth Avenue, N. Y. 13

Please rush Free catalog to:

Name.....

Address.....

City..... State.....

PASTE ON PENNY POSTCARD



# Wide Range Reproduction For the Home

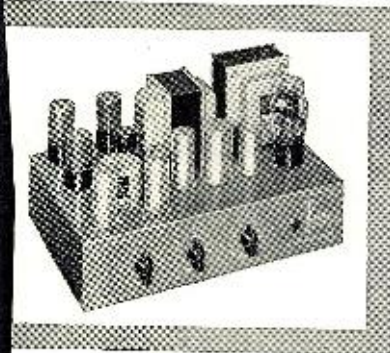

## \* Triad Hi-Fidelity Amplifier Kit...

The Triad HF-10 Amplifier, from a circuit designed in cooperation with J. N. A. Hawkins, prominent sound engineer, has been produced especially for those who like to build their own sound reproducing systems. When used with the high quality speakers, tuners, turntables, and pick-ups now available, a system can be built that will meet the requirements of even the most critical music lover. The Triad HF-10 kit supplies the basic engineering and solves the most difficult mechanical layout problems. With 18 db. of feedback, affording a reflected impedance of less than 2 ohms to the 16 ohm speaker tap, within 1 db. linear frequency response from 20 to 20,000 cycles, and with a minimum of distortion over this same range, the HF-10 is worthy of use in the very finest home music installations.

### \* Features...

- Wide Frequency Response:** Within one db. from 20-20,000 cycles.
- Low Distortion:** Less than 2% from 50-18,000 cycles at full 10 watts output. Less than 1% from 20-20,000 cycles at 5 watts.
- Heavy Speaker Damping:** Reflects less than 2 ohms to speaker from 16 ohm tap.
- Equalization:** Continuously variable to +12 db. or -30 db. at 50 or 8000 cycles.
- High Gain:** 74 db. from crystal microphone or radio receiver; 96 db. (equalized for magnetic pickup) through preamplifier.
- Low Noise:** Hum and other noise 60 db. below maximum output. A-74J equalizing coil has 70 db. shielding.
- Beautiful Appearance:** Gray hammertone chassis with ivory silk-screened lettering, matching gray Triad transformers.

### \* Prices

- HF-10 Kit**—Includes S-31A, R-14A, A-74J, and C-10X Triad transformers, chassis, prints and assembly instructions. List Price \$43.00
- HF-10A Kit**—Same as above except for substitution of HS-81 output transformer for S-31A. List Price \$63.50

Also available with 500/250/150 ohm secondary output transformers.  
Write for Catalog TR-51



2254 Sepulveda Blvd.  
Los Angeles 64, Calif.

compromise pressure while retaining as many of the newly developed advantages as possible.

### The Stylus Assembly

After studying various materials for the stylus point, it was decided that sapphires offer the greatest advantage of low mass and high wear resistance. Diamonds naturally wear longer but for a given cubic volume, the sapphire weighs less. The next consideration was the configuration of the flexible stylus mounting assembly and its material. To obtain a resonance of 17,000 cycles-per-second or higher, it was necessary to use a mechanical structure and material with the maximum stiffness and the minimum mass, otherwise the length of the stylus becomes so short that its compliance cannot be made great enough. Consequently, a tubular structure was used and aluminum alloy was the ultimate choice for the material.

A viscous block was so located and proportioned that it dampened the vertical as well as the horizontal modes of the stylus assembly. The damping was so applied that little energy was absorbed by the block except at frequencies near the stylus resonance. This eliminated the familiar dip in response near resonance as encountered with most stylus systems.

The tone arm for use with this pickup was made as light as possible, although resonating with the stylus compliance at 20 cycles. Tubular aluminum alloy was used for the arm with an inside diameter of 1/4 inch. With the inside conductor in place, and the socket assembly for the plug-in head added, the pressure on the stylus point was 5 grams. With a tone arm of such low mass, the stability under vibration is almost unbelievable, as attested by the fact that the turntable can be jarred heavily without causing the pickup to jump grooves.

Counter-balancing of the arm was tried in order to reduce the pressure, and it was discovered that operating pressures of one gram could be achieved, the jumping of grooves being about on a par with a good magnetic pickup working at 8 grams when the turntable was jarred.

Although at this stage, this pickup performed far better than anything tried previously, dust collected around the stylus, and operation wasn't quite stable enough for use on moving vehicles at one gram pressure. A brush was placed on the pickup head so that the bristles engaged the record a few grooves in advance of the stylus point. The dimensions of the bristles were chosen so that the brush would not engage the grooves and act as a lead-in device but would ride along the record surface and take the excess weight off the stylus point. Thus the dust is stripped off the record just ahead of the stylus, and collected in a convenient little ball which drops off harmlessly when the pickup is raised from the record.

The stiffness of the brush was pro-

**★ BUY WITH CONFIDENCE ★**  
**★ 5 Day Money Back Guarantee ★**  
**★ ELECTRONIC SURPLUS MATERIALS ★**

**★ AUDIOTONE CONTINUITY & LEAKAGE TESTER—New Item • Not Surplus • Tests by Sound No Tubes • Wide Range • Checks all Circuits • Safe • 0 Ohms to 100 Megohms. Current 300 Microamps. \$19.50 ★**

**★ CODE OSCILLATOR—tubeless, learn code \$7.45 ★**  
 Singly or group, complete w/key...  
**★ DUPLEX FONG SET—excellent for TV and installation, etc., leaves hands free for working, complete \$5.95 ★**  
**★ SELENIUM RECTIFIER—V W B up to 90 VAC input, 150 ma. continuous duty, 20 plates, special \$1.50 ★**  
**★ HAND DRIVE GENERATOR—6V/3A & 315 VDC/200ma, a natural for portable & C D equipment, used, good condition... \$6.95 ★**  
**★ 2 Midget carbon buttons suit. Hi gain lapel mike, elect. nurse, less strap... \$0.69 ★**  
**★ TERMINAL STRIP—6 term. molded, 8-32 brass studs w/ nuts, washers, barrier type, 5000 V insul. bargain @ \$0.29 ★**  
**★ PRECISION GANG CARDWELL VARI. CAPS—150 mm/sect, 3 air trimmers, suitable test units, oscillators, etc... \$3.95 ★**  
**★ SOUNDER COIL ASSY—7000T # 38 Formex, 500 ohm 10 to 50 VDC. Makes excellent 110 VAC buzzer... \$0.39 ★**

**★ RELAY BUYS ★**

**★ CLARE SMALL TEL TYPE, DPST NO—makes @ 11 V, breaks @ 4 V, 375 ohm coil... \$1.25 ★**  
**★ CLARE—same as above, DPST, 350 ohm 8 ma coil, excellent sensitive plate relay... \$1.75 ★**  
**★ ALLEN BRADLEY BS—enclosed solenoid ac. 24V 100ohm coil, 50 amp, silver plated contacts... \$1.75 ★**  
**★ HART MFR.—same as above, 12-24V operation... \$1.95 ★**  
**★ KLIXON TYPE ER THERMAL RELAY—110/220VAC, 15/10 amp, control of low current controls, et room thermostats, etc., control circuit requires 7 W/115VAC/DC, a wonderful buy at... \$1.95 ★**  
**★ LINE NOISE FILTER—Mallory NF-1, oper. 60-6-240V AC/DC. Makes excellent... \$0.89 ★**  
**★ FILTER KIT ASSY—consist dual cond. & 15 amp coil, pr... \$0.69 ★**

**★ COMPONENT KITS OF QUALITY—SPECIAL SEE OUR ADV. IN OCT. RADIO NEWS PAGE 165. ACT FAST FOR EXTRA BONUS SALE. ★**

**★ ELECTRONIC SPECIALTY SUPPLY COMPANY ★**  
 ★ 56 Lispenard St., Dept. RN-11, New York 13, N. Y. ★

## WHY WILL YOU CHOOSE YOUR TAPE RECORDER?

- Q. Higher Fidelity and Smoother Performance?**  
**A. THEN BUY TWIN-TRAX!\***
- Q. Longer Continuous Playing Time?**  
**A. THEN BUY TWIN-TRAX!\***
- Q. Professional Specifications at Popular Price?**  
**A. THEN BUY TWIN-TRAX!\***
- Q. Wider Selection of Models?**  
**A. THEN BUY TWIN-TRAX!\***

No matter which of these features you consider most important. You'll find them all—and many other exclusive features—in our Twin-Trax Recorders. Send today for your free copy of our Catalog #5272. \*Reg. U. S. Pat. Off.

**AMPLIFIER CORP. OF AMERICA**  
 398 Broadway, New York 13, N. Y.

**CODE SENDING SPEED**  
**CODE RECEIVING SPEED**

**HIGH SPEED WITHOUT NERVOUS TENSION**  
 REVEALING BOOK shows how "crazy" operators develop high speed and proficiency. Learn code for amateur or Commercial Radiotelegraph License, or improve your sending and receiving with the Candlor System which develops radio-telegraph code champions.  
**CANDLER SYSTEM CO. FREE BOOK!**  
 • Box 928, Dept. 2-M, Denver, Colo.

**QUALITY • SERVICE • DEPENDABILITY**  
**DUMONT** PERFECTLY CENTERED  
 COMPLETELY MOLDED **CAPACITORS**  
 Sold and Preferred Everywhere  
**DUMONT Electric Corp.**  
 308 Dyckman Street, New York 34, N. Y.



portioned so that the pressure on the point was reduced from 5 grams to approximately 1 gram. From a stability standpoint this pickup with a brush left little to be desired. It will even track 78 rpm shellac records at 1 gram and never miss a groove, even when operating in a moving vehicle.

The frequency response is good from 20 to 20,000 cycles-per-second as shown in Fig. 3. The distortion is noticeably lower than that of the most expensive magnetic pickups. The surface noise from the record is less noticeable than that of any other pickup. The direct sound, or "needle talk" radiated by the pickup is many decibels lower than any previously established standards. The records never seem to wear out and the sapphire points are still in good condition after months of practically continuous operation.

### Performance

The audio output of the pickup and complete oscillator unit from a Cook frequency disc is on the order of 5 volts at 1000 cps and the frequency response is substantially constant in amplitude from 35 to 15,000 cps. See Fig. 3. Below 35 cps there is a 4 db rise, reaching a maximum at 20 cps. This maximum at 20 cps is caused by a light "build-up" due to resonance of the tone arm in conjunction with the compliance of the stylus; however, this slight rise is indicative of the effectiveness of the arm damping.

Above 15,000 cps there is a broad rise reaching a maximum of 2 db at 17,000 cps, with the 20,000 cps response only down 1 db below the 17,000 cps response.

### Conclusions

The removal of all mechanical resonances from the range of audibility in this pickup results in sound from new high quality microgroove recordings as good as the sound from the original tape master. The low mechanical forces required of the record extends the record life many times, and the low pressure on the jewel extends the life of sapphires indefinitely.

Experience with this type of pickup over a period of years has shown that records are scratched and worn more by removing them from their envelopes, placing them on turntables, and rubbing them together than from dropping this pickup on the records, or even from scrubbing the stylus back and forth across the grooves. Even when scratches or other abrasions do appear on the record, the resultant noise when using this pickup for reproduction is not as distracting as in the case of pickups having sharp cut-offs or resonant peaks.

Since there is less groove wall flexing at high frequencies when using this pickup, the stylus response to steep wave front and strong high frequencies produces the effect of additional high frequency response; thus a higher signal-to-noise ratio is immediately apparent.

# Sam's Surplus Sells For Less

**COMMAND AND/OR ARC5 TRANSMITTERS and RECEIVERS**

BC-412 Antenna Relay, Less Vac. Cond.	USED	NEW
BC-430 3 Receiver Control	\$ 1.95	
3 6 MC Receiver	6.95	\$11.95
6-9-1 Receiver	6.95	9.95
Triple Receiver Track	\$1.95	
V.H.F. ARC5 Transmitter or Receiver, Complete w/tubes	19.95	
2-3 MC Transmitter with tubes	14.95	
1-5.3 MC Transmitter with tubes	5.95	
5-10 MC Transmitter with tubes	5.95	
7-8 MC Transmitter with tubes	9.95	19.95
3-4 MC Transmitter with tubes	12.95	
28V Receiver Command Dynamotors	\$0.97	

**MODULATORS**

BC-456 with Tubes, less dyn.	2.95
MD-7/ARC5 Plate Modulator	7.95
MD-7 Modulator Dynamotor, 28V.	3.95

**BC-433 Receiver—w.o. tubes** \$12.95  
**—with tubes** 24.95  
**MN-26C Compass Receiver** 24.95 **\$39.50**  
**BC-357 Marker Beacon Rec. W.O. Tubes** 4.95

**BC-375 Trans, 100 Watt Voice, CW, MCW, freq. range 200 kc to 12 mc, uses Plug-in Tuning Units listed complete with tubes, less Tuning Units** \$18.95 **\$29.95**

**TUNING UNITS for BC-375 or 191 Trans:**

TU- 7 4500-6200 kc	\$2.49
TU- 8 6200-7700 kc	2.49
TU- 9 7700-10000	2.49
TU- 10 10000-12500	2.49
TU- 22 & TU-23 200-500 kc	each 4.50
FT-151 Shock Mounting for BC-375 or 191	2.95
BC-306 Antenna Loading	1.95

**GP-7 NAVY TRANSMITTER:** 100 watt master os. Can use on any freq. from 350-9050 kc. by using proper plug-in. With 1 tuning unit. **\$15.95**

**LOOP ANTENNAS**

DU-1 Has 2 tube amplifier	New \$25.95
MM-20-F	New 7.95

**FL5 Filters—A's, B's, C's** New \$ 1.95  
**FL5 Filters** New .95  
**Hand Keys—J-38** New .79  
**TSC TRANSMITTER & RECEIVER with 12V Power Supply and Cables, Good used** 179.50  
**Heinemann Circuit Breakers, 115 V., 20 amp.** 1.00  
**115 V., 5 amp.** .97  
**Prop Pitch Transformer, only** New 6.95  
**RT-7APN-1 Transceiver, tubes & dyn.** Used 9.95

**TRANSFORMERS**

12V 24V 2 am 110V primary	\$2.95
---------------------------	--------

**ARC-4 2 Meter Transceiver, tubes—good, used** \$29.95  
**522 2 Meter Transceiver with tubes—good, used.** 59.50  
**BC-434 Control** Used—\$1.95 New 2.95  
**Code Practice Tapes for TG-10 15 rolls.** New 7.95  
**Field Phones E-E 8's. Used** \$15.95 pr. New \$34.50 pr.  
**Mobile Relay, SP.-ST. Leach 6 V or 12 V.** New 1.49

Cash with order. Prices subject to change without notice. California Orders Please Include 3 1/2% Sales Tax. What You Will be refunded. What Have You in Surplus? Submit

**ESEGE SALES COMPANY INC.** 1306 BOND STREET, at PICO LOS ANGELES 15, CALIFORNIA

**HARVEY WELLS AIRCRAFT TRANSMITTER**

Complete with 12 Volt Vibrationator Supply, can be modified to 6 Volt for mobile operation. Inter-9 705 Modulators Controlled. 3105 KC. Consists of 7C5 Pierce Oscillator, 7C5 RF AMP, 9 705 Modulators. Excellent for 75 meters—or Marine. Complete with Instruction Manual. NEW.

**\$31.50**



**DYNAMOTORS**

PE-103 NEW, ORIGINAL CASE	\$29.95
PE-103 NEW, Less Base—Dynamotor	19.95
DM-32A Input 28V. Output 250 DC. .06 amps	Used 1.95
DA-1A Input 28V @ 1.6 amps. Output 230 DC @ 1 amp	Used 5.95
PE-73 20V @ 20 amps. output 1000V @ 350 amps	New 5.95
PE-77 14V @ 40 amps output 1000V @ 350 amps	New 15.95
SPEC. 27V @ 400V @ 7.50 mil 750V 350 mil	New 12.95
PE-94 or SCR—522 24V. Used	\$5.95 New 14.95
PE-94 Dynamotor only	4.45
DM-34 12V @ 2.8 amps. Output 220V @ 160 amps	New 5.95
SPEC. 9V @ 450V output @ 80 ma. New	5.95
SPEC. 12V @ 320V output @ 80 ma. New	4.95
SPEC. 8V @ 250V output @ 80 ma. New	5.95
SPEC. 12V @ 440V output @ 200 ma. New	8.95
ARC-1 DY-9/ARC-1	Used 11.50
ARC-1 DY-10-12V	Special 9.50
14 Volt Input—425 Volt Output at 163 mls. Starting Filter and Relays in base	Like New 3.95

**RL-42B Antenna Reel Ass. Less wire** New 9.95

**OIL CONDENSERS**

Standard Makes—New

2 mfd 600V	\$0.48	10 mfd 600V	\$ 1.95
4 mfd 600V	1.35	2 mfd 2500V	2.95
1 mfd 1000V	.65	2 mfd 4000V	5.95
3 mfd 4000V	7.55	2 mfd 5000V	5.95
		2 mfd 7500V	29.95

**EVERY RADIOMAN Can Use These SERVICE HINTS!**

**Valuable Manual Yours—FREE!**

Every page of "How to Simplify Radio Repairs" is backed with on-the-bench practical ideas. Contains photos, charts, diagrams—no fluff—no vague theory. In plain every-day language it gives you priceless suggestions—new servicing ideas. You'll use and benefit from the experience of experts. Partial list of contents: How to Localize Trouble; How to Service Amplifiers; How to Test for Distortion; How to Test Audio Circuits; How to Test Speakers; How to Find Faults in Oscillators; How to Test Radio Parts—and it's all yours—FREE! No obligation.

**FEILER** SEND COUPON OR PENNY POSTCARD FOR YOUR FREE COPY TODAY!

**FEILER ENGINEERING CO., Dept. 11H1**  
 8026 N. Monticello Ave., Skokie, Ill. (Suburb of Chicago)

Please RUSH my FREE copy of "How to Simplify Radio Repairs."

Name .....  
 Address .....  
 City ..... Zone ..... State .....

**Trained men always welcome in RADIO • TV • ELECTRONICS**

**CREI trains you for better jobs, higher pay—in minimum time!**

Industry approves CREI by (1) welcoming our graduates, and (2) using CREI training for their technicians (e.g., RCA-Victor Division, United Air Lines, Sears Roebuck). Win your lifetime career with CREI Residence School training in historic Washington, D.C. Average time required: 22 months.

**SEND FOR ILLUSTRATED FREE CATALOG**

Get your copy of new descriptive catalog, with survey of opportunities, and details of course and school. New classes start twice a month. Act now!

**CAPITOL RADIO ENGINEERING INSTITUTE**  
 An Accredited Technical Institute Founded in 1927  
 Dept. 1311 C, 16th & Park Rd., N.W., Wash. 10, D.C.

**KAAR RADIOPAK THE MOBILE RADIOTELEPHONE**

**KAAR ENGINEERING CO. FALD ALTO, CALIFORNIA**





**NEW** a "must" book for every TV Service Technician

**"Servicing TV in the Customer's Home"**



**SAVES TIME SAVES WORK Earns More for You on Outside Service Calls**

**shows how to diagnose trouble using capacitor probe and VTVM**

Here's the book you've been asking for—practical, proved help to make your outside TV servicing really effective and profitable. Saves time, work and chassis hauling . . . shows you how to make successful repairs on the spot. You learn the following: 1. A simple, effective method for tracing down trouble, using your VTVM and a simple capacitor probe. 2. Methods for finding your way around a strange circuit—shows you how to "pull tubes" and diagnose trouble by observing audio and picture effects. 3. How to judge TV set performance by analysis of the test pattern. 4. Methods for making adjustments in the field. You'll want this essential, profit-building book. Handy pocket size; sturdy cover. **\$150**

ORDER TC-1. Only . . . . . Pays for itself on the very first job.

**HOWARD W. SAMS & CO., INC.**

Order from your Parts Jobber, or write direct to HOWARD W. SAMS & CO., 2201 E. 46th St., Indianapolis 5, Ind.

**ORDER TODAY**

Send . . . copy(ies) of "SERVICING TV IN THE CUSTOMER'S HOME," \$1.50 per copy.

(Check) (money order) for \$ . . . . . enclosed

Name . . . . .

Address . . . . .

City . . . . . State . . . . .

**Classified**  
Rate 50c per word. Minimum 10 words  
**RADIO ENGINEERING**

RADIO Engineering Broadcasting, Aviation and Police Radio, Servicing, Marine Operating and Electronics taught thoroughly. Expenses low. Write for catalog. Valparaiso Technical Institute, Dept. N, Valparaiso, Ind.

**SALE**

FIVE Element TV Yagi Beams, Aluminum Tubing, etc. Write for prices. Willard Radcliff, Fostoria, Ohio.

RECORD changer parts for leading makes. We ship everywhere. Friend's Wholesale Distributors, 106 N. 6th St., Philadelphia 6, Pa.

TUBES 1626, 1629, 10, 45 special bulk 25c, cartoned 35 cents. RK 34, 843, 705A, 708A, 6B8, 6D6, cartoned 50c, 12A6 metal 75c, 902, \$2.50. New band switch motors & gear box. \$2.50. \$2.00 min. order. Leonard Vik, Box 724, Richland, Wash.

20 RADIO & TV Theory books for sale. \$10. Worth much more. Kenneth A. Jones, 2450 Pearl St., Dubuque, Iowa.

SMALL quantities of excellent meters at low prices. Write for list. A. P. Schaupner, 14216 Warwick Rd., Detroit 23, Mich.

DIAGRAMS Radio, Record Changers, Recorders, 75c; Television with Service Data, \$1.25 up. State manufacturer and model number. Kramer's Radio Service, Dept. N8, 36 Columbus Ave., New York 23, N. Y.

HOTTEST surplus list in the country. Electronics-Hydraulics, Aircraft-Gadgets. Dick Rose, Everett, Wash.

LONG distance TV and FM antennas. Yagi beams, stacks, etc. Wholesale Supply Co., Dept. H, Lunenburg, Mass.

TUBES, surplus, bought-sold. Free list. Betz, 73 Caroline Ave., Yonkers, N. Y.

TUBES: radio & TV., complete line, std. brnds. Write for prices of types needed. Washington Radio, 1988 W. Washington, L.A.

**WANTED**

NEED BC-611 or BC-721 Handie-Talkie (or any part); ART-13; ARC-1; ARC-3; DY-17; TS-12; TS-13; MN-26 J or K; BC-342; BC-312; I-100; BC-348; BC-788 A, AM, B or C; I-152A, AM, B or C; TS-67; Teletype, test or any other equipment. Cash or trade. Write: Bob Sanett (WV6REX), 4668 Dockweiler, Los Angeles, Calif.

WILL buy all ART-13/type T-47A, \$200.00, ART-13/type T-47, \$150.00, BC348's, \$65.00, APN-9, \$100.00, ARC-3 complete, \$750.00, R77 Receivers only, \$100.00, ARC-1's, \$600.00, BC312's, \$65.00, BC-342's, \$60.00. Ship via Express C.O.D., subject to inspection to: H. Finnegan, 49 Washington Ave., Little Ferry, N. J.

**HELP WANTED**

AIRLINE Radio Maintenance Mechanic to work in Washington, D. C. Second class radio license and some aircraft experience mandatory. Contact R. D. Warfel, All-American Airways, Inc., National Airport, Washington 1, D. C.

**CORRESPONDENCE COURSE**

USED Correspondence Courses and Books sold and rented. Money back guarantee. Catalog free. (Courses bought.) Lee Mountain, Pisgah, Ala.

RADIO Servicing Course shows latest short cut methods. Lessons easy to follow. Only \$3.00, postpaid in U.S.A. Buyers Syndicate, 30 Taylor St., Springfield, Mass.

AMATEUR Radio Operator License Preparation. Correspondence course. Low cost. Personal coaching. Federal Electronics Institute, 34 E. Putnam, Dept. F, Greenwich, Conn.

**MISCELLANEOUS**

SPEAKERS repaired, wholesale prices, guaranteed workmanship. Amprite Speaker Service, 70 Vesey St., New York City 7.

**PHOTO CREDITS**

Page	Credit
35, 36, 37	Voice and Vision, Inc.
40, 41	Weathers Industry
51	Newcomb Audio Products Co.
51	Rauland Corporation
51	Triad Transformer Mfg. Co.
51	Herman Hosmer Scott Inc.
52, 53, 59, 60 (Fig. 3B)	Radio Corporation of America
55, 66, 158	General Electric Company
60 (Fig. 3A)	Altec Lansing Corporation
63	Radio Free Asia
70, 71	J. Dale Healy
72, 73, 110	The Langevin Company
98	De Forest's Training, Inc.



those costly TV service calls with . . .

**ELECTRO CHEMICALS**

**• ANTENNA KOTE • CORONA-X • CONTACT CLEANER**

ANTENNA KOTE—Our newly developed chemical compound for safely coating all exposed exterior television connections. Non-electric conductor. Eliminates use of tape. Non-corrosive, weatherproof and oil-proof. Brush attached to cap of bottle.



CONTACT CLEANER—A fast drying combination of special solvents that offers a great cleaning solution. Recommended for treating volume controls, band switches, tuning condensers, etc. Leaves a non-corrosive film on contacts after drying. Brush attached to cap of bottle.



CORONA-X—The new and superior product used to control and prevent corona arc discharge on high voltage circuits in television. Has excellent high voltage insulating qualities. Easy to apply. Air dries. Brush attached to cap of bottle.



A Complete Line of Electronic Chemicals Exclusive territories for sales representatives Write for circular "R-1"

**DAKOLINE CHEMICAL CO., INC.**  
ELECTRONIC CHEMICALS DIVISION  
357 ATLANTIC AVE., BROOKLYN 2, N. Y.

**Communication Problems Solved**  
with ARMY FIELD  
**TELEPHONES and TELEPHONE WIRE**  
All-purpose—all-weather

Reconditioned LIKE-NEW EE-3 Phones, per pair. **\$32.50**

GRADE 1—Unused, excellent condition. Mile reels (wt. 160 lbs.) . . . . . \$19.50 Half-mile reels (wt. 80 lbs.) . . . . . 10.00 500 ft. reels (wt. approx. 13 lbs.) . . . . . 4.95

W-130—Lightweight Assault Wire—2 conductor. Excellent inter-com wire. Unused, excellent condition. 10,500 ft. reels. **57.50** Approx. 3,300 ft. reels. . . . . 19.50

Send for FREE FOLDER All prices F.O.B., Sacramento. No C.O.D. (Calif. residents add 3% for sales tax.) Prices subject to change without notice. Send check or money order.

LORIS SALES, P. O. Box 1896-M9, Sacramento, Calif.

**When answering Advertisement Please Mention RADIO & TELEVISION NEWS**

**WHOLESALE PHOTO SUPPLIES**  
KODAK • ANSCO • GRAFLEX • Others

Radio Service Shops Coast to Coast Increase Profits with Photo Supplies

You can add big photo equipment sales to your gross almost over night. Gamera's fast wholesale service on any quantity, low inventory investment, and low space requirements make it easy to capitalize on photo equipment sales. WRITE FOR CATALOG AND DETAILS NOW.

**GAMERMAN** DEPT. R-11 3805 EASTERN AVE. BALTIMORE 24, MD.

**RADIO & TELEVISION NEWS**



# INDEX OF Advertisers

While every precaution is taken to insure accuracy, we cannot guarantee against the possibility of an occasional change or omission in the preparation of this index.

NAME	PAGE
Acorn Electronics Corp.	120
Airex Radio, Inc.	167
Alliance Mfg. Co.	15
Allied Radio Corporation	9
Almo Radio Company	168
Altec Lansing Corp.	144
Alvaradio Supply Co.	170
American Microphone Company	136
American Phenolic Corporation	22
American Television & Radio Co.	154
Amperite Company Inc.	138
Ampex Electric Corporation	127
Amplifier Corporation of America	174
Approved Electronics Instrument Co.	162
Arrow Sales, Incorporated	103
Ashe Radio Company, Walter	111
Atlas Sound Corp.	124
Atlas Tel-Rad Company	118
Baltimore Technical Institute	134
Barry Electronics	150
Bell Telephone Laboratories	18
Belmont Radio Corporation	29
Blonder-Tongue Laboratories	119
Bond Equipment Company	163
Boyce-Roche Book Co.	172
Brach Mfg. Co.	158
Brociner Electronics Laboratory	130
Brook Electronics, Inc.	154
Brush Development Company, The	109
Burstein-Applebee Company	156
C & H Sales Co.	134
Candler System Co.	174
Capitol Radio Engineering Inst.	87, 175
Centralab Inc.	12, 13
Channel Master Corp.	16
Chicago Industrial Instrument Co.	114
Chicago Transformer Company	30
Clarostat Mfg. Co., Inc.	138
Cleveland Institute of Radio Electronics	32
Collins Audio Products Co., Inc.	26
Color Sales Corp.	136
Colorfone Television	108
Columbia Electronic Sales	112
Comet Electronic Sales Co.	141
Communications Equipment Company	123
Concord Radio Corporation	98, 137
Cornell-Dubilier Electric Corp.	159
Coyne Electrical School	118, 178
Dakoline Chemical Co., Inc., The	176
Davis Electronics	178
DeForest's Training Inc.	5
De Mambro Radio Supply Co.	150
Dow Radio, Inc.	144
Drillick Electronic Sales Company	167
DuKane	158
Dumont Electric Corp.	174
Dumont Labs, Allen B.	3rd Cover
East Coast Electronics	162
Editors & Engineers, Ltd.	162
Edlie Electronics, Inc.	116
Electro Products Laboratories	150
Electro Sales	171
Electro Voice, Inc.	121
Electronic Expeditors, Inc.	166
Electronic Instrument Co., Inc.	34
Electronic Measurements Corp.	130
Electronic Specialty Supply Co., Inc.	174
Electronic Technical Institute	170
Electronic Vision Projection Co.	112
Electronics Institute, Inc.	160
Esege Sales Co.	175
Fair Radio Sales	157
Federated Purchaser, Inc.	90
Feiler Engineering Co.	175
Franklin Technical Institute	136
Freshman and Company, Charles	152
G. L. Electronics	104, 169
Gardner's	176
Garrard Sales	148
General Electric Company	3, 23
General Test Equipment	163
Gonset Company	132
Greenlee Tool Co.	156
Greylock Electronics Supply Co.	172
Hario Sales Co.	108
Harrison Radio	158
Harvard Laboratory	153
Harvey Radio Company, Inc.	117
Heath Company	76-83
Henry Radio Stores	114
Hickok Electrical Instrument, The	126
High-Fidelity Magazine	125
Hytron Radio & Electronics Co.	33
Illinois Condenser Co.	119
Indiana Technical College	124
Instructograph Co.	120



# IT'S ALL ED FOR RCA Electron Tubes for Industry



## Quick, Expert Service on RCA Tubes

ALLIED maintains in stock for quick shipment, the world's largest distributor inventory of RCA special-purpose tubes—of all types. We specialize in supplying the needs of industrial, broadcast, governmental and other users. To save time, effort and money—phone, wire or write to ALLIED. Fill all your needs quickly from the complete, dependable electronic supply source.

## See Your 1952 ALLIED Catalog

Refer to your ALLIED Catalog for all electronic supplies—parts, tubes, test instruments, tools, audio amplifiers, accessories—available from the world's largest stocks. Write today for your FREE copy of the complete 212-page ALLIED Catalog.



FREE! Send for it now

## ALLIED RADIO

833 W. Jackson Blvd., Dept. 1-11-1, Chicago 7, Ill.

Everything in Electronics from ONE Source

## SAVE UP TO 95% SENSATIONAL SURPLUS VALUES!

### TOP DOLLARS FOR HANDIE-TALKIES

Complete or Chassis of BC-611  
Your chance to make a big profit on your BC-611 or parts. Send us complete information and we'll reply promptly!

ELECTRIC MOTOR 115V DC 1.4 amps 1/8 HP. Shunt wound. 1725 RPM. \$9.95  
Continuous duty, reversible. New.

Chassis Specials -  
11" x 17" x 2". Black  
craquelé with bottom  
cover. 16 Ga. metal  
11 1/2" x 15" x 2" \$2.49  
as above \$2.95

PE 218-C Inverters—28 V input at 100 amps. Output 110V 400 Cycles 1 KW. Xint condition \$18.00

RT-7 APW-7 Remote Control Transmitter-Receiver—Operates on tones with stepper relay for telemetering. Freq. vicinity 400 megs. \$70.00  
New \$42.00

Visors 1452, New \$2.00  
FL-20 AUDIO FILTERS. Newly mfgd. (quantities avail) \$17.50  
MP-37 MAST BASE with Spring & Insulator \$4.00  
MAST SECTIONS for above \$4.00 each 50c

### 274-N & ARC-5 EQUIPMENT RECEIVERS

BC-946B, 550 to 1500 KC  
New \$3.00  
3-6 MC. Used. Originally \$30. NOW \$6.95  
6-9-1 MC. Used \$8.95  
1.5-3 Megs. New \$34.95

### TRANSMITTERS

T-22 ARC-5, 7-9 Megs  
Used Xint. \$14.95

MD7-ARC5 Modulator Plate and Screen for T23ARC5, with Dynamotor. \$15.00  
T-21 ARC-5, 3-7 MC. New. Orig. \$40. Now \$8.95  
4-5-3 MC. Used. Orig. \$30.00. Now \$6.95  
2-1-3 MC. Ln. Orig. \$40. Now \$16.95  
T-19 ARC-5, 3 to 4 Megs. \$19.95  
T-23 ARC-5, 190 to 550 KC. Loop or Straight wire antenna input. \$18.95



**EXPORT INQUIRIES INVITED!**  
We carry an unusually large stock of Airline Equipment, Test Equipment, Radar Sets, etc. Write for our low prices and complete information. We furnish immediate answers to all inquiries! Write today.

**IMPORTANT!**  
NO ORDER LESS THAN \$5.00. Send 30% deposit. All merchandise subject to prior sale. Prices subject to change at any time. All Foreign orders add \$1 min. service charge.

### CONDENSER SPECIALS!

- Type 345 Molded Paper Condensers. Used in BC-433 & ARN-7. .1 Mfd 400 V and .05 Mfd. 600 V. Hi leakage resistance. \$35.00 Per 1000
- 5 x 5 Mfd. 400 V DC. 3 3/4" x 1 1/2" x 4 x 8 Mtd. \$18.00
- 2" x 3 3/4". 1 common 1 common terminal. 600 V terminal \$60.00 DC. Oil. \$2.95

### FM EQUIPMENT

DC, 34 MC. Alum. case with antenna relay. Xmt'r uses 1073.125 KC xtal in osc stage (1C7). 4 Dblrs & 1 fin. amp. (XV65). Rcvr is superhet, xtal controlled, osc at 8060 kc. All tubes inst. heatin'K. Includes control box, French phone hand set, 8" speaker, extra mike. Complete \$45.00

25 WATT FM TRANSCIEVER  
—30-40 megs. xtal controlled. Uses 815 tube in final. 6V DC input. Uses 2 dynamotors: one for rcvr (250V @ 60 MA) and one for Dynamotor (500 V 100 MA). Made by REL, Model 567A. Used. Less crystal & bottom cover, but with all tubes...\$55.00

### NEW STANDARD BRAND CHOKES

HY	MILS	OHMS	PRICE	VOLTAGE	CASE WT.
8-40	175	100	2.75	3KV	Closed 3.5
8-30	200	80	3.25	3KV	Closed 4.5
5-25	200	100	4.95	2KV	Closed 5
5-25	300	90	9.95	5KV	Closed 18
8-25	300	80	5.95	5KV	Open 2 1/2
5-25	500	60	12.95	7KV	Closed 28
8-40	1 amp	50	39.95	10KV	Closed 58

HY	MILS	OHMS	PRICE	VOLTAGE	CASE WT.
5	500	600	4.95	2KV	Closed 4
7	150	200	1.25	2KV	Open 2
10	500	60	12.95	7KV	Closed 28
12	300	80	5.95	5KV	Closed 9
12	375	105	3.95	5KV	Closed 8
12	400	100	6.95	2KV	Closed 15
15	200	120	2.95	3KV	Open 4.5 lbs.
20	300	80	4.95	3KV	Closed 9 lbs.

### SAVE \$ ON POWER SUPPLIES

Chokes with Hum Bucking Tap

HY	MILS	OHMS	PRICE	VOLTAGE	CASE WT.
20 Series	1A	50	39.50	10K	Closed 80
5 Parallel	2A	12.5			Closed 15
16 Series	175	96	5.95	2.5K	Closed 15
4 Parallel	350	24			Closed 4
26 Series	200	112	6.95	3.5K	Closed 15
6.25 Parallel	400	28			Closed 15

A Complete Stock of Commercial Airline and Military Aircraft Electronic Equipment

## VED RADIO & ELECTRONICS SUPPLY

DEPT-R-27, 2033-37 W. VENICE BLVD. LOS ANGELES 6, CALIFORNIA





## CASH IN ON FRINGE AREA SALES!

THE SUPER RHOMBIC ANTENNA eliminates costly stacked arrays...GIVES all-channel coverage with a gain of over 12 DB...FEATURES exclusive 15-degree tilt to take advantage of horizontal wave lengths...SUPER-SENSITIVE 12 degree directivity for maximum distance (DX) reception...EXTENSIVELY lab and field tested. Constructed with aluminum alloy elements that out-perform copper wire rhombics...SPACE TAPERED element construction gives automatic match to all commonly used lead-ins without matching transformer...PRE-ASSEMBLED lightweight construction cuts installation time to minutes!

the SUPER RHOMBIC ANTENNA will...

- ★ OUT-DISTANCE
- ★ OUT-PERFORM
- ★ OUT-SELL

any Antenna at any price!



**TO: DAVIS ELECTRONICS**  
 3047 W. Olympic Boulevard., Los Angeles 6, California  
 Sir: Rush information to me as checked below:  
 Send free technical data on Super Rhombic Antenna.  
 Send name and address of nearest jobber.

Name \_\_\_\_\_  
 Street \_\_\_\_\_  
 City \_\_\_\_\_ State \_\_\_\_\_

**DAVIS ELECTRONICS**  
 3047 WEST OLYMPIC BOULEVARD  
 LOS ANGELES 6, CALIFORNIA

**FREE!** Just For Examining **COYNE'S** New 5-Volume Set **APPLIED PRACTICAL RADIO-TELEVISION**

Get this Book of TV PICTURE PATTERNS & WAVE FORMS...FREE. Gives you dozens of actual TV Test Patterns and wave forms—tells how to use them to shoot trouble and repair TV sets quicker, easier. Money-making short cuts that help you get ahead in Television. It's yours FREE!

**Complete**

**Practical...Up-to-Date!**  
 This book is our gift to you for examining Coyne's brand new 5-volume set APPLIED PRACTICAL RADIO-TELEVISION. Here is the most complete up-to-date set of reference books in America! 1500 easy-to-understand pages; 1000 illustrations. Covers all phases of radio and television. Tells you how to install, service, trouble shoot, align all types of radio and television sets. "Break-down" photos help you understand quicker.

**Sensational Free Book Offer Send No Money!**  
 Mail coupon now to get this great new 5 volume set and the FREE Book of Picture Patterns. Use the set 7 days. If you keep the set, pay just \$3.00 after 7 days and \$3.00 a month until \$16.50 plus postage is paid. (Cash price \$15.00.) If not 100% satisfied with set send it back and owe us nothing. EITHER WAY THE BOOK OR TV PICTURE PATTERNS IS YOURS FREE. Coupon is just a request to see set and get Free book of picture patterns. This offer is limited. ACT NOW!

**FREE ON 7 DAYS TRIAL**

**MAIL COUPON NOW!**

COYNE ELECTRICAL & TELEVISION-RADIO SCHOOL  
 500 S. Paulina St., Dept. BI-T3, Chicago 12, Ill.  
 Rush "APPLIED PRACTICAL RADIO-TELEVISION" on 7 days' FREE TRIAL, per offer above.

NAME \_\_\_\_\_ Age \_\_\_\_\_  
 Address \_\_\_\_\_  
 City \_\_\_\_\_ Zone \_\_\_\_\_ State \_\_\_\_\_

Where Employed \_\_\_\_\_  
 Check here if you want set sent C.O.D. You pay \$15.00 plus C.O.D. postage. Same money-back guarantee of satisfaction.

**PHOTOCON SALES**  
 1062 N. Allen Ave. SYcamore 4-7156  
 Pasadena 7, Calif. RYan 1-8271

**WRITE FOR OUR LATEST SURPLUS SALES CATALOGUE**

WE WILL BUY YOUR NEW OR CLEAN USED ELECTRONIC SURPLUS: ARC-1, ARC-3, BC-224, BC-348, BC-312, BC-342, ATC, ART-13, APS-13, BC-221, LM's, TS-12, TS-13, TS-23, TS-34, TS-35, IE-19A, I-222, SCR-522, TS-100, or any BC, I, IE, TS, APR.

**WRITE FOR PRICES:**  
 APR4, APR5A, APR7, TS-34, 804CS2, APA-38, BC-348, ART-13, TS-12, APN-9, ARC-1, BC-610, TCS.

DuMont 208 5" Oscillograph	EXCELLENT	\$225.00
804B General Radio Signal Generator 8-830 mc.	EXCELLENT	350.00
APN-1 Altimeter Indicator 0-1 ma. shunt, 250° dial.	NEW	2.95
LM & BC-221 Frequency Meter with cal. book, crystal, and tubes.	EXCELLENT	99.50
SCR-625 Mine Detector.	NEW	39.50
AN/APN4B Complete	EXCELLENT	150.00
PE-218 Inverter 400N	NEW	29.50
PE-206 Inverter 800N	NEW	12.50
Weston Model 545 Tachometer Meter	NEW	17.50
HS-33 600 ohm Headsets.	USED	3.50
400 cycle Inverters—G.E. 5D21NJRA Input 24V. DC. Output 115V. AC. 400 cycles 485 V.A.	NEW	24.50
DuMont 224 Oscillograph less front cover	EXCELLENT	125.00
DuMont 241 Oscillograph	EXCELLENT	300.00
G.E. Oscillograph CRO5Y	EXCELLENT	225.00
804LX-1 U.H.F. Signal Generator 8-830 mc. Complete.	NEW	500.00
RCA T.D.Q. Transmitter 115-156 mc. 115-230 volt, 50-60 cycle Power Supply Rated Carrier Power 45 watts	EXCELLENT	300.00
Drafting machine 16" & 18" less seat	EXCELLENT	35.00 and \$40.00 resp.
CRT-3 Two-Channel Gibson Girl.	NEW	75.00
RTA1B Radio Transmitter-Receiver	NEW	600.00
804TL Tubes		6.50
889B Tubes		100.00

One of the largest and most complete electronic surplus stocks in the country. We have thousands of tubes, capacitors, plugs, accessories, transmitters-receivers, test equipment, etc. Send us your requirements.

**TERMS:** Prices F.O.B. Pasadena, California. 25% on C.O.D. orders. Californians add 3% Sales Tax. Prices subject to change without notice.

J. F. D. Manufacturing Company, Inc.	164
J. S. H. Sales Company	136
Jackson Electrical Instrument Co.	129
Jensen Industries	116
Jensen Mfg. Co.	161
Kaar Engineering Company	175
Kester Solder Co.	152
Lafayette Radio Corporation	173
La-Pointe Plasmomold Corporation	166
Lectronic Research Labs.	110
Leotone Radio Corp.	132
Loris Sales	176
Lowell Metal Products Corp.	122
MacMillen Company	168
McConnell's	134, 165
McGee Radio Company	88, 89
McGraw-Hill Book Co.	156
McIntosh Engineering Company	172
Mallory & Co., P. R.	4th Cover
Mark Electronics	155
Midway Company	165
Midwest Radio & Television Corp.	85
Miles Reproducer Company, Inc.	155
Milwaukee School of Engineering	120
Moss Electronic Dist. Co., Inc.	122
Nassau Company	170
National Co., Inc.	163
National Radio Institute	99, 100, 108
National Schools	11
Newark Surplus Materials	130
Newcomb Audio Products	155
Niagara Radio Supply Corporation	115
Offenbach & Reimus Company	151
Ohmite Mfg. Company	92, 93
Olson Radio Warehouse	92, 93
Onan & Sons, D. W.	154
Opad-Green Company	128
Peak Electronics Company	124
Penn Boiler & Burner Mfg. Corp.	24, 25
Pfanstiehl Chemical Company	146
Phillips Mfg. Co.	142
Photocon Sales	178
Pickering and Company, Inc.	106
Platt Electronics Corp.	86
Poly-Tech Company	134
Precise Development Corp.	132
Precision Electronics, Inc.	164
Premier Radio Tube Co.	96, 97
Prentice-Hall, Inc.	142
Progressive Electronics Company	140
Pyramid Electric Company	28
Quam-Nichols Company	116
RCA Institutes, Inc.	27, 167
Radcom Engineering Co.	113
Radio Corporation of America	75, 2nd Cover
Radio Craftsmen, Inc., The	86
Radio Ham Shack, Inc.	107
Radio-Music Corp.	159
Radio Parts Co.	95
Radio Receptor Co., Inc.	139
Ram Electronics, Inc.	152
Rauland Corporation, The	21
Raytheon Manufacturing Company	7
Rek-O-Kut Col, Inc.	168
Rider, Publishers, Inc., John F.	165
Rinehart Books, Inc.	135
Rose Company, The	164
Royal Television Company	171
Sams & Company, Howard W.	94, 146, 161, 176
Sarkes Tarzian, Inc.	101
Schott Company, Walter L.	119
Shaw's Surplus	167
Shure Brothers, Microphones	153
Simpson Electric Co.	102
Sprague Products Co.	20
Sprabrey Academy of Radio	17
Stan Burn Radio & Electronics Co.	144
Standard Surplus	143
Standard Transformer Corp.	173
Star Electronics Distr., Inc.	128
Stephens Mfg. Co.	166
Steve-El Electronics Corp.	147
Streamlined Self Study Courses	169
Sun Radio of Washington, D. C.	104
Superior Instruments Co.	106
Sylvania Electric Products, Inc.	19
TAB	179, 180
Tech-Master Products Co.	122
Television Communications Institute	149
Television Supply Co.	146
Transvision, Inc.	145
Triad Transformer Mfg. Co.	174
Trio Manufacturing Co.	10
Triplet Electrical Instrument Co.	6
Tri-State College	171
Tung-Sol Electric Inc.	160
Turner Company	13
Unger Electric Tools Company, Inc.	139
United Catalogue Publishers, Inc.	118
United Surplus Materials	128
United Technical Laboratories	112
Universal Electronics	133
University Loudspeakers, Inc.	131
V & H Radio & Electronics	438, 177
Valparaiso Tech. Institute	165
Ward Products Corp.	31
Weller Electric Corp.	8
Wells Sales, Inc.	91
Western Radio-Television Institute	163
West Region Electronics	160
Wholesale Radio Parts Co., Inc.	84
Wincharger Corporation	142
Workshop Associates, Inc.	105
World Radio Laboratories, Inc.	169
YMCA Trade & Technical School	155







**866A KIT and XFORMER**  
 2 tubes, Sockt. xfmr. 115v  
 60cyc Inpt, outpt. 2.5vct/10a  
**DIODE PROBE TUBE** \$6.98  
 Unexcelled for NO-LOSS  
 UHF Testing, Ultra-Sensitive  
 Sub-Miniature—E-100, 3A  
 Element & Probe at Tip. Low Pwr. Htr.  
 BRAND NEW w/Data. VR92, 25c; 5 for \$1.

**"WILLIAMSON"**  
**10W HI-FI KIT**  
 10 to 20000 cycles with Ease!  
 Internationally Famous; For  
 HiFi enthusiasts supply. Pwr. RCA  
 Chassis, Less Pre-Amp & outpt. xfmr.  
 Pre-selected parts. Balanced resist. \$29.95  
 W/moon Pre-amp. 10000 cps. 10000  
 chasis, parts, pwr supply. \$34.95  
**SUPER-Wide-Range HI-FI TRIODE 10W KIT.**  
 10 to 20000 cycles. 6B4's. Max Harmonic  
 Distortion 1 1/2% at full output & only 1/2 at  
 5W outpt. Includes Bass & Treble tube  
 boost & Tone ckt. & Preamp 4 C.E. pickup  
 3 dual and 2 output (7) tubes. Parts, RCA  
 chasis & info., less output xformer. \$29.95  
**UTC Hi-Fi Outpt. Xfmr for P.P. 2A3, 6B4,**  
**6A5 & 6L6. Cap. 30W. Sec. 1.0 to 250**  
**ohms. \$6.98**  
**GE Reluc Cartridge perm needle. \$1.98**  
**GE Dual Reluc. CRX 1000. \$2.99**  
**GE Reluc Cartridge RPX400 or 041. \$7.29**  
**GE S1201D Hi-Fi Heavy Duty 12" PM**  
**Speaker \$14.20**  
 Sensational 10" HiFiSpkr Ideal 10 Watt  
 Home Size. Concentric, Separate Driver  
 W/woofer & Horn Driver Tweeter—30 to 16000  
 cps Range.  
 Electro Voice EV16H dual twilt Cart. \$3.98  
 Extra dual needle for Two Cart. \$1.20

**Hi Gain Dynamic Mike & Xfmr. Buy**  
 Complete. 2 Tube. 115v. \$1.98  
 XFMR Hmt-sold UTC/Xmtr/Elect 3  
 wdg. 600ohmct & 4000 tapped 250  
 ohm. 5000 ohm. 10000 ohm. 20000  
 ohm. Grid. Line to Grid & Line to Line.  
 C&I Hmt Sold.  
 SPECIAL 49c; Ten for \$4.49

**LINE FILTERS**  
 10AMP/130vacdc  
 Csd USN 0.1 to  
 1000 Mc's. \$1.29  
 30AMP/250vacdc  
 Csd USN 0.1 to  
 1000 Mc's. \$3.98; 2 for \$6.00  
 50AMP/600vac/250vac. Filters both sides  
 of the SOLAR "Thin-O-Stat" Now \$3.98  
 100AMP/usable 110 vacdc GE 2 for \$1.98

**KITS**  
 Silver & Mica Cndrs. \$30 for \$2.50  
 Controls, 50 ohm to 500,000. \$1.98  
 Resistors, 1/2W, 10 to 2 Mega. 100 for \$1.98  
 Vitreous W/V Resistors. \$5 for .69  
 Sockets, Assid. 8, 7, 5, 4P. \$25 for 2.49  
 Rotary Switches, Assid. \$5 for 1.49  
 G&P Tube Caps, Assid. \$50 for 1.00  
 Coil Forms, Th'd Sm HF. \$50 for 1.00  
 Iron Core Slub & Screw. \$10 for 1.00  
 Elastic Stop Nut. Assid. \$50 for 1.00  
 Knobs, Assid. w/insert. \$50 for .98  
 Spaght 5/16x3/8. \$75 for 1.00  
 Ceramicon Cndrs, Assid. \$12 for 1.00  
 Fuses, Assid. LP & Buss. \$75 for 1.95  
 Grammet, Rubber Assid. \$50 for 1.00  
 Resistors, 2 W Assid. \$25 for 1.69  
 Tie-Point Lugs, Assid. \$35 for .98

**FL-5 FILTER**  
 Range or Voice. Filters  
 1020cyc Audio. Exc for CW  
 Work. \$1.98  
**APNA Receiver Less tubes, Guid. As is. \$12.95**  
**CRS 2000 New. Cds. \$1.98**  
**TG10 Code unit Less tubes As is. 19.95**  
**Compass Rcvrs Less tubes As is. 5.98**  
**CRW/74 Rcvr. Less tubes As is. 2.49**  
**168B KMTR w/Metal Case Less tubes**  
**As is. 2.98**

**"TAB"**  
**THAT'S A BUY**

**MERCURY THERMO-REGULATOR**  
 DualCkt. 105°F & 32°F. Extremely Sensitive & Accurate for Most Exacting Requirements—RESEARCH TUBE PRECISION CONTROL, or MAX-MIN TEMP Control. Brand New Individ. Boxed w/Data & ckt. List Over \$20.00. Price \$12.95  
**"TAB" SPECIAL... @ 98c; 12 for \$10.00**  
 Ball Pens Gtd Blue or Red... 5 for \$1.00  
 Ball Pens Draftman Bk... 2 for \$1.00  
**"LP" Anti-Static fluid 1000 plays... 69c**  
 Gov. Wts. for "G-I" Motors. 2 for 39c; 6/51

**STORAGE BATTERIES**  
 36 Volt WILLARD Mini-BRAND. NEW! 52.5. Designed Portable Equip Model... 97c; 4 for \$3.95  
 2V/27AH Willard BB54 PLUS 2 Volt Vibrator... \$1.98  
 6V/6AH Wildt NT6/BB2140 1.75  
 Battery Acid. (R-Exp.) 1 pt. 59c; 2 pts. .98  
 Hydrometer 1.06 to 1.24 Sp. Grav... 1.98  
 Electrolyte Meas Tube, 1 1/2" Lg... .25  
 Spec Grav Ind & Merc. Thermom... .98

**BANDPASS FILTER XFORMERS**  
 SHARP CUTOFF HIQ CASED & SHIELDED 60, 90, 150 cys  
 List Over \$2.00. Price \$1.25  
 UTC S54, 1024, 1250 cys \$4.50  
 S195... 3 for \$6.50

**Infrared Sniperscope**  
 Image-Converter Tube Hi-Sensitivity  
 Simplified Design & 15  
 2 1/2" dia. Lens. 1000 Yards  
 Willmette screen—Resolution up  
 to 350 lines/in. Complete data  
 & tube. Each \$4.98; 2 for \$9.49

**New Thrift-Life Lifetime Photo-Flash**  
 Not a Kit. Incl Pwr pck, 24cell Lamp, 1000 Sec. & 15 cord. 1/1000 Sec. Flash. Grey 7sec. True daylight color. Usable a 11 cameras oper 115VAC w/115V. Price \$4.49  
 Gtd Lifetime Lamp. \$41.98  
 Complete Outfit for AC & Battery opr. Incl AC/DC. 115V. 1000 Sec. 111 access for KODAK/COMPUR shutters. Complete... \$69.95  
 Write for Complete "THRIFT-LIFE" Data  
 Boosterpacks, Ext. lites, Units for Focal plane shutters & accessories. WE BUY, SELL & SWAP.

**TAB "SUN-FLASH" LAMPS**  
**"TAB"** Replaces W-Sc. Each  
 U10 GE FT110 100 5 9.98  
 No. 1 AMLOG 804X 100 10.98  
 23ST GE FT110 100 5 9.98  
 53GT GE FT403 500 16.98  
 VA SLYV. 4330 200 11.98  
 R340 FL585 Tube—Nationally vstd @ \$57. NEW... \$36.00  
 X-400 Air Corps Lamp... 14.98

**I-F TRANSFORMERS**  
 456 Kc Double Slug Tuned Shielded. 3 for \$2.99  
 10 to 14Mc FM/TV Double Slug Tuned. Shld'd 2 for \$1.5; 5 for \$2.2  
 2.2 to 2.7Mc COLLINUS Tuned Coil. 5 pro. Mtd. 5 for \$1.8  
 15 to 10Mc Double Slug Tuned. Shielded. Incl Sil. 16-25mmf Ceramic trimers. 5 for \$1.98  
 & 3-AB Resistors. 5 for \$1.98

0A2	\$ 1.58	2J31A	79.95	6AU6	.69	78S	.79	14W7	1.09	58	.79	355A	14.15	865	1.29
0A3 VR75	1.47	2J32	79.95	6AV6T	1.29	78E	.79	14X7	1.23	6X5	1.45	371A	.90	866A	1.29
0A4	1.23	2J33	79.95	6BE6	1.89	78F	.79	14Y7	1.47	6X4	1.45	371B	.90	867A	1.29
0B2	1.58	2J34	38.50	6BA6	.79	78G	.79	15A7	1.47	6Y6	10.49	388A	1.19	868A	1.29
0B3 VR90	1.23	2J36	120.00	6AX5GT	1.89	78H	.79	15B7	1.47	6Y7	4.98	393A	3.80	869A	1.29
0C3 VR105	1.58	2J37	1.39	6BE5	1.39	78J	.79	15C7	1.47	6Y8	1.33	393B	3.80	870A	1.29
0D3 VR150	1.58	2J38	17.75	6B5	.89	78K	.79	15D7	1.47	6Y9	1.59	393C	3.80	871A	1.29
0Y4	2.53	2J39	49.50	6B6G	.89	78L	.79	15E7	1.47	6Z6	1.79	400	14.98	872A	1.29
0Z4	1.49	2J40	250.00	6B8G	1.49	78M	.79	15F7	1.47	6Z7	1.79	400B	14.98	873A	1.29
VS-1	12.49	2J48	39.45	6BA6	.79	78N	.79	15G7	1.47	6Z8	1.79	400C	14.98	874A	1.29
CI4	9.75	2J49	39.45	6BA6	.79	78P	.79	15H7	1.47	6Z9	1.79	400D	14.98	875A	1.29
O14	1.23	2J50	27.50	6A7	.79	78Q	.79	15I7	1.47	6Z9	1.79	400E	14.98	876A	1.29
1B3	1.10	2J51	19.95	6B7C	1.23	78R	.79	15J7	1.47	6Z9	1.79	400F	14.98	877A	1.29
1A4P	.79	2J56	199.50	6B7C	1.23	78S	.79	15K7	1.47	6Z9	1.79	400G	14.98	878A	1.29
1A5GT	1.49	2J55	49.45	6B85GT	1.85	78T	.79	15L7	1.47	6Z9	1.79	400H	14.98	879A	1.29
1B7	1.49	2J55	49.45	6B85GT	1.85	78U	.79	15M7	1.47	6Z9	1.79	400I	14.98	880A	1.29
1A7GT	.98	2K25	34.95	6B8E	.79	78V	.79	15N7	1.47	6Z9	1.79	400J	14.98	881A	1.29
1A4E	1.80	2Z3AB	29.45	6B8E	.79	78W	.79	15O7	1.47	6Z9	1.79	400K	14.98	882A	1.29
1B3/8016	.89	2K28	23.95	6B8H	.69	78X	.79	15P7	1.47	6Z9	1.79	400L	14.98	883A	1.29
1B4P	.89	2K29	23.95	6B8H	.69	78Y	.79	15Q7	1.47	6Z9	1.79	400M	14.98	884A	1.29
1B5/25S	.99	2V36	1.29	6B8G	.79	78Z	.79	15R7	1.47	6Z9	1.79	400N	14.98	885A	1.29
1B7G	1.49	2V36GT	1.29	6B8G	.79	79A	.79	15S7	1.47	6Z9	1.79	400O	14.98	886A	1.29
1A7GT	.98	2K25	34.95	6B8E	.79	79B	.79	15T7	1.47	6Z9	1.79	400P	14.98	887A	1.29
1A4E	1.80	2Z3AB	29.45	6B8E	.79	79C	.79	15U7	1.47	6Z9	1.79	400Q	14.98	888A	1.29
1B3/8016	.89	2K28	23.95	6B8H	.69	79D	.79	15V7	1.47	6Z9	1.79	400R	14.98	889A	1.29
1B4P	.89	2K29	23.95	6B8H	.69	79E	.79	15W7	1.47	6Z9	1.79	400S	14.98	890A	1.29
1B5/25S	.99	2V36	1.29	6B8G	.79	79F	.79	15X7	1.47	6Z9	1.79	400T	14.98	891A	1.29
1B7G	1.49	2V36GT	1.29	6B8G	.79	79G	.79	15Y7	1.47	6Z9	1.79	400U	14.98	892A	1.29
1A7GT	.98	2K25	34.95	6B8E	.79	79H	.79	15Z7	1.47	6Z9	1.79	400V	14.98	893A	1.29
1A4E	1.80	2Z3AB	29.45	6B8E	.79	79I	.79	16A7	1.47	6Z9	1.79	400W	14.98	894A	1.29
1B3/8016	.89	2K28	23.95	6B8H	.69	79J	.79	16B7	1.47	6Z9	1.79	400X	14.98	895A	1.29
1B4P	.89	2K29	23.95	6B8H	.69	79K	.79	16C7	1.47	6Z9	1.79	400Y	14.98	896A	1.29
1B5/25S	.99	2V36	1.29	6B8G	.79	79L	.79	16D7	1.47	6Z9	1.79	400Z	14.98	897A	1.29
1B7G	1.49	2V36GT	1.29	6B8G	.79	79M	.79	16E7	1.47	6Z9	1.79	401A	14.98	898A	1.29
1A7GT	.98	2K25	34.95	6B8E	.79	79N	.79	16F7	1.47	6Z9	1.79	401B	14.98	899A	1.29
1A4E	1.80	2Z3AB	29.45	6B8E	.79	79O	.79	16G7	1.47	6Z9	1.79	401C	14.98	900A	1.29
1B3/8016	.89	2K28	23.95	6B8H	.69	79P	.79	16H7	1.47	6Z9	1.79	401D	14.98	901A	1.29
1B4P	.89	2K29	23.95	6B8H	.69	79Q	.79	16I7	1.47	6Z9	1.79	401E	14.98	902A	1.29
1B5/25S	.99	2V36	1.29	6B8G	.79	79R	.79	16J7	1.47	6Z9	1.79	401F	14.98	903A	1.29
1B7G	1.49	2V36GT	1.29	6B8G	.79	79S	.79	16K7	1.47	6Z9	1.79	401G	14.98	904A	1.29
1A7GT	.98	2K25	34.95	6B8E	.79	79T	.79	16L7	1.47	6Z9	1.79	401H	14.98	905A	1.29
1A4E	1.80	2Z3AB	29.45	6B8E	.79	79U	.79	16M7	1.47	6Z9	1.79	401I	14.98	906A	1.29
1B3/8016	.89	2K28	23.95	6B8H	.69	79V	.79	16N7	1.47	6Z9	1.79	401J	14.98	907A	1.29
1B4P	.89	2K29	23.95	6B8H	.69	79W	.79	16O7	1.47	6Z9	1.79	401K	14.98	908A	1.29
1B5/25S	.99	2V36	1.29	6B8G	.79	79X	.79	16P7	1.47	6Z9	1.79	401L	14.98	909A	1.29
1B7G	1.49	2V36GT	1.29	6B8G	.79	79Y	.79	16Q7	1.47	6Z9	1.79	401M	14.98	910A	1.29
1A7GT	.98	2K25	34.95	6B8E	.79	79Z	.79	16R7	1.47	6Z9	1.79	401N	14.98	911A	1.29
1A4E	1.80	2Z3AB	29.45	6B8E	.79	80A	.79	16S7	1.47	6Z9	1.79	401O	14.98	912A	1.29
1B3/8016	.89	2K28	23.95	6B8H	.69	80B	.79	16T7	1.47	6Z9	1.79	401P	14.98	913A	1.29
1B4P	.89	2K29	23.95	6B8H	.69	80C	.79	16U7	1.47	6Z9	1.79	401Q	14.98	914A	1.29
1B5/25S	.99	2V36	1.29	6B8G	.79	80D	.79	16V7	1.47	6Z9	1.79	401R	14.98	915A	1.29
1B7G	1.49	2V36GT	1.29	6B8G	.79	80E	.79	16W7	1.47	6Z9	1.79	401S	14.98	916A	1.29
1A7GT	.98	2K25	34.95	6B8E	.79	80F	.79	16X7	1.47	6Z9	1.79	401T	14.98	917A	1.29
1A4E	1.80	2Z3AB	29.45	6B8E	.79	80G	.79	16Y7	1.47	6Z9	1.79	401U	14.98	918A	1.29
1B3/8016	.89	2K28	23.95	6B8H	.69	80H	.79	16Z7	1.47	6Z9	1.79	401V	14.98	919A	1.29
1B4P	.89	2K29	23.95	6B8H	.69	80I	.79	17A7	1.47	6Z9	1.79	401W	14.98	920A	1.29
1B5/25S	.99	2V36	1.29	6B8G	.79	80J	.79	17B7	1.47	6Z9	1.79	401X	14.98	921A	1.29
1B7G	1.49	2V36GT	1.29	6B8G	.79	80K	.79	17C7	1.47	6Z9	1.79	401Y	14.98	922A	1.29
1A7GT	.98	2K25	34.95	6B8E	.79	80L	.79	17D7	1.47	6Z9	1.79	401Z	14.98	923A	1.29
1A4E	1.80	2Z3AB	29.45	6B8E	.79	80M	.79	17E7	1.47	6Z9	1.79	4			



guaranteed  
for

6

months from date of installation

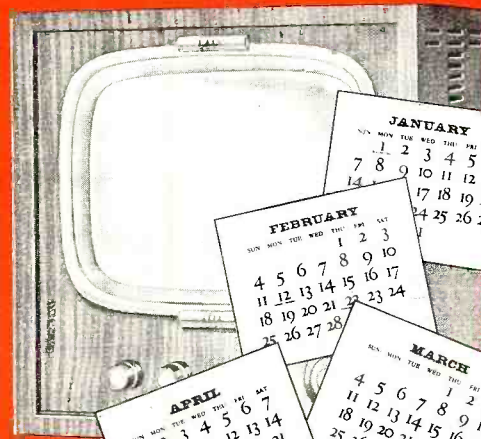

REGISTRATION  
No. 10861

**USER'S REGISTRATION**

**IMPORTANT**

**DUMONT**

**REPLACEMENT TELETRON WARRANTY**

Teletron Serial Number \_\_\_\_\_  
Purchased From \_\_\_\_\_ (Name of dealer)  
User's Signature \_\_\_\_\_  
Street Address \_\_\_\_\_  
City \_\_\_\_\_ State \_\_\_\_\_  
Make of TV Set \_\_\_\_\_  
replacement  conversion replacement  Teletron purchased for repair  
Indicate one.

On \_\_\_\_\_ (Date)

Teletron Type Number \_\_\_\_\_

USER—COMPLETE, SIGN AND MAIL THIS SECTION IMMEDIATELY AFTER YOUR PURCHASE. UNLESS YOU DO SO YOUR WARRANTY IS NOT VALID.

Write for complete information  
on the Du Mont tube line.

Here is a warranty with sales appeal—with your customer participating in the registration of his Teletron. A series of three cards are supplied with each Teletron. One copy is retained by you, a second is retained by the set owner and the third is sent to Du Mont providing complete protection for the set owner for a period of six months from the date of installation against any defects in the Teletron.



\* TRADE MARK

CATHODE-RAY TUBE DIVISION, ALLEN B. DU MONT LABORATORIES, INC., CLIFTON, N. J.



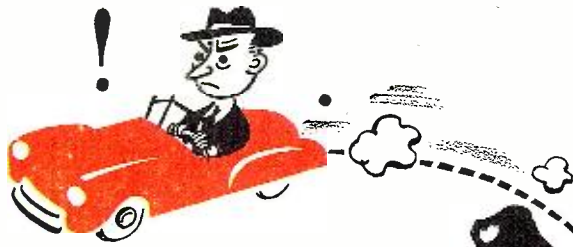

958 & Huron

Blaza Home  
Guttek



You wouldn't want a car that drives only in circles!

Of course not. What you want is a car that will go where you want it to go. And so it is with volume controls, too... a survey of hundreds of servicemen revealed the importance you place on adaptability to the job at hand. Naturally, you want a control that is easily tailored to any job.

## Make Sure! Make it Mallory!

Using the Mallory Midgetrol\* helps you make sure that the installation is exactly as you want it... easier for you and insuring complete customer satisfaction.

There are three big reasons why the Midgetrol  $\frac{15}{16}$ " control does a better job... because the *permanently fixed tubular brass shaft* can be adapted for any popular knob in a few seconds... because AC switch attachment is simple and positive... because the precision-controlled carbon element gives

smoother taper, quieter operation, more accurate resistance value and less drift in TV sets.

These same advantages are available in the Dual Concentric Midgetrol, tailor-made on the job to match each specific requirement. It is assembled in five easy steps, in less than five minutes, using complete, *factory-inspected* control sections. You can make over 10,000 different combinations from sub-assemblies available in distributor stocks.

*Make it Mallory and make sure! Ask your distributor to show you the Mallory Midgetrol... with the features that make installation faster and surer than ever.*

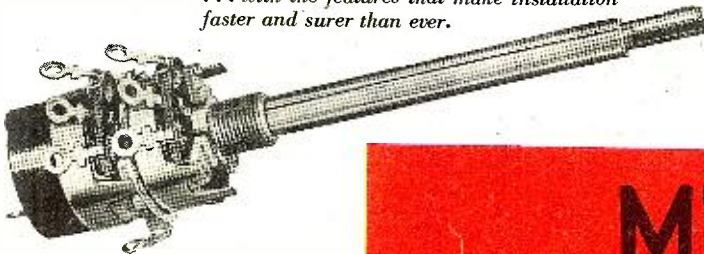

Complete Dual Concentric Midgetrol illustrated. Single section control available in complete line of resistance values.

P. R. MALLORY & CO. INC.  
**MALLORY**

CAPACITORS • CONTROLS • VIBRATORS • SWITCHES • RESISTORS  
• RECTIFIERS • VIBRAPACK™ POWER SUPPLIES • FILTERS

APPROVED PRECISION PRODUCTS

P. R. MALLORY & CO., Inc., INDIANAPOLIS 6, INDIANA