

# RADIO & TELEVISION NEWS

JULY  
1951  
35¢  
In Canada 40¢



*Keller*



THE SAGA  
OF THE ARMED FORCES  
RADIO SERVICE

PAGE 29

**"SERVING THE COMMUNITY"**  
YOUR NEIGHBORHOOD RADIO-TELEVISION TECHNICIAN



We use **RCA TUBES**

*for long life and dependable performance*

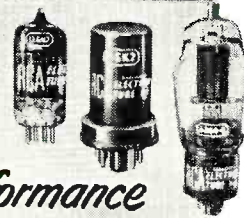

*Let's talk about you...*

You're the radio and television serviceman up the street or around the corner who helps the show go on. The full importance of your services is not recognized until somebody's receiver goes bad. Then you're needed . . . just as a policeman or a doctor or a fireman is needed when the occasion arises. You're that important to your community.

We think people ought to be told about you. So, we decided to talk about you in a full-color display you can

place in your window and on your counter . . . to remind folks that you—the radio and television technician—recognize and live up to your responsibilities as a member of the community.

We owe it to you—and you owe it to yourself—to sell your community on your services. Your local RCA Tube Distributor has a complete packaged promotion built around the Community Service theme. See him today.

*Keep informed—keep in touch with your RCA Tube Distributor.*



**RADIO CORPORATION of AMERICA**  
ELECTRON TUBES

HARRISON, N. J.

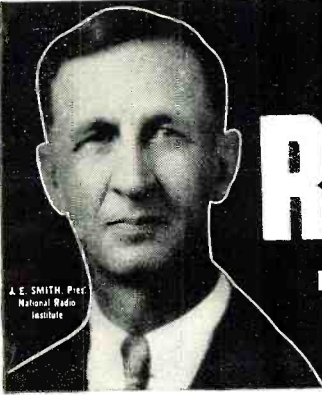

# BE A SUCCESS AS A RADIO-TELEVISION TECHNICIAN

2 FREE BOOKS SHOW HOW MAIL COUPON

America's Fast Growing Industry Offers You

Available to VETERANS under G.I. Bill

## 1. EXTRA MONEY IN SPARE TIME

Many students make \$5, \$10 a week extra fixing neighbors' Radios in spare time while learning. The day you enroll I start sending you SPECIAL BOOKLETS to show you how to do this. Tester you build with parts I send helps you service sets. All equipment is yours to keep.

## 2. GOOD PAY JOB

Your next step is a good job installing and servicing Radio-Television sets or becoming boss of your own Radio-Television station and service shop or getting a good job in a Broadcasting Station. Today there are over 90,000,000 home and auto Radios. 3100 Broadcasting Stations are on the air. Aviation and Police Radio, Micro-Wave Relay, Two-Way Radio are all expanding, making more and better opportunities for servicing and communication technicians and FCC licensed operators.

## 3. BRIGHT FUTURE

And think of the opportunities in Television! In 1950 over 5,000,000 Television sets were sold. By 1954 authorities estimate 25,000,000 Television sets will be in use. Over 100 Television Stations are now operating, with experts predicting 1,000. Now is the time to get in line for success and a bright future in America's fast-growing industry. Be a Radio-Television Technician. Mail coupon for Lesson and Book—FREE.



### I TRAINED THESE MEN

**Chief Engineer, Police Radio**  
"Soon after finishing the N. R. I. course, worked for servicing shop. Now I am Chief Engineer of WCLN, WRRS, WSPK, two-way FM Police Radio Installations." S. W. DINWIDDIE, Jacksonville, Ill.

**Shop Specialist in Television**  
"I have my own shop. Am authorized serviceman for a large manufacturer and do servicing for 7 dealers. N. R. I. has enabled me to build an enviable reputation in Television." P. MILLER, Maumee, O.

**Over \$40 Month Spare Time**  
"When I enrolled, had no idea it would be so easy to learn. Have equipped my shop out of spare time earnings. I am clearing about \$40 to \$60 a month. Full credit to N. R. I." J. D. R. NIGHT, Denton, Texas.

**Shop Graduate Doubles Salary**  
"Am with Station WJBO as transmitter operator. Have more than doubled salary since starting in Radio. Future looks bright. N. R. I. has been constant help to me." A. HERB, New Cumberland, Pa.

**218 Week in Spare Time**  
"Before finishing your course, I earned as much as \$10 a week in Radio servicing, at home in my spare time. I recommend N. R. I. to anyone who shows interest in Radio." S. J. PETRUCCI, Miami, Fla.

**Gets First Job Through N. R. I.**  
"My first job was operator with KDLR. I obtained for me by your Graduate Service Dept. I am now Chief Engineer of Police Radio Station WQOX." T. S. NORSTON, Hamilton, Ohio.

**Tests of Success with Shop**  
"I operate my own shop and have over 300 customers. My profits average about \$250 a month. Have had years of successful experience and I still praise N. R. I. training." J. H. ANDERSON, Atlanta, Ga.

**Regrets Not Enrolling Before**  
"Am proud of my diploma. I cannot say enough for the N. R. I. course. Regret I didn't take it years ago when I used to see your ads. Now I have a spare time shop." FRANK S. TUCKER, Hilton Village, Va.

## I Will Train You at Home Read How You Practice Servicing or Communications with Many Kits of Parts You Get!



**YOU BUILD** this modern Radio (above) as part of my Servicing Course. Build this complete, powerful Radio Receiver that brings in local and distant stations. N. R. I. gives you ALL the Radio parts—speaker, tubes, chassis, transformer. You use material to get practical Radio experience. Make EXTRA money fixing neighbors' Radios in spare time while training.

**YOU MEASURE** current, voltage (AC, DC and RF), resistance and impedance in circuits with Electronic Multitester (above right) you build as part of my Servicing or Communications Course.

**YOU BUILD** this Transmitter (right). As part of my Communications Course, I SEND YOU parts to build this low-power broadcasting transmitter. You learn how to put a station "on the air," perform procedures demanded of Broadcast Station operators, make many practical tests.

**YOU BUILD** this Wavemeter (below) in my Communications Course with parts I send you. Use it to determine frequency of operation and make other tests on transmitter currents. You conduct many interesting experiments.

This is just part of the equipment my students build. You keep all parts I send.

**NOW! Advanced Television Practice**

New, special TV kits furnished to build high-definition SCOPE... RF OSCILLATOR with flyback power supply... complete TV set... many other units. You see pulse, trapezoidal, saw-tooth wave forms. Get valuable PRACTICAL EXPERIENCE locating and correcting TV troubles. Mail coupon for facts, pictures and prices!

Keep your job while training at home. Hundreds I've trained are successful RADIO-TELEVISION TECHNICIANS. Most had no previous experience; many no more than grammar school education. Learn Radio-Television principles from illustrated lessons. Get PRACTICAL EXPERIENCE—build valuable Electronic Multitester for conducting tests; also practice servicing Radios or operating Transmitters—experiment with circuits common to Radio and Television. At left is just part of the equipment my students build with many kits of parts I furnish. All equipment is yours to keep. Many students make \$5, \$10 a week extra fixing neighbors' Radios in spare time.

### Mail Coupon For 2 Books FREE

Act Now! Send for my FREE DOUBLE OFFER. Coupon entitles you to actual lesson on Servicing; shows how you learn Radio-Television at home. You'll also receive my 64-page book, "How to Be a Success in Radio-Television." You'll read what my graduates are doing, earning; see photos of equipment you practice with at home. Send coupon in envelope or paste on postal. J. E. SMITH, Pres., Dept. 1GE, National Radio Institute, Washington 9, D. C. . . . Our 38th year.

### Good for Both—FREE

Mr. J. E. SMITH, President, Dept. 1GE, National Radio Institute, Washington 9, D. C.

Mail me Sample Lesson and 64-page Book about How to Win Success in Radio-Television. Both FREE. (No salesman will call. Please write plainly.)

Name.....Age.....  
Address.....  
City.....Zone.....State.....  
 Check if Veteran Approved Under G. I. Bill

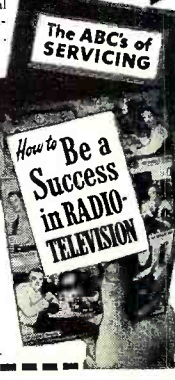

*Editor*  
**OLIVER READ, D.Sc., D.Mit., W9ETI**  
*Managing Editor*  
**WM. A. STOCKLIN, B.S.**  
*Technical Editor*  
**H. S. RENNE, M.S.**  
*Associate Editor*  
**RAY FRANK, W9JU**  
*Eastern Editor*  
**HAROLD BECKER**  
*Television Consultant*  
**MILTON S. KIVER**  
*Short Wave Editor*  
**KENNETH R. BOORD**  
*Editorial Assistants*  
**I. M. CARROLL**  
**E. V. HITZEL**  
**P. B. HOEFER**  
*Staff Artist*  
**R. S. KUJACK**  
*Chief Draftsman*  
**B. L. NEWMAN, W9ROB**  
*Associate Advertising Director*  
**M. J. CULLIGAN**  
*Advertising Manager*  
**L. L. OSTEN**  
*Midwest Adv. Manager*  
**JOHN A. RONAN, JR.**  
*Western Adv. Manager*  
**JOHN E. PAYNE**  
*Art Director*  
**HERMAN R. BOLLIN**



COVER PHOTO: Since servicemen interviews have proven popular with AFRS listeners, this group tapes a show for release to G.I. audiences both in this country and overseas. (Ektachrome by Peter J. Samerjan)

*Chairman of the Board and Publisher*  
**WILLIAM B. ZIFF**  
*President*  
**E. G. DAVIS**  
*Secretary-Treasurer*  
**ARTHUR T. PULLEN**  
*Vice-Presidents*  
**MICHAEL H. FROELICH**  
*Dir. Eastern Div.*  
**H. J. MORGANKOTH**  
*Production Director*  
**LYNN PHILLIPS, Jr.**  
*Advertising Director*  
**H. G. STRONG**  
*Circulation Director*

**BRANCH OFFICES**  
**NEW YORK (17)**  
 366 Madison Ave., Murray Hill 7 8080  
**LOS ANGELES (14)**  
 815 S. Hill St., Tucker 9213

# RADIO & TELEVISION NEWS

*First in*  
*radio-television-electronics*  
 Average Paid Circulation over 200,000

Reg. U.S. Pat. Off.  
 Radio News Trademark Reg. U. S. Pat. Office • Television News Trademark Reg. U.S. Pat. Office.

## CONTENTS

## JULY, 1951

Saga of the AFRS.....	Lt. G. Marakas, USN	29
An Inexpensive Electronic Switch.....	James G. Arnold	32
Converting the G-E Model 809.....	Roland Kempton	34
Calibrating the 3-30 mc. Gonset Converter.....	Major H. L. Ulyat, W3PTQ	36
The "Childs" Custom-Built Amplifier.....	Ulric J. Childs	37
An A.C. Power Test Panel.....	John M. Heinrich	41
Sweep Alignment in AM Receiver Servicing (Part 2).....	P. F. Rhodes	43
A Compact 10 Meter Mobile.....	Robert J. Garon, W6CQU	46
A Six Foot Radio-Controlled Model Boat.....	Walter B. Ford, W6YT	49
A Cascade Type Antenna-Mounted TV Booster.....	Gilbert Voyles	54
A Compact 40 Watt Rig for Car or Field.....	Robert F. Lewis, W8MQU	56
Mac's Radio Service Shop.....	John T. Frye	58
TV Console Incorporates Compact AM Tuner.....	Ken Kleidon	59
Practical Sound Engineering (Part 5).....	H. M. Tremaine	60
Radio-TV Service Industry News.....		82

## DEPARTMENTS

For the Record.....	The Editor	8	Short-Wave.....	K. R. Boord	42
Spot Radio News.....		16	Technical Books .....		72
Within the Industry.....		24	What's New in Radio.....		92



COPYRIGHT 1951  
 ZIFF-DAVIS PUBLISHING COMPANY  
 185 North Wabash Ave., Chicago I, Ill.  
 VOLUME 46 • NUMBER 1



Member  
 Audit Bureau of  
 Circulations

RADIO & TELEVISION NEWS is published monthly by the Ziff-Davis Publishing Company at 185 N. Wabash Ave., Chicago I, Ill. Copyright under International copyright convention. All rights reserved. Entered as second-class matter July 21, 1948, at the Post Office, Chicago, Ill., under the act of March 3, 1879. Entered as second-class matter at the Post Office Department, Ottawa, Canada. **SUBSCRIPTION RATES:** in U. S., Canada, Mexico, South and Central America and U. S. Possessions, \$4.00 for twelve issues; in British Empire, \$5.00; all other foreign countries, \$5.00 for twelve issues. **RADIO-ELECTRONIC ENGINEERING EDITION SUBSCRIPTION RATES:** in U. S., Canada, Mexico, South and Central America and U. S. Possessions, \$6.00 for twelve issues; in British Empire, \$7.00; all other foreign countries, \$7.00 for twelve issues. Subscribers should allow at least two weeks for change of address. All communications about subscriptions should be addressed to the Director of Circulation, 185 N. Wabash Ave., Chicago I, Ill. **CONTRIBUTIONS:** Contributors are advised to retain a copy of their manuscripts and illustrations. Contributions must be accompanied by return postage and they will be handled with reasonable care, but this magazine assumes no responsibility for their safety. Any copy accepted is subject to whatever adaptations and revisions are necessary to meet the requirements of this publication. Payment covers all author's, contributor's and constant's rights, title, and interest in and to the material accepted and will be made at our current rates upon acceptance. All photos and drawings will be considered as part of the material purchased.

**RADIO & TELEVISION NEWS**

**NOW . . . GET EVERYTHING YOU  
NEED TO LEARN AND MASTER**

# TELEVISION

**RADIO-ELECTRONICS  
... AT HOME!**

**Use REAL commercial-type equip-  
ment to get practical experience**

Your future deserves and needs every advantage you can give it! That's why you owe it to yourself to find out about one of the most COMPLETE, practical and effective ways now available to prepare AT HOME for America's billion dollar opportunity field of TELEVISION-RADIO-ELECTRONICS. See how you may get and keep the same type of basic training equipment used in one of the nation's finest training laboratories . . . how you may get real STARTING HELP toward a good job or your own business in Television-Radio-Electronics. Mail the coupon today for complete facts — including 89 ways to earn money in this thrilling, newer field.



**Here's the  
REAL THING!**

**SET UP YOUR OWN  
HOME LABORATORY**



Oscilloscope

R-F Signal  
Generator

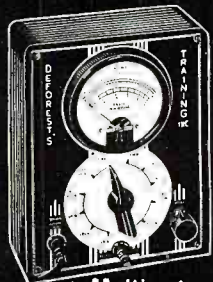

Multimeter

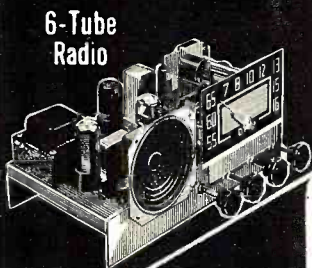

6-Tube  
Radio



**HOME  
MOVIES**

ABOVE: Build and keep a real 16 INCH commercial TV receiver. Optional after completing regular training at slight additional cost.

**D.T.I., ALONE, INCLUDES BOTH MOVIES and HOME LABORATORY**

In addition to easy-to-read lessons, you get the use of HOME MOVIES — an outstanding training advantage — plus 16 big shipments of Electronic parts. Perform over 300 fascinating experiments for practical experience. Build and keep real commercial-type test equipment shown at left.

**MODERN LABORATORIES**

If you prefer, get all your preparation in our new Chicago Training Laboratories — one of the finest of its kind. Ample instructors, modern equipment. Write for details!

**MILITARY SERVICE!**

If you're subject to military service, the information we have for you should prove doubly interesting. Mail coupon today.

**Get BOTH of these  
information packed  
publications FREE!**



**ACT NOW! MAIL COUPON TODAY!**

DeFOREST'S TRAINING, INC., Dept. RN-7-H  
2533 N. Ashland Ave., Chicago 14, Ill.

Without obligation, I would like you to send me News-Bulletin showing 89 ways to earn money in Television-Radio-Electronics . . . and how I may prepare to get started in this thrilling field.

Name ..... Age .....

Street ..... Apt. ....

City ..... Zone ..... State .....

**De FOREST'S TRAINING, INC.**  
CHICAGO 14, ILLINOIS  
A De VRY INSTITUTION



## It tells how you talk

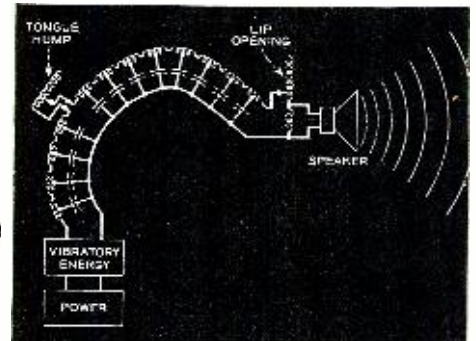
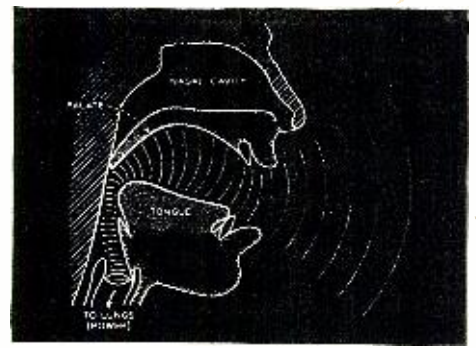

The machine at the left is saying "Ah!" It's the new electrical vocal system developed at Bell Laboratories. Top sketch shows human vocal system also saying "Ah!" The electrical model is sketched below it. Energy source at bottom of "tract" can emit a buzz sound, like vocal cord tone, or the hiss sound of a whisper.

No one else speaks exactly like you. Each of us uses different tones to say the same words. To study and measure *how* we make speech, acoustic scientists of Bell Telephone Laboratories built a model of the vocal system.

Electric waves copy those of the vocal cords, electric elements sim-

ulate the vocal tract, and, by adjustments, vowels and consonants are produced at pitches imitating a man's or woman's voice.

Using this electrical system, telephone scientists will be able the better to measure the properties of people's voices. Knowing more about speech they can find better

and cheaper ways to transmit it.

This is another step in the research at Bell Telephone Laboratories which pioneered the exact knowledge of speech. Past work in the field is important in today's fine telephone service. A still deeper understanding of speech is essential in planning for tomorrow.

## BELL TELEPHONE LABORATORIES

Exploring and inventing, devising and perfecting, for continued improvements and economies in telephone service.



RADIO & TELEVISION NEWS

**YOUR OPPORTUNITY IS HERE NOW! LEARN**

# TELEVISION

**RIGHT AT HOME!**

By the new method of  
**TRANSPONDENCE**

training on film and tape recordings

Now the De Forest-Sanabria Corporation—a division of the world's largest television training school—brings class-room instruction to you right in your own home! You actually hear your instructor's recorded voice. At the same time you watch "blackboard" size projected pictures, diagrams and illustrations. It's the quick, easy way to equip yourself for the big earnings in television—today!

**LOOK . . . You get the tape recorder and projector right at the start of your course!**



**HEAR your instructor**

It's even better than the classroom, because you can repeat the instructor's lectures until they're thoroughly understood.

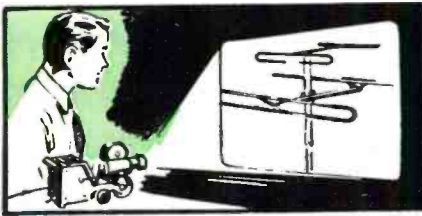

**SEE 2000 illustrations**

You learn quicker when you see diagrams and illustrations in black-board size.

APPROVED FOR VOCATIONAL REHABILITATION

You get the famous "TRANSPONDER" precision built, high fidelity tape recording machine with your very first lesson—and a powerful projector with which you can view diagrams and illustrations enlarged to a size that makes them easy to see and understand.

**APPROVED FOR VETERANS UNDER G.I. BILL**



**READ from reference library**

You receive complete books, pamphlets and manuals to supplement your instructor's lessons.



**ASK your questions on tape**

Tell your instructor about anything that puzzles you and get his answers back pronto.



**BE A SUCCESS . . . ACT NOW!**

Millions of television set owners are demanding qualified television technicians to service their sets. There is a tremendous shortage of such qualified men today and will be for many years to come. Get in on the ground floor of this booming industry and be prepared to accept a steady, big pay job for life. We can qualify you quickly, easily, surely—and help get you a job when you complete your course. Send for illustrated booklet that gives the complete details.

**MAIL COUPON TODAY!**

De Forest-Sanabria Corporation **FREE BOOK**  
Dept. RN-7  
5050 Broadway, Chicago 40, Ill. **TELLS HOW**

Dear Sirs:  
Please send me copy of your free illustrated booklet which describes the new TRANSPONDENCE method of learning television at home under the direction of Dr. Lee de Forest and U. A. Sanabria.

NAME \_\_\_\_\_ AGE \_\_\_\_\_

ADDRESS \_\_\_\_\_

CITY \_\_\_\_\_ STATE \_\_\_\_\_

Check here  IF VETERAN  NON-VETERAN

**The De Forest-Sanabria Corp.**

An affiliate of American Television, Inc.

5050 North Broadway, Chicago 40, Illinois

# Specially Designed



For ticklish TV soldering, there's no tool like the new 135-watt Weller Gun. Dual spotlights eliminate shadows. Precision balance assures accurate soldering. Long length reaches deep into chassis. 5-second heating saves time and current. Your Weller Gun pays for itself in a few months.



## Check This Exclusive Combination of Features

- **5-SECOND HEATING**—No waiting. Saves power.
- **OVER/UNDER DESIGN**—Tube construction gives bracing action to tip, and improves visibility.
- **DUAL SOLDERLITE**—Prefocused spotlights completely eliminate shadows—let you see clearly.
- **LONGER REACH**—Slides easily into the most complicated set-up. Reaches tight corners.
- **COMPACT DESIGN**—Streamlined and precision balanced for delicate "pin-point" soldering.
- **TRIGGER-SWITCH CONTROL**—Adjusts heat to the job. No need to unplug gun between jobs.
- **DUAL HEAT**—Single heat 100 watts; dual heat 100/135 watts; 120 volts, 60 cycles. Handles all light-duty soldering.

See new Model WD-135 at your distributor, or write for bulletin direct.

- **SOLDERING GUIDE**. Get your new copy of "Soldering Tips"—revised, up-to-date and fully illustrated 20-page booklet of practical soldering suggestions. Price 10c at your distributor, or order direct.

**WELLER**  
ELECTRIC CORP.

810 Packer Street, Easton, Pa.



For the **RECORD.**

BY THE EDITOR

## DOCTORS, LAWYERS AND THE RADIO-TV TECHNICIAN

IT IS generally agreed that "professional people" are poor business men and, consequently, do not take the initiative when it comes to selling themselves and their services to customers. In the radio and television service field there are many thousands of qualified experts who fail to conduct themselves in a manner proper to one having a "professional" status along with doctors, lawyers, CPA's, dentists, and other professional men. Failure to recognize their professional status has defeated many top flight technicians who depend upon a steady clientele for their livelihood.

Many honest and capable technicians, faced with opposition from unscrupulous "screwdriver mechanics" are sitting patiently by, waiting for the competition to hang itself. Some are a lot harder to hang than others and, while time passes, the sitter loses his customers to the chiseler who will attempt to do the job for half the price that has been established by the professional man.

He cries aloud, but like the voice in the wilderness, is seldom heard. Few people pay attention to an individual, but when his voice is added to others in loud protest on matters bearing on his reputation and quality of work, he is able to command attention. In small towns, cities, and communities, his best counter-attack on the chiselers is to "keep company" with other respectable men doing the same kind of work or operating a similar business who have organized locally to combat the incompetent and unscrupulous people that are setting up shop and reaping rich rewards from the lush radio-TV industry.

These local organizations, however, can only solve problems in their own communities—not on a national scale where the entire industry is faced with the task of selling the set owner the idea that the electronic industry is able to give honest and competent service to the customer—in spite of continued pressure from those who tag us as a bunch of "gyps." It will take the combined efforts of local and national organizations to ward off the daily attacks on the service industry. After all these months we still lack a complete working national organization that can devote its full time, energy, and resources to conducting a hard hitting campaign to convince a discouraged public that the industry is doing its utmost to solve its problems and to back up its products and prices with warranties, codes of ethics, and programs designed to build the prestige of the deserving service technician and

dealer by a well planned counter-attack against "fly-by-night" operators who have neither the know-how or technical brains to properly maintain the equipment they sell and hope to maintain.

There is real and added opportunity for the fly-by-night technician to prey on unsuspecting customers to sell them a color conversion to CBS standards at ridiculous fees and with no warranty to protect the "sucker." This practice will be another blow at the reputation of TV technicians and is sure to be exploited in the press. All reputable service dealers and technicians should be on the alert for such a possibility and plan to smash such operations as soon as they start.

Several manufacturers have already launched campaigns on a national scale to give concrete help to the qualified technician and to close the gate on the unqualified. Such programs help tremendously to win the confidence of the public as well as to give recognition to the deserving and honest technician or dealer—but it's only part of the answer.

The most potent ammunition, however, is still lacking. We mean a national organization that has the backing of our industry and all of its people toward a common goal. We don't claim that such an organization is not in the making. We have high praise for TCA, NATESA, and others who are making a real contribution towards a better industry and we eagerly look toward the day when all radio and television service technicians will be active in a national organization headed by talent from the ranks.

One of its objectives would be to defeat any and all forms of licensing of qualified technical personnel. The very word "license" in a community is distasteful to any merchant or his customers. To many it implies that some political agency is being "paid off" for the privilege of conducting business.

The reputable technician-dealer doesn't need such sanction. He simply requires the good will of his customers, earned by fair dealings with those that he contacts and the good will that always results from prompt and satisfactory service to the set owners. But once he has earned a reputation in his community he must continue to sell himself as a professional and to recognize his debt to the community in which he operates. His customers do not owe him a living—rather he owes his living to his customers.

By conducting himself as a man with a professional status—his chances for success in the radio-television service business are assured. . . . O.R.

RADIO & TELEVISION NEWS



# ALL ED for peak service! Hallicrafters for peak performance!



**S-72 4-Band Portable.** Tops for versatile, powerful all-wave reception. Covers 4 bands: 540-1600 kc, 1500-4400 kc, 4.3-13 mc, 12-30.5 mc. Features: 2 built-in antennas—loop for standard AM, 61" whip for short wave; has sensitivity control, AVC, BFO, main and fine tuning controls, phone jack. Handsome brown leatherette carrying case, 14 x 12 1/4 x 7 1/4". For 105-125 volts DC, or 50-60 cycle AC, or self-contained battery. With tubes, less battery. Shpg. wt., 16 lbs.

97-505. S-72 Portable. Only . . . . . **\$109.95**  
\$16.49 down, \$8.26 monthly for 12 mos.  
80-585. A-B Battery Pack. Net . . . . . **\$4.17**



**SX-71 Popular Double-IF Receiver.** Covers 5 bands: 538-1650 kc, 1600-4800 kc, 4.6-13.5 mc, 12.5-35 mc, 46-56 mc. Features: electrical bandspread; tuned RF stage, 3-step crystal filter; NBFM adapter; automatic noise limiter; calibrated "S" meter; BFO; tone control; wide-vision dials; temperature compensation; universal antenna input. Steel cabinet, 18 1/2 x 7 3/8 x 12". For 105-125 volts, 50-60 cycles. Complete with all tubes. Shpg. wt., 33 lbs.

97-506. SX-71, less speaker. Only **\$199.50**  
\$29.93 down, \$14.98 monthly for 12 mos.  
SX-71, with R-46 speaker. 63 lbs. Net **\$219.45**



**S-76 New Double-Conversion Receiver.** Amazing selectivity at moderate cost! Exclusive 5-position, 50 kc adjustable second IF, providing 500 cycle band width at 6 db down, 3 kc at 60 db down, and 3 broad selectivity positions. Covers 538-1650 kc, 1720-4900 kc, 4.6-13 mc, 12-34 mc. Full electrical bandspread; built-in 4 1/2" "S" meter; tuned RF; BFO; ANL; tone control. Steel cabinet, 18 1/2 x 9 x 9 1/2". For 115 volts, 50-60 cycles AC. Complete with all tubes. Shpg. wt., 40 lbs.

97-746. S-76, less speaker. Only **\$169.50**  
\$25.43 down, \$12.73 monthly for 12 mos.  
S-76, with R-46 speaker. 70 lbs. Net **\$189.45**

## For the Short Wave Fan!

## For the Novice Licensee!



**S-77 Special AC-DC Value.** Here's versatile communications quality at low cost. Covers 540 kc to 44 mc continuously for all AM broadcast and Amateur and foreign short wave. Controls: main tuning and bandspread dials, noise limiter, AVC, BFO on-off, BFO pitch; RF gain, volume, AM-CW switch, Tone-AC on-off, Standby-Receive. Built-in PM speaker and headphone jack. In steel cabinet, 18 1/2 x 8 1/2 x 11". For 105-125 volts DC or 50-60 cycles AC. Complete with tubes. Shpg. wt., 29 lbs.

97-747. S-77 Receiver. Only . . . . . **\$99.95**  
\$14.99 down, \$7.51 monthly for 12 mos.



**S-38B** Here's the all-star, all-wave value that amazes even the experts. Covers 4 full wave bands, continuous range from 540 kc to 32 mc. Receives AM broadcast and all important short wave frequencies. Features: full electrical bandspread; Band Selector; Voice-Code switch; Speaker-headphones switch; Standby-Receive switch; latest PM speaker. Handsome furniture-steel cabinet, 12 1/8 x 7 3/8 x 7 1/4". For 105-125 volts DC, or 50-60 cycles AC. Complete with tubes. Shpg. wt., 15 lbs.

97-508. S-38B Receiver. Only . . . . . **\$49.50**  
\$4.95 down, \$5.25 monthly for 9 mos.



Get on the air at **LOW COST!**

**SR-75** A complete basic Ham station for transmitting and receiving on all popular Amateur bands! Features: 4 band tuning—540-1650 kc, 1.65-5.1 mc, 5-14.5 mc, 13-32 mc. With 5" speaker and headphone jacks. Crystal-controlled transmitter includes coils for 80, 40, 20, 11 and 10 meter bands. 10-watt input 50L6GT final amplifier also serves as receiver output. Has keying relay. In steel cabinet, 12 1/8 x 7 3/8 x 7". For 105-125 volts 50-60 cycles AC. Complete with all tubes and coils. Shpg. wt., 18 lbs.

97-745. SR-75 Station. Only . . . . . **\$89.95**  
\$13.50 down, \$6.75 monthly for 12 mos.

## free 212-PAGE ALLIED CATALOG

Send for the only complete Buying Guide to everything in Radio, TV and Industrial Electronics. Make your selections from the world's largest stocks of quality equipment—at lowest, money-saving prices. Get every buying advantage at ALLIED—speedy delivery, expert personal help and assured satisfaction. Write for your FREE copy of the 212-page ALLIED Catalog today.

# ALLIED RADIO

ALLIED RADIO CORP. Dept. 1-G-1  
833 W. Jackson Blvd., Chicago 7, Illinois

- Send FREE 212-Page ALLIED Catalog  
 Enter order for Hallicrafters Model \_\_\_\_\_

Enclosed \$ \_\_\_\_\_  Full  Part Payment.  
Payment (Bal. C.O.D.)

Name \_\_\_\_\_

Address \_\_\_\_\_

City \_\_\_\_\_ Zone \_\_\_\_\_ State \_\_\_\_\_



Here's how YOU  
 can sell more  
 Picture Tubes  
 WITH  
 HYTRON'S NEW  
 EASY BUDGET PLAN!

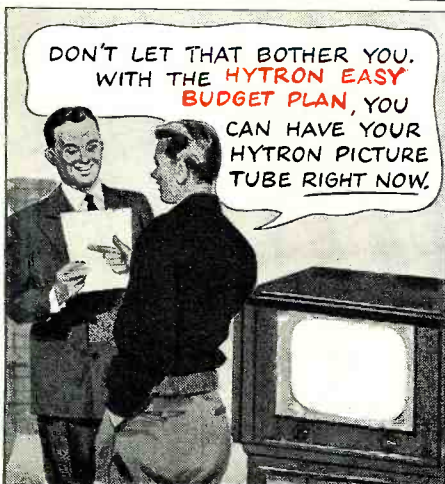

**ANOTHER HYTRON FIRST FOR YOU!**

No need to miss that profitable picture-tube sale — just because the customer doesn't have the cash. The original Hytron Easy Budget Plan saves the sale. Gives you a competitive edge. Hytron has arranged the details for you. A national credit organization, with facilities in all TV areas, stands ready to serve you.

Find out how you can put this wonderful, timely Hytron plan to work right now! Write for complete information today.

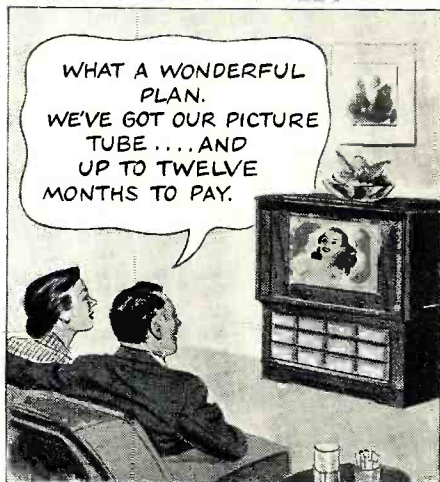

**ANOTHER  
 HELPFUL SERVICE  
 FOR YOU FROM...**



MAIN OFFICE: SALEM, MASSACHUSETTS  
 RADIO & TELEVISION NEWS

# GET INTO RADIO-TELEVISION

## ELECTRONICS By Shop-Method Home Training

### GOOD JOBS AWAIT THE TRAINED RADIO-TV TECHNICIAN

There is a place for *you* in the great Radio-Television-Electronics industry when you are trained as National Schools will train you at home!

Trained technicians are in growing demand at good pay—in manufacturing, broadcasting, television, communications, radar, research laboratories, home Radio-TV service, and other branches of the field. National Schools Master Shop-Method Home Training, with newly added lessons and equipment, trains you in your spare time, right in your own home, for these fascinating opportunities. **OUR METHOD IS PROVED BY THE SUCCESS OF NATIONAL SCHOOLS TRAINED MEN, ALL OVER THE WORLD, SINCE 1905.**

### EARN WHILE YOU LEARN

Many National students pay for all or part of their training with spare time earnings. We'll show you how you can do the same! Early in your training, you receive "Spare-time Work" Lessons which will enable you to earn extra money servicing neighbors' and friends' Radio and Television receivers, appliances, etc.



Signal Generator

Audio Oscillator

T. R. F. Receiver

### National Schools Training Is All-Embracing

National Schools prepares you for your choice of many job opportunities. Thousands of home, portable, and auto radios are being sold daily—more than ever before. Television is sweeping the country, too. Co-axial cables now under construction will soon bring Television to every city, town, and farm! National Schools' complete training program qualifies you in all fields. Read this partial list of opportunities for trained technicians:

- Business of Your Own • Broadcasting
- Radio Manufacturing, Sales, Service • Telecasting
- Television Manufacturing, Sales, Service
- Laboratories: Installation, Maintenance of Electronic Equipment
- Electrolysis, Call Systems
- Garages: Auto Radio Sales, Service
- Sound Systems and Telephone Companies, Engineering Firms
- Theatre Sound Systems, Police Radio
- And scores of other good jobs in many related fields.

### TELEVISION TRAINING

A complete series of up-to-the-minute Television lessons is an important part of your course. They cover all phases of Television repairing, servicing and construction. The same lesson texts used by resident students in our own modern and complete Television broadcast studios, laboratories and classrooms!

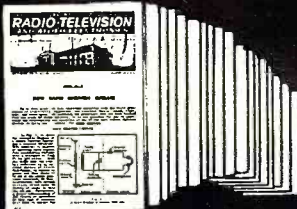

## MASTER ALL PHASES!

Get Master Shop-Method Home Training from an Established Practical Resident School with its own Training Shops, Laboratories, and Studios—and almost 50 Years of Successful Experience in Training Ambitious Men.

**We Bring National Schools To You**

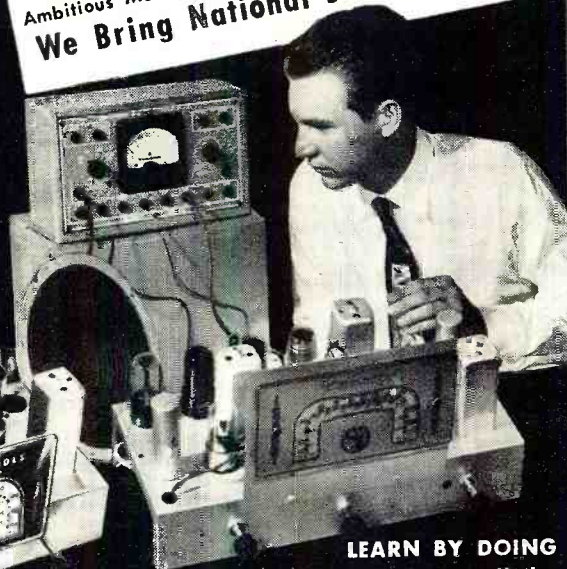

### LEARN BY DOING

You receive and keep all the modern equipment shown above, including tubes and valuable, professional quality Multitester. *No extra charges.* You build the fine Superheterodyne Receiver with parts we send you.

**FREE!** These 2 Free Books give you all the facts. Send today for National Schools' new, illustrated Book of Opportunity in Radio-Television-

Electronics, and an actual Sample Lesson. No cost—no obligation. Use the coupon now—we'll answer by return airmail.

**VETERANS HURRY! ACT NOW! G.I. BILL expires July 25**

**Both Resident & Home Study Courses offered**



## NATIONAL SCHOOLS

LOS ANGELES 37, CALIF. • EST. 1905

### FIND OUT NOW... MAIL COUPON TODAY

National Schools, Dept. 7-RN  
4000 South Figueroa Street  
Los Angeles 37, California

Mail in envelope or paste on penny postal.

Send me your FREE book "Your Future in Radio" and the sample lesson of your course. I understand no salesman will call on me.

NAME \_\_\_\_\_ AGE \_\_\_\_\_

ADDRESS \_\_\_\_\_

CITY \_\_\_\_\_ ZONE \_\_\_\_\_ STATE \_\_\_\_\_

Check here if Veteran of World War II

# REPLACEMENT CONCENTRICS?

**"Roll Your Own"**  
with IRC's Amazing New  
*Concentrikit*

**Replaces Over 90% of ALL  
Concentric Dual Controls!**



How long does it take *you* to get replacement concentrics? Days or weeks, maybe, if you're looking all over the landscape for exact duplicates. *Minutes*—when you "roll your own" with IRC's astonishing new CONCENTRIKIT!

## ASSEMBLE ALMOST ALL CONCENTRIC DUALS IN JUST A FEW MINUTES

Here, if we do say so ourselves, is the most sensational control development ever! A handy CONCENTRIKIT of 11 universal parts—a shaft end and a couple of base elements—a few minutes with ordinary tools—and you have the *exact concentric dual you need* for home or auto radio as well as TV. More than 90% of all concentric duals can be replaced quickly and easily with CONCENTRIKIT! Think what this means in time-and-inventory savings.



## EASY, FOOL-PROOF CONCENTRIC REPLACEMENT

Step-by-step instructions, furnished with every CONCENTRIKIT, make concentric dual assembly simple and easy. And IRC's comprehensive new TV Replacement Manual gives full data on concentrics from the earliest home and auto radio sets to modern TV. Be sure to get your copy from your IRC Distributor.

# IRC *Concentrikit*

## Stock Assortment Covers over 500 TV Models



ONLY  
**\$24<sup>78</sup>**  
 DEALER NET COST

This Complete Assortment  
**AND METAL CABINET**  
 at Only the Price of the Parts!

Quantity		Quantity	
Complete Concentrikits	4	B19-133X	1
Base Elements		B11-137	3
B11-108	1	B13-137	2
B11-114	1	B13-137X	1
B11-115	1	B18-137XX	1
B11-116	1	B19-137X	1
B17-116	1	B11-139	2
B11-119	1	B13-139	1
B11-120	1	B13-139X	1
B11-121	1	Inner Shaft Ends	
B11-123	2	E-187	3
B11-128	2	E-190	1
B11-130	1	E-202	2
B13-130	2	Sleeve Bushings	
B13-130X	1	S-4	1
B18-130X	1	S-5	1
B18-132X	1	Resilient Retainer Rings	10
B11-133	2	Switches	
B13-133	2	76-1	3
B13-133X	1		
B18-133X	1		

With this compact CONCENTRIKIT Stock Assortment on your bench, you're ready for all TV concentric dual requirements. Hand-some, durable metal cabinet contains all you need to assemble any of 144 different concentric duals. Parts cover over 500 different TV models . . . RCA, Admiral, Air King, Belmont, Emerson, General Electric, Motorola, Philco, Westinghouse, Zenith, and many more. Order from your IRC Distributor now—or clip coupon for more information. International Resistance Company, 401 N. Broad St., Philadelphia 8, Pa.

This handsome, enamelled all-metal cabinet keeps your CONCENTRIKIT Stock Assortment safe and handy. Four drawers with individual compartments keep parts in order. Cabinets may be stacked with IRC Resist-o-Cabinets for convenience and good looks in the shop. ALL-METAL CABINET IS SUPPLIED AT NO EXTRA CHARGE—You pay only the regular price of the parts—\$24.78.

**ORDER YOURS TODAY!**



**INTERNATIONAL  
 RESISTANCE COMPANY**

401 N. Broad Street, Philadelphia 8, Pa.

*Wherever the Circuit Says*

In Canada: International Resistance Co., Ltd., Toronto, Licensee

**INTERNATIONAL RESISTANCE COMPANY**  
 415 N. Broad Street, Phila. 8, Pa.

I'm interested in saving time and inventory investment with CONCENTRIKIT. Send Catalogs DC1B and DC2A with full information on CONCENTRIKIT and Dealer Stock Assortment.

Enclosed find 50c in stamps or coin for my copy of IRC's new TV Replacement Manual.

NAME .....

COMPANY .....

ADDRESS .....

J. F. ARNDT & CO., ADV. AGENCY



With every \$2.00 purchase of WALSCO products or \$10.00 worth of antennas...

it's

**FREE!**

**WALSCO**

**12<sup>th</sup>**

**ANNIVERSARY**

**GIFT** package



**...all YOURS!**

- WALSCO LUBRICATOR
- WALSCO CONTACTENE INJECTOR
- WALSCO TUNERLUB
- WALSCO NO-OX
- WALSCO CEMENT



**\$2.00** value **FREE**

with every \$2.00 purchase of WALSCO products... or \$10.00 worth of WALSCO antennas.

**A TERRIFIC FREE OFFER!**

Each item in this attractive GIFT package will be useful to you. And it's yours at *no extra cost!* All 5 handy items in this package are from the famous line of WALSCO quality products. Every radio and TV service man will want one. Get yours today!



**FREE GIFT PACKAGE** available at your local parts jobber. Get yours today!

**WALSCO**

**WALTER L. SCHOTT CO.**  
Los Angeles 18, Calif. • Chicago 6, Ill.

**RADIO & TELEVISION NEWS**

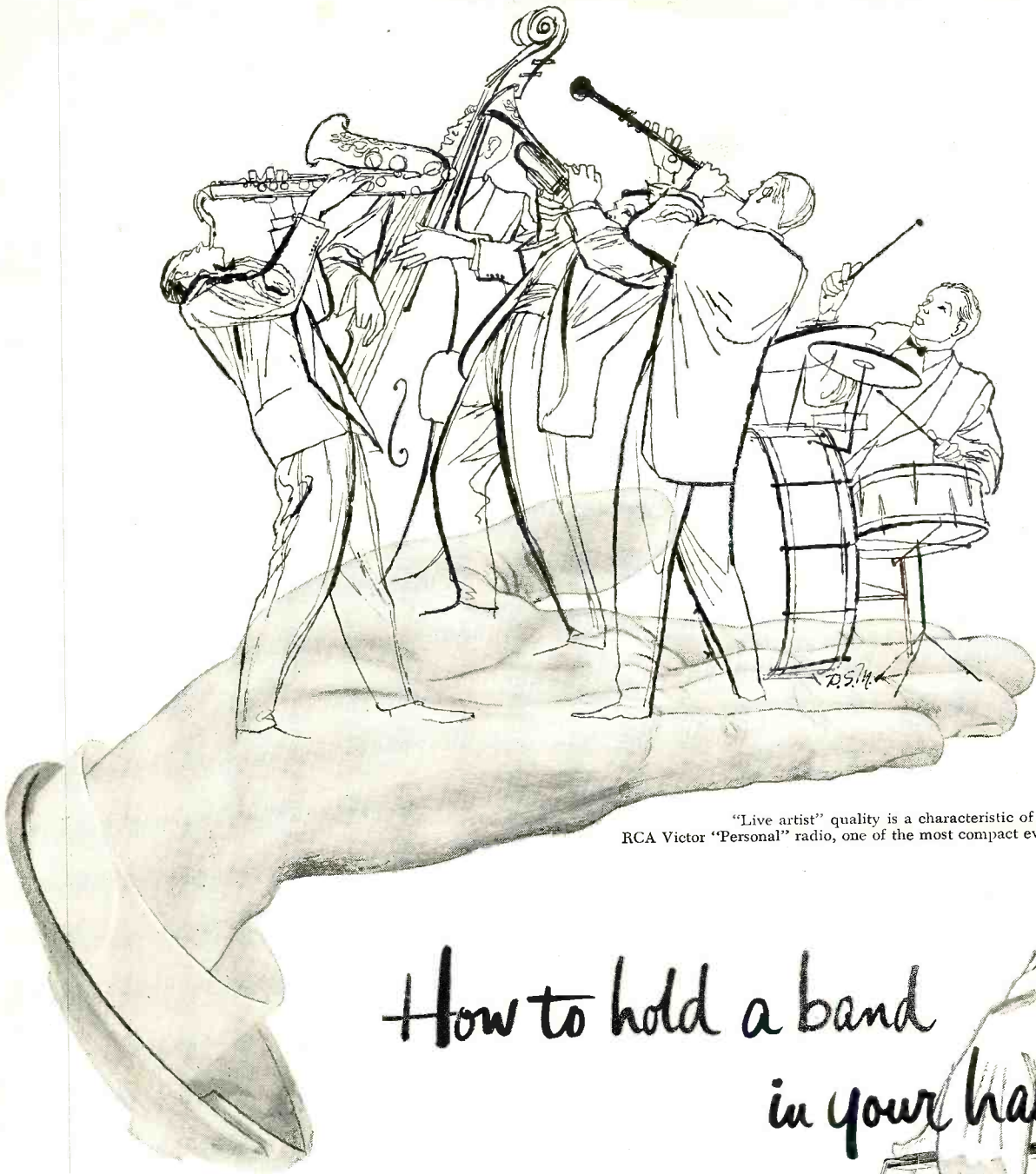

"Live artist" quality is a characteristic of the new RCA Victor "Personal" radio, one of the most compact ever built.

## How to hold a band in your hand!

Tune in this RCA Victor "Personal" radio —no bigger than a book. Out pour the full tones of any orchestra—so full of "living presence"—that it's like holding a band in your hand.

This compact instrument grows directly from basic research conducted at RCA Laboratories. Scientists and engineers here perfected highly efficient circuits and electron tubes—powered by compact RCA Batteries. Its built-in antenna gives peak performance anywhere—at home or "on the

road." Its miniature loudspeaker offers fine acoustical performance in a minimum of space.

Development of this handsome portable radio, weighing less than 4 pounds, is another example of RCA research and engineering at work for you. Result: a totally new satisfaction from a small "Personal" radio.

\* \* \*

See the latest wonders of radio, television and electronics at RCA Exhibition Hall, 36 West 49th Street, N. Y. Admission is free. Radio Corporation of America, RCA Building, Radio City, New York 20, N. Y.



See the compact new RCA Victor "Personal" radio today. Model B411—now on display at your local RCA Victor dealer's.



**RADIO CORPORATION of AMERICA**  
World Leader in Radio — First in Television



## New 3<sup>rd</sup> Edition SPRAGUE TV CAPACITOR REPLACEMENT MANUAL

Here—just off press—is the new Sprague Manual that tells you in a jiffy just what capacitor to use on practically any television replacement job. Includes complete electrolytic capacitor replacement data on 964 TV receivers—saves you time, paves the way to better work on practically every job!

### GET YOURS... TODAY!

Ask your Sprague distributor for a FREE copy of this new Manual M-473. Or, write your name on the attached coupon and enclose 10c to cover handling and mailing and we will rush your copy directly to you!

Mail to:

**SPRAGUE PRODUCTS COMPANY**

51 Marshall Street, North Adams, Mass.

Enclosed is 10 cents for your M-473 TV Manual.

Name \_\_\_\_\_

Street \_\_\_\_\_

City \_\_\_\_\_ Zone \_\_\_\_\_

State \_\_\_\_\_

# Spot Radio News

★ Presenting latest information on the Radio Industry.

By RADIO & TELEVISION NEWS'

WASHINGTON EDITOR

**THE FCC NEW DEAL IN TV**, providing for a coast-to-coast chain of thousands of new stations in the higher bands, and lower bands, too, which was scheduled to have been judged by industry in an early-spring hearing, will now have to wait for the sweltering days before its fate can be determined, because of a sudden avalanche of briefs from over 700 prospective licensees, educators, associations, consultants, network owners, manufacturers, and labs offering varied opinions on the plan.

Three professional groups played a major role in effecting a deferment of the fact-finding sessions: the Federal Communications Bar Association, Association of Federal Communications Consulting Engineers, and the National Association of Radio and Television Broadcasters. All claimed that the storm of comments would require many more weeks and months to digest than anticipated, for the preparation of their complete reviews on the situation. Survey reports filed by these associations were highly critical of the proposals offered by government. According to NARTB, the Commission has suggested the subtraction of large number of channels for a . . . "special class of applicants by means of a blanket reservation . . ." This *special class*, or educators were not, in their opinion, entitled to this broad indefinite assignment at a time when frequencies were precious. They felt that alternative methods of providing school programs should be considered; wire lines or microwave relays. It was their opinion, too, that universities were not too keen about TV, with many groups, such as the NCAA (representing around 300 of the country's largest schools) on record suggesting that no sports, such as football, should be telecast.

The legal specialists indicated in their comments that the recommended policy was . . . "predicated upon an invalid legal foundation . . .", the procedures suggested violating the present law, since there was no recognition of the rights of applicants to . . . "an equal and fair opportunity to be heard on the merits of applications."

Even members of Congress entered the argument, with some making personal pleas for their areas. Senator Edwin C. Johnson of Colorado pointed out in a brief that Denver should certainly have more than the three com-

mercial very-high channels assigned. This allocation, he declared, actually . . . "discriminates" against the city, and in his opinion was therefore . . . "contrary to Congressional policy of fair, efficient, and equitable distribution of TV broadcast facilities . . ." The Senator asked that there be a re-assignment of channels in his home state or among the states of Colorado, Wyoming, and Nebraska.

Dissatisfaction was also voiced by WIP in Philadelphia, who declared that the removal of channel 12 from that city was improper. It appears as if WIP had applied for this channel, and extensive hearings on the case were completed before the freeze was clamped on, a procedure which was quite costly to the station. Executives of this station felt that the channel should now remain in the City of Brotherly Love.

An alternate allocation plan was also filed with the Commission by one of the networks, *Du Mont*. Their proposal showed that the FCC could, through some reshuffling, add some 98 stations in the very-high bands and 61 in the higher bands. Specifically, *Du Mont* pointed out that in 375 communities it should be possible to provide for 655 very-high stations, instead of 557 outlets in 342 communities. In the ultra-high scheme, which involved an area north and east of Memphis, 598 stations were cited as being possibilities, instead of 537 outlined by the Commission.

The *Du Mont* proposal also contained one allocation-solution suggestion which may become a headline topic during the summer hearings. It seems as if some of the researchers of this pioneer manufacturer had had some interesting experience with automatic computing equipment, particularly with the *Whirlwind One* machine at the Massachusetts Institute of Technology, the device providing unusually complete and accurate answers to complex problems, one of which involved allocations. In view of these results, they feel that Mr. Whirlwind can perhaps provide the answers to the whole allocation problem. So, they have fed some typical cases to the machine and plan to feed more to the huge electronic gear. And if FCC permits, the answers will be entered on the record. The results of this test may introduce a new era in frequency charting.

**RADIO & TELEVISION NEWS**



Here's a "BOND"  
That Money  
Can't Buy...  
**THE**  
**RAYTHEON**  
**BOND**  
or **ELECTRONIC**  
**TECHNICIANS**



It's a bond of integrity — a bond of ability — a bond of confidence between customer and service dealer. It's a bond resulting from Raytheon's desire to improve relationships between customers and service dealers. It's a bond of great value — yet it's yours *at no cost* if you can qualify. It's a bond that's Raytheon's investment in your future.

For more than five years the Raytheon Bond, which cash protects service dealers' 90-day guarantee on TV and Radio Repairs, has helped radio and television shops throughout the country to increase volume, build customer good will and has shielded them against attacks on their integrity. *It can do the same for you!*

Better ask your *Raytheon Tube Distributor* if you can qualify for this outstanding business asset.



RIGHT... FOR SOUND AND SIGHT



**RAYTHEON MANUFACTURING COMPANY**

Receiving Tube Division

Newton, Mass., Chicago, Ill., Atlanta, Ga., Los Angeles, Calif.

*Excellence in Electronics*

RADIO AND TELEVISION RECEIVING TUBES, CATHODE RAY TUBES, SPECIAL PURPOSE TUBES, SUBMINIATURE TUBES, MICROWAVE TUBES

COPYRIGHT 1951

# CHICAGO

hermetically-sealed TRANSFORMERS  
and Filter Reactors meet the  
full requirements of **MIL-T-27**

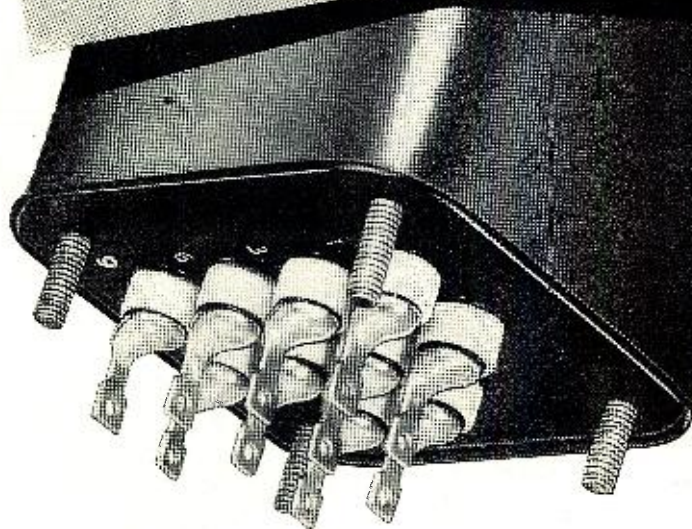

## the Complete Transformer line that Meets Military Specifications

If you require fully approved MIL-T-27 Transformers and Filter Reactors for prototype models, pilot runs or special applications, and need them in a hurry—call your electronic parts distributor for *quick service* on CHICAGO Hermetically-Sealed units. Chances are he'll have them in stock—and you'll save valuable time and effort. There's a *complete* range of CHICAGO MIL-T-27 Transformers available: *Power, Bias, Filament, Filter, Audio.*

CHICAGO Hermetically-Sealed Transformers are the world's toughest units, preferred by engineers for those rugged applications. These stock transformers may be incorporated in your equipment with full assurance that they meet *complete* MIL-T-27 specifications.



### SEND FOR "NEW EQUIPMENT" TRANSFORMER CATALOG

Have the full details at your fingertips on CHICAGO'S *New Equipment Line*—covering all MIL-T-27 units as well as famous Sealed-in-Steel transformers engineered for every application and geared to today's circuit requirements. Write for your free copy of this important catalog today, or get it from your distributor.

## CHICAGO TRANSFORMER

DIVISION OF ESSEX WIRE CORPORATION

3501 ADDISON STREET • CHICAGO 18, ILLINOIS



The torrent of briefs snarled plans made by many, particularly those at the Commission, who expected the hearings to begin earlier and end around August. FCC Headman Wayne Coy had told a group of newspaper men during a Washington meeting that this . . . "hearing may take as much as two months. That would bring us up to the forepart of August. The Commission may need August and September to study the record and render a final decision on its allocation master plan. Thereafter, it will allow a reasonable time, perhaps as much as two months, for the filing of new applications and the amending of old ones. That would bring us up to the first of December when the Commission could begin granting new construction permits or ordering hearings for contested applications."

With the hearings now set to begin just a few weeks before the Commission had felt they might end, and with about triple the amount of testimony to study, it appears as if several and perhaps even more months will have to be added to Coy's timetable for the processing of permits for new stations. The general consensus is that the spring of '52 might see the beginning of a flow of station approvals. Whether the towers will go up and buildings will be constructed immediately or in the future, will depend on the needs of the military and the success of the CMP plan in allocating material for defense and the civilian front. According to Coy, TV transmitters do not . . . "require a large amount of materials and there is considerable optimism in the trade that a reasonable amount of such materials may be made available during '52." The outlook for '53, opined Coy, appears bright. Citing Charles Wilson's favorable report to the President, Coy said that . . . "within the present framework of defense planning, the radio manufacturing industry has a reasonable expectation that there will be a continued, though somewhat curtailed, flow of materials."

**COLOR TV**, still a subject of sharp debate everywhere and destined to be a controversial topic for a long time, in spite of the decision of the jurists in Washington, had been adopted prior to the final decision by some members of the Commission, particularly its chief, Wayne Coy, as a favorite speech item. In an address before the National Newspaper Promotion Association in Washington, commenting on the fact that it had been suggested that he touch on the subject of color, he said: "Confidentially, I would have touched on it even without a suggestion. I am a color enthusiast. And I know that most of you, too, are becoming increasingly color-minded."

Describing the Commission's new interest in color, Coy declared that they have found that . . . "color opens up whole new fields for effective broadcasting."

(Continued on page 120)

**RADIO & TELEVISION NEWS**

# Golden Opportunity

## to prepare for better pay jobs in

# Television Servicing

for men in  
radio-electronics



### YOU STUDY AT HOME

In your spare time, you learn pre-tested "How-to-do-it" techniques with "How-it-works" information in easy-to-study lessons. The course is based on the experience of the RCA Service Company in servicing thousands of home television receivers.

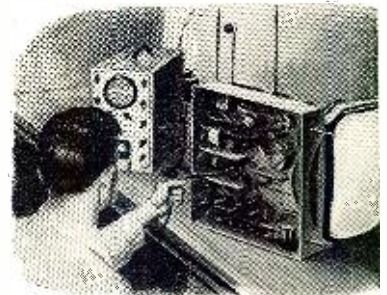

### YOU KEEP WORKING ON YOUR JOB

Because you work in the radio-television-electronics industry, your job provides the laboratory work of the course. There are no kits, parts or equipment to buy. Self-employed independent radio and television servicemen are eligible for enrollment.

No vocational field offers more opportunities for "career" jobs and good pay than television—America's fastest growing industry. The demand for TRAINED and EXPERIENCED TV SERVICEMEN is growing. There is a big shortage of such men now and will be for several years to come.

### PLENTY OF GOOD JOBS OPEN TODAY

Radio-Television jobbers, dealers and service companies offer lifelong opportunities with excellent salaries for qualified service technicians. Manufacturers of television receivers are looking for men with good service training as inspectors, testers and troubleshooters. Many experienced servicemen go into business for themselves. Others hold their regular jobs and earn extra money servicing TV receivers in their spare time.

Radio-electronics manufacturers busy with defense equipment contracts offer excellent job opportunities for men with a television technician background. Servicemen called into military service are further reducing the supply of skilled TV servicemen available for civilian activities. Think what television servicing offers *you* in terms of a lifetime career and financial security.

### RCA INSTITUTES Home Study Course in TELEVISION SERVICING—

#### A Service to the Industry

Because of the critical shortage of TRAINED and EXPERIENCED TV SERVICEMEN, RCA Institutes is offering this highly specialized and practical home study course as a service to the working members of the radio-television-electronics industry. Its object is to train more *good* servicemen and to help make good servicemen *better*.

Never before has this course been available to anyone outside of RCA. It is now offered to *you*, through RCA Institutes, one of America's oldest and most respected technical training schools. The course covers most major makes and types of TV receivers. Available exclusively to men in the radio-television-electronics field. Not offered to the general public, or under G.I. Bill.

The cost is low . . . only \$9 a unit for 10 units or \$90 total, on an easy pay-as-you-learn plan. At successful completion of the course you earn an RCA Institutes certificate that can lead straight to a better job at higher pay.

★ **LOWER RATES FOR GROUPS!** Employers in the radio-electronics industry who desire to enroll six or more of their employees for this course, may do so at lower rates for the group. A special group application form is available for employers desiring to take advantage of this offer. ★

**SEND FOR FREE BOOKLET.** Find out complete details of the RCA INSTITUTES Home Study Course in TELEVISION SERVICING. Don't pass up this opportunity to prepare yourself for a money-making career in the television industry. Illustrated booklet explains all the features of the course. Mail coupon in an envelope or paste on a penny postcard—NOW!

## MAIL COUPON NOW!

RCA INSTITUTES, INC.  
Home Study Department, RN-751  
350 West Fourth Street, New York 14, N.Y.

Without obligation on my part, please send me copy of booklet "RCA INSTITUTES Home Study Course in TELEVISION SERVICING." (No salesman will call.)

Name \_\_\_\_\_ (Please Print)

Address \_\_\_\_\_

City \_\_\_\_\_ Zone \_\_\_\_\_ State \_\_\_\_\_



**RCA INSTITUTES, INC.**  
A SERVICE OF RADIO CORPORATION of AMERICA  
350 WEST FOURTH STREET, NEW YORK 14, N.Y.

July, 1951

19

# Free!

# PRINTED

**First Guide for Printed  
Electronic Circuits Ever  
Offered in the  
Industry**

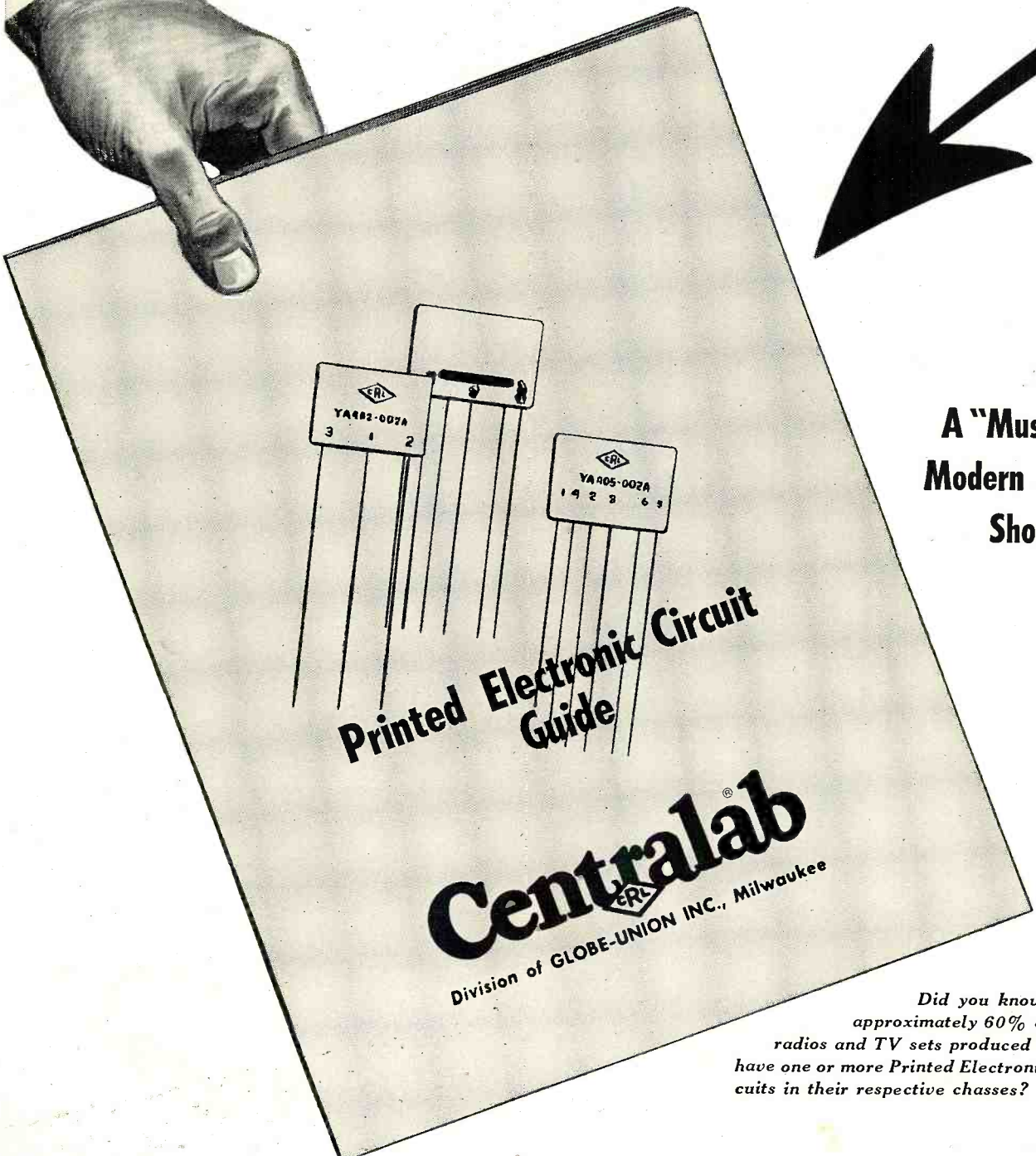

**A "Must" for  
Modern Service  
Shops**

*Did you know that  
approximately 60% of the  
radios and TV sets produced today  
have one or more Printed Electronic Cir-  
cuits in their respective chasses?*

# ELECTRONIC CIRCUIT GUIDE

*Mr. Service Engineer... Here's one of the most modern helps you've ever had for modern TV, AM-FM Service... exact listings show you all Centralab complete PRINTED ELECTRONIC CIRCUIT REPLACEMENTS... prepared especially for you by Centralab, originators and exclusive manufacturers of all complete PRINTED ELECTRONIC CIRCUITS used today... and it's Absolutely FREE!*

## SAMPLE LISTING

MAKE			MAKE		
Identification Printed on Part	Mfr's. Part Number	CRL Cat. No.	Identification Printed on Part	Mfr's. Part Number	
<b>ADMIRAL</b>			<b>GAROD</b>		
63A4-1	63A4-1	PC-90	YA103-003†	B-10.100-1	
63A4-2	63A4-2	PC-91	YA105-043	B-10.100-1	
63A4-3	63A4-3	PC-91	YA402-002		
63A5-1	63A5-1	PC-80	<b>GENERAL ELECTRIC</b>		
63A6-1	63A6-1	PC-101	YA402-002		
YA105-043	63A3-1	PC-50	<b>HALLICRAFER</b>		
YA400-003	63A5-2	PC-70			
<b>KIR KING</b>					
YA402-002		PC-100			
<b>NSLEY</b>					

**MAIL TODAY  
FOR YOUR FREE COPY**

CENTRALAB Div. of Globe-Union Inc.  
910 E. Keefe Ave., Milwaukee 1, Wisconsin  
Please send me without delay, a copy of Centralab's first Printed Electronic Circuit Guide.

Name.....

Address.....

City.....Zone.....State.....

# Centralab

Division of GLOBE-UNION INC. • Milwaukee

July, 1951

21

# 2 New Trio Products

## TRIO TV ROTATOR AND DIRECTION INDICATOR

### TWO HEAVY DUTY MOTORS For Trouble-free • Two Direction Rotation

Here's the rotator that provides the ultimate in trouble-free dependable operation. Designed to support the heaviest TV arrays — even in 80 M.P.H. winds! This outstanding rotator has undergone extensive tests for three years, standing up under every abuse and temperature extremes.

Here, indeed, is the rotator that abolishes TV callback problems!

#### Two Heavy Duty Motors

Two 24 volt motors are used — one for clockwise and one for counter-clockwise rotation. Even if children play with the unit and leave it on continuously, a motor cannot burn out since load on a single motor is never on more than 50% of the time!

Positive acting electrical stops at both ends of 360° turn eliminates lead damage.

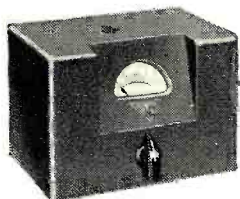

Indicator always shows exact antenna position.

#### Compare These Features

- Cast TENSALLOY aluminum mast holder withstands 4500 lbs. bending movement.
- 1 1/16 steel shaft withstands 4500 lbs. bending movement
- Automatic Electro-Mechanical Brake — reduces coasting to minimum
- Can be fastened to any pipe up to 2" OD
- Two direction rotation
- All-aluminum case — no cast zinc!
- Numbered terminal boards on rotator and indicator
- Turns 1 RPM, lifetime lubricated
- Ball-bearing end thrusts on shafts
- Ideal for 10, 6 and 2 meter amateur use

## NEW TRIO *All Aluminum* TOWER

Weighing less than a pound per foot, this sturdy, extremely handsome, all weather-proof triangular tower represents a great refinement in streamlined appearance and installation ease over all others. Its all-aluminum components permit the most flexible arrangements for construction of the *exact* tower needed for *any* installation.

Tower may be raised from horizontal position in heights up to 40 feet. For additional height, sections may be added from *bottom*.

Comes in 5 foot sections, a bottom section, a top section and as many center sections as desired.

#### FEATURES

- Sturdy, Yet Light In Weight — Less Than A Pound Per Foot
- Forever Rust Proof
- High Quality Extruded Aluminum
- Interchangeable Sections
- Preferred Riveted Construction . . . No Welded joints
- Dual Swivel Base — 180° and 360° permits vertical or horizontal plane mounting
- Low Installation Cost
- Completely Cartoned For Protection In Shipping — Compact Storage

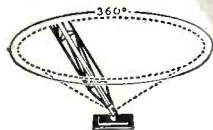

Dual Swivel Base  
180° and 360°

## TRIO YAGIS

*Lead the Field . . .*

### TRIO DOUBLE FOLDED DIPOLE

(Model 304)

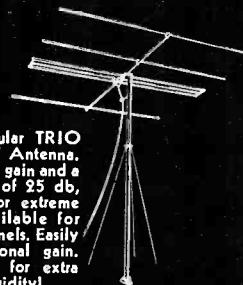

Here is the popular TRIO Double Dipole TV Antenna. With 10 db forward gain and a front-to-back ratio of 25 db, it is unexcelled for extreme fringe areas. Available for each of 12 TV channels. Easily stacked for additional gain. Reinforced fittings for extra strength — extra rigidity!

- Exact Impedance Match To 300 ohm Line!
- Sturdy Construction — Light Weight!
- Partially Assembled!

### TRIO 2-CHANNEL YAGIS

(Models 445 & 479)

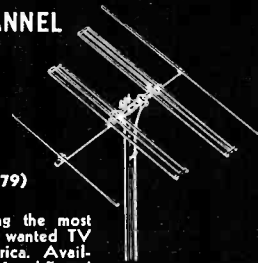

Rapidly becoming the most popular — most wanted TV antenna in America. Available for channels 4 and 5, and channels 7 and 9. Provides gain on two channels equal to any two conventional 4-element yagis!

- Full 10 db Gain On 2 Channels!
- Less Weight Per Gain Than Any Other TV Antenna!

### TRIO PHASITRON Now available separately

(Model No. PC-600)



The TRIO PHASITRON, originally sold only as part of the TRIO Controlled Pattern TV Antenna System, is now available separately for TV set owners who want to get the very best results from their sets and antennas, or to hams and other experimenters.

PHASITRON acts as a continuously variable tuning stub and will provide an exact impedance match between line and booster and helpful in matching output impedance of booster to set input impedance. Due to exact matching, losses in line become negligible and set performance greatly improved.

May also be used to coordinate input from two or more antennas to provide added balanced output to set. Write for full details.

### NEW TRIO TV ACCESSORY CONTROL UNIT

(Model No. RY-1)



A handy control unit that hides away inside or in back of the TV set and provides an automatic line switch for booster, rotator, TV lamp or other accessories. By plugging the line cords from these accessories into the TRIO Control Relay Unit, all accessories are turned on with the one switch controlling the TV set. Quickly installed without making any wiring changes in set.

# THOMPSON CORPORATION

AFFILIATED WITH TRIO MANUFACTURING CO.

GRIGGSVILLE, ILLINOIS



## Trio MFG. CO.

GRIGGSVILLE, ILLINOIS

# YOU'RE ALWAYS WITH G-E PICTURE TUBES! **1<sup>ST</sup>**

**FIRST** with a long-term user warranty. G.E. pioneered the customer warranty on picture tubes . . . commencing with date of retail purchase . . . safeguarding your customers and you, as tube dealer, for six months after installation. By this **BIG** step forward, G.E. removed any worry that its picture tubes on your shelves might run beyond the manufacturer's warranty period. Now you can stock a full line with confidence. And no matter when the tubes are installed, your customers will get full-term, registered G-E warranties in every case!

**FIRST** to benefit from full-page tube consumer advertising. General Electric made tube history when it launched full-page tube advertising in LIFE and the POST—a continuing campaign that is reaching regularly more than 24,000,000 readers from coast to coast. As a G-E dealer, you profit directly from the tremendous G-E tube acceptance which this advertising creates.

**FIRST** in wide range of G-E tube types and sizes available. Round tubes and rectangular—glass, metal—small, medium, large-screen—General Electric builds virtually all types and sizes, giving you *the biggest picture-tube line*. You can service any TV set with assurance that a G-E tube will meet your needs! Conversions to larger screens often are practical—and profitable. With G-E tubes, you can give set owners the larger, easier-to-view pictures they want. And G-E Aluminized Tubes enable you to give them *brighter TV pictures!*

**FIRST** in proved tube quality. You can't beat G-E picture-tube performance! Quality features (example: all-glass electron-gun beading) typify the care G.E. gives to design details that make for superiority. Afterwards comes precision manufacture by ultra-modern equipment in new, well-lighted premises . . . followed by final tests which relentlessly reject any tubes with faulty screen or other characteristics. G-E picture tubes uniformly are *good tubes!* They give top owner satisfaction—build profits and prestige for *you!*

**CASH IN NOW ON THESE G-E "FIRSTS"!  
SEE YOUR G-E TUBE DISTRIBUTOR!**

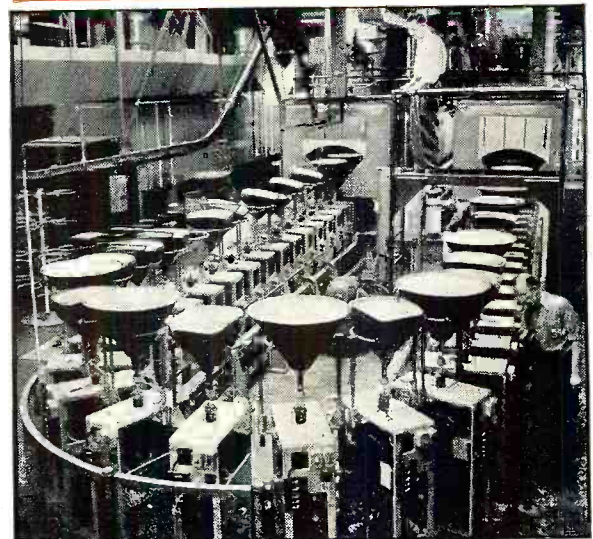
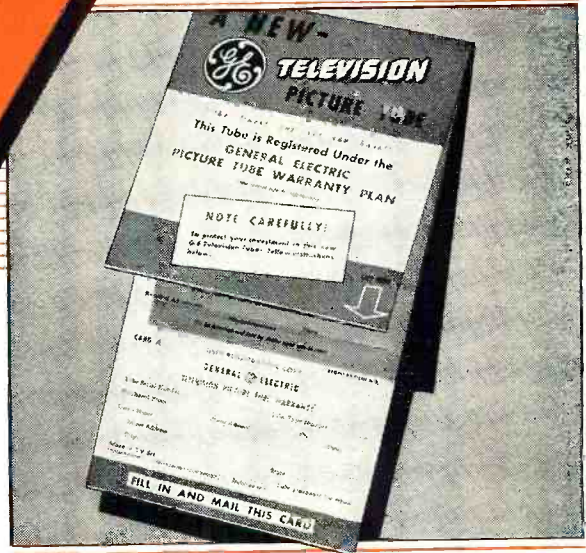

**GENERAL  ELECTRIC**

181-KA7

# new!

ACTUAL SIZE



## PYRAMID TINY TYPE 85LPT TUBULAR PAPER CAPACITORS

Fit anywhere!

Suitable for  
85°C. operation!

CAPACITANCE RANGE:  
.0001 TO .5 MFD.

VOLTAGE RANGE:  
200 TO 600 V., INCLUSIVE

Sturdily built in phenolic-impregnated tubes. Ends are plastic-sealed.

WRITE FOR COMPLETE LITERATURE  
Representatives and Distributors  
Throughout the U.S.A. and Canada



## PYRAMID

### PYRAMID ELECTRIC COMPANY

1445 Hudson Boulevard  
North Bergen, N. J., U. S. A.

TELEGRAMS: WUX North Bergen, N. J.  
CABLE ADDRESS: Pyramidusa

# Within the INDUSTRY

**EDWARD K. FOSTER** has been named vice-president and member of the administration committee of *Bendix Aviation Corporation*.



He will continue as general manager of the company's radio communications division, Baltimore. Mr. Foster went to Baltimore in 1940 as factory manager of the radio division and was successively promoted to assistant general manager and general manager.

Mr. Foster has been in the radio industry since 1928 when he went to work as a stock clerk for the *DeForest Radio Company* and subsequently served as purchasing agent and production manager of that firm. He was also associated with *Sylvania Electric Company Inc.*, joining *Bendix* in 1936.

**CAPITOL RECORDS, INC.** has expanded its custom service operation with the establishment of a studio and recording services division in Hollywood, California.

All of the studios and recording equipment at the company's Melrose Avenue plant in Hollywood will be made available for custom recording. Harvey J. Richardson has been named sales manager for this new service department.

James Bayless, in addition to his duties as manufacturing plant manager, will supervise the Melrose studios.

The company announces that it is equipped to handle all types of custom recording and interested persons should contact the Studio and Recording Services Division at 5515 Melrose Avenue, Hollywood, California.

**THEODORE LINDENBERG** has been appointed chief design engineer of *Pickering & Company*, Oceanside, Long Island manufacturer of audio components for record playing equipment.



Mr. Lindenberg began his career in audio back in 1929 while still in college, collaborating with his father in the design of speakers and portable 16 mm sound recording systems. Later he established and operated a sound and recording studio in Columbus, Ohio.

At the outbreak of World War II, he joined *Fairchild Camera & Instrument Corp.* as a recording design and production engineer. When the *Fair-*

*child Recording Equipment Corp.* was formed, he was placed in charge of engineering for its instrument and disc recording division.

He is a charter member of the Audio Engineering Society and New York Sapphire Club. He was president of AES during 1949-50 and is currently a member of the board of governors.

**TRACERLAB, INC.** has leased the entire sixth floor at 286 Congress Street in Boston primarily for the assembly of electronic instruments . . . **AIR ASSOCIATES INCORPORATED** has leased additional plant capacity at 511 Joyce Street in Orange, New Jersey to permit increased production of its line of electronic equipment . . . **ALPHA WIRE CORPORATION** has recently moved to new and larger quarters at 430 Broadway in New York . . . **SPRAGUE ELECTRIC COMPANY** has purchased part of a woolen mill in Bennington, Vermont in order to provide increased facilities for the manufacture of its high-temperature magnet wire . . . **RAYTHEON MANUFACTURING COMPANY** of Waltham, Mass. has moved its New York and international sales offices to 19 Rector Street in New York . . . **AMERICAN TELEVISION & RADIO CO.** of St. Paul, Minn. has moved its New York offices to 6 East 39th Street, New York 16, New York. Lee Rocke is the metropolitan area representative . . . **VARIETY ELECTRIC CO., INC.** has recently moved to its own three-story building at 468 Broad Street, Newark, New Jersey.

**T. J. FALK** has been appointed supervisor of technical publications for the *General Electric Company's Receiver Division*.



He has been with the company since 1935 when he became service manager for the New York metropolitan area.

From 1941 to 1945 he was employed as an engineer for the Receiver Division in Bridgeport, Conn. Later he entered technical service in Bridgeport, then returned to New York City as service manager. Prior to his appointment as supervisor, he worked in the technical publications section in Syracuse.

**AEROCOIL INC.** has been recently formed to manufacture a line of coils, coil assemblies, and specialized electronic equipment. Principals in the new firm are Victor G. Matto, president; Walter J. Bonazza, chief engi-

RADIO & TELEVISION NEWS



*Six Months from Today*

# Which will YOU hold?

REGRET TO ADVISE  
YOU FAILED YOUR  
FCC EXAMINATIONS -

← THIS  
OR THIS →

1<sup>ST</sup> CLASS  
RADIO TELEPHONE  
OPERATOR'S LICENSE

ADD TECHNICAL TRAINING TO YOUR PRACTICAL EXPERIENCE

## GET YOUR FCC LICENSE IN A HURRY!

THEN—Use Our Amazingly Effective JOB-FINDING Service

Get this Valuable Booklet **FREE**



**TELLS HOW—**

### WE GUARANTEE

TO TRAIN AND COACH YOU AT HOME  
IN SPARE TIME UNTIL YOU GET

### YOUR FCC LICENSE

If you have had any practical experience—Amateur, Army, Navy, Radio repair, or experimenting.

**TELLS HOW—**

Employers make

**JOB OFFERS Like These**

**to Our Graduates Every Month**

Telegram, August 9, 1950, from Chief Engineer, Broadcast Station, Pennsylvania, "Have job opening for one transmitter operator to start immediately, contact me at once."

Letter, August 12, 1950, from Dir. Radio Div. State Highway Patrol, "We have two vacancies in our Radio Communication Division. Starting pay \$200; \$250 after six months' satisfactory service. Will you recommend graduates of your school?"

These are just a few examples of the job offers that come to our office periodically. Some licensed radiomen filled each of these jobs . . . it might have been you!

**HERE'S PROOF FCC LICENSES ARE OFTEN SECURED IN A FEW HOURS OF STUDY WITH OUR Coaching AT HOME in Spare Time.**

Name and Address	License	Lessons
Lee Worthy, 2210 1/2 Wilshire St., Bakersfield, Calif.	2nd Phone	16
Clifford E. Vogt, Box 1016, Dania, Fla.	1st Phone	20
Francis X. Foerch, 38 Beucier Pl., Bergenfield, N. J.	1st Phone	38
S/Sgt. Ben H. Davis, 317 North Roosevelt, Lebanon, Ill.	1st Phone	28
Albert Schoell, 110 West 11th St., Escondido, Calif.	2nd Phone	23

**CLEVELAND INSTITUTE OF RADIO ELECTRONICS**  
Desk RN-31, 4900 Euclid Bldg., Cleveland 3, Ohio  
Approved for Veteran Training Under G.I. Bill

**TELLS HOW—**

Our Amazingly Effective  
**JOB FINDING SERVICE**

Helps CIRE Students Get Better Jobs

Here are a few recent examples of Job-Finding results:

**GETS FIVE JOB-OFFERS FROM BROADCAST STATIONS**

"Your Chief Engineer's Bulletin is a grand way of obtaining employment for your graduates who have obtained their 1st class license. Since my name has been on the list I have received calls or letters from five stations in the southern states, and am now employed as Transmitting Engineer at WMMT." Elmer Powell, Box 274, Sparta, Tenn.

**GETS CIVIL SERVICE JOB**

"I have obtained a position at Wright-Patterson Air Force Base, Dayton, Ohio, as Junior Electronic Equipment Repairman. The Employment Application you prepared for me had a lot to do with my landing this desirable position." Charles E. Loomis, 4516 Genessee Ave., Dayton 6, Ohio.

**GETS JOB WITH CAA**

"I have had half a dozen or so offers since I mailed some fifty of the two hundred employment applications your school forwarded me. I accepted a position with the Civil Aeronautics Administration as Maintenance Technician. Thank you very much for the fine cooperation and help your organization has given me in finding a job in the radio field." Dale E. Young, 122 Robbins St., Owosso, Mich.

OURS IS THE ONLY HOME STUDY COURSE WHICH SUPPLIES FCC-TYPE EXAMINATIONS WITH ALL LESSONS AND FINAL TESTS.

Your FCC Ticket is always recognized in all radio fields as proof of your technical ability.

## Get All 3 FREE

**MAIL COUPON NOW**

**CLEVELAND INSTITUTE OF RADIO ELECTRONICS**  
Desk RN-31—4900 Euclid Bldg., Cleveland 3, Ohio  
(Address to Desk No. to avoid delay)

Approved For Veteran Training Under G. I. Bill

I want to know how I can get my FCC ticket in a minimum of time. Send me your FREE booklet, "How to Pass FCC License Examination" (does not cover exams for Amateur License), as well as a sample FCC-type exam and the valuable new booklet, "Money-Making FCC License Information."

NAME.....  
ADDRESS.....  
CITY..... ZONE..... STATE.....  
Paste on penny post card or send air mail.

# THIS SUMMER

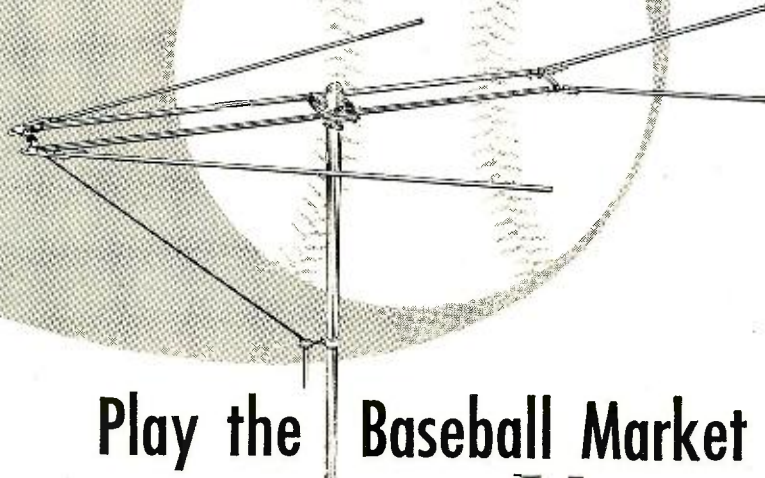

## Play the Baseball Market with the WORKSHOP DUBL-VEE

U.S. PATENT NO. 2-538-915

Baseball television is big business — well over half\* of the total viewing audience in the summertime. To get the full drama of "grand slam" home runs and hair-trigger plays on your television screen, you need a superior antenna. This is where the Workshop Dubl-Vee fits the picture. Its high gain and sharp directivity bring in strong, clear, steady pictures. Ghosts and snow are reduced to the barest minimum even in the toughest locations, and performance is boosted on the difficult high channels 7 to 13.

For good baseball and summertime profits get the Workshop Dubl-Vee.

\*Estimated at 63 per cent.



**THE WORKSHOP ASSOCIATES**  
INCORPORATED

*Specialists in High Frequency Antennas*  
135 Crescent Road, Needham Heights 94, Massachusetts

near; and Peter Bedoian, general manager. The firm has headquarters at 507 26th Street in Union City, New Jersey . . . **THE POLYMER CORPORATION OF PENNSYLVANIA** has been set up by **THE POLYMER CORPORATION** of Reading, Pa. to handle all of the concern's sales activities. The parent company will restrict its activities to production, research, and development . . . **LOWELL METAL PRODUCTS CORPORATION** of St. Louis has announced a change in the corporate name to **LOWELL MANUFACTURING COMPANY**. The concern manufactures ceiling and wall speaker baffles and allied acoustical equipment . . . **BERGEN WIRE ROPE COMPANY** of Lodi, New Jersey has been acquired by **REEVES SOUNDCRAFT CORP.** of New York by outright purchase. The Lodi company will be operated as a wholly-owned subsidiary of the New York firm . . . **UTAH RADIO PRODUCTS COMPANY, INC.** has been formed in Huntington, Indiana and has begun the manufacture and sale of radio speakers and allied products. The new corporation is a wholly-owned subsidiary of the **NEWPORT STEEL CORPORATION**.

\* \* \*

**H. B. FANCHER** has been appointed division engineer of commercial products for *General Electric Company's* Commercial Equipment Division.



A graduate of Brown University, Mr. Fancher joined *G-E* in 1936 and in the following year was assigned to the

Advanced Engineering Program in Schenectady.

In 1940, he joined the Transmitter Division at Schenectady and during the war was actively engaged in development and design work on microwave relay equipment, military television, and radar.

Following the war he was project engineer for developing the company's 5 kw. high channel television transmitter. He was named section engineer for broadcast studio equipment in 1949 and was appointed assistant division engineer of commercial products in January of this year.

\* \* \*

**NARDA**, the National Appliance & Radio Dealers Association, is currently offering its Certified Television and Installation Program to television technicians and dealers throughout the country, irrespective of their affiliation with NARDA.

The only requirement for participating in this plan is that the dealer or technician must agree to conform to the CTIS Code of Ethics and cooperate with others in his business area in making the program a success.

Basically, the six-point code requires that: 1. All work shall be done only by competent, qualified technicians; 2. Only the best materials, which have been approved by the

(Continued on page 116)

**RADIO & TELEVISION NEWS**



# Service Clinic!

Engineering information to help you better service Raytheon

**A Sync. Amplifier** may be used to perform several advantageous functions. One function is to invert the polarity of the sync. so that the negative output of a triode sync. separator may provide the positive triggering needed to sync. a blocking-oscillator type of sawtooth generator.

**Another function** is to isolate the 'kick-back' pulse generated by the vertical blocking oscillator from effecting horizontal synchronization. Also, the sync. amplification and limiting of this stage is needed to provide the constant sync. amplitude required by the vertical blocking oscillator to produce a 'roll-free' vertical scan.

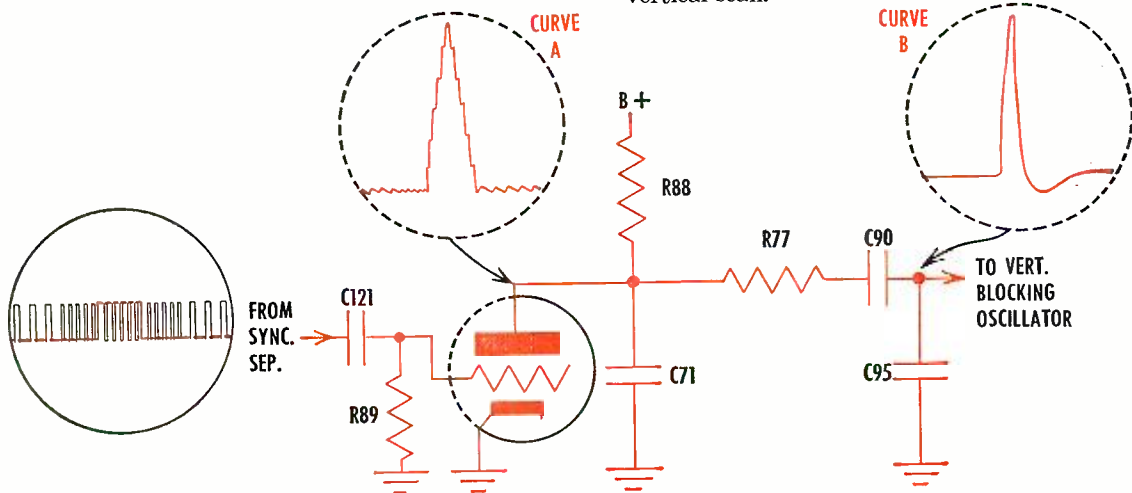

FIG. 1 VERT. SYNC. AMP.

**The Vertical Sync. Amplifier** circuit, shown in Fig. 1, uses a triode section of a 6SN7 tube which is signal biased by the action of R89 and C121. The output developed across the plate load R88 is by-passed by C71, thus forming the first integrating filter to remove the horizontal sync. and retain the vertical sync., as shown in Curve A.

**The second stage** of integrating filter, involving R77, C90 and C95, provides the hori-

zontal free vertical sync., shown in Curve B, that is essential for good vertical interlace. (Note: Curve B is 1/10th the amplitude of Curve A and does not show the blocking oscillator generated pulse that accompanies the sync. at this point.)

**Improved circuitry** such as this is one of the many reasons why you can feel free to recommend Raytheon TV to a friend or customer.



**Dependably Built for Dependable Performance**



THE STARLIGHT—Model RC-1720

Belmont Radio Corp., 5921 W. Dickens Ave., Chicago 39, Ill.  
Subsidiary of Raytheon Manufacturing Co.

Raytheon TV Presents  
**JOHN CAMERON SWAYZE**  
Sundays on NBC. See local paper for time and station.

July, 1951

**EICO**  
TEST EQUIPMENT

*Guards*

**Tele King**  
HIGH STANDARDS OF  
TELEVISION PRODUCTION QUALITY



**EICO KITS  
and INSTRUMENTS**

Tele-King Production Test Foreman James Adler and Harry R. Ashley, President of EICO, inspecting the use of the EICO Model 425 Oscilloscope and Model 221 Vacuum Tube Voltmeter at one of the important constant-duty alignment positions on the Tele-King television production line, New York City.



**New 555K MULTIMETER**

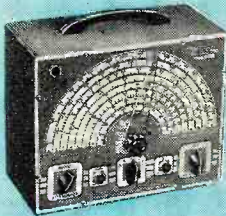

**320K SIG. GEN. KIT \$19.95**  
Wired \$29.95

**New 322K SIG. GEN. KIT \$23.95**  
Wired \$34.95



**New 950K COND.-RES. COMP. BRIDGE KIT \$19.95**  
Wired \$29.95



**New 1040K BATTERY ELIM. KIT \$25.95**  
Wired \$34.95



**HV PROBE (Wired only) \$6.95**



**511K VOM KIT \$14.95**  
Wired \$17.95



**New 526K MULTIMETER KIT \$13.90**  
Wired \$16.90

**New 1171K RES. DECADE BOX KIT \$19.95**  
Wired \$24.95

**EICO**

**ELECTRONIC INSTRUMENT CO., Inc.**  
276 NEWPORT STREET, BROOKLYN 12, NEW YORK



**New 315K DELUXE SIG. GEN. KIT \$39.95**  
Wired \$59.95



**New 625K TUBE TESTER KIT \$34.95**  
Wired \$49.95

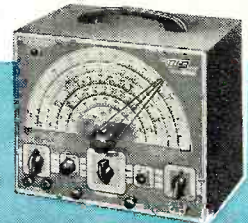

**360K SWEEP GEN. KIT \$34.95**  
Wired \$49.95



**145K SIG. TRACER KIT \$19.95**  
Wired \$28.95



**New 221K VTVM KIT \$25.95**  
Wired \$49.95



**New 425K 5" SCOPE KIT \$44.95**  
Wired \$79.95

**For Laboratory Precision at Lowest Cost—  
the Leaders Look to EICO!**

No work in electronics is tougher on test equipment than the manufacture of quality television sets. Every week, every day, set production is pushed to ever greater volume, accelerated to ever faster pace—with no interruptions tolerated. Yet tests must be held to highest precision, costs must be kept to absolute minimum.

At the many vital testing positions along the production line of the great Tele-King Corporation—day after day, hour after hour—EICO instruments stand guard. From engineer to production chief to line tester, the men at Tele-King know that for speed, precision and utmost dependability, at maximum economy, they can always count on EICO instruments.

From coast to coast, in one famous TV factory after another, EICO instruments again and again prove their superiority. The top-flight TV set makers have discovered—just as over 70,000 servicemen have learned—that for the industry's greatest instrument values, at the industry's lowest costs—it's EICO!

Before you buy any higher-priced equipment, be sure you look at the EICO line! Each EICO product is jam-packed with unbelievable value. YOU be the judge—compare EICO at your local jobber today—and SAVE! Write NOW for free newest Catalog 7-R.

**FOLLOW THE LEADERS...INSIST ON EICO!**

Prices 5% higher on West Coast. Due to unshelved conditions, prices and specifications are subject to change without notice.

# Saga OF THE AFRS

By  
**LT. G. MARAKAS, USN**  
Liaison Officer, AFRS

Stancil-Hoffman amplifier and Western Electric mixer on location at Travis Air Base, Cal.

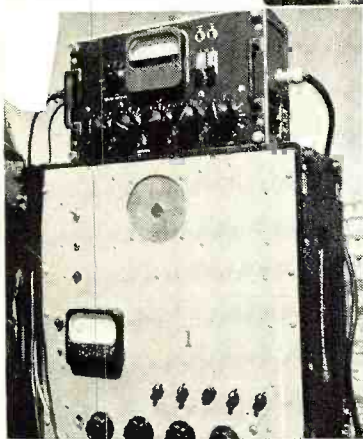

Arthur R. DeJong, RM2, and Vernon McKenny, chief remote recording engineer, AFRS, recording interview by Sgt. Robt. Caskey with Lt. George Marakas, USN.

**The Armed Forces Radio Service is the world's largest non-commercial radio network comprising 60 stations ranging from 25 watts to 200 kw.**

RACTICALLY synonymous with Armed Forces Radio Service are terms like "show business", "decommercialize", "short-wave", "air checks" and "command performance." Naturally, they generate thoughts of motion picture stars, radio performers, football games, news events, and glamour; but behind the scenes exists another world almost foreign to the general public.

Headed by Major Clifford A. Frink, USA, the Technical Production Branch personnel monitor the recording, processing, and pressing of all AFRS transcriptions. They also procure, install, and maintain equipment used in recording, assembling, and broadcasting radio programs. Visualize a radio broadcast network consisting of over sixty radio stations that vary from 25 watts to 200,000 watts in power. Think in terms of providing each and every one of these radio stations with sixty-three hours of program material weekly. Then add to the mission another major task of broadcasting daily, by short-wave, thirteen hours of specially prepared program material to military personnel located all over the world. The output is fabulous—about 400 hours of radio programs broadcast overseas by short-wave and 40,000 transcriptions sent overseas each month.

The equipment used by the *Armed Forces Radio Service* represents a cross-section of the entire broadcast equipment manufacturing industry. Included are some German and Japanese equipped stations serving military personnel in Europe and the Far East. The technicians at AFRS repair, modify, rebuild, and sometimes invent electronic items

for the overseas stations. The maintenance shop serves as a repair depot. Turntables, control consoles, transmitters, and many other pieces of broadcast gear are sent to the Hollywood installation, from AFRS stations all over the world, to be repaired or replaced.

The home plant in Hollywood is equipped with three studios, a recording room, a master control room for short-wave broadcasting, and twelve soundproof audition tanks. Under the same roof is housed a modern and well-equipped

Altec amplifier used with the 21B for "single mike" pickup.

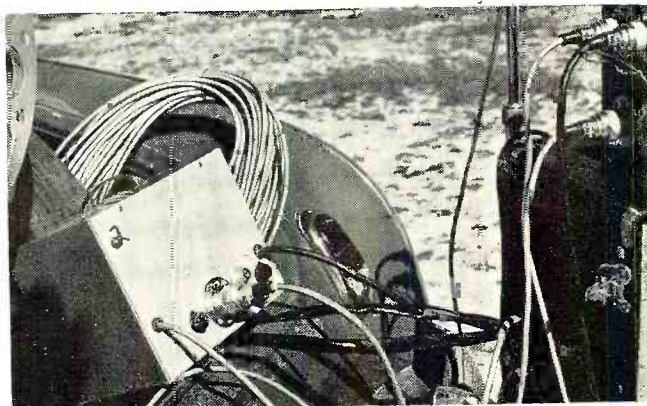

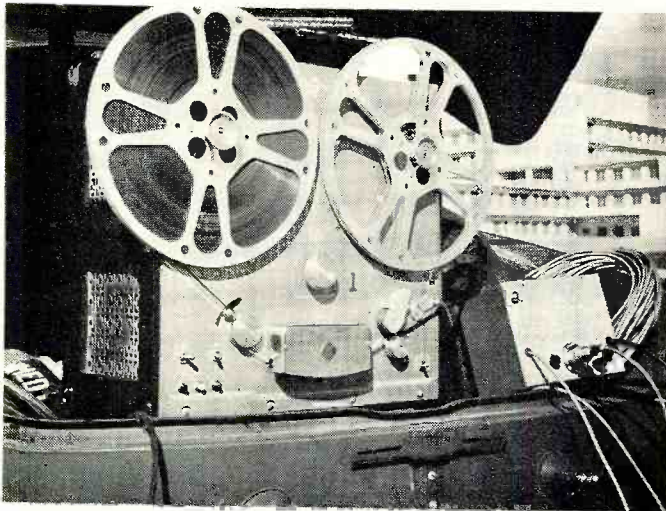

A Stancil-Hoffman professional tape recorder used for most of the Armed Forces Radio Service's remote assignments.

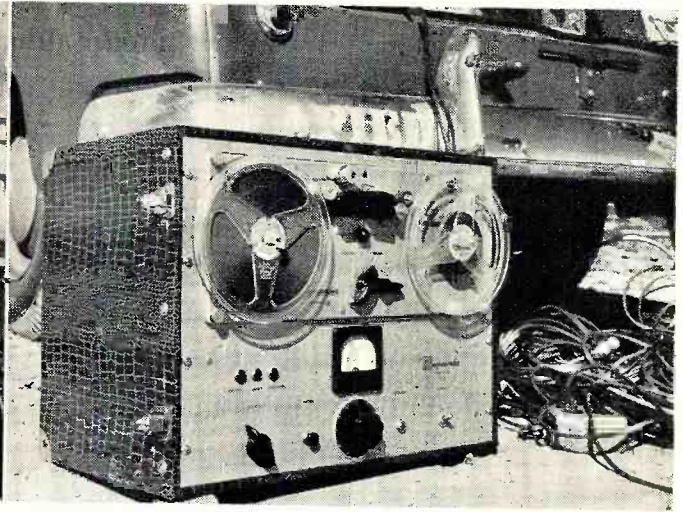

Magnecorder PT6 tape recorder and amplifier is particularly well suited for the remote pickup work done by the AFRS.



A section of the AFRS disc recording facilities in Hollywood.

maintenance shop, a tape assembly studio, a remote recording section, and office space occupied by the Technical Production Branch.

A certain portion of the recording is done initially on magnetic tape rather than cut on acetate discs. Editing and assembly problems are handled with ease by the use of tape. Two *Ampe*x type "200" tape recorders and ten *Stancil-Hoffman* type R4 units are used throughout the installation to handle the recording and programming requirements. These machines are checked daily for frequency response, distortion, and mechanical difficulties. For the most part, all tape recording is done at 15" per second. After a program has been put into shape on tape, it is transferred to an acetate by dubbing. This permits processing and the subsequent transfer to a finished product, the Vinylite pressing.

Ed Price, chief of the Recording Production Section, brings out the point that all AFRS recordings must meet the exacting requirements as recommended by the NARTB. This organization has adopted as its standard the sixteen inch Vinylite disc.

Frequency response, distortion, and level checks are made on every 10th transcription that comes off the press, thereby making possible a constant control over the quality of the finished product. There are 36 manufacturing steps in the process. The pressing itself is done with hydraulic presses capable of delivering over 200 tons' pressure. The dies are heated by steam and cooled by water. Each pressing cycle involves heating the dies until the Vinylite plastic flows to conform to the disc pattern. After the plastic flows, the dies must be cooled to harden the plastic before the press is opened. Each groove must be properly formed without air bubbles, water marks, or impurity defects to produce a usable transcription. Each transcription is close-

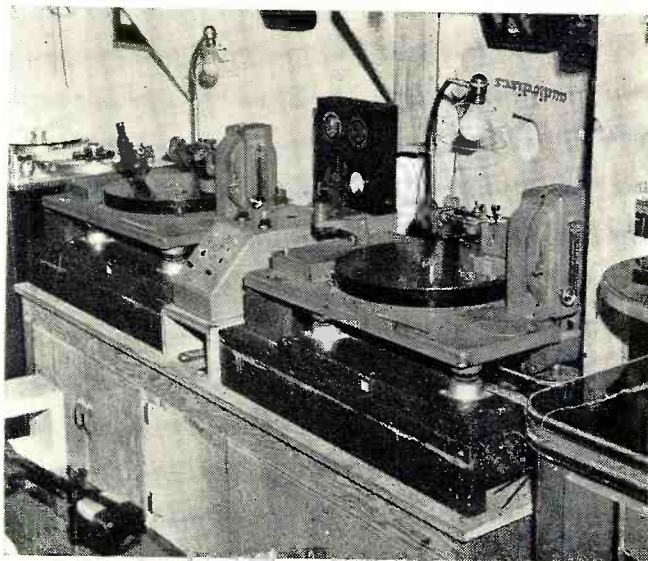

One view of the studio showing two RCA recording lathes. These units were formerly used by the OWI and were given to AFRS.

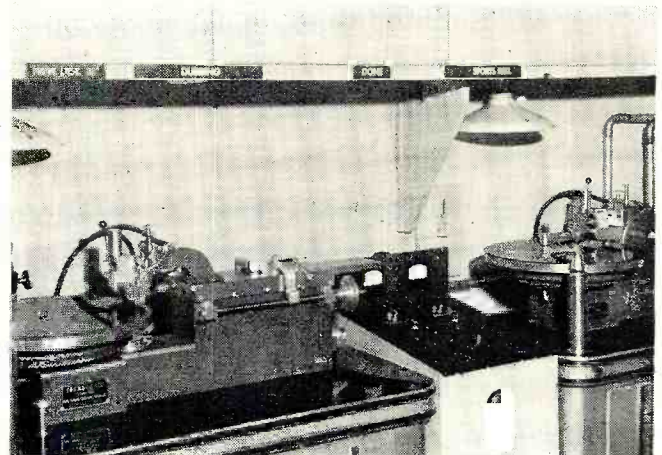

Two Arcturus "transcript" professional recording lathes installed in one of the AFRS studios in Hollywood, California.

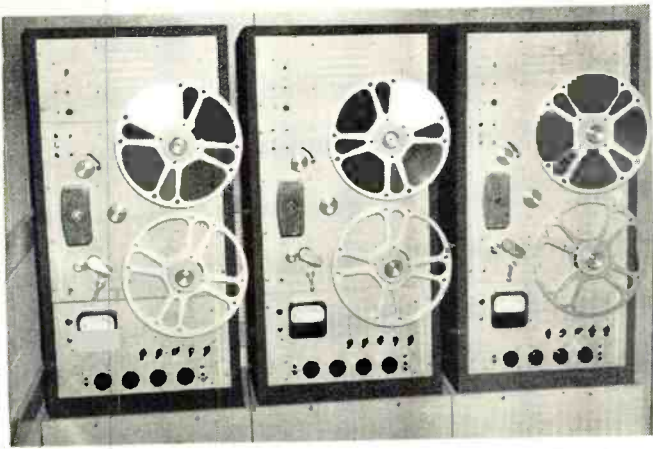

A bank of three Stancil-Hoffman tape recorders and audio amplifiers used in the Armed Forces Radio Service studios.

sole and line amplifiers so that more than two channels can be utilized. Eight selector switches which enable the operator to select any of twenty items, eight at a time, are incorporated. The plant audio wire system was expanded to such an extent that programs can be piped from the recording room to any other place in the building. Upon completion, the recording room will be able to handle seven functions simultaneously by using the dual-channel console for two channels and piping five other channels to recording equipment located remote from the recording room. The eighth selector switch permits the operator to monitor any one of the seven channels.

At the present time AFRS is moving about 40 thousand 16-inch 33 $\frac{1}{3}$  rpm Vinylite transcriptions monthly. A small amount of material is recorded in New York, but the major portion is done in Los Angeles.

A backward glance at the more than eight years of AFRS activity would uncover many stages and dramatic highlights of the organization's expansion which cannot be covered here. Much credit is due the commanding officer of AFRS, Col. Wm. M. Wright, Jr., AGD, for his guidance of AFRS functions.

-30-



Checking a Stancil-Hoffman "Minitape" machine is function of maintenance section.

Tape editing and splicing is done on a large scale by a skilled AFRS sound engineer.



ly inspected before being accepted. AFRS quality standards must be maintained.

Little has been said about gathering raw material with which to produce a show. Most of the programs come in off-line but some of them come the hard way. The Remote Recording Section completes about 30 remotes a month. The most interesting problems are solved in the vast variety of microphone setups, mixing problems, acoustic difficulties, and location impossibilities. Vernon McKenny, chief of the Remote Recording Section, has solved the basic problems by choosing a wide variety of equipment. All remote assignments are recorded on tape. Two Stancil-Hoffman type R4 portable tape recorders are usually fed by one and sometimes two Western Electric type 22-E portable mixer amplifiers.

One of the most interesting phases of the work done by the Technical Production Branch is the engineering and installation of new equipment. In order to keep pace with the industry, both quality and quantity wise, it becomes necessary to revamp, change, or modify existing equipment. The equipment installed in the Recording Room includes two Ampex type 200 tape recorders, one Stancil-Hoffman R4 tape recorder, and three recording lathes. This equipment is complemented by the various amplifiers, equalizers, etc., mounted in three seven-foot racks. All of this equipment works into a single-channel control console. There are nine input channels to the console, which can be mixed, and one output channel. The AFRS technical staff recently developed a dual-channel control console. Three racks of equipment have been redesigned to include amplifiers for all nine input channels to the con-

Proper storage temperature and correct humidity help insure long life for the program discs recorded by the AFRS.



Some of the AFRS studio equipment. Shown are the RCA turntables, control console, recording amplifiers, hi-fi receiver, limiting amplifiers, line switching panel, patch panel, and equalizers.



# An Inexpensive ELECTRONIC SWITCH

By  
**JAMES G. ARNOLD**



Front view of electronic switch. To identify parts, see diagram, Fig. 3.

**Construction details on a simple unit which will increase the usefulness of any ordinary scope.**

THE electronic switch can be used to advantage in many applications. With the electronic switch it is possible to observe two waveforms on one oscilloscope screen. This extends an oscilloscope's use greatly. A common example is the comparison of the input and output waveforms of an amplifier. Another interesting example is the measurement of phase shift.

The electronic switch shown was constructed by the author and found to be very satisfactory in operation. It has very few critical points in the circuit construction. Components may be varied to suit special applications. It should prove to be an interesting project and, in addition, will produce an instrument of great utility for anyone possessing an oscilloscope. All resistors and condensers are of the common 10% and 20% tolerance variety respectively.

The 6SN7 forms a conventional free running multivibrator circuit while the 6SL7 is used as a two-channel RC-coupled amplifier with parallel output. An external power supply was used but an individual power supply can easily be included. Any voltage from 250 to 450 volts at 30 milliamperes will work well with the circuit shown and lower voltages may be used with slight modifications of the circuit. The filaments require 6.3 volts. Individual gain controls are provided for each waveform amplifier by using 500,000 ohm potentiometers for the grid resistor of each section of the 6SL7.

The input capacity of the 6SL7 is approximately 90  $\mu\text{fd}$ . but is of little importance since the frequency range of the switch is limited by more predominant factors as will be shown later.

In the unit constructed by the author a switch was included in the plate circuit of the 6SN7. This makes the unit available as a two-channel audio

voltage amplifier simply by switching off the multivibrator.

The switching action is illustrated in Fig. 1A. This is the output waveform and is obtained by the rapid switching from one amplifier to the other. Only one section of the two channel amplifier is operating at any one time. The switching action is obtained by changing the bias on each amplifier section in such a manner that one amplifier section is cut off while the other section is conducting. The current flow in the multivibrator is illustrated in Fig. 1B. It can be seen that the bias for the amplifier sections is obtained from the current flow through resistors  $R_3$  and  $R_{11}$  (Fig. 3). These resistors are carrying the plate current of the multivibrator sections. When the

plate current of  $V_{1-A}$  increases,  $V_{2-A}$  is biased beyond cut-off and no plate signal is obtained from this amplifier. At the same time  $V_{1-B}$  is cut off and the bias is zero on  $V_{2-B}$ . Therefore,  $V_{2-B}$  is operating as an amplifier and a small portion of the waveform on the grid of  $V_{2-B}$  is amplified and fed into the oscilloscope. At this time the multivibrator performs its switching action and the cut-off bias is applied to the grid of  $V_{2-B}$ . The bias is now removed from  $V_{2-A}$  and the waveform on the grid of this amplifier is amplified. On the oscilloscope screen the trace from one waveform to the other is too rapid to leave more than a dim trace. Therefore the actual picture on the screen is that of the two waveforms, each reproduced as a dotted line.

It can be readily seen that the actual signal applied to the input of the oscilloscope is one wave and is essentially a square wave of much higher frequency than that of the signal being viewed. Here the frequency limitation is apparent. A square wave contains an infinite number of harmonics. In the practical case, the tenth harmonic is required to produce a good square wave. Therefore the amplifiers of the oscilloscope must pass the band of frequencies from the waveform signal to the tenth harmonic of the switching frequency. For a given waveform a minimum number of dots per cycle will be required to give a well defined reproduction on the oscilloscope screen. For a great number of the simpler waveforms a minimum of 50 dots per cycle will be satisfactory. Now if we wish to observe two waves of 400 cycles on the oscilloscope and we use 50

Fig. 1. (A) Switching action of electronic unit. (B) Current flow in the multivibrator.

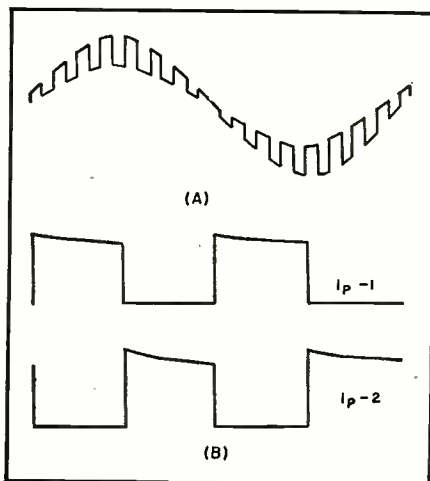



dots per cycle the frequency of the switching action will be 200,000 cycles per second. If it is necessary to pass frequencies up to the tenth harmonic then the oscilloscope amplifiers must be relatively flat up to 2 megacycles. Fair traces may be obtained with less than 50 dots per cycle and it is possible to get fair representations with amplifiers with less than a tenth harmonic flat response. In this way the frequency range can be made to cover the audio range with a good oscilloscope. It should again be noted, in view of other applications, the frequency limits are in the range of the oscilloscope and not within the switch.

Referring again to Fig. 1A it is seen that the amplitude of the composite signal corresponds to the distance between waveforms while the individual waveform amplitudes determine the degree of "modulation" imposed on the composite wave. We may now observe that as the vertical gain of the oscilloscope is increased the separation between the two waveforms is increased. Thus we can control the spacing on the screen by the vertical gain of the oscilloscope. After separating the waves some compensation may be needed and is furnished by adjustment of the input gain controls of the switch. To exactly superimpose the two waveforms as shown in Fig. 1A would imply that the gain of oscilloscope amplifiers is zero. This is correct. To have the waves superimposed, the voltage applied to the vertical plates of the cathode-ray tube is equal to the output of the switch.

The frequency of switching is controlled by  $R_6$ ,  $R_9$ ,  $C_1$ , and  $C_3$ . The values of these components may be varied to take greatest advantage of the oscilloscope to be used with the switch. In order to maintain a sharp switching action to resistors  $R_7$  and  $R_8$  should be maintained above 20,000 ohms. In the switch constructed, a variable switching frequency control was made by using dual potentiometers for these

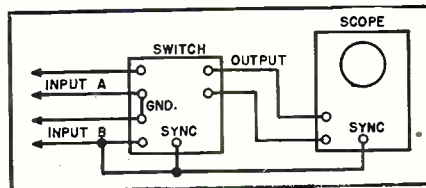

Fig. 2. Another method of hooking up electronic switch. See text for the details.

VALUES OF  $(R_6 + R_7)C_3$  AND  $(R_8 + R_9)C_1$  WHEN "B+" = 340 VOLTS

FREQ. (cps)	RC (farads x ohms)
100	.002080
500	.000417
1000	.000208
2000	.000104
3000	.000069
4000	.000052
5000	.000042

RC values for determining resistor-condenser combinations at various frequencies.

resistors. Series fixed resistors were used to keep the total resistance in each grid circuit above 20,000 ohms. The frequency of switching is proportional to  $1/(R_6 + R_7)C_3$ , and  $1/(R_8 + R_9)C_1$ . A balanced switching action is obtained by keeping  $1/(R_6 + R_7)C_3 = 1/(R_8 + R_9)C_1$ , hence the dual potentiometer. The frequency control may be omitted and a dual pot will not be required. For most purposes a variable switching frequency is not necessary.

If the variable switching frequency is used, it will be possible to extend the use of the switch considerably. In Fig. 2 another method of application is illustrated. Let us say we wish to observe two waves of 40,000 cycles per second. Apply the two signals to the inputs of the switch and apply either of the signals to the sync input of the switch. By increasing or decreasing the sync voltage control, sync the switch on some even sub-multiple of the signal frequency, let us say  $1/4$  in this case. Now our switch is operating at a rate of 10,000 switches per

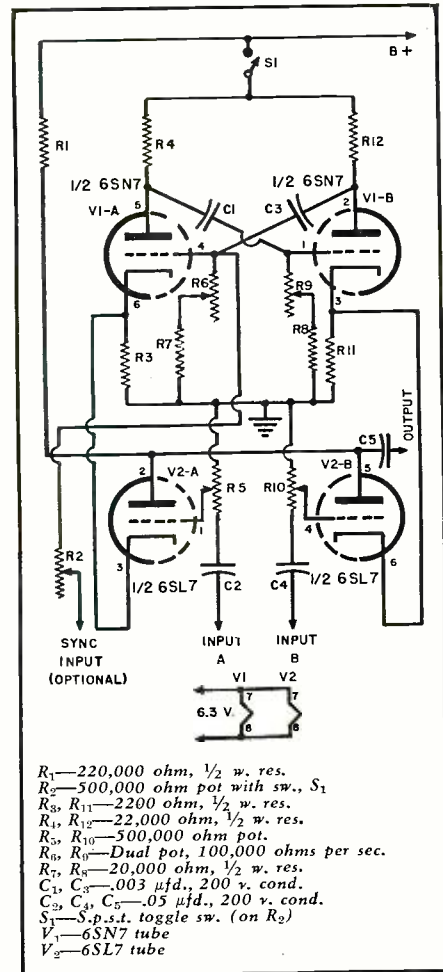
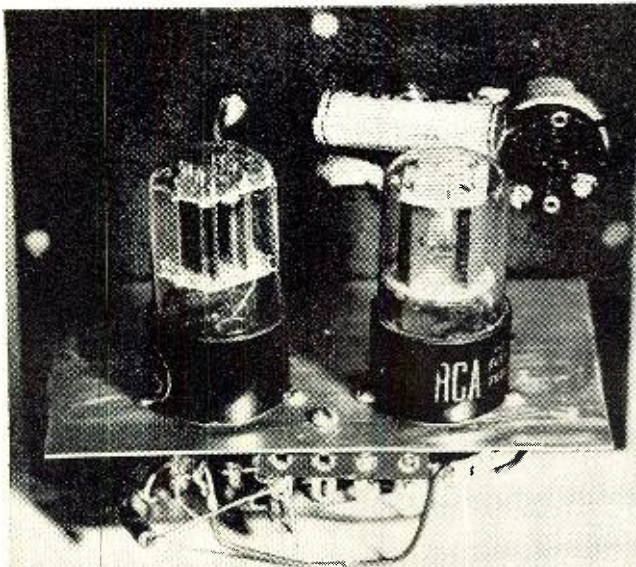

Fig. 3. Schematic of the electronic switch.

second. Now sync the scope on twice this frequency by using the signal frequency and sync on every second cycle. Now the amplifiers in the switch are conducting on alternate sweeps of the oscilloscope. This system is troublesome to set up and the sync is quite critical but it greatly extends the use of the switch.

-30-

Top chassis view of the electronic switch. The comparatively few components required makes this unit easy to construct.



Under chassis view. All wiring is direct and in most cases the components are wired into the circuit by their own leads.

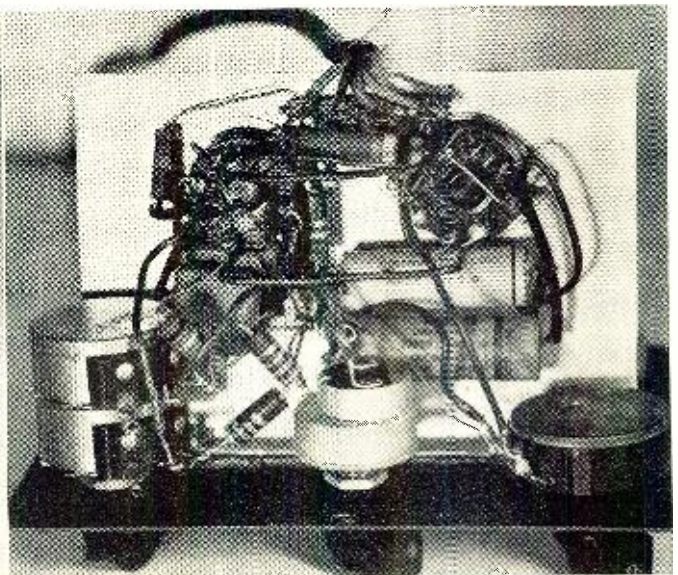

# Converting The G-E MODEL 809 \*

**Complete circuit and cabinet changes for converting a 10" set for 16" or 17" tube.**

IN THE May and June issues of this magazine we gave details for converting two popular small-screen television receivers to operate with larger picture tubes.

This month we present both circuit and cabinet changes for still another early-model 10" receiver, the *General Electric* Model 809. As was the case with the other two sets, the changes described produced satisfactory results on the particular model converted but should conversion be attempted on similar models of an earlier or later manufacture, additional changes may be required. Although all of the changes described in this article have been carefully worked out by *General Electric* engineers, these changes have not been approved by the manufacturer and may, therefore, invalidate the manufacturer's warranty.

The Model 809 is a series filament type receiver using a 10FP4 picture tube. The cabinet, Fig. 1, is somewhat unusual in that the chassis is mounted at an angle, with the top of the front panel slightly recessed. There is adequate cabinet space to mount either a 12, 14, 16, or 17 inch picture tube. Both a 16 inch *General Electric* 16KP4 and a 17 inch *General Electric* 17BP4-A were used in this conversion since they are currently preferred sizes.

The chassis was removed from the cabinet and the yoke was replaced by a new *General Electric* Cat. No. RLD-024 deflection yoke and an RLF-038 focus coil. The old focus coil may be used if it can be easily mounted on the new yoke. However, considerable time can be saved in both mounting and ad-

Fig. 1. G-E Model 809 receiver before conversion.

Fig. 2. Same set converted for 16KP4 tube.

By  
**ROLAND KEMPTON**  
Editor, "Techni-talk"

Fig. 3. Set converted to use 17BP4-A tube.

justing the units if a new focus coil is used.

The same thing applies to the horizontal sweep transformer. The old transformer can be used if it is of the ferrite core type, marked 77J1. A few of the early Model 809 receivers were manufactured with the same transformer used in the Model 810 receiver. Information on rewiring these receivers is available from *General Electric Company* as there are not enough of these sets in the hands of customers to make it worthwhile to run a separate article on their conversion.

It was considered advisable, but not necessary, to replace the horizontal sweep transformer with a *General Electric* RTO-085, a unit which was designed for use in 16, 17, and 19 inch receivers. This transformer supplied a higher anode voltage, provided additional sweep width, as well as permitting the use of the width control.

It was found that the original transformer could be used by disconnecting the horizontal size control. The two wires originally connected to this control were disconnected and the ends taped. The white wire was transferred from the No. 8 terminal of the sweep transformer to the No. 4 terminal which placed the horizontal coils across terminals 4 and 6 of the sweep transformer. These same connections were used on the new transformer. The horizontal drive control was then

adjusted for adequate width. It may be necessary to check the "B+" voltages and try substituting a new 12SN7GT ( $V_{10}$ ) and/or a 19BG6G ( $V_{12}$ ) tube if the width is insufficient.

If the horizontal linearity is somewhat stretched on the left side after the linearity control has been properly adjusted, change the .03  $\mu$ fd. condenser ( $C_{333}$ ) which is connected between the cathode of the damper tube and "B—" to a .05  $\mu$ fd. unit. This capacitance may vary and can be determined experimentally.

The height was found to be inadequate which posed a knotty problem for the engineers. The revised circuit, as it finally evolved, is shown in Fig. 5. The vertical charging condenser ( $C_{205}$ ) was varied experimentally. This resulted in non-linearity and foldover at the bottom. A similar result was obtained when the plate resistor ( $R_{206}$ ) was varied. A number of possible circuits were considered and the one finally selected was chosen because it involved a minimum of wiring changes and therefore took the least time. The changes shown in Fig. 5 consist merely of connecting either one-half of a 6SN7GT or a 6S4 in parallel with the output section of the 12SN7GT ( $V_{10B}$ ). The chassis for some Model 809 receivers are already punched for this additional octal tube socket. The hole is located next to the vertical multivibrator tube ( $V_{10}$ ). Several wires run through this hole and must, therefore, be relocated if a 6SN7GT tube is used. The 6S4, which is a nine-pin miniature, can be mounted in this space without rearranging the wires. Chassis not having this extra socket hole will have to be punched or drilled out. The re-

\* These conversion notes originally appeared in the December-January 1951 issue of *General Electric Company's* copyrighted publication "Techni-talk."

son a 6 volt tube was selected in this instance instead of a 12 volt tube was due to the .6 ampere current requirement. This current can be obtained by connecting either the 6SN7GT or the 6S4 filament between the a.c. plug and pin 12 of the 16KP4 picture tube. In this way the voltage across each filament string is reduced by 6.3 volts and the operation of the receiver is not affected.

The 12SN7GT ( $V_{10B}$ ) cathode resistor ( $R_{290}$ ) was changed to 2000 ohms and a .02  $\mu$ fd. condenser was substituted for charging condenser  $C_{305}$  in order to obtain sufficient height with good vertical linearity.

Mounting the picture tube on this chassis posed another problem for the engineers. The front section of the chassis on which the 10FP4 picture tube rested was removed by first removing the controls and then the three self-tapping screws on each side. The filter choke and the audio output transformer were also removed. The triangular sections of the front, marked A in Fig. 4A, were removed by cutting along the dotted line with a hack saw. The vertical side pieces were then bent over as shown in Fig. 4B to provide a support bracket for the picture tube. This was  $\frac{3}{4}$ " above the top of the chassis. A piece of sponge rubber cushion was fastened to each support to provide shock mounting.

The shield around the high voltage compartment was then removed. The width and horizontal linearity controls were removed and the high voltage anode wire disconnected. The rivets holding the yoke support bracket and the resistor terminal strips were drilled out. A section four inches down from the top and extending one inch toward the side and one and one-half inches toward the back was cut out with a hack saw. A one-inch wide diagonal section of the perforated top cover was also removed. Tin snips may be used without removing the shield from the chassis but the resulting job is rather rough looking.

The yoke bracket was remounted about one and a quarter inches above and about one and a half inches back from the former mounting holes. The half-moon section of the yoke bracket was removed and reformed by bending so that the yoke was raised an additional  $\frac{1}{4}$ ". All this was necessary in order to keep the bell of the picture tube from resting on the 12AT7 oscillator-converter tube. The resistor terminal strips were remounted and a new eight inch piece of high voltage lead was used for the anode connection.

The yoke and focus coils were assembled and the picture tube inserted. The top of the picture tube was tipped slightly toward the front but this was compensated when the mask was mounted. Some of the wires on the picture tube socket had to be lengthened. If any difficulty is experienced with the 12AT7 tube move the front of the picture tube slightly toward the opposite side.

All necessary connections, including

a grounding wire from the graphite coating on the picture tube to chassis, were made. A piece of bare wire, fastened to the picture tube in several places with *Scotch* tape, was used and then grounded under one of the self-tapping screws.

The front of the 16KP4 picture tube was fastened to the chassis with a piece of metal hanger strap of the type commonly used on antenna chimney mounts although a canvas strap could have been used with equal success.

The safety glass and mask were removed from the cabinet first. The safety glass is held in place by a polished brass bar which is fastened to the cabinet with four machine screws. A cardboard template, about  $\frac{1}{8}$ " larger on all sides than the faceplate of the 16KP4 tube, was made and fastened to the center of the front panel about  $1\frac{1}{2}$ " above the four screw holes. A scriber or sharp pointed tool was used to mark along the edge of the template and a keyhole saw was used to cut out this section.

A 16 inch rectangular mask, measuring  $12" \times 15\frac{1}{2}"$ , was placed flush with the front panel. This type of mask is manufactured by both the *Deitz Miracle Lens Co.*, 141 President Street, Passaic, New Jersey and the *Tele-Plastics Co.*, Division of *Willmax Mfg. Co.*, 177 South 8th Street, Brooklyn 11, New York. The panel area which showed on either side of the mask was lighter in color than the rest of the cabinet so this area was touched up with a walnut varnish stain. When this dried the mask was inserted into the recessed top section and held in place by the brass bar, using the four original screws. The rubber strip was removed from the bottom of the safety glass panel and placed with the open end down between the mask and the brass bar. This held the bottom of the mask securely between the front of the panel and the brass bar. A  $\frac{3}{8}$ " rubber grommet was inserted from the back between each top corner and the wooden panel. This held the mask in place and when the chassis was placed in the cabinet, the faceplate of the picture tube was practically flush with the inside of the mask. Any small variation between the mask and the picture tube faceplate may be corrected by shifting the mask or chassis slightly before the final assembly. The finished conversion is shown in Fig. 2.

If a 17BP4-A picture tube is used

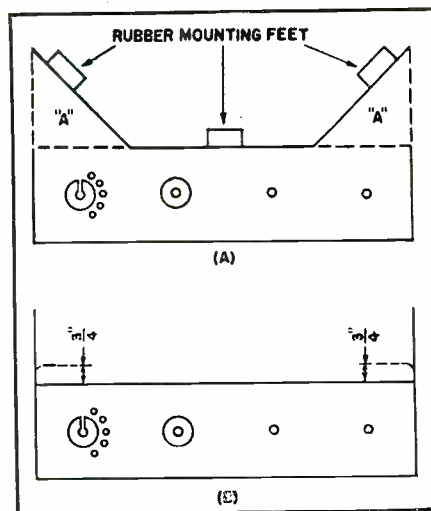

Fig. 4. (A) Front portion of G-E Model 809 chassis showing the cuts (broken lines) which should be made to accommodate the larger size picture tube. (B) Vertical portion of the chassis with the part to be bent shown dotted. See text for details.

the same type of mask as shown in Fig. 2 is used except that it will have to be the seventeen inch size. A somewhat different effect can be obtained, and at a slightly reduced cost, by using a mask designed for use in back of a safety glass. A 17" conversion using this type of mask is shown in Fig. 3. These masks are made of a thin plastic and are available in a light or dark Royalite (a shade of green). They are made in all popular picture tube sizes and are particularly suited for use with either the *General Electric Model 809* or *Model 811* because of the large panel of safety glass. This type of mask is manufactured by *Precision Plastics Inc.* of Chicago and distributed by the *Hy-Art Co.*, 136 Liberty St., New York.

The inside wooden panel must be cut out using a seventeen inch template and following the same procedure outlined for making the sixteen inch cut-out. The original safety glass may be used with the paint masking removed. This paint can be scraped off with a sharp razor blade but the job is considerably easier if done with a sharp putty knife and some acetone.

The mask may then be placed in the new opening and the safety glass placed over it. Both pieces will be held in place when the brass bar is attached.

Fig. 5. Vertical multivibrator circuit after making the necessary changes to obtain sufficient sweep for either 16KP4 or 17BP4-A rectangular picture tube.

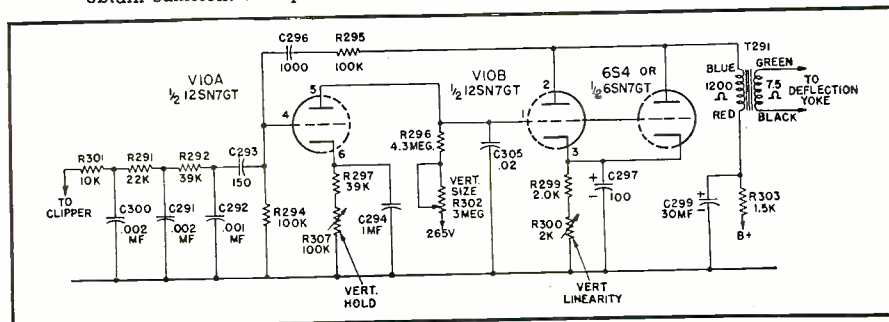

# CALIBRATING The 3-30 mc. GONSET CONVERTER

By  
MAJOR H. L. ULYAT, W3PTQ

***It is an easy task to calibrate the converter's vernier dial to read directly in frequency.***

NE of the most compact jobs on the market today is the *Gonset* 3-30 mc. converter. This little box can do wonders with a broadcast receiver when the receiver's input is properly matched to the converter's output on 1500 kc.

There was one disadvantage I found with this set-up. The converter being of continuous coverage, had very little bandspread. A vernier dial is provided, which is fine for spotting dial positions, but is of little use in determining the frequency.

The numbers on this vernier dial correspond to certain frequencies in each band, although this may vary somewhat with different converters. I checked these numbers several times against a frequency meter but would forget what the number was the next time I got on the air. I would find myself tuning as far as I could hear the ham stations and assuming that I had reached the edge of the band.

I therefore decided to make a calibrated chart and paste it on the front of the converter underneath the tuning knob. When this chart was made I noticed that the 10, 20 and 40 meter bands occupied different areas of the vernier dial, each area being separated so that there was no overlapping. The 75-80 meter band occupied more area than any of the other bands and overlapped all of the others.

This led to the conclusion that although the vernier dial was small,

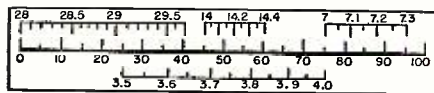
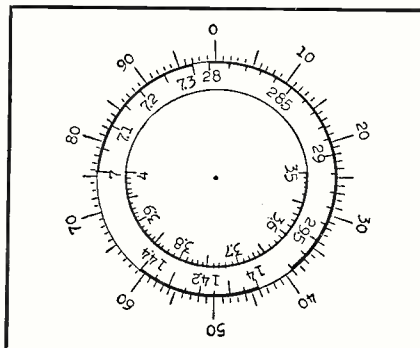

Fig. 1. Typical linear scale, made according to instructions. This scale makes resetting to a specified frequency relatively easy.

there was room for two rows of frequency figures, which was all I would need. Furthermore, the frequency numbers would not be much closer together in a circle the size of the dial than I had made them on my chart.

It is advisable to make a linear chart first. It will show the exact relation between each frequency and its dial number. Using a metric ruler, draw a line 10 centimeters long, marking all

Fig. 2. Typical dial made according to the text. The outer circle should measure 2 1/4 inches in diameter on the finished dial.



of the graduations and figures on your line just as on the ruler. This represents the 100 degree markings on the vernier dial of the converter. Using a frequency meter whose signal can be heard through the converter, write down the main spot frequencies in the 10, 20, 40 and 75-80 meter bands and the corresponding numbers where they are found on the vernier dial.

These frequency numbers can then be drawn on lines scribed close to the original metric line with the frequency numbers and dial numbers corresponding. The finished chart should look something like the drawing of Fig. 1.

This chart could be used just as it is, pasted on the front of the converter. This had been the original idea, but this requires interpolating, and comparing dial numbers with frequency. By going to just a little more trouble the frequencies can be drawn on a circular scale and pasted over the corresponding numbers and thus show direct frequency readings.

A circle should be drawn 2 1/4 inches in diameter and divided into 100 degrees. This can be done by copying the graduations on a 100 degree dial, or if no dial can be found, a protractor may be used. Each degree on your paper dial should equal 3.6 degrees on the protractor. Ten degrees on your circle would equal 36 degrees on the protractor, etc. These 100 degree graduations should be made on the outside of the 2 1/4 inch circle as they will be cut off later.

Using your calibration chart, write the frequencies of the 10, 20, and 40 meter bands *inside* the circle, using short lines on the inside edge of the line. Make the 100 and 50 kilocycle points heavier to make the scale easier to read. Be sure to draw the numbers so as to be read at the *top* of the dial.

Another circle, 1 1/16 inch in diameter, is drawn inside the larger circle. On this circle is drawn the 75-80 meter scale, with the graduations and figures also on the inside of the circle.

Cut out the circular dial on the outside line, cutting off the 100 degree graduations. They will not be needed any more. Cut a 1/2 inch hole in the center and attach to the vernier dial with rubber cement, being careful to line up the frequency numbers with the proper vernier dial numbers.

This paper dial will be slightly larger than the metal dial but this will make it easier to read. The black letters against a white background are also easier to see than the original coloring. The lettering should be done with India ink using a fine point pen.

An alternate method is to make the paper dial about 4 inches in diameter and write the numbers on the typewriter. This can then be photographed and reduced to 2 1/4 inches, making a much neater dial than could be drawn in such a small size.

You will now have a continuous coverage converter, plus a direct frequency reading vernier dial on the ham bands.

By  
**ULRIC J. CHILDS**



Top view of amplifier. Component placement is not critical but that shown is a neat and practical arrangement. Chassis plug, lower left, is for power supply cable.

THE author, having been a builder of audio equipment for many years, contends that the custom-built amplifier has much to offer the audio enthusiast in the way of circuit refinements, individual calibration, and the use of over-rated components.

#### Requirements

An amplifier to be recognized as a high quality unit must satisfy certain requirements.

1. It must exhibit no noticeable distortion up to the limit of its rated power output. This means that harmonic distortion must be 0.1% or less, intermodulation between 0.4% and 0.5%.

2. In an amplifier which uses inverse feedback (and every good amplifier does) frequency response must be flat between 10 and 60,000 cycles, at least, to allow high feedback without oscillation.

3. It should have sufficient power output, without distortion, to reproduce the highest instantaneous peaks to be found in any music with absolutely no clipping. This requires a no-distortion rating of at least 30 watts, even though average level to the speaker is only around 2 watts. This is a point too often overlooked.

4. It must be absolutely free of all noise—hum, tube hiss, thermal hiss from current-carrying resistors, and microphonics.

5. It must be so trouble-free that years will pass before servicing is needed—and then it should be necessary only to replace tubes. In addition to dictating the use of highly over-rated components, this means that heating, even from tubes, must be kept to a minimum.

6. The effective output impedance must be extremely low—less than 0.5 ohm effectively at the 16-ohm tap. This is required to damp out speaker reso-

nances (even the best speakers have them), cabinet resonances, and "hang-over."

#### The "Childs" Amplifier

An amplifier which meets these requirements is diagrammed in Fig. 1. The key to its quality is the care with which each individual circuit was designed and with which each and every unit is constructed. There is nothing complex or difficult about constructing it—any technician with a reasonable degree of experience and technical knowledge can do it. Every part is standard, available from dealers' shelves, including the output transformer.

The low distortion, output impedance, and noise level are achieved largely by over 25 db of balanced inverse feedback in two overlapping loops. To give the feedback loops less work to do and improve results even more than this amount of feedback could accomplish by itself, the entire amplifier is balanced push-pull (with a fine balancing control).

Phase inversion takes place right at the input in a cross-coupled circuit which is genuinely self-balancing. The output of cathode follower  $V_{1a}$  feeds both the grid of  $V_{2a}$  and the cathode of  $V_{2a}$ . For that reason, the two plates of the 6SL7GT show two replicas of the signal, 180 degrees apart. At the same time, the cathode of each 6SL7GT triode supplies feedback to the grid

of another triode and the cathode of an opposing one. This is the case with each of the four triodes in the first stage. The result is an initial balance with the 2000 ohm potentiometer  $R_4$ , after which the complete cross-coupled feedback in the stage corrects any dynamic unbalance by instantaneous conditions during operation.

The second 6SN7GT,  $V_{3a}$  and  $V_{3b}$ , is an amplifier stage which is also used as part of one of the feedback loops.

The third 6SN7GT,  $V_{4a}$  and  $V_{4b}$ , is the driver stage. It is a balanced cathode follower instead of the usual plate-coupled driver. This allows for a low impedance between the grids of the power tubes and ground.

The bias for the driver grids is obtained from a voltage divider across a regulated -105 volt supply. Bias is adjusted with  $R_{2a}$  so that the cathode voltage at each triode of the driver is approximately -35 volts. The driver grid voltage is then around -43 volts. The center of the two cathode resistors is returned directly to the bias supply.

The power stage consists of four push-pull parallel 807's connected as triodes. (The small resistors in the grid and plate leads are parasitic suppressors.) The 807's have much higher plate and screen dissipation ratings than 6L6's or any other receiving-type tubes. This means they will not heat up to a point where they might endanger other components. In addition,

**Complete design data on a high quality amplifier  
along with details on a unique preamplifier unit.**

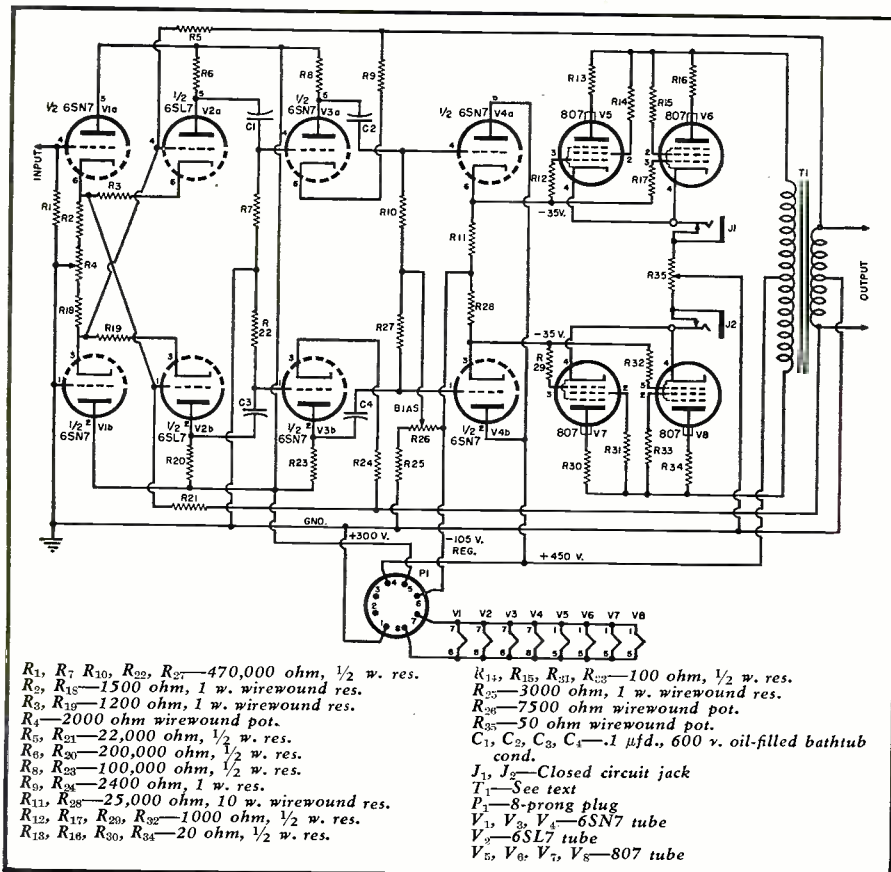

Fig. 1. Circuit diagram of the power amplifier. Well balanced push-pull design throughout and unusually high feedback make this unit's superiority noticeable.

they can handle much more power and are used here in class A (except at the very highest levels, where they operate in class AB<sub>1</sub>). In this way the amplifier can produce a full 30 watts of power without distortion.

The plate currents of the output tubes must be balanced. A pair of metering jacks and a small cathode potentiometer allow precise adjustment for balance.

The output transformer is one of the most important items in the entire amplifier. It must have very low leakage inductance, high primary inductance, low interwinding capacitance, ample power-handling capacity, well-balanced windings, and flat frequency response from 10 to at least 60,000 cycles. It must also

have a secondary which can be balanced. The writer has found such units as the UTC LS-58 or LS-614, Peerless SQ-265, and Partridge VDN-436-B (with specifications made when ordering) satisfactory in this application. Others with the same specifications are probably just as satisfactory.

The first of the two balanced feedback loops is an over-all one covering all stages. It is taken directly from the two sides of the balanced secondary, through 22,000 ohm resistors, to the grids of the 6SL7GT. The second loop goes from the secondary through 2400 ohm resistors, to the cathodes of the V<sub>5a</sub>, V<sub>5b</sub> amplifier stage. The cathodes of this stage are grounded through the feedback resistors and the transformer secondary. Both loops

Underchassis view of amplifier. Although only a few parts are used they must be of the highest quality. The four condensers in the circuit should be "bathtub" units.

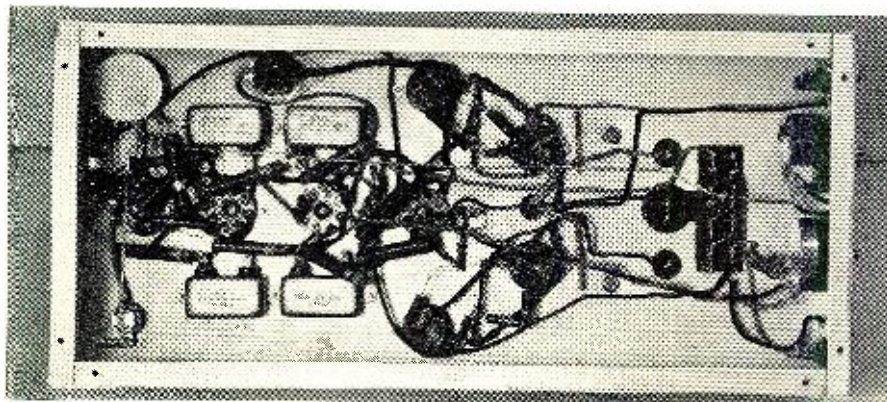

are low-impedance to avoid any frequency discrimination or phase shift that might be caused by stray capacitance, and as a result blocking condensers, another source of phase shift, are unnecessary.

The total of over 25 db of feedback is proportioned between the two loops. There is, of course, the mutual feedback in the triodes of the cross-coupled input and the unbypassed cathode resistors of the following amplifier stage as well.

### Power Supply

The complete power supply is diagrammed in Fig. 2. There are actually two separate supplies, one for the driver and output stages and another one for the preceding stages. This insures that there will be no instability caused by coupling through a common supply.

The supply for the initial stages employs a single 5U4G and a two-section condenser-input filter. The 1000 ohm resistor places the transformer center-tap about 130 volts negative with respect to ground. A VR105 supplies a regulated 105 volt bias for the driver and power stages.

To balance out hum, a 50 ohm wirewound potentiometer is connected across the heater winding of the larger power transformer (which supplies all heaters and the arm connected to a tap about 35 volts above ground on the bleeder of the smaller supply).

The larger power supply is conventional although it uses a pair of 5U4G's with elements paralleled in each to carry the necessary current (about 230 ma.) without heating excessively and for better regulation.

The supplies are mounted on a separate chassis. Two output receptacles carry power to the amplifier and to the special preamplifier which will be described. The primary circuits are fused and balanced to chassis with a pair of 0.1 μfd. condensers. The line input is switched at the preamplifier.

### Construction

The chassis for both the power supply unit and the amplifier measure 8 x 17 x 3 inches. Steel chassis should be used to support the components safely. Both chassis appear in photographs which illustrate the general layout.

The components are chosen for greatest reliability. All the important noise-producing resistors are wirewound.

There are only four condensers in the amplifier. Each of these is a 0.1 μfd., 600 volt, oil-filled "bathtub" unit. In the power supply unit there are seven oil-filled condensers—the three filter units in each supply, and the 20 μfd. condenser which bypasses the smaller transformer's center-tap to ground. These are individual oil units or combinations, depending on the supply of components when each amplifier is assembled. The 50 μfd. condenser between the heater-balancing

potentiometer and ground is an electrolytic.

Each chassis includes a heavy 14-gauge ground bus which is attached to the chassis at only one point. This point is at the input plug on the amplifier chassis. In the power supply unit, the selection of the chassis grounding point is not important.

Although the author has built many almost identical amplifiers, there has been no attempt to cable under-chassis leads. Wiring is strictly point-to-point, with supporting lugs wherever necessary. This avoids any possibility of unwanted stray couplings.

The amplifier metering jacks must, of course, be insulated from chassis, as must be the speaker connectors.

After the units have been built and the supply voltages checked, the first procedure is to see that the power stage plate currents are correct and balanced. Adjust  $R_{25}$  so that current readings across the two metering jacks are equal. The total current should be approximately 200 ma. If the output voltage of the final amplifier power supply is less than 450 volts, the 807's may be adjusted for somewhat less plate current, possibly as little as 80 ma. per side of the push-pull circuit. As little as 400 volts may be employed in the supply; the result will be a reduction in the distortionless audio power output rating to about 25 watts instead of 30.

The power amplifier adjustment may be made with the feedback lines disconnected from the transformer secondary to avoid any possible trouble with feedback. The lines should then be reconnected to the balanced 16 ohm secondary. Correct polarity must be observed. Connect an a.c. meter to the transformer secondary and a source of tone to the amplifier input. Try connecting the feedback lines at both polarities. When the polarity is wrong the output level, as read on the meter, will rise and the amplifier will probably oscillate. When it is right, the output will be lower and there will be no output when the tone generator is disconnected.

Next, the input circuit must be balanced. Disconnect the grid of  $V_{10}$  from ground and connect it in parallel with the grid of  $V_{10}$ . Then connect the output of a tone generator (or any other audio source) to the input jack. Carefully adjust  $R_1$  until there is zero output from the secondary of the output transformer.

The last adjustment is for minimum hum. The heaters float about 35 volts above ground to eliminate heater-to-cathode emission. The source of +35 volts in the power supply is connected to the arm of a 50 ohm potentiometer. After the sound system is completely set up—including connection of a preamplifier if one is used—adjust the 50 ohm control for minimum hum. If care has been used in construction there will be no hum whatsoever after adjustment unless the listener places his ear right against the speaker. Even so, the hum should

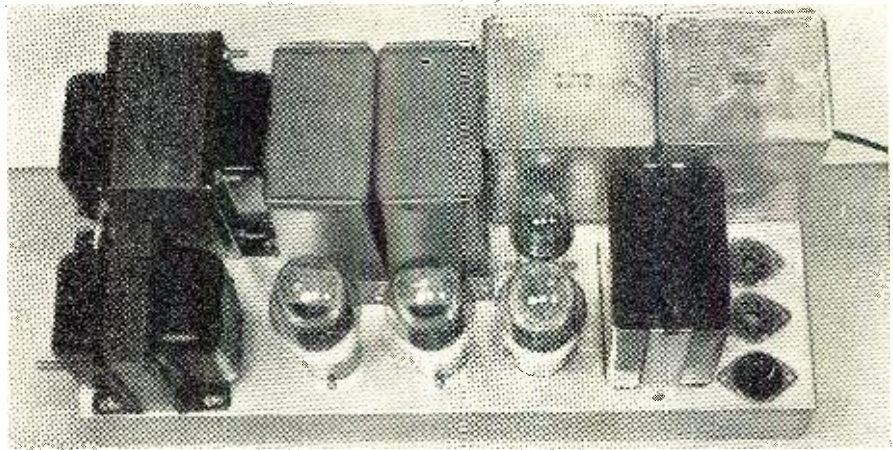

Top chassis view of power supply unit. Although usually built on a separate chassis, this unit can, by careful design, be combined with the amplifier on one chassis.

be difficult to detect. The tap on the bleeder of the lower voltage supply, which furnishes the filament bias, should be adjusted for approximately 35 volts with the aid of a voltmeter.

Once made, these adjustments should be permanent unless a tube is changed, in which case it might be necessary to touch up the unit slightly.

#### Preamp-Control Unit

The amplifier described in this article is driven to full output with a 1.5 volt input signal. This may be furnished by any source, of any impedance.

There is, however, very little point in driving such an amplifier from an inferior source.

The writer has so far been unable to find a commercial preamplifier for magnetic-type pickups which satisfies the most idealistic requirements for sound realism. There is, however, a perfectly straightforward method of providing the necessary equalization and low distortion rating which has been incorporated in the preamplifier-control unit which is normally used with the amplifier.

Even with genuinely calibrated step-

Fig. 2. Schematic diagram of dual power supply for the audio amplifier and preamp.

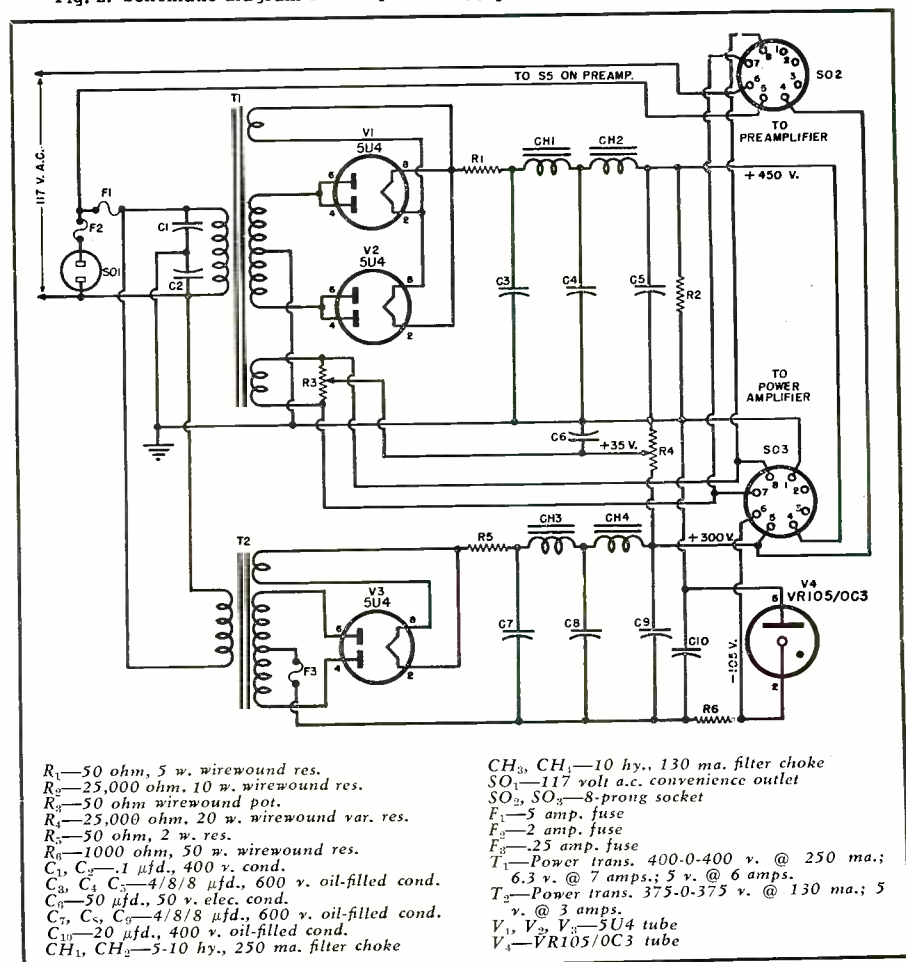

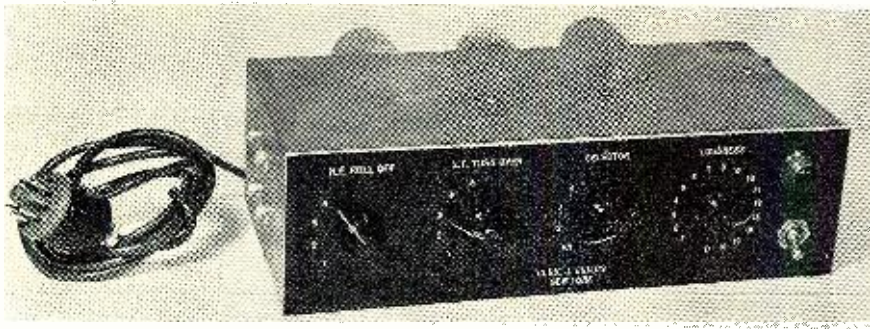

Front panel view of the preamplifier control unit as built by the author.

type commercial equalizers (of which few are available), too few bass turnovers are provided and bass equalization is carried down to only about 100 cycles. The writer's unit provides five bass turnovers, selectable with the "L.F." switch on the preamplifier shown in the photograph. These are 250 cycles (for *HMV* and other European records), 400 cycles (for *London frr* 78 rpm discs), 500 cycles (an American "standard"), and 800-900 cycles (NAB and LP's). For each, the bass response of the preamplifier rises at the rate of 6 db per octave down to 10 cycles, after which it begins to

flatten out. The exception is a *Columbia* LP position (No. 4), in which the turnover is 500 cycles but the drop of about 3 db. at 100 cycles specified by *Columbia* is provided.

Fig. 3 is a schematic diagram of the entire preamplifier-control unit. The preamplifier is a pair of pentodes, with a frequency-selective feedback system providing the bass rise. The more usual circuit of a high-mu duo-triode does not provide enough gain to allow sufficient feedback for the bass rise necessary to carry equalization down to 10 cycles; the two pentodes correct that situation. The feedback at 1000

cycles is about 45 db. With the highest turnover frequency selected, feedback of 15 db still exists at the lowest frequency to minimize distortion. Thus, a full 30 db (actually slightly more) of bass accentuation is provided at the lowest frequency to correct the recording curve precisely.

Four high-frequency responses are provided: flat, roll-off of 3 db per octave from 3000 cycles (*London frr*), roll-off of 2.5 db per octave from 1000 cycles (*RCA Victor*), and roll-off of 6 db per octave from 1590 cycles (NAB). With the two switches, a total of 20 equalization combinations can be had, which will provide accurate compensation for just about any record.

The preamplifier unit also is the central control point for the entire system. The a.c. for the amplifier is controlled by a switch on the preamplifier panel, the leads for this purpose being a part of the 5-wire cable which furnishes power to the preamplifier from the same supply used for the preliminary stages of the amplifier. A selector switch with two sections and four positions selects either of two phonograph pickups or one of two other inputs—tuners, etc.

(Continued on page 101)

Fig. 3. Schematic of the preamplifier. This unit provides 20 calibrated equalizer combinations for records and acts as control unit for entire audio system. The "loudness" control is designed to compensate for ear deficiencies at low sound levels.

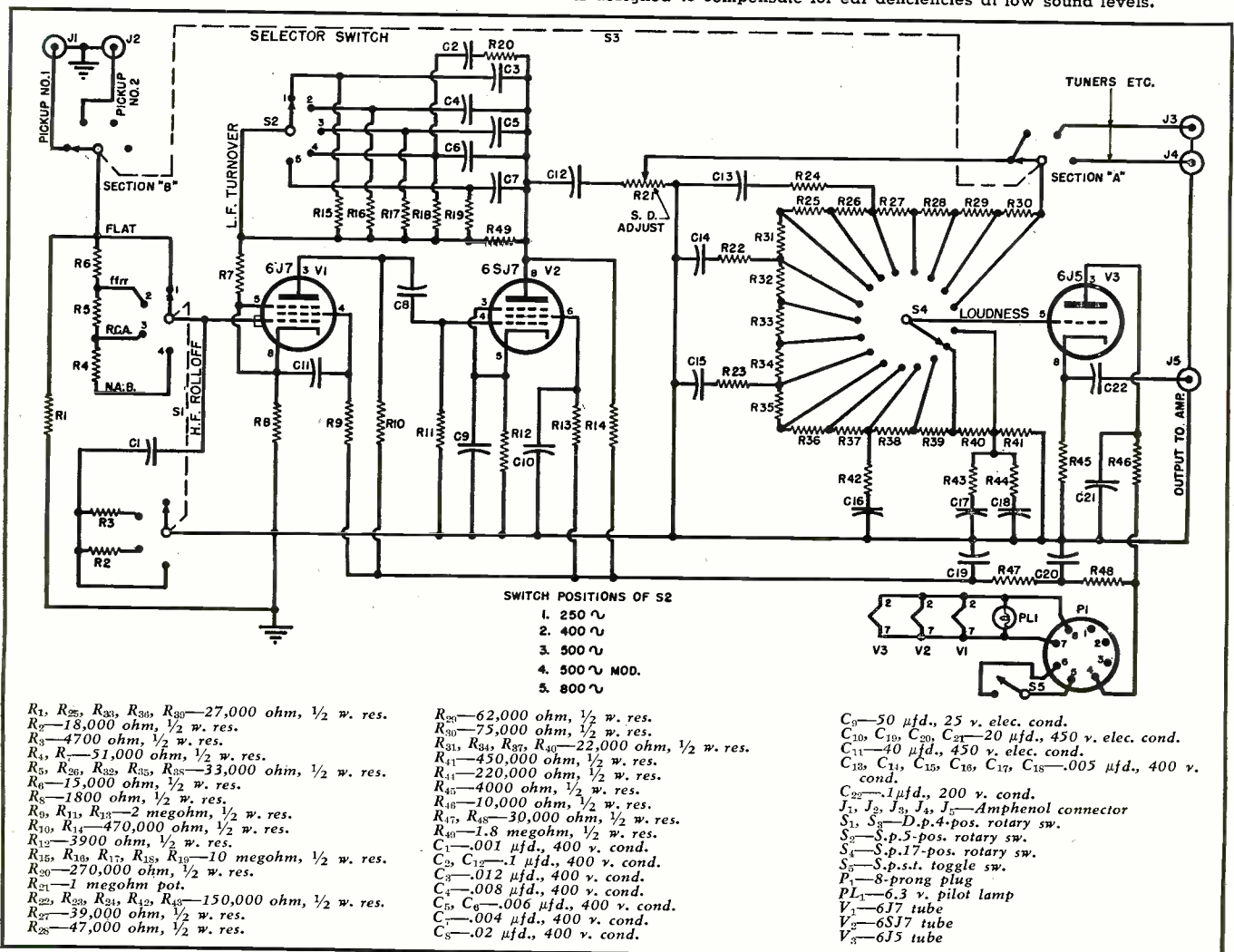



# An A.C. POWER TEST PANEL

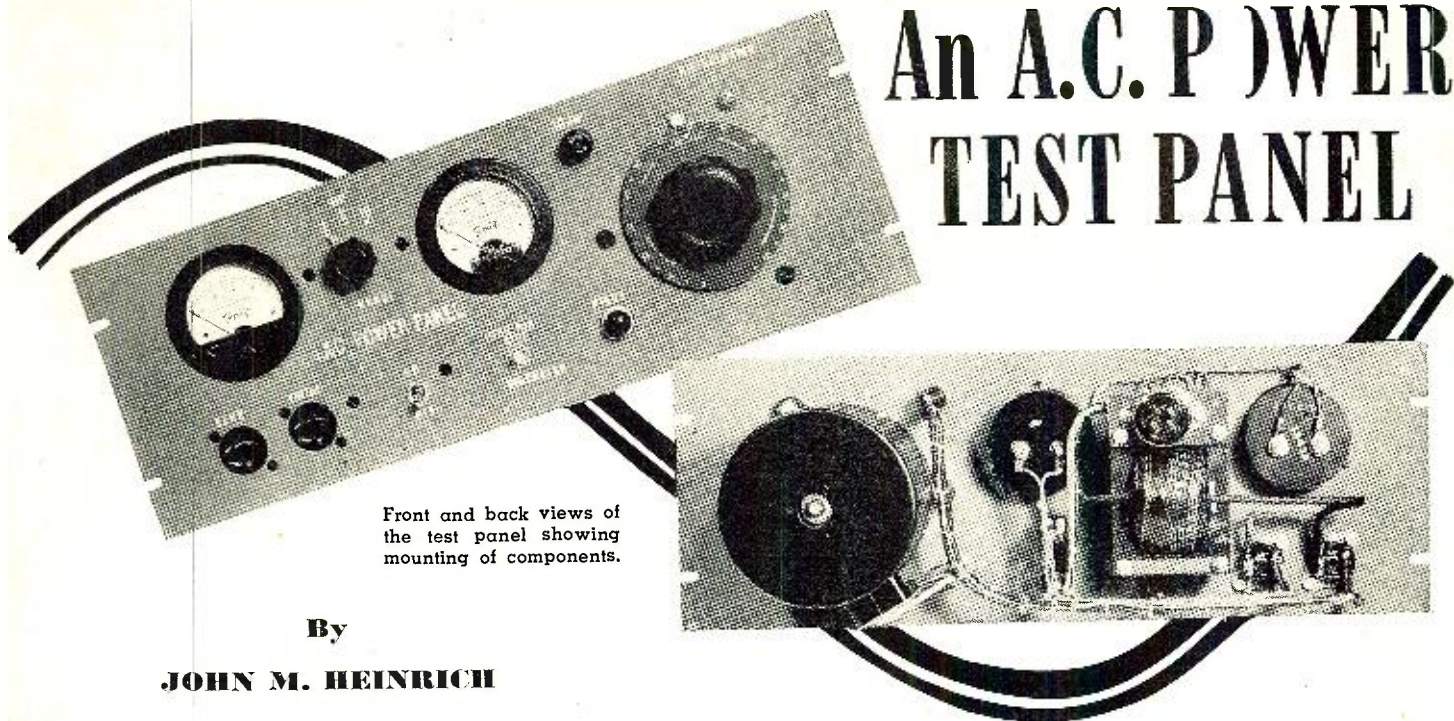

Front and back views of the test panel showing mounting of components.

By

**JOHN M. HEINRICH**

A VARIABLE line voltage control unit serves many useful and varied purposes in everyday radio and electrical work, the most common application being the determination of the behavior of certain pieces of electronic equipment at both a reduced and greater than normal line voltage. The usefulness of such a unit extends considerably beyond this fundamental application and finds application in meter calibration, motor speed control, lighting control, and power factor correction when used in conjunction with the self-contained ammeter. Many other applications will undoubtedly suggest themselves as the user gains familiarity with the unit.

The unit to be described is built around a *General Radio Company* Type 200-CU "Variac" which has a normal output current rating of 5 amperes and a maximum rating of 7.5 amperes. Since the line voltage fluctuates between the normal "Variac" rating of 117 volts, a 0-150 volt a.c. voltmeter is included as an integral part of the unit in order to provide greater over-all accuracy. A s.p.d.t. spring-return microswitch normally connects the voltmeter across the output terminals of the "Variac." Depressing the switch bridges the meter across the line terminals to indicate the line voltage.

A 0-1 ampere ammeter used in conjunction with a home-wound current transformer provides extended current ranges of 0-1-5-10 amperes. The primary winding of the transformer is permanently connected in series with the common side of the output circuits while the meter and range switching is confined to the tapped secondary winding. Two *Amphenol* a.c. receptacles provide independent line and "Variac" output voltages.

The complete unit is constructed on a 8 3/4" grey crackle-finish relay rack

**Provides a continuously metered power source that is variable from 0 to 135 volts at 7.5 amperes maximum.**

panel with a straightforward layout. With the exception of the current transformer, all parts are standard, commercially available items. Should the builder so desire, other parts values and components may be substituted at will.

The current transformer is the only component which could cause any real

difficulty; however, with a reasonable amount of care an accurate and reliable unit can be wound without any trouble. The transformer used in this unit is accurate to the extent that when switching from overlapping ranges the current indication on the ammeter is exactly the same on any range.

In a current transformer the primary ampere-turns is equal to the secondary ampere-turns. However, at low values of primary current this does not hold absolutely true because the current in the primary is composed of two quantities—one which supplies a field for the secondary winding and the other which supplies the core magnetizing current or hysteresis and eddy current losses of the core material. This will cause the meter to indicate high since the effective primary-to-secondary ampere-turns ratio is reduced. With a 1 x 1 inch core and 16 turns of #14 enameled wire on the primary, it requires only 15 turns on the secondary winding to get full-scale deflection of the meter with a current flow of 1 ampere on the primary side. The 5 ampere range has a total of 80 turns or a 1-to-5 turns ratio for a 1-to-5 current ratio and the 10 ampere range has 160 turns or a 1-to-10 turns ratio for a 10-to-1 current ratio. Whereas the primary carries the full load current, the secondary only has to accommodate the meter current of 1 ampere and thus requires only a #20 wire. The impedance of this transformer varies inversely as the current range, as should be. The impedance at

(Continued on page 104)

Wiring diagram of a.c. power test panel.

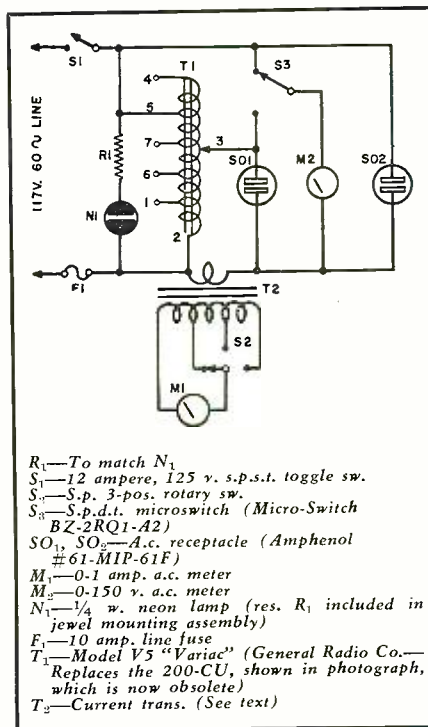



# International SHORT-WAVE

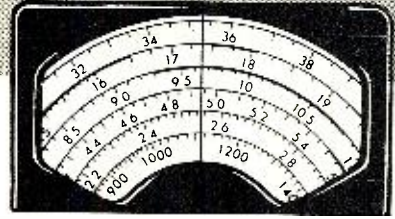

Compiled by **KENNETH R. BOORD**

IT IS a privilege this month to dedicate the *ISW DEPARTMENT* to radio in Portugal. Through the courtesy of Bill Herd, Delaware, and Flavio Serrano, Rio de Janeiro, this data has been received from Emissora Nacional de Radiodifusao, Service de Intercambio, Rua do Quelhas, 2, Lisboa, Portugal:

**Home Service**—Lisboa I, 719 kc., 50 kw. (National); Lisboa II, 665 kc., 15 kw. (Regional); Porto, 755 kc., 10 kw. (National—North); Coimbra, 1367 kc., 1 kw. (Regional—Middle); Faro, 1350 kc., 1 kw. (Regional—South); Atlantico Regional, 1214 kc., 2 kw., Ponta Delgada, Azores; Madeira, 1529 kc., 1 kw. (Funchal, Madeira); Azores Regional, 4.845, 1 kw., Ponta Delgada, Azores; Lisboa, 6.374, 10 kw. (National); Azores Regional, 11.090, 1 kw., Ponta Delgada, Azores; Lisboa, 15.380, 10 kw. (National).

**Overseas Service**—6.374, 10 kw.; 7.018, 10 kw.; 7.049, 10 kw.; 9.670, 50 kw.; 9.746, 50 kw.; 11.027, 50 kw.; 11.040, 50 kw.; 11.920, 50 kw.; 11.958, 50 kw.; 11.995, 50 kw.; 12.749, 10 kw.; 15.100, 50 kw.; 15.150, 50 kw.; 15.380, 50 kw.; 17.740, 5 kw.; 17.860, 5 kw.; 21.490, 5 kw.; 21.660, 5 kw.; 25.660, 5 kw., and 25.690, 5 kw.

**Home Service** programs are listed—Lisboa I weekdays 0330-0500, 0700-0900, 1330-1900; Sundays 0330-0500, 0630-1900; news in Portuguese 0335, 0800, 1400, 1600, 1800; dance music, 1330, 1815. Lisboa II daily 1500-1900 (during football season—September to July—1045-1900 Sundays). Porto I (North

National), Coimbra (Central Regional), Faro (South Regional), weekdays 0700-0900, 1330-1900, Sundays 0630-1900; Atlantico, weekdays 0700-0900 in 19-m. band, 1330-1900 in 47-m. band (Sundays 0630-1300, 1300-1900); Azores Regional, daily 1500-1600 (currently, for summer, 1400-1500—KRB) in 27-m. band, and 1700-1900 in 62-m. band. Highlights of programs on m.w. include Symphony Concert, 1645 Thursdays; Chamber Music, 1630 Tuesdays; Drama, 1700 Fridays; Variety Show, 1700 Mondays; Guitar Concert, 1800 Sundays. During summer—first Sunday of April to first Sunday of October—the Home Services “are delayed one hour.”

Daily programs for *Overseas Services* (in Portuguese) are listed—For Sao Tome, Angola, Mozambique (Portuguese East and West Africa), 0330-0500 in 13-, 19-m. bands; 1230-1530 in 13-, 19-, 27-m. bands or 16-, 25-, 30-m. bands; for Macau, Timor (Portuguese Far East), 0600-0800 in 13-, 19-, 27-m. bands; for Goa, Damao, Diu (Portuguese India), 0915-1145 in 13-, 19-, 27-m. bands; for Brazil, Cape Verde Islands, Portuguese Guinea (South Atlantic), 0915-1145 in 13- or 16-m. band;

(Note: Unless otherwise indicated, all time is expressed in American EST; add 5 hours for GCT. “News” refers to newscasts in the English language. In order to avoid confusion, the 24 hour clock has been used in designating the times of broadcasts. The hours from midnight until noon are shown as 0000 to 1200 while from 1 p.m. to midnight are shown as 1300 to 2400.) The symbol “V” following a listed frequency indicates “varying.” The station may operate either above or below the frequency given. “A” means frequency is approximate.

1600-1800 in 19-, 27-m. bands, or 27-, 30-m. bands; for North Atlantic (Portuguese Fishing Fleet, and USA), 1900-2030 (now seems extended to 2100—KRB) in 27-, 30-, 49-m. bands. Programs consist of program preview, music, news, drama, talks. (Where two sets of frequencies are listed, the first applies in summer, the second in winter.)

Announcement in *Home Service* (minus accent marks) is “Lisboa, Emissora Nacional a trabalhar com os emissores de . . . (Lisboa I, Lisboa II, Porto, Coimbra, Faro) e as estacoes de Ondas Curtas em . . .”; for *Overseas Service* is “Aqui Lisboa, Estacao de Ondas Curtas da Emissora Nacional a trabalhar nos comprimentos de onda de . . . mas frequencias de . . .” Interval signal is a gong. Reports are answered by QSL cards or letters.

Radio Renascenca, Emissora Catolica Portuguese, Rua Capelo, 5, Lisboa, Portugal, is listed as a private (commercial) station; no other details are given but *World Radio Handbook* lists Radio Renascenca as Lisbon, 1286 kc., 2 kw., Lisbon, 1169 kc., 1 kw., and Porto, 6.154, 2 kw., daily at 1200-1800 (Sundays also 0515-0700); announcement in Portuguese is “Aqui Radio Renascenca, Emissora Catolica Portuguesa”; in *English*, “This is the Portuguese Roman Catholic Broadcasting System”; interval signal, gong; all transmissions open with a religious choir. (Pearce, England, just reported Radio Renascenca heard on 6.154 with varied light recordings, then closing announcements and program preview (all-Portuguese) at 1759, and closing down 1800 with choir singing. And ISWL, London, recently received schedule from the station of 1200-1800 in summer; 1300-1900 in winter.—KRB.)

*World Radio Handbook* also lists Radio Clube Portugues, Parede, CSB2, 1034 kc., 20 kw., and CSB51, 12.865, 10 kw., daily in Portuguese 0645-0900 (Sundays to 0930), 1400-1700; announcement is “Radio Clube Portugues, Parede, Portugal;” verifies by QSL card.

Officials of Emissora Nacional de Radiodifusao, Lisbon, are listed—president, Antonio Eca de Queirez; technical director, Manuel Bivar; administrative director, Armando Stichini Vilela; production manager, Jose Luiz da Silva Dias; transmitting department chief, Fernando da Cunha de Eca; studios (Continued on page 97)

The Anson Boice family of New Britain, Conn., takes SWL-ing quite seriously. “Ans” is editor for the “United 49’ers Radio Society” which will hold its annual outing Sunday, July 15th, at the home of the president, Edward I. Broome, Route 1, Vincentown, N. J. Mrs. Boice (Julia) is secretary of the club. Their receiver is a Hallicrafters SX-43.



# SWEEP ALIGNMENT in AM RECEIVER SERVICING

**Part 2. A step-by-step analysis of  
a conventional AM radio receiver.**

**By  
P. F. RHODES**

LAST month we showed how to connect sweep-alignment instruments to an AM radio receiver, and how to obtain the response curve on the scope. It was pointed out that there are sources of curve distortion, double traces, etc., which can be easily eliminated when the operator obtains a clear mental picture of the test procedure.

In this article, we ask you to go with us on a journey through our service shop, where we go through the visual alignment of a Stromberg-Carlson Model 925 radio receiver. The principles shown in this typical alignment job will also apply to any standard receiver.

## Connecting Instruments

After the dial pointer has been adjusted to the calibration marks at the low-frequency end of the scale (so that we will be able to track the tuned circuits with the dial scale indications), we set the range switch to the standard broadcast position. In most AM-SW-FM receivers, it is found advantageous to align the AM circuits first.

Since the i.f. circuits are the first to be adjusted, the sweep generator is connected between the modulator (mixer) grid and chassis ground, as shown in Fig. 2. The .01  $\mu$ fd. condenser is required to avoid short-circuiting the grid bias of the 6AC7 to ground. Since the intermediate frequency of this circuit is 455 kc., we tune the sweep generator to this center frequency.

This receiver is designed for a pass-band of approximately 10 kc. (see Part 1 for a definition and measurement of bandwidth). If the sweep-width con-

trol of the generator is set for  $\pm 50$  kc., the skirts and base line of the curve will be visible on the scope.

As in all alignment work, the a.g.c. system of the receiver should be overridden in order to stabilize the grid bias of the tubes during alignment. About 6 volts negative bias is ample, and can be supplied from flashlight cells, as shown in Fig. 2.

To obtain a response curve with minimum distortion, the scope is connected across the volume control, as shown in Fig. 1E. If connection were made across the interstage transformer, or across the output transformer, the leakage reactance of the transformer would cause severe response curve distortion.

The receiver makes use of a compensated volume control, and it is nec-

essary to align the receiver with the control set at or near to maximum, otherwise the compensating network  $R_{26}, C_{77}$ , introduces marked distortion, as shown in Fig. 5A.

ear is also insensitive to phase shift. But we are aligning the receiver by visual indication, and hence the test conditions must meet the requirements of the eye, as well as those of the ear. The eye is quite intolerant of phase distortion, less so of frequency distortion, as television technicians are well aware. Further, it will be observed that the response curve is somewhat distorted at some settings of the receiver treble control, as shown in Fig. 5B. Accordingly, the operator should adjust the treble control to the point which exhibits the least curve distortion. The receiver bass control also has some influence on the shape of the response curve, as does the bass reactor, although these two latter sources of distortion are less severe.

The distorting properties of tone control networks may be better understood by recalling the fact that a visual-response curve is essentially a 60 cycle "square wave" response. Of course, the re-

sponse curve is not a true square wave, because the corners are quite rounded, but generically, the response curve belongs to this class. Further, it should be recalled that phase distortion introduces *tilt* into a square wave, that is, the tops of the wave are no longer level after the wave has suffered phase distortion. This basic principle explains the type of distortion seen in the response curve when the tone controls influence the response.

*Those technicians who have carefully studied Part 1 of this series and who have applied sweep alignment equipment to their AM radio service problems, have undoubtedly met with some success and perhaps with some degree of failure.*

*The high points of the visual alignment technique were outlined in the preceding article, but many details (sometimes troublesome details) were necessarily omitted. In this article we pick up numerous details such as the influence of treble and bass controls, compensated volume controls, overloading, bass reactors, i.f. trap adjustment, and "rocking in."*

*Again, the reader is assured of the fundamental importance of the subjects discussed in this article. It has been said that visual alignment equipment serves to separate the "boys" from the "men." And you cannot send a boy to do a man's job in the rapidly expanding field of electronics.*

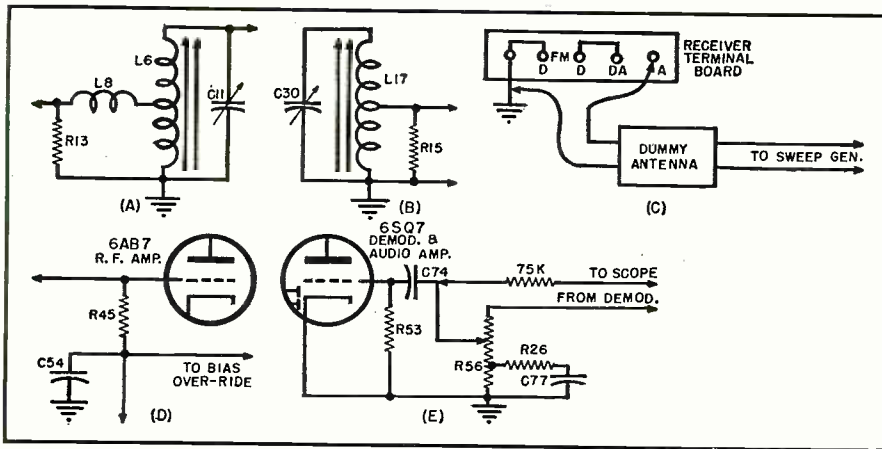

Fig. 1. (A & B) The "rocking in" step described in text involves trimmers  $C_{11}$  and  $C_{30}$  plus inductive trimmers  $L_6$  and  $L_{17}$ . (C) How to sweep the receiver, described in article, through the antenna circuits to obtain the over-all response curve. (D) When over-all curve is obtained, the bias override should be applied to the r.f. stage as shown. (E) Scope signal taken from volume control through 75,000 ohm isolating resistor.

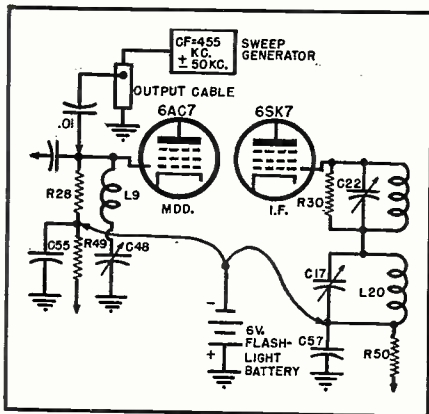

Fig. 2. Sweep generator i.f. signal is applied to grid of modulator through a blocking condenser to avoid shorting out grid bias applied through  $R_{28}$ . Six volts of override bias are applied to the grid return leads of modulator and first i.f. stage.

Unless a tone control (treble control, bass control, compensated volume control, etc.) will pass a true square wave when tested with a square wave generator and scope, it follows that the tone control will similarly distort a visual response curve.

When the foregoing precautions have been observed, a response curve is obtained as shown in Fig. 5C. For a quick check of curve distortion, the operator may unblank the curve, as shown in Fig. 5D. Because trace and retrace are nearly coincident, we know that distortion is negligible. However, if the curve appears as in Fig. 5E, steps must be taken to minimize the distortion, as outlined before. Although 60 cycle line sweep is used to obtain Fig. 5C, a double trace is not seen because a blanking network was connected to the beam-blanking post of the scope, as explained in Part 1. It may be necessary to reduce the output from the sweep generator to avoid overload and artificial flattening of the top of the curve, as seen in Fig. 5F.

The operator will note that as the primary and secondary trimmers of the first and second AM i.f. trans-

formers are adjusted, the response varies in height and width. Relative gain of the i.f. strip is indicated by the height of the curve, while the relative bandwidth is indicated by the width of the curve.

#### Aligning I.F. Circuits

The service data for this receiver specifies that the four i.f. circuits be peaked at 455 kc. When the curve is at its maximum height, we know that the circuits are peaked to the same frequency, although we still have to know how to determine what this frequency may be. In general, there are two methods of determining this value:

1. The sweep generator may be provided with a closely calibrated tuning dial, which indicates the center frequency of the swept output. In such case, the sweep generator is set to 455 kc., and the i.f. circuits are peaked up for maximum response.

2. The sweep generator may be provided with a dial which serves only as a *guide* to the operator, and which is not intended to indicate accurate center frequencies. In this case, the operator must make use of a *marker*, as explained in the previous article.

To introduce a marker, the technician may connect an AM generator in parallel with the sweep generator. As the AM generator (now used as a marker generator) is tuned, it will be observed that a wiggle, or marker, appears upon the response curve. The operator should set the marker generator to 455 kc., and then adjust the i.f. circuits to make the wiggle (long loop) appear on top of the response curve. It is understood that maximum height of the response curve is also required, as well as proper placement of the marker.

In the case of these particular AM circuits, it will not be necessary to check the bandwidth after the i.f. amplifier has been peaked up, because the i.f. transformers have been adjusted at the factory for 10 kc. bandwidth when all primaries and second-

aries are peaked to 455 kc. Note: If the local oscillator is disabled during i.f. alignment, no spurious response curves will be encountered.

#### Wave Trap Adjustment

Referring to Fig. 2, it will be observed that a series-resonant circuit  $L_9$ ,  $C_{48}$  is connected between the modulator grid and chassis. The purpose of this circuit is to trap out interfering signals which might otherwise "feed through" to the i.f. amplifier without conversion (see i.f. response obtained through the antenna input terminals, described in Part 1).

To adjust this wave trap, watch the response curve on the scope as the trap trimmer is varied. The trap is in adjustment when the response curve is at *minimum* height.

#### R.F. Adjustments

It is next necessary to adjust the r.f. oscillator and the antenna tuning circuits. The sweep and marker generator (if used) are disconnected from the modulator grid and connected to the antenna and ground terminals of the receiver through an artificial antenna, as previously described. Accordingly, the antenna terminal board is connected as shown in Fig. 1C.

The receiver tuning dial has already been set to 600 kc. Set the range switch to the standard broadcast band. Add a jumper to the a.g.c. bias override network, as shown in Fig. 1D, so that the bias override includes the r.f. stage.

Set the center frequency of the sweep generator to 600 kc., and the over-all response curve will be seen on the scope. This over-all curve shows the response of the receiver from the antenna to the second detector, at 600 kc. As before, if the center frequency of the generator is not accurately indicated on the dial, use a marker to determine the center frequency.

The powdered iron cores of the oscillator and antenna coils are then adjusted to maximize the response. It will be observed that the oscillator and antenna coils have both inductive and capacitive trimmers, as shown in Figs. 1A, 1B. The inductive trimmers are used to track the tuning condenser at the low-frequency end of the band, while the capacitive trimmers are used to track the tuning condenser at the high-frequency end of the band. This result can be obtained because the relative settings of the slug and compression mica trimmers determine the  $L/C$  ratio of the tuned circuit.

Next, the tuning condenser is set to indicate 1500 kc. on the dial and the sweep (and marker, if used) are also set to 1500 kc. Then, the 1500 kc. trimmer condensers are adjusted to maximize the response.

#### Rocking-In Trimmers

At this point, the 600 kc. alignment procedure is repeated, and any necessary readjustment made in the cores

to compensate for the trimmer adjustments which were made in the 1500 kc. position.

If the alignment procedures have been properly followed, it will now be found that the bandwidth of the over-all response curves is approximately 10 kc. at 600 kc. and at 1500 kc. Furthermore, the gain of the receiver, as indicated by the height of the response curve, should be essentially constant over the entire broadcast range. The rocking-in process is most important in obtaining these response characteristics.

Furthermore, as a final check, the response should be found negligible at the *image frequencies*. For example, if the receiver is tuned to 600 kc., the local oscillator is operating at 1055 kc. in order that the difference beat frequency may be equal to 455 kc., the i.f. frequency. But, if the r.f. circuits are not correctly adjusted, it is also possible that a station operating at 1510 kc. will beat through to the i.f. amplifier, and cause interference.

### Aligning the S.W. Band

Since this receiver has a short-wave band, the next step is to check the antenna and oscillator trimmers at 9 and 12 mc. The i.f. AM strip, having already been aligned, is not checked during the short-wave AM adjustments.

Because the core and trimmer adjustments for the short-wave section are entirely analogous to those which were detailed for the standard broadcast band, the step-by-step procedure does not need to be recounted.

If it is desired to check the built-in loop, this may be done by the operator after the chassis has been replaced in the cabinet.

### The FM Section

The receiver also contains an FM section. However, discussion of FM alignment procedures is beyond the scope of this article, since frequency modulation is a considerable study in itself. The procedures which have been outlined for the AM sections will serve as an excellent foundation for the technician who wishes to extend his knowledge into the fields of FM and TV.

After the theory of operation of limiters, discriminators, and wide-band amplifiers has been mastered from the excellent texts which are now available, alert service engineers will find small difficulty in transferring their basic alignment knowledge into the new field.

### Center Frequency and Bandwidth

At this point, the reader will realize that marking is one of the most serious problems confronting the user of visual-alignment equipment for narrow-band applications. Fortunately, there exist certain expedients which considerably simplify this problem.

For example, the marker generator can be eliminated entirely, provided

the sweep generator is calibrated. In such case, the dial indication of the sweep generator represents the frequency at the center of the trace. Further, by rotation of the sweep generator dial, the visual response curve can be moved with respect to the vertical axis of the scope screen, and the bandwidth determined thereby. Examples will be illustrated at a later point.

The sweep generator dial may or may not be calibrated, as purchased from the supply house. If the dial is uncalibrated, or if it is calibrated at too great intervals, the operator will first have to provide suitable dial indicating points. For general work, calibration at 5000 cycle intervals in the range from 400 to 1500 kc. is most desirable.

In many cases, calibration at 5000 cycle intervals will be found impractical unless a bandspread tuning condenser, or micro-drive dial is added to the commercially available generator. However, this type of modification is quite familiar to constructors of ham receivers and others, and should not present serious difficulty.

For purposes of calibration, the output of a good AM generator can be beat against the output of the sweep generator using zero deviation, and marking the sweep-generator dial at 5 kc. intervals. That is, during calibration, the sweep generator is operated as a straight signal generator, to deliver a c.w. output. The AM generator is advanced in 5 kc. steps and the sweep generator is then zero-beat at each step, and the calibration point marked on the sweep generator dial.

To make the beats audible, the outputs of the two generators should be connected in parallel, rectified through a crystal diode, and then applied to

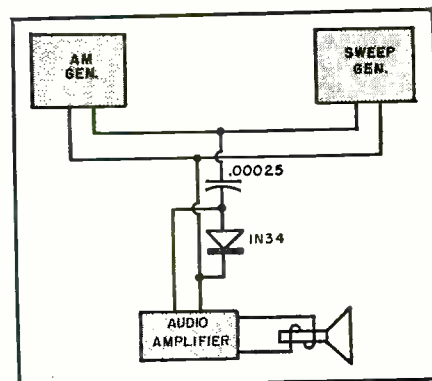

Fig. 3. Method for setting up test equipment for the purpose of providing an audible beat for calibrating sweep generator.

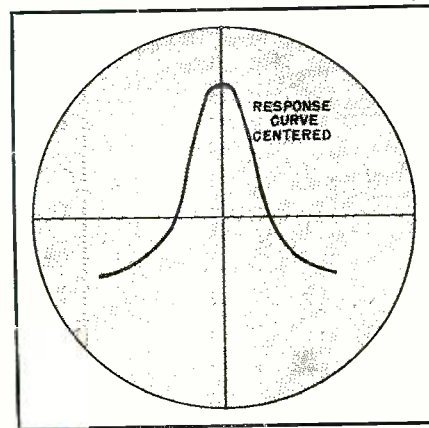
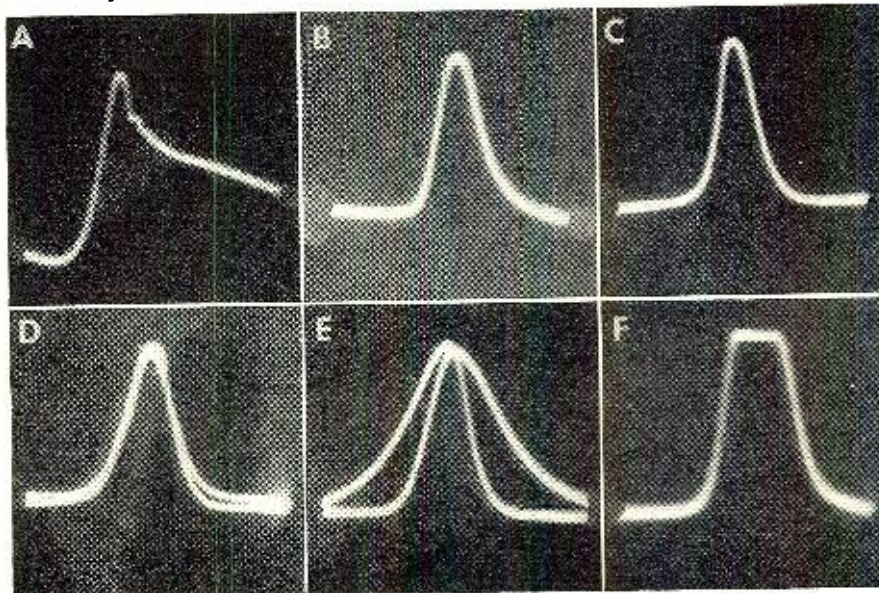

Fig. 4. Scope pattern obtained when sweep generator is tuned to center of the response curve of the receiver under test.

any convenient audio amplifier, as illustrated in Fig. 3.

After the sweep generator has been  
(Continued on page 69)

Fig. 5. (A) Curve distortion caused by  $R_{20}$  and  $C_{17}$ , shown in Fig. 1E, because volume control was not set to maximum. (B) Lesser distortion introduced by incorrect setting of treble control during alignment. (C) When volume and tone controls are properly set, the response curve is essentially distortionless as shown here. (D) Disconnecting the blanking voltage to make both trace and retrace visible helps to insure that curve is undistorted. (E) Incorrect setting of treble control causes trace and retrace to fall apart. (F) Too much sweep signal causes receiver overloading and the resulting artificial flat-topping of the response curve shown here.



# A COMPACT 10 METER MOBILE

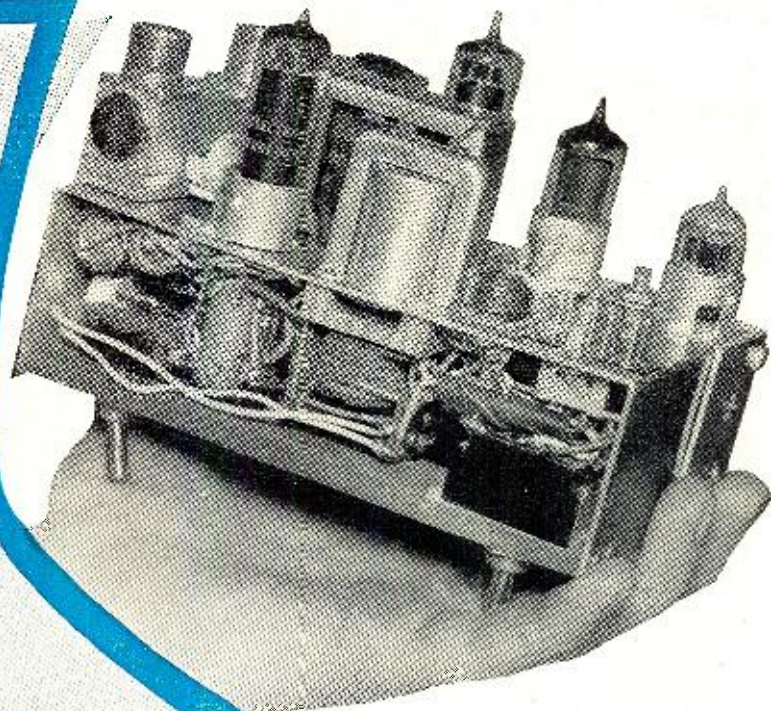

Fig. 1. Over-all view of mobile transmitter. Unit is built on chassis that measures only 6½ x 3½ x 2 inches.

By **ROBERT J. GARON, W6CQU**

Wyle Laboratories, El Segundo, Cal.

**Small enough to be mounted under the dash, this rig allows continuous coverage of the 10 meter band.**

THE unit described in this article resulted from the author's desire to develop a small, compact mobile rig which would allow the operator to obtain maximum use of an economical installation. Low power was considered essential to allow a maximum time on the air each day. Low power without a v.f.o. is almost a lost cause on today's 10 meter band, so a v.f.o. was added to the list of essentials. Since the installation was to go into a new automobile, an attractive appearance and simple installation were also necessary. Such a unit in a convenient, economical package was the goal of the entire construction project.

## Design

With the above requirements in mind the midget 7 watt v.f.o. mobile rig, as shown in the photographs, was designed. Because QSY is frequently necessary while in motion, the tracking system of the oscillator and final were combined to allow one knob control. The large *National* vernier knob provides close control of the transmitted frequency. The two switches at the lower left and right of the control knob provide, respectively, transmitter "on" and "off," and a means for turning the oscillator on to check the transmitted frequency in the receiver. This, then, is the entire transmitter with no other controls. All the knobs are readily accessible.

The selection of the oscillator circuit proved to be a difficult problem. Experiments with the popular Clapp circuit indicated that the large grid coil was too sensitive to vibration to be used in this type of mobile installation. The Hartley oscillator, doubling in the plate, was finally chosen. Operating the grid on 40 meters with the plate on 20 meters simplifies the frequency doubling problem yet provides good grid-plate isolation. A 6AK5 is a good choice here. The result is an oscillator of excellent stability. With a careful choice of oscillator components, the unit is stable, the drift cannot be measured in a HQ129-X receiver from a cold start, and there are no undesirable effects from the vibration of mobile operation. Regulated voltage must be supplied to

the oscillator and to the driver, if possible.

Plenty of driving power is required to provide proper grid drive to the final amplifier over the ten meter band without retuning the doubler. A 6AK6 power amplifier does the job well with plenty of reserve. The oscillator plate and the doubler driver plate are slug-tuned to make them as broad as possible.

The decision to use 7 watts is a straightforward one. A logical choice for a modulator is a single 6AQ5. With 200 volts on the plate about 3½ to 4 watts is the maximum audio available to drive the plate modulated final. This limits the plate input to about 7 watts for modulation with a good punch. A 6AQ5 is used as a final amplifier operating straight-through to allow maximum efficiency.

The antenna coupler works well over the entire 10 meter band.  $C_{15}$  (Fig. 2) is used to tune the link in a series coupling system. With a 2 turn link, the "Q" of the antenna circuit is low enough to cause only a slight rise in the center of the band. The unit, as shown, is designed to work into a flat line of 52 ohm or 72 ohm coaxial cable. If excessive standing waves are present in the antenna line, the tracking system will not function properly.

In the photographs (Figs. 3 & 4) a companion converter can be seen. It consists of a straightforward 6AK5-6J6 broadband, crystal-controlled converter ("A Two-Tube Crystal-Controlled Converter for 10 Meters," *QST*, August, 1950). The only innovation is the use of two crystals. This allows the three-position switch on the front panel to provide: (1) a tuning range from 28.00 to 29.05 megacycles, (2) a

Table 1. Jones plug (PL<sub>1</sub>) connections. For terminal identification see diagram, Fig. 2.

PIN NO.	CONNECT
1	+ 6 v. d.c. supply to trans. fil. and relays
2	Supplies the 4 v. used on single-button carbon mike
3	+ 150 v. (regulated) to receiver
4	Gnd. from power supply (bonded to inside of chassis)
5	+ 150 v. (regulated) from power supply
6	Grounding this pin actuates relay which controls dynamotor in power supply
7	+ 230 v. from power supply
8	Grounding this pin actuates both relays. A wire from this pin goes to push-to-talk button on mike

tuning range from 28.57 to 29.61 megacycles, and (3) coverage of the standard broadcast band.

### Circuit

Fig. 2 is the complete circuit diagram of the mobile unit. The first thing that is evident is that a large number of "necessary" parts are left out. In order to make the unit as compact as possible, the author experimented quite a while in order to eliminate or reduce the required size of as many circuit elements as practical. The diagram includes the control system for receiving and transmitting as well as the complete transmitter.

The oscillator is the standard Hartley. The grid is on 40 meters, while the plate doubles to 20 meters.  $C_1$  is a very sturdy double-bearing variable condenser. The condenser used was originally a 50  $\mu\text{f}$ d. unit. Some plates were rearranged by experimentation until the v.f.o. coverage was 1.15 megacycles, just less than the 10 meter phone band. Thus, when properly adjusted, the control knob will not set the oscillator outside the band.  $C_2$  is a 13  $\mu\text{f}$ d. trimmer used to set the oscillator range to the 10 meter band. As shown, it will vary the oscillator setting by 480 kilocycles.  $C_3$  must be a zero-coefficient unit such as a *Centralab* ceramic condenser. If the layout is not followed exactly and some padding must be done, the same type zero-coefficient condenser must be used.  $L_2$  is a permeability-tuned coil with a high-frequency slug. A 6AK6 pentode is used as a doubler-driver to insure sufficient 10 meter drive at the edges of the band as well as at the center. This plate tank is also broadbanded with a high-frequency permeability-tuned coil. No grid choke is used as the drive from the 6AK5 is sufficient to permit its omission.

The final operates straight-through as a plate modulated class C amplifier. Experiments with an r.f.c. in the 6AK5 grid circuit showed that it tended to become inductively coupled to the tank coil causing self oscillation. The 6AK6 provides enough ten meter drive to permit the losses due to the omission of the screen dropping resistor. The size of the screen dropping resistor has been adjusted, together with the load, to provide a plate input of 7.3 watts. The condenser rotor is grounded to simplify the tracking arrangement. The plate tank capacity consists of two condensers in parallel; the tracking condenser, a *Johnson* 2-11  $\mu\text{f}$ d. midget and a 15  $\mu\text{f}$ d. padder. Since the tank coil is underneath the chassis, considerable care must be taken to prevent components of the grid circuit from being electrically coupled to the plate of the final amplifier. Note in the photograph that the tank coil is at right angles to the other coils in the unit and as far away from the other parts as possible. This is essential if feedback is to be reduced enough to allow stable operation.

Since 100% modulation is required to get out well on low power, standard

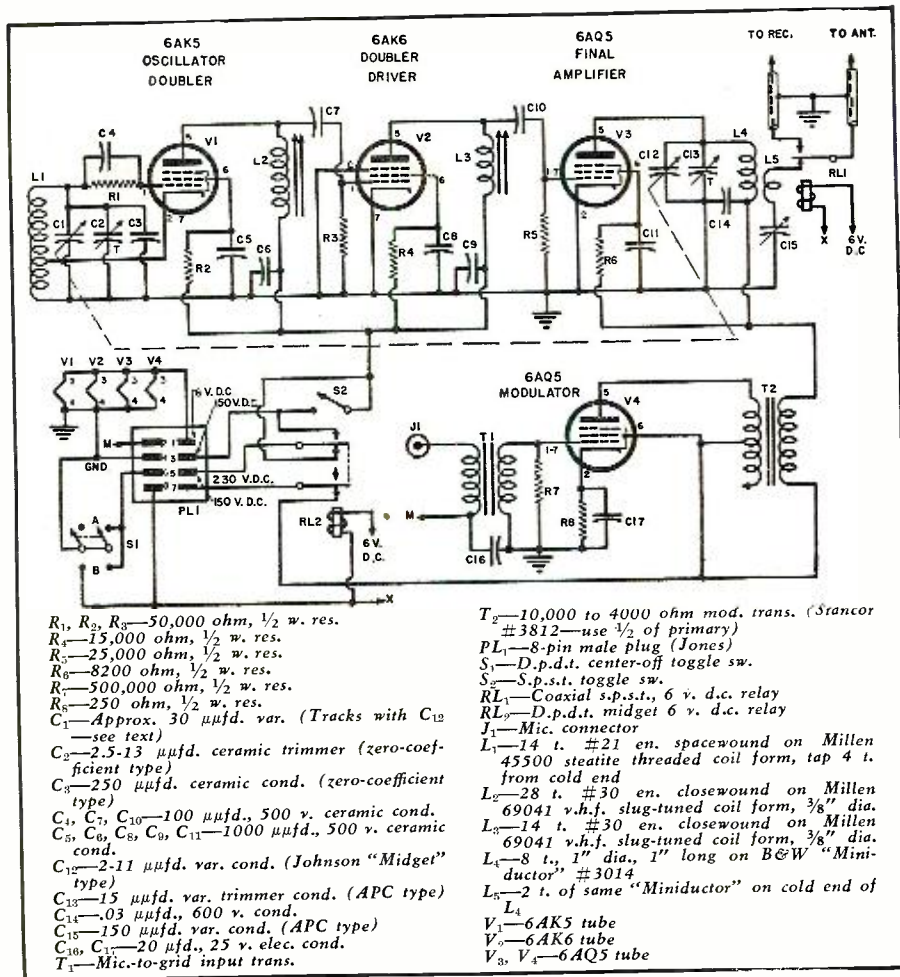

Fig. 2. Schematic diagram of transmitter. It is extremely compact and easy-to-build.

plate modulation is used. The unit is designed to use a single-button carbon microphone. A dropping resistor from the 6 volt d.c. supply is used to provide proper mike voltage. If an F-1 or similar type is used, it is recommended that a 125 ohm resistor be used. The author uses pin 2 on the *Jones* plug to

	6AK5	6AK6	6AQ5 (Final)	6AQ5 (Mod.)
Grid Volts		-40	-65	-12
Plate volts	150	150	230	230
Screen volts	60	90	180	230
Plate ma.	7	15	32	34

Table 2. Operating conditions of tubes used in the 10 meter mobile transmitter.

Fig. 3. Top view of the mobile transmitter. Unit to the left (not covered in text) is a 10 meter converter. Its output feeds directly into the automobile receiver.

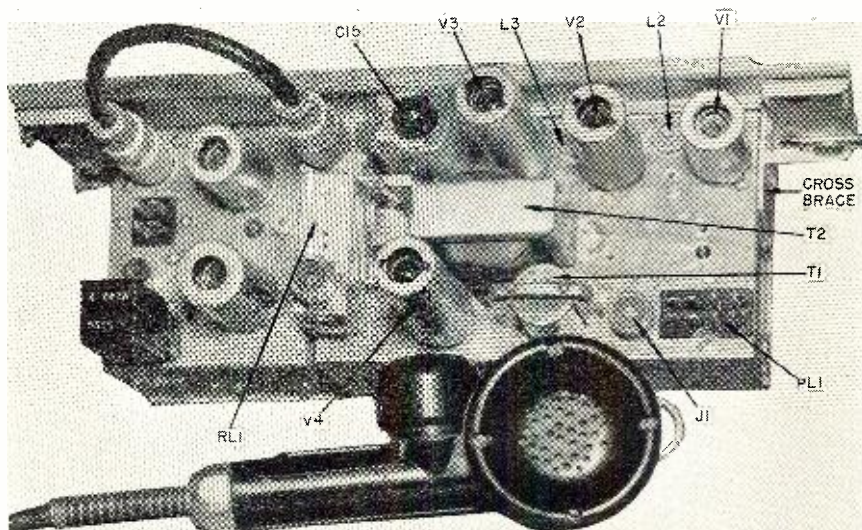

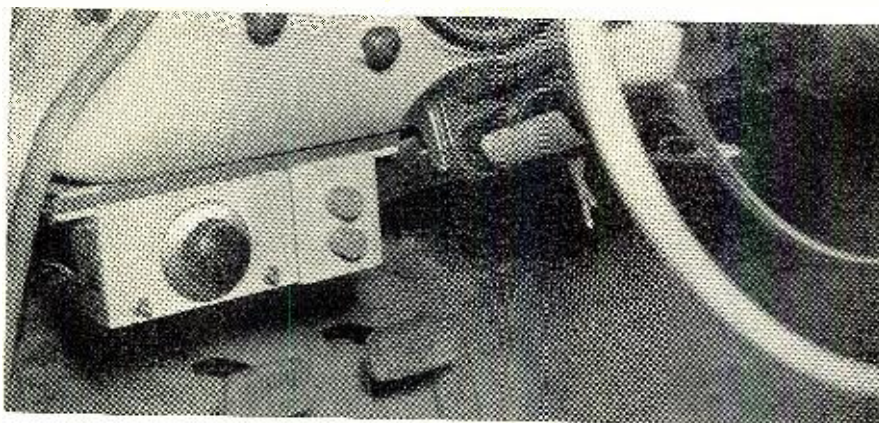

Fig. 4. Unit installed in car. Converter used in conjunction with transmitter, shown also in Fig. 3, can be seen at the right of the mobile transmitter unit.

lead the mike circuit to a 125 ohm resistor which is mounted in the shell of the female Jones plug. This is done so that if the unit is tested with a standard 117 volt a.c. power pack, microphone voltage can be supplied through pin 2 from flashlight cells. Some amateurs use such a mike directly on the 6 volt d.c. supply, but the author does not consider this good practice. The 125 ohm resistor, along with  $C_{16}$ , serve as a filter to keep generator hash and other noise from the mike circuit.  $C_{16}$  and  $C_{17}$  are the largest condensers in the unit. Care must be used in their selection if the modulator section is to be compact. The screen dropping resistor and bypass condenser were found to be unnecessary and were omitted. The modulator transformer calculation is given here so that if slightly different values are used, good modulation can be obtained:

Final amplifier current: .032 amp.  
 Final amplifier voltage: 230 v.  
 6AQ5 load (class A): 5000 ohms.  
 Trans. impedance ratio:

$$\frac{230}{.032 \times 5000} = 1.44$$

Fig. 5. Underchassis view. Compact size of unit requires careful parts planning.

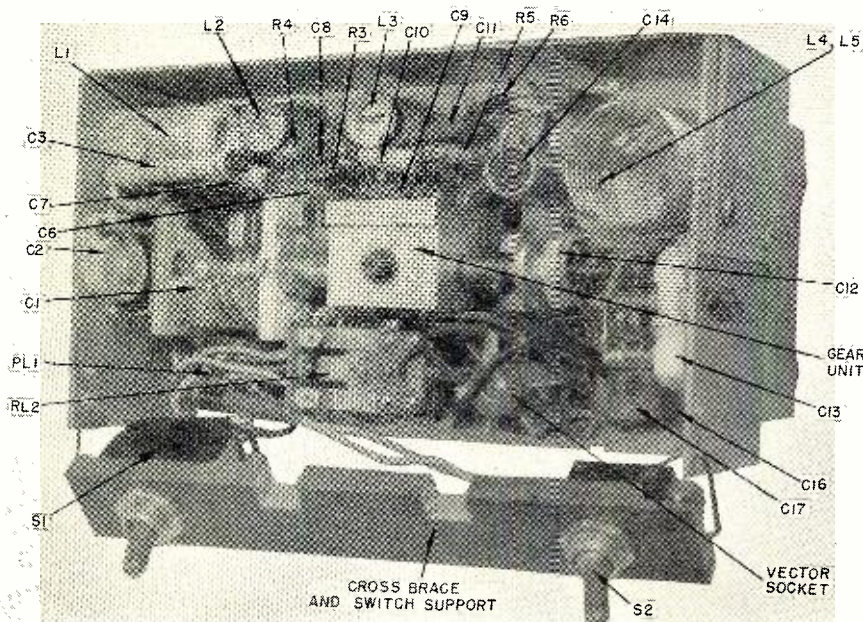

testing, or if the mike is "passed around." An ordinary s.p.s.t switch can be used for  $S_1$ , if this added feature is not desired.

The author has two d.c. milliammeters mounted on a small panel connected into an 8-wire cable with male and female Jones plugs on the ends. The meters are connected in series with the regulated 150 and 230 volts from the power supply. This allows adjustment of the slug-tuned stages and the final amplifier while the unit is in operation. With the modulator tube removed, the meters read the 6AK5 plus the 6AK6 current, and the 6AQ5 current in the final. If the modulator tube is inserted the second meter reads the final plus the modulator current.

### Layout and Construction

The photographs show the chassis layout. It is most important to mount everything solidly so that there will be no vibratory effects. Lock washers should be used throughout. As can be seen, two cross chassis braces are used, both for assembly purposes and for strength. The wiring, as shown in Fig. 5, starting at the upper left and going clockwise around the central gear unit, is as follows: 6AK5 oscillator, 6AK6 doubler-driver, 6AQ5 final and antenna circuit, 6AQ5 modulator at the lower right, the relay, and finally the 8-pin male Jones plug. The central toggle switches are mounted onto the front brace so that the cover can be removed leaving the switches intact. The brace is removed in the photograph of Fig. 5 to permit an unobstructed view of the interior. The gear unit is a surplus item. Several types of gear units are available commercially, but this unit seemed to meet the requirements perfectly. Any "T" drive will do. The spline eliminates the necessity for providing a means of tightening a set-screw on the drive shaft after putting on the cover. The vernier drive is mounted permanently on the cover, so that it engages the spline drive when it is installed. The front cover can be removed for servicing, leaving the switches still mounted to the supporting strap. Two holes are provided for the two toggle switches. The cover is "U" shaped to fit tightly around the chassis thereby completely sealing it from dust.

To facilitate assembly, as much of each tube socket as possible was pre-wired. Insulated tie points are used in several places to insure a good wiring job. All leads should be kept as short as possible. When all adjustments are complete, where possible all movable parts should be glued down with polystyrene cement.

### Adjustment

With the transmitter constructed as shown, the following instructions constitute the complete procedure for properly adjusting the unit. Table 2 can be used as a guide to the voltages to be expected.

When the wiring is complete the  
 (Continued on page 118)



# A Six Foot RADIO-CONTROLLED MODEL BOAT

By  
WALTER B. FORD, W6YT

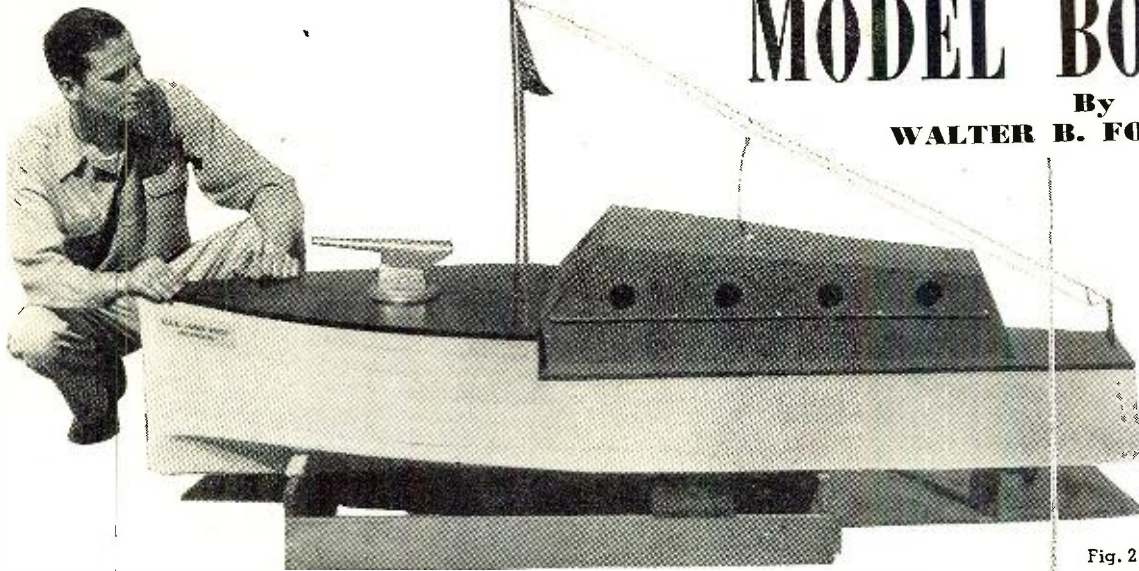

Fig. 1. "Coast patrol" type, radio-controlled model boat. The receiving antenna consists of two strands of wire, 4 feet long, strung from flagpole.

**Details on a radio control unit which starts, stops, and reverses drive motor; turns rudder left and right; sounds horn; raises flag; and fires a gun.**

NEVER dyed-in-the-wool hams will ever forget the thrill of their first radio contact, whether it was with the fellow in the next block, or spanned a distance of several thousand miles. But with all of the subsequent thrills that the hobby of amateur radio provides, in the author's opinion the nearest approach to that feeling of profound elation resulting from the first contact is reached when one puts a radio-controlled model through its paces for the first time.

Radio control of models has been an important part of the author's amateur radio activities for a number of years. Previous models have been of small size, which necessarily limited the controlled operations to a small number. In planning the boat described herein, the initial requirements were that it would be large enough to carry the equipment for at least eight controlled operations, with provisions for possible future additions of several more. The completed results of such planning is a model six feet long, patterned after a coast patrol boat and capable of attaining a speed of approximately 12 miles an hour. The present controlled operations are: start motor, stop motor, reverse motor, swing rudder right, swing rudder left, sound horn, raise flag, and fire gun.

Space will not permit giving constructional details of the hull, but plans may be obtained from a number of model supply houses so that it may be duplicated. Undoubtedly other con-

structors would vary the lines to suit their particular fancies, which is entirely in order so long as the completed craft is seaworthy and capable of safely carrying the necessary equipment. The upper structure of the boat may be a replica of any one of number of vessels, passenger cargo, or warship, but in any case it should be removable so that the control equipment may be readily reached. In the model boat shown the coast patrol design was chosen merely because it seemed more in keeping with the forward gun and the whole general lines.

The driving motor is a six volt, 1/16 h. p. shunt-wound motor, mounted in approximately the center of the boat. A d. p. d. t. relay switch (*RL*, Fig. 4) which changes the direction of the current in the shunt field serves as a reverse switch for the motor and is mounted at the base of the motor. The propeller is a three blade unit, four inches in diameter, and is connected to the drive motor with a 1/4 inch brass rod extending through a piece of brass tubing. A short section of rubber hose serves as a flexible connection between the drive shaft and motor.

Solenoid magnets were first tried on the steering control, but were discarded in favor of the control magnets shown at Figs. 3 and 5, the desirable feature of which is quick, positive action under any conditions. The unit consists of an electromagnet attached to the rudder shaft and pivoted between two stationary electromagnets, both of which are connected so that

Fig. 2. Quarter-wave antenna, transmitter, and power supply mounted on tripod.



ends of the soft steel yoke upon which they are wound will have the same polarity. The movable magnet is connected so that the end between the two stationary magnets is opposite in polarity. Whenever either right or left position of the rudder is desired, the movable magnet is placed in series with one of the stationary magnets, the magnetism of each combines with the other and the rudder snaps into position instantly.

The details of the gun, which shoots a .32 blank cartridge, are shown in Fig. 3. The barrel was turned from a piece of soft steel, 7/8" in diameter, 6 1/16" long. The threaded end of the barrel was turned to 1/2" and threaded 13 threads per inch. The breech piece was made from a piece of soft steel, 7/8" x 1 1/2" x 3", and drilled and shaped as shown in the drawing. The electromagnet is mounted on the breech and held in place with the metal cover. The coil leads extend through the breech piece and a piece of metal tubing, which is threaded into the breech piece at such an angle that the tubing will be at a right angle with the wood

(Continued on page 52)

Fig. 3. Mechanical details for building some of the component parts for the six-foot radio-controlled model boat.

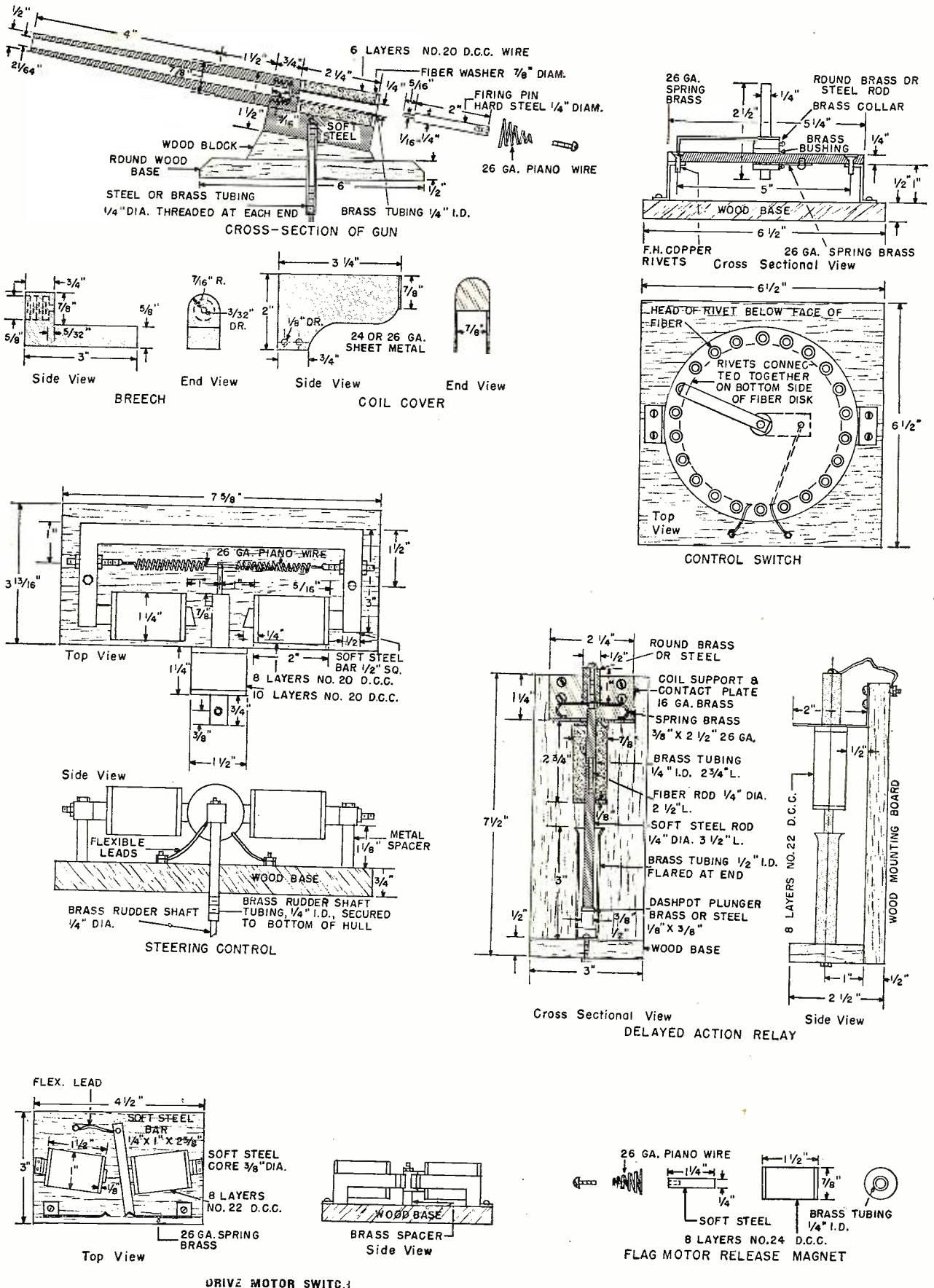

## SOURCES OF SUPPLIES FOR RADIO-CONTROLLED BOAT

### Boat plans, Propellers, Fittings

A. J. Fisher, 1002 Etawah Ave., Royal Oak, Michigan

Bill Wild's, 510 E. 11th St., New York 9 James Bliss & Co., Inc., 220 State St., Boston, Mass.

Model Shipways, 476 Main St., Ft. Lee, N. J.

### Stepping Switches (RL<sub>2</sub>, Fig. 4)

Blan, 64 Dey Street, New York 7, N. Y. Wells Sales, Inc., 833 W. Chicago Ave., Chicago 22, Ill.

Herbach and Rademan, Inc., 522 Market St., Philadelphia 6, Pa.

### Impulse Relays (S<sub>2</sub>, Fig. 4)

Herbach and Rademan, Inc., 522 Market St., Philadelphia 6, Pa.

Chase Electronic Supply Co., 105 225th St., Queens Village, N. Y.

### Sensitive Relays, Time Delay Relays, and Low Resistance Relays for Controlling Main Current and Rudder Magnets

Wells Sales, Inc., 833 W. Chicago Ave., Chicago 22, Ill.

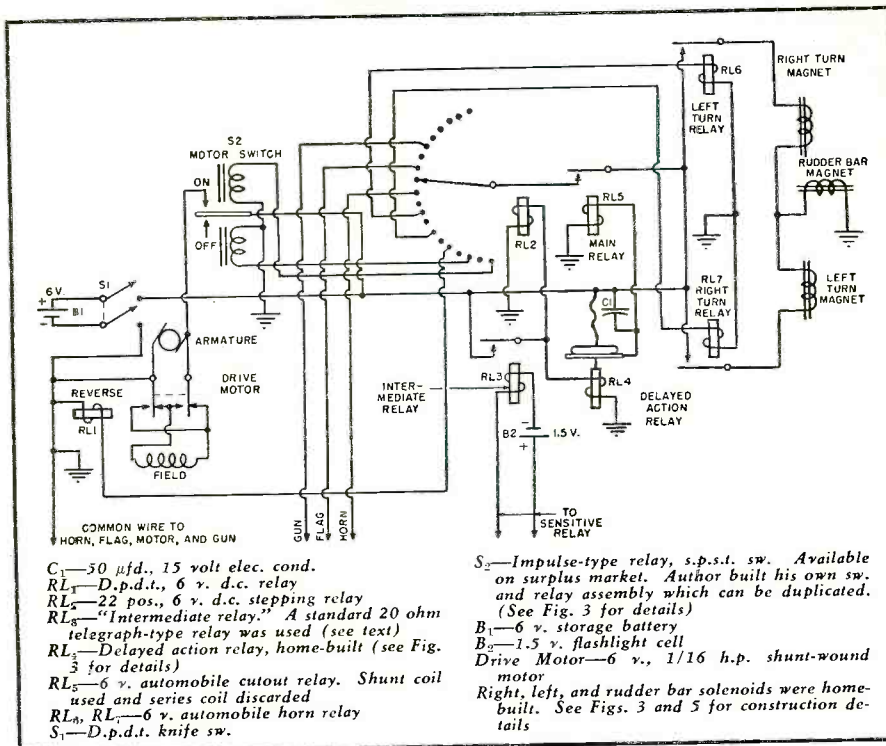

Fig. 4. Complete wiring diagram of relay panel. Many of the components are home-built.

Fig. 7. Side and top views of relay panel. For identification of components see Fig. 4.

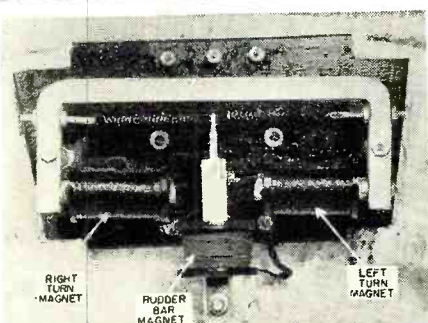
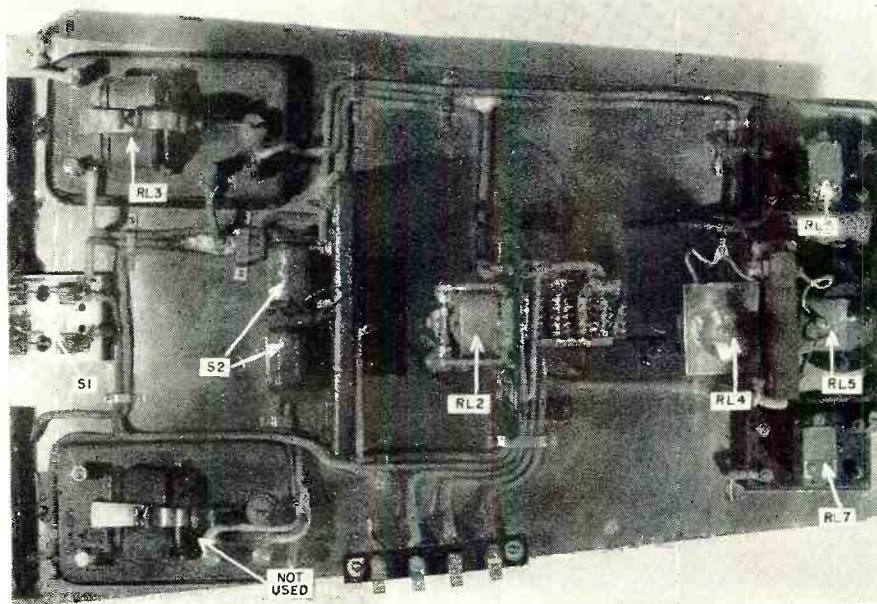
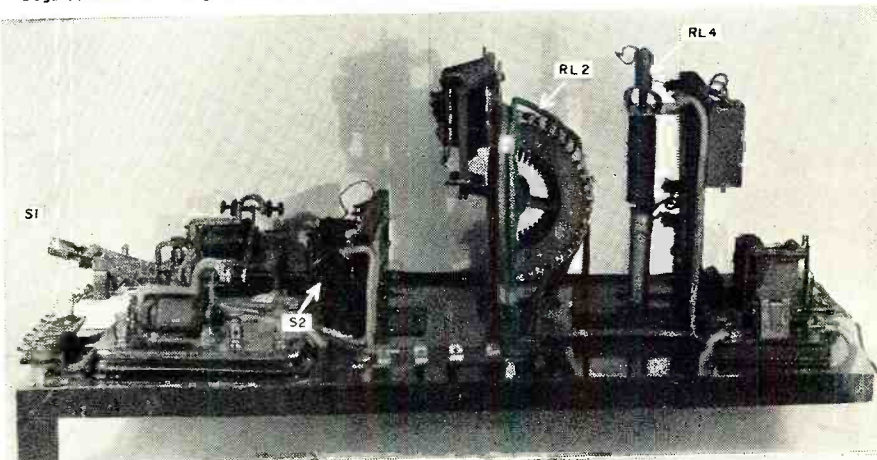
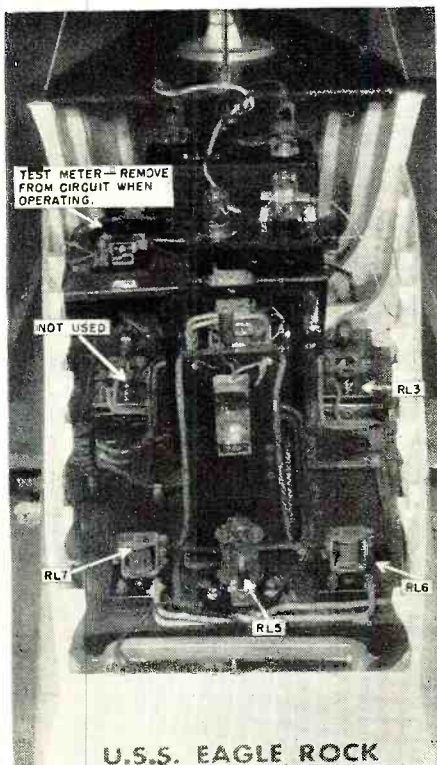

Fig. 5. Rudder coil assembly. The entire unit is home-built. See Fig. 3 for details.

Fig. 6. Top view of interior of boat. Rudder control relays are shown in foreground. Identified components are shown in Fig. 4.



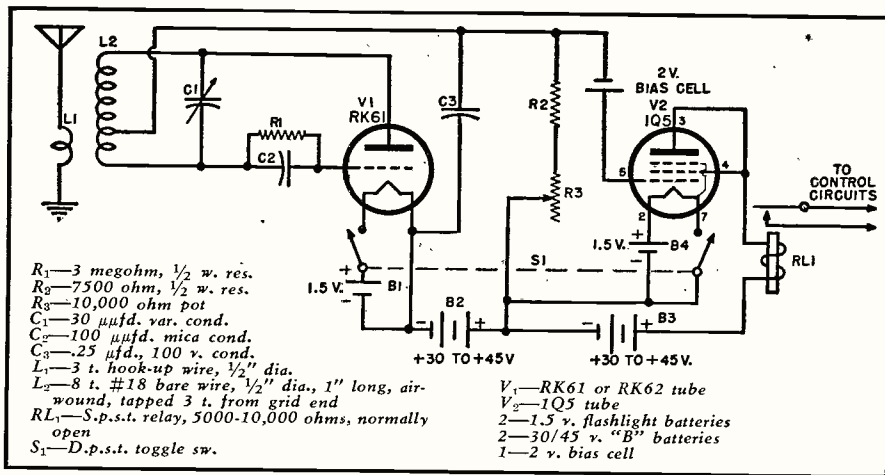

Fig. 8. Complete schematic of receiver. The unit is entirely battery operated.

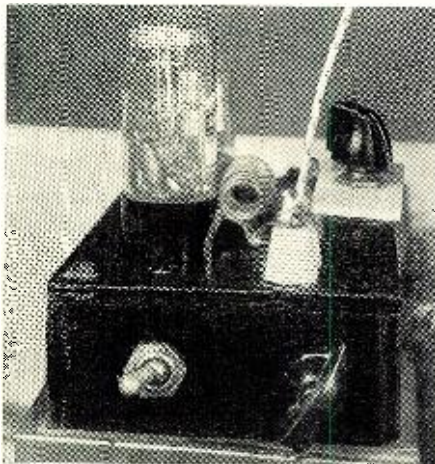
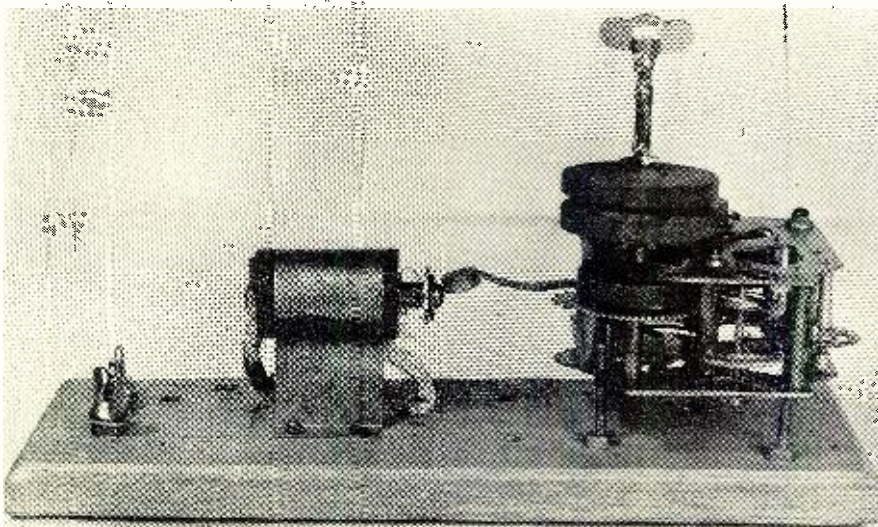

Fig. 9. Over-all view of receiver. Unit is mounted directly over the drive motor in the hull of the six-foot model craft.

base. Some experimenting with the firing pin spring tension was necessary to determine the proper tension for positive firing. The barrel of the gun is unscrewed to load the gun.

Fig. 10. Flag raising motor uses the alarm mechanism from an old alarm clock and is controlled by an electromagnet. Details for building your own electromagnet are shown in Fig. 3. When in non-operating position, electromagnet plunger keeps alarm clock clapper from vibrating. When plunger is actuated, the hammer vibrates and the spring drum rotates thus raising the flag on the radio-controlled boat model.



Since it was desired that the motor switch ( $S_2$ , Fig. 4) be independent of the other controls, in order that the boat could be in motion while other operations were taking place, a special type of relay switch was necessary. This is known as the impulse type switch and is obtainable on the war surplus market, but the author made up a very satisfactory substitute, the details of which are shown in Fig. 3. The switch consists of a soft steel bar, notched at one end to fit the ends of contact springs and pivoted at the opposite end between two electromagnets. In operation the steel bar is pulled against one magnet with a short impulse and remains in that position until another impulse pulls it in the opposite direction.

The flag raising motor (Fig. 10) is simplicity itself. Slow motion was desired for that operation so that the flag could be stopped when it had reached the top of the mast. A battery motor geared down to a few rpm would have served very satisfactorily for raising the flag, but lacking that,

the author found the alarm mechanism of a discarded alarm clock a very good substitute. The alarm winding shaft was extended and a grooved wood pulley was secured to the extended shaft. A loop of twine to which a small flag is attached extends from the wood pulley to a small brass pulley at the top of the mast. When the magnet adjacent to the alarm clapper is energized the flag rises slowly up the mast and may be stopped at any point by releasing the magnet plunger. One winding of the alarm spring is sufficient to raise the flag several times, and to reset the flag it is only necessary to pull the twine against the friction of the wood pulley to the desired position. The flag raising unit is mounted under the forward deck, with the wood pulley in a downward position. The flag motor release magnet is shown in Fig. 3 and can be seen in photograph, Fig. 10.

Since it was desired to use a stepping switch for selecting the desired operation, some means had to be provided to prevent undesired operations taking place while the stepping switch was making contact with the various controlled points. The delayed action relay shown in Figs. 3 and 7 is the final result of the author's experimenting and planning. The switch works on the dashpot principle and a wide range of time delay periods may be obtained by filling the oil chamber to various levels with 30 or 40 grade motor oil. Undoubtedly any of the various time delay switches available on the surplus market would have served satisfactorily, but in this particular boat project the author preferred to construct the necessary parts whenever it was possible to do so.

The wiring diagram for the control panel is shown in Fig. 4. With the exception of the sensitive relay ( $RL_1$ , Fig. 8), which is mounted adjacent to the receiver, and the motor reverse switch ( $RL_2$ , Fig. 4), which is mounted at the base of the drive motor, all relays and switches are mounted on a metal covered board 12" x 20", and tapered to fit the shape of the hull. All negative terminals of the relays and switches are connected to the metal covering. In the top view of the relay control panel, Fig. 7, two telegraph relays are shown, only one of which is being used at present. The author happened to have two such relays on hand, so both were installed with the idea in mind of giving the panel a balanced appearance, and also to provide an additional relay for future use. Most of the sensitive type relays available have a maximum carrying capacity of one ampere for their contacts, but for positive operation and to prevent any possibility of the contacts sticking it was found advisable to work such relays well under their maximum rating and provide an intermediate relay to break the heavier currents. One of the telegraph relays serves as the intermediate relay ( $RL_3$ , Fig. 4) and since it had to control both the stepping switch and the time delay

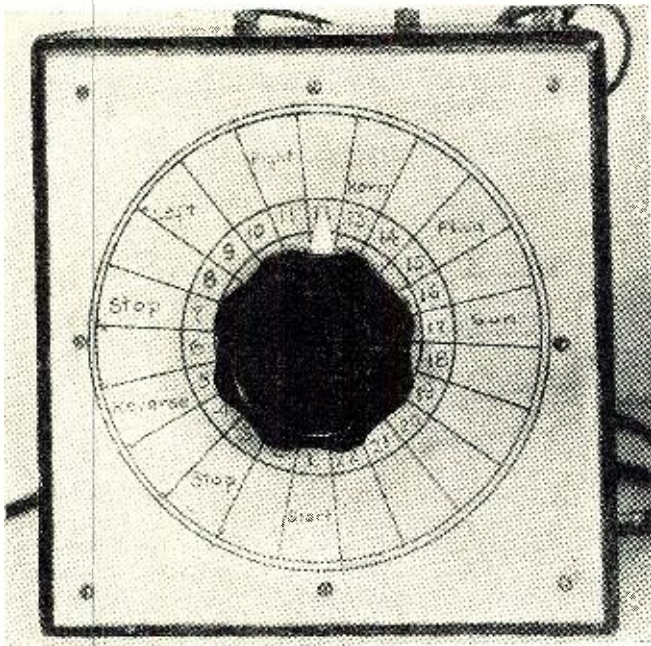

Fig. 11. Panel view of control switch. Numbers on the dial correspond to the numbers on the stepping switch mounted on boat. This control switch is a part of the transmitting equipment.

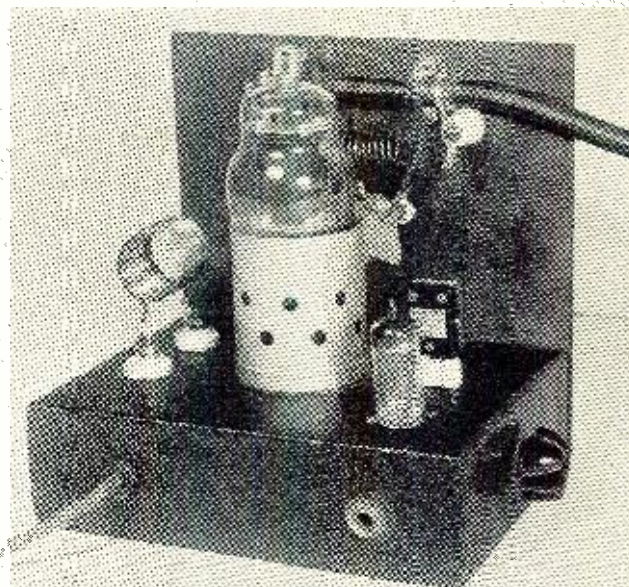

Fig. 12. Transmitter view showing cathode and final coils. The doubler tuning unit is mounted below chassis. This unit, control panel (left), and power pack comprise transmitting gear.

relay, the original contacts were replaced with round jeweler's silver contacts,  $\frac{3}{16}$ " diameter. The relays have a resistance of 20 ohms each. In between and directly back of the telegraph relays the motor control switch ( $S_2$ ) is mounted. This switch was described earlier. The stepping switch is located directly behind the motor switch and consists of a 22-point switch operated by a six-volt coil. While the stepping switch has many more contacts than are needed at present, it was obtained on the surplus market at a very moderate cost and most of the extra contacts will undoubtedly be used when additional mechanisms for operation are developed. The time delay relay ( $RL_4$ , Fig. 4), which has already been described, is located back of the stepping switch, and directly back of the time delay switch is the main relay. This relay controls the main current through the stepping switch, but since it is not energized until the time delay relay has closed, the stepping switch contacts are not required to break any current and the possibility of their pitting is avoided. The main relay ( $RL_5$ , Fig. 4) is a salvaged automobile battery charging relay. The rudder magnet control relays are located on each side of the main relay and consist of salvaged automobile horn relays. All wiring is done with No. 14 solid, rubber covered wire and securely stapled to the mounting board. Haywire connections have no place in an installation of this kind and too much time cannot be devoted to making the wiring and connections secure and tight.

The receiver uses the thyratron RK62, or the newer subminiature version RK61 tube, and consists of a superregenerative detector (Fig. 8) and a one-stage amplifier. The character-

istics of the RK61 or RK62 are such that when no signal is being received the plate current will be between 1 and 1.5 ma., which will drop to 0.5 or 0.1 with a signal. While it is possible to operate a sensitive relay with that much change in plate current, it means that the relay has to work in reverse so that it will operate the intermediate relay only when it is open, an arrangement that does not seem very satisfactory. By adding an amplifying tube to the circuit, the characteristics of the thyratron may be utilized to produce an enormous change in the plate current of the amplifier tube, thereby assuring positive action of the sensi-

tive relay under any conditions. The circuit of the receiver is shown in Fig. 8. Since the receiver was designed to work in the 50-54 mc. band, all connections were made as short as possible. The circuit requirements are such that separate filament and plate batteries are required for each tube, but since the plate current drain of the thyratron is on the order of 1 ma., a miniature "B" battery will serve very satisfactorily for the plate supply. The drain on the 1Q5GT may run up to five or six milliamperes, depending upon how close the transmitter is located, so a larger "B" battery would

(Continued on page 76)

Fig. 13. Schematic diagram of transmitter. Output frequency is 52.2 mc. Power supply requirements include a 6-volt storage battery and either a dynamotor or a vibrator whose output supplies 300 to 400 volts at from 100 to 125 milliamperes.

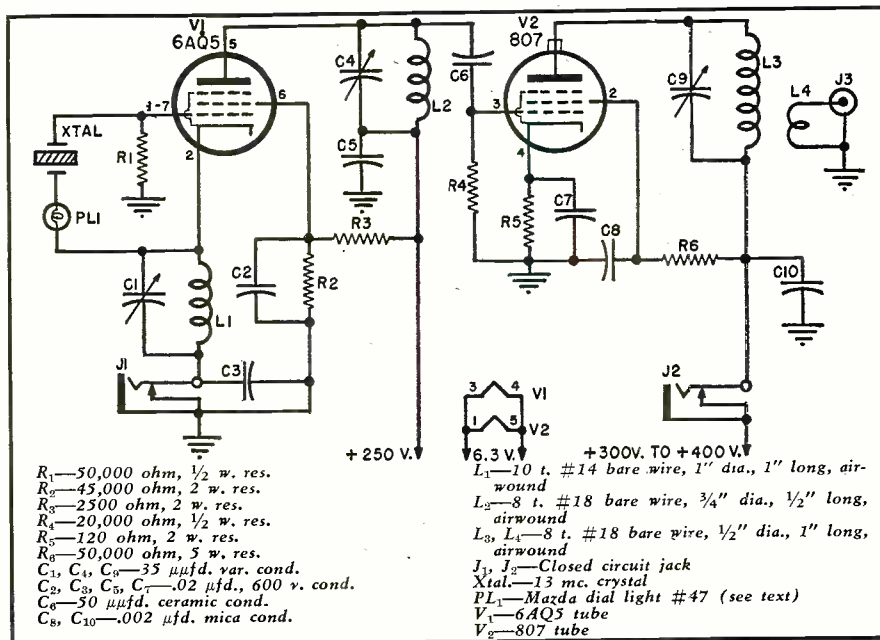
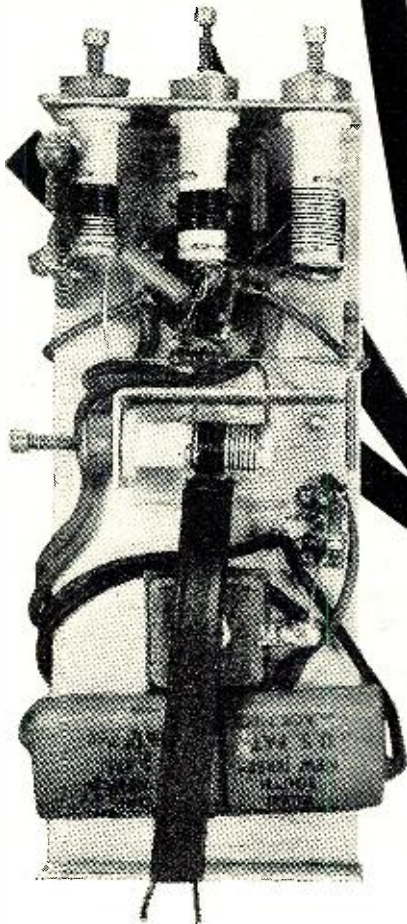

Fig. 1. Over-all view of the TV booster.



# A CASCADE TYPE ANTENNA-MOUNTED TV BOOSTER

*This booster, based on the "Wallman Cascade" circuit, features high gain, good signal-to-noise ratio, and a novel self-contained power supply.*

By  
**GILBERT VOYLES**

URING this season of the year "television-itis" seems to be a fairly common malady and all over the country viewers in fringe areas are dreaming of new and better ways of "souping up" their existing antenna equipment, improving their booster or boosters, sharpening up the i.f. stages, or adding new i.f. stages, etc.

Having developed an acute case of

the disease, the author decided to try to improve his existing antenna system. While there is nothing new about his final decision to install a high efficiency booster on the antenna, the way it was done and the results achieved might prove of interest to other readers of this magazine.

As most readers know, one of the big headaches in fringe area reception is signal-to-noise ratio. This noise or man-made interference can be caused by such diversified sources as the ignition systems of passing cars, electric motors which use brushes for feeding operating current to the rotor or armature, electrically-operated signs which depend on the make and break of supply current for operation, etc. All of these devices have one thing in common, namely the interfering signals which they emit generally have a vertically polarized characteristic. Thus, maximum pickup of this noise is effected when the TV receiving antenna is mounted with the elements in a vertical plane or at right angles to the earth.

Fortunately the author's antennas,

due to the horizontally polarized television signal characteristic, had to be mounted in a plane parallel to the ground to achieve maximum effectiveness. However, our feedlines are, in most cases, run in a vertical position and act as excellent receptors of this picture-destroying noise. This noise is carried into the set along with the desirable signal and is amplified along with that signal.

The problem, then, was to add a booster with high gain which didn't contribute too much noise within itself. The idea was to place the booster at the antenna where it could amplify the weak television signal before the noise picked up by the feedline was added. The answer to the problem proved to be a "Wallman cascade" circuit. This circuit was developed at M.I.T. during the war and features pentode gain with triode noise level.

This booster enables the user to turn the set gain down thus reducing the snow and, in some cases, eliminating it altogether. Most readers will probably have most or all of the parts needed to build this unit in the junk box but even if all of the parts must be purchased the cost will run only about seven dollars.

## Construction

Since it was deemed undesirable to run separate wires to the booster for filament and plate operating currents we ran our operating voltages up the same twin lead down which our television travels to the receiver. It is a simple way of handling the problem and works out surprisingly well.

The chassis is constructed of light gauge aluminum, in our case a transcription disc from which we had removed the acetate coating by soaking the disc in hot water for a few minutes. Chassis dimensions are 6½ x 2½ inches with a 1¼ inch long lip of ninety degrees bent up on either end.

Complete details for winding your own coils to cover any television channel.

	CHANNEL 2	CHANNELS 3, 4	CHANNELS 5, 6	CHANNELS 7, 8, 9	CHANNELS 10, 11, 12	CHANNEL 13
L <sub>1</sub>	8 t. wound over gnd. end L <sub>2</sub>	6 t. wound over gnd. end L <sub>2</sub>	6 t. interwound gnd. end L <sub>2</sub>	3 t. interwound gnd. end L <sub>2</sub>	2 t. interwound gnd. end L <sub>2</sub>	1 t. interwound gnd. end L <sub>2</sub>
L <sub>2</sub>	16 t. closewound	14 t. closewound	11 t. spacewound wire dia.	7 t. spacewound wire dia.	5 t. spacewound wire dia.	3 t. spacewound wire dia.
L <sub>3</sub>	18 t. closewound	17 t. closewound	15 t. closewound	8 t. closewound	6 t. closewound	4 t. closewound
L <sub>4</sub>	14 t. closewound	12 t. closewound	9 t. spacewound wire dia.	5 t. spacewound wire dia.	4 t. spacewound wire dia.	3 t. spacewound wire dia.
L <sub>5</sub>	15 t. closewound	13 t. closewound	10 t. spacewound wire dia.	6 t. spacewound wire dia.	4 t. spacewound wire dia.	3 t. spacewound wire dia.
L <sub>6</sub>	8 t. wound over gnd. end L <sub>5</sub>	6 t. wound over gnd. end L <sub>5</sub>	6 t. interwound gnd. end L <sub>5</sub>	3 t. interwound gnd. end L <sub>5</sub>	2 t. interwound gnd. end L <sub>5</sub>	1 t. interwound gnd. end L <sub>5</sub>

All coils wound on 3/8" dia. ceramic slug-tuned forms with No. 24 enamel wire.

A shield of the same material is mounted across the narrow dimension of the chassis 2 1/4 inches in from one end. The shield is 1 1/4 inches high by 1 3/4 inches long with a 3/4 inch lip bent lengthwise along the main chassis.

The dimensions for the tube socket mounting have not been included since they will vary with different types of sockets. The socket should, however, be mounted in the center of the compartment formed by the shield and the chassis end lip. Three holes for mounting the ceramic type slug-tuned coils are drilled in the lip located at the socket end of the main chassis. The size of these holes will vary with the different sized coils. The forms used in this unit were purchased on the surplus market but are available from almost any well-stocked parts store. It is best to mount the coils in the order indicated on the diagram so as to avoid interstage oscillation. With the layout shown, no trouble was experienced along this line.

The selenium rectifier is mounted on the same side of the chassis as the shield and is located in the center of the chassis, approximately two inches from the end. A long mounting screw which runs through the center of the rectifier is employed and the filter condenser,  $C_5$ ,  $C_6$ , is mounted under the nut by means of the metal strap which is a part of the condenser. The power transformer, which is a small filament transformer hooked up in reverse, is mounted on the opposite side of the chassis from the rectifier by means of two machine screws run through the mounting straps. Two tie posts of two terminals are required. One is mounted near the rectifier for supporting  $R_6$ . All leads from  $C_5$ ,  $C_6$  are run directly to this same tie post. The other tie point is mounted near the tube socket and supports  $C_3$  and  $C_4$ . A two-terminal block is mounted on the top of the chassis at the end nearest the tube socket. The r.f. chokes,  $RFC_1$  and  $RFC_2$ , are mounted on the underside of the chassis on either side of the tube socket and near the edge of and parallel to the chassis edge. The chokes are supported by their own leads, which are of stiff hookup wire, fed through small holes drilled in either end of the 1/4 inch diameter poly rod on which the chokes are wound. The coils are all wound in the same direction with #24 enamel wire. These coils are tunable to either Channel 5 or Channel 6 but can be made to work on other channels by changing the number of turns. Coils  $L_1$  and  $L_6$  are interwound at the ground ends of  $L_2$  and  $L_5$  respectively. After completing the wiring of the unit it may be mounted in any weatherproof box. A quart-size tomato juice can makes an ideal housing for this booster. We were fortunate in being able to obtain several aluminum cans at surplus which were originally used as gasoline pressure lantern housings. They are especially suitable since the two parts telescope and lock by a twist of the wrist, thus making a good weather-

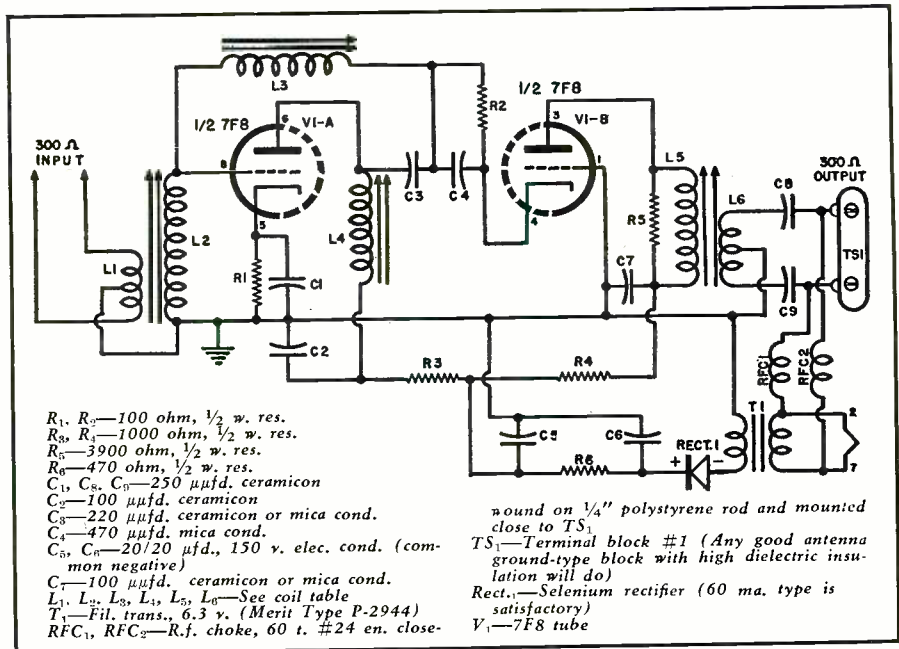

Fig. 2. Diagram of TV booster. It can be used with any 300 ohm antenna.

tight job. The leads from  $L_1$  are brought up to two feedthrough insulators spaced about 1/2 inch apart. The leads from these insulators will vary in length with different installations but will probably be from six inches to one foot in length. The length is not critical but should be kept as short as possible. The twin lead from the receiver or booster is brought up through a rubber grommet fitted in an oblong hole located in the press-in lid of the housing.

Now that the booster is completed and ready for final adjustment, let's turn to the unit which is to be used at the television receiver. The purpose of this little unit, which can be constructed of sheet poly or bakelite, is to let the six volts a.c. supply voltage through the feedline without permitting a loss of TV signal through the filament circuit. At the same time, the unit blocks the same 60 cycle current from the TV set or booster input circuit. The unit consists merely of a 2 x 3 inch strip on which is mounted the three double terminal posts. The unit may be mounted on the rear of the television receiver.

(Continued on page 90)

Fig. 4. Internal view shows how chassis assembly slips in. Two bolts hold lid tight.

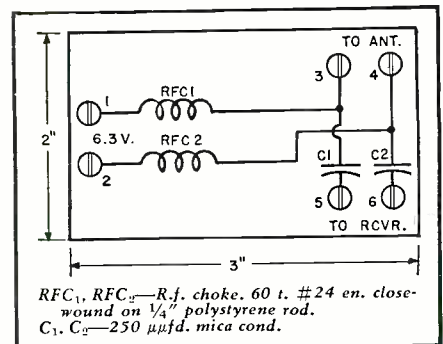
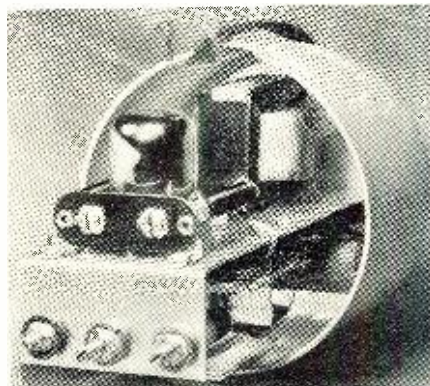
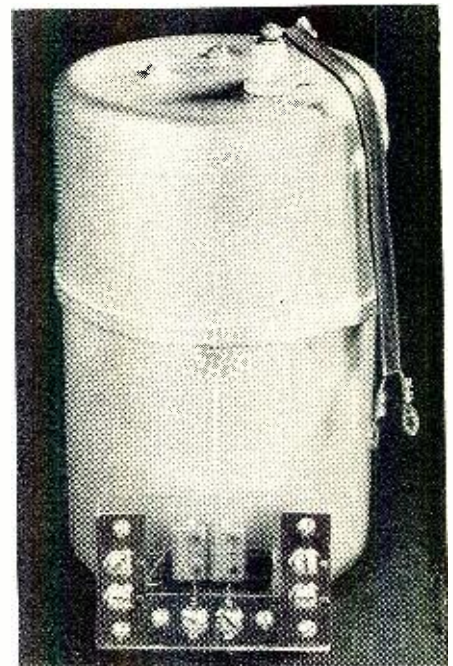

Fig. 3. Filter unit mounted at TV receiver. Completed assembly is shown in foreground of photo, Fig. 5. The 6.3 volts can be taken directly from power supply of the set.

Fig. 5. Over-all view of TV booster. The can assembly mounts to antenna mast and terminal strip in foreground mounts at receiver.



By  
**ROBERT F. LEWIS, W3MQU**

# A Compact 40 Watt Rig For CAR or FIELD

Over-all view of compact mobile rig which will operate in 75, 20, or 10 meter ham bands.



**A straightforward ham transmitter designed for mobile, field, or emergency contacts.**

AFTER the usual false starts, Summer has finally arrived. With it has come the wide diversity of outdoor activities which hams enjoy. It may be a long vacation trip or just an afternoon outing. Maybe it's a field-day operation or a simulated emergency test. On the serious side, there may be genuine disaster operation. One thing is certain, the well-dressed ham's outfit, this season, is not complete without some kind of portable radio equipment which can be operated independent of commercial power sources.

The transmitter described herein was designed originally for mobile operation, in conjunction with the "Com-

pact 3-Band Mobile Converter" described in the March, 1951, issue of RADIO & TELEVISION NEWS. As work progressed, however, it became apparent to the writer that the little rig could serve equally well outside of the car for field and emergency work. Most mobile transmitters are not easily adaptable to portable work due to the multiplicity of units and the complexity of control systems. The majority of portable rigs are even more difficult to adapt to the car.

The circuit of the transmitter will be immediately recognized, as it is not at all new. By careful planning of mechanical layout, choice of parts, and elimination of unnecessary frills, it

was not difficult to construct a one-unit transmitter of small size which would operate at 40 watts' input. A 6V6 crystal oscillator is followed by an 807 as a final amplifier. A 6J5 grounded-grid speech amplifier was incorporated in the audio section, followed by a pair of 6L6G's as modulators. The speech amplifier is designed to operate with a single-button microphone in series with the 6J5 cathode, the cathode current also serving as button current. By virtue of  $L_1$  and  $C_1$ , the oscillator stage becomes a triode circuit on 10 and 20 meters, with 20-meter crystals being used on both bands. On lower frequencies, however, the 6V6 cathode circuit becomes ineffective and the stage operates as a straight tetrode oscillator. Parallel plate feed is used on the 807 in order to remove the d.c. voltage from the tank circuit, thus permitting smaller plate spacing and grounding of  $C_{12}$ . Metering jacks are provided only for measurement of final amplifier grid and plate current.

Three relays are incorporated in the transmitter. Relay  $RL_1$  supplies heater current plus operating voltage for the other two relays. The filament relay is energized through a remote control lead from the driver's position when the transmitter is used in a car. It can be actuated in the same way when operating in the field or it may be closed manually by slipping a piece of cardboard between the armature and the upper contact. Relays  $RL_1$  and  $RL_2$  are actuated by means of a push-to-talk switch on the microphone. The former is a solenoid-type relay designed to carry heavy current for dynamotor starting and is similar to the

Under chassis view of the 40-watt mobile rig for operation on 75, 20, or 10 meters.

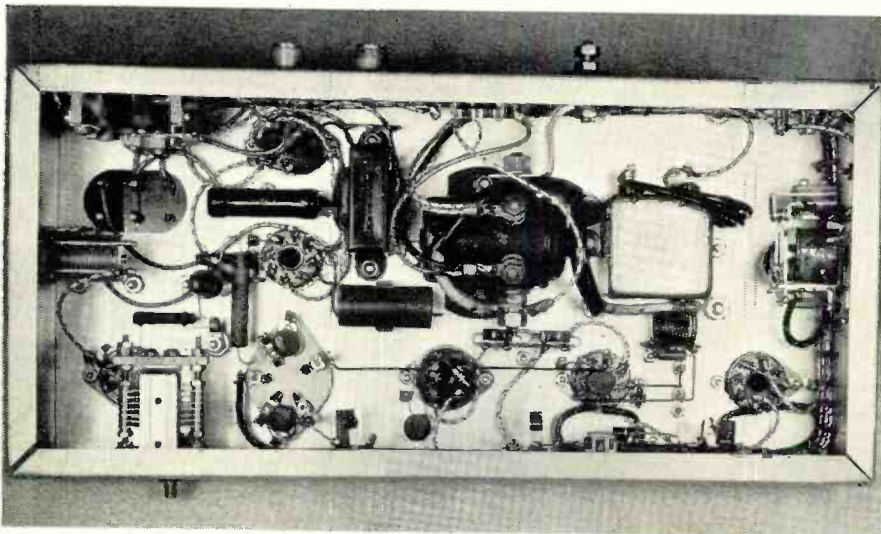



starting relay used in most late-model cars. Relay *RL<sub>1</sub>* performs two functions one, that of antenna changeover. The second function, that of a plate voltage switch, was born of necessity. It was discovered from previous experience that dynamotor-powered rigs often exhibit a "hangover" due to the inertia of the generator, making it difficult to work fast break-in.

Any single-button microphone having a push-to-talk switch can be used with the transmitter. The one used with the original rig is a T17B. Here is a suggestion for improving the gain and fidelity of the T17 microphone: Drill a single hole about three quarters of an inch in diameter in the front in place of the three small holes previously used. It is advisable to put a small piece of screen and microphone cloth behind the hole to protect the button. To permit operation outside the car, the transmitter is provided with an additional PL63 microphone jack in parallel with the remote microphone connections. This is also handy during the tuning-up process, as it is possible to operate the rig from either the driver's position or from the rear of the car, in case the unit is trunk-mounted.

Having covered the electrical aspects pretty thoroughly, we now turn to the mechanical description of the rig. The entire transmitter is constructed on an aluminum chassis 15 inches long, 7 inches wide, and 3 inches high. Most components can be recognized from the photos. Referring to the top view, from left to right, are: the 6J5 speech amplifier, crystal, 6V6 oscillator, oscillator tank coil, 807 grid amplifier, and final amplifier tank coil. At the back of the chassis are the dynamotor, 6L6 modulators, and modulation transformer. On the front drop of the chassis are the microphone jack, 807 grid current jack, 807 plate current jack, and final tank tuning condenser, *C<sub>12</sub>*. The oscillator plate tuning condenser, *C<sub>5</sub>*, is mounted inside the oscillator tank coil, *L<sub>2</sub>*, and is adjusted with a screwdriver. It should be tuned to the high frequency side of resonance, and, once set, it will not normally have to be readjusted. Of course a separate oscillator padder is used for each band. Capacities are given in the parts list.

The bottom view shows all parts on the underside of the chassis. Filament relay, *RL<sub>3</sub>*, is at the right end. Dynamotor starting relay, *RL<sub>2</sub>*, is in the center, and at the upper left is the antenna changeover relay, *RL<sub>1</sub>*. The small air condenser at the left end of the chassis, *C<sub>13</sub>*, serves to tune out reactance in the transmission line on the 10-meter band. One corner of the end rotor plate is bent slightly so that it shorts out the condenser when operating on other bands. The small transformer next to the 6L6 sockets is the interstage transformer, *T<sub>1</sub>*. Most of the other components are mounted close to their associated circuits and can be easily identified.

(Continued on page 68)

Complete schematic diagram of the compact 40-watt rig for car or field. A 6-volt car battery supplies "A" voltage while a dynamotor is used to supply "B" voltage.

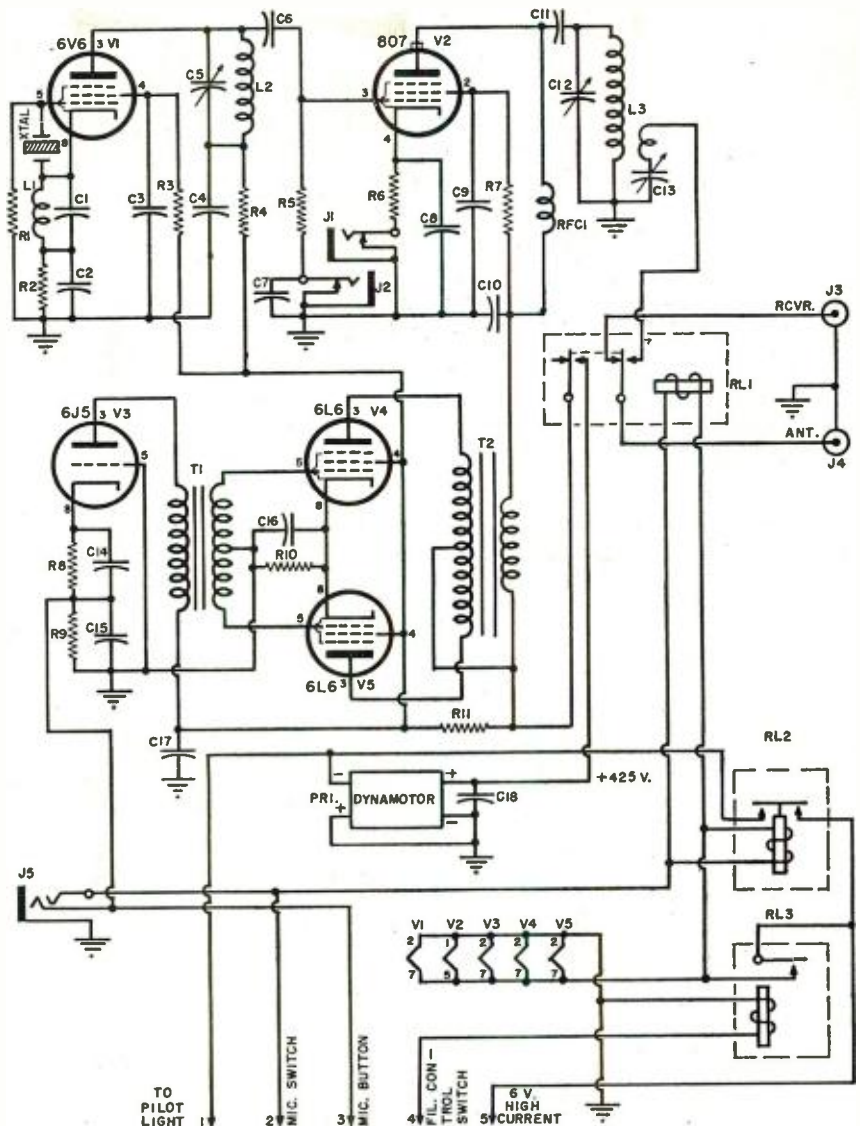

- R<sub>1</sub>*—50,000 ohm, 1/2 w. res.
- R<sub>2</sub>*—*R<sub>1</sub>*—220 ohm, 1/2 w. res.
- R<sub>3</sub>*—5000 ohm, 1/2 w. res.
- R<sub>4</sub>*—33,000 ohm, 1 w. res.
- R<sub>5</sub>*—220 ohm, 2 w. res.
- R<sub>6</sub>*—10,000 ohm, 2 w. res.
- R<sub>7</sub>*—470 ohm, 1/2 w. res.
- R<sub>8</sub>*—10,000 ohm, 1/2 w. res.
- R<sub>9</sub>*—250 ohm, 2 w. res.
- R<sub>10</sub>*—3000 ohm, 20 w. wirewound res.
- R<sub>11</sub>*—250 ohm, 2 w. res.
- C<sub>1</sub>*—30 μfd. ceramic cond.
- C<sub>2</sub>*—*C<sub>3</sub>*—01 μfd. ceramic cond.
- C<sub>3</sub>*, *C<sub>4</sub>*, *C<sub>7</sub>*, *C<sub>9</sub>*, *C<sub>11</sub>*, *C<sub>15</sub>*—002 μfd. ceramic cond.
- C<sub>5</sub>*—Air trimmers (APC—see coil data below for values)
- C<sub>6</sub>*—50 μfd. ceramic cond.
- C<sub>10</sub>*—002 μfd., 1000 v. cond.
- C<sub>12</sub>*—75 μfd. var. cond. (National ST75)
- C<sub>13</sub>*—100 μfd. air trimmer (APC)
- C<sub>14</sub>*, *C<sub>16</sub>*—25 μfd., 25 v. elec. cond.
- C<sub>17</sub>*—8 μfd., 450 v. elec. cond.
- C<sub>18</sub>*—2 μfd., 600 v. oil-filled cond.
- RL<sub>1</sub>*—Ant. changeover relay, 6 v. d.c. coil, d.p.d.t. contacts, r.f. insulation.
- RL<sub>2</sub>*—Dynamotor starting relay, 6 v. d.c. coil, solenoid type, 100 amp. contacts
- RL<sub>3</sub>*—Filament relay, 6 v. d.c. coil, s.p.s.t. contacts to carry at least 5 amps.
- Dyn.—Dynamotor, 6 v. d.c. input, 425 v. @ 200 ma. output
- RFC<sub>1</sub>—2.5 mh., 125 ma. r.f. choke (National R100U)
- J<sub>1</sub>*—Closed circuit jack (final amplifier plate current)
- J<sub>2</sub>*, *J<sub>3</sub>*—Open circuit jack
- J<sub>4</sub>*—Closed circuit jack (final amplifier grid current)
- J<sub>5</sub>*—PL 63 mike jack
- T<sub>1</sub>*—Interstage trans., single plate to push-pull grids, 3:1 ratio

- T<sub>2</sub>*—Mod. trans., push-pull 6L6's class AB<sub>1</sub> (4000 ohm load), 20 w.
- Xtal—75 m. for 75 meter operation. 20 m. for 10 & 20 meter operation
- V<sub>1</sub>*—6V6 tube
- V<sub>2</sub>*—807 tube
- V<sub>3</sub>*—6J5 tube
- V<sub>4</sub>*, *V<sub>5</sub>*—6L6 tube
- Coils
- L<sub>1</sub>*—Osc. cathode coil. 15 t. #16 en., 1/2" dia., 3/4" long
- L<sub>2</sub>*—75 m. #3/4" of #22 en. wire. *C<sub>5</sub>* is 50 μfd. 20 m. #10 t. #22 en., 3/4" long. *C<sub>5</sub>* is 25 μfd. 10 m. #10 t. #18 en. 1/2" long, 1/2" dia. *C<sub>5</sub>* is 25 μfd. \*Coils for the 75 and 20 meter bands are wound on 1 1/2" plug-in type coil forms. The coil for the 10 m. band is slipped inside a 1 1/2" coil form. Condensers *C<sub>5</sub>* are APC type air trimmers, mounted inside coil forms.
- L<sub>3</sub>*—75 w. plug-in coil for band used, end link (Bud or B & W 5-prong base)
- Terminal Connections
- 1.—To pilot light indicator when used in remote position indicates when high voltage is on
- 2.—To remote mike push-to-talk sw.
- 3.—To remote mike button
- 4.—To remote filament control sw. Other side of sw. goes to 6 volt source
- 5.—To 6 volt storage battery. Use very heavy lead
- J<sub>5</sub>*—To receiver antenna input
- J<sub>1</sub>*—To antenna. Low impedance line
- Relays in diagram are shown in "off" position
- Polarities shown on dynamotor are correct for automobiles having grounded positive. In cars having grounded negative, reverse primary leads

# Mac's RADIO SERVICE SHOP

By JOHN T. FRYE

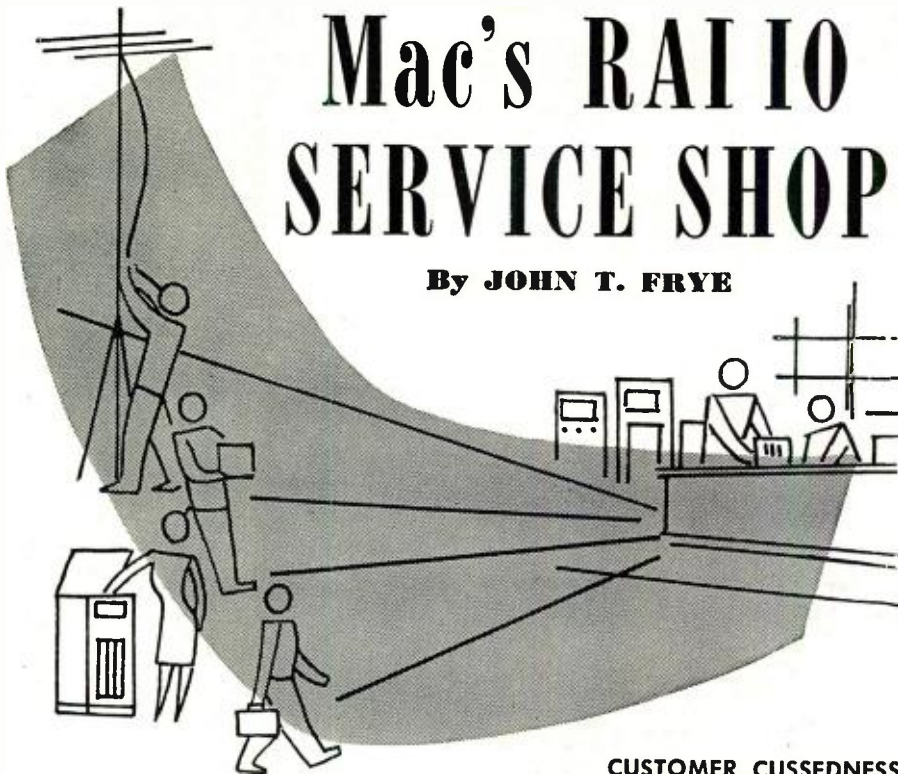

## CUSTOMER CUSSEDNESS

AS BARNEY entered the door of the service shop after his lunch hour, a customer was just leaving.

"There can't be much the matter with the set," he was telling Miss Perkins. "It was playing all right last night, but when we turned it on this morning it made a frying noise and began to smoke. I'm sure it's just a tube."

Miss Perkins only forced a strained, noncommittal little smile as she continued to make out the service tag; but after the door closed behind the customer, Barney exploded:

"Why is it that four out of five customers seem to feel they gotta make that stupid remark?" he wondered. "I'm sure it's just a tube," they say, with no more reasons for thinking so than I have for believing the moon is made of green cheese."

"That's just an illustration of what is known as 'customer cussedness,'" Mac drawled as he strolled out of the service department and perched on a corner of Miss Perkin's desk. "There are lots of other examples you meet up with in this business."

"You can say that again!" Barney said in quick agreement. "One of my chief gripes is the Something-For-Nothing guy who says as he brings in his set: 'This is just an old clunker that we keep in the basement and use only four or five times a year; so I don't want to put any money into it. Just patch it up so the little woman can listen to Arthur Godfrey over the local station while she is doing the washing.'

"You follow these instructions to the letter, and then a day or so later he calls up and complains because the clunker will not pull in a 250 watt

station a couple of hundred miles away on which his wife's brother's little niece is going to recite a four-line poem."

Mac chuckled at this all-too-true characterization and then said, "Well, I can match him with The Man With The Catalogue. This fellow has got hold of a wholesale radio parts catalogue—usually one, two, or three years old with out-of-date prices to match—and he questions every parts charge on his bill, slyly letting you know that he is on to your little game of charging list prices for parts. He seems to think your cost of maintaining an inventory should be charged off to good clean fun."

Barney and Matilda exchanged looks of surprise. It was most unusual to hear Mac speak critically of anyone. But finally, after a little hesitation, Miss Perkins contributed:

"I believe the I-Can't-Wait-er annoys me more than anyone else. He gives me a pitiful story about how the radio belongs to his poor old shut-in aunt who just lives for her daily radio program. Touched by this tale, I prod you boys into getting the radio out in a great big rush—and then Mr. I-Can't-Wait doesn't pick it up for a solid month."

"He's no worse than the Perfectionist," Barney broke in. "This sport insists that you adjust the test-pattern circle until it matches precisely the rim of a dinner plate he holds against the screen. You can explain until you are black in the face that perfect linearity is practically impossible to achieve in a receiver, especially since the transmitted signal itself is seldom perfect in this respect, but he will not listen. The advertising copy has led him to believe he has an absolutely

perfect receiver, and he expects you to make good in fact what the copy writer has implied in print."

"How about Old Diehard?" Mac asked. "You know the fellow who has a four-tube punchboard set he won while in college and that should have been discarded long before his first child was born; but, contrary to your advice, he keeps on having it repaired time after time on the premise that 'they don't build 'em like that any more.' However, he never fails to make sarcastic comparisons between the original cost of the receiver and the size of your bills."

"A person I could learn to loathe," Miss Perkins offered, "is the I-Think-You-Ought-To-Know character who thinks you ought to know that the receiver you repaired for him over a year ago only lasted a couple of days but he has been so busy that he never had time to bring it back until now. The funny thing is, though, this busy bee now finds time to drop in a couple of times every day to see if the receiver is ready yet."

"The Big Operator always gives me a laugh," Mac said with a reminiscent grin. "He informs you very importantly that he has made careful inquiry before deciding that you are the one man in town with whom he can intrust his precious receiver. Then he leads you to this jewel, and you find that it is a beat-up old 1940 console that has obviously been in more service shops than a parts salesman."

"The-Trouble-I've-Known chap is another fairly common type," Miss Perkins suggested, really getting into the spirit of the brickbat tossing. "Right along with his radio he delivers a lengthy and heart-rending recital of the way he has been taken by other technicians, explaining in great detail how they scratched his cabinet, stole his tubes, fouled up the wiring, and then over-charged him. All the time I am listening, I know that the name of Mac's Radio Service Shop is going to be added to that list, no matter how expertly you boys repair the set nor how reasonable are the charges. Complaining is a career with his kind."

"A form of low-life I have been running into lately might be called The Tinker—and it makes no difference how you pronounce it," Barney said bitterly. "His sort always has been with us, but it is reaching its full flower now that TV sets, with their many critical adjustments, are becoming common. He goes into his set and screws every trimmer and moves every adjusting screw he can find until finally he has things so fouled up that the set will not operate at all. Then he calls in the technician and tells him, without batting an eye: 'The set just suddenly stopped playing. It probably needs a little adjusting.' Only a lie-detector test would make him admit that he ever had the back off; but sometimes a fed-up wife will spill the beans on her screwdriver-happy husband."

(Continued on page 127)

# TV CONSOLETTA INCORPORATES COMPACT AM TUNER

**Raytheon's new miniaturized AM tuner permits combination phono-radio-TV to be built into a consolette cabinet.**



A UNIQUE new feature has been incorporated in Raytheon's Model RC-1720 "The Starlight" which permits the units of a combination receiver to be presented in a consolette type cabinet.

The Model RC-1720 is a television-radio-phonograph combination receiver and features a 17 inch rectangular black picture tube, a three-speed phonograph which will play any size or speed records, and an AM radio covering the standard broadcast range of 540 to 1600 kilocycles.

The unique feature is an AM tuner which is combined with the television chassis as a separate sub-chassis. The AM tuner sub-chassis is located between the television tuner and the front flange of the chassis. Since the television tuner is of the continuous type, the AM tuner is coupled to its tuning shaft by dial cord. Rotation of the tuning shaft tunes both the AM and TV tuners.

A selector switch is provided on the

By  
**KEN KLEIDON**  
Belmont Radio Corp.

Raytheon's Model RC-1720 combination 17" set.

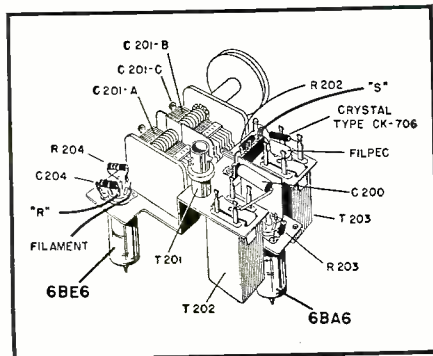

Assembly details of AM tuner sub-chassis.

front of the receiver to select the desired unit of the receiver for operation, either television, radio, or phonograph. The switch connects the audio signal points from each unit to the vol-

ume control and switches the "B + " voltage to the AM tuner and a portion of the television circuit. Switching the "B + " voltage to a portion of the television circuit disables the fourth i.f. amplifier, horizontal deflection, and high voltage which renders the picture tube inoperative and prevents interference when using either the radio or phonograph. The filament leads to either the television or AM tuner are not switched to enable immediate operation. A warm-up or waiting period is not required when switching from one unit of the receiver to another.

The AM tuner sub-chassis utilizes 6BE6 and 6BA6 tubes as a conventional converter and i.f. amplifier and a germanium crystal (Raytheon CK-706) as the detector. The AM tuner consists of the two tubes and crystal  
(Continued on page 100)

Schematic diagram of the two-tube AM receiver. A three-position switch on TV set selects either TV, radio, or phono operation.

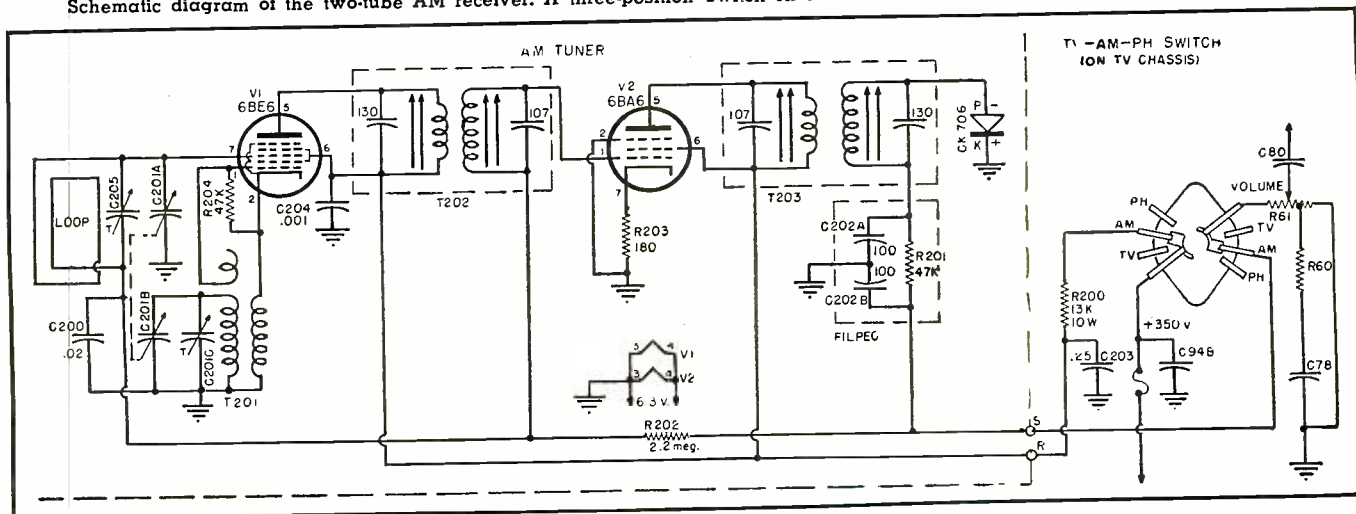

By  
**H. M. TREMAINE, D.Sc.**  
 College of Audio Engineering  
 University of Hollywood

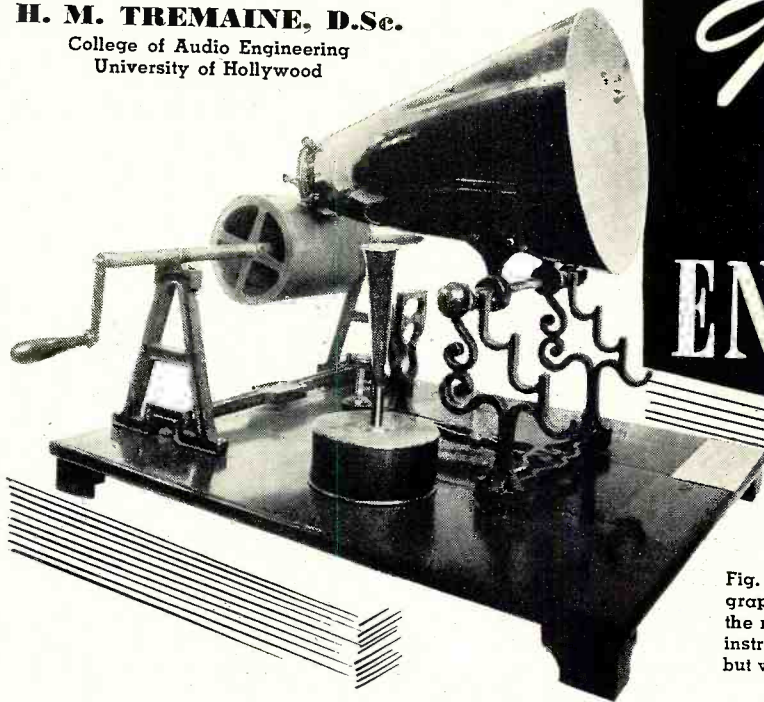

# Practical SOUND ENGINEERING

Fig. 1. Leon Scott's "Phonautograph," an early forerunner of the modern phonograph. This instrument could record sound but was unable to reproduce it.

## Part 5. A brief history of early experiments in reproducing sound as compared with modern systems.

IN THE YEAR 1857 Leon Scott invented the "Phonautograph," shown in Fig. 1, the ancestor of the modern phonograph. Although this device would record sound, it could not reproduce it. The sound waves were impressed upon a diaphragm which was attached to and actuated a hog bristle, which was in contact with a cylinder coated with lamp black. By revolving the cylinder and moving it laterally during the recording, a helix of the impressed sound wave was traced.

In 1877 Thomas A. Edison invented the first machine that would actually record and reproduce sound, Fig. 2. The sound waves were picked up by a small horn and concentrated on a dia-

phragm to which was attached a sharp stylus. The movement of the diaphragm caused the stylus to trace a path on a revolving tinfoil cylinder. The recorded sounds were reproduced by the sound track actuating the stylus, which in turn moved the diaphragm. The motion of the diaphragm caused by the stylus following the tracing in the tinfoil disturbed the air column in the horn and thus reproduced the sound waves impressed on the cylinder. Naturally, such a system as this was limited in its frequency range and intelligibility, and the quality of reproduction was so poor it was not considered to have any great commercial value.

The art of recording was given im-

petus by the development of the wax record and gouge-shaped stylus by Bell and Tainter, as the quality of the reproduction was considerably improved. This aroused the interest of many minds and the art began to move forward at a more rapid pace. At first each record was a master, since no way of duplicating had been developed. However, a machine was later devised which duplicated the master mechanically and made possible large scale production.

The next development came when Berliner and Johnson introduced the circular flat disc record, which is in use today. A model exhibited by them at the Franklin Institute in 1888 is shown in Fig. 5.

The cylindrical record of Edison indented the sound track in the tinfoil in a vertical manner, which is known today as "hill and dale" recording. The records cut on the Berliner-Johnson machine cut the sound track in a lateral manner across the flat disc. This is known as "lateral recording."

Early attempts to record sound photographically date back to 1878 when Professor G. E. Blake of Brown University described a method whereby a mirror actuated by a microphone moved a beam of light over a photographic plate. In 1886 Bell and Tainter patented a system for both variable density and variable area, using a light beam in conjunction with a slit aperture. Many different investigators continued to work on the recording of sound photographically until 1911, when Theodore Case and Lee De Forest began their work which was to be the forerunner of the present day sound motion picture.

Magnetic recording of sound was an early invention of Vlademar Poulsen

Fig. 2. Experimental apparatus for illustrating the principle of Edison's speaking phonograph, Patent No. 154, Feb. 19, 1878. Made by S. Bergman & Co., New York City.

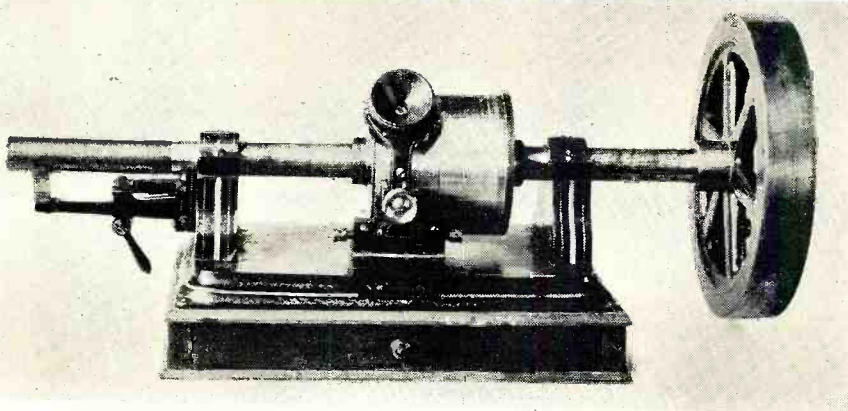

in the year 1898. Many experimenters both in the United States and abroad worked to perfect a magnetic recording system using either wire or tape. However, it was not until 1939 that any special attempt was made to develop a commercial machine. World War II speeded up its development, as magnetic recording offered a rather inexpensive and simple system of recording for the Armed Forces. Magnetic recording has now been developed to a point where it has taken its place with the best of recording systems.

All recording systems, irrespective of type, require some sort of a mechanical constant speed drive for moving the recording medium. For disc recording, either gears, rubber pucks, or belts are employed. Magnetic recorders are more complicated in their transport systems. Generally, three motors are required; one for pulling the tape, a second to drive the take-up reel, and a third acting as a holdback on the supply reel and high speed rewind. Film recorders are somewhat less complicated, but also require a steady pull on the film and a constant speed past the light valve or recording galvanometer. Included with these mechanical systems are starting relays, distributor systems, flywheels, motor control circuits, and many other devices. It will be noted that Edison, in his original model, employed a heavy flywheel on one end of the drive shaft in an attempt to obtain a more constant speed.

The early commercial wax record phonograph, which Edison produced for home use, employed a spring-driven motor and a fly-ball governor to regulate the speed. The metal cylinder holding the record was belt-driven by the spring motor and a lead screw fed the reproducer head in a lateral direction across the surface of the record. It is surprising how steady the speed of these early machines was. Generally, the speed was made adjustable, so the user could alter it to suit his personal desires.

Flutter or speed variations in the early phonograph did not attract too much attention, as the quality of the recording was not always good and the machine was still a novelty. However, as the phonograph became more common and its quality of reproduction improved, more thought was given to the driving mechanism.

The term "flutter," defined, relates to the irregular motion in recording and reproducing equipment. Such variations, when of low frequency character, are often referred to as "wows." This is the usual once-around heard from the average record reproducing turntable.

The flutter rate is the frequency at which the signal deviates from its true frequency. Flutter is expressed in percentage and is the ratio of the root-mean-square deviation in frequency to the average frequency in percentage.

When the first "Orthophonic" phonograph was marketed by the *Victor Talking Machine Company* in the early

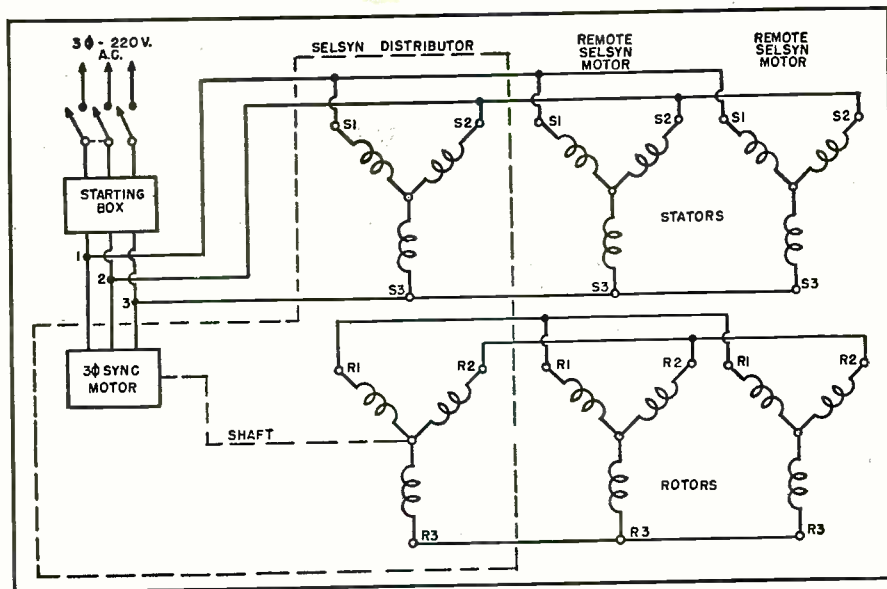

Fig. 3. Electrical wiring details of a 220-volt, 3-phase selsyn distribution system.

twenties, although still a mechanical reproducer system, its frequency range had been extended considerably over that of the previous models and its quality of reproduction was greatly improved. This new design demanded a better drive system, and with it came the general use of the electric motor.

The first electric motors employed a fly-ball governor to control the speed. A fly-ball governor is designed to introduce mechanical friction if the speed exceeds a predetermined amount. As this is an economical and practical method of controlling the speed, it is still used with spring- and electrically-driven machines.

Among the many methods devised for driving and securing a constant speed was the weight driven disc recorder. This machine was mounted on a stand elevated about 6 feet above the floor. The weights were wound up by a windlass, and the device operated much like a weight driven clock. A governor with a small fan attached to provide damping was also included. This machine ran at 78 rpm. and was limited to the recording of 10 and 12 inch records.

Several drive systems have been developed employing springs in one form or another to keep the vibration of the driving source from being transmitted

to the recording mechanism. Elaborate systems of flywheels and other type filters were used by the early experimenters because of the lack of suitable governors and gears. A modern disc recorder designed for recording both microgroove and standard disc records is shown in Fig. 4. The motor is connected to the gear box through a flexible coupling consisting of adhesive tape similar to that used for surgical work. The gear box is designed for three speeds. The lines per inch of recording can be varied.

As the speed of rotation is decreased, the problem of securing a constant speed is multiplied many fold. This was one of the major obstacles that confronted the development engineer in the early days of the sound motion picture. Before the general acceptance of the sound-on-film system of recording and reproduction, 16 inch disc records were used in the theater. These records were placed on a turntable which was driven by the projector in sync with the picture at 33 $\frac{1}{3}$  rpm.

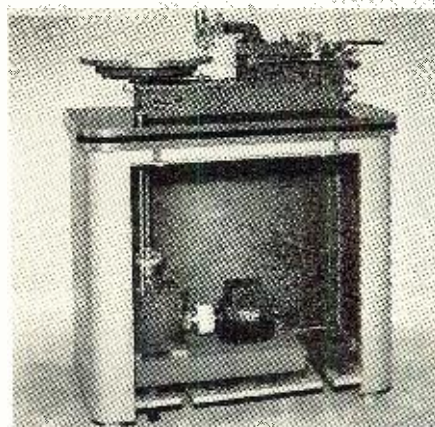

Fig. 5. The "Berliner Gramophone." This instrument was first displayed to the public by the Franklin Institute in 1888.

Fig. 4. A modern disc recorder unit which is designed to handle both microgroove and standard discs. Arcturus makes this unit.

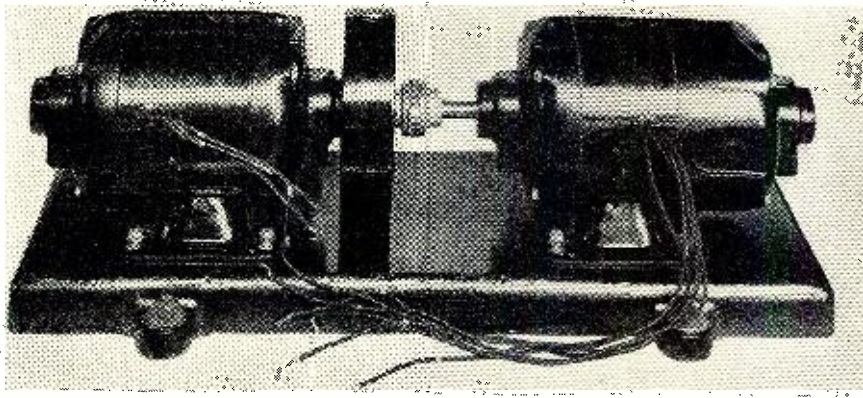

Fig. 6. A 220-v., 3-phase selsyn distributor set. Unit is used to obtain synchronization between cameras and recording equipment used in movie production.

It has been generally agreed that for disc recording the speed of rotation must be maintained within plus or minus 0.30 per-cent, and that the instantaneous peak deviation from the mean speed shall not exceed plus or minus 0.10 per-cent of the mean speed. For magnetic tape recording the instantaneous peak flutter shall not exceed 0.20 per-cent (peak-to-peak 0.40 per-cent) when recording and reproducing on the same equipment. Flutter in film recorders is held to less than 0.10 per-cent, and theater projection equipment to 0.25 per-cent maximum.

In the production of motion pictures, synchronization is of prime importance. To achieve this objective it is necessary that the cameras and recording equipment in the studios operate in complete synchronization, although they may be separated on the lot some distance physically. The most commonly used method for obtaining synchronization between a large number of units is the "selsyn distributor" (self-synchronizing), electrically connected to a selsyn motor at each device to be driven in sync, Fig. 6. This is often referred to as an interlock system. A diagram of the electrical connections of such a system is shown in Fig. 3.

At the left (in dotted lines) is the distributor, consisting of a 220 volt, three-phase 50 or 60 cycle synchronous motor and synchronous generator, mechanically connected by a flexible coupling. A heavy flywheel is mounted

on the motor shaft. The generator unit is always the largest in the chain, as it is the characteristic of such a system that the largest unit becomes the control unit and the smaller units the slaves.

The generator unit has two separate windings, star connected. The outside winding is called the stator and is connected to the three-phase power supply. This voltage is also carried to the stators of all units in the system. The inner winding of the distributor is called the rotor and has no direct connection to the power source, but is connected to all the rotors of the driven units. The distributor and the motors are phased by connecting similar numbers of the windings to the same phase.

A control box, Fig. 7, limits the initial current in the driving motor of the distributor set, thus preventing damage to the windings and controls during the time required for the system to come up to speed, which is about four seconds. Approximately 15 feet of film will run through before the system settles down.

Before the advent of sound, projection machines ran at a speed of approximately 80 feet per minute. Because of certain considerations dealing with the recording of sound, the speed was increased to 90 feet per minute, or 24 picture frames per second. This is standard speed adopted for sound projectors.

Elaborate speed control systems were developed which employed mo-

tors with speed regulating field windings, controlled from a vacuum tube bridge circuit. However, with the advent of the interconnected power systems throughout the United States and their close adherence to frequency, most theater equipment uses either a single or three-phase synchronous motor requiring no control circuits except a starting system to bring it up to speed in a given time, thus preventing the breakage of the film by coming up to speed too quickly.

The general term "filter" has been applied to any system which is employed to smooth out or remove variations in speed of a rotating member of a drive system. Although it is possible to manufacture gears with a high order of precision, they will still transmit a vibration which is a frequency of the gear teeth, multiplied by the speed of rotation. Such vibrations will, if transmitted to a disc recording turntable, produce a pattern in the completed disc, and if of great enough amplitude will be reproduced with the program material as a low frequency rumble, or it may sound similar to a gear train, running in the background. If vibrations are transmitted to a reproducer turntable, perfect recordings will be reproduced with noise or background rumble. Such noises detract from the program, add distortion, and have a masking effect on the high frequencies.

One method used to reduce the imperfections during the manufacture of gears for driving disc recorders is to take four laminations the diameter of the gear to be cut and bolt them together, then mill and hob as one. After milling, the laminations are separated and rotated 90 degrees. They are then bolted together in such a manner that a slight play exists between the four laminations. This scheme reduces the effect of the imperfections and averages out the vibrations caused by the gear teeth. The main drive gear is driven by a worm gear. The turntable shaft is driven from the main gear by a system of springs with an oil dashpot, equipped with vanes to provide damping. The whole assembly is then immersed in oil.

The problem of constant speed for film recorders and projectors does not differ in its fundamental principle from that of the disc recorder, except that the recording medium is unwound from a reel and pulled at a constant rate of speed before a modulating device or, in the case of the projector, a photocell. In the projection machine, the film transport system must be so designed that the film passing the photocell in the sound head is not affected by the pull of the "intermittent motion" of the picture head.

This problem is met by the use of constant speed sprockets both ahead of and behind the sound head film transport mechanism. Between these constant speed sprockets is generally an impedance wheel or drum on a shaft with a rotary stabilizer or heavy fly-

(Continued on page 123)

Fig. 7. A 3-phase distributor and control cabinet. The control box limits the initial current in the driving motor of the distributor set to prevent damage.

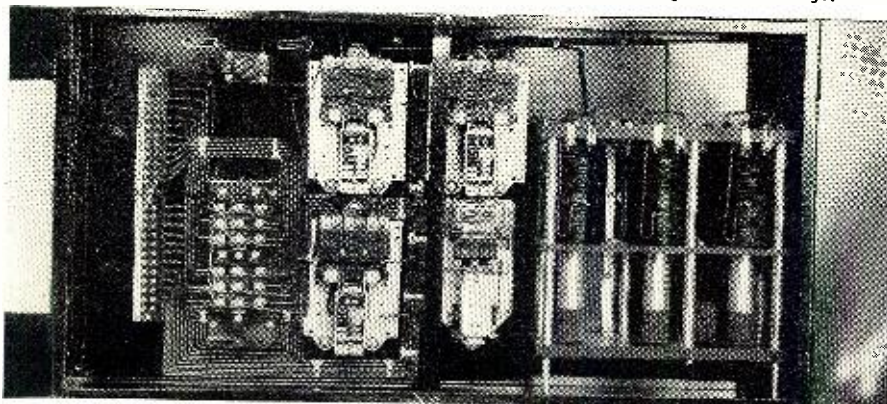

**Rauland** Now Offers The First

# LOW FOCUS VOLTAGE ELECTROSTATIC TUBE

*Rauland's new low potential electrostatic-focus picture tube is not just a "defense period" substitute but a permanent and major advance in television cathode ray tube development*

**FOCUSES** with D.C. voltage already available from the receiver's power supply.

**ELIMINATES** focusing coils and magnets—saves critically scarce copper and cobalt.

**REQUIRES NO** re-engineering of present television chassis . . . **NO** added high voltage focus circuit . . . **NO** added receiver tubes—**NO** additional components except an inexpensive potentiometer.

**BETTER** in all ways! Not only saves materials but also gives an actual improvement in picture quality because the over-all focus is better . . . and because it is completely stable in focus under considerable variations in voltage.

*This new Rauland development is now available in substantial quantities in 17 and 20 inch rectangular tubes. For further information, address . . .*

**THE RAULAND CORPORATION**



*Perfection Through Research*

4245 N. KNOX AVENUE • CHICAGO 41, ILLINOIS



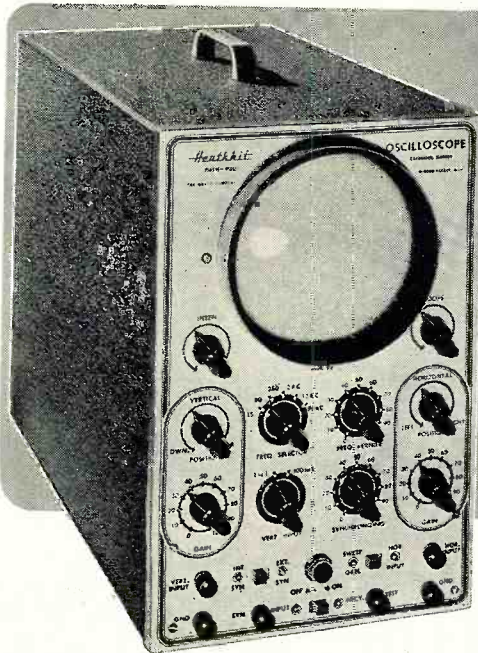

## Heathkit MODEL 0-6... PUSH-PULL... 5" OSCILLOSCOPE KIT

The new Heathkit 5" Push-Pull Oscilloscope Kit is again the best buy. No other kit offers half the features — check them.

Measure either AC or DC on this new scope — the first oscilloscope under \$100.00 with a DC amplifier.

The vertical amplifier has frequency compensated step attenuator input into a cathode follower stage. The gain control is of the non frequency discriminating type — accurate response at any setting. A push-pull pentode stage feeds the CR tube.

New type positioning control has wide range for observing any portion of the trace.

The horizontal amplifiers are direct coupled to the CR tube and may be used as either AC or DC amplifiers. Separate binding posts are provided for AC or DC.

The multivibrator type sweep generator has new frequency compensation for the wide range it covers: 15 cycles to over 100,000 cycles.

The new model 0-6 scope uses 10 tubes in all, including 5" CR tube. Has improved amplifiers for better response useful to 2 megacycles. Tremendous sensitivity .04V RMS per inch horizontal — .09V RMS per inch vertical. Only Heathkit Scopes have all the features.

New husky heavy duty power transformer has 50% more laminations. It runs cool and has the lowest possible magnetic field. A complete electrostatic shield covers primary and other necessary windings and has lead brought out for proper grounding.

The new filter condenser has separate sections for the vertical and horizontal screen grids and prevents interaction between them. An improved intensity circuit provides almost double previous brilliance and better intensity modulation.

A new synchronization circuit allows the trace to be synchronized with either the positive or negative pulse, an important feature in observing the complex pulses encountered in television servicing.

Model 0-6..... Shipping Wt. 24 lbs.

# \$3950

The kit is complete, all tubes, cabinet, transformer, controls, grid screen, tube shield, etc. The instruction manual has complete step-by-step assembly and pictorials of every section. Compare it with all others and you will buy a Heathkit.

## NEW INEXPENSIVE Heathkit ELECTRONIC SWITCH KIT

The companion piece to a scope — Feed two different signals into the switch, connect its output to a scope, and you can observe both signals — each as an individual trace. Gain of each input is easily set (gain A and gain B controls), the switching frequency is simple to adjust (coarse and fine frequency controls) and the traces can be superimposed for comparison or separated for individual study (position control).

Use the switch to see distortion, phase shift, clipping due to improper bias, both the input and output traces of an amplifier, — as a square wave generator over limited range.

The kit is complete; all tubes, switches, cabinet, power transformer and all other parts, plus a clear detailed construction manual.

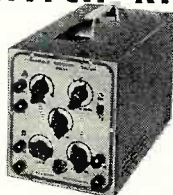

Model 5-2  
Shipping Wt. 11 lbs.

# \$1950

## New MODEL V-4A

# Heathkit VTVM KIT

The new Heathkit Model V-4A VTVM Kit measures up to 30,000 Volts DC and 250 megacycles when used with accessory probes — think of it, all in one electronic instrument more useful than ever before. The AC Voltmeter is so flat and extended in its response ( $\pm 1$  db from 20 cycles to 2 megacycles) that it eliminates the need for separate expensive AC VTVM's.

The new 200 microampere,  $4\frac{1}{2}$ " streamline meter with quality Simpson movement (five times as sensitive as the commonly used 1 MA meter) has a shatter proof plastic meter face for maximum protection. Meter has all the desirable scales and indicates AC volts, DC volts, ohms, db (direct reading), and even has a special zero center marking for quick FM alignment.

There are six complete ranges for each function. Four functions give total of 24 ranges. The 3 volt range allows 33 1/3% of the scale for reading 1 volt, as against only 20% of the scale on the 5 volt types.

New 1/2% ceramic precision resistors are the most accurate commercial type available — you find the same make and quality in the finest laboratory equipment selling for thousands of dollars. The entire voltage divider decade uses these 1/2% resistors.

Both AC and DC voltmeter measurements use a push-pull electronic voltmeter circuit, and the meter circuit makes the meter burn-out proof. Electronic ohmmeter circuit measures resistance over the amazing range of 1/10 ohm to one billion ohms, all with internal 3 volt battery. Ohmmeter batteries mount on the chassis in snap-in mounting for easy replacement.

Voltage ranges are full scale — 3 Volts, 10 Volts, 30 Volts, 100 Volts, 300 Volts, 1000 Volts. Complete decoding coverage without gaps.

The DC probe is isolated for dynamic measurements. Negligible circuit loading. Gets the accurate reading without disturbing the operation of the equipment under test. Kit comes complete: cabinet, transformer, Simpson meter, test leads, complete assembly and instruction manual.

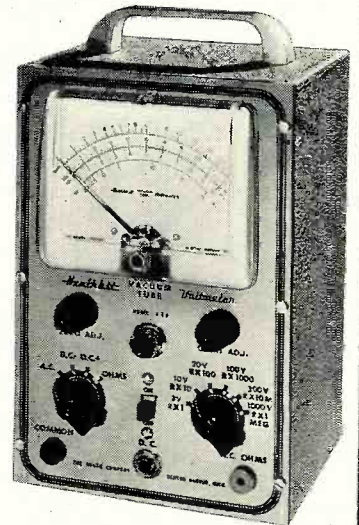

Model V-4A..... Shipping Wt. 8 lbs.

Note New Low Price

# \$2350



# \$550

No. 336 High Voltage Probe Kit..... Shipping Wt. 2 lbs.

## Heathkit 30,000V DC PROBE KIT

A new 30,000 V DC Probe Kit to handle high voltages with safety. For TV service work and all other high voltage applications. Sleek looking — Two color molded plastic — Red body and guard — jet black handle. Comes with connector, cable, and PL55 type plug. Plugs into Heathkit VTVM so that 300V scale is conveniently multiplied by 100. Can be used with any standard 11 megohm VTVM.

## Heathkit RF PROBE KIT

This RF Probe Kit comes complete with probe housing, crystal diode detector, connector, lead and plug and all other parts plus clear assembly instructions. Extends range of Heathkit VTVM to 250 Mc.  $\pm 10\%$ . Works on any 11 megohm input VTVM. Specify No. 309 RF Probe Kit.



Shipping Wt. 1 lb.

# \$550

EXPORT AGENT  
ROCKE INTERNATIONAL CORP.  
13 E. 40th ST.  
NEW YORK CITY (16)  
CABLE: ARLAB-N.Y.

# The HEATH COMPANY

... BE ITON HARBOR 15, MICHIGAN



# NEW Heathkit TV ALIGNMENT GENERATOR KIT

Here is an excellent TV Alignment Generator designed to do TV service work quickly, easily, and properly. The model TS-2 when used in conjunction with an oscilloscope provides a means of correctly aligning television receivers.

The instrument provides a frequency modulated signal covering, in two bands, the range of 10 to 90 Mc. and 150 to 230 Mc. — thus, ALL ALLOCATED TV CHANNELS AS WELL AS IF FREQUENCIES ARE COVERED.

An absorption type frequency marker covers from 20 to 75 Mc. in two ranges — therefore, you have a simple, convenient means of frequency checking of IF's, independent of oscillator calibration.

Sweep width is controlled from the front panel and covers a sweep deviation of 0-12 Mc. — all the sweep you could possibly need or want.

And still other excellent features are: Horizontal sweep voltage available at the front panel (and controlled with a phasing control) — both step and continuously variable attenuation for setting the output signal to the desired level — a convenient instrument stand-by position — vernier drive of both oscillator and marker tuning condensers — and blanking for establishing a single trace with base reference level. Make your work easier, save time, and repair with confidence — order your Heathkit TV Alignment Generator now!

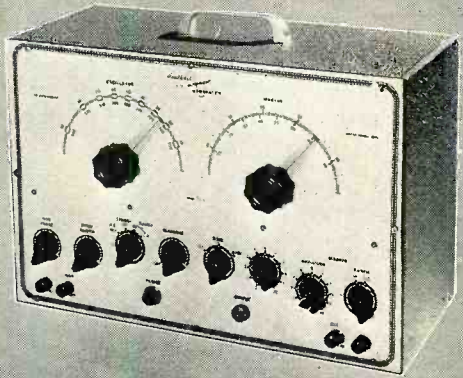

**\$3950**

Model TS-2  
Shipping Wt. 20 lbs.

## Heathkit SIGNAL GENERATOR KIT



Model SG-6  
Shipping Wt. 7 lbs.

**\$1950**

for external audio testing. Switch provided allows the oscillator to be modulated by an external audio oscillator for fidelity testing of receivers. Comes complete, all tubes, cabinet, test leads, every part. The instruction manual has step-by-step instructions and pictorials. It's easy and fun to build a Heathkit Model SG-6 Signal Generator.

The new Heathkit Signal Generator Kit has dozens of improvements. Covers the extended range of 160 Kc to 50 megacycles on fundamentals and up to 150 megacycles on useful calibrated harmonics; makes this Heathkit ideal as a marker oscillator for TV. Output level can be conveniently set by means of both step attenuator and continuously variable output controls. Instrument has new miniature HF tubes to easily handle the high frequencies covered.

Uses 6C4 master oscillator and 6C4 sine wave audio oscillator. The kit is transformer operated and a husky selenium rectifier is used in the power supply. All coils are precision wound and checked for calibration making only one adjustment necessary for all bands.

New sine wave audio oscillator provides internal modulation and is also available

## Heathkit SIGNAL TRACER and UNIVERSAL TEST SPEAKER KIT

and UNIVERSAL TEST SPEAKER KIT

The popular Heathkit Signal Tracer has now been combined with a universal test speaker at no increase in price. The same high quality tracer follows signal from antenna to speaker — locates intermittents — finds defective parts quicker — saves valuable service time — gives greater income per service hour. Works equally well on broadcast, FM, or TV receivers. The test speaker has an assortment of switching ranges to match either push-pull or single output impedances. Also tests microphones, pickups and PA systems. Comes complete; cabinet, 110V 60 cycle power transformer, tubes, test probe, all necessary parts, and detailed instructions for assembly and use.



Model T-2  
Shipping Wt. 7 lbs.

**\$1950**

## Heathkit TUBE CHECKER KIT

Test your tubes the modern way — dynamically — the simplest, yet fastest and surest method — your Heathkit has a switch for each tube element and measures that element — no chance for open or shorted elements slipping by, all the advantages of the mutual conductance type without the slow cumbersome time consuming setups. Checks for opens, shorts, each element individually, filament and filament tap continuity, and emission.

This Tube Checker has all the features — beautiful 3 color BAD-?-GOOD meter — complete selection of voltages — roller chart listing hundreds of tubes including the new 9 pin miniatures — finest quality Centralab lever switches — high grade birch, counter-type cabinet — continuously variable line adjust control — every feature you need to sell tubes properly. The most modern type tube checker with complete protection against obsolescence. Uses only the best of parts — rugged oversize 110V 60 cycle power transformer, finest of Mallory and Centralab switches and controls, complete set of sockets for all type tubes with blank spare for future types. Fast action, gear driven roller chart quickly locates the setting for any type tube. Simplified switching cuts necessary testing time to a minimum and saves valuable service time. Simple method allows instant setup of new tube types without waiting for factory data. No matter what the arrangement of tube elements is, the Heathkit flexible switching method easily handles it. Order your Heathkit Tube Checker Kit today and see for yourself that Heath again saves you two-thirds and yet retains all the quality. Complete with instructions, all parts, and cabinet.

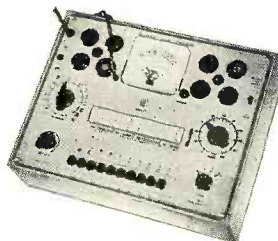

Model TC-1  
Shipping Wt. 12 lbs.

**\$2950**



**\$1950**

tube, magic eye tube, cabinet, calibrated panel and all other parts. Has clear detailed instructions for assembly and use.

Model C-2 Shipping Wt. 6 lbs.

## NEW Heathkit HANDITESTER KIT

A precision portable volt-ohm-milliammeter. Uses only high quality parts — All precision 1/2% resistors, three deck switch for trouble-free mounting of parts, specially designed battery mounting bracket, smooth acting ohm adjust control, beautiful molded bakelite case, 400 microamp meter movement, etc.

DC and AC voltage ranges 10-30-300-1000-5000V. Ohms range 0-3000 and 0-300.000 Range Milliampers 0-10 Ma, 0-100 Ma. Easily assembled from complete instructions and pictorial diagrams.

Model M-1 Shipping Wt. 3 lbs.



**\$1350**

EXPORT AGENT  
ROCKE INTERNATIONAL CORP.  
13 E. 40th ST.  
NEW YORK CITY (16)  
CABLE: ARAB-N.Y.

The HEATH COMPANY

... BENTON HARBOR 15, MICHIGAN

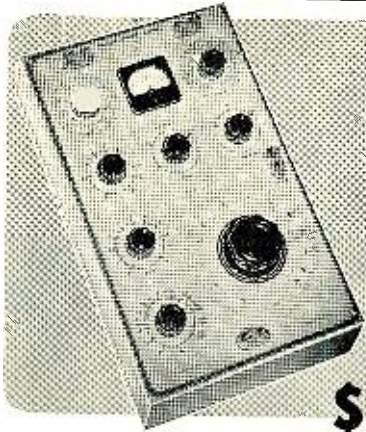

## NEW *Heathkit* IMPEDANCE BRIDGE KIT

This Impedance Bridge Kit is really a favorite with schools, industrial laboratories, and serious experimenters. An invaluable instrument for those doing electrical measurements work. Reads resistance from 0.1 Ohms to 10 megohms, capacitance from 0.0001 MFD to 100 MFD, inductance from 10 microhenries to 100 henries, dissipation factor from .002 to 1, and storage factor from 2 to 1000. And you don't have to worry about selecting the proper bridge circuit for the various measurements — the instrument automatically makes the correct circuit when you set up for taking the measurement you want. Bridge utilizes Wheatstone, Hay, Maxwell, and capacitance comparison circuits for the wide range and types of measurements possible. And it's self powered — has internal battery and General Radio 1000 cycle hummer. No external generator required — has provisions for external generator if measurements at other than 1000 cycles are desired.

Kit utilizes only highest quality parts. General Radio main calibrated control, General Radio hummer, Mallory ceramic switches, excellent 200 microamp zero center galvanometer, laboratory type binding posts with standard 3/4 inch centers, 1/2% precision ceramic body type multiplier resistors, beautiful birch cabinet and ready calibrated panel. (Headphones not included.)

Take the guesswork out of electrical measurements — order your Heathkit Impedance Bridge Kit today — you'll like it.

**\$6950**

Model IB-1B...Shipping Wt. 15 lbs.

### *Heathkit* LABORATORY RESISTANCE DECADE KIT



Model RD-1

An indispensable piece of laboratory equipment — the Heathkit Resistance Decade Kit gives you resistance settings from 1 to 99,999 ohms IN ONE OHM STEPS. For greatest accuracy, 1/2% precision ceramic-body type resistors and highest quality ceramic wafer switches are used.

Designed to match the impedance bridge above, the Resistance Decade Kit has a beautiful birch cabinet and attractive panel. It's easy to build, and comes complete with all parts and construction manual.

Ship. Wt.  
4 lbs.

**\$1950**

### *Heathkit* LABORATORY POWER SUPPLY KIT



Model PS-1  
Ship. Wt. 20 lbs.

Every experimenter needs a good power supply for electronic setups of all kinds. This unit has been expressly designed to act as a HV supply and a 6.3 V filament voltage source.

Voltage control allows selection of HV output desired (continuously variable within limits outlined), and a Volts — Ma switch provides choice of output metering. A large, plainly marked, and direct reading meter scale indicates either DC voltage output in volts or DC current output in Ma. (Range of meter 0-500V DC, 0-200 Ma DC). Instrument has convenient stand-by position and pilot light.

Comes with power transformer, filament transformer, meter, 5Y3 rectifier, two 1619 control tubes, completely punched and formed chassis, panel, cabinet, detailed construction manual, and all other parts to make the kit complete.

**LIMITS:**

No load.....Variable 150-400V DC  
25 Ma.....Variable 30-310V DC  
50 Ma.....Variable 25-250V DC  
Higher loads.....Voltage drops off proportionally

**\$2950**

### *Heathkit* BATTERY ELIMINATOR KIT

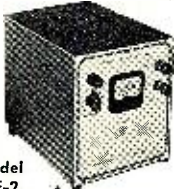

Model BE-2

Ship. Wt.  
19 lbs.

**\$2250**

A few auto radio repair jobs will pay for the Heathkit Battery Eliminator Kit. It's fast for service. The voltage can be lowered to find sticky vibrators or raised to ferret out intermittents. Provides variable DC voltage 5 to 7 1/2 Volts at 10 Amps, continuous or 15 Amps, intermittent.

Also serves as storage battery charger. A well filtered, rugged power supply uses heavy duty selenium rectifier, a husky choke, and a 4000 MFD electrolytic condenser for clean DC. 0-15V voltmeter indicates output which is variable in eight steps. Better equipped for all types of service — it means more income.

### NEW *Heathkit* SINE and SQUARE WAVE AUDIO GENERATOR KIT



Model AG-7

Ship. Wt. 15 lbs.

**\$3450**

We proudly present the NEW MODEL Sine and Square Wave Audio Generator Kit. Designed with versatility, usefulness, and dependability in mind, the AG-7 gives you the two most needed waveshapes right at your fingertips — the sine wave and the square wave.

The range switch and plainly calibrated frequency scale give rapid and easy frequency selection, and the output control permits setting the output to any desired level.

A high-low impedance switch sets the instrument for either high or low impedance output — on high to connect to high impedance load, and on low to work into a low impedance transformer with negligible DC resistance.

Coverage is from 20 to 20,000 cycles, and distortion is at a minimum — you can readily trust the output waveshape.

6 tubes, quality 4 gang tuning condenser, power transformer, metal cased filter condenser, 1/2% precision resistors in the frequency determining circuit, and all other parts come with the kit — plus, a complete construction manual. A tremendous kit, and the price is truly low.

### TWO HIGH QUALITY *Heathkit* SUPERHETERODYNE RECEIVER KITS



Model BR-1 Broadcast Model Kit covers 550 to 1600 Kc. Shipping Wt. 10 lbs.

**\$1950**



Model AR-1 3 Band Receiver Kit covers 550 Kc. to over 20 Mc. continuous. Extremely high sensitivity. Shipping Wt. 10 lbs.

**\$2350**

Two new Heathkits. Ideal for schools, replacement of worn out receivers, amateurs and custom installations.

Both are transformer operated quality units. The best of materials used throughout — six inch calibrated slide rule dial — quality power output transformers — dual iron core shielded I.F. coils — metal cased filter condenser. The chassis has phono input jack, 110 Volt output for phono, motor, and there is a phono-radio switch on panel. A large metal panel simplifying installation in used console cabinets is included. Comes complete with tubes and instruction manual incorporating pictorials and step-by-step instructions (less speaker and cabinet). The three band model has simple coil turret which is assembled separately for ease of construction.

### *Heathkit* FM TUNER KIT



Model FM-2

Ship. Wt. 9 lbs.

**\$2250**

The Heathkit FM Tuner Model FM-2 was designed for best tonal reproduction. The circuit incorporates the most desirable FM features — true FM.

Utilizes 8 tubes: 7E5 Oscillator, 6SH7 mixer, two 6SH7 IF amplifiers, 6SH7 limiter, two 7C4 diodes as discriminator, and 6X5 rectifier.

The instrument is transformer operated making it safe for connection to any type receiver or amplifier. Has ready wound and adjusted RF coils, and 2 stages of 10.7 Mc IF (including limiter). A calibrated six inch slide rule dial has vernier drive for easy tuning. All parts and complete construction manual furnished.

ROCKE INTERNATIONAL CORP.  
12 E. 40th ST.  
NEW YORK CITY (ED)  
CHIC. ARK. N.Y.

**The HEATH COMPANY**

... BE TON HARBOR 15, MICHIGAN

## Heathkit ECONOMY . . . 6 WATT AMPLIFIER KIT

**\$12.50**



Model A-4. Ship. Wt. 8 lbs.

This new Heathkit Amplifier was designed to give quality reproduction and yet remain low in price. Has two preamp stages, phase inverter stage, and push-pull beam power output. Comes complete with six

tubes, quality output transformer (to 3-4 ohm voice coil), husky cased power transformer and all other parts. Has tone and volume controls. Instruction manual has pictorial for easy assembly. Six watts output with response flat  $\pm 1\frac{1}{2}$  db from 50 to 15,000 cycles. A quality amplifier kit at a new low price. Better build one.

No. 304. 12 inch Speaker . . . . . \$6.95

## Heathkit HIGH FIDELITY . . . 20 WATT AMPLIFIER KIT

Our latest and finest amplifier — the Model A-6 (or A-6A) is capable of a full 20 Watts of high fidelity output — good faithful reproduction made possible through careful circuit design and the use of only highest quality components. Frequency response within  $\pm 1$  db from 20-20,000 cycles. Distortion at 3 db below maximum power output (at 1000 cycles) is only .8%.

The power transformer is rugged and conservatively rated and will deliver full plate and filament supply with ease. The output transformer was selected because of its exceptionally good frequency response and wide range of output impedances (4-8-16-150-600 ohms). Both are Chicago Transformers in drawn steel case for shielding and maximum protection to windings.

The unit has dual tone controls to set the output for the tonal quality desired — treble control attenuates up to 15 db at 10,000 cycles — bass control gives bass boost up to 10 db at 50 cycles.

Tube complement consists of 5U4G rectifier, 6SJ7 voltage amplifier, 6SN7 amplifier and phase splitter, and two 6L6's in push-pull output. Comes complete with all parts and detailed construction manual. (Speaker not included)

MODEL A-6: For tuner and crystal phono inputs. Has two position selector switch for convenient switching to type of input desired. Shipping Wt. 18 lbs. . . . . \$33.50

MODEL A-6A: Features an added 6SJ7 stage (preamplifier) for operating from variable reluctance cartridge phono pickup, mike input, and either tuner or standard crystal phono pickup. A three position selector switch provides flexible switching. Shipping Wt. 18 lbs. . . . . \$35.50



**\$33.50**

## Heathkit RECEIVER AND TUNER CABINETS



**\$4.95**

Blonde birch veneer cabinet for either of the receivers or tuner. The modern styling is an asset to any room. 5" speaker fits in end of cabinet when used with receivers (Speaker not included.) Size 7 x 13 $\frac{1}{2}$  x 18 $\frac{1}{4}$  inches. Order No. 345 for either receiver model. Specify No. 350 for the FM Tuner

Shipping Wt. . . . . 5 lbs.

Metal professional type communications receiver cabinet. Finished in deep grey and fits the panel supplied with Heathkit BR-1 and AR-1 Receivers. 5" speaker mounts in end of cabinet. (Speaker and panel shown not included with cabinet.) Gives professional appearance to Heathkit receivers. Size 7 x 14 x 7 $\frac{3}{4}$  inches.

Specify No. 335 . . . Shipping Wt. 6 lbs.

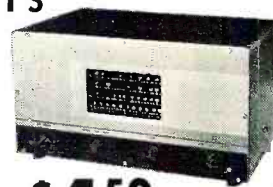

**\$4.50**



MAIL TO THE  
**HEATH COMPANY**  
BENTON HARBOR 15,  
MICHIGAN

## ORDER BLANK

From \_\_\_\_\_

SHIP VIA

- Parcel Post  
 Express  
 Freight  
 Best Way

Quantity	Item	Price	Quantity	Item	Price
	Heathkit Oscilloscope Kit — Model O-6			Heathkit R.F. Probe Kit — No. 309	
	Heathkit VTVM Kit — Model V-4A			Heathkit H.V. Probe Kit — No. 336	
	Heathkit FM Tuner Kit — FM-2			Heathkit R.F. Signal Gen. Kit — Model SG-6	
	Heathkit Broadcast Receiver Kit — Model BR-1			Heathkit Condenser Checker Kit — Model C-2	
	Heathkit Three Band Receiver Kit - Model AR-1			Heathkit Handitester Kit — Model M-1	
	Heathkit Amplifier Kit — Model A-4			Heathkit Power Supply Kit — Model PS-1	
	Heathkit Amplifier Kit — Model A-6 (or A-6A)			Heathkit Resistance Decade Kit — Model RD-1	
	Heathkit Tube Checker Kit — Model TC-1			Heathkit Impedance Bridge Kit — Model IB-1B	
	Heathkit Audio Generator Kit — Model AG-7				
	Heathkit Battery Eliminator Kit — Model BE-2				
	Heathkit Electronic Switch Kit — Model S-2				
	Heathkit T.V. Alignment Gen. Kit — TS-2				
	Heathkit Signal Tracer Kit — Model T-2				

On Parcel Post Orders, include postage for weight shown and insurance. (We insure all shipments.)

On Express Orders, do not include transportation charges — they will be collected by the Express Agency at time of delivery.

Enclosed find  Check  Money Order for \_\_\_\_\_

Please ship C.O.D.  Postage enclosed for \_\_\_\_\_ lbs.

ALL PRICES SUBJECT TO CHANGE WITHOUT NOTICE

EXPORT AGENT  
ROCKE INTERNATIONAL CORP.  
13 E. 40th ST.  
NEW YORK CITY (16)  
CABLE: ARLAB-N.Y.

# The HEATH COMPANY

. . . BENTON HARBOR 15, MICHIGAN

**CHECK THESE MONEY-SAVING SURPLUS "BUYS"!**

Still Going Strong! Hundreds of Bargains in Good Equipment During this Money-Saving Event!

# WAREHOUSE SALE! CLEARANCE SALE!

CLEARANCE OF

## TECH MANUALS

Out goes our entire stock of over 10,000 valuable, useful Tech-Manuals at these drastically reduced prices—covering every phase of telephone, teletype, power units, transmitters, receivers, remote controls etc. Buy even what you don't need now—for if you use 'em just once, you'll be \$8 ahead.

**ALL PRICES POSTPAID AND INCLUDE SHIPPING AND HANDLING TRANSMITTERS-RECEIVER MANUALS**

- SCR-536 TM-11-255 Handie-Talkie .....
- SCR-608-628 Tank Set .....
- SCR-593 .....
- SCR-508, 528, 538 TM-11-600 .....
- SCR-506A, TM-11-630 .....
- SCR-593A .....
- SCR-543 TM-11-850 .....
- SCR-300A, TM-11-242 .....
- AN/TRC-1, 2, 3, 4, TM-11-2601 .....
- AN/TG-1, 2 Tools, Gauges, and Maintenance Equipment .....
- TCS Transmitter-Receiver Manual .....

### TELEPHONE AND TELETYPE EQUIPMENT MANUALS

- Model 14 Type Bar Tape Printer, Parts List & Photos .....
- MODEL 14 Teletype Perforator .....
- Western Electric Voice Frequency Ringer Packaged Equipment .....
- Western Electric Voice Frequency Telephone Repeaters, Packaged Equip. ....
- Telephone Central Office Set, TC-2 .....
- Telephone Central Office Set, TC-4 .....
- Telephone Central Office Set, TC-10 .....
- Repeater Set TC-15 TM-11-2005 .....
- RC-261 TM-11-2632 Remote Control Equipment .....
- BE-77A TM-11-359 Line Unit .....
- BD-71 Switchboard .....
- AN/TRA-2 Remote Control Equipment .....
- TS-26/TSM TM-11-2017 Test Set .....
- 1-72-J TM-11-3075 Signal Generator .....

### POWER UNITS AND RECTIFIERS TECH MANUALS

- PU-58/G Generator Set .....
- PE-49F Generator Set .....
- PE-75 Generator Set .....
- RA-34 TM-11-959 Rectifier Unit .....

### WE PAY MORE FOR EQUIPMENT!

Especially interested in all types of aircraft, radio, test equipment and need ARC-1's, ARC-3's, RSA, ARN-T, RC-348's, AIT-19's, TS-34's. Send list of your equipment, present condition and asking price. Try us LAST for proof we pay top \$\$\$!

### CONTACT MIKE ASSEMBLY



Consists of 2 mikes, on-off-switch, amplifying transformer, batteries, battery case and connector to attach to any radio, AC, DC or battery portable. Tremendous amplification up to full volume output of sound system used. FB for watch repair, diesel engine injector adjustment, gas engine diagnosis, theatrical use. 100 and 1 uses.

**\$3.95**

Postpaid in U.S.A.

### WESTON AIRCRAFT METERS



1 Milliampere, zero center. FB for field strength meters, grid-dip or tuning meters, beam antenna indicators, vacuum volt indicators. New.

**\$1.95**

Postpaid in U.S.A.

### BEAM MOTORS



**\$3.95**

Postpaid in U.S.A.

With operating instructions for 110 V. 60 cy. Use for CW aeri-als, ham stations.

### GRID DIP METER KIT



**\$7.95**

Postpaid in U.S.A.

100's sold! 100's where your equip. is in the radio spectrum. 9.5 5 O.S.C. range 3 to 170 mc g.s. 6.3 filament, 150 V DC. With instructions on calibrating coils, etc.

### VIBRATOR TRANSFORMER

F.B. for that mobile rig. 6 V. input. 345 V. 135 MA output. 15 V. Bias Tap. Shipping wt. 4 lbs. ....

**\$1.49**

### TRANSFORMER BUY

110 V. 60 cy. input. Output 13 volts tapped at 12, 11, 10, 9 at 3 amps. Shipping wt. 4 lbs. ....

**.98c**

### CLEARANCE OF MOUNTING RACKS

.MT-171/U (Double ATR) \$2.50	.FT-213A (SCR-629 Compass) .....
.MT-167/U (Single ATR) 1.50	.FT-251 (Loran with tilt) 3.00
.MT-108/APX-1 (BC-966) 2.00	.FT-446 (Loran) 2.00
.MT-137/APQ-13 3.50	.FT-409 (BC-929 Scope) 2.00
.MT-14/ARN-1 2.50	.FT-225A 1.00
.MT-149A/APS-13 2.75	.FT-227A 1.00

**A Complete, Efficient FOREIGN DEPT. Fully Staffed for EXPORT ORDERS**

We maintain a complete staff of Export Specialists to take care of all Foreign Orders. Correspondence and prompt replies in all languages. Address: "Foreign Department, Alvaradio."

### ORDER DIRECT FROM THIS AD!

Prompt, speedy shipment. Cash with order. Minimum order \$3.00. 25% posit on C.O.D. orders. Shipments by collect, or RR express. Please add state sales tax. All money subject to change. All merchandise subject to prior sale.

# ALVARADIO SUPPLY CO.

DEPT. A-15, 341 S. VERMONT, LOS ANGELES 5, CALIF., DuNkirk 8-2211

## Compact 40 watt Rig

(Continued from page 57)

All of the d.c. wiring is cabled and run around the corners of the chassis. Filament and other 6-volt wiring is done with No. 16 stranded automotive wire, while high-voltage wiring is done with No. 22 stranded hookup wire. Radio frequency wiring is done with bare, solid wire and is run direct. Bypass condensers and ground leads are connected to the nearest socket mounting screw. Any part that might be subject to vibration should be mounted on lug strips or otherwise secured.

Under normal load the dynamotor draws around 25 amperes, and considerably more than that during starting periods. Therefore it is important that heavy leads be used in the primary circuit and that all connections be very good. At such high currents even a very small amount of resistance will sap the power from the rig. The leads from the 6-volt battery should be heavy, No. 0 gauge is a good size.

If the transmitter is to be used in the car it will be necessary to run a 4-wire remote control cable, connected as indicated in the circuit diagram. In addition to this, a coaxial antenna lead will be run to the receiver and another to the transmitting antenna. Of course a heavy lead will also have to be run to the battery or starter switch. It is suggested that a 50-ampere delayed-action fuse or circuit breaker be placed between the battery and the transmitter, preferably near the battery.

For use in the field or for emergency operation, the rig can be quickly removed from the car, connected to another storage battery, microphone plugged in, antenna connected, and you're in business. A simple type of antenna for this sort of operation would be a quarter-wave working against ground. A more efficient type would be a half-wave dipole fed with low-impedance line. In an extreme emergency one could use the mobile antenna.

Tuning of the transmitter is conventional. The oscillator tank condenser should be tuned to the high side of the crystal frequency for easiest crystal starting. With this setting, an 807 grid current of 3 to 4 ma. should be obtained. With normal loading, the final plate current should run 80 to 100 ma.

Although antenna systems vary considerably on mobile installations, the setup on the writer's car is probably typical of many. The antenna consists of an 8-foot bumper-mounted whip with a loading coil inserted in the center. For 10-meter operation the coil is shorted out with a jumper. At this writing no 20-meter mobile operation has been done. However, it could be easily accomplished by shorting out part of the loading coil. It is the usual practice to wind a loading coil which will resonate with the top section of

big FREE GIFT offer

SEE PAGE 14

## EASY TO LEARN CODE

It is easy to learn or increase speed with an Instructograph Code Teacher. Affords the quickest and most practical method yet developed. For beginners or advanced students. Available tapes from beginner's alphabet to typical messages on all subjects. Speed range 5 to 40 WPM. Always ready—no QRM.

**ENDORSED BY THOUSANDS!**

The Instructograph Code Teacher literally takes the place of an operator-instructor and enables anyone to learn and master code without further assistance. Thousands of successful operators have "acquired the code" with the Instructograph System. Write today for convenient rental and purchase plans.



## INSTRUCTOGRAPH COMPANY

4711 SHERIDAN ROAD, CHICAGO 40, ILLINOIS

the whip to the operating frequency, the whole system acting similar to a quarter-wave radiator. There are several schools of thought when it comes to designing antenna systems for the 75-meter band. Experience appears to indicate that the loading coil does a good portion of the radiating as well as serving as a resonator. This writer has experienced best results with loading coils having a large length-to-diameter ratio. The present coil is wound on a phenolic tubing form three-quarters of an inch in diameter and 18 inches long at 20 turns of No. 22 enameled wire per inch.

At this writing the 10-meter band has been very poor, so no contacts outside of ground-wave have been made on this band. However, on 75 meters excellent results have been obtained. With a full-size, fixed antenna attached, possibilities are unlimited. It looks like the ideal all-purpose, battery-powered rig for fixed, mobile, or emergency communication.

-30-

### Sweep Alignment

(Continued from page 45)

thus calibrated (if required), the determinations of center frequency and bandwidth are made as follows:

First, adjust the tuning dial of the sweep generator to center the response curve of the receiver under test, as seen on the screen of the oscilloscope, as shown in Fig. 4. The sweep gener-

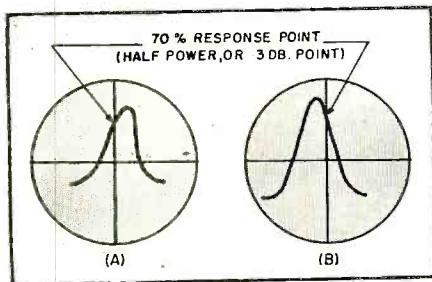

Fig. 6. Determining bandwidth of the curve. Scope pattern of first (A) and second (B) steps. Difference in associated dial readings is the bandwidth of the response curve.

ator tuning dial then reads the center frequency of the response curve.

To determine the bandwidth of the curve, the tuning dial of the sweep generator is first adjusted to bring the 70% response (half-power) point on the left-hand side of the curve to the center of the screen, as shown in Fig. 6A. Note the tuning-dial reading. Second, adjust the tuning dial to bring the 70% response point on the right-hand side of the curve to the center of the screen, as shown in Fig. 6B. Note the dial reading again. The difference between these two dial indications is the bandwidth of the curve.

This is a very useful expedient which side-steps the difficulty of interpreting frequency markers on narrow-band response curves.

-30-

July, 1951

# it's TREMENDOUS

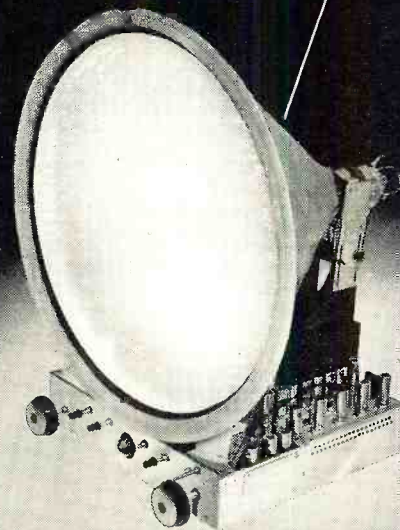

## it's 24 inch high fidelity TV

**I**T'S no longer a dream! This very minute, home theater television is a reality—a tremendous reality!

Tremendous not only in size, but in clarity and picture definition . . . in fidelity of sound. See it—and view a

new standard of excellence for custom installations. Write today for information or name of your dealer

- Extra high voltage—16 kv—for clean highlights and true edge-to-edge focus.
- Perfect interlace and full 4 mc. band width permits comfortable viewing from 8 feet.
- Operates 24-in. round or 20-in. and 17-in. rectangular tubes, including new 17HP4, 20HP4.
- Available with Standard Coil turret tuner (pretuned channel selector) or Mallory tuner (continuous type; FM coverage, phono selection).

THE RADIO

# craftsmen

INCORPORATED

4401 N. RAVENSWOOD AVE. • CHICAGO 40, ILLINOIS

# McGEE'S GIGANTIC SUMMER SALE OF RADIO-TV PARTS

## 5-STATION INTERCOM MASTERS

**\$16.95**

**SUB-STATIONS \$3.95**

Model 2700 5-station intercom master, in an attractive walnut cabinet 10x15x20". Push-button for each sub and talk-station switch and volume control. AC-DC amplifier with lots of power and full size Alnico V PM speaker. 1950 production. A famous factory. Only 300 left, weight 7 lbs. Model 2700, net, \$16.95.

Model MG-300 molded walnut plastic substation with call-back switch and heavy PM speaker. 5 1/2x8 1/2x3 1/2", for wall or desk. Weight 2 lbs. Net, \$3.95 each; 5 for \$18.95.

3 wire intercom cable, plastic, \$1.95 per 100 ft.; 500 ft., \$9.50.

## 6-TUBE AUTO RADIO

**SALE PRICE \$27.95**

with separate 5" PM speaker, 6x9 or 7" PM, \$2.00 Extra

A Red Hot close-out value, 6-tube superhet auto radio for universal underdash mounting. Size 1 3/4" deep, 6" wide and 4" high. Uses 2-6SK7, 6SA7, 6S01, 6X4, 6X3, 6X4 tubes. Stock No. AM-6, auto radio, complete with heavy duty 5" PM speaker, to mount in dash. Deal for all cars and trucks. May be purchased with 6x9" or 7" PM speaker for extra \$2.00. Shipping weight 16 lbs. Net price with 5" PM, \$27.95. 6x9" 3 section side cowl antenna, shipping weight 2 lbs. Net, \$1.95. 5 1/2" 3 section top cowl antenna, shipping weight 3 lbs. Net, \$3.20.

## 10 FP ELECTROLYTICS DEAL RN-10DS \$3.49

10 assorted F.P. aluminum can electrolytics. Popular twist tap mounting. Mostly multiple section banks, 50, 30 and 450 volts, a red hot deal. Shipping weight 2 lbs. Deal #RN-10DS, Net \$3.49.

## 10 BOXES OF PILOT LIGHTS \$5.49

Pilot lamps, boxed 10 to a handy carton. American made, 7 boxes #47, 1 box #40, 1 box #44 and 1 box #46. A total of 100 lamps. Deal #CX-57, Net \$5.49. 100 #47 imported panel lamps. Guaranteed 100 to the carton. Deal #RN-J47, Net \$4.49.

## 50 8 MFD. 450 VOLT COND. MONTHLY SPECIAL \$16.95

McGee's serviceman's monthly special for April. You get 50 of our regular 30E MNS 8 MFD 450 Volt Tubular Electrolytics for only \$16.95. Full one-year guarantee. Aluminum Tubular design with cardboard insulating sleeves. Fresh stock 1951 production, 2nd to none. Shipping weight 3 lbs. Deal No. RN-10, 50 8MFD 450 Volt Tubulars for \$16.95.

## UNIVERSAL OUTPUTS

Universal placement output transformers for push-pull or single plate, 2500 to 13,000 ohms, from 2 to 16 ohm voice coil. Standard size 8 x 4 mounting with long leads and lugs for voice coil connections. Deal #5 watt universal, \$1.99. U-15, 15 watt universal, \$1.19. U-20, 20 watt universal, \$1.79. 5 watt, single universal output transformer. Any tube to 3.2 ohm voice coil. It pays to have some of these around the shop. They come in handy. Shipping weight 4.4, ea. 79c; 10 for \$7.50; 25 for \$17.50.

## RCA OUTPUT \$2.95

Standard strap mounting RCA public address output transformer for PP 616 tubes, 5000 ohms plate to plate with sec. 5-8-16-250-500 ohms. 200 ohm replacement for 20 30 watt Amplifiers. Deal No. RN-V5, 21 x 2 1/2" mtg. centers, 1" core. Has long flexible leads. Stock No. 370-RN. Net price \$2.95 ea.

## McGEE'S "SUPER STORE" OPERATION SAVES YOU MONEY!

024 4 PRONG VIB. 5 OZ4 TUBE & 5 VIB. DEAL No. RN-V5 ..... **\$9.50**

Here's a red hot deal for you fellows that do a lot of auto radio service. 5 standard brand metal 024 tubes and 5 of our famous 4-prong serrated can vibrators. This vibrator is of the latest design for long life. Standard diameter can, short enough to fit all Chrysler auto sets, also fits Motorola, etc. Our 20th Anniversary. You can get 5 024 metal tubes and 5 4-prong vibrators, all for \$9.50. Shipping weight 3 lbs.

## 100 Molded Plastic Bypasses \$9.95

100 molded plastic tubular bypass condensers. All 600 volt. And all by the same nationally known mfg. Regular dealers net is over two and one-half times our 20th Anniversary sale price. You'll chuckle when you look these over. Here's what you get: 10-.001, 10-.002, 20-.005, 20-.01, 10-.02, 10-.05 and 10-.1. Our big deal No. RN-202, 100 molded tubulars. Shipping weight 2 lbs. Net price, \$9.95.

## 4-PRONG VIBRATORS \$1.29; 10 FOR \$11.90

4 MILLION AUTO RADIOS BUILT IN 1950 AND HERE IS THE PERFECT REPLACEMENT VIBRATOR FOR MOST OF THEM

Latest 1951 production by a top quality manufacturer. Fully guaranteed six months. Quiet tuning. A result of modern vibrator engineering and research. Replaces Motorola, Chrysler and any standard 4 Prong non-sync vibrator. McGee contracts for a tremendous quantity to take care of your 1951 needs. Stock #V-53 Standard 4 Prong Vibrator \$1.29 each. 10 for \$11.90; 50 for \$55.00.

7 prong reversible sync. vibrator, Mallory model 534C. Popular in many 2-way Taxi radio installations, also in a few mikes of Auto radios. Mallory #34C, \$1.95 ea., 10 for \$19.95.

Delco style off set 4 prong vibrator. Fits many General Motors built original equipment Auto sets. Stock No. VO-13, Net \$1.39 ea., 10 for \$12.90.

## SUPER HEAVY DUTY 10" PM \$6.95

We made a special purchase on several hundred 20 watt, 10", 32 oz. Alnico 3 magnet PM speakers. High fidelity sound and radio replacement. The magnet on this speaker is usually used a 1 1/2 size. Very efficient, good high and bass response. You'll appreciate it when you get your hands on this speaker. Attractive copper finish, 8 ohm voice coil, Stock No. 1025PS. Weight 7 lbs. Net price \$6.95 each.

Order three of these and use them in a cluster of three. They will take 60 watt of audio and have more cone area than any 15" speaker. For high power, top quality P.A. work. Think this over. 3 No. 1025PS speakers for only \$19.95.

## BUY YOUR WIDE RANGE COAXIAL SPEAKER AT McGEE

### 12" COAXIAL PM \$12.95

A \$32.50 retail value, 20 watt 12" coaxial PM speaker of quality built on radios of the \$300 to \$500 bracket. Hook up like any PM speaker. High pass filter is built on speaker. Matches 8 ohm output of radio amplifier. Wide frequency response, 20 to 17,500 CPS. Model No. CU-14X. Ship. wt. 9 lbs. Special sale price, \$12.95.

### 15" COAXIAL PM \$17.95

Only \$19.95 buys a full 15" 20 watt coaxial PM speaker with built-in high pass filter. Hook to any 8 ohm output on radio or amplifier. Response below 20 to above 17,500 CPS. Good bass response. A lucky purchase makes this price possible. Full 8 ohm magnet in the woofer. 5" tweeter. Model P15-9. Ship. price, \$17.95.

### PHONO \$9.50 MOTOR

9" Turntable heavy duty 78 RPM 110 Volt 60 Cycle phono motor with heavy 1 1/2 lb. turntable 4 pole motor. Don't confuse this with ordinary motor. Shipping weight 3 1/2 lbs. Stock #GS-87, Net, \$3.50; 3 for \$10.00.

### 1 or 4 VOLT CRYSTAL CARTRIDGES \$1.99

McGee offers you a famous make crystal cartridge in standard shape but very light weight. Will track on 3/4 oz. or more pressure. Stock A-6, one volt output, replaces Astatic L-70 etc., Net \$1.99. Stock No. A-10, 4 volt output, replaces Astatic L-72 and L-82, etc., Net \$1.99. Buy 10 assorted for \$19.00.

## TREMENDOUS SALE ON AUTOMATIC CHANGERS

### GENERAL INSTRUMENT 78 R.P.M. Record Changer SCOOP PRICE \$10.95

General Instrument 78 RPM automatic record changer. Plays 10- or 12-inch records automatically. One of the latest models made. Beautiful golden brown hammettone finished base. 12x12 1/2" Equipped with an Astatic L-70 crystal cartridge. Heavily flocked turntable and plastic fittings are deep maroon colored. This may be our last chance to offer a 78 RPM changer at this price. Comes packed two to a master carton. Just like they would be shipped to a set manufacturer. Order 2 changers for an additional saving. Shipping weight for 2 changers, 20 lbs. Stock No. IT-SGI. Net price, \$10.95 each; two for only \$21.00.

### V.M. 3 SPEED CHANGERS \$22.95

VM Model 406 deluxe 3 speed automatic record changer—plays them all—intermixes records of the same speed—equipped with a flip over crystal pickup with twin needles—base size 12 1/4x13. Ship. weight 12 lbs. VM-406. Net, \$22.95.

Buy the VM-950 changer with or without base. Choice of G.E. VR or crystal cartridge. We think the VM-950 record changer is the finest in America. It automatically plays all records all speeds and all sizes: 12 1/2-in., 33 1/3 or 78 rpm, 10 1/2-in., 33 1/3 or 78 rpm and 12 and 10-in. records of the same speed intermix. 12 7/8-in. or 7-in. 45 rpm. Automatically shuts off after the last record. Size 13 1/2x16 1/2x7 1/4 in. high. OES30 with crystal cartridge, G.E. VR cartridge, or either with VM-950, 3 speed changer with standard crystal cartridge all speeds and all sizes. VM-950G.E. 3 speed changer for 1 and 3 mil. (78 rpm, 33 1/3, 45 rpm). Net \$22.62. VM-950G.E. 3 speed changer with the new VM-950G.E. magic, all-in-one variable reluctance cartridge with stylus. Net \$32.60. VM-955, 3 speed changer with crystal cartridge on a base. Net \$32.01. VM-955G.E. 3 speed changer with RPN-050 VR cartridge with base. Net \$35.19.

## 12" 32 OZ. PM SPEAKER \$7.95

12", 32 oz. magnet, 20 watt PM speaker, with 8 ohm voice coil. A regular \$17.00 list Consolidated speaker. Weight 8 lbs. No. CN-1232, \$7.95 each, 4 for \$29.95.

## Special Sale Buy PM Speakers and Baffles for Less at McGEE

Combination offer, buy a speaker and baffle at the same time and save money. Baffles are all plywood construction with Brown Leatherette covering and are the slanting, wall mounting type.

6 inch baffle and 6" PM 6-CR \$4.79  
8 inch baffle and 8" PM 8-CR \$4.49  
10 inch baffle and 10" Heavy duty 10-CR \$4.95  
12 inch baffle and 12" Heavy duty 12-CR \$4.95  
5% discount on above speaker baffle combinations on orders of 3 or more.

## 25-WATT TRUMPET AND DRIVER \$16.95

Full 12-month guarantee on this 25 Watt, all-weather reentrant trumpet and driver combination. 15 Ohm impedance. 9" Bell diameter, 93 1/2" length. Made by a famous speaker manufacturer. New 1951 production, offered to you at a tremendous saving. Ideal for a deluxe pagoda speaker as well as general P.A. use. Complete with adjustable mounting bracket. Shipping weight 6 lbs. Model RE-17X, 25 Watt Trumpet and Driver. Net price, \$16.95.

## 30-WATT TRUMPET and DRIVER \$28.95

Model XX100-RM35. The finest trumpet driver combination value that we know. You get a full 30 Watt, 15 Ohm, PM Driver, guaranteed for 12 months and a 3 1/2 ft. spun aluminum trumpet. (Bell diameter 18", air column 3 1/2 ft., 18" overall length.) Both driver and trumpet have standard threads, (13/16-18) Driver is completely weather and rust proof. This is not surplus, but the latest 1951 production, by a famous speaker manufacturer. Trumpet furnished complete with adjustable mounting bracket. RM-35, 30 Watt Driver unit only, shipping weight 6 lbs. Net price, \$15.95. XX-100, 3 1/2 ft. Trumpet unit only, shipping weight 15 lbs. Net price, \$13.95. XX100-RM35, combination trumpet and driver complete. Net price, \$28.95.

## McGee's Super High Fidelity Best Value in U.S.A. OUTPUT TRANS. \$7.95

Model A-403 High fidelity output transformer. Why pay \$20 or \$30 for an output, when our A-403 is available at \$7.95? Impedance 600 ohms plate to plate, for PP 616 or 6V6, 100% feedback winding, 4-15-250 and 500 ohm secondary. Housed in a potted case. Net weight 6 lbs. Recommended for all amplifiers up to 34 watts.

## RED HOT SPEAKER VALUES

McGee has a tremendous stock of 100,000 speakers to fill your needs. Every speaker is fully guaranteed. Order your speakers now.

4 inch, square, . . . . . 1 oz. magnet \$1.69  
5 inch, pincushion, . . . 1 oz. magnet 1.79  
6 inch, pincushion 1.47 oz. magnet 2.79  
4 x 8 inch, . . . . . 1 oz. magnet 2.29  
5 x 7 inch, oval, . . . . . 1 oz. magnet 2.49  
7 inch, pincushion 2.15 oz. magnet 3.49  
8 inch, pincushion 2.15 oz. magnet 3.49  
6 x 9 inch, oval, . . . . . 2.15 oz. magnet 3.49

## 1951 "PLANET" YEAR GUARANTEE ELECTROLYTICS

MNS	8 Mfd	450v	Each	10 Lot
MN16	16 Mfd	450v	\$0.39	\$0.35
MN30	30 Mfd	450v	.59	.55
MN40	40 Mfd	450v	.59	.55
MN30	30 Mfd	150v	.39	.35
MN220	20-20 Mfd	150v	.49	.45
MN30	50-30 Mfd	150v	.59	.55
MN442	40-40-20 Mfd	130v	.69	.65

## 100 600 VOLT TUBULARS \$6.95

100 top quality 600 volt tubular by-pass condensers. Made this year by a famous condenser factory. Don't confuse these with grab-bag surplus. McGee's deals are guaranteed to please you. Here's what you get: 10-.001, 10-.002, 20-.005, 20-.01, 10-.02, 10-.05 and 10-.1 600 volt condensers. Our big deal No. RN-203. Shipping weight 2 lbs. Net price, \$6.95.

## 20 50 x 30 150 V. \$10.50 ELECTROLYTICS

Here's a red hot value, 20 of our XX quality replacement electrolytics. The most popular condensers in use today. Takes care of 90% of your AC-DC radio filter needs. Compact construction 1950 production. 1-year guarantee, 50-30 mfd. 150 volt, housed in a cardboard tube with one negative, has long flexible leads. 20th Anniversary, big deal No. RN-204. Sale price \$10.50.

## SELENIUM RECTIFIERS

65 mil Selenium Rectifier, net . . . . . \$9c each  
100 mil Selenium Rectifier, net . . . . . \$9c each  
150 mil Selenium Rectifier, net . . . . . 79c each  
200 mil Selenium Rectifier, net . . . . . \$1.09 each  
250 mil Selenium Rectifier, net . . . . . 1.19 each  
350 mil Selenium Rectifier, net. 1.59 each  
450 mil Selenium Rectifier, net. 1.79 each  
McGee offers you the best Selenium rectifiers. All standard 130 volt.

McGEE RADIO COMPANY  
Prices F.O.B. K.C. Send 25¢ deposit with Order. Balance Sent C.O.D. With Parcel Post Orders, Include Postage  
TELEPHONE VICTOR 9045. WRITE FOR FLYER  
1422 GRAND AVE., KANSAS CITY, MISSOURI

# McGEE'S GIGANTIC PICTURE TUBE AND TV MATERIAL SALE

## CONVERT TO A RECTANGULAR PICTURE



With each conversion kit you get a plastic mask, 70 degree deflection yoke, 90 day guaranteed black face picture tube, plus new 7771-X 14,000 Volt Universal Transformer and horizontal deflection transformer that works on any output tube and any sinu-oid rectifier (1B3 or 1X2). A suggested diagram is furnished for use of the transformer with several different output tubes and rectifiers, and this kit is the finest and best priced conversion kit in the country. Shipped Truck or Express, only.

Kit No. TCK-14, with 14BP4A 14" rectangular tube. Net price . . . . . \$32.95  
 Kit No. TCK-16, with 16RP4A 16" rectangular tube. Net price . . . . . \$44.95  
 Kit No. TCK-17, with 17BP4A 17" rectangular tube. Net price . . . . . \$37.95

## PICTURE TUBE SALE

Values like this 17BP4, \$22.95

Look over these picture tube prices and you will see, that for set replacement and conversion use, McGee offers you more for your money. Every picture tube guaranteed full replacement for 90 days. Every tube a tremendous value. These tubes are not seconds, but 1st quality.

NOTE: 10MP4 Replaces a 10BP4 Without Any Circuit Changes.

Tube No.	Diameter	Defl. Angle	Overall Length	Neck Length	Envelope	Face Type	Ion Trap	Net Price
10M P4	10"	34	17 1/2	7-9/16"	Glass	Clear	Single	\$16.95
12P P4	12"	30	18 3/4	8 1/4"	Glass	Clear	Double	17.95
12Q P4	12"	35	17 1/2	7 1/2"	Glass	Clear	Double	19.95
14B P4A	14"	(R)	20 16-13/16"	7 7/8"	Glass	Clear	Double	25.95
15P P4	15"	60	20 3/4	7 9/16"	Glass	Clear	Double	29.95
16A P4	16"	53	22 3/16"	7 1/2"	Glass	Clear	Double	22.95
16P P4	16"	70	17-11/16"	6 7/8"	Metal	Filter	Single	25.95
16Q P4A	16"	52	22 3/4	7 1/2"	Glass	Filter	Single	24.95
16R P4A	16"	(R)	20 18 3/4	7 1/2"	Glass	Filter	Single	23.95
17B P4A	17"	(R)	20 18 3/4	7 1/2"	Glass	Filter	Double	35.95
19D P4A	19"	60	20 3/4	5 1/2"	Glass	Filter	Double	39.95
20C P4A	20"	(R)	70		Glass	Filter	Double	39.95

Note: (R) Designates a rectangular type tube. 10M P4 perfect for 10B P4.

## SARKES-TARZIAN

13-CHANNEL T.V. FRONT END

WITH TUBES AND DIAGRAM \$795

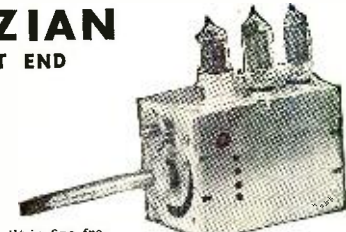

This popular Sarkes-Tarzian television front end is widely used today. The 13 channel rotary switch type with individually tuned coils. Price includes a schematic diagram and 3 tubes. 6C4 osc. 6BH6 RF and 6AG5 mixer. Regular factory cost is twice over \$795. Each tuner and its own tube sockets are wired, ready to hook up to a video and sound IF strip. May be used with either intercarrier or separate sound IF circuits. Built-in fine frequency control. Ship. weight 3 lbs. Sarkes-Tarzian Type 2 TV tuner with tubes net . . . . . \$7.95  
 Combination deal. Sarkes-Tarzian TV tuner and 205-XX video coil kit, both for . . . \$14.95  
 Sarkes-Tarzian Type 3—Same as Type 2 only has input IF coil built-in. Tapped for sound IF channel. Net. . . . . \$9.95  
 Sarkes-Tarzian Type 3 tuner and 205-XX coil kit both for . . . \$16.95

**Video Coil Kit \$7.95**  
 20 matched TV video and sound I.F. coils. Intended for use with the RCA circuit. You get 6 peaking coils, 4-25.75 mc sound I.F.'s, 2-21.25 mc sound I.F.'s, discriminator and converter coil and 5 filament chokes. Stock No. 205-XX, weight 3 lbs. Net price, \$7.95. \$6.95 if purchased with a Sarkes-Tarzian TV tuner; all coils identified.

**New 2-Tube Sarkes Tuner \$7.95 Less Tubes**  
 Sarkes-Tarzian new two-tube model, type TT-3A, 13 channel television tuner. This is the new two-tube model requiring a 6J6 plus 6AK5 or 6AG5, or 6CB6, or 6AL6 RF tubes. Pre-factory aligned by trained factory personnel. Input feeds 21 M.C. broad band. Fine tuning control is over the channel selector shaft. Power requirements 120 to 140 Volts D.C. at 17 Mills plus 6.3 Volt filament. This tuner is offered at a terrific saving to you. Stock No. TT-3A. Net price, \$7.95; two for \$15.00. Less tubes. Specify shaft length desired—2 lengths available. 7 1/2" as used on many late sets or 2 7/8".

## BRAND NEW R. C. A. TELEVISION FRONT END-TUNERS

Sale Price **\$1495**  
 A fortunate purchase from a T.V. set manufacturer makes this value possible. RCA 13 channel, completely wired, 1st set and aligned T.V. tuner. A 13 channel selector switch with outer sleeve fine frequency control. Converter output transformer is attached for direct coupling to video and sound I.F. stages. Shaft length, 3 3/8". Original dealer's cost of this item was over \$30.00. McGee offers them to you brand new (they have never been soldered to or in sets) for only \$14.95 less tubes. (3 6J6 tubes required). Shipping weight 2 lbs. Stock No. RCA-13P, less 3 6J6 tubes. Net \$14.95, two for \$27.95.

## T.V. BOOSTER REGENCY \$19.10

Regency DB-410 television booster. A real genuine unit, small and compact. Slug tuned, using 1-6B6 tube as neutralizing u.h.-pull amplifier. Dollar for dollar, your best booster buy. 5 3/8" long. For 110 volt ac operation. Weight 6 lbs. Net price \$19.10.

Astatic AT-1. "Channel-Chief" booster. Two tuned circuits and two broad band channels. Dual controls. Tune sound and picture independently. 8 1/2 x 6 1/2 x 7 1/4". Weight 6 lbs. Net price, \$32.05.

Astatic BT-1 television booster. For either 72 or 300 ohm input and output. Woodrill metal cabinet. Weight 4 lbs. Net \$19.10.

## TUBES

Guaranteed quality tubes for radio sets and TV. Tubes have been difficult for us to keep in stock. If you need tubes and will accept them, we will ship them individually cartoned or unboxed, we will do our best to supply your needs.

Note: (B) Uncartoned, (C) Cartoned, (R) Raytheon, (KR) Ken-Rad, (S) Sylvania, (TS) Tung-Sol, (NU) Nat'l. Union, (J) Jewel, etc.

024	CR	B	\$0.62	6A17	7A5	R	C	\$1.10	14N7	R	C	\$1.32				
1B	CR	B	1.32	6AQ5	7A7	R	C	.90	14R7	R	C	1.32				
1C6	KR	C	1.60	6AT6	.75	7A6	R	C	.90	14Y4	KR	C	1.20			
1H5	S	B	.90	6AU6	1.00	7A7	R	C	.90	14X7	KR	C	1.32			
1L4	S	B	1.00	6B8	B	1.60	7B6	S	B	.90	19B6G	R	C	3.00		
1LA4	R	C	1.32	6BA7	R	1.20	7C4	R	C	1.60	19C6G	R	C	1.60		
1LA6	R	C	1.32	6BG6	R	2.40	7E7	P	1.10	25L6	R	C	1.00			
1L5	S	B	1.32	6BQ6	R	1.00	7E7	S	B	1.32	25W4G	R	C	1.00		
1LC6	S	B	1.32	6CS	R	.83	7E7	S	B	1.10	25Z6H	KR	C	1.00		
1LD5	S	B	1.32	6C6	R	C	1.10	7H7	NU	B	C	1.32	27	R	C	.90
1L5	S	B	1.32	6C6	R	C	1.10	7H7	NU	B	C	1.32	27	R	C	.90
1LH4	S	B	1.32	6F7	R	C	1.60	7N7	J	B	C	1.10	35/51	GE	C	1.10
1LN5	R	C	1.32	6K5Gy	H	B	1.20	7V7	S	B	.90	35C5			1.00	
1L5	KR	B	1.00	6K9t	R	C	1.00	7Z4	S	B	.90	35Y4			.90	
1L5	R	C	1.00	6K9t	W	C	1.60	100	R	C	1.90	35Z5			.75	
174	R	C	1.00	6L7	R	C	1.00	12A8gt	R	C	1.10	39/44	R	C	1.32	
174	R	C	1.00	6G7	R	C	.90	12AL5			1.00	41	R	C	1.00	
174	R	C	1.00	6G7	R	C	.90	12BA7			42	KR	C	1.00		
174	R	C	1.00	6G7	R	C	.90	12BD6			43	R	C	1.00		
1V2	R	C	.75	6SA7	R	C	1.00	12J5et	S	C	.75	47	S	C	1.45	
1X2A	R	C	1.32	6SA7	T	S	C	1.45	12J7	NU	B	C	1.10	50A5		1.00
2A5	R	C	1.10	6SD7	T	S	C	1.45	12J7	NU	B	C	1.10	50B5		1.00
2A7	R	C	1.32	6SF5	T	S	B	1.8	12K8	KR	C	.90	50L6		.90	
3A4	R	C	1.00	6SH7	R	C	1.00	12L7	KR	B	C	1.00	50Y6		.90	
31F4	R	C	1.32	6SG7	R	C	1.00	12SA7			50Y6		.90			
3Q4	R	C	1.10	6SH7	KR	B	1.10	12SB7			50Y6		.90			
35A	R	C	1.00	6S17	R	C	.90	12SK7			50Y6		.90			
474	R	C	2.40	6SK7	R	C	.90	12SL7	R	C	1.20	58	GE	C	1.00	
5U4G	R	C	.83	6SQ7	R	B	.75	12SQ7			58	GE	C	1.00		
5V4	R	C	.90	6S77	R	B	1.00	12TA7			58	GE	C	1.00		
5Y3gt	R	C	.63	6SV7	KR	C	1.45	14A4F	J	B	1.2	58	GE	C	1.10	
5V4	R	C	.83	6S77	KR	C	1.45	14A4F	J	B	1.2	58	GE	C	1.10	
5Z4	R	C	1.32	6V6	KR	B	1.00	14C5	KR	C	1.32	117L7	R	C	1.95	
6A5	R	C	1.32	6W4	KR	B	.90	14E6	R	C	1.10	117W7	R	C	1.95	
6AG7	R	C	1.60	6X4	R	C	1.60	14H7	R	C	1.20	117Z6	CR	B	1.20	
6AL5	R	C	1.95	6Y7g	R	C	1.60	14N7	R	C	1.20	9003 JAN	C	1.00		

## McGEE HAS COMPLETE KITS FOR SCHOOLS AND CUSTOM BUILDERS

### 7-TUBE FM-AM TUNER

**\$29.95**

- ★ AC SELF POWERED
- ★ 3 GANG TUNING
- ★ A COMPLETE KIT

McGee has ready for delivery, this self powered AC, 7 tube FM and AM superhet tuner kit. Build yourself a professional looking tuner that may be connected to any audio amplifier. Receives broadcast 550 to 1650 kc and FM 88 to 108 mc. A 3 gang tuning condenser is used on both FM and AM. This extra stage of TRF makes a smoother working tuner. 2 IF stages on FM and one IF stage on AM (I.F. frequency 456 and 10.7 mc). Lighted slide rule dial with metal escutcheon plate. Our own lab designed and wired an original tuner using these parts. Chassis is ready punched and painted. Everything furnished including tubes and diagrams. Shipping weight 12 lbs. Stock No. RAL-8, net price \$29.95.

### MODEL ME6-2 \$14.95

### NEW MODEL 6-TUBE, 2-BAND RADIO KIT

A FULL 2-GANG SUPERHET KIT  
 RECEIVES 550-1600 KC PLUS 6-18 M.C.

McGee's new 1951, 6 tube; AC-DC 2 band radio kit. Receives broadcast, 550 to 1600 kc and short wave, 6 to 18 mc. A straight forward superhet circuit with 2 gang tuning condenser, 456 kc I.F. transformers, etc. 5" speaker illuminated slide rule dial. Everything furnished, including tubes, diagram and a photo showing view of underside of completely wired chassis. The chassis pan and dial parts are factory production. With this kit, you can build a commercial looking and factory quality 2 band radio, housed in a streamlined plastic cabinet. Size: 13 x 6 x 6 1/4". Stock No. ME6-2, shipping weight 10 lbs. Net \$14.95.

### SELF POWERED AC

Broadcast Tuner Kit. 3-Gang Tuning. Complete Kit, \$12.95

A self-powered, 3-gang superhet tuner kit with R.F. stage. When wired according to our diagram will make a top quality broadcast tuner (550 to 1650 kc), for use with any amplifier. Don't class this with ordinary tuners; this has its own power transformer. This complete kit is furnished with a diagram, photos and tubes: 6SH7 R.F., 2-7E7 converter-mixer and 6B7G I.F. detector and T4 rectifier. Connect labor, 6S77 I.F. amplifier. Ideal for use with our S-2020, TM-16 or 7X5 amplifier kits. Chassis size, 9 1/2 x 4 1/2" high. Shipping weight, 7 lbs. Broadcast tuner kit Model BT-35X. Net price, \$12.95.

### 8-TUBE 22 WATT Wide Range Amp. Model 7x5 Kit Only \$37.95

A complete kit, including tubes (3-7E5, 2-7F7, 2-6A3, plus rectifier), diagram and photos. All triode circuit makes for minimum harmonic distortion. Inputs for radio tuner any kind of phono pickup (crystal or G.E. variable reluctance) and either crystal or dynamic mike. Output transformer matches 8 ohm voice coil. Twin electronic tone controls, bass and treble with range selector switch for either juke box quality with heavy bass response or brilliant symphonic range. The best quality amplifier kit we know how to make. Response 18 to 20,000 CPS. 8 tube all triode amplifier kit, complete with tubes. Weight 25 lbs. Net \$37.95.

### 10-TUBE RADIO KIT \$29.95

3-GANG TUNING MIKE INPUT 12 WATT HI-FI AUDIO BASE-TREBLE BOOST

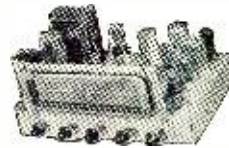

### A NEW 1951 ALL-PURPOSE RADIO KIT

10-Tube Broadcast (550 to 1700 kc) Radio Kit for custom builders. Features 3-gang superhet circuit with A.V.C., high gain IF circuit, 8" slide rule dial. Chassis size 12 1/2" long, 10" front to back, 6 1/2" high. Audio inputs for a crystal or dynamic mike, and record changer or General Electric variable standard crystal pickup or 6Y6 output tubes, shielded high fidelity output transformer matches 8 ohm PM speaker, husky power transformer, 2 tone controls for separate base and treble boost. A complete kit, including tubes (3-7E5, 6SH7, 6SF7, 2-7F7, 2-6V6, plus rectifier), diagram and instructions. Shipping weight 18 lbs. Stock No. EK-R10, net price \$29.95. 10" PM speaker, \$6.95 extra. Crystal mike and desk stand \$4.95 extra. VM-406 3-speed automatic record changer, \$22.95 extra.

### 5-TUBE BROADCAST SUPERHET RADIO KIT \$12.95

Model NS-5X 5 tube AC-DC superheterodyne radio kit. Has loop antenna and 2 gang condenser, with lighted slide rule dial and attractive plastic cabinet. Receives broadcast 550 to 1650 kc. Full size dynamic speaker, matched 456 I.F.'s, automatic volume control. This is a complete radio kit. Everything furnished, including diagram, photos and tubes: 14B6, 14Q7, 14A7, 50B5 and rectifier. Shipping weight 7 lbs. Stock No. NS-5X. Net price \$12.95.

### Build Your Own Phono-Mike Broadcaster \$7.95

Kit Model DE-6R. With this simple kit, you can broadcast over any radio, within your home, (about 75 feet) from 800 to 1500 kc. Inputs for crystal mike or crystal phono pickup. Factor control index for minimum harmonic distortion. Ideal for a home P.A. system, baby listener and home entertainment. A complete kit of parts, including tubes, Kit Model DE-6R. Net price, \$7.95. DE-6RWT, wired and tested. Net price, \$9.95. Crystal mike and desk stand, \$4.95 extra. Console microphone unit, only 1/2" in diameter and 1/4" thick. Specify hidden mike when ordering. Stock No. T-001. Net, \$3.95 extra.

### T.V. TUNERS \$2.95

General Instrument 12 Channel TV Tuners, less the 3 6J6 tubes. Good condition, but have been removed from sets. Stock No. GI-13PX. Net Price, \$2.95 ea. GI-13P, same as above only new. Net price, \$7.95 ea. Sarkes-Tarzian 3 tube TV tuners, less 6BH6, 6C4, and 6AG5 tubes. Net price, \$3.95 ea. (Good condition, but have been in sets.)

WRITE FOR McGEE'S NEW FLYER

McGEE RADIO COMPANY  
 Prices F.O.B. K.C. Send 25¢ Deposit with Order. Balance Sent C.O.D. With Parcel Post Orders, include Postage

TELEPHONE VICTOR 9045. WRITE FOR FLYER 1422 GRAND AVE., KANSAS CITY, MISSOURI

# TRT Tubes Reduced Terrifically

## !! Prices Smashed !!

TRT tubes undergo rigid tests before leaving the TRT plant. This guarantee of testing is but one assurance of quality. Rugged construction, dependable performance and economical service make TRT tubes more desirable. Compare performance and quality with any standard tube.

✓ Check This  List For Fully Guaranteed Tubes

Type	Price	Type	Price	Type	Price	Type	Price	Type	Price
OZ4	.63	5AX4	.47	6BL7	1.10	6T8	1.10	12SA7GT	.68
1AB5	1.22	5AZ4	.54	6BJ6	.76	6U5	.76	12SG7	.76
1A6	1.22	5Y3GT	.39	6BN7	1.22	6V6GT	.76	12SK7GT	.68
1B3GT	.84	5Y4G	.57	6BQ6GT	1.22	6W4GT	.68	12SL7GT	.91
1B3GT	1.01	5U4G	.57	6BY5	1.01	6W6GT	.76	12SN7GT	.84
1B5	1.22	5X4	.68	6C4	.63	6X4	.57	12SQ7	.57
1B7GT	1.22	5Z3	.63	6CB6	.76	6X5	1.01	12SR7	.76
1CSGT	.84	6AC7	1.10	6CD6G	2.28	6X5GT	.57	19BG6G	2.28
1HSGT	.63	6AB4	.76	6E5	.84	6Y6G	.91	19T8	1.10
1L4	.76	6AG5	.91	6F5GT	.63	7C5	.68	25BQ6GT	1.22
1L6	1.01	6AK5	1.48	6F6G	.63	7E6	.84	25AV5	1.01
1LA6	1.01	6AL5	.68	6H6GT	.68	7F7	.84	25L6GT	.63
1LC5	1.01	6AQ5	.76	6J5GT	.57	7J7	1.01	35A5	.68
1LC6	1.01	6AQ6	.68	6J7G	.84	7Q7	.68	35B5	.63
1LH4	1.01	6AT6	.57	6J8G	1.22	7X6	.84	35C5	.63
1LN5	1.01	6AU6	.76	6K6GT	.57	7Y4	.68	35L6GT	.63
1R5	.76	6AV6	.57	6L6G	1.10	7Z4	.68	35W4	.47
1S5	.68	6AX5GT	.63	6L6GA	1.10	12A8GT	.84	35Y4	.68
1T4	.76	6B4G	1.22	6S4	.68	12AT6	.57	35Z5GT	.47
1T5	.91	6BA6	.68	6S8	1.01	12AT7	1.10	42	.76
1U4	.76	6B7	.91	6SA7GT	.68	12AU6	.76	45	.76
1U5	.68	6BC5	.76	6SD7GT	1.10	12AU7	.91	50B5	.76
1X2	1.01	6BD5GT	1.22	6SK7GT	.63	12AV7	1.10	50C5	.76
2A3	1.22	6BE6	.68	6SL7GT	.68	12AX7	.91	50L6GT	.63
3E4	1.82	6BF5	.84	6SN7GT	.91	12BA6	.68	50X6	.84
3Q4	.84	6BF6	.63	6SQ7GT	.84	12BA7	.91	70L7GT	1.48
3V4	.76	6BG6G	1.82	6SR7	.57	12BE6	.68	80	.54
	.76	6BH6	.76		.68	12S8	1.08	117Z3	.57
								807	1.98

Save 5% Discount on Orders of 100 or More

### PICTURE TUBES

Type	Price	Type	Price
17BP4	23.95	16RP4	22.95
16TP4	23.50	14BP4	17.50

**TERMS:** A 25% deposit must accompany all orders—balance C. O. D. All shipments F. O. B. Newark warehouse. All tubes guaranteed for 90 days. Orders under \$5.00—\$1.00 Handling Charge. Subject to prior sale.



**TELEVISION and RADIO TUBE CO.**  
412 HALSEY STREET NEWARK 2, NEW JERSEY



## AGNAFILTER'S Top Sales Prove

• CUSTOMERS DEMAND MAGNAFILTER • BIGGER PROFITS FOR YOU!

MAGNAFILTER'S a HIT with TV set owners because it provides easy-on-the-eyes, non-glare, distortion-free enlargement. The image is filtered, enlarged and has a third dimensional effect. MAGNAFILTER combines brilliance with balance... complete full vision.

Made of finest quality materials...selected and fabricated to give ideal contrast in light values and the greatest magnification without distortion. A SURE SELLER—MAGNAFILTER!

Write Today For Literature and Prices

MAGNAFILTER CORPORATION, 11056 Cumpston St., North Hollywood, Calif.

## Technical BOOKS

**"A ROMANCE IN RESEARCH"**  
(The Life of Charles F. Burgess) by Alexander McQueen. Published by *The Instruments Publishing Company*, Pittsburgh. 421 pages. Price \$6.00.

While the name "Burgess" is virtually synonymous with the word "battery," relatively few persons know anything about Charles F. Burgess—the man behind the enterprise.

His life was a many-faceted one, embracing careers in teaching, research, and industry. In many respects his life paralleled those of other industrial giants of his era in that his beginnings were exceedingly modest, he worked from boyhood, worked his way through the University of Wisconsin, and later was a member of the faculty of his *alma mater* for many years.

Dr. Burgess established his laboratories in 1910 and later founded the *Burgess Battery Company* to manufacture the dry battery to which he was devoting much of his time and energy.

This biography is a painstaking and detailed chronology of "C.F.'s" life from boyhood to his death in 1945. This volume, written about a contemporary of Dr. Lee de Forest, adds another chapter to the history of radio as told through the lives of its pioneers.

\* \* \*

**"TELEVISION PROGRAMMING AND PRODUCTION"** by Richard Hubbell. Published by *Rinehart & Company, Inc.*, New York. 234 pages. Second Edition.

This second edition of Mr. Hubbell's book is an even more valuable contribution to the art of television than the original edition which appeared in 1945. Since the appearance of the first edition many new and specialized techniques have been developed by those responsible for the material which appears on the video screen, and Mr. Hubbell's book provides the tools for successful programming.

The book is divided into seven parts, dealing with the nature of television, the camera, video technique and theory, the audio, TV programming in Europe, and going on the air, in addition to an over-all picture of television as an educational and entertainment medium.

The text material, which reads like a novel, is lavishly illustrated by photographs of actual telecasts which show behind-the-scenes production problems as well as the picture that is transmitted over the air.

This handbook richly deserves the reputation it has gained as the "bible" of television programming and production.

\* \* \*

**"VACUUM-TUBE VOLTMETERS"** by John F. Rider. Published by *John F. Rider Publisher, Inc.*, New York. 413 pages. Price \$4.50. Second edition.

This volume which deals exclusively

**RADIO & TELEVISION NEWS**



with a single piece of test equipment is, we believe, unique in the radio field. The widespread use of the v.t.v.m. in servicing not only makes this book practical but necessary.

In this second edition of a book originally published in 1941, the author and his revisor, Alfred W. Barber, have presented complete circuit details on virtually all commercial v.t.v.m.'s currently available, presented a detailed analysis of the circuits, covered the design of such instruments, and provided full information on how such test instruments are to be used and maintained.

One section, of particular value to technicians, covers the step-by-step procedures to be followed in using the v.t.v.m. for the basic measurement of inductance, resistance, capacitance, r.f., a.f., and d.c. voltages and currents.

Details are given on all types of v.t.v.m.'s including diode, triode, rectifier-amplifier, tuned, amplifier-rectifier, and slide back.

An extensive bibliography covering over 200 references completes this text. The book is suitable for home-study, as a text book in technical schools, or as a reference work for engineering libraries.

**"TRANSFORMERS — THEIR PRINCIPLES AND DESIGN FOR LIGHT ELECTRICAL ENGINEERS"** by F. C. Connelly. Published by Sir Isaac Pitman & Sons, Ltd., London. 483 pages. Price 35/-.

This is a thoroughly practical handbook for the engineer whose job entails the designing of transformers for radio communications, r.f. heating, electronics, portable machine tools, electromedical equipment, illumination, and measuring equipment.

While the author has assumed that those using this text will be familiar with the basic principles of electricity and magnetism, and have a working knowledge of calculus and the "j" operator, the material as presented is fundamental and those with no previous experience in designing transformers should find this book useful and instructive.

There are twenty-four chapters dealing with the fundamental principles; the magnetic properties of iron and steel; theory; losses, efficiency, and regulation; constructional details; temperature rise; designing small power transformers; magnetic leakage; tappings and tap changing; core excitation; transients; three-phase transformers; transformers supplying rectifiers; high voltage transformers; autotransformers; variable-ratio units; transformers depending on magnetic saturation; vibrator transformers; instrument units; audio frequency types; output transformers; inter-tube transformers; transformers for television receivers; and design data.

Design engineers will certainly want to investigate this new work as much of the information contained in this volume is applicable to their everyday tasks.\*

-30-

July, 1951

# STAY TUNED IN!

*Always*

## There's *^* a NEWS Program from the TELETOWER!



Teletower always has... does... and always will... place "high priority" upon development engineering. It was constant design study that pushed Teletower to top position in sales. *Continuing* design study will keep it "the tower in your future".

Penn's newest development is a "revolution"—a *new* self-supporting tower that carries two hundred and fifty pounds of head-load without using a single strand of guy wire! You'll be hearing *plenty* more about this one soon... from Penn... from dealers... from set owners.

Watch this publication for our advertising... and watch your mail for timely messages from Teletower.

### STAY TUNED IN... WITH TELETOWERS!

A FEW DEVELOPMENT ENGINEERING ACHIEVEMENTS OF JUST ONE YEAR!

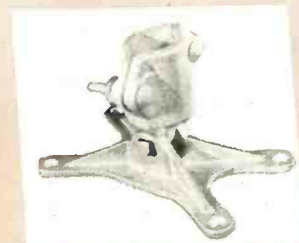

**Pole Base Mount.**  
Durable aluminum base with adjustable socket to accommodate 1" O.D. tubing to 2" pipe. Competitively priced.

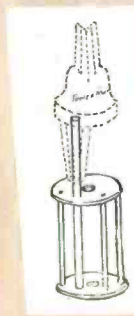

**Universal Motor Mount.**  
Easy to adapt to all antenna rotors.

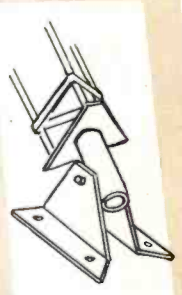

**Built-In Base** permits raising tower on slope after base is fastened to roof.

# PENN

Teletowers  
Wristowers  
Antenna-Mast  
Hardware

PENN BOILER & BURNER MFG. CORP., LANCASTER, PA.

# TO SAVE MONEY ORDER FROM OLSON RADIO



## V-M 3-SPEED RECORD PLAYER

100% automatic in operation. Plays 33 1/3, 45 and 78 R.P.M. records. Load capacity is twelve 10" or ten 7" (33 1/3 or 78 R.P.M.) twelve 7" (45) or 12" records of the same tone arm can be held at any time without damage to mechanism. Shuts off after last record. Size 1 1/2" x 12 1/4" x 5 3/4" above and 2 1/4" below. Plate, 115 volts AC, 60 cycles. Includes turn-over cartridge and dual needles. Reg. List Price \$46.50. **Model 950**

**\$29.62**  
Model 950

Olson's Price, each.....**\$29.62**  
With GE triple-play variable reluctance cartridge and dual needles. Reg. List Price \$31.50. **Model 950 GE**  
Olson's Price, Each.....**\$32.80**



## PHONO CARTRIDGES

A truly universal type. A perfect replacement for Astatic L-70, L-71, L-72, L-40, etc. Delivers 3 volts output. Brand new, fresh stock. Order plenty during this sale.

**XC-30**, Single, ea. .... **\$1.79**  
Lots of 10, ea. .... **\$1.59**  
**HIGH OUTPUT CARTRIDGE**  
Similar to above but will deliver 9 volts. Can be used on all speed discs. 33 1/3, 45, and 78 R.P.M.  
**XC-47**, Single, ea. .... **\$2.19**  
Lots of 10, ea. .... **\$1.99**



## TUBULAR ELECTROLYTICS

All standard types. Most popular sizes. Aluminum tube with cardboard insulating sleeve. Olson was Johnny-on-the-Spot and he got a bargain—you can cash in. Every condenser unconditionally guaranteed a full year.

20 MFD. 150 V STOCK NO. C-628 <b>25c</b>	40 MFD. 150 V STOCK NO. C-629 <b>27c</b>	50-30 MFD. 150 V STOCK NO. C-630 <b>49c</b>
6 MFD. 450 V STOCK NO. C-631 <b>33c</b>	20 MFD. 450 V STOCK NO. C-632 <b>40c</b>	40 MFD. 450 V STOCK NO. C-633 <b>45c</b>

## PHILCO 1951 AUTO RADIO

## THE ONLY UNIVERSAL ONE-PIECE AUTO RADIO FOR ALL CARS



A brand new Philco 6-tube super-het auto set with 30% more undistorted sound output for rich, clear-voiced volume and greater range. New 3-gang permeability tuner. Built-in interference filtering.

New streamlined design, with slide-rule dial encased in gleaming chrome finish to harmonize with modern cars. Rugged, compact steel case finished in dark blue hammer-type lacquer, has sloping front—neat, attractive, space-saving—out of passengers' way. Installed in a few minutes beneath the instrument panel of the car. Controls are easy to reach and tune... yet set is out of the way and virtually out of sight like a built-in part of the car. Complete with tubes, mounting bracket, generator condenser and distributor suppressor. Size: 5 3/4" x 5 3/4" x 7 1/4". Shpg. wt. 20 lbs.

Model CR-501  
**\$34.37**

FITS ANY CAR OLD OR NEW **OLSON'S GREAT VALUE!**

**4 PRONG VIBRATOR**. Popular 4 prong vibrators as used in 90% of auto sets. We promised not to mention the manufacturer's name. Save more than 70%. Guaranteed. Replaces Motorola, Chrysler and any standard 4 prong vibrator. Replaces Mallory 294, \$59. 901M; Radiart 5300, 5501. Can size 1 1/2" x 2 1/8". Reg. List Price \$4.90. Single, Each..... **\$1.49**  
Lots of 10, each..... **\$1.29**

### AUTO RADIO ANTENNAS

**RUSTPROOF BRASS TUBING INSTANTLY ADJUSTED!**

**TRIPLE CHROME PLATED HIGH QUALITY INSULATORS!**

**SIDE COWL MOUNT 3 section; extends to 66". Includes low loss lead-in cable. AU-1** **\$1.99**

**AU-8 GENERATOR CONDENSERS** For all auto sets. Single each, 25c. C-220, Lots of 10, each **25c**

**RPX-040 XC-45** Variable Reluctance Cartridge with Removable Stylus  
**\$3.49 EACH**

**12" CO-AXIAL SPEAKER**  
S-160  
Months of research went into the design of these high efficiency speakers. The 12" woofer section is driven by a heavy Alnico 5 6.8 oz. magnet and this part delivers the bass notes. The high pass filter is built into the speaker and the entire combination gives you tone you never dreamed possible. There are only two wires to connect to any radio or amplifier and the speaker is ready to play for you. Voice coil impedance is 8 ohms. This high quality speaker should not be confused with inferior makeshift units. Olson sells these speakers on an irrevocable money-back guarantee if you are not 100% satisfied. Order today. Shpg. wt. 8 lbs.



ORDER NOW!

### Exact Replacement GE Needles

Used in ALL GE VARIABLE RELUCTANCE CARTRIDGES

Stock No.	GE Type	Cartridge	Tip	Your Cost
N-32	RPJ-001	RPX-040	3 MIL	2.06
N-33	RPJ-005	RPX-040	1 MIL	2.06
N-34	RPJ-010	RPX-050	DUAL	3.50

### OLSON'S BIG BARGAIN

Stock No.	Size	Watts	Lbs.	Each
S-4	4"	3	2	\$1.69
S-5	5"	5	2 1/2	1.79
S-6	6"	5	2 1/2	2.29
S-7	10"	6 1/2	3	2.69
S-114	6"	6	3	3.39
S-96	7"	6	3	3.39
S-86	8"	6	4	3.49
S-11	11"	10	4	3.99
S-112	12"	13	6	6.99

Genuine Alnico 5 PM Speakers. Because of the shortage of Cobalt (used in Alnico 5) speakers will not be available after our stock is gone. Protect yourself—Order now! Order enough. These speakers are made by a nationally famous manufacturer and are guaranteed to give 100% satisfaction. Frequency response is excellent. All speakers have 3 1/2 ohm voice coils except 12" which are 6-8 ohm.

BUY ALL YOUR RECORDING NEEDS FROM OLSON

### TAPE

Fine magnetic recording tape, 1/2", Frequency response, 50 to 5000 cycles at 7 1/2" per second. Uniformly coated with red oxide, available in paper base and plastic base which is stronger. Order with the best from Olson. Get the best for less.

### PAPER BASE

Stock No.	Size	Olson's Price, ea.
X-203	1 1/2" x 600 ft.	\$1.35
X-205	1 1/2" x 1200 ft.	2.10

### PLASTIC BASE

Stock No.	Size	Olson's Price, ea.
X-204	1 1/2" x 600 ft.	\$2.10
X-206	1 1/2" x 1200 ft.	3.30

### NEW CRYSTAL MIKE

Nationally famous 5 m.m. Smart-Nut Design, simple, easy to hold. Used in many tape, wire and disc recorders. Can be used on P.A. systems, amplifiers, etc.

**Olson's Special** response is excellent. **\$4.29**

### STEEL RECORDED WIRE

For all standard wire recorders. Frequency response is excellent. Stainless steel wire. **X-165** 1/2 hr. spool..... **\$1.98**  
**X-166** 1 hr. spool..... **\$2.98**

### PANEL LAMPS

Westinghouse, GE, and Tung-Sol bayonet panel lamps. 100 of a type to the box.

Stock No.	Type	Price per 100
X-161	47	\$5.59
X-174	44	
PL-25	51	\$4.29

### OLSON'S NEW AKRAD KIT

WITH 4-DRAWER STEEL CABINET **FREE**

Reg. Value \$16.38. **\$6.95**

We have a limited quantity of Olson Akrad "Super Sealed" by-pass condensers available in 4 drawer steel cabinets, size 6 1/4" x 3 1/4" x 3 1/4". Drawers have compartments. Condensers are designed to give long dependable service even in the tropics. Kit Contains 42 Condensers. You get the 4 drawer steel cabinet and the following 42 Olson Akrad "Super Sealed" by-pass condensers.

Qty.	Cap.	Volts	Qty.	Cap.	Volts
2	.001	600	10	.05	600
2	.002	600	10	.1	600
2	.005	600	2	.005	1600
5	.01	600	2	.008	1600
5	.02	600	1	.01	1600

### OLSON HAS ONLY THE BEST IN TV

#### SPRAGUE TV FILTERS

20-10-10-10 MFD-450 V This is it. A four-section Twist-Prong electrolytic condenser that will operate up to temperatures of 185° F. Widely used in TV sets, amplifiers and radios. Will withstand high ripple and voltage surges. Size 1 3/4" x 2". **C-617**. While they last, ea. **99c**

#### DEFLECTION YOKE

Deflection Yoke for use with 10BP4, 12BP4, 16BP4 and all similar kineoscopes, same RCA 205D1 WT. 2 1/2". **T-84**, Ea. \$2.79. Lots of 3, ea. **\$2.29**

Deflection Yoke for use with kineoscopes requiring 70 degree magnetic field. Such as Rectangular 14BP4, 14CP4, 16BP4, 16CP4 and round 16GP4. WT. 2 1/2". **T-93**, Ea. \$3.49. Lots of 3, ea. **\$2.99**

#### Hi-Voltage Flyback output transformer for 10" & 12" kinescopes. Provides 9KV. Same as RCA 2170 WT. 4 1/2". **T-82**. Olson's Price, Each only **\$2.99**

### TV ANTENNAS

Here is a real bargain for TV installation men. Genuine Conical TV Antennas scientifically designed to give optimum reception. Highest grade aluminum tubing is used. Complete with antenna elements, cross arm and cross arm brackets. Less mast and 300 ohm twin-lead line. Take any size masts up to 1 1/2" O.D. Packed in factory sealed cartons of 6 Antennas to a box.

**SOLD ONLY IN BOXES OF 6 ANTENNAS**

**AU-62**, In lots of 6, each **\$3.83**

**AU-63**, Carton of 6, wt. 25 lbs., **\$22.98**

### TV INSTALLATION MEN

If you install TV Antennas, Olson wants you to take advantage of this terrific Antenna Array with high frequency stubs. Ideal for "Fringe" Area Reception. Sturdily constructed elements are aluminum. Easily assembled.

**This is a Terrific Value!** Each Antenna consists of two conical bays plus a pair of matching Q bars. Less mast. Packed in cartons. This gives you the six bays and 3 pairs of Q bars.

**Sold Only in Boxes of 3 Antennas**

**AU-66**, In lots of 3, each **\$8.66**

Carton of 3..... **\$25.98**  
Weight 25 lbs.

### ALLIANCE TENNA-ROTORS

The Alliance Tenna-Rotor makes it possible for you to "beam" or turn your antenna in the direction best suited to pick up any TV station within range. When so turned the signal is delivered by the antenna to the TV set is increased by giving you a better carrier picture. The rotor unit is fully enclosed in a moisture-proof housing. Fully lubricated for long constant focus. This focus coil is used in scores of TV sets including General Electric, Stromberg-Carlson, Air King and many more. Can be used on all 16"-70" and 19"-66" kinescopes. Here's a real value. Buy now and save. Because of the shortage of Cobalt they will not be available after our present stock is gone.

**AU-15**, MODEL ATR. Tenna-Rotor with control box which shows end of 360° rotation by means of an indicator lamp on control box. Does not show direction of antenna. Each **\$20.53**

**AU-12**, MODEL DIR. Tenna-Rotor with control box which shows an indicator dial showing direction antenna is beamed, ea. **26.43**

**AU-21**, MODEL HIR. Tenna-Rotor with automatic control box. You set the pointer for direction desired and antenna turns to that direction and stops automatically. Each..... **\$26.43**

### POPULAR TV COMPONENTS

These TV parts are made by famous name manufacturers. A lucky purchase makes possible these bargain prices. Stock up now. Each part shown here uses Alnico 5 magnet material which is practically impossible to obtain. Get your share of these scarce components at far less than wholesale.

#### EM-PM FOCUS COIL

**T-90 Special**. While they last, each... **\$2.98**

### ION TRAP

**T-91 Special**. While they last, each... **98¢**

### FOCALIZERS

**T-89 Special**. While they last, each... **\$1.98**

Genuine focalizers, also known as focus magnets. Provides sharp focus relatively independent of regulation in the low voltage power supply. No connections necessary. Widely used in many 1950 models. Utilizes heavy duty Alnico 5 magnet.

#### 4 CONDUCTOR CABLE

For use with all Alliance Tenna-Rotors. **W-62**, 100 ft. Coil, ea. **\$4.00**

#### THRUST BEARING BRACKET

For use with any above Alliance Tenna-Rotors where extremely heavy antenna is to be used. Supports up to 200 lbs. **AU-13**, each **\$2.99**

#### 300-Ohm Lead-in

High grade, low loss. For all TV installations. Ship. wt. 3 lbs. **W-68**, 100 ft. coil. Ea., Lots of 10 Each **\$4.00**

### ALL AMERICAN TUBE KIT

5 most popular tubes, 1 each of the following: **12SA7-12SK7-12SQ7-35Z5-50L6**. Made by Raytheon, Ken-Rad, Sylvania, etc. 100% guaranteed. **AS42 Kit of 5 tubes..... \$3.99**



# OLSON RADIO WAREHOUSE 73 E. Mill St., Akron 8, Ohio

RADIO & TELEVISION NEWS





### DUMONT 4-CIRCUIT INPUTUNER

Featuring FM BAND reception, as well as 13 TV channels. Fits into dual channel IF system Type 630 receivers without alteration. Higher gain 2-1 ratio on high channels, low noise; input impedance 300 ohms. 21.25 mcs. sound center IF. Continuous tuning. Complete with TUBES and KNOBS drastically reduced to....

**\$19<sup>95</sup>**

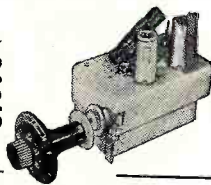

### SIGMA PLATE RELAY—8000 ohms DC resistance

SPDT .....\$2.95

6-VOLT DPDT RELAY—Automatic electric, No. R22, 18 ohms DC. ....\$2.95

### METERS

#### SUPREME MODEL 542

#### MULTIMETER

#### SCALES:

- 4 DC MIL ranges 0/0.3/6/30/150
- 4 DC VOLT ranges 0/6/150/300/1500
- 4 OHM ranges 0/20000/20000/200000/2 meg
- 4 AC VOLT ranges 0/6/30/150/600
- 4 OUTPUT ranges 0/6/30/150/600
- 4 DECIBEL ranges -6/+10, +8/+24/, +22/+38, +34/+50



Less Leads and Battery Bakelite Moulded Case. **\$15<sup>95</sup>**

TRIPLETT MILLIAMETER—Model 327A, 3" square, 0 to 3 mils DC.....\$3.95

SIMPSON 2 1/2" Round RF Ammeter, 0 to 8 amps RF, Type 1S-89.....\$3.49

WESTON Model 507, Thermocouple 0 to 4 amps. RF.....\$3.95

WESTON MODEL 731, 0 to 5 amps., DC, white face, 3" square.....\$5.95

WESTON Model 731, 0 to 1 amp DC, white face, 3" square.....\$5.95

7 1/2" 0-200 MICROAMP METER Made Specifically for VTVM

5 SCALES: ohms, DC volts, Kilovolts, AC **\$17<sup>95</sup>**



#### SPEAKERS

RCA 12" SPEAKER—3.2-ohm v.c. Alnico V magnet.....ea. \$4.95

MAGNAVOX 12"—8-ohm v.c. Alnico V magnet, 12-watt output.....ea. \$5.95

QUAM-NICHOLS 7"—3.2-ohm v.c. Alnico V magnet. Excellent response.....ea. \$2.59

#### HEAD SETS

Low impedance, lightweight, Type TH37, complete with headband, plug, etc.

Brand New .....\$2.95

#### PIONEER GEN-E-MOTOR

Type E-3: Input 14 VDC @ 8 amps DC. Output 550 V @ 120 mils...\$14.95

SP-125: Input 28 VDC @ 2.2 amps DC. Output 270 V @ 120 mils...\$6.95

DS-125: Input 28 VDC @ 1.2 amps DC. Output 260 V @ 60 mils...\$4.95

Type DA-1A: Input 28 VDC @ 1.6 amps DC. Output 230V @ 100 mils.....\$5.95

#### Carter Dynamotor

Stock No. 4037AS

DC input 6VDC; output 400 V @ 375 mils DC. Perfect for mobile communications in car, plane or boat.

BRAND NEW

List \$71.40

Our Price .....\$34.95

Phone WO 4-3270

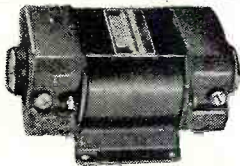

### ACORN ELECTRONICS CORP.

76 Vesey St., Dept. N-7, New York 7, N. Y.

TERMS: 20% cash with order, balance C.O.D. unless noted. All prices F.O.B. our warehouse in N. Y. C. Minimum order \$5. NOTE: Due to conditions beyond our control, prices are subject to change.

### IF YOU BUY ON SPECIFICATIONS



and tops in value, you'll buy the

### TWIN-TRAX\* TAPE RECORDER

"Choice of Engineers Everywhere"

Compare the guaranteed specifications of a Twin-Trax Tape Recorder with any other recorder in any price class. You'll find that Twin-Trax gives you more features, better all-around performance and more value for your money.

Complete specifications, performance ratings and direct factory prices in our catalog 5109. Send for it today.

\*Trademark Reg.

### AMPLIFIER CORP. of AMERICA

398 Broadway, New York 13, N. Y.

## WHOLESALE PHOTO SUPPLIES

KODAK • ANSCO • GRAFLEX • Others  
Radio Service Shops Coast to Coast  
Increase Profits with Photo Supplies

You can add big photo equipment sales to your gross almost over night. Gamerman's fast wholesale service on any quantity, low inventory investment, and low space requirements make it easy to capitalize on photo equipment sales. WRITE FOR CATALOG AND DETAILS NOW.

### GAMERMAN

DEPT. R  
3808 EASTERN AVE.  
BALTIMORE 24, MD.



### THE MOBILE RADIOTELEPHONE

KAAR ENGINEERING CO.  
PALO ALTO, CALIFORNIA

### Radio-Controlled Boat

(Continued from page 53)

be more economical at this point. Since *Raytheon* recommends that the plate current be kept as low as possible and should never exceed the maximum rating of 1.5 ma., a milliammeter is very desirable when making initial adjustments of the thyatron circuit. The plate current is controlled with the potentiometer,  $R_3$ . In operation the current flowing in the plate circuit of the thyatron places a negative charge on the grid of the amplifying tube, 1Q5GT, and reduces the plate current of that tube to practically zero. When a signal is received the plate current of the thyatron drops, the negative bias on the 1Q5GT is removed and its plate current rises to several milliamperes, which operates the sensitive relay. The receiver is mounted in a metal chassis, 1 1/2" x 4" x 5". The boat antenna consists of two strands of wire about four feet long, strung between the flag mast and the stern. Although both the RK61 and RK62 have been tried with equal success, the author prefers the older, more rugged type RK62, to the newer sub-miniature version RK61, but perhaps the preference was influenced by the fact that a number of the older tubes were obtained on the surplus market.

The transmitter circuit is shown in Fig. 13, and consists of a 6AQ5 tube, working as a crystal oscillator and doubler into an 807 tube, serving as a doubler and amplifier. At first glance this may seem like excessive power for an installation of this sort, but after having seen in the past several model planes getting beyond the range of their transmitters and crashing, the author is convinced that adequate power is essential for the successful operation of any and all radio-controlled models. The transmitter is mounted on a metal chassis, 2" x 5" x 6". The cathode coil and tuning condenser,  $L_1$  and  $C_1$ , are mounted underneath the chassis, near the 6AQ5 tube. The crystal has a frequency of 13,050 kc. and is mounted next to the 6AQ5 tube. This particular frequency makes the output frequency 52,200 kc., which is approximately the center of the six meter band. The 807 tube is mounted in the center of the chassis and is partly shielded to insure stable operation. The plate coil of the 6AQ5 tube,  $L_2$ , is mounted to the left of the 807 tube, as viewed from the rear of the transmitter, with the plate tuning condenser,  $C_2$ , mounted directly below the plate coil. The final tank coil,  $L_3$ , the antenna coil,  $L_4$ , and the final tank tuning condenser,  $C_3$ , are mounted on a Masonite panel directly in front of the 807 tube. A short piece of coaxial cable connects the antenna coil to the antenna. A dial light,  $PL_1$ , serves as a protective fuse for the crystal and also as a resonance indicator for the tuned circuit,  $C_1$  and  $L_1$ . This dial light is mounted underneath the chassis so

# ★ TO A MAN INTERESTED IN ★ A Better Paying Job in Television

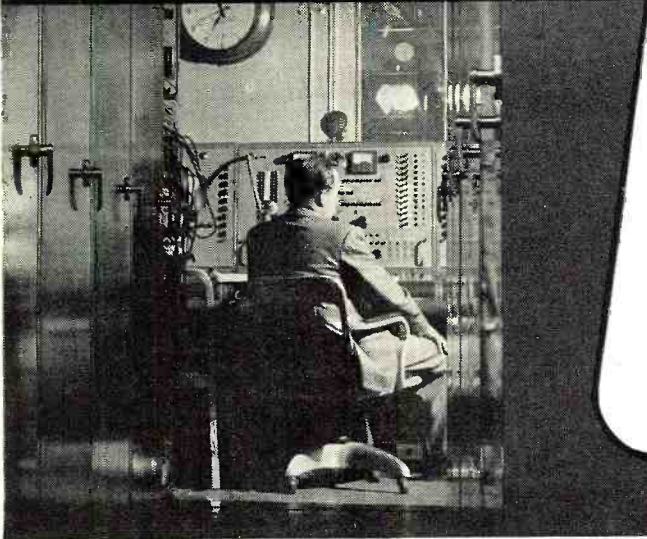

**ASK YOURSELF THESE QUESTIONS:**

1. Are new men—with less experience than yourself—passing you by?
2. Has it been "too long" since you have received a satisfactory raise?
3. Are you tied down to a routine, production-line job?
4. Does your future seem limited to small stations and small salaries?
5. DO YOU GENERALLY FINISH WHAT YOU START?

**If your answer is YES to most of these questions, CREI'S Home Study Course can help you get a BETTER JOB in Television**

**W**HAT YOU DO to keep yourself abreast of new developments is what counts toward advancement in television. Obviously, everyone cannot qualify. *Those who do are well rewarded.* The television industry offers almost unlimited opportunity to trained engineers and technicians. CREI training helps all levels, from novice to experienced engineer, because its specialized individual instruction brings out the best in a man and takes him as far as his own aptitude and effort will let him go.

CREI is an accredited technical institute founded in 1927. Its home study graduates fill important jobs throughout the radio, television and electronics industries. Leading industrial firms—RCA Victor, Pan American Airways, United Air Lines, to name only a few—have used or are now using CREI group training

programs. Industry welcomes CREI grads—CREI training is recognized as a respected reference.

Make your own opportunity in television! Add CREI technical training to your present experience—start either at the beginning or at an advanced stage. Get yourself a better TV job—make more money—enjoy increased security. The next two years can be the most important of your lifetime. Write today for complete information. The cost is popular, the terms easy.

**NOTE TO MEN WHO EXPECT TO BE IN UNIFORM SOON:**

TV-Electronics training is excellent background for vitally important radar, communications and navigation work in the Armed Services. If you expect to enter service, prepare now to qualify for a higher rating in interesting technical work.

**THE THREE BASIC CREI COURSES:**

- ★ **PRACTICAL RADIO ENGINEERING**  
*Fundamental course in all phases of radio-electronics*
  - ★ **PRACTICAL TELEVISION ENGINEERING**  
*Specialized training for professional radiomen*
  - ★ **TELEVISION AND FM SERVICING**  
*Streamlined course for men in "top-third" of field*
- ALSO AVAILABLE AS RESIDENCE SCHOOL COURSES**



## CAPITOL RADIO ENGINEERING INSTITUTE

*An Accredited Technical Institute Founded in 1927*  
Dept. 117C, 16th & Park Rd., N. W. Washington 10, D. C.  
Branch Office: San Francisco (2) 760 Market St.

**MAIL COUPON FOR FREE BOOKLET**

**CAPITOL RADIO ENGINEERING INSTITUTE**  
Dept. 117C, 16th & Park Road, N. W., Washington 10, D. C.

Gentlemen: Send booklet, "Your Future in the New World of Electronics," together with details of your home study training, CREI self-improvement program and outline of course. I am attaching a brief resume of my experience, education and present position.

Check the Field of Greatest Interest:

<input type="checkbox"/> Practical Television Engineering.	<input type="checkbox"/> Aeronautical Radio Engineering.
<input type="checkbox"/> Practical Radio Engineering.	<input type="checkbox"/> Broadcast Radio Engineering (AM, FM, TV).
<input type="checkbox"/> TV, FM & Advanced AM Servicing.	<input type="checkbox"/> Radio-Electronics In Industry

NAME \_\_\_\_\_ AGE \_\_\_\_\_  
ADDRESS \_\_\_\_\_  
CITY \_\_\_\_\_ ZONE \_\_\_\_\_ STATE \_\_\_\_\_

If Residence School in Wash., D.C. Preferred, Check Here

# Build 15 RADIOS AT HOME

With the New Improved 1951 Progressive Radio "EDU-KIT" ONLY \$19.95

**FREE TOOLS WITH KIT**

**ABSOLUTELY NO KNOWLEDGE OF RADIO NECESSARY**

**NO ADDITIONAL PARTS NEEDED**

**EXCELLENT BACKGROUND FOR TELEVISION**

**10-DAY MONEY-BACK GUARANTEE**



## WHAT THE PROGRESSIVE RADIO "EDU-KIT" OFFERS YOU

The Progressive Radio "Edu-Kit" offers you a home study course at a rock bottom price. Our Kit is designed to train Radio Technicians, with the basic facts of Radio Theory and Construction Practice expressed simply and clearly. You will gain a knowledge of basic Radio Principles involved in Radio Reception, Radio Transmission and Audio Amplification. You will learn how to identify Radio Symbols and Diagrams; how to build radios, using regular radio circuit schematics; how to mount various radio parts; how to wire and solder in a professional manner. You will learn how to operate Receivers, Transmitters, and Audio Amplifiers. You will learn how to service and trouble-shoot radios. In brief, you will receive a basic education in Radio exactly like the kind you would expect to receive in a Radio Course costing several hundreds of dollars.

### THE KIT FOR EVERYONE

The Progressive Radio "Edu-Kit" was specifically prepared for any person who has the desire to learn Radio. The Kit has been used successfully by young and old in all parts of the world. It is not necessary that you have even the slightest background in science or radio. The Progressive Radio "Edu-Kit" is used by many Radio Schools and Clubs in this country and abroad. It is used by the Veterans Administration for Vocational Guidance and Training. The Progressive Radio "Edu-Kit" requires no instructor. All instructions are included. All parts are individually packaged, and identified by name, photograph and diagram. Every step involved in building these sets is carefully explained. You cannot make a mistake.

### PROGRESSIVE TEACHING METHOD

The Progressive Radio "Edu-Kit" comes complete with instructions. These instructions are arranged in a clear, simple and progressive manner. The theory of Radio Transmission, Radio Reception and the Audio Amplification is clearly explained. Every part is identified by photograph and diagram; you will learn the function and theory of every part used.

The Progressive Radio "Edu-Kit" uses the principle of "Learn By Doing." Therefore you will build radios to illustrate the principles which you will learn. These radios are designed in a modern manner, according to the best principles of present-day educational practice. You begin by building a simple radio. The next set that you build is slightly more advanced. Gradually, in a progressive manner, you will find yourself constructing still more advanced radio sets and doing work like a professional Radio Technician. Altogether you will build fifteen radios, including Receivers, Amplifiers and Transmitters.

### THE PROGRESSIVE RADIO "EDU-KIT" IS COMPLETE

You will receive every part necessary to build 15 different radio sets. This includes tubes, tube sockets, variable condensers, electrolytic condensers, mica condensers, paper condensers, resistors, tie strips, coils, tubing, hardware, etc. Every part that you need is included. In addition, these parts are individually boxed, so that you can easily identify every item.

### TROUBLE-SHOOTING LESSONS

Trouble-shooting and servicing lessons are included. You will be taught to recognize and repair troubles. While you are learning in this practical way, you will be able to do many a repair job for your neighbors and friends, and charge fees which will far exceed the cost of the Kit. Here is an opportunity for you to learn radio and have others pay for it.

### FREE EXTRAS IN 1951

- ELECTRICAL AND RADIO TESTER
- ELECTRIC SOLDERING IRON
- BOOK ON TELEVISION
- RADIO TROUBLE-SHOOTING GUIDE
- MEMBERSHIP IN RADIO-TELEVISION CLUB
- CONSULTATION SERVICE
- QUIZZES

Order your Progressive Radio "EDU-KIT" Today, or send for further information.

## PROGRESSIVE ELECTRONICS CO.

497 UNION AVE.  
DEPT. RN-7 BROOKLYN 11, N. Y.

that it may be seen through a hole in the front panel. A closed circuit jack,  $J_1$ , is mounted on the rear of the chassis for connecting the control switch to the transmitter. This jack also provides for the use of a regular telegraph key, so that the call letters of the transmitter may be sent at regular intervals, as required by the FCC regulations. Another closed circuit jack,  $J_2$ , may be provided for the insertion of a 0-100 ma. milliammeter to facilitate tuning. In the author's installation this meter is mounted on the power supply. The power requirements for the transmitter are a six volt storage battery and dynamotor or vibrator power supply with an output of 100 to 125 milliamperes at 300 to 400 volts. The power supply used by the author is one obtained on the surplus market and consists of a transformer, vibrator, rectifier tubes, and filter. A voltage divider was installed to provide a lowered voltage for the oscillator tube. The transmitter and power supply are mounted on shelves installed on a wood camera tripod, with a quarter-wave antenna mounted at the top.

To tune the transmitter the power lead to the 807 is disconnected and the cathode circuit,  $C_1$  and  $L_1$ , tuned to maximum glow of the dial light, then advanced slightly beyond the point of resonance to insure stable operation. The 6AQ5 plate circuit,  $C_2$  and  $L_2$ , is next adjusted for minimum glow of the dial light, then the 807 plate supply is reconnected and the final tank circuit,  $C_3$  and  $L_3$ , is tuned for a minimum current reading on the plate milliammeter. An additional dial light could be substituted for the milliammeter with fair results, but for precision tuning the milliammeter is to be preferred.

The details of the transmitter con-

trol switch are shown in Fig. 3. It consists of a rotary switch with 22 contacts, which correspond to those on the stepping switch. The copper rivets which serve as contacts are press fitted into the holes in the fiber disc, which are countersunk so that the arm of the switch will drop to each contact as it is rotated. A dial and pointer knob are provided to indicate the position of the switch with reference to the operating position of the stepping switch on the boat. Whenever the boat is to be operated, the position of both switches should always correspond. In the photograph of the control switch (Fig. 11) the designations for the various operations are shown at alternate rather than at adjacent contacts. This was done to distribute the operations around the dial and will be changed as the number of operations are increased. When operating the transmitter with the control switch it is necessary only to make a momentary contact for such operations as turning the motor on or off, or firing the gun, then move the switch arm to a neutral contact or to a position between two contacts. On other operations such as raising the flag, sounding the horn, reversing the motor, or swinging the rudder to right or left, the switch remains in contact with the desired position until the operation has been completed.

In concluding it should be stressed that no attempt should be made to operate any type of radio transmitter without first having complied with the Federal Communications Commission regulations by obtaining both amateur station and operator licenses. Information regarding the qualifications for such licenses may be obtained from the "ARRL Handbook" or by contacting the nearest office of the Federal Communications Commission. -30-

The mayor of Bombay, Mr. S. K. Patil, recently inaugurated the Radio and Electronics Society of India. This new group's first major undertaking will be the sponsorship of an international radio and electronics exhibition in Bombay from February 9 to 28, 1952. The first four days of the meeting will be reserved for businessmen while the last seventeen days will be open to the public. The show will feature the latest electronic developments from all parts of the world. In the photograph Mr. Y. A. Fazalbhoy, chairman of the governing body of the Radio and Electronics Society of India, addresses the New Delhi meeting of press and trade representatives.



# Walter Ashe HEADQUARTERS FOR Hallicrafters

Whether you are a beginner or an old-timer, Hallicrafters is the equipment for you and Walter Ashe is the place where you can buy it at a record-breaking saving with a "Surprise" trade-in allowance. Trade used factory-built test or communication equipment now. What have you got to trade? Wire, write, phone or mail the handy coupon today.

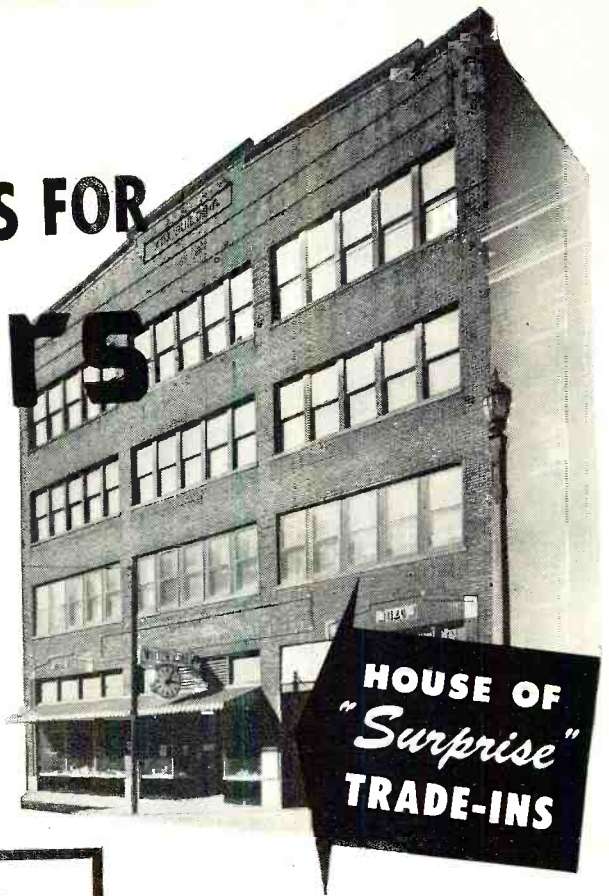

## Hallicrafters S-72

Long Range Portable. Wherever you may roam, preserve the home ties with this extra-sensitive, portable broadcast-shortwave radio. Can be used on 110-120 volt AC or DC or self-contained batteries. Shpg. wt. 16 lbs. Only

**\$109.95** (Less batteries)

For the very thriftiest way to buy your new S-72, trade your used equipment. Profit with a "Surprise" trade-in.



S-38B

All prices F.O.B. St. Louis  
Phone CHestnut 1125



## Hallicrafters S-76

New dual conversion Receiver with 50-KC 1-F. The most-wanted features at the lowest possible price. Shpg. wt. 44 lbs. Only

**\$169.50** (Less speaker)

R-46 speaker..... Only **\$19.95**

Apply our liberal "Surprise" trade-in allowance against the above price.



## Hallicrafters SX-71

Eleven-tube, double conversion receiver 538KC to 35MC 46-56MC. Crystal filter. Shpg. wt. 33 lbs. Only

**\$199.50** (Less speaker)

R-46 speaker..... Only **\$19.95**

## Hallicrafters S-38B

Shpg. wt. 14 lbs. Only \$49.50. Buy it for less with a "Surprise" trade-in. What have you got to trade?

**\$49.50**

# FREE!

New 164-page catalog. Features all the latest and best in ham gear, radio equipment and electronic supplies for home, workshop, schools and industry.

**Walter Ashe**  
**RADIO CO.**  
THE HOUSE OF "SURPRISE" TRADE-INS  
1125 PINE ST. • ST. LOUIS 1, MO.

Walter Ashe Radio Co. RN-51-7  
1125 Pine St., St. Louis 1, Mo.

O. K. Walter, Rush "Surprise" Trade-in offer on my \_\_\_\_\_  
(describe used equipment)

for \_\_\_\_\_  
(show make and model No. of new equipment desired)

Rush Free Copy of your new 164 page Catalog.

NAME \_\_\_\_\_  
ADDRESS \_\_\_\_\_  
CITY \_\_\_\_\_ Zone \_\_\_\_\_ STATE \_\_\_\_\_

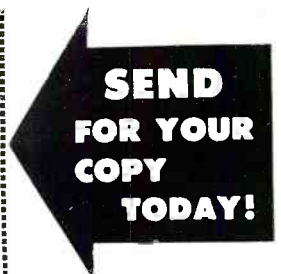

Coaxial relay K-101—SPDT—24v DC.....\$ 6.59  
 Set of 83-1SP coax-connectors for above.....89  
 RG59U coaxial cable—75 ohm  
 150' roll.....\$11.95 300' roll..... 22.50  
 300 ohm twin lead. 300' minimum—per ft..... .03  
 Sigma plate relay 8000 ohm—SPDT..... 1.75



1000KC crystal BT cut.....\$3.95  
 3"scope shield..... 1.29  
 2 speed dial drive for 1/4" shaft ratios 5:1 to 1..... .39  
 ATC 100 mmfd air trimmer screwdriver shaft..... .29  
 Centralab 850 S 50MMF 5KV button cond..... .39  
 Rotary switch mycalex, 2 deck SP3T..... .39

# TUBES!! BRAND NEW! STANDARD BRANDS! NO SECONDS! COMPARE! TUBES!!

0A3/VR75 \$1.69	3C24 \$2.25	227A/5C27 \$5.95	812H \$6.90	8014 \$2.95	0A2 \$2.95	524 \$1.40	6SN7GT \$1.60	12SL7 \$1.10
0B3/VR90 1.29	3C31/C1B 2.25	249C 3.95	813 3.95	8020 1.29	0A4G 1.35	6A3 1.35	68Q7 1.15	12SN7 1.35
0C3/VR105 1.49	3C45 1.95	250R 1.25	815 1.25	8025 2.95	0Z4 1.35	6A6 1.15	68R7GT 1.10	12SQ7 1.25
0D3/VR150 1.29	3CP1 2.25	250TH 22.50	816 2.95	9001 2.25	01A 1.35	6A7 1.15	68T7 1.45	12T7 1.10
1B22 3.45	3CP7-S1 4.95	250TL 35.50	826 1.98	9002 2.25	01A 1.35	6A8 1.25	68U7GT 2.25	14A4 1.20
1B23 1.29	3DP1 4.95	274E 2.65	828 12.75	9004 2.75	1A4P 1.30	6A9 1.49	68V7 1.65	14B6 1.15
1B24 9.95	3DP1A 6.95	276A 9.95	829 12.95	9005 2.95	1A5GT 1.05	6AC8GT 1.45	68W7 1.65	14C4 1.20
1B26 35.95	3DP1-2SA 8.95	289B 14.95	830B 3.95	9006 2.49	1A6 1.30	6AC8GT 1.45	68X7 1.65	14D4 1.20
1B27 24.50	3D21A 1.98	294A 5.75	830B 3.95	9007 2.95	1A7GT 1.10	6AC8GT 1.45	68Y7 1.65	14E4 1.20
1B29 2.75	3E29 14.95	300B 5.95	832 12.95	9008 2.95	1A8 1.30	6AC8GT 1.45	68Z7 1.65	14F4 1.20
1B32 2.25	3FP7 3.95	300H 24.95	832A 12.95	9009 2.95	1A9 1.30	6AC8GT 1.45	68Z7GT 1.65	14G4 1.20
1B36 24.95	4-1 4.75	304TL 29.95	833A 39.50	9010 2.95	1A9 1.30	6AC8GT 1.45	68Z7GT 1.65	14H4 1.20
1B38 32.50	4-1 4.75	305A 34.95	836A 39.50	9011 2.95	1A9 1.30	6AC8GT 1.45	68Z7GT 1.65	14I4 1.20
1N21A 1.25	4-1 4.75	307A 24.95	837 12.95	9012 2.95	1A9 1.30	6AC8GT 1.45	68Z7GT 1.65	14J4 1.20
1N21B 4.25	4-250A 29.95	310A 8.95	838 2.95	9013 2.95	1A9 1.30	6AC8GT 1.45	68Z7GT 1.65	14K4 1.20
1N22 1.25	4AP10 4.95	316A 6.5	841 1.65	9014 2.95	1A9 1.30	6AC8GT 1.45	68Z7GT 1.65	14L4 1.20
1N23 2.25	4B2 EL3B 7.95	320A 2.95	843 1.65	9015 2.95	1A9 1.30	6AC8GT 1.45	68Z7GT 1.65	14M4 1.20
1N23A 3.25	4B2A EL3C 7.95	327A/5C37 4.95	843 1.65	9016 2.95	1A9 1.30	6AC8GT 1.45	68Z7GT 1.65	14N4 1.20
1N23B 6.95	4B25/6CF 8.95	328A 13.95	849 29.50	9017 2.95	1A9 1.30	6AC8GT 1.45	68Z7GT 1.65	14O4 1.20
1N27 1.69	4E26/2000 8.95	331A 12.95	851 26.50	9018 2.95	1A9 1.30	6AC8GT 1.45	68Z7GT 1.65	14P4 1.20
1N34 1.40	4B28 4.95	338A 8.95	852 23.95	9019 2.95	1A9 1.30	6AC8GT 1.45	68Z7GT 1.65	14Q4 1.20
1N34A 1.40	4B32 9.95	350B 4.95	860 6.95	9020 2.95	1A9 1.30	6AC8GT 1.45	68Z7GT 1.65	14R4 1.20
1N34 2.95	4B32 9.95	350B 4.95	861 29.50	9021 2.95	1A9 1.30	6AC8GT 1.45	68Z7GT 1.65	14S4 1.20
1N34 2.95	4B32 9.95	350B 4.95	861 29.50	9022 2.95	1A9 1.30	6AC8GT 1.45	68Z7GT 1.65	14T4 1.20
1N34 2.95	4B32 9.95	350B 4.95	861 29.50	9023 2.95	1A9 1.30	6AC8GT 1.45	68Z7GT 1.65	14U4 1.20
1N34 2.95	4B32 9.95	350B 4.95	861 29.50	9024 2.95	1A9 1.30	6AC8GT 1.45	68Z7GT 1.65	14V4 1.20
1N34 2.95	4B32 9.95	350B 4.95	861 29.50	9025 2.95	1A9 1.30	6AC8GT 1.45	68Z7GT 1.65	14W4 1.20
1N34 2.95	4B32 9.95	350B 4.95	861 29.50	9026 2.95	1A9 1.30	6AC8GT 1.45	68Z7GT 1.65	14X4 1.20
1N34 2.95	4B32 9.95	350B 4.95	861 29.50	9027 2.95	1A9 1.30	6AC8GT 1.45	68Z7GT 1.65	14Y4 1.20
1N34 2.95	4B32 9.95	350B 4.95	861 29.50	9028 2.95	1A9 1.30	6AC8GT 1.45	68Z7GT 1.65	14Z4 1.20
1N34 2.95	4B32 9.95	350B 4.95	861 29.50	9029 2.95	1A9 1.30	6AC8GT 1.45	68Z7GT 1.65	15A4 1.20
1N34 2.95	4B32 9.95	350B 4.95	861 29.50	9030 2.95	1A9 1.30	6AC8GT 1.45	68Z7GT 1.65	15B4 1.20
1N34 2.95	4B32 9.95	350B 4.95	861 29.50	9031 2.95	1A9 1.30	6AC8GT 1.45	68Z7GT 1.65	15C4 1.20
1N34 2.95	4B32 9.95	350B 4.95	861 29.50	9032 2.95	1A9 1.30	6AC8GT 1.45	68Z7GT 1.65	15D4 1.20
1N34 2.95	4B32 9.95	350B 4.95	861 29.50	9033 2.95	1A9 1.30	6AC8GT 1.45	68Z7GT 1.65	15E4 1.20
1N34 2.95	4B32 9.95	350B 4.95	861 29.50	9034 2.95	1A9 1.30	6AC8GT 1.45	68Z7GT 1.65	15F4 1.20
1N34 2.95	4B32 9.95	350B 4.95	861 29.50	9035 2.95	1A9 1.30	6AC8GT 1.45	68Z7GT 1.65	15G4 1.20
1N34 2.95	4B32 9.95	350B 4.95	861 29.50	9036 2.95	1A9 1.30	6AC8GT 1.45	68Z7GT 1.65	15H4 1.20
1N34 2.95	4B32 9.95	350B 4.95	861 29.50	9037 2.95	1A9 1.30	6AC8GT 1.45	68Z7GT 1.65	15I4 1.20
1N34 2.95	4B32 9.95	350B 4.95	861 29.50	9038 2.95	1A9 1.30	6AC8GT 1.45	68Z7GT 1.65	15J4 1.20
1N34 2.95	4B32 9.95	350B 4.95	861 29.50	9039 2.95	1A9 1.30	6AC8GT 1.45	68Z7GT 1.65	15K4 1.20
1N34 2.95	4B32 9.95	350B 4.95	861 29.50	9040 2.95	1A9 1.30	6AC8GT 1.45	68Z7GT 1.65	15L4 1.20
1N34 2.95	4B32 9.95	350B 4.95	861 29.50	9041 2.95	1A9 1.30	6AC8GT 1.45	68Z7GT 1.65	15M4 1.20
1N34 2.95	4B32 9.95	350B 4.95	861 29.50	9042 2.95	1A9 1.30	6AC8GT 1.45	68Z7GT 1.65	15N4 1.20
1N34 2.95	4B32 9.95	350B 4.95	861 29.50	9043 2.95	1A9 1.30	6AC8GT 1.45	68Z7GT 1.65	15O4 1.20
1N34 2.95	4B32 9.95	350B 4.95	861 29.50	9044 2.95	1A9 1.30	6AC8GT 1.45	68Z7GT 1.65	15P4 1.20
1N34 2.95	4B32 9.95	350B 4.95	861 29.50	9045 2.95	1A9 1.30	6AC8GT 1.45	68Z7GT 1.65	15Q4 1.20
1N34 2.95	4B32 9.95	350B 4.95	861 29.50	9046 2.95	1A9 1.30	6AC8GT 1.45	68Z7GT 1.65	15R4 1.20
1N34 2.95	4B32 9.95	350B 4.95	861 29.50	9047 2.95	1A9 1.30	6AC8GT 1.45	68Z7GT 1.65	15S4 1.20
1N34 2.95	4B32 9.95	350B 4.95	861 29.50	9048 2.95	1A9 1.30	6AC8GT 1.45	68Z7GT 1.65	15T4 1.20
1N34 2.95	4B32 9.95	350B 4.95	861 29.50	9049 2.95	1A9 1.30	6AC8GT 1.45	68Z7GT 1.65	15U4 1.20
1N34 2.95	4B32 9.95	350B 4.95	861 29.50	9050 2.95	1A9 1.30	6AC8GT 1.45	68Z7GT 1.65	15V4 1.20
1N34 2.95	4B32 9.95	350B 4.95	861 29.50	9051 2.95	1A9 1.30	6AC8GT 1.45	68Z7GT 1.65	15W4 1.20
1N34 2.95	4B32 9.95	350B 4.95	861 29.50	9052 2.95	1A9 1.30	6AC8GT 1.45	68Z7GT 1.65	15X4 1.20
1N34 2.95	4B32 9.95	350B 4.95	861 29.50	9053 2.95	1A9 1.30	6AC8GT 1.45	68Z7GT 1.65	15Y4 1.20
1N34 2.95	4B32 9.95	350B 4.95	861 29.50	9054 2.95	1A9 1.30	6AC8GT 1.45	68Z7GT 1.65	15Z4 1.20
1N34 2.95	4B32 9.95	350B 4.95	861 29.50	9055 2.95	1A9 1.30	6AC8GT 1.45	68Z7GT 1.65	16A4 1.20
1N34 2.95	4B32 9.95	350B 4.95	861 29.50	9056 2.95	1A9 1.30	6AC8GT 1.45	68Z7GT 1.65	16B4 1.20
1N34 2.95	4B32 9.95	350B 4.95	861 29.50	9057 2.95	1A9 1.30	6AC8GT 1.45	68Z7GT 1.65	16C4 1.20
1N34 2.95	4B32 9.95	350B 4.95	861 29.50	9058 2.95	1A9 1.30	6AC8GT 1.45	68Z7GT 1.65	16D4 1.20
1N34 2.95	4B32 9.95	350B 4.95	861 29.50	9059 2.95	1A9 1.30	6AC8GT 1.45	68Z7GT 1.65	16E4 1.20
1N34 2.95	4B32 9.95	350B 4.95	861 29.50	9060 2.95	1A9 1.30	6AC8GT 1.45	68Z7GT 1.65	16F4 1.20
1N34 2.95	4B32 9.95	350B 4.95	861 29.50	9061 2.95	1A9 1.30	6AC8GT 1.45	68Z7GT 1.65	16G4 1.20
1N34 2.95	4B32 9.95	350B 4.95	861 29.50	9062 2.95	1A9 1.30	6AC8GT 1.45	68Z7GT 1.65	16H4 1.20
1N34 2.95	4B32 9.95	350B 4.95	861 29.50	9063 2.95	1A9 1.30	6AC8GT 1.45	68Z7GT 1.65	16I4 1.20
1N34 2.95	4B32 9.95	350B 4.95	861 29.50	9064 2.95	1A9 1.30	6AC8GT 1.45	68Z7GT 1.65	16J4 1.20
1N34 2.95	4B32 9.95	350B 4.95	861 29.50	9065 2.95	1A9 1.30	6AC8GT 1.45	68Z7GT 1.65	16K4 1.20
1N34 2.95	4B32 9.95	350B 4.95	861 29.50	9066 2.95	1A9 1.30	6AC8GT 1.45	68Z7GT 1.65	16L4 1.20
1N34 2.95	4B32 9.95	350B 4.95	861 29.50	9067 2.95	1A9 1.30	6AC8GT 1.45	68Z7GT 1.65	16M4 1.20
1N34 2.95	4B32 9.95	350B 4.95	861 29.50	9068 2.95	1A9 1.30	6AC8GT 1.45	68Z7GT 1.65	16N4 1.20
1N34 2.95	4B32 9.95	350B 4.95	861 29.50	9069 2.95	1A9 1.30	6AC8GT 1.45	68Z7GT 1.65	16O4 1.20
1N34 2.95	4B32 9.95	350B 4.95	861 29.50	9070 2.95	1A9 1.30	6AC8GT 1.45	68Z7GT 1.65	16P4 1.20
1N34 2.95	4B32 9.95	350B 4.95	861 29.50	9071 2.95	1A9 1.30	6AC8GT 1.45	68Z7GT 1.65	16Q4 1.20
1N34 2.95	4B32 9.95	350B 4.95	861 29.50	9072 2.95	1A9 1.30	6AC8GT 1.45	68Z7GT 1.65	16R4 1.20
1N34 2.95	4B32 9.95	350B 4.95	861 29.50	9073 2.95	1A9 1.30	6AC8GT 1.45	68Z7GT 1.65	16S4 1.20
1N34 2.95	4B32 9.95	350B 4.95	861 29.50	9074 2.95	1A9 1.30	6AC8GT 1.45	68Z7GT 1.65	16T4 1.20
1N34 2.95	4B32 9.95	350B 4.95	861 29.50	9075 2.95	1A9 1.30	6AC8GT 1.45	68Z7GT 1.65	16U4 1.20
1N34 2.95	4B32 9.95	350B 4.95	861 29.50	9076 2.95	1A9 1.30	6AC8GT 1.45	68Z7GT 1.65	16V4 1.20
1N34 2.95	4B32 9.95	350B 4.95	861 29.50	9077 2.95	1A9 1.30	6AC8GT 1.45	68Z7GT 1.65	16W4 1.20
1N34 2.95	4B32 9.95	350B 4.95	861 29.50	9078 2.95	1A9 1.30	6AC8GT 1.45	68Z7GT 1.65	16X4 1.20
1N34 2.95	4B32 9.95	350B 4.95	861 29.50	9079 2.95	1A9 1.30	6AC8GT 1.45	68Z7GT 1.65	16Y4 1.20
1N34 2.95	4B32 9.95	350B 4.95	861 29.50	9080 2.95	1A9 1.30	6AC8GT 1.45	68Z7GT 1.65	16Z4 1.20
1N34 2.95	4B32 9.95	350B 4.95	861 29.50	9081 2.95	1A9 1.30	6AC8GT 1.45	68Z7GT 1.65	17A4 1.20
1N34 2.95	4B32 9.95							



**WANTED! WANTED!**

ATTENTION colleges, schools, hams, industrialists!! Highest prices paid for surplus equipment, parts, and tubes. We are especially looking for test equipment TS-12, 13, 35, 14/AP, 15/AP, 146/UP, 173, 174, 175, 239, 259, 263. Any types with TS prefix. Write, wire or call.



**WANTED! WANTED!**

APR-4, 5, 7 and tuning units. ARC-1, 3, ART-13, ATC, APS-10, microwave equipment in S, K, X-band. APS-15, APQ-13, APS-13, SCR-300, 284, 694, etc. BC-221, 342, 348. BC-1016 tape recorders. Write, wire or call.

**RADAR—COMMUNICATIONS AND TEST EQUIPMENT**

TS-35/AP X-band Signal Generator. Pulsed and C.W. freq. range. 8400-9600 mcs. This unit will measure power and frequency. 115v 60-2600 cyc.

TS-3/AP S-band Frequency and Power Meter. Portable. Battery operated. Complete with all cables.

TS-33/AP X-band Frequency Meter. 8500-9600 mcs. Contains crystal detector and indicating meter. Output to scope will indicate pulse wave shape.

TS-62/AP X-band Echo Box. 8400-9600 mcs. tuned and untuned input. Will indicate resonance on meter. Complete with pick up antenna and meter.

TS-208/UP Crystal Diode Test Set. Used to check 1N21, 1N22, 1N23, etc. Battery operated. Portable. Complete with spares.

TS-89/AP Voltage Divider. 1:10 and 1:100 ratios. Wide band for true pulse shape. Output to scope.

TS-10/APN Altimeter Test Set. Good condition. Complete with cables and dummy antenna \$35.00

TS-12/AP V.S.W.R. Test Set for X-band. Complete with amplifier, slotted line, termination, adaptors, etc. In 2 carrying cases. Excellent.

TS-23/APN Test Set to check freq. and power output of SCR-718 transmitter. Complete with all cables.

TS-36/AP X-band Power Meter. Consists of power measuring circuit. Horn antenna, co-ax to wave guide adaptor, connecting cable and probe. Will measure either absolute or relative power. Nominal band of usefulness is approx. 8.5-9.7 KMC. Excellent condition.

TS-118/AP R.F. Wattmeter for the range of 20-750 mcs. Will measure power up to 500 watts. Complete.

TS-174/UP Freq. Meter. Freq. range is 50-250 mcs. High freq. version of BC-221. Excellent Condition.

1-185 Signal Generator. L-band search. S-band track. Used with SCR-545 and similar sets. Complete with cables. Good condition.

TS-61/AP S-band Echo Box. Using meter provided it is possible to maximize the XMTR adjustment and determine relative power output. Complete with probe and cable. Very good condition.

TS-131/AP Field Strength Meter. Consists of pickup unit, control box C-111/AP, cord CX-143/AP adaptor M-359 and case. Unit will check output in range 200-1000 mcs. Excellent condition.

TS-226/AP used to measure peak power output of any xmtr in the range of 200-1000 mcs. Has provision for oscilloscopic signal observation and built in calibration. Part of AN/APM-29. Excellent.

TS-108/AP X-band Dummy Load. Consists of a length of X-band guide filled with sand. One end closed other terminates in a coupling choke. Excellent.

TS-174/AP consists of S-band signal generator, freq. meter, wattmeter and cables. Power input is 115v 50-2600 cyc. Used to check various S-band radars and beacons.

TS-170/ARN-5 XTAL controlled test osc. with the following freq. ranges: 332.6, 333.8, 335.0 depending on XTAL in use. This set is used to align glide path receivers. Batteries and antenna are self contained. Excellent condition.

AN/APS-3 Airborne X-band Search and Homing radar. Complete. Contains RF head, modulator, synchronizer, control boxes, plugs, antenna, etc. 115v 400 cyc. Excellent condition. \$875.00

ASB-5 L-band Search and Homing radar. Complete. Contains xmtr, receiver, power unit, control box, plugs, etc. 115v 400 cyc. Excellent condition. \$125.00

SCR-518 Radar Altimeter. 500 mcs. equipment. Complete with xmtr, receiver, control box, power unit, junction box with all cables, racks, etc. Unit will indicate altitude up to 50,000 ft. Power input is 28v. New condition. \$125.00

AN/APS-15 R.F. Head and Modulator. X-band. Complete with all tubes. Good condition. \$125.00

AN/APA-23 Automatic Signal Strength and Time Recorder. Unit will scan a receiver thru its range and record all signals on electro-sensitive paper. Input is 115v 60-2600 cyc. and 28v DC. Excellent condition. \$175.00

AN/CRT-3 Victory Girl. Dual frequency emergency lifeboat xmtr. Complete with xmtr, kite hydrogen generator, etc. New in knapsack. C.A.A. approved. \$129.50

AN/APR-5 Radar Search Receiver. Freq. range 1000-3100 mcs. Will detect signals up to 10,000 mcs. with reduced sensitivity. Contains oscillator and mixer cavity, IF strip, power supply. Input 60-2600 cyc. 115v. Excellent condition. \$375.00

T-50 Radiotelegraph Transmitter complete with power supply and all accessories with spares. Portable. New in cases. \$375.00

AN/APT-5 300-1500 mcs. xmtr cavity oscillator using 3C22 lighthouse tube. Power output 30 watts. Noise modulated. Excellent condition. Complete with all tubes. \$149.50

SK-1M Radar Receiver Indicators. Freq. 195 mcs. 2 R.F. stages, 3 IF stages. 1 video, etc. New condition. \$125.00

SCR-183 Airborne Command Equipment. Freq. range 201-398KC and 2500-7700KCS. Complete. Contains receiver, xmtr, dynamotor, antenna switch, control box, coils, etc. Power input 24-28v. Brand new in original case. Manufactured by Western Electric. \$125.00

NAVY RU Command Equipment. Similar to SCR-183. \$125.00

DU-1 Direction Finding Equipment for SCR-183 and RU Series Equipment. Can be used with any receiver for direction finding in freq. range 200-1600KC. New. Complete. \$45.00

SCR-515 (BC-645) contains xmtr, receiver, dynamotor PE-101, control box, manual, etc. New. \$18.95

AN/PPN-1 EUREKA! Ground portable, beacon responder. Unit will work into the AN/APN-2 transponder for purposes of homing. C.W. communication can also be carried on between plane and ground. Unit comes complete with xmtr, receiver, power pack, phones, etc. Brand new in knapsack. AN/APN-2 EQUIPMENT CAN BE SUPPLIED ON ORDER.

SCR-269/G Automatic Radio Compass. Freq. range 200-1750KC. Complete with BC-433-G receiver, BC-434, LP-21, 1-81, 1-82, BK22, etc. Very good condition. \$129.95

SCR-300 Frequency Modulated Transceiver. Freq. range 40-48 mcs. complete with 18 tubes, hand-set and antenna. Powered from self contained battery pack. Excellent condition. Weight approx. 35 lbs. with battery, each. \$450.00 Pair \$800.00

TCS Marine Radio Telephone and Telegraph Xmitting and Receiving Equipment. Freq. range 1500-12000KC. Consists of xmtr, receiver, antenna loading coil, remote control box, power unit, cables, etc. Power input is 112 or 32v DC. can supply an 110v AC power supply for stationary use at additional cost. Excellent condition.

SCR-536 Xmtr-Receiver (handy talkie). Freq. range 3885-5500KC. Complete with coils, tubes, crystals. Very good condition. \$89.95

AN/APA-10 Panoramic Adaptor for use with any receiver with following IF's: 455KC, 5 mcs, 30 mcs. Unit will give panoramic presentation (1 mc wide for 455KC input) (100KC for 5MC input) (2MC for 30 mcs input). Power input 115v 400 cyc. but can be changed with the addition of a proper power transformer. Excellent condition. \$175.00

AN/ARN-5 Glide Path Receiver. Freq. range 332.6, 333.8, 335.0 mcs. selected by changing crystals. Complete with receiver, mounting MT-28, AS-27 antenna, BC-732 control box, and indicator 1-101-C. Power input is 28v 1.7 amp. Excellent condition. \$49.95

With B model receiver. \$99.95

SCR-510 Freq. Modulated Portable Transceiver. Covering range of 20.0-27.9 mcs in 80 channels 100KC apart. Complete equipment consisting of BC-620 transceiver, power supply PE-97A, T-17 mike, handset, AN-45 antenna, battery operated or 6 or 12v input. Excellent condition. \$69.95

SCR-610 similar to SCR-510 except for freq. range which is 27.0-38.9 mcs. \$79.95

AN/APA-11 Pulse Analyzer to work with Search Receiver for analysis of received pulsed signals. PPS, pulse width, wave shape, can be displayed on an CR tube. Unit can also be used as a standard oscilloscope for general servicing work. Input is 115v-400-2600 cyc. but can be changed with the addition of a 60 cyc. transformer. Very good condition.

SCR-694 Field Radio. Light weight version of SCR-284. Freq. range is 3.8-6.5 mcs. Power output is A1-20, A3-5; comes with transceiver BC-1306, GN-45 or 58 hand generator, antenna system, microphone, headset, etc. In excellent condition.

PE-237 AC Power Supply for stationary use can be supplied at additional cost.

SCR-522 VHF Airborne Command Equipment. Freq. range 100-156 mcs. in 4 channels receiver and transmitter. Crystal controlled. Complete equipment. Consists of trans/rec. control box, BC-602, dynamotor PE-94, AN104A antenna, plugs, etc. Power input with PE-94 is 28v. Excellent condition. We can supply PE-98 dynamotor for 12v input at additional cost.

**COMMAND EQUIPMENT**

**ARC-5 274N OTHERS RECEIVERS**

ARA 500-1500KC. New. \$24.95  
 453B 200-550KC. New. 14.95  
 455B 60 mcs. New. 16.50  
 433 200-1750KC. Good. 29.95  
 ARR-2 234-258 mcs. New. 19.95

**TRANSMITTERS**

459-A 7-9.1 mcs. New. \$12.85  
 696-A 3-4 mcs. New. 29.95  
 TYPE O 5.3-7 mcs. New. 9.95  
 AVT-23 3000-13,000KC complete w/control box, manual, etc. C.W. or phone. 14 or 28v input. Brand new. Original cases. 79.50  
 BC-950A 100-156 mcs. New. 59.95

**ACCESSORIES**

BC-456 Modulator. Good. \$2.25  
 BC-450 Control Box (3 reel). Used. 1.25  
 BC-451 Control Box (xmtr). Used. .98  
 BC-442 Relay Unit (ANT.). Used. 1.95  
 Flexible Shafting Available

**MISCELLANEOUS SPECIALS!**

Sound Powered Chest and Headsets MI-2454-B type O, mgf. RCA. Brand new in original boxes. Pair. \$ 29.95  
 Trailing Wire Antenna Feed Tube. New. 5.95  
 Coniometer for SCR-277 Direction Finder. Excellent. 39.95  
 RL-7 Interphone Control Box. New. 1.95  
 FT-154 BC-348 Shock Mounts. 2.98  
 AN/CRW Receiver for Remote Control. 5.95  
 BC-1206 Beacon Receiver 200-400KC, 28v in. Excellent. 4.95  
 MN-226-V Compass Receiver. Very good. 24.95  
 BC-433G Compass Receiver. 200-1750KC in 3 bands. Excellent. 39.95  
 BC-778 Gibson Girl 500KC. Good condition. 459.50  
 BC-1016 Tape Recorder. Complete. New. 14.95  
 CFI Unit with 200KC Xtal. New. 1.59  
 T-17 Carbon Mike. Used. Good. 89.95  
 BC-329 Transmitter. Excellent. 89.95  
 QBG-1 Sonar complete with Hydrophone. Excellent. 125.00  
 BC-1091 RF Head. Very good condition. 69.95  
 AN/104A Antenna for SCR-522, ax handle. New. 3.95  
 LP-21 Direction Finding Antenna. Good. 12.95  
 ASB-50 mcs. VAGI Antenna Dual 6 Element Single 5 Element. 14.95  
 AN/APA-17 Radar Direction Finding Antenna, back to back parabola, freq. range 300-1000 mcs. Horizontally and vertically polarized. Excellent. 8.95  
 AN/APA-17 Radar Direction Finding Antenna, back to back parabola, freq. range 300-1000 mcs. Horizontally and vertically polarized. Excellent. 59.00  
 CG-(172/173) CPN-8 10CM Coax Patch Cable. New. 4.95  
 CX-548/GRD-3 Cable. New. 1.25  
 CX-546/CRD-3 Cable. New. 1.25  
 CD-508A with SW 14-U and 2 Cord Attachments with JK-48 Jack and PL-68 Plug. New. .75  
 CD-307A with PL-55 and JK. New. 1.29  
 Spares for ARC-5 and 274/N, APX-1, ASG-10. We have a large stock of TS-344/AP Spares.

**COAXIAL CABLE CONNECTORS**

83-1AP . . . . . \$ .30 83-1SP . . . . . \$ .45 83-168 . . . . . \$ .15  
 83-1F . . . . . \$ .130 83-1SPN . . . . . \$ .50 83-185 . . . . . \$ .15  
 83-1H . . . . . \$ .09 83-17 . . . . . \$ .130 UG-27/U . . . . . \$ .65  
 83-1R . . . . . \$ .80 83-22AP . . . . . \$ 1.10 UG-58/U . . . . . \$ .63  
 83-1R . . . . . \$ .40 83-22R . . . . . \$ .48 UG-85/U . . . . . \$ .88  
 Others in stock. Write for prices.

**CORDS AND PLUGS**

CD 508A Cord Assembly with SW 14-U Switch and 2 cord attachments with JK 48 Jack and PL 68 Plug. Value—\$5.00. Our Special Low Price. Brand New. .59c  
 CD307A with PL 55 and JK. New. .20c  
 JK 26 Jack only—Brand New. .35c  
 PL 55 Plug—New. .25c  
 PL 68 Plug—New. .25c  
 Jones plug 8 contact male and female. .25c  
 PL-Q-59 . . . . . 49c  
 PL-P-60 . . . . . 49c  
 PL-Q-61 . . . . . 49c  
 PL-Q-62 . . . . . 69c  
 PL-Q-77 . . . . . 49c  
 PL-Q-171 . . . . . 89c  
 PL-153-A . . . . . 69c  
 PL-172 . . . . . 89c

**BC-221 FREQUENCY METER**

This is a Terrific Value! QUANTITY IS LIMITED—so first come, first served. They are just like new, with original calibration charts. Range 125-20,000 KC with crystal check points in all ranges. \$99.50 Complete with crystal and tubes. ONLY \$99.50

**DYNAMOTORS AND POWER UNITS**

Type	Input Volts	Output Volts	Amps	Price
DM-19	12	500	.200	\$ 6.95
DM-25	12	250	.050	4.95
DM-32	28	250	.040	1.75
DM-33	28	570	.160	2.95
DM-34	12	220	.080	8.95
DY-12	12	275	.110	
PE-73	28	500	.350	10.00
PE-94	28	300	.260	
		150	.010	
		14.5		2.25
PE-97	Vibrator Power Supply			8.95
PE-98	12v	300v		35.00
PE-101	28	400		5.75
		800		35.00
PE-103	6 & 12	500	.160	15.95
PP-18-AR	Vibrapak			29.95
RA-42	(for BC-639 Receiver)			
ATR	12v	110v AC	125 watts	14.95

PHONE DIGBY 9-0347

WRITE FOR QUANTITY PRICES  
 Prices subject to change without notice.  
 C.O.D., N.Y.C. minimum order \$10.00.  
 20% deposit required. All merchandise guaranteed.

**RADHAM SHACK INC.**  
 189 GREENWICH STREET, NEW YORK, N. Y.

# TRANSVISION

ANNOUNCES

## NEW LOW PRICES

on 17"-20" TV KITS, SETS,  
CHASSIS and CABINETS

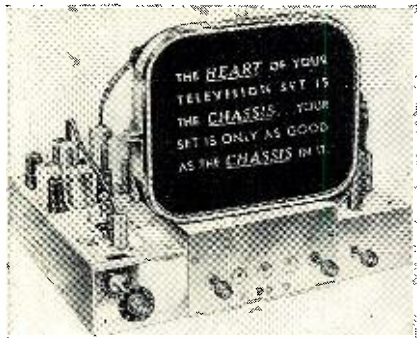

**SAVE UP TO 50%!**

Transvision makes the finest TV KITS, SETS, and WIRED CHASSIS that money can buy. PRICED AMAZINGLY LOW. Kits are easy to assemble. Give top quality picture and sound. Ideal for both hobbyists and dealers. **BEAUTIFUL NEW CABINETS.**

Write for Catalog RN.

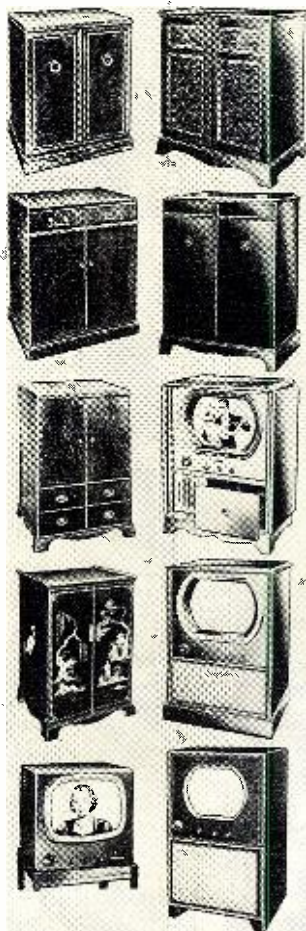

Write for Prices and Details Today!

**TRANSVISION, INC.**

Dept. RN

NEW ROCHELLE, N. Y.

# RADIO-TV

## Service Industry News

AS REPORTED BY THE  
TELEVISION TECHNICIANS LECTURE BUREAU

### TV Service Industry Gets a Jolt

**L**IKE a bolt of lightning out of a cloudless, blue sky the news of the launching of the *Western Union Services, Inc.*, to handle television receiver installation and service jarred the independent radio and television servicing industry as nothing ever has before. A subsidiary of the giant *Western Union Telegraph Company*, the first official news of the existence of *Western Union Services, Inc.*, came in the form of an announcement that this new servicing agency was authorized to handle the installation and servicing of *Du Mont* television receivers.

The initial announcement stated that *W.U. Services* would, at the outset, confine its activities to three counties in northeastern New Jersey—Passaic, Essex and Union. It is interesting to note, however, that these three counties have about the largest concentration of television receivers in the country and provide what is perhaps the choicest training ground available for developing the nucleus for the extensive national servicing organization that is being planned by this new company.

The reaction of television service contractors to the birth of this potentially huge competitor was a spontaneous and, in many cases, vitriolic condemnation of the *Western Union Telegraph Company* and the *Allen B. Du Mont Laboratories*. Some of the television service associations questioned the legal right of a public utility to employ its resources to compete with a multitude of small businesses and practically all of them castigated *Du Mont* for being a party to these new developments.

However, a few of the television service associations that have been deeply concerned with the chaotic conditions in independent television service activities took a more realistic view of this startling new development. The members of these associations have recognized for a long time that the immense dollar volume of business inherent in television installation and service automatically placed it in the category of big business. The growth of v.h.f. television had been so phenomenal and the business opportunities so plentiful that the lush business of receiver installation and service was

dropped into the laps of any and all service operators who asked for it. This condition spawned a host of inefficient service businesses which folded up quickly during the natural levelling off periods in the mushrooming growth of the industry.

To the members of these service associations the advent of *Western Union* into the television service business presented a needed opportunity to focus the attention of all top-flight independent TV contractors on the absolute necessity for cooperation in the solution of their mutual problems. They feel that the current business slump is but a brief interlude in television's growth and that u.h.f. television alone will usher in another frenzied period of expansion. And now is the time, they say, to effect the right kind of a national organization.

The unfortunate factor that persists in television thinking and planning is that far too many people in all phases of the TV business are still "pre-war radio service-minded." It seems very difficult for lots of people in the business to grasp the broad concept of television as a spectacularly new industry. It is not an off-shoot of radio. It is an entirely new business. Although it has used the marketing machinery that was created for radio there is every indication that it will eventually hew out new channels of distribution.

The advertising philosophies that sold millions of radio sets do not "click" in selling television receivers. Radio sets that sold for more than twenty-five dollars were marketed as an adjunct to the furniture in which they were housed. But the one-eyed cyclops that is a TV receiver is a problem child for the interior decorator and is tolerated in the living room only because of the entertainment it provides. It will not be long before good television viewing will influence the design of new homes.

Here is an entirely new business with an enormous service income potential but it must be efficiently and satisfactorily served.

Successful television service contractors do not fear the competition of big business in installation and service. They know that in operating under the same marketing and supply

**RADIO & TELEVISION NEWS**

# RELAYS FOR EVERY PURPOSE



## Over a Million in Stock!

Whether you require large quantities of relays for production runs or single units for laboratory or amateur work, Wells can make immediate delivery and save you a substantial part of the cost. Our capable engineering staff is prepared to offer assistance in the selection of correct types to suit your

exact requirements. Each relay is brand new, standard make, inspected, individually boxed and fully guaranteed. The following list represents only a tiny portion of our relay stock. Write or wire us for information on types not shown.

STOCK NO.	D.C. VOLTAGE	OHMAGE	CONTACTS	UNIT PRICE	STOCK NO.	D.C. VOLTAGE	OHMAGE	CONTACTS	UNIT PRICE	STOCK NO.	D.C. VOLTAGE	OHMAGE	CONTACTS	UNIT PRICE
<b>STANDARD DC TELEPHONE RELAYS</b>														
R-806	115*	900	1A	\$2.05	R-525	12/24	200	1C/10 Amps.	\$1.55	R-736	18/24	600	3C	\$1.50
R-161	6	10	2B & 1A	1.10	R-794	12	3 Coils, 16 Ohms Ea.	3B & 3A/15 Amps. S. Mk.	3.35	R-585	12	650	2C	1.30
R-100	24	600	2A & 1C	2.45	<b>CONTACTORS</b>					R-287	12/24	650	2C	1.30
R-289	40	3300	5A	2.20	R-188	24	200	1A/75 Amps.	\$3.70	R-164	24/32	1000	1A	1.50
R-518	85/125	6500	1C	3.60	R-183	24	60	1A/50 Amps.	3.45	R-646	24/48	1300	1B	1.50
R-266	150	6500	1A	2.45	R-187	24	100	1A/50 Amps.	3.70	<b>W-E-TYPE "E" RELAYS</b>				
R-633	180/350	10,000	1C & 5 Amps.	2.90	R-554	24	85	2A/100 Amps.	5.90	R-736	18/24	600	3C	\$1.50
R-664	110*	...	2B & 1A, Oct. Skt.	2.45	R-788	100*	...	3B & 2A	5.45	R-585	12	650	2C	1.30
R-684	115*	...	1C	2.45	R-682	115*	35	5A/10 Amps.	6.10	R-287	12/24	650	2C	1.30
R-264	220*	...	1B	2.45	R-767	24	20	2A/10 Amps.	3.70	R-164	24/32	1000	1A	1.50
R-564	220*	...	1B & 3A	2.45	R-180	12	25	1A/50 Amps.	4.05	R-646	24/48	1300	1B	1.50
R-667	6	.75	1B/10 Amps.	1.45	R-657	24	50	4A/100 Amps.	6.95	<b>SEALED RELAYS</b>				
R-632	6	12	5A & 1C	1.25	R-265	24	60	1A/100 Amps.	3.45	R-658	6	35	2C/Octal Plug	\$3.45
R-154	6/12	200	1A	1.50	R-535	24	70	1A/100 Amps.	4.80	R-125	24	300	2C/Octal Plug	3.45
R-517	12	250	2A	1.50	R-556	24	70	1A/100 Amps.	4.80	R-261	12/24	1900	1C/5 Pin Plug	3.75
R-777	12/24	70	1A & 1B	1.30	R-557	24	100	1A/50 Amps.	3.85	R-673	48/150	7500	1C/5 Amps.	2.80
R-578	24/48	2500	1B & 1A	3.05	R-178	24	100	1A/100 Amps.	4.80	<b>VOLTAGE REGULATORS</b>				
R-116	85	3000	1B	2.20	R-727	10	20	1A/20 Amps.	1.85	R-745	6	2	1A/10 Amps.	\$1.05
R-583	110	3300	1A	1.90	R-608	24	125	1A/200 Amps.	2.80	R-780	24	350	1C/6 Amps.	1.05
R-631	100/125	3300	2A	2.45	R-184	28	50	1A/100 Amps.	4.90	R-509	6/12	35	1B/2 Amps.	1.05
R-827	150	6500	2A, 1B	2.45	R-719	24	10	1A/200 Amps.	4.90	<b>SPECIAL RELAYS</b>				
R-623	150	6500	1C & 2A	2.45	R-182	28	80	1A/25 Amps.	2.40	R-503	12/32	100	3A, 2C	\$2.80
R-571	150	7000	1B	2.45	R-244	75*	265	1A/20 Amps.	2.20	R-749	600	...	Max. 28 Amps.	7.45
R-565	150	7000	1A & 2B	2.45	R-659	12	7.2	2A/20 Amps.	1.70	R-804	550*	...	1B/38 Amps.	4.35
R-545	110/250	7000	1C	1.55	R-681	12/15	16	2A/15 Amps.	1.55	R-250	115*	...	Adj. Cir. Bk. -04-.16A	17.50
R-124	300	12,000	1A	3.05	R-552	24	70	4A/50 Amps.	5.35	R-579	220*	...	1B	8.70
R-511	24	200	W/Micro N.O.	1.30	R-185	24	100	1A/50 Amps.	3.45	R-294	27.5	200	1B	5.35
R-160	6	12	3C & 3A	1.35	R-186	24	132	1A/50 Amps.	4.35	R-686	115*	...	2C	6.10
R-591	6	40	1B & 1C	1.35	R-817	24	150	1A/50 Amps.	3.45	R-246	115*	...	1B	11.20
R-592	12	160	1B & 2C	1.35	R-534	14	45	1A/30 Amps.	2.05	R-246A	115*	...	1A	11.20
R-155	12	100	4A & 4B	3.45	R-223	28	150	1A/40 Amps. /48 VDC.	1.70	R-614	18/24	60	1A/15 Amps.	4.35
R-520	200/300	14,000	2C	3.45	R-680	6	3	1A/50 Amps.	3.90	R-262	...	...	1C	4.70
R-159	6	50	2A	1.35	R-677	6	3.5	1A/50 Amps.	3.90	R-245	...	...	4" Micalax Lever	1.20
R-158	6	50	4A	1.35	R-532	6	15	1A/50 Amps.	3.90	R-527	6/12	50/50	In Series	1.20
R-576	12	200	2A	1.35	R-676	12	16	1A/50 Amps.	3.90	R-544	12/24	60/60	1A	2.05
R-153	12	200	1C & 1A	1.55	R-678	12	18	1A/50 Amps.	3.90	R-255	...	...	1C	1.20
<b>SHORT TELEPHONE RELAYS</b>														
R-635	12	100	1C & 1A	\$1.35	R-656	12	100	1A/100 Amps.	2.60	R-669	...	...	1B, 1A	1.20
R-648	12	170	1E	1.35	R-553	24	55	1A/5 Amps.	4.05	R-666	...	...	3/8" Stroke	1.20
R-826	12	150	2C, 1B	1.55	R-679	24	80	1A/50 Amps.	3.90	R-651	6	100	Solenoid Valve	3.10
R-770	24	150	1A/10 Amps.	1.45	R-610	24	80	1A/50 Amps.	3.90	R-111	12	275	Annunciator Drop	2.70
R-538	24	180	2A	1.55	R-555	24	100	1A Dbl. Bk.	2.05	R-295	5/8	2	2A, 1C	2.70
R-771	24	200	1A/10 Amps.	1.45	R-533	24	150	1A/50 Amps.	4.80	R-813	12	12	Wafer	5.35
R-603	18/24	400	2A	1.55	R-717	24	200	1A/50 Amps.	3.45	R-275	24	750	1A, 1B, 1C	3.45
R-575	24	500	2C	2.40	R-703	12	20	2A/25 Amps.	2.80	R-716	24	70	2A/5 Amps.	1.80
R-764	48	1000	2C & 2A	1.85	R-748	24	60	1A/30 Amps.	2.45	R-620	6/12	35	2C, 1A	1.30
R-563	60/120	7500	1A	1.70	R-655	24	80	1A/50 Amps.	6.05	R-629	9/14	40	1C/10 Amps.	1.55
R-801	115*	...	NONE	1.45	R-654	24	150	2A/40 Amps.	2.40	R-720	24	50	2C, Ceramic	1.70
R-213	5/8*	...	2A	3.10	R-742	24	70	1A/25 Amps.	3.05	R-500	12	10/10	2C/6 Amps.	3.55
R-690	115*	...	2C	2.45	<b>ROTARY RELAYS</b>					R-816	12	10/15	2C/6 Amps.	3.55
R-589	12	125	2A	1.30	R-709	6/8	1	12 Pos. 3 Wafer	\$3.90	R-524	24	...	...	1.20
R-113	12	150	4A	1.55	R-197	9/16	70	2C	1.45	R-566	115*	...	Coil Only	1.00
R-689	12/24	255	1C	1.55	R-713	9/14	125	1C & 1A	2.05	R-710	...	...	150 Coil Only	.75
R-799	24	500	None	1.00	R-198	9/14	125	3B, 3A, 1C	2.05	<b>*AC.</b>				
R-114	24	500	4A	1.60	R-616	28	7	5B & 1A	1.90	†AC/DC.				
R-115	24	500	1C	1.70	R-712	24	200	2B	2.05	<b>SPECIAL!</b>				
R-110	24/32	3500	1C	1.70	R-711	24	200	2C & 1B	2.05					
R-121	150	5000	2A & 1C	2.05	R-573	28	200	1C & 1B	2.05	<b>CO-AXIAL RELAY</b>				
R-634	150/250	6000	1A & 1B	2.45	R-284	28	200	4C & 1B	1.45	D153766 SPDT, 6 VDC, 19 OHM COIL. DESIGNED TO ACCOMMODATE 75 WATTS MAXIMUM. PERFECT FOR ALL TYPES OF ANTENNA SWITCHING. DESIGNED FOR USING STANDARD 83-1SP COAXIAL FITTINGS. PART OF RAX-1 EQUIPMENT. NO. R-845—\$6.95 EA.				
R-800	12	150	2C & 1A	1.55	R-200	24/32	275	3C & 1B	2.05	12 Pos. 8 Deck, 1B & 12 Pos. W/7" Shaft for Wafers.				
R-537	12/24	150	2C & 1B	1.55	R-766	24	230	12 Pos. 8 Deck, 1B & 12 Pos. W/7" Shaft for Wafers.	4.90	<b>DIFFERENTIAL RELAYS</b>				
R-750	24	400	1A	1.60	R-809	28	7	1B & 12 Pos. W/7" Shaft for Wafers.	2.45	R-208	120	2000	2C/3 Amps.	\$2.45
R-547	24	200	1C-Slow Bk.	\$1.80	<b>BASIC CONTACT ASSEMBLIES SHOWN IN UNOPERATED NORMAL POSITION</b>					R-209	220/250	8000	1C/3 Amps.	3.10
R-548	48	1000	1B-Slow Make	2.00										
R-128	50	2100	1C-Slow Bk.	2.80										
					Form A—"Make" (Single Throw, Normally Open)					Form B—"Break" (Single-Throw, Normally Closed)				
					Form C—"Break-Make" (Double-Throw)					Form D—"Make-Before-Break"				
					Form E—"Break-Make-Before-Break"									

**SPECIAL!**



**CO-AXIAL RELAY**  
 D153766 SPDT, 6 VDC, 19 OHM COIL. DESIGNED TO ACCOMMODATE 75 WATTS MAXIMUM. PERFECT FOR ALL TYPES OF ANTENNA SWITCHING. DESIGNED FOR USING STANDARD 83-1SP COAXIAL FITTINGS. PART OF RAX-1 EQUIPMENT. NO. R-845—\$6.95 EA.

**WELLS SALES, INC.**

WRITE FOR WELLS CATALOG

Telephone SEeley 8-4143

833 W. CHICAGO AVE., DEPT. R-7, CHICAGO 22, ILL.

# ALWAYS RIGHT SIDE UP PEAKS PRICES ARE

**1000 KC CRYSTAL**  
Accurate to .02% or better. Mounted in plug-in holder.  
Only..... **\$2.98**

**METER BARGAIN**  
2" Sq. Bakelite Case, 0-100 MA DC (0-300 Scale) made by Weston Ltd.  
Brand New .... **\$2.39**

## PANEL METERS

GE—General Electric  
WH—Westinghouse  
W—Weston S—Simpson  
\*Special Scale  
SQ—Square Case



**READ THIS CAREFULLY**

**2" Meters**  
0-100 UA, GR.....\$6.95  
0-5 MA, S, SQ.....2.95  
0-5 MA, GE.....2.45  
0-20 MA, S.....1.95  
0-100 MA, W.....1.25  
0-200 MA, S.....2.95  
0-5 AMP RF, S, SQ.....2.39  
0-2 AMP RF, S, SQ.....2.95  
0-4 AMP RF, DC, GE.....2.95  
0-30 AMP DC, GE.....4.50

This high quality 2" Square, Bakelite cased meter is made by WESTON LTD. Its range is 0-500 ma RF (0-.5 Amp) with an internal thermocouple. By simply moving the thermo, it becomes a LINEAR 0-2 ma. DC meter which can easily be shunted for other ma ranges. It has an approx. 6 millivolt rating. Brand new, packed in original boxes.....\$2.39 (Discount on quantity orders)

**3" Meters**  
0-4 KV, DC, RS.....\$7.95  
0-2 MA, S.....4.50  
0-20 MA, GE, SQ.....3.95  
0-20 MA, WH\*.....2.95  
100-0-100 MA, GE.....3.95  
0-30 VOLT DC, DA.....2.75  
0-200 MA, GE.....4.50



**HIGH CURRENT MICAS**

**OIL CONDENSERS**  
1.75 mfd 400 vdc \$0.39  
6 mfd 600 vdc .95  
8 mfd 600 vdc 1.79  
10 mfd 600 vdc 1.95  
1 mfd 1000 vdc 1.95  
1 mfd 5000 vdc 4.50  
1/1 mfd 7000 vdc 2.95  
2 mfd 7500 vdc 1.25  
2 mfd 6000 vdc 12.95

Tolerance 5%  
**TYPE G1**  
CAP Amps. KV Price  
MFD 1 Mc DC Each  
.00024 1 10 5 \$ 4.95  
**TYPE G2**  
.0003 4 10 5 \$ 5.95  
.0006 5 10 6.95  
**TYPE G3**  
.00015 8.2 20 \$12.95  
.0012 16 15 17.95  
**TYPE G4**  
.001 16 20 \$34.50  
.002 22 20 34.50  
.0039 30 20 34.50  
**TYPE G5**  
.00015 10 35 37.50  
**1% W. W. Resistors**  
Ohms: 2K, 5K, 8500  
50K, 100K.....\$0.35 ea.

**PIGTAIL MICAS**  
MMF: 5, 20, 50, 60, 100, 250, 300, 400, 500, 750, 900, 1000, 2000, 3000, 4000, 5000, 6000, 10000.....\$0.09 ea.

**Ceramicons**  
MMF: 20, 120, 500.....\$0.05 ea.  
**Silver Mica Capacitors**  
MMF: 10, 50, 60, 340, 750, 780, 1000.\$0.12 ea.

**Non-Inductive Resistors**  
Ohms: 500, 2000, 12,500  
100 watts.....\$0.75  
Heavy Duty 4 Conductor Rubber Covered Cable, .10 per foot

**Choke Bargains**  
Fully Cased  
6 Hv, 200 MA.....\$2.49  
8 Hv, 175 MA.....1.95

**RAYTHEON SWINGING CHOKE**  
2 to 12 Henrys, 1 Amp to 100 Ma, 15 Ohms DC fully cased. High voltage insulation, ceramic insulators. Very conservatively rated. Weight 2.0 Lbs.  
.....\$16.95 ea.

**Meter Multipliers**  
1 Meg. 1/5 of 1% Cage Enclosed 1 KV.....\$2.95  
2 Meg 1/2 of 1% Tubular 2 KV.....\$2.95  
4 Meg 1/2 of 1% Tubular 4 KV.....\$3.95

**GE KV METER**  
0-15 KV DC, 3 1/2" SQ. Bakelite case, 500 MA movement. Includes 30 Meg. 1% Ext. multiplier.....\$15.75 ea.

**BAKELITE CASED MICAS**  
MFD VDC Price MFD VDC Price MFD VDC Price  
.001 600 \$1.18 .024 1500 \$ .65 .001 5 KV \$1.60  
.002 600 .24 .02 2 KV .75 .0015 5 KV 1.60  
.01 600 .02 .02 2 KV .55 .005 5 KV 1.90  
.02 600 .26 .005 2500 .45 .005 5 KV 2.50  
.01 1 KV .45 .004 2500 .50 .0003 8 KV 2.50  
.002 1200 .35 .00015 KV .70 .0005 8 KV 2.90

**WIRE WOUND RESISTORS**  
5 watt ohms: 25-50-200-2500 \$ .09 ea.  
10 watt ohms: 25-40-84-400-1325-2K-4K 7 15 ea.  
20 watt ohms: 50-70-100-300-750-1K-1.5K 2.5K-2.7K-5K  
30 watt ohms: 100-2500-5300-18K .....29 ea.  
100 watt ohms: 100-3750-1500-2K, 10K, 20K, 25K-50K .....59 ea.

**GUARDIAN LATCHING RELAY**  
SPDT, 110 V 60 cy Coil, 15 Amp Contacts.....\$1.95  
**ADJUSTABLE SLIDER RESISTORS**  
20 Watt: 1, 50 Ohms.....\$0.25  
50 Watt: 500 Ohms......35  
75 Watt: 100, 1000 Ohms......39  
100 Watt: 50, 100 Ohms......49

**MISCELLANEOUS BARGAINS**  
25 ohm 675 watt Rheostat.....\$2.95  
50 meg 35 watt Resistor......99  
250 mmf Widget Var. Ceramic Ins......99  
15 mmf Widget Var. Ceramic Ins......39  
4PST Lever Switch Mossman......89  
Ceramic RF Switch SP 11 Pos......89  
4PST Relay, 4500 Ohm DC Coil.....1.95  
05 600V Oil Tubular......12 for .99  
10K, 15K Pots......24  
5-20 mmf Ceramic Variable......24  
1.5-7 mmf Ceramic Variable......24  
SPST Push Button Switch......29  
5X5 MFD 400 VDC Oil......59  
1X1X1 MFD 1200 VDC Oil......59  
Fil Transf. 2 1/2 V CT, 40 AMPS, 110V CY.....6.95

**HIGH WATTAGE ANTENNA RELAY**  
110/220 Volt 60 Cy. coil, 5000 Volt, 15 Amp contacts, DPST, Ceramic insulation.....\$9.95 ea.

**PEAK ELECTRONICS CO.**  
188 WASHINGTON ST., NEW YORK 7, N. Y.  
Phone COrrlandt 7-6443-4

conditions their small, personally managed businesses can be handled far more efficiently and profitably than any branch operation of a large servicing organization.

Also, many television contractors have done well in the business of converting sets for larger picture tubes. They realize that u.h.f. conversions alone will create a billion dollar business for service shops in the present major TV markets. It is the kind of business that can be merchandised effectively and profitably handled in a well-organized shop. And it is the type of activity that can be handled readily by a branch of a national servicing organization which has the facilities and the know-how for selling service to the general public.

The major headaches and threats to the business of television contractors come from the thoughtless management practices employed in some competing independent businesses. The worst black eyes that have been plastered on the TV servicing industry have come from the failures of the independents who have folded through mismanagement and the careless handling of contract monies.

From the standpoint of bigness in competition it is an accepted fact throughout the television service industry that the *RCA Service Company* has been the major stabilizing influence for the entire television servicing industry. The *RCA Service Company* has conducted its operations on a sound business basis and its pricing policies have been instrumental in checking a complete deterioration of service through thoughtless, profitless pricing in many television areas.

In the event that *Western Union* or any other giant corporation succeeds in establishing a complete national TV installation and servicing organization the effect on independent service contractors will be secondary to its impact on the independent replacement parts manufacturing and distributing industries.

The only economies that can be effected by size are in the facility it affords to buy supplies in large enough quantities to warrant dealing directly with the original manufacturers. The task of training, maintaining and directing a vast army of field technicians whose duties require more than mechanized thinking will require a national servicing organization to carry a very heavy overhead burden. This in itself precludes any danger of a big organization underpricing the independents.

As a matter of fact, a national servicing organization would, of necessity, have to confine its activities to the receivers of only one or two large manufacturers which it would handle on a reasonably exclusive basis. This concentration of attention on a limited number of receivers and circuits would permit a standardization of service procedures that is not possible in a shop that "free-lances" the field.

There will always be plenty of opportunities for the individual service

## Stage a "Music Festival" in your own LIVING ROOM



For "Live" Symphony reproduction . . . .

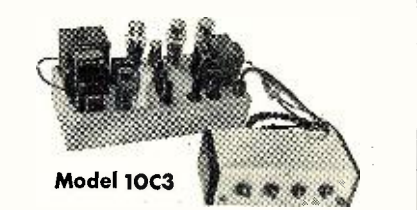

Model 10C3  
the **BROOK** High Quality All-Triode  
**AUDIO AMPLIFIER**

Write for free Technical Bulletin, detailed Distortion Analysis & booklet "Better Listening"  
**Brook Electronics, Inc., Dept. RG-1**  
• • 34 DeHart Place, Elizabeth, New Jersey

THE WORLD'S SMALLEST, YET  
**Most Powerful Radio Loop Antenna**  
GRAYBURNE  
*Ferri-Loopstick*  
©Grayburne

Length: 2". Diameter: 1/2"  
**HIGHEST EFFICIENCY:** Has a Q of 240-275; ordinary loops have only 110. (Measurements made with Boonton Q-Meter.)  
**OMNI-DIRECTIONAL:** Equally sensitive and efficient at every angle. Needs no orientation.  
**GREATER RECEIVING RANGE:** Boosts sensitivity and signal-to-noise ratio—of special importance to portables.  
**INCREASED BUSINESS:** Ferri-Loopstick improves set performance so amazingly, your customers will call you a "miracle man." Every AM set-owner is a **HOT PROSPECT!**  
**LOW COST:** Consumer List Price only 75c. Liberal discounts.  
**SERVICEMEN!** For name of your nearest Ferri-Loopstick distributor, write to us NOW!

**GRAYBURNE**  
CORPORATION  
103 LAFAYETTE ST. NEW YORK 13, N.Y.

operator who possesses the combination of managerial and technical TV service "know-how."

It is interesting to speculate on the effect that national television servicing organizations will have on the replacement parts and equipment distributing industry. As Henry Ford once phrased it so pertinently, "There is only one thing we can be sure of in American business and that is change," and we can be sure that we will witness plenty of it in the television industry in the years just ahead.

#### Unions Aggressive

The drop in the television service business that accompanied the deep sag in receiver sales ushered in a stepped up program on the part of the unions to organize the television service industry. Several unions are fighting for the business. The IBEW of the American Federation of Labor and the Electrical Workers Union of the CIO have been sparring for the attention of the television technicians and we learned recently that the Teamsters Union was also interested in this field.

It is most unfortunate that practically all of the organizers who are engaged in this unionization activity are conducting their campaigns in a manner that resembles more closely the underground activities of a subversive movement than it does the accepted American way of presenting issues honestly and fairly.

The editors of this department have talked with hundreds of television servicing dealers and contractors and they have yet to find one who is opposed to the unionization of his technical employees. However, they state that union organizers are contacting their employees surreptitiously and making promises about the benefits of unionization that cannot possibly be fulfilled.

Job security is the chief sales argument in the unionization campaigns now underway. Yet service dealers and contractors have always considered it good business to keep their skilled technical employees during periods of slack business even though this placed a severe strain on their personal resources. So when economic pressures force these employers to lay off men no outside organization could prevent it. This occurs under conditions where it is absolutely necessary to either drastically curtail expenses or go out of business. So if the employer is prevented from reducing his expenses he will go out of business and his technical employees will be jobless anyway.

The attitude of TV service dealers and contractors generally was stated succinctly in a recent bulletin issued by the Television Contractors Association of Philadelphia:

"There is considerable, but mostly uninformed, talk among contractors concerning labor relations and unionization. Those who seek to organize the employees of a contractor seem not to know that a contractor exists in pursuing their efforts.

July, 1951

# Here's what W. J. SCHNELL, of Sentinel, says about the Tarzian Tuner



We have used Sarkes Tarzian Tuners in all of the television receivers we have produced and we are very well pleased with the very satisfactory performance and service we have experienced both in production and in the field.

We know that this tuner has in a large manner contributed to the excellent performance and quality reputation enjoyed by Sentinel Television Receivers throughout the trade.



W. J. SCHNELL,  
Director of Engineering,  
Sentinel Radio Corp., Evanston, Ill.

We can't honestly say this is an unsolicited statement. Sure, we wrote to Bill Schnell. Asked him point blank what he, as director of engineering for one of our oldest customers, actually thought about the TARZIAN TUNER. Naturally, we were pretty sure of what he'd say, for engineers appreciate the many desirable features—such as pin-point oscillator alignment . . . unexcelled stability—which are characteristic of the TARZIAN TUNER. Manufacturers are invited to write for complete engineering data on the TARZIAN TUNER.

## SARKES TARZIAN, Inc.

Tuner Division • Bloomington, Indiana

AN IMMEDIATE SENSATION!

# FISHER

## HIGH QUALITY Phonograph Preamplifier

Here is the *top* quality, *reasonably priced* preamplifier you have always wanted. The FISHER provides exact equalization for low-level magnetic pickups of *any* make, such as GE, Pickering, Audax, Clarkstan and others; also used as a microphone preamplifier.

Net price only \$12.57



### Outstanding Features:

- Uniform response, 30 to 20,000 cycles. Self powered. Two stages of triode amplification. Extremely low hum.
- Full low-frequency equalization. High gain. Completely enclosed chassis with bottom cover. Plugs supplied.
- Output cable can be up to 50 feet in length. size: 3 $\frac{3}{4}$  x 3 $\frac{5}{8}$  x 3 $\frac{5}{8}$  high.

WRITE FOR FULL DETAILS  
FISHER RADIO CORPORATION  
39 E. 47TH ST., NEW YORK

**RCA RADIO and TELEVISION**  
Thorough training for men and women in all Technical phases  
**APPROVED FOR VETERANS**  
**WEEKLY RATES DAYS—EVENINGS**  
**FREE PLACEMENT SERVICE FOR GRADUATES**  
For Free Catalog write Dept. RN-51  
RCA INSTITUTES, INC.  
A Service of Radio Corporation of America  
350 West 4th St., New York 14, N. Y.

**PEN-OSCIL-LITE**  
Extremely convenient test oscillator for all radio servicing; alignment • Small as a pen • Self powered • Range from 700 cycles audio to over 600 megacycles u.h.f. • Output from zero to 125 v. • Low in cost • Used by Signal Corps  
• Write for information.  
**GENERAL TEST EQUIPMENT**  
38 Argyle Buffalo 22, N. Y.

# TUBES

Every Critical Type

WE BUY FIRST QUALITY TUBES FOR CASH!

Fully Guaranteed • Brand New • Immediate Delivery

1S5  
1U5  
5U4G  
5Y3GT  
6AT6  
6AU6  
6AV6  
6BE6  
6J5GT  
6K6GT  
6W4GT  
35W4  
35Z5GT

59¢  
ea.

1R5  
1T4  
1U4  
354  
3V4  
6AL5  
6AR5  
6BA6  
6SA7GT  
6SK7GT  
6SN7GT  
6V6GT  
6X5GT  
12BH7

69¢  
ea.

1B3GT  
154  
3Q4  
6AB4  
6AQ5  
6AS5  
12A8GT  
12AU7  
12SA7GT  
12SK7GT  
12SQ7GT  
35L6GT  
50L6GT

79¢  
ea.

Write TODAY for Complete Listing!

Terms: 25% with order, balance C.O.D. All merchandise subject to prior sale, F.O.B. New York City

**TeleVision Materials Corp.**  
114 LIBERTY ST., NEW YORK 6 N.Y. • COrtlandt 7-4307

"It would be well for the organizers, as a matter of good public relations, to come out in the open and make known their aims and purposes. If they are at all successful in their efforts they must ultimately talk to employers. Their disregard of the employer in the beginning can only have the unfortunate effect of building up a wall of resistance that does not augur well for either employee or employer.

"Union organizers would do well to remember that what people don't know they fear, and what they fear they fight. Perhaps a little of the light of understanding would tend to dispel fears. At least it might help to reduce frictions."

### OPS Confusion

Of the estimated sixty million gainfully employed people now said to be working in the U.S. about ten million of them will have to quit their present jobs and go to work for the Office of Price Stabilization if the screwball regulations of that office are to be enforced.

And if the pricing formula for all industries is as unrealistic as that for the radio and television servicing industry there will be a lot of retail businesses closing their doors if they are enforced.

Categories #878 and #884 cover radio replacement parts and television antennas, boosters, accessories, and replacement parts. The permissible dealer mark-up on both of these categories is 58% of cost. This method of pricing would completely change the pricing structure of the servicing industry and force a reduction in the prices of all parts used in repairs as well as accessories sold with TV sets.

As an example, take a 50L6 tube. Its present list is \$1.80. In some areas dealers are buying tubes at 50% off list and in others at 40% off list. The dealers' costs are respectively .90 at 50% off list and \$1.08 at 40% off. Under the OPS pricing system the dealer who buys his tubes at 50% off list would have to sell 50L6's at \$1.41 each and the dealer who gets 40% off would have to sell them for \$1.69.

Since 40% off list is the conventional dealer discount on practically all of the equipment and parts used in service work the rigid application of this system of pricing would require a reduction of about 5% in all of the prices charged to service customers for parts, tubes, equipment, and accessories.

### RTMA-BBB Parts Replacement Proposals

Nineteen specific recommendations to manufacturers, distributors, dealers and service contractors were recently presented jointly by the Radio-Television Manufacturers Association and the Association of Better Business Bureaus. These recommendations were developed cooperatively by members of the RTMA Service Committee and representatives of the Better Business Bureaus for the purpose of maintaining an adequate supply of parts for TV set servicing.

# A "CARRY-ALL" DESIGNED TO FIT EVERY V-RAD O SERVICE NEED

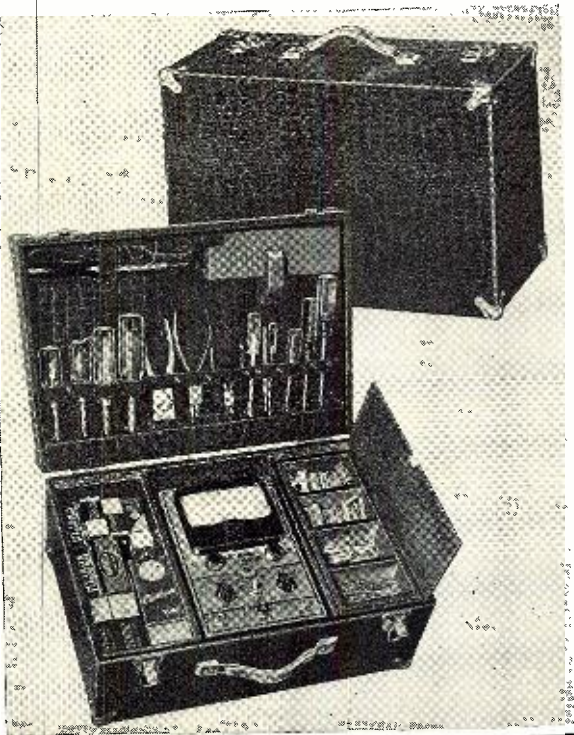

## FEATURES:

- Detachable Tool Compartment
- Adjustable Partitions to Accommodate a Multi-Purpose Meter
- Removable Compartment for Small Replacement Parts
- Space Provision for Bulky Replacement Components
- Special Compartment for All Required TV-Radio Replacement Tubes
- Code Charts and Replacement Tube Information
- Beautiful Carrying Case Covered with Durable Alligator Leatherette—Reinforced Metal Corners for Lasting Service. Overall Size 17 1/2" x 12" x 8 1/2".

"CARRY-ALL" \$12.50 CASE ONLY

### SPECIAL

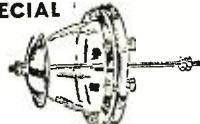

Navy entering type insulator. Porcelain Ringed Bowl with brass rod and fittings and aluminum shield. Dimensions: 4 3/8" high, 6-5/16" O.D. at base. New \$4.50 Spare Bowl .95

### CAPACITORS

UPRIGHT MOUNT	EA.	TEN
2X.25 MFD 400 VDC	\$ .35	\$ .30
5 MFD 400 VDC	.35	.35
1 MFD 600 VDC	.40	.35
2X.05 MFD 600 VDC	.40	.35
25 MFD 600 VDC	.40	.35
2X.1 MFD 600 VDC	.45	.40
5 MFD 600 VDC	.45	.40
1 MFD 600 VDC	.45	.40

### BATH TUB

4 MFD 50 VDC	.45	.40
4 MFD 100 VDC	.55	.50
2X.1 MFD 400 VDC	.30	.25
3X.1 MFD 400 VDC	.40	.35
2 MFD 400 VDC	.40	.35
.05 MFD 600 VDC	.35	.30
.25 MFD 600 VDC	.40	.35
.5 MFD 600 VDC	.40	.35
1 MFD 600 VDC	.45	.40
2 MFD 600 VDC	.65	.60
2X.1 MFD 1000 VDC	.55	.50
5 MFD 1000 VDC	.55	.50

### OIL FILLED AND GE

.5-3 MFD 400 VDC	\$.65	\$.60
1 MFD 500 VDC	.55	.50
1 MFD 500 VDC	.70	.65
1 MFD 600 VDC	.85	.80
2 MFD 600 VDC	1.15	1.10
4 MFD 600 VDC	1.60	1.55
5 MFD 600 VDC	1.85	1.80
1-8 MFD 600 VDC	2.75	2.65
.5 MFD 1000 VDC	.95	.90
2 MFD 1000 VDC	1.65	1.60
.5 MFD 2000 VDC	2.00	1.90
.25 MFD 3000 VDC	2.85	2.80
.1 MFD 3000 VDC	2.95	2.90
.1 MFD 7500 VDC	7.50	7.00
1 MFD 7500 VDC	12.50	12.00
.1 MFD 15000 VDC	14.95	14.90
.0006 MFD 15000 VDC	12.50	11.75
.045 MFD 16000 VDC	12.95	12.50

### PAPER

8-8 MFD 600 VDC	\$2.25	\$2.15
3X8 MFD Tobe Filtermite 600 VDC	\$2.55	\$2.40
8-8-4 MFD 600 VDC	2.45	2.25
160-160 MFD 150 VDC	1.50	1.25

### ELECTROLYTICS

2500 MFD 5 VDC	\$.40	\$.35
500 MFD 12 VDC	.90	.85
8-8-4 MFD 600 VDC	2.45	2.25
25 MFD 25 VDC	1.40	.90
50 MFD 25 VDC	1.25	1.15
1000 MFD 25 VDC	1.50	.45

### Ceramic Rotary Switches

Pole Position	Section	Shaft	Price
1	3	1/8"	\$0.60
2	4	1/8"	.55
4	10	3/4"	.50
2	12	4"	.75
2	18	2	30A 9KVA Flash Over 2.50
2 Pole 2 Circuit 6 Cont. W/Knob			.40
DPST Toggle Switch 3A 250V.			.35

## CUSTOM-BUILT AUTO RADIOS

by *Automatic Radio* 1949-1950-1951  
**PLYMOUTH — DODGE — CHEVROLET — FORD — HUDSON — HENRY "J" — STUDEBAKER**

Each Auto Radio Is Designed to Fit the Cars Listed Above—Six Tubes—3 Gang Condenser, Weight 10 Lbs.

List Price for Each \$59.95—Grille for 51 Plymouth, \$3.95  
**ATTRACTIVE DISCOUNTS TO DEALERS**

## MICROWAVE EQUIPMENT

- 10 CM Echo Box Frequency Range 2890MC-3170MC. Direct Reading Micrometer Head. Ring Prediction Scale Plus 9% to Minus 9%. Type "N" Input. Resonance Indicator Meter with Accessories and 10CM Directional Coupler and Spares—Brand New
  - TS-172/UP
  - SO Radar 10CM Rotating Antenna 24" Parabola in Turret 360° Span—Brand New
  - SO-3 Bearing Control
- PRICES UPON REQUEST  
**All Sizes of Crystal Electrodes**

## WIRE AND CABLE

ARMOUR—DR1A-23, FRIA-4, DHPA7. Many other types available.  
 TELEPHONE—52 Conductor.  
 CORDAGE—CO-119 2 Cond. #20 AWG—CO-122 3 Cond. #22—CO-127 Single #14 Braided and Shield—CO-221 Twisted Pair #16 Shield SJ.  
**HIGH VOLTAGE**—Single Cond. #10 Shielded Terminal Lug on Each End Lengths of 100' and 150'.  
**NYLON CORE**—#22 Spiral Wound Around Nylon Core Plastic Insulation.

## SWITCHES

GE Type SB-1 1 Pole 3 Position Rotary.....\$2.95  
 Impact Switch SA3/A SPST Normally Open. Operates on 10G in Horizontal Plane 20 Amp..... 4.25  
**HEAVY DUTY ROTARY W/KNDSBS**

Pole	Pos.	Section	Type	Price
4	4	10	2H-10	\$3.95
4	2	4	JR-423	2.75
2	8	1	JR-153-B	1.25

## CHECK THESE VALUES

BC-709 Interphone Amplifier, ideal for aircraft-booster telephone. New \$ 4.00  
 MN-26Y Radio Compass Receiver 150-325KC. 325-695KC. 3.4-7.0 MCS. 2 volt Bendix. Brand new 44.50  
 BC-733D Receiver, n.w., used, excel. cond. 19.95  
 Used w/dynamotor 11.95  
 BC-224 Receiver, n.e.w., less mgf. 100.00  
 R5/ARN-7 Radio Compass Receiver, w/ tubes, used, excel. cond. 39.95  
 BC-433G Radio Compass Receiver, used, excel. cond. w/tubes 39.95

## TUBES

2C34	\$.05.85	1629	\$.04.40
2X2/879	.90	2051	1.15
3C24	1.85	7193	.50
7C4/1203A	.85	8011	2.40
10Y	.45	9006	.50
15R	.45	9006	.50
30/44	.65	CEQ72	1.40
45 Spec.	.35	CK-70	4.25
203A	8.80	CR-70	1.40
316A	.70	E1148	.30
WL-531	4.95	HY-615	.40
702B	2.50	RKR-72	.75
713A	1.45	RK-75	.75
803	.55	VT-127A	3.75
826	.45	VT-93	21.00
864	.95	3BP1	3.45
869B	29.95	5BP4	5.95
CK1005	.85	5FP7	.95
CK1007	1.95	3A4	.60
1826	.95	6SG7	1.95
		6X4	1.45
		93	.65

## TRANSMITTING MICA

.065 MFD 1800 VDC	\$ 0.65
.006 MFD 2000 VDC	.65
.008 MFD 2000 VDC	.65
.02 MFD 2000 VDC	1.20
.006 MFD 2000 VDC	1.15
.00025 MFD 2500 VDC	2.60
.00075 MFD 5000 VDC	3.50
.001 MFD 6000 VDC	9.50
.007 MFD 5000 VDC	8.95
.0002 MFD 6000 VDC	32.50
.0012 MFD 20,000 VDC	32.50

## TIME DELAY SWITCHES

1 Minute 115 VAC 60 Cy Enc. in Waterproof Metal Case.....\$5.25  
 3 Micro Switches Make Contact at 40-41-42 Sec. Time Delay 110 VAC Motor. New..... 4.50  
 Thermo Switch 50° to 300° F. 115 VAC @ 6A. 230 VAC @ 1.5A. Breaks Contact with Increase of Temperature. New 1.35  
 30-40 Second Mercury Time Delay Relay 110 VAC AD..... 7.50  
 Iako. New..... 7.50

## VALUES

De-Ton Line Starter DPST 115V 60 Cy 15A West. New.....\$6.95  
 Genuine Upright Desk Telephone and Ringing Box New 4.95  
 1 Micro Second Delay Line 15 KV 400 Cy 50 Ohm. New.....24.95  
 CO-122 3 Conductor Cable.....

## ROUND PANEL METERS

LEADING BRANDS		
0-5 RF Amps—Westing	3 1/2"	\$4.50
0-30 MA DC—Simpson	2 3/4"	3.75
0-100 Amps DC—Hoyt	3"	5.00
0-3 Volts DC—Sun	2 1/2"	3.50
0-15 Volts AC—GE	3 1/2"	4.95
0-2500 Volts DC—Simpson	3 1/2"	5.95
With Multiplier		5.50
0-5KV DC 0-10 MA DC	3 1/2"	5.50
0-150 Volts DC—Hoyt	3 1/2"	4.50

PORTABLE METERS		
0-10 Amps DC—Weston	489	9.50
0-3-6-30 Volts DC—Weston	280	19.95
0-100 Amp DC—Weston with 100 Amp—Shunt	269	27.95
0-25 Amps AC—Weston	433	37.50
0-1.5-6 Volts AC Output-meter—Weston	571	14.95

## LINEAR POTENTIOMETERS WW

Ohms	Watts	EA.	TEN
200	2	\$.50	\$.40
1000	2	.50	.45
3000	2	.55	.50
10,000	2	.55	.50
5000	3	.85	.80
7500 Dual	3	.55	.50
10,000	3	.65	.60
50,000	4	.90	.85
15	25	.95	.90
20	25	.95	.90
25	25	.95	.90
100	25	1.20	1.10
200	25	1.20	1.10
500	25	1.30	1.25
1000	25	1.40	1.35
3000	25	1.70	1.60
15,000	25	2.00	1.95
20,300	25	2.15	2.00
150/Switch 50 AN 3155-50		2.15	2.00
200/W Switch 50		2.15	2.00
800	50	2.65	2.50
10,000	50	2.95	2.75
15	60	2.95	2.75
15	75	2.95	2.75
750	150	3.95	3.85
20,000	5	9.50	
20,000	5 433C AC	8.50	
5000		1.95	
6000		2.25	

## POWER EQUIPMENT

Voltage Regulator Raytheon 95/130 V 60 Cy 1.25 Amp Output 115V 60 Watt. New.....\$12.50  
 Generator Voltage Regulator 115V 400 Cy GE GBA-20C. New..... 19.95  
 Vibrapak VPG 369 12 VDC Output 250V @ 70MA Synchronous Mallory. New..... 5.95  
 ATR Inverter and Regulator 110VDC to 110 VAC 50/60 Cy 150 Watt Model RSB. New..... 24.95  
 VIBRATOR ATR 2410 24 VDC Output 110V 100W. New..... 2.50

**COMET**

**ELECTRONIC SALES CO.**

22 Washington St. • Beacon 2-7863 • Brighton 35, Mass.

**TERMS:** Minimum order \$5.00 — Mail orders promptly filled—All prices F.O.B. Boston, Mass. Send M.O. or check. Shipping charges sent C.O.D. 25% deposit required with all C.O.D. orders.

# FREE to Radio-TV Service Technicians



## the new fact-packed PF INDEX! (PHOTOFACT INDEX AND TECHNICAL DIGEST)

★ Each issue packed with authoritative articles on TV, Radio, latest servicing techniques

★ Latest complete Index to PHOTOFACT, world's finest service data

Don't miss a single issue! Be sure to get your PF INDEX—the valuable new publication you'll read from cover to cover—and use at your bench every working day.

PF INDEX brings you complete, fully illustrated discussions of latest developments in Radio and TV. Keeps you up-to-date on new circuit designs, latest testing methods, time-saving repair techniques, good shop practices—helps you operate a better, more profitable business.

Have all this practical, authoritative information plus the complete Index to PHOTOFACT Folders—the quick reference guide to the world's finest service data. PF INDEX is worth dollars to you—and costs you nothing. Get your FREE copy today!

**Ask Your Jobber for It!**

**HOWARD W. SAMS & CO., INC.**

Get the current PF Index from your Parts Jobber, or write us direct on your letterhead (or enclose business card). Address: Howard W. Sams & Co., Inc., 2201 E. 46th St., Indianapolis 5, Ind.

**FREE**

Send FREE copy of the current PF Index

Name.....

Address.....

City.....State.....

The following are the recommendations to television service contractors:

1. Make every effort to keep an adequate stock of tubes and parts.
2. Maintain adequate stock records from which to order.
3. Educate customers on the problems involved in television service.
4. Give reasonably prompt service; try to keep appointments.

Both organizations also recommended that long-range programs be undertaken to inform the public of factors involved in the purchasing and servicing of a television set. Also, that steps be taken to bring to the attention of local educational institutions the opportunities for trained service technicians and the need for training courses in vocational and various types of trade schools.

### Manpower Problems

The television industry is heading into a severe shortage of technically trained men that may seriously impede the forward progress of the industry. The amazing speed with which v.h.f. television swept across the country, made possible by the ability of the manufacturers to produce transmitting equipment and receivers at a phenomenal rate, provided an immense training ground for thousands of men to become television technicians from practical experience under competent supervision and instruction.

Various phases of the national defense program have been draining the servicing industry of some of its most capable personnel and our growing armed forces are absorbing most of the young men who normally would be available to the servicing industry for training as technicians.

The situation with respect to engineering colleges is equally dark. The burgeoning electronics industry needs more and more trained engineers but

college enrollments are dropping. This year, for instance, practically every graduate in electrical engineering will have a choice of jobs open to him provided, of course, that the armed services don't have a priority claim for his services.

Several forecasts indicate that if the present trends continue the enrollment in electrical engineering colleges will be at a critically low point by 1953 and that industry will go begging for trained engineers.

This alarming shortage of men trained in the electronics art should inspire every man now engaged in radio and television service to supplement his regular work and reading with an organized course of study in electrical, radio, or television engineering. The opportunities of the past in radio are insignificant in comparison with those of today and in the glowing future in electronics and television. The hours spent today on organized study will pay big dividends in the years to come.

### Trade Show for Service Industry?

In their travels about the country your editors have found a growing interest among television service contractors in an annual, national trade show and convention for the television servicing industry. The threat of competition from big business in the service industry may crystallize an effective national organization of TV service dealers and contractors which, in turn, would provide the centralized organization necessary to bring a national convention and show into being.

Perhaps 1952 will usher in that annual service trade show that service operators have dreamed of for years. Certainly if the demand is strong and clear the necessary steps will be taken to bring such a convention about. What do you think?

-50-

## ATTENTION ALL HAMS

THE FCC has been advised by the United States Army of large-scale military maneuvers to be staged in North and South Carolina from August 6 to September 7, 1951. Because of the size and nature of these maneuvers, the use of the frequency band 3700-3900 kc. will be required in addition to frequencies outside this amateur band to be made available temporarily for military use.

The problem is essentially one of interference from amateur operations to low-power military training operations in the southeast portion of the United States. Therefore, on behalf of the Army and with the concurrence of the ARRL, the Commission requests the voluntary cooperation of radio amateurs within interference range of the maneuver area to observe the conditions set forth below:

1. For amateurs in North Carolina, South Carolina, Georgia, Delaware, Maryland, Virginia, West Virginia, the District of Columbia, and in Tennessee east of and including Hamilton, Rhea, Roane, Anderson, and Campbell counties: No operation in the band of frequencies 3700-3900 kc.

during the period of the maneuvers.  
2. For amateurs outside the area defined in (1) and east of the Mississippi River: (A) No special limitations during daylight hours. (B) No night-time operation (local sunset to local sunrise), in the band of frequencies 3700-3900 kc. during the period of maneuvers.

3. For amateurs west of the Mississippi River or outside of the Continental United States: no limitations. The Commission and the United States Army officials are of the opinion that careful observance of the limitations proposed herein will permit essential radio communication in connection with the maneuvers to be conducted with a minimum of harmful interference. Since the military operations will be conducted with low power, the absence of any signal should not be construed as indication that maneuver operations are not in progress.

The Commission wishes to emphasize that this public notice is a request for the cooperation of the radio amateurs and an opportunity to further enhance the excellent reputation for cooperation which that group already enjoys. -30-

**RADIO & TELEVISION NEWS**



# OUTSTANDING VALUES NOW AVAILABLE

## ORDER AUTO RADIO PARTS AND EQUIPMENT NOW!

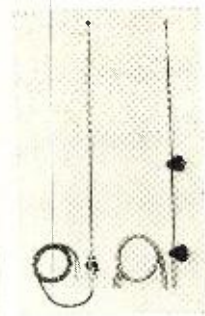

### AUTO ANTENNAS

**TOP COWL:** 3 section staff, 58" extension. Bakelite insulator, chrome trim. Single hole mount. Simple installation. Complete with lead. **\$2.19** each. Case of 25.....**\$1.95** each

**SIDE COWL:** 3 section staff, 63" extension. Complete with tenite insulators. Static ball and tip shielded. Low loss lead.

**\$1.89** each. Case of 25. **\$1.75** each

### STANDARD MANUFACTURE VIBRATORS

Standard 4 prong..... **\$1.35** each.  
10 for.....**\$12.50**

Offset 4 prong—Delco type. **\$1.45** ea.  
10 for.....**\$13.50**

Buick type 5 prong.....**\$2.95** each.  
10 for.....**\$28.00**

Generator Condensers..... **19c** each  
10 for.....**\$1.75**

### BUFFER CONDENSERS

.005 —2000 V... } **25c** each  
.006 —1600 V... } 10 for **\$2.25**  
.0075—2000 V... }  
.01 —2000 V... } 100 for **\$19.50**  
OZ4 Tubes. Fully Guaranteed.  
**69c** each. 10 for **\$6.50**

### GUARANTEED RECTANGULAR PICTURE TUBES

A real bargain for these first-rate tubes.

16"—16RP4.....**\$23.50** each  
17"—17BP4.....**\$24.50** each  
20"—20CP4.....**\$45.00** each

**PHONO CARTRIDGES**—Brand New  
—Will replace 95% of all cartridges.  
1 volt—Standard Mounting.**\$1.75** ea.  
3½ volt—Standard Mounting.**\$1.85** ea.

## NOW! LARGE 14" or 16" PICTURE FROM YOUR 10" or 12" TELEVISION SET

Servicemen: Convert customers' sets for extra profits! 90% of all conversions can be made by use of the RAPARCO conversion kit.

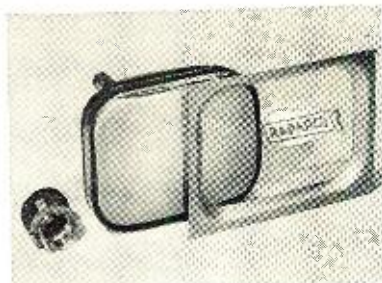

**14" Kit**—14BP4 CR tube, 70° Deflection yoke. Attractive Lucite mask. **\$32.95**

**16" Kit**—16" Rectangular CR tube, 70° Deflection yoke. Attractive Lucite mask, 16" HV Flyback transformer.....**\$39.95**

### HARD-TO-GET TUBES Fully Guaranteed

Quantities Limited—Subject to Prior Sale.

1B3GT..	\$1.20	6K6GT..	\$.69
5Y3GT..	.57	6BC5...	.90
6AK5...	1.76	6BH6..	.90
6AL5...	.90	6CB6...	.90
6AQ5...	.90	6BJ6....	.90
6AU6...	.90	12AT7..	1.31
6AV6...	.68	12AU6..	.90
2X2A...	\$.59		

### SPEAKER BUYS OF THE YEAR

4" PM Alnico V Magnet } **\$1.49** each  
5" PM Alnico V Magnet } **10 assorted for \$14.25**

### THE PERFECT SPEAKER FOR REPLACEMENT OR SOUND WORK

10" PM 3.15 oz. Alnico V Magnet.  
Rated at 15 watts..... **\$3.95** each.  
6 for **\$3.75** each.

### TUBE CARTONS

Made of heavy red stock. For miniature tubes.

**\$1.25** for 100.  
**\$11.00** for 1000.  
GT OR METAL TUBES  
100 for **\$1.50**  
1000 for **\$12.50**

## CUSTOM BUILT AUTO RADIOS

Easily installed. Fine, top quality. Ready to place in your car. Designed for each specific car.

**All sets—6 tube.** 3 gang; super heterodyne. Extra sensitive circuit. Low battery drain. Beautiful finish and dial. These models now available:

1951—Ford	1948-49-50-51—Hudson
1949-50—Ford	1951—Henry J rolet
1951—Chevrolet	1951—Dodge, Plymouth
1949-50—Chevrolet	1949-50—Dodge, Plymouth
1950-51—Studebaker	

List Price, **\$59.95**

YOUR PRICE.....**\$41.95**

## HERE'S A REAL TOOL BUY



This handy, useful 6-piece set with unbreakable, shockproof, nonflammable amber handles, with flange aluminum screw chuck. Blades hardened, tempered and fully polished. In attractive leatherette pouch. **NOW ONLY \$1.11** each.

Case of 12 sets.....**\$12.00**

## FLYING ARROW TV ANTENNA DOUBLE V ARRAY

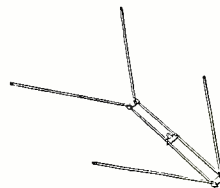

Hi-gain for fringe areas. Completely pre-assembled. Packed two arrays per carton. Can be stacked for extra signal strength. Price per carton of two **\$7.10**  
Lots of 6 cartons.....**\$40.50**  
**10 ft. 1¼" heavy gauge steel mast, rustproof.....\$2.29** ea.  
10 for.....**\$21.90**  
5 ft. sections.....**\$1.29** ea.

**CHIMNEY MOUNTS**—2 piece heavy-duty, rust-proof brackets. No drilling or guy wire needed. Includes strapping. **\$1.30** each 12 for **\$1.20** each

# Radio Parts Company, 614 RANDOLPH ST., CHICAGO 6, ILL.



**BIG WAREHOUSE-WIDE SUMMER SALE!**

ARC-5 OR 274-N TRANSMITTERS COMPLETE	
3-4 mcs. Fair cond. ....	\$10.95
4-5.3 mcs. Used ....	3.95
5-7 mcs. Used, excel. cond. Less xtal. ....	4.50
7-9.1 mcs. Used, excel. cond. Less xtal. ....	10.95
ARC-5 OR 274-N RECEIVERS	
3.6 mcs. Used ....	\$ 5.50
6-9.1 mcs. Used cond. ....	7.95
6-9.1 NEW, with dynamo. ....	11.95
190-550 kcs., excel. cond. ....	12.50
Command Receiver, 28V dynamo. ....	9.95
12 V. Command dynamo. NEW ....	9.95
MD7/ARC-5 Plate Modulator. Less dyn. ....	7.95
274-N ANTENNA RELAY BOX	
Contains RF meter plus 50 mmfd H. V. vacuum cond. and relay. New in carton. ....	\$3.50

**Ahoy! Marine Gear Specials! Look Alive!**

**BOAT OWNERS! COLUMBIA MARINE TRANSMITTER:** Kill your transmitter trouble once and for all! Check these outstanding features! 12 or 24 V. optional. 120 W. output rated at 100% modulation. 4 channels. xtal control on your freq. WILL MATCH ANY ANTENNA! FCC approval guarantee. Dimensions: 19 1/2 x 16 9/16 x 7 3/4 inches. COMPLETE with dynamo, cords, mike, tubes, pretuned and ready to go. We got it cheap, so we're sellin' it cheap! **ONLY \$249.00**

**COMMAND SET MARINE RECEIVER.** 1.5-3 mcs. Brand new with dynamo. .... **\$24.50**

**TCS XMTR & REC. COMBO:** Complete with all tubes. Covers 1.5-12 mcs. MI control. 12 V. input; 35 W. output. Includes dynamo and antenna loading box. Excel. cond. Less xtal. .... **\$175.00**

**BC223 MARINE TRANSMITTER:** 25 W. with marine tuning unit. Extra tuning units, mounting rack, MI or xtal control. NEW with tubes, less xtal. SPECIAL! .... **\$47.50**  
Set of 4 xtal. Only. .... **19.95**

**DU-1 MDF LOOP:** New. This month. With schematic and conversion dope. .... **27.50**

**COMPLETE SCR-269 MARINE ADF COMPASS:** DON'T GET SEA! Includes 24 V. inverter, loop, compass indicator, control box, relay, plugs, flex cable and rack. Excel. cond. Plus FREE tech. manual! Only. .... **\$95.00**

**JEFFERSON-TRAVIS "Emerson" Radio Corp. RADIO TELEPHONE-5 W. marine.** This is it. Brand new. NOT SURPLUS. The latest thing for emergency stand-by on small boat gear. Covers 2-3 mcs. xtal controlled. Ship-to-ship and ship-to-shore. Has 6 V. input or will run 8-10 hours on its own self-charging 6 V. battery pack. Needs no special installation. A kid can operate. Has built-in speaker. Unit comes in small metal case with carrying handle. Size: 10 1/2 x 8 x 1 3/4 inches. Add \$30 for complete with mike, 110 V. recharging unit, instructions. Ready to go less xtal and battery. .... **\$79.50**

**MIN-26C RECEIVER:** Freq. 150-1500 kc. 28 V. with control box, flex cable, azimuth indicator, loop, and loop cable. EXTRA HOT for aircraft or marine use. Most parts brand new. With left-right indicator & plug. FOR FAST ACTION ONLY. .... **\$45.00**

**DYNAMOTOR:** BD-77 12 V. input; 1000 V. 350 mils. Used. .... **9.50**

**DYNAMOTOR:** PE73-C 24 V. Brand new. .... **7.95**

**T-23/ARC-5 TRANSMITTER:** The BEST VHF job made - bar none! 100-156 mcs. 28 V. input. 4 channels. xtal controlled. Can be used with ARC-5 Command Equipment. Uses 12-82 tubes. Ideal for CAP, aircraft, VHF & 2-meter ham band. If you order NOW you'll RECEIVE FREE Conversion Manual Vol. 2 (worth \$2.00). Has all conversion dope on VHF, ARC-5 & others. THE WHOLE DEAL. THIS MONTH ONLY! JUST **\$27.50**

**ARC-4 VHF TRANSCEIVER:** 140-144 mcs. With all tubes, less dynamo. LIKE NEW! .... **\$32.50**  
SPECIAL

**SCR-625 MINE DETECTOR**  
Supply limited. These may never be repeated again! Ideal for locating hidden minerals or metals. Used by miners, prospectors, plumbers, etc. LIKE NEW. .... **\$55.00**

**APQ-2 TRANSMITTER:** UHF. Freq. range 375-575 mcs. Has silver plated tuning cavity. Uses pair of 388 doorknob tubes in for UHF experimentation or 420 meter ham or citizens' band. Good cond., less tubes. .... **\$7.50**  
A STEAL AT THIS LOW PRICE.

**BC-221 FREQUENCY METER CASE:** Wood or metal. Good cond. Ea. .... **\$2.95**

**BC-375 TUNING UNIT:** NEW! Excluding TU-5. ONLY. .... **\$3.50**

**METERS! OUR BARGAIN SPECIALS!**

0-3 VDC 2 in. rd. Simpson. ....	\$2.49
0-200 amp. AC 4 in. rd. Weston. CT ratio 200:5. Only. ....	4.50
0-100 VDC movement with 20-0-20 scale. 2 in. sq. Simpson. Used. ....	2.25
0-20 kilovolt DC 3 in. rd. Westinghouse. FS equals 1 ma. Use external multiplier. Only. ....	4.95
0-50 amp. AC 2 in. sq. Triplett. ....	2.99
0-25 MADC 2 in. rd. Weston. ....	2.99
0-2 amp. RF 2 in. rd. Thermocouple type. ....	2.99
0-9 amp. RF 2 in. rd. Westinghouse. ....	2.99

**PROP PITCH MOTORS:** Rotate ver beach antenna with these like new motors. 20-30 W. AC-DC. Half hp. motor rotates 1 1/4 rev. with terrific torque. Used, excel. cond. .... **\$9.95**

**T5-16 APN SIGNAL GENERATOR:** Used with radio-aircraft altimeter for checking and aligning sets. Complete. Excel. cond. .... **\$39.95**

**HAMS! HIGHEST PRICES PAID FOR CLEAN EQUIPMENT. TELL US WHAT U HAVE.**

All orders F.O.B. Los Angeles. 25% deposit required. All items subject to prior sale.

**COLUMBIA ELECTRONIC SALES**  
522 South San Pedro Street  
LOS ANGELES 13, CALIFORNIA

**TV Booster**  
(Continued from page 55)

The counterpart of this unit is part of the main unit itself and supplies current for the filament of the type 7F8 dual-triode as well as to the power transformer,  $T_1$ , which steps up the 6 volts and feeds it to  $Rect_1$  and the filter network consisting of resistor  $R_6$  and condenser  $C_5$ ,  $C_6$ . The rectified voltage appearing at the junction of  $R_6$  and  $R_2$  will be around 100 volts which is sufficient for proper operation.

**Adjustment**

Rough adjustment of the unit may be made as follows. Connect a 6 volt a.c. supply to terminals 1 and 2 shown in Fig. 3. Connect a short length of twin lead from terminals 5 and 6 to the antenna input terminals on the TV set or booster. The set should be tuned in on the channel for which the unit is to be adjusted. If it is impossible to receive a signal on the set, it is better to wait until a fair signal is coming through before attempting to align the antenna booster.

Having completed these connections, the picture or test pattern should once more appear, along with the sound. Now adjust the tuning slug of  $L_2$  for the best picture and adjust  $L_4$  for maximum sound. Adjust  $L_5$  first for the optimum sound and then for the best picture. Next set the slug of the coil at a point midway. Adjust  $L_3$  for the best picture and minimum snow. If a scope and signal generator are available, so much the better and the unit may be aligned in a more orthodox manner. After installing the unit at the antenna it may be advisable to make a slight readjustment of  $L_2$ .  $L_5$  is less critical in adjustment than the other tuned circuits as it is loaded with  $R_5$  and tunes very broadly.

After assembling the unit in its weatherproof cover it may be mounted to the mast by means of a band of

**for music lovers only**



Your records (LP's or Standard) need not produce fuzzy, noisy, distorted music. In their sound grooves is fine musical realism of concert hall quality that can be recreated by record players if equipped with fine audio components: pickup, arm, compensator, preamplifier, etc. Such components by Pickering are the finest available; the choice of engineers, leading record critics, music lovers and specialists in the production of custom record playing systems.



Pickering High Fidelity Components are available through leading jobbers and distributors everywhere; detailed literature will be sent upon request.



**PICKERING & CO., Inc.**  
Oceanside, L. I., N. Y.

Address Department C



**POINT-TO-POINT ANTENNAS FOR CIVIL DEFENSE**

Fig. 6. Chassis and housing assembly.

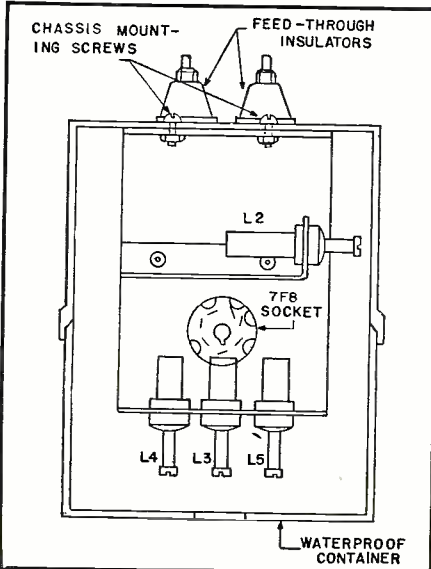

Follow the lead of military communications experts and use the easy-to-erect, efficient and economical vertical antennas for those point-to-point frequencies in the 160, 80 and 75 meter bands, plus CAP, MARS and joint disaster channels.

Premax can supply aluminum, stainless steel and steel Antennas at heights up to 35 feet with base and standoff insulators. Also coil-loaded Antennas at 9 1/2 and 17-foot heights which give super-efficiency with smaller size.

Vertical Antennas with their omnidirectional coverage work better with vertically equipped mobiles.

See your distributor or write for Catalog.

**PREMAX PRODUCTS**  
DIVISION CHISHOLM-RYDER CO., INC.

5105 Highland Ave., Niagara Falls, New York

**RADIO & TELEVISION NEWS**

Save Time  
Save Money  
with these...

# New STANCOR REFERENCES

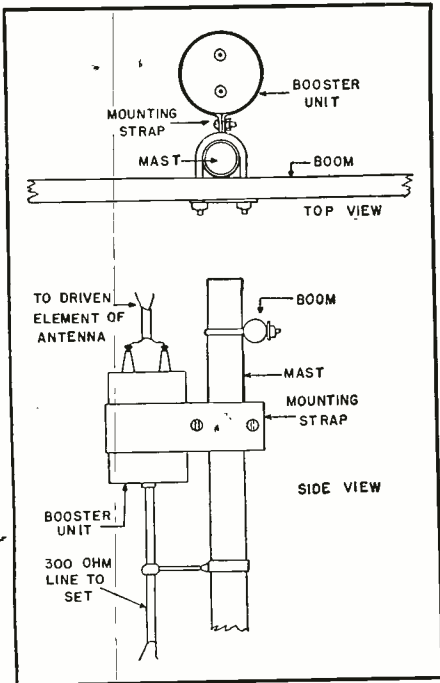

Fig. 7. Method for mounting the booster unit on the television antenna mast.

aluminum about 2 inches wide, drawing it up tight around the can with a machine screw. The remaining end should be drawn up snug around the mast proper. A short length of 300 ohm line connects the two feedthrough insulators to the antenna terminals. The antenna is now ready to be placed back in position. At the set the lead should be connected to terminals 3 and 4 (Fig. 3) and you are in business.

It will be found that when this unit is adjusted to Channel 5, for example, Channels 4 and 6 will also be received, although not as clearly as the channel to which the booster is peaked.

At our location we are using a home-made 5-element yagi constructed from 1/2 inch aluminum tubing and using a two-diameter, transformer-type folded dipole.

The antenna is cut for Channel 6 and, of course, we are using the booster described in this article. We use a *National* TV-10T receiver and a *Regency* booster. Stations received include the following: WFMB-TV (Channel 6), Indianapolis (160 miles)—excellent; WAVE-TV (Channel 5), Louisville (100 miles)—good; WSM-TV (Channel 4), Nashville (170 miles)—good; and WLW-TV (Channel 4), Cincinnati (200 miles)—good.

All of these stations are received with the unit adjusted for Channel 6. The present system has been in use now for over a year and has given no trouble whatsoever. We are now building another combination for Channel 4. The complete booster costs only about \$7.00 to build from scratch but we have gotten our money's worth out of it long ago.

Experience with this unit has demonstrated that mounting the booster on the antenna proper cuts the snow considerably as compared to the former method of using it at the set. —30—

The big new Stancor 1951 Mid-Year Catalog lists 441 Stancor transformers...the most complete catalog line in the industry. All transformers, including television components, are classified and indexed so you can easily locate the unit you need. Each listing includes electrical specifications, dimensions, weight and list price. Clear illustrations show each mounting type in detail.

★ ★ ★

The 8th Edition of the Stancor Television Catalog and Replacement Guide provides you with quick, easy-to-read replacement information on 1511 TV models and chassis made under 79 brand names. All manufacturers are listed alphabetically and the models and chassis are listed in numerical order. A separate section lists all Stancor TV transformers and related components by part number.

Both of these up-to-date references are now stocked by your Stancor distributor, or write Stancor directly for your free copies.

★ ★ ★

**AUDIOPHILES**—Use Stancor transformers to build the famous Williamson High Fidelity Amplifier. Circuit diagrams and complete parts lists are available in Stancor Bulletin 382 at your Stancor distributor.



Most Complete Line  
in the Industry

## STANDARD TRANSFORMER CORPORATION

3584 ELSTON AVENUE, CHICAGO 18, ILLINOIS

### WE PAY TOP DOLLAR

for all types of

### SURPLUS ELECTRONIC EQUIP.

Regardless of Condition. Ready Cash for:

- ART-13 Xmitter
- DY-17 Dynamotor
- TS-12 Test Sets
- TS-13 Test Sets
- MN-26 J or K
- BC-342
- BC-312
- BC-611 Handie Talkie (or any part)
- I-100 Test Sets
- BC-348 Rcvr.
- BC-788A, AM, B or C
- I-152A, AM, B or C
- ARC-1
- ARC-3
- Teletype Equipment
- Any Test Equipment
- TS-67

Plus anything you have in Electronics Equipment. Send your complete list, present condition and asking price to:

WEST REGION ELECTRONICS

Dept. V-3

1437 S. Norton Ave. Los Angeles 19, Calif.

### YOUR SERVICE BUSINESS NEEDS!!

- TELEVISION SERVICE REPORT..... \$3.95  
(Box of 100—3 copy business form)
- TELEVISION SERVICE PLAN..... 2.25  
(Book of 100 TV service contracts)
- TELEVISION JOB TICKET..... 1.60  
(Book of 100 TV job tickets)
- TELEVISION SERVICE CALL BOOK..... .75  
(Salesbook of 50 duplicate sets)
- RADIO SERVICE RECORD..... 1.50  
(Book of 100 Radio job tickets)
- RADIO WORK SHEET..... .60  
(Pad of 50 repair sheets)
- RADIO SERVICE STANDARD RATE BOOK.... 1.00
- TROUBLE TRACING IN AC-DC RADIOS..... 1.00

See them at your RADIO PARTS DISTRIBUTOR or write for illustrated Catalog 2A

### OELRICH PUBLICATIONS

4135 N. Lawler Ave. Chicago 41, Ill.

# HERE'S HELP—



## Now, in 1800 pages

All data, basic knowledge, methods and theory of Radio, Television, Electronics, digested into 32 sections in complete, quick to find, easy to read Handbook form.

Plan every operation in Radio-TV and Electronics with this library set consisting of *The Radio Electronics Handbook* and the *Video Handbook*. These Handbooks will be your lifelong tools—you will use them every day on the board, at the bench, in the field. Use them for construction, production, installation, operation—use them for adjusting, troubleshooting, measuring and testing. They will be your invaluable aid in research, design, development, manufacturing or maintenance. With data and servicing procedures complete, they will make your work faster, better, easier.

They give complete coverage of everything in Radio, TV and Electronics—and you will find them easy to use—everything is presented in plain language—all terms explained; schematics, working diagrams and pictures are clearly illustrated for fast and easy understanding.

The Radio Electronics Handbook and the Video Handbook are works of complete authority prepared by the well-known engineers Scheraga & Roche, under the direction of William F. Boyce, famous for the preparation of hundreds of handbooks and manuals for the U. S. Signal Corps, Navy Communications, Air Force Electronics Section, Western Electric Co., General Electric Co., Bell Laboratories, R. C. A., Sylvania, DuMont Laboratories, National Radio Co. and many others.

These Handbooks are endorsed by leading schools for instruction and reference. The armed services make them available to their technicians in libraries, schools and in the field. Engineers, Draftsmen, Laboratory and Production men in every industry have purchased over 50,000 of these books for use in their work.

500 Radio jobbers keep them constantly in stock for the convenience of their service and industrial customers. These are the most commonly used books in Radio & TV. Contents are too long and complete to describe here—so, see them at your Radio jobber, your bookstore, or send for them on free examination. See for yourself what they will do for you.

**SEND NO MONEY  
10 DAY FREE EXAMINATION**

**SPECIAL OFFER: Save one dollar—get both handbooks as shown above in library set for \$10.90**

### COUPON

**BOYCE-ROCHE BOOK CO.  
Caldwell 27, New Jersey**

Send ( ) Library Set (2 books) @ \$10.90  
( ) Radio Electronics Handbook @ \$5.95  
( ) Video Handbook @ \$5.95

In ten days I will send price plus postage, or I will return books postpaid.

(Offer good in U. S. A. and to men in Armed Services overseas only.)

Name.....

Address.....

Employed by.....

Save postage—we pay postage and packing if you send money NOW. Money back on same return privilege.

## WHAT'S

# New in Radio

For additional information on any of the items described herein, readers are asked to write direct to the manufacturer. By mentioning RADIO & TELEVISION NEWS, the page, and the issue number, delay will be avoided.

### SPEAKER LINE

British Electronic Group, 366 Madison Avenue, New York 17, New York, is the U. S. representative for a new



line of loudspeakers being manufactured by *Electro Acoustic Industries Ltd.* of London.

The new Series 2P features an overall diameter of 2½" and a 2.4 ounce Alnico magnet. The heavy electrical damping resulting from the high flux design as well as the flexibly mounted low-resonance diaphragm is said to provide excellent reproduction free from pronounced resonances. The diaphragm is especially treated to make it termite-proof and to reduce fungus growth to a minimum.

Although designed especially for intercoms, this speaker is also suited for application in "personals," portables, mobile receivers, test equipment monitors, and other military and non-military uses.

### REPLACEMENT CARTRIDGE

The *Astatic Corporation* of Conneaut, Ohio, has announced a new cartridge which was designed as a replacement unit for the 78 rpm snap-in *Admiral* tone arms.

Designated the 402-M ceramic cartridge, it replaces the *Admiral* cartridge part No. A1372.

Output of the 402-M is given as .7 volt at 1000 cps on *Audio-Tone* test record, the frequency range is 50 to 10,000 cps. Recommended minimum

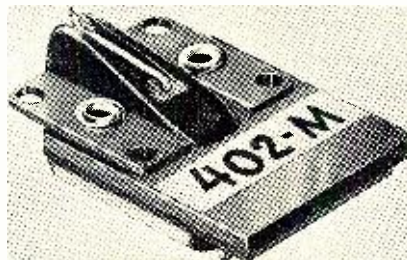

needle pressure is 12 grams and the net weight of the cartridge is 8 grams.

The new unit uses the *Astatic* type

"G" replaceable needle with a 3 mil precious metal tip.

### STAND-OFFS

*Erie Resistor Corporation* of Erie, Pa. has developed a new type of hermetically sealed stand-off for v.h.f. and u.h.f. applications.

Designated the Style 326 stand-off Ceramicon, the new unit provides, in a hermetically sealed case, a bypass-to-ground through the shortest possible path. Full advantage is taken of the concentric electrode configuration in maintaining this short path by making connection to the outer electrode at the plane of the chassis. The result is an extremely low and uniform series inductance.

The Style 326 is for threaded mounting installation. According to the specifications furnished it is available in standard capacitance values 10, 33, 47, 68, 82, 100, 680, 1000, and 1500  $\mu$ fd., with a voltage rating of 500 volts d.c.

### INDICATOR LIGHT

A new miniaturized indicator light, believed to be the smallest on the market, has been announced by *Alden Products Company*, 117 N. Main Street, Brockton 64, Massachusetts.

This compact 6-volt light, 86L, gives

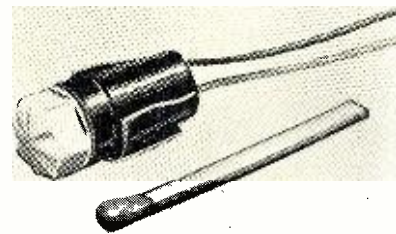

a sharp indication that can be viewed from any angle. Bulky screw machine parts are entirely eliminated and the light is only ¼" in over-all length and less than ⅜" in diameter. The functional design permits easy mounting on a panel without complicated tools or processes—it simply pushes into an "S" drill hole.

Complete information is available from Norman Curtis at the address given above.

### RECORD-REPRODUCE HEAD

A new multi-channel magnetic record-reproduce head has just been announced by *The Brush Development Company* of 3405 Perkins Avenue, Cleveland 14, Ohio.

The BK-1500 series is available with from 3 to 14 channels. Design features include balanced magnetic construc-

**RADIO & TELEVISION NEWS**

# NEW!! CONDENSERS



## ELECTROLYTICS

Prong Mount  
D. Y. Type

Mfd.	Volts	Price
50	500	
50	400	
50	450	
100	350	
2x4	500	
2x8	450	
2x10	450-350	
1x10	450	
80-10	400	
80-20	450-350	
3x8	150	
3x10	150	
800	15	
30	450	
32	450	
20-20	400-25	
2x30	25	
20-10	2x15	
40-20	150-25	
45	175	
150-50	150	
2x10	150	
20-10	150-50	
10-2x20	150-50	
Price	.....	29c ea.

Mfd.	Volts	Price
2x20(50)	450(350)	
2x30(20)	350	
80-40(150)		
2x40(20)	350(25)	
20-10(50)	450(50)	
50-40		
Price	.....	49c ea.

Mfd.	Volts	Price
8-50	450-50	
40-50	400-300	
40-10	475	
90-10	350	
3x10	450	
50-40	450	
90-10	350	
40-15	450	
2x30	350	
16	450	
2x16	450	
20-10 (50)	450 (50)	
100	150 (15)	
80-50	450-50	
2x8 (10)	450-(25)	
10-15 (20)	350 (25)	
2x16-25	450-50	
2x15-20	450-25	
10-10-20	450	
Price	.....	39c ea.

# COMMUNICATIONS EQUIPMENT COMPANY



Mfd.	Volts	Price
8	100	.18
8	150	.18
8	350	.20
10	50	.18
10	150	.20
12	450	.23
16	100	.20
16	150	.22
16	300	.30
16	450	.40
20	25	.10
20	50	.15
20	40	.18
20	350	.30
24	350	.30
25	25	.10
30	300	.25
30	450	.30
40	150	.22
40	450	.40
50	25	.22
50	50	.23
50	150	.30
50	50	.50
50	100	.60
50	150	.75
100	10	1.20
2000	6	1.35
1200	1.5	1.10

AVAILABLE  
1,000,000  
BATHTUBS  
250,000  
HIGH VOLT  
CONDENSERS  
WRITE OR  
PHONE FOR  
LISTS

## LARGE ASST. OF PIGTAIL MICAS IN STOCK

Mfd.	Volts	Price
13-15	220 \$1.20	
20-24	110 1.00	
25-30	220 1.35	
43-63	110 1.25	
43-48	110 1.25	
50-75	110 1.25	
60-80	220 1.50	
61-69	320 1.60	
72-82	110 1.25	
75-84	110 1.25	
88-106	110 1.50	
100-120	110 1.65	
130-157	110 1.75	
130-150	70 1.50	
130-180	110 1.85	
158-191	110 1.85	
161-180	110 1.75	
180-210	110 1.95	
200-220	110 1.95	
270-300	110 2.10	
324-309	110 2.40	
378-420	175 3.00	
388-390	110 2.75	
390-450	110 2.35	

WRITE FOR LISTINGS



## MICA CAPACITORS

SOLAR XMB  
TAPPED POLES

Mfd.	Volts	Price
2500 V Test		\$0.35
.000025		.35
.00003		.35
.00005		.35
.000075		.35
.0001		.35
.00015		.35
.00025		.35
.0003		.35
.0004		.35
.0005		.35
.00075		.35
.001		.35
.0015		.35
.002		.35
.0025		.35
.003		.35
.00375		.35
.004		.35
.0045		.35
.005		.35
.005625		.35
.006		.35
.006375		.35
.007		.35
.0075		.35
.007625		.35
.008		.35
.01		.35
.0125		.35
.015		.35
.02		.35
.025		.35
.027		.35
.03		.35

## OIL CONDENSERS

Mfd.	Volts	Price
5	50	\$0.45
650	80	1.95
5	150 AC	1.45
15	220 AC	2.20
1	500	.40
7	600	1.25
20	600	2.10
0.5	750 AC	1.39
0.000	0.5	1000
.000025	2x0.5	1000
.00003	1	1000
.00005	1.5	1000
.000075	2	1000
.0001	4	1000
.00015	3x.01	1200
.0002	0.0016	1500
.00025	1	1500
.0003	1.5	1500
.0004	2	1500
.0005	2x0.1	2000
.0005625	1	2000
.0006	2	2000
.0006375	3	2000
.0007	0.5	2500
.00075	1.5	2500
.0008	0.15	4000
.00085	2x0.1	4500
.001	0.1	4000
.00125	2x0.1	7000
.0015	0.1	7500
.00175	2x0.15	8000
.002		4.75

MANY OTHERS

Mfd.	Volts	Price
250-1000		
2x15-120	10-6	
150-1.6		
10-50-100		
20-10-50		
1000-500		
1000		
Price	.....	69c ea.

Mfd.	Volts	Price
80	500	
40	450	
100	400	
50	450	
2x10	475	
2x20	400	
4	450	
2x8	500	
300	500	
40-10	450-350	
40-35	450-350	
80-20	450	
80-10	450	
3x16	350	

Mfd.	Volts	Price
5	50	1.10
4	100	1.15
4	150	1.10
4	220	1.18
5	25	1.10
5	150	1.10
5	10	1.00
5	150	1.15
8	25	1.15
8	25	1.10



Transmitters  
40 Watt  
Output  
These Famous  
V.F.O. Drivers  
Available  
4-5.3MC. \$ 5.95  
5.3-7MC. \$ 5.95

ARC 5  
MODU-  
LATOR  
MD7/ARC5  
Plate Mod-  
ulator w/  
dynamotor complete  
w/Tubes 1-2J5, 2-  
1625, 1-1V35 Good  
cond. Price.....\$6.95  
BC456 Screen  
Mod.....\$2.25

EERSA  
TELEPHONE  
REPEATER  
Used to extend range  
of field telephones,  
teleg., & 20 cyc. ring-  
ing possible over lines  
complete w/302 tube  
& phone. Feather-  
weight. Price \$9.95

ANTENNA MAST  
Are you in a dead spot.  
Here is a Six Arms Ant.  
Here is a Six Arms Ant.  
mast 30' high of rugged  
plywood construction  
to solve your problem.  
Telescopes into 3 foot  
sections for easy  
storage. Easy to Mt.  
Comp. with stakes &  
rods. Sold as is. \$19.95

HEINEMAN Ckt Bkrs  
for AC-DC operation.  
AM 1510M 7 Amp  
1614 80 AMP  
1614 50 AMP  
Price each \$1.10

932 PHOTO TUBE  
Gas Photo-  
tube having  
S1 response,  
particularly  
suitable for  
Red and Near  
Infrared Ra-  
diation. Can  
be used with  
incandescent  
light source. Sensi-  
tivity.  
Price..... 75c

AMP-RR  
0-4 Amp RF GE Type DW52.  
2% Accuracy. Expanded scale.  
2 1/2" dia. Infrared thermocouple.  
List Price \$19.75.  
Our Price.....\$2.95

ARC 5 SPARES & PARTS  
2830 KC 1Fs for 6-9 Rec. (3  
cols, inp, int, out) per set \$1.25  
#6234 6-9 RF..... .65  
5856 2830 KC BP..... .49  
5414 Cond. 3 x .05 300V..... .05  
5415 Cond. .05-.01-.05  
300V..... .10  
6261 Xfmr, Mike to Grd..... .79  
6929 Osc. coil..... .79  
6930 Osc. coil Thermocouple..... .79  
6932 Osc. coil..... .79  
7247 coil Pa..... .79  
Parasitic Suppressors..... .05  
Plug 6 pin for IF..... .10  
Plug 7 pin for Rec. chassis..... .10  
Plug 8 pin, rec. dyn. male &  
female..... .15  
Plug 3 pin, mod. dyn. female  
# 7023 5 pin, chassis mnt..... .29  
5842 plug rear Rec. & Xmtr.  
male..... .39  
5577 Plug 5 pin, chassis Rec.  
mnt..... .29  
6418 plug 8 pin, chassis Rec.  
mnt..... .29  
7027 plug 18 pin mod. chassis  
20 pin..... .49  
PL 148 3 pin, male..... .49  
PL 156A 5 pin, male..... .49  
#2674 3 pin, plug for IF  
Rack..... .29  
Rec. plates 190-550 KC..... .10  
(control box plates 190-550)..... .10  
#6035 Loading coil..... .59  
#6034 Loading coil..... .59  
Dual Fuse mnts..... .12  
Xtals for Xmtrrs Tube Type..... 1.00  
Tubes: 1626 1629 1625

VARIABLE  
TRIMMER  
CONDENSERS  
CS90 15 MMF  
CS81 20 MMF  
C993 50 MMF  
C677 60 MMF  
32c ea.

MOBILES!  
C.A.P. C.D.J.  
6 V. DYNAMOTOR SUPPLY  
RATINGS  
OUTPUT INPUT  
130 VDC 8 VDC  
Amps..... 350 MA 45 A  
Volts..... 450 OH  
Amps..... 450 VDC 6 VDC  
220 MA 22 A  
Originally designed for 14,  
but mobiles over U.S.A. re-  
port ex. results on 6V.  
Brand New, w/Filter Box, Starting  
Relay, Mounting Plate  
\$12.95  
Plugs. Set of 2..... \$1.00  
(With Dynamotor only)

CH Toggle Switch  
SPST Wire Leads Hal-  
Handle GA 250 Volt,  
18c ea.; 10 for \$1.50

CAPACITORS  
CERAMICON  
MMF. MMF. MMF.  
3.1 47 125  
4 50 200  
11 50 240  
13 60 250  
14 62 345  
15 65 350  
20 70 500  
220 1000

\$7 PER 100  
SILVER MICA  
BITONS  
MMF. MMF. MMF.  
40 175 500  
50 180 500  
100 185

Variable Ceramicon  
Series N500  
4-30 MMF  
23c ea.; 5 for \$1.00

EE8 TELEPHONE  
PARTS AND  
EQUIPMENT  
AVAILABLE  
IN STOCK  
PHONE OR WRITE



## TRANSFORMERS

These XFRMRS are Army  
Spec. All Underrated.

Comb. Transformers—115V/50-60 cps input.

Item	H.V.	Imp.	Filaments	Price
CT-861	2100VCT	.175	7.5VCT/4A, 2.5V/10A.....	\$10.95
CT-142	645VCT	.060	5V/2A, 6.3V/12A.....	4.25
CT-825	360VCT	.340	6.3VCT/3.6, 6.3VCT/3A.....	3.95
CT-076	600V	.100	2 x 12.6V/1.....	1.95
CT-626	1500V	.160	2.5/12, 30/100.....	9.95
CT-15A	350VCT	.070	6.3/6, 6.3/1.8 3 lbs.....	2.95
CT-071	110V	.200	3.0/200, 5V/10, 2.5/10.....	4.95
CT-378	2500V	4 MA	2.5/2.....	6.95
CT-367	580VCT	.050	5VCT/3A.....	2.25
CT-721	550VCT	.100	6.3/1A, 2.5VCT/2.....	2.95
CT-99A	2x110VCT	.010	6.3/1A, 2.5 VCT/7A.....	3.25
CT-91A	725V	.100	5V/3A, 6.3/3.5.....	3.25
CT-441	50V	.200	5V/2A, 5V/1.2.....	2.29
CT-408	350VCT	.026 MA	5V/3A.....	2.75
CT-931	585VCT	.086	5V/3A, 6.3V/6A.....	4.25
CT-610	1250	.002 MA	2.5V/21A, 2.5V/175A.....	4.95
CT-137	350VCT	.026 MA	5V/3A.....	2.75
CT-102	1080VCT	.055	25V/3A, 6.3V/1.8A, 6.3V/ 1.2A.....	5.95
CT-866	330V	.065	6.3V/1.2, 6.3V/60 MA.....	1.75
CT-319	330VCT	.085	5V/2, 6.3/7.5, 6.3/3.....	3.25

Filament Transformers—115V/50-60 cps input.

Item	Rating	Each
FT-029	13.5V/1.11A	\$ .79
FT-346	5VCT/13/5, 5VCT/6.75, 5VCT/6.75.....	5.95
FT-781	866 Trans. 2 x 2.5/5A.....	2.25
FTG-31	2.5V/2.5, 7V/7A (Tape @ 2.5V/2.5A), 16 lbs	9.95
FT-674	8.1V/1.5A.....	1.10
FT-157	4V/16A, 2.5V/1.75A.....	2.95
FT-391	6.4V/3A.....	1.10
FT-736	2 x 6.3VCT/3.2-1.2A.....	1.49
FT-899	2 x 5V/5.5A 29000 Rms.....	22.95
FT-418	6.3VCT/1A, 6.3VCT/7A.....	1.95
FT-735	6.3VCT/5A, 6.3VCT/1A.....	1.79
FT-101	6V/25A.....	.79
FT-738	6.3VCT/1A, 5V/2A.....	1.66

Plate Transformers—115V/50-60 cps input.

Item	Rating	Each
PT-976	Auto: 120VCT/10 MA.....	\$ 0.69
PT-31A	2 x 300V/5 MA.....	.79
PT-46A	4080VCT N.L. 3% to 1 1/8" H x 6" W x 7" L 20 lbs	29.95
PT-033	4150V/400 MA 1 1/2" x 9 1/4" x 9" D 70 lbs.....	49.95
PT-75-2	3780/3446/3112VCT/77 MA.....	10.95
PT-28-1	4600VCT/077.....	12.95
PT-403	Auto: 70V/1A.....	2.29
PT-160	1120VCT/770 MA, 950VCT/82 MA, 25 lbs.....	24.95
PT-170	Auto: 156/146/137/128-71A.....	3.29
PT-139	42V/46V/50V/55V/15.2A 7 1/2" W x 6 3/4" H.....	10.95
PT-31A	2 x 300V/5 MA.....	.79
PT-976	120VCT/10MA.....	.79



## Special Offer On This Complete RADIO ENGINEERING LIBRARY

*New, Up-To-Date Edition of Famous Library Covers Whole Field of Radio Engineering. Places Latest Facts, Standards, Data, Practice, and Theory At Your Fingertips.*

THE five big volumes of the new edition of the Radio Engineering Library now include the very latest facts, standards, data, and practice. This Library will help solve hundreds of problems for designers, researchers, engineers, and students in any field based on radio.

Written by leading radio engineers, these books cover circuit phenomena, networks, tube theory, vacuum tubes, amplification, measurements, etc.—give specialized treatment of all fields of practical design and application. They provide you with a complete and dependable encyclopedia of facts.

5 Volumes • 3872 Pages • 2770 Illustrations

- Eastman's FUNDAMENTALS OF VACUUM TUBES, 3rd Edition.
- Terman's RADIO ENGINEERING, 3rd Edition.
- Everitt's COMMUNICATION ENGINEERING, 2nd Edition.
- Hundt's HIGH FREQUENCY MEASUREMENTS, 2nd Edition.
- Henney's RADIO ENGINEERING HANDBOOK, 4th Edition.

### SEND NO MONEY

Special Low Price • Easy Terms

On this special offer you get this Library for \$34.50, instead of \$39.00. You save \$4.50 and may pay on easy terms. Mail coupon below to examine the Library FREE for 10 days. No obligation. These books are recognized as standard works; you are bound to need them. So take advantage of this special money saving offer. *Mail coupon at once!* McGraw-Hill Book Co., Dept. RTN-7, 327 W. 41st Street, New York City.

**McGraw-Hill Book Co., Dept. RTN-7,  
327 West 41st St., New York 18, N. Y.**

Send for 10 days' FREE trial, the RADIO ENGINEERING LIBRARY. If not satisfied I will return books. Otherwise I will send \$4.50, plus delivery charges, then, and \$5 a month for 6 months. (Reg. price \$39.00; you save \$4.50).

Name.....

Home Address..... RTN-7

City & State.....

**WE'LL PAY DELIVERY CHARGES** if you enclose \$4.50 first payment WITH coupon. Same return privilege for full refund.

tion with gaps at front and rear. All gaps are in perfect alignment and individual channels are cast into one integral block of specially selected synthetic resin.

The complete assembly is non-microphonic and impervious to moisture.

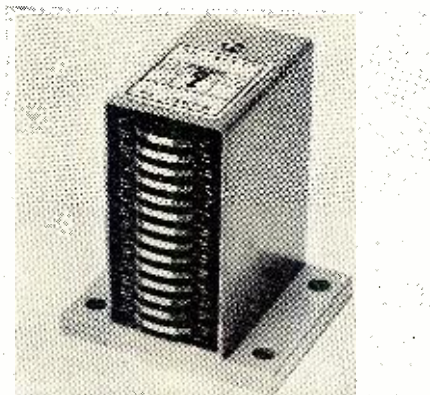

Shields and pole pieces are grounded to the housing. The head has a channel width of .050" with center-to-center spacing between channels of .125". The gap is .0005". Maximum output level at 1000 cps and 7.5 inches/sec. tape speed is .002 volts rms.

### NEW CRYSTALS

Valpey Crystal Corporation, 1244 Highland Street, Holliston, Massachusetts, has recently introduced a new crystal type dual frequency standard.

The Type DFS is designed for standard frequency applications and incorporates two separate quartz crystals entirely independent of one another but so designed that frequency stability and zero frequency adjustment are equal on 100 and 1000 kc. Both crystals are highly active and capable of producing high oscillator output together with instant starting when used in conventional circuits.

Calibration accuracy at 28 degrees C is  $\pm .005$  per-cent. Crystals are matched so that one trimmer may be



used for both crystals which can easily be adjusted to zero beat with WWV or other standard frequency. A data sheet on the Type DFS unit is available from the company.

### NEW RECORDER

Production has begun on a new model synchronous magnetic film recording and reproducing unit at the plant of *The Stancil-Hoffman Corporation*, 1016 N. Highland Ave., Hollywood 38, California.

Known as the Model S5, the new unit has been developed to meet the requirements of both the motion picture

and television industries. All the features of portability, large film capacity, minimum flutter, and ease of operation have been incorporated. A maintenance-free, unique drive system permits both synchronous and interlock drive. The equipment is available with both motors installed.

Using the same electronic section as is furnished with the company's R4 non-synchronous recorder-reproducer, the Model S5 has a frequency response flat to 9000 cycles at 16 mm speed or 15,000 cycles at 35 mm speed.

### AM-FM SIGNAL GENERATOR

Radio City Products Co. of 152 W. 25th Street, New York 1, New York has recently announced the availability of a pocket size, super-speed signal generator that combines a real FM signal generator, an r.f. signal generator, and an audio oscillator.

Known as the Model 730, the four FM fixed frequencies are actually FM modulated to give ample sweep for use with ratio detectors. Alignment can

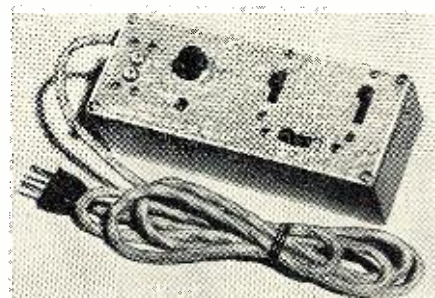

be quickly made at the ends of the band at the 88 and 108 mc. switch position. Correspondingly, the 10.7 and 9.1 mc. switch positions permit alignment of the i.f. sections.

The ends of the broadcast band can be readily aligned at the 1500 kc. and 550 kc. switch positions. Intermediate frequency alignment is provided by fixed frequency switch positions of 456 kc. and 465 kc. An audio outlet terminal is provided for supplying a 400 cycle signal externally.

The unit, which measures 7"x2 $\frac{1}{8}$ "x2 $\frac{3}{8}$ " and weighs 2 pounds, comes complete with all tubes, shielded output cables, and comprehensive instructions.

### 100 VOLT CONDENSERS

The Electric Transformer and Allied Products Division of the *General Electric Company*, Pittsfield, Massachusetts has announced a new line of 100 volt d.c. condensers, with double the capacitance designed into the same condenser space.

These components meet all the requirements of "F" characteristics of JAN-C-25 for 100 volt d.c. units. For applications where an expected life of 1000 hours is satisfactory, the rating can be increased to 150 volts and temperatures to 40 degrees C. Test results show that there is negligible change in capacitance from -40 degrees C to 105 degrees C and the units give full life expectancy at temperatures as low as -55 degrees C.

The thin-paper, thinfoil condensers

**RADIO & TELEVISION NEWS**





## ENTER RADIO TELEVISION

### thru this Proven Plan

As a young man with a career to build, you may *today* be interested primarily in training for Radio — and perhaps for TV. But — *who knows* . . . you may some day have both the desire and opportunity to climb further and become an Electrical Engineer! Here, then, is a world-renowned educational plan that permits you to use your Radio training as a *major stepping-stone* to an even greater career.

### IN 12 MONTHS BECOME A RADIO TECHNICIAN

Train here for radio shop operator or serviceman, mobile receivers and all types of transmitters, and for supervision of service personnel. You may then advance immediately, or at any future date, into courses described below.

### IN 6 ADDITIONAL MONTHS you become a Radio-Television Technician

An additional 6-months course gives you intensive TV Technician's training — under the *personal guidance* so necessary in this expanding field.

### ALSO...YOUR RADIO COURSE IS FULL CREDIT TOWARD THE B.S. DEGREE IN ELECTRICAL ENGINEERING

The Radio course, while complete in itself, is *one-third* of the college program (major in Electronics). Further — you are guided scientifically toward specialization beyond basic engineering training.



*B.S. Degree in 36 months. Military, practical or prior academic training evaluated for advanced credit. Terms open July, October, January, April.*

## MILWAUKEE SCHOOL of ENGINEERING

Technical Institute • College of Electrical Engineering

FREE — Write for "Occupational Guidance Manual" and 1951 Catalog.

MILWAUKEE SCHOOL OF ENGINEERING  
Dept. RN-751, 120 N. Broadway  
Milwaukee, Wis.

Without obligation, mail Occupational Guidance Manual on:

Radio-TV  Electrical Power  Welding  
 Heating, Refrigeration, Air Conditioning  
Also send 1951 Catalog for Electrical Engineering, B.S. degree in  Electric Power  Electronics

Name..... Age.....  
Address.....  
City..... Zone..... State.....

Check if World War II Veteran

are comparable in all ways to previously offered paper dielectric units and, in addition, are smaller in size and lighter in weight. They will not introduce noise into the system and will pass signal voltages approaching zero. While primarily intended for d.c. application with ripple voltages in accordance with JAN-C-25, they will withstand occasional heavy discharges. They can also be used in low voltage a.c. circuits under many conditions.

### MAGNETIC TAPE RECORDER

The Mark Simpson Manufacturing Co., Inc., Long Island City, New York has developed a new Sound Reel, dual-speed, dual-track magnetic tape recorder which is currently available in six models.

A precision recorder, the new unit combines all of the features found most desirable for commercial, professional, educational, and home uses. It records at speeds of either 3.75 inch/sec. or 7.50 inch/sec. The higher speed offers fine tone quality and the slower speed provides economy. Re-

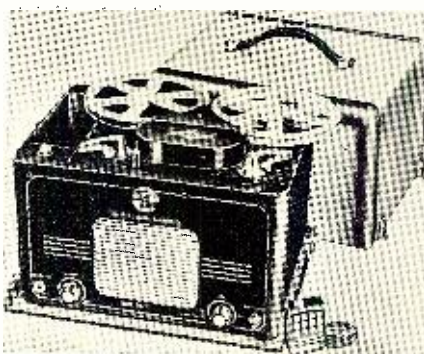

cordings are made at both speeds on the same track. The dual track permits full two-hour recording on a single 7" reel.

Several of the six models available have built-in AM radio. All are easy to thread and operate. The recording unit is built into an aluminum housing, finished in green hammertone, which fits into a portable carrying case.

The company will provide complete details on these new recorders.

### HIGH VOLTAGE "HYPASS"

Development of 1000 and 2500 volt d.c. "Hypass" three-terminal network feedthrough condensers has been announced by the Sprague Electric Company of North Adams, Massachusetts.

These new units are especially adapted for suppression of radio interference and harmonic generation in high voltage circuits in transmitters and industrial electronic equipment.

Complete sizes and ratings are included in the company's Engineering Bulletin 212B, available upon request written on company letterhead.

### NEW VIBRATOR DESIGN

The James Vibrapower Company of 4036 N. Rockwell Street, Chicago 18, Illinois has developed a new principle in vibrator design. The new "Angle Drive" vibrator principle is based on a recently-issued U.S. Patent.

## Users' Reports Prove THE OUTSTANDING PERFORMANCE of the STRAIN-SENSITIVE PHONOGRAPH PICKUP!

Enthusiastic letters from users all over the country are unanimous in praising the quality of reproduction obtained with the new STRAIN-SENSITIVE Pickup made by the Pfanstiehl Chemical Company.

There are good reasons why this amazing new transducer brings out the brilliance of great voices and orchestras . . . the latent music on your records that other pickups leave untouched.

- The STRAIN-SENSITIVE PICKUP is an amplitude transducer with a **CONSTANT RESISTANCE** of about 250,000 ohms.
- Signal output is at a practically **CONSTANT IMPEDANCE LEVEL**.
- Excellent Transient Response.
- **NO DISTORTION**, phase shift or evidence of intermodulation is audible.
- **LINEAR RESPONSE**, free from peaks or resonances.

Cartridges are available for both standard and micro-groove, and can be had with Famous PFANSTIEHL M47B Precious Metal Alloy or diamond tipped styli.

A special preamplifier is necessary to provide the correct D.C. voltage for the pickup element and to provide the first stages of signal gain. Four styles are ready, or, if you prefer, you can build your own from the circuit in the literature.

Ask your radio supply man, or write today for complete **FREE INFORMATION**.

## PFANSTIEHL CHEMICAL COMPANY

107 Lake View Avenue, Waukegan, Illinois

### RED ARROW BARGAINS!!

#### TRANSMITTING MICAS

.0025 @ 1200 V, .005 @ 1200 V, .04 @ 1200 V, .01 @ 1200 V, .004 @ 1200 V, .49c each

.027 @ 2500 V Test, .001 @ 2500 V, .59c each

.0035 @ 5000 V, .0001 @ 5000 V, .00025 @ 5000 V, .79c each

#### GE PYRANOL

.15 @ 12,000 volts. Brand New, Individually Boxed . . . . . \$9.95 each

BC 929 RADAR SCOPE	HEAVY DUTY LINE CORD
Excellent condition . . . \$17.95	3 ft. lengths with molded rubber plug, 1c each

#### SCR 625 MINE DETECTOR

Brand New, export packed . . . . . \$59.95

#### BC 456 MODULATOR

6 o d, used with tubes . . . ONLY \$1.89

#### FILTER UNIT

This unit is an excellent buy for parts alone. Some parts are worth more than we're asking for the whole unit.

1-40 MFD @ 450V; 1-1600 MFD @ 12V; 1-1.5 MFD @ 400V; 2-.5 MFD @ 50V; 1-.01 MFD @ 400V; 2-20 watt Resistors; 2-Filter Chokes; 3-RF Chokes; 1-DEPT Toggle Switch. Miscellaneous hardware, wire, etc. Brand New, Original Packing . . . . . 89c ea. (10 for \$7.50)

#### GRAB BAG! 10 LBS. RADIO PARTS

Transformers, Chokes, Condensers, Switches, Resistors, Sockets, Knobs, Insulators, etc. HOW CAN YOU GO WRONG? ONLY . . . \$1.79

#### TUNING EQUIPMENT

IE 6A F / BC-338-A BK 22 RELAY Brand New . . . \$4.89

#### TRANS MITTER

. . . \$39.95

#### TERRIFIC KIT SALE

Kit of 50 Assorted KNOBS . . . \$1.19  
Kit of 100 Assorted PAPER TUBULAR CONDENSERS, 200 to 800 V. . . 5.75

Kit of 10 Assorted VOLUME CONTROLS . . . 2.79

Kit of 100 MICA CONDENSERS . . . . . 4.95

Kit of 50 TRIMMERS . . . . . 1.98

Kit of 100 CERAMICON CONDENSERS . . . 4.95

#### DYNAMOTORS

PE 73—used, F/BC 375 . . . . . \$4.95

PE 94—used, F/SCR 522 . . . . . 4.95

DM 33A—brand new, original carton . . . 4.95

#### SLEEPING, various colors and sizes, 3 ft. lengths

. . . . . 10 for 25c (100 for \$2.00)

#### MINIMUM ORDER—\$2.00. Send 25¢ deposit with order, balance C.O.D. Shipped F.O.B., N.Y.C. (N.Y.C. residents add 3% sales tax.)

#### RED ARROW SALES CO.

Dept. A  
214 STANTON ST., NEW YORK, N. Y.  
Phone: COrthand 7-5425

RADIO & TELEVISION NEWS



According to the company, excessive hash noise, stuck contacts, poor starting, and piling are eliminated by means of this new design.

### HORN ENCLOSURE

*Electro-Voice, Inc.* of Buchanan, Mich. has just announced a new Klipsch-licensed folded corner horn enclosure with direct front radiation for 12" full-range speakers.

The "Aristocrat" is said to provide at least one full octave of added bass range at full efficiency (to 35 cps). It

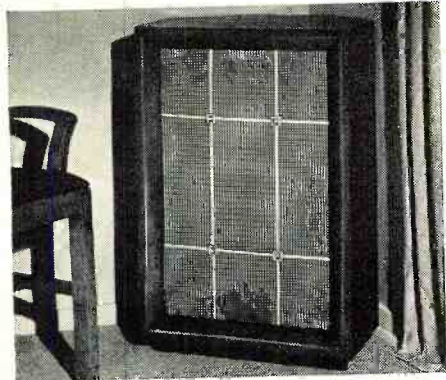

increases the power handling capacity of any 12" speaker by as much as 50%, according to the company.

Full details on the enclosure, which measures 29½" x 19" x 16½", are included in Bulletin 180 which is available free from the company. —30—

### International Short-Wave

(Continued from page 42)

department chief, Henrique Leotte Tavares; chief for the administrative bureau, Jose Carmo Carrilho.

Our best wishes go to the *Portuguese Radio* and its capable staff for a long and successful career.

### Club Notes

On July 8 the Canadian Chapter of the *United 49'ers Radio Society* will be officially inaugurated at the home of the Canadian Director, R. A. (Bob) Vance, 117 Wellington St., North Woodstock, Ontario. The annual outing of the *United 49'ers* will be held Sunday, July 15, at the home of the president, Edward I. Broome, Route 1, Vincentown, New Jersey; all members are invited to attend either or both meetings. (Boice, Conn.)

### This Month's Schedules

*Albania*—OTC, Belgian Congo, recently reported Tirana on 5.825, with a m.w. relay 1130-1700. (Stark, Texas) ZAA, 7.842, Tirana, noted with news 1615 to 1630 sign-off. (GDX-aren, Sweden)

*Algeria*—Radio *Algerie*, 9.57, still noted to 1800 sign-off. (Machwart, Mich.)

*Anglo-Egyptian Sudan*—Cushen, N. Z., reports Radio *Omdurman* heard on 5.975 at good strength in the 2315-2345 Arabic period. Is heard then in USA on 9.747. Has *English* on Fridays only at 1230-1300 on 9.747.

July, 1951

## SALE CONTI UED . . . By Popular Demand

### 30 TUBE 630 CHASSIS

Licensed Under  
RCA Patents

THE PERFECT  
CHASSIS FOR  
16"-17"-19"-20"-24"  
PICTURE  
TUBES

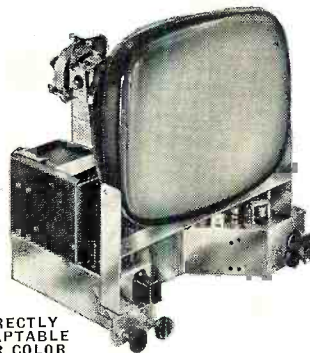

## A SET

CHASSIS  
MOUNTING  
BRACKETS  
FOR TUBE  
**\$495**

RMA  
GUARANTEE

Factory wired,  
aligned &  
tested.

DIRECTLY  
ADAPTABLE  
FOR COLOR

Thousands of our 16", 17", 20" and 24" sets are giving new viewing thrills to TV-watchers all over the country. This extra powerful super chassis is designed to bring in sharp, clear pictures, even in fringe areas. Works in most areas on only an indoor antenna. Has Improved Keyed AGC; Full 4 Megacycle Band Width; 15 KV output; 3 stage SYNC Separator & clipper; Moulded Plastic Condensers; Uses new voltage doubler; 5-Hour Min. Heat Run at Factory; Improved high gain front end, down to 45 microvolts; Synchro Lock; Freedom from arcing & corona leakage; Armstrong FM Sound System; Improved linearity adjustment & second horizontal linearity control.

# \$139.95

With Hi-gain Standard  
Coil Tuner and RCA  
HI-FI 12" Speaker  
Complete with Fed. Taxes  
LESS CATHODE TUBE

AVAILABLE with DUMONT INPUTUNER FM RADIO & **\$149.95**  
RCA 12" SPEAKER



**\$89.95**

### A PRICE-SMASHING VALUE IN TV CABINETS FOR THE 630 CHASSIS

Full Doors for  
16"-17"-19"-  
20" & 24"  
Picture Tubes

Without Doors  
for 16", 17",  
19", 20", 24"  
Picture Tubes

Beautiful, richly finished, hand rubbed mahogany cabinets specially designed to house the 630 chassis with a 12" speaker. A perfect picture deserves a perfect cabinet. It will be a focal point of beauty in your home. 40" high x 24" x 24". All complete with brackets, mask & hardware. Above cabinets in blond—\$10 EXTRA. Other models in stock. Send for circular.

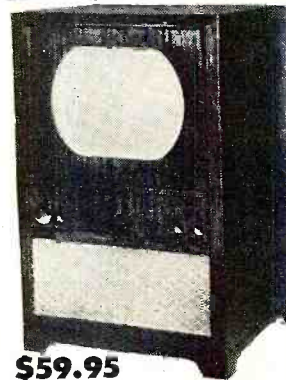

**\$59.95**

We carry a complete line of 630 component parts. Write for Price List

### TV TUBE SCOOP

All Black, Glassless  
Sheldon, Zetka & TRL

12" round	22.50
14" rectangular	23.95
16" rect. or round	29.95
17" rectangular	32.95
20" rectangular	42.95
24" Round, Metal	99.50
Ring & sleeve for 24"	7.50
Mask for 24"	14.95

All Tubes Fully  
Guaranteed for 6 Months

DuMont Inputuner for  
FM and TV Bands \$23.85

Standard	Brand	Tubes—Guar.—Up	to 40%	off.
List	Price	List	Price	
1B3	\$2.65	1T4	\$2.00	\$1.20
3V4	2.00	3S4	5.00	1.20
5V4	1.65	5Y3	1.25	.75
6A1.5	2.00	6AC7	2.00	1.74
6AV6	2.00	6AU6	2.00	1.20
6BL5	2.00	6BA6	1.80	1.08
6BC6	2.65	6BC5	2.00	1.40
6BO6	4.80	6BL7	2.90	1.74
6IQ6	3.20	6J5	1.50	.90
6J6	2.50	6K6	1.65	.99
6S1.7	2.40	6V6	2.00	1.20
6W4	1.80	6X3	2.65	1.59
12AU7	2.40	12AT7	2.90	1.74
12SQ7	1.50	.90 12SK7	1.80	1.08
12SA7	2.00	1.0 25T6	1.65	.99
25Z6	1.90	.90 35Z5	1.50	1.05
50A5	2.20	1.32 50L6	1.65	.99

\$10.00 Minimum Order on Tubes. Many others in stock. Write for 100 lot prices.

- RCA Hi-Fi 12" Speaker—\$5.95
- Standard coil tuner—\$19.95
- Regency Booster DB410—\$18.95
- TV Masks 16"-17" \$4.95; 19"-20" \$7.95
- 300 OHM TV Wire—Brown \$3 100 ft.; Clear \$3.50 100 ft.
- Conversion Kits to 16" thru 24"—\$14.95

All merchandise is brand new, factory fresh & fully guaranteed. Mail & phone orders filled upon receipt of certified check or money order for \$25 as deposit on TV chassis. 20% on other items. Balance C.O.D., F.O.B., N. Y. Prices subject to change without notice. No additional taxes to pay. Prices in accord with OFS regs.

**AIREX RADIO CORP.**

171 WASHINGTON ST., N. Y. C. 7, N. Y.  
Worth 2-4029; Worth 2-9576

## Sold to WHOLESALE Distributors only

(EFFECTIVE APRIL 1, 1951)

ROTOR 4 CONDUCTOR WIRE  
Very Low Price on 1000 Ft. Metal Spools

300 OHM TV WIRE—POLYETHYLENE INSULATION

20-Gauge 80 Mil Web  
20-Gauge 50-55 Mil Web  
22-Gauge 50-55 Mil Web  
22-Gauge 40 Mil Web

TERMS:  
30 Days  
Net-Rated Concerns.  
C.O.D.,  
Non-Rated.

Back in Production on Our Full Line

WRITE FOR PRICES

**JERSEY SPECIALTY COMPANY**

LITTLE FALLS, NEW JERSEY

All Phones: Little Falls 4-0784, 1404, 1405

**INDISPENSABLE!**

# PHOTOFACT BOOKS



**Photofact Television Course.** Covers TV principles, operation and practice. 216 pages; profusely illustrated; 8½ x 11". Order TV-1 ..... Only \$3.00

**Television Antennas. New 2nd edition.** Describes all TV antenna types; tells how to select, install, solve troubles. Saves time; helps you earn more. 200 pages; illustrated. Order TAG-1 ..... Only \$2.00

**Television Tube Location Guide.** Accurate diagrams show position and function of all tubes in hundreds of TV sets; helps you diagnose trouble without removing chassis. 200 pages; pocket-size. Order TGL-1 ..... Only \$1.50

**1949-1950 Record Changer Manual.** Vol. 3. Covers 44 models made in 1949, including multi-speed changers and wire and tape recorders. Original data based on actual analysis of equipment. 286 pages; 8½ x 11"; paper-bound. Order CM-3 ..... Only \$3.00

**1948-1949 Changer Manual.** Vol. 2. Covers 45 models made in 1948-49. Paper bound. Order CM-2. Only \$4.95

**1947-1948 Changer Manual.** Vol. 1. Covers 40 post-war models up to 1948. Order CM-1 ..... Only \$4.95

**Recording & Reproduction of Sound.** A complete authoritative treatment of all phases of recording and amplification. 6 x 9". Order RR-1 ..... Only \$5.00



**Post-War Audio Amplifiers.** Vol. 2. A complete analysis of 104 well-known audio amplifiers and 12 well-known tuners made in 1949-50. 368 pages, 8½ x 11". Order AA-2 ..... Only \$3.95

**Post-War Audio Amplifiers.** Vol. 1. Covers 102 amplifiers and FM tuners made through 1948. 352 pages. Order AA-1 ..... Only \$3.95

**Auto Radio Manual.** Complete service data on more than 100 post-war auto radio models. Covers over 24 mfgs. 350 pages, 8½ x 11". Order AR-1 ..... Only \$4.95

**Communications Receiver Manual.** Complete analysis of 50 popular communications models. 246 pages, 8½ x 11". Order CR-1 ..... Only \$3.00

**Radio Receiver Tube Placement Guide.** Accurate diagrams show where to replace each tube in 5500 radio models, covering 1938-1947 receivers. 192 pages, pocket-size. Order TP-1 ..... Only \$1.25

**Dial Cord Stringing Guide.** Vol. 2. Covers receivers made from 1947 through 1949. Shows you the one right way to string a dial cord in thousands of models. Pocket-size. Order DC-2 ..... Only \$1.00

**Dial Cord Guide.** Vol. 1. Covers sets produced 1938 through 1946. Order DC-1 ..... Only \$1.00

**Radio-TV Industry Red Book. 2nd Edition.** Complete data on replacement parts for 22,000 sets made 1938-1950, including valuable TV information. Covers all major replacements. Over 600 pages. .... Only \$3.95



**Making Money in TV Servicing.** Tested, proved methods of operating a profitable TV service business. Written by Eugene Eklund, B. E. E., former manager of the National Service Department, Allen B. DuMont Laboratories, Inc. Covers planning, financing, work control, purchasing, service charges, advertising—plus much more. Own this practical guide to success now. Over 130 pages. Order MM-1 ..... Only \$1.25

Order from your Parts Jobber or write direct to  
HOWARD W. SAMS & CO., INC., 2201 E. 46th St., Indianapolis 5, Indiana

**HOWARD W. SAMS & CO., INC.**

**Angola**—*Radio Diamang*, Dundo, was logged recently on 9.190 at 1350, probably testing. (Pearce, England) *WRH* lists this one on 8.242; some overseas sources say has moved to 9.210, a frequency listed for OTH, Belgian Congo. *ISWC*, London, others, report CR6RD, Nova Lisboa, moved from 11.925 to 9.705, also on 7.152, at 1300-1530.

**Argentina**—LRS2, *Radio Splendid*, noted to 0000 sign-off. (Cushen, N. Z.) *Radio El Mundo*, Buenos Aires, is on the air 0530-2235 over LRX1, 6.120, 10 kw., and LRX, 9.660, 7.5 kw.; all-Spanish. (*WRH Bulletin*) The Argentine outlet on 11.84 is not *Radio Belgrano* but LRT, Tucuman, although at times it does relay *Radio Belgrano* programs and the *Radio Belgrano* announcement is heard. (Rastorfer, N. Y., others)

SIRA programs in *English* noted at good level 1930 over LRA, 9.69. (Freas, Wisc.)

**Australia**—VLM, 4.917, Brisbane, noted signing on daily 1500. (Pearce, England) Heard mornings (EST) in the USA.

**Austria**—*Blue Danube Network*, 9.617, Salzburg, noted 0400 with headline news, weather report. (Pearce, England) Innsbruck, 6.000, noted 0000 with music; all-German. (Bellington, N. Y.)

**Azores**—Ponta Delgada, 11.090, is definitely on summer schedule of 1400-1500. (Bellington, N. Y., others)

**Bolivia**—"Radio La Cruz del Sur" ("The Southern Cross Radio Station"), La Paz, 9.505, is scheduled weekdays 0930-1300, 1800-2100; Sundays 0700-0830, 1100-1700; has had all-Spanish programs but soon will have *English* half hour Saturdays 2115-2145. (*WRH Bulletin*)

**Brazil**—*Radio Quitandinha*, 5.045; Petropolis, heard at good strength in Scotland after 1700; all-Portuguese programs. (McWalter) Wants reports from anywhere in the world.

*Radio Jornal do Commercio*, Recife, Pernambuco, sent schedule of 15.145 at 0455-1400; 6.085 at 1700-2100; 9.565 at 0455-1200, 1400-2100; "Brazil Calling" (*English*) is now 2005-2030. (Boggs, Mo.) PRL4, 9.770, Rio de Janeiro, Radio Ministerio de Educacao, is well received 1600 in Britain but with slight spread at times from OTC2, 9.767, Belgian Congo; PRK5, 6.000, *Radio Inconfidencia*, Belo Horizonte, has been logged at good strength in Britain after 1730. (*ISWL Bulletin*, London) PR17, 9.72, Rio de Janeiro, heard opening 0400 with melody on chimes. (Bellington, N. Y.)

**British Guiana**—ZFY, *Radio Demerara*, "The Voice of Guiana," listed by the station on 6.000 (actually around 5.985), is scheduled 0515-1145 (Sundays from 0545), 1445-2045; power is now 600 watts but soon will be increased to 2 kw. (Lane, South Dak.) Heard in Scotland 1815-1845. (Rodger)

**British Honduras**—Stark, Texas, hears a weak signal from Belize on approximately 4.963-4.965 evenings (EST); noted to after 2100 some days.

**Bulgaria**—Sofia noted with *English* 1500-1530 and 1615-1630 on 7.255 paral-

lel with 7.671. (Pearce, England) Noted in dual on these channels in Bulgarian 2255. (Bellington, N. Y.)

**Burma**—When this was written, Balbi, Calif., was hearing *Radio Mandalay*, 7.41, after 0615 when the USSR signs off on 7.40; *Radio Mandalay* has news 0615; French 0700; weak most days.

**Canada**—VED, 8.265, Edmonton, Alberta, heard 0130 with dance music; CWQRM. (Russell, Calif.)

**Canary Islands**—*Radio Clube Tenerife* recently sent three QSL cards—one for report of more than a year ago, one for report a year old, and one of six months ago; must reply only at intervals! (Pearce, England)

**Ceylon**—*Radio Ceylon*, 15.12, noted 0930-1200 when closes with "God Save the King." (Saylor, Va.) Noted closing Commercial Service 1145 on 11.975. (Pearce, England) Heard on 9.52 at 1900. (Stark, Texas)

**Chile**—CE1515, 15.15, Santiago, *Radio Corporacion*, verified via airmail in 21 days, with attractive pennant. (Cushen, N. Z.) CE619, 6.19, another *Radio Corporacion* outlet, heard in Brazil around 2100-2300 closedown. (Serrano) Valparaiso, 11.900, noted 1815-1900 on a Saturday with dance music. (Rastorfer, N. Y.)

**China**—Chinese news originating in Peking noted 0700 on 5.915, 5.985, 6.10, 6.155, 6.34, 6.39, 6.43, 6.65, 7.10, 7.50, 9.73, 10.26. (Balbi, Calif.) *Radio Peking*, 15.060V, 11.685, noted in Chinese at 1650. (Pearce, England) When this was compiled, *POW messages* (Korean War) were heard around 0445 (*English*). (Balbi)

**Colombia**—HJDE, 6.145, sent new pictorial QSL card. (Pearce, England) HJCT, 6.20, and HJCQ, 11.68, noted 2320 in dual, news in Spanish by man. (Bellington, N. Y.)

**Costa Rica**—*Radio Athenea*, San Jose, lists schedule of 0730-0000 on 11.972. (Boggs, Mo.) Actually, TIHH operates on approximately 11.965. Cushen, N. Z., reports TIRH, 6.150, heard at weak strength to 0000. (Cushen) Signs off 0000; has QRM from HJDE, 6.145, Medellin, Colombia. (Rastorfer, N. Y.)

**Cuba**—COCY, now "dropped" to around 11.735, noted to 0030 when signs off with both Spanish, *English* announcements. (Cushen, N. Z.) *Radio Cadena Suaritas* has moved up to 9.853. (Stark, Texas)

**Czechoslovakia**—Prague, 9.55, noted 1605 with *English* in progress; in *English* 1940 on 9.55, 11.84 (another day on 9.55, 11.875); on 9.55, 11.875 with *English* 1400-1430; opening 2345 in Czech on 9.504. (Bellington, N. Y.) Heard in Britain on 9.55, 11.875 with *English* 0715, 1400-1430, 1600-1630; in Spanish 1700 on 9.504 after time pips, with program for Spain. (Pearce) Noted with news 0130 on 11.84. (Saylor, Va.)

**Denmark**—Summer schedule to North America is 1630-1715 on 15.320, repeated 2030-2115 and 2145-2230 on 9.520. (Herd, Dela.) First half-hour is Danish, remainder *English*.

**Dominican Republic**—H19T, 6.190,

# PARTS and TUBES

ORDER from "PREMIER" Your reliable source since 1926

5c per Tube extra for less than 50 tubes

Individually Boxed—All Brands—Standard Factory Guarantee

## TUBE KITS

- 3Q4, 1T4, 1R5, 1S5. List Value \$2.39  
\$8.00. Tube Kit only.....
- 3S4, 1T4, 1S5, 1R5. List Value \$2.39  
\$7.80. 4 Tube Kit.....
- 1U4, 3S4, 1S5, 1R5. List Value \$2.39  
\$7.80. All Four Tubes for.....
- 3V4, 1R5, 1S5, 1T4. List Value \$2.39  
\$7.80. All for.....
- 117Z3, 1U5, 3V4, 1R5, 1T4. AC-DC Portable Kit. All for \$2.89
- 12AT6, 12BA6, 12BE6, 35W4, 50B5. 5 Tubes for..... \$2.95
- 50L6, 35Z5, 12SQ7, 12SK7, 12SA7. 5 Tubes for..... \$3.22

## TV CONVERSION KITS

Convert 10" and 12" sets to 14"—includes 14BP4 Tube 70 Degree Deflection Yoke and Attractive Lucite Mask to eliminate all finish work on cabinet. Complete..... **\$29<sup>95</sup>**

## 17" CONVERSION KIT

Consisting of rectangular tube, 70 Degree Yoke, Beautiful Mask and Flyback Transformer. Complete..... **\$37<sup>95</sup>**

## BY-PASS CONDENSERS

Tubular condensers. Nationally advertised brands. High Quality. Overstock sale price: .001-600V .002-600V per hundred **\$5<sup>00</sup>**

Special Sale!

## FILTER CONDENSERS

Close-out on all the cats and dogs on our shelves! You can substitute these for the more expensive filter condensers.

- |                 |                 |                |
|-----------------|-----------------|----------------|
| 40/20—150/25V   | 30-30—350V      | <b>29c</b> ea. |
| 30/30—400/350V  | 30-30/25—400/25 |                |
| 20/40—450/400V  | 35-35—300V      |                |
| 35-35—300V      | 30-10/20—400/25 |                |
| 40/20—250/25V   | 10/10/10/10/20— |                |
| 20/20—300/25V   | 450/350/150/25  |                |
| While They Last |                 |                |

## 6 FOOT LINE CORDS

will be scarce—UL approved cord and plug—10 for..... **\$1.95**

## TWIN LEAD

55 Web virgin polyethylene, 300 ohm twin lead in either clear or brown 1000 ft. \$19.95 100 ft. 2.25

# TUBES—Radio and TV

45c ea.

5Y3GT  
35W4  
80  
VT51  
VT52

54c ea.

5Y4G  
6AT6  
6AV6  
6J5GT  
6SQ7  
6X4  
6X5GT  
12AT6  
12AV6  
12J5GT  
12SQ7  
35Z4GT  
35Z5GT  
117Z3

59c ea.

5U4G  
5W4  
5W4GT  
6AR5  
6BF6  
6B6  
6C4  
6C5GT  
6F5GT  
6F6GT  
6H6  
6K6GT  
6SF5  
6SQ7GT  
12BF6  
12SF7GT  
25Z5

65c ea.

1A5GT  
1H5GT  
1U5  
5X4G  
5Z3  
6A4Q  
6BA6  
6BE6  
6H6GT  
6Q7GT  
6S4  
6SF5GT  
6SJ7  
6SJ7GT  
6SR7GT  
6W4GT  
7A6  
7A7  
7A8  
7B4  
7B5  
7B6  
7B7  
7B8  
7C5  
7C6  
7C7  
7Y4  
7Z4

65c ea.

12BA6  
12BE6  
12F5GT  
12H6  
12Q7GT  
12S7GT  
25L6GT  
35A5  
35L6GT  
35Y4  
35Z3  
45Z5GT  
50L6GT  
50Y6GT

72c ea.

1N5GT  
1R5  
1S5  
1T4  
1U4  
3S4  
3V4  
6AL5  
6AQ5  
6AS5  
6AUG  
6BC5  
6BM6  
6BJ6  
6CB6  
6SA7GT  
6SC7  
6SF7  
6SK7GT  
6SS7  
6U5  
6V6GT  
7A4  
7H7  
7Q7  
12AU6  
12SA7GT  
12SF5GT  
12SF7  
12SK7GT  
25W4GT  
35B5  
35C5  
41  
42  
43  
45  
50B5  
50C5  
50Y7GT  
75  
77  
78

79c ea.

1A7  
2A5  
3Q4  
6A8GT  
6B6G  
6BC7  
6BF5  
6C6  
6D6  
6E5

79c ea.

6J7G  
6K7GT  
6SH7GT  
6SN7GT  
6U6GT  
6U7G  
6U6GT  
7A5  
7E6  
7F7  
7N7  
7R7  
7X6  
12A8GT  
12K7GT  
12SC7  
12SH7GT  
12SN7GT  
12SR7GT  
14A7  
14B6  
14B8  
14F7  
14F8  
25Z6GT  
35/51  
50A5  
50X6  
85

87c ea.

3Q5GT  
5V4G  
6AK6  
6BA7  
6K5GT  
6K8GT  
6L7  
6N7GT  
6P5GT  
6SL7GT  
6Y6G  
12AU7  
12AX7  
12BA7  
12BH7  
12SL7GT  
14AF7  
14C7  
71A  
11726GT  
7193

95c ea.

1B3GT  
1J5GT  
1LA4  
1LA6  
1LC6  
1LD5  
1LE3  
1LH4  
1LN5  
1P5GT  
1Q5GT  
1X2A  
3LF4  
5Z4  
6AB5/6N5  
6AG5  
6AU5GT  
6G6G  
6L5G  
6R7GT  
6S8GT  
7E7  
7G7  
7J7  
7K7  
7L7  
7S7  
7V7  
7W7  
7X7  
12AH7GT  
12AW6  
12S8GT  
12Z3  
14C5  
14X7  
35Z6G

\$104 ea.

6AC5GT  
6AC7  
6J6  
6SD7GT  
12AT7  
19T8  
25AC5GT

\$104 ea.

25Y5  
46  
47  
50C6G

\$115 ea.

1H6G  
2A3  
6A3  
6AB7  
6AG7  
6B4G  
6B5  
6B8GT  
6BD5GT  
6BN6  
6BQ7  
6C8G  
6D8G  
6F8G  
6J8G  
6S7GT  
6T7G  
6T8  
7C4  
7F8  
12A7  
12AV7  
12C8  
14F8  
25BQ6GT  
32L7GT

\$140 ea.

5T4  
6AH6  
6AK5  
6N6G  
20  
70L7GT  
117L7  
117N7GT  
117P7GT

6BG6G ea..\$1.73  
6CD6G ea.. 2.15  
19BG6G ea. 2.15  
813 ea. .. 9.95

## TV PICTURE TUBES

- |                   |                 |
|-------------------|-----------------|
| 10BP4..... \$1195 | 16JP4... \$2995 |
| 12LP4..... \$1995 | 16RP4... \$2995 |
| 14PB4..... \$2295 | 16TP4... \$2995 |
| 7JP4..... \$1795  | 17BP4A \$3195   |
|                   | 19AP4A \$4495   |

Catalog of tubes and parts included with each order.

Order Today!

Premier RADIO TUBE CO.

551 West Randolph St.  
Chicago 6, Illinois  
Phone ANdover 3-1590

Low-Priced for **QUICK SALE!**

All Standard & Nationally Known Tubes

Many below wholesale

**TV TUBES—All Black**

Nationally Advertised Brands

14" rect. .... \$23.25	16" rect. or rd. .... \$36.49
17" rect. .... 56.41	19" rd. metal .... 56.41
20" rect. .... 56.94	All Factors Guaranteed
Tubes Guaranteed. Individually Boxed.	
Extra Discounts—25 or more, 5%; 100 or more, 10%.	
0Z4A ..... \$ .81	6BE6 ..... .98
1A6 ..... 1.00	6BG6G ..... 2.40
1A7G ..... 1.40	6BH6 ..... 1.39
1B3GT ..... 1.32	6BJ6 ..... 1.49
1B3/2SS ..... 1.51	6BN6 ..... 1.59
1C ..... 1.00	6BQ6GT ..... 1.59
1C7G ..... .74	6C5 ..... .99
1D7G ..... .74	6CB6 ..... .99
1F4 ..... .74	6CD6G ..... .99
1F5G ..... .74	6CF6G ..... .99
1G4GT ..... .74	6G6G ..... 1.32
1J6G ..... .84	6H6 ..... .93
1L4 ..... .74	6H6/65GT ..... .93
1L6A ..... 1.30	6I6 ..... 1.95
1L6S ..... 1.30	6J7G or GT ..... 1.20
1L6C ..... 1.30	6K7G or GT ..... 1.49
1L6D ..... 1.30	6K6GT ..... .83
1L6E ..... 1.30	6L7 ..... .82
1L6S ..... 1.30	6M7 ..... 1.09
1L6T ..... 1.30	6N7 ..... 1.48
1N6GT ..... 1.00	6L5G ..... 1.45
1R5 ..... .99	6L6GA ..... 1.98
1S4 ..... .74	6L6GA ..... 1.98
1S7 ..... 1.19	6L7G ..... 1.27
1T4 ..... 1.00	6L7G or GT ..... 1.19
1U4 ..... .97	6N7 or GT ..... 1.19
1U5 ..... 1.00	6R6 ..... 1.48
1V ..... .75	6R6G ..... 1.28
1X2/1X2A ..... 1.32	6R7 ..... .90
2A5 ..... 1.49	6S4 ..... .81
2A4G ..... .84	6S8 ..... 1.32
2A5G ..... .84	6SA7 or GT ..... 1.09
2A6 ..... .84	6SC7 ..... .99
2A7 ..... .44	6SC1 ..... .99
2X2/879 ..... 1.69	6SF7 ..... 1.00
3A4 ..... .69	6SH7 or GT ..... .84
3A5GT ..... 2.39	6SH7 or GT ..... .84
3Q4 ..... .99	6S7 or GT ..... .90
3R4 ..... .99	6SL7GT ..... 1.19
3V4 ..... 2.25	6SN7GT ..... 1.09
504G ..... 1.19	6ST7GT ..... 1.27
5V4G ..... 1.18	6SS7 ..... .79
5W4 ..... .83	6T8 ..... 1.41
5X4 ..... .79	6T8G ..... 1.23
5Y3GT ..... .62	6V6G or GT ..... .99
6AU6 ..... 1.06	6W4GT ..... .89
6Z4 ..... 1.19	6W6GT ..... 1.40
6A6 ..... 1.19	6X ..... .74
6AB4 ..... 1.19	6X5GT ..... .74
6AR7 ..... 1.39	6Y6G ..... .94
6AC7 ..... 1.00	6Y8 ..... 1.34
6AF6G ..... 1.28	7B4 ..... .89
6AG5 ..... 1.32	7B6 ..... 1.49
6AG7 ..... 1.49	7C5 ..... .89
6AH6 ..... 1.31	7C5 ..... .89
6AK5 ..... 1.86	7E5 ..... 1.21
6AK6 ..... 1.19	7F7 ..... 1.33
6AL5 ..... .99	7G7 ..... 1.33
6AQ5 ..... .99	7H7 ..... .99
6AR5 ..... .99	7J7 ..... 1.04
6AS5 ..... .99	7N7 ..... 1.10
6ASTG ..... 5.39	7Y4 ..... .89
6AT6 ..... 1.79	84 ..... 1.23
6AU5GT ..... 1.69	12A6 ..... 1.34
6AU6 ..... .99	12A8GT ..... 1.10
6AV5GT ..... 1.31	12A7 ..... 1.64
6AV6 ..... .74	12AU7 ..... 1.19
6B7 ..... 1.21	12AX7 ..... .99
6B8 ..... 1.45	12BC6 ..... 1.45
6BA6 ..... .89	12BE6 ..... .89
6BA7 ..... 1.19	12BH7 ..... 1.89
6BC5 ..... .99	12CA7 ..... .99
6BD6 ..... 1.35	12H6 ..... .89

Special All-American Kit—5 Tubes ..... \$4.29

**Part Specials**

**Vibrators**

4 Prong 6 Volt. .... \$1.19

T.V.-H.V. Cartwheel Cond.

500 Mmf. 10 KV ..... 49c

500 Mmf. 15 KV ..... 59c

500 Mmf. 20 KV ..... 69c

**P.M. Speakers**

Alnico #5	Each	10 or more
4"	\$1.59	\$1.44
5"	1.65	1.49
6"	1.92	1.73
8"	3.49	3.05
10"	5.59	5.04
12"	8.85	6.17

**Speakers with 50L6 Outputs**

4" PM ..... \$2.10 ..... \$1.90

5" PM ..... 2.20 ..... 2.00

8" Dynamic ..... 6.59 ..... 2.45

450 ohm field

**Replacement Output Trans.**

For 50L6, 6V6, 6K6, 6F6, 6S4, 3V4 ..... 49c

**Push-Pull Outputs for 50L6, 6V6, 6K6, 6F6, 6S4**

**Controls**

1 Meg w/sw 3/4" shaft ..... 54c

1/2 Meg w/sw 3/4" shaft ..... 54c

1 Meg w/DP switch ..... 54c

1" Knurl Shaft ..... 49c

1/2 Meg w/switch ..... 49c

1" Knurl Shaft ..... 49c

10K w/sw 3/4" shaft ..... 39c

100 K w/sw 3/4" shaft ..... 39c

100 K control 3/4" shaft ..... 24c

milled shaft ..... 24c

250 K control 3/4" shaft ..... 24c

500 K control 2" shaft ..... 26c

Mica Kits 100 assort. .... \$5.95

Ceramic Kits 100 assort. .... 5.95

Resistor Kits 100 assort. .... 3.79

**Electrolytics**

40x20—150V Tubular ..... 39c

20 Mid 25V Tubular ..... 15c

20 x 20x20 P.P. Type ..... 15c

450 ..... 25 ..... 49c

30x30x20 x 20 ..... 25 ..... 49c

150 V ..... 25V ..... 69c



**TV-FM BOOSTER**

Improved TV reception in weak signal areas. Reduces noise and mizes "ghosts". Mini-

List \$39.95. Our Price \$18.95 Ea.

**LATEST 30-TUBE 630 TV CHASSIS**

Finest for fringe area reception. RCA licensed. Takes all picture tubes from 16" to 20" round or rectangular. Complete with 12" RCA Speaker & Hi-Gain standard COH Tuner \$133.50 (less C. R. Tube) Available with DuMont Input Tuner-FM Radio (less C.R. Tube) \$143.50.

**PHONO PARTS**

78 RPM Motor & Turntable	..... \$2.49 Ea.
3 Speed Motor & Turntable	..... 4.69 Ea.
Regular Pick-up	..... 1.89 Ea.
3 Speed Pick-up	..... 5.25 Ea.

300 Ohm Twin Lead—100 ft. .... 2.89 Ea.

**Battery Operated SIGNAL TRACER KIT**

Complete with steel cabinet, speaker, all components, tubes and easy-to-follow instructions. \$9.95 (less batteries).

Terms: 20% cash with order, balance C.O.D. All prices F.O.B. New York City warehouse. Minimum order \$5.

**NOTE:** Availability of merchandise subject to prior sale. Prices subject to change without notice.

**STEVE-EL ELECTRONICS CORP.**  
Dept. RN-7, 65 Reade St., New York 7, N. Y.  
CORHandt 7-0086

Puerto Plata, noted to 2100 sign-off. (Rastorfer, N. Y.)

**Ecuador**—HC1AC, 6.210, now signs off 0012; (Cushen, N. Z.) *Emissora Costa Sul*, Salinas, noted on 6.885 (up from 6.853), signing off 2245 although at times runs as late as 2400. (Stark, Texas)

**El Salvador**—YSLI sent nice verification in letter (Spanish); said out of QSL cards but would send one when printed. (Machwart, Mich.)

**Finland**—Helsinki, 15.19, 9.55, noted with news 0715, announced repeat at 2200 on announced channels then in use (15.19, 9.55, 17.800) (Pearce, England) Strong in N. Y. on 15.19 at 2200 (English news repeat). (Bellington)

**France**—English schedules for summer are 0300-0315, 6.145, 7.240; 1345-1400, 6.200, 7.180; 1500-1600, 6.200, 7.180. (Catch, England) Principal overseas beams from Paris now are 1900-1930, 9.560, to Antilles, Fr. Guiana; 2300-2330, 9.620, to Madagascar, Reunion; 0030-0130, 9.550, 17.850, to Tahiti, Pacific Islands; 0145-0245, 15.240, 17.850, to Fr. East Africa, Fr. Equatorial Africa; 0300-0345, 11.700, 17.850, to New Caledonia, Pacific Islands; 0630-0700, 17.850, to Antilles, Fr. Guiana; 0815-1030, 15.400, 17.850, to Indo-China; 1115-1215, 9.680, 15.350, to Madagascar, Reunion; 1515-1645, 11.700, 15.240, to Fr. East Africa, Fr. Equatorial Africa; 1730-1800, 9.680, to Indo-China. (WRH Bulletin)

**French Indo-China (Vietnam)**—When this was compiled, Balbi, Calif., was hearing *Radio France-Asie's* announced 9.524 channel on 9.755 instead, mornings; RFA also was noted with a separate program on 7.225 (but had been moving around the 41-m. band widely). And "The Voice of Vietnam" was being heard up to 0715 on only 9.62 (should also use 6.115, 6.19); news 0915. Rosenauer, Calif., notes the 11.78 channel of RFA running as late as 1100 now.

**French West Africa—Radio Dakar** sent schedule of 0200-0300, 0600-0830, 1300-1800 for 11.896; 1400-1600 for 15.346; still noted with English news 1400. (Serrano, Brazil, others) Noted on 11.896 at 0245-0300 with news in French at slow speed. (Bellington, N. Y.)

**Germany**—"Radio Free Europe" has received the Peabody Award for "its contribution to international understanding." (Bellington, N. Y.) Noted on 6.130 yet but opening now 0950 with bell tolling instead of former 1020; begins program 1000. (Pearce, England)

**OTC, Belgian Congo**, recently listed "Free Russia Radio" on 7.550 at 1515-1555. (Stark, Texas)

**Hamburg, 7.29, and Osterloog, 11.795**, noted in dual recently 0057. Leipzig, 9.728, heard signing on 2227 with series of 9-note chimes followed by march-song by chorus; man announced in German; fair level in N. Y. (Bellington) Baden-Baden, 6.320, is scheduled now Sundays 0100-1900; Saturdays 0000-2000; Wednesdays 0000-1900; other days 0000-1815. (Catch, England)

**Greece—Radio Athens** still heard

opening 2000 to North America (Greek and English) on 11.720; noted opening 0000 on 7.300 in Greek. (Bellington, N. Y.) *Radio Sweden* reports an additional Greek Forces Station on 8.054, 1200-1600 weekdays (to 1630 Sundays).

**Greenland**—Godthaab's (measured) 6.677 channel is being heard by Pearce, England, in Greenlandic and Danish around 1755-1850 sign-off; on with orchestral notes; off with "funeral-like" orchestral number. Bellington, N. Y., says reports for *Gronlands Radio* may be sent either direct to Godthaab or to The Greenland Department, Cultural Division, Vangehusvej 12, Copenhagen, Denmark.

**Guatemala**—TGWA, 9.76, noted with English program, Tue., Thur., Sat. 1930-2000. (Boggs, Mo.) By this time, TGNA should have its new 25-m. outlet (11.850) in operation; English is 2200-2230 or later. (Herd, Dela., others) *Radio Nuevo Mundo*, about 6.145 (listed TGJA, 6.230), noted 2300-2400 sign-off. (Rastorfer, N. Y.)

**Haiti**—4VEH, Cap Haitien, sent schedule of 0600-1830 on 9.750, from 1830 on 9.758; now uses 700 watts but expects to have a new 10 kw. transmitter, now being built, in operation by the end of 1951. (Dary, Kans.) When this was written, 4VRW had moved from 9.850 to 9.845. (Stark, Texas) 4VCM, 6.407, Port-au-Prince, "Magloire Broadcasting Circuit," heard in Sweden 1945-2030 sign-off. (GDX-aren)

**Holland**—Hilversum noted recently on 9.59 at 0230-0300 or later testing (with recordings, Dutch and English (Continued on page 106)

**New AM Tuner**  
(Continued from page 59)

detector, tuning condenser, oscillator coil, i.f. transformers, and only five other components. The AM radio makes use of a loop antenna which is located on the side of the cabinet.

The AM tuner obtains its filament and "B+" voltage from the television power supply and uses the TV sound strip for audio amplification. The 350 volt "B+" bus in the TV section is applied to the tuner through the selector switch and resistor R<sub>200</sub>. Resistor R<sub>200</sub> and condenser C<sub>203</sub> form a voltage dropping and decoupling network. The audio signal from the filpec (r.f. filter) at point "S" is connected through the switch and developed across the volume control. The signal is then applied through condenser C<sub>50</sub> to the grid of the audio amplifier in the TV sound strip.

The same control knobs are used for all three sections of the receiver. The "Off-On-Volume" control turns the receiver off and on and adjusts the sound level and the "Tone" control varies the output response from bass to treble. The "Station Selector" knob is calibrated in television channel numbers and radio station frequencies and is used in tuning both the AM radio and television.

**Custom-Built Amplifier**  
(Continued from page 40)

The output of either the preamplifier or the tuners is fed to a "Loudness Control." This control is used to vary volume but it differs from a simple volume control in that it compensates for the fact that the human ear becomes less sensitive to low frequencies as the volume of sound decreases. If every reproduced sound were heard at its original volume there would be no difficulty. Since the average living room would be lifted right off its foundations by the volume of a symphony orchestra, listeners play their records and radio at much lower than original volume. The balance between highs and lows changes, then, and the bass seems to disappear.

To restore as nearly as possible the original balance, the "Loudness Control" accentuates the bass as it reduces the volume. The amount of accentuation is very closely calibrated according to the characteristics of the average ear as displayed in the famous Fletcher-Munson curves. The control is a rotary switch with 17 positions. Volume is varied in steps of 2 db, with bass compensation every third step. The effect on the hearer is amazing and a "Loudness Control" is one of the important features of these audio systems.

There is one "Loudness Control" available through some parts jobbers (though no commercial amplifier includes one). This may be used with good results. The writer has found, however, that the switch of this control sometimes does not make positive contact; he therefore builds his own. It is a fairly intricate job, for there are 23 resistors and six condensers mounted on the switch. Persons duplicating this amplifier are advised to use the commercial product.

The arm of the "Loudness Control" connects to the grid of a 6J5 cathode follower. The cathode output is in the neighborhood of 500 ohms and the line between preamplifier and main amplifier may, therefore, be as long as would ever be required in a house, even if the amplifier itself is concealed in a closet in another room. The .1  $\mu$ f. blocking condenser is satisfactory because the amplifier input is at high impedance.

Fig. 4 shows a variation in the output circuit of the control unit designed and used by the writer when a tape recorder is part of the installation. The arm of the A section of the selector switch, instead of connecting to the "Loudness Control," goes to the grid of one section of a 6SN7GT, which is used in place of the original 6J5. The cathode output of this triode goes to the high-impedance input of the recorder and also to a switch. The other contact of the s.p.d.t. switch connects to the playback output of the recorder and the arm goes to the top of the "Loudness Control." The arm of the

July, 1951

# IS YOUR RECTIFICATION PROBLEM LISTED HERE?

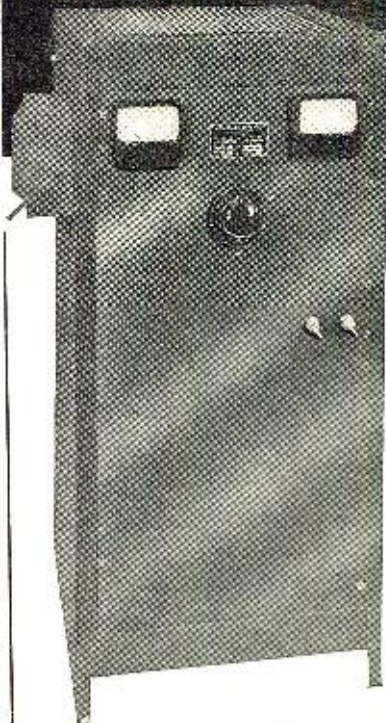

GPA 28100\*

- Battery Charging
- Battery Elimination
- Business Machines
- Carbon Arc Lamps
- Dynamotors
- Electroplating
- Elevator
- Exciter Lamps
- General Laboratory Use
- Generator Fields
- Magnetic Brakes, Chucks, Separators
- Motors
- Relays
- Solenoids
- Telephone

Whatever your particular application of D.C. may be, it need not be a problem. The OPAD-GREEN COMPANY is prepared to offer its services in designing and constructing Selenium Rectifier power supplies and equipment for your specific needs.

Write today for our Power Supply Specification Form which will assist you in establishing your requirements. Our proposals and recommendations will be forwarded promptly upon receipt of this data. There is no obligation for this service.

\*Custom Power Unit rated 0-28 Volts D.C. at 100 Amperes: maximum ripple 5%.

## OPAD-GREEN COMPANY

71-3 WARREN ST., NEW YORK 7, N. Y. PHONE: BEekman 3-7385-6

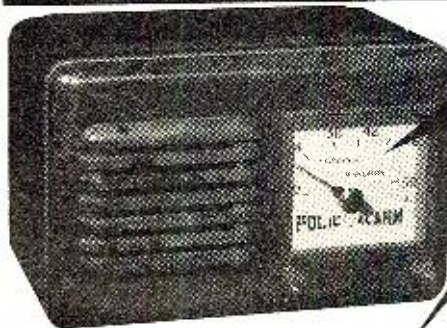

Get  
**EMERGENCY BAND**  
CALLS *At Home!*

• Many fans spend hundreds of happy hours listening to city and state police calls on their Polic-Alarm radios. Polic-Alarm Model PR-31 is a quality radio which will give years of trouble-free service on the 30-50 mc. band. Can be used on either AC or DC current of 115 volts.

Besides police calls, the 30-50 mc. band also is used by fire departments, ambulances, border patrol, forestry, maritime, railroads, bus lines, and other services. Enjoy the thrill of listening to these vital messages **\$44.95** at home. Model PR-31 (illustrated)

Polic-Alarm Model PR-8 is available for 152-162 mc. band reception. **\$44.95**  
Price, complete.....

## POLIC ALARM

RADIO APPARATUS CORPORATION

DEPT. RN-7, 310 FOUNTAIN SQUARE THEATRE  
BLDG., INDIANAPOLIS 3, INDIANA

# For Military Prototype Equipment Use TRIAD "HS" Transformers



## Eliminate Redesign

Triad "HS" (Hermetically Sealed) transformers built to MIL-T-27 requirements are carried in stock as standard items by all Triad distributors. Available as a complete line in matching construction, they simplify and expedite the design and production of any electronic equipment.

- "Climatite" Treated
- Wide Frequency Range
- Reduced Field Pick-up
- Small Size
- Low Distortion

Write for  
Catalog TR-51

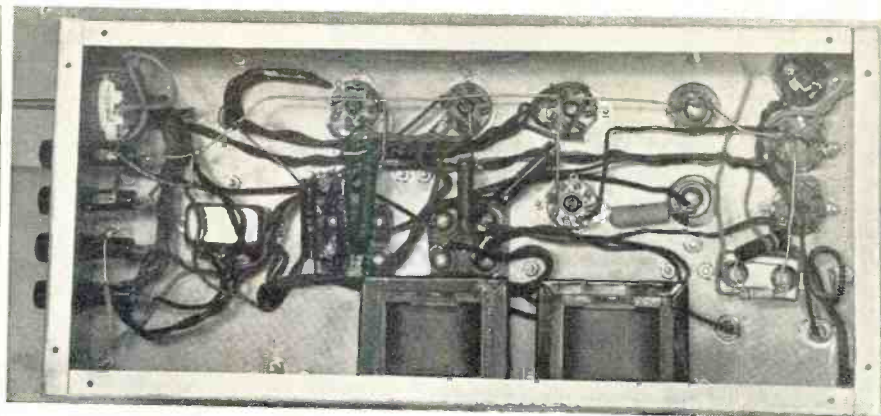

Heavy bus bar is used for ground connections in this power supply as well as in the amplifier. Be sure to make holes for condenser connection lugs large enough to prevent any possibility of arc-overs in the power supply circuit.

latter connects to the grid of the second 6SN7GT triode, the cathode output of which goes to the power amplifier.

For normal use, then, the switch is set to the "N" or "Normal" position. The output of the preamplifier or tuner (depending on the position of the rotary selector switch) goes through *both* cathode followers, between which it encounters the "Loudness Control." At the same time, the first cathode follower feeds the input of the tape recorder, which, if turned on, will record the records or radio programs. When it does so, it is not affected by the "Loudness Control" and frequency response is perfect.

To play back a tape or monitor from the tape while recording, the switch is set to the "T" position. Then the tape output goes directly through the "Loudness Control" and the second cathode follower to the amplifier. With this circuit, all undesirable interactions are eliminated and the "Loudness Control" is in the circuit only when it should be. There is a loss of 6 to 8 db between selector switch and the amplifier due to the extra cathode fol-

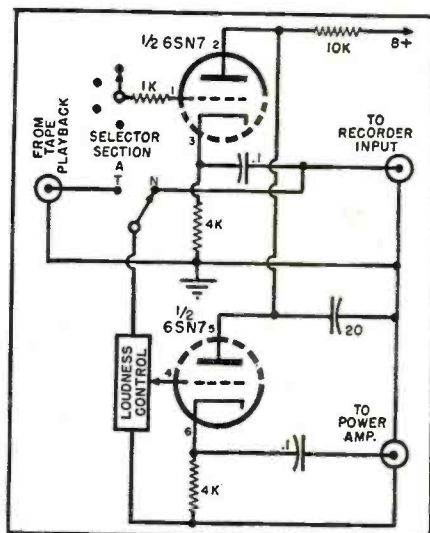
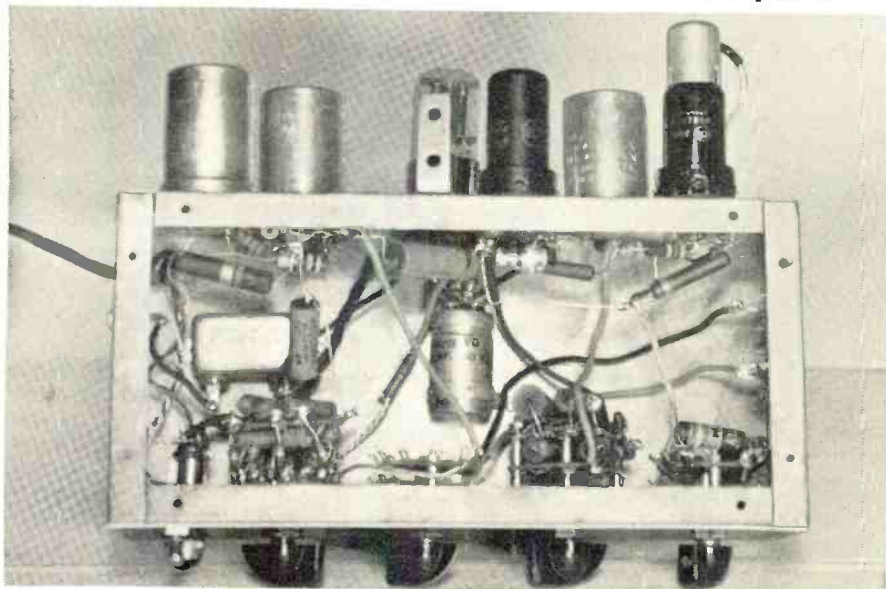

Fig. 4. Modification of the preamplifier circuit permits use of a tape recorder. This circuit replaces everything in Fig. 3 following the output of switch S<sub>1</sub>.

lower, but this may be compensated for by advancing the 1 megohm, screw-driver-adjusted volume control (R<sub>21</sub>,

Underchassis view of preamplifier shows how tubes are mounted on rear apron of the chassis. All of the wiring under the chassis must be kept very short.



# ARROW "The Home of Values!"

## SCR 508 EQUIPMENT

BC 603 Receiver	\$24.95	Exc.	Used
BC 604 Transmitter	12.95	Exc.	Used
BC 605 Amplifier	4.95	New	
BC 606 Control Box	.95	Exc.	Used
FT 237 Mounting	9.95	Exc.	Used
MF 48 Mast Base	2.95	Exc.	Used
MS Mast Sections	.49		
TM 11-600 Tech Manual	1.95		
Crystals, Set of 80	19.95		

## PE 206 INVERTER

24 VDC to 80 VAC at 800 CPS 500 VA Used **\$3.95**

## SCOTT HI-FI OUTPUT TRANSFORMER

Made for Scott Navy Receiver. Fully Potted. Primary 5000 ohms. Secondary: 600 ohms center tapped and 60 ohms center tapped with inverse feedback. New **\$1.49**

## CW 49505

High impedance headset complete with leather headband and rubber cushions. Used. **98c**

## AD-1 MOTOR

24 VDC-1/12 HP 6000 RPM Intermittent Duty. **98c**

## PE 97 or PE117

Vibrator Power Supply for BC 620 and BC 659. Used—Less Tubes, Vibrator and Condenser. **\$2.95**

## PE 120

Vibrator Power Supply for BC 620 and BC 659 with Tubes, etc.—Complete for 6 or 12 Volt operation. Used **\$6.95**

## TU-5B

TUNING UNIT for BC-375 New **\$3.95**

## SCR 625 Famous Army Mine-Detector

For Prospectors, Miners, Oil Companies, Plumbers, Etc.

This unit is being offered now at a considerable reduction in price. Recently advertised at \$79.50 it is now available in the same brand new wrappings in suitcase style carrying case (less batteries) at

**\$59.50**

WHILE THEY LAST!



## TUBES!

01A	1G1	30 spec.	1625	2V3G	
01B	1G6GT	33	1626	6J7G	
01C	1H4G	34		6T7G	
1A6	1H6G	38		6Z7G	
1B4P	2C26A	39 44		12A6	
1B5/255	3B7	49		12F5	
1C6	3D6/1299	CRP 72		12H6	
1E7GT	10Y	843		12J5GT	
1F4	15R	954		77	
1F5G	19	1619		211	957

## TUBES!

024A	CK1005	1B26	6C4	9002
1A5GT		1B32	6H6	9003
2X2		1LD5	6K6GT	
6J5GT		1LN5	6K8G	
6L7G		1S4	6SH7	
6R7GT		2A4G	6V6GT	
6S77		3S4	VR90	
6W7G		5W4	VR150	
12Z3		6AC7	717A	
705 A		6AL5	1613	

## TUBES!

\$1.59	2E22	\$1.09	805	\$3.29
6AG5	100TH	9.95	807	1.89
6AK6	304TH	10.95	813	9.95
1624	304TL	10.95	866A	1.69
	307A	4.95	872A	2.29
	803	2.89	830B	2.95

**CATHODE RAY TUBES**  
3FP7..\$1.95 5FP7..\$1.95  
4AP10. 1.95 5GP1.. 3.95  
5BP4...\$3.95

## CABINET CH-118

Olive drab in color, this cabinet has a full length interlock access door on the rear. The front takes the standard 19" panels with 60 inches of height and 20 inches deep. It is shock mounted on a heavy steel platform and has a two-inch protrusion fully covering one side to accommodate wave trap and wiring. Louvered vents allow air circulation top and bottom. Each F. O. B. Chicago. **\$34.50**

## RA 52-RECTIFIER

A transtat controlled rectifier to produce high voltage DC from 110 VAC 60 cycle source. Up to 11,500 volts DC at 50 watts. Metered high voltage (0-15KV) and current (0-20 MA). New. **\$74.50**

## BC 768

Radio Receiver Chassis. Complete except for 13 tubes. This chassis with standard 19" panel front contains the receiver for 493.5 MC complete with power supply and an additional low voltage power supply that originally supplied the keyer BC 770 as described below.

110 VAC 60 cycles is the primary voltage. Five 10 mfd—600 VDC oil filled GE condensers are used as filters. Five stages of 49 MC IF's. Two of 10.4 MC, 6.3 VAC Transformer and of course power transformers—chokes and miscellaneous parts.

All units are in good condition as removed from new equipment. Even the salvage value is a great deal more than the low price **\$9.95** of

## BC 770 Keyer P/O RC 100 Radar Equipment

This unit was used to pulse the transmitter BC 769 as described below. It is in a standard 19" panel chassis and contains many valuable parts such as a 10 Amp. 110 VAC 60 cycle circuit breaker, a 10 mfd 600 VDC oil condenser, a 6.3 Filament transformer, switches, pots, resistors **\$4.95** and numerous others. Less tubes.

## BC 769 TRANSMITTER

Originally designed to transmit RF pulses at 470 MC with the use of two 15E tubes. Power was supplied by RA 52 rectifier. Parts consist of 0-150 VAC 60 cycle meter, 6.3 VAC filament transformer, associated circuits for VHF transmission, standard 19" panel chassis, and a 15 **\$6.95** Mid-12000 VDC oil cond. Less Tubes.

Shipments FOB warehouse. 20% Deposit on orders. Minimum order \$5.00. Illinois residents, add regular sales tax to remittance. Prices subject to change without notice.

## MISCELLANEOUS SPECIALS!

RA 10 DA Receiver	Used	New
BC 347 Interphone Amplifier	\$17.50	\$24.95
BC 442 Less Condenser	1.49	1.95
APS 13 UHF Antenna, Pair	.98	
FL 8 Filter	2.95	4.95
L-97 Bias Meter	3.95	4.95
RL 42 Antenna Gearbox Motor and Reel	4.95	7.50
AN ARC-5 VHF Transmitter (T-23/ARC5)		29.95
One Tube Interphone Amplifier—Small compact aluminum case fully enclosed 2 1/4"x3 3/4"x5 3/4" case Tube	.79	.59
40 Amps Circuit Breaker		
Collins VFO Dial—5 calibrated ham bands form 3.2 Mc to 32 Mc; complete with pointer, gears, logging dial and flywheel. Scale 6" on 8" plate, each		.95
C-18 Antenna coil assembly slug tuned used in BC 603 receiver. Frequency range 20-27.9 Mc—fully shielded, New for 10		1.95
I 82 F Five Inch 360 degree compass indicator and Selsyn receiver		4.95
A-81-2 Transmitters Selsyn for 182 indicator (both 182F & Trans. Selsyn for \$7.00)		2.45

## COMMAND (SCR 274 N) EQUIPMENT

BC-455	Used	New
BC-457	\$ 7.95	\$14.95
BC-458	4.95	
BC-458	4.95	
BC-450 3 Receiver Remote Control	.89	1.95
BC-442	1.95	2.95
3 Receiver Rack	1.95	
2 Transmitter Rack	1.50	

## MN 26Y COMPASS RECEIVER

Twelve stage superhet covering frequencies of 150 to 325 KC; 325 to 695 KC, and 3400 to 7000 KC in three bands. These units are brand new but with Dynamotor, Band Switch motor and tubes removed. Schematic Furnished. While they last, ea... **\$4.95**

## T-32

Desk Stand microphone. Good used cond.	\$2.95
Throat Mike—T 30—New	98c
Lip Mike—Navy Type—New	98c
Extension Cord and switch Assembly for these Mikes—New	98c

## OIL FILLED CONDENSERS

2 mfd	1000 VDC	59c	2 for \$1.00
4 mfd	500 VDC	39c	3 for 1.00
1-1-1 mfd	1200 VDC	59c	2 for 1.00
1-1-1 mfd	2000 VDC	39c	3 for 1.00
5 mfd	750 VAC	39c	3 for 1.00
5 mfd	1500 VDC	39c	3 for 1.00
.25 mfd	600 VDC B/T	24c	5 for 1.00
40 mfd	25 VDC	24c	5 for 1.00

10 Assorted Condensers. A real value at. **98c**

## MONTHLY SPECIAL!

R-9/APN-4, 160 meter Loran receiver plus high (for scope) and low voltage power supply. 3 channels tuneable 1.6-3.3 mc; one channel tuneable 7.58-11.75 mc. This 400 cycle receiver may be converted for 60 cycle operation. Excellent condition, with tubes **\$14.95**

## CHOKES

10 Henry	20 MADC	29c	4 for \$1.00
10 Henry	50 MADC	39c	3 for 1.00

## AM 61

Indicator amplifier—New with blower and all parts except tubes **\$7.95**

## VIBRATORS

2 Volt—7 Prong Synchronous	69c	10 for \$6.00
6 Volt—4 Prong Non synchronous	98c	10 for 9.00

## BC 709

Battery operated lightweight interphone amplifier. Complete with tube and shock mount, but less battery. New **\$3.95 ea.**

## FLAP PITCH MOTOR

24 VDC will operate on AC 3300 or 11,000 R.P.M. Complete with gear box and limit switches, ea **\$2.95**

## AS-138/ARN

10 inch streamline loop as used with direction finding receivers. Fixed position, it is ideal for planes, boats, automobiles. New **\$1.95**

## TS/10

Sound powered phones. Brand New, each **\$10.00**  
2 for **\$17.95**  
Used **\$6.50 ea.**

## TEST EQUIPMENT

No. 155 A RCA Oscilloscope used **\$75.00**  
No. M-840 Triumph Oscilloscope used **39.95**

## WANTED!

304 TL Tubes, I 152 Indicators, BC 788-C Transceivers, APS 13 Transceivers, ARC 3 Equipment, R 89 Glide path Receivers, APN-9; ARC-1; APR-4. Or—Send in a list of what you have in good clean surplus equipment. State Lowest Price in first correspondence.

**ARROW SALES, Inc.**

Dept. N, 1712-14 S. Michigan Ave., Chicago 16, Ill.  
PHONE: HARRISON 7-9374

# YOUR BEST BUY IN POWERFUL P.A.



## IMMEDIATE Delivery from **ALLIED!**

Here's the outstanding 30 Watt Sound System buy of the country—KNIGHT—tops for power, quality, value. Just check these features: Covers up to 25,000 square feet outdoors, or up to 4,000 persons indoors. Full 30 watts usable output at 3 db down, ± 2 db from 40 to 20,000 cps on phono and microphone; 3 inputs—two for high-impedance mikes, one for phono, each with individual volume control; tone control attenuates treble 15 db at 10,000 cps. Complete system includes: 30 watt amplifier and tubes, Electro-Voice unidirectional "Cardax" microphone with adjustable floor stand and 20' cable; two 14.7 oz. Alnico V magnet General Electric 12" "Safused" PM speakers, each with 30' cable; portable carrying case, 16 3/4 x 12 3/4 x 25". For 110-130 volts, 60 cycle A.C. Shpg. wt., 75 lbs.

93-372. Complete System (less phono-**\$118.75** top). Only . . . . .

\$17.81 down, \$8.92 monthly for 12 months

93-340. 3-Speed Phono Top with dual crystal cartridge, for above system. Only . . . **\$16.95**

### Headquarters for P.A. and Hi-Fidelity

ALLIED carries the world's largest stocks of P.A. amplifiers and systems—8 to 80 watts. Look to ALLIED, too, for High-Fidelity amplifiers, tuners, speakers, and all other Custom Sound components and accessories.

### FREE 212-PAGE ALLIED CATALOG



Write today for the only complete Buying Guide to everything in Sound, Radio and Television. Make your selections from the world's largest stocks at lowest money-saving prices. You save time and effort and get the best when you order from your ALLIED Catalog. Send for your FREE copy now.

## ALLIED RADIO

ALLIED RADIO CORP., Dept. I-GG-1  
833 W. Jackson Blvd., Chicago 7, Illinois

Send FREE 212-Page ALLIED Catalog  
 Ship the following:

\$\_\_\_\_\_ enclosed.  Full Pay.  
 Part Pay. (bal. C.O.D.)

Name \_\_\_\_\_

Address \_\_\_\_\_

City \_\_\_\_\_ Zone \_\_\_\_\_ State \_\_\_\_\_

Fig. 3) which follows the plate of the 6SJ7. That control should be adjusted for every installation so that with the "Loudness Control" at maximum volume the sound is a little louder than the owner of the system is ever likely to want it. All further volume controlling is done with the "Loudness Control."

Construction of the preamplifier-control unit is merely a matter of following the diagram and keeping all leads, especially in the equalizer section, as short as possible. As the photo indicates, the tubes are mounted on the rear chassis apron and the controls on the front apron. The chassis measures 5 x 10 x 3 inches.

To avoid ground loops, no ground connection to the power supply is made in the power cable. The shield of the lead carrying audio from preamplifier to main amplifier serves this purpose. Thus, a source of noise and hum is eliminated. When using this arrangement, however, never disconnect the audio lead with the power on, since the full "B" supply voltage will then exist between preamplifier chassis and lead shield.

After building many such units for custom installation, the author has found that the time and effort involved in constructing a quality sound system is more than amply repaid in customer satisfaction and increased business as a result of word-of-mouth boosts from such satisfied customers.

-50-

### A.C. Power Panel

(Continued from page 41)

the lowest range with a .21 ohm meter impedance across the secondary winding is equal to:

$$\left(\frac{\text{Pri. turns}}{\text{Sec. turns}}\right)^2 \times .21 = \left(\frac{16}{15}\right)^2 \times .21 =$$

$$.2394 \text{ or } .24 \text{ ohm} \dots \dots \dots (1)$$

On the 5 ampere range the primary impedance is reduced to .0084 ohm and .0021 ohm on the 10 ampere range.

From this it can be seen that the primary impedance is dependent on the turns ratio squared and the impedance of the ammeter in the secondary. Thus, any combination of primary-to-secondary turns can be wound as long as it remains in proper relationship to the current ratio. However, on a multi-range transformer this could result in a bulky unit due to the great number of turns required on the secondary for the higher ranges, especially if the current ratio between the lowest and the highest ranges is considerable. Thus, to keep the physical size within reasonable dimensions the minimum number of turns in the primary which will result in satisfactory and reliable operation must be determined experimentally. The most important factor is the resistance of the leads between the transformer secondary and the meter terminals. In an experimental model one foot of #20 wire caused the meter

STEEL RADIO-AMPLIFIER CABINET (Minerva Type Master) . . . . . Portable, Walnut finish. Exc. for Test Eqpt., Power Supply, Medical or Industrial Apparatus. 8" sq. x 14" L. NEW. . . . . \$2.49  
IN21 CRYSTAL DIODES . . . SPECIAL! 1.69c; 10/6.50 = 30 P.E. M A G N E T WIRE 400'. 25c  
#28 SCE M A G N E T WIRE 500'. 29c  
#20 PUSH-BACK WIRE . . . . . Stranded. 100'. 89c  
W-110B FIELD WIRE . . . . . fols. 100-400 ft. . . 1/2c ft.  
2000 OHM-15 WATT DeJaur Pot. Wire-wound. \$0.69  
5 FT. PHONE CORD . . . . . scle. tip-tip. . . . . 23c; 5/1.00  
20 FT. PHONE-SPKR. EXT. CORD . . . . . tip-lug. . . . . 98c  
6 PUSH-BUTTON ASSBY. . . . . D.P.S.T. 3 1/2" x 1 1/4" x 1", wired, with knobs. . . . . .98

**Leotone**

HEARING AID AMPLIFIER (2 tube) . . . . . MAKE A REAL VEST POCKET KIT, adding simple tuner 1/4"x2"x3/8" WITH SCHEMATIC FOR 2 OR 3 TUBE SET. Less tubes, case. . . . . \$2.49  
2 HEARING AID TUBES (for above) . . . . . \$2.49  
HEARING AID BONE CONDUCTION RECVR. . . . . Exc. CONTACT MIKE, MINI. SPKR. 1 1/2" Lo-imped. . . . . \$2.49

FREQ. METER TECH. MANUAL (TS-173) . . . . . \$0.39  
R-89/ARN-5A GLIDE PATH RCVR. DIAGRAM . . . . . 25c  
SCR-511 TECH. MANUAL (TM11-245) . . . . . 75c  
DPT ANTENNA RELAY . . . . . 12V. DC. 2"x1 1/4". . . . . 79c  
GE 1/20 H.P. MOTOR . . . . . 110V. DC. 2". 79c  
1725 RPM. Shunt. O.D. 4 3/4"x3 1/4". . . . . 2.95  
TV SCREEN FILTERS . . . . . Lt. blue or Smoke. 10". 98c; 12". 1.39  
AC-DC NEON TEST-LITE . . . . . 110-220V. 15c; 8/1.00  
AN CONNECTORS . . . . . NEW 3100-14S-2P. 18c  
3102-22-13S. 25c; 3102-14S-2S. 18c  
83-1AP (M-359) CO-AX ANGLE PLUG. 23c; 5/1.00

• "MOTOR CONSTRUCTION KIT" HOBBY •  
• ISPS! STUDENTS! EXPERIMENTERS! •  
• Build a 1/2 h.p. 1750 RPM. 4 1/2" V. D.C. •  
• Motor. 1 1/4" x 2 1/4" x 2 1/2". Simple asbly. •  
• Instruct. Less batt. . . . . \$1.49

HIGH FIDELITY CRYSTAL MIKE . . . . . Hi-imped. Rubber shock-mtd. 1 3/4"x1/4. Less housing. \$1.29  
ALUMINUM HOUSING for crystal mike . . . . . 15c  
T-44A MAGNETIC MIKE (SCR-522). NEW. . . . . 79c  
HARDY CARBON MIKE (R883) . . . . . Press-to-talk 1.39  
T-50B THROAT MIKE . . . . . Brand new. 45c; 5/2.49  
CD-508 EXT. CORD & SWITCH for T-30 mike. . . . . 49c  
ANB-MCI MAGNETIC MIKE . . . . . cord & plug. . . . . 98c  
RADIO HARDWARE TREASURE . . . . . FULL POUND CAN. Nuts, Screws, Lugs. . . . . 69c; 3/1.98  
PORTABLE UTILITY CASE 1 pc. steel, hinged lid, snap locks. 6 5/8" web strap . . . . . 10" sq. x 4". . . . . 79c  
"ALNICO CHIP MAGNETS" . . . . . irregular sizes. Approx. 100 pcs. per oz. . . . . 15c/oz.; \$1.50/lb.  
ALNICO MAGNET KIT . . . . . Powerful Bar, Block, "U" etc. Kit of 10 assorted. . . . . 1.98  
TUBE CARTONS . . . . . plain white (prices per 100). Min. (1" sq. x 2 3/4). \$1.20; (1 1/2" sq. x 1 1/4" sq. x 3/4). \$1.45; Med. (1 1/2" sq. x 1 1/4" sq. x 2"). Large (2" sq. x 3"). \$1.98  
"FACTORY SPEAKER REPAIRS SINCE 1927". 1.98  
Min. order \$3.00. 20% deposit req. on all C.O.D.'s. Full remittance with foreign orders. Please add sufficient postage—excess refunded.

**LEOTONE RADIO CO.**  
67 Dey Street  
New York 7, N.Y.

**TELESCO**

SINGLE REFLECTOR CONICALS

1259—Single Bay 3/8" elements. 2.49  
1256—Single Bay 1/2" elements. 2.98  
1254—Double Bay 3/8" elements. 5.20  
1258—Double Bay 1/2" elements. 6.16  
1257—Four Bay 3/8" elements. 11.59  
1253—Four Bay 1/2" elements. 13.41

LESS THAN COST

FIVE ELEMENT YAGI BEAMS

2002 to 2006—any lo channel. . . . . 6.78  
2007 to 2013—any hi channel. . . . . 2.51

1236—Single Bay Twin-V. . . . . 2.92  
1237—Double Bay Twin-V. . . . . 5.84  
1231—Four Bay Conical . . . . . 13.92  
1230—Double Bay Conical . . . . . 6.10  
1243—Swift Rig Folded Hi Folded Low. . . . . 3.03  
1240—Single section conical—lots of 6 . . . . . 1.30  
1244—Swift Rig Folded Hi Straight Low. . . . . 2.71  
2113—Deluxe Indoor Antenna . . . . . 1.75  
1860—Chimney Mount . . . . . Dozen Lots .98  
1805—3/2" Mast Snap-On Standoff . . . . . Per 100 3.60  
1873—3/2" Mast Standoff Insulator. . . . . Per 100 5.50  
1872—4" Nail-In Insulator . . . . . Lots of 50 .02  
1870—3 1/2" Wood Screw-Eye Insulator. Lots of 50 .02  
1229—Single Bay Conical . . . . . 2.93  
1861—5 Ft. 1 1/4" Diam. Galv. Steel Mast. . . . . 68c

Send for quantity prices and complete list

**TELEVISION SUPPLY CO.**  
Box 13 Greenpoint Station Brooklyn, N. Y.



indication to decrease two subdivisions with only 10 turns on the primary winding. With 16 turns the meter indication decreases only one subdivision with a four-and-one-half foot length of #20 wire. This initial test for minimum primary turns should be made on the lowest intended range with the secondary meter circuit indicating the same current flow as in the primary circuit. It should be noted that when making these initial tests the core is to be solidly clamped together as would be the case when the unit was completed, otherwise there will be a discrepancy between the test model and the completed transformer.

After the transformer is completely wound and the core positioned, the entire unit should be baked in an oven for several hours at about 250 degrees F. in order to remove the moisture. The entire unit is then dipped in varnish to seal it.

The range switch, S<sub>2</sub>, can be a single-pole, 3-position high quality rotary type switch. In building this panel, however, the author used a *Mallory* 4-pole, 3-position switch with all four poles and the individual position contacts connected together. Although this technique adds to the cost and the bulk of the unit it does have the advantage of reducing the contact resistance to a minimum and insures reliable and accurate operation over a long period of time.

It might be of interest to point out that the current transformer can also be used with a dynamometer to extend the current range of the instrument.

The finished instrument was lettered with a rubber lettering set using lettering paint. —30—

## CALLSIGNS FOR NOVICES

THE FCC has recently announced that distinctive callsigns will be issued to amateur Novice class licensees.

In order to identify clearly ham stations licensed to the holders of Novice class licenses, a callsign prefix of two letters will be issued. Thus, in the continental United States where the callsign prefix would normally be "W" or "K", the prefix for the Novice station callsign will be "WN" or "KN" and the callsign. In the territories and possessions of the United States where the callsign prefix would normally be two letters beginning with the letter "K", the letter "W" will be substituted for the letter "K" in the prefix.

This procedure will permit the Novice to retain the same amateur callsign with the exception of a change in the callsign prefix if he qualifies for and obtains a higher grade of amateur operator license and obtains a new station license during the normal one-year period of his license as a Novice. It should be noted however that after the expiration of a Novice class license, the previous holder of such license cannot be considered to be assigned the counterpart callsign.

The new Novice class of license became effective on July 1st of this year and district FCC offices are currently conducting examinations. Code speed of 5 wpm and a simple written exam are the only elements required. —30—

# O-R now in a new location ON SAN FRANCISCO'S BUSIEST STREET!

## NOW! POSITIVELY IDENTIFY U-235 IN THE FIELD!

O-R now offers you a simple and positive method for identifying U-235 in the field! Save assaying charges—**know** what you have without delay. The kit contains all necessary chemicals, torch, etc., for treatment of specimens for examination under ultra-violet light. Kit also contains special "black light" tube, starter, switch, resistor and necessary hardware for excellent portable U-V source. This unit operates from 180 volts DC obtained from standard type B batteries. (Not supplied) Unit is very simple to assemble and complete instructions enable anyone to perform necessary operations leading to positive identification of Uranium 235 when present in the specimen. Complete kit, (less batteries and housing) . . . only **\$11.95** (shipped by express only).

## U-V LIGHT SOURCE

8 watt ultra-violet light source. In kit form including Sylvania black-light tube, (for U-V light in the 3660 Angstrom unit region) ballast, starter, mounting panel, reflector, line cord/plug, hardware, instructions. An invaluable device for schools, labs, service shops, home workshop, etc. Here is a genuine value. Complete kit, (less outer housing) . . . only **\$4.95**

## Power Supply for Any 274-N Receiver

A shipment of the special transformers has just been received and this popular power supply is now once again available. Just plug it into the rear of your 274-N RECEIVER . . . any model! Complete kit, and black metal case, with ALL parts and diagrams. Simple and easy to build in a jiffy. Delivers 24 volts plus B voltage. No wiring changes to be made. Designed especially for the 274-N receiver. All necessary parts for conversion of rest of receiver also included. **ONLY \$8.95.** Complete kit, (less outer housing) . . . only **\$4.95**



TUNING KNOB for 274-N Receiver, 59c ea.

## TELEPHONE EQUIPMENT:

EE89 Repeaters (see previous ads). Only a few left. NEW! Regularly **\$9.95** ea. . . now **\$6.95** ea. **TS-10 Sound powered handsets.** A limited quantity only. BRAND NEW! . . . **\$25.95** pair **Handset hanger.** Beautiful cast aluminum shell finished in black wrinkle. Takes all makes and models. An extremely useful, well-made item only **\$1.95** ea.

## 274N/ARC-5 ACCESSORIES

Mounting rack, holds three receivers. Easily modified for single receiver—NEW . . . only **\$1.95** ea. 274N/ARC-5 Spline tuning knobs. . . . **.59** ea. Same as above except with deluxe tuning crank . . . . **.89** ea. Tuning crank. Fits RU 16-17, BC 433 etc. for manual tuning . . . . **.89** ea.

## HV VACUUM CAPACITORS

VC-50 — 50 MMF . . . . . **\$ 3.95** ea.  
VC-150 — 150 MMF . . . . . **10.95** ea.  
VC-150 — 200 MMF . . . . . **13.95** ea.  
All Brand New Merchandise—Excellent Values.

## 100 KC CRYSTAL

Model VC5-KS Precision 100 KC crystal in holder. (Similar to Biley AR21-W.) Ideal for Crystal Calibrators and Frequency Standards. A Buy At . . . . . **\$3.95** ea.

## ALUMINUM CHASSIS

Drawn, Bright Dipped. 5 1/4" long, 3 3/8" wide, 1 7/8" deep. Bargain At . . . . . **49c** ea.

## CONDENSER TESTER

• One of our best sellers! Useful, versatile laboratory item, in kit form. Simple, and easy to build in less than an hour. Checks condenser leakage and continuity up to 8 megs. Will test any paper, electrolytic, mica or oil capacitor from 50 mmf. to 50 mfd. Self-contained power supply and neon bulb indicator with socket and bezel. Drilled metal cabinet. Complete instructions and diagrams included with each kit. Only **\$5.00.**



## TWO-CIRCUIT JACKS

Long-type, standard two-circuit jack. Has standard 3/8" thread bushing for panel mount. A buy at **30c** ea. New, surplus. Limited quantity.

## SMALL PRECISION LATHE—110-V. AC

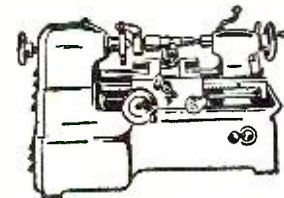

Now with Larger Motor **\$59.75**

A small lathe for radio shops, jewelers, laboratories, dentists, hobby-crafters, model makers, machine shops, schools, etc. Automatic Feed. Work capacity 3" between centers. Swing over bed 2". Constructed of steel and cast iron. Accurately machined and finished. Fan-Cooled Motor mounted inside the base. Complete with 1 1/4" face plate, 2 lathe centers, tool post and rocker, one lathe dog, one tool-bit and test rod.

## COMPLETE ACCESSORY KIT

including 4-jaw chuck, drill chuck, center counter-sink drill, 2 tool-bits, 2 lathe dogs, 1 face plate with 8 drilled and tapped holes. 2 collets, 1 collet chuck, 1 Allen wrench. . . . . **\$29.50**

FL-8 Filters, New . . . . . only **98c** ea.

## 220 TO 110 TRANSFORMERS

Excellent, line-to-line transformer rated at 150 watts. New, fully-cased, upright mount, complete with cord/plug and receptacle. . . . only **\$3.95** ea.

## CATHODE RAY TUBES

3DP1A . . . . . **\$2.50** ea.  
3PPTA . . . . . **2.50** ea.  
5MP1 standard, (2.5V fil.) . . . . . **2.50** ea.

836 hi-vacuum rectifiers. 2 for . . . . . **\$1.50**

## TRANSFORMERS-CHOKES:

2.5V, 10A, 10KV insulation. Suitable for 866, 836, etc. Reduced to **\$3.39** ea.

10H, 200 ma choke. Hermetically-sealed steel case. Also has hum-bucking tap. A beautiful item only **\$1.98**.

10H, 50 ma choke. Strap mounting. Handy for dozens of applications. Reg. 98c, reduced to **65c**. Charger or fil. trans. Pri. 110V, 60 cycle. Secondary, 9-10-11-12-13 volts @ 1.2 A. Fully cased. A buy at **\$1.49**.

Vibrator transformer. 6V inp. Secondary 345-0-345 @ 150 ma. Also has bias winding. Fully cased. Bargain at **\$1.49** ea.

Power Transf. 350-0-350 @ 70 ma. 5V @ 3A. 6.3 @ 3A. Pri. 110V, 60 cy, AC. Upright mtg. . . . . **\$3.25** ea.

Power transf. Pri. 115V, AC, 60 cy. Sec. 520-0-520 @ 200 ma. . . . . **\$5.25** ea.  
Power transf. Pri. 115V, 60 cy. AC. Sec. 310-0-310 at 50 ma. Cased, upright mount. . . . . only **\$1.95** ea.

Output transf. 50L6 to voice coil. . . . . **79c** ea.  
Choke, 6 Henry, 200 ma. Strap mtg. . . . . only **\$1.95** ea.

HS-16 phones. Used, with headband and 6' cord. A hot buy at. . . . . **98c**

## VACUUM TUBE SPECIALS

8012 . . . UHF triode . . . . . **\$1.50** ea.  
WE-717A . . . . . **1.00** ea.  
WE-316A . . . Trans. doorknob . . . . . **.75** ea.  
WE-388A . . . Large doorknob . . . . . **1.00** ea.  
815 . . . twin-beam tet. . . . . **2.50** ea.  
6L6 . . . metal . . . . . **2.25** ea.  
6L6G . . . . . **1.95** ea.  
6L6GA . . . . . **1.95** ea.  
1636 . . . VHF converter. . . . . **1.00** ea.  
Hytron HV-615 . . . . . **.30** ea.

## LOOK! NO HANDS!

This mike leaves both hands free for mobile QSO's. Fastens to operator by simple snap strap. Adjustable. Double action sw. operates push-to-talk or holds on. BRAND NEW only **\$2.00** ea. POSTPAID in U.S.A. and CANADA.



## NOTE NEW ADDRESS!

Minimum order \$2.00. All items subject to prior sale. All prices subject to change without notice. 20% deposit must accompany all orders, balance C.O.D.

# OFFENBACH & REIMUS CO.

1564 MARKET ST., SAN FRANCISCO, CALIF.

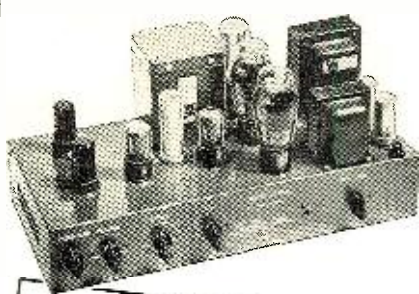

**AGAIN AVAILABLE  
for Immediate Delivery**

## Sun Radio's Famed CR-10 AMPLIFIERS\* All-Triode Design

For the first time in 2 years, increased supply has finally caught up with demand and we can now guarantee immediate delivery on these highly popular amplifiers. Tubes: 1 - 6SC7, 2 - 6SN7, 1 - 6J5, 2 - 6B4G and 1 - 5U4G.

Inputs: One Radio, One Phonofor magnetic cartridges. Built-in preamp.

Output Impedances: 4, 8, 16, 250, 500 ohms. Frequency Response: 20-15,000 cps  $\pm$  1 db. Harmonic Distortion: Less than 2.5% at 10W. 2.5% at 11.8W at mid-frequencies.

Hum Level: Down 60-70 db at 10W. Gain: Radio 75 db; Phono 97 db; Magnetic pickup at 50 cycles 117 db.

Chassis: Punched and finished in bronze hammertone. Front panel silk screened. Chassis Size: 8" x 17" x 3".

Kit complete with instructions.

MODEL CR-10, standard model. Kit \$54.00 Lab wired, tested, ready to use . . . \$84.50

MODEL CR-10-P, uses Peerless transformers throughout. Kit . . . \$54.00 Lab wired, tested, ready to use . . . \$84.50

MODEL CR-10-Q using Peerless transformers throughout, features famous Peerless S-240-Q output transformer for real presence effect. Frequency Response  $\pm$  1db, 20 - 20,000 cps. Less than 2% harmonic distortion at 10W. Kit . . . \$64.00 Lab wired, tested, ready to use . . . \$94.50

SOLD EXCLUSIVELY BY SUN RADIO, N. Y.

Mail orders filled promptly and carefully. Write for complete literature on these amplifiers and other high fidelity equipment. All Kits Less Wire & Solder.

\*Adapted from design published by CONSUMERS' RESEARCH, INC., WASHINGTON, N. J. (Special Bulletin #31). Present tube shortages have made it advisable for Sun Radio to substitute a type 6A3 output tube for the 6B4G in the original design. These 2 tubes are identical except that the 6B4G has an octal base, and the 6A3 has a four-prong base. This change in no way impairs the amplifier's performance.

**Sun Radio**  
& ELECTRONICS CO. INC.

124 Duane St. • New York 7, N. Y. • BRanch 7-1840

TWO BLOCKS NORTH OF CHAMBERS STREET  
Established 1922 • Open Daily 9-6, Sat. 9-4:30

## International Short-Wave (Continued from page 100)

announcements) to Australia-New Zealand. (Pearce, England)

**Honduras**—HROW, listed 6.575, *Radio Monserrat*, noted 2100-2305 close-down. (Serrano, Brazil) Appears to vary somewhat in frequency at times, noted as low as 6.660. (Stark, Texas; Ferguson, N. C.)

**Hong Kong**—ZBW3, 9.525, sent QSL card via airmail; previously sent letter. (Pearce, England)

**Hungary**—Budapest has replaced 6.248 with 11.910 for *summer*. (Fried, Mich., others)

**Iceland**—TFJ, 12.175, Reykjavik, noted 1120-1145 sign-off Sundays only; all-Icelandic. (Saylor, Va.)

**India**—AIR, 15.29, fair to good in news 1930 in West Indies beam; 11.85 parallels, badly QRM'd usually. (Bellington, N. Y.) The 15.16 channel has powerful signal in West Virginia nightly from 2030 sign-on; all-native. (Dalton) Noted with news 1330 on 15.29, 17.84, and at 1030 on 15.16, 9.59. (Pearce, England) AIR appears to be sending "typographed" verifications now instead of former cards. (Pearce)

**Iran**—EPB, 15.100, noted in Persian 1415; clock chimes at 1430 for "11 p.m.," then with call in *English*, announcement of special programs for overseas listeners on 895 kc., 15.100, 6.150—news in French 1430, in *English* 1500, in Russian 1515; closes 1530. (Pearce, England) Usually has good signal in Eastern USA 1500 on 15.100.

**Iraq**—Radio Baghdad's new 16-kw. transmitter on 7.092 is scheduled 2330-0100, 0430-0600, 0830-1500, mostly in Arabic. (Radio Australia)

**Ireland**—Radio Sweden recently reported Athlone heard on approximately 3.450, closing 1700.

**Israel**—Kol-Israel now has news 0600 on 6.830; 1415 on 6.830, 9.010. (Pearce, England) "Voice of Zion" (World Zionist Organization program in *English*) for *summer* is now on 9.010 at 1600-1700 sign-off although listed widely by overseas sources as at 1800. (Bellington, N. Y.) Announces Yiddish for 1430; French for 1515; "non-stop" music for 1600-1615, and *English* for 1615-1700 closedown. (Pearce) By this time, the new 50 kw. transmitter should be on regular schedule—allocations include 21.455, 17.880, 15.415, 11.935, and in the 31-m. has tested on 9.500, 9.615, 9.640.

Israel Army Broadcasting Services, A.P.O. 162, Israel, 4X4EA, is scheduled now 1130-1500 on 6.725; appreciates reports. (ISWC, London)

**Italy**—Rome says that since March 18 has been using these channels at least once each 24 hours—21.56, 17.803, 17.77, 15.425, 15.12, 11.905, 11.81, 9.71, 9.67, 9.63, 9.575, 7.11, 6.010. (Guentzler, Ohio) Now has *English* for South Africa 1345-1425 on 17.803, 15.420; noted on 11.91, 7.110 at 1308 with news in French. (Pearce, England) Fine level afternoons (EST) in West Virginia on the 15.420 outlet. (Dalton; Board) Sent

## BARRY JULY SPECIALS ALL MERCHANDISE FULLY GUARANTEED

### ULTRA-COMPACT MULTIMETERS

3 1/2" x 2" x 1 3/4"  
AC & DC: 0-15V; 0-150V; 0-750V.  
DC: 0-150 MA. OHMS: 0-100,000 OHMS.  
With Leads, Battery & Instructions. Brand new,  
boxed.  
only \$8.65 postpaid

● 304-TH or 304-TL in \$13.95  
Original Boxes (Eimac) ea.  
(Ask for Quantity Price)  
Specify Which Type Wanted

● 450-TH JAN — Eimac @ \$29.95

● Maguire Deluxe AM Mobile 75 Meter Xmtr.,  
New, Complete, Not Surplus, factory price \$69.00—Only a few left \$25.00

Top Quality, Tested and Branded Tubes		
024/024G \$0.65	6AK5 . . . \$1.60	6Y6G . . . \$ .85
1B3GT . . . 1.25	6AL5 . . . .95	12AT7 . . . 1.35
1U4 . . . .80	6AU6GT. 1.59	12AU7 . . . 1.10
1X2A . . . 1.59	6AU6 . . . .95	12BA6 . . . .85
2B7 . . . .35	6BA6 . . . .90	12BH7 . . . 1.70
304 . . . .90	6BQ6GT. 1.45	12SK7GT. .90
354 . . . .97	6BY5G . . 1.65	25L6 . . . .90
574 . . . 1.75	6BL7GT. 1.59	50A5 . . . 1.05
5U4G . . . .80	6J5GT . . . .60	50B5 . . . .95
5V4G . . . 1.10	6J6 . . . .40	50L6 . . . .85
5X4G . . . .90	6SG7 . . . .95	IN21 . . . .80
6AC7 . . . 1.40	6SN7GT. 1.00	IN21B . . 3.00
6AG5 . . . 1.30	6T8 . . . .40	IN23 . . . 1.00
6AH6 . . . 1.80	6W4GT . . .80	IN23B . . 4.00

Many others, including xmtr and special purpose types stocked . . . Write for prices.

### SELENIUM RECTIFIERS IN STOCK

Full-Wave Bridge Types		
2 Amp. . . . .	18/14 V. 36/28 V.	54/40 V.
4 Amp. . . . .	\$ 2.50 \$ 2.75	\$5.25
8 Amp. . . . .	4.00 5.50	Other Types
12 Amp. . . . .	6.00 7.50	Made to Order—
24 Amp. . . . .	8.00 10.00	Write.
	12.00 20.00	

Selenium Rectifier Xmtr. 110 V. 60 Cy./6, 12, 24, 30, 36 V. @ 4 Amps. new, herm. sealed. . . . \$3.95

PHONE: REctor 2-2563 CABLE: BARRYLECT, N. Y.

## BARRY ELECTRONICS CORP.

136 Liberty St. New York 6, N. Y.  
25% Deposit with Orders. Send Full Remittance to  
Save C.O.D. Charges.  
ALL MERCHANDISE FULLY GUARANTEED

## THE WORLD'S LEADING TWIN LEAD TELEVISION LIGHTNING ARRESTER

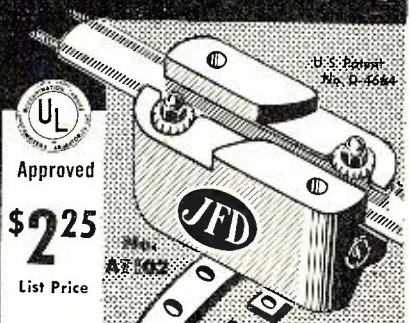

Approved  
\$225  
List Price

completely waterproof

## JFD SAFE TV GUARD

Protects television sets against lightning and static charges. Simple to install everywhere and anywhere . . . no stripping, cutting or spreading of wires. More than 500,000 in use today!

See your jobber or write to —

JFD MANUFACTURING CO., INC.  
6105-G 16th Ave., Brooklyn 4, New York  
FIRST in Television Antennas and Accessories

new QSL card for reception on 7.110. (Pearce)

**Jamaica**—Radio Jamaica, 3.360, good 2130. (Hoffman, N. Y.)

**Japan**—NHK, 6.005, Tokyo, noted from before 0515 to leaving the air around 0700. (Stark, Texas) NHK, 3.475, heard 0800-0845, parallel 4.940, 7.285; listed JO9H. (Rosenauer, Calif.)

**Kenya Colony**—Nairobi still noted on 4.855 with BBC news relay 1300. (Pearce, England)

**Liberia**—When this was written, ELBC, Monrovia, was still using 6.025 daily 1445-1845, but had notified Belington, N. Y., others, that soon would have two additional 1 kw. transmitters in operation—in the 25- and 19-m. bands, respectively.

**Luxembourg**—Radio Luxembourg, 6.090, noted Saturdays 1700-1730 with "Bringing Christ to the Nations" (English). (Pearce, England)

**Madagascar**—Radio Tananarive, 6.171, noted at fair strength around 1130 in South Africa. (Hannaford) Heard on 9.515 at 2240. (Riggle, Ohio) And as late as 2315. (Kroll, N. Y.)

**Malaya**—When signing off 11:30 with "God Save the King," BFEBS, Singapore, 15.300, announces frequencies of 15.300, 11.880, 9.690, 6.175, and says "will be back tomorrow at 0915 GMT" (0415 EST). (Boice, Conn.) Noted with BBC news relay 1000. (Sutton, Ohio)

**Malta**—At the time this was compiled, the Forces Broadcasting Service, Middle East, had closed down on Malta and was being moved to Fayid, Suez Canal Zone, as "an economy measure." (ISWL, London)

**Martinique**—Fort-de-France, 9.700, heard 1700 to after 2000. (Sutton, Ohio)

**Mexico**—XECC, 15.205, relaying XEMC, Mexico City, noted at best strength in N. Z. around 2300; interferes there with reception of Radio Australia. (Cushen) Measured 15.2051 at 0720. (Oskey, N. J.)

**Mozambique**—Lourenco Marques noted recently on 9.855 at 1340 tune-in to after 1400; all-Portuguese. CR7BU, 4.920, noted in English 1300, when CR7BV, 4.825, was also heard, but in Portuguese. (Pearce, England)

**New Caledonia**—FK8AA, Radio Noumea, measured 6.0338, noted signing on 0200 in French. (Slattery, Ore.) Signs off around 0535. (Stark, Texas) Now verifies with a white card, listing 6.035, 1 kw., using "Telephonique Paris" transmitter, doublet antenna oriented NW-SE. (Cushen, N. Z.)

**Nicaragua**—Managua, 6.005, noted 2345 with North American tunes; YNHB, 6.550, heard 2230-2330 with Latin American dance music. (Rastorfer, N. Y.)

**Norway**—Fine QSL card just received for reception last year of Oslo University station, 7.240; said only just got QSL cards printed! (Pearce, England)

**Pakistan**—Radio Pakistan noted on 7.095 with news 1015. (Hannaford, Sou. Afr.) Heard parallel at that time on 11.725, announcing as "General Overseas Service of Radio Pakistan"; also

**TDQ TRANSMITTER**—45 Watts, 115 to 156 MC Crystal Control, Phone, MCW, & CW. Complete with Tubes, 110/220 Volt 60 cycle Power Supply. Excellent condition. NEW.....\$450.00

**SCR-269F RADIO COMPASS**—complete with Dual Controls. NEW.....\$250.00

**MP-28BA MODULATOR & DYNAMOTOR POWER SUPPLY**—for TA-12 Transmitter. Operates from 25 to 28 VDC. Complete with Tubes. NEW.....\$29.50

**DYNAMOTOR** only for TA-12.....\$9.95

### BC-223 TRANSMITTER



30 Watt transmitter with Crystal or MO control on four pre-selected channels. CW, MCW cover frequency range 2000-5200 KC. by use of plug-in coils. Complete with 1 lb tube and choice of one Tuning Unit (listed below). Less Mtg.—Prices:

NEW: \$32.50  
USED: Gov't Reconditioned.....\$26.50

**CABLE**—Trans. to Power Supply.....\$2.00

**TUNING UNITS**: TU-17—2000-3000 KC.; TU-18—3000-4500 KC.; TU-23—3500-5250 KC. \$3.50 EACH

**SPARE TUBE KIT** in metal box, f/BC-223...\$4.95

**OPERATING MANUAL** for BC-223.....\$2.50

**PE-125 POWER SUPPLY** f/BC-223—12/24 Volt input; output 500 Volt 150 MA.....NEW: \$14.95

**SPARE VIBRATOR & TUBE KIT** f/PE-125...\$5.95

**SHOCK MOUNTING** for PE-125.....\$1.50

**FT-173 MOUNTING** for BC-223.....2.50

**BC-223 TRANSMITTER**—Incomplete, for parts. No front panel or meters. Price—As Is.....\$4.95

### 2 FOR 1 SPECIAL

#### A-220 MC. CONVERTER FROM THE SURPLUS R-1/ARR-1 RECEIVER

Ideal compact unit for conversion to the 1 1/4 meter band. Uses four 954 Acorn tubes. Size: 3 1/2" x 3 1/2" x 10". For complete conversion instructions, see Radio News, Jan., 1949—AND—

#### BC-230 TRANSMITTER

w/ 0-1.5 RF Ampmeter, less tubes. \$6.95

### AMPLIFIERS:

**BC-605 AMPLIFIER**—Ideal for conversion to Intercomm. set. Includes two 1619 Tubes, input and output Transformers, Volume Control, Jacks, Switch, and Schematic. Prices: NEW: \$5.95 USED: \$3.95

**BC-709 AMPLIFIER**—Portable, pocket size battery operated. Ideal for small planes, home, or portable use. Complete with 185 Tube, Jacks, etc. Less batteries. Prices: NEW: \$3.95 USED: \$2.95

**BC-347 AMPLIFIER**—Aircraft Type, contains 2 Midret UTC Oncer Transformers, complete with 6F8 Tube. NEW.....\$2.95

### BLOWERS:

115 Volt 60 cycle BLOWER (pictured), approx. 100 CFM Dis. 2 1/4" intake; 2" outlet. Quiet running. Motor size e: 2 1/2" x 3 1/2". NEW—not Gov't surplus. Order No. RN-520.....\$7.99



**DUAL BLOWER**—Same as RN-520 above, except has blower assembly on each side of motor. Order No. RN-800.....\$12.95

### GUY CABLE

Regular Aircraft Control Cable, 3/32"—7x7—49 Strands galvanized weatherproof, 920 lb. Test. Ideal for television or radio mast guying. Prices:

2 3/4¢ per Ft.—1000 Ft. or more: 2 1/2¢ per Ft.  
CONTROL CABLE, 4 wire flat.....5¢ per Ft.

### AERIAL WIRE:

Aerial Wire—Phosphorous Bronze #16 Stranded. 200 lb. test. Weatherproof. 150 feet on Reel. RL-3 with Clips.....\$1.50

Address Dept. RN • Minimum Order \$2.00 • Prices F.O.B., Lima • 25% Deposit on C.O.D. Orders

## FAIR RADIO SALES

132 SOUTH MAIN ST. LIMA, OHIO

### RADIO COURSES

- RADIO OPERATING • CODE
  - RADIO SERVICING • ELECTRONICS
  - F.M. TELEVISION
  - PREPARATION FOR CIVILIAN, MARITIME, ARMY AND NAVY LICENSE REQUIREMENTS.
- Write for Catalog T.S.

YMCA

TRADE & TECH. 229 W. 66 St., N. Y. 23  
SCHOOL INDIAN 2-8117

## WHIP ANTENNA EQUIPMENT

### MAST BASES—INSULATED:



**MP-48 Base** (Illustrated at right) Insulated type with heavy coil spring. Requires 1 1/2" mounting hole. Weight: 11 lbs. Price.....\$4.95



**MP-132 Base** (Illustrated at left) 1" heavy coil spring. 2" insulator. Overall length: 11 1/2". Weight: 2 3/4 lbs. Price.....\$3.95

**MP-22 Base**—Spring action direction of bracket. 4" x 6" mounting. Price.....\$2.95

### MAST SECTIONS FOR ABOVE BASES:

Tubular steel, copper coated, painted, in 3 foot sections, screw-in type. MS-53 can be used to make any length, with MS-52-51-50-49 for taper. Price, each, for any section.....(Ea.) 50¢

**WHIP ANTENNA**—9 1/2 Ft. rigid mount. Uses three screw-in sections: MS-49-50-51 and rigid ID.....\$2.25 mount w/ antenna connection.....

### 6-VOLT POWER SUPPLY

**VIBRATOR TYPE**—6 Volt DC input; output 230 Volt DC 50 MA. filtered w/tube. Size: 6 1/2" x 4 1/2" Price.....\$6.95

**VIBRATOR TYPE**—6 Volt DC input; output 230 Volt DC 50 MA.—not filtered—w/tube. Ideal for Command Receiver operation as receiver is filtered internally. Size: 4 1/2" x 4 1/2" x 3 1/2".....\$4.95

### 3/4 RPM ANTENNA ROTATOR MOTOR

High torque, reversible motor—operates directly from 110 Volt 60 cycle by use of condenser. Light weight, quiet running, ruggedly built, positive stop, easily mounted. Normally operates from 110 Volt 400 cycle. Complete—with instructions. NEW.....\$4.95



10 MFD 400 Volt Cond., \$1.00.

### DYNAMOTORS:

INPUT:	OUTPUT:	STOCK No.	PRICE
9 V. DC @ 6 V. DC	450 V. 60 MA. 275 V. 50 MA.	DM-9450 w/Blower	\$3.95
12 V. DC	220 V. 70 MA.	DM-24	6.95
12 V. DC	220 V. 100 MA.	DM-18	4.95
12 or 24 V. DC	440 V. 200 MA. & 220 V. 100 MA.	D-104	9.95
12 V. DC	600 V. 300 MA.	BD-86	7.95

PERMANENT	MAGNET FIELD	DYNAMOTORS:
12 or 24 V. DC @ 6 V. DC	275 V. 110 MA. 500 V. 50 MA.	USA/0516 USA/0515
	240 V. 50 MA.	2.95

Tell Us Your Dynamotor, Inverter, & Motor Needs!



### GEAR TRAIN MOTOR

Ball bearing, low inertia reversible type motor, 588 RPM. Low speed gear 14 RPM. Extra large Gear 7/8 RPM. Operates 26 V. 400 cycle or 12 V. 60 cycle. Price—each—only.....\$295

### JULY SPECIALS:

FL-8 Filter, 1020 cycle Audio Filter. Used..	\$1.50
T-17 Microphone, Carbon w/Cord & Plug. Used	1.00
116/U Headset w/Cord and Plug. Used....	1.50
Leg & Seat Assembly for Iland Generators..	3.50
CD-501 Cord for GN-45 Generator.....	2.00
MR-9C Control Box f/RA-10 Rec. w/Plug. NEW: \$12.50 USED:	6.75
C-87/ART-13 Control Box f/ART-13 Trans. NEW: \$6.95 USED:	4.95
CD-318 Cord f/Throat or Lip Mikes.....	.59
CD-307 Cords 65" w/PL-55 & JK-26.....	.99
CD-604 Cord w/C-410 Trans. & PL-54 Plug..	.89
CD-365 Cord f/LP-21 Loop.....	1.50
PL-112 Plug f/LP-21 Loop.....	1.00
PL-118 Plug f/L-81 or I-82 Indicator.....	1.00
PL-122 Plug f/ARN-7 Receiver.....	1.50
TS-13 Handset—Used—Tested.....	6.95
118-30 Headset:.....NEW: \$1.95 USED:	1.00
Head & Chest Set w/Plug for KE-8..USED:	2.95
Microphone & Headset, Dynamic type f/MARK II:.....NEW: \$2.95 USED:	1.95

### CONVERSION DATA!

See Ad—Page 88

for MOTOROLA VF103  
see PF INDEX No.27  
FREE—GET IT NOW!

# Insist on VEE-D-X

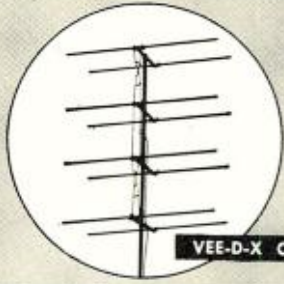

VEE-D-X Colinear

## THE WORLD'S

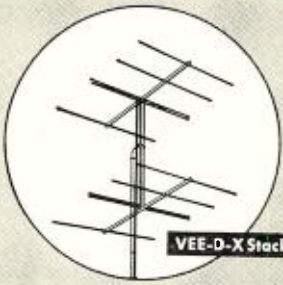

VEE-D-X Stacked Yagi

## MOST POWERFUL



VEE-D-X Yagi

## T V ANTENNAS

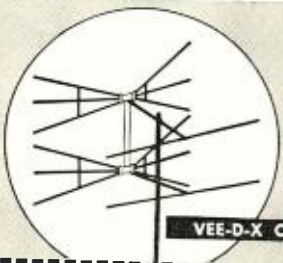

VEE-D-X Conical

LaPOINTE-PLASCOMOLD CORP. 10  
WINDSOR LOCKS, CONN.

Please send me new 1951 catalog of VEE-D-X antennas and accessories.

NAME \_\_\_\_\_  
STREET \_\_\_\_\_  
CITY \_\_\_\_\_ ZONE \_\_\_\_\_ STATE \_\_\_\_\_

noted with slow-speed news 1210-1230 near 11.920. (Pearce, England) Lahore, 4.810, relays 1015 news. (ISWC, London) Still has news 2100 on 15.335, badly QRM'd by USA. (Dalton, W. Va.)

**Panama**—Radio Programas Continental, 6.042, opens 0600. (Stark, Texas) HOB, 6.199, noted to 2300 sign-off. (Leary, Ind.) HOJA, 9.644, measured 0640; signs on 0630 with march. (Oskay, N. J.)

**Paraguay**—ZPA5, 11.950, Radio Encarnacion, has been logged with fine level in Britain around 1845, slight QSB; call is "Radio Nacional de Paraguay." (ISWL Bulletin, London) ZPA3, 11.850, Asuncion, Radio Teleco, noted 2100. (GDX-aren, Sweden)

**Peru**—OAX4J, Lima, Radio Colonial, noted to 2200 and later on 9.340 now (up to 10 kc.); OAX4Z, Lima, Radio Nacional de Peru, is heard back on its old 5.895 channel (from 6.077). (Stark, Texas) Both noted evenings (EST).

**Philippines**—DZH7, 9.735, noted 0500-0600; news 0515. (Chatfield, N. Y.) Unconfirmed reports say the new outlet, DZH9, 11.85, is now on the air.

**Poland**—When this was compiled, Radio Warsaw was scheduled with English to North America 1745, 1930, 2300, 0015 on 11.815 (if not found there, try 11.740 where has been found at times although announcing 11.815—KRB). (Boice, Conn., others)

**Portuguese India**—Emissora Goa, 9.610, still reported heard in Sweden around 1125-1200 sign-off. (GDX-aren)

**Roumania**—Bucharest, 9.252, still has news 1400. (Pearce, England) Heard on 11.900 with news in Roumanian 1230 (GDX-aren, Sweden)

**Saudi-Arabia**—Djeddah, 11.95, noted in Arabic talk recently 1210. (Pearce, England) Noted in Arabic 2300-2350A on both 11.85, 11.95. (Dary, Kans., others)

**South Africa**—Johannesburg still noted with experimental transmission on 11.935 (announced 11.927), around 1430-1500. (Pearce, England)

**Southern Rhodesia**—Salisbury, 3.320, noted signing on 1253 with church bells; call 1255; BBC news relay 1300, then weather, local news at 1315; closing announcements 1500, and signing off 1504 with "God Save the King." (Pearce, England) Radio Sweden lists schedule as weekdays 0400-0615, 1015-1500, Sundays 0330-0615, 1300-1500, on 3.320, 7.280, and 9.490 (experimental).

**Spain**—Radio Sweden reports Murcia heard on 7.940 to 1710 sign-off (Sundays, at least); call is "Aqui Transmite Radio Juventud de Murcia." Pearce, England, reports Radio SEU, Madrid, now near 7.140, noted 1640 with recordings. A station noted in Spanish underneath Warsaw, 7.205, around 1730-1800 announcing as "Transmite Radio . . . Cadiz" (?) is believed to be Cadiz, says Pearce; uses recordings mostly, some with English lyrics. Pearce has received a letter-verse from Radio Mediterraneo, 7.037, Valencia; station officials apologized for it being one year old! Oskay, N. J., just received a nice QSL in 12 weeks from EDV10, Madrid; listed 1 kw. on

Easy, fast  
way to cut  
"Key" and "D"  
openings  
in chassis



...with new GREENLEE  
Radio Chassis Punches

Now, in 1½ minutes or less make perfect "Key" or "D" holes for sockets and other equipment. Simply insert GREENLEE Punch and turn with an ordinary wrench . . . get a "clean" opening in a hurry! Write today for details on these as well as GREENLEE Radio Chassis Punches for round and square openings. Greenlee Tool Co., 1887 Columbia Ave., Rockford, Illinois



No. 732 "Key" Punch



No. 733 "D" Punch



## GREYLOCK TUBES

• JULY-AUGUST SPECIALS •

RTMA 90-Day Guarantee

5% off on lots of 100 or more, assorted. For other type tubes and parts, see catalog.

Type	Each	Type	Each
1L4	\$.59	6SA7GT	\$.79
185	.49	6SD7GT	.79
1T4	.59	6SK7GT	.79
1U4	.59	6SN7GT	.89
1X2A	.99	6SQ7GT	.59
3A4	.49	6U4GT	.89
3Q4	.69	6V6GT	.79
3S4	.69	6W4GT	.69
3V4	.69	6X4GT	.59
6AG5	.99	6X5GT	.79
6AK5	1.09	12AV6	.59
6AL5	.69	12AU7	.99
6AQ5	.69	12AV7	1.49
6AR5	.69	12AX7	.99
6AS5	.79	12BA6	.79
6AU6	.69	12SA7GT	.79
6AV6	.59	12SK7GT	.79
6BA6	.69	12S8GT	1.09
6BA7	.69	19BG6G	1.49
6BQ6G	1.29	25L6GT	.79
6BQ6GT	.99	25Z5	.59
6CB6	.79	35Z5GT	.59
6CD6G	1.79	50B5	.79
6J5GT	.49	50C5	.79
6S4	.69	50L6GT	.79
		117Z3	.59

**FREE** Send for complete up-to-date Greylock Catalog today. Dept. N-7

GREYLOCK ELECTRONICS SUPPLY CO.  
115 Liberty Street - New York 6, N. Y.

RADIO & TELEVISION NEWS

7.170, but at present is measured 7.139V.

*Sweden*—Summer schedules through August for *Radio Sweden* are 1900-2030, 10.780, 15.155; 0015-0215 (Home Service) and 0215-0235, 6.065, 15.155; 0235-1015, 11.705, 15.155; 1015-1330, 10.780, 15.155; 1330-1400, 15.155; 1330-1400, 15.155 (separate program); 1400-1700 (Home Service), 10.780, 15.155. "*Swedish DX-ers Calling*" is scheduled Saturdays 0215-0230, 6.065, 15.155; 1515-1530, 10.780, 15.155, and 2015-2030, 10.780, 15.155. Other *English* programs include 1900 (news), 2000 (news), 0230 (program preview), 0715-0730 ("*Sweden Today*"), 1015-1030 (Sunday only; youth program), 1345-1400 (press review).

*Switzerland*—United Nations Radio, announced 6.672, Geneva, has *English* news bulletin 1330; *French* 1345. (Pearce, England)

*Syria*—Damascus, 12.000, noted with news 1530; announces news also for 0600. (Pearce, England)

*Tahiti*—Radio Tahiti, 6.135, Papeete, now has good signal in N. Z. from around 2300 to 0045 sign-off. (Cushen) USA DX-ers say has *English irregularly* at 2300 or 2330.

*Taiwan*—Taipeh, approximately 6.40, noted 0600-0700. (Balbi, Calif.)

*Tangier*—The Panamerican Broadcasting System is now broadcasting on 7.400—*English* 0800, 0845, 1500, 1545; *French* 0830, 0930, 1530, 1630; *Spanish* 0815, 0915, 1515, 1615, with over-all schedule of 0800-1000, 1500-1700. (*WRH Bulletin*) This one recently advised Oskay, N. J., it is *altering antennas and soon will install more powerful transmitters*. Will then expand schedule still further. QRA is Panamerican Broadcasting System, The International Banking Corporation of Tangier, Boulevard Pasteur, 39, Tangier, International Zone, Morocco, Africa. Pearce, England, reports *Radio International*, 6.110 from 1700 with recordings; announcements mostly in Spanish, occasionally in French.

*Thailand*—Bangkok noted on 15.912 at 0935 in native and *as late as* 1020 when QRN becomes quite heavy in South Africa. (Hannaford) The 6.24 channel no longer signs off 0630 at end of *English* session but continues in native. (Balbi, Calif.)

*Trinidad*—VP4RD, 9.625, Port-of-Spain, opens 0515 now. (Stark, Texas)

*Turkey*—Direct from ISW Monitor Tonuk, Ankara, come these *summer* (regular) schedules for *Radio Ankara*—TAV, 17.820, 100 kw., to Far East, 0415-0520, special program for Turkish Forces in Korea; 0520-0615, program in *English*, TAQ, 15.195, 20 kw., 0415-0500 in parallel with TAV; 0500-0600 relay from Home Service (Sat. to 0700); 1000-1030 in Urdu (parallel with TAT); 1030-1045 news in Persian (parallel with TAT), TAT, 9.515, 100 kw., to Middle East, 1000-1030 in Urdu (parallel with TAQ); 1030-1100 in Persian; 1730-1800, to South America, in Spanish, TAP, 9.465, 20 kw., 1100-1115 news in Turkish (from Home Service); 1115-1145 in Arabic; 1145-1200 news in Bul-

# SAVE UP TO 95% SENSATIONAL SURPLUS VALUES!

**BC-620 FM TRANSCIEVER AND PE-120 VIBROPACK**  
20 to 20.9 Megacycles. Xtal Controlled. Part of SCR-509. Includes PE-120 Vibrator Power Supply Battery Case, Shock Mounting. For 6V or 12V operation. Used, but in excellent condition... **\$29.50**

## 274-N & ARC-5 EQUIPMENT RECEIVERS

TESTED BEFORE SHIPPING. Guaranteed working!  
36 MC. Used. Originally \$30, NOW... **\$6.95**  
6-9-1 MC. Used... **\$8.95**

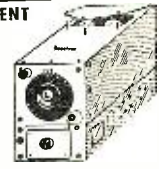

**TRANSMITTERS**  
T-22 ARC-5, 7-9 Megs. Used xint... **\$14.95**  
T-23/ARC-5 100-156 Megs. 4 channel Xtal, used. Complete with tubes. Internally Perfect. **\$39.50**  
Complete with tubes. Internally Perfect. **\$39.50**, with Dynamotor. **\$59.50**  
MDY-ARC5 Modulator Plate and Screen for T23ARCS, with Dynamotor. **\$15.00**  
T-21 ARC-5-3 MC. New. Orig. \$40. Now... **\$8.95**  
4-5-3 MC. Used. Orig. \$30.00. Now... **\$5.95**  
2-13 MC. LN. Orig. \$40. Now... **\$16.95**  
T-19 ARC-5, 3 to 4 Megs. **\$18.95**  
R-23 ARC-5, 190 to 550 KC, Loop or Straight wire antenna input. **\$19.95**  
R28-ARC-5 VHF Revr. Xtal Cond. **\$40.00**

**ATTN: AIRLINE OPERATORS**  
Available for Immediate Delivery from Stock:  
SCR-718C or AM 0-16 or 0-17 ART-13  
AN/APN-9 CU-25/ART-13  
ARC-1 MT-164/ART-13  
T47 or T-47A/ART-13 MT-283 or MT-284/ART-13  
ARC-5 VHF DY17-ART-13  
BC-348QR or L

**WESTERN ELECTRIC SOUND POWER HEAD & CHEST SET**  
Type M, Stock No. D-173013... each **\$9.95**  
or **\$17.50** per

**JACK & HEINTZ AIRCRAFT STARTING MOTOR & GEAR BOX.** Operates on 110V AC, 60 cy. Used... **\$18.95**

**US MARINE CORPS HANDSET. Type MTS-1.** Late model. Original Phone Set curved to fit head contour. Push-to-talk switch in handle. Has 20' 4-conductor heavy duty rubber cord. Equipped with mike and earphone rubber covers for comfort, shock insulation. Used, xint cond... **\$8.95**

**K-7 GUN MOUNT.** Xint rotating device for antennas of all types. Used... **\$4.95**

## PORTABLE F.M. XMITTERS & RCVR'S!

These operate on 6V DC, 34 MC varied either direction depending xtals, xmttr and Rcvr has aluminum case with antenna relay. Xmttr uses 1073.125 KC extra in osc. stage followed by 4 doubles and 1 fin. amp. all using HY 65 tubes. Mike amp. and Fre. Mod. use 1C7G tubes. Xmttr stages have metering jacks. Rcvr is superhet. Xtal cont. local osc at 8060 KC. Power Supply on chassis using Carter 6V gen. output 450 V 250 ma 6V vibrator power supply for receiver. All tubes inst. heating included in control box. French Phone Hand Set, 8" speaker and extra microphone. Used, complete set priced at only... **\$45.00**

**APN-4 ACCESSORIES.** Consists of complete set of cables with plugs, antenna switch, FT446 and FT447, Brand new... **\$16.00**  
**FILTER CONDENSER, AEROVOX Type 15108C.** 5X5 mfd., 40V dc, 3 terminals. Sizes 3/4" X 2" X 3/4". Complete with brackets. Quantities available... **65c ea.**

**PORTABLE LITEWEIGHT HAND MIKE**  
A beauty! Cups easily into the hand. Made by MAGNAVOX. Type RS-38. Single Button Carbon with standard PL-68 plug and cord. Like new... **\$2.95**

**WANTED! YOUR EXCESS RADIO RECEIVER, TRANSMITTER AND TRANSCEIVERS** such as ARC-1, ATC, ART-13, RTA-1B, ARC-3, BC-312, BC-348, BC-611 or parts.

## EXPORT INQUIRIES INVITED!

We carry an unusually large stock of Airline Equipment, Test Equipment, Radar Sets, etc. Write for our low prices and complete information. We furnish immediate answers to all inquiries! Write today.

## Now Available! Fully Equipped CONVERSION & REPAIR SHOP FACILITIES

We are equipped to convert and repair all types of electronics equipment. No job too small or too large. All work unconditionally guaranteed. Xint. references. Prompt replies to all estimate requests.

## IMPORTANT

NO ORDER LESS THAN \$5.00. Send 30% deposit on cost of item or full amount to save C.O.D. charges. Do not send shipping costs. It will be C.O.D. only. Shipments sent via Railway Express unless other instructions given. Merchandise subject to prior sale. Prices subject to change at any time. All Foreign orders add \$1 minimum service charge.

## Just a Few Left! While They Last! GO-9 XMITTERS

Complete With Spare Parts Kit  
Frequency range 3-18MC and 300-600 KC. Band switching 100 W. output. Brand new in original mfg. crates. Comes with tubes and spare parts kit—in three units: high and low frequency xmitter and rectifier. Dimensions: 14" deep X 27" long X 29 1/4" high. Net wt. 137 lbs. Shpg. wt. approx. 250 lbs. Finished in black crackle, shock mounted. Has 7 meters for indicating plate and grid current, also antenna current. Operates 110V, 800 cycles. Single phase and 24V DC. Contains 2-803 tubes, 1-807 1-801 2-837 1-5Z3, 2-1616. Comes with \$72.50 maintenance manual and test data

**EXPORT QUANTITIES AVAILABLE.**  
SURPLUS CONVERSION MANUAL No. 1—SCR-274, TBY, BC-221, BC-342, BC-312, PE-103, etc. **\$2.50**  
SURPLUS CONVERSION MANUAL No. 2—TA-12B, GO-9/TBW, APS-13, BC-357, 10 meter BC-454, etc. **\$2.50**

**BC-611 HANDIE-TALKIE.** Part of SCR-536. Frequency 3.5-6 MC. Attention Construction men, builders, surveyors. Perfect for short distance communication. Weighs only 5 1/2 lbs., hand-held like a hand set. Pre-set to your frequency. Push-button controlled. Transmitter and receiver in same case 15 1/4" x 3 3/4" x 5 3/4" sturdy aluminum case. Comes complete with tubes, crystals, one set batteries. Extra batteries available. Models B, C, D, E, F, available. We supply these sets with newly mfd. batteries, tested in accordance with Tech. Manual, PRICE ON REQUEST.

**VACUUM CONDENSER** 12 mfd. 20 KV... **\$7.50**  
**VARIAC, GR. O-130** Volts, AC 60 cycles, 18 amps. 2 KVA. Used, excellent condition... **\$39.50**  
**ARC-4 VHF TRANSCIEVER.** 140 to 144 Megs. Complete with tubes, dynamotor and crystals... **\$35.00**  
**FILTER CHOKE.** .02 HY, 2 1/2 amps. New... **\$1.95**  
**PLATE TRANSFORMER.** 2400 V CT at 350 MA. 2 1/2 V. 10 amps for 866's. 10 V. 8 amp. filament. Primary 110 V. 60 cycle... **\$11.95**  
**ART-13 AUTOTUNE MOTOR.** Brand new... **\$14.95**  
**FILAMENT TRANSFORMER 6.3 V.** at 5 amps. New... **\$1.95**

**BENDIX TYPE 3611 INTERPHONE AMPLIFIER.** Uses 6SJ7 pre-amplifier, 6V6 Pwr. Amplifier. Has provisions for Carbon or Magnetic Mike. Power supplied by self-contained 24V Dynamotor. **\$14.95 ea.** Brand new. Finished in grey wrinkle.

## NEW STANDARD BRAND CHOKES

HY	BRAND	MILS	OHMS	PRICE	VOLTAGE	CASE	WT.
8-40	Stancor	175	100	2.75	3KV	Closed	3.5
8-30	Stancor	200	80	3.25	3KV	Closed	4
5-25	UTC	200	100	4.95	2KV	Closed	5
5-25	UTC	300	90	5.95	5KV	Closed	18
5-25	Stancor	300	80	5.95	5KV	Open	8 1/2
5-25	Stancor	300	80	4.95	3KV	Open	4
5-25	UTC	500	60	12.95	7KV	Closed	28
8-40	UTC	1 amp	50	39.95	10KV	Closed	58

HY	BRAND	MILS	OHMS	PRICE	VOLTAGE	CASE	WT.
7	GTC	500	600	4.95	2KV	Closed	4
7	Stancor	150	200	1.25	2KV	Open	2
10	UTC	500	60	12.95	7KV	Closed	28
12	Stancor	300	80	5.95	5KV	Closed	9
12	Thordarsen	375	105	3.95	5KV	Closed	9
12	Thordarsen	400	400	6.95	2KV	Closed	15
15	Stancor	200	120	2.95	3KV	Open	4.5 lbs.
20	Stancor	300	80	4.95	3KV	Closed	9 lbs.

## SAVE \$ ON POWER SUPPLIES

HY	BRAND	MILS	OHMS	PRICE	VOLTAGE	CASE	WT.
20 Series	UTC	1A	50	39.50	10K	Closed	80
5 Parallel	UTC	2A	12.5			Closed	
16 Series	UTC	175	96	5.95	2.5K	Closed	15
4 Parallel	UTC	350	24			Closed	
26 Series	UTC	200	112	6.95	3.5K	Closed	15
6.25 Parallel	UTC	400	28			Closed	

**VACUUM CONDENSERS.** 50 MMFD 5 amps, 5 KV... **\$1.25**

## SAVE ON ASB-7 EQUIPMENT!

• ASB-7 RECEIVER. Contains 446 Lighthouse tube amplifier, 955 local oscillator, 955 mixer, 5 stages of I.F. amp, using 5-6AC7 tubes. Uses 2-6AC7 Video Amp, 1-6H6 detector and 1-6J5 tube. Used, good shape. Complete with tubes... **\$17.50**  
• ASB-7 TRANSMITTER. Contains 2-15E Osc. Tubes, 1-15R Rectifier Tube. Also has blower, relay and post-transformer. Complete with coax tuning lines... **\$6.95**  
• ASB-7 POWER SUPPLY. Supplies 1/2 V, 5V, 6.2V, 750V, 2000V, from 800 cycle source. Contains 2x2 rectifier, 574 Rectifier Tube, Filter Condensers and 1-6AC7 Tube. Complete with tubes. Xint shape... **\$6.95**

## V&E RADIO & ELECTRONICS SUPPLY

DEPT. R-23, 2033-37 W. VENICE BLVD. LOS ANGELES 6, CALIFORNIA

**CODE SENDING SPEED**  
**HIGH SPEED WITHOUT NERVOUS TENSION**  
REVEALING BOOK shows how "crack" operators develop high speed and proficiency. Learn code for Amateur or Commercial Radiotelegraph Licenses, or improve your sending and receiving with the Candor System which develops radiotelegraph experts and code champions.  
• Box 928, Dept. 2-H, Denver, Colo. **FREE BOOK!**

#1 **EAGLE TIME RELAY** "Timofex" series, 110V, 60 cys. with SPDT micro sw. Set for 20 min., may be altered for 2-55 min. interval. Bakelite cover 3 1/2 x 4 1/4 x 1 1/2... **\$9.95**  
#2 **POLE DOUBLE THROW RELAY.** Allied control #BN-18D-39. Operation @ 25 1/2 dc. 3000 ohm coil operates on 75V, cts rated 10 amps 5x2 1/4 x 1 1/2... **\$3.95**  
**4V STORAGE BATTERY** miniature, 3 1/2 x 2 1/4 x 1 1/2. Spillproof. Shipped dry... **\$2.95**  
**RADIO DEVELOPMENT & SALES CO.**  
323 Atlantic Ave., Bklyn 2, N. Y.

# At CONCORD You PAY LESS

for...

## FM TUNER SAVE 50%

Enjoy clear, static-free reception of your favorite music and sport events—convert to FM for less than \$10.00 with this exclusive Concord FM tuner. Easily converts any AM receiver, phono amplifier or PA system for FM. Covers the entire 88-108 FM band. Tuning and on-off controls on front panel with terminals for connection of 300 ohm twin lead antenna on back. Extremely easy to install. Uses a 7F8 in a fremodyne circuit, plus a 6H6 rectifier. Size of chassis: 6-3/4 x 4 x 4-1/8". Complete with tubes. For 110-120 volts AC-DC. **9.95** 99-9502R—Shpg. Wt. 2 lbs. . . . Net.

## BARGAIN CONICALS

High quality conical TV antennas designed for superior performance. Full-hard elements and all-aluminum construction provide maximum strength and eliminate excessive weight and rust problems. Broad band reception on all TV channels plus FM are yours with these Concord conicals. High signal-to-noise ratio, excellent front-to-back ratio, matches 72, 150, or 300 ohm input impedance. Ridged U-bolt prevents antenna from slipping or twisting on mast. Fits masts up 1-1/2" O.D. Supplied less mast.

Single Bay. (Not Illustrated).  
28-24265R—Wt. 6 lbs. . . . . **4.45**  
Double Bay. (Illustrated).  
28-24266R—Shpg. Wt. 12 lbs. . . . . 8.95

300 OHM FLAT TWIN LEAD.  
Per 1000 ft. \$25.00 Per 100 ft. \$2.75.  
19-17141R. . . . . Per ft. . . . . **3¢**



## EMERGENCY UNIT

Smooth, quick-action emergency tire pump and fire extinguisher. Compact...easily mounted in limited space. Highly effective against oil, gas or electrically caused combustion. **2.75** 99-6549R. . . . . Net.

## FREE NEW! 1951 SUMMER BUYER'S GUIDE CONCORD RADIO

CONCORD RADIO CORP. Dept. RG-51  
901 West Jackson Blvd., Chicago 7, Illinois

Enclosed \$ . . . . . (Include shipping charge)  
Rush me the following equipment.

99-9502R—FM Tuner  
 28-24265R—Single Bay Conical  
 28-24266R—Double Bay Conical  
 19-17141R—300 Ohm Twin Lead  
 99-6549R—Emergency Unit

Send FREE Summer Buyer's Guide

Name. . . . .  
Address . . . . .  
City. . . . . Zone. . . . . State . . . . .

FILL IN AND MAIL TODAY

garian; 1200-1215 news in Roumanian; 1215-1230 news analysis in Turkish (from Home Service); 1230-1300 in Greek; 1300-1315 news in Serbo-Croat; 1315-1330 news in Polish; 1330-1345 news in Hungarian; 1345-1600 in parallel with TAS. TAS, 7.285, 100 kw., to Western Europe, 1315-1345 in German; 1345-1415 in Italian (parallel with TAP); 1415-1445 in French (parallel with TAP); 1445-1500 news in Turkish (from Home Service); 1500-1545 in English (parallel with TAP); 1545-1600 Home News in Turkish (parallel with TAP).

USI—"Voice of Indonesia," Djakarta, noted in English for Europe 1400-1500 on 11.770, 15.15; news 1400-1415 and headline (home news) again just before closedown. (Pearce, England) YDQ, 9.550, Makassar, noted 0600 to after 0800, fair level in N.C. (Ferguson)

USSR—Soviet outlets of 6.07, 7.40, 5.265, announced Khabarovsk, noted 0530-0615 with all-Chinese programs. (Balbi, Calif.) Radio Moscow noted in news 1718 on 11.63. (Bellington, N.Y.) Sverdlovsk, 9.500, heard 1740-1800 with QRM from Brazilian on 9.505. (GDJ-aren, Sweden)

Radio Moscow lists summer schedule for North America in English as 0800-0830, 17.83, 15.44, 15.20, 15.12, 11.96, 11.91, 11.63, 9.83; 1820-1930, 15.23, 15.18, 15.11, 11.91, 11.82, 11.81, 9.83, 9.67, 9.55; 1930-2030, 15.23, 15.18, 15.11, 11.82, 9.67; 2030-2300 same as at 1820-1930; 2300-0100 (especially for West Coast), 17.81, 15.23, 15.18, 15.11, 11.82. (Guentzler, Ohio) Has "Mail Bag" program Sat., Sun. at 2100. (Harris, Mass.) At least some days reads POW (Korean War) messages around 2230. (Balbi, Calif.) The North American transmissions are relayed irregularly, but widely, by such satellite outlets as Warsaw, Prague, Budapest.

Vatican—HVJ noted on 11.74 recently 1300 with QRM from Warsaw. (Maurice, N.Y.)

Venezuela—YVKD, Caracas, Radio Cultural, noted moved to approximately 5.082; heard 1930. (Stark, Texas) YVMM, Radio Coro, 4.910, now sends QSL card with "correct" call letters (previously YV1RY). (Pearce, England)

\* \* \*

### Last Minute Tips

Cushen, N.Z., flashes that Radio Peking now has English 1700-1730, 0430-0500, 0830-0900 on 655 kc., 700 kc., 725 kc., and short-wave channels of 6.100, 10.260, 11.690 (actually 11.685), 15.060V; the 1700-1730 period is new. A check here revealed Peking opening 1700 in English (by woman) on 15.060V (not found on 11.685 or 10.260), weak level, with QRM from a powerful carrier on high side (just below BBC's 15.070 channel); into Chinese around 1733 and still going after 1800; only partially readable but should improve.

Rome announces summer channels to North America evenings (EST) as 17-800, 15.430, 15.120, 11.900, 11.810. (Ferguson, N.C.) Should have news at least 1900, 2145.

Radio Tamoio, ZYC8, 9.61, and ZYC9,

# PHOTOCON SALES

1060-2 N. Allen Ave. 5Ycamore 4-7156  
Pasadena 7, Calif. RYan 1-8271

## WRITE FOR OUR LATEST SURPLUS SALES CATALOGUE

WE WILL BUY YOUR NEW OR CLEAN USED ELECTRONIC SURPLUS: ARC-1, ARC-3, BC-224, BC-348, BC-812, BC-842, ATC-1, ART-13, APS-13, BC-221, LM's, TS-12, TS-23, TS-34, TS-35, IE-19A, I-222, SCR-522, TS-100, or any BC, I, IE, TS, APR.

APR4, APR5A, APR7, TS-34, APN9, 804CS2, APA-38, BC-348, ART-13, TS12.  
WRITE FOR PRICES

- APN-1 Altimeter Indicator 0-1MA. 5MA. shunt, 250° dial. . . . .NEW \$ 2.95  
Sound Powered Head and Chest Sets—  
U.S. Instrument Co.  
GOOD—Each \$4.95 Pair 8.50  
PAIR—Each \$2.95 Pair 5.00  
BC-464 Target Receiver—5 channel control, sensitive relays, battery case, antenna 68-73MC. . . . .NEW 14.95  
LM Frequency Meter with cal. book crystal, and tubes. . . . .EXCELLENT 99.50  
Variac-General Radio Type 50A 0-135V. @ 50 amps. . . . .EXCELLENT 95.00  
9 CW3 Receivers in 113A Bay. EXCELLENT 600.00  
DuMont 274 5" Oscillograph. . . . .NEW 135.00  
Hallcrafters S-36, 27.8-143MC. A.M.&P.M. . . . .EXCELLENT 200.00  
RUI9 Receiver complete. . . . .NEW 29.50  
SCR-578 Gibson Girl. Complete. . . . .NEW 12.50  
SCR-625 Mine Detector. USED \$39.50—NEW 69.50  
AN/APN4B Complete. . . . .EXCELLENT 150.00  
AN/APN4A Complete. . . . .EXCELLENT 125.00  
2" Aircraft Meter 1-0-1 milliammeter scale calibrated 0-0-50. . . . .NEW 1.95  
PE-218 Inverter 400 cycle. . . . .NEW 29.50  
PE-206 Inverter 800 cycle. . . . .NEW 14.50  
PUT Inverter 400 cycle. . . . .GOOD 19.95  
Weston Model 545 Tach. Meter, 0-2000 R.P.M. . . . .NEW 17.50  
One of the largest and most complete electronic surplus stocks in the country. We have thousands of tubes, capacitors, plugs, accessories, transmitters-receivers, test equipment, etc. Send us your requirements.  
TERMS: Prices f.o.b. Pasadena, California. 25% on all C.O.D. orders. Californians add 3% Sales Tax. Prices subject to change without notice.

# BUILD THIS RCP KIT!

IT'S EASY! IT'S FUN!  
IT SAVES YOU MONEY!



MODEL 345K  
SUPER VACUUM  
TUBE VOLTMETER

Complete Kit Only... **\$26.95**

Nothing Else to Buy!

MORE THAN 150,000 RCP INSTRUMENTS IN USE TODAY... PROVE THEIR SUPERIORITY

Now you can get in KIT form the best professional test equipment made by Radio City Products Co. You get kits that are complete with all necessary parts and easy-to-follow assembly instructions. There is nothing else to buy! Yes, an RCP kit provides an enjoyable few hours in construction and instruction plus a finished test instrument at a tremendous saving!

Features long scale 4 1/2" meter in burn out proof meter circuit—electronic balanced bridge type push pull circuit—negligible current drawn due to high input impedance of 25 megohms—Isolation Probe—center of ohm scale 10 ohms—5 ohmmeter ranges reading from 2 ohms to 1 billion ohms (1000 megohms). 20 voltage ranges 0-1000 volts including AC and DC—Complete D.B. meter. Discriminator alignment scale with zero center permitting operation in both directions. Operates on 105-130 volts, 50-60 cycles—Extra heavy panel, case and chassis. Size 10" x 6" x 5". Weight 8 1/2 lbs. Shipping weight 11 lbs.

BUY FROM YOUR JOBBER • INSIST ON RCP INSTRUMENTS • WRITE FOR CATALOG RN-7

RADIO CITY PRODUCTS CO., INC.

152 West 25th Street, R.P.C. New York 1, N. Y.

RADIO & TELEVISION NEWS

15.37, *Radio Tupi*, Brazil, do not QSL although *Radio Tamoio* does have some printed QSL's; an effort is being made to get the station to start sending QSL's out; also to get the International Program of ZYN7, *Ceara Radio Clube*, back on the air, flashes Serrano, ISW Monitor in Rio de Janeiro.

USSR noted with news 1130 on 15-360. (Hanniford, Sou. Afr.) Heard signing on with *English* 0130 on 15.34 or 15.36 parallel 15.10. (Bellington, N.Y.)

When this was written, *Radio Ankara*, Turkey, was conducting these experimental broadcasts—0630-0715, TAV, 17.820, to Australia, New Zealand; 1730-1800, TAT, 9.515, to Latin America; and 1815-1900, TAT, 9.515, to North America; widely reported for last two. Wants reports.

Paris noted on (measured) 15.400 recently to 1030 sign-off; good signal in N.C. (Ferguson)

Station noted recently on 9.770 at 0730 with (*English*) request program is believed to be Lourenco Marques, Mozambique. (Stark, Texas)

Pearce, England, flashes that he has recently noted Damascus, Syria, on approximately 11.922 around 1430 in Arabic; announces "Syrian Broadcasting Station, Damascus," at 1530, followed by news; announces as on 25.41-m. (which would be roughly 11.805—KRB) and 50-m. (6.000); may be test; recent regularly-scheduled channels have been 6.000, 12.000.

Barbados Radiodiffusion Service, Ltd., Trafalgar St., Bridgetown, M.5, Barbados, recently sent letter-verification for reception of ZNX32, 7.547, operated by *Cable & Wireless, Ltd.*; power 5 kw.; broadcasts only international cricket, tennis, and turf club race meetings; race meetings are approximately 1130-1630 on a Saturday and a Thursday at beginning of March and August, and in mid-November each year, the verie stated. (Pearce, England) *Watch for this one early in August—on a Saturday and/or Thursday.*

GDX-aren, Sweden, reports CSB51, 12.865, Parede, *Radio Clube Portugues*, is still on the air, noted around 0810 with "non-stop" musical program; QSB.

A Spanish-speaking station noted recently testing on 11.78 around 0055-0200 and announcing as "La Voz de America Central," Managua, Nicaragua; may be YNOW? (Bellington, N.Y.)

ISWC, London reports "Radio Grece Libre, La Voix du Peuple Greque," a Communist-partisan transmitter, on approximately 9.455, heard with news in French 1300.

Madrid has four 100 kw. transmitters almost completed; should test mid-summer. (OTC2 DX session, via Stark, Texas)

N.Z. DX Times says the projected 100 kw. transmitter now under construction at the Vatican has been assigned calls and frequencies of HVJ2, 15.120; HVJ3, 11.740; HVJ4, 9.660, 9.645; HVJ5, 5.970.

AIR schedules just in airmail from

# HARVEY

## has a message for the Civilian Defense Purchaser!



It has been proven that the Two-Meter (144 to 150MC) Communications Equipment is the most dependable and reliable equipment for Civilian Defense use. Through simulated bomb attacks, floods, fires and other disasters which disrupt normal communications, it has been found that emergency communications go forward with remarkable ease in your town or city, and from town-to-town and city-to-city, through the use of this equipment.

We, here at HARVEY, have all the equipment and parts that you may need, whether for installation or construction, of an emergency communications station for operation on any of the designated bands... fixed station, mobile or portable. We also have complete packaged units for installation in autos, homes, public buildings, bomb shelters, etc. We can custom build equipment to fit your individual requirements.

We carry stocks of the nation's foremost brands... transmitters, tubes, receivers, speakers, transformers, AC power supplies for fixed stations, mobile power supplies for 6v or 12v operations, gas engine operated generators for 6v DC or 110v AC, antennas, meters, noise-cancellation and standard microphones (carbon, dynamic and crystal), etc.



### Crystal Controlled Transmitter

Designed for stable, trouble-free operation in the 144-150 mc bands. Couples to any co-ax fed 2 Meter antenna. Uses any power supply providing 300v. at 200 ma. Screw-driver adjusted tuning controls. 7 tubes. Components and tubes are standard for replacement ease. Co-ax connectors. 5 1/2 x 9 1/2 x 5 1/2 in., with universal mounting flanges. Prices are less power supply.

Transmitter.....\$74.95  
Wired and tested  
Transmitter.....\$49.95  
In kit form

Also Ideal For CAP

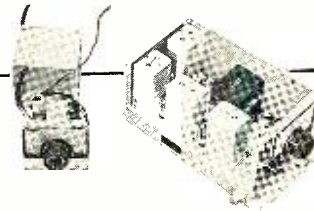

### Superhet Receiver

An excellent 10 tube receiver, sensitive, stable, selective. Highly efficient with precision vernier tuning over 144-150 mc. Exceptional signal-to-noise ratio. Minimized power requirements with total battery drain only 22 watts. Matching cabinet, same size as xmitter, with universal mounting flanges. Jones plug and co-ax connectors. Prices are less power supply and speaker.

Receiver.....\$94.95  
Wired and tested  
Receiver.....\$59.95  
In kit form, uses Oscillator of Receiver  
For external local oscillator, Mounting kit less oscillator, add to above \$5.00

**Gonset Converters**  
3-30 Gonset Converter, 10-11 Gonset Converter; 20 Meter Gonset Converter; 75 Meter Gonset Converter. Shipping weight each, 4 1/2 lbs.....\$44.75  
Gonset Tri-Band Converter.....\$47.60  
Model B Noise Clipper.....\$9.25  
Universal Steering Post for use with all Gonset Converters.....\$3.90

**NEW GONSET TWO - METER CONVERTER**; superheterodyne... same size and appearance as Tri-Band Converter and FM Tuner. ....\$44.50

HARVEY is headquarters for these famous Emergency Receivers. High quality emergency band FM receivers for application, ANYWHERE you are you can HEAR police calls, fire alarms, bus dispatchers, railroad communication, ships at sea, etc.

**POLICE ALARM**  
Mobile FM Receiver 152  
Model M-101 covers 152 mc to 162 mc Band.....\$72.50  
Model M-51 covers 30 to 50 mc's.

**UNIVERSAL ADI**  
For Home or Fixed Location  
Model PR-31 for 30 to 50 mc band...\$44.95 complete.  
Model PR-8 for 152 to 162 mc band...\$44.95, complete with 14" whip indoor antenna.

MUNICIPALITIES AND EMERGENCY SERVICES are invited to consult us on any of their emergency radio communications equipment problems. Six members of our staff are fully qualified and licensed operators. Their services are available to you. No obligation, of course.

Telephone: LUxemburg 2-1500  
**HARVEY RADIO COMPANY INC.**  
103 West 43rd St., New York 18, N. Y.

VISIT HARVEY'S AUDITORIUM—Come in and visit our new Sound Department...  
NOTE: In view of the rapidly changing price situation in both complete units and components we wish to emphasize that all prices are subject to change without notice, and are Net, F.O.B., N. Y. C.

Advance with **ELECTRONICS CITY**  
You need firm grasp of fundamentals to keep pace with these complex, fast-growing fields. In thorough 2-year course learn electricity, electronics, physics, mathematics, drafting, etc. Employers want Franklin graduates. Coed. G.I. approved. Day, evening. 43rd year. Write for Catalog.  
**FRANKLIN TECHNICAL INSTITUTE**  
46 Berkeley Street Boston 16, Mass.

**WANTED**  
• PE-237 POWER SUPPLY  
• GN-58 GENERATOR  
• 1306 TRANSMITTER RECEIVER  
BEST PRICES—NO QUANTITY TOO BIG, NONE TOO SMALL.  
WRITE TODAY GIVING DETAILS TO — **Box 515**  
c/o RADIO & TELEVISION NEWS  
366 Madison Ave. New York 17, N. Y.

LET US PUT THIS **19 1/2 INCH** MAMMOTH NEW 1951 19 1/2 Picture  
**MIDWEST TELEVISION**  
In Your Home on **30 DAYS TRIAL**  
Don't buy any radio or television receiver until you've seen the new 1951 Midwest Line — it's the finest in 31 years.  
**FACTORY-TO-YOU** **EASY TERMS**  
SEND THIS COUPON ON 1c POST CARD FOR NEW 1951 FREE 4 COLOR MIDWEST CATALOG  
**MIDWEST RADIO & TELEVISION CORP.**  
Dept. 37-P, 909 Broadway, Cincinnati 2, Ohio  
NAME \_\_\_\_\_  
ADDRESS \_\_\_\_\_  
CITY \_\_\_\_\_ ZONE \_\_\_\_\_ STATE \_\_\_\_\_

## PORTABLE POWER

### Look at These Combination Kits!

1. 2 volt, 30 amp. hour wet cell BB-54. Light-weight transparent plastic. Non-spill. Portable separators. 3-ball hydrometer. 4" x 3" x 5 1/2" high overall. Shipped dry, with filling and charging instructions.
  2. 2 volt synchronous vibrator. No tube needed.
  3. 2 volt charger, 115 v, 50/60 cy in. High quality unit uses step-down transformer and dry-cell rectifier, with pilot lamp in output to indicate and regulate charging rate. With instructions.
  4. Ecydrometer-type battery filler.
- ALL 4 ITEMS, ALL BRAND NEW, ONLY \$3.95**
- 6 v. VIBRATOR, alatory 650, 4-prong, non-syn. 1 1/2" dia., 3 3/16" over can, 115 cycle, 6 amp. \$1.59

### FOR MARINE RADIOMEN G.L. "MARINER" TRANSMITTER

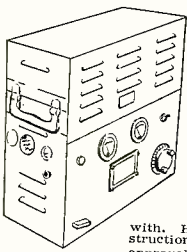

180 w input, 120 w to antenna, 90% modulated, 4 channel xtal cont. 12 or 24 v input with dynamotor, condenser, coils, xials, tubes, mike, all aligned and ready to operate. (Specify volt. and freq. when ordering.) Contains break-in relay for recvr. in addition to ant. switching relay. Dimensions: 8 1/4" deep, 17 1/4" wide, 19 1/2" high. Tubes included: 10Y speech amp., two 211 mod., 2 250 081, 1625 12A, two 814 parallel PA. We offer \$150 worth of skilled engineering and parts to equipment which cost U.S. over \$1200 to start with. Has 8000 parts list with instructions. FCC license approval guaranteed. . . . \$275.00 (Includes external harmonic filter)

**G.L. "MARINER" 200 WATT TRANSMITTER**  
Same dimensions as above. Uses parallel 813's of output. 5 CHANNEL PUSH-BUTTON. Add \$25.00 each for additional pushbutton channels up to 10. Complete with dynamotors (12 to 14 or 24 to 28 v. Specify which!), connecting cords, microphone, crystals (specify frequencies!) and harmonic suppressor described below . . . . . \$450.00

### G.L. "MARINER" RECEIVER

Long wave, broadcast, marine and short wave reception. A beautiful conversion of finest Navy surplus! All controls, vernier tuning, BFO ON-OFF and AVC. MVC on entire new front panel. Coaxial type antenna fittings furnished. Tagged wires out of rear to battery to power a DU-1 loop, and to kill B+ with xtal break-in relay. 12 or 24 v DC. Only 15 1/2" long, 8" wide, 6 3/4" high, and self-contained, no plug needed. With 6 tubes, 2 neon voltage limiters, and dynamotor. Requires an external speaker. Alignment instructions and schematics furnished. . . . . \$69.50  
Specify voltage . . . . . \$5.95

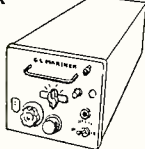

**SPEAKER** in neat bulkhead mounting baffle, wired with transformer and cord and plug to match 4000 output of G.L. Mariner receiver. . . . . \$5.95

**3-SECOND MANUAL DIRECTION FINDER**  
DU-1, 12 or 24 v. Goes ahead of the G.L. "Mariner," ARA, or any other receiver. We convert it to the Marine band. Still retains half of broadcast band, and all the lighthouse and beacon band. 2-tube phasing circuit, no 180° ambiguity. Gives true bearing in 3 seconds! Schematic diagram included. . . . . \$32.50

Now FCC rules require harmonic suppressor for Marine transmitters. Don't get pink tickets. Suppressor Filter, complete with 4 amp. Ant. Current meter . . . . . \$24.95

### G.L. "MARINER" A.D.F.

Here is the ideal combination of receiver and AUTO-MATIC direction finder! Tune to any station from 300 KC-1750 KC, 2500-2800 KC, and the needle swings tomers; they'll be crazy about it. You get specially engineered dual-channel 6-tube converter, dynamotor box, inverter, starting relay, plug-in indicator, control thing you need! Includes complete set-up instructions, 24 to 28 v input. You save \$450 but don't sell it for less than \$595. Add \$100 for 12 v. No sense required for installation. It comes all checked out ready to bolt down to your ship. If you want us to make wiring harnesses, read up on plug-in components together, send \$50 with sketch and dimensions of layout.

**BC-223 TRANSMITTER.** 15 to 25 w output, 4 chan xtal control. To modify for FCC approval, just remove a few knobs and put one metal screw into panel to keep channel selector switch from being turned to MO position. WE CHECK THEM OUT! With marine freq. xials, mike, and schematic. . . . . \$99.50  
Don't forget to specify xtal freq. . . . . \$9.95  
(Add \$24.95 for Harmonic Suppressor.)

### COMMAND EQUIPMENT

With free dope sheets and schematics.

**RECEIVERS**  
ARC-5 or ARA, 3-6 mc. Good used. . . . . \$5.95  
BC-455, 6-9 mc. NEW \$12.95. GOOD USED. . . . . 7.95

**COMMAND TRANSMITTERS**  
BC-457, 4-8.3 mc. excellent used. . . . . \$ 4.95  
BC-458, 5.3-7 mc. excellent used. . . . . 34.50  
T-23 ARC-5, 100-156 mc. New, with tubes. . . . . 24.95  
Excellent used. . . . . 24.95  
MD-7 ARC-5, Push-pull mod., excellent. . . . . 9.95  
MOD BC-455, Brand New \$5.95. Excellent used 2.49

**274N PLUG.** 7 prong male plug to fit back of command recvr. and xmtr. This is the same plug as used in the racks. NEW, each, 21c; five for. . . . . \$1.00

Local Control Adaptor parts for 274N or ARC-5 recvr. Exact pot, switch, knobs, etched plate, and instruction data. Ready to mount. . . . . \$1.29  
Spline tuning knob. . . . . .79c

### 10 METER DEFENSE NET

BC-659 Mobile xmtr recvr 27 to 38.9 mc. FM, 10 meter and new defense net. 2 chan xtal control with PE-117 or PE-97 6 tube. . . . . \$39.50  
Good used . . . . . \$28.50

### 4 USES—4 DOLLARS

The most versatile dynamotor in surplus! The best dynamotor for conversion to 6v. Multiple windings! After conversion you get choice of 190 or 350 v at 50 MA or 250 v at 100 MA. No brushes to sift ground, no mechanical work. Or use it as a 2:1 or 1:2 step-up or step-down transformer for DC voltage! Changes 6 to 12, or 12 to 24 or vice versa. up to 2 A. Or use it as a GENERATOR. Turn with motor, get 12 v DC at 12.6 A or 24 v DC at 6.3 A, plus high voltage. Includes easily removable self-contained 300:1 sealed-in-oil gear reduction unit. Complete dope sheet furnished. BRAND NEW. . . . . \$4.00

**WANTED!**  
Your Spare Surplus Equipment and Tubes, Dynamotors, Recvrs., Xmtrs., Test Equipment. Sort List, stating condition and rack bottom price.

### G.L. ELECTRONICS

905 S. Vermont Ave., Los Angeles 6, Calif.  
All Prices F.O.B. Los Angeles.  
Calif. Buyers Add Sales Tax.

New Delhi list *English* news for 1400-1410, 9.720, 7.155; 1930-1945, 15.290, 11.850; 2315-2330, 17.740, 15.160; 0300-0310, 17.740, 15.190; 0830-0840, 17.840, 15.190; 1045-1100, 15.290, 11.830.

Latest CBC International Service schedules are—*European Service*—0850-1130, CKNC, CKCX; 1130-1440, CKNC, CKCS; 1440-1500, CKCS; 1500-1545, CKCS, CHOL; 1545-1600, CHOL; 1600-1830, CHOL, CKLO. *Australasian Service*—2300-2335 (except Sat., Sun.), commentaries from the *United Nations*, CHOL, CKLO; 0340-0450 (Sun. and Wed. only), CHOL, CKLO. *Caribbean and Latin American Service*—1850-2130 (*English* 2100-2130), CKCX, CKRA; 2130-2235, CKCS, CKRA. Channels are CKNC, 17.82; CKCS, 15.32; CKCX, 15.19; CKRA, 11.76; CHOL, 11.72; CKLO, 9.63.

According to a leading American scientist, writing recently in the *New York Times*, the next low point of sun-

spot activity is expected to occur at approximately the end of 1954. (Ferguson, N.C.)

### Press Time Flashes

Athens noted on 11.718 starting *English* to North America 2040. Warsaw usually uses 11.815 now for *English* broadcasts to North America evenings (EST), but at press time the 2300 period was noted on 9.57. *Radio Sweden* reports Damascus, Syria, testing on 6.165, 9.555, 11.915, 2330-0200, 0630-0830, 1100-?, and 2130-2230. (Bellington, N. Y.)

Only MELF transmission at present is from the Mackinnon Road, East Africa (Kenya), outlet—scheduled on 6.115 Sundays 0000-0600, 0800-1400; Saturdays 2200-2400, 0430-0630, 0900-1500; other days 2200-2400, 0430-0630, 0900-1400. (Oskey, N. J.)

Copenhagen's DX session on *Tuesdays* now should be 1700 on 15.320;

## CORRECTIONS ON "RADAR" ARTICLE, APRIL ISSUE

WE have received a letter from Lt. Commander Jack Halpern, officer-in-charge of the Radar and Loran School at the U.S. Maritime Service Training Station in Alameda, California, in which he has pointed out several errors that appeared in the article "Radio-Radar-Sonar in Naval Applications" by Samuel Freedman (April 1951).

In the description of loran, second paragraph on page 33, the statement was made that "the master station (the one which initiates the pulsing event) actuates and is followed by a pulse transmission (40 microseconds later) by another station (called the slave station) which may be as much as 300 miles distant. There can only be one place within the radio receiving range of about 600 miles ground wave or 1400 miles skywave where a predetermined time difference in reception of these two pulses will exist".

As Commander Halpern points out, the master pulse is followed by a slave pulse after a delay of a period of time which is in excess of 15,000 microseconds (for "H" stations\*) and in excess of 20,000 microseconds (for "L" stations\*). The transmission is composed of three separate time delays, i.e., one-half the recurrence interval, plus the baseline transit time, plus the coding delay.

In addition, slave stations may be more than 300 miles from the master station. Normally, distances between 200 and 400 nautical miles are employed. When the signal path between the master and the slave stations is completely over water, the distance may be increased to 600 nautical miles.

The lower power (200 kw. peak) loran transmitters have ground wave ranges in excess of the 600 miles mentioned in the article, and 750 nautical miles would more nearly represent the correct figure. High power stations (1000 kw. peak) have ground wave ranges of approximately 900 nautical miles over salt water.

\* \* \*

FROM Elton Dunbar of Washington, D.C. have come further corrections on this same article. In addition to pointing out the errors mentioned by Commander Halpern, Mr. Dunbar takes exception to the statement that "There

can be only one place within the radio receiving range . . . where a predetermined time difference in reception of those two pulses will exist". There are theoretically an infinite number of points at which a given time difference may be observed in the service area of a loran system. Collectively, they define the loran line of position shown in Fig. 6, which is a line of constant time difference.

The accuracy with which a ship's position may be determined is not a constant (one-quarter of a mile), but varies with the ship's position in the service area of the system and is a function of several other factors.

The article gives the impression that a "fix" may be determined from one loran observation and that two or three observations serve merely to substantiate it. Mr. Dunbar points out that one observation tells the navigator that he is located "somewhere" on a particular loran line of position. Charts are available which have these lines, spaced at suitable intervals, drawn directly on them. Tables are also available which permit the navigator to draw a small segment of the given line on standard navigation charts. The intersection of two or more lines then determines a "fix".

The reference to the use of "low frequencies" when talking about standard loran operating near 2 megacycles is misleading because there is a low frequency loran system now being developed that will employ carrier frequencies in the 100 to 300 kilocycle band.

In addition, not all loran receiver-indicators employ veeer counters. There are still many in use which employ marker pulses and visual counting techniques.

Finally, Mr. Dunbar points out that in addition to the Coast Guard loran stations are operated by the U.S. Air Force, and by the governments of Canada, Great Britain, Denmark, and Iceland.

To both of these gentlemen, our thanks for correcting these errors.

\* The difference between an "H" station and an "L" station is in the pulse frequency. The "L" station has a pulse rate near 25 while the "H" station has a pulse rate near 33.



2100 and 2215 on 9.520. (Bellington, N. Y.)

*Short Wave News*, London, reports Bangkok, 6.240, signing on 1857 in native. Says DYH4 is a Christian Missionary Station at Dumaguete, Negros Island, Philippines, operating on 6.055, 0500-0800.

*Radio Belize*, 4.959A, British Honduras, is heard in England at 1800, announcing as "Radio Belize operating on 4.9 megacycle band;" news 1825; bad CWQRM. (Pearce, others)

Seldom reported here, Vienna is logged in Britain on 7.245 at 0600; on 9.665, used in parallel, around 1100. FG8AA, 7.447, Guadeloupe, radiates in French 1100-1230, 1745-2000. Ulan-Bator-Choto, Outer Mongolia, has moved from 8.400 to 8.000; best 0930-1000 closedown. (*Short Wave News*, London)

At press time, Chatfield, N. Y., reported tests to 1830 closedown from *Radio International Red Cross*, Geneva, Switzerland, 7.210; asked for reports.

On occasion, Accra has used 5.979 for special programs. Jordan Broadcasting Station, Jerusalem, Trans-Jordan, has been heard with news 1212-1240 on 7.075. (*Nattugglan*, Sweden)

*Radio Tananarive*, 9.515, Madagascar, more recently has been signing on 2305 rather than 2230, as formerly. (Machwart, Mich., others)

"Short" QRA for *Radio Corporation* is Casilla de Correo 244-V, Santiago, Chile; s.w. channels are 15.150, 6.190; full schedule is 0630-2305; all-Spanish. (Serrano, Brazil)

Kuala Lumpur, 6.024, Malaya, noted with news 0900; Shanghai, 5.989, China, heard in Chinese 0900; Taipei, 6.997, Taiwan, heard 0830 with commentary in Chinese. (Russell, Calif.)

*Radio Jamaica*, 4.950, noted in Cuba 1300-1345 in *English*. (Poza G.)

Rome noted on 11.905 with news 2150. (Hoffman, N. Y.)

CR6RD, 9.705, Nova Lisboa, Angola, noted to 1532 closedown; CR7BE, 9.8575, Mozambique, heard around 1300 with all-Portuguese program; Warsaw, 11.74, noted 1300 with *English*; OXI, 5.9425, Godthaab, Greenland, heard closing 1750, and re-opening at 1753 on 6.678. (Catch, England)

By this time, BFEBBS, Singapore, will have its 100 kw. transmitters in use on this schedule—0415-0630 to North, South and East China, Japan, and Indo-China, and 0800-1130 to India, Pakistan, Ceylon on 21.720; 0415-0915, 0930-1030 to North, South, and East China, Japan, and Indo-China, and 1045-1130 to India, Pakistan, Ceylon on 17.755; 0645-0745 to North, South, and East China, Japan, and Indo-China, and 0800-1130 to Burma and Thailand on 15.300; 0630-0745 to North, South, and East China, Japan, and Indo-China on 11.880; 0415-0615 to Malaya, Indonesia on 9.690; 0630-0700 and 0730-0745 to North, South, and East China and Indo-China, and 0700-0730 and 0800-1130 to Malaya, Indonesia on 7.200; and 0415-0615 to Malaya, Indonesia on 6.175. (Radio Australia)

SEE LEO FIRST FOR . . .

# hallicrafters!



I can SAVE you money . . . Liberal Trade-ins

## A TAILOR-MADE SET FOR THE BEGINNING AMATEUR OR NOVICE...



\$8995

### New SR-75 TRANSCEIVER

Receives on 540 Kc through 32 Mc — Transmits on 10, 11, 20, 40, or 80 meter bands. 5 tubes plus regulator. Housed in grey steel cabinet. Shipped with coils, less crystals. Low down payment.



\$169 50

### New S-76 RECEIVER

Extra selectivity with double superheterodyne circuit. One RF, two conversion and 3 IF stages. Range 550-1550 Kc, 1.7-34 Mc in four bands. 8 tubes plus voltage regulator and rectifier. Complete with tubes, less speaker.

R-46 Speaker \$19.95

## HALLICRAFTERS RECEIVERS AVAILABLE FOR IMMEDIATE SHIPMENT

S-38B	.....	\$49.50	S-72 Portable	.....	\$109.95
S-40B	.....	\$99.95	SX-62	.....	\$289.50
			SX-71	.....	\$199.50

### WRITE FOR DETAILED SPECIFICATION EQUIPMENT SHEETS



**RADIO REFERENCE MAP**  
CU ON 10-20 & 75 METERS  
Just right for your control room walls. Approximately 28" x 36". Contains time zones, amateur zones, monitoring stations. Mail coupon today and... **25c**

**FREE**

Send for the 1951 complete WRL Catalog containing everything new in radio and television. Deal with the "World's Most Personalized Radio Supply House."



Trade for a new Hallicrafter Receiver. I'll allow you more for your present equipment. WRL buys more equipment . . . WRL sells more equipment. Our large volume of sales means faster turnover, greater savings for you! We finance our own paper—no red tape! **LOW DOWN PAYMENTS NAME YOUR TERMS PERSONALIZED SERVICE**

PHONE 7795

WRITE—WIRE



## WANTED "S O" TYPE RADAR PARTS

Write or Phone  
World Wide Packing & Shipping Co.  
350 Pearl St., Brooklyn, N. Y. MA. 4-8371

## CONVERSION DATA!

See Ad—  
Page 88

For RCA Victor 730TV1  
see PF INDEX No. 26  
**FREE—GET IT NOW!**



## RADIO ENGINEERING TELEVISION ELECTRONICS

Thorough training in all phases of radio and electronics, open to high school and junior college graduates. Old established school specializing in Radio training exclusively. Modern laboratories and training courses. Enrollments limited. Approved veteran training.  
**VALPARAISO TECHNICAL INSTITUTE**  
Dept. RD Valparaiso, Ind.

# EDLIE'S LAST MINUTE SPECIALS GENERAL RADIO VARIACS

Type 200 CU

Input 115 Volts, 50/60 cycles, 5 amperes Output—fully adjustable from 0-135 volts. Price..... \$17.75

## BRAND NEW PRECISION RESISTORS

These are standard I.R.C., SHALLCROSS & MEPCO BRANDS priced ridiculously low. All are brand new, non-inductive, non-aging **wire-wound** types, insensitive to wide temperature variations. Sizes not listed below can readily be made up by series, and/or parallel arrangements at a fraction of the cost of precision resistors available elsewhere.

Following sizes are \$.25 each; \$19.50/100

220,000 2% WW5	10,000 1% WW3
95,000 1% WW1	7,500 1% WW3
92,000 1% WW3	5,000 1% WW3
84,000 2% WW4	4,300 2% WW3
80,000 1% WW4	4,000 1% WW3
74,975 1% WW3	2,200 1% WW3
50,000 1% WW4	1,500 1% WW5
46,000 1% WW3	1,000 1% WW3
33,000 2% WW3	
30,000 1% WW3	750 1% WW3
25,000 1% WW4	500 1% WW3
20,000 1% WW3	165 1% WW3
17,000 1% WW3	180 1% WW3
15,000 1% WW3	30 1% WW3
14,975 1% WW3	22 1/10% WW4
12,000 2% WW3	14 1% WW4
11,000 1% WW4	12 1/10% WW4

Following sizes are \$.35 each; \$27.00/100

800,000 1% WW5	600,000 1% WW4
700,000 1% WW5	125,000 1% WW5
	120,000 1% WW3

Following sizes are \$.15 each; \$12.50/100

54,500 1% WW3	212 1% WW3
26,500 1% WW3	235 2% WW3
22,000 5% WW3	110 5% WW3
17,300 1/10% WW5	70 5% WW3
14,460 1/4% WW3	50 5% WW3
2,500 5% WW3	40 5% WW3
2,230 1% WW3	35 5% WW4
475 1% WW3	30 5% WW3
280 1/10% WW3	6.0 3% WW4
500,000 1% WW4	40 5% WW3
100,000 1% WW4	
	\$0.55
	.55

Following sizes are \$.10 each; \$8.50/100

53.96 1/2% WW4	4.35 1% WW3
23.29 1% WW4	4.3 1% WW4
13.52 1/4% WW3	3.94 3% WW4
13.333 1% WW4	3.5 5% WW4
10.2 2% WW4	2.56 1/2% WW4
10 5% WW3	
5.1 1% WW4	.29 3% WW4
4.4 1% WW3	.25 5% WW4

## TYPE 433-AC PRECISION RHEOSTAT-POTENTIOMETER

For use in Wheatstone Bridge or other precision equipment. Total Resistance 20,000 ohms, maximum dissipation 25 watts. Wound with low coefficient wire.

Has a built-in Justifying Mechanism which permits accurate adjustment of resistance to produce a linear resistance variation over the 322 degrees rotation. Maximum current—35 milliamperes. Manufactured by Muter Co. less knob. Price only \$1.75

## SENSITIVE SUBMINIATURE RELAY

SPDT—measures 7/8"x1"x1 1/8". Coil resistance 110 ohms. Operates with less than 1 1/2 volts, 15 milliamperes. Price \$3.35

SPECIAL—1% Precision Resistors—Mepco—removed from equipment (clipped leads)—GUARANTEED—only 10¢!

1,000;	5,000;	10,000;	20,000;
25,000;	40,000;	50,000;	100,000;

ALSO—500,000 ohms—only 15¢!

WRITE FOR COMPLETE CATALOG N-7

# EDLIE ELECTRONICS INC.

154 Greenwich St. New York 6, New York

*Radio Tahiti*, 6.1338 (measured), Papeete, usually signs 0045 but has been noted at times as late as 0150. (Slattery, Ore.) Swedish sources report *Radio Tahiti* on a new channel on 9.053 ending an *English* program 0030; not confirmed at press time.

Commercial Service, *Radio Ceylon*, noted on 9.52, excellent, 1945-2025. CR5SB, 17.677, Sao Tome, noted Sundays 0700-0800. (Peddle, Newfoundland)

In the new *English* transmission 1700-1730 from *Radio Peking*, 11.685 (best on West Coast) and 15.060 (best in East), news is at start; POW messages at 1715. RFA, Saigon, Indo-China, seems settled down on 9.755, noted signing on 0520; also heard mornings on 7.255; Taipeh, 6.095, Taiwan, does not have news 0630 as do 7.133, 11.735; *English* on 15.255, 11.735 is now an hour earlier—2200-2300, followed by Chinese to 0100 sign-off. Hong Kong, 9.525, is now on summer time—one hour earlier—signs on 0400, and only some days takes BBC news relay 0600; relays "Radio Newsreel" 0900 and signs off now 0915. (Balbi, Calif.)

At press time, Leopoldville, Belgian Congo, was using 9.745 at least evenings (EST) and/or 9.767; widely reported.

*Radio France-Asie*, 11.78, Saigon, noted with news at 0900; DZHT, 9.734, Manila, noted 0245 with religious services in Spanish; JKI2, 9.656, heard 0230 in Japanese. (Russell, Calif.) *Radio France-Asie* noted 0500 on 11.83 with news. (Winch, Calif.)

Laurence Marques, Mozambique, is reported by Ribeiro, Brazil, as noted usually from 2300 with musical programs, on 4.819.

CHNX, 6.13, Halifax, Nova Scotia, Canada, appears to be on daylight time now; heard closing recently 2215. (Bellington, N. Y.)

A new Greek station noted on 6.450 around 1200-1500 closedown gives call of "Edho Alexandropolis." (Bluman, Israel, via *WRH Bulletin*)

The Nordwestdeutscher Rundfunk (British Zone of Germany) has a new 1 kw. transmitter on 11.795 (heard by Bellington, N. Y., around 2300), which parallels Hamburg, 7.290, 20 kw. The 11.795 station is Osterloog.

Tashkent, 6.825, Turkestan, USSR, noted 1200-1230 with *English* for India on Fridays, Sundays; also may be Wednesdays. (*United 49-ers Radio Society*)

*English* broadcasts for Europe from Moscow are listed—0130-0159 on 9.680, 11.630, 15.100, 15.440, 15.360; 0230-0259 on 9.680, 11.630, 15.360, 15.440; 1130-1159 on 9.640, 11.630, 11.820, 15.360; 1230-1259 on 9.640, 11.630, 15.360; 1400-1430 on 9.640, 9.670, 9.680, 11.630, 15.360; 1430-1459 on 9.550, 9.640, 9.833, 11.630, 11.910, 15.360; 1530-1559 on 9.550, 9.600, 9.640, 9.833, 11.630, 11.910, 15.360; 1630-1659 on 9.550, 9.640, 9.833, 11.630, 11.910, 15.360; 1700-1759 on 9.640, 11.630, 15.360; also reported with *English* at 0300-0329 on 11.780, 15.100, 17.810; 0400-0459 on 9.680, 11.630,

# ALMO SPOTLIGHT SPECIAL HARD-TO-GET T. V. TUBES

TYPE	1 to 49	50 or over	TYPE	1 to 49	50 or over
024	\$ .89	\$ .83	6J5	\$ .81	\$ .75
0Z4G	.83	.83	6L6	1.57	1.45
1B3GT	1.43	1.33	6K6GT	.89	.83
1U4	1.08	.90	6SA	.97	.90
1U5	.97	.75	6V6GT	1.08	1.00
1V2	.81	.75	6V4GT	.97	.90
1X2	1.43	1.33	6X4	.81	.75
3Q4	1.19	1.10	6Y6G	1.30	1.20
354	1.08	1.00	7F7	1.19	1.10
514G	.81	.75	7N7	1.19	1.10
6AK5	2.11	1.95	12AT7	1.57	1.45
6AL5	1.08	1.00	12AU7	1.30	1.20
6AU6	1.08	1.00	12SA7	1.08	1.00
6BD5	1.73	1.60	12SK7	.97	.90
6BL7	1.57	1.45	12SQ7	.81	.75
6BR6GT	1.73	1.60	8SZ5	.81	.75
6CB6	1.08	1.00	50L6GT	.97	.90
6BG6G	2.59	2.40			

10% Cash with Orders

## ALMO RADIO CO.

509 ARCH ST. & 6205 MARKET ST.  
Philadelphia, Pa.  
6th & ORANGE STS. • Wilmington, Del.  
4401 VENTNOR AVE. • Atlantic City, N. J.  
1133 HADDON AVE. • Camden, N. J.

# SCARCE RADIO TUBES TV

**TUBES BOUGHT, SOLD, and TRADED**  
Send Your Want and Trade List!

Many Types Available for IMMEDIATE DELIVERY — WRITE NOW!

Radio and TV service men, experimenters, amateurs . . . we have many types of scarce tubes ready for immediate shipment. Don't use make-shifts or spend valuable time looking for tube sources. Try Electro FIRST . . . and get the tubes you need without delay. Get complete list and Electro's low prices. It's FREE . . . write today!

## ELECTRO SALES

425 W. Randolph St. Chicago 6, Illinois

## OUR SPECIALTY

EXPERT

## SPEAKER RECONING SERVICE

Guaranteed Workmanship—Fast Service

JOBBERS—DEALERS

Write for Price Lists

ACRO RADIO CO.

2 E. 184TH ST.

BRONX 68, N. Y.

## POWER!

Your ad in the Classified Section of RADIO AND TELEVISION NEWS is read by the largest audience in the field—monthly circulation—over 200,000.

## RADIO ENGINEERING DEGREE IN 27 MONTHS

Radio engineering is a big field. There's room for you in it—if you're good. Get first-class training at Indiana Tech. Intensive specialized course, including strong basis in mathematics and electrical engineering, advanced radio theory and design, television. Modern laboratory. Low tuition. Also 27-month courses in Aeronautical, Chemical, Civil, Electrical and Mechanical Engineering. Approved for G.I.'s. Enter September, December, March, June. You can earn part of your expenses right here in Fort Wayne while you are studying.

## INDIANA TECHNICAL COLLEGE

971 E. Washington Blvd., Fort Wayne 2, Indiana  
Please send me free information on B.S. Engineering Degree in 27 months as checked.

Radio-Television  Aeronautical  
 Civil  Mechanical  Electrical

Name.....  
Address.....

## RADIO & TELEVISION NEWS

11,780, 15,100, 15,200, 15,360, 15,440,  
17,810; 0530-0559 on 9,680, 11,630,  
11,780, 15,200, 15,410, 15,360, 17,810,  
and 17,840. (WRH Bulletin)  
\* \* \*

### Acknowledgment

Sorry, fellows, that space would not permit use of all the FB reports received for the July issue; please keep reports coming to 948 Stewartstown Road, Morgantown, West Virginia, USA. Thanks and good listening!  
KRB.

### HAM PLATES GAIN

THE movement to grant licensed radio amateurs the right to carry distinctive license plates on their automobiles is gaining momentum as more and more states pass or consider enabling legislation.

The latest states to join Florida, Mississippi, Louisiana, Arkansas, and the Canal Zone in providing special license tags include Georgia, Nevada, North Dakota, and Tennessee.

Legislation is pending in Indiana, Kansas, Washington, New Jersey and Wisconsin. Bills have been introduced in California, Connecticut, Delaware, Illinois, Maryland, Nebraska, Ohio, Pennsylvania, and Rhode Island.

Similar bills were voted down by the legislatures of Oregon and Iowa. -30-

### MORE HAMFESTS

THE Egyptian Radio Club, Inc. will hold its Annual Picnic and Ham-boree on Wednesday, July 4th.

This year's affair promises to be bigger and better than ever before with prizes and plenty of contests. Hidden transmitter hunts, both mobile and afoot; code speed contests; QLF contests; contests for phone NCW operators; SWL's; etc. have been planned by the committee in charge.

The Picnic and Ham-boree will be held on the grounds and in the club house of the organization at 700 South Choteau Slough Road, near Granite City, Ill. From the new highway bridge on Route 66, just east of the Chain of Rocks river bridge at St. Louis, the route to the grounds will be clearly marked.

Those desiring additional details on this affair should contact F. A. Waelterman, 415 Alma Avenue, Webster Groves 19, Missouri.

\* \* \*

HAMFESTERS Radio Club of Chicago will hold its 17th annual picnic and hamfest on Sunday, August 12 from dawn to dark at the Frankfort Park Picnic Grove, Frankfort Park, Illinois. The grove is situated 1/2 mile north of the junction of U.S. 45 and U.S. 30.

The committee promises that there will be over \$1000 in prizes, food, and other refreshments. Prizes will be offered in various games, races, and contests. Music will be furnished and in case of rain, a covered pavilion is available.

Plenty of picnic tables will be available for those bringing their own lunches. Tickets entitling the holder to a try for the prizes are \$1.50 but tickets are not required. Those wanting tickets and further details should contact Bill Roberts, W9HOV, 7921 S. Woodlawn Ave., Chicago 19, Illinois.

-30-

# don't junk that tube

YOUR DEFECTIVE PICTURE TUBES NOW RECOVERED FOR AS LITTLE AS 1/6th OF NEW TUBE COST!

H & A's sensational new, GUARANTEED recovery process turns junkers into perfect-performance tubes . . . converts loss to profit for dealers and servicemen three ways:

- 1) Slashes cost of tube replacement on service policy sets.
- 2) Reduces costs of tube failure jobs on regular service repairs.
- 3) Permits lower reconditioning costs, hence higher profits on trade-in set sales.

ALL AT NO RISK TO YOU!

Send your defective tubes to H & A (mail the coupon below for full information and shipping instructions.) If tube failure is due to any of eleven basic causes, such as shorts, low emission, leakages or opens, H & A will make all necessary repairs guaranteed for 60 days and return tubes promptly. If tube can't be repaired, H & A will send you check for glass allowance (see chart) which in most cases will reimburse you for shipping charges.

DON'T DELAY! SEND COUPON TODAY!  
TURN JUNK TUBES IN TO \$\$\$.



SEE HOW YOU SAVE!

Sizes And New Tube Prices	H & A Recovery Prices	Glass Credit Allowance
10" - \$25.50	\$4.25	\$1.00
12 1/2" - 26.25	4.50	1.00
14" - 26.50	8.00	1.50
15" - 37.50	8.00	2.00
16" - 44.00	8.00	2.00
17" - 43.50	8.00	2.00
19" - 68.25	12.50	3.50
20" - 75.50	12.50	3.50



H & A Television Tube Co.  
3547 West Montrose Ave.  
Chicago 18, Ill.

Gentlemen:

Please send me full information on your Tube Recovery plan. I understand there's no obligation.

NAME \_\_\_\_\_

ADDRESS \_\_\_\_\_

CITY \_\_\_\_\_

Prepare Now!

## RADIO ENGINEERING

B.S. DEGREE IN 27 MONTHS

Complete Radio Engineering course incl. Telev., U.H.F., and F.M. BS Degree Courses also in Mech., Civil, Elect., Chem. and Aero Eng.; Bus. Adm., Acct. Extensive campus, modern buildings, well equipped labs. Low cost. Prep courses. Personalized instruction. Heavy demand for graduates. Placement service. Founded in 1884. Prepare now for the civil and military opportunities ahead. Enter Sept., Jan., March, June. Write for Catalog.

**TRI-STATE COLLEGE**  
1671 COLLEGE AVE. ANGOLA, INDIANA

big FREE GIFT offer

SEE PAGE 14

# SUN SUPER SPECIALS

Who Says Prices Are Going Up?  
Now at Sun They're Lower Than Ever.

## WEBSTER—CHICAGO Dictation—Model 18 WIRE RECORDERS Brand New—Discontinued Model

Includes microphone with stand, 1/4 hour spool wire, plastic dust cover, and removable foot switch.

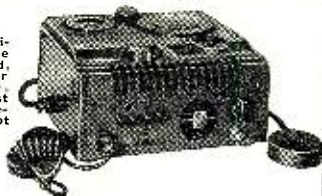

### Dictation • Transcription • Playback

For Doctors, Dentists, Lawyers, Accountants, Secretaries, Clergymen, Speakers, Businessmen, Hams, etc. Includes the following exclusive Webster-Chicago features:

- Automatic Stops — shut off machine at end of wire
- Pushbutton record-listen switch
- Immediate playback thru 2 inch speaker
- Neon recording volume indicator
- Removable take-up drum
- Elapsed time indicator

DRASTICALLY REDUCED FROM ORIGINAL PRICE  
OF \$135.00 TO AN ALL TIME LOW OF

RECORDING WIRE	
1 hour . . . \$3.50	
1/2 hour . . . 2.10	
1/4 hour . . . 1.40	

**ONLY \$89.50**  
Portable Carrying Case—  
Reg. \$12.50—Only **\$8.95**

## Attention Hams! Last Call On this Great Buy!

### BENDIX 100 WATT TRANSMITTER C-W

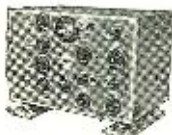

Easily converted to 20-40-80 meter VFO and 10 meter crystal. Each ECO dial has 3000 divisions enabling quick precision shifting. This transmitter was constructed of the highest quality precision parts. Four separate output tanks; one 4 position selector channel switch having 7 sections which changes the ECO, IPA, and output tanks simultaneously. All controls are mounted on the front panel. The housing is cast aluminum. Shields and case are sheet aluminum dimensions 11x12x15 inches. Wt. 35 lbs. Complete instructions furnished. Uses 3-807, 4-12sk7—each a separate master oscillator. Has a 5 AMP R.F. meter. Requires 750 volt 300 MA power supply and modulator for phone operation. We cannot supply either the power supply or modulator. This is a complete coverage transmitter for the new or experienced amateur. A true ham value. Complete with tubes, not many of these units left. So hurry and get yours while they last.

NOW ONLY  
**\$29.95**  
LIKE NEW

SHIPPED  
COLLECT ONLY

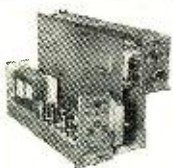

### WAVEMETER BC-1073A

Used. Good Condition. Covers 150-210 MC. Companion to BC 1068A receiver. Contains resonant cavity wavemeter, oscillator, heterodyne amplifier, tuning eye. 110V-AC 60 Cycle Power Supply.

LESS TUBES  
**\$4.95**

SHIPPED COLLECT ONLY

**TERMS:** All items F. O. B. Washington, D. C. order. All orders \$30.00 or less, cash with order. Above \$30.00, 25 per cent with order, balance C. O. D. Foreign orders cash with orders, plus exchange rate.

**SUN RADIO**  
OF WASHINGTON, D. C.  
938 F STREET, N. W. WASH. 4. D. C.

## Within the Industry (Continued from page 26)

standards of the radio and television industry, shall be used; 3. All local safety regulations and building codes shall be strictly adhered to by CTIS members; 4. Ample protection against lightning shall be provided on all installations; 5. The television owner's person and property shall be fully protected by liability and property damage insurance while installations are in progress; and 6. Special care shall be taken to make each installation safe, both electrically and mechanically.

Full details on the new program are available from NARDA at 1437 Merchandise Mart, Chicago 54, Illinois.

**BILL C. SCALES** has been named general sales manager of the Cathode-Ray Tube Division of the *Allen B. Du Mont Laboratories, Inc.*



He will direct the sale of the company's CR tubes both to manufacturers and parts distributors throughout the

world. He has been with the company since September 1949 and was formerly southwestern regional sales manager for the Receiver Sales Division.

Mr. Scales has been active in television circles since the end of World War II and in sales circles since 1936. During the war he served as a captain in military intelligence, from 1941-1946, in the Pacific Theater.

**JOSEPH Y. RESNICK**, formerly general manager of *Channel Master Corp.*, has been named chairman of the board and **HARRY RESNICK** has been named president and general manager of the firm . . . **ROBERT E. BURROWS** has been appointed general sales manager of *Thomas Electronics, Inc.* of Passaic . . . The election of **DR. ADOLPH H. ROSENTHAL** as vice-president and director of research and development has been announced by *Freed Radio Corporation* of New York . . . **EDWARD A. PECARA** has been appointed sales promotion manager of *Motorola, Inc.* He formerly held the same post with *Zenith Radio Corporation* . . .

**HAROLD M. BRETT**, wage and salary administrator of *Allen B. Du Mont Laboratories, Inc.*, died recently after a short illness. In point of service, he was one of the firm's oldest employees . . . **JACK M. WISEMAN**, patent attorney, has joined *Belmont Radio Corporation* where he will be in charge of the establishment and administration of patent procedures for special products manufactured by the company, and the development of an incentive plan for the company's engineers . . . **SAUL FELDMAN** has been named controller of *Jewel Radio Corporation*. He was formerly associated with *Tele-*

*Tone Radio and RCA* . . . **HERMAN T. KOHLHAAS**, retired assistant vice-president of *International Telephone and Telegraph Corporation*, died recently of injuries received in an automobile accident near Jacksonville, Florida. He had been associated with the company for more than 42 years . . . *Westinghouse Electric Corporation* has named **E. W. RITTER**, manager of the company's new Electronic Tube Division, a vice-president of the firm and has appointed **E. V. HUGGINS** to the newly-created position of executive vice-president of the *Westinghouse Electric International Company* . . . **RICHARD H. DORF** has joined the staff of *Brach Manufacturing Division of General Bronze Corporation* as an electronics project engineer . . . **HAROLD W. GIESECKE** has been named assistant to the general manager of the *Bendix Radio Division*. He was formerly associated with *Westinghouse and Bell Labs* . . . **EPHRAIM N. OSTERBERG** has been appointed director of purchases for *Stewart-Warner Corporation*. He has been with the radio firm since 1916 . . . **GEORGE O. SMITH** is the new manager of components engineering for *Emerson Radio and Phonograph Corporation* . . . **HAROLD L. OLESEN**, executive assistant of the *Weston Electrical Instrument Corp.*, has retired after twenty years' service with the firm . . . **DR. HARRY N. WALKER** has been named vice-president in charge of sales for the *Richardson-Allen Corporation*, manufacturers of selenium rectifiers . . . **JOHN G. THOMPSON** has been appointed manufacturing manager of the new tube plant that *Westinghouse Electric Corporation* will build in Bath, New York . . . *Burlingame Associates* of New York has named **S. K. BURNELL** to the post of advertising director . . . **REX WILSON**, chief engineer of *Tele-Vogue, Inc.* the manufacturing subsidiary of *Muntz TV*, has been named vice-president in charge of engineering for the firm . . . **WILLIAM H. ROUS**, sales manager of the *American Phenolic Corporation* of Chicago, was elected vice-president of the company by the board of directors . . . **WILLIAM SLAWSON** has joined the *John F. Rider Publisher, Inc.* organization as general sales manager.

**RAYMOND W. ANDREWS**, formerly merchandising manager of the Radio Tube and Television Picture Tube Divisions of *Sylvania Electric Products Inc.*, has been promoted to the post of manager of factory sales.

In his new capacity, Mr. Andrews will direct tube merchandising, sales planning, and customer service activities and will be responsible for maintaining sales department liaison with tube plants.

He joined *Sylvania* in 1945 as merchandising manager of the Radio Tube Division after serving as a Command-



er in the navy during World War II. He is a member of the IRE, ARRL, Society of Military Engineers, Radio Club of America, and the Reserve Officers of the Naval Services.

**DR. HARRY F. OLSON**, director of the Acoustical Research Laboratory of *RCA Laboratories*, has been elected president of the Acoustical Society of America for the year 1952.

Dr. Olson was the recipient of the John H. Potts Medal of the Audio Engineering Society in 1949.

**THE BRITISH INSTITUTION OF RADIO ENGINEERS** is opening its "Festival Convention" on July 3 at University College in London with a session on "Electronic Instrumentation in Nuclonics."

Subsequent sessions include: "Tube Technology and Manufacture" (July 5-6, University College, London); "Radio Communication and Broadcasting" (July 24-25, University College, Southampton); "Radio Aids to Navigation" (July 26-27, University College, Southampton); "Television Engineering" (Aug. 21-24, Kings College, Cambridge); and "Audio Frequency Engineering" (Sept. 4-6, Earls Court, London).

**MILTON R. BENJAMIN**, national sales manager of *Majestic Radio & Television*, has been named vice-president in charge of sales for both *Majestic* and the products of the parent company, *The Wilcox-Gay Corporation*.



He has been national sales manager for *Majestic* for the past year and prior to that served as regional sales manager.

Mr. Benjamin was formerly associated with *Sonora Radio* and in past years engaged in various manufacturing and wholesale activities in this field. He will soon celebrate his 25th anniversary in the radio industry.

-30-



## Ungar's little Angels

### DO A HEAVENLY SOLDERING JOB

Pick any job and you'll find a pip of a tip to use with the trim, slim Ungar Pencil. Any of the 8 Ungar Angels interchange in the No. 776 Handle to make a honey of a tool that does work faster and better than larger, heavier irons. Whatever your problem, you'll bless the day you discovered these saintly soldering cherubs!



No. 1239 3/8" HI-HEAT, Chisel Tip, 37 1/2 Watts. Used and recommended for radio, radar and TV repair and maintenance, but because of greater tip temperature and more heat capacity, they are used on production lines for smaller work. Tip material is special pre-tinned alloy. Loss of tip material at high temperatures is less than with copper alloys.

Write for Catalog No. 400

**Ungar** ELECTRIC TOOLS, INC., Los Angeles 54, Calif.

## Seletron SELENIUM RECTIFIERS

May be up your alley, too!

AS THEY ARE FOR  
THE BRUNSWICK-BALKE-  
COLLENDER COMPANY



Illustrated above is the "Tel-E-Foul" control box. When the bowler oversteps the foul line the electronic brain conveys an impulse causing a light to flash above the alley. A 75 MA SELETRON miniature is built into the control box on each bowling line.

The new "Tel-E-Foul" photo-electric Foul Indicator produced by The Brunswick-Balke-Colleander Company, famous manufacturer of bowling equipment, includes 75 MA SELETRON miniatures in its electronic circuits.

SELETRON Selenium Rectifiers are the choice of an increasing number of manufacturers in diversified fields because they are so thoroughly dependable under all types of grueling conditions. SELETRON is available in the miniature sizes required for radio, TV and other electronic circuits, all the way up to heavy duty power stacks used in a wide range of industrial applications.

Whenever you meet up with a power conversion problem, no doubt SELETRON engineers can be of substantial assistance in recommending the right rectifier for your needs. Write us today!



SELETRON DIVISION  
**RADIO RECEPTOR COMPANY, INC.**

Since 1922 in Radio and Electronics

Sales Dept.: 251 W. 19th St., New York 11, N. Y. • Factory: 84 N. 9th St., Brooklyn 11, N. Y.

# SAVE

THAT GOOD LOOKING OLD CONSOLE—  
REPLACE YOUR OBSOLETE RADIO  
with a modern, easily installed  
**ESPEY AM/FM CHASSIS**  
and your favorite console is "right-up-to-date"



Rated an excellent instrument by America's foremost electronic engineers. Fully licensed under RCA and Hazeltine patents. The photo shows the Espey Model 511-B, supplied ready to play. Equipped with tubes, antenna, speaker, and all necessary hardware for mounting.

**NEW FEATURES**—Improved Frequency modulation circuit, drift compensated • 12 tubes plus rectifier, and pre-amplifier pick-up tubes • 4 dual purpose tubes • High quality AM-FM reception • Push-pull beam power audio output 10 watts • Switch for easy changing to crystal or variable reluctance pick-ups • Multi-tap audio output transformer supplying 4—8—500 ohms.

Makers of fine radios since 1928.

Write for literature RN for complete specifications on Model 511-B and others.

**ESPEY** TEL. Trefelger 9-7000  
**MANUFACTURING COMPANY, INC.**  
520 EAST 72nd STREET, NEW YORK 21, N. Y.

# SERVICE-MEN!

REEVES Soundcraft Laboratories afford you the best in television picture tubes at prices consistent with such quality. When replacement requirements dictate the need for high efficiency and fidelity, Reeves products are the answer. Experienced servicemen have found that they always result in satisfied customers — and a profitable service operation.



Soundcraft rectangular

television tubes are available in 16", 17" and 20" sizes. You can use and recommend them with assurance because they are backed by the greater integrity and experience of the Reeves name, a foremost manufacturer in the electronics and recording field throughout the country for twenty years.



REEVES  
Soundcraft  
CORP.  
TWENTY YEARS OF LEADERSHIP IN SOUND ELECTRONICS  
10 EAST 52nd STREET, NEW YORK 22, N. Y.  
EXPORT—REEVES EQUIPMENT CORPORATION  
10 EAST 52nd STREET, NEW YORK 22, N. Y.

## 10 Meter Mobile

(Continued from page 48)

oscillator should be adjusted. Plug in the 6AK5 and supply a regulated "B+" of 150 volts to the oscillator circuit. With the help of a good wavemeter tune a reasonably accurate receiver until the fundamental note of the oscillator is found. Do not be disturbed by the many birdies which will be found in a standard superhet. If the layout has been followed closely, adjustment of the trimmer should bring the oscillator's fourth harmonic to the low edge of the 10 meter band with the variable condenser in full. If this does not occur, the 250  $\mu$ fd. capacity of the grid tank condenser may have to be padded somewhat. When the proper setting has been found, the variable condenser must be modified so that the oscillator cannot be tuned outside the 10 meter phone band. Plates may either be removed or, if permitted by the construction, rearranged to alter the amount of variable capacity available. The variable condenser used can be seen in this latter condition in Fig. 5. The author reassembled the condenser several times before a good setting was obtained, i.e., a frequency range of 28.53 to 29.67. By using the oscillator, together with a wavemeter and a multimeter, adjustment of the doubler-driver and the final amplifier can be performed.

The next step is to set the two slug-tuned coils to provide proper drive to the final amplifier. Set the oscillator to about the middle of the band. Plug in all the r.f. tubes, using a "B+" of about 150 volts. At this voltage no damage will be done to the tubes while tuning up. When tuning the 6AK5 plate, the 6AK6 grid circuit must be operating, and when tuning the 6AK6 plate circuit, the 6AQ5 grid circuit must be operating. This is because the grid circuit of the following stage as well as the plate of the circuit being tuned, form the shunt capacitance across the slug-tuned plate tank. The wavemeter, set to 20 meters, should be coupled to  $L_2$ .  $L_2$  should then be adjusted for the maximum indication. If the peak setting cannot be obtained within the range of the slug adjustment, the number of turns should be adjusted as follows: using the *Millen* form specified, a maximum reading with the slug all the way out indicates that more turns are required; if maximum reading is obtained with the slug all the way into the coil, turns should be removed. If an iron-core slug form is used these tuning instructions should be reversed. This procedure should then be repeated with the wavemeter set to 10 meters and coupled to  $L_3$ . Even if the layout shown is changed considerably, proper adjustment can be obtained with this procedure in short order.

With proper drive, the final amplifier, the final tank condenser, padding condenser, and antenna condenser can be set. A temporary dummy an-

## TV KITS



BIG SCREEN TELEKITS  
NOW ONLY \$79.95 LIST

It's easy to own your own big screen receiver. Over 20,000 TELEKITS have been assembled. Big illustrated, easy-to-follow instruction book guides you step-by-step through easy assembly. TELEKIT 219 C uses 19" or 20" inch tube. Has wide-angle 70° electro-magnetic deflection. Gives brilliant picture. Has hum-free, high-fidelity intercarrier sound. Automatic Gain Control, A.F.C., horizontal hold control, new high sensitivity, low power consumption circuit. Kit complete, with all parts, less tubes, \$79.95 list. Write for free catalog with confidential dealer prices.

BIG SCREEN CONVERSION KIT, \$12.95  
Here's all you need to convert to big screen television. Comes complete with easy instructions for conversion of any brand set.

Write "Dept. A" for FREE catalog of conversion kits, TV Parts, scarce TV Tubes, Picture Tubes and accessories, and Antennas all listed at confidential dealer prices.

### TELEKIT

ELECTRO-TECHNICAL INDUSTRIES  
1437 N. BROAD ST. PHILADELPHIA 21, PA.

## NEW ADDRESS

Same Big Bargains in NEW EQUIPMENT

	Each
BC348 Dual-section volume control.	\$2.50
MC215 Tuning Shaft for SCR274N.	1.25
MC124 Tuning Shaft for MN26 306"	6.00
MC136 Right Angle for MC124...	2.25
MC211A Right Angle for MC215...	.85
BC732A Localizer Control Head...	2.50
F10 Fairlead .....	1.50

Please include sufficient postage.

### LONG ISLAND RADIO COMPANY

P.O. Box 474 Montrose, Penn.

## BRAND NEW TUBES

1B36-T	\$ 1.05	7E4	\$ 0.85	7Z4B	\$ 2.75
1B24 Syv.	1.45	4C35	1.25	6X4	6.65
1B27	17.95	4J31	89.50	756C	49.50
1B38	24.25	4J52	199.50	812	9.75
6C40	2.25	6A15	1.35	812A	9.55
6C51	4.65	6B8	1.35	816	2.85
6D21	2.59	6AV6	5.95	837	1.85
2J21A	11.45	6K4	3.95	872A	1.35
2J22	11.45	6K4	3.95	884	1.75
2J31	29.05	6H7GT	89	1616	1.25
2J32	89.25	12A5	12.85	1824	1.50
2J33	29.50	164TL	15.50	8025	4.95
2J34	29.50	700A/B/D	29.50	5001	1.75
2J36	89.25	706CY	10.95	5002	8.50
2J56	199.50	706GY	14.95	5003	1.75
3Q24	3.95	717A	11.15	5004	.85
3Q28	19.85	723A/B	11.15	5005	1.75
3Q4					

1000'S OF OTHER TYPES IN STOCK!  
Send us your inquiries! We carry a complete stock of Radio and TV Tubes & electronic parts, 25% deposit with order. Bal. C.O.D. We pay highest prices for surplus stocks in tubes!

### J. S. H. SALES CO.

Dept. R-2, 7552 Melrose Ave., Los Angeles 46, Calif.

BECOME  
A RADIO  
AMATEUR

Complete Home-Study  
Course for Passing FCC  
Amateur Radio Examinations

• LOW COST •  
PERSONAL COACHING

Write for Details

FEDERAL ELECTRONICS INSTITUTE

45 East Putnam Ave., (Dept. D), Greenwich, Conn.

## ON-THE-SPOT BATTERY RECORDER

WALKIE-RECORDALL 8 lb. miniature BATTERY RECORDER-PLAYBACK

Continuous, permanent, accurate, indexed recording at only 5¢ per hr. Instantaneous, permanent playback. Picks up sound up to 60 ft. Records conferences, lectures, dictation, 2-way phone & sales talks; while walking, riding or being. Records in closed briefcase with "hidden mike"! Write for Detailed Literature.

### MILES REPRODUCER CO., INC.

812 BROADWAY, Dept 1 RN-8, NEW YORK 3, N. Y.

RADIO & TELEVISION NEWS

tenna should be attached to the antenna circuit. A short length of 52 ohm coaxial cable terminated in a 52 ohm, 1 watt carbon resistor will suffice. Set the oscillator to the low edge of the band. The  $C_{15}$  padder should be peaked and the final tuned to dip. A wavemeter tuned to 10 meters set near the 52 ohm load should show maximum reading at these settings. The oscillator should then be retuned to the high edge of the band. If the padder must then be set to a lower value to re-dip the final (which will not happen if the circuit diagram is followed) a larger variable condenser must be used for tracking. If a larger value of padder is required the tracking condenser should be tapped down on the final coil until the condenser tracks across the band. About a quarter turn from the top was found to be correct in this layout. When all settings are complete, the mobile should overheat the 52 ohm, 1 watt resistor in about 15-30 seconds.

There are no adjustments to make in the modulator. The mike need only be plugged in the "B+", raised to the proper value, and the unit is ready to operate.

### Operation

Imagine, if you can, a mobile in which every station heard can be zero beat without taking one's eyes off the road! Just throw on the oscillator, turn the *National* vernier knob until the oscillator covers the station to be worked and it is done. No longer does a station calling CQ say, "W— tuning this frequency first and 100 kc. either side . . ." leave the mobile operator out.

The results have been terrific. A large number of stations called are 100% contacts—and believe me 7 watts in the clear on ten meters is plenty. The author has worked 19 states in clear complete QSO's and the DX log includes a KZ5 and a KP4 while in motion; all in a period of three weeks. Using a dynamotor power pack, the entire battery drain to the relays, tubes, filaments, and "B+" for both transmitter and converter amounts to only 11.5 amperes! Here's an installation that's small, convenient, easy on the battery, easy to service, and really effective—an *ideal mobile!*



July, 1951

# PRICES ARE DOWN HERE NO INFLATION!!!

**RADIO  
STANDARD  
SURPLUS  
ELECTRONICS**

**BC-438 BEACON RECEIVERS**  
Similar to BC 1206. Manufactured by Detroit Radio. 200 to 300 KC. For Direction Finder. Contains 2—2N1G, 1—6SA7, 1—6SP7, 1—6SK7, 1—6K7. Excellent condition.  
Complete. **\$7.95**

**2 VOLT WET CELL RADIO BATTERY**  
NEW, Uncharged (Appr. wt. 4 lbs.) TYPE 20-2 . . . . . **\$1.45**  
Complete set of three with Box and Connections to make a 6 volt, 20 Amp. Hrs. Battery Uncharged (Approx. Wt. 15 lbs.) . . . . . **\$5.95**

**MG-149F INVERTER**  
Input 24 Volt DC 36 Amps. 110 V. 400 Cy. AC 500 V.A. Output at 90% P.F. Used, excellent condition . . . . . **\$8.95 ea.**

**MIDGET SELSYNS**  
AY type operates from 6-12 Volts 60 Cycle. Use as both transmitter and receiver. These compact little units draw almost no current and work fine for all remote position indicating applications. OD 2 1/2" x 2 1/2" x 2". All New (Appr. wt. 1 lb.) . . . . . **\$1.50 Each**

**PROP FITCH MOTORS**  
For your Beam Antenna: 20 Volt to 32 Volt, A.C. or D.C. 1/2 H.P. Motor; 1/4 RPM Gear Reduction, 7000 to 1. All BRAND NEW . . . . . **\$13.95 ea.**

**REVERSIBLE MOTOR**  
1/4 H.P. Ball-bearing 3450 R.P.M. in Blast-proof case. Needs only .5 capacitor for starting. All Brand New. 1/2 V. 60 Cy. Special Low Price. . . . . **\$3.95**

**3" TRIUMPH OSCILLOGRAPH**  
Complete Test Scope, with built-in Wobbulator, so as to be used on TV or FM servicing. Operates from 110 Volt, 60 Cy. A.C. Excellent condition. **REAR SPECIAL . . . . . \$34.95 Ea.**

**MODEL GO-9 TRANSMITTER**  
All brand New, 100 Watts CW, or MCW, emission. Operates from 110 V., 800 Cycle, easily converted to 60 cycle operation. Low frequency range, 300 KC. to 600 KC. High frequency 3,000 KC. to 18,000 KC. using an E.C.O. We furnish complete conversion data with each transmitter. Complete with schematics . . . . . **\$59.95**

**RU-19 RECEIVERS**  
These units are ideal for ship-to-shore receivers, ADF, and mobile operation. They come complete with 9 coils covering frequency range of 195 KC. to 13570 KC. 24 Volt Dynamotor, all cable connectors, complete tuning head and cables, spare tubes, tuning meter, instruction manual, junction box, mounts, etc., etc. **NOTHING ELSE TO BUY. ALL BRAND NEW. COMPLETE \$39.95**

Westinghouse—G.E.—Weston  
MILLIAMPERE D.C. KILOVOLT D.C.

3"—0 to 50... **\$3.95 Ea.** 3"—0 to 400 DC. **\$3.95 Ea.**  
3"—0 to 100... **3.95 Ea.** 3"—0 to 500 DC. **3.95 Ea.**  
3"—0 to 150... **3.95 Ea.** (All are 1 Ma. full scale, require external multiplier.)  
3"—0 to 200... **3.95 Ea.**  
3"—0 to 250... **3.95 Ea.**  
3"—0 to 750... **3.95 Ea.**

**VOLT METERS**  
3"—0 to 8 AC. **\$2.95 Ea.**  
3"—0 to 15 AC. **2.95 Ea.**  
2"—0 to 20 DC. **3.95 Ea.**

**ALTIMETERS**  
Sensitive type—Ideal for planes or automobiles. Operate from Barometric pressure. No special hookup needed. Excellent condition. Low priced at **Ea. \$7.95**

**FL-B FILTER**  
Range of Voice for 1020 cycles A u d i o. Switch mounted on Filter. Excellent for C W. . . . . **Ea. \$1.25**

**DESK TELEPHONE**  
French Type C. Western Electric. Kellong Monophone, etc. Can be used for rural service, extension phone or remote control apparatus. With Dial . . . . . **\$12.95**  
Less Dial . . . . . **9.95**

**DEEP GENERATORS**  
12 Volt DC Output @ 60 Amp. Complete with Voltage Regulator and Ammeter. Ideal for Boats, Trucks or Mobile Radio use. Excellent condition. . . . . **\$49.95**

**12 VOLT BLOWER MOTOR**  
Trade Winds Blower—Operates from 12 Volt DC @ 6.6 AMPS. Diameter of cage 7". Ideal for Boats or Trucks. BRAND NEW . . . . . **\$4.95**

**POLE INSULATORS**  
Glass 2" Insulator with 3" screw, overall length 5" for telephone use. **\$10.00 Per Hundred**

All California Orders—Add 3% Sales Tax . . . Do not send postage stamps. Write for our free booklet listing our stock and prices on Radio, Electronics, Tools, Hardware, Motors, Wire, Meters, Batteries, Aluminum Sheets, etc. 20% Dep. on all C.O.D. orders. All items subject to prior sale.

## STANDARD SURPLUS 1230 Market St., San Francisco 3, Cal. Telephone HEMlock 1-3106

**Get the practical training you need to qualify for high-paying TV servicing jobs. Take TCI Training!**

You train at home with an easy-to-follow, PRACTICAL program, designed by servicemen for servicemen. It's non-mathematical . . . all practical television servicing without theory; without repeating your radio training. It's based on field-tested servicing techniques perfected by more than 200 TV servicing experts. You learn testing, servicing, repair, set conversion, master antenna installation field-servicing short-cuts. Complete sections on COLOR TV, COLOR CONVERSION and UHF are also included!

**YOU LEARN BY DOING!**

You actually build and train on a large-screen TV receiver, given to you as part of the course. This set is yours to keep! In addition, as an optional feature, you can get TWO WEEKS ACTUAL FIELD EXPERIENCE going on service calls and working on the repair bench for Chicago's largest independent TV servicing organization. Age is no barrier. Many TCI students are over 40.

**ACT NOW!** Fill out and mail coupon for FREE Catalog and Sample Lesson. Write TODAY.

**1** You Train at Home...  
Set Your Own Pace...  
Learn by Doing.

**2** You Build and Train on Large-Screen TV Receiver Given With Course.

**3** You Get Actual Field and Bench Experience with a Service Company.

**MEN WITHOUT RADIO TRAINING! T.C.I. offers you a low-cost, 5-7 week Pre-Television Course in Radio — as special preparation for TV. Mail coupon for details.**

Milton S. Kiver, Active President of T.C.I., is a Registered professional engineer, TV consultant, author of TV Books.

**MAIL NOW FOR FREE BOOKLET**

● MILTON S. KIVER, President  
● TELEVISION COMMUNICATIONS INSTITUTE  
● 205 W. Wacker Dr., Dept. 1-L, Chicago 6, Ill.

● Yes, Mr. Kiver! Rush FREE Catalog and Sample Lesson on practical home training in TV servicing. I am not obligated. Salesman will not call.

● Name . . . . . Age . . . . .

● Address . . . . .

● City . . . . . Zone . . . . . State . . . . .

●  Beginners: check here for full facts on Pre-TV Radio Course.

**TELEVISION COMMUNICATIONS INSTITUTE**  
205 W. Wacker Dr., Dept. 1-L, Chicago 6, Illinois

# SUMMER SALE ALL PRICES CUT TO BONE

Don't Buy Tubes until you get our prices. Quantities Limited. Prices Subject to Change Without Notice. Low Prices.

## RADIO & TELEVISION TUBES

These prices apply only on orders for 12 or more tubes. Orders for less than 12, write for quotation.

1B3	\$.11	6BA6	\$.72	6X4	\$ .60
1L4	.80	6BA7	.96	12AT6	.75
1R5	.80	6BE6	.72	12AT7	1.16
1S5	.72	6BG6	1.92	12AU6	1.00
1T4	.80	6BH6	.80	12AU7	1.20
1U4	.80	6BC6	1.28	12AX7	.96
1U5	.72	6CB6	.80	12BA6	.90
3Q4	.88	6CD6	2.75	12BE6	.90
3S4	.80	6CA4	.66	198G6	2.40
3V4	.80	654	.72	19T8	1.16
6AK5	1.56	65D7	1.16	25B6	1.28
6AL5	.80	65K7	.90	25L6	.72
6AQ5	.80	65N7	1.10	35C5	.80
6AT6	.60	678	1.28	50C5	.80
6AU6	1.00	6V6	.90	117Z3	.75
6AV6	.60	6W4	.72		

## All Other Types at Vast Reductions

Westinghouse Kuprox Rectifier 0.64 Amp. 28 Volts. Reg. \$11.00 ea. Special. . . . \$1.95  
**TUBE SALE #247-55-27-85-31-56-57, No Mixed Ass't. 6 Each Type. . . . \$2.25**  
**12 BRAND NEW 10" PHONO RECORDS—Ass't. Jazz—Popular. Please specify. . . . \$1.79**  
 Single Pole—10 Pos. 2 Gang Switch. . . . .29c

## FRESH EVEREADY BATTERIES IN STOCK FOR PORTABLES, ETC.

'B'-'A' 'B' Batts.		'A' Batts.	
457	. . . . . \$1.75	717	. . . . . 70c
482	. . . . . 1.75	720	. . . . . 39c
490	. . . . . 1.58	724	. . . . . 42c
753	. . . . . 2.28	726	. . . . . 49c
755	. . . . . 3.95	736	. . . . . 60c
756	. . . . . 4.03	742	. . . . . 74c
950 Flash Cells.	48 for . . . . . \$3.90		

3 Ft. 5 Wire Shielded Cable with Amphenol Connection. . . . .8 for \$1.00  
 Signal Corps Phones—2 M. Ohms (8 M. Ohms Imp.) . . . . . \$1.00  
 2 Ft. Ext. Cord (and Plug) . . . . . 40c  
 2 MFD—1000 V Upright Bottom Lug. . . . .89c

## TOBE TUBULAR ELECTROLYTICS

20-20 MFD. 150 V. . . . .49c 30-30 MFD. 150 V. . . . .57c  
 40-40 MFD. 150 V. . . . .59c

## Low-Loss Short Wave Lock Type Air Trimmer Variable Condensers

3 Pl.—12-15 Mmfd. . . . . 12c	3 GANG T.R.F. VARIABLE CONDENSERS .0009365 Con. 65c
7 Pl.—25-30 Mmfd. . . . . 15c	D.P.D.T. SLIDE
8 Pl.—30-35 Mmfd. . . . . 16c	TOGGLE
14 Pl.—56 Mmfd. . . . . 24c	SWITCH . . . . . 15c
27 Pl.—100-110 Mmfd . . . . . 35c	

4 PR. WAFER SOCKETS—\$1.49 per C, each. . . . .3c  
 5-6 PRONG WAFER SOCKETS . . . . . \$2.50 per C  
 100 ASST. SOCKETS—4-5-6-7 . . . . . \$3.50 per C  
 1,000 OHM WIRE WOUND POTENTIOMETER. . . . . \$1.25  
 30 HY-FILTR CHOKES SHIELDED. . . . . 3 for 1.00  
 2,000 ohm Wire Wound Potentiometer. . . . . \$1 per doz.  
 CARTER WIRE WOUND C.T. VARIABLE. 29 OHM RESISTORS . . . . . 85c per doz.  
 GEN. ELEC. WESTINGHOUSE, etc. 60 CYCLE WATT HOUR METERS, slightly used, perfect condition, same as used in your home. 110-125 volts. 5 Amps. . . . . \$3.95

## PIEZO CRYSTAL HOLDERS.

12 for \$1.00—\$6.00 per hundred—\$50.00 per 1,000

RCA Band Switches— 3 gang, 3 pos. 3 band. 30c 6 gang, 4 pos. 4-5 band. 40c  
 Trimmer-Padder Asst.—all isolantite—singles, dual: triples—100 asst. pieces. . . . . \$2.25

Philco Push button Rotary Switch Double Pole. . . . . 35c

ATTENTION: Prospectors, Explorers for Hidden Treasures! Construct a U.S. Army Type of Metallic Mine Detector Amplifier. Amplifier unit only (less tubes and batteries) with cables, headphone cord, and jack. Army wiring diagram. Type AN/PRS-1. . . . . \$1.95

RCA Ass't Mica By-Pass Cond. .001. 100 for . . . . . 95c  
 8 or 9 Gang Push Button Switch. . . . . 49c

DRILLED CHASSIS FOR 5-6 tubes 5"x10"x1 1/2". . . . . 25c  
 PHONE JACKS—OPEN & CLOSED AUTO. . . . . 18c  
 BEY SPEAKER VOL. CONTROL—60 OHMS. . . . . 15c  
 SALE—PHONO RECORD ALBUMS—12"—3 comp. 15c; 10"—3 comp. 15c; 4 comp. 20c; 12 comp.—69c

6 Prong Amphenol Sockets. . . . . \$4.00 per C

AMERTRAN FILAMENT TRANSFORMER—6.3 V. 1 Amp. Encased Isolantite Terminal Posts. . . . . \$1.50

VULCAN HEAVY DUTY 100 WATT SOLDERING IRON. Built for U.S.N.—Brand New—Equip. sells for \$8.50. . . . . OUR PRICE \$2.99

AMERTRAN AUDIO OUTPUT XFORMER—Pri. 10,000 @ 15 MA; Sec. 300. 6:1 Ratio. . . . . \$1.00

AMERTRAN MIXER AUDIO XFORMER—Pri. 600-10,000 Ohms . . . . . \$1.00

156-1 RATIO VERNIER DIALS—4 in. . . . . 3/8 in. Hub. 35c

LINE VOLTAGE NOISE ELIMINATOR—Plugs in Between Radio and Elec. Socket. . . . . 35c

12 in. MAGNAVOX SPEAKER, 1100 Ohms. . . . . \$2.95

HEARING AID CORDS—Assortment of 12 for . . . . . \$1.00

BY-PASS COND. ASST.—25 Cans. Bake. Paper. etc. . . . . \$1.00

MINIMUM ORDER \$3.00—NO C.O.D. SHIPMENTS—PLEASE INCLUDE POSTAGE

## NEWARK SURPLUS MATERIALS CO.

Dept. JY 324 Plane Street NEWARK 1, N. J.

# Spot Radio News (Continued from page 18)

Defending the recent color decision of the Commission during another talk in Bloomington, Indiana, he pointed out that . . . "in the heated public debate over the correctness of the Commission's decision to adopt color standards embodying the CBS field-sequential color television system, some people have lost sight of the care taken by the Commission to insure that its final decision would be based on a fully-informed judgment and in the public interest. . . . The color television issue which was part of a larger rule-making proceeding was not, as many persons seem to believe, a private litigation between two or three large broadcasting interests. It was a typical rule-making proceeding to determine what transmission standards for color television, if any, should be established for television stations."

**MULTIPLEX FACSIMILE BROADCASTING**, for years and years a lab project, has now entered that long-anticipated stage of transmission on a consistent basis, thanks to temporary rulings of the Commission. Now, FM broadcast stations can transmit multiplex facsimile, provided the transmission does not reduce the quality of the aural programs simultaneously transmitted, and provided that no degradation of the aural programs results from such facsimile transmissions when received by FM receivers not equipped with a filter or any other additional equipment.

Action on this interesting phase of broadcasting was taken in part as a result of striking demonstrations made by fax's premier enthusiast and inventor, John V. L. Hogan, in his labs a few months ago in New York City. Transmitting over a circuit between Major Armstrong's lab at Columbia University and the Major's station in Alpine, N. Y. (KE2XCC), reception in downtown New York was recorded as excellent.

An ingenious technique is used by Hogan to provide quality signals. A scanner is employed to modulate a 10-kilocycle carrier. This, in turn, introduces the output to a 35-kilocycle oscillator and mixer, producing an amplitude-modulated subcarrier of 25 kilocycles. A filter is used to remove frequencies below 15,000 cycles. Thus, no appreciable facsimile signals can penetrate the aural range of frequencies. This amplitude-modulated subcarrier and the normal FM aural signal are then introduced into the FM transmitter for transmission in the ordinary manner.

Further proof that the Hogan system was an excellent medium appeared in the results of tests conducted during the summer of '48, when a series of qualitative field studies were made in conjunction with WQXR-FM.

In the course of this survey, more than 120 standard FM chassis of more than 20 makes were checked and no interference was found with the sound program caused by the simultaneous fax program. During this entire testing period, the FCC was told, no listeners ever complained of any interference. Similarly during field tests involving a few test receivers in Philadelphia (WFIL-FM), Chicago (WEAW and WMAQ-FM), no interference or degradation was observed by the Hogan staff or other interested persons. (Bench tests, conducted by Hogan to determine the effectiveness of the system, also appear in the record to illustrate the possibilities of the multiplexing plan. In these tests, fax signal were applied to a multiplexer, the output of which was passed into an FM signal generator. For the first measurements no sound input was applied to the multiplexer. The deviation of the signal generator was set at plus or minus 5 kilocycles on a full black fax signal. The radio-frequency FM output of the signal generator was connected to the antenna terminals of the receiver under test. The output of the set was then passed through a 15-kilocycle low-pass filter and applied to the terminals of a vacuum-tube voltmeter. The low-pass filter was used to prevent the voltmeter from responding to the inaudible carrier and side-band components in the vicinity of 25 kilocycles, but still permitted an indication of any voltage injected in the full audible spectrum by the fax signal. As an initial calibration procedure, the fax input to the multiplexer was disconnected, an audible tone was applied to the sound channel input of the multiplexer, and its level adjusted to produce 100 per-cent modulation, or plus or minus 75 kilocycles deviation, of the signal generator. The output of the system, as read on the voltmeter, was then recorded. In the interference test, the audio input tone was disconnected from the multiplexer and the fax input reconnected. The fax scanner was set to scan repeatedly a 110 line per inch black and white raster in order to produce a continuous modulation of the 25 kilocycle subcarrier. The vacuum-tube voltmeter was carefully watched under this condition, but in no instance was there obtained a reading which could be attributed to interference caused by the fax signals.)

During the New York session, the Commission also heard William S. Halstead, prexy of *Communications Research Corp.*, describe a system which differed from the Hogan approach in one phase, the use of frequency shift instead of AM. In this method, a scanner is also used to modulate a 10 kilocycle carrier. However, the resultant output is connected to a demodulator for removing the 10 kilocycle carrier; the demodulated signal is in turn introduced into a frequency-shift modulator and oscillator, which provides at its output an FM subcarrier. This is fed to the transmitter for



**AMATEUR • INDUSTRIAL  
COMPONENTS**

Brand New • Standard Makes  
Not War Surplus

**VARIABLE CONDENSERS**

**Single Section**

.75 Mmfd-6750V. Gap-15 Plate-Ham	.....	\$5.50
.115 Mmfd-6000V. Gap-15 Plate-Ham	.....	3.50
.50 Mmfd-5000V. Gap-15 Plate-Ham	.....	3.50
.100 Mmfd-2000V. Gap-19 Plate-Card	.....	1.50
.150 Mmfd-1000V. Gap-27 Plate-Bud	.....	1.25
.35* Mmfd-1000V. Gap-13 Plate-Card	.....	.55
.40 Mmfd-1000V. Gap-19 Plate-Butterfly	.....	1.25
28* Mmfd-50* Mmfd-75* Mmfd APC Type-Each	.....	.39

**Split Stator**

25 Mmfd-Ea. Sect. 1KV Gap-18 Plate	.....	1.75
35 Mmfd-Ea. Sect. 1KV Gap-26 Plate	.....	1.75
50# Mmfd-Ea. Sect. 3KV Gap-22 Plate	.....	2.50
100 Mmfd-Ea. Sect. 1KV Gap-14 Plate	.....	1.95

\*Screw dr. adjustment—# Straight Line Freq.

**Rheostats—25 Watts—New—Clean**

15, 25, 40*, 60*, 70* 150, 200 ohms. Ward Leonard, IRC, Ohmite.	.....	\$0.75
Each 79¢. Lots of 10	.....	
*Screw driver adj. 2 lug, 3 lug.	.....	

**BAT HANDLE TOGGLE SWITCHES**

SPST-5A-125VAC	.....	Each 10 Lots
SPDT-3A-125VAC	.....	\$0.29 \$0.26
DPST-3-125VAC	.....	.36 .34
DPDT-3-125VAC	.....	.43 .40
DPDT-3-125VAC	.....	.53 .50

**Bakelite Panel Meters—Famous Brands**

2 1/2" RD-0-25 Mils	} Each	.....	\$ 3.95
0-300 Mils			
0-1000 Volts			
Weston Meters in Stock—Inquire for Quotes.	.....	Set of 3	11.00

50 Amp. magnetic contactor G.E. Cat 8664211-62-110V. 50 cy coil. .... New \$15.95

Audio Input Xformer—Special—New Streamline series Thordarson. 30, 250, 333, 500 to 50K Grid-Plat. shield. New ..... Each \$2.95

Bathub condenser—Special 20 Mfd—50V. DC Side terminal—2 lug. .... Each 29¢; 100 lots \$0.25 Many sizes in stock.

Channel Condenser-GE 28F50—Dual .1-1(1000VDC). Ea. \$0.69; 100 lots \$0.60

Hi-Voltage Condenser—.001 Mfd-75,000 Volts. D.C. Nationally known manufacturer's #75026X—New—Orig. Pack. 2 in carton. .... Each \$74.95

Transformers, Chokes, Oil Condensers—Spec. Purpose. Tubes in stock. Quotations on request by return mail.

TERMS: 25% with order. Balance C.O.D. Shipped Railway Express F.O.B. N. Y.

**GREENWICH SALES CO.**

59 Cortlandt St.  
NEW YORK 7, N. Y.

transmission along with the normal aural signals.

In a commentary on both systems, the Commission noted that there were three points which prompted the issuance of temporary rather than permanent regulations for transmission. One involved the use of test receivers with, in the main, a de-emphasis circuit, operating prior to the first audio stage. The FCC experts pointed out that where de-emphasis is used after the first audio, intermodulation or other similar effects which may occur may be considerably increased, owing to the presence of the fax signal at its original amplitude at that point. The fact that the tests were, for the most part, qualitative rather than quantitative, and no definitive comparative studies of both systems had been conducted, was cited as another reason which made it difficult to establish permanent standards. However, the Commission felt that the art would profit by a temporary ruling which would permit continuous tests and studies of both systems, and eventually provide data which would disclose which system is best for public service.

In the meantime, multiplex fax will be on the air on an unlimited time basis.

**THE PETROLEUM INDUSTRY,** one of the most active users of mobile radio systems, recently reported that it was running out of frequencies in the Texas-Louisiana producing areas where service demands are heavily concentrated. In an investigation of this problem, it was found that there are several solutions involving regional re-allocations which could be used, not only to help the oil folks, but others, such as the forest products group.

A lucid explanation of how this unique plan might work was presented by Commissioner George Sterling during a recent talk before the Petroleum Industry Electrical Association in Dallas, Texas. He pointed out that, in the instance of the oil diggers, the exclusive frequencies of the Forest Products Radio Service in the 49 mc. band might be used. Explaining that since the foresters have a regional concentration of logging activity in the Pacific Northwest and since the oil activities it may be possible to adjust the present allocations in a manner which would be beneficial to both groups. "Such a plan," he said, "presumably would take the form of an arrangement whereby some of the (oilers') 48 and 49 mc. frequencies would be released to the logging group and they would do likewise with some of their frequencies for use in states where the oilers are crowded."

Channel splitting was offered as a second solution by the Commissioner, who indicated that operation in the 25 to 50 kilocycle band could be on a 20 kilocycle separation basis, rather than the present 40 kc. arrangement. Sterling declared that he realized that this type of change would have to be of an

The Hottest item since the picture tube!

ONLY \$9.95 LIST

the **TURRET BOOSTER**

Patent Applied For

- Operates on Intermediate Frequency—one setting for all channels.
- Removed or installed without disrupting wiring of set.
- Fully concealed within set—no exterior units.
- Improves reception—increases video output 15% upwards.
- Improves receivers having poor sound (Emphasis placed on sound by IF coil adjustment.)
- Comes on when receiver is on—no extra switches to complicate the tuning of the receivers.

\*Less additional tube.

WRITE FOR FURTHER DETAILS

Money Back Guarantee

**BARB-CITY INDUSTRIES, INC.**  
1154 FOURTH ST. DEKALB, ILL.

**EVERY RADIOMAN Can Use These SERVICE HINTS!**

Valuable Manual Yours—FREE!

Every page of "How to Simplify Radio Repairs" is packed with on-the-bench, practical ideas. Contains photos, charts, diagrams—no fluff—no vague theory. In plain every-day language it gives you priceless suggestions—new servicing ideas. You'll use and benefit from the experience of experts. Partial list of contents: How to Localize Trouble; How to Service Amplifiers; How to Test for Distortion; How to Test Audio Circuits; How to Test Speakers; How to Find Faults in Oscillators; How to Test Radio Parts—and it's all yours—FREE! No obligation.

SEND COUPON OR PENNY POSTCARD FOR YOUR FREE COPY TODAY!

**FEILER ENGINEERING CO.** Dept. 7H1  
8026 N. Monticello Ave., Skokie, Ill.  
(Suburb of Chicago)

Please RUSH my FREE copy of "How to Simplify Radio Repairs."

Name .....  
Address .....  
City ..... Zone ..... State .....

# TV PARTS

Replace with the Right Part  
at the Right Price . . . From  
Wholesale Radio!  
**TV TRANSFORMERS**

## VERTICAL OUTPUT TRANSFORMERS

57T01—Replacement for 204T2. 19,000 ohms pri. imp. Turns ratio 10:1. Mounting center 1 19/32 x 1 3/4 . . . . . **\$2.95**

43T01—Same as above with 2 13/16" mtg. center . . . . . **1.79**

## VERT. BLOCKING OSC. TRANSFORMERS

16TB11—Replaces 208T2. Mtg. Center 1 15/16" . . . . . **\$1.49**

21TB11—Same as above, 2" mtg. center . . . . . **1.19**

For General Elec. Type TV Circuits  
Use Genuine GE Parts



## Horizontal Sweep Output and HV Transformer

RTO-085. For 66 to 70 degree tubes such as 14CP4, 16KP4, 19AP4, 24AP4. Max. HV to CRT anode 15 KV . . . . . **\$7.05**

RTO-092. For 52 to 60 degree tubes. Max. HV 15KV to load. Long leads . . . . . **\$6.90**

## DEFLECTION YOKE RLD-025

To sweep 70 degree tubes—\$6.87

## EM-PM FOCUS COILS—\$4.50

RLF-026 for 10"-52" tubes  
RLF-028 for 12"-52" & 16"-53" tubes  
RLF-038 for 16"-70" round and rect. tubes

## RTO-064 VERTICAL SWEEP OUTPUT TRANSFORMER (10:1 Ratio)—\$3.60

## WIDTH & LINEARITY COILS—78c

RLD-014—Width/Linearity—.27 Mh  
RLD-016—Linearity—1.3-11.5 Mh  
RLD-019—Width—6.5-40 Mh  
RLD-020—Linearity—.3-3 Mh

## HORIZONTAL OSCILLATOR COIL

RLC-091 Ferrite core oscillator coil is center-tapped for use in sine wave horiz. oscillator circuit with AFC. . . . . **\$1.05**

## SINGLE ION TRAP MAGNETS—93c

RET-005 for 10" and 12" round 11KV and 19" round 14KV. Gauss—35  
RET-003 for 14" and 16" rect. 13 KV and 24" round 18 KV. Gauss—42

## 70° DEFLECTION YOKE \$4.50

DYB-130

## Quam Focalizer

Replaces wire-wound focus coils. Up to 12 KV \$2.85. 12 KV and over \$3.50.

## For Up to 20" Tubes H.V. TRANSFORMERS

More voltage than you'll ever need for tubes up to 20". Operates in nearly every make set. Fits original type transf. mounts. This transf. a 20,000, 500 mmfd. cond. and 70° defl. yoke above makes comb for big picture conversion. Model 8129 only



\$660

## Hottest TV Antenna Buy! 8-ELEMENT CONICAL ARRAY HI-GAIN FOR FRINGE AREAS



Can be stacked for ultra fringe areas. 8 interchangeable elements. Use with any type lead-in 72 to 300 ohms. Snyder XA-44. . . . . **\$495** less mast!

48 ASSEMBLY for connecting 2 double-stacked arrays . . . . . Set \$1.95  
CONICAL TIE RODS, for stacking conical aerials .85  
STEEL EXTENSION POLES. Weather treated.  
10 ft. long. 1 1/4" dia. . . . . \$2.19  
5 ft. long. 1 1/4" dia. Crimped end. . . . . 1.35  
3 1/2 ft. long. 1 1/4" dia. Crimped end. . . . . 1.19

WRITE FOR FREE FYI BULLETIN  
Address Orders to Dept. RN-7  
Or call MULberry 2134

**WHOLESALE RADIO PARTS CO., Inc.**  
311 W. Baltimore St.  
**BALTIMORE 1, MD.**

evolutionary type, since . . . "its advantages could be realized fully only over a period of years." However, since it is possible to produce FM equipment which could operate with such separations, according to Sterling . . . "the principal problem is to devise a means whereby we can take advantage of these equipment developments without working hardships on existing licensees operating on the present basis."

Another band was described as having become quite important to the oil industries; the microwave band. (The provisions on the books today provide for the temporary use of the 1750 to 1800 kc. band for petroleum geophysical operation, on a shared basis with the Disaster Communications Service.)

Describing the possibilities of these higher bands, Sterling said: "New vistas in the field of point-to-point radio-communications are being opened through increasing use of multi-channel microwave installations. The pipeline portion of the petroleum-natural gas industry has been a leader in pioneering large-scale use of this type of equipment. It is a tribute to the flexibility and foresight of the industry . . . that this relatively new development . . . has been reduced to practical terms and applied on a wide scale."

Noting that eight pipe-line companies have been granted a total of 209 station authorizations and that two more companies have asked for 33 additional stations, and that in addition, there were four more companies who had signed equipment contracts and were in the process of preparing applications for stations, Sterling said that the oil-communications system was rapidly becoming quite a healthy service. It was disclosed that investments and commitments to invest in this service were on the order of ten to fifteen-million dollars, and that the bulk of the activity had occurred during the past six months.

Here, truly, is an industry in which radio has more than proved its worth, having become an indispensable tool in accelerating the productive capacity of not only the oil processors, but of other industries throughout the nation, to whom oil is so essential. . . . L.W.



" . . . and now, the next most wanted criminal-at-large!"



Standard Models to 50,000 cps.

Custom-built Models to 100,000 cps.

## PRECISION PERFORMANCE

Unrivaled in audio spectrum recording . . . pioneers in critical instrumentation recording . . . 1 to 14 channel models.

# AMPEX Magnetic Tape RECORDERS

Ampex Electric Corp.  
San Carlos, California

Standard of the Great Radio Shows

## AN CONNECTORS—IMMEDIATE SERVICE Phone! Wire! Write! Your Needs

### 1N34 CRYSTAL DIODES . . . . . 79c

VERNIER DIAL or DRUM (from BC-221) DIAL—2 3/8" dia. 0-100 in 360°. Black with silver marks. Has thumbblock. DRUM—0-50 in 180°. Black with silver marks. . . . . either 85c

SELSYN 2J1G1—Brand New—400 Cye. . . . . Ea. \$1.90

THROAT MIKE (MT 81-A). 2 mikes in leather zipper case with 50' cord & PL68—Brand New. . . . . 59c

CARBON MIKE T-17, used—Guaranteed—Has 5 ft. cord and PL68. . . . . 89c

### POSTAGE STAMP SILVER MICAS

MMF	MMF	MMF	MMF	MFD	MFD
10	80	125	360	500	.001 .003
18	82	150	370	510	.001625 .0033
22	66	180	390	525	.0022 .0039
23	68	200	400	560	.0023 .005
24	75	208	410	570	.0026 .0051
30	82	225	430	600	.0028 .0056
39	100	240	460	700	.00282 .006
40	110	270	470	750	.002826 .0082
50	115	325	488	875	
51	120				

Neon Glow Lamp NE 16 . . . . . each 30c

Variac—General Radio 100W . . . . . each \$10.00

Spaghetti Steeving—Ass't. 99 ft. . . . . \$1.00

Dynamotor DM 33  
In 28 Volts Out 575 Volts at .16A. . . . . \$3.75 each

Price Schedule  
10 MMF to .001 MFD . . . . . 10c  
.001625 MFD to .0021 MFD . . . . . 20c  
.00282 MFD to .0032 MFD . . . . . 30c

Minimum Order, \$3.00—All Orders F. O. B. Philadelphia

## RELIANCE Merchandizing Co.

2221 Arch Street • Philadelphia 3, Pa.  
Telephone: Rittenhouse 6-4927

# TELEVISION

PREPARE FOR A GOOD JOB!  
BROADCAST ENGINEER  
COMMERCIAL OPERATOR (CODE)  
RADIO SERVICEMAN

## Television Servicing

(Approved for Veterans)  
SEND FOR FREE LITERATURE  
**BALTIMORE TECHNICAL INSTITUTE**  
1425 EUTAW PLACE, BALT. 17, MD.

## Sound Engineering

(Continued from page 62)

wheel. The impedance wheel, or drum, is pulled around by the friction of the film on its surface and when up to speed, resists any attempt to change its speed. This system will impart a constant motion to the film as it passes in front of the photocell. In Fig. 9 is shown the film transport system of a typical motion picture projector.

It is interesting to follow the path of the film in its travel from the supply reel through the projector to the take-up magazine, and observe the precautions that have been taken in the design to insure a constant motion in the sound head.

Starting at the upper magazine which houses the supply reel (A), the film is pulled down by a constant speed sprocket (B), then past the picture head aperture at (C). Below the picture aperture, at (D), is another sprocket mounted on the shaft of an intermittent movement.

The intermittent movement consists of a cam in the shape of a Maltese cross and a pin. This type movement is often referred to as the "Geneva movement," because it was developed in Geneva by a Swiss watchmaker. The purpose of this movement is to pull the film downward, one picture frame at a time, for exposure to the screen. While the film is in motion a shutter cuts off the light from the lamp house, hiding the movement of the film from the viewers. The speed of the movement and the amount of exposure time for each frame will vary with different makes of projectors.

Each picture frame is exposed for approximately 1/24 of a second. Due to the persistence of the human vision, the picture on the screen appears to be in continuous motion. Such a movement can, if not properly isolated from the sound head, induce a considerable amount of poor motion or flutter in the sound reproduction.

Below the intermittent sprocket (D) is placed another constant speed sprocket (E). It will be noted a loop is left in the film between the constant speed sprocket (B) and the top of the picture aperture (C); also, a similar loop is made below the picture aperture before the film engages the constant speed sprocket at (E).

The purpose of these loops is to create slack in the film to allow the intermittent movement a sufficient amount of film during its downward pull; also, the loop isolates the jerky motion of the intermittent movement sprocket (D).

From sprocket (E) the film passes between the impedance roller (F) and over the sound drum (G) which is mounted on a free-running shaft. On the opposite end of this shaft is an oil damped flywheel or rotary stabilizer. The friction of the film on the surface of the drum (G) causes it to rotate. The inertia of the rotary stabilizer on



# HENRY HAS THE NEW hallicrafters MODEL SX-71 NOW!

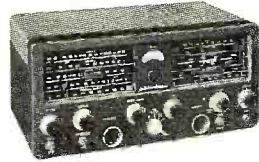

This new type of receiver—the first of its kind on the market—has extra sensitivity, selectivity, and definitely superior image rejection. Continuous AM reception from 538 kc to 35 Mc, and 46 to 56 Mc. One RF, 2 conversion, and 3 IF stages. 105-125 volts AC. 11 tubes plus voltage regulator and rectifier. Only \$199.50. (R-46 matching speaker only \$19.95.)

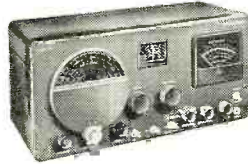

### NEW DUAL-CONVERSION RECEIVER HALLICRAFTERS Model S-76

Note these features: Dual conversion (1650 Kc and 50 Kc)—more elaborate selectivity than the best crystal. Giant 4-in. "S" Meter—calibrated in microvolts and "S" units. Four bands 538-1580 Kc, 1720 Kc to 32 Mc. Calibrated electrical bandspread. 5 position selectivity. Sensitivity 2 microvolts or better with 5 watt output. 9 tubes plus regulator, rectifier. \$169.50.

I have a complete stock of Hallicrafters receivers and transmitters. I'll make you the best deal on a trade-in for your communications receiver. I give you prompt delivery, and 90-day FREE service. Nobody can beat Bob Henry on a trade-in, and I offer you the world's lowest credit terms. Write, wire, phone, or visit either store today for the best deal. Export orders solicited.

*Bob Henry*  
W4ARA

Butler 2, Missouri

## HENRY RADIO STORES

11240 Olympic Blvd.  
LOS ANGELES 25  
CALIF.

"WORLD'S LARGEST DISTRIBUTORS OF SHORT WAVE RECEIVERS"

## LOOKING FOR RADIO PARTS?

SEE POLY-TECH FIRST  
For Complete Stocks of

**TRANSFORMERS:** Audio, Filament, Plate, Power, Etc.

**CHOKES:** R. F., Filter, Swinging, Etc.

**METERS:** Amp., Microamp., Milliamp., Volt Meters, R. F. Meters.

**CAPACITORS:** Electrolytic, Mica, Oil, Paper, Etc.

**RESISTORS:** Carbon, Potentiometers, Wire Wounds, Rheostats, Etc.

**TV COMPONENTS:** Focus Coils, Ion Traps, Flybacks, Etc.

**TUBES:** Transmitting, Receiving, Special Purpose, Etc.

**CHASSIS & PANELS:** Steel and Aluminum.

**CO-AX CABLE:** JAN Approved RG8/U, RG11/U, RG12/U, RG58/U, RG59/U.

PLUGS, TUBE SOCKETS, CONNECTORS, Etc.

• SEND FOR NEW BULLETIN •

## POLY-TECH

919 Dawson St., New York 59, N. Y.  
Tel. MUrray Hill 6-2650

LEARN

# Television -Radio OR Electricity

IN THE GREAT SHOPS OF COYNE



**TRAIN QUICKLY!**  
**OLDEST, BEST EQUIPPED**  
**SCHOOL of ITS KIND in U.S.**  
*Young and Older Men*

Come to the Great Shops of Coyne in Chicago. Get practical training in TELEVISION-RADIO or ELECTRICITY—vital in Defense Program. Prepare now for a better job or better service rating.

### START NOW—PAY LATER

You can finance most of your tuition, pay for it later in easy monthly payments. Special plan for men of Draft Age. Part time employment service available. GI APPROVED

**FREE BOOK** Clip coupon for Big Free Illustrated Book. Indicate below, course that interests you. No salesman will call. Act NOW.

An Institution not for Profit

B. W. COOKE, Pres.  
COYNE Electrical & Television-Radio School.  
500 S. Paulina St., Chicago 12, Ill. Dept. 81-85H

Send FREE BOOK and full details on:  
 TELEVISION-RADIO  ELECTRICITY

NAME.....

ADDRESS.....

CITY..... STATE.....

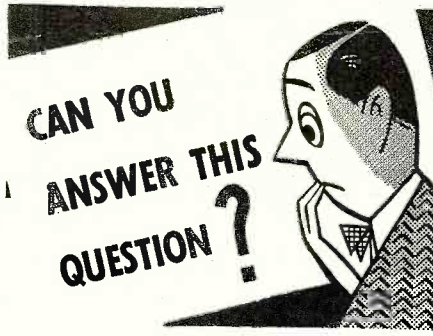

**What is the best source for complete circuit analysis?**

*The answer to this and all your servicing questions are*

**RIDER MANUALS  
WITH THESE FAMOUS  
EXCLUSIVE FEATURES**

- ▶ Circuit Action Descriptions
- ▶ Complete Alignment Data
- ▶ Signal Waveforms for Trouble Shooting
- ▶ Large, Easy-to-Read Diagrams
- ▶ Complete Parts List and Values
- ▶ Unpacking and Installation Data
- ▶ Factory Authorized Data

**6 RIDER TV MANUALS**  
12,864 Pages  
(Equiv. of 8 1/2" x 11")  
2,486 Models

**21 RIDER MANUALS**  
AM-FM-Auto Radio-Phono  
31,382 Pages. 28,341 Models

**REVISED AND ENLARGED  
VACUUM-TUBE  
VOLTMETERS**  
by John F. Rider

Up-to-the-minute in its coverage of all types of vacuum-tube voltmeters. Discusses design, construction, maintenance and applications. Review questions at the end of each chapter. 432 pages, 5 1/4" x 8 1/2", 215 illustrations. . . . Only \$4.50

At your Jobber's or  
Write for Free Catalogues.

**JOHN F. RIDER PUBLISHER, Inc.,**  
430 Canal St., New York 13, N. Y.

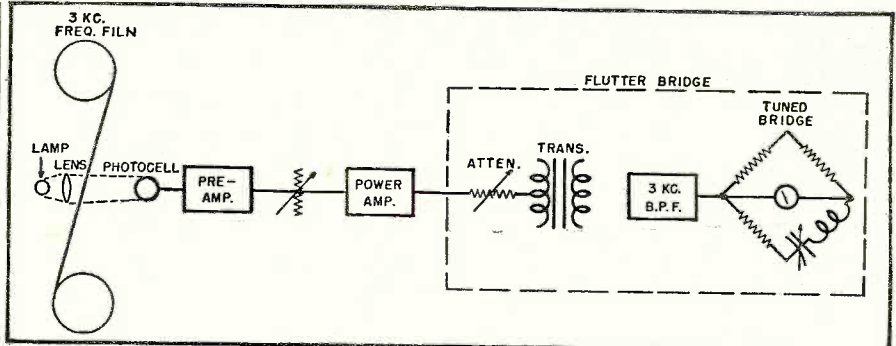

Fig. 8. Block diagram of "flutter bridge" connected across picture projector output.

the drum shaft irons out irregularities in speed and resists any changes in speed, thus reducing flutter.

Leaving the drum, the film passes to the sound sprocket (H) and over idler roller (I) to the take-up reel (P) and take-up mechanism (Q), on rear of lower magazine. Rollers O<sub>1</sub> and O<sub>2</sub> act as fire traps in the upper and lower magazines in the event of a film break. A third loop is allowed between the sound sprocket (H) and the idler roller (I) to isolate the motion of the take-up reel from the sound sprocket.

The sound exciter lamp and objective lens barrel are shown at (J) and (K), the photocell housing at (M). An optical prism is mounted inside the drum (G) and reflects the light from

the exciter lamp after it has passed through the sound track on the film to the photocell. Because of the mechanical construction the prism assembly is not visible.

Small rollers are placed at the various sprockets to hold the film in contact with the sprocket teeth. The center of the roller which holds the film in contact with the surface of the drum (G) is faced with felt. This is referred to as a pad roller, and is the most important roller of the whole assembly. Any irregularities in its surface will induce flutter in the reproduction. To obtain a smooth surface on the pad roller, it is ground on a lathe using a high speed grinder.

Regardless of the constancy of the

Fig. 9. Film transport system of motion picture projector. See text for identification.

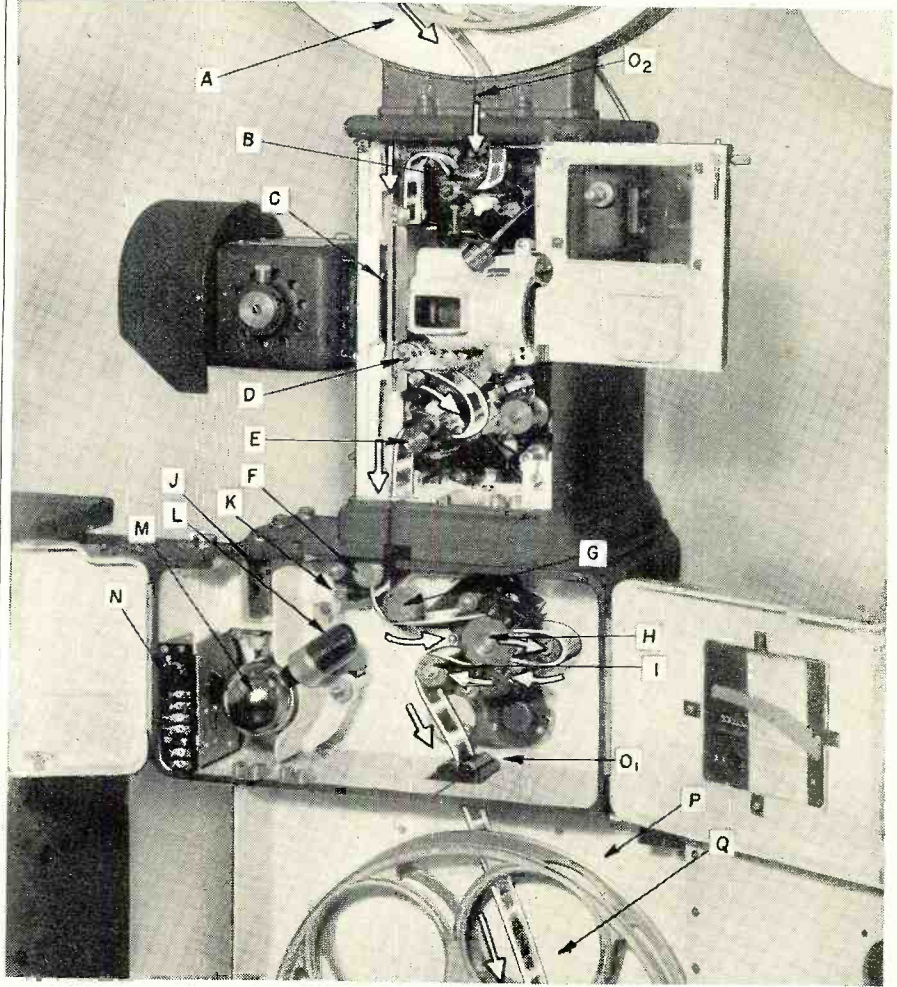

*The Original!*  
**LOW LOSS OPEN WIRE LINE**  
 (lowest loss lead-line mfd.)

**"GONSET LINE"**

- 1/6 THE LOSS OF NEW MOLDED RIBBON
- 0.5 DB LOSS PER 100 FT. AT 200 M.C.
- POLYSTYRENE SPACERS

*Ideal for*

- TELEVISION
- AMATEUR
- COMMERCIAL
- FRINGE AREAS
- LONG RUNS
- BEACH AREAS

send for latest bulletin

**GONSET CO., BURBANK, CALIF.**  
 72 E. TUJUNGA AVE.

**STAR SPECIAL!**

**6-Tube Auto Radio**  
 Complete with Speaker and Antenna

Powerful 6-tube auto radio made by leading manufacturer. Mounts under dash of any car; compactly built. Circuit features include automatic gain control to prevent fading. Shipped complete with all tubes, Alnico 5 PM speaker, heavily chrome-plated 66" side cowl antenna, battery and antenna cables, etc. Ready for immediate installation. Worth far more than our low price!

**\$27.50**

**Webster-Chicago 3-Speed Changer**

Popular Model 100 Webster-Chicago at a price you can afford. Plays 33 1/3, 45 and 78 rpm records in 7", 10" and 12" sizes. This is the complete changer ready for installation in custom designs or for modernization of old-type consoles. Buy now and save while limited quantities are available!

**\$25.95**

**Popular-Make Record Changer**

Same high-quality 78 rpm used by prominent manufacturer. Changes twelve 10" or ten 12" records with smooth, silent action. Beautiful hammertone-finish metal mounting board and metal base enclosing all operating mechanism. May be mounted in radio or used on table, etc. Originally sold for several times our low price!

**\$19.95**

COMPLETE STOCKS All Standard Brands Just off the press

**STAR ELECTRONIC DISTRIBUTORS, INC.**  
 Dept. RN 7-7736 S. Halsted, Chicago 20, Ill.

drive system used, variations in speed will occur at times due to the changes in frequency of the power system and also play in the drive mechanism. Variations in speed can also be caused by the medium used for recording or reproduction. In disc recorders, variations in speed are caused by the drag of the cutting head on the record. In some designs this may cause the turntable to rotate slower than standard speed, resulting in an increase of pitch and tempo when the recording is played back at the correct speed.

Speed variations occur in film projectors many times because of the drag of the film over the sprockets. If the film has shrunk, it binds on the sprocket teeth, thus creating a drag on the drive system. If the take-up mechanism is not in correct adjustment, it will also cause variations in speed as the take-up reel gets larger. Vibrations from the motor and gear trains in projectors may be such that they are transmitted to the photocell and preamplifier, and reproduced as a mechanical noise.

In magnetic tape recorders, this type noise is not as important; however, a constant source of speed is important. Several methods of transporting the tape from the supply reel to the take-up reel have been devised. The most common method is the pinch drive system, consisting of a rubber and a steel puck. The magnetic tape is pinched between these two, and pulled through the transport system. Separate motors operate the take-up and supply reels.

Fluctuations in the speed of reproducing and recording devices are measured with a "flutter bridge." A block diagram of such a device is shown connected across the output of a motion picture projector in Fig. 8.

The flutter bridge consists of a 3000 cycle bandpass filter, a tuned bridge, and an indicating meter. A film sound track of 3000 cycles is placed on the projector and the bridge connected across the output of the projection system power amplifier.

The 3000 cycle signal from the sound track is amplified and applied through an attenuator and input transformer, to the input of the bandpass filter. At the output of the filter is a Wien bridge circuit, which may be tuned to the frequency of 3000 cycles. If the output from the projector sound head is constant, the bridge will be balanced and no deflection of the meter obtained. However, if the projector has poor motion, the variation in speed of the film as it passes the photocell will unbalance the bridge and deflect the meter. The filter removes any hum or harmonics that might be introduced by the amplifier system. Two full-scale sensitivity ranges are available on the flutter indicator, one reading from 0 to 0.5% and the other 0 to 2.0%.

Careful observation of the meter pointer action will generally give a clue to the type flutter. Low frequency flutter and "once arounds" are indicated by low swings of the meter

**For AC CURRENT ANYWHERE . . .**  
**NO MAGIC just use**  
**ATR INVERTERS**

**STANDARD AND HEAVY DUTY INVERTERS**



**For Inverting D. C. to A. C.**  
 Specially Designed for operating A. C. Radios, Television Sets, Amplifiers, Address Systems, and Radio Test Equipment from D. C. Voltages in Vehicles, Ships, Trains, Planes and in D. C. Districts.

**NEW MODELS** **NEW DESIGNS**  
**NEW LITERATURE**

"A" Battery Eliminator, DC-AC Inverters  
 Auto Radio Vibrators

**ATR** See your jobber or write factory

**AMERICAN TELEVISION & RADIO CO.**  
 Quality Products Since 1931  
 SAINT PAUL 1, MINNESOTA-U. S. A.

# FIRST IN SPEAKER ENGINEERING

## Adjust-A-Cone SPEAKERS



THERE'S a good reason why Quam builds more speakers for original equipment than any other speaker manufacturer. It's because Quam speaker engineering has always been ahead of the field—and because Quam has pioneered more speaker improvements. When you sell Quam Replacement Speakers you are selling the finest!

### QUAM-NICHOLS COMPANY

522 E. 33rd Place CHICAGO 16, ILL.

MAKERS OF QUALITY SPEAKERS FOR 27 YEARS, UNDER THE SAME MANAGEMENT

### WANTED

AMPHENOLS—UHF CONNECTORS—PULSE TRANSFORMERS—RELAYS—NET WORKS—MICRO SWITCHES—6V DYNAMOTORS

E. SMITH, Room 12, 391 Fulton St. Brooklyn 1, N. Y. Phone MAin 4-2666

### CONVERSION DATA!

See Ad—  
Page 88

For RCA Victor 630TS  
see PF INDEX No. 25

FREE—GET IT NOW!

needle. The magnitude of the disturbance is indicated by the amplitude of the meter swing. The frequency of the disturbance will be one-half the meter swing. Medium high frequency flutter is indicated by rapid motions of the meter needle; however, 96-cycle sprocket hole and other high frequency disturbances are indicated by a steady deflection of the meter, because the meter movement cannot follow the rapid changes of the disturbance.

Films used for measuring the flutter of projection equipment are made on special recorders having negligible flutter. Measurements on disc recorders are made by first recording a 3000 cycle tone starting at the outside of the record and recording to the smallest diameter. Without disturbing the record, relative to its placement on the turntable, it is played back and the flutter measured with a flutter bridge connected across the output of an amplifier. Magnetic tape recorders are measured in a similar manner.

The most important thing in all flutter measurements is: if a film sound track or a pre-recorded record is used for the signal source, it must have very low flutter within itself or the measurement is of no value. Specially processed disc records can be obtained for the measurement of reproducing equipment. The trick in using these records is to center them perfectly on the turntable before making the measurement. This may be difficult due to the center pin of the turntable not fitting the record center hole tightly. If this is the case, a weight should be placed over the center pin and the record centered while making a measurement. When the lowest flutter reading is obtained, the record will be centered.

When measuring the flutter of a projection machine, at least 1000 feet of 3000 cycle sound track should be used, and about 200 feet of it run onto the take-up reel before attempting a measurement. Special films for flutter measurements, frequency response, and optical adjustments of sound heads may be obtained from *The Motion Picture Research Council*, Hollywood, California.

(To be continued)

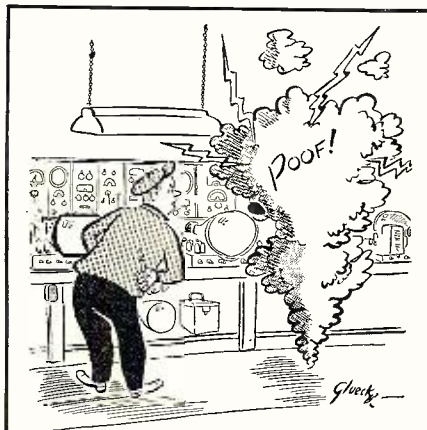

"Durn it, Filbert, be careful! Yuh wanna blow a fuse?"

LEARN DAY and EVENING CLASSES  
**TELEVISION**  
ELECTRONICS-RADIO  
Modern Laboratory  
Instruction in

- SERVICING
- BROADCAST OPERATING
- ELECTRONIC and TV ENGINEERING

WRITE FOR ILLUSTRATED CATALOG  
**ELECTRONICS INSTITUTE, Inc.**  
21 HENRY, DETROIT 1, MICH.

**G.I. APPROVED**

SENSATIONAL NEW BOOK  
ELEMENTS of SINGLE and DUAL TRACK MAGNETIC TAPE RECORDING and 1001 APPLICATIONS  
by A. C. Shaney

INFORMATIVE! INSTRUCTIVE! INTERESTING!

ONLY \$1.00 POSTPAID

The book that brings you up-to-date on tape recording. Complete history, theory, design and uses. 144 pages of FACTS!

Order today. Remit with order, please. Booklet mailed same day.

**AMPLIFIER CORP. of AMERICA**  
398-2 Broadway, New York 13, N. Y.

big FREE GIFT offer

SEE PAGE 14

50% OFF LIST PRICE!

**RADIO-TV TUBES**  
All types in stock. Positively no second s. Standard Guarantee. 25% Deposit—cash, check, or M.O.

**RADIO CITY LAB**  
2634 N. Clark St., Chicago 14, Ill.

**SPEAKERS RECONED**  
guaranteed repairs made on all makes of speakers  
fast service - lowest prices

**AMPRITE SPEAKER SERVICE**  
70 Vesey St. New York 7, N. Y.

**SCHEMATICS—CONVERSIONS FOR SURPLUS GEAR**

NEW LIST! MANY ADDITIONS!  
Send stamped, self addressed envelope for List B. Add 25c for chart explaining AN nomenclature.

R. E. BOX 1220  
GOODHEART BEVERLY HILLS, CAL.

**Mac's Service Shop**  
(Continued from page 58)

For a few minutes no one said anything. Then Mac asked, "What's the matter? Have you two run out of gripes?"

"No, we've just run out of breath," Barney retorted. "However, Boss, to tell you the truth, we're kind of puzzled. Ordinarily you are the man who could pose for all three of those little monkey statues called Hear No Evil, See No Evil, and Speak No Evil; but suddenly here you are cussing customers right along with us. We simply don't get it."

"Maybe a little explanation is in order," Mac admitted. "Here's how I look at it: there is no denying that anyone in business is certain to meet up with a lot of exasperating quirks of human nature. Quite possibly in service work you encounter more of this sort of thing than you do in retail selling, for the service customer is already in an unhappy frame of mind to discover that his radio or his watch or his automobile is not going to run forever without needing some repairs."

"But putting up with this is just a part of the job that you took on when you went into servicing. Disagreeable customers go right along with discovering that mice have been keeping house in a set you have to work on, with the attar-of-rotten-eggs smell you have to endure while removing a burned-up selenium rectifier, and with the patience-trying job of restringing one of the Rube Goldberg dial cords often found in modern sets. If you take these things in stride as just part of the day's work, that is all there is to them."

"I have found two things," he went on, "that help a lot in keeping my sense of humor. The first is to do just what we are doing here: let off steam by chuckling over these customer foibles *here*, inside the privacy of our own little organization, where it can do no harm. Customer cussedness is something you can either laugh at or get mad about, and laughing is much better for both your business and your digestion."

"The second thing is always to keep in mind a motto I saw recently that said:

"Be kind, for everyone you meet is fighting a hard battle."

"This certainly is the truth today. There is not a person without some worry or other that is reflected in his or her behavior. Possibly the woman who is so irritatingly insistent on getting her set back without delay has a son in the service and is terribly eager to get every bit of news about the armed forces."

"Few people," Mac concluded, "are deliberately aggravating; and unless you honestly believe this, you have no business doing work that brings you into direct contact with your customers."

**NEW! MOSLEY 3-WAY TV ANTENNA SWITCH**

**Quickly Installed, Anywhere—Anytime!**

Here's a TV antenna switch that can be installed in a jiffy—in the set, on wall, baseboard, window sill—in any convenient place.

Servicemen and Installers will find in the MOSLEY 3-Way TV Antenna Switch a neater, more efficient method of making installations where one set and several antennas must be connected or, as in dealer demonstrations, where several TV sets must utilize one antenna.

Four sections of standard 300 ohm transmission line factory wired to constant impedance switch. MOSLEY Solderless Transmission Line Splicers are supplied for speedy installation. In brown or ivory molded plastic case. Complete with mounting wood screws.

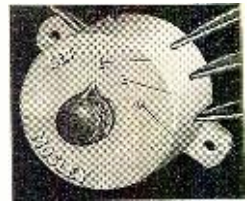

Cat. No. F-20—MOSLEY TV Antenna Switch. List .....\$3.75

**NEW! UNIVERSAL TV LEAD-IN SOCKET**

**Ultra Compact! Truly Universal!**

The socket servicemen and TV installers have been waiting for! Ideal for TV antenna lead-in, test bench, dealer display, etc. Constant impedance. Molded of low loss polystyrene. Available in brown or ivory and furnished complete with mounting screws. Use Cat. No. 301 MOSLEY Transmission Line plug with this and other MOSLEY sockets.

**Look at These Features:**

- **Small! Requires only 1 3/4"x7/8" mounting space. Cover extends only 5/8".**
- **Mounts anywhere—on wood or metal!**
- **Universal—use as terminal or tap socket!**
- **For standard 300 ohm transmission line!**

MOSLEY low-loss TV products assure a better, more efficient installation. MOSLEY plugs, sockets and other high quality TV antenna accessories are available at leading radio parts jobbers everywhere.



Cat. No. 343—MOSLEY Universal Transmission Line Socket. List \$0.80

**MOSLEY ELECTRONICS**

2125 LACKLAND ROAD  
OVERLAND, MISSOURI

The NEW  
Leader!

**CLEAR BEAM T-MATCH YAGI**



This powerful, all weather T-Match Yagi with its mighty 5-element beam, perfect 300-ohm match, rugged dual aluminum construction and other exclusive design features, assures ultra-high gain reception in any area, any climate. Choose Clear Beam for complete customer satisfaction now and for the years ahead!

*all weather*  
**5-ELEMENT ARRAY**  
**300-OHM MATCH**  
**LOW IN COST**  
**60-Second Snap-Open Assembly**  
Simply snap open ... and tighten!

A COMPLETE LINE OF QUALITY ANTENNAS TO MEET EVERY TV RECEPTION REQUIREMENT

**Clear Beam Antennas**

618 N. LaBrea Ave., Los Angeles 36, Calif., YOrk 1682





# Classified

Rate 50c per word. Minimum 10 words

## RADIO ENGINEERING

RADIO Engineering, Broadcasting, Aviation and Police Radio, Servicing, Marine Operating and Electronics, taught thoroughly. Expenses low. Write for catalog. Valparaiso Technical Institute, Dept. N, Valparaiso, Ind.

### SALE

TWO complete APS 15A Sea Search Radar sets. Walter C. Wellman, 335 S. Sycamore St., Centralia, Ill.

HOTTEST surplus list in the country. Electronics-Hydraulics, Aircraft-Gadgets. Dick Rose, Everett, Wash.

53 OHM Coax: 300 ohm twin; reasonable. Inquire: Harry Van Dick, Little Falls, N. J.

FIVE Element TV Yagi Beams. Aluminum Tubing, etc. Write for prices. Willard Radcliff, Fostoria, Ohio.

RECORD changer parts for leading makes. We ship everywhere. Friend's Wholesale Distributors, 106 N. 6th St., Philadelphia 6, Pa.

DIAGRAMS Radio, Record Changers, Recorders, 75c; Television with Service Data, \$1.25 up. State manufacturer and model number. Kramer's Radio Service, Dept. N8, 36 Columbus Ave., New York 23, N. Y.

ALL popular tubes, lowest prices. 200 ohm/25W Clarostat boxed rheostats, 29c. Plus postage. Free list, no dealers. Tubes, surplus bought, send list. Betz, 73 Caroline Ave., Yonkers 5, N. Y.

### WANTED

TELEPHONES & Telephone equipment. W. E. HA I Receiver and F I Transmitter capsules. State condition, price and quality. W. L. Jennings, 139 State St., Montrose, Mich.

WANTED: TS/34/AP Oscilloscope, any condition. Crest Laboratories, 2117 Mott, Far Rockaway, N. Y. FA 7-2732.

"WANTED" MX215/APG Blowers 28 V.D.C. 1/100 7000 R.P.M. A-1 Refrigeration Service, 13833 San Antonio Drive, Norwalk, Calif.

NEED ART-13; ARC-1; ARC-3; DY-17; TS-12; TS-13; MN-26 J or K; BC-342; BC-312; BC-611 Handie Talkie (or any part); I-100; BC-348; BC-788 A, AM, B or C; I-152A, AM, B or C; TS-67; teletype, test or any other equipment. Will trade. Write: Bob Sanett (W6REX), 4668 Dockweiler, Los Angeles, Calif.

AN/APR-4, other "APR," "ARR," "TS," "IE," ARC-1, ARC-3, ART-13, everything surplus; Tubes, Manuals, Laboratory equipment. Describe, price in first letter. Littell, Farhills Box 26, Dayton 9, Ohio.

### HELP WANTED

BE your own Boss. Sales Kit free. Mail post card. Adelphia Specialty Co., 1512 Sanson St., Philadelphia, Pa. Your future begins at this address.

### CORRESPONDENCE COURSE

USED Correspondence Courses and Books sold and rented. Money back guarantee. Catalog free. (Courses bought.) Lee Mountain, Pisgah, Ala.

USED Correspondence Courses and Educational Books bought, sold, rented, catalog free. Educational Exchange, Summerville, Ga.

RADIO Servicing Course shows latest short cut methods. Lessons easy to follow. Only \$3.00, postpaid in U.S.A. Buyers Syndicate, 30 Taylor St., Springfield, Mass.

### MISCELLANEOUS

CONVENTION Notice! ARRL West Gulf Division Convention in Austin, Texas, August 18th and 19th, 1951. The Convention Committee is planning a great program with fun for the whole family! Plan for a great time in Austin in August! For general information, write: Austin Amateur Radio Club, Box 1716, University Station, Austin, Texas.

## AD-VANTAGE

Take advantage of the world's biggest Classified Ad opportunity—Your ad in RADIO & TELEVISION NEWS Classified Section will get more action—more inquiries—quicker, and at less cost than in any other magazine. Monthly net paid circulation over 200,000.

# the **chicago** V.T.V.M.

## ELECTRONIC MULTITESTER

A versatile new Chicago Vacuum Tube Volt Meter with more ranges and greater utility—at the lowest price in the industry!

**\$39<sup>00</sup>**  
net



### RANGES

#### DC VOLTS

0-5, 10, 50, 100, 500, 1000, 5000. Input impedance: 20 megohms (including 10 megohms in the DC probe).

#### AC VOLTS

0.5, 10, 50, 100, 500, 1000, 5000  
Input impedance: 10 megohms

#### OHMS

0 to 1000 megohms in 6 ranges with center scale readings of 10, 100, 1000, 10K, 1Meg., 10Meg.

#### CAPACITANCE

50 MMF to 5000 MF in 6 ranges. Low voltage-power source enables testing of electrolytic condensers.

#### MILLIAMPERES

DC 0-1, 10, 100, 500  
(Not electronic) 50 millivolt drop.  
Operates on 115 V.A.C. Dimensions: 6 3/4" Wide x 9 1/8" High x 6" Overall Depth

The big 5 1/2" meter is mounted in a handsome brown Hammerloid case slanted for easy reading.

See Your Parts Distributor or Write for Complete Information

## CHICAGO INDUSTRIAL INSTRUMENT CO.

536 W. ELM ST. • CHICAGO 10, ILL.

### NEW! SENSATIONAL GAIN

## PHOENIX YAGI

- 300-ohm Impedance
- Exclusive Mast Clamp Design
- Quick Rig Installation
- Long-Lasting . . . Trouble-Free

**PHOENIX ELECTRONICS**  
INC.  
LAWRENCE, MASS.

## Profitable Careers in Radio TELEVISION ELECTRONICS

### CREI RESIDENCE SCHOOL

trains you for  
vital industry  
—qualifies you  
for better jobs  
in the armed  
services.



• Your success in this highly technical field depends on how much you know and how well you apply it. Whether you want a career in the electronics industry, where critical shortages of trained men exist, or plan to enter military service, CREI Residence School training is your key to a **better** job at **higher** pay.

Recognized as outstanding by engineers, educators, the Armed Services, and important firms like RCA-Victor, Bendix, and United Air Lines (whose technicians have received CREI training at company expense) your course can be completed in approximately twenty months.

### ILLUSTRATED CATALOG FREE

Send for the new descriptive catalog, with survey of opportunities, and details of course and school. New classes start twice a month. Act now!

VETERANS: Training available under G.I. Bill, July 25, 1951 is deadline for most veterans. Don't delay!

**CAPITOL RADIO ENGINEERING INSTITUTE**  
An Accredited Technical Institute Founded in 1927  
Dept. 137C, 16th & Park Rd., N. W., Wash. 10, D. C.

Please send FREE Residence School Catalog 137C

Name \_\_\_\_\_

Street \_\_\_\_\_

City \_\_\_\_\_ Zone \_\_\_\_\_ State \_\_\_\_\_

Veteran  Non-Veteran Age \_\_\_\_\_

Send details about Home Study Courses.



**THE FINEST IN  
ELECTROSTATIC FOCUSING**

*Teletrons\**

**7FP4**

**20GP4**

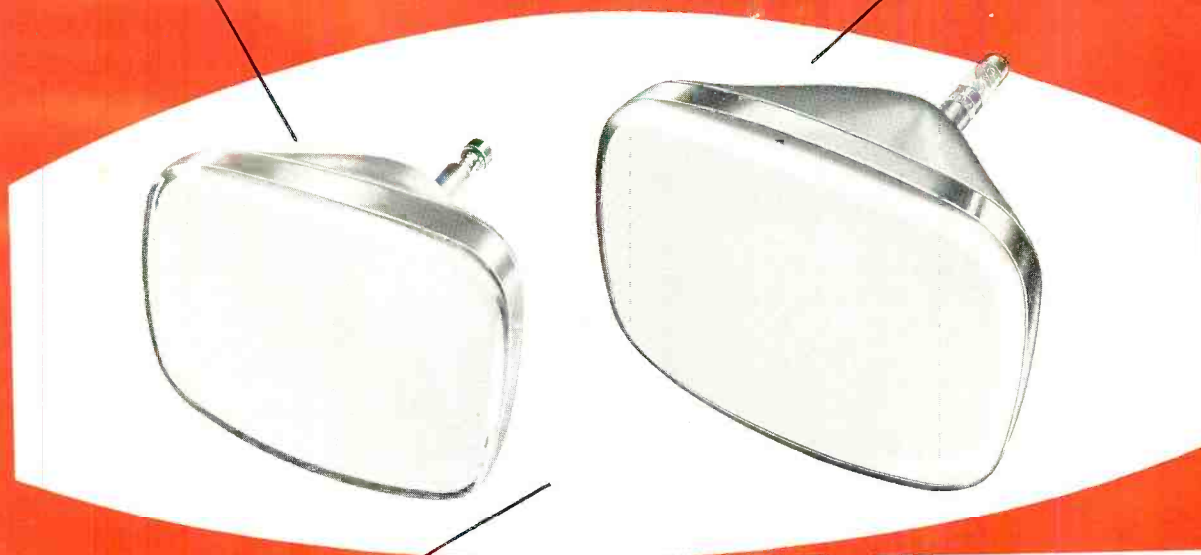

**complete  
engineering data  
on request**

**DUMONT**

TUBE DIVISION, ALLEN B. DU MONT LABORATORIES, INC., CLIFTON, N. J.

\*Trade-mark.

*Because*  
**They're Free of  
Contamination...**



## MALLORY CAPACITORS

### Give Long, Continuous Service!

One reason why Mallory Capacitors deliver full rated capacity throughout their long life is the unusual care taken in production to prevent contamination, which is the source of corrosion and shortens the life of capacitors.

Even at high temperatures, Mallory Capacitors operate perfectly over extremely long periods of time. Tests consistently show dependable performance for more than 2000 hours at temperatures up to 185°F (85°C). Special design and meticulous production methods make such records possible.

Mallory Capacitors have set new long-life standards for the industry, yet cost no more. You will find it pays to rely on the complete Mallory Capacitor line . . . electrolytic, plastic tubular, paper, mica and ceramic.

*See your Distributor for Mallory Precision Quality Parts at Regular Prices.*

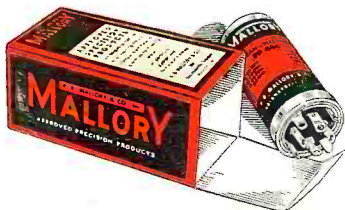

P. R. MALLORY & CO. Inc.  
**MALLORY**

CAPACITORS • CONTROLS • VIBRATORS • SWITCHES • RESISTORS  
• RECTIFIERS • VIBRAPACK\* POWER SUPPLIES • FILTERS  
\*Reg. U.S. Pat. Off.

**APPROVED PRECISION PRODUCTS**

**P. R. MALLORY & CO., Inc., INDIANAPOLIS 6, INDIANA**